



---

VOLUME 14

SEPTEMBER 1997

NUMBER 9

---

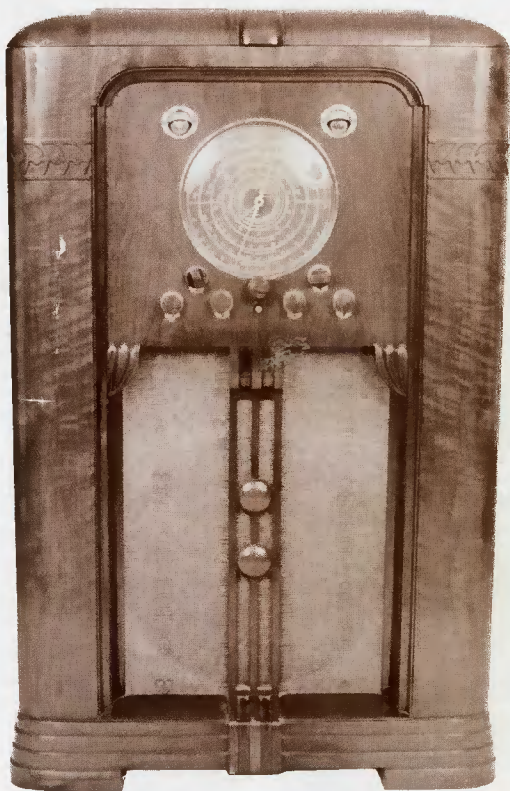

**A Scott Classic**  
from the  
**Breed Collection Auction**

---

A.R.C. — THE NATIONAL PUBLICATION FOR BUYERS AND SELLERS  
OF OLD RADIOS AND RELATED ITEMS — PUBLISHED MONTHLY



## ANTIQUE RADIO CLASSIFIED

Antique Radio Classified (ISSN:8750-7471) is published monthly, 12 times per year, by John V Terrey, One River Road, P.O. Box 2, Carlisle, MA 01741. Periodicals postage paid at Carlisle, MA, and additional mailing offices. Telephone: (508) 371-0512, 8:30 AM to 6:00 PM ET weekdays; machine answers phone at other times.

Annual subscription rates within the U.S. are \$38.95 by Periodicals mail and \$55.95 by First Class mail.

Annual foreign rates. By air: Canada \$59.00; Mexico \$65.00; Other foreign countries \$100.00. Surface mail: Canada \$49.00; Other foreign countries \$55.00. (Surface delivery to countries other than Canada may take two or more months and cannot be guaranteed.)

Two-year subscriptions are twice these rates and receive an extra month. Sample issues are available free on request.

© Copyright 1997 by John V Terrey.

**POSTMASTER: Send address changes to Antique Radio Classified, P.O. Box 2, Carlisle, MA 01741.**

Printed in U.S.A.

### STAFF:

**Publisher and Editor:** John V Terrey  
**Production Manager:** Scott J. Young  
**Office Manager:** Lisa A. Friedrichs  
**Advertising Manager:** Cindie P. Bryan  
**Managing Editor:** Dorothy Schecter  
**Publishing & Editorial Staff:** Ray Bintliff, Peggy Brink, Dave Crocker, Dick Desjarlais, Bobby Lyman, Jean Meldonian  
**Founding Publisher/Editor:** Gary B. Schneider  
**Contributing Writers:** Mike Adams, Richard L. Arnold, Ray Bintliff, Ron Boucher, Paul J. Bourbin, Norman S. Braithwaite, Dave Crocker, Alan S. Douglas, Richard C. Foster, Fred Geer, Jim Kreuzer, Ron Ramirez, Henry Rogers, Ian L. Sanders, Gary B. Schneider, Daniel Schoo, Dwane Stevens, Frank R. White, Ralph Williams

**PURPOSE.** *Antique Radio Classified* is published for people involved in the radio collecting hobby. Its purpose is to stimulate growth of the hobby through the buying, selling and trading of radios and related items, and to provide a monthly forum for the interchange of ideas and information.

**CONTACTING ANTIQUE RADIO CLASSIFIED.** All correspondence should be sent to:

A.R.C., P.O. Box 2, Carlisle, MA 01741.

Only UPS, Federal, etc. items to street address: One River Road.

Telephone: (508) 371-0512; Fax: (508) 371-7129

E-mail: ARC@antiqueradio.com Web: www.antiqueradio.com

Please, no classified ads by telephone; thanks.

Your ads, renewals, letters, etc. can be handled faster and more efficiently if your name, address and SUB# are written on each.

Unfortunately, A.R.C. is not staffed to answer letters with questions about antique radios or requests for advice. However, A.R.C. does solicit letters of interest to its readers and publishes them as space permits. A.R.C. assumes that permission is given to edit and to publish all correspondence and articles received unless otherwise indicated.

### DISPLAY AND BUSINESS CARD ADS - DETAILS AND RATES

The deadline is the first of the month for display and business card ad artwork, payment and repeat requests.

Advertising is accepted only for early items related to radio, communication, etc. All items must be described fairly; reproductions, reprints and non-original items must be so identified. Advertisers must agree to respond promptly to inquiries and orders, to resolve problems promptly if the buyer is not satisfied, and to comply with a buyer's refund request on unaltered returned items.

Advertising must be prepaid, except as noted below; see "Payment" paragraph above for details. Late ads will be run only if space and time permit. Since artwork is reduced to 63% in the printing process, originals must be the artwork size listed below. Do not send in artwork on art board or send negatives. Ads should be typeset or typed neatly with a carbon ribbon, black ink (not pencil) on white. If used, reverse type must be limited to 25% of the ad. If you want us to prepare your ad, include the one-time cost below for A.R.C. to make up the ad.

Photos should be at an 85-line screen; otherwise, add \$15.00 per photo for screening. Do not cut or trim photos or glue photos to artwork; submit separately.

If you are confused by these requirements and terms, please

Page	ARTWORK SIZE (SEND IN THIS SIZE)		As Printed (size in magazine)		Cost for 1-month	Cost for 3-months	Cost for 6-months	Cost for 12-months	One Time to make up Ad
	H x W (inches)	H x W (inches)	H x W (inches)	H x W (inches)					
Full	12 7/16 x 7 1/2	7 3/4 x 4 3/4	7 3/4 x 4 3/4	7 3/4 x 4 3/4	\$269.00	\$719.00	\$1239.00*	\$2159.00**	\$69.00†
1/2 H	5 1/4 x 7 1/2	3 5/16 x 4 3/4	3 5/16 x 4 3/4	3 5/16 x 4 3/4	136.00	363.00	629.00*	1095.00**	37.00†
1/2 V	12 7/16 x 3 9/16	7 3/4 x 2 1/4	7 3/4 x 2 1/4	7 3/4 x 2 1/4	136.00	363.00	629.00*	1095.00**	37.00†
1/4	5 1/4 x 3 9/16	3 5/16 x 2 1/4	3 5/16 x 2 1/4	3 5/16 x 2 1/4	69.00	184.00	319.00	555.00	19.00†
1/8	2 5/8 x 3 9/16	1 5/8 x 2 1/4	1 5/8 x 2 1/4	1 5/8 x 2 1/4	35.50	95.00	165.00	285.00	9.00†
Business Card (1st)	2 x 3 3/4	1 1/4 x 2 3/8	1 1/4 x 2 3/8	1 1/4 x 2 3/8	not avail.	49.00	84.00	147.00	7.00†
Business Card (2nd....)	2 x 3 3/4	1 1/4 x 2 3/8	1 1/4 x 2 3/8	1 1/4 x 2 3/8	not avail.	64.00	110.00	191.00	7.00†

\* Full & 1/2 page, 6-mos.: 1/2 due with order; 1/2 due in 3 mos. \*\* Full & 1/2 page, 12-mos.: 1/2 due with order; 1/4 due at 3, 6 & 9 mos.

† For 6 and 12 month ads, no ad make-up charge if no change is made to ad for entire run.

**GUARANTEE.** You may cancel your subscription at any time and receive a pro rata refund for issues not yet mailed. If errors to ads are made by A.R.C., upon request a free correction will be run in the next available issue.

**PAYMENT.** Please send in full payment with your order or ad. A.R.C. does not carry accounts; all subscriptions, ads, etc. must be prepaid (except for the 6 and 12 month display ads indicated below). Pay in U.S. funds. Checks drawn on a U.S. bank, money orders, VISA or MasterCard (\$10.00 min.) are preferred. Make check out to "A.R.C." U.S. stamps or cash are OK for small amounts. Canadian payers may send a Canadian check but specify U.S. funds. Subscriptions will be prorated to amount sent if amount is incorrect.

**FAX & E-MAIL PROCEDURES/PAYMENT.** Subscriptions, book orders, classified ads, display ads, etc. are welcome by fax or e-mail. Deadlines are the same as for ads received by mail. Please calculate the amount due. Payment by VISA or MasterCard is preferred if your order is over \$10. If under \$10, or if you prefer to send a check or money order, state the amount being sent and that the payment is in the mail. Do not send another copy of your ad with your payment; simply indicate that it is a fax or e-mail payment. If you want confirmation of our receipt of your fax, call immediately after sending your fax.

**CHANGE OF ADDRESS.** Please notify us 4 weeks in advance of a change of address. Send both your new and old addresses, and include your SUB# and effective date of your new address. Temporary address changes can be made also.

**SUBMISSION OF MATERIAL.** *Antique Radio Classified* welcomes and solicits information that pertains or relates to radio history or collecting. This may include articles, book reviews, photos, information on upcoming radio events, meetings, antique radio organizations, radio auctions, sources of old radio and restoration supplies, and other related and interesting material. All material submitted should be carefully researched, typed and accompanied by good photos, if appropriate. Computer disks are appreciated. Writing guidelines are available upon request. Unless prior arrangements are made, all submitted materials may be edited, become the property of *Antique Radio Classified* and will not be returned. Publication is subject to approval by A.R.C. and to time and space constraints.

**MAILING OF ISSUES.** U.S. subscribers can receive A.R.C. by First Class or Periodicals mail (Periodicals is the way most magazines are mailed). The mailing of First Class copies is staggered with faraway copies mailed before local copies. Non-U.S. copies are mailed on the first day. Periodicals copies are mailed on the last day. Mailing dates change each month, but mailing is usually completed by the 27th of the month. First Class copies usually are received by the 5th of the month; copies by Periodicals mail, by the 10th.

**ETHICS.** No person involved in the production of A.R.C. is to act on any information in the magazine until the first delivery day after local copies are mailed.

**DISCLAIMER.** The publisher is not responsible for any buying and selling transactions incurred, or for any other use of the contents of this publication.

**Antique Radio Classified** subscription rates, frequency of publication, content, policies, size and ad details, and rates are subject to change at any time by A.R.C.

contact A.R.C. before beginning to prepare your ad. We will be happy to advise you on your ad ideas, estimate how much the ad will cost, recommend an ad size, etc.

We assume that advertisers want all ads which are submitted to run without delay; therefore, we will run the ad and bill for any additional work required for the ad to meet these specifications. A late ad will run beginning with the next month. "Tear sheets" will be sent only for 1/8-page or larger ads and only if requested when the ad is submitted.

**First business card per advertiser is at lower rate.**

The 3-month rates represent about an 11% discount, the 6-month rates 23%, the 12-month rates 30%. Placement requests: add 15% but call first. Clubs: write for discount policy.

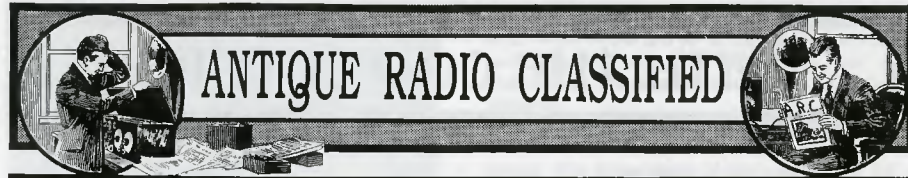

## EDITOR'S COMMENTS

No question about it the big season of radio events is underway. Reports of meets and auctions abound in our files, and we try to get them out there as soon as possible for all of you to savor.

But once in awhile, an event stands out as something unique, or at least extra special, and we must give it precedence. The Breed Collection auction reported in this issue struck me as one such event for many reasons. First, it is the largest private collection up for auction in my recent memory; second, its proceeds will go to a good cause — scholarships at two educational institutions; and third, its owners, Arie and Catherine Breed, are still enjoying an active life and can participate in the recipients' pleasure in their generosity.

In addition, this remarkable auction seemed to contain something for nearly everyone — breadboards, rare horns, novelty sets, Catalins, etc. In our report, you will note one very special category over 100 Zenith radios, including consoles, chairside, tombstones, and cathedrals, with one splendid Zenith Louis XV Model 15U273 selling for over \$4,000.

Small wonder that so many at the Elgin, Illinois, Radiofest asked me when the Breed auction would be reported in A.R.C. Obviously this is an event everyone wants to know more about, and so we have done our best to give you the full flavor of a memorable day for the collectors lucky enough to have been there.

We also report on the smaller Boccelli auction in nearby Watertown, Mass. The A.R.C. "radio boys," Dick Desjarlais and Ray Bintliff, remind us not to forget to check out the estate auction ads because that's where they found 100 or more radios on the block. Unfortunately, many others read the same ad. Still, as we all know, such is the up-and-down life of a "radiophile."

On the up-side is Ted Depto's significant auction find a Modernola Delano Sheraton which also resulted in an article for A.R.C. readers. After successfully purchasing the Delano Sheraton 5-tube set, Ted researched the Modernola Company and even found that the factory building was still standing. An old newspaper ad for the set was a nice find too. He shares his research with us this month.

We're always glad to have Ian Sanders back with another British crystal set article this time, on the Fuller Sparta crystal set. Among the unusual features of this set were the availability of three colors, as well as long wave coils and a 1 tube amplifier.

For AC set collectors, Richard Arnold describes the General Electric Model S-22, 8-tube, tombstone radio, ca. 1930s. This early GE set was manufactured when RCA was marketing GE sets. Arvin "Rhythm" sets seem to have caught the

A.R.C. readers' fancy. After a letter in our June issue on the Rhythm Belle, a follow-up letter appears this month. And Ted Depto sent in a short piece on the Rhythm Maid, which we include as well.

*Photo Review* shows a surprise Hallicrafters set not a "boat anchor" communications receiver but a sleek plastic table model with 2 bands. A rare Kodel 2-tube portable set and a radio card game are also shown.

Daniel Schoo presents another of his detailed repair articles testing and replacing selenium rectifiers. From 1938 to the late 1960s, these plate-type rectifiers were used in radios. However today, they are very expensive when they have to be replaced. A sidebar by Blake Dietze adds to Schoo's discussion of the replacement of the selenium rectifier with the less expensive and easier-to-find silicon rectifier.

*Radio Miscellanea* is doing its job when it contains feedback on earlier articles, as well as an exchange of ideas about how to make sales transactions better with clearer information and common courtesy. Alton DuBois has built Gary Strelow's tube substitutes (A.R.C. February 1996), while Dave Gonsior opens a discussion about whether a set is priced with or without tubes. We're also glad to report that services advertised in A.R.C. are successful and that the pleasures of radio collecting are as far-reaching as Japan.

**Coming Radio Events.** With the Elgin, Illinois Radiofest '97 just past (we will report on this very successful meet in a future issue), collectors are looking forward to the September 5-day, Antique Wireless Association Conference in Rochester, New York. Over 1,000 are expected to attend this event which includes the requisite flea market, plus seminars, banquets, museum visits, equipment contest, and 4 auctions. This is a show not to be missed.

And October brings the 3-day, Dallas area Vintage Radio and Phonograph Society Convention '97 A.R.C. will be at both of these events, so I hope that you will look us up and say, "Hi." Of course, there are dozens of other late summer and fall events all across the country. Since something is near everyone, there is almost no excuse not to get out and meet with your fellow collectors!

Happy Collecting!

John V Terrey, Editor

## ON THE COVER

Our cover features a Scott Philharmonic 30-tube receiver in a Warrington console cabinet from the Arie and Catherine Breed Collection. This classic sold for \$6,050 at the auction held by the Tom Harris Auction Co. in Pella, Iowa, on April 26. Many beautiful examples of radio cabinetry were in evidence at this event, which truly offered "the best of the best."



# WITH THE COLLECTORS

## The Modernola Delano Sheraton A Thoroughly Modern Modernola

BY THEODORE P. DEPTO

*Ted Depto's story of his unexpected find of a Delano Sheraton radio, ca. 1920s, in beautiful condition is a lesson to us all. Never dismiss the potential of a seemingly innocuous auction ad. You may find one of your greatest treasures. (Editor)*

Just when you think all of the good, early radios have been located, an event comes along to prove otherwise. Such was my good fortune when I noticed an auction ad in the local daily paper Midway in a 7" advertisement for a two-day auction, I noticed the listing of a "Delano Sheraton" battery radio. I thought it was a misprint and really meant "Delco or Detrola." However, I decided to check it out anyway since I previously had found a Philco 90 cathedral at an auction whose ad read simply, "A Philco table radio."

The auction was held on a Friday and Saturday with the radios, furniture and larger items scheduled for Saturday. The location in an upscale section of Westmont Boro, a suburb of the city of Johnstown, Pennsylvania, was about 25 miles from my home. Upon arriving in the early morning with my chair and umbrella (there was a threat of rain), I noticed many out-of-state license plates and assumed the auction would be rather heated since quality items were being offered.

Previewed were two nice Stromberg-Carlson consoles, ca. 1938 — one with a record player and the other in a custom cabinet of Chippendale design. Also in this display were several unused Corbett radio cabinets.

Then I saw the Delano Sheraton sitting on a low table next to the fireplace in one of the larger rooms. Its doors were closed, and at first glance, it appeared to be only a fancy sewing cabinet or maybe a dinner utensil cabinet. Sure enough, it

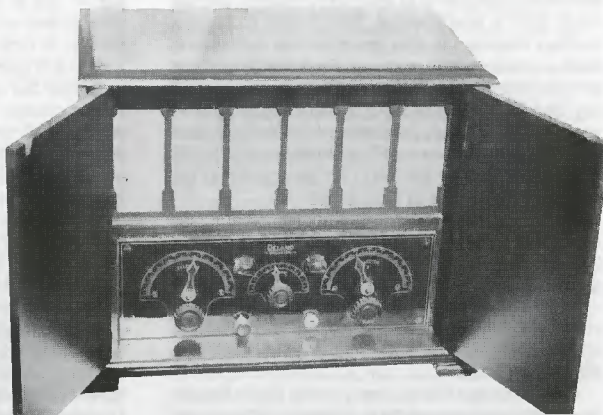

Figure 1 Front view of the Delano Sheraton ca. 1926.

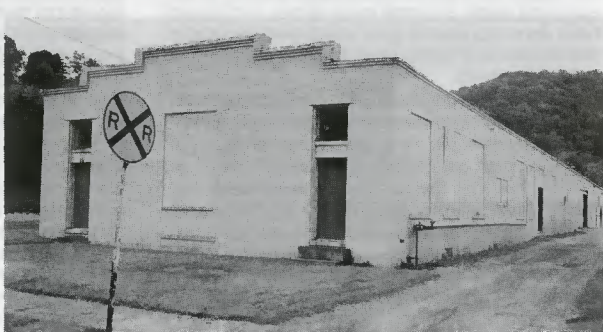

Figure 2. The Modernola Company factory, Johnstown, Pa., as it stands today

was a Delano Sheraton with five 01-As. Best of all, it was built right there in Johnstown by the Modernola Company, and it was in superb condition, as shown in Figure 1

### BIDDING

I decided to bid whatever it would take to acquire this desirable radio. Since many people expressed interest in the radio now that the doors were open, I anticipated some serious competition. When the radio came up for bid, I started at half a hundred, and it went from there. Needless

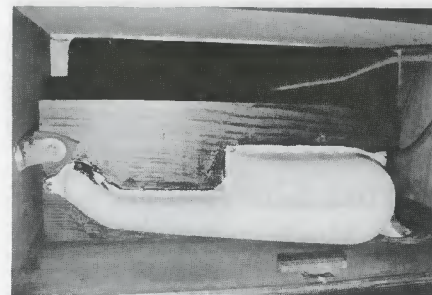

Figure 3. A rear view of the Utah horn located above the radio chassis.

to say, I was ecstatic to have bought the radio at a much better price than I had projected. My guess is that most of the auction attendees who showed an interest in the Modernola did so out of curiosity and because it was displayed with other quality items. These people, however did not grasp the significance of this find.

### THE MODERNOLA COMPANY

According to my research (with the assistance of the Johnstown Public Library), the Modernola Company originally formed as a business venture to make phonographs and console talking machines. It was incorporated on April 29, 1874, with an initial capital stock of \$10,000.

The principals of the company were H.M. Farr, Guy McCormick, and D.H. Wendell. It is uncertain where the company was first located — perhaps on Stony Street; however the 1922 and 1923 Johnstown business directory, page 743, lists the location of the Modernola Company at 105 Station Street in the city's Ferndale section.

The building, as shown in Figure 2, still stands. I could find no existing records showing the year the company began to build radio receiving sets or production figures.

It is unclear whether the Modernola Company failed due to the stock crash of 1929 and the Depression that followed or due to market pressures that closed the company. What is clear is that the company, noted for its round phonographs with a lamp and shade built in, made a novel departure from traditionally-designed phonographs of the day.

McMahon's *Radio Collectors' Guide 1921-1932* lists the "Delano," the "Sheraton" and a "Caddy" as 1926 models. The Delano sold for \$135, while the Caddy sold for \$50, and the Delano Sheraton sold for \$75. An advertisement from the Dec. 18, 1926, *Johnstown Tribune* shows four models in the Modernola line. My radio is identified as a Delano Sheraton A-1. Also shown are two high-boy models the Delano B2 and Delano B3 and a table model the Delano Sheraton B2.

### THE DELANO SHERATON

I am not certain whether any other Delano radios are still in existence, but I am certain that

this radio was produced in some quantity; perhaps other styles are yet to be found. Although I have collected radios for some time now, until this auction, I had never heard of a radio named "Delano."

A quality radio throughout, the Delano Sheraton is a 5-tube TRF, not unlike other radios of the period. The dimensions of the cabinet are 18" x 15" x 13 3/4" It boasts a built-in Utah horn, as shown in Figure 3.

The radio's tuning range is 500 kHz to 1400 kHz. Tuning is accomplished by two variable capacitors and a variocoupler. Note the inverted vacuum tubes in the underside of the radio shown in Figure 4. The battery terminals are located at the rear apron of the chassis. Storage space is provided for all batteries except for the 6-volt storage battery.

The beautifully engraved front panel and the well balanced design make this radio one of my

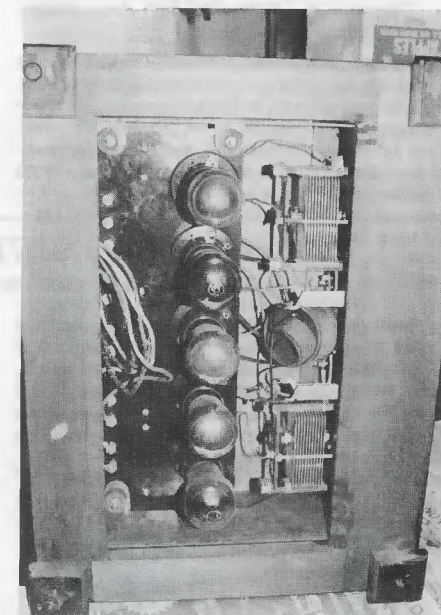

Figure 4. An underside view of the Delano Sheraton shows the radio's tubes and chassis components.

greatly prized possessions. There is no serial number stamped on the chassis; however, there is a chalk mark inscribed in the bottom frame of the cabinet indicating that the radio number might be 00037

I can just imagine adjusting the selector on the Delano Sheraton in the 1920s and hearing the opera rebroadcast every Saturday evening at 8 over Station WHCB located in Johnstown. In its day, the Delano Sheraton was certainly "a thoroughly modern Modernola!"

(Continued on following page)



(Modernola Delano Sheraton, continued)

**Additional Pennsylvania manufacturers of radios and related items:**

Pennsylvania Wireless Company  
Equitable Radio Company, Hughesville, Pa.  
Keller-Fuller Co., Pittsburgh, Pa.  
Corbett Cabinet Works, St. Mary's, Pa.  
Hamburg Bros., Pittsburgh, Pa.  
Radio Apparatus Co., Pottsville, Pa.  
S. R. Leutz Co., Altoona, Pa.

**References:**

Cambria Co. *Deed Book* (Incorporation D. B. 80), p. 603.  
JACO News Flyer Johnstown Automobile Company, October 1926.  
*Johnstown Tribune*, Johnstown, Pa., Jan. 14, 1922, p.14; Dec. 18, 1926.  
McMahon, Morgan E., Ed. *Radio Collector's Guide 1921-1932*, revised edition. Palos Verdes Peninsula, Calif.. *Vintage Radio*, p. 119.

(Theodore P Depto, 913 Fifth Ave., Patton, PA 16668)

Ted Depto, a registered professional engineer in three states, is a consultant in engineering design. Involved in radio for most of his life, he has an extensive collection of cathedral and early battery radios, but admits to a fondness for Philco. He holds a General Class Radiotelephone License which dates back to his service with the U.S. Army Signal Corps in the Korean conflict.



The author's adaptation of a Delano advertisement created in the style of the 1920s.

## Arvin Model 617B — Rhythm Maid

BY THEODORE P. DEPTO

The Arvin Model 617B tombstone radio, shown in Figure 1 was bought at an auction of the contents of an old country grocery store in Central Pennsylvania, which had closed long ago. The radio was discovered along with many radio-related items. Some were new and never sold, and others, I suppose, belonged to the store's owners for personal use.

The set's dimensions are a large 22 1/4" high x 16"

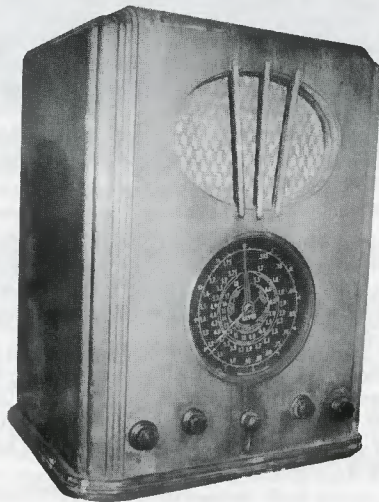

Figure 1 The Arvin Model 617B Rhythm Maid.

wide x 12" deep a pretty hefty radio in anyone's lexicon. It is a 6-tube, battery-operated radio, which was the mainstay for the rural community for news and entertainment before commercial electrical power came to the neighborhood. Manufactured by Noblitt-Sparks Industries Inc. in 1936, the set boasts a 7" airplane dial in four colors and covers the frequency range of 535 kilocycles through 18.5 megacycles in three bands. The set also has an 8" dynamic speaker and is relatively heavy for its cabinet size.

This particular radio carries a serial number of 102131. See Rider's Volume VII for more information.

When I began to restore the set, I found that the bandswitch was frozen on its shaft, so I applied a little heat plus some WD-40. The shaft freed itself, and now the switching mechanism clicks flawlessly. I cleaned the tone and volume controls and replaced about half of the paper capacitors along with the necessary new filter caps. I added Quietrole into the bearings of the tuning capacitor and minor touchup of the trimmers got the set working as well as new.

Arvin was noted as much for its automobile heaters and defroster fans as for its radios. The 1936 line included such names as "Rhythm Baby," "Rhythm King," and "Rhythm Queen."

(Theodore P. Depto, 913 Fifth Ave., Patton, PA 16668)

Eight 1936 Arvin "Rhythm" radios may be seen on page 58 of "Flick of the Switch." Commentary on the "Rhythm Belle" and the "Rhythm Maid" may be found in the June A.R.C. "Radio Miscellanea," as well as in this issue. (Editor)

# WITH THE COLLECTORS

## The General Electric Model S-22

BY RICHARD ARNOLD

According to the book *Invention and Innovation in the Radio Industry*, the General Electric Company did not begin to sell the radios it manufactured until 1935. Up to that time, the radios that GE made were marketed through RCA. One of these models was the GE S-22, shown in Figure 1, which was manufactured by GE in 1931-1932, and marketed by RCA during a period of negotiations with the Department of Justice.

These negotiations concerned an antitrust action brought in 1930 by the Department of Justice vs. RCA, GE, and Westinghouse. The defendants were said to have some 4,000 patents on radio apparatus that allowed them to dictate terms that were unfavorable to their competitors.

After 18 months of negotiations, GE and Westinghouse agreed to release certain interests in RCA. They also agreed to a time frame of 2 1/2 years during which they would not sell or make any radios, thereby allowing RCA to establish itself as an independent company. Given the fact that GE and RCA were virtually one and the same company in the early '30s, it is not surprising that the GE S-22 has the same chassis as the RCA R-7 and R-9. The R-7 is a 1931 table model, while the R-9 is a 1931 console. The DC-operated versions R-7DC and R-9DC correspond to the GE S-22A.

The GE S-22 is a large, unusually styled tombstone with a cabinet measuring 19 1/2" x 14" x 10". The brass handle at the top is best used for decoration, as the radio is quite heavy. Lifting this set by

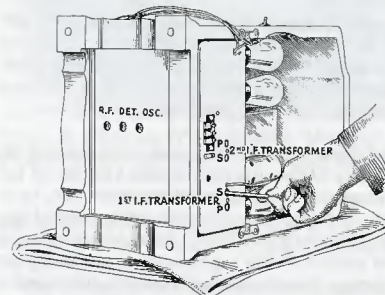

Figure 2. The radio lying on its side shows the unusually convenient access to the basic trimmers.

its handle could cause some structural damage.

The speaker is covered with an embroidered grille cloth having a basket/floral design, but without the protection of any wooden grille work. A colorful photo of the S-22 on a decorative stand appears in Bunis' *The Collector's Guide to Antique Radios, 2nd Edition*, on page 91

The deep chassis of this 8-tube superhet, as with other early GE sets, has a wraparound metal enclosure over the sides and bottom to protect the components from the elements and possibly to act as a shielding unit. The tube types include the following: 35 (2), 27 (2), 24 (1), 45 (2), and 80 (1).

The three wooden knobs are for volume control, station selection, and tone control. The on/off switch is located on the upper right-hand side of the cabinet. In Figure 2, note the convenient access to the RF, the detector and oscillator trimmers on the bottom of the set, and the IF trimmers on the rear face of the chassis. This is a very well built radio and a good addition to your collection of 1930s radios.

**References:**

Bunis, Marty and Sue. *The Collector's Guide to Antique Radios, Second Edition*. Paducah, Ky.. Collectors Books, 1992.  
MacLaurin, W. Rupert. *Invention and Innovation in the Radio Industry*. New York: The MacMillan Co., 1949.  
*RCA Victor Service Notes, Vol. 1, 1923-1937* Camden, N. J.. RCA Victor Division of Radio Corporation of America, First Edition, 1941

(Richard Arnold, P.O. Box 275, Lone Grove, OK 73443)

Richard Arnold has been collecting radios since 1985. His interest is primarily in cathedrals and 1920s battery sets, and his collection ranges from crystal sets to a 1928 American Bosch in a Pooley cabinet. His prize is the 1932 Jackson Bell Peter Pan featured in the June 1991 A.R.C.



Figure 1. The GE Model S-22's unusual features are the brass handle and the open grille cloth area.



## The Fuller Sparta Crystal Set

BY IAN L. SANDERS

"Fuller Sparta Radio Apparatus covers a complete range of up-to-date accessories, mechanically and electrically perfect... You can rely on it." (Advertisement appearing in "Amateur Wireless" magazine, October 1924)

The "Sparta" trademark was used extensively by Fuller's United Electric Works, Limited, of Essex, England, for its range of receivers, kits, loudspeakers, batteries and components offered during the early to mid-1920s. Like many companies of the period, Fuller's produced a single crystal set design. The Sparta set however produced in July 1924, is of particular interest because of its

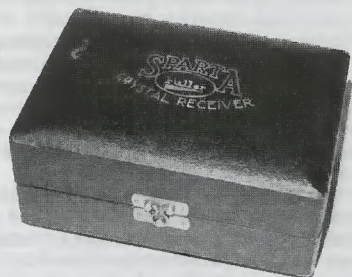

Figure 1. The Sparta crystal receiver was available in three colors - black, brown or gray.

unusual detector arrangement and unconventional longwave coil design. A matching one-valve amplifier was also offered.

### SPARTA CRYSTAL SET

The Sparta crystal receiver is shown in Figures 1 and 2. It was constructed in a compact wooden case with a lid, measuring 6½ x 4¾ x 3 inches. Finished in imitation morocco leather with the Sparta trademark imprinted on the lid, the set was available in at least three colors - black, brown and gray. The ebonite control panel and the removable loading coil were also colored to match the case. Black, however is the most common color to be found today and, therefore, was probably produced in the greatest numbers. All of the fittings are heavily nickel-plated and are of extremely high quality.

The aerial and earth connec-



Figure 2. The control panels of the Sparta models were colored to match the case; shown here is the brown version.

tors are unusual in that the aerial socket accepts a plug which can be connected directly to the removable socket of the earth terminal, intended as a safety feature for protection against lightning. Two earth sockets were provided: one (S) for use when the antenna was between 30-50 feet in length, and another (L) for antenna lengths between 50-100 feet.

The wavelength range is the standard 300-500

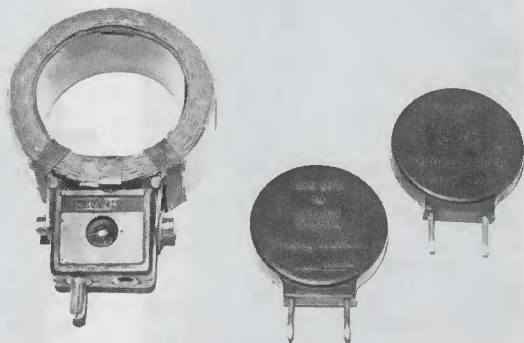

Figure 3. The two Sparta long-wave coils (right), measuring only 1¾ inches in diameter, are shown in contrast to a larger conventional coil (left).



Figure 4. The long-wave coil in place at the top left of panel.

meters, but could be extended to cover the BBC's 1600 meter long-wave station by means of an atypically small plug-in coil; see Figure 3. Measuring just 1¾ inches in diameter the coil pins are made of heavy-gauge wire instead of the common split-pin and socket arrangement. The coil replaced a removable shorting link (also made of heavy-gauge wire) located at the top left of the panel; see Figure 4.

Although the detector is the standard catwhisker/galena type, it has a novel design, as shown in Figure 5. The swivel arrangement is double-pivoted at the rear of the detector arm, rather more in continental European style than in the contemporary British style of crystal detectors. The crystal itself is held in place by a spring-loaded plunger, and the unit is fitted with a retractable cup cover

Another unusual feature is that the control panel is sealed in the case. All Sparta products carried a one-year warranty, but the manufacturer warned that "... no responsibility for defects will be taken if the seals are broken."

In 1924, the Sparta crystal set sold for one pound, one shilling (£1.05) an amount known at that time as one guinea. Hence, the Sparta was often advertised as the "guinea Crystal Set." The long-wave coil was an additional three shillings and six pence (£0.175).

### SPARTA ONE-VALVE AMPLIFIER

The Sparta one-valve amplifier was a companion to the Sparta crystal set, and was built in a matching case; see Figure 6. The component layout is necessarily cramped given the size of the enclosure and would have generated considerable heat if operated with a "bright-emitter" type valve. For this reason it was designed for use with a low-current



Figure 5. Close-up of the detector showing rear-pivoted detector arm and crystal holder with cover.

dull-emitter type, requiring only 0.06A for the filament. Even so, it was probably not a good idea to operate the unit with the lid closed.

There is no control panel, and because of space limitations, the input/output and battery terminals are located around the sides of the case. The only adjustment is a filament rheostat. All of the fittings are nickel-plated to match the crystal set.

The amplifier sold for three pounds, three shillings (£3.15), less valve and batteries, and was also subject to a Marconi royalty.

### References:

- Amateur Wireless and Electrics, Vol. V No. 122. October 4, 1924, p. 434.
- The ELR Company 1925-26 Wireless Catalogue. East London Rubber Co.
- Hill, Jonathan. Radio! Radio!. Devon, England: Sunrise Press, 1986.
- Popular Wireless and Wireless Review, Vol. V No. 120. September 13, 1924, p. ii.

(Ian L. Sanders, 16715 Wild Oak Way, Morgan Hill, CA 95037)

Ian Sanders has been collecting and restoring early 1920s crystal and battery receivers since 1974. He specializes in British sets of this period, and would be happy to try to answer any readers' inquiries on this subject.

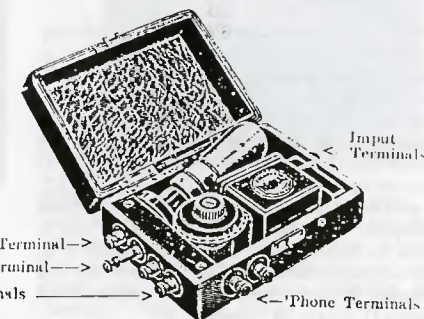

Figure 6. The Sparta one-valve amplifier was built in a case to match the crystal receiver.





## PHOTO REVIEW



This column presents in pictorial form many of the more unusual radios, speakers, tubes, advertising, and other old radio-related items from our readers' collections. The photos are meant to help increase awareness of what's available in the radio collecting hobby. Send in any size photos from your collection. Photos must be sharp in detail, contain a single item, and preferably have a light-colored background. A short, descriptive paragraph **MUST** be included with each photo. Please note that receipt of photos is not acknowledged, publishing is not guaranteed, and photos are not returned.



**PARKER BROTHERS RADIO GAME** — This radio game, copyright 1923 by Parker Brothers, uses 56 cards with station call letters and plays similar to rummy. (Don Howland — Spokane, WA)

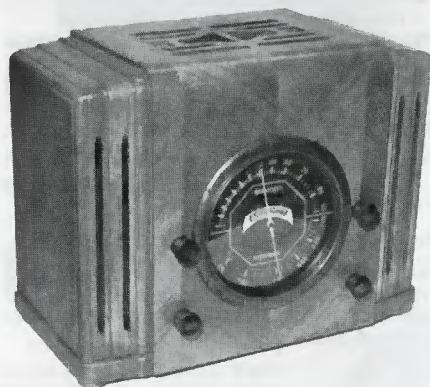

**SILVERTONE UNKNOWN** — This remarkably well-preserved AC set was unearthed at a North Carolina antique shop in June 1996. Resembling a 1930s era console with the bottom sawed off (actually, the speaker is built-in to the top), it's a strong performer on both the AM (550-1700 kHz) and shortwave (2.5-7 MHz) bands, yet uses only 5 tubes (Types 42, 75, 80, 6D6, and 6A7). The bottom of the wooden case is stamped "MAR 24, 1936." The same set is pictured in *Evolution of the Radio, Volume 2*, and is similarly identified. Can anyone tell me the model number and year of production? (Douglas D. Fox — St. Charles, IL)

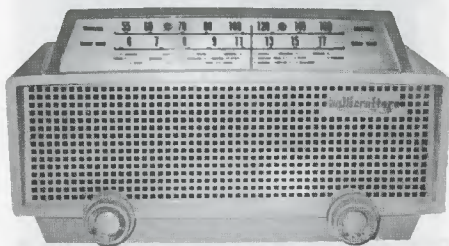

**HALLCRAFTERS MODEL 621** — This 6-tube, 2-band plastic receiver ca. 1955, is good-looking enough for any room in the house. Its dimensions are 8" x 13 $\frac{3}{4}$ " x 7". A Model 612, cosmetically and electronically similar to the 621 exists but possibly with different colors. Does anyone know what those colors are? (Bob Perry — Painted Post, NY)

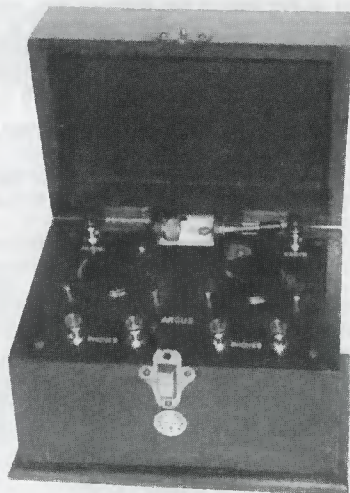

**ARGUS CRYSTAL SET BY ANDERSON'S WIRELESS AGENCY** This rare set, purchased in a Vienna flea market in 1994, carries a round white label below the lid clasp which reads: "Arnold Lederer Prague." (Erwin Macho — Vienna, Austria)

## PHOTO REVIEW

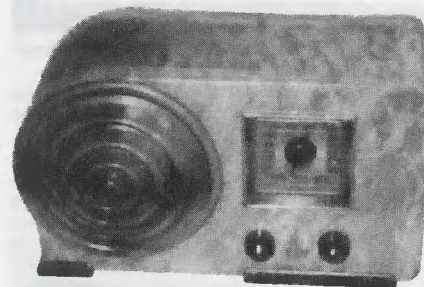

**EMERSON MODEL AX212** — This tiny 5-tube superhetrodyne was made in either maple or walnut finish. The cabinet is distinguished by the large wooden "bullseye" over the speaker. The chassis is similar to many small Emerson Catalins. (Donald M. Maurer — Lebanon, PA)

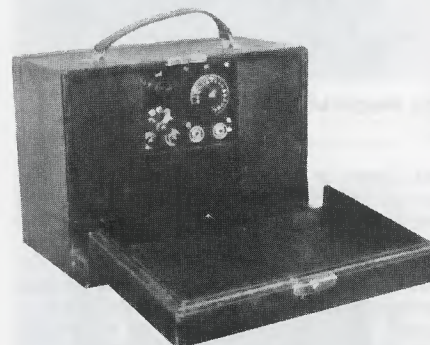

**CLAPP-EASTHAM MODEL HR** — While the original owner might have grafted the Atwater Kent 2-step amplifier onto his Clapp-Eastham HR, department stores were known to have sold similar combinations in order to dispose of outdated stock. I could easily restore the HR, but it tells a much better story this way. (Alan S. Douglas — Pocasset, MA)



**KODELL MODEL P2** — This leatherette portable radio, ca. 1925, uses two Type 199 tubes. There is room inside the case for the A and B batteries, as well as the headphones. (Wally Worth — Wollaston, MA)

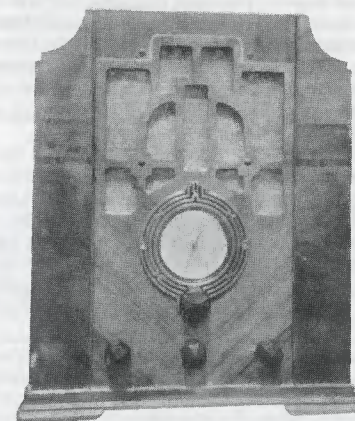

**CROSLY MODEL 61** — This 5-tube, 1934 tombstone has two bands broadcast and shortwave. Except for the filter condensers and the P.M. replacement speakers, all components are original or direct substitutes. (Anton George — Kenosha, WI)





# AUCTION REPORT

## Breed Collection Auction Tom Harris Auction Company Pella, Iowa — April 26, 1997

REPORTED BY TOM HARRIS

The sale of the collection of Arie and Catherine Breed gives us the chance to report on an event significant both for the quality of the items and for the generosity of the owners the Breeds donated the considerable proceeds to educational institutions. We salute them, and we thank them for this opportunity to share in the auction of their impressive collection. (Editor)

The radio collection of Arie and Catherine Breed was auctioned off on Saturday, April 26 1997, at the Kuyper Gymnasium in Pella, Iowa. Tom Harris Auction Company of Marshalltown, Iowa, arranged and conducted the auction of over 300 rare radios. There were 181 bidding numbers registered to buyers from the United States, Canada, England, Germany and Korea. Twenty-two U.S. states were represented from as far away as New York, California, Florida and Minnesota.

All monies raised from this radio auction will go to the "Benefit Scholarship Programs" for the Central College of Pella in Pella, Iowa, and the Iowa State University in Ames, Iowa. Of the 10 percent buyer's premium charged, half will also go to these institutions. The 308 items sold for an impressive total of close to \$100,000. The top dollar sale of the auction was a Scott Philharmonic 30-tube console in an excellent Warrington cabinet, selling at \$6,050, including the 10 percent buyer's premium.

Other highlights included a 1938 Zenith top-of-the-line Louis XV Model 15U273 in excellent condition selling at \$4,400; another 1938 Zenith Georgian Model 15U272 burl walnut, black-dial console with sliding doors, at \$4,125; a 1938 Zenith Model 7S261 black-dial console with bookshelves at \$2,530; a 1938 Zenith, Model 15U270, console at \$1,870; and a 1938 Zenith Model 15U269 clock-

**A warning:** Auction prices are not current values. A listing such as this cannot adequately include the condition of cabinets, chassis, transformers, tubes, the operating status of the set, and the inclusion of incorrect, restored or replica components, etc. Auction prices are the result of the excitement of the auction process, the skill of the auctioneer and the specific interests of the participants. Nevertheless, auction prices serve as useful references and as another element in the value determining process. The possibility of error always exists, and if we are notified, corrections will be reported.

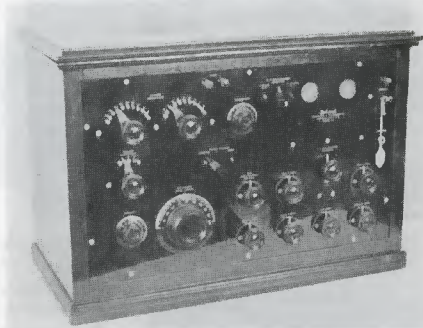

This Federal Model 61, ca. 1924, sold for \$1 100.

dial console at \$2,310. Two other 1938 Zeniths brought good prices a Walton Model 9S232 black-dial tombstone at \$2,750 and a Walton Model 7S232 black-dial tombstone at \$1,870.

Commanding a bid of \$1,430 was a 1937 Zenith Model 10S157 Zephyr black-dial console, partially restored. A 1937 Zenith Model 8A137 Zephyr black-dial tombstone went for \$1,870. Other 1937 Zeniths included a Model 12U159 console radio at \$1,100; a Model 12S235 black-dial, chairside radio with lift-top side compartments at \$1 155; and the Model 10S130 black-dial tombstone at \$1,540.

Finding a new home at \$2,750 was a 1940 Zenith Model 12S475 console. An Emerson Model AU-190 butterscotch Catalin radio sold at \$1,540. A rare Timbretone wooden horn speaker with violin base went for a surprising \$1,870.

An Atwater Kent 12 (4910) breadboard, very clean, sold at \$1,430. Also going for \$1,430 was a 1938 Philco Model 38-690 20-tube console with tambour door

For \$1,210 you could buy a 1936 Zenith Model 12A58 multi-color dial console, or a Zenith Model S-829 chrome-front Art Deco tombstone.

All prices shown in this article include a 10% buyer's premium.

e/r=electrically restored, o/f=original finish, ref=refinished, BBT=brass-based, tipped, unk=unknown

Airline 54-BR-1503B ..... \$16  
Airline 84-KR-1520B, metal ..... 33

Airline 93-BR-421B ..... 77  
Arvin 54-OT metal ..... 44  
Arvin 341 T metal, (2) ..... 44, 66  
Arvin 444A, metal ..... 44  
Arvin 451-TL ..... 16  
Atwater Kent 10A (4560) breadboard,  
original, unrestored with tags ..... 880  
Atwater Kent, 10A (4560) breadboard,  
clean, BBT ..... 880  
Atwater Kent 10C breadboard, clean ..... 935  
Atwater Kent 12 (4910) breadboard, clean 1,430  
Atwater Kent 19 ..... 467  
Atwater Kent 32 ..... 66  
Atwater Kent 33, battery, wooden case ..... 44  
Atwater Kent 52 ..... 88  
Atwater Kent 55, Kiel table, e/r ref ..... 550  
Atwater Kent Type L horn speaker ..... 38  
Atwater Kent Type M horn speaker (2) ... 55, 77  
Belmont 41 cathedral, e/r o/f ..... 187  
Bendix 65-P4 ..... 11  
Bendix 300 ..... 11  
Bendix 526 MC, green and black Catalin,  
(as is, side damage) ..... 330  
Bendix 526-A ..... 24  
Bendix 0526-E ..... 44  
Bendix 526-MB ..... 33  
Browning Drake, battery, wooden, (new top) ..... 55  
Cap w/visor Radio Station KMA 960 ..... 11  
Clapp-Eastham Radak Type R-4 ..... 302  
Coca Cola bottle radio, plastic ..... 16  
Coca Cola machine novelty radio ..... 55  
Coca Cola mini-cooler novelty radio, w/box ... 55  
Collins No Battery flashlight, 1924 ..... 33  
Coors beer can novelty radio ..... 16  
Crosley 4-29 ..... 132

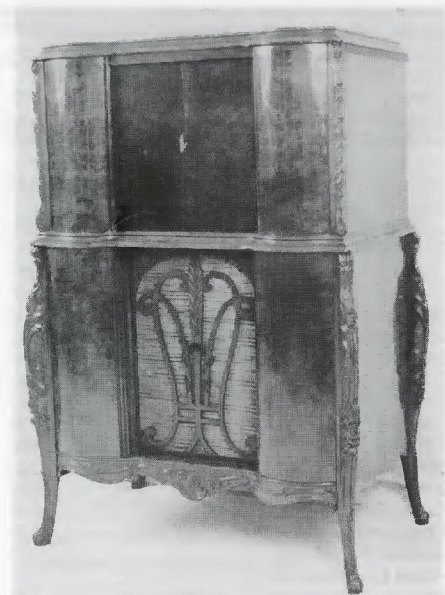

This 1938 Zenith Model 15U273 in an ornate, carved, burl walnut cabinet brought \$4,400!

Crosley 10-135 ..... 44  
Crosley 10-136-E ..... 55  
Crosley 10-137 ..... 77  
Crosley 10-138 ..... 44  
Crosley 10-140 ..... 55  
Crosley 11-101-U, (2) ..... 88, 88  
Crosley 11-106-U ..... 27  
Crosley 11-107U ..... 22  
Crosley 11-108-U ..... 33  
Crosley 52, needs work ..... 49  
Crosley 56-TD, cream plastic radio ..... 66  
Crosley 56-TD, maroon plastic radio ..... 77

(Continued on following page)

### Thanks from the Breeds

I would like to take this opportunity to thank all those who attended our radio auction on April 26, 1997. It was a truly memorable day for Catherine and me, and it enabled us to see many old friends and meet many new people. We sincerely hope that those who purchased radios will enjoy them as much as we have.

This auction will enable us to meet and perhaps exceed our goal of providing a named scholarship at Central College, Pella, Iowa, and Iowa State, Ames, Iowa. Again, thanks to all who attended.

Sincerely, Arie and Catherine Breed  
The Breeds are to be commended for their foresight in planning for the future of their collection. In addition to knowing that their treasures are in willing hands, they are also able to enjoy the pleasure of giving scholarships to grateful students in the years to come. (Editor)

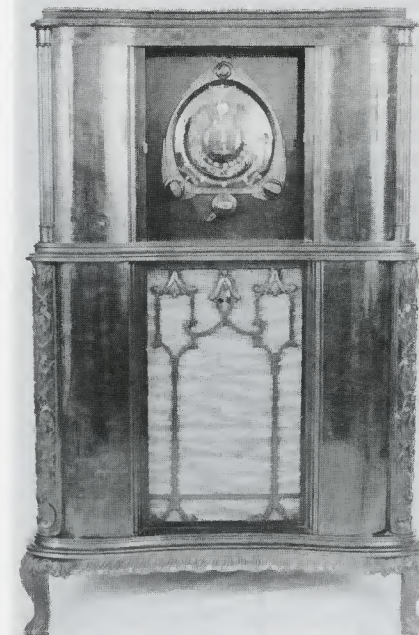

This unique Zenith "Georgian" Model 15U272 console with sliding doors won a bid of \$4,125.



(Breed Collection Auction, continued)

Crosley 58, Buddy Boy Repwood	357
Crosley 58-TK	27
Crosley D-10-BE	71
Crosley D-25-CE, clock radio	93
Crosley D-25-GN clock radio	55
Crosley D-25-MN clock radio	88
Crosley E-15-BE, E-15-SL	110 each
Crosley E-15-TN	38
Crosley E-15-WE	148
Crosley E-20-GN, E-20-GY	16 each
Crosley E-20-MN	22
Crosley Musicone B, cone speaker	88
Crosley VI	220
Day-Fan 5	33
Dictogrand, mantle speaker, wooden	55
Elkay Super Selector, w/advertisement	275
Emerson 504-A, small hairline, as	148
Emerson 547-A, (2)	22, 38
Emerson 587 Series B	33
Emerson 652	16
Emerson 811	22
Emerson AU-190, butterscotch Catalin	1,540
Emerson BA-201	55
Emerson Gemini 8, transistor radio	13
Federal 61 ref	1 100
Freed Eisemann NR-7	55
Freshman Masterpiece, w/integral speaker	66
GE L-571, butterscotch Catalin, e/r small hairline on grille, as is	385
GE 114W	16
GE 115	16
GE 400	22
GE 422	11
GE 516-F clock radio	22
GE 517 clock radio	27
GE 518 clock radio	22
GE 518-F clock radio, off-white plastic/chrome	22
Gloritone 27 tombstone, o/f	143
Grunow 5-B, metal front, wooden case	165
Guild Country Belle 556, wall phone radio	44
Hallcrafters 5-R-30A	44
Hallcrafters Continental 5-R-31A	55
Herald horn speaker, w/non-metal bell	880
Hoffman, transistor radio, solar/battery powered	126
Howard S-G-A console, o/f	137
Knight in armor on horseback novelty radio	55

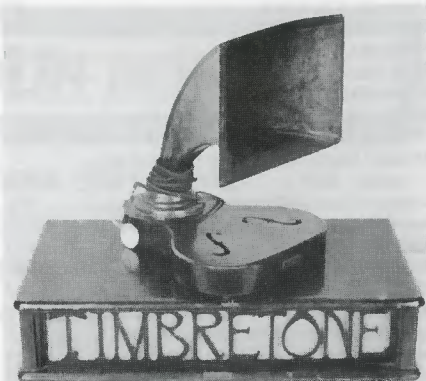

Two Timbre-tone speakers. The rare wooden horn at the top with the violin base sold for \$1,870. The rectangular horn at the bottom sold for \$440.

Kraft Macaroni & Cheese Dino-Matic novelty radio	11
Microphone novelty AM/FM radio in box	66
Miller beer can novelty radio	16
Mitchell 1260, Lumitone lamp radio	330
Montgomery Ward (Tri-City) 63-645	137
Mork from Ork Eggship novelty radio	22
Motorola 5-A7R, metal	49
Motorola 5-M-1U	44
Motorola 48-L-11	27
Motorola 55-L-24	49
Music Master horn speaker, p	110
Newcombe Hawley mantle speaker wooden	33
Peerless cathedral-style speaker	33
Philco 38-690 console, e/r	1,430
Philco 39-55 remote control console	385
Philco 39-55 remote control unit	110
Philco 46-131	16
Philco 46-420	22
Philco 48-250	16
Philco 48-460	27
Philco 52-541	22
Philco 53-561 (2)	22, 22
Philco 76, console, tapestry speaker panel, o/f	121
Philco car radio, steering column controls	55



This Zenith Model 12S475 brought \$2,750.

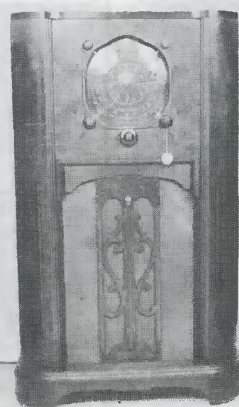

This Zenith Model 12U159 brought \$1,100.

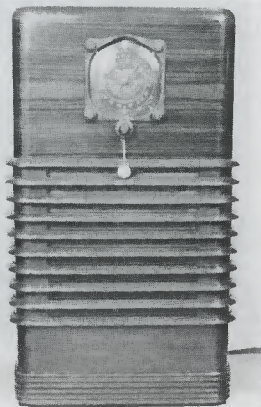

This 1937 Zenith Zephyr Model 10S157 console sold for \$1,430.

Philco B-572	22
Philco Jr 80 cathedral, e/r ref	104
Philco PT-25, no knobs, as is	16
Philco PT-46, no knobs, as is	66
Philco Transitone 49-500	11
Philco Transitone 50-522	16
Philmore Super Radio Crystal Set, w/headset, in original boxes	88
Radio Girl perfume bottles, (5) and (1) Avon	27
RCA 100-B speaker metal, Art Deco	55
RCA B-411	33
RCA Radiola horn speaker	170
RCA Radiola II, w/headset	330
RCA Victor dealer pocket pen set	55
Scott Philharmonic 30-tube console in excellent Warrington cabinet, e/r, o/f	6,050
Sentinel 284-NI, butterscotch Catalin, e/r	577
Signal 341-T snakeskin style, Silvertone 1	16
Silver Marshall 60 console, e/r o/r	93
Silvertone 2016	33
Silvertone 3005	11
Silvertone 6408	22
Silvertone 9022	33
Silvertone WLS horn speaker (cracked horn)	44
Skin-So-Soft bottle novelty radio, w/box	44
Slide tuner crystal set, (as is)	165
Snoopy novelty radio	33
Stewart-Warner 206-FA	49
Stewart-Warner A-61-P1 radio	33
Stromberg-Carlson 1500-H	22
Thorola 4 horn speaker Bakelite	176
Timbre-tone speaker rectangular wooden	440
Timbre-tone horn speaker wooden, w/violin base, rare!	1,870
Timbre-tone speaker wooden	165
Tower Meistersinger horn speaker	33
Trav-Ler 5054, (2), (as is)	22, 49
Truetone 636, (damaged)	11
Van Camp 571 novelty radio	22
Westinghouse Aeriola Sr amplifier	275
Westinghouse Aeriola Sr receiver	110

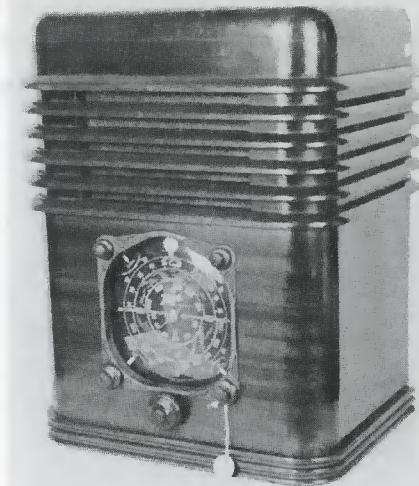

A 1937 Zenith black dial Model 8A137 Zephyr. This table model sold for \$1,870.

Zenith 4B106, boat and trailer radio, w/matching speaker 6-volt	132
Zenith 5J217 e/r, ref	165
Zenith 5R216, e/r ref	99
Zenith 5R226 tombstone, child's radio, e/r, ref	605
Zenith 5R236 chairside, e/r ref	413
Zenith 5S119, 1937, e/r ref	137
Zenith 5S126 table, e/r ref	385
Zenith 5S127 tombstone, e/r ref	275
Zenith 5S220, e/r o/f	220
Zenith 5S222, e/r o/f	187
Zenith 5S228 tombstone, e/r ref	154
Zenith 5S237 chairside, e/r, ref	302
Zenith 5S250 console	165
Zenith 5S29 tombstone, o/f	247
Zenith 5S56 console, e/r, o/f	357
Zenith 6S52 console, 1936, e/r o/f	357
Zenith 6B107 boat and trailer radio, w/matching speaker 6-volt	457
Zenith 6D015	33
Zenith 6D029	33
Zenith 6D030	27
Zenith 6D117	88
Zenith 6D219, 1938	93
Zenith 6D311	165
Zenith 6D315, "Wavematic"	247
Zenith 6S128 tombstone, e/r ref	385
Zenith 6S152 console, e/r	358
Zenith 6S223, e/r ref	137
Zenith 6S229 tombstone, e/r o/f	550
Zenith 6S238 chairside, e/r, ref	660
Zenith 6S239 chairside, e/r o/f	275
Zenith 6S241 bar/chairside, e/r ref	550
Zenith 6S254 console, e/r o/f	385
Zenith 6S256 console, e/r, ref	302
Zenith 6S27 tombstone, e/r o/f	715
Zenith 6S275, console, e/r ref	330
Zenith 7H920	33
Zenith 7J259, console, e/r o/f	440

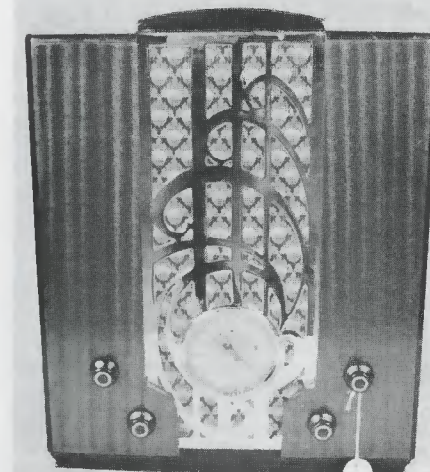

This Zenith Model S529 chrome front Deco tombstone received a final bid of \$1,210.

(Continued on following page)



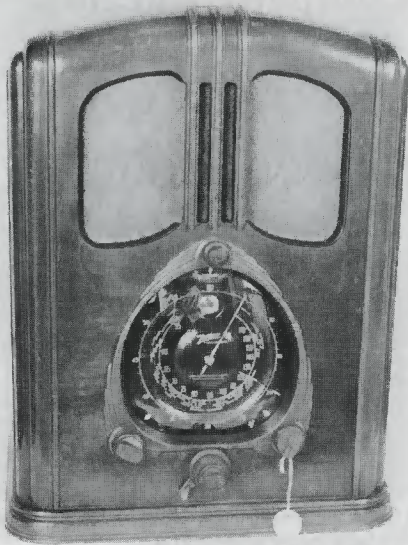

This 1938 Zenith Model 9S232 Walton radio won a bid of \$2,750.

(Breed Collection Auction, continued)

Zenith 7S28-A tombstone, o/f, e/r	495
Zenith 7S53, console, e/r o/f	467
Zenith 7S232 Walton tombstone, e/r o/f	1,870
Zenith 7S240, e/r o/f	495
Zenith 7S242, Zephyr chairside, e/r o/f	550
Zenith 7S258 console, e/r, ref	330
Zenith 7S260, console, e/r ref	385
Zenith 7S261 with bookshelf console, e/r, o/f	2,530
Zenith 8A137 Zephyr tombstone, e/r o/f	1,870
Zenith 8S129 tombstone, e/r, ref	880
Zenith 8S154 console, o/f, e/r	385
Zenith 8S154W white console, e/r ref	247
Zenith 9S30 tombstone, e/r o/f	935
Zenith 9S54 console e/r, ref	440
Zenith 9S55 console, e/r, o/f	770
Zenith 9S204 console, phonograph, e/r ref	715

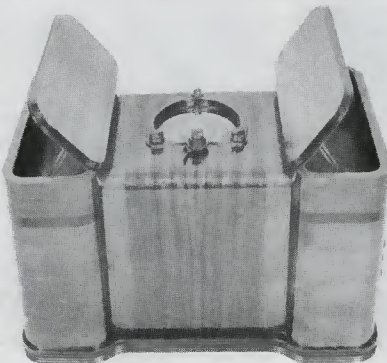

This Zenith Model 12S245 unusual chairside brought a bid of \$1 155.

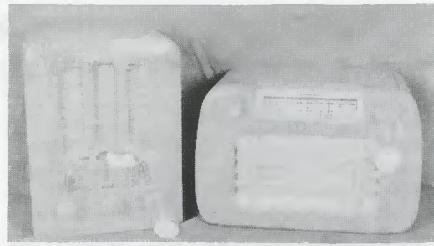

The Emerson Model AU-190 butterscotch Catalin (left) brought \$1,540, while the Sentinel Model 284-NI butterscotch Catalin (right) brought \$577

Zenith 9S232 Walton tombstone, e/r o/f	2,750
Zenith 9S244 chairside, e/r, o/f	660
Zenith 9S262 console, o/f, e/r	550
Zenith 9S263 console, e/r, o/f	715
Zenith 9S264 console, ref, e/r	825
Zenith 10H571 console (piano style), o/f	770
Zenith 10S130 tombstone, e/r, o/f	1,540
Zenith 10S147 Zephyr chairside, e/r o/f	550
Zenith 10S153 console, e/r ref	440
Zenith 10S155 console, e/r o/f	412
Zenith 10S156 console, e/r o/f	330
Zenith 10S157 Zephyr console, e/r, partly ref	1,430
Zenith 10S160 console, e/r ref	440
Zenith 10S470 console	440
Zenith 12A57 console, e/r, o/f	770
Zenith 12A58 console, o/f, e/r	1,210
Zenith 12S245 chairside, w/lift top side compartments, e/r ref	1 155
Zenith 12S265, 1938, e/r o/f	990
Zenith 12S266 console, e/r ref	990
Zenith 12S268 console, e/r, ref	990
Zenith 12S475 console radio, o/f, e/r	2,750
Zenith 12U158 console, e/r o/f	990
Zenith 12U159, e/r o/f	1 100
Zenith 15S373A console, 25 cycle, push buttons, e/r ref	1 100
Zenith 15U269 console, e/r o/f	2,310
Zenith 15U270, o/f, e/r	1,870
Zenith 15U272 Georgian console, e/r o/f, e	4,125
Zenith 15U273 console, Louis XV ornate, carved burled walnut, e/r, o/f	4,400
Zenith 807 tombstone, e/r ref	302
Zenith 808 tombstone, e/r ref	385
Zenith 809 tombstone, chrome front, e/r, ref	825
Zenith 811 tombstone, Art Deco, e/r ref	990
Zenith 975, 6-legged console, ref	935
Zenith G274	27
Zenith H511F	38
Zenith H511G	22
Zenith H511W	19
Zenith H724	11
Zenith H725, e/r	33
Zenith J615	33
Zenith K526	19
Zenith R-615	33
Zenith S-829 tombstone, chrome front, Art Deco, e/r ref	1,210
Zenith S-8501 wood case, wireless phono	203
Zenith, 6' long cloth curtain w/emblems, old	77

(Tom Harris, Tom Harris Auction Company, 105 N. 2nd Ave., Marshalltown, IA 50158. 515-753-3865)

## Sharon Boccelli and Company Auction June 4, 1997 — Watertown, Massachusetts

REPORTED BY DICK DESJARLAIS AND RAY BINTLIFF

The auction notice read: "Sharon Boccelli and Company presents an Auction of the Contents of Several Area Estates." Such a heading would stir the juices of any radiophile, but what made this auction a must was this following announcement: "An extensive single collection of radios to be sold at 5 P.M."

Armed with the radio auction listing, we trotted down to the Hibernian Hall in Watertown, Massachusetts, on June 4, 1997 to take part in the action. We knew in advance that all of the radios were to be auctioned off before the main auction at 6 P.M. This was to our advantage, of course, but the crowd waiting for the main event made it difficult to hear the auctioneer and to concentrate on what was happening.

Approximately 120 radios, plus 5 cone speakers, were auctioned off in just under an hour as auctioneer Sharon Boccelli proceeded at a brisk but professional pace. In several instances, radios were sold in lots ranging from 2 to 10 radios in one lot. This speeded up the auction, but it also meant that if a bidder was interested in just one radio in the lot, he or she had to bid on the entire lot. This practice, although common enough, did not appeal to some of the 35 or so radio-active bidders present, who had interest in only one item in a lot. Admittedly, selling each of the auction items singly would have taken longer but it might have resulted in more bidders spending more money. The radio auction took in \$5,550.

The highlights of the auction included an Emerson "Strad" table radio selling at \$330, an RCA Radiola V at \$350, a Philco Model 70 chairside at \$90, a Federal Orthosonic Type H at \$105, and a Browning Drake 6A at \$120. A 10 percent buyer's premium was charged, but is not included in the auction price listing.

vg=very good, g=good, f=fair WT=with tubes, BBT=brass based, tipped, unk=unknown

Admiral 5Y22AN	\$20
American Bosch 28, g	85
Atwater Kent 30, speakers F4 & E, g	160
Atwater Kent 55, 42, g	95
Atwater Kent 60 console, g	95
Atwater Kent 318 console, g	95
Blaupunkt 431390, g	30
Browning Drake 6A, g	120
Brunswick 6KR, g	75
Crosley 56-TV-O, g	40
Emerson "Strad," g	330
Emerson 507 522	60
Emerson 517 F182	40
Fada 177, World Radio, g	130
Federal Orthosonic, Type H, g	105
Freed-Eisemann NR6, g	85
GE A-63, replacement PM speaker g	185
GE S2, g	75
Grundig 1070, R250, vg	45
Grunow 6D, g	110



This chairside version of the Philco Model 70 went for \$90.

Kolster K21, g	45
Motorola 6Y	25
Motorola 68X11A, g	65
Motorola 581 radio-phono, g	75
Motorola 678X13	40
Philco 18 console	55
Philco 38-15, 37-610	115
Philco 70 chairside, g	90
Philco 70 console	45
Philco 511 Atwater Kent 42, g	105
RCA 55X, g	40
RCA 125, good cabinet, dirty chassis, g	95
RCA Radiola 18, w/hood, g	55
RCA Radiola V WT BBT g	350
RCA T60, T62, g	55
Silvertone 3561 f	35
Skypower 740	80
Sonora RCU208, g	65
Splitdorf 21035	75
Standardyne, AC, some cabinet scratches, vg	75
Stewart-Warner A61P1	10
Stromberg-Carlson 925H	20
Stromberg-Carlson 6531 g	85
Thompson 570	95
Westinghouse: WR209, WR260, f-g	35
Wilcox-Gay Recordio, vg	55
Zenith Trans-Oceanic, g	40

(Dick Desjarlais, Ray Bintliff, c/o A.R.C., PO Box 2, Carlisle, MA 01741)

(Sharon Boccelli and Co. Auctioneers, 358 Broadway, Cambridge, MA 02139. 617-354-7919)



# RESTORATION TOPICS

## Testing and Replacing Selenium Rectifiers

BY DANIEL SCHOO

*Many collectible radios and TV sets use selenium rectifiers. This article describes their development and application. Also included is practical information for testing and replacing these rectifiers. (Editor)*

Radios and home entertainment electronics must have direct current to operate. Since the power available in your house is alternating current, some means must be employed to convert the alternating current into direct current to operate the circuits in the radio. The most common way of doing this is through the use of a device called a rectifier.

There are many types of rectifiers, but they all do the same thing. They convert AC to DC by allowing current to pass through in one direction with a low resistance and not letting the current pass in the opposite direction. This property is called asymmetric conduction. When the alternating current from a household wall receptacle, which switches from positive to negative and back again 60 times a second, is connected to a rectifier the rectifier allows the current to flow only when the polarity is the correct value to operate the radio. The rectifier stops the current when the polarity is not the correct value.

Many types of rectifiers have been developed for power conversion. For many years vacuum tubes were most often used to perform this function in radios. Today the silicon diode is the dominant type of rectifier.

### EARLY SELENIUM RECTIFIERS

One of the earliest solid-state metallic rectifiers used to convert alternating current into direct current for power is the selenium cell. In 1877 Werner Siemens studied selenium cells and discovered their ability to rectify. In 1883, C.T. Fritts was experimenting with the photoelectric sensitivity of selenium cells, but also noted their ability to conduct current much better in one direction than in the other. His design of a selenium cell was, in many ways, similar to the construction of modern selenium rectifiers. His interest in this property of asymmetric conduction prompted him to write that some day it might be useful in converting "to and fro currents into uni-directional current."

The first practical application of selenium cells as a rectifier were reported by Pochettino in 1909. Even though a practical rectifier was demonstrated using selenium, for many years much of the interest in selenium cells was focused more on their photoelectric characteristics. The first commercial selenium rectifiers were made in 1924. In

1928, improved versions were available in Germany. They were not marketed in the United States until the Federal Telephone and Radio Company introduced them in 1938. In 1946, Federal marketed a selenium rectifier stack designed for use in radio and television receivers. Seleniums became a popular device and were used extensively in home entertainment equipment until the decline of the vacuum tube in the late 1960s.

When transistors replaced tubes on a large scale, silicon rectifiers replaced seleniums because of their smaller size, better performance and much better reliability. Selenium rectifiers continue to be manufactured as replacement components for older industrial equipment. In the mid-1960s, a small replacement rectifier for a table radio would cost about 75 cents. Because of the small volume of sales, newly manufactured rectifiers of this size now cost about thirty dollars.

### BASIC CONSTRUCTION

The physical construction of a selenium rectifier is relatively simple. Various manufacturers have slightly different methods, but the general manufacturing process is the same. A slightly roughened base plate, usually of aluminum but sometimes steel, is coated with a thin film of pure selenium to which a small amount of a halogen-like chlorine or bromine has been added. This plate will become the anode of the cell.

Heat treating the base causes the selenium to convert into the metallic crystalline state. A barrier layer is then formed over the selenium film by oxidation or the application of a special coating. The final layer is formed by applying a coating of cadmium or an alloy of tin, cadmium or bismuth over the barrier layer. This coating becomes the cathode, and the terminal connected to it is usually marked with a red dot or + sign.

In order for the cell to work properly, it must be formed much like an electrolytic capacitor to reduce the reverse leakage current. A voltage is applied to the cell in the reverse direction until the leakage current drops down below an acceptable level. This can take from one hour to more than 24 hours, depending on the construction and application.

After construction and forming, the cells are assembled into stacks. The smaller very low current ones are assembled simply by stacking one on another the larger ones use spacers and connection terminals. The final stacked assembly is covered with a protective coating of paint or varnish to prevent moisture and contamination from interacting with the layers and causing dam-

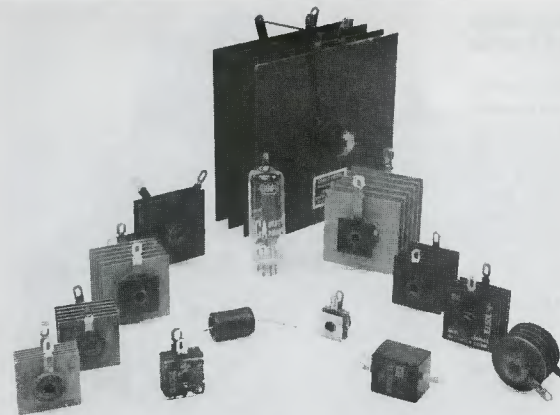

Figure 1 Some examples of selenium rectifiers compared in size to a Type 35W4 vacuum tube rectifier.

age. Mercury vapor is particularly damaging to selenium rectifiers, and even the coating is not very good protection from mercury damage. Some stacks are encapsulated in potting compound or sealed in hermetic containers for use in severe environmental conditions.

### EXAMPLES AND USES

Selenium rectifiers came in a variety of shapes and sizes depending on the voltage and current ratings. Figure 1 shows a sampling of commonly used rectifiers. The 35W4 vacuum tube rectifier in the photograph gives a reference for judging relative size. Most rectifiers in small radios are of the open plate type, as shown in Figure 2. These are made of a stack of six plates about 1" to 1½" square with about ¼" of space between them.

Some smaller rectifiers are made with the plates stacked one on the other with no spacing. For high voltage/low current applications, small circular plates from ¼" to ½" in diameter are tightly stacked and assembled into an insulating tube

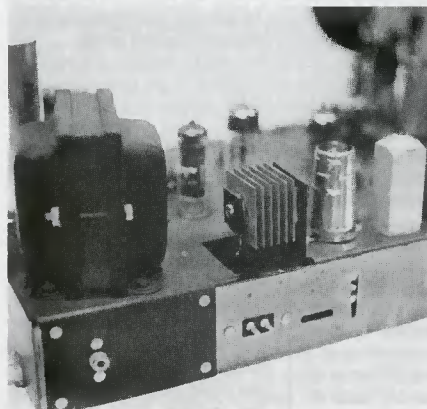

Figure 2. A radio and its selenium rectifier.

made of fiberboard or sometimes glass. Metal caps, sometimes with solid connecting wires attached, are installed on the ends, making the assembly look very much like a cylindrical precision power resistor. A diode symbol or + sign on the body usually lets you know that the component is a rectifier and not a resistor.

Some rectifiers are potted in small cubical blocks. The positive terminal is marked with a red spot or + symbol to indicate polarity. Not all stacks are single diode type. Some are assembled as full wave or bridge rectifiers. These look similar to the single type but have three or four connecting terminals. The largest example, shown in the background of Figure 1, is a bridge stack used for charging lead acid batteries in a fire alarm system.

Selenium rectifiers were used in many applications where AC power was required to be converted to DC to operate equipment. The radio collector will see them primarily in radios manufactured from the 1940s up through the mid-1960s. Selenium rectifiers were also used in television sets for the main power rectifiers. Small low current cylindrical cartridge types were used for CRT focus rectifiers. Large rectifiers were used in lead acid battery chargers, power supplies for electroplating, and DC motors for operating elevators and cranes.

Power supplies for electronic air cleaners and other applications where a high voltage at a low current was needed used stacks containing sometimes hundreds of cells. Another related use is for relay contact protectors and arc suppression.

### OTHER METALLIC RECTIFIERS

Other types of metallic rectifiers that are similar in appearance to the selenium are magnesium copper sulfide and copper oxide. Magnesium copper sulfide rectifiers were used mostly in small low voltage power supplies capable of several amperes such as a battery charger. An example of a magnesium copper sulfide rectifier is shown in the photo of a small power supply in Figure 3.

While asymmetric conduction was discovered in selenium cells years before it was discovered in copper oxide, commercial rectifiers using copper oxide were developed before seleniums. Copper oxide rectifiers were used in many of the same applications as seleniums. Copper oxide rectifiers were popular as small instrument rectifiers for metering circuits and sometimes in field coil power supplies in early radio speakers. They were rarely if ever used in radio receivers.

### RATING A SELENIUM RECTIFIER

Unlike vacuum tubes or silicon rectifiers, the rating of a selenium rectifier can be determined to a fairly close degree by looking at it. The number

(Continued on following page)



(Selenium Rectifiers, continued)

of plates determines the reverse voltage rating. The typical voltage rating for each plate is about 35 volts peak.

Although silicon rectifiers are always rated for the peak reverse voltage that they can safely block, the more common rating for selenium is not peak voltage but by the applied AC RMS voltage. This is the maximum AC operating voltage to be applied to the rectifier. Single plate rectifiers are usually rated at about 20 to 25 volts RMS. The most common rectifier stacks found in radio and television sets are 6 plates and 8 plates, rated typically at 130 and 160 AC volts RMS.

Current ratings for selenium cells are based on several factors mostly having to do with the forward voltage drop and the amount of heat dissipated. Rectifiers with fewer plates can safely handle more current because the voltage drop is smaller for fewer plates and the heat generated is more easily dissipated around fewer sources.

Rectifiers with large plates spaced widely apart can handle more current than smaller ones with closely spaced plates. Wider spacing between the plates improves air flow and helps to dissipate the heat. A rough estimate of the current handling capability of an unknown cell can be determined by measuring the size and spacing of the plates. Table I shows the current capacities of common rectifiers depending on the number of plates and their size and spacing.

The size of the plates is approximate to the nearest eighth, and the spacing is approximate to the nearest 16th. These should be used as a guide and are only rough approximations for replacement and testing purposes.

#### CAUSES OF FAILURE

Selenium rectifiers fail by three means: excessive voltage, excessive heat and aging. Operating the rectifier at higher than rated voltage causes a greater leakage current that generates heat. If the voltage is high enough, the barrier layer will break down. Short low energy breakdowns will cause a failure in a small area which will self-heal. Larger amounts of energy will create an arc and burn a larger area that will result in a permanent short. Excessive heat caused by insufficient ventilation or excessive current will cause premature aging and, if extreme, will cause the cell coatings to melt, thus leading to immediate failure.

The most common cause of eventual failure is aging. Aging is defined as "any permanent change (except failure) in the forward or reverse charac-

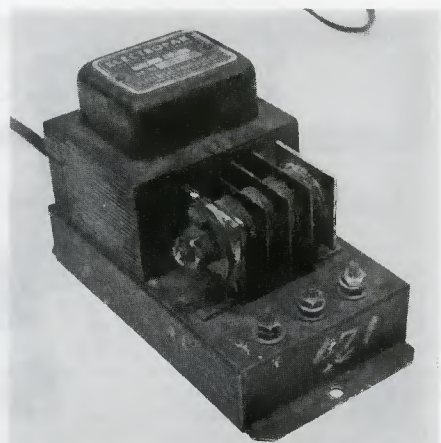

Figure 3. A power supply that utilizes a magnesium copper sulfide rectifier.

teristics of a selenium cell." As the cell gets older the forward resistance tends to increase.

There are several guidelines for defining the point where a rectifier is bad. One common industry guideline for cell life suggests that when the cell has aged to the point where its forward resistance has become two or more times higher than it was when it was new, it should be replaced. The noticeable effect of aging is reduced output voltage.

#### TESTING

Testing a rectifier before putting it into service again is an important step before powering up an old radio. Since the selenium rectifiers found in most radios today have been there for better than 30 years, it is highly likely that the forward resistance has increased to the point where the rectifier should be replaced. Often the radio will work only marginally or not at all.

Even if the radio works, this is not a good indication of whether the rectifier is suitable for service or not. Many times the radio will continue to work at what might seem to be normal performance even though the rectifier has deteriorated badly.

There are good reasons to replace the rectifier even though the set seems to be operating well. Bad rectifiers tend to run hotter than normal and can completely fail by shorting without warning.

Also, just like electrolytic capacitors, selenium rectifiers develop increased reverse leakage current after years of disuse. Applying power can cause a bad rectifier to heat up and fail within minutes.

When a rectifier fails by shorting, the result is unpleasant. In addition to the electrical damage that can occur to the radio components when the rectifier short circuits, it will release a large quantity

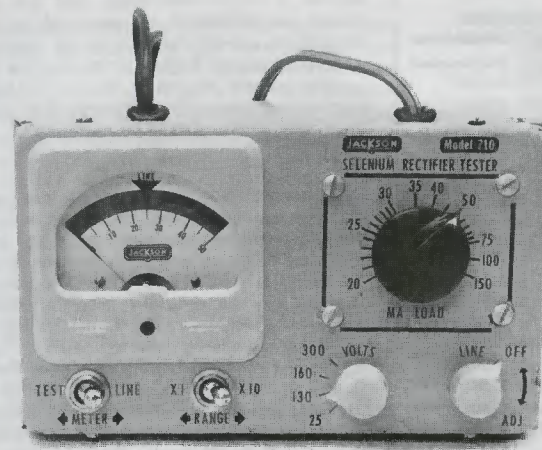

Figure 4. The Jackson Model 710 selenium rectifier tester. Note the meter's "Bad-Good" scale and AC line voltage setting.

of very foul smelling smoke. This smoke contains a quantity of selenium compounds which can be toxic and should not be inhaled.

#### A COMMERCIAL TESTER

In the mid-1950s, the Jackson Electrical Instrument Company made the Model 710 selenium rectifier tester shown in Figure 4. The tester originally sold for \$29.50. It came with a handy little ruler called a "Sele-Rater" if you did not know the rating of a rectifier that you wanted to test, you measured the physical size and spacing of the plates with the Sele-Rater and read out the approximate current rating on a special scale. You then used that information to set up the instrument for testing. Figure 5 shows a full-size reproduction of my own scale that you can use to determine the approximate current rating of an unknown rectifier.

The Model 710 measured the voltage drop across the rectifier at a known current. The meter scale was calibrated with a BAD/GOOD scale similar to tube testers. The higher the drop, the worse the reading was. The Model 710 did not measure reverse leakage, but a low resistance shorted rectifier would cause the needle to sit at the lower end of the BAD scale and vibrate at the line frequency indicating a fault. A silicon rectifier tested on the 710 causes the needle to peg beyond the top of the good scale, an indication of the great difference in the forward resistance between a selenium and a silicon rectifier.

#### OTHER TESTERS

You do not need a special instrument like the Jackson Model 710 to test your rectifiers. A simple test of the forward voltage drop and reverse leakage is more than enough to determine if a rectifier is still serviceable. An easy and effective way to test a rectifier is to pass its rated current through it and measure the voltage drop across it. You can obtain the current from an adjustable 0 to 24-volt bench power supply. Connect a 25-

ohm, 10-watt ballast resistor in series with it to limit the current to a safe value.

A volt-ohm-milliammeter can be used to measure the voltage and current. If you do not have a bench supply, you can build a simple power supply for testing. Figure 6 shows a suggested circuit for an easy-to-build test setup.

#### TEST METHODS

To test a rectifier you must first determine the rated current. You can do this by looking for identifying markings, by checking the reference material on the model rectifier that you want to test, or by measuring the physical dimensions. You can also guess the approximate rating of the rectifier from the value for the normal DC power supply current indicated on the schematic for the radio it was used in.

Once you know the current rating, connect the rectifier to the power source. Set the voltage control to the minimum setting. Turn on the power and measure the forward current. Adjust the voltage control upward until the current is at the rated value of the rectifier. If you advance the adjustment all the way up and cannot get to the rated value, the rectifier is so bad that the forward resistance is too high to be measured.

After you have the current adjusted to the proper level, measure the voltage drop directly across the rectifier. Take the measurement right away, and do not leave the current on for very long. The rectifier will begin to heat up, especially if it has a high forward drop, and the voltage will change as it does.

Now that you know what the forward drop is, you can decide whether the rectifier needs to be replaced. A new rectifier will have a forward drop of about 1 volt for each plate when it is conducting the rated current. A new 6-plate rectifier will be about 5 to 7 volts and an 8-plate will be about 8 to 9 volts. If the forward drop is a volt or more below normal, one or more of the plates is shorted and the rectifier should be replaced. If the voltage drop is more than about 1.7 volts for a single plate, 10 volts for a 6-plate or 16 volts for an 8-plate rectifier it should be replaced.

If you have a radio that has been operating and want to do a quick test of the rectifier you can do it without removing the rectifier from the radio. Measure the B+ supply at the output of the rectifier and note the voltage reading. This will be the terminal which is connected to the electrolytic filter capacitor either directly or through a low value resistor. Unplug the radio, wait for the filter capacitor to discharge, and connect a 1N4005 or equivalent silicon rectifier directly across the selenium. Be careful to match the polarity and attach the banded cathode end of the silicon rectifier to the + side of the selenium, which is, in turn, connected to the first filter capacitor. Apply power

(Continued on following page)

Table I

#### Approximate Ratings for Square Plate Selenium Rectifiers

PLATES	SPACING	SIZE	CURRENT RATING
1	NONE	1/2"	200mA +25mA for each additional 1/8" up to 3"
6	NONE	3/4"	50mA +25mA for each additional 1/8" up to 3"
6	1/8"	1/2"	50mA +25mA for each additional 1/8" up to 3"
6	1/4"	1/2"	100mA +25mA for each additional 1/8" up to 3"
8	NONE	1"	50mA +25mA for each additional 1/8" up to 3"
8	1/8"	1/2"	50mA +25mA for each additional 1/8" up to 3"
8	1/4"	1/2"	75mA +25mA for each additional 1/8" up to 3"



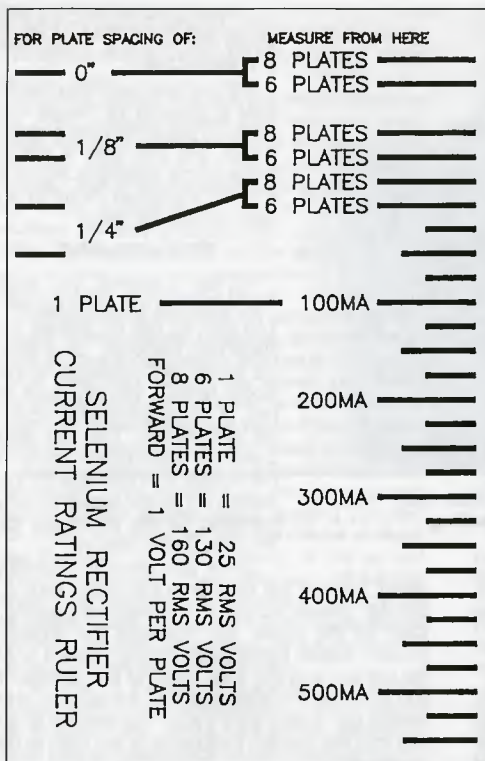

Figure 5. A handy scale for estimating the current rating of a selenium rectifier.

(Selenium Rectifiers, continued)

to the radio, and measure the B+ supply again. If the supply voltage has increased by more than 10 volts, then the selenium rectifier should be replaced.

If the rectifier passes the forward voltage test, then the reverse leakage test should be done. Connect the rectifier to the test setup in the opposite direction. Apply power and slowly run the control up until you have about 24 volts across the rectifier. A large single-plate rectifier like the battery charging type in Figure 1 may normally pass several tens of milliamperes.

Smaller 6-plate rectifiers typically found in radios should have less than 200 microamps of initial leakage. If the current is higher it means that the

rectifier is excessively leaky and the test should be terminated. A period of several minutes to several hours may be required while the leakage current drops to allow the rectifier to form. Watch for the rectifier leakage to drop below 50 microamps. If it never does, the rectifier should be replaced.

### SILICON DIODES

To replace a selenium rectifier you could put in an exact duplicate. These are available but new ones are very expensive. If you have them, old stock replacement rectifiers should be tested to see if they are still functional. Unless there is a special reason for keeping the radio exactly as built, like maintaining the originality of a special collectors radio, the best substitute is a silicon rectifier diode. These diodes make excellent replacements but do not have quite the same characteristics as the original rectifier. Simply dropping in a silicon diode will frequently work, but in many cases a series resistor should be added to maintain the B+ supply voltage at the proper level.

In choosing a suitable replacement, any common diode like a 1N4005 will work. These diodes can safely pass 1 ampere and block 600 volts. These characteristics are far better than any small selenium rectifier and the silicon diode can be bought for a few cents.

The only thing left to do is to add a small amount of resistance to make up for the lower forward resistance of the silicon diode. A small 6-plate selenium rectifier rated at 150 milliamperes, common in many small radios, has about 8 to 15 ohms of dynamic resistance. By adding a 10-ohm, 2-watt resistor in series with a silicon diode, you can approximate the characteristics of the selenium that you replace.

Even with the 10-ohm resistor, the forward voltage drop will be several volts lower for a silicon diode replacement. An almost perfect match for a 6-plate rectifier can be made by connecting 5 silicon diodes in series along with the 10-ohm resistor. This arrangement is almost never necessary, but it is a very close substitute for critical applications like bias supplies.

After you replace the rectifier, be sure to be aware that the old electrolytic filter capacitor may not stand up to the strain of the higher voltage produced by a new silicon rectifier. It would be best to bring up the voltage slowly using a variable transformer and reform the capacitor. If the radio has not been in use for a long time, the electrolytic will probably have to be replaced too.

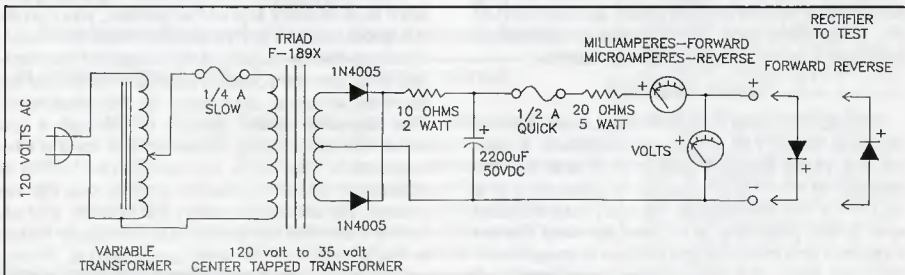

Figure 6. A schematic diagram of a selenium rectifier tester that you can build.

### CONCLUSION

Troubleshooting selenium rectifier circuits is simple once you know how they work and how they fail. A selenium rectifier is a simple but elegant device that continues to serve the industry in older equipment. Like so many other things in the electronics industry, improvements and advances in device manufacture lead to better components. Transistors replaced tubes; silicon devices replaced tubes and other metallic rectifiers. Even though many of the selenium rectifiers have aged to the point of failure, the radios that they powered can live on with modern components.

### References:

- Federal Selenium Rectifier Handbook, 2nd Edition. Federal Radio and Telephone Company, 1953.
- International Rectifier Cartridge Rectifiers/Selenium Rectifiers, Data Sheet PD-5.005, 1973.
- International Rectifier Semiconductors Catalog SR-900, 1961

- Jackson, Stuart P. Selection and Application of Metallic Rectifiers. McGraw-Hill, 1957
- Metallic Rectifier Manual. Bradley Laboratories, Inc., 1954.
- Radio's Master Reference and Buying, 18th Edition. United Catalog Publishers, Inc., 1954.
- Sarkes Tarzian Selenium Rectifier Replacement Guide, 1954.
- Selatron Selenium Rectifiers Bulletin No. 104.

(Daniel Schoo, 526 Colonial Dr., DeKalb, IL 60115)

Daniel Schoo is an electronics design engineer with a lifetime interest in antique technology, especially radio and television equipment. In addition to his collection of '30s and '40s radios and videocassette recorders, he has a collection of vintage vacuum tubes and neon lamps, as well as tube data books.

## More on the Selenium Rectifier

BY BLAKE M. DIETZE

Since selenium rectifiers are no longer readily available, the radio restorer must use a viable alternative. The replacement of a selenium rectifier is usually achieved by substituting the selenium stack with a single silicon diode. The wiring diagram for a selenium rectifier is shown in Figure 1, and its equivalent circuit consisting of a diode and resistor is shown in the center of Figure 2.

Due to the nature of the simple power supplies in which seleniums were used, the silicon diode substitute should have a Peak Inverse Voltage (PIV) rating of at least 500 volts and a forward current carrying capability of 1 amp or better. My choice is the 1N4005 (600V PIV @1 amp) which is available at most electronic stores for less than a dollar. [The 2-ohm resistor is added to approximate the internal resistance of the selenium rectifier.] The strip mounting method shown at the bottom of Figure 3 is a clean and simple way to replace the failed selenium rectifier. It is not a good idea to bridge the new diode across the failed selenium, although I have seen many replacements performed this way.

One final note in closing; something probably caused the selenium rectifier to fail. Look for shorts in the power supply, notably the filter capacitors, and don't forget the safety rules that apply to working on power supplies, especially the AC/DC type chassis where seleniums are often found.

(Blake M. Dietze, 3201 Augusta Drive, Flower Mound, TX 75028)

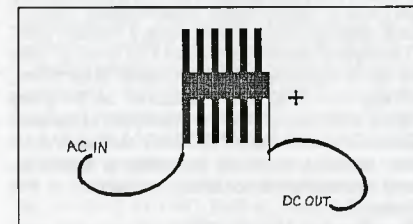

Figure 1. Wiring diagram for a selenium rectifier.

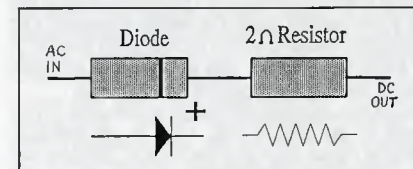

Figure 2. The equivalent circuit of a selenium rectifier.

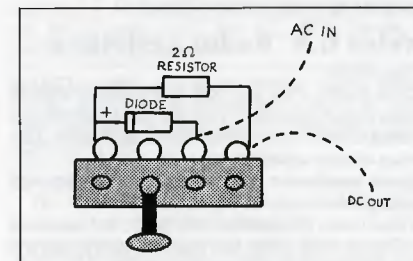

Figure 3. Terminal strip mounting of the silicon diode and resistor.





# RADIO MISCELLANEA

"Radio Miscellanea" includes items of general interest selected from A.R.C.'s incoming correspondence. "In The Marketplace" items are based on information submitted by the businesses themselves. "From The Internet" items are obtained from internet newsgroups and other internet resources. Submitted items should be verified for accuracy; items may be edited by A.R.C. for publication, and publication is not guaranteed. See the masthead for more details.

## More on the Arvin Rhythm Belle

Dear Editor:

In response to Mr. Lopes' "Arvin Rhythm Mystery" in the June issue, I offer the following: I have an Arvin 617 Rhythm Maid. All five knobs are functional; there are no dummies. The functions are on/off, volume, tone, band, and tuning. A collector friend has a 1939 Fada 913, which is a huge 13-tube tombstone with six knobs on the front panel. Two of these are dummy knobs.

John Pelham, Suwanee, GA

## Prices With or Without Tubes

Dear Editor:

Convention seems to be that battery sets from the 1920s are priced without tubes. However, price guides such as Marty and Sue Bunis' guide imply that the listed prices are for complete radios, including tubes. This can make a huge difference. For example, a Western Electric 7A amplifier lists for up to \$500. This amplifier uses three tennis ball-type Western Electric 216A tubes, which might run \$100 each if functional. So, the tubes alone are worth around half the listed price of the item! It seems as if spokesmen for the hobby, such as *Antique Radio Classified*, could do the hobby a service by helping to establish a consistent convention on this subject.

Dave Gonshor Littleton, CO

*Although establishing a consistent convention regarding tubes in battery sets is a good idea, insuring that over 8,000 readers follow it is next to impossible. Our suggestion is to verify always with the seller whether or not tubes are included, and whether they are good tubes or duds, before agreeing to a purchase.*

*Of course, all of the other issues of mail-order buying should be clarified as well, such as set condition, operating status, who pays for packing, shipping and insurance, how the item will be packed, payment policy and refund/return policy. Since these are usually discussed in a telephone call, make sure to restate in writing your understanding of the terms of the purchase when sending your payment. (Editor)*

## Envy U.S. Radio Activities

Dear Editor:

Once again, I tell you how much I have enjoyed *Antique Radio Classified*. There are no such marvelous societies of classic radio lovers like yours in Japan. I am envious of your activities.

I have twenty sets of classic radios with tubes, and repairing them is consuming my spare time.

When I have the chance to visit the U. S., I would like to find some of the shops that appear in your books and attend the meetings of some of the clubs.

A. Mizote, Nara City, Japan

*We're sure Mr. Mizote will have an open invitation to all our radio activities when he visits the U. S. (Editor)*

## Strelow Tube Substitutes Work

Dear Editor:

I finally built six of Gary Strelow's "tube substitutes that glow" as described in the February 1996 A.R.C. and installed them in my Atwater Kent Model 33. It works beautifully. With the scarcity and high price of 01-A tubes and power supplies, Strelow's substitutes are a great innovation, making operation of these radio gems feasible.

All the parts I used came from Radio Shack. The only change I made was to eliminate the lamp socket and solder directly to the lamp. I showed the result to the Radio Shack manager, and he was excited about it. Of course, we had to rig an antenna because he had none in his shop.

Alton A. DuBois, Queensbury, NY

## In the Marketplace

Sonoran Publishing announces the availability of a new computer program called *TubeData*. This is the most comprehensive listing of vacuum tubes and data ever produced, covering over 25,000 tube types from the U. S., Canada, Great Britain, Holland, Germany, Russia, and other countries. Both receiving and transmitting tubes are included, ranging from antique to modern, with military and foreign designations as well. This is an ideal aid for tube collectors, circuit designers, historians, and anyone making tube substitutions in vacuum tube equipment. *TubeData* retails for \$39.95 and is supplied on a 3 1/2" diskette for IBM compatible computers. Check with A.R.C. and other dealers for this Sonoran product.

## Common Courtesy

Dear Editor:

Maybe you could mention something about people calling asking you to hold an item and then not following through. Thanks.

Michael Crain, Harveys Lake, PA

*The other side of this coin is people agreeing to sell you an item and then renegeing on the deal. In both cases, if common courtesy prevailed, collecting would be even more enjoyable. (Editor)*

## Good Services in A.R.C.

Dear Editor:

I just wanted to let you and your other subscribers know that I purchased some test equipment from Boca Electro Magnetic Labs, one of your advertisers. The equipment, service, and price were all excellent. I also did some business with Wendall Hall through your classifieds. His calibration on my Hickok tube tester was excellent and his information very helpful. I would recommend both of these businesses to any subscriber who wants honest service and fair prices.

I am a new subscriber and want you to know that I enjoy your magazine.

Mike Piskunoff, Olmsted, OH



**WANTED:** WWII Japanese military radio of any kind; anything WWII Japanese hardware, aircraft related. Takashi Doi, 1-21-4, Minamidai, Seyaku, Yokohama, 246 Japan. Fax: 011-8145-301-8069. E-mail: taka-doi@kk.iij4u.or.jp

**WANTED:** Plastic cylinder station band for Zenith Trans-Oceanic 7000, Chassis No. 182T40Z3. Bruce Raig, 10005 Bay Pines Blvd. #642, St. Petersburg, FL 33708. (813) 398-0966

**WANTED:** UHF channel selector knob (P/N X-4020-705-0) for Sony TV Model TV-121 a 1979 12" B&W. Write: Earl Friedman, 27 N.E. 5th Ave., Hialeah, FL 33010-5014. (305) 884-2175, answering machine

**WANTED:** Amateur Radio Handbooks, 1950 and back. I have to trade Adults New Electric Library, 12 books printed in 1935, very good cond. Industrial Training Institute of Chicago, 60 lessons in three hardbook covers. This covers complete radio. Have other books on radio. A.R. Terry, RR # 3, Box 19, Ellington, MO 63638. (573) 663-7935. E-mail: Terry3@juno.com

**WANTED:** Zenith T-Os, Royal 7000 and military tube models. Buy or trade for tube audio equipment. B. Brown, 26315 486th Ave., Valley Springs, SD 57068-7308. (605) 582-6762

**WANTED:** Allen brand radio (as in Bunis 3, p. 22), external condition most important. Dale B. Allen, 606 Third St., Herndon, VA 20170. (703) 904-9895. E-mail: radiodale@dclink.com

**WANTED:** Any factory advertising, manuals for Midwest Radio, Munston 1510 signal generator. George Harris, 3212 36th St., Lubbock, TX 79413. (806) 799-2589. E-mail: gharris@juno.com

**WANTED:** Mini-tombstones from 1930s. Randy Giles, 4020 San Ardo Cove, San Diego, CA 92130. (619) 792-7376. Fax: (619) 794-7682

**WANTED:** Crystal sets. Crystal detectors or crystal set literature, top dollar paid. Hal Kravig, 2615 Juneway Dr., Memphis, TN 38134. (901) 388-2857 Fax: (901) 388-5102

**WANTED:** Headphones, very serious money paid for select sets. Send your list. Include prices, appearance. Specify if working. Bob Sukosky, 62 Strong St., Manchester, CT 06040

**WANTED:** McIntosh: tube amps, all tuners, parts, cabinets, whole systems; factory 15" Karlson Karlsonite cabinets; Thorens 124, Garrard 301, Linn turntables, Altec VOT cabinets, 604 B, C, factory cabs. Walt Fleming, 182 Plain Hill Rd., Norwich, CT 06360. (860) 889-1957 9 pm EST best

**WANTED:** Old reflection/mirror television. Fair to poor condition OK if priced accordingly. Also instructions, documentation, etc. for Supreme Model 85 tube tester Julian Brook, PO Box 130307 Birmingham, AL 35213. (205) 879-1191 Fax: (205) 870-9255

**WANTED:** Tube hi-fi/commercial amps, preamps, mixers, compressors, tuners, etc. Altec, McIntosh, Marantz, IPC, Ampex, Leak, Fisher, Scott, Dynaco, Western Electric. Sonny Goldson, 1413 Magnolia Ln., Midwest City, OK 73110. (405) 737-3312. Fax: (405) 737-3355

**WANTED:** Football helmet radios of the N.F.L. I am looking for New York Jets, New York Giants, Phila. Eagles and San Diego Chargers only. I'll pay top \$ and won't squawk. Scottie McElroy, KC5MTM, 2309 Driftwood, Apt. 1007 Mesquite, TX 75150. (972) 279-6138, anytime

### A.R.C. Advertising Policy

Sellers and Buyers, Please Note!

- Advertising is accepted only for early items
- related to radio, communication, etc. All
- items must be described fairly; reproductions, reprints and not-original items must be
- so identified. Advertisers must agree to respond promptly to inquiries and orders, to
- resolve problems promptly if the buyer is not
- satisfied, and to comply with a buyer's
- refund request on unaltered returned items.

**WANTED:** At Rochester show in September. Bendix 115 or 114, Belmont 6D111 1950's Crosleys like 10-135, 11-101U, 11-115U, D-25-E, Detrola (Super) Pee Wee, Philco 49-501 Sterling Deluxe, Sonora Sonorette, cracked, chipped or good Catalin/beetle/Plaskon radios, Japanese pocket tube radios, reverse plastic Japanese transistors like Zephyr, Crown, Global, and chrome jukebox remote units. Will purchase outright, but would prefer to trade my early wooden sets like Clapp-Eastham, Crosley, Stromberg-Carlson, old 3-dialers and home brews. Also have many early tubes and literature for sale or trade. You won't be disappointed. Look for the Radio Orphanage sign. See you there! Bruce Phillips, 127 Bunker Hill Ave., Stratham, NH 03885. (603) 772-7516, after 5 pm

**WANTED:** Rider books: Servicing by Signal Tracing; Servicing Superheterodynes, etc. Army TM's on Synchros & Selsyns, Servicing hydraulic equipment, etc. Bill Johnston, K5ZI, Box 370, White Sands, NM 88002. (505) 382-7804

**WANTED:** NBC chimes on wooden board, Marconi radios, advertising & related items. Barry A. Janov, 2454 Dempster St., Suite 416, Des Plaines, IL 60016. (847) 827-9100

**WANTED:** Small transistor reel-to-reel tape recorders & TR mics from 50s/60s. Bob Davidson, 310 Main St., Concord, MA 01742. (508) 369-2007

**WANTED:** Mint condition: Hallicrafters S-120; Zenith Y600L T-O, leather need not be working; Sony TR-714, grey. Jeff Wayne, 61 Allendale Dr., North Haven, CT 06473. (203) 281-6038. E-mail: wayne4@snet.net



**FOR SALE:** Copies of pamphlets: Care and Straightening of Warped Records - \$10. VOM & VTVM Usage 101 Ways - \$10. Tube Substitution Guide - \$5. Radio Hookups 100 (1923) - \$10. Radio Set Analyzer Usage (1931) - \$10. Radio Stations and Stars of 1933 - \$10. Sams Dial Restrunging Guides DC1 - \$15; DC2, DC4, DC6, DC8 - \$10 ea. Sams TP1 Radio Tube Replacement Guide (1938-1948) 1880 sets - \$20. Profitable Transistor Radio Service by Motorola - \$10. 1924 Course Practice and Theory of Modern Radio, 20 Lessons - \$30. Radio Dial Belt Guide - \$10. Plus shipping. Book list send LSASE w/55¢ postage. J.J. Papovich, 53 Magnolia Ave., Pitman, NJ 08071 (609) 582-8279. E-mail: jipapo@juno.com

**FOR SALE:** Magnavox horn speaker - \$100. Victor VV VI oak - \$200, mahogany - \$260. Midwest 18 tube, needs restored - \$135. Mac tuner - \$450. Victor credenza, brass reproducer - \$850. Philco 20 - \$225. EV SRO 15 - BO. Busy Bee grand horn - \$125. RADA no tube sockets - \$150. (2) N.I.B. RCA 211s - \$150.

**WANTED:** Cards for Hickock automatic tube tester, crane for Triumph "D" 1- to 3-tube radios. Mike Fletcher, 1204 Cedar St., Niles, MI 49120. (616) 684-2174

**FOR SALE:** My personal super delux Zenith Trans-Oceanic Model R600 chassis 6R40, original schematic, instruction and log manuals, cosmetic excellent, worked when put away years ago, now with broken dial cord and no B+ - BO. Also stack of 1950 vintage radio and TV news magazines. Frank Thomas, PO Box 3271, Bristol, TN 37625. (423) 764-9725

**FOR SALE:** Books. We'll be at AWA Rochester this September, indoors opposite the auction room. Frank Bequaert, Rainy Day Books, PO Box 775, Fitzwilliam, NH 03447 (603) 585-3448

**FOR SALE:** Amateur, SWL, stereo, test equipment, manuals, parts, list - \$1 and SASE. Joseph Bedlovics, PO Box 139, Stratford, CT 06497

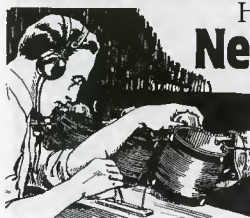

## How to Make A Neutrodyne Receiver

by FF Webb

Inexpensive re-  
print of 1925 how-  
to booklet on

building, adjusting and using a neutrodyne receiver. Includes details on winding the "neutroformers" assembling the set, neutralizing it, troubleshooting and more. 5x7 softcover 64 pages only \$7.95 postpaid • Be sure to request a free catalog of unusual technical reprints. All books guaranteed! Visa & MC



## Lindsay Publications

PO Box 538-WH5, Bradley IL 60915-0538  
www.keynet.net/~lindsay fax 815/935-5477

**FOR SALE/TRADE:** Morse keys; unique collection of (105) keys: British, American, Russian, German, Japanese, Czech; various types, straight, two-lever paddle, bug, W.T. 8 amp - offers or trade early Marconi gear. Jim Taylor, G4ERU, No. 5, Luther Rd., Winton, Bournemouth, England BH9 1LH. Tel/fax: +44-1202-510400

**FOR SALE:** Send for list. Radio books, test equipment, 40s and 50s radios. SASE please. Specify which list. Robert J. Stone, 721 Fisk Street, Piqua, OH 45356-3729

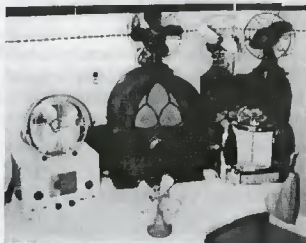

**FOR SALE:** Atwater Kent 84 cathedral, all original, plays - \$375. Seaburg 100 O-matic chrome jukebox selector - \$400. The Hallicrafters S-41 w/ cream, nice, plays - \$135. KM-ACK-ROST 8" all chrome fan, excellent - \$150. Polar cub 6" fan, green - \$75. Cardinal 9" fan, nice - \$100. Barber Coleman Co. 10" 2-blade, Bakelite base & motor - \$85. Will trade fans for radios. Buissy B 8" 2-blade, all black, early - \$100, for jukebox or radio. Wall loudspeaker MI-12414 RCA wood wall speaker 14" x 18" x at top 6" deep bottom, 4" slant front 50" cord, finish nice - \$200. Thomas Edison small round battery oil bottle, 4 1/2 tall - \$25. If included other item. Torpedo red and white - \$100. (3) 12" brass elect. fans, will trade fans for radios. Edison Mabry, 715 W. Longview Ave., Mansfield, OH 44906. (419) 526-1175

**FOR SALE:** Books for radio people. Paul Washa, 4916 Three Points Blvd., Mound, MN 55364-1245

**FOR SALE:** Crystal radio book with color photos of 74 models, novelties, rockets, and pocket sets from 1929 to 1966, many shown with original boxes, with price guide. Title: Toy Crystal Radios - \$19.95 includes postage. Eric Wrobbel, Dept. A, 20802 Exhibit Ct., Woodland Hills, CA 91367 (818) 884-2282

**FOR SALE:** Zenith wood table 6D630, not working, knobs warped - \$40. Zenith plastic table H-724, looks, works good - \$25. Silver-Marshall Model 30, console chassis & speaker, untried, spkr needs reconed - \$60. Plus shipping. Raymond Humphreys, 904 Jackson, Macon, MO 63552. (816) 385-2821

**FOR SALE:** Tubes, new and used: TV, radio, WE, N.E. Also, some radios. Call weekends. Pete Raidt, 45 Maria St., Clinton, Ontario, Canada N0M 1L0. (519) 482-7920

**FOR SALE:** Electronic and technical military manuals for sale. Basic electricity, basic electronics, antenna theory and mechanical books. Write or call for listing: Art's Book World, Inc., 6822 22nd Ave. N, Ste. 175, St. Petersburg, FL 33710. (813) 525-4880; 1-888-414-BOOK, toll free. E-mail: abw@ix.netcom.com; http://artsbookworld.com

**WANTED:** Japanese-made tube portable radios but no rust in battery compartment; Japanese-made early type transistor radios like Crown, NEC, Koyo, Sony, Mitsubishi, and so on. Takashi Doi, 1-21-4, Minamidai, Seyaku, Yokohama, 246 Japan. Fax: 011-8145-301-8069. E-mail: taka-doi@kk.ij4u.or.jp

**WANTED:** Hi-fi/theatre/commercial speakers, corner speakers, coax/triax. Altec, Western Electric, Electro-Voice, JBL, Tannoy, Goodmans, Jensen, RCA (LC/A). Drivers, horns, woofers, crossovers, parts, etc. Sonny Goldson, 1413 Magnolia Ln., Midwest City, OK 73110. (405) 737-3312. Fax: (405) 737-3355

**WANTED:** Looking to build missing power supply section for National Carbon Eveready Model 2. Can anyone supply me the component values? Also looking for pointer/cable assembly for Philco 41-230 and metal dial escutcheon for Philco 57C. Tony Herzog, 402 Walnut St., Ridgeway, PA 15853. (814) 772-5256

**WANTED:** Hallicrafters R46, R46B speakers, S38, and the cover only for SX100 S meter. H.I. Stark, K9UBL, 3215 S. Meridian St., Indianapolis, IN 46217 (317) 788-1210

**WANTED:** Emerson BA-199, original, no cracks, with back (Bunis 4, p. 80). Karen McCoy, 8104 N.W. 114th St., Oklahoma City, OK 73162. (405) 722-0595

### HAS YOUR SUBSCRIPTION

*EXPIRED?*

It has if your mailing label reads  
"EXP=SEP97" or earlier.  
Renew now!

*BONUS: Renew before  
your "EXP" month and receive  
13 issues per year instead of 12!*

Renewal rates are:

\$38.95 for Periodicals Mailing  
\$55.95 for First-Class Mailing

(Two-year renewals are twice above rates.)

**WANTED:** National NC-98TS, NC-125TS, and NTS-1 speakers. Gene Williams, 2184 E. Linker Rd., Columbia City, IN 46725. (219) 691-2323

**WANTED:** RCA Type UV-201A or Cunningham Type C-301A tubes. Seeking composition base, short pins. Dennis Craft, 10513 E. Clinton, Scottsdale, AZ 85259. (602) 860-8951 after 5 pm MST

**WANTED:** Original advertisement, owners manual and dial face for Stromberg-Carlson 231-F radio. Joseph Di Caro, 4155 Lastrada Hts., Mississauga, Ontario, Canada L5C 3V1 (905) 848-7759

**WANTED:** White's Radio Log, Broadcasting Yearbook, other radio station lists before 1980 (including photocopies). Ralph Marson, 8070 Busch, Centerline, MI 48015. (810) 754-3808

**WANTED:** Atwater Kent Model 60C chassis with speaker, also Zenith Model 7S 363 push buttons. John Humphries, 233 Lofton Rd., Stuarts Draft, VA 24477 (540) 337-2566

## "Unquestionably the most comprehensive photo references on the subject to date."

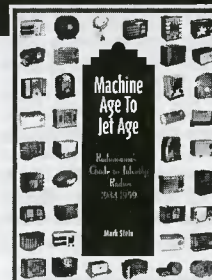

Volume I references  
1,400 tabletop radios,  
individually pictured,  
described and valued.  
256 pgs. (1997 radio  
value update included.)  
Retail \$24.95



Volume II references  
2,700 tabletop radios,  
individually pictured,  
described and valued.  
360 pgs.  
192 color photos.  
No overlap w/ Vol. I  
Retail \$28.95

Order your autographed copy of either or both books directly from the author and save:

Vol. I \$20.95 plus \$2.75 S&H (\$4.00 S&H Foreign)

Vol. II \$24.95 plus \$3.00 S&H (\$5.00 S&H Foreign)

Vol. I & II 44.95 plus \$5.00 S&H (\$7.50 S&H Foreign)

1997 Radio value update Vol. I \$5.95 -shipped free

**SPECIAL LIMITED TIME OFFER:**  
1997 Radio Value Update for Vol. I will be included  
with every Vol. I or II book order. (\$5.95 Retail)

Maryland Residents add 5% Sales Tax.  
Allow 3-6 Weeks for domestic orders.  
Add \$3.00 per book for Priority Mail  
Satisfaction guaranteed or money back!

**Send Check or Money Order Payable to:**

Radiomania®  
2109 Carterdale Road, Baltimore, MD 21209

**Or Charge Your Order:**

Mail Card info to address above,  
or Fax Info to: (410) 466-0815,  
or E-Mail to: Radioman@crosslink.net





**FOR SALE:** Listen to those 78 records in style with a commercial type 3-speed portable phonograph w/8" speaker, power transformer power supply - \$50 plus shipping. J.J. Papovich, 53 Magnolia Ave., Pitman, NJ 08071 (609) 582-8279. E-mail: jipapo@juno.com

**FOR SALE:** Speakers & radios from the 1920s. Send for list. SASE please. Robert J. Stone, 721 Fisk St., Piqua, OH 45356-3729

**FOR SALE:** Hallicrafters radio Model S38, works OK - \$65. Hallicrafters radio Model S-38E - \$60. Philco radio Model 40-115 - \$40. Radiola Model 100, speaker tapestry good - \$65. Jackson Model 648-1 tube tester, works and roll chart good - \$40. Acme Electric Corp. isolation trans. with AC meter - \$15. Senocore color bar generator Model CG 126, works - \$15. (6) rolls Silvertone recording wire, 7,500 ft. per roll - \$10 ea. roll. Sams Photofacts misc. Numbers 902 through 1377 - \$35 for all. Plus shipping on all things. Don Chandler, Don's Electronics, 907 W. 15th, Lexington, NE 68850. (308) 324-3301

**FOR SALE:** Used 807 tubes, tested and guaranteed - \$5 ea. plus \$3 priority mail. James T. Schliestett, W41MQ, PO Box 93, Cedartown, GA 30125. (770) 748-5968. E-mail: imq@bellsouth.net

**FOR SALE:** Transistors: Realtone Comet TR-1088 (cover M.I.J.) black. Universal PTR-62B, aqua with original case, box, paperwork, etc. Vista (like Fleetwood in M.I.J. p. 67), red with case. Mike Sullivan, 212 Beechwood Ln., Coppell, TX 75019. (972) 393-5084

**FOR SALE:** Zenith radios. Send for list. SASE please. Robert J. Stone, 721 Fisk St., Piqua, OH 45356-3729

**FOR SALE:** Transistorized Zenith Trans-Oceanic Model 3001, excellent condition, charts and AC adapter included, asking - \$135. Hank Trabold, 2058 Nakiska Ct., Toms River NJ 08755. (908) 244-2345. E-mail: trabold@exit109.com

## Coming to AWA?

**Vintage Radio Emporium**  
is selling everything  
(by appointment only)

September 1st-5th, 1997

Located at 97 Edinburg Street  
Rochester, NY 14608  
Tel. (716) 546-6383 or,  
Fax (716) 454-5067

Sorry to say, that after 50 years of  
sales and service, "it's quittin' time."

An accumulation of early battery & AC sets, TV sets from 1959-, TV picture tubes, manuals, signs and all that's necessary for a repair shop, must go. 1928 player piano & 200+ single play rolls.

**FOR SALE:** Gecophone BC3000, one-tube set - \$650. Adey one-tube suitcase radio - \$450. B.T.H. one-tube amplifier - \$375. B.T.H. twin crystal set - \$450. Sterling 3-tube R1589A open panel set. Rare Pure Oil Co. 5-tube doll's house radio, 1934 - \$650. Amplion AR19 oak petal horn, superb - \$850. Jim Taylor, G4ERU, No. 5, Luther Rd., Winton, Bournemouth, United Kingdom BH9 1LH. Tel/fax: +44-1202-510400

**FOR SALE:** Used globe tubes: RCA Radiotron 82 & UX-281 Cunningham X-32, 301A, 310, all for - \$75 incl. UPS. H. Andreoni, c/o 250-D So. Lyon Ave., Hemet, CA 92543

**FOR SALE:** Test equipment Sensitive Research Corporation universal measuring test set Model UTS #501546 circa 1954 large (18.5 x 25") with leads and instructions, oak case, exc but no handle, 50lb. shipping weight! - \$150. Accurate Instrument Co. transistor radio tester Model 158 with probes, exc condition, 1950's - \$100, add estimated UPS. PR Novelty, PO Box 140, Milwaukee, WI 53201

**FOR SALE:** One tube, Montgomery Ward, TRI City mfg. radio; two tube Pfanstiehl, Serial #36, same as Montgomery Ward P2; AK Model 3925, coupled circuit tuner variometer, 2-tube detector-amplifier; AK 10C, restored; Ace V Crosley; Westinghouse RA receiver tuner and DA detector/amplifier; Montgomery Ward Airline Jr. 1-tube, with repro instr. book, Airline 201A tube, Airline headset; AK Model 30, with tubes; Zenith 6S532, 1941 refinished; Fada 1000 bullet, wine with butterscotch trim and handle; Fada table plastic Model 740, wht, small stress line on grille; Automatic B44 Tom Thumb metal bike radio, 1949; Philco Jr. 80, black; Grantline 502, 1947 wht Art Deco table radio; Utah metal speaker Sonochorde spkr, needs paint touch up; RCA 103 spkr, original cover, slight tear **WANTED:** Emerson Strad; Emerson Patriot; Western Electric radio; prefer trade for items listed above. All work & plus S&H. Send SASE for list of early radio books or contact via e-mail. Dan Clayton, 12441 Coconut Creek Ct., Fort Myers, FL 33908. (941) 466-6644. E-mail: dpcclayton@aol.com

**FOR SALE:** Beginner's radio repair guides, charts and repair information. Send SASE for list. Charles Ahr, 2291 Sylved Ln., Cincinnati, OH 45238

**FOR SALE:** Victor Victrola 1-1 excellent original finish and condition - \$265. John Poore, 1120 Driftwood Dr., Lincoln, NE 68510. (402) 489-8648

**FOR SALE:** Sparant Bluebird - \$3,000. Federal Mod 59 - \$1,100. Both excellent - call. Mike Greene, 19113 Alpenglow Ln., Brookeville, MD 20833. (301) 774-3203

## VACUUM TUBES

1920's - 1950's

We stock more than 1,000 types of New Old Stock vacuum tubes including scarce G types. Also selected used tubes. Write for latest price list.

### ANTIQUÉ TRIODE

653 Commercial St., Farnham, NY 14061  
Fax 716-549-3823

**WANTED:** Japanese Koyo-made subminiature tube portable radios; Japanese-made early type transistor radios. Takashi Doi, 1-21-4, Minamidai, Seyaku, Yokohama, 246 Japan. Fax: 011-8145-301-8069. E-mail: taka-doi@kk.ij4u.or.jp

**WANTED:** Mics: Shure 705, CR88, CR80, 520/440, 707A. EV638/641/605. Astatic T-3. Also parts & elements. Tom Ellis, PO Box 140093, Dallas, TX 75214. (214) 328-3225. Fax (214) 328-4217 E-mail: 74053.3164@Compuserve.com

**WANTED:** Paying \$\$\$ for Art Deco style sets 1930-1940s, especially with chrome or metal grilles, trim. Adam Schoolsky, 15149 S.W. Cabernet Dr., Tigard, OR 97224. (505) 579-1080. Email: Adam@ArtDeco.com, http://www.ArtDeco.com

**WANTED:** Hallicrafters S-29 or S-39. Would pay \$100 for complete radio. Bill Gustavson, 1819 Green Tree Ln., Duncanville, TX 75137 (214) 981-3310, work

**WANTED**  
**PICTURES FOR PHOTO REVIEW OR**  
**TELEGRAPH REVIEW**  
**PHOTOS MUST BE SHARP IN DETAIL**  
**A SHORT DESCRIPTION IS A MUST!**  
**SEE PHOTO REVIEW PAGES FOR**  
**ADDITIONAL INFORMATION**

**WANTED:** Fisher 500 gold faceplate, antenna assembly, operating manual. Sansui 500 antenna assembly. Soterios Gardiakos, 63 S. Broadway Ave., Aurora, IL 60505-3325. (630) 844-0590. Fax: (630) 844-0591

**WANTED:** Radio mail order catalogs from 1930 to 1959 for Allied, Lafayette, Radolek, Bursteen-Applebee, Montgomery Ward, others. I pay top dollar for catalogs I don't have. Also buying any radio product line brochures for brand names or off brands. Tell what you have! Mark V. Stein, 2109 Caterdale Rd., Baltimore, MD 21209. Fax: (410) 466-0815. E-mail: radioman@crosslink.net

## A. G. Tannenbaum

Electronic Service Data  
PO Box 386, Ambler, PA 19002  
Phone: (215) 540-8055  
Fax: (215) 540-8327

THE



FOR

Vintage Parts & Service Data  
1920's - Present

Free Catalog  
Credit Cards Welcome  
Browse our web page at  
www.agtannenbaum.com

**WANTED:** Old guitars/guitar amps, effects pedals. Vox, Gibson, Gretsch, Rickenbacker, Fender, Univibe, Fuzzface, Selmer, Marshall. Sonny Goldson, 1413 Magnolia Ln., Midwest City, OK 73110. (405) 737-3312. Fax: (405) 737-3355

**WANTED:** Philco 54C, excellent condition and original finish. Jacob Voelker, 144 Concord St., Indiana, PA 15701. (412) 463-6474

**WANTED:** Chassis punches, any round sizes. Buying alum. chassis various sizes. Byron Tatum, WA5THJ, Rt. 9, Box 163, Alvin, TX 77511 (713) 331-2956

**WANTED:** Motorola TVs VT-105, 12VF4, GE Models 800, 803. Michael Storey, 412 10A St. NW, Calgary, Alberta, Canada T2N 1W8. (403) 283-3746

**WANTED:** Juvenile books Walter and the Wireless and Billy Whiskers and the Radio. Robert Stapleford, 1800 S.W. Randolph Ave., Topeka, KS 66604-3158

**WANTED:** Electron tubes, ball bearings, radio & aircraft receivers & transmitters, connectors, lamps, relays, switches, breakers. Hy Ness Company, 709B Delair Rd., Cranbury, NJ 08512-4212. Phone: (609) 395-1116. Fax: (609) 395-1117

**WANTED:** Emerson 707-B, red only. Clint Miller, 1604 N. Harrison St., Little Rock, AR 72207 (501) 664-8424

**WANTED:** Need a copy of "His Master's Voice in America." John Pisarski, 114 Evans Rd., Norristown, PA 19403. (610) 539-0756

**WANTED:** Freed-Eisemann BC-SW circa 1937 dial glass measures 3 1/8" round. Lee Baumin, 129 Azalea Dr., Harwich, MA 02645. (508) 430-0197

**WANTED:** Old microphones, AM/FM Bakelite radios, Firestone 4-A-12, Aircastle WEU-262, etc. Deco Bakelite radios, Motorola 41A, Fada 263, etc. Steve Puryear, 1310 Osprey Ave., Orlando, FL 32803. (407) 894-7743

## YARD SALE!

(GRILLE CLOTH)

\$20 per yard (51" x 36") for any quantity of yards of these patterns: #15, 16A, 17, 19A, 20, 21, 22, 23, 24, 25, 26, 27 until gone.

\$15 per yard for #11 until sold out.

### 4 New Patterns!

#30 and 31 are not what I expected so I'm selling them cheap to recover my costs - \$12/yard! (36" x 44"). (If you can use a low cost generic look, this works.) #32 is a rust-colored Philco 90 type pattern for late 30's Zenith. #33 is for Buddy Boy, Kennedy tombstone and Temple speaker, and others.

Send 55¢ LSASE (4"x10")  
for full set of samples.

MICHAEL KATZ  
3987 DALEVIEW AVENUE  
SEAFORD, NY 11783  
(516) 781-6202 (EVENINGS/WK-ENDS)



**FOR SALE:** Sams Photofacts for Automotive Radio's, many 1950s types, send SASE for large list. Zenith nice circa 1952 poster, full color shows maroon AM/FM clock radio and green AM clock radio, really nice condition - \$55. PR Novelty, PO Box 140, Milwaukee, WI 53201

**FOR SALE:** (2) Weston wood meters, 8 chan. video mixer & fader, Akai 2 chan. tape recorder, RCA laser disc VLP F.H. Montgomery, 505 Congress, #710, Havre de Grace, MD 21078-3043. (410) 939-2099

**FOR SALE:** 1946 Packard Bell console, Model 1391, phono/radio recorder with microphone, manuals, blank records and much more, exc - \$250. Norton Thompson, PO Box 422, Paonia, CO 81428

**FOR SALE:** Used tubes - \$1 ea. 1V 1C7G, 6K7, 6Q7 6D6, 6CD6, 6A4LA, 78, 1626. James S. Looney, Rt. 1 Box 54, Grundy, VA 24614. (540) 531-8677

**FOR SALE:** Stromberg-Carlson 30-watt A-432, hi-fi control center, (2) 12AX7 60BA, 6L4, 5T4, Z7027 not tested - \$50 plus postage. Elmer H. Jorgensen, 3535 E. Cook Lot 181 Springfield, IL 62703

**FOR SALE:** Victor Model RE 57 radio, phonograph, recorder w/microphone, fancy tonearm - \$500. Jim Allen, 420 S. 46th, Lincoln, NE 68510

**FOR SALE:** N.O.S. knobs, GRR-GRC Series, R-392, etc. - \$1.25 ea. or \$5/5 + \$3 S&H. John Eickhof, PO Box 258, Wendell, ID 83355

**FOR SALE:** Replacement castings for automatic Victrola phonograph mechanisms: Models 10-50, 51 70 and 9-55. Charlie Weatherbee, 2120 The Crescent, Clermont, FL 34711 E-mail: wd4cgx@aol.com

**FOR SALE:** Garage sale: radios, laboratory test equipment, books, tubes, parts, ham gear By appointment. Cash and carry. Stuart T Carter, II, W4NHC, 680 Fernwood Dr., Melbourne, FL 32904. (407) 727-3015



Sylvania  
**TYPE 6D6**  
RF PENTODE

CHARACTERISTICS	
Heater Voltage AC or DC	6.3 Volts
Heater Current	0.3 Ampere
<b>Direct Interelectrode Capacitances:</b>	
Grid to Plate (with tube shield)	0.007 pfd Max.
Input	4.7 pfd
Output	6.2 pfd
Maximum Over-all Length	4 1/2"
Maximum Diameter	1 1/2"
Sub	5 1/2"

## Sylvania Tube Manual

Complete reprint of the 1937 Sylvania Technical Manual. Complete details on ST tubes as well as the new metal octals. Also references to earlier tubes such as 01A, 2A5, 12A, many others and special tubes for Majestic sets. Sample schematics. Biasing tables. Valuable reference! Only \$15.95 postpaid • Be sure to request a free catalog of unusual technical reprints. All books guaranteed! Visa & MC

### Lindsay Publications

PO Box 538-WH4, Bradley IL 60915-0538  
www.keynet.net/~lindsay fax 815/935-5477

**FOR SALE:** (1) set of (8) Goldenvoice speakers: (2) 12" (2) 5 1/2" (4) 3 1/2" - \$50 + S/H. (1) Sencore PS, 148 working with manual, no probe - \$50 + S/H. (1) Feiler electronic stethoscope, looks nice, untested - \$25 + S/H. Carlos Gimenez, 15091 Shamrock Dr., Fort Myers, FL 33912. (941) 482-0198

**FOR SALE:** Thousands of tested tubes w/warranty! Buy xmit, rec or audio spare tubes for your unit. Tubes are used, tested at about 1/3 of new, many are around \$1 Bunches of octal, 7- and 9-pin tubes. All tubes are tested on TV-7D/U tester and then boxed. 30-day replacement or refund warranty. Send wants or SASE with two stamps for list. **SERVICES:** Repair/calibration of TV-7 tube testers. Contact for arrangements. Repair starts at \$45 + U-pay shipping. Daniel Nelson, 1025 E. Desert Ln., Phoenix, AZ 85040. (602) 243-7421 machine/evenings. E-mail: djn@goodnet.com

**FOR SALE:** (3) curved glasses for DeWald 501 Model 51 - \$125 each. Come to Rochester. G. Faassen, Heideweg 1 5953 TL Reuver, Holland. Fax: 0031-77-474-6683

**FOR SALE:** Marconi crystal set, marked "Marconi's Wireless Telegraph Co. Ltd.", No. 19394, in mahogany case. Photo, details. AlesanderKoppen, Vintage Radio Apparatus, 197 Onslow Rd., Shenton Pk. 6008, West Australia, Ph/fax: 08-9381-6336. E-mail: atap@tempest.com.all

**FOR SALE:** World 5-tube battery set, vg - \$70. Crystal set in wood box - \$55. Browning & Drake 4R, vg, engraved panel - \$95. Large 4-tube HB, cabinet very good - \$50. Philco 84 cathedral, plays - \$85. Sonora horn speaker in cabinet, good - \$55. Crosley 5-50, slant front - \$65. Hickock tester & VOM, metal box - \$50. Crosley 51 with tubes - \$85. Sylvania TR86, early transistor, playing - \$18. Wally Worth, 2 W. Elm Ave., Wollaston, MA 02170. (617) 479-4512, please call before 9pm

**FOR SALE:** Grundig TK45 tube type reel-to-reel tape recorder - BO. Robert Gerber 636 W. Wildrose, Ridgecrest, CA 93555. (619) 375-6912

**FOR SALE:** Presto K10 record cutter - \$245. Presto 75A 16" record cutter, port case, 1C 8 ohm head - \$245. Ampex 620 tape recorder & 622 speaker/amp, mono, Sampsonite cases, exc - \$300. Ampex 601 7" mono tape recorder, needs work - \$50. Ampex 620-2 7" stereo tape recorder, needs work - \$75. Dytronics 242MML phase sensitive volt meter, manual - \$50. Potter Blumfield octal plug-in relays, 6v DPDT (10) - \$10 ea. Alan C. Graves, PO Box 5469, Eugene, OR 97405. (541) 345-3991

Electricity Telegraphy  
Telephony  
Television Radio Wireless  
Books and Literature  
Bought and Sold

Send for our catalog  
Old Authors

PO Box 403 Morrisburg ON Canada K0C 1X0  
Tel: (613) 543-3337 Fax: (613) 543-2380  
e-mail: authors@mor-net.on.ca

IBM OR  
Mac

# FREE

SATISFACTION  
GUARANTEED

*That's right! We are that proud of our Rider's on CD set. Try them in the comfort of your own home ABSOLUTELY FREE.*

*If you like them - keep them. If you don't - return them.*

*It's that easy!*

**35,000 Pages At The Click of A Button!**

**Easy & Fun To Use.**

**Volumes One through Twenty-three - Complete**

Check Out These Exciting Features:

- View any page on your screen.
- Print any page.
- Zoom-in, zoom-out.
- Flip through pages with lightning speed.
- Go directly to any page.
- Complete Rider indexes - included!
- Rider updates - included!
- Auto radios, records players & changers - included!



**Great For The Non-Technical Collector Too!**

Identify unknown radios by:

- Picture
- Cabinet design
- Tube layout
- Chassis numbers
- Production numbers

**Don't Delay - Order Today - (210) 546-6913**

**Visa, MasterCard, Discover, & American Express, or mail check or money order in the amount of \$249.00 to:**

**BPS, INC., 164 Winter Haven  
Brownsville, TX 78521**



**FOR SALE:** Electromagnetic radiation report, HAARP GWEN, ELF - \$5. H. Andreoni, c/o 250-D So. Lyon Ave., Hemet, CA 92543

**FOR SALE:** Parts Western Electric transistor N.O.S. circa 1959, original boxes marked "#2114" on transistor, boxes marked in pen "2114 yellow" - \$10 ea. Carbon film resistors half watt size as low as - 6¢ ea., FP can capacitors - \$3 ea. Send SASE for lists. PR Novelty, PO Box 140, Milwaukee, WI 53201

**NOTICE TO ALL  
CLASSIFIED ADVERTISERS!  
OUR CLASSIFIED AD DEADLINE IS  
12:00 NOON  
ON THE 10th OF EACH MONTH**

**FOR SALE:** (185) 78 records, assorted big bands of 1930s, some 20s - \$50 plus freight. David S. Kendall, 401 Himes, Huntington, IN 46750. (219) 356-5096. E-mail: ke9wi@fwi.com

**FOR SALE:** Have (6) Thomas Edison original phonograph records - Best Offer. Robert F. Fermazin, 26053 Highland Palm Dr., Homeland, CA 92548. (909) 926-3354

**FOR SALE:** Bogen M0100 tube power amplifier, 100 watts, 2-6550 GE power tubes, exc cond. - \$200. Mark Schackow, 307 4th Ave. E, Lemmon, SD 57638. (605) 374-3424

**FOR SALE:** Ancient (30s-40s) neons, one-watt 110v size 1 1/4-inch globe - \$5 ea., \$7.50 for two etc. Request info. Charles Graham, 4 Fieldwood Dr., Bedford Hills, NY 10507 (914) 666-4523

**FOR SALE:** (1) Eico 324 signal generator near mint - \$65 + S/H, (1) Weston Model 772 analyzer in oak case with all plugs, adapters, cables, etc. - \$65 + S/H. Carlos Gimenez, 15091 Shamrock Dr., Fort Myers, FL 33912. (941) 482-0198

**FOR SALE:** RCA radios. Send for list. SASE please. Robert J. Stone, 721 Fisk St., Piqua, OH 45356-3729

**FOR SALE:** (2) Philco cat. Model 89 WT light and hum, refinished cabinet as is - \$180 ea. + S/H. (1) Philco cabinet Model 91 as found, fair \$40 + S/H. (1) CB radio Bogen, not tested - \$30 + S/H. (1) Columbia suitcase record player Model 512 - \$35 + S/H. Carlos Gimenez, 15091 Shamrock Dr., Fort Myers, FL 33912. (941) 482-0198

**FOR SALE:** Atlas radio horn - \$90. Emerson Model AX211 white, miniature - \$55. Silvertone Model 7024, hums - \$55. Emerson Model 336, plays - \$45. Gary Nitkin, 102 Long Highway, Little Compton, RI 02837 (401) 635-2816

**FOR SALE:** Books: Radios The Golden Age, Collins, hardcover - \$23. Radio Redux, Collins, softcover - \$15. Collecting Phonographs & Gramophones, hardcover - \$15. Gernsback's Radio Encyclopedia 1927 - \$8. All above mint. The Cat's Whisker (50 Years of Wireless Design), Hill - \$15. Ex. Vintage Radio 1887-1929, McMahon - \$10. Flick of the Switch, McMahon, fair - \$6. Add \$2 shipping. Maureen Martin, 1407 Memory Ln., Lutz, FL 33549. (813) 949-1835

**FOR SALE:** Atwater Kent, Model 32, receiving set, 7 tube, looks good! - \$95. Bill De Vries, PO Box 376, Dixfield, ME 04224-0376. (207) 562-7066

**FOR SALE:** Tube stereo recorders, Voice of Music 722, Lafayette RK-140 - \$50 ea. plus shipping. Greg Jones, 26 Greenman Ave., Westerly, RI 02891 (860) 599-6104

**FOR SALE:** Clean-out time. Save me the time to make lists, pack, run to UPS or post office - call, stop by. Buy cash. Sets, tubes N.O.S. and box lots. Sets, test eqpt., service manuals, magazines, parts, plus 1000's other items. Hours 9 a.m. to 5 p.m. F. Krantz, 100 Osage Ave., Somerdale, NJ 08083-1136. (609) 783-0400

**WANTED:** All microphones, cheapies OK, guitars, guitar amps, effect, catalogues, etc. Alex Pepiak, 330 Third Ave., Bellmawr, NJ 08031 E-mail: alpep@aol.com

**WANTED:** Black tuning knob for Silvertone 4500. Bob Turner 11632 Co. Rd. 48, Fairhope, AL 36532. (334) 928-0051 E-mail: RadioColl@aol.com

**WANTED:** Round dial glass and cover for Philco 38-38. Hank Trabold, 2058 Nakiska Ct., Toms River, NJ 08755. (908) 244-2345. E-mail: trabold@exit109.com

**WANTED:** Chairside radios, poor condition sets OK. R.J. Dial, 2709 Vista Diablo Ct., Pleasanton, CA 94566. (510) 426-1470

**WANTED:** Electron tubes, ball bearings, radio & aircraft receivers & transmitters, connectors, lamps, relays, switches, breakers. Hy Ness Company, 709B Delair Rd., Cranbury, NJ 08512-4212. (609) 395-1116. Fax: (609) 395-1117

**WANTED:** EL-37, N.O.S. or used; pre-recorded reel tapes; Talisman alchemist phono cartridge; unbuilt amp kits. Bill South, 13101 Foster Rd., Anchorage, AK 99516. (907) 345-9006

**WANTED:** Hallicrafters portable radio TW-1200, and Grundig Ocean Boy 209, xln/mint only. Ed Kalpa, 4622 Melbourne Ave., Los Angeles, CA 90027 (213) 661-1221

**WANTED:** Turquoise Bulova 620, red Sony TR-63, German transistors, transistor components, related advertising. Rudi Herzog, PO Box 140 108, 30959 Hemmingen, Germany. Phone: 011 49-5045-7464 Fax: 011 49-5101-5100

**WANTED:** Top price paid for catalog of GPL broadcast television camera equipment of the 1950s. Also want GPL image orthicon camera, lenses, etc. Can arrange shipping. Andy Emmerson, G8PTH, 71 Falcutt Way, Northampton, NN2 8PH, England. Fax: 011-44-1604-821647 E-mail: midshires@cix.co.uk

**WANTED:** Crosley radios from 50's like D25, E10BE, E15TN, 11-104 and so on. Radio should be original, excellent condition and working. Takashi Doi, 1-21-4, Minamidai, Seyaku, Yokohama, 246 Japan. Fax: 011-8145-301-8069. E-mail: taka-doi@kk.ij4u.or.jp



**WANTED:** Emerson Catalin radios. Would you believe that my mother's last request is that I gather every known example of this radio ever made. I guess she wanted me to suffer a long time. Please write or call collect: Rain Buttignol, 214 State St., #7 Portsmouth, NH 03801 (603) 427-1384

**WANTED:** Dial glass Philco 41-260. Bill Johnson, 34 Springlake Pl. NW, Atlanta, GA 30318

**WANTED:** Knobs for Arvin 444. Need complete chassis (all tube shields, etc.) and speakers for the following: Philco 57, Philco 620, Atwater Kent 60 (no speaker needed for this one). Cabinets for RCA TG-1, Philco 38-89 with intact photo finish. Coil winder. Ed Martin, 485 Benwood Hill Rd., Benwood, WV 26031-1336. E-mail: ebm@prodigy.net

**WANTED:** For Airline 62-357 console: whatever goes in center of the telephone dial ring. Chuck Regen, 2724 N. 27th St., Sheboygan, WI 53083

**WANTED:** Tuning knob for Crosley Model 11-114U radio. Erich von Gaertner 27808 Espinoza, Mission Viejo, CA 92692. (714) 859-7595

**WANTED:** Centralab replacement switch #K-157 Fred Cranshaw, 1624 Bitter Ck., Garland, TX 75040. (972) 494-4099

**WANTED:** Pocket lighter(s) with radio station call letters 'WRAY' above microphone on the side. Randy Ray Massey, 20937 Indiana, Brownstown, MI 48183

**WANTED:** Stancor transformers PC8412 and PS8415. Also looking for Western Electric transformers and chokes. Michael Payne, 803 S. Taylor, Alvin, TX 77511 (281) 331-9217 Fax: (281) 585-2727

**WANTED:** IC: LA5112N, (ECG1479), (SK9188) Sears part #46-13237-3. Bob Sherwood, 202 D St. SW, Miami, OK 74354. (918) 542-6058

**WANTED:** For plating operation: 12Vdc, 0-100A (or higher) power supply, 120 or 240 VAC. R. van Gaalen, 218 Sandpiper Portland, TX 78374. (512) 643-1589

**WANTED:** Crosley headphones, good or better condition. Jim Bollman, 3323 Eaton Rd., Williamson, NY 14589. (315) 589-8815. E-mail: bollman@wrc.xerox.com

**WANTED:** Payphones: three slot, Gray, Western Electric, Automatic Electric. I pay highest prices. Stanley Schreier, 350 Hendrickson Ave., Lynbrook, NY 11563. (516) 887-4966. Fax: (516) 887-4780

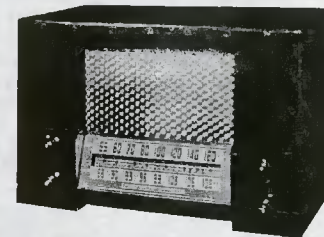

**WANTED:** Emerson Model 556 pictured, working or not. Richard W. Gleitz, 2390 Grandview Dr., York, PA 17403. E-mail: rgleitz@netrax.net

**WANTED:** Metal back for 10' Admiral Bakelite console television. Steve Cavell, 30144 Torry Ave., Flat Rock, MI 48134. (313) 379-3254. E-mail: cavell@wdl.net

**WANTED:** E.H. Scott Laureate Grande Allwave 23, good chrome, tweeters, good cabinet, working? - \$4,000. Robert Alexander, 270 Haycamp Rd., St. Paul, MN 55127 (612) 483-6177

**WANTED:** Bogen H010 audio amp any condition, has green chassis, Grommes 216BA with chrome chassis, and EICO HF52 integrated amp, any condition. Purchase or swap. Michael Payne, 803 S. Taylor, Alvin, TX 77511 (281) 331-9217 Fax: (281) 585-2727

**New Jersey Antique Radio Club  
Antique Radio Swap Meet**

**Saturday, September 27, 8:00 AM - 1:00 PM\***

**New Location: National Guard Armory, Freehold N.J.**

NJARC presents its Summer all-indoor swapmeet in a spacious, new location with vendors displaying a spectrum of collectible old-time radios, military and civilian communication equipment, audio equipment, phonographs, and associated parts and literature. Convenient, ground level access for vendors; snacks are available. Buyer admission is \$2.00 to help defer rental fee. Everyone is welcome! **Reservations are required to guarantee a space. NOTE: Tables will not be provided; floor space is ample and clean.**

**DIRECTIONS: From the North:** N.J. Turnpike Exit 8A to Route 522 East; in Freehold, take Route 79 South for about 1 mile to BUSINESS ROUTE 33 (Park Ave.) East - The Armory is about a block East of Route 79 on BUSINESS ROUTE 33. **From the South:** N.J. Turnpike Exit 8 to Route 33 East for about 10 miles; continue on BUSINESS ROUTE 33 (Park Ave.) through Freehold - The Armory is about a block East of Route 79 on BUSINESS ROUTE 33.

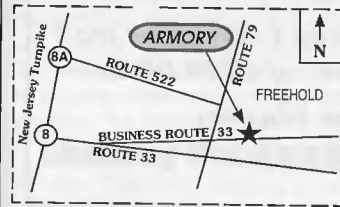

**RATES:**

NJARC members \$15/space; non-members \$20/space.

**CONTACTS / RESERVATIONS:**

Marv Beeferman, 2265 Emeraldal Park Drive, Forked River NJ 08731 (609-693-9430). James Whartenby, 120 W. Franklin St., Bound Brook, NJ 08805 (908-271-7701)

\*Vendors set up at 7:00; no early admittance!



**FOR SALE:** Consoles: Crosley 72CA, RCA's 111K, 17K, all play - \$100 ea. Table: Zenith 7H820Z, G725 - \$45 ea. Bendix 0526A, 0526B - \$60 ea. Sentinel 241T - \$35. Philco H765124 - \$60. Chassis: Sentinel 68B136S, no speaker - \$45. Clarion 280 lowboy 2 speakers - \$80. Buzz Miller, 725 Mt. Rock Rd., Carlisle, PA 17013. (717) 776-3279

**FOR SALE:** Zenith Trans-Oceanic 3000-1, working, has some pits and bubbles on case - \$100. Jim Montague, 1907 S. Stanley Ln., Spokane, WA 99212. (509) 535-9576

**FOR SALE:** WWII aircraft radio collection. ARN-7 APN-1, BC-348 and control boxes - \$300 for all. Chris Cross, Box 94, McConnell, IL 61050. (815) 868-2323

**FOR SALE:** National NC-1830, condition unknown - \$125, plus UPS, very heavy. Jack Shaymow, Vintique Electronics, 52-C Tilford, Deerfield Beach, FL 33442. (954) 427-1222

**FOR SALE/TRADE:** Restored Philco 70 - \$395, plus S/H. Mark Murphy, 1400 Chicago Ave. #802, Evanston, IL 60201. (847) 328-5036

**FOR SALE:** Astatic D-102 microphone with stand - \$30 plus shipping. Floyd Paul, 1545 Raymond, Glendale, CA 91201 (818) 242-8961

**FOR SALE:** Audio and recording: Heathkit W4-AM, W-5M amplifiers; Sony TC-200 stereo recorder, microphone and speakers; Revere T-2200 stereo recorder; Companion T2200 stereo tape amp; Turner 500, 600, 211 microphones. Bill Coolahan, 1450 Miami Dr NE, Cedar Rapids, IA 52402-2933. (319) 393-8075

**FOR SALE:** New Johnson Viking II, Model 122 Hy-Gain multiband verticals, low pass RT filter 52 ohms, pick up only - \$950. John Nosbaum, W9BJP, 2743 Wilmette Ave., Wilmette, IL 60091 (847) 256-0547

**FOR SALE:** Attention dealers and repairmen. Want to sell off large group power and audio transformers low voltage power supplies. Test equipment, (60) boxes radio tubes, other repair service parts, PM electro dy speakers, AM/FM tuners, amps, transistor types, small table radios. No single items; buyer picks up, cash deal. Phone. F. Krantz, 100 Osage Ave., Somerdale, NJ 08083-1136. (609) 783-0400

**FOR SALE:** Have (84) transistors, (40) tube sets, (22) novelties, LSASE. Specific interest. H.B. McMahan, 313 W. Shaw, Tyler TX 75701 (903) 593-5433

**FOR SALE:** Leader LB0310A 3" oscilloscope - \$99, plus shipping. Clark Trissell, 3530 Pawnee, Lincoln, NE 68506. (402) 488-5263

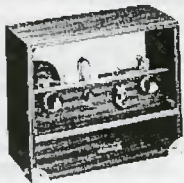

## WANTED

Amrad 3670 as shown, any condition. Also a Type E crystal set, 3500-2 and other pre-1926 Amrad sets & parts.

Andrew Mooradian, 5 Priscilla Lane  
Winchester, Massachusetts 01890  
tel. 617-729-1873 after 7 pm

**FOR SALE:** Tubes, good emission. CX12 and WX-12, used - \$25. UX120, used - \$18, N.I.B. - \$26. UV199, used - \$20, N.I.B. - \$28, BBT - \$50. UX199, used - \$16, N.I.B. - \$24. UX200, 200A N.I.B. - \$18. UX201A N.I.B. - \$17.50. UX112A, N.I.B. - \$20. Plus postage. Ed Bell, 5311 Wooddale Rd., Raleigh, NC 27606. Fax/ph: (919) 851-1517

**FOR SALE/TRADE:** Offers? Zenith 6-D-219 black face, very nice - \$150. Crestline, vg in box w/leather case - \$30. Realistic 90LX661 multiband, exc - \$10. Novelities for sale, trades welcomed: "Fred Flintstone" BPL #86, N.I.B. - \$100; "Scooby Doo" BPL #103, good, works but MBC - \$4-\$5; "Mark Twain" Riverboat BPL 41 exc - \$50; Wristwatch BPL #493, exc - \$50. Fada bullet reproduction AM/FM alarm clock, M.I.B. - \$35; Joe Camel Raft radio, full size floating raft with built in radio camel, cigarette promo M.I.B. - \$85, Coke radio with flashing red icon on top w/wood base M.I.B. - \$50; full size Coke cooler B&B PL#215 M.I.B. - \$90, new limited edition "Pepsi cathedral radio" with Pepsi logo embroidered into grille M.I.B. - \$50; Lady Bug radio BPL #199 N.I.B. - \$40; Spirit of St. Louis repro large 1946 Wurlitzer jukebox repro, M.I.B. was - \$85, (1) left - \$45; Mickey Mouse BPL #109 MBC, good - \$15, very rare Marlboro advertising radio, (see picture and description on p. 134, Bunis 3rd ed.); solid-state RCA radio, vg condition, works - \$600 or BO; "Annie and Sandy" BPL #67 very rare, exc - \$45; "Computer Radio" (looks like PC) M.I.B. - \$15; Cadillac "Cad-1" BPL #10 M.I.B. - \$50; Coke mini cooler B&B PL216 M.I.B. - \$40; Sony TR1829 desktop radio, exc - \$30; Kodak instant color film B&B PL#175, rare, good MBC - \$45; baseball, exc - \$15; Barbie in Convertible, AM/FM digital alarm clock, very pretty, coral/blue M.I.B. - \$50; Exxon Uniflo BPL #26, excellent - \$50; (2) '57 Chevy rear end B&B PL #551 pink or black M.I.B., your choice - \$75 ea., Pound puppy BPL #130, excellent - \$10; Tropicana orange M.I.B. - \$15; Havoline oil can B&B PL #30 M.I.B. - \$30; Hamburger Helper radio BPL #284, exc - \$40; Tire B&B PL587 (not working) NIB, exc - \$45; Coor's can BPL #342, exc - \$25; Love Is, for Us BPL #205, rare, exc - \$45; Pet Milk BPL #374 M.I.B. - \$30; Welch's grape juice can BPL #354, exc - \$30; Simplex BPL #2 M.I.B. - \$40. All plus S/H, MC, Visa, Amex accepted by phone, days 10am-6pm EST Free JPEG picture of any radio, available by e-mail, just ask. Dan Phelan, Consolidated Electronics, 2709 Chili Ave., Rochester, NY 14624. (716) 247-2540. Fax: (716) 247-2314. E-mail: dans-world-o-radios@worldnet.att.net

**FOR SALE:** Hallicrafters SX-101A - \$200. **WANTED:** Central Electronics 100-V Robert Braza, N1PRS, 23 Harvard St., Pawtucket, RI 02860. (401) 723-1603

## OLD TIME RADIO BROADCASTS ON CASSETTES

Many of your old time radio favorites are available on quality cassettes at a reasonable cost. You select the shows you want and purchase them by the hour. Fast, friendly service too. Send for our catalog listing over 5,400 shows arranged by show category & title, many including original broadcast dates.

Only \$2.00 (P & H). Send request to:

ERSTWHILE RADIO - P.O. BOX 2284  
PEABODY, MA 01960

# RADIO CRAZE

John Sakas po box 4124 So. Hackensack NJ 07606-4124  
Phone (201)794-0437 ~ Fax 24 Hours (201)794-8359  
visit our web site at <http://www.radiocraze.com>

## WANTED

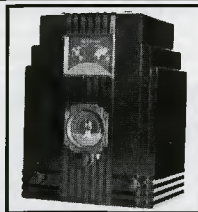

### AIR KING SKYSCRAPERS

paying \$12,500.00+ for near mint condition red or blue  
\$8,000.00+ for green, lavender or yellow  
\$3000.00+ for black and \$2000.00+ for white or brown

I also buy parts sets, they don't have to be MINT  
**ALSO WANTED ANY COLOR-ANY CONDITION**  
COLLECTOR PAYING TOO MUCH, CALL ME LAST

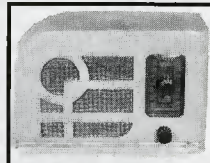

### TOM THUMB RADIOS WANTED

paying \$2500.00+ for any mint one and  
\$6000.00+ for mint cond. red, green, orchid, blue or gray  
**ALSO WANTED ANY COLOR-ANY CONDITION**

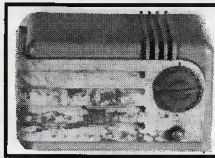

### DETROLA PEE WEE & SUPER PEE WEE WANTED

paying \$600.+ for mint cond. black, white  
\$1000.+ for beetle, gray, salt & pepper  
\$2000.00+ for red, blue \$3000.+ for green or lavender

### WANTED ANY CATALIN RADIO

FADA 115, 116, 200, 1000, all yellow \$575.00, maroon & yellow \$675.00  
yellow & red \$800.00, pea green \$900.00, blue & yellow \$2,000.00  
EMERSON AU 190 & BT 245, yellow \$1,200.00, green \$1,700.00  
dark red \$2,250.00, blue \$4,250.00, bright red \$11,000.00  
FADA L56, P55, 52, 5F50, 5F60, 136, 53X, yellow \$900.00  
light green \$1,350.00 maroon & yellow \$1,500.00, yellow & blue \$1,700.00  
yellow & red \$2,400.00, yellow & bright green \$2,500.00,  
blue & yellow \$5,500.00, emerald green & yellow \$5,750.00  
HALSON any color \$1,500.00 to \$5,000.00  
SPARTON CLOISONNE any color \$2,500.00 to \$5,000.00  
MOTOROLA 50XC green & yellow (UNRESTORED ONLY) \$4,250.00  
EMERSON BM 258 yellow \$750.00, green \$1,350.00  
red \$1,850.00, blue \$3,000.00  
DeWALD A501 (HARP) brown \$300.00, yellow \$400.00, red \$1,000.00  
ARVIN 532 any color combination \$1,350.00, EMERSON 520 \$60.00

always buying any catalin or pre-war colored bakelite radios  
we will buy one piece or entire collection  
watch out there's a new guy in town

## FOR SALE

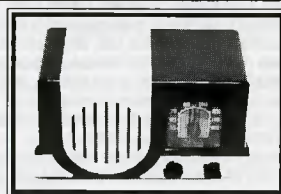

### ADDISON 2

Brown Bakelite / white trim, Untested \$475.00  
Brown Bakelite / Brown trim, Untested \$395.00

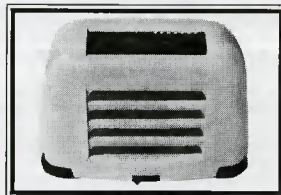

### K.B. TOASTER

White Bakelite, Untested \$225.00

### TUBES---TUBES---TUBES

Bakelite Base used UX-201A \$9.00 each

Bakelite Base used UX-200A \$8.00 each

Bakelite Base used UX-200 \$8.00 each

Brass Base & Tipped used UX-201A \$45.00 each

Brass Base & Tipped used UX-200A \$40.00 each

Brass Base & Tipped used UX-200 \$38.00 each

Bakelite Base used UX-199 \$15.00 each

Bakelite Base used UX-120 \$15.00 each

224A used Globes \$3.00 each

226 used Globes \$5.00 each

227 used Globes \$4.00 each

ALL TUBES ARE TESTED GOOD

I have other tubes not on this list that are for sale

ALL PRICES ARE WITHOUT  
SHIPPING CHARGES



## PUETT ELECTRONICS

PO BOX 28572 DALLAS TX 75228 U.S.A.  
PHONES 214-321-0927 w/ANS. MACHINE  
214-327-8721 WITH FAX

### CATALOG NO. 8

80-PAGES

#### CATALOG \$5.00 POSTPAID

\$5.00 DISCOUNT COUPON WITH CATALOG  
APPLICABLE TO A \$20.00 OR LARGER ORDER

#### WE OFFER - MORE THAN 2,300

DIFFERENT ANTIQUE RADIO BOOKS AND  
PUBLICATIONS FROM 1902 UP, HIGH-QUALITY  
BOUND REPRINTS HISTORICAL BOOKS,  
INSTRUCTION & SERVICE MANUALS, ETC.  
BY NEARLY ANY MANUFACTURER FOR  
RADIOS, TEST EQUIPMENT, COMMUNICATIONS  
RECEIVERS, HAM GEAR, ETC.

WE OFFER TUBES, OLD-TIME RADIO SHOWS  
ON CASSETTES, SCHEMATIC DIAGRAMS, AND  
MUCH MORE!

ORDER YOUR CATALOG TODAY!

#### SUMMER SALE

JULY AUGUST SEPTEMBER 1997  
SCHEDULED TO EXPIRE 30 SEPTEMBER 1997 - BUT  
SUBJECT TO EXPIRATION WITHOUT NOTICE.

### 50% DISCOUNT

ON ALL MERCHANDISE IN CATALOG NO. 8  
WITH EXCEPTION OF TUBES WHICH ARE OUT OF STOCK.

#### HOW IT WORKS

- (1) ADD TOTAL COST OF ORDERED MERCHANDISE.
- (2) DIVIDE BY 2 TO RECEIVE 50% DISCOUNT.
- (3) ADD ONLY ONE \$2.00 HANDLING FEE WITH ORDER.
- (4) USE THE FULL NON-DISCOUNTED TOTAL OF YOUR MERCHANDISE TO DETERMINE YOUR SHIPPING COST FROM THE CHART ON BACK OF ORDER FORM OR FROM THE BACK OF THE CATALOG FRONT COVER.
- (5) TEXAS RESIDENTS ADD 8.25% STATE SALES TAX BY STATE LAW APPLICABLE TO TOTAL OF MERCHANDISE PLUS HANDLING AND SHIPPING COST. YOU PAY NO STATE SALES TAX IF YOU DO NOT LIVE IN TX. NO OTHER DISCOUNTS OR COUPONS WILL BE ACCEPTED IN COMBINATION WITH THIS SPECIAL 50% DISCOUNT SALE.

#### PAYMENT ACCEPTED BY

MASTER CARD/VISA, CHECK OR MONEY ORDER.  
ORDER BY TELEPHONE, FAX, OR MAIL

### SHORT WAVE LISTENERS

BROADCAST BAND LISTENERS

SUBSCRIBE TO

#### ANTIQUE RADIO TOPICS

THE RADIO DX ASSOCIATION BULLETIN

REGULARLY \$10. SUMMER SPECIAL \$7. FOR  
ONE YEAR - SIX ISSUES

YOU RECEIVE REPORTS ON STATIONS WHICH HAVE  
BEEN HEARD, LISTS OF SOURCES FOR SWL/BCL  
RECEIVERS, EQUIPMENT AND BOOKS,  
TESTS ON VARIOUS RECEIVERS. AND MUCH MORE!

SUBSCRIBE TODAY!

### THE PUETT ELECTRONICS ANTIQUERADIO CLUB

WE OFFER 20 DIFFERENT SERVICES AND  
DISCOUNTS, THE NEW ACQUISITIONS LIST TO  
MEMBERS IN WHICH WE OFFER RADIOS, TEST  
EQUIPMENT, BOOKS, RARE TUBES ETC.

REGULAR MEMBERSHIP - \$15. SUMMER SPECIAL \$7.

**FOR SALE:** Two Acme A-2 audios, good - \$15 ea. Four 01-A tube sockets, Bakelite - \$3 ea. Two honeycomb coils, one w/tickler - \$10. Two Gracato tuners w/BMS metal dials w/verniers - \$10 ea. Classic Radio & Television, 541 Riverside Dr., Box 61 Augusta, ME 04330. (207) 623-2059

**FOR SALE:** Regulated 5-volt power supply rated at 3 amps and OVP set at 6 volts - \$25, plus UPS. Jim Sinwell, 511 Newport Dr., Greensburg, PA 15601 (412) 834-0763

**FOR SALE:** Zenith 8S586 chassis with tubes - \$35. Crosley 646 chassis with speaker and battery eliminator - \$55. Plus UPS. M.B. Gaskins, WB4MNZ, 227 Risen Ave., Campbellsville, KY 42718. (502) 465-3755

**FOR SALE:** Vintage radio, tube audio, ham, CB. Send SASE for photo catalog of over (120) items. Vintage Electronics, PO Box 436, Fallston, MD 21047

**FOR SALE/TRADE:** Rek-O-Kut, Garrard, Miracord, Collaro, Cobra (double), Fairchild, Gray, Grado.

**WANTED:** Arborphones, Internationals, Kadettes. Nevins Museum of Radio, Ken Nevins, 406 Jipson St., Blissfield, MI 49228. (517) 486-3019, evenings please

**FOR SALE:** Marantz 8, nice - \$1,250. Mac MC240, mint - \$1,700. Jensen GP805 cabinet (1940s) with XP101 horn and M1285 Concert Vibrato 18" woofer - \$1,000. E.H. Scott Phantom Deluxe BFM 5-band with 3 Scott speakers, nice chrome, no cabinet - BO. Fluke 301C regulated high voltage power supply, supplies any voltage up to 1011Vdc at 500mA. This will power any stereo 845 or 211 triode amp; or pair of Mac M1200 tons of .0047UF at 8KVdc caps - \$150 per hundred ship. Paid. Garard 301 - \$500. Vitavox horn and 12" woofer - BO. Craftsman C500 class A triode connected, chrome amps - \$750/pr. Weeco 124 amp, no tubes - \$1,000. Many HP GR, Textronix cats. - \$25 ea. Ship paid. Send me your wants on these. Gates Sta-level, Altec 436A, 438C tube compressor-limiters - BO. McIntosh quack medical high frequency apparatus, contains Tesla and Oudin coils and sparkgap Model 8085 - BO. Fluke 97 scopemeter - \$1,000. British Hartley 10" fullrange in original cabinets, Mod 220MSG - BO. E.S. Greeley straight key and sounder, dated Dec. 26, 1882 - BO. Mac M1200 - \$2,000. Altec condenser power supplies 526, 527 - \$200 ea. Hickcock 600A, 6000A tube tester - \$125, \$150. Weeco KS16607LI amps - \$600 pr. Data Precision-Analogic data 6000 digital, computerized signal analyzer for audio, RF - \$3,500. Radiomasters catalogs - \$25 ea. New solder mount 820UF 450Vdc caps - \$7.50 ea. Sound Technology 1500A taperecorder calibrator - \$1,500. Sonoradio-RCA 1926 radio with UV199 tubes and mechanical windup phonograph in a console - BO. Urei 521 electronic crossover, many big JBL 2" compression drivers, same as 375 but plastic diaphragm good, up to 5kHz - \$500 pr. Bruel & Kjaer 2801 condenser power supplies - \$200. Many black anodized aluminum rackmount faceplates, new - \$5-\$10. Pair original JBL (1960s) boxes with D130, 075 - \$1,250/pr. (18) pcs. modulation transformers - \$400. Sansui 1000A output trans, the best for low power, single-ended amps - \$200/pr. Taking best written offers on UTC, Acrosound, Dynaco, Weeco, Peerless transformers. Don't call on lowbuck items. Write. Don't call and only leave your number; leave a detailed, complete message. Vernon Vogt, 330 S.W. 43rd St. #247 Renton, WA 98055. (206) 382-5571

**WANTED:** Bendix radios, ads, signs, etc. Radios need not work. Aaron Mall, 903 Dropleaf Ct., Baltimore, MD 21208. (410) 486-8813

**WANTED:** Collections, bulk and estate sales of radios, tubes, literature, advertising, etc. John & Kathy Slusser, Radio Daze, PO Box 144, Mendon, NY 14506. (716) 624-9755. Fax: (716) 624-7857. E-mail: info@radiodaze.com

**WANTED:** Mitchell, Mitchell, Mitchell radios and appliances. Many models still needed. Thanks! Appreciatively. Lee Mitchell, The Mitchell Collector, 175 E. Delaware, 8209, Chicago, IL 60611 (800) 869-7869 or (312) 337-3123

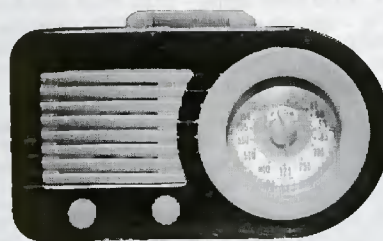

**WANTED:** Fada Catalins. I like 'em perfect or in pieces - whatever you have to offer. Don't humiliate yourself by letting some other "big shot" collector take advantage of you. Go ahead and use me. Uh oh! Please write or call collect: Rain Buttignol, 214 State St., #7 Portsmouth, NH 03801 (603) 427-1384

**WANTED:** Speaker and chassis for Crosley Buddy Boy Model 58. Dick Grogg, 206 N. Walnut, Newton, IL 62448. (618) 783-3514

**WANTED:** Always looking for Espey table radios, advertising, literature. Also, cold war era stuff, CD posters, helmets, early A-bomb photos and press. Vintage microphones, RCA 77A, 4AP box camera, other film and broadcast mics, tube audio equipment, mic preamps, compressors, audio amps, buy or trade. We also have several Webcor wire recorders from restored to parts, for sale or trade. Ward Kremer, 5807 Papaya Dr., Ft. Pierce, FL 34982. Ph/fax: (561) 468-7732. E-mail: WKremer798@aol.com

**WANTED:** 1920s or 30s massive, huge, tall, any style floor model console radios. Or with phonograph combination. The bigger the better! Will pick up anywhere. Pay your price. Keith Cenedella, PO Box 6763, Thousand Oaks, CA 91359-6763. (805) 492-7111

### TUBES BOUGHT & SOLD

Industrial • Power • Receiving  
Special Purpose • CRT's

— Vast Inventory —

Contact: Donna - Sales Mgr.  
(201) 751-2591 / (800) 526-1275  
Fax → (201) 481-1524

United Electronics Co. Est. 1935  
Tube Manufacturing Equipment For Sale  
Assorted Tube Bases For Sale

**WANTED:** Philco help, need working chassis and speaker for Philco Model 37-620 round dial Cathedral. Many thanks. Loren H. Dudley, 14 Valley Rd., Bath, ME 04530-2811 (207) 442-8419

**WANTED:** Zenith chairside '38 (or '39), 7 or more tubes, working, cabinet, etc. in fair to good condition. For Philco 37-166-122, set of station call letters and very good cabinet. Dick Friedman, 1502 Elmwood, Wilmette, IL 60091 (847) 803-3050

**WANTED:** Static electricity rotating disk machines, Wimshurst or Holtz machine, Crooke's or Geissler tubes. Louie Scribner, 510 Linden Rd., Pinehurst, NC 28374. (910) 295-8050. E-mail: louie@pinehurst.net

**WANTED:** Knight DX-er. Dick Lowe, PO Box 296, Santa Clara, CA 95052-0296. (408) 984-1555

**WANTED:** McElroy Mac Keys, key boxes, oscillators, catalogs, correspondence. Tom French, W11MQ, "The McElroy Collector" 151 Barton Rd., Stow, MA 01775. (508) 562-5573

**WANTED:** Fairbanks Morse console, Model 9C or 12B preferred. Charles E. Patterson, 2621 Sweetwater Rd., SP#33, National City, CA 91950. (619) 475-7141

**WANTED:** Cassette tapes of "The Big Broadcast" radio show with Rich Conaty from 1560 WQEW, N.Y.C. Also copies of his new show on 90.7 in N.Y.C. Evan J. Chase, 108 Cass St., Swanton, OH 43558. (419) 826-3776

**WANTED:** Miniature tube plastic portable radios. Attractive specimens purchased, even those with damage. Also collecting transistor phonographs and attractive hearing aids. Mike Brooks, 7335 Skyline, Oakland, CA 94611. (510) 339-1751

**WANTED:** AK 9-posts or AK 9A-cable types factory original with tags. Paying \$1,400 if nice. David Habermehl, 516 W. Randle, Lebanon, IL 62254. (618) 537-6785, eves.

## • WANTED • EARLY PLASTICS

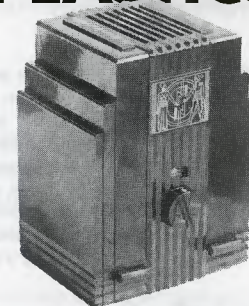

Top prices paid for prewar plastic radios  
by Air King, Kadette, Detrola, RCA, etc.

### RADIOART

Jim Meehan  
P.O. Box 102 • Centerbrook, CT 06409  
(860) 526-1762





Harold N Cones, Ph.D.  
and  
John H Bryant, FAIA  
with Martin Blankinship & William Wade

The authors of "The Zenith Trans-Oceanic: The Royalty of Radios" are pleased to present their new book, "Zenith Radio, The Early Years: 1919-1935." This first of a planned three-book series tells for the first time the *fully documented* story of Zenith radio and company development, and presents a wealth of never before published photographs, documents and information. Highlighting the book are 110 black and white photographs, 68 other illustrations and 120 color portrait photographs of many of the rarest and most beautiful Zenith radios of the era. Complimenting the Zenith story is an Illustrated Catalog with images of nearly every Chicago Radio Laboratory and Zenith radio model produced between 1919 and 1935. The Catalog is followed by a Database with valuable—and some unique—information covering every radio produced by the company during this period.

This Schiffer Publishing, Ltd. 224 page, highly illustrated, landscape formatted, book is available for \$29.95 + \$2 S&H (\$3 Canada) from:

**The Radio Professors**  
P.O. Box 592  
Stillwater, OK 74076

Your purchase direct from the authors supports further research on Zenith plus provides you an autographed and numbered copy of this important new book. You will also receive a catalog of Zenith authorized memorabilia available for purchase and your name will be added to our mailing list for early notification when new books in this series are available.



**FOR SALE:** (40) magazines of Radio and TV News of 1950s + (8) of Radio Electronics of 1950s - \$2 ea. + S/H. Carlos Gimenez, 15091 Shamrock Dr., Fort Myers, FL 33912. (941) 482-0198

**FOR SALE:** Original owners manuals for Crosley Model 26, Majestic 91 and 92, Philco 19 Series. Test equipment manuals: RCA Senior Voltohmyst, RCA Scope WO91 and B&K Scope 1461 - \$15 ea. plus \$3 postage. Maurer Television, 29 S. 4th St., Lebanon, PA 17042. (717) 272-2481

**FOR SALE:** EICO tube tester 667 - \$55. Hallicrafters TW2000 brown leatherette - \$150. TW500 green leatherette - \$125. RCA 3BX671 brown leather - \$150. RCA 7BX10 brown leather - \$125. Royal 3000-2 w/o top lid - \$80. All plus ship. **WANTED:** Hallicrafters: TW1200, Phillips multiband, and military T-O R-520/URR. Denis Burke, 308 Person St., Rannels, IA 50237 (515) 966-2871 E-mail: zeenith@msn.com

**FOR SALE:** Capacitors: Twislok, coupling, bypass, high voltage, mica, and military. (16) pages free for - 55¢ + SASE. Chuck Vaccaro, 708 Booth Ln. #S, Ambler PA 19002. (215) 646-3641

**FOR SALE:** Bowman car radio CB, AM/FM, all in one - \$45. WE candlestick phone. Norman Landis, 1315 Marbendale Ct., Kirkwood, MO 63122-6932. (314) 821-7933

**FOR SALE/TRADE:** Will sell or trade 20s vintage battery sets. **WANTED:** Catalin clocks and radios in any condition. Jim Leckrone, 12174 Lynn St., Bear Lake, MI 49614. (616) 864-3365

**FOR SALE:** Used Scotch recording tape, (9) 3600 ft. 10 1/2 aluminum reels - \$27 plus UPS. Louis J. Philipp, 502 Greenwich Ave., Paulsboro, NJ 08066. (609) 423-4306

**FOR SALE:** Crosley 1929 Jewel Box parts radio, complete, NT - \$50 plus postage. David Buck, 3630 Wilcox St., San Diego, CA 92106. (619) 224-5821 E-Mail: whnf46a@prodigy.com

**FOR SALE:** Rider's Volumes 7-14 - \$20 ea. or all for - \$120 plus shipping. Larry Dowell, 8490 Hurdle Mills Road, Hurdle Mills, NC 27541 (910) 364-2756

**FOR SALE:** Early RCA 44 mic with stand - \$1,300. 77DX with plain stand - \$1 100. Mike Dupuis, 116 First Ave., Tuckerton, NJ 08087 (609) 296-4883

**FOR SALE:** Two plastic radios, no cracks, all knobs. RCA black & white Model 4RA41 - \$10. Silvertone brown Model 25 - \$12. Zorro wristwatch 1950s, running with leather band - \$60. All items plus UPS. Phone or write: Thomas Burnside, 4838 S. Westhaven Dr., Jackson, MS 39209. (601) 922-2235

**FOR SALE:** Sams Servicing Transistor Radios Volumes 10 to 22. (643) models, pictures and service data and TSMs 24-26, 41-50, 59-69. (24) books. Both BO + ship. R.F. Haworth, 112 Tilford Rd., Somerdale, NJ 08083. (609) 783-4175

**FOR SALE:** British and Japanese valve and transistor sets. Enrico Tedeschi, 54 Easthill Dr., Brighton BN41 2FD, United Kingdom. E-mail: www.brighton-uk.com

**FOR SALE:** Two sets Riders manuals, 1-16 - \$150, 1-21 - \$350. Pick up only. Willie Carr, N4XE, 2739 Colonial Ave., Roanoke, VA 24015-3835. (540) 343-5606

## The Radio Collector's Directory and Price Guide, 1921-1965, 2nd Ed.

by Robert E. Grinder

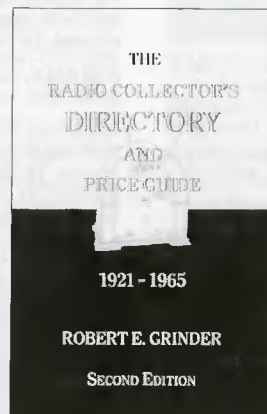

### 20,000+ Models Listed

U.S. models manufactured from 1921-1965.

Listing includes:

*Model Name,  
Year of Production,  
Type of Power,  
Cabinet Style, and  
Current Market Value Range.*

Rewritten Chapters On:

*Early Broadcasting,  
Radio Broadcasting Regulation,  
Advances Made in Receivers,  
The Evolution of Radio Cabinet Styles.*

**\$26.95 - Softcover**

U.S. Orders Enclose \$3.00 per order for packing & book-rate shipping if total order is under \$35.00. If using VISA or MasterCard, include name on card, card number and expiration date. Send payment with order. Mass. residents add 5% sales tax. Money back return policy. Softcover unless stated otherwise. Most orders shipped the same day received, but allow 2-4 weeks to receive order. Foreign orders - write for shipping costs, or use credit card and specify air or surface (allow 2-3 months for surface shipping).



A.R.C., P.O. Box 2, Carlisle, MA 01741 Tel: (508) 371-0512

Fax: (508) 371-7129

Web: <http://www.antiqueradio.com/>



(Oct-96)



**FOR SALE:** Ampex AG-350 full track R/R solid-state amplifier - \$375. Ampex 600 portable R/R - \$150, w/ manuals. Danny Brou, 212 Wainwright Rd., Pineville, LA 71360. (318) 445-4843

**FOR SALE:** GE's table radios - \$30 ea. Models: 50, 517, 114, 200, 480. Dave Pewowaruk, 931 23rd St. SE, Rochester MN 55904. (507) 280-5975. E-mail: hp95@aol.com

**FOR SALE:** 55¢ LSASE for list of new/used receiving/transmitting tubes. Sell or trade for old or unusual tubes or related material for my collection. John H. Walker, Jr., 16112 W. 125th St., Olathe, KS 66062. (913) 782-6455. E-mail: johnh.walker@alliedsignal.com

**FOR SALE:** N.I.B. tubes (4) 816 Marconi - \$14, (1) 2050 - \$10, (1) 2051 - \$5, (3) 884 - \$4, (1) 7360 RCA - \$25, (1) 7377 Amperex - \$35, (70) 1µF 1000Vdc Vit Q - \$3.25 ea. Plus \$3. shipping. Dana Parsons, PO Box 55426 Bridgeport, CT 06610-5426. (203) 333-0659

**FOR SALE:** Freshman Masterpiece console 6F3 or 47 cabinet water damage - \$90. Philco 18 cathedral - \$225. Transistors, Zenith Royal 800, black - \$175. Airline Gem 1245A - \$10. Portables, Zenith 6G001Y - \$20. Jewell 801 Trixie, cracked face plate - \$30. Silvertone 225 - \$15. RCA 9Y510, 45 player - \$50. Garrard RC88/4 - \$45. Olympic Bakelite LP213 - \$55. Puritan 506, cabinet needs help - \$35. 1955 Ford auto radio, solid-state, vibrator - \$75. Pair EE8 field phones, original manual and mint wire reel - \$100. Guy Forstrom, PO Box 159, Quinnesec, MI 49876. (906) 774-8116

**FOR SALE:** Industrial Instruments DK-10 Capacitance Decade box, 3-dial, oak case, .0001-.111 µf - \$32 + UPS. Alan J. Kriss, 1872 Portsmouth Way, Union, NJ 07083. (908) 688-2092

**FOR SALE:** New copy of Radios Redux by Collins (\$17.95 list) - \$12. J. Finkelstein, 205 Alapocas Dr., Wilmington, DE 19803

**FOR SALE:** Heath CR-1 headphones, manual - \$100. Zenith 4V32, restored, perfect - \$150. Zenith speaker #49-312, excellent - \$45. Grommes Little Jewel LJ-5, excellent - \$100. Tektronix Waveform monitor Model 528, excellent - \$150. RCA jumbo tube sockets Model UT-541 green porcelain - \$15 ea. George M. Bonanno, K2XL, 34 Charles St., Clifton, NJ 07013. (201) 746-5953. E-mail: K2xl@webtv.net

**FOR SALE:** GE P911AA transistor untested, fine cosmetically - \$50; Superior TV 11 tube tester working - \$75; SASE for photos of above and list of (15) radios and radio ads. Gasper Gilardi, 181 Berkeley Ave., Harahan, LA 70123. (504) 738-1415

**FOR SALE:** Marine S-S HF Rigs, radio record players. SASE. H.N. Felder, 7517 Granada Dr., Bethesda, MD 20817

**FOR SALE:** Hallicrafters: SX101 SX16, SX14, SX42 + speaker, S.38.B.C.D., SX71 + speaker SX110 + speaker SX130 + speaker, S120, SX99, WR4000, WR1000. National: SP600, NC240D + speaker NC183 + speaker, HQ129X, HQ140 + speaker, NC46 + speaker, WRR2, R390A. (6) off, restored + meters & covers. Phillips B4X23A, Saaba Villingen 2, Kortwa Billy, Bernou Naven (Berlin) #1, Grundig 1042, Allied SX190, Knight R100, R55, StarRoamer, Howard 437, Howard Deco 225, Corona Model 209? Deco, E.H. Scott SLRM. National HRO Sr. + coils & CN, xmtr + power supply. Lots of Trans-Oceanics, no junk or parts. Philco 960 mahogany & leather, a collection of CW buttons, paddles, bugs & repeaters & some microphones, and much more. Alan Carpenter, 524 Ponderosa Dr., Estes Park, CO 80517 (970) 577-0677

**FOR SALE:** Over (400) books and catalogs on radio, wireless, telegraphy, television, electricity, etc. Roger Hart, Old Authors, Gibson Ln., Box 403, Morrisburg, Ontario, Canada K0C 1X0. (613) 543-3337 Internet: <http://www.abebooks.com/home/oldauthors>

**WANTED:** Hallicrafters Models S/SX 4, 5, 6, 9 or 10. Grebe synchrophase Models 5, 6, or 7 Crosley small cathedral, Models 125-A, 131 or 125. All should be in nice/vg condition. Bob Allington, Isco, Inc., 4700 Superior St., Lincoln, NE 68504. (402) 464-0231 days. Fax: (402) 464-4543. E-mail: boba@isco.com

**WANTED:** Deco radios: Catalins, Fada, Emerson, Detrola, Kadette, Garod, Motorola, Tom Thumb, Air King, Ross Litrenta, PO Box 41 Eastchester NY 10709-0041. Tel/Fax: (914) 337-7176

**WANTED:** Crystal sets, crystal detectors or crystal set literature - top dollar paid. Hal Kravig, 2615 Juneway Dr., Memphis, TN 38134. (901) 388-2857 Fax: (901) 388-5102

**WANTED:** 1951 RCA Model A-101 in mahogany finish. Thank you. Mark Minks, Mid-America Antique Radio Store, 233 S. Tulane, Liberal, KS 67901

**WANTED:** Crosley center bullseye radio in clean original condition. Bill Jewell, 3800 Ridgeway Rd., Fort Worth, TX 76116. (817) 377-4664. E-mail: oldradios@aol.com

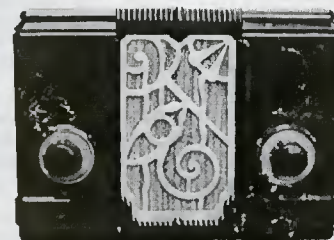

**WANTED:** Kadette pictured, Detrola, RCA, Air King, etc. prewar plastics. I am new to the field of collecting but have plenty of money to live with big mistakes. Please write or call collect: Rain Buttignol, 214 State St., #7 Portsmouth, NH 03801 (603) 427-1384

**WANTED:** Small size QST binder R.J. Eastwick, N2AWC, 224 Chestnut St., Haddonfield, NJ 08033. (609) 429-2477

**WANTED:** H-65/m headphones or equivalent with 4K impedance and pin terminations. Harold S. Meltzer 592 Loma Verde Ave., Palo Alto, CA 94306. (415) 493-1016. E-mail: techni@netcom.com

**WANTED:** Push-pull knobs for Zenithite 9S369, 1 1/4" long with hook on end. Also need iron-shaped icons for tone pad. Louis deGonzague, 15 Gail Ln., Latham, NY 12110. E-mail: Zenithite@aol.com

**WANTED:** Fisher 500C in any condition, must have 7591 tubes, on/off volume control. Rich Blanchard, 2621 Alta Vista, Newport Beach, CA 92660

**WANTED:** Lionel J-36 identification plate from parts unit, or loaner for reproduction. Thank you! Robert Baumann, 1985 S. Cape Way, Lakewood, CO 80227 (303) 988-2089

**WANTED:** Vibroplex Zephyr, McElroy bug, Early Collins Radio equipment, memorabilia, promotional items, signal magazines. Brian Roberts, K9VKY 130 Tara Dr., Fombell, PA 16123. (412) 758-2688

**WANTED:** Speaker for a Philco 90 cathedral. Edgar McBee, 114 S. Ashley Park, Wichita, KS 67209. (316) 721-3021

**WANTED:** Rider's Volume XX; Radio Manufacturer's of the 1920s, Volume 3; Wilcox-Gay information of any kind; factory service manual, catalogues, misc. Book: The Boy Electrician. **FOR SALE:** Sams sets, most from 200s-500s - \$5 ea. set, includes postage. Doug Hershberger, 12 Lockport Ave., North Tonawanda, NY 14120. (716) 692-7836

**WANTED:** Victor Hyperion radio/phono. Also other Victor Electrola's Models 9-25, 8-60, 10-51, 10-70, Tuscany and others! Have some radio trades. Jeff Lendaro, 1107 Logan St., Noblesville, IN 46060-2346. (317) 773-3969. E-mail: lendaroj@indy.tce.com

**WANTED:** Windup horn phonographs, related items, parts. Picture records. Berliner, Johnson 78 rpm discs. James J. McGrath, W2IOJ, 2 Centerview Ln., West Seneca, NY 14224-2124

**WANTED:** Working driver for a Rola horn speaker. E.J. Reed, PO Box 427 Union, OR 97883. (541) 562-5967 E-mail: Skinner@ucinet.com

**WANTED:** Philco 70 cabinet w/original finish. Michael Harrington, PO Box 250995, Little Rock, AR 72225

**WANTED:** Sentinel 400 television, complete, unrestored; knobs and plastic CRT front for Predicta H3408C. Frank Johnson, 530 Elford Rd., Fairless Hills, PA 19030. (215) 943-8295

**WANTED:** JBL 2231A 15" woofer Will buy 1 or pair, dead or alive. Russell Hulme, 8504 Soneto Ln., Las Vegas, NV 89117 (702) 233-1379. Fax: (702) 242-3857

**WANTED:** Good pictures inside IP501A audio portion, measurements, parts info, any help appreciated. Marc Gottlieb, Box 1112, South San Francisco, CA 94083-1112

**WANTED:** 1950's, 1960's blonde TV sets. Keith Domijan, 8040 Dale, Center Line, MI 48015. (810) 781-2628, days; Fax: (810) 781-3912, 24 hrs.

**WANTED:** Catalin radios, don't have to be perfect, just presentable. Don Moody, 1600-M Glenwood Ave., Raleigh, NC 27608. (919) 821-3530. E-mail: Don21480@aol.com

**WANTED:** Emerson dealer displays, clocks, lights, signs. Top prices paid. Carl R. Shirley, 824 Fairwood Dr., Columbia, SC 29209. (803) 776-6850. E-mail: shirleyc@garnet.cla.sc.edu

**WANTED:** Amrad 3366 Reflex (see p. 11 Aug. '97 A.R.C.). Also Connecticut J113 rheostat. J.C. Woychowski, 81 Penn. Ave., Niantic, CT 06357 (860) 739-6579

## FREE

Booth Set-up In Our On-line Collectibles Mall

## TECH-COLLECTIBLES ON-LINE

<http://www.octonet.com/~brianh/techcoll>

Your custom booth will have full graphics and text advertising your collectible items.

Low Monthly Update fees from \$20-

Contact us at (250)595-2829

E-mail: Brianh@octonet.com

## TUBES • PARTS • SUPPLIES YOUR COMPLETE SOURCE FOR...

### TUBES:

Over 3500 receiving, transmitting, audio and industrial types in stock, including many foreign and early types.

### TRANSFORMERS:

Hard to find power, filament and output transformers as well as filter chokes for tube equipment. We feature HAMMOND performance transformers as well as many new old stock transformers.

### CAPACITORS:

High voltage electrolytic and mylar capacitors, multi-section capacitors and more for tube circuits.

### PARTS:

Resistors, tube sockets, potentiometers, knobs, dial belt lamps, diodes, speakers, wire, phonograph needles and cartridges and much more.

### LITERATURE:

Extensive selection of literature and books on antique radios, tubes, circuits diagrams, communication gear and hi-fi equipment. Some items not available elsewhere!

### SUPPLIES:

Grill cloth, cabinet restoration supplies, batteries, chemicals, tools, test meters, gifts and kits.

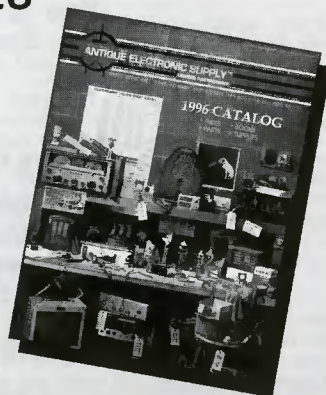

CALL OR FAX FOR OUR NEW 40 PAGE CATALOG!

ANTIQUE ELECTRONIC SUPPLY™

LIMITED PARTNERSHIP

6221 S. MAPLE AVE. • TEMPE, AZ 85283 • (602) 820-5411 • FAX (602) 820-4843 or (800) 706-6789



**FOR SALE:** Crystal sets: Automotive Specialty Co. - \$150; Philmore Selective - \$165; Western Tinytone toy - \$145. Dick Kowalski, KB8MR, 32823 Gloede Dr., Warren, MI 48093. (810) 294-4117

**FOR SALE:** Philco 116 15-tube deluxe mint - \$600. Zenith 9S367 mint - \$575. Zenith 7S633, excellent - \$225. Gerry Harmon, 10704 Callanish, Austin, TX 78750. (512) 219-0499

**FOR SALE:** RCA cathedral - \$195. Airline metal set - \$55. Zenith 555 Suncharger, brand new - \$150. Tube stereo gear by Scott and H-K. Restored floor model Predicta. I need a chassis for any Air King tombstone, from Model 66, 100 or 120. Got one? I'll buy or trade for it. Brad Jones, 4801 Crofton Springs Ct., Greensboro, NC 27407 (910) 547-1919

**FOR SALE:** Fada 652 Temple butterscotch Catalin - \$600. Fada 652 Temple butterscotch Catalin, new, case only - \$400. Fada 740, ivory - \$100. Atwater Kent 82 cathedral - \$450. AK 725 tombstone - \$160. GE S-22 Junior tombstone - \$225. GE J-83 tombstone - \$225. Gulbransen 130 cathedral - \$325. Kadette 41 Jewell - \$195. Philco 90 cathedral - \$400. Philco 66 tombstone, clean - \$120. RCA Radiola 60 - \$150. RCA R-7 tombstone - \$150. Zenith LH Zenette cathedral - \$300. J. Gary Cameron, 824 Andrews St., Southington, CT 06489. (860) 276-9200

**FOR SALE:** Great new book on the Zenith Royal 500 Owl Eyes radios. Lots of pictures and charts. For your copy, send - \$10 to: Eldon A. Horton, 8187 LaHabra Ln., Indianapolis, IN 46236. (317) 823-6374. E-mail: radio@innetdirect.net

**FOR SALE:** Tubes, 12AH7, 12BQ6, 1632, 1291, 25AV5, 233A, 6ST7, 6SD7, 4523, 6BJ6, 5963, 5915, 9006, 636, 1P5G, 1D7G, 1P5G, 1Q5G, 1F6, 1A4, 1LC5, 3LF4 - \$1 ea. (25+) free ship. Kelly Nichols, RD1, Box 103K, Greenwood, DE 19950. Ph/fax: (302) 349-5059

## OLD RADIOS TALK AGAIN! AM100 LINK TRANSMITTER

A Broadcast Quality Transmitter  
For The Antique Radio Enthusiast

Entertain your friends with authentic,  
"on the air" radio demonstrations!

### Features:

- Selectable Flat/Phonograph Inputs
- High Fidelity, 100% Modulation
- Peak Modulation Limiter
- 800 KHz Ceramic Oscillator
- Antenna Matching Network
- Compact, Solid State Construction
- Rugged FET Linear Amplifier

Call or write today for technical  
and delivery information.

Tusa Consulting Services Phone: (504) 892-7348  
19 Augusta Dr. Fax: (504) 892-2075  
Covington, LA 70435

**FOR SALE:** Used tubes: 83 Radiatron, CX-310 Cunningham, 807 Ampere, appear new. (2) Radiatron, Norelco, 5692 red, RCA, all - \$100 plus UPS \$10? Hank Andreoni, c/o 250-D So. Lyon Ave., Hemet, CA 92543

**FOR SALE:** Microphones: Realistic Highball #33-985 - \$12, Astatic D104 with G-stand - \$35 plus UPS. Ed Povraznik, 9606 Biddulph Rd., Brooklyn, OH 44144. (216) 661-0032

**FOR SALE:** Microphones; RCA 77DX - \$1,200. 2-Astatic D104 - \$80 ea. Shure 315 ribbon - \$300. Shure 708A ribbon - \$250. EV 638 - \$80. EV 726 - \$150. Shure 520 crystal - \$80. Amplifiers; Bogen M0100 watt 6550 tubes - \$150. Rauland Borg 40 watt - \$100. Mark Schackow, 307 4th Ave. E, Lemmon, SD 57638. (605) 374-3424

**FOR SALE:** Western Electric plus others. Sockets: 100A, 100L, 100M, 100N with resistor mounting, 112A, very large 119A and a similar marked D-76671 Following similar but not marked with Western Electric name: 100R, 125A, 131A, 134A. A Federal #14. Transformers: Kellogg audio code 507, also audio insulating, both have had secondary. WE 234C input, 1 side no continuity, WE Radio Co. good, WE 127D, appears new, unused - Best Offer one or all. Michael Crain, 3 Hillside Ave., Harveys Lake, PA 18618-9782. (717) 639-2794. E-mail: mcrain1952@aol.com

**FOR SALE:** Zenith 8H034. **WANTED:** Correspondence with Grunow 1101 remote control set owner, Motorola S-10. Curt Schreiber, 3923 E. Latoka St., Springfield, MO 65809. (417) 887-5184, collect. E-mail: Curradio@aol.com

**FOR SALE:** Old Timer by Guild, mantle clock radio, vg - \$125. French phone tube radio, wood, vg - \$55. Plus shipping. SASE - list of novelties. Dan Sipola, 2840 Copeland Rd., Maple Plain, MN 55359. (612) 972-8214. E-mail: philco90@minn.net

## Vintage Mics, Tube Gear & More!

Check Out The Recording  
Industry's Best Kept Secret!

*Pro-Audio Marketplace* is the only nationwide classifieds publication dedicated to recording gear sold by individuals, project & major studios, etc. Over 1500 pieces of gear per issue! \$25 subscription includes 12 issues and 1 **FREE ad per issue.**

Never seen one?  
**Call now for a FREE copy!**  
**1-800-469-0023**  
www.proaudiomarketplace.com

**Pro-Audio  
Marketplace**



# Radio Restoration Parts

## Vacuum Tube Repair Wafers

These tube repair wafers are solid-state devices for quick and easy repair of early vacuum tubes. The wafer is installed by simply sliding it over the tube pins and reinserting the tube into its socket. If the filament is intact, but there is little or no emission, the filament may be lit for best visual effect. However, the tube can be open filament.

No change in radio operating voltages is required. Any number of tubes may be repaired in a radio. If wafers are installed on all tubes, the B+ voltage may usually be reduced without sacrificing volume or sensitivity. Performance will vary between radio models.

\$10.00/each (\$7.50/ea. 3 or more)

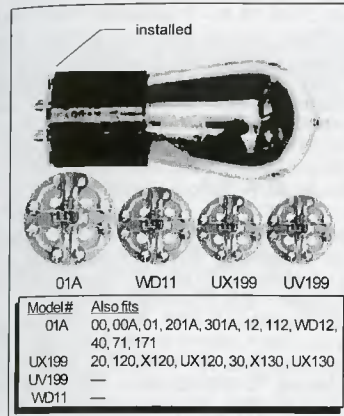

## New Atwater Kent Breadboard Switch

Exact replacement for Models.

9 • 9C • 10 • 10A • 10B • 10C • 12

and all additional models with board mounted switch.

Newly manufactured under high pressure heat from the same type brown thermoset resin used in the original. Beryllium copper spring contacts are used for long, trouble-free life. Custom built knurl is used to exactly reproduce the original.

\$50.00/each

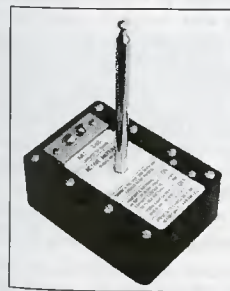

## Active Antenna

Allows antique radios which were designed for a long wire outdoor antenna to operate on a 42" indoor whip antenna. Portable, operates from a 9 volt battery

Only \$34.95

Order from: PTI, 7925 Mabelvale Cutoff, Mabelvale, AR 72103

Orders shipped UPS, prepaid in continental U.S. Please allow 3 weeks for delivery. Arkansas residents add 5.5% sales tax.

To Order: Call (501) 568-1995





# of the Audio Recorder

The "Vintage" Years: late '40s - early '70s



Theory • History • Restoration • Identification • Prices

by Phil Van Praag

- \* the definitive wire & tape recorder guide
- \* over 500 pages, with over 500 illustrations
- \* over 125 brands, hundreds of models
- \* over 250 color photos
- \* simplified theory of magnetic recording
- \* history & evolution traced: '40s - early '70s
- \* service & restoration tips
- \* coverage of special purpose recorders
- \* identification & price guide
- \* first 500 receive numbered, limited edition signed by author

For a limited time: **\$34.95** (\$39.95 cover price)

Please add \$3.00 pack / ship, except Canada \$7.00  
WI residents add 5% sales tax.

**The only book  
of its kind!**

Send check or money order to:

**EC Designs, Inc., P.O. Box 33,  
Genesee Depot, WI 53127**

**FOR SALE:** Working wood radio. Fada 192A WT - \$100; Airline 62-425 - \$90; Delco R-1157 - \$35; Philco PT-3 - \$25; Wilcox-Gay Model? looks like Model 7A5 but only BC - \$35. All plus shipping. Bill Lindley, 4265 Pont Dr., Bridgeton, MO 63044. (314) 739-0722

**FOR SALE:** Philco cathedrals, Mod 80, 84 - \$100 ea. Mod 44, 60, 37-89, 50, 89 - \$135 ea. Mod 19, 91 - \$250 ea. Other Philcos, Mod 42-350 - \$85; Mod 54 - \$105. General Electric tombstones E-81 A-82, FE-82, M-61 - \$195 ea. A-63 - \$150; A-52, M-52 - \$125. RCA Mod 143 - \$275. Majestic Mod 20 - \$125. Floor models: can be delivered to Rochester. Atwater Kent: Mod 52, 53, 55, 60, 66, 89, 89 w/phono, 96, 99, 112, 188, 310, 310 w/doors, 328, 376, 435, 456, 469, 480, 510, 612, 976, keil table w/model 60, P w/phono. Philcos: 20, 71 90 w/doors, 212, 40-190. RCAs: 62, 80, 82, 240, 280, GE H-51 Majestic 50 on thin legs, GM radio/phono w/Queen Anne legs. Transistors: Hitachi: WH-829 - \$40. WH-817 - \$50. Toshiba: 7TP30 w/metal box - \$45, 6P-15 - \$40. 6TP-314A - \$95. 9TL-365S - \$55. Sony TFM-825L - \$25. Panasonic R-1000 - \$50. Channel Master, following are nice in original boxes: 6514, red - \$50; 6501, red - \$50; 6503, red - \$40; 6516, black - \$30; 6506A (chipped) - \$10; 6515, black - \$30; 6515, red - \$40. Emersons: 888s, Explorers, turquoise, mint - \$125; black, gray - \$90. Vanguards: red, turquoise - \$95; gray, black, white - \$75. Pioneers: gray, black, white - \$75; red, green - \$90; turquoise, cracked - \$35. No-names: red - \$110; white, black - \$100; green, chipped - \$35. Atlas, white - \$75. 899 Mercury - \$25. 31P58 Gemini, N.I.B. - \$35; 808 red - \$30; 31P62, N.I.B. - \$25. John Kern, 2320 Rosedale Rd., Quakertown, PA 18951 (215) 538-2128. E-mail: rqv12a@prodigy.com

**FOR SALE:** Majestic tombstone, vintage 31, rough - \$80. Temple '29 vintage tuner and PS chassis - \$70. Cabinet for pickup only. Hickock tube testers: Cardmatic 118B, an excellent tester with full card set, calibrated, manuals, government cost \$5,000, but now - \$230. Hickock 123 cardmatic with large set of cards, manual, as is, but decent - \$110. GenRad 3 decade capacitor box - \$75. Tek 453 portable dual channel 50 MHz oscilloscope, solid-state, triggered, delayed sweep - \$150. Tek 7834 analog storage scope frame - \$100. N.O.S. NiCad battery pack, 21 F cells in plastic case, F cells are 7AH. These also charge like new. Case can hold 3 more cells for 24v - \$45. Tek 1105 hand carry 100w 115v inverter, with NOW NiCad pack - \$95. N.I.B. 6336 tubes - \$25. All of above in good condition and completely functional. Plus shipping. **FOR TRADE:** Swap: T368 xmtr N.I.B. 6000 tube for good T368 knob with crank, plus high voltage spring connector clip. Note: Sorry to have been absent for last 8 months due to severe lead/cadmium/++poisoning, nasty stuff, plus the treatment. Stan Krumme, KO6YB, 16432 Lakemont Ln., Huntington Beach, CA 92647 (714) 841-5866, evenings

**FOR SALE:** Attention Midwest owners: 1936 full-line brochure copies, 40 pps., shows all models - \$32 ea. ppd. 1931-1938 Midwest service manual copies, in binders - \$25 ea. ppd., only (10) to sell. Atwater Kent manual copies - \$20 ea. We are your source for factory original schematics, most only \$4. Send your model # & brand or a chassis layout. We also offer discount fresh stock capacitors and the only real wood repro knobs sold nationally. Send SASE for free flyer. Antique Audio, 253 Blanche St., Plymouth, MI 48170. (313) 20-RADIO

**WANTED:** Confidence Brand tube testers and other Arkansas Mfg. test equipment. Tom Burgess, 9 Belle Meadow Ln., Little Rock AR 72210. (501) 455-0773

**WANTED:** Crystal sets, toy crystal radios, diode radios and BC14A Signal Corp field crystal radio. The Crystal Radio Guy, Galen Feight, 3104 S.E. 20th, Portland, OR 97202. (503) 231-9708

**WANTED: NRI Radio Course kits; unused preferred. Must have building manual in either case. Art Sabin, 315 Plymouth, Chicago, IL 60604**

**WANTED:** Cathedrals of the 1930s to be lovingly restored and prominently displayed in a new collection. Domi Sanchez, 902 Orange Dr., Silver Spring, MD 20901 (202) 736-3876. E-mail: ddsanchez@pepco.com

**WANTED:** Tubes: 75TH, 6528 (octal); 7242, 813 sized, no plate cap. Manual and/or schematic to T368D, the "D" version. Stan Krumme, KO6YB, 16432 Lakemont Ln., Huntington Beach, CA 92647 (714) 841-5866, evenings

**WANTED:** Yaesu FP-800HD; cash or swap mint FP-757HD plus ??? Have available HP-200CD AF osc., HP-330B distortion analyzer long list components, panel meters (over 100!), other accumulated stuff. SASE for list. Also want manuals for 330B, Micromatch 263 SWR meter. George Goldstone, W8AP 1010 Burnham, Bloomfield Hills, MI 48304. (248) 647-3399

**WANTED:** Robot IM4U, have IM1 & IR12 for trades. Need chassis for Addison 5F. Steve Lange, 1351 N. 58 St., Milwaukee, WI 53208. (414) 259-1031

**WANTED:** Coronado (or Gamble-Skogmo) wood console radio. Steve Danielson, 7630 Grand Oaks Cir., Lincoln, NE 68516. (402) 472-8693. E-mail: sdd@unlinfo.unl.edu

**WANTED:** Tubes, 5881 12AX7 5AR4, 6L6GC, 7027 G550 7591, 6973. Jensen Alnico speakers, good/blown. John McGrath 29 Ripley Rd., Belmont, MA 02178. (617) 484-0515, eves. Fax: (617) 484-6180

**WANTED:** E.H. Scott, McMurdo Silver radios. Call before Rochester AWA meet for cash offer. Mike Greene, 19113 Alpenglow Ln., Brookeville, MD 20833. (301) 774-3203

**WANTED: Philco 70 or 90, RCA 143, Atwater Kent 356 and Stewart-Warner R-1301-A, excellent condition, and original finish. Mark Murphy, 1400 Chicago Ave., #802, Evanston, IL 60201. (847) 328-5036**

**WANTED:** General Television tabletop radios. Thank you. Robert Lutz, 9041 Gillette St., Lenexa, KS 66215. (913) 894-1327

**WANTED:** The base and attaching clamp for a Burns, American Electric, horn speaker Charles Combs, 508 E. Daniel, Albany, MO 64402. Ph/fax: (816) 726-3038

**WANTED:** Collections or singles of radio reception verification stamps, 1920s/40s, Ekko, others. Doug Messimer, Box 2162, Richmond, VA 23218-2162. (804) 786-1553, weekdays 8 am-3 pm

**WANTED:** Magnavox 18 in. horn for R-2C driver. Bruce Prange, 420 Eastridge Dr., Lincoln, NE 68510. (402) 489-0499, days

**WANTED:** 245/345 tubes, N.I.B. - \$50, good used - \$25. H. Kato, c/o Mr T Kato, 6868 Chelsea Rd., McLean, VA 22101

**WANTED:** Catalin parts: paying \$20-\$100/knob; grilles - \$100; handles - \$50+; chassis - \$100-\$200. Ray Carroll, 158 Oakwood Dr., Wayne, NJ 07470. (973) 696-1149

**WANTED:** Deforest grid leaks & vernier condenser in glass case. Rob Loeser 390 Beech St., South Hempstead, NY 11550. (516) 483-0463

**WANTED:** Wood radios with metal grilles or trim. Jay Malkin, 1250 Galapago #206, Denver, CO 80204. (303) 623-6451

**WANTED:** Silver Marshall coils Type 131 T U and V coils. Have UX250 to trade and/or cash. Kenny Mills, 1324 W. Shore Dr., Lancaster, SC 29720. (803) 283-4046

**WANTED:** Air King Skyscraper radios with tuning eye, not the unbearably ugly model with the clock that resembles an alarm clock! Sound familiar? Don Niess, 133 N. 17th St., Wheeling, WV 26003. E-mail: donniess@aol.com

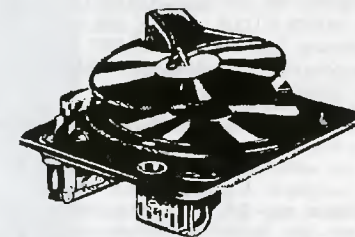

**WANTED:** Garrard record changers: RC-30, RC-20, RC-10. John T Meredith, 2462 Stantonburg Rd., Suite 152, Greenville, NC 27834. (919) 551-1882

**WANTED:** Brass ring to mount horn to Music Master base, approx. 5" diameter. 958A tube for project. Ted Depto, The Philco Collector, 913 5th Ave., Patton, PA 16668. (814) 674-8834

**WANTED:** For RCA CR91A (similar to AR88) cabinet, RCA button logo, good copy circuit diagram. Brian Cauthery, RR#1 Caledon, Ontario, Canada L0N 1C0. (519) 927-5858

**WANTED:** Catalogs: WRL 1952, 1953, 1963; BA 1950, 1951 1952, 1953, 1955, 1958, 1959, 1960. A. J. Bernard, PO Box 690098, Orlando, FL 32869-0098. (407) 351-5536

**WANTED:** Emerson Mae West, Philco 70 speaker, European 4V octal or 4-pin tubes. Jiri Placek, 60 Applewood Ln., Boyertown, PA 19512. (610) 367-0861

**WANTED:** Single plate 2A3; Pilotone AA-901 Garrard 301; factory prerecorded open reel tapes. Richard Brown, PO Box 686, Farmington, CT 06034. (860) 677-4828

**WANTED:** Knobs for Eveready 42 console, Philco 37 both dial and push-button bezels for GE H-73, handle pattern for Philco 46-350. Thanks. Ron Lockwood, RR1 Box 230, Mt. Vernon, ME 04352. (207) 293-3150, eves.

**WANTED:** 7-inch TV sets & junkers, knobs for Hallicrafters T-54 TV Bryan Durbal, 1164 Ladd Rd., Walled Lake, MI 48390. (800) 654-8991



**FOR SALE:** Tubes, parts, books, radios. Pink Emerson 915-SB, Emerson 547A, Crosley F-51Y M.W. Airline 93BK-423B Radiola 16, others. 2-stamp LSASE, 16 page lists. W. F. Horn, 13110 Marsh Rd., Bealeton, VA 22712. (540) 439-9781

**FOR SALE:** Zenith Trans-Oceanic G-500, working, good condition—\$175; L-600 with book, working—\$130. Ted Demski, 5806-225 Pl. SW, Mountlake Terrace, WA 98043. Phone/fax: (425) 778-7100

**FOR SALE:** Drake SW-4A — \$150. Knight R-100A — \$60. Kenwood R-600 — \$200. Hallicrafters S-38D — \$35. Mike Brillhart, 12551 Maiden Creek Rd., Abingdon, VA 24210. (540) 944-4387 9-11pm EST

**FOR SALE:** AK 206, original, very good condition — \$300. Philco 70 console, good cabinet, needs grille cloth, complete — \$125. Philco 42-355 chassis/speaker, WT — \$30. Stewart-Warner A61P3, AC/DC/portable, looks like a small Trans-Oceanic — \$45. Classic Radio & Television, 541 Riverside Dr., Box 61 Augusta, ME 04330. (207) 623-2059

**FOR SALE:** Tubes: (45) N.I.O.B. — \$50 ea., (45) used — \$20 ea., 5U4G, N.I.O.B. — \$15 ea., 807 used — \$5 ea., Arcturus Blue 124, 127 used — \$10 ea., 6AS7G, used — \$9 ea., 6AS7G, N.I.O.B. — \$20 ea., 829, used — \$12 ea. Plus shipping. Special tube list — LSASE. J.J. Papovich, 53 Magnolia Ave., Pitman, NJ 08071 (609) 582-8279. E-mail: jjpapo@june.com

**FOR SALE:** Atwater Kent #3529 variocoupler, N.O.S. in original box w/logo on cover & knob — \$250. Giffillian Bros. Inc. variocouplers N.O.S. with mtg. template — \$50. Langbean Kaufman, New Haven, Conn. variocoupler, exc — \$35. F&H Laboratories resonator w/ knob, exc — \$30. Zenith Royal 500 with leatherette case, works, 1" chunk out of side — \$60. All above + UPS. Phil Guinan, 106 Page Rd., Litchfield, NH 03052. (603) 889-6213

**Call the CHRS Hotline: 415/821-9800**

## FREE ANTIQUE RADIO MAGAZINE 4 TIMES A YEAR ...WHEN YOU JOIN CHRS

- Four Journals per year. "The finest radio club magazine in the nation."
- Join now and receive *Hints & Kinks*, a valuable collection of restoration articles from 20 years of CHRS.
- 14 collector's events scheduled for 1997 all over Northern and Central California.
- Members receive access to the CHRS technical reprint service.
- All this and more for \$20 per year.



California Historical Radio Society  
PO Box 31659  
San Francisco, CA 94131  
<http://www.wp.com/chrs>

**FOR SALE:** Clough-Brengle capacity and resistance bridge Model CLB-60007 circa 1942 for Navy — \$40. Andrew Mitz, WA3LTJ, 4207 Ambler Dr., Kensington, MD 20895. (301) 897-5531 E-mail: arm@helix.nih.gov

**FOR SALE:** Electronic magazines & books — SASE with 55¢ postage or will e-mail. Harry Pewowaruk, 1535 N. 8th Ave., St. Cloud, MN 56303. E-mail: hpewowaruk@aol.com

**FOR SALE/TRADE:** Original Marconi wireless stock cert. — \$45 ea. Sears wireless cat. 1916 ? — \$40; game Prof. Mike Krophone radio question game, using a wooden stand, microphone, 1938 Parker Bros., complete — \$150; Conn. Tel. & Tel. toy microphone in original box — \$75; radio game, Milton Bradley, cover of box has picture of 3 dial radio, complete — \$100. Radio related toys, U.S. Navy bulkhead blinker with J38 key, No. 26B1, code learning device ? — \$80; earphones, Federal Brush, Victor, etc., assorted radio maps, log books & call books from mid 20s — \$100/all. Telegraph key & sounder AM radio — \$100; bronze paper weight, 3" diam. David Sarnoff 50th anniversary 1956 — \$100; RCA Radiotron doll, needs work — \$325; RCA tags, 2" diam. — \$25. Bob Fuschetto, 1758 Michael Dr., Whitehall, PA 18052. (610) 435-8944, call between 7-9PM

**FOR SALE:** Philco 51 chassis — \$15. Medical device in case, unknown function, ca. 1900 — \$25. Bowman wall-mount wire/hose reel rack — \$14. Sprague TO4 capacitor tester — \$88. Hickok 288X sig. gen., manual — \$88. Heath IT12 signal tracer, manual — \$39. EICO 955 in circuit capacitor tester manual — \$33. RCA, Raytheon tube caddies — \$20-\$40. TV2C/U tube tester — \$325. Lots of reasonably priced test equipment, 10-page list — LSASE. Kirk Ellis, KK4YP 203 Edgebrook Dr., Pikeville, NC 27863. (919) 242-6000, evenings

**FOR SALE:** Bumper car radios, N.I.B., AM/FM, red/white — \$88; teal/white — \$99. Ray Palmer, N7MFG, 6523 S. Roosevelt St., Tempe, AZ 85283. (602) 831-1149. E-mail: bumpercar@asu.edu

**FOR SALE/TRADE:** Collins 75A-2, beautiful — \$450. Viking Challenger — \$125. Working command sets — \$50. SASE. Sam Timberlake, PO Box 161 Dadeville, AL 36853. (205) 825-7305. E-mail: stimber@lakemartin.net

**FOR SALE:** N.O.S. tubes: Type 4X150A — \$25; Type 4-125/4D21 — \$60. Bob Putnak, 1507 4th St., Monongahela, PA 15063. (412) 258-6236

**FOR SALE:** Plastic Nipper salt and pepper shakers (1) N.I.B., (1) used. Radiotron Designer's Handbook, poor cover — \$30. Angelo Pallotta, 1367 D'Angelo Dr., N. Tonawanda, NY 14120. (716) 695-0329

### TUBES WANTED HIGHEST PRICES PAID \$\$\$

W.E. 101F, 205D, F, Tennis Ball, 274B, 300B, 211, 845, KT66, 77 88. EL34, PX25, 280, 245, 250, Telefunken, Mullard, Bugle Boy ECC81, 82, 83, 801S, 802S, 803S.

### —AUDIO EQUIPMENT WANTED—

McIntosh, Marantz, UTC, W.E. Trans, Black Beauty, A & B Resistor etc.....

### FULL RANGE ELECTRON TUBE SHOP Jonathan Woo

Flat B, 37/F, Block 5, Greenfield Garden,  
Tsing Yi, Hong Kong  
Tel: (852) 24349466 Fax: (852) 24344963  
<http://www.jeis.com/~fullrang/>

## John Sideli's Classic Plastic Radios of the 1930s and 1940s A COLLECTOR'S GUIDE TO CATALIN MODELS

IT'S BACK!

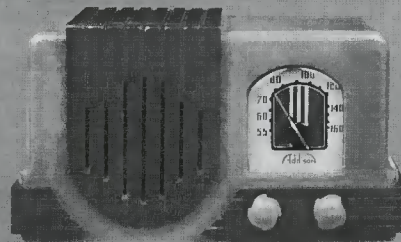

Classic Plastic Radios  
of the 1930s and 1940s



A COLLECTOR'S GUIDE TO CATALIN MODELS

John Sideli

ADDISON  
AIR KING  
ARVIN  
AUTOMATIC RADIO  
BENDIX  
CROSLEY  
CYARTS  
DEWALD  
EMERSON  
ESPEY  
FADA  
GAROD  
GENERAL ELECTRIC  
GENERAL TELEVISION  
HALSON  
KALETTE  
LAFAYETTE  
MOTOROLA  
R.C.A.  
SENTINEL  
SONORA  
SPARTON  
STEWART-WARNER

127 Pages — Over 200 Illustrations of Radios in Full Color  
55 different models from 25 manufacturers are extensively covered. Included for each is a description, the year of manufacture, dimensions, colors found and photos illustrating the various colors and variations. A 15-page introduction describes the growth of Catalin radio collecting, the Catalin material itself the "Catalin" style, rarity and value, and colors and restoration. The introduction contains an additional eighteen photos, twelve in full color.

## Softcover\* — \$19.95

\*Remainder Copies Complete, slight mark on bottom edge indicating that they are remainders.

U.S. Orders Enclose \$3.00 per order for packing & book-rate shipping if total order is under \$35.00. If using VISA or MasterCard, include name on card, card number and expiration date. Send payment with order. Mass. residents add 5% sales tax. Money back return policy. Softcover unless stated otherwise. Most orders shipped the same day received, but allow 2-4 weeks to receive order. Foreign orders write for shipping costs, or use credit card and specify air or surface (allow 2-3 months for surface shipping).



A.R.C., P.O. Box 2, Carlisle, MA 01741 Tel: (508) 371-0512  
Fax: (508) 371-7129

Web: <http://www.antiqueradio.com/>



(Jun-97)



**FOR SALE:** All items this ad, pick up only, cash. (6) floor model sets. (40) boxes pull out tubes - \$7/box. Record player changers - \$10/unit. Radio record players table models - \$27 ea. Philco 1001 10" TV - \$100. Motorola 7" port TV - \$45. Lots of small AM clock AM/FM table sets. Boxes of parts. Large old Electro DY speakers. Reel-to-reel 2-4 track recorder players - \$20 to \$60. AM/FM stereo transistor tuners amps. PM speakers, mixed sizes tube caddys. Test eqpt. as parts units, 3" to 8" scopes. Lab quality test eqpt. SC wireless 19 Mark II tank radio. RAK-8 low freq. mil rec. and power unit - \$100. Will be adding more items to this list. Some photo items. Buyers call first. Not always here. F. Krantz, 100 Osage Ave., Somerdale, NJ 08083-1136. (609) 783-0400

**FOR SALE:** Zenith 500, hand-wired - \$150; Sparton 410 Jr - \$215; Zenith 6D315 - \$195. John Lyle, 1161 S.W. Mulvane, Topeka, KS 66604-1456. (913) 232-0128

**FOR SALE:** Atwater Kent Model 5 (parts are mint) - \$6,800. Zenith 6S-254 console, nice - \$425. Stromberg-Carlson 140L, super mint - \$375. Philco 60 cathedrals - \$255 ea. Philco 89 cathedrals - \$275 ea. Philco 39-31 console, mint - \$225. General Electric H-116 10-tube console - \$175. RCA 121 cathedral - \$225. Can deliver AWA Rochester show. Call for free pictures. Harvey Daniel Rieff, PO Box M-372, 659 1st St., Hoboken, NJ 07030. (201) 659-0401 work or (201) 262-9466, home

**FOR SALE:** (80) pages - \$2 first class. Books, catalogs, manuals, radios, televisions, amateur, scientific, photographic, military. Francis H. Yonker P.E., W21BH, 1229 Inverary Pl., State College, PA 16801. (814) 867-1400

**FOR SALE:** Hallicrafters S-38E comm. rcvr, complete original, works AM, untested SW - \$35. Donald Sochurek, W191 S7500 Richdorf Dr., Muskego, WI 53150. (414) 679-0212

**FOR SALE/TRADE:** Any radio for electric, battery, or water fans, porcelain toasters, and electric heaters. Richard D. Padron, Jr., 1005 E. Idlewild Ave., Tampa, FL 33604. (813) 238-8535

**FOR SALE:** Zenith 15U269, clean, complete, original, 8 1/2 on 10 scale, electrically untested, photos available - \$1,400. Ron Kudasik, 2235 Tanya Dr., Chambersburg, PA 17201 (717) 267-9468, 3-11 pm, Eastern

**FOR SALE:** Transistor Trans-Oceanic 1000, original box, sales info, manual, complete, operates, charts, wave magnet - BO. Sam Hevener, W8KBF, 3583 Everett Rd., Richfield, OH 44286. (216) 659-3244

**FOR SALE:** 1913 Stutz Bearcat radio in original box, mint; horn elbow made by Reichmann - accepting offers. **WANTED:** Plastic trim for push buttons on a Truetone D-714, series A; owners manual for same; automatic changer for a Zenith 12H090. Norm Secor, 3333 Grand Ave., #361, Des Moines, IA 50312. (515) 277-4243

**FOR SALE:** Rider's Vol. 1-20, with index - \$300, plus freight. C & R Audio Video, 625 E. Main St., Turlock, CA 95380. (209) 632-3921

**FOR SALE:** Rider's VI, VII, VIII, IX, X, XI, XII, XIII, XIV XV, XVI - \$35, plus S/H. Ed Crockett, Vintage Electronics, 128 Buccaneer Dr., Hattiesburg, MS 39402. (601) 264-4755. Fax: (601) 264-0226

**FOR SALE:** Rider Radio 1-3, 5 - \$150; 6, 12, 13 - \$15. Supreme radio 1926-1942 - \$60. Richard L. Bednarcik, 28 Steele Ave., Lincoln Park, NJ 07035. (201) 694-6374

**FOR SALE:** Radio books, manuals, printed materials, parts and junk. Send SASE for list. P. Majewski, PO Box 92, Tamaqua, PA 18252

**FOR SALE:** Tubes, radio, TV, 40s through 50s, SASE for list. Lee C. Dickinson, 401-3 Talcottville Rd., Vernon, CT 06066

**WANTED:** Midwest consoles and tabletop radios from 1933 to 1939. Looking for the strong Deco ones. I can coordinate shipping anywhere in the U.S., so don't hesitate to call! Mark V. Stein, 2109 Carterdale Rd., Baltimore, MD 21209. (410) 466-2814. Fax: (410) 466-0815. E-mail: radioman@crosslink.net

**WANTED:** Going to radio swaps, meets or flea markets? Please send a stamped envelope for the high prices I pay for 1950s tiny tube portables and toy crystal radios. Mike Brooks, 7335 Skyline, Oakland, CA 94611

**WANTED:** Free catalogs that list old antique radios and repair supplies. Lloyd M. Page, Rt. 4, Mullins, SC 29574-9359

**WANTED:** Schematic and service information for the Philco Model 41-226, code 121 Richard J. LaMark, 6822 Tuckahoe Rd., Williamson, NY 14589-9589. (315) 589-2552

**WANTED:** Philco PT61. Still looking for this table radio. Must be in good condition with original knobs, back, etc., as well as restorable. (Listed Bunis 2, p. 141 for \$95.) I will pay \$175, plus shipping. Rod Kennedy, 2 Teodora Ct., Moraga, CA 94556. (510) 376-7885

**WANTED:** RCA WC-528B Quicktester, (Q.S.T., 2/75, p. 51). Louis D'Antuono, 8802 Ridge Blvd., Brooklyn, NY 11209. (718) 748-9612, after 6pm

**WANTED:** Sammy Kaye and Sunday Serenade radio transcriptions (big 16 in. records). Anything Sammy Kaye: photos, memorabilia, magazine articles and other big bands for World's Only "Big Band Hall of Fame" Robert DeMars, 222 Lakeview Ave., Suite 160/256, W. Palm Beach, FL 33401 (561) 844-7434. Fax: (561) 844-1493. E-Mail: BigBandHof@aol.com

**WANTED:** For 1937 Stromberg-Carlson 1.40 M, dial scale, hexagonal glass. Other models the same? Glenn Bubenheimer, 27851 Terrence, Livonia, MI 48154. (313) 421-5574

**WANTED:** Philco 70 w/original finish and brass escutcheon. Michael Harrington, PO Box 250995, Little Rock, AR 72225

**WANTED:** Atwater Kent speakers, horn for 10 C and cone for 20, good condition. Vern Lang, 619 Sunrise Cr., Muscatine, IA 52761 (319) 263-2697



## BUYER FROM ANOTHER PLANET...

**WANTED:** Seeking any brand of blue, red, yellow, orange or green radios. Also buying microphones, 60s & 70s space-age design TVs, radio tubes and parts. Specializing in buying Fada radios, speakers and literature. Tom Meers, 773 Carlisle Club Dr., Stone Mountain, GA 30083. Phone: 800-777-1452

**WANTED:** Dead metallic and Bakelite crystal phono cartridges. Will pay \$1 ea. plus postage. West-Tech, PO Box 1415, Sebring, FL 33871

**WANTED:** A working four-track tape player of any make or model. Stephen Mauck, 428 S. Purdy, Lyons, KS 67554. (316) 257-5582

**WANTED:** Prewar Japanese QSL cards; spark transmitter and loose coupler-type crystal receiver Takashi Doi, 1-21-4, Minamidai, Seyaku, Yokohama, 246 Japan. Fax: 011-8145-301-8069. E-mail: taka-doi@kk.iij4u.or.jp

**WANTED:** Audio transformers, Peerless G252Q and S265Q, HS25 triad, and HA137 by UTC. Also looking for Western Electric transformers, etc. Michael Payne, 803 S. Taylor Alvin, TX 77511 (281) 331-9217 Fax: (281) 585-2727

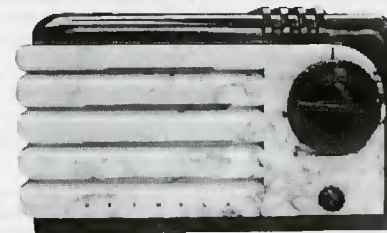

**WANTED:** Prewar plastics by Detrola, Kadette, RCA, Philco, etc. My cousin Vinny and I we was thinking, "Hey, we got the cash," (a cool mil, to be exact), "so let's spend some before dem girls gets hold of it." You know what I'm saying? Please write or call collect: Rain Buttignol, 214 State St., #7 Portsmouth, NH 03801 (603) 427-1384

### One Month Free!

#### BONUS FOR EARLY RENEWALS

If you renew **before** the month shown on your mailing label (your expiration month), you will receive an extra month on your subscription: 13 months instead of 12! 26 months for an early 2-year renewal!

**WANTED:** Manual receiver Type R1451A/WLR6. Harry A. Weber, 4845 W. 107th St., Oak Lawn, IL 60453-5252

**WANTED:** Zenith chairside Model 9S244, 9S242 or 7S242, in nice condition. Larry Bosher PO Box 193, Palo Pinto, TX 76484. (940) 325-5333

**WANTED:** One yellow Catalin DeWald pinwheel knob; Kadette Classic in nice condition; Kadette Copper. Peter Fee, 26 Smull Ave., Caldwell, NJ 07006. (201) 403-8913

**WANTED:** Housing/cabinet for Crosley Victory Model 63TA. Bryon Bernor, 33855 McEnery Cyn., Acton, CA 93510. (805) 269-5459

**WANTED:** Antique medical and scientific devices, especially very early, ornate or unusual. Richard Cane, 1333 N.W. 127th Dr., Sunrise, FL 33323. (954) 846-7116

**WANTED:** Special 6.3 VAC lamps for VU meters used in TEAC & Sony tape recorders. They must have pigtailed on either end and measure approx. 1/2" long x 1/8" dia. Ray Barnes, 38 Woodmere Rd., Framingham, MA 01701



*Southeastern Antique Radio Society Presents,*

## The Annual Fall Mega-Meet In Atlanta!

**New Indoor Location!!!**

Howard Johnson Midtown

(Formerly the Castlegate Hotel)

Located at, 1750 Commerce Drive NW

Atlanta, GA 30318

### Friday, September 26

Event	Time
"No host" dinner	7:00 p.m.
(Ho Jo Midtown Hotel)	

*followed by:*

Atlanta Radio theater	8:30 p.m.
Players (an excellent "Golden Age" radio Production)	

### Saturday, September 27

Event	Time
Registration/Set up	7:00 a.m.
Flea Market	8:00 a.m. (all day)
Philco Display/contests	All day

### Fee Schedule

	In Advance	At Door
Vendor Space* (First space, table provided)	\$15.00	\$17.50
Additional Space (table provided)	8.00	10.00
Registration (per family)	5.00	7.50

\*Vendor space includes registration fee

*There will be no buying, selling or trading of merchandise before 8:00 a.m. on Saturday-Enforced!*



**FOR SALE:** Elements of Radio, Marcus - \$12, Radio Physics Course, Ghirardi - \$20, Radio Station Treasury, 1900-1946 - \$8, The Transistor Radio Handbook - \$12, Elements of Radio Servicing, Marcus & Levy - \$20, Zenith 3000-1 Manual (ex. copy) - \$6, Novelty radios, testers, manuals, catalogs, magazines, my 33 plus page list - \$1 & 2 stamps - \$1 refund with your order Ben Martin, 18334 Pepper St., Castro Valley, CA 94546. (510) 582-6804

**FOR SALE/TRADE:** Beautiful Saba Freudensadt 7 large table top radio, not working - \$55, plus UPS. Paul Fulton, 711 Jacquelyn Rd., Westwood, NJ 07675. (201) 664-5260

**FOR SALE/TRADE:** Many N.I.B. Japanese transistor and novelty radios from 1960s. Trade for HP calculators, old marbles. Free list, LSASE. Bill Hyde, 34 Cerrado Loop, Santa Fe, NM 87505. (505) 466-6613

**FOR SALE:** GE M61 tombstone, nice cabinet, needs knobs, 1934, shouldered, BE, SW, AC - \$50. Dave Pewowaruk, 931 23rd St. SW, Rochester MN 55904. (507) 280-5975. E-mail: HP95@aol.com

**FOR SALE:** Standard Micro Ruby SR-H436 with shell box, dark brown, a real beauty, works - \$115. Norman M. Landis, 1315 Marbendale Ct., St. Louis, MO 63122-6932. (314) 821-7933

**FOR SALE/TRADE:** Beautiful aqua 1964 3" reel/reel recorder (O.M.G.S., Model 1778), approx. 7" x 8" x 2 1/2" perfect cosmetics/operation, in original box, w/manual - \$150 or trade for novelty radio(s). Many novelties/pockets for sale/trade. SASE for list. Ray Weaver, 1047 Bunker Hill Rd., Columbus, GA 31907 (706) 687-1733

**FOR SALE:** AC power cords. Stock up now. Brown, 62 inch, polarized, 18 gal. (25) pieces - \$10, plus shipping - \$2.50. I hope to see you at Rochester Gerald Cromer, K4NHN, 1014 Summerland Dr., Cayce, SC 29033. (803) 794-1483

**FOR SALE:** Philco 66 - \$100. Dewald 563 wood - \$30. RCA X51 - \$20. Hallicrafters S38C - \$35. Paul Roche, 9914 Indian Ln., Silver Spring, MD 20901 (301) 754-3608



**FOR SALE:** Emerson Catalin case, excellent - \$550. Delco white radio R-1230A, excellent - \$75. Arvin black midget 4-tube 6" x 5" - \$40. RCA dog and music wind-up player, the two music box and dog - \$200. Edison Pathé phonograph made for Silvertone, plays disk, nice oak case, works, open top excellent - \$250. Sylvania clock antique sign, excellent metal back, old - \$255. Thomas A. Edison cylinder, 20, nice - \$200. Western Elect. telephone switchboard, nice wood case, nice, complete - \$250. Drum metal radio speaker in iron frame 14" - \$65. RCA Victor tan cowhide case, seven band, portable, like Zenith Oceanic, fine knob control radio - \$100. Zenith Trans-Oceanic H-500, nice - \$125. Stromberg-Carlson amplifier Model AU-42 portable metal, old - \$55. Wards Airline airwave loop system aerial 7-tube 22" x 12" x 14" 4-knobs, six push buttons, dial 4" x 6" left end rounded, built-out grille with seven wood slats, complete beautiful two-tone burl. wood - \$135. All radios play. Will trade fans for book radios or breadboards. Philco Model 20 cathedral batt. type, doesn't play, finish nice - \$55. Philco Model 40-155 slant front wood, push buttons - \$55. Packard Bell, white, mint in box - \$40. BK TV analyst 1076. Hercules 12" 6 brass blade wall mount fan, polished - \$200, will trade for book radios. Temple tan metal, plays - \$40. Howard 201A, white Bakelite - \$40. Airline Bakelite 6-button AM Model 84BR-1518A ivory 14", nice - \$40. Airline 5 push buttons, cream Bakelite - \$35. Briston horn speaker, black, brass bell, polished - \$125. Seeburg Colette 120 selections stereo, chrome nice jukebox selector - \$250. The Gyroy ceiling two-motor fan - \$4,000. Will trade fan for breadboard radios. AC Dayton Model XL-5 table, glass 1925 plate glass see-through case, 5-tube battery, this is a rare set, underpriced in books, excellent - \$1,800. Crosley Model 50, portable soft wood leatherette, black, very, very rare, never put on market, only two known - \$11,000. General Elect. 16" elect. fan brass, polished - \$300. Peerless 12" fan brass, five 1/2" holes around outside of base, early - \$450. Century 12" brass large open ends, cast motor, excellent - \$300. Westinghouse 12" 6-blade brass - \$200. Emerson 10" brass blades, iron telescoping stand - \$375. **WANTED:** Radios look like one book or like set of books, tube or transistors type, early light bulbs. Edison Mabry, 715 W. Longview Ave., Mansfield, OH 44906. (419) 526-1175

**FOR SALE:** Grandfather clock radio Playtime 124, vg cond., no ship, will help 250 miles PU. Buzz Miller, 725 Mt. Rock Rd., Carlisle, PA 17013. (717) 776-3279

**FOR SALE:** Kennedy shortwave converter Model 53, real nice - \$125 plus shipping. Ed Bell, 5311 Woodsdale Rd., Raleigh, NC 27606. Fax/ph: (919) 851-1517



## RIDER'S PERPETUAL TROUBLESHOOTER'S MANUAL ON CD-ROM

DUE TO THE MANY QUESTIONS AS TO WHY OUR RIDERS SERIES COST MORE THAN "BRAND X" ?? CHECK THESE FEATURES TO SEE WHY QUALITY ALWAYS WINS OUT!

FEATURES	OURS	THEIRS
Program Driven By Database Search Engine?	Yes	No
Installation Program On CD-Rom?	Yes	No
Each CD Set (ie, Vol 1-4) A Stand-Alone Program?	Yes	No
Can Read And Print Smallest Printed Schematics?	Yes	No
The ONLY Accurate Rider Index?	Yes	No
Search By Manufacturer, Model, Chassis, Vol?	Yes	No
On-Line Help File?	Yes	No
Available In Separate Volume Sets (V5-8 example)?	Yes	No
CD's Can Be Bought And Used Separately?	Yes	No
Photographic GrayScale Display?	Yes	No
High Resolution Images?	Yes	No
Search For Radios Using Multiple Datafields?	Yes	No
Rotate Image On Screen To Keep From Breaking Your Neck?	Yes	No
50 Different Manufacturers Radios Not In "Brand X" Riders?	Yes	No
CD-Jukebox Ready Without Swapping CD's?	Yes	No
Application Program Available For Other Programs?	Yes	No
Such As Antique Radiophile Or Repair CD's Series?	Yes	No
Uses Riders Error Filled Index To Find Schematics?	No	Yes
Not Even ONE Set Returned Because The User Could Not Read The Values Of The Components In A Schematic?	Yes	No **

\*\*\* Ask "Brand X" how many of their sets have been returned for credit!

TRY OUR RIDER CD SET - ABSOLUTE MONEY-BACK GUARANTEE - SEE WHY QUALITY ALWAYS WINS AND WHY IT TOOK OVER TWO YEARS TO PRODUCE THIS SERIES???

STILL ONLY \$ 85.00 per 4-Volume Set - ONLY \$ 450 all 23 Volumes (6 CD's)  
Quality is always the Best Choice

**Other CD's - The Radiophile Series** Articles, Books, Reference Data, Resource Books, Technical Info, Troubleshooting Courses, Theory, Schematics and more are available on this series. *Volume 1* 29 books with theory, reference, history, and troubleshooting information; *Volume 2* Gemsback *Radio Serviceman's Books* from 1931-1936, and Zenith service manuals Vols 1 & 2 from the beginning of Zenith through 1942; *Volume 3* Tube substitution foreign and USA, The Book of Radio, The fabulous *Yaxley-Mallory Radio Encyclopedia*, and the equally famous *RCA Radiotron Design Handbook*; *Antique Radio Repair Volume 1*, the first CD produced with just about everything that one would need to repair antique radios or to learn how to and soon *Antique Radio Repair Volume 2* - "Rider Mania" a real classic collection!

Only \$ 85 each postage paid USA, export plus shipping

**SCHEMATIC DIAGRAM SERVICE** NOW WITH ELECTRONIC DELIVERY BY EMAIL CALL, WRITE, FAX, OR EMAIL AND VISIT US ON THE INTERNET @ <http://www.electrosys.com>

**RADIO ERA ARCHIVES** div. ECS, Inc.

2043 Empire Central  
Dallas, Texas 75235  
Inquiries: 214-358-5195  
Fax: 214-357-4693  
Hours: 9-5 M-F CST

Visit us on the Internet:  
<http://www.electrosys.com>

We take all major credit cards

Come and meet  
**BOB STEELE**  
Radio personality at WTIC AM  
in Hartford, CT  
for six decades!!  
Saturday September  
6th  
11AM to 12PM  
at the  
Vintage Radio &  
Communications  
Museum of CT.

1173 Main Street  
East Hartford, CT  
Admission will be charged  
Call (860) 675-9916 for info



**FOR SALE:** RCA Victor Model 3-US-5 radio/record player, AM, AC/DC - \$50, plus shipping. Leroy Neal, 603 Butterworth, Dyersburg, TN 38024. (901) 285-5120

**FOR SALE/TRADE:** Cool military stuff, WWII Japanese field telephone, beautifully made, excellent condition. Teak case, lots of bright work, Japanese "Megger" magneto driven galvanometer, for detecting cracks in hulls of subs. Condition of both pieces, very good/excellent. Offers of trade or cash on both pieces. WWII U.S. airplane gauges, Navy tachometer, 3 inches, General Electric Mark V excellent - \$75. Gas gauge, 2 inches, reads gas, 54 gallon max number. Oil pressure gauge, 2 inches, reads to 200 lbs. per sq. in., with white paint mark at 60 lbs., guessing from small aircraft. Also, Navy - \$25 ea. Make offer on all three. Navy 3 inch oscilloscope OS-80 in CV-845 U case, cool slant front, nice condition, works, uses 9 pin tubes - \$85. Meters, Weston Volt meter, 10 inches, nickel, scroll faced, pre-1900, excellent - \$125 OBO. Westinghouse 7 inch am meter to 80 amps, 20s/30s type - \$35 OBO. Still have lots of camera stuff, see p. 28, Aug. A.R.C. Offers of cash or trade accepted on all stuff. Always looking for vintage mics, tube audio, RCA memorabilia, advertising, etc. Always looking for Espey table radios, literature, advertising. Ward Kremer, 5807 Papaya Dr., Ft. Pierce, FL 34982. Ph/fax: (561) 468-7732. E-mail: WKremer798@aol.com

**FOR SALE:** Toshiba 8TM-294 - \$45. Magazines from the 50s, Radio Electronics & Radio and TV News. Jim Charney, 4007 Monroe, Dearborn Heights, MI 48125. (313) 274-7766

**FOR SALE:** Sylvania Thunderbird radio, inner plastic cover has crack - \$175 ppd. Larry Brososky, 15514 Windover Trl., Ft. Wayne, IN 46845. (219) 637-5339

**FOR SALE:** Tubes, old car radios! Grab boxes and specials! SASE, please, for lists. Mitchell Thermionics, 211 Argosy Dr., Gaithersburg, MD 20878

**FOR SALE:** Reproduction dials for Belmont 6D111, Setchell-Carlson 417 427 Trav-Ler #5061 Philco PT 41 - \$24 ea. ppd. Reproduction light cover & emblem for Air Rite - \$32 ppd. Doyle Roberts, HC63, Box 236-1, Clinton, AR 72031 (501) 745-6690. E-mail: drob@artelco.com

**FOR SALE:** Books: Motorola Semiconductor Databook, 1968, HB, 2 1/2" thick - \$25. Catalog: Lafayette transistor T4-56 - \$10. Fundamentals of Television Eng., 1955, HB - \$10. Bulletin: Ballantine Electronic AC voltmeter 300A-300B, 1939, 12 pp. - \$15. Pop. Mechanics, 12, 1924-1933, not a set - \$100. Bernie Seaman, 113 Old Palmer Rd., Brimfield, MA 01010. (413) 245-7174. Fax: 0441

**FOR SALE:** Assortments of used radio tubes postpaid! (100) octals - \$39, (50) locals - \$25, (100) 4-5-6 pin - \$70. Evan J. Chase, 108 Cass St., Swanton, OH 43558. (419) 826-3776

**FOR SALE:** Scott #1510 chassis - \$80. Zenith H500 for parts - \$25. Zenith #160D portable - \$80. (2) Sony cassette recorders - \$15. Victor Japan #6A-2605 radio - \$45. Radio Amateur's Handbook - \$8. Stancor #752 power supply - \$10. ATR DC to AC Inverter #32 - \$8. Aiwa R/R #TP-801 recorder - \$20. RCA #WO-37A oscilloscope - \$15. Zenith Royal 500 - \$50. Zenith #G-503Y portable - \$40. Craig 7-band portable - \$30. Lloyds #9NZ4 portable - \$50. Universal Color tube tester - \$10. Tom Thumb cathedral - \$40. B&K #960 transistor tester - \$10. Gloritone #27S cathedral - \$140. Phaostron #MA-1 VOM - \$20. Zenith #X347 stereo radio - \$50. **WANTED:** Philco cabinet and chassis for Crosley Elf # 48. Walt Wrabek, Rt. 4, Box 370, Menahga, MN 56464. (218) 564-4623

**FOR SALE:** Empire Grenadier 9000 speakers. American, 15" woofers, marble tops - \$550 pick-up please. Walter Bernd, 99 Parkwood Dr., Fairfield, CT 06430. (203) 254-8140

**WANTED:** Military grey rackmount headphone amp AM43C by United Television Co. Michael Payne, 803 S. Taylor Alvin, TX 77511 (281) 331-9217 Fax: (281) 585-2727

**WANTED:** Voice of Music (VM), reel and cassette recorders. Also VM literature, demo records. Gary Stork, 37530 E. Meadowhill, Northville, MI 48167 (248) 478-0990

**WANTED:** Adapter E105 to test 829-B and 832 tubes in my TV-7D/U military tester Robert B. Toenjes, 1724 2nd Ave. NW, Waverly, IA 50677 (319) 352-3321

**WANTED:** Spark transmitter P4 type, Amrad crystal set ID tags, information on Radak R4. Paul Recupero, 265 Union St., Portsmouth, RI 02871-2209

**WANTED:** Ivory plastic knobs for tuning & volume control, Zenith 7-S-363, (Bunis 1, p. 168). Marv Glassman, 19300 Romar St., Northridge, CA 91324. (818) 993-4560. Fax: (818) 886-7101

**WANTED:** Front panel, tuning dial, tube socket for Grebe CR-5. Radiocraft dials (white). Bob Nicholson, 3423 S.E. Long St., Topeka, KS 66605-2486. (785) 266-9473

**WANTED:** Will pay top price for Crosley 50 amplifier, Crosley 50 portable, Crosley VI, Crosley Audio detector, Crosley Radio frequency tuned amplifier Rider's 23. Bill Moss Settle, 120 Clarksdale Cir., Glasgow, KY 42141 (502) 651-6525

**WANTED:** BC-342-N and R-274. Michael Harrington, PO Box 250995, Little Rock, AR 72225

**WANTED:** Early crystal sets, detectors. One-tube sets with exposed tube. Unusual horn and cone speakers. Scarcer, pre-1925 battery sets. Will buy one piece or an entire collection. Ed Bell, 5311 Woodsdale Rd., Raleigh, NC 27606. Fax/ph: (919) 851-1517

**WANTED:** Heathkit manual for signal tracer, Model T4, photocopy OK. Michael Durand, 21 Le Grande Ave., Tarrytown, NY 10591 (914) 631-0493



**WANTED:** Pilot set pictured and similar, also Pilots with drum-type dials. Pay to \$1,500 or have trades. Pay finders fee for information leading to purchase. Shipping from anywhere no problem. Thanking everyone in advance. Bill Moore, 3049 Box Canyon Rd., Huntsville, AL 35803. (205) 880-1207

**WANTED:** Hallicrafters, Collins, complete radios or parts. What have you? Call: John R. Suker, W1TX, 216 Grove St., Rutland, VT 05701 (802) 775-6732. E-Mail: w1txjohn@aol.com

**WANTED:** Pilotone AA-901; Grommes 50PG; classical/jazz reel-to-reel tapes. Richard Brown, PO Box 686, Farmington, CT 06034. (860) 677-4828

**WANTED:** Emerson, help, desperately wanted Emerson Model AX-240 working chassis and speaker for my newly acquired Emerson bookcase style cabinet. It came with wrong radio and speaker. Many thanks. Loren H. Dudley, 14 Valley Rd., Bath, ME 04530-2811 (207) 442-8419

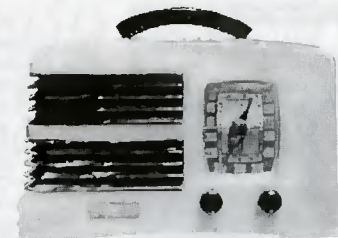

**WANTED:** Symphony and Detrola Catalans. If only you knew how necessary these radios are to my very existence. Gee, if you knew that you'd probably never call and hope I'd wither away ending once and for all these stupid ads. Please write or call collect: Rain Buttignol, 214 State St., #7 Portsmouth, NH 03801 (603) 427-1384

**WANTED:** General Electric Model 7-4135 wood radio, made in early 1980s. B.J. Cox, PO Box 272, Kiowa, KS 67070. (316) 825-4816

**WANTED: I will pay \$200+ for Western Electric 205 D (tennis ball shape) used. \$150+ for Western Electric 274 A/B (engraved base) used. \$450+ for Western Electric 300 A/B (engraved base) used. \$100+ for 2A3 (single plate) used. If you have any questions, please call. Don Singerhouse, 350 W. 3rd St., New Richmond, WI 54017. (715) 246-3899**

**WANTED:** Tuning shaft or var cap Philco #31-1172; ten inch spkr with voice coil, field coil and pot assembly for Philco 118H. Burt Werthman, RD2, Little Falls, NY 13365. (315) 866-4854

**WANTED:** Dial pointer and dial lens for a 1946 Fada bullet Model 1000, reproductions OK. **FOR SALE:** Gloritone Model 27 cabinet, needs some reworking - \$25 + UPS or trade for General Electric Model K-43 cabinet. Douglas Wright, 625 Rolling Hills Dr., Canyon Lake, TX 78133. (830) 899-5800, after 5 pm

**WANTED:** 3000-1 Trans-Oceanic parts sets. Also want parts or near parts sets of the Westinghouse Little Jewel radio. Jim Montague, 1907 S. Stanley Ln., Spokane, WA 99212. (509) 535-9576

**WANTED:** Cartridge shell and manual play spindle for Dual 1258 turntable; manual and auto spindle for 1019. Alexander Kruedener, 161 E. 89 St., Apt. 4E, New York, NY 10128. (212) 831-0662

**WANTED:** Philco PT-84 or 41-81, Minerva W117 Detra 219. Ichiro Yamada, 10-21 Chiyodadai-cho Kawachi Nagano-shi, Osaka, Japan 586. Phone/fax: 011-81-721-52-4695, mid./eve. local. E-mail: yamadnr1@osk.threewebnet.or.jp

**WANTED:** RCA vintage microphones wanted: 44-BX, 77-DX, KU-3A. Also RCA "On Air" lights, "recording" lights, mic. Flags, signs & station clocks w/call letters. Top prices paid. Bill Bryant Management, 2601 Hillsboro, Ste. G12, Nashville, TN 37212. (615) 269-6131 Fax: (615) 292-3434

## New Wireless Pioneers

### Books, Magazines, Literature Bought and Sold

New Wireless Pioneers buys and sells books, catalogs, magazines and other literature from the 1800's to 1950 that deal with early radio, wireless and electricity. A selection from our list of specialties:

Pre-1900 Electricity  
Pre-1925 Radio or Wireless  
Pre-1950 Computers

Pre-1900 Telegraphy  
Pre-1940 Television  
Early X-Ray

Magazines, Catalogs, Autographs or Ephemera related to the above topics. Also: Pre-1920 Wireless and Telegraph Apparatus - Radio-Related Novelties and Advertising - Early Vacuum Tubes and Electrical Devices. *Some items available in other technical subject areas also.*

Several catalogs featuring items for sale are published each year.

New Wireless Pioneers - Jim & Felicia Kreuzer  
P.O. Box 398, Elma, NY 14059  
Phone: (716) 681-3186 Fax: (716) 681-4540



# Order These Popular Books From Antique Radio Classified

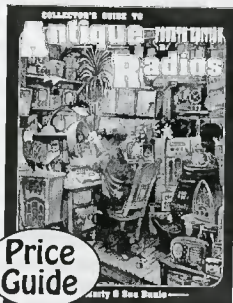

**The Collector's Guide to Antique Radios 4th Edition** by Marty & Sue Bunis. 8,500+ Battery & AC sets from the '20s to the '60s. Updated prices. Many new photos. 1996. Shipping Now. **\$18.95**



**The Collector's Guide to Transistor Radios 2nd Edition** by Marty & Sue Bunis. This book will help you identify the most sought-after vintage transistor radios. Over 2,900 models, all with current prices. Includes radio club listing. 375 all new color photos, 320 pages. 1996. **\$16.95**

Price Guide

Price Guide

## NEW BOOKS.....

**The Magnetic Cone Speaker Notebook**, Paul. 250+ cone speakers from 120+ companies. Photocopy. 1995. 58 pages. **\$10.90**  
**Shortwave Receivers Past & Present, Communications Receivers, 1945-1996, 2nd Ed.**, Osterman. For the radio collector, the informed receiver buyer or anyone interested in the history of shortwave radios. 500 radios listed. 350 pages. **\$19.95**

Hams! We now have 8 ham books - See our full page ad

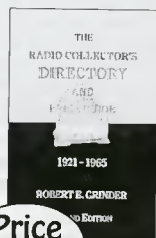

**The Radio Collector's Directory and Price Guide, 1921-1965, 2nd Ed.** by Robert Grinder. Over 20,000 radios by manufacturer, model number, year, etc. with prices. Radio history, cabinet style chapters. No photos, 264 pages. **\$26.95**

Price Guide



**Transistor Radios, A Collector's Encyclopedia and Price Guide** by Robert Lane and David Lane. Identification guide to over 2,500 transistor and novelty radios. History and key to collecting chapters, 170 pages. **\$19.95**

Price Guide

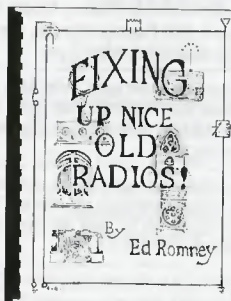

**Fixing Up Nice Old Radios** by Ed Romney. Written by a retired radio instructor. Plastic binding. 300+ figures, 185 pages. **\$29.00**

**Old Time Radios Restoration and Repair** by Joseph J. Carr. A self-paced training guide. History, theory and practical operation of antique and classic radios. 200 illustrations, 256 pages. **\$19.95**

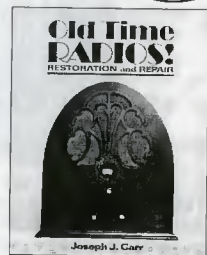

U.S. Orders Enclose \$3.00 per order for packing & book-rate shipping if total order is under \$35.00. If using VISA or MasterCard, include name on card, card number and expiration date. Send payment with order. Mass. residents add 5% sales tax. Money back return policy. Softcover unless stated otherwise. Most orders shipped the same day received, but allow 2-4 weeks to receive order. Foreign orders - write for shipping costs, or use credit card and specify air or surface (allow 2-3 months for surface shipping).



A.R.C., P.O. Box 2, Carlisle, MA 01741 Tel: (508) 371-0512

Fax: (508) 371-7129

Web: <http://www.antiqueradio.com/>



(Aug-97)

IF  
YOUR SUBSCRIPTION HAS  
**EXPIRED**

(or if it will soon)

Please fill out the coupon  
and mail with your payment to:

**ANTIQUERADIO CLASSIFIED**  
P.O. Box 2  
Carlisle, MA 01741 U.S.A.

Entry of your SUB# (subscriber number)  
and EXP: (last issue in your subscription)  
will speed the processing of your renewal.  
These can be found on your mailing label.

Thanks!

Call: (508) 371-0512, or  
Fax: (508) 371-7129

Price Guide

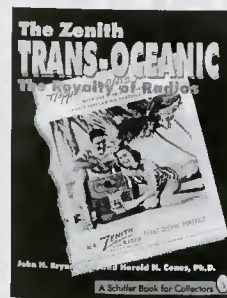

tion to troubleshooting and repairing AC table model radios. 145 pages. **\$14.95**

**The Zenith Trans-Oceanic: The Royalty of Radios** by Bryant and Cones. Presents the fascinating story of the development and use of the Trans-Oceanic. Several photos, documents, ads, etc. 160 pages. **\$24.95**

**Communications Receivers, 3rd Ed.** by Ray Moore. Information on vacuum tube receivers by 66 manufacturers. 402 radios illustrated, 115 pages. **\$19.95**



**COMMUNICATIONS RECEIVERS**

3rd EDITION



U.S. Orders Enclose \$3.00 per order for packing & book-rate shipping if total order is under \$35.00. If using VISA or MasterCard, include name on card, card number and expiration date. Send payment with order. Mass. residents add 5% sales tax. Money back return policy. Softcover unless stated otherwise. Most orders shipped the same day received, but allow 2-4 weeks to receive order. Foreign orders - write for shipping costs, or use credit card and specify air or surface (allow 2-3 months for surface shipping).



A.R.C., P.O. Box 2, Carlisle, MA 01741 Tel: (508) 371-0512

Fax: (508) 371-7129

Web: <http://www.antiqueradio.com/>



(May-97)



**IF**  
you are not yet a subscriber  
and...

if you buy, sell, collect  
(or are interested in)  
old radios, you need...  
**Antique Radio Classified!**

Please fill out the coupon  
and mail with your payment to:

**ANTIQUERADIO CLASSIFIED**  
P.O. Box 2  
Carlisle, MA 01741 U.S.A.

Call: (508) 371-0512, or  
Fax: (508) 371-7129

**YES! SEND ME ANTIQUE RADIO CLASSIFIED!**

Name: \_\_\_\_\_ 9H  
Address: \_\_\_\_\_ Date: \_\_\_\_\_  
City: \_\_\_\_\_ State: \_\_\_\_\_ ZIP: \_\_\_\_\_

Radio Amateur Call: \_\_\_\_\_ Phone: \_\_\_\_\_

New Subscription 1-Year U.S. 2-Years U.S. (extra month free)  
 Renewal Subscription  \$38.95 by Periodicals Mail  \$77.90 by Periodicals Mail  
Sub#: \_\_\_\_\_  \$55.95 by 1st Class Mail  \$111.90 by 1st Class Mail  
Exp: \_\_\_\_\_

<p><b>6-Month Trial</b> <b>Periodicals Mail</b> <b>New Subscribers Only</b></p> <p><input type="checkbox"/> \$19.95 in U.S. <input type="checkbox"/> \$25.00 in Canada (U.S. Funds)</p>	<p><b>FOREIGN RATES FOR 1-YEAR (U.S. DOLLARS):</b></p> <p><input type="checkbox"/> \$59.00 Canada by Air <input type="checkbox"/> \$100.00 Other Foreign by Air <input type="checkbox"/> \$49.00 Canada by 2nd Class <input type="checkbox"/> \$55.00 Surface Mail to <input type="checkbox"/> \$65.00 Mexico all other foreign countries.</p> <p>Non-Canadian surface delivery may take two or more months and is not guaranteed. Pay in U.S. Funds by charge card, money order, travelers check, U.S. cash or a check on a U.S. bank. Canadian check in U.S. funds is OK.</p>
---	---

Please print neatly and pay in U.S. funds. Make check or money order payable to A.R.C. Send to A.R.C., P.O. Box 2, Carlisle, MA 01741 U.S.A. Phone: (508) 371-0512 / Fax (508) 371-7129. Payments received at old rates will be prorated to new rates. Early renewals get one extra issue/year. Two-year new subscriptions get 25 issues. Sample free.

Charge to: Visa \_\_\_\_\_ MasterCard \_\_\_\_\_ Name on card: \_\_\_\_\_

Card No. \_\_\_\_\_ Exp: \_\_\_\_\_

Your answers to any (or all) of the questions below and on the other side will be appreciated.

How did you hear about A.R.C.? \_\_\_\_\_

Member of any radio clubs? \_\_\_\_\_ Which ones? \_\_\_\_\_

How long have you been a collector? \_\_\_\_\_

About how many sets do you have? \_\_\_\_\_ Speakers? \_\_\_\_\_

What other antique radio publications do you receive? \_\_\_\_\_ 9/97

**Price Guide**

by Robert E. Grunder  
Lane and David Lane. *Identification guide to over 2,500 transistor and novelty radios. History and key to collecting chapters, 170 pages.* \$19.95

**Price Guide**

**Old Time Radios!**  
RESTORATION AND REPAIR  
Joseph J. Carr

**Fixing Up Nice Old Radios** by Ed Romney. *Written by a retired radio instructor. Plastic binding. 300+ figures, 185 pages.* \$29.00

**Old Time Radios Restoration and Repair** by Joseph J. Carr. *A self-paced training guide. History, theory and practical operation of antique and classic radios. 200 illustrations, 256 pages.* \$19.95

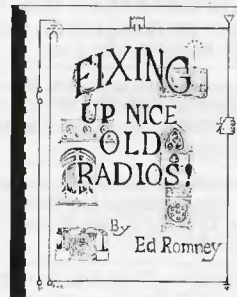

U.S. Orders Enclose \$3.00 per order for packing & book-rate shipping if total order is under \$35.00. If using VISA or MasterCard, include name on card, card number and expiration date. Send payment with order. Mass. residents add 5% sales tax. Money back return policy. Softcover unless stated otherwise. Most orders shipped the same day received, but allow 2-4 weeks to receive order. Foreign orders - write for shipping costs, or use credit card and specify air or surface (allow 2-3 months for surface shipping).

VISA A.R.C., P.O. Box 2, Carlisle, MA 01741 Tel: (508) 371-0512  
Fax: (508) 371-7129 Web: <http://www.antiqeradio.com/>



(Aug-97)

**Price Guide**

tion to troubleshooting and repairing AC table model radios. 145 pages. \$14.95

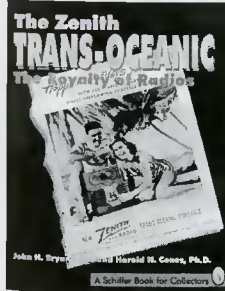

**The Zenith Trans-Oceanic: The Royalty of Radios** by Bryant and Cones. *Presents the fascinating story of the development and use of the Trans-Oceanic. Several photos, documents, ads, etc. 160 pages.* \$24.95

**Communications Receivers, 3rd Ed.** by Ray Moore. *Information on vacuum tube receivers by 66 manufacturers. 402 radios illustrated, 115 pages.* \$19.95

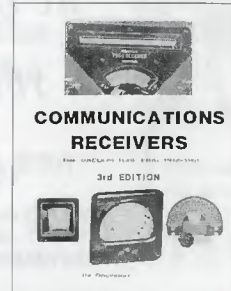

U.S. Orders Enclose \$3.00 per order for packing & book-rate shipping if total order is under \$35.00. If using VISA or MasterCard, include name on card, card number and expiration date. Send payment with order. Mass. residents add 5% sales tax. Money back return policy. Softcover unless stated otherwise. Most orders shipped the same day received, but allow 2-4 weeks to receive order. Foreign orders - write for shipping costs, or use credit card and specify air or surface (allow 2-3 months for surface shipping).

VISA A.R.C., P.O. Box 2, Carlisle, MA 01741 Tel: (508) 371-0512  
Fax: (508) 371-7129 Web: <http://www.antiqeradio.com/>



(May-97)



Could you write an article for A.R.C.? \_\_\_\_\_ On what subjects? \_\_\_\_\_

Describe your specialties \_\_\_\_\_

What do you like best about A.R.C.? \_\_\_\_\_

What do you like least about A.R.C.? \_\_\_\_\_

What type of articles would you like to see? \_\_\_\_\_

Comments: \_\_\_\_\_

### COLLECTING INTERESTS

- |                              |                                |                         |
|------------------------------|--------------------------------|-------------------------|
| _____ Radios, battery, '20's | _____ Radios, other            | _____ Cylinder phonos   |
| _____ Radios, pre-1920       | _____ Television, CRT          | _____ Disc phonos       |
| _____ Radios, batt. superhet | _____ TV, spinning disk        | _____ Electric phonos   |
| _____ Radios, crystal sets   | _____ TV, projection           | _____ Broadcast equip.  |
| _____ Radios, cathedral AC   | _____ Speakers, horn type      | _____ Test equipment    |
| _____ Radios, table AC       | _____ Speakers, cone type      | _____ Meters, panel     |
| _____ Radios, console AC     | _____ Speakers, misc. type     | _____ Hi-fi equipment   |
| _____ Radios, Bakelite       | _____ Vacuum tubes             | _____ Telephones (old)  |
| _____ Radios, celluloid      | _____ Transmitters, tube       | _____ Telegraph items   |
| _____ Radios, plastic        | _____ Transmitters, spark      | _____ Microphones       |
| _____ Radios, amateur        | _____ Components               | _____ Jukeboxes         |
| _____ Radios, classic        | _____ Magazines, radio         | _____ Light bulbs       |
| _____ Radios, transistor     | _____ Books, radio             | _____ Electric gadgets  |
| _____ Radios, automobile     | _____ Catalogs, radio          | _____ Medical equipment |
| _____ Radios, shortwave      | _____ Literature, misc.        | _____ Other _____       |
| _____ Radios, novelty        | _____ Advertising items        |                         |
| _____ Radios, character type | _____ Novelties, radio related |                         |

Thank You... John V. Terrey, Publisher

9/97

### Price Guide

Lane and David Lane. *Identification guide to over 2,500 transistor and novelty radios. History and key to collecting chapters, 170 pages.* \$19.95

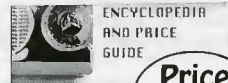

### Price Guide

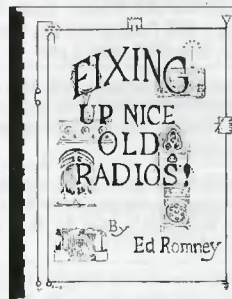

**Fixing Up Nice Old Radios** by Ed Romney. *Written by a retired radio instructor. Plastic binding. 300+ figures, 185 pages.* \$29.00

**Old Time Radios Restoration and Repair** by Joseph J. Carr. *A self-paced training guide. History, theory and practical operation of antique and classic radios. 200 illustrations, 256 pages.* \$19.95

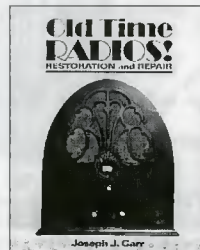

U.S. Orders Enclose \$3.00 per order for packing & book-rate shipping if total order is under \$35.00. If using VISA or MasterCard, include name on card, card number and expiration date. Send payment with order. Mass. residents add 5% sales tax. Money back return policy. Softcover unless stated otherwise. Most orders shipped the same day received, but allow 2-4 weeks to receive order. Foreign orders - write for shipping costs, or use credit card and specify air or surface (allow 2-3 months for surface shipping).



A.R.C., P.O. Box 2, Carlisle, MA 01741 Tel: (508) 371-0512

Fax: (508) 371-7129

Web: <http://www.antiqueradio.com/>



(Aug-97)

# Order These Popular Books From Antique Radio Classified



**Crystal Clear Volume 1 and Crystal Clear Volume 2** by Sievers. *Comprehensive reference to crystal sets, crystal detectors, and crystals. Each volume contains different illustrations and information. Order by volume.* \$29.95

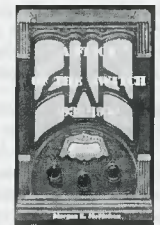

**Flick of the Switch** by Morgan McMahon. *The classic photo reference guide for 1930s 1950s radios. 1000+ photos of radios, 5" x 8" 263 pages.* \$11.95

### NEW BOOKS.....

**Radio!Radio! 3rd Edition.**, Hill. *New transistor radio section, includes directory of 3,000 transistor radios. Brought up-to-date. 75 new pages, 50 new illustrations. 320 pgs.....* \$64.95

**Classic Plastic Radios of the 1930s and 1940s A Collector's Guide to Catalin Models, Sideli.** *It's back! Over 200 models from 25 manufacturers listed in full color.....* \$19.95

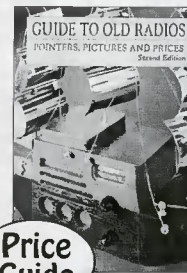

**Guide to Old Radios, Pointers Pictures, and Prices, 2nd Ed.** by Johnson. *Introduction to radio collecting. Includes hundreds of photos and a price guide. 272 pages.* \$19.95



**Antique Radio Restoration Guide, 2nd Ed.** by Johnson. *Beginner's introduction to troubleshooting and repairing AC table model radios. 145 pages.* \$14.95

### Price Guide



**The Zenith Trans-Oceanic: The Royalty of Radios** by Bryant and Cones. *Presents the fascinating story of the development and use of the Trans-Oceanic. Several photos, documents, ads, etc. 160 pages.* \$24.95

**Communications Receivers, 3rd Ed.** by Ray Moore. *Information on vacuum tube receivers by 66 manufacturers. 402 radios illustrated, 115 pages.* \$19.95

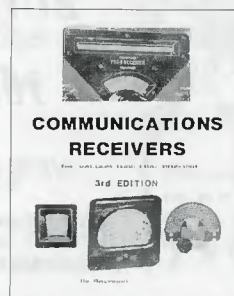

U.S. Orders Enclose \$3.00 per order for packing & book-rate shipping if total order is under \$35.00. If using VISA or MasterCard, include name on card, card number and expiration date. Send payment with order. Mass. residents add 5% sales tax. Money back return policy. Softcover unless stated otherwise. Most orders shipped the same day received, but allow 2-4 weeks to receive order. Foreign orders - write for shipping costs, or use credit card and specify air or surface (allow 2-3 months for surface shipping).



A.R.C., P.O. Box 2, Carlisle, MA 01741 Tel: (508) 371-0512

Fax: (508) 371-7129

Web: <http://www.antiqueradio.com/>



(May-97)



**FOR SALE:** 1950's record directories/catalogs for 33, 45 & 78 records. Dan Gutowski, 12132 Cavell, Livonia, MI 48150. (313) 261-5058

**FOR SALE/TRADE:** Beautiful Atwater Kent Mod 90 cathedral - \$600. RCA Mod 19 cathedral - \$200. Jax cathedral (as seen on p. 16, E.O.R. II) - \$300. Call: Larry Drago, 383 Lincoln Dr., Cheshire, CT 06410. (203) 272-6030 or fax: (203) 272-2002. E-mail: theradioman@webtv.net

**FOR SALE:** Huntron Tracker semiconductor analyzer, with service manual and probes - \$250. Tom Bump, 4127 142nd Ave., NE, Lake Stevens, WA 98258. (425) 334-4732. E-mail: tbump86857@aol.com

**FOR SALE/TRADE:** Radiola Super VIII, chassis only, no tubes or speaker; has knobs, dials, and pointers, some rust. Also Philco Model 87 chassis only, no knobs; has tubes and speaker, some rust. Looking for good condition Zenith Golden Triangle or Regency TR1 or offers. S&H extra. Danny Sertich, 5870 Brookgreen Rd., Atlanta, GA 30328. (404) 255-6761

**FOR SALE:** 21' Philco Predicta tandem w/25" cord, working - \$850. Philco #90, exc - \$400. Edison standard cyl. phono w/large horn plus crane - \$650. AK #84, exc - \$375. GM "Little General" - \$290. Philco 70 - \$275. Tabletop louvered Columbia Graphonola - \$225. Victor 1-2 small crank phono - \$150. Scott 222C stereo tube amp - \$110. Pair McIntosh #ML 1C spkrs, refoamed, exc - \$350. Westinghouse RC (RA-DA) - \$275. Call: J.L. Acclavatti, PO Box 806, Upton, MA 01568. (508) 476-3229

**FOR SALE:** Two 7027A tubes; unique 1960s wall radio, built into a 23" x 17" picture. Charles Harper 2000 Jackstown Rd., Paris, KY 40361 (606) 484-9393

**FOR SALE:** Mitchell Lumitone lamp radio, case restored, chassis rebuilt, new shade - \$300. Alvin Heckard, RD1 Box 88, Lewistown, PA 17044



**BUY/SELL**

**TUBES**

**NEW & USED**

SEND FOR OUR "WANT LIST"  
OR  
OUR FREE 1997 CATALOG

**ELECTRON TUBE ENTERPRISES**  
P. O. BOX 8311  
ESSEX, VT 05451-8311

TEL: 802-879-1844  
FAX: 802-879-7764

EMAIL: etetubes@vbimail.champlain.edu

**FOR SALE:** Zenith Trans-O H500, vg++, original - \$160. (3) small metal sets - \$79. Stromberg stereo 8 amp - \$79. Dyna; PAM 1 - \$35; FM 1 - \$40; FM 3 - \$50. Rob Taylor, PO Box 161 Frankfort, MI 49635. (616) 352-7672

**FOR SALE:** (1) Altec IIA attachment for 639, N.I.B. - \$45. (1) RCA 44BX Sain and Umber, vg - \$800. Marcel Vailee, 703 Boul Saint-Germain, Rimouski, Quebec, Canada G5L 3S6

**FOR SALE:** S-7B4, S-7B8, S-7A6, S-7A8, N.O.S. - \$15 + tax. Louis L. Veltre, 643A Sherwood, Lakehurst, NJ 08733-4207 (908) 657-7592

**FOR SALE:** FM receivers: Realistic RP 30/50 - \$15; Lafayette PF175 LF/HF - \$20; Patrolman PR03A LF/HF/UHF - \$30. Dave Fearing, 1072 Sea St., Quincy MA 02169. (617) 773-6436

**FOR SALE:** Used 807 tubes, tested OK, guaranteed - \$5 ea. + \$3 priority mail. James T. Schlietstet, W4IMQ, PO Box 93, Cedartown, GA 30125. (770) 748-5968. E-mail: imq@bellsouth.net

**FOR SALE/TRADE:** Pilot Model T-502, BC and SW white Plaskon cabinet w/black wraparound grille and large gold face dial - \$500. Vogue pedestal speaker, emerald green w/gold leaf Repwood grille & base - \$600. Limited edition Amplion horn speaker in black and brass cathedral metal cabinet (the most beautiful version I've ever seen) - \$700. Midget Co. cone pedestal speaker, approx. 6" in diameter, N.I.B. - \$200. Call: Larry Drago, 383 Lincoln Dr., Cheshire, CT 06410. (203) 272-6030 or fax: (203) 272-2002. E-mail: theradioman@webtv.net

**FOR SALE:** DeForest, (3) honeycomb coils with crown mounting - \$45. (3) Edison battery oil bottles - \$8 ea. (18) Little Wonder records, pat. 1909 - BO. Herman Fothe, 5292 Tiffany Ann., West Palm Beach, FL 33417 (561) 688-2794

BUY • SELL • TRADE

## CATALIN RADIOS

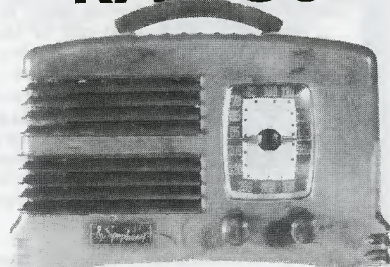

I'll buy single pieces or  
whole collections. Top prices paid.

**RADIOART**

Jim Meehan  
P.O. Box 102 • Centerbrook, CT 06409  
(860) 526-1762

# The Collector's Guide To Antique Radios - 4th Edition

By Marty & Sue Bunis

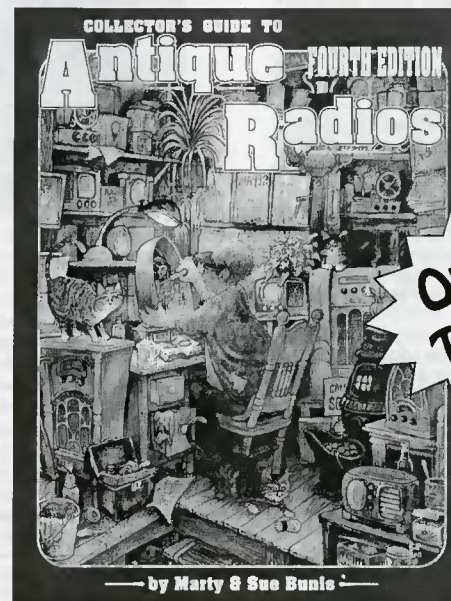

**Order  
Today!**

**8,500+ Battery & AC sets from the '20s - '60s**  
**400+ color photographs**  
**Updated prices**  
**\$18.95 - Softcover**

There are no transistor radios listed in the fourth edition. You will find them in *The Collector's Guide to Transistor Radios* available from A.R.C. for \$16.95.

U.S. Orders Enclose \$3.00 per order for packing & book-rate shipping if total order is under \$35.00. If using VISA or MasterCard, include name on card, card number and expiration date. Send payment with order. Mass. residents add 5% sales tax. Money back return policy. Softcover unless stated otherwise. Most orders shipped the same day received, but allow 2-4 weeks to receive order. Foreign orders - write for shipping costs, or use credit card and specify air or surface (allow 2-3 months for surface shipping).



A.R.C., P.O. Box 2, Carlisle, MA 01741 Tel: (508) 371-0512

Fax: (508) 371-7129

Web: <http://www.antiqueradio.com/>



(Apr-97)



**FOR SALE:** Used tubes: 5U4GB (40) - \$2.50 ea.; 6BK4 (50) - \$4 ea.; 6JB6/6LQ6 (85) - \$15 ea.; 5965 (284), equal to 12AV7 - \$1 ea. All tubes tested good. Call, fax or write to: George Stagakis, 1714A 41st St., North Bergen, NJ 07047 (201) 867-9136. Fax: (201) 867-4044

**FOR SALE:** Master violet ray, in box - \$25. Nice B&O Beomaster 3000 - \$225. B&K 707 - \$65. Precision 612 - \$30. B&K color & B/W rejuvenators - \$40 & \$25. Akai X-200D 3-motor deck, x-fid - \$60. Heath AA-141A preamp - \$40. Display of Recoton needles, #90+ - BO/ all. B&H & Heath scopes - \$20 & \$35. B-B RCA 201 N.I.B. & B-B Cunningham C-300 w/tp. N.I.B. stickers on both - BO. JVC port VCR - \$20. More! SASE for 5 pp. list. **WANTED:** Zenith #5619 chassis, Emerson 520 or similar back, transistor trades. Thanks! Michael L. Hagan, 428 Sharron Dr., Woodway, TX 76712. (254) 776-4760

**FOR SALE:** Tubes: (3) GE6CA7 - \$25 ea. (2) GE6550A - \$20 ea. (2) 45 - \$40. (4) 6JE6/6LQ6 - \$30. (2) 6L6G - \$18. (1) 813 - \$25. (1) 171A - \$35. Have many 12AU7A - \$3. 12AX7A - \$6. 6BQ5 - \$7. 6FQ7 - \$7. 6SN7GTB - \$5. 12BE6, 12BE6 35W4, 50C5 - \$2. 6EA7 - \$1.50. 6EN4 - \$3. Above all N.I.B. Used tested: (2) 10/VT25 - \$25. 80ST - \$4. Globe 280 - \$20. Have many others and lots of sweep tubes. Call or write: Tony Rinaldo, 308 Lenox Ave., Oneida, NY 13421 (315) 363-3644

**FOR SALE:** New tubes: two 6146B - \$12 ea., two 8156 - \$8 ea., one 12DW7/7247 - \$14; one 866A - \$8; one 2050 - \$7; one 7189 - \$8; five 6AL5s - \$4 for all. Classic Radio & Television, 541 Riverside Dr., Box 61 Augusta, ME 04330. (207) 623-2059

**FOR SALE:** Rider's Troubleshooter's Manuals, Vol. 1 or 2 - \$300. RCA 45 rpm record player Model 45-J-2, with new cartridge. Harry Kundrat, 29 Walton Ave., New Providence, NJ 07974. (908) 665-1873

## Visit the A.R.C. Web Site!

The URL to access the A.R.C. Web site is:  
<http://www.antiqueradio.com/>

Our site includes highlights from current and recent issues:

- Editor's Comments
- Image of the Cover
- Feature Article
- Radio Miscellanea

- Plus:
- Photo Reviews
  - Book Reviews
  - Coming Radio Events
  - Complete Club Listing
  - List of Books For Sale
  - Subscription Information

While visiting our site, you may send e-mail and orders for books, videos and subscriptions.

Let us know what you think about A.R.C. on the Web!

**FOR SALE:** Good used tubes. One UX171A - \$15. One 71A - \$20. Four UX226 - \$7 ea. One CX 326 - \$10. One 37 globe - \$10. Two Majestic 27s - \$8 ea. One 5Y-227 - \$5. One UY-227 - \$5. One Y-227 - \$5. Classic Radio & Television, 541 Riverside Dr., Box 61 Augusta, ME 04330. (207) 623-2059

**FOR SALE:** 1 Malone-Lemmon Model C Stenola Supreme cabinet, vg - BO. 2. Freshman Masterpiece Model 6F6, 1926, cabinet only, vg - \$25. Espey portable 1938? Model Tommy Dorsey, vg - \$30. Gilbert Simpson, 18 Beechwood Dr., Ansonia, CT 06401 (203) 734-4085

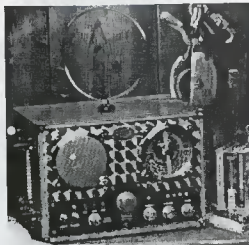

**FOR SALE:** Spirit of St. Louis 1940's military style receiver whose ancestors once reported troop movements on the Western Front. You flip on the toggle switch, the indicator light turns on, and you leap forward into the 21st century. Tune the lighted airplane dial to your favorite AM or FM station, fine tune the loop antenna with the rotary dial and sit back. You'll enjoy the great sound and tone. Beautifully constructed with its wood cabinet, chiseled aluminum dash, AM-FM, TV-1 & TV-2, weather band, cassette. Four side handles, portable AC/DC with adapter included, batteries not included. Units dimensions are: 15 1/2H x 14 3/4W x 8 1/2D - \$99.95 inc. S&H. Send your check or money order to: Ben Martin, 20885 Redwood Rd., Castro Valley, CA 94546. (510) 582-6804

**FOR SALE:** Hallicrafters portables: TW-1000 - \$125. TW-500 - \$100. S-72 - \$75. S-140, complete station; HT-40, HA-5 VFO, and attached Dow TR switch - \$200. S-86 receiver - \$100. Please add shipping and handling to each item above. Loren H. Dudley, 14 Valley Rd., Bath, ME 04530-2811 (207) 442-8419

**FOR SALE:** National HRO50 - \$295. NC109 - \$115. RME 45 speaker - \$85. Hallicrafters SX-71 - \$195; SX-100 - \$250. Gonset G-11 - \$75. Heath DX-40 - \$85. Ameco TX-86 - \$95. Conar 400 - \$45. New list - free! Richard Prester, 131 Ridge Rd., West Milford, NJ 07480. (973) 728-2454

**FOR SALE:** Play those oldies on this professional 4-speed phonograph with treble, bass and pause controls, 6 x 9 speaker, aux. inputs and outputs - \$39. John Walch, 381 County Route 17 Bernhards Bay, NY 13028. (315) 675-8135. E-mail: Jwalch@juno.com

**FOR SALE:** Ampex SP300 tape recorder, seven channels, transport similar to 350 - \$400. Vintage plastic/Bakelite phono collection, approx. 10 pieces, prefer to sell as one lot Zenith H664, twin-seven, etc. - \$475. Phil Van Praag, W282 S3580 Ringneck Ct., Waukesha, WI 53188. (414) 524-9856, please call before 8 pm CST

**FOR SALE:** Audio limiters: RCA BA-6, Collins 26W, Gates SA-39B, Gates Sta-Level - Offers? John Tiedeck, 212 Grandview Rd., Media, PA 19063. (610) 566-8049

**WANTED:** Large Amperex tube manual from the 1950s/1960s. Also, odd or unusual tube types. Will pay \$100 for Eimac 500T tube. John H. Walker Jr., 16112 W. 125th St., Olathe, KS 66062. (913) 782-6455. E-mail: johnh.walker@alliedsignal.com

**WANTED:** Knobs and escutcheon for Grunow Mod 501 radio, (see Stein's Machine Age, Vol. 1 pg. 112). Jeff Hoskins, 824 E. Madison Ave., Stuart, FL 34996. (561) 283-2291 after 7 pm

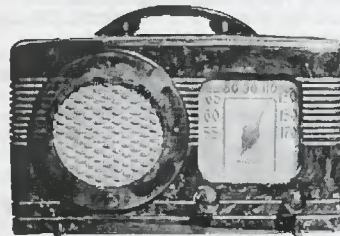

**WANTED:** Motorola Catalins. I have been commissioned by the Almighty Himself to gather as many of these wonderful jewels for preservation before judgment day is upon us. Forsake these worldly objects before it's too late! I pay cash. Please write or call collect: Rain Buttignol, 214 State St., #7 Portsmouth, NH 03801 (603) 427-1384

**WANTED:** Yaesu FRG-7 shortwave receiver. **FOR SALE:** 1954 radio handbook - \$15. Daniel Seidler 3721 W. 80 St., Chicago, IL 60652-2415. (773) 284-8221

**WANTED:** Knobs for Victor radio Model No. R35. Jack Ghere, 1753 Community Beach Rd., Odun, IL 62870. (618) 532-5548

**WANTED:** Philco cathedral cabinet Model 80-202, good working 37-84 chassis & speaker. F.E. Oswald, 711 Cail Ave., Altoona, PA 16602. (814) 944-7199

**WANTED:** Information on Feldstern-McCusker Co., Philadelphia and their 1927 "Electron" battery radio. Mike Parker KB7RSS, 945 S.E. Linn St., Portland, OR 97202-7027

**WANTED:** Phonograph related items: best prices for Vogue picture records, Edison, Columbia, and any wax cylinder records, toy phonographs, needle tins and cutters, Nipper, record dusters, puzzles, fans, calendars, pocket advertising mirrors, dealer lapel pins, phonograph toys, posters, broadsides, original dealer advertising items from Edison, Victor and Columbia. Thank you. Bernie Seinberg, 714 Moredon Rd., Meadowbrook, PA 19046-1907 (215) 886-6124. E-mail: phonoman-bernie@worldnet.att.net

**WANTED:** Operation/technical manuals: Scopes, Hickok 675, RCA-WO33A, Tektronix RM503; Hickok 156 traceometer, Lafayette TE25 CR analyzer Generators: RCA WR59B, Precision E200C, Eico 324; HP 510B meter. Noel S. Ilg, 228 Beck Rd., Avon Lake, OH 44012. (440) 933-5668. Fax: (440) 933-8864

**WANTED:** Used Western Electric 350B - \$110, mesh 252A - \$80, 300A - \$300, 104D - \$50, National Union 350B - \$50, SP 2A3 - \$60. New tubes higher. WE2A power supply with tubes - \$310. Ming Yang, 1995 University Ave., #119, Berkeley, CA 94704. (510) 376-4220. Fax: (510) 376-8861 E-mail: zoldtubes@aol.com

**WANTED:** Philco help, need working chassis for Philco console Model 20 or power transformer for same. Many thanks. Loren H. Dudley, 14 Valley Rd., Bath, ME 04530-2811 (207) 442-8419

**WANTED:** Atwater Kent items. AK display lamps, AK green horn, AK 12, AK 10 w/green cans. All items must be original and in excellent condition. Pay your price. Keith Cenedella, PO Box 6763, Thousand Oaks, CA 91359-6763. (805) 492-7111

**WANTED:** For 1950 Chevrolet truck radio Model 986443. Combination power, volume and tone switch part number 7256188. N.O.S. or good used. Gregg Humanic, 540 Wicklow Ln., Monroe, OH 45050. (513) 539-8926

**WANTED:** Almost all Western Electric tubes, 205D/E, tennis ball shape only - \$350. 300A/B - \$650. 252A - \$675. Etc., other brands, balloon shape only, 10, 45, 50, 80. Call, fax, or write to: George Stagakis, c/o George's Antique TV & Radio Repair 1714A 41st St., North Bergen, NJ 07047 (201) 867-9136. Fax: (201) 867-4044

**WANTED:** Eucharistic minister seeking Catalins, beetle, Plaskon, Detrolas, Kadettes, Fada, Addison, transistors. Bob Masterson, Box 172, Valley Cottage, NY 10989. (914) 353-3151 E-mail: BMradio@aol.com

**WANTED:** Bakelite radio panels, blank 7" x 19" or other sizes. Bob Mattson, KC2LK, 10 Jane Wood Rd., Highland, NY 12528-2607 (914) 691-6247 E-mail: bobmattson@juno.com

**WANTED:** E.H. Scott! E.H. Scott! E.H. Scott! Interested in Scott battery and A.C. sets, military, accessories, advertising and literature. John & Kathy Slusser, Radio Daze, PO Box 144, Mendon, NY 14506. (716) 624-9755. Fax: (716) 624-7857. E-mail: info@radiodaze.com

**WANTED:** Supreme Publications volumes (schematics) for 1949, 1954 and 1955. Zach Taylor, 1413 Broadway, Lincoln, IL 62656. (217) 735-3772

**WANTED:** Book showing the Pooley cabinets that were made for AK radios in the 20s. Bill Schultz, 7213 Donet Ct. NE, Rio Rancho, NM 87124. (505) 867-8178

**WANTED:** Zenith Stratosphere 25-tube, Crosley WLW (large console with 4 chassis), E.H. Scott Philharmonic w/cabinet & good chrome. Grant Steger, 627 N. Main St., Juneau, WI 53039. (920) 386-2575, 5 to 9 pm

**WANTED:** Tubes. 6SK7WGT EZ900, 6BL5, 2160, Sylvania gold brand 6X4W. Tom Miller, PO Box 20138, London Terrace Station, New York, NY 10011 (212) 675-7704, eves.

<b>CATALIN</b>	<b>WANTED</b>
<b>WANTED</b>	<b>RADIOS</b>
<b>TOP PRICES PAID!</b>	
<b>Michael Lawlor</b> P.O. Box 179 Santa Barbara, CA 93102 (805) 682-2336	



**FOR SALE:** (1) Grundig R/R tape recorder Model TK-35, original, no scratches, clean, untested - \$150 + S/H. Carlos Gimenez, 15091 Shamrock Dr., Fort Myers, FL 33912. (941) 482-0198

**RATE FOR ADDITIONAL WORDS:  
27¢ per word**

**FIRST 20 WORDS FREE!**

*Cash or stamps OK for small amounts.  
Your payment helps to keep A.R.C. healthy!*

**FOR SALE:** RCA 45 45EY2 player & amp untested - \$37 45J 45 early, no amp - \$25. 45J2 45, no amp - \$25. 2-tube RCA amp and 2 parts units 45 pans, all - \$20. (50) assd. binding posts and clips - \$8. Meissner signal shifter Model EX, no outer case, untested - \$45. Flash photo bulbs, single contact type - 15¢ ea. Eico 950-A rescap bridge w/papers - \$27.50. Superior 76 CR bridge and signal tracer - \$25. Eico 214 VTVM, large 6 1/2" meter - \$25. Mixed TV knobs, 1 lb. - \$5. Mix 1 lb. resistors - \$7.50. RCA VTVM WV 77-E, clean, papers - \$20. Still have some Simpson 260 VOM as parts units - \$6 ea. Some Heath-Eico VTVM and some parts units. Heath Vectorscope 10-101 for TV - \$25. Have scopes 3" to 8" RCA 100-A speaker, only - \$10. Lot dial drive parts shafts for Philco, 1930 sets - \$10. Mix of 50. Volume-tone bias controls - \$10. Dial scale mix - \$10/10. 25 assd. sockets - \$5. (4) VOMs parts units - \$18. (5) VOMs parts units - \$18. Emud Junior 196 radio Rekord, wood cab needs clean up - \$30. Small round case avoid trans. 5 assd. - \$10. Superior genemeter TV 50-A signal gen. - \$30. 50 watt 150Ω rheostat - \$4. Pair Shure hand mics, both - \$20. Lot 7-CB hand mics, all - \$21 RCA 3BX671 batt-AC port leather case, knob missing, needs some service - \$60. Nordmende Transita export port AM/FM 2 SW bands - \$30. Zenith Royal 3000-1 port. plating has some pitting - \$65. Watch case meters, list SASE. Radio World, (6) copies, 1922 - \$24. (5) small AM/FM sets, all - \$20. (5) assd. AM small sets transt., all - \$20. Have (1,000s) of unlisted items. All plus shipping. Write wants, LSASE. Min. orders - \$8. Have a tube and paper list, SASE ea. F. Krantz, 100 Osage Ave., Somerdale, NJ 08083-1136. (609) 783-0400

**FOR SALE:** Browning RJ-20A AM/FM tuner - \$75; Granco UHF TV audio receiver - \$15. Glenn Hendrix, HC70, Box 117, Ardmore, OK 73401 (405) 226-4644 or (405) 223-6709

**FOR SALE:** Panasonic TR-1000P 1 1/2" CRT TV, in box - \$175 plus shipping. Richard Jendrucko, 458 Hillvale Turn East, Knoxville, TN 37919. (423) 523-7323

**FOR SALE:** RCA power amp Model M1-12236, w/cage - \$85. Norton Thompson, Box 422, Paonia, CO 81428. (970) 527-3017

**10 BAND MINIATURE SHORTWAVE RADIOS!**

Listen to the entire world! This unusual shortwave radio, 7 x 1 1/4 x 3 1/8 inches, is one of the smallest and most sensitive radios ever built. It has AM/FMMV and 7 shortwave bands; you can listen to the entire world! It uses only two AA batteries or 3-volt adapter (not included). The cost including shipping and insurance is: Only \$35.00 per set N.I.B. 12, 9, 3 bands also available. If you purchase 2 or more, 10% discount will apply! E-mail: [RGENBENT@AOL.COM](mailto:RGBENT@AOL.COM).

Call 908-607-0299, Fax 908-679-8524.

Mail your check or money order to:

R.G.B. Enterprises, Dept. 71

P.O. Box 5367, Old Bridge, N.J. 08857, U.S.A.

**FOR SALE:** Want your radio shop to have that 1930s look? Buy these three pieces of antique test equipment, all large black cabinets: NRI Signal Tracer, NRI Resistor Capacitor Tester and EM Multimeter - \$100 plus shipping. Maurer Television, 29 S. 4th St., Lebanon, PA 17042. (717) 272-2481

**FOR SALE:** N.I.B. Sylvania 2A3 - \$53 ppd. (130) issues A.R.C. 09/86 through 06/97 - \$100. Al Haasken, 8422 Berea Dr., Vienna, VA 22180. (703) 560-4869

**FOR SALE:** Philco S1930 light green plastic, no cracks, half round dial on top - \$75. M. Leopold, 788 Duxbury Ln., Bartlett, IL 60103. (630) 289-8788

**FOR SALE:** National 1-10 receiver - \$150+. National NC-101X, various equipment, tubes, parts, coils. Hundreds of books/catalogs/old QSTs - SASE for list. John Travis, 66 Willowbrook Rd., Asheville, NC 28805. (704) 298-1847

**FOR SALE:** Stromberg-Carlson stereo tube amp & preamp Models ASE-8 & ASP-80, rated at 40 watts/ch, vg condition. Asking - \$143 + shipping. Sheldon Kane, 360 Rhinecliff Dr., Rochester NY 14618. (716) 442-6338. E-mail: [Auxch@aol.com](mailto:Auxch@aol.com)

**FOR SALE:** Dynaco PAT-4 pre-amplifier, Dynaco stereo 120 amplifier, H.H. Scott FM broadcast monitor tuner 4312, and Tandberg 64 reel-to-reel tape recorder. See you at the VRPS/AWA convention in Dallas in October. Thomas Peters, PO Box 3925, McAllen, TX 78502

**FOR SALE:** Craftsman C-250 tube amp and CT-3 tuner - \$100. Viking 85RMQ deck and tube electronics - \$90. Charles Johnson, 21 Holly Hill Dr., Mercer Island, WA 98040. (206) 232-2040

**FOR SALE:** Regency MR-10B1 hi-band receiver - \$25. Zenith 6D612, black dial table model - \$40. Jim Ligouri, 7 Sycamore Ct., Atkinson, NH 03811 (603) 362-5712. E-mail: [jligouri@aol.com](mailto:jligouri@aol.com)

**FOR SALE:** Taking bids. Radiola III with tubes, headset & original instruction booklet. Bids close 9/15. Tom Tamberelli, 106 Carpenter St., Muncy, PA 17756. (717) 546-6515

**FOR SALE:** Tubes, new, used, WE, Arcturus, Lighthouse, (60,000) others. SASE with wants, fast response. Joe Pratt, Tube Central, 53 Liberty St., Clark, NJ 07066

**FOR SALE:** Fisher KX100 amplifier - \$75. RCA BX6 portable - \$15. **WANTED:** RCA 2XF941 AM/FM. All items plus UPS. Jon Andreasen, PO Box 22, Newton, NJ 07860. (973) 579-6261 6-9 pm Eastern. E-mail: [jdjaandreasen@Compuserve.com](mailto:jdjaandreasen@Compuserve.com)

**WANTED**

**WESTERN ELECTRIC**

**TUBES, SPEAKERS, HORNS & AMPS**

**TUBES:** Telefunken, Genalex, RCA, Radiotron, etc. **General Electric, Ampere, JAN, Sylvania, GEC, National Union**

**McIntosh, Marantz, Dynaco, Jensen, Linn, Levinson, Fisher, Leak, Tannoy, Altec, EV, Thorens, EMT JBL ... Amps, Spkrs., Turntables**

**MAURY CORB**

12325 Ashcroft, Houston, TX 77035

Tel: (713) 728-4343 Fax: (713) 723-1301

**WANTED:** Fada Catalin Model 652, 1000 and so on. Radio should be original, excellent condition and working. Takashi Doi, 1-21-4, Minamidai, Seyaku, Yokohama, 246 Japan. Fax: 011-8145-301-8069. E-mail: [takadoi@kk.ij4u.or.jp](mailto:takadoi@kk.ij4u.or.jp)

**WANTED:** Info, schematic for National receiver high freq., Type HRO, 9-tube. Joe Wood, 6511 Chester Hodgkins, IL 60526

**WANTED:** Anything on "The Chicago Theater of the Air" or Marion Claire. Eric Beheim, 25114 Oak Ln., Descanso, CA 91916

**WANTED:** Homebrew or kit regenerative receivers from the 1920s. One to three tubes preferred. Doug Fox, 603 S. 12th Ave., St. Charles, IL 60174. (630) 584-5915

**WANTED:** Pre-war television receiver, electronic and/or mechanical. I would also like to meet and correspond with others who are interested in collecting vintage TVs. I work an odd rotating schedule, so please write or leave message when rates are cheap. I will call back at your convenience. Thanks. Mike Drown, PO Box 2101 Imperial, MO 63052. (312) 942-1387

**WANTED:** Dial assembly and/or chassis for Silvertone Model 1981 console radio, also power supply transformer with 5v & 2.5v f.l. windings for Silver-Marshall radio. Craig Huffman, 5020 West Ave., Ashtabula, OH 44004. (216) 992-0562

**WANTED:** 1950s Teletype/font sets. Write for samples required. Top dollar paid. Consider entire machine. Bill Clement, 3400 Quirt, Lubbock, TX 79404. (806) 747-9005. Fax (806) 747-8602

**WANTED:** Zenith 6-S-656 chassis in working condition. Don't need tubes, knobs or speaker. Ross W. Hoff, 1510 Rolling Meadows, Vermilion, OH 44089. (216) 967-7591

**WANTED:** Patterson radios, from crystal sets to consoles. Also communication receivers PR-15 or Deluxe 16. Randy Patterson, 9104 E. Farm Rd. 116, Strafford, MO 65757 (417) 736-2354

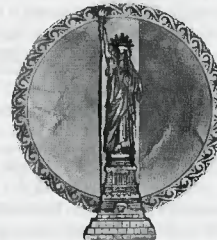

**WANTED:** This and other metal framed speakers especially Pathé, Grecian and Tower (as shown on page 13 Feb. 1996 A.R.C.); also Tower Castle and Tower Pirate Ship speakers (pictured on pages 6 & 7 Sept. 1993 A.R.C.). Richard Howarth, PO Box 9, Junortoun 3551 Victoria, Australia. Phone/fax: (3) 54-493207

**WANTED:** Tube setup information, Triplett (3214) newer setting, power transformer for B&K 606 tester. Larry Cook, 362 E. South St., Richland Center, WI 53581-2721

**WANTED:** Crystal sets, crystal radio kits, toy crystal sets and pocket crystal radios. Erwin Macho, Ambrosweg 17/A/8, A-1230 Vienna, Austria

**WANTED:** I need the RCA Red Book Annual Volumes for 1933, 1934, 1935, 1941 and 1942. I am willing to pay \$25 for each edition in nice condition. Also buying pre and postwar Radio Retailing (\$10 and \$5/issue respectively), Radio Today, Radio-Music Merchant, Radio Record and other trade magazines. Tell me what you have! Mark V Stein, 2109 Carterdale Rd., Baltimore, MD 21209. Fax: (410) 466-0815. E-mail: [radianman@crosslink.net](mailto:radianman@crosslink.net)



**WANTED:** Air King Skyscrapers, wealthy extraterrestrial seeks examples of this architectural marvel for new intergalactic communications museum. Please write or call collect: Rain Buttignol, 214 State St., #7 Portsmouth, NH 03801 (603) 427-1384

**WANTED:** Detrola radio/phonograph with push buttons. Detrola wood tabletops and consoles. Scott Flaughter, 41100 Plymouth Rd., Plymouth, MI 48170. (313) 451-4221 E-mail: [scottflaughter@unn.unisys.com](mailto:scottflaughter@unn.unisys.com)

**FREE - 20 WORD AD EACH MONTH**  
To get your free 20 words,  
include your SUB# with your Ad.  
Additional words are 27¢ each.  
Read inside back cover for details.  
**MANY THANKS!!!!**

**WANTED:** Brighton "True-Blue" UV-201A tubes. Top dollar paid for good or duds. Ernie Hite, 2625 Colecreek Ln., Rock Hill, SC 29732. (803) 366-9998

**WANTED:** Fresh 3000- and 6000-volt capacitors to repair 1940s TV 7JP4 CRT Wilbert K. Kimple, 3015 Kelsey Creek Rd., Spartanburg, SC 29302. E-mail: [WKKimple@aol.com](mailto:WKKimple@aol.com)

**WANTED:** Small Japanese shirt-pocket transistor radios. Roger Handy, Box 24527 Los Angeles, CA 90024. (310) 451-4040

**WANTED:** Chassis for Majestic 71 back panels for Emerson 504, Regal 205. Charles Phillips, 8607 Rembrandt Cir., Newark, DE 19702. (302) 832-9592

**WANTED:** Zenith 5G500 Universal good cond. & working. Scott Julius, 3 Haley St., Mystic, CT 06355. (860) 442-5767 E-mail: [fredehl@uconnect.net](mailto:fredehl@uconnect.net)

**WANTED:** E.H. Scott Model 800B record player in a Scott cabinet. Paul Capito, 637 W. 21st St., Erie, PA 16502

**WANTED:** Clean and complete Crosley 40S chassis, less tubes, and with good transformers. Martin Piepenburg, PO RR 1 Box 56B, Monterey, IN 46960. (219) 542-2591

**WANTED:** New Zenith deluxe Chinese radio, (Vintage Radio, p. 114; Douglas 3, p. 257). Gerald Schneider, 3101 Blueford Rd., Kensington, MD 20895-2726. (301) 929-8593



**FOR SALE/TRADE:** N.I.B. finial tubes for globe Champion TX Mod 300 and 350, Amperex 9909 aka Amperex 6083 Arizona list - \$120 ea., my price - \$50. Call: Larry Drago, 383 Lincoln Dr., Cheshire, CT 06410. (203) 272-6030 or fax: (203) 272-2002. E-mail: theradioman@webtv.net

**FOR SALE:** Rider's Troubleshooters, Volumes 13 and 14 - \$30 ea. plus. Elwood Hunt, 308 Georgetown Rd., Carneys Point, NJ 08069-2512. (609) 299-5259

**FOR SALE:** Philco, RCA, signs and wall banners for your collection. Call: Larry Drago, 383 Lincoln Dr., Cheshire, CT 06410. (203) 272-6030 or fax: (203) 272-2002. E-mail: theradioman@webtv.net

**FOR SALE:** Graetz 4R1417 - \$100. Hallicrafters 5R10A - \$85. Hallicrafters SX24, mint - \$150. Zenith 1600 - \$85. Norelco B4X12A/54, nice - \$100. Ernest Odeneal, K5QJF, 2710 Lee, Greenville, TX 75401 (903) 455-2113 or 5788

**FOR SALE:** Dual electrolytic capacitors. 50-30 mFd at 160 Vdc - \$375 ea. for 4 or more, includes P&H. Many other types in stock. Write, phone, or fax for free flyer DH Distributors, PO Box 48623, Wichita, KS 67201 Phone/fax: (316) 684-0050

**FOR SALE:** Vibroplex Champion, mint in original box - BO. Rek-O-Kut T12 turntable w/16" gray arm - \$75. Electro-Voice SP12B - \$85/pr McIntosh MR66 AM/FM mono - \$75-125. Walt Fleming, 182 Plain Hill Rd., Norwich, CT 06360. (860) 889-1957

**FOR SALE:** Philco 48-1256 (see 46-1203, Bunis 3, p. 164), SWR/field strength meter Reccoton Cat #CB177C & Archer antenna matcher - \$25. Fada 740, missing one knob - \$110. Lafayette Comstat 23, Mark 6, tube CB unit, Bearcat 250 (needs repair). Wilbur Gilroy, PO Box 459, Lake Winola, PA 18625. E-mail: wlbrg@aol.com

**FOR SALE:** N.O.S. tubes: VT4C, loose packed - \$35 ea. VT127, boxed - \$15 ea. Fred Watson, KF8BP 581 W. Summit St., McClure, OH 43534. (419) 748-8798

**FOR SALE:** Atwater Kent Model 110 radio - \$65. Speaker RCA 100-A - \$55. B&K Dyna Jet Model 707 tube tester with manual & tube chart - \$45. Tube caddy 22 1/2" x 11 1/2" x 8", very nice - \$40. Paul M. Williams, 2364 Beaver Valley Pike, New Providence, PA 17560-9266. (717) 786-3803

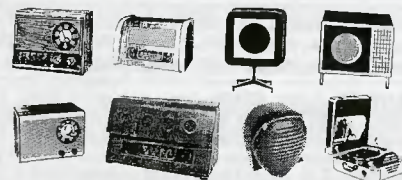

**WANTED:** TELE-TONES radios model # 117, 117A wood with grill holes or slots, 1946-50 EMERSON wood radios with front speaker perforations, # 503, 507 513, 517 519, 535, etc. RCA VICTOR 78 record players in ALUMINUM CASE or parts. STEPHENS floor speakers 1956-64 wooden cabinet on metal legs with formica on front. Also WANT plastic ZENITH Radio Nurse and boxes or parts. Steven Cabella / mod. I. 500 Red Hill Ave. San Anselmo, CA 94960 415-461-6810

**FOR SALE:** Mint Sony TR-610 - \$120. Arvin 540T - \$60. Sony 3F-61 - \$25. Emerson Atlas 88 - \$75. Detrola 194 - Offer. Tube testers: U.S. Navy Model OQ-2 (Weston Model 788), each function adjustable, minimum offer - \$150, wt 39 ea. Dynjet 707 - \$55. Hickock Models 530, 539C, 560 - \$115 ea. Knight 600 - \$60. Triumph 400 - \$45. Hickock 540 - \$115. Also, Airline tombstone 62-177 - \$125 and GE-M62 - \$125. All plus UPS. Charles R. Boller, 3108 N.W. 91st St., Seattle, WA 98117 (206) 782-8318

**FOR SALE/TRADE:** Hallicrafters SX-28, beautiful condition - \$500. 1958 Hallicrafters SR34 transmitter/receiver - \$300. Clean, Hammarlund SP 600 w/bud cabinet, works great - \$575. National 183D w/speaker - \$475. Hammarlund HQ 170 w/matching speaker - \$450. Hammarlund HQ 180 w/speaker and clock - \$475. Call: Larry Drago, 383 Lincoln Dr., Cheshire, CT 06410. (203) 272-6030 or fax: (203) 272-2002. E-mail: theradioman@webtv.net

**FOR SALE:** Recent acquisition, selling extras! Gernsback Manuals I - \$35; II - \$45; III - \$45; Vol. II Supplements V & VI - \$7. Ghirardi's Troubleshooter's Manual, 1st ed. - \$20; Rider Tube Substitution #1 - \$10; Motorola Service Manuals: 1931-42 auto/home & 1937-42 home - \$20 ea., Rare supplement to Modern Radio Servicing, Radio Field Servicing - \$20. Heathkit catalogs fall/winter, 1962 - \$15; & 1962 Supplements 1 2 & 3 - \$7 ea., Radio Amateur (1936 & 62 license manuals, 1979 handbook, 1968 hints & kinks, 1965 UHF manual); Allied Dictionary of Electronics 1970 - \$10 ea., Fisher KS-1A sprk instructions - \$5; Hallicrafters SR-40 - \$30. N.O.S. Windsor tube cartons - 50¢ ea. Deforest 01-A tipped ceramic dud - \$35. Dan Gutowski, 12132 Cavell, Livonia, MI 48150. (313) 261-5058

**FOR SALE:** N.O.S. tubes: (10) Sylvania 6L6GC - \$25 ea., (10) Tung-Sol 5881 - \$25 ea., (20) Sylvania 7025 - \$10 ea., (10) GE 7027 - \$30 ea., (3) Telefunken ECC 8015 - Call. DeForest Audion DL7 DV3, DV5, DL5, and (5) Brightson True Blue tubes (in a flip-top display case) - Best Offer (3) 1L6 - \$20 ea., (20) GE 6201 - \$5 ea., (3) Sylvania 7199 - \$20 ea., McIntosh 2505 - \$400; McIntosh 2205 - \$800 BO. Steve Harrell, 1179 Boylston St., #30, Boston, MA 02215. Phone/fax: (617) 247-0672

**FOR SALE:** Antique radios & TVs. Can deliver to Rochester. Keith Park, 795 Grooms Rd., Rexford, NY 12148. (518) 373-0417 Web: <http://members.aol.com/radiorest/index.html>

**FOR SALE:** National HRO 500 receiver, with LF-10 preselector - \$950 OBO. Zenith 3000-1 **WANTED:** Manual & schematic for Heathkit IT-11 capacitor checker. Irv Sanders, RD 3, Box FA53, Harrisburg, PA 17112. (717) 469-2185

**FOR SALE:** Tubes N.I.B., new bulk, used tested, large stock. Send stamp for list. David Boardman, 10 Lemaistre, Sainte-Foy, Quebec, Canada G2G 1B4. (418) 877-1316, evenings

**WANTED:** Collins Radio Company Catalogs, promotional literature, manuals 1933-1983. Jim Stitzinger, 23800 Via Irena, Valencia, CA 91355. 1-805-259-2011

**FOR SALE:** Radio tubes, many New Old Stock. Send large SASE (64 cents) for large list. PR Novelty, PO Box 140, Milwaukee, WI 53201

**WANTED:** Westinghouse WL-461 Taylor 833, deForest 433 through 440 tubes, duds OK. John H. Walker, Jr., 16112 W. 125th St., Olathe, KS 66062. (913) 782-6455. E-mail: johnh.walker@alliedsignal.com

**WANTED:** Radio Boys book: Air Patrol by Breckenridge. Jeff Hoskins, 824 E. Madison Ave., Stuart, FL 34996. (561) 283-2291 after 7 pm.

**WANTED:** Stromberg-Carlson radios, Model 240-R or 420-R, in good working condition. Call me collect after 5pm or write to: Arnie Sanchez, 9615 Rockhurst, Houston, TX 77080. (713) 939-9221

**WANTED:** Thordarson spark coil (such as 8508.6 in July A.R.C., p. 13), Dionne Quintuplets and Zenith 805 cases, Sorber cathedral and AK 165 chasses. Richard B. Jehlik, 14441 N. River Rd., Omaha, NE 68112. (402) 457-4604, after 7pm Central.

**WANTED:** Victor Electrolas/Radiolas, including parts sets. Especially need RCA power amplifiers AP-736 and AP-777, right-handed magnetic pickup and Radiola 64 drawer/chassis for VE 9-54. Jeff Lendaro, 1107 Logan St., Noblesville, IN 46060-2346. (317) 773-3969. E-mail: [lendaroj@indy.tce.com](mailto:lendaroj@indy.tce.com)

**WANTED:** Copy of manual for General Radio Type 1360-A microwave oscillator. Ross Wollrab, 229 N. Oakcrest Ave., Decatur, IL 62522-1810. (217) 428-7385

**WANTED:** Photo and dimensions of lid for Detrola 1932 Treasure Chest; someone please help. Dennis Smith, Box 113, Trenton, MI 48183. (313) 675-5847

**WANTED:** Knight Ocean Hopper, Crosby and Madison Fielding stereo receivers. Realistic 214 tuner and 212 preamp. Thordarson T-90513 output and T-15R03 power xfmr's. Charles D. Maples, 1623 Saddle Dr., Murfreesboro, TN 37130-3410. (615) 893-0255

**WANTED:** 1924 Radiola Super VIII, 1926 Fada 480-A, 1928 Brunswick 5N0, Federal E-10 and G10-60. Ken Martin, 12667 Eckard Way, Auburn, CA 95603. (916) 885-0243

**WANTED:** Transistor radios, buying more early Japanese pocket transistor radios. Ken Wong, 1460 Belleville Way, Sunnyvale, CA 94087 (408) 735-1815

**WANTED:** Detector coil and externally mounted 16 meter detector coil for 6-S-52 or 6-S-27 Zenith or junker chassis with same. Clifford G. Berthelsen, 5305 W. McSwain Rd., Merced, CA 95340. (209) 384-0993, days; (209) 722-1819, nights

**WANTED:** Unbuilt radio kits by Heathkit, Knight K17, etc. Gene Peroni, Box 58003, Philadelphia, PA 19103. (215) 665-6182

**WANTED:** Outside horn phonographs, horns, boxes or parts. Also Zenith #6-S-27 chassis & Bezel F/Zenith #12S471 Thanks. J.L. Acciavatti, PO Box 806, Upton, MA 01568. (508) 476-3229

**ANTIQUÉ RADIO RESTORATION Satisfaction - Guaranteed.** Ray Sanders, 342 South Third, Cottage Grove, OR 97424. 541-942-0866

**PHONO NEEDLES & CARTRIDGES:** (Ceramic & magnetic) What do you need? Send SASE. J.J. Papovich, 53 Magnolia Ave., Pitman, NJ 08071 (609) 582-8279

**WANTED:** Music Master 21" bell horn speaker Will buy or trade with 14" bell with money. Severin T. Dvorsky, 380 Morrison Dr., Pittsburgh, PA 15216. (412) 344-6633

**WANTED:** Original or replica dial timepieces for Philco 39-116, 42-1010, and Firestone 4-A-30 consoles. Tom Stiefel, ABOER, Box 376, Yutan, NE 68073. (402) 625-2144

**WANTED:** Philco 41-230, 41-240, 41-235, 41-245, entire radio or chassis and speaker for parts. D.W. Donaghy, 19791 Lombardy Ln., Yorba Linda, CA 92886. (714) 693-8632

**WANTED:** 2nd IF for Majestic Model 390, RCA 10T tombstone, nice shape. Bob Gidney, 411 W. Spruce St., West, TX 76691 (254) 826-5105

**WANTED:** RDP panadaptor, any condition, and/or manual. John A. Benyo, 25 Schley St., Garfield, NJ 07026

**WANTED:** Paying \$\$\$ for Art Deco style sets 1930-1940s, especially with chrome or metal grilles, trim. Adam Schoolsky, 15149 S.W. Cabernet Dr., Tigard, OR 97224. (503) 579-1080. E-mail: [Adam@ArtDeco.com](mailto:Adam@ArtDeco.com); <http://www.ArtDeco.com>

**WANTED:** Upper bass and treble push buttons for Zenith 6G-537, 6S-556, etc. Need complete units, working or not. Good power transformers for Philco 65 and Zenith 9S-262. Still looking for 8" speaker for AK cathedral. A.R.C. is the only way I have to get these parts. Please respond. Ralston Bailey, Rt. 1 Box 479, Benton, TN 37307 (423) 338-5923

**WANTED:** Eveready radios, speakers. Old flashlights, related items. Flashlight Newsletter - \$12/year. Bill Utley, PO Box 4095, Tustin, CA 92781. (714) 730-1252. E-mail: [flashlights@worldnet.att.net](mailto:flashlights@worldnet.att.net)

**WANTED:** Restorable cabinet and speaker for AK 82 and speaker for Jackson Bell 62. Also, dial pointer for Crosley 66TC, brass dial escutcheon for Gilfillan 510, 520, and component mounting clips. Claude J. Dellevar, Jr., 13009 Maclay St., Slymar, CA 91342. (818) 365-1629

**WANTED:** 1927 Erla chassis S-50, C-12 battery model, 1926 Stewart-Warner chassis Model 325. David Buck, 3630 Wilcox St., San Diego, CA 92106. (619) 224-5821 E-mail: [whnf46a@prodigy.com](mailto:whnf46a@prodigy.com)

**WANTED:** Zenith wooden table Model 6S322 in nice condition. Larry Bosher, PO Box 193, Palo Pinto, TX 76484. (940) 325-5333

**Victrola Repair Service:** Windup phonograph repairs, parts, springs, needles via U.P.S. Rod Lauman, 19 Cliff St., St. Johnsbury, VT 05819. (800) 239-4188, eves.

**WANTED, ANY CONDITION:** RBY, Hallicrafters S-35, PR-1 Collins 478R-1, Squires-Sanders SS-1V panadaptors; also schematics, manuals, ads, articles, technical data on them. John A. Benyo, 25 Schley Street, Garfield, NJ 07026

**DONN'S ANTIQUÉ RADIOS -** IF you have nice quality Philco radios for sale, please call. Also buying some Crosleys and FADAs. Donn Frederick, 8402 Hwy. 30 SE, Chatfield, MN 55923. (507) 867-4868



**FOR SALE/TRADE:** Kenwood ham station consisting of the following TR-7400A, TS-430S, TS-440S, TS-820S, AT-250. Take all these near mint beautiful condition items, with all manuals and microphones for—\$2,650 or will consider selling individual units. Also complete Collins S-line w/round emblems, includes all manuals, like new condition—\$2,450. Call: Larry Drago, 383 Lincoln Dr., Cheshire, CT 06410. (203) 272-6030 or fax: (203) 272-2002. E-mail: theradioman@webtv.net

**FOR SALE:** Detrola SW #568-1—\$75. Atomic #568-1—\$85. Radiola AR-812—\$175. Cathedral spkr—\$75. Dial glasses & projector bulbs. Zenith transistors. Ernest Odenal, K5QJF, 2710 Lee, Greenville, TX 75401 (903) 455-2113 or 5788

**FOR SALE:** Philco 52 cathedral—\$250. Philco 89 cathedral—\$145. Philco 37-620 tombstone—\$60. Philco 20's, deluxe—\$275; regular—\$200; parts—\$75. Sparton Jr. cathedral—\$150. General Electric K-64 cathedral—\$325. GE J-70 cathedral, nice—\$275. GE E-81 tombstone—\$165. RCA 120 cathedral, needs wood work—\$100. Echophone S-5 cathedral, needs veneer repair—\$275. Radiola 17, with hood—\$85. U.S. Apex 32 cathedral, large with burl woods—\$225. Zenith 9-S-367 excellent with spectacular veneers—\$400. E.H. Scott Allwave 23 in a New Wellington, Gothic Grand, cabinet, fully restored—\$4,500. McMurdo Silver II, no cabinet—\$850. Western Electric 10-D driver, works—\$85. Standardyne single dial battery set—\$85. Bremer Tully Counterphase 70K37 early AC set—\$75. 5-tube 3-dial kit, nice—\$75. Two 1-tube home brews—\$35 ea. Crosley 51—\$150. Emerson BJ 200—\$75. Norelco B5X98A, works—\$100. RCA AR812 and AG814 matching loop antenna, nice—\$225. Automatic Radio Tom Thumb portable, with built-in camera—\$150. Capehart Amperion, circa 1930, large, coin-op radio/phonograph—\$1,800. Victor oak horn—\$1,200. Victor 240 exceptional original—\$200. Edison suitcase home with 14-inch brass horn, nice original—\$750. Edison B80 table top diamond disc—\$175. Cylinder records: 2-minute—\$6; 4-minute—\$4; diamond discs—\$3. Rochester delivery possible. **WANTED:** Garrard Model 6 complete phonograph changer, parts, or a spindle. John Hayes, 27 Highland Dr., Henniker, NH 03242. (603) 428-3053. Fax: (603) 428-8315. E-mail: JHayesamfm@aol.com

**FOR SALE:** 30's-50's radios, some working some not. Send SASE for list. Barbara White, 13171 Woodrose Way, Grass Valley, CA 95945

**WANTED:** 1930 to 1942 Police Radio communications equipment. Any 6 VDC mobile communication equipment. Raymond Miller 953 N. 1st St., Albemarle, NC 28001 (704) 982-0228

**MILLEN ORIGINAL PARTS, manuals, equipment.** New and used. Bought and sold. James Millen Electronic Equipment Mfg., PO Box 4215, Andover, MA 01810-0814. (508) 975-2711. Fax at (508) 474-8949

**VINTAGE MANUALS AVAILABLE** for amateur, audio, and radio-related equipment. Quality is number one customer priority. Satisfaction guaranteed. Send three \$.32 stamps for catalog. Pete Markavage, **THE MANUAL MAN**, 27 Walling St., Sayreville, NJ 08872-1818. (908) 238-8964

**FOR SALE:** Sweep/ham tubes: New 6JB6A—\$10; 6KD6—\$18; used 5894 (Amperex)—\$18; 802—\$5; VT 136 (1625)—\$3; 5933—\$5; 807—\$5; 6146—\$10; 6JE6, 6JS6C, 6LX6, 6LF6, 20LF6—\$10 ea. Dan Gutowski, 12132 Cavell, Livonia, MI 48150. (313) 261-5058

**FOR SALE:** Reproduction Zenith dial glass. Lexan polycarb. 6 3/4" x 7" and 5 3/4" x 7"—\$14 ppd. DH Distributors, PO Box 48623, Wichita, KS 67201 Phone/fax: (316) 684-0050

**FOR SALE:** Thorens 124 replacement turntable bases, improved performance, available in walnut teak, mahogany—Call. 124 blank arm boards—\$20. I'll buy 124 turntables, parts. Walt Fleming, 182 Plain Hill Rd., Norwich, CT 06360. (860) 889-1957

**FOR SALE/TRADE:** Brand new RF audio transformers for Federal 58, 59 and 61—\$100 ea. Also brand new Remler audio transformers—\$100 ea. Plus Rasla, Acme, and many other brands N.I.B. audio RF transformers—\$50. Call: Larry Drago, 383 Lincoln Dr., Cheshire, CT 06410. (203) 272-6030 or fax: (203) 272-2002. E-mail: theradioman@webtv.net

**FOR SALE:** Western Electric M98 battery-powered volt/ohm/ammeter—\$25. Weston Model 45 DC voltmeter, wood case, circa 1929—\$35. Zenith Trans-Oceanic A600, very good condition, with schematic, station charts—\$85. Interesting home brew (Tesla?) transmitter, needs 811's—\$20. McMurdo Silver VTVM, needs work—\$8. Superior TV-11 tube tester, needs adjustment—\$16. Power transformers 370/0/370, 5 & 6 volt, for 5AR4/6L6GC—\$15 ea. 10 lb. grab bags: connectors, terminals, sockets, shields, resistors, capacitors, etc.—\$15 ea. Massive 6/12 volt transformer, 30 lbs.—\$9. (35) misc. metal tubes, tested—\$10/all. CDE vibrator #C3—\$4. N.O.S. tubes: Mullard 6W6GT 12SQ7GT RCA JAN 12SK7—\$4; KenRad JAN 12SA7Y—\$3; RCA 12V6GT—\$6; Hallicrafters 35L6—\$9; RCA 1R5, 1U4—\$2. All plus shipping. C.J. Poulos, 29 Doubleday Rd., Columbia, CT 06237 (860) 228-7680. Fax: 228-7681

**FOR SALE:** Heathkit Mohican SW receiver w/original manual—\$45 + shipping. George Wright, 4181 Enders Way, Doylestown, PA 18901 (215) 997-4144

**FOR SALE:** 20s Capehart Amperion w/chain-drive, flip-over changer visible mechanism—Best Offer. Greetings to Dave's Antiques in sunny Tucson! James Burnett, 640 Mason, 702, San Francisco, CA 94108-3801 (415) 433-1930

**FOR SALE:** Assortments, turntables, changers, test equipment, speakers, components, much more.

**WANTED:** Klipschorn. Gerald Shirley, 133 Sagamore Rd., #A9, Tuskahoe, NY 10707 (914) 395-1169, 6-9 am or pm EST

**ELECTRON TUBES:** Over 1 Million Tubes in Stock. Buy & Sell. Daily Electronics, 10914 NE 39th St. #B-6, Vancouver WA 98682. 800-346-6667 360-896-8856. 360-896-5476, fax

**WANTED:** Broadcast-type MICROPHONES. Early carbon, condenser, ribbons, etc. Cash or trade. James Steele, P.O. Box 620, Kingsland, GA 31548-0620. (912) 729-2242. E-mail: JSteele@k-bay106.com. Microphone collectors Internet site: <http://www.k-bay106.com/mics.htm>.

**WANTED:** Following Raytheon "RK" series tubes: RK15, RK16, RK25A, RK25B, RK30, RK32, RK41, RK44, RK45, RK46, RK53, RK56, RK58, RK63A, RK100. John H. Walker, Jr., 16112 W. 125th St., Olathe, KS 66062. (913) 782-6455. E-mail: johnh.walker@alliedsignal.com

**WANTED:** Original, perfect red or blue knobs &/or handle for Experson Patriot. Al Wirtenberg, 15 Wilson Rd., Weston, CT 06883. (203) 544-9270. E-mail: mswaw@mail.snet.net

**WANTED:** Antique and novelty tube and transistor radios. We buy complete collections or quality individual pieces. Also tubes, parts, literature, magazines and advertising. Call or send list. John & Kathy Slusser, Radio Daze, PO Box 144, Mendon, NY 14506. (716) 624-9755. Fax: (716) 624-7857. E-mail: info@radiodaze.com

**WANTED:** Literature for Heath FMO-1 oscillator and Leader LSG230 FM stereo generator. John Lomas, 253 Elm Ave., Glen Riddle, PA 19063-5739. (610) 459-0186, home

**WANTED:** Tuning mechanism (all or part) for AK#318. Jim Regan, PO Box 880752, San Francisco, CA 94188. (415) 664-7814

**WANTED:** Black tuning knob for Silvertone 4500. Bob Turner 11632 Co. Rd. 48, Fairhope, AL 36532. (334) 928-0051 E-mail: radiocoil@aol.com

**WANTED:** Air King chassis, will fit plastic Model 66 or wood Models 100 and 120. If you've got anything that will work, I'll buy it in any condition. Brad Jones, 4801 Crofton Springs Ct., Greensboro, NC 27407 (910) 547-1919

**WANTED:** Prepay wathour meters or earlier, slide rules, calculator watches. Bill Peterson, 3722 Swift Dr., Raleigh, NC 27606

**WANTED:** Parts for Continental piano radio. Escutcheon and dial glass RCA K80 or similar. **FOR SALE:** Crosley 515—\$45. Philco 42-380 cabinet and speaker Matt Hussey, 31 Linden St., Rochester, NH 03867 (603) 332-9927

**WANTED:** Pre-WWII aircraft radios and flight gear such as helmets, goggles and parachutes. James Treherne, 11909 Chapel Rd., Clifton, VA 20124. (703) 830-6272

**WANTED:** Hallicrafters Models S-2, S-33, S-35, EP-132, HT-2, HT-3, HT-8, HT-12, HT-14, and R-8 console speakers. For descriptions see my book "Radios By Hallicrafters." Chuck Dachis, "The Hallicrafter Collector," 4500 Russell Drive, Austin, Texas 78745, 512-443-5027

**WANTED HAMMARLUND:** Comet, Comet Pro, HQ-66, HQ-88, HQ-225, S-200 and any other Hammarlund rarities. Charles P. Jedlicka, N9SOR, 1611 Clemens Rd., Darien, IL 60561-3510. (630) 515-1836. E-mail: sp600@aol.com. Hammarlund site <http://home.aol.com/sp600>

**WANTED: FACTORY SERVICE MANUAL** for Panasonic RS460S Radio/Tape. Original Preferred. Copy Acceptable. No Sams Please. James M. Craft, 604 W. Michigan Ave., Jackson, MI 49201 (517) 787-0077

**WANTED:** Tuning knob for Arvin Model 242T, or 243T (Bunis 3, p. 28). Need one knob for Emerson 615B, (in Machine Age Book 2, p. 42). Need four knobs for Motorola Model 65T21. All help would be appreciated. Thank you. Joe DeBari, 194 Ramal Church Rd., Barnesville, GA 30204

**WANTED:** Book for Scope K1KV5V1 555G. Thankyou. Edward S. Krawczyk, 64 Old Chimney Rd., Upper Saddle River, NJ 07458. (201) 825-3828

**WANTED:** Lionel telegraph key, prefer N.I.B. Donald B. MacLean, PO Box 2025, Toluca, CA 91619. Ph/fax: (805) 947-7149

**WANTED:** Panasonic RF-9000. Offering finder's fee. Daryl Jorud, R#1 Box 180, Battle Lake, MN 56515. (218) 864-5725

**WANTED:** Built-in antenna for RCA Victor K105 console. Please help my restoration project! Phil Brunais, 14185 Pleasanton Hwy., Bear Lake, MI 49614. (616) 864-3143

**WANTED:** Volume knob for 1942 Zenith table Model 6S632, black with brass. Igor Gollioto, 17 Addison Dr., Fairfield, NJ 07004. (201) 386-4284. E-mail: igollioto@atmail.gc.lucent.com

**WANTED:** Schematics for a Bogen Model MX60A tube PA amplifier, circa 1966. David Brown, 22520 S.W. Hells Canyon Rd., Sherwood, OR 97140. E-mail: djbrow@pacifier.com

**BOXED CLASSIFIED ADS WORK!** This is a boxed classified ad. These ads can be run more than two months. See the inside back cover for details. Boxed ad deadline: the 1st of the month.

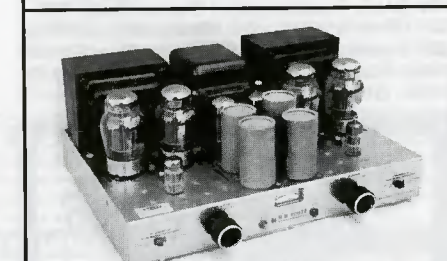

**WANTED:** Tube Hi-Fi components & commercial amplifiers by Marantz, McIntosh, Tannoy, Acrosound, Brook, Brociner, Fairchild, Hadley and others. Also want Western Electric theater amplifiers, speakers, tubes, & microphones. Richard Sharisky, PO Box 521 Belmont, MA 02178. Phone (617) 484-5784. Fax (617) 489-6592

**WANTED: Vintage Electronic Music Synthesizers** and modules by the following manufacturers, especially the listed models. Aires Modular, System III. ARP 2500. Buchia Modular 100, 400. E-mu Modular EML Electrocomp 100, 101, 200. EMS Synthi A, Synthi AKS, VCS3. Korg Modular PS-3100, PS-3200, PS-3300. Moog Theramin, Modular, Series 15, 35, 55. Oberheim SEM modules, 2-, 4- & 8-Voice Systems. Paia Modular 2700, 4700. Roland Modular Systems 100, 700. Serge Modulars, System 79. Synton Modular System. Call and surprise me; make my day! John V Terrey, 498 Cross St., Carlisle, MA 01741 (508) 369-9770. Fax: (508) 371-7129.



**FOR SALE:** Kenwood R-5000 sprk/Am filter - \$595. Joel Levy, 8 Waterloo, Morris Plains, NJ 07950-1438. (201) 285-0233

**FOR SALE:** Edison spark plugs, Type 2, 3, 43, 45, look unused, in box - \$12 ea. Shure mic ring 3 in., ID - \$15; Sterling midget tube reactivator in walnut carry case, looks new - \$50; Schranz and Bieber Little Mike, looks NIB - \$5; Lafayette Radio telegraph set, one wire and gnd. connector N.I.B. - \$50; Aerioia Sr., vg, good paper - \$185; WD-11 duds, phenolic base - \$18; WD-11 dud, BBTT, with paper - \$40; 01A duds - \$2 ea. Calrad mic, Model 500C, desk stand, vvg - \$75. Shipping extra. Richard A. Botzum, R.D. 2, Box 419, Morgantown, PA 19543. (610) 286-0047 Fax: (610) 286-5315

**FOR SALE:** Late arrivals: Fischer 800 B, beautiful, deluxe tube AM/FM receiver separate AM/FM dials, band width on AM, multiplex output, center channel output, etc. Definitely the big kahuna for that year, uses 7591 output tubes - \$150 OBO. Pioneer 202-W reverb unit, early 70s, clean, works fine. Garrard RC-98-L, very speed record changer - \$50 OBO. Garrard lab 80 turntable, fair restore or parts - \$25 OBO. Crescent Bakelite 45 record player, plugs into radio set - \$25. RCA Bakelite 45 record player, same. Both very early 45s, unusual - \$25. Ward Kremer, 5807 Papaya Dr., Ft. Pierce, FL 34982. Ph/fax: (561) 468-7732. E-mail: WKremer798@aol.com

**FOR SALE/TRADE:** RCA U.S. Navy RAC-7 military receiver w/separate power supply in perfect condition w/manual - \$300. Larry Drago, 383 Lincoln Dr., Cheshire, CT 06410. (203) 272-6030 or fax: (203) 272-2002. E-mail: theradioman@webtv.net

**FOR SALE:** Transistor radios! Channel Master 6503 - \$20; Hitachi TH-627R - \$20; Standard Micronic Ruby - \$30; Sceptre 2 transistor - \$20; Aurora (Sony 610 look alike) - \$20. Bob Furtado, 23 Garden Rd., Alameda, CA 94502. (510) 521-3084

**FOR SALE:** Arvin 747-P tube portable, like 746-P, but has small windup clock in center of grille, perfect - \$95. Motorola 62X, ivory, nice - \$35. Zenith H615, nice - \$35. Classic Radio & Television, 541 Riverside Dr., Box 61 Augusta, ME 04330. (207) 623-2059

**FOR SALE:** Four volumes: Frederick Manuals. Specs of military contract test equipment - \$85 + shipping. Allen Jochem, 2205 Broadway, Quincy, IL 62301 (217) 223-6751

**FOR SALE:** Very nice Radiola III with good WD-11s - \$250. Don Howland, 4621 W. Shawnee, Spokane, WA 99208. (509) 466-0939

**FOR SALE:** Vintage Hallicrafters transmitter Model HT37 100W 10-80M AM-CW-SSB, vgc - \$150. James Kroegel, KE8VP, 856 Old Farm Rd., Columbus, OH 43213. (614) 864-8327

**FOR SALE:** Fada 652 - \$350. Sentinel 284 - \$375. Delco 1107 - \$115. GE S-22 - \$85. Emerson Violin - \$500. Crosley 56TD - \$125. Belmont 6D111 - \$165; 6D121 - \$160; 6D1K0 - \$130. Detrola 568-1 - \$85. Philco 40-140 - \$60; 39-30 - \$110. Transistors: Emerson 888 Vanguards, Minivox watch radio - \$125. Crosley JM8BK - \$175. Philco T 1000-124 - \$90. GE 676, red - \$110. New, large photo list - \$1 + LSASE 2 stamps.

**WANTED:** Kadette, Detrola, Fada, Addison, Catalin, beetle, Plaskon, transistors. Bob Masterson, Box 172, Valley Cottage, NY 10989. (914) 353-3151 E-mail: BMradio@aol.com

**FOR SALE/TRADE:** Atwater Kent Mod One breadboard in exquisite working and cosmetic condition - \$1,550. Also 1931 dual dial E.H. Scott Allwave 12 w/power supply and original manual and all coils, chrome is excellent - \$950. Connecticut Sodian Model D-6 w/S-13tube - \$1,800. Larry Drago, 383 Lincoln Dr., Cheshire, CT 06410. (203) 272-6030 or fax: (203) 272-2002. E-mail: theradioman@webtv.net

**WANTED:** We buy tubes of all types. Please fax or send us a list and we will promptly send our offer. Leeds Electronics, 68 N. 7th St., Brooklyn, NY 11211 (718) 963-1764. Fax: (718) 963-1963

**WANTED/FOR SALE:** Mini mics, wire and tape recorders. Jon Golden, Box 205, Waban, MA 02168. (617) 332-5460. E-mail: 3dman@ziplink.net

**WANTED:** Zenith 811, 835, 5R317, 12S267 RCA 811K. John Pelham, W1JA, 1185 Bend Creek Trl., Suwanee, GA 30024. (770) 476-0473. E-mail: jpelham@mindspring.com

**WANTED:** Knobs for Crosley 02CA console. Thanks! Mark Cowart, N4FBL, PO Box 550766, Jacksonville, FL 32255-0766. (904) 724-1364

**WANTED:** Outpaying foreign collectors for Japanese transistors. Keep 'em here in the states. Also 1.5" to 5" TVs. Fax or write: Tom Christopher 45 Boway Rd., South Salem, NY 10590. Fax: (914) 763-5936

**WANTED:** Fairchild 670 tube limiter, UREI, Collins, Pultec, Westrex, Scully, Ampex, disk recording blanks. Kim Gutzke, 7134 15th Ave. S, Minneapolis, MN 55423. (612) 869-4963

**WANTED:** JIL SX400 scanner parts; looking for parts sets, schematics, auxiliary converters, info. John Black, KB5AG, 330 S. Main St., Wake Forest, NC 27587 (919) 556-2445. E-mail: jblack@radiomail.net

**WANTED:** Zenith table Model 8S443, 10S443, or 12S445 for Mother's birthday. Restorable, working or not. Jon Lyons, 16 Southworth St., Deep River, CT 06417 (860) 526-9032. E-mail: jml Lyons@snet.net

**WANTED:** Main tuning knob for Hallicrafters SX-100. Original manuals, amateur audio, and radio-related. Pete Markavage, The Manual Man, 27 Walling St., Sayreville, NJ 08872-1818. (732) 238-8964. E-mail: manualman@juno.com

**WANTED:** 12-tube Zenith black dial console Model 12U159, 12S371 or 12S471 Mark Hewitt, 6659 Tipperary Trail, Roscoe, IL 61073. (815) 623-8729

**WANTED:** DeForest unit panels (4 1/2 in. sq. Bakelite). Richard Bury, PO Box 25, Gurnee, IL 60031 (847) 623-7746. E-mail: pabury@aol.com

**RATE FOR ADDITIONAL WORDS:**

27¢ per word

**FIRST 20 WORDS FREE!**

Cash or stamps OK for small amounts.  
Your payment helps to keep A.R.C. healthy!

**WANTED:** Mint 1950s plastic tube radios by Philco, Motorola and Emerson, plus sales fliers, catalogs and instructions. KLH 8, plus accessories and instructions. McIntosh MC225 tube cage. Marantz, Acrosound, Fairchild, Fisher, Hadley, Karg, REL, etc., tube hi-fi equipment, plus instructions, accessories and sales literature. Unusual tube hi-fi equipment. 1950-1965 hi-fi books, magazines and catalogs. 1930s-1950s clocks by General Electric, Telechron, Lawson, Lackner, Herman Miller, Howard Miller, etc. Old fountain pens by Parker Waterman, Sheaffer Eversharp, Conklin, Chilton, etc. Paul Creasy, 6216 Worlington Rd., Bloomfield Township, MI 48301 (248) 737-0429. E-mail: good2go@compuserve.com

**WANTED:** Arvin Rhythm series tombstones. Johnny Johnson, 7075 W. 32nd Ave., Wheat Ridge, CO 80033. (303) 274-5474

**WANTED:** Need scope and sedat receiver for old time radio station. **FOR SALE:** Old Weston meters. Henry Weiland, 8946 W. Grantosa Dr., Milwaukee, WI 53225. (414) 463-4681

**WANTED:** Tuning knobs for Hammarlund HQ129X. Richard K. Daggett, KOPSH, 204 S. Hudson, Spring Valley, MN 55975. (507) 346-2983. E-mail: k0psh@deskmedia.com

**ANNOUNCING**  
**ZENITH and Philco**  
**Grille Cloths**  
the 41st Pattern:  
Philco's large chevron ("V") used on most siant-front consoles also

- ★ Generic console patterns for Philco, Zenith and others
- ★ 2 silver/black deco patterns
- ★ 12 Philco patterns
- ★ 8 Zenith patterns
- ★ Plus Stromberg, GE, RCA, Westinghouse, and Scott patterns

Send a 55¢ LSASE for samples and info to:  
John Okolowicz, N3VSR  
624 Cedar Hill Rd.  
Ambler, PA 19002  
or  
SEE THEM ALL ON THE WEB @  
<http://www.Grillecloth.com>  
E-mail: Grillecloth@compuserve.com

**CLASSIC RADIO**  
**WALL CLOCK**

New!  
Great Gift Ideal  
\$19.95

Big, 10 inch wall clock with black "radio" dial face and brass colored bezel. Quartz controlled movement, sweep second hand, acrylic dial crystal and bezel. Battery included. \$19.95 includes shipping anywhere in the U.S. via Priority Mail. Massachusetts residents please add \$1 sales tax. Send check with order, please.

Antique Radio  
835-A Pleasant Street  
Framingham, MA 01701  
Tel: 508-879-2778

**NEW AND USED TUBES WANTED**

We urgently need the following tubes. All tubes must be well known brands such as GE, RCA, Sylvania, Tung-Sol, Philips, etc. of U.S. or W. Europe manufacture. New tubes must be in their original boxes. All tubes are subject to inspection. Ship by UPS (ground); we'll mail a check to you upon receipt and testing at prices shown plus your shipping charges. Call or fax for buying procedures and complete bid list. Call before sending more than 10 pieces of one type of tube.

NEW TUBES																			
01A	\$9.00	6F8G	\$5.20	12BH7A	\$5.10	274B(WE)	\$85.00	6146B/8298A	\$12.00	1L6	8.50	6GS/6U5	8.00	12DW7/7247	9.00	275A(WE)	85.00	6267/EF86	6.00
2A3	24.00	6KS6	5.00	20LF6	16.00	300B(WE)	250.00	6550/A	12.00	2B6	6.00	6KD6	15.00	26LX6	6.00	350B(WE)	100.00	6550 (ST)	34.00
5R4GY/A/B	3.40	6L6GC	8.40	35LR6	6.00	623	35.00	7189/A	5.30	5U4G	6.70	6LB6	7.50	45	45	808	16.00	7591A	20.00
5V4G	4.70	6LF6/6MH6	18.60	50	110.00	805/331A	32.00	8005	50.00	5Y3G	3.80	6V6	6.00	71A	8.20	845	80.00	8068	20.00
6BK4C/6EL4A	8.00	6V6G	6.50	80(ST)	5.60	864	5.00	8908	27.50	6CA7/EL34	11.00	10	25.00	211(VT-4C)	35.00	5691	15.00	8950	25.00
6F5G	5.80	12A	11.00	274A(WE)	110.00	5692	18.00	M-2057	32.00										

USED TUBES																			
01A	\$5.00	10	\$16.00	171A	\$7.00	245	\$23.00	845	\$31.00	2A3	12.00	12A	7.00	183/483	9.30	246	11.00	7591	8.60
5AR4/GZ34	6.00	20LF6	7.30	210	20.00	247	8.00	8417	8.50	6B4G	6.50	42(GLOBE)	8.00	211(VT-4C)	14.50	250	65.00	8950	12.30
6LF6/6MH6	9.20	45(VT-52)	25.00	230	25.00	280	12.00	V201A	6.50	6V6G	2.10	45	11.00	237	8.50	282	8.00	WD-11	35.00
				50	60.00	240	8.50	401-CARDON	9.60	WD-12	24.00								

**ANTIQUE ELECTRONIC SUPPLY™**  
LIMITED PARTNERSHIP

6221 S. MAPLE AVE. • TEMPE, AZ 85283 • (602) 820-5411 • FAX (602) 820-4643 or (800) 706-6789



**FOR SALE:** Crosley 56TU - \$60. Emerson 517 - \$55, 561 - \$60, GE 62, Ivory - \$60, 512F - \$50, 521F, clean - \$60, Motorola 67X13 - \$60. RCA 96T4 - \$70. Radiola 17 - \$95, 18 - \$95. Silvertone 8010 - \$60. J. Gary Cameron, 824 Andrews St., Southington, CT 06489. (860) 276-9200

**FOR SALE/TRADE:** The Internet is great! Send me your e-mail address for 8 pages of exotic vintage equipment. I will trade generously for medium format cameras or turn-of-the-century (the last one) open frame dynamos and motors. Steve Lipsky, W2VVN, PO Box 404, Barnegat Light, NJ 08006. Tp: (609) 361-8175; alt: (215) 884-1817 E-mail: slipsky@worldnet.att.net

**FOR SALE:** Transceivers, Swan 350 120/12 volt - \$350; Yaesu FT101EE - \$350; Hammarlund Comet Super Pro - \$350; McIntosh MR71 plays, rusty - \$195; Pilot 172/177 speaker - \$150; GE int. amp, tubes, A1-320, mono - \$150; Marantz receiver 2265B - \$150. Bernard Bank, 303 DeVoe Ave., Yonkers, NY 10705-2709. (914) 476-5933

**FOR SALE:** AK 80 - \$325. AK 82 - \$325. Clarion AC 60 - \$175. GE K-52 (same as RCA 120) - \$225. Philco 118 cath. - \$275. Philco 91 cath. - \$225. Majestic 310A - \$125. RCA 128 - \$250. RCA 40X53 LaSiesta - \$425. Guild spice chest - \$115. Philco 90 basket case - \$50. Philco 89 Deco basket case - \$25. Large literature list. Send SASE. Mark Miner 11430 Tuscarora Ln., Clermont, FL 34711 (352) 394-6596

**FOR SALE:** Hallicrafters S40 - \$65. Zenith Inter-Oceanic - \$50. Int. amps: Telefunken S82U - \$90; Heathkit EA-3 - \$35; Pacemaker (Bell) #2285 - \$25; Grommes 55PG - \$30; Eico ST-40 NT - \$30; Heathkit WA-P2 (w/man.) - \$35. Tuners: Heathkit BC-1A (w/man.) - \$22; FM-3A (w/man.) - \$22; AJ-41 - \$35. Shipping extra. Lars Roose, 10100 Chapala Ct., NE, Albuquerque, NM 87111 (505) 296-4129



**Craig L. Graybar  
Furniture Works Ltd.**

(414) 258-2390

**SPECIALISTS IN RESTORING,  
REPAIRING AND REPRODUCING  
CLASSIC STYLED ANTIQUE TV,  
RADIO & PHONOGRAPH CABINETS**

Send us your plans or your project  
via UPS for immediate price quotes



1535 S. 84th St.

West Allis, WI 53214



"We Turn Ideas Into Heirlooms"

**FOR SALE:** Zenith 5S319 - \$100. Rider's Index - \$15 plus shipping. **WANTED:** Westinghouse RA/DA "pointer" knob. Claude Chafin, NOFMO, 4223 E. 42nd Way, Independence, MO 64055. (816) 478-4518

**FOR SALE:** We have been selling tubes and related components since 1923. September specials: (new) 12BY7A - \$8; 5755 (Raytheon) - \$5; 5654, 6Y6GT 12AV7 6AQ7 12BE6, 7A8, 6T8A, 12AU6 - \$2 ea. Used tube specials: 6E5 - \$8; 7719, 5751 (GE 5 Star) - \$6; 2E26, 25L6GT 6189, 5V4GA - \$2; 6K7 6H6, 6SH7 6005, 12SK7 12SN7 6AU6, 6X4 - \$1 ea. No catalog at this time. We stock over 3,000 different types. Leeds Electronics, 68 N. 7th St., Brooklyn, NY 11211 (718) 963-1764. Fax: (718) 963-1963

**FOR SALE:** BC-611F, WWII walkie-talkies, pair - \$250. Dumont RA-104 TV works, with stand - \$75. Mark Weidmayer, 10 Devon Dr., Newtown Square, PA 19073. (610) 325-3816

**FOR SALE:** Guaranteed N.I.B. tubes: 7F8, 5755 (420A) - \$2.50; 6AZ8 - \$3.50; 2-150D - \$6. Quantities. Lowell Thomas, K6KC, PO Box 15026, Fresno, CA 93702. (209) 227-1605. E-mail: k6kc@lightspeed.net

**FOR SALE:** Novelties, N.I.B., Japan: Santa Maria, golf cart, overland stagecoach, red - \$60 ea. Sam Samuelian, 2305 W. Deerfield Dr., Media, PA 19063. (610) 566-7248

**FOR SALE:** Collins 32-S-1 75-S-1, 30L1, 30S1, 312B-3, 312B4, SM-2, phone patch 189A2, R-388 (51J-3), with cabinet. Transmitter Hammarlund, four-20 w/coils, near mint. Bach Simpson Model 77 wameter N.I.B. Heathkit SB104 extension card. Gonsset Hybrid phone patch GPP-1, N.I.B., mint. French tube circa 1919, tennis ball shape Mazda 263 horizontal plate assy. Myers RAC-3, 1921 N.I.B. Rockwell/Collins HF2050. Luc Dugas, 235 Rte. Neigette, St. Anaclet, Quebec, Canada G0K 1H0. (418) 723-9689

Join the  
**AWA**

**ANTIQUE WIRELESS ASSOCIATION  
THE ORIGINAL AND LARGEST HISTORICAL  
RADIO-COLLECTOR GROUP**

- Publishes *Old Timer's Bulletin* with:
  - Battery and AC receiver restoration
  - Vacuum-tube history and collecting
  - Old-time amateur-radio contests
  - Communications receivers
- Free want-sell-swap ads
- Early television
- Horn loudspeakers
- Reviews of current books
- Keys and land-line telegraphy
- News of U. S. and foreign clubs
- Information on public radio museums.
- Maintains unique radio-TV museum.
- Produces the annual Rochester meet.
- Co-sponsors local meets.
- Publishes the annual *AWA Review*.



Membership is only \$15 per year (\$27 for two years, \$18 per year for overseas). Mail check to:

**Antique Wireless Association, Inc.  
Box E, Breesport, NY 14816**

**FOR SALE/TRADE:** Amrad Neurodyne - \$400; DeForest F-5-AW - \$500; excellent working Grebe Mod CR-9 - \$850; Sodian DR-6 rcvr - \$1,500; Grebe 5 - \$675. Call: Larry Drago, 383 Lincoln Dr., Cheshire, CT 06410. (203) 272-6030. Fax: (203) 272-2002. E-mail: theradioman@webtv.net

**FOR SALE:** Military ART-13 in original military packing case - BO. Herb Ellmers, 775 Howard St., Ft. Pierce, FL 34982. (561) 466-0926

**FOR SALE:** Hallicrafters Model SX-111 receiver - \$75. Joe Duffin, 4 W. Central Ave., Moorestown, NJ 08057 (609) 778-1436

**FOR SALE:** Coronado radios #806 & 43-8515A. Airline 64WG 1801C, wood. Arvin 581-T white Bakelite. Heath T C 2 tube tester Ted Gasiorek, 201 Golden Ave., Briggsville, WI 53920. (608) 981-2051

**FOR SALE:** Bakelite panels, 3/16" thick, cut to size, black. SASE or postcard for quote. Steve Imms, 51a Old Shannock Rd., Wakefield, RI 02879. (401) 783-5387 E-mail: imms@brainiac.com

**FOR SALE:** National IV - \$30. Rider's VI thru XIV - \$15 ea. DeForest N-5 - \$270. Marion Van Hal, 1328 Orchard, Pella, IA 50219. (515) 628-2347

**FOR SALE:** Beginner's vintage radio repair information. Repair guides, etc. Send SASE for list. Charles Ahr, 2291 Sylveld Ln., Cincinnati, OH 45238

**FOR SALE:** Jensen 12" special design speaker - \$20. E&L table radio, Mod 2701 (Bunis 3, p. 69) - \$25. Robert Parke, 504 Essex St., Gloucester City, NJ 08030-1015. (609) 742-8221

**FOR SALE:** Midwest 18 tube, power tune w/large ghost dial, impressive cabinet w/doors, restored - \$795. **WANTED:** Sparton 1867 console. Grant Steger, 627 N. Main St., Juneau, WI 53039. (920) 386-2575, 5 to 9 pm

**FOR SALE:** Air condensers with 4" knobs - \$9 ea. plus. **WANTED:** Power supply for AK84. Elwood Hunt, 308 Georgetown Rd., Carneys Point, NJ 08069-2512. (609) 299-5259

**FOR SALE/TRADE:** E.H. Scott's First Chrome Set. A 1931 (Allwave 12) Deluxe with 12 plug-in coils, separate chrome power supply, excellent chrome, dual dials - \$800. Call: Larry Drago, 383 Lincoln Dr., Cheshire, CT 06410. (203) 272-6030. Fax: (203) 272-2002. E-mail: theradioman@webtv.net

**FOR SALE:** Radios/Books SASE. **WANTED:** Early Radio News magazines; books on telegraphy, wireless, biographies. Steve Russell, 121 Horseshoe Dr., Kalispell, MT 59901 (406) 755-3321

**FOR SALE:** Hallicrafters T.W. 1000A - \$110, 5R10A - \$40, S108 - \$60. All work. FADA 100, nice case, plays, operating instructions - \$40. Buzz Miller 725 Mt. Rock Rd., Carlisle, PA 17013. (717) 776-3279

**FOR SALE:** Global Model GR711 (see Bunis 2) - \$100 plus UPS. Novelty radio, plate 50, Breed 94 price update - \$70 plus UPS. Have more for sale. Send LSASE. George Kelsay, 509 23rd St., Box 4, Niceville, FL 32578. (850) 678-0031

**FOR SALE/TRADE:** McIntosh Mod 240 w/cage near mint condition - \$1,700; MC-67 tuner - \$600; Lafayette Mod 255 stereo amp - \$325; Vintage McIntosh A-116 (30 watt) power amp - \$400. Call: Larry Drago, 383 Lincoln Dr., Cheshire, CT 06410. (203) 272-6030. Fax: (203) 272-2002. E-mail: theradioman@webtv.net

**FOR SALE:** Tubes, transistor radios, micro recorder books, old electrical items, much misc. List SASE. Jim Dill, Box 5044, Greeley, CO 80631

**FOR SALE:** General Electric projection television Model 901, their finest postwar set. Craig Roberts, 132 Northway, Greenbelt, MD 20770. (301) 474-3506

## Attention Fellow Microphone Collectors and Enthusiasts:

We are pleased to announce that we are assembling a book on microphones. The object of this book will be to encompass, not only pictures and data on the microphones themselves, but the stories, experiences, applications and memories of those involved in all facts of using microphones; from the beginning to the present from normal applications to the most bizarre. We wish to include all types of microphones, from the simplest and cheapest, to the most sophisticated and expensive. Anything that has to do with the art and application of microphones.

If you have a spot in your heart for microphones and wish to submit pictures, stories, etc., anything that you think would be interesting to share with fellow enthusiasts, please don't hesitate to e-mail, fax, or mail your interests. Full credit will be given to everyone involved.

Kindest regards and thanks for your attention and support.

**Ward Lionel Kremer  
Kremer Kraft and friends**

5807 Papaya Drive, Fort Pierce, Florida 34982

Ph/Fax: 561/468-7732

E-Mail: WKremer798@aol.com



**FOR SALE/TRADE:** E.H. Scott SLRM marine receiver w/tuning eye in beautiful condition - \$400. James Millen Transmatch Mod 92200 - \$235. Call: Larry Drago, 383 Lincoln Dr., Cheshire, CT 06410. (203) 272-6030 or fax: (203) 272-2002. E-mail: theradioman@webtv.net

**FOR SALE:** Books: TV Theory, Circuits & Servicing, Grob; TV Servicing, Levy & Frankel; TV Servicing, Heller & Shulman; TV Simplified, Kiver - \$15 ea. or all four for \$45. Classic Radio & Television, 541 Riverside Dr., Box 61 Augusta, ME 04330. (207) 623-2059

**FOR SALE:** Four N.I.B. Tung-Sol 6E50 - \$300; Marantz 8B, excellent, cageless - \$1,300. Mike States, Box 81485, Fairbanks, AK 99708. Ph/fax: (907) 456-3419. E-mail: mstates@polarnet.com

**FOR SALE:** Western Electric WWI vintage CW-938 transmitter-receiver, very good condition unmodified. Delivery AWA Rochester 9/97 Daughter getting married! Richard Brewster 145 Little Peconic Bay Rd., Cutchogue, NY 11935. (516) 734-5063

**FOR SALE/TRADE:** As seen in Aug. '97 A.R.C. p. 16, beautiful Crosley Buddy Boy Repwood cathedral - \$600. Also Crosley Mod 54 New Buddy tombstone - \$400; and Mod 48 Elf w/o chassis - \$275. Call: Larry Drago, 383 Lincoln Dr., Cheshire, CT 06410. (203) 272-6030 or fax: (203) 272-2002. E-mail: theradioman@webtv.net

**FOR SALE:** Tubes N.O.S. and used, tested. Call/fax/write wants. (1) ea. 803-RCA N.O.S. - \$15; (2) ea. VT 166-N.O.S. - \$25; (6) ea. 3E29-NOS - \$10; (2) ea. 3C24 - \$25. Kirk Cline, 1818 Walker Ave., Greensboro, NC 27403-1760. Ph/fax: (910) 379-7197

**FOR SALE:** TeleMatic color TV jig, 35 adapters for tube/transistor sets - \$50. Charles A. Days, PO Box 80205, S. Dartmouth, MA 02748-0205. (508) 979-3758. E-mail: radiodaz@ici.net; http://www.ici.net/cust\_pages/radiodaz/radiodaz.html

## TUBES WANTED

New tubes must be well known brands made in U.S. or W. Europe with complete boxes. Used tubes need clear markings and silver color flashing. All must be undamaged and pass an electrical inspection. Write or fax for complete bid list.

NEW TUBES	USED TUBES
2A3..... \$25.00	2A3..... \$15.00
2A3(RCA)..... 40.00	2A3(SP)..... 80.00
2A3(SP)..... 125.00	6A3..... 7.00
6A3..... 14.00	6B4G..... 8.00
6B4G..... 14.00	10Y..... 15.00
6F6G..... 8.00	45..... 14.00
6P5G..... 8.00	171A(globe) .. 14.00
12A..... 12.00	245(globe)..... 30.00
46..... 8.50	250(globe)..... 120.00
47..... 6.00	280(globe)..... 15.00
71A..... 14.00	300A/B(WE) 200.00
350B(WE) .. 150.00	350B(WE)..... 80.00

### ANTIQUÉ TRIODE

653 Commercial St., Farnham, NY 14061  
Phone 716-549-5379 Fax 716-549-3823

**FOR SALE:** Dynaco A431 encased - \$90. Dukane DUK20 Ionovac, walnut, 3-way w/magic tweeter - \$400. Fairchild 539G cutting table, heavy, motor OK - \$150. Presto K8 record player-cutter, pp45 amp, Jensen P8S in carrying case - \$175. Presto K pp45 amp - \$85. Presto K pp45 amp - \$85. Samsom PAM16 working pair, highly stylized 1930 pp210 amps - \$800. Sun radio CR10 pp6B4 amps. Thordarson trans hammettone grey pair - \$650. Thordarson T30W05 studio mixer-amps, Tru Fidelity opts - \$700/pr **WANTED:** Amertran 678, 151CB; Peerless A100; Silver Marshall 692; Sansui H30-5; Summit Sound RA15, MP15; Thordarson T3S22, T90S13; UTC HA135, HA106; other AFTs; Altec 416; Jensen R106/RP103 (p/n 220550). Lary Rubins, 172 Bennington Dr., E. Windsor, NJ 08520. (609) 426-9744, before 10pm Eastern please

**FOR SALE/TRADE:** Radiola III - \$100. RCA AG-814 loop antenna - \$125. RCA UZ-1325 horn - \$95. EV 930 microphone - \$25. RCA 74 microphone, excellent Philmore crystal set - \$60. Zenith 5R312 - \$135. Zenith 6S127 large tombstone - \$150. Many other items available w/SASE. **WANTED:** Unusual horn speakers and telegraph keys. Jerry Finamore, 1374 Stafore Dr., Bethlehem, PA 18017-1633. (610) 861-4660. Fax: (610) 861-0166

**FOR SALE:** Sencore CR143 CRT tester, vg - \$45. RCA T6-1 TS, vg - \$125. Zenith G500 TO, vg - \$89. Bob Fuerderer Holly Farm, 813 Rte. 12A, Surry, NH 03431 (603) 352-3005

**FOR SALE:** Toshiba TR-193 lace grille in blue, excellent condition - \$285. **WANTED:** Dial scale for Coca-Cola cooler radio. Gary Milner, 106 Henry Little Cir., Pea Ridge, AR 72751 (501) 451-1343

**FOR SALE/TRADE:** Patterson Radio First Co. Allwave Communications receiver Mod PR-10 (made in Los Angeles, Ca.) beautifully appointed w/two brass escutcheons, center meter and excellent chrome chassis with black wrinkle finish cabinet, very rare - \$600. Call: Larry Drago, 383 Lincoln Dr., Cheshire, CT 06410. (203) 272-6030 or fax: (203) 272-2002. E-mail: theradioman@webtv.net

**FOR SALE:** Hallicrafters, Hammerlunds, Nationals. SASE for list. Microphones, novelty radios, no list. Send your wants. Ed Eddy, 1209 E. Geneva Dr., Tempe, AZ 85282. (602) 966-1397

**FOR SALE:** Zenith console 1939 Model 15S373, 15 tubes, excellent working condition, very nice radio - \$1,900. Call collect after 5pm or write to: Arnie Sanchez, 9615 Rockhurst, Houston, TX 77080. (713) 939-9221

## Virginia City RADIO MUSEUM 109 So. "F" St.

On display Wireless and Radio Apparatus from 1915 through the 1950's. Plus hundreds of accessories, photos and Vintage Ham Radio Station.

**OPEN DAILY DURING SUMMER  
CALL AHEAD FOR WINTER HOURS**

Henry (W7BUG) & Sharon (KK7EI) Rogers,  
P.O. Box 511, Virginia City, Nevada 89440  
Tel: 702-847-9047 or  
Website: www.tek-majic.com/radio

**FOR SALE:** (1) Philco Model 37-84, original, hums - \$160 + S/H. (3) Philco 89 chassis, (2) complete, (1) for parts - \$160 for all + S/H. Carlos Gimenez, 15091 Shamrock Dr., Fort Myers, FL 33912. (941) 482-0198

**FOR SALE:** Mikes: Turner 250 and Shure Bros. CR84. Tube tester Supreme 85. Large Western Electric tube 354A. Many tube radios, 1950 to 1960 transistors and novelties. Send want list to: Charles Leahy, Box 336, Ireton, IA 51027 (712) 278-2553

**FOR SALE:** Copies of manuals for PACO, Precision, Simpson, Triplett, Eico and others. Write your needs. Also have tubes, test equipment, scanners and RCA 66X8 red Catalin, mint cabinet, chassis rough - \$295. Clayton Mundine, 6112 S. Flores St., San Antonio, TX 78214

**FOR SALE:** Weston Model 45 voltmeter in wooden case, manufactured before WWII - \$45. Richard Lemay, 611 Charles St., Fall River MA 02724. (508) 679-8751

**HAVE YOU MOVED? ARE YOU MOVING?  
PLEASE NOTIFY US A.S.A.P.  
SEND US YOUR...  
OLD ADDRESS  
NEW ADDRESS and  
SUB #  
MANY THANKS!!!!**

**FOR SALE:** All radios restored and excellent. Free photos, can bring to Rochester. Philco cathedrals, rare 52 - \$325, 70 - \$335, 91 - \$450, 144 - \$435, 20 - \$225, 71 - \$345, (2) different 60s - \$225 ea. Cathedrals: AK84 - \$475, Crosley 158 - \$325. Philco tombstones: 625 - \$275, 116 - \$395. RCA tombstones: 8T - \$295, 9T - \$375, 143 - \$435, 140 - \$395. Plus shipping. Joe Milano, 57 Hillcrest Dr., Wayne, NJ 07470. (201) 694-3721

**FOR SALE:** Western Electric 597A, mint - \$6,000; Marantz 10B, mint, w/very early starbird stand - \$2,500. Vincent Gallo, 532 LaGuardia Pl., #600, New York, NY 10012. (212) 274-0432

**FOR SALE:** 1950s Zenith Bakelite table Cobramatic phono-radio (#R566, chassis 5L08), absolutely beautiful condition, perfect Bakelite case - \$175. P. Martone, 303 Franklin St., Melrose, MA 02176. (617) 665-4568, call before 10 pm EST

**FOR SALE:** Sony original sales literature/brochures, late 1960s, all different, large format - \$10/5. Three early 1970s brochures, including 1st Trinitrons - \$10; large 50-page, late 1960s full line catalog, recording equipment - \$15. Ellsworth O. Johnson, 364 S. Coeur d'Alene St., Spokane, WA 99204-1063. (509) 838-2161 Fax: (509) 838-5159. E-Mail: eojohnsonw2@worldnet.att.net

**FOR SALE:** Ferguson - \$75; Radiola 18 - \$90; U.S. Radio Model 7D - \$125; speakers 100A, 100B, Pausing - \$60 ea. All prices plus S/H. Bud Santoro, 3715 Bower Rd., Roanoke, VA 24018. (540) 774-9153. E-Mail: budsantoro@aol.com

**FOR SALE:** Heathkit 14" solid-state portable color TV Model GR-169, excellent condition with all manuals. TCM, PO Box 363, Rotterdam Jct., NY 12150-0363

**FOR SALE:** Rider's Volumes 1 and 2. Union Tube binders, very good - \$125 plus UPS. Dale Parsons, 5312 Koontz Dr., Cross Lanes, WV 25313. (304) 776-2180. E-mail: dale@wvinter.net

**FOR SALE:** Volumes 1 to 8 inclusive Sams Record Changer Manuals, most 1st editions, include wire recorders, disc recorders and tape recorders - \$160 for lot plus shipping. Will include "Pinpoint Record Changer Troubles in 5 Minutes" and other material, covers 1947 to 1956. Maurer Television, 29 S. 4th St., Lebanon, PA 17042. (717) 272-2481

**FOR SALE:** Tandberg multiband portable TP41 - \$50. Telefunken Concertino - \$100. National NC300 - \$350. Zenith R 7000 - \$475. Zenith Royal 755 - \$50. Charles Voigt, 94 Cleveland St., Norfolk, MA 02056. (508) 528-7928

**FOR SALE:** Radio Amateur's Handbook, 1946 edition - \$10 plus UPS. Bob Uhelski, 21015 Meadowlark Dr., Farmington, MI 48336-5061 (248) 615-1828

**FOR SALE:** Partial Deforest D7A, good cabinet, all knobs, variocoupler and condenser, not sure if original tap switch like D-7, some hardware - Best written bid; or possible trade? Pat Stewart, W7GVC, 1404 Ruth Ave., Walla Walla, WA 99362-3558

**FOR SALE:** Tubes. Please check out my tube sales website at <http://www.cinternet.net/~vactubes>. Jim Cross, Vacuum Tubes Unlimited, 3246 Floridale Ln., Cincinnati, OH 45239-6203. (513) 385-3855. E-mail: vactubes@cinternet.net

**FOR SALE:** Sams Auto manuals: 19-247 (205 manuals). All good or better - \$125, pick up only. Shirley/Bob Kendall, 1435 Burnley Ct., Columbus, OH 43229. (614) 888-7479

**FOR SALE:** Lafayette CB transceiver tube type HB444, white and chrome, vg - \$35 plus UPS. Kenneth Miller, 10027 Calvin St., Pittsburgh, PA 15235. (412) 242-4701

**FOR SALE:** Radios, misc., SASE list. NRI-33 signal-tracer, works - \$25 plus UPS. Tom Tetzlaff, 23 Nelson Dr., Silver Bay, MN 55614. (No phone)

**FOR SALE:** New experimental data on crystal detectors, for both well known and unusual types. Measurement results for relative sensitivity are given, and other properties are described. Order Report No. 9 - \$4.50, ppd in U.S.A. Crys Tech, c/o P.A. Kinzie, PO Box 6805, Kingman, AZ 86402

**FOR SALE:** Tubes: all new and boxed, most RCA at 1/2 market price: (3) 5823, (2) 7586, (3) 6012 (no box on 1), (2) 7586, (1) 6JB6, (3) 5751 and (1) 6CW4. F.H. Montgomery, 505 Congress Ave., Apt. 710, Hvre De Grace, MD 21078-3043. (401) 939-2099

**FOR SALE:** (200) N.O.S. four digit tubes: e.g. 5894, 6681 6360 and 8106, fifty different types. Stan Marlin, Box 1035, Assiniboia, Saskatchewan, Canada S0H 0B0. (306) 642-3824

**FOR SALE:** New and used eye tubes: GE5, 6G5, 6N5, 6V5 plus more. Call or SASE with your want list. Jeff Arndt, 1215 Division St., Manitowoc, WI 54220-5734. (414) 684-8830

**FOR SALE:** Three Hallicrafters: SX24, S27 and S53A - \$50 ea. No shipping. Bill Truesdell, PO Box 1519, Monrovia, CA 91017-5519. (818) 358-5025

**FOR SALE:** Zenith hardback service binders (5), including (1) 50th anniversary edition. RCA tube caddy, like new, includes over (125) tubes, 90% N.I.B. - \$50. William L. Clark, 15476 Wellington Pl. Dr., Basehor, KS 66007 (913) 724-1203



**FOR SALE/TRADE:** Flawless Federal 59, absolutely beautiful inside and out and works like a new radio, asking - \$1,750. Call: Larry Drago, 383 Lincoln Dr., Cheshire, CT 06410. (203) 272-6030 or fax: (203) 272-2002. E-mail: theradioman@webtv.net

**FOR SALE:** 20, 80, 120, 171A, 183, 199, 201 226, 381 485, BH, others. Steve Marsh, 20N. Lake Dr., Hamden, CT 06517 (203) 288-5183. E-mail: smmarsh@ct2.nai.net

**FOR SALE:** JFD dial belts, Messiner IF and osc. coils, color glass tubes and 8 page list. LSASE 55¢. Andy Bruck, RR1 Box 356, Cleveland, VA 24225. (540) 889-5591

**FOR SALE:** Edison TR receiver chassis & 8P power/ audio chassis less tubes. Power xfmr & choke test OK - \$40+ship. Harold D. Wright, RR1 Box 259, Chancellor, AL 36316-9749. (334) 347-0393

**FOR SALE:** Sams, 1001 thru 1171 Best offer plus shipping. Herb Ellmers, 775 Howard St., Ft. Pierce, FL 34982. (561) 466-0926

**FOR SALE/TRADE:** The following Collins: 51J4, near mint - \$750; 75A4 w/3 filters; Serial #5533 - \$1,250, complete S-line station w/round emblems - \$2,450, vintage radio station (line amp) Mod 6X2 - \$300. Plus many Collins filters. Send for list. Call: Larry Drago, 383 Lincoln Dr., Cheshire, CT 06410. (203) 272-6030 or fax: (203) 272-2002. E-mail: theradioman@webtv.net

**FOR SALE:** GE HJ-624 Deco, near mint - \$80; Philco 46-200 Bakelite - \$25; Stewart-Warners: 01-52 wood - \$50; 206FA (Machine Age, p. 190) - \$60. St. Regis K617, rough - \$30. Dennis Schrank, 3129 S. Quincy Ave., Milwaukee, WI 53207 (414) 744-3374

**FOR SALE:** Federal Mod 59 in excellent condition, including tubes. The set plays; asking - \$1,350 plus shipping. David A. Wright, 5225 Pooks Hill Rd. #214N, Bethesda, MD 20814-2032. (301) 530-3587

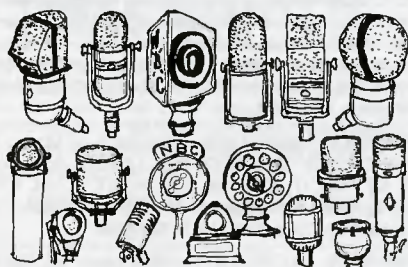

**WANTED**

FOR MY BROADCASTING MUSEUM

Microphones, stands, call letter plates. Tube amplifiers, mixers, compressors, Hi-Fi equipment. Speakers, on-air lights, equalizers. Disk, wire & tape recorders. Blank recording disks. Catalogs, magazines, manuals. 16" transcriptions, turntables, arms, pickups. Early TV cameras & receivers. Elaborate console, deco, plastic, mirror, novelty & wireless radios. Jukeboxes & parts. Acoustic phonographs.

We are looking for all makes of equipment, and especially Western Electric, Telefunken, Neumann and RCA. The museum contains various duplicates and items surplus to our needs, and many of these articles are available for sale or trade. The collection is located in my Victorian seaside inn, The Caffrey House, situated on a bay next to the ocean, in the Southampton resort area of Long Island. A trade of equipment for a stay at the hotel is always encouraged.

Robert Van Dyke, 2 Squires Ave., East Quogue NY 11942  
516 728 9835

**FOR SALE:** Gold Lion Tubes (5) #Z729 (6267) - \$20 ea., (10) #U707 (6X4) - \$10, (8) #D717 (6AL5) - \$5; University #N3 two-variable control cross-over - \$50. Amrad Quenched spark gap 14 4" copper plates cast iron on wood #G3 serial #127 (on p. 48 Clymer Blue Wireless & Radio). DeForest 3 coil tuner complete - \$125. William Harder, 911 W. Northrup St., Lansing, MI 48911-3640. (517) 882-2303

**FOR SALE:** Hallicrafters speaker R-46B and Sony TR-1000, works - \$40 ea. All plus shipping. Ed Kalpa, 4622 Melbourne Ave., Los Angeles, CA 90027 (213) 661-1221

**FOR SALE:** Telefunken Jubilate - \$50, Nordmende Stradella - \$40. Nordmende Globetraveler SeaB, poor - \$5. Don Behrens, 2417 W. Acacia Rd., Glendale, WI 53209. (414) 228-1980

**FOR SALE/TRADE:** Original Radiola II, w/built-in loop antenna - \$500. Radiola III - \$175. Radiola Special - \$750. Radiola IIIA - \$250. Philco 70 (parts set) cathedral - \$200. Radiola IV no horn, no cabinet, but works beautiful - \$375. Call: Larry Drago, 383 Lincoln Dr., Cheshire, CT 06410. (203) 272-6030 or fax: (203) 272-2002. E-mail: theradioman@webtv.net

**FOR SALE:** Kolster K-20, exc - \$125; Emerson 911 transistor - \$30. Armand Cote, 6 Sycamore Ct., Atkinson, NH 03811-2727 (603) 362-8715. E-mail: arcote@aol.com

**FOR SALE:** N.I.B. Beane Weenee, Kraft Macaroni and Chesse novelties - \$30 ppd. Enlarged copy Majestic 52 instruction manual, including schematic, parts layout and Ghirardi's Troubleshooting Notes - \$9 ppd. Herman Gross, 1705 Gordon Dr., Kokomo, IN 46902. (765) 459-8308. E-mail: w9itt@juno.com

**FOR SALE:** Packard Bell white Deco table model, green dial, original and complete - \$18. Curt Brohard, 1417 Court St., Alameda, CA 94501 (510) 521-4299

**A.R.C. BACK ISSUES**

April '87 to current issue: Originals available 32 to 100 pages each.

**Oct. '86 to Mar. '87: Reprints available**  
Reprinted from original artwork; 28 to 32 pgs. ea. Quality & appearance same as an original copy.

**June '84 to Sept. '86: Photocopies available**  
Not original quality, useful for info., 16 to 28 pages each. Publication of *Antique Radio Classified* began in 1984 which had only five issues: June, Sept., Oct., Nov. & Dec. 1984. 1985 through current year have had 12 issues each.

**\$5.00 each - Postpaid to U.S., Canada and Mexico.**

*Orders of 6 issues or more may take a 10% discount. Orders for a full calendar year may take a 50% discount. Foreign orders other than Canada and Mexico: \$8.00 each by air. Mass. residents, please add 5% sales tax.*

**A.R.C. UNCUT, UNFOLDED COVERS**

June 1991 to the present  
9.25" x 12.5" \$9.95 each

Postpaid to U.S., Canada, & Mexico  
Mass. residents, please add 5% sales tax.

Send Order To:

A.R.C., P.O. Box 2, Carlisle MA 01741  
Or Call (508) 371-0512



**FOR SALE/TRADE:** Tubes. Blue Arcturus 101-A, set of five, good emission - \$395. DeForest H transmitting tube, new - \$235. 1919 Weagant valve, excellent - \$325. Ed Bell, 5311 Wooddale Rd., Raleigh, NC 27606. Fax/ph: (919) 851-1517

**FOR SALE/TRADE:** (1) Thordarson CHT driver trans. 15D78 - \$115, (1) pair Dyna. A25 speakers - \$85. Copies of manuals for sale: Heath, Marantz, H.H. Scott, Dynaco, many others. All plus shipping. **WANTED:** OTL amps by Futterman, mono or stereo, working or not. Greg K. Lee, 2164 Auhuhu St., Pearl City, HI 96782. (808) 454-0426. Fax: (808) 484-1540

**FOR SALE:** Various values capacitors, resistors for PC - 5¢ to 25¢. Heathkit Q Meter - \$25. Sine Square Generator - \$35, plus shipping. Guido Montella, 2714 Charleston Dr., Plant City, FL 33565. (813) 752-7174

**PHONE NUMBER FOR ANTIQUE RADIO CLASSIFIED (508) 371-0512**

**Best time to call is weekdays: 8:30 am to 6 pm Eastern Time**

(Please no classified ads by phone. Thanks!)

**FOR SALE:** Microphone book, 300 pages. History of identification, How They Work - \$29.95 includes shipping. Victor Bang, Video Tech Service, 7520 S. Rural Rd., #3, Tempe, AZ 85283. (602) 491-1811

**FOR SALE:** Our active, tunable power loop will make your antique radio come alive. Guaranteed - \$29.95 + \$6.95 shipping. Loomis Labs, 2012 Citrus Ave., Jessup, MD 20794-9785. (410) 799-7763

**FOR SALE:** 1926-1956 NBC 30th anniversary section Herald Tribune; books, parts, tubes, ham stuff, much more, SASE list. Bill Tucker, W4FXE, 1965 S. Ocean Dr., Apt. 15-G, Hallandale, FL 33009. (954) 456-1349

**FOR SALE:** 1937 Zenith 8-S-154 - \$375, Zenith Trans-Oceanic Royal 7000-1 fair condition, plays - \$100. Brian Morelli, 1932 Las Gallinas Ave., San Rafael, CA 94903. (415) 472-2866

**FOR SALE:** Zenith AM/FM N731 miniature console - \$35. Radio Fundamentals 1944 army manual TM11-455 - \$15. Rich Yoch, 22410 Bartlett Dr., Rocky River, OH 44116. (216) 331-9206

**FOR SALE:** Sony CRF-320A - \$300. Hallicrafters S38E - \$45. Drake SW8 - \$495. Panasonic B-45 L.N., boxed - \$115. Aiwa multiband portable - \$45. General Electric Superadio II L.N., boxed - \$150. Realistic Hyperscan 80 channel pro-2030 scanner - \$45. Sony ICF-SW1 L.N., boxed, complete kit - \$250. All plus shipping. Gerald Silver, 10863 W. Clairmont Cir., Tamarac, FL 33321 (954) 720-1972

**FOR SALE:** Pickup radios only: nice Zenith consoles, 10S567 - \$150, 12H689 - \$225, ormate Sparton 301 - \$300, Philco 37-675 - \$250, (2) choice AK84 cathedrals - \$425 ea., Echophone Commercial - \$120. Rare tubes, (WE) VT52 - \$70, RCA 210 - \$50, 171A - \$29, 112 - \$29. Evan J. Chase, 108 Cass St., Swanton, OH 43558. (419) 826-3776

**FOR SALE:** Rider's TV 1 - \$20; 2 - \$15; 3 to 6 - \$6 ea., 8, 15 to 23 - \$5 ea. Serv. Man.. Crosley 1928-1938, Zenith 1928-1938 - \$45 ea. plus shipping. Manual list SASE or fax #. Steve Rosenfeld, PO Box 387 Ocean Gate, NJ 08740. (732) 269-2022. Fax: (732) 269-2897

**FOR SALE:** KWM-380, excellent and loaded, 1 to 18 service bulletins, self study training manual & cassettes. Bill Coolahan, 1450 Miami Dr., NE, Cedar Rapids, IA 52402-2933. (319) 393-8075

**FOR SALE/TRADE:** "Made in Japan" by Handy, sharp color pictures of RARG transistor radios, long out of print, my last few mint copies - \$35 ea. Older Eveready radio battery "Point of Sale" rack, nice - \$60; Trancel TR60, blue Continental TR682 transistors - \$65 ea. **WANTED:** Wooden "black dial" Zeniths, Emerson AX-212, "Little Spitfire" horn driver, Regency TR1/1G, Capehart, Toshiba 8TP90 transistor radios. See my Website, http://members.aol.com/dmradios/index.html for more radios. Donald M. Maurer, 29 S. 4th St., Lebanon, PA 17072. (717) 272-2481 E-mail: DMradios@aol.com

**FOR SALE:** Rider's Radio Manuals, 1-5 abridged, Vol. 6-21 with index - \$350, pick up. Four large binders Lafayette service notes, early 70s - \$25/all. Majestic 130A chassis - \$25, six-inch stack Toshiba service data - \$10, Zenith 6R880R, Admiral 5D32R/RP - \$20 ea. Grundig Model 3059, fair condition - \$30. Zenith 10S690 R/RP - \$75, pick up. Zenith Z508-R - \$7 M510-R - \$15, both cracked, plus shipping. **WANTED:** Chassis for U.S. Apex 9, GM 250, Westinghouse WR-14 cathedrals, Majestic 363, Crosley 1137 cabinet for Radiola Regenoflex. Brian Kurrle, 2222 Nodleigh Ter., Jarrettsville, MD 21084. (410) 692-0450

**FOR SALE:** To give me room for other hobbies, many items from my collection of old radios, televisions, transistor military, novelty radios. Hearing aids, telephones, microphones, earphones. Rare medical, science, aviation books, test equipment. Sell or trade for Catalins. For expanded new list, send two-stamps, LSASE. John Enigi, Sr., K9HJL, 5425 Cherry Ln., Egg Harbor WI 54209. (920) 743-3672

**FOR SALE:** Heath Kit SB-310 shortwave, like new with SB-600 speaker - \$125. Singer #TV6U 5.5" TV - \$35. Six spools recording wire - \$25. GE millivolt meter 8DP9V-Y51 - \$35. Weston footcandle meter 614 - \$35. Triplett #10 VOM/amprobe - \$20. Triplett #321 VOM/tube tester - \$25. Superior Instrument RF generator, uses two 6A7s - \$20. Mike Itzo, 515 77th Ave., Saint Pete Beach, FL 33706. (813) 360-1189. E-mail: Soldradios@aol.com

**FOR SALE:** Philco Mod 38-35 tombstone - \$95. Fada Mod 177 large wd 4 kn @ 10 - \$95. Zenith M-6S527 BC/SW A/O N/D @ 9 - \$70. Philco M-PT-6 Sm WD 2 kn @ 9 - \$40. Spkr box Majestic M-20 w/grille @ 10 - \$35. AK spkr Type E, black - \$25. Radio City prod. multitester M-662 - \$25. Bike radio Motorola M-B150 red, some surface rust, chassis clean, 10" long - \$190. Plus P&S, Bernie Samek, 113 Old Palmer Rd., Brimfield, MA 01010. (413) 245-7174. Fax: 0441

**FOR SALE:** Plastic dial covers for AK 145, Belmont 6D111 Crosley D-25M clock cover Delco R-1185, Emerson 375, 400, 520; Fada 200, 1000; Hallicrafters RE-1, S-38, S-39; Zenith G-500, Northern Electric 5000, and hundreds of others - \$15 ppd. Doyle Roberts, HC63, Box 236-1 Clinton, AR 72031 (501) 745-6690. E-mail: drob@artelco.com

**FOR SALE:** The Antique Radio Gazette series from Spring of 1990 through final summer edition, 1994, (18) books complete - \$50. I pay postage. Bob Barr, 3130 Bellanca St., Columbus, GA 31909. (706) 322-2180



**FOR SALE/TRADE:** The following speakers: "Vogue" pedestal, emerald green w/dark brown background plus large goldleaf, ornate Repwood grille and base, two Radiola 103 Tapestry speakers - \$175 ea. Amplion w/black wrinkle finish elongated goose neck w/chrome 14" bell and shiny brass base, "Mack" horn speaker w/ 2 horns sprouting out of main horn at base that you attach earphones to obtain sound, rare Magnavox R 2-C base in near mint condition, Amplion "cathedral style" cabinet w/large ornate "brass grille" that encloses a genuine Amplion horn and driver, extremely rare, Philco 1929 round speaker on long curved base that compliments their first AC metal radio. Call: Larry Drago, 383 Lincoln Dr., Cheshire, CT 06410. (203) 272-6030. Fax: (203) 272-2002. E-mail: theradioman@webtv.net

**SEND ALL A.R.C. MAIL TO**  
**Antique Radio Classified**  
**P.O. Box 2, Carlisle, MA 01741**

**FOR SALE:** Gonset CD 2-meter communicator, good condition and working - \$65 plus shipping. Herb Ellmers, 775 Howard St., Ft. Pierce, FL 34982. (561) 466-0926

**FOR SALE:** Signal generator Eico Model 320 with manual - \$35 plus. Elwood Hunt, 308 Georgetown Rd., Carneys Point, NJ 08069-2512. (609) 299-5259

**FOR SALE:** Zenith Trans-Oceanics, original, complete, working, 100% cosmetically restored to showpiece condition: 8G005YT - \$195; H-500 - \$190; L600 - \$190. Frank J. Manzano, 82 Monhegan Ave., Oakland, NJ 07436. (201) 337-5263

**FOR SALE/TRADE:** Immaculate and all original E.H. Scott 15 tube allwave (perfect chrome/working set), inside Wellington cabinet w/original record player, manuals, catalogs, etc. - \$1,795. Can ship anywhere. Call: Larry Drago, 383 Lincoln Dr., Cheshire, CT 06410. (203) 272-6030. Fax: (203) 272-2002. E-mail: theradioman@webtv.net

**FOR SALE:** 1951 Rockola - \$1,100. JBL C-36 spkrs - \$650/pr. Scott 4312 - \$300. LK-48B - \$90. 240 amps - \$750/pr. Pilot 232 amp - \$300. Fisher FM-100-B - \$185. Mac MR-65B tuner - \$250. Plus EV Altec, HK, JBL stuff. Tim Simpson, 915 Enright Ave., Cincinnati, OH 45205. (513) 471-1916

**FOR SALE:** Best offer by Nov. 1, 1997: Breadboard 4340A Radiodyne, (5) rainbow 01-A's, exc shape; breadboard 9, 4445A, (4) tipped tubes, exc shape. SASE and \$1 for photo. Rose Wenum, 3111 Gabler Ave. SE, Buffalo, MN 55313. (612) 477-9023

## ARBE-III - Universal Battery Eliminator

\$149.95 Shipped USA

Contact:

Antique Radios Inc.

Box 6352, Jackson, MI 49204

(517) 787-2985 or

Fax (517) 782-7422



**FOR SALE:** Regency Range Gain I. Earliest version with anodized aluminum front panel, exc - \$150. Clyde Powell, 3822 Edwards Ter., Chattanooga, TN 37412. (423) 867-5022

**FOR SALE:** Rider's 1-5, abridged - \$40. Box of old microphones, mostly Turner and American, selling entire box, will not separate - Best Offer. Complete set of Audel's Electric Library - \$50. **WANTED:** Pilot Super Wasp coils. Frank Franowsky, 440-A Jemez Rd., Santa Fe, NM 87501 (505) 473-4150

**FOR SALE/TRADE:** Steinite crystal radio and interference eliminator, Brandes headphones, all - \$175/ trade. Dave Gonshor, 7121 S. Jellison St., Littleton, CO 80123. (303) 979-9511

**FOR SALE/TRADE:** Large collection of microphones by RCA, Altec, Western Electric, Shure, American, Sony, Turner, Wonderboy, Electro-Voice, etc. Many TV broadcast and radio versions as well as spring held carbon microphones of the 1920s. Send for video tape (\$10 refundable) of entire collection. Call: Larry Drago, 383 Lincoln Dr., Cheshire, CT 06410. (203) 272-6030. Fax: (203) 272-2002. E-mail: theradioman@webtv.net

**FOR SALE:** Received more books, test equipment, plus the usual - 32¢ LSASE for 5+ pages. Stan Lopes, 1201-74 Monument Blvd., Concord, CA 94520-4402. (510) 825-6865. E-mail: splopes@aol.com

**FOR SALE:** Philco 46-350, NT, n/handle - \$20. Zenith T505 - \$45. Patrick Franzis, 235 Millville Ave., Naugatuck, CT 06770-3848. (203) 723-8976. E-mail: n1ocj@qsl.net

**FOR SALE:** General coverage receivers Kenwood R600 - \$200. Yaesu FRG100 - \$350. Hallicrafters S120 - \$25. Realistic SP150 speaker - \$10; PRO IIA studio headphones - \$20. AN/URM 25G signal generator 10Kc-50Mc - \$45. Eico 369 sweep generator - \$30. Eico 150 solid-state signal tracer - \$25. Eico 625 tube tester - \$25. Hewlett Packard 204C audio oscillator - \$55. Schlumberger Heath SM21A VTVM - \$40. Isolated, variable 0-130v, metered AC line control box - \$55. Heath IT121 in/out circuit transistor checker - \$35. **WANTED:** 3 inch flat face CRT (WA5078P1) for small Eico or RCA oscilloscope. Andrew Gretchenuk, 12233 Rosaro Ave., Warm Mineral Springs, FL 34287 (941) 423-0647

**FOR SALE:** Rare 1930 National SW-5 Thrillbox, vg, working, (1) coil set, no PS - \$400; **WANTED:** Nice SX-88; have several very rare 1928 National SW-2 receivers in optional cabinets with full coil sets in original boxes to trade. Greg Gore, WA1KBQ, 11528 Watermoss Ln., Charlotte, NC 28262. (704) 549-4719

*I am a serious collector and historian interested in all aspects of E. H. Scott.*

Please contact me first if you are selling your E. H. Scott Radio, Selec- E H RADIO tone Coils, World's Record Superhet, or Scott Transfor- mer Co. items.

*Always interested in any E. H. Scott stock certificates, literature, and military sets.*

**John T Meredith**  
**2462 Statonsburg Rd., Suite 152**  
**Greenville, NC 27834 - (919) 551-1882**

**FOR SALE:** Telephone hookup wire, 500 feet - \$15; 2 for \$25. Mathew W. Lineberger, 295 Grove St., Providence, RI 02909. (401) 831-0976. E-mail: mlineb534@aol.com

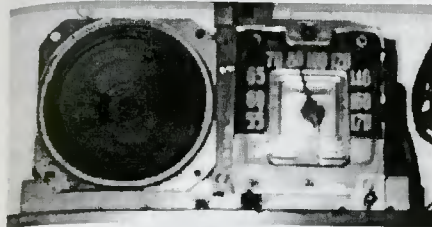

**FOR SALE:** Three chassis for Catalin radios. Fifty more cathedral, gothic, tombstone, wood table models, Bakelites, from 1930s, 1940s. Most all brands, condition is nice to rough - \$65 up. Amphenol Dragon horn, Bolex cameras, Ampro 8mm projector Beta VCRs, high quality VHS VCRs, foreign VHS machines, 1970s stereo receivers, Fisher Marantz, others. Test equipment. Closed television store after 33 years, selling everything. Call: Charles Seidel, PO Box 1500, Merlin, OR 97532. (541) 474-2596

**FOR SALE/TRADE:** Marantz tube stereo preamp, very good/excellent, perfect face and knobs, all original caps, no leaks, works as new - \$950 OBO. Dynakit PAS-3, like new, works - \$150 OBO. Lafayette stereo 250 tube amp preamp w/four Telefunken EL-96 in outputs, like new, sounds sweet - \$175. DBX 224 noise reduction, very nice - \$50. Sony TC-8, 8-track cassette tape recorder, excellent - \$50. Rek-O-Kut M-5 lathe, w/ Presto 1C cutter head, 16 inch turntable, offers. Radiola 26 portable superhet, very good/excellent, missing tube cover, but knobs would work, escutcheons excellent, offers. Three chassis pre-WWII homebrew ham transmitter, made from mostly milspec stuff, pictures available, offers. Test equipment, Hickok 533 tube checker, complete, shabby case, roll chart OK, but gears have missing teeth, offers. B&K 175 VTVM, excellent - \$20. RCA signal generator from RCA Institutes, excellent - \$25. Three inch RCA scope from same - \$25. Three inch Navy scope, slant front in case, excellent, works - \$85. Ninda Model 207, five inch dual trace scope to 2 microseconds, works - \$75. We have several wire recorders from fully restored to parts machines. Mostly Webcor and Silvertone. Interested in trading, selling, etc. Need mics and accessories for same. Microphone for sale, RCA BK 5-B w/yoke, shock-mount, excellent, works - \$450. Always looking for vintage mics, RCA advertising, clocks, thermos, chairs, curtains, signs, especially neon, Espey table radios, literature, advertising, CD/cold war era stuff, helmets, posters, photos of A-bomb, A-bomb press, etc. Offers accepted on anything. Trade or cash. Don't be bashful! I buy too much stuff! **MESSAGE:** I received over (25) calls on Heathkit 2 chassis amp. Sorry for not returning all calls, guys, but I'll go broke! Ward Kremer, 5807 Papaya Dr., Ft. Pierce, FL 34982. Ph/fax: (561) 468-7732. E-mail: WKremer798@aol.com

**FOR SALE:** Moving, must sell most of my collection: some novelties, tables, consoles, cathedrals, tombstones, battery sets, plus test equipment, speakers and phonographs; over (130) units. Send SASE for list. Dick Grogg, 206 N. Walnut, Newton, IL 62448. (618) 783-3514

**FOR SALE:** Knight Mod. KG625 VTVM, gc - \$20. Electro-Voice PA horn Mod. PA30AT - \$15. McGohan FM tuner Mod. M522B, gc - \$20. McGohan 10 w audio amp Mod. M5103, gc - \$20. Regency Monitor radio Mod. TM-HZ, gc - \$10. Wellers soldering kit Mod. 8100K, exc - \$18. Zenith Royal 500D, maroon w/case, exc - \$70. Zenith Royal 500, white w/case, gc - \$60. Zenith Royal 275, brown/tan, exc - \$35. Zenith Royal 400, black, exc - \$40. Hitachi Model TH667 pin, exc - \$35. RCA Trans. T2-K, tan, exc - \$15. York 12 Tran TR-122 pocket, exc - \$12. Farnsworth T.M. Mod. GT-061 white, gc - \$35. 1947 RCA Mod. X551 TM, brown Bakelite gc - \$35. RCA Model 6-BX-63, gray portable, gc - \$15. Zenith TM 5F05, brown, plays good - \$15. Science Fair AM-SW radio kit Mod. 28-176 - \$10. Gus Nianouris, 1316 Richard St., Miamisburg, OH 45342. (937) 866-1865

**FOR SALE:** Catalins: Stewart-Warner, DeWald Lyre, Fada bullet, Temple, 711 Garod Commander, also a few damaged Catalins. Also, Philco 90, Emerson Ingraham (Stein I, p. 75 middle), Crosley small bullseyes, ivory Emerson 200, Truetone D101Z, Truetone Boomerang, Hallicrafters 5R1Z blue, red pre-war Emersonette (crack), yellow Weltron space helmet. Also, 888 Explorers, Atlas, hand-wired Royal 500, Catalin S&P, poker chip rack & chips, clocks, red/butterscotch checkers, (3) sets - \$50. Xtra-Deco Pettipoint iron with fins, Reddy Kilowatt N.O.S. pins/charms. Ted Chronister, 7073 Carlisle Pk. #26, Carlisle, PA 17013. (717) 766-6436

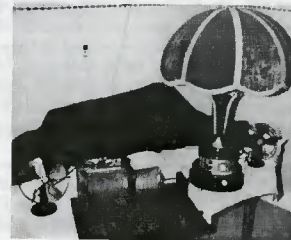

**FOR SALE:** Wireless radio lamp, Chicago, Il., works - \$750. Wireless slide tuner, transmitter on black board 14" x 16" x 1" complete, very rare - \$850. Thomas Edison battery oil bottle - \$25. IF included with other item. Edison round cylinder records, 4-minute play, excellent - \$200. Diehl ribbon air brown Bakelite fan, nice, runs - \$275. Polar cub fan 6" brass blades and 6" black, both - \$150. Edison Mabry, 715 W. Longview Ave., Mansfield, OH 44906. (419) 526-1175

**FOR SALE:** Silvertone Midget 2001 brown, like new, works - \$95. General Electric A-70 tombstone, mint, original - \$110. Truetone Airtscope 361-5Q, brown Bakelite push-button table, mint - \$70. RCA grandfather clock cabinet w/clock, no radio (takes Superette R-7), mint, original finish - \$95. All plus S/H. F.O.B. Swarthmore. Sam Mannino, PO Box 233, Swarthmore, PA 19081 (610) 353-6747

**FOR SALE:** Sears Silvertone Model 1928 tombstone battery set - \$50. Admiral Model 7T10, wood grain, plastic - \$40. Sears Silvertone Model 7006 (M.A.J.A. II, p. 270) - \$20; Montgomery Ward Airline Model 25BR-1548B clock radio - \$35. All work, and are cleaned and restored. Mark Mowrey, 510 S. 12th St., Clear Lake, IA 50428. (515) 357-3492



**FOR SALE/TRADE:** High Serial #5533 Collins 75A4 w/ 3 of the most requested filters, 4-tube noise blanker, original manual and nice cond. - \$1,275. Collins amplifier Mod 6X2 (circa 1930) - \$300. 30L-1 - \$550. Larry Drago, 383 Lincoln Dr., Cheshire, CT 06410. (203) 272-6030 or fax: (203) 272-2002. E-mail: theradioman@webtv.net

**FOR SALE:** Early transistors: Emerson 555V case bad, chassis good - \$25. Arvin 9562, 1957, works good - \$55. RCA 1-BT-58 Globe Trotter - \$20. Classic Radio & Television, 541 Riverside Dr., Box 61, Augusta, ME 04330. (207) 623-2059

### Classified Ad Deadline Noon

Sep. 10 for Oct. 1997 Issue

Oct. 10 for Nov. 1997 Issue

Boxed, Photo, & Display Ads 1st

**FOR SALE:** RCA Victor 8" portable TV Model 8PT 7034, tilt stand, case - \$160 + UPS. Paul Hametty, 4805 Parkmoor Dr., Westerville, OH 43082. (614) 882-1979

**FOR SALE:** Grundig 75-WE, small German radio - \$35. Packard Bell 5-R1 red - \$35. GE L6-22, maroon. Arthur Kreitner, 2013 E. Belle Ave., Belleville, IL 62221 (618) 233-5610

**FOR SALE:** Table radios in working condition, Crosley 11-104U, black, original w/back, hairline in top - \$75. Silvertone midget 6405 - \$90, Delco R1238 - \$40. Emerson 544, restored - \$55. RCA 120 cathedral, restored - \$175. All plus shipping. Stan Ward, 56 Third Ave., Berea, OH 44017 (216) 243-7197

**FOR SALE:** Literature and radio collection. Manuals, catalogues, many Rider's, much TV literature. Cathedrals, tombstones, battery sets, crystal sets. Large list SASE. Bill Rolf, 30131 Center Ridge, Westlake, OH 44145. (216) 871-4547

**FOR SALE:** Scarce Dumont RA-346 lattice/clock front - \$80. Sonora RWFU-238, small ivory Bakelite, phonograph - \$45. John Koop, 48 Wheelbarrow Ln., Wantagh, NY 11793. (516) 731-6711

**FOR SALE:** Dynamotor DM-21B, missing cover - \$10. Sencore TC-136 w/book - \$15. 23 Lessons in Radio (HC), 1931 - \$10. Shipping extra. Patrick Marineau, K9HF, 6300 Kingsway Dr., St. Louis, MO 63123

**FOR SALE:** N.O.S. 16GP4 - \$40. "Music Mike" Kodak microphone speaker - \$250. Television Daily Yearbook (1957 Anniversary) - \$35. Robert Shuck, 10512 Winston Ln., Fishers, IN 46038. (317) 849-0381

**FOR SALE:** Edison trophy cup, awarded 1919, Edison phonograph, works - \$75. Philco 52C - \$75. Vance Rayburn, 2718 Homestead Rd., Madison, WI 53711 (608) 274-3002

**FOR SALE:** Radiola Model R-7, tombstone - \$125. Transistor, Standard Model SR-F22, plus leather case - \$125. Don Sicksels, Box 174, Forestville, WI 54213. (414) 856-6651

**FOR SALE:** (2) '50 ST19 RCA N.O.S. beat up boxes emission holds at 5 volts - Offers? Pete Putra, 1429 Lawndale Ave., Racine, WI 53403. (414) 632-2543

**FOR SALE:** 10 amp Variac transformer, exc cond., works & looks great - \$40. Vincent Cormier 6096 Pine Hill, Kountze, TX 77625. (409) 246-4318

**FOR SALE:** Hallicrafters Continental Pink - \$34; S-700, exc - \$75; TW-1000, exc - \$165. Hammarlund HQ 145, nice - \$175. Superex Germanium diode pocket, red, cool - \$35. Motorola 10Y 3-band floor radio, nice - \$175. Matsushita T-41, wht/blk w/case - \$35. Realistic DX-400, exc - \$65. Jade J-1039 in box - \$16. Aiwa 3-band - \$15. Hawkins Elec. Guide 1914, 9 vol. - \$45. Zenith Cool Superhet 30s 705-11 - \$75. '57 1000D Trans-O, exc - \$75. Royal 450 pink - \$30. Ross multiband #2311 - \$18. Aiwa AR-819 3-band in box - \$37. AR-141 Allwave - \$29. Panasonic RF-100MA, exc - \$55. Xonex #980-300 in box - \$35. Airline GSL-1079A like Trans-O - \$55. Heath SB-104, no pwr sup, exc - \$65. Catron Mini-mini 10-band - \$19. Gruen/Guild 4506 #31, Elgin AM/FM 12 tran - \$27. Aquatron VX-33C stereo AM/FM 8tk "egg" - \$36. Midland "Weather Station" - \$19. Motorola #8X26S trans. - \$19. Sonotone mini hearing aid 6 tubes, clear Zenith aid - \$15 ea. Sylvania Golden Shield #2701 - \$35. Huge (60 lb.) Phantom linear amp - \$75. Delmonico (JVC) mini TV w/pwr - \$45 & compact tube 9" TV 8PV-47U, Lafayette KT-195 broadcast amp - \$36. Valiant Deluxe Transistor 10 - \$38. 30s Echophone com. rcvr, EC-1a - \$45. Capehart #4 jukebox, missing mech. - \$95. Grunow remote tr #2A - \$50. Novelities! Japanese clear illum. globe radio - \$55. 40s tube decafter radio - \$95. Solar Hat radio, sealed box - \$33. '63 Cadillac - \$13. Leather Bonafone - \$17. Japanese canon - \$35. Sears 4-band #2278 - \$16. Panasonic! Cool 6230 Autotune table, unique - \$45. Philco CR-4 car radio comp - \$19. Baby Trinitron - \$85. '86 Trinitron, 10" - \$95. ICF-150 - \$115. Motorola Ranger - \$19. Turquoise! Model 56L4 - \$45. Sphere clock radio, inop. - \$35. Jeff VanAssche, 103 W. Silvermeadow, Midwest City, OK 73110. (405) 732-5747. Fax: (405) 741-0458

**FOR SALE:** New large photo catalog - \$1 + LSASE 2 stamps. Bob Masterson, Box 172, Valley Cottage, NY 10989. (914) 353-3151 E-mail: BMradio@aol.com

**FOR SALE/TRADE:** McIntosh MC-60 amps - \$1,600/pr. MC 240 - \$1,700. Marantz 8-B - \$1,550. Scott 340 amp/tuner - \$375. Scott 330-C tuner - \$175. (2) David Bogen DB-10 amps - \$200. Lafayette super powerful LA-235 stereo 70-watt amp - \$400. (2) Fisher Mod 70 mono blocks pure amps - \$400/pr. Fisher 500-C receiver - \$375. Scott 290 amp, 90 watt - \$500. Scott Mod 208 stereo power amp. (2) Bogen DB20 amplifiers - \$350/pr. Sherwood 8000 receiver - \$300. McIntosh Mod 230 amp - \$400. (2) Heath Kit W 5-M power amps w/pair of WA-P1 preamps - \$900. Heath Kit W M-1 power supply with Heath Kit W 3 M amp - \$400. Dynaco ST-70 w/ upgrade pad - \$350. Dynaco PAS-2 and FM 3 tuner - \$350/both. A pair of original Dyna Kit ST-70 power amps - \$600. Leak Varislope III preamp - \$100. Leak Point One Plus preamp - \$100. Harman Kardon Citation I Eleven preamp solid-state - \$225. Citation II 120-watt power amp - \$900. Citation preamp - \$425. Scott 355 preamp tuner - \$375. Scott 399 AM/FM tuner - \$350. Call: Larry Drago, 383 Lincoln Dr., Cheshire, CT 06410. (203) 272-6030 or fax: (203) 272-2002. E-mail: theradioman@webtv.net

**FOR SALE:** Philco wood table Model PT3, 1940, works - \$35. Regency TR6, black leather, works - \$50. Coronet Deluxe Transistor Boy radio, white & black, in original box, works - \$25. Complete chassis for Philco 38-4 - \$25. All plus shipping. Raymond Humphreys, 904 Jackson St., Macon, MO 63552. (816) 385-2821

**FOR SALE:** Musicmaster mahogany horn speaker - \$275. GGH red tortoise shell pyrallin (celluloid) horn speaker w/small crack - \$495. Majestic N.I.B. tubes, IF xtms and those hard-to-find Deco set knobs. Majestic bank - \$150. **WANTED:** Majestic & Grunow advertising, promotional items & chrome-front radios. 1st IF for Majestic 15. See you at Rochester! Chip Taylor, 2223 53rd St., Sarasota, FL 34234. Toll free: (888) 526-5566. Fax: (941) 359-6778

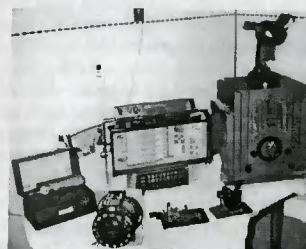

**FOR SALE:** Old volt amp battery No. 6 (Majestic), PA - \$55. Rowe AM jukebox selector, 50 selections, chrome excellent, clean - \$350. Silvertone radio tombstone Model 180, 7-tube, has foreign - \$150. Variac General Radio Co. Mass. 2.30v input - \$75. Very old Vibroplex Bug Key No. 82875 6" x 4" x 1/2" base, iron back, tire like covered - \$195. Western Elect. sounder - \$75. Edison Mabry, 715 W. Longview Ave., Mansfield, OH 44906. (419) 526-1175

**FOR SALE:** Radiotron Handbook, 2nd ed. - \$25. Tube sub guides, N.O.S. tubes, many \$1 specials. Cleaning out all used tested tubes: 5U4GB, 6FQ7 - \$1; 6SN7GTB - 50c; many others. Large SASE for Sept. list of tubes, radios and much misc. Charles D. Blair, 815 N. 5th St., Cambridge, OH 43725. (614) 432-4453, 9-5. E-mail: blair@jadeinc.com

**FOR SALE:** Majestic 71, RE-45 & RE-57 Electrola, in various condition. Call: Bob Sherman, 105 School St., Lebanon, NH 03766. (603) 448-1015

**FOR SALE:** Last list minus 25%. C/KU band 3' dish/receiver. More tubes/stuff. SASE. Randy Seifert, Box 45, Middle, IA 52307 Fax: (319) 622-3641

**FOR SALE/TRADE:** Cathedrals: Philco 21 (Ramirez, cover) cabinet only, nice - \$150. Philco 116B, chassis only - \$175. Truetone - \$125. Chairside, Zenith 7S681 R/RP - \$200. Plastic, Delco R-1231 Ribbon (Bunes 3), brown, plays - \$50. Transistor, Emerson 856 (looks like 839), original case/instructions - \$85. Zenith trades considered. Rochester delivery. Bill Timoszyk, 35283 Leon, Livonia, MI 48150. (313) 421-2076

### REPLACEMENT DRIVERS FOR ATWATER KENT HORNS

Driver w/housing for Model M & Pooley horns (this assembly replaces all pot metal) \$65.75 + \$4.75 s/h

Driver w/repair ring for Models G, H, & L (repair ring replaces threads in base) \$59.85 + \$4.75 s/h

All drivers above include diaphragm, gaskets, spacer, and spring. All parts are also sold separately. Send SASE for price list.

M. Harold Ezzone, 4901 Park Drive  
West Des Moines, IA 50265 — (515) 221-9447

**FOR SALE:** Zenith Royal 400, good - \$25. Zenth early model, SS, cassette AM/FM - \$20. Admiral Clipper 3-band transistor - \$20. Aiwa TP-50 3" R/R, N.I.B. - \$50. Marconiphone 4140, vgc - \$25. Craig Nixie tube calculator #4503 - \$100. Hallicrafters HC-100 walkie-talkie (1) - \$38. American Watch Tool Co. lathe - \$78. Heathkit audio analyzer - \$40. Boonton capacitance bridge - \$50. Telefunken bajazzo TS-105 - \$40. Newcomb EL-84 transcription player - \$110. RCA Victrola 55-U - \$30. All plus ship. Mary Ellen & Roger Ruddick, 33 Emily Ln., Ft. Myers Beach, FL 33931. Phone/fax: (941) 463-8887

**FOR SALE:** WWII Japanese tubes, all N.O.S., tested and ppd; UZ-30MC for Mod 94 Mark 6 - \$80 ea. RH-4 - \$30 ea. KH-2 - \$30 ea. International Postal Money Order please! **WANTED:** Japanese tube portable, any model. Noriyoshi Tezuka, 1-11-2-403 Hiroo, Shibuyaku, Tokyo 150, Japan. Fax: 011-813-3440-8396

**FOR SALE:** N.I.B. U.S. tubes: (4) RCA 811-A - \$90; (20) 7247 - \$10 ea., (4) RCA 8005 - \$75 ea., (4) RCA 8000 - \$65 ea., (3) IL6 - \$22 ea., (3) RCA 7027 - \$35 ea., (4) SYL 8417 - \$130; (7) 7199 - \$15 ea., (4) 6973 - \$15 ea., (20) 6267/EF86 - \$12 ea., (4) 6B4G - \$100; (10) 12BH7A - \$6 ea., (8) 7868 - \$20 ea., (10) RCA 6CG7 clear top - \$9 ea., (20) 12AU7-12AT7 - \$4 ea. Roland Barbeito, 19 Murray Ave., Westfield, MA 01085. Phone/fax: (413) 572-4745

**FOR SALE:** Ivory Plaskon: Packard Bell 501, top crack - \$35; Pilot T504, minor stress - \$220. Unpainted Bakelite: Silvertone 6405 - \$80; Northern Electric Midge double bulls-eye - \$85; RCA 96X2, small bottom chip - \$140; GE 202 - \$30; Majestic 5LA5, bottom cracks - \$30; Howard 901A, ivory paint - \$25. Others: RCA clock 4-C-621 Meteor 7000, RCA 4-X-644 - \$15 ea. Mike Stambaugh, 506 W. Springettsbury Ave., York, PA 17403. (717) 854-1368. E-mail: mlstam@rocketmail.com

300+ STALLHOLDERS  
will be exhibiting at the next

## National Vintage Communications Fair

HALL 11 • NEC (Birmingham) • UK  
• Sunday 26th October 1997 •  
— 10.30am 4pm —  
Britain's premier event for buying  
VINTAGE  
RADIOS,  
EARLY  
TVS, and  
GRAMS  
etc. etc.

For further details/bookings:  
NVCF, 13 Belmont Road, Exeter, Devon, ENGLAND  
— Telephone (01392) 411565 —  
e.mail sunpress@mail.zynet.co.uk  
Internet http://web.ukonline.co.uk/p.foden/radio.htm



**FOR SALE:** To reference our Zenith models, order our 60-page 11 x 17 Zenith Brochure Book - \$28.95 ppd. 1938 Zenith Georgian 15 tube, very rare. Mint Zenith 15U269. Nice Hoffman solar black, no cracks - \$250. Nice original Zenith 6S128 Deco tombstone. Zenith 835 chrome-front. Zenith 10S130. N.O.S. Majestic chrome grilles for Mod 161 - \$120; 463 - \$100. Two 7G605s: one bomber, one sailboat. Zenith 7S240, chairside. Stromberg 61T tombstone - \$235. We have hundreds of radios for sale. Call or refer to last month's ad. Call for current availability of Rider's manuals. Vol. VI or VII - \$20. Also most Trans-Oceanics. Others available: Zenith, Stromberg, GE, RCA, Fada, Philco. We can and do ship consoles anywhere and we do it right. Delivery available at Rochester meet. All radios unrestored electrically unless noted. Shipping extra unless noted. Satisfaction guaranteed, highest quality possible assured. Send for our free parts and supply catalog. Electrical restoration service available. Visiting Minneapolis? Visit our store, Great Northern Antiques, 5159 Bloomington Ave., just five minutes from the airport. We accept Visa, Discover and Mastercard. Alan Jespersen/Mike Emery, PO Box 17338, Minneapolis, MN 55417 (612) 727-2489. Fax: (612) 727-1908, ans. mach. after 4 rings, 8 am-8 pm, 7 days. E-mail: mte612@aol.com.

**FOR SALE:** Zenith 12-tube shutter dial chassis, 3 bands, 39-40 vintage - \$100. Zenith speaker, large - \$70 OBO. Wavemagnet antenna - \$45. HP410C VTVM with AC probe and manual - \$95. Specialty products WWV receiver, all freqs 2.5 to 25 MHz tone filters, speakers - \$145. Tek P6046 differential scope probe, 100 MHz, with kit - \$250. HP 456 AC clip on current probe - \$35. Tek P6019 AC current probe, amp, PS - \$90. Tek 453 50 MHz dual trace scope. ESI-250 DELCR bridge, small battery powered, high accuracy - \$150. All plus shipping. **WANTED:** 7735/A/B vidicon, no burns. Stan Krumme, K06YB, 16432 Lakemont Ln., Huntington Beach, CA 92647 (714) 841-5866, evenings



**WANTED!**

**Microphones—all types:**  
Telefunken, Neumann, AKG, RCA, Sony, etc.  
Also buying recording studio equipment,  
tube compressors, EQ's: Pultec, Lang,  
Teletronix, Urei, Fairchild, RCA, etc.

**818.784.7611 • Fax 818.784.7564**  
Moving Hands Studios Los Angeles, CA

TELEFUNKEN  
NEUMANN  
AKG  
RCA  
SONY

**FOR SALE:** Signal generators: HP8604B/323 RF signal generator, rugged, in transit case, AM/FM/CW pulse, metered 6 LED digit frequency display, 0.450 to 520 MHz - \$365. HP8604B/3, commercial version of the above/323 model, includes reverse power protection - \$650. Call for other HP8640 options. HP 8660C RF synth. generator mainframe - \$600. HP8660C mainframe parts set - \$250. HP8660C with RF and AM/FM modulator plugins, 0.1 to 110 MHz in 1 Hz steps - \$1,000. Option 100 module for HP8660 - \$250. HP8601A RF sweeper 0.1 to 110 MHz, AM/FM/CW, metered - \$180. HP3330B synth. generator 1 Hz to 13 MHz in 0.1 Hz steps, output in 0.01 db steps - \$375. HP652A, 10 Hz to 10 MHz sine, 50 and 600Ω audio - \$95. All good condition, completely functional, except parts set. Plus shipping. Stan Krumme, K06YB, 16432 Lakemont Ln., Huntington Beach, CA 92647 (714) 841-5866, evenings

**FAX NUMBER FOR  
ANTIQUERADIO CLASSIFIED  
(508) 371-7129 - 24 hours a day  
Ads - Subscriptions - Book Orders  
See inside front cover for details**

**FOR SALE:** Tubes! Most all radio types in stock. September specials: 24A, 27 77/6C6, 78/6D6, and any local, except 7AF7 only - \$3 ea., 01A, 12A only - \$9 ea., Types #83 & 5Z3 only - \$8 ea. All tested and guaranteed. \$4 ship per order, while they last. Antique Audio, 253 Blanche St., Plymouth, MI 48170. (313) 20-RADIO

**FOR SALE:** Wurlitzer Sideman, rhythm attachment, 12" wide x 24" high x 30" deep, wt. 50 lbs., circa 1940 - \$100. Ed Davis, Box 203, West Baden, IN 47469. (812) 936-9611

**FOR SALE:** Sony TC-106A mono R-R tape recorder - \$75. Concord #444 stereo R-R tape recorder - \$75. RCA VTVM WV97A - \$35. Fisher 49T tuner & 49A amp, 2 pc. set - \$75. Garrard RC88-4 record changer - \$45. Zenith H724 AM/FM radio - \$35. RCA 6-B-5-A, 1955, tube radio - \$35. Bell & Howell 8mm film projector #253AX - \$45. Sylvania sign, gold on black, 9" x 45" - \$25. Fisher 400 FM receiver w/case, working - \$125. 15 drawer resistor cabinet loaded with wire-wound power resistors - \$30. Heathkit AA-14 stereo amplifier - \$20. 60-watt power amp tube-type w/6550's - \$125. Heathkit BE-2 battery eliminator - \$45. Heathkit IT-5230 color/B&W picture tube tester - \$35. Electrolytic capacitor grab bag: Twist prong cans, all N.O.S. most N.I.B., assorted single section up to 4 section caps - \$20 for (10) pcs. All prices plus UPS. Bob Lynn, 26 E. Orchard St., Somerville, NJ 08876. (908) 685-9070

**FOR SALE/TRADE:** Stylish UK, European, Australian, African radios of all eras/mediums for Catalin, beetle, Plaskon, early novelty, Repwood, cathedrals. Have stunning Kenmac book ER Fone crystal set M.I.B., black & chrome circular Ekco, mirror glass French boudoir radio (with lamp), gold Emor Globe, French Teakettle, Pure Oil Dolls House. Specific wants - yellow/brown/blue AU190, USAs, Fada 254/260, Baby Addisons, Crosley/Emerson Repwoods, Ozarkas, RCA 121, J Bells, Echophone S5, circular wooden and wooden Catalin sets. May buy small choice collections. Back in UK, more passionate than ever! Could deliver swaps/trades to Rochester. Please fax/call if you would like to meet. Simon Wade, Finchcroft, Broadwater Down, Tunbridge Wells, Kent TN2 5PE, United Kingdom. Telefax: (44) 1892 543505

**FOR SALE:** NEW!!! Knobs with brass centers for the 600 series Zenith Trans-Oceanics - \$16 ea. NEW!!! Excellent exact wooden reproduction knobs for the 25 tube Stratosphere. We offer speaker field coil rewinding and complete speaker repair. Call. NEW!!! Color Laser cover/Xerox copy of a Sparton full line catalog showing the Nocturne, 558 and many others - \$22 ppd. Replica copy of Zenith 25 tube Stratosphere owner's manual - \$15. Replica face plate for 1938 Zenith Robot dial, an exact copy of the original - \$45 with your restorable trade-in. Call for details. Reproduction 1936 or 1937 Zenith full line poster - \$19 ppd. Zenith 7G605 Trans-Oceanic log chart reproduction - \$19.95 ppd. Excellent repro knobs, owner's manuals for most Zeniths and other brands, grille cloth and other radio parts. Universal Dial Belt kit - \$8.95 ppd. Send for free catalog. Visa, Discover and Mastercard accepted. Alan Jespersen, PO Box 17338, Minneapolis, MN 55417 (612) 727-2489. Fax only: (612) 727-1908. E-mail: mte612@aol.com

**FOR SALE:** Stromberg-Carlson Mod 1A w/tubes - \$275. Scott Phantom chassis, amp and speaker - \$600. Radiola 103 sprk, vg cond., working - \$175. Atwater Kent Mod 20C no/tubes - \$95. Edison Standard repro horn, 3 cylinders, working - \$775. Commerce Radio Phone crystal set - \$600. We enjoyed seeing everyone at the meets in Lansing and Elgin and are looking forward to the meet in Rochester. For more info, contact us at: Waves, 110 W. 25 St., Suite 1005, New York, NY 10001 (212) 989-9284. Fax: (201) 461-7121 E-mail: c1wave@aol.com

**FOR SALE:** Kolster 6-D - \$70. Airline 93BR-460A wood battery set - \$45. Stewart-Warner A61-P1 portable, very nice - \$40. Zenith T-O H500, excellent - \$125. Instructograph code-practice tape sender, windup - \$45. Gloritone 26 cathedral, pristine original condition - \$130. Plus UPS. Ernie Nagy, PO Box 822, Elk Rapids, MI 49629-0822. (616) 264-9412

**FOR SALE:** Zenith Mod 53 radio, no cabinet, all parts/tubes, plays great - \$175. Larry Wilson, 310 75th Ave. N #3, Myrtle Beach, SC 29572. Ph/fax: (803) 449-5839

**E-MAIL ADDRESS FOR  
ANTIQUERADIO CLASSIFIED  
ARC@antiqueradio.com  
Ads - Subscriptions - Book Orders  
See inside front cover for details**

**FOR SALE:** Zenith 8G005YT Trans-Oceanic, works well - \$145. Air King 4608A Plaskon Deco mini, crack - \$35. Atwater Kent Type F condenser - \$45. Radiola IIIA, excellent but no tubes - \$125. WFLN Audition FM promo radio - \$55. Accustion chrome tube hearing aid - \$20. Cambridge wooden Thermionic voltmeter - \$35. Precision E-400 sweep generator - \$35. Commodore SX-64 luggable color computer w/printer - \$55. Hewlett-Packard HP-75 pocket computer, M.I.B. + - \$125. Royal #5 typewriter - \$45. Unbuilt Heathkits: GR-151A transistor radio - \$75; IM-18 VTVM - \$50; IG-102 RF generator - \$35. Science Fair 3tr. SW receiver kit, N.I.B. - \$55. Transistors: Modernage 612 - \$20; Bulova 130 - \$45; Marvel AM/FM w/underpainted top - \$25; Saxton A-982 aircraft pen style mini radio, N.I.B. - \$35. Sonys: TFM-825 - \$25; TFM-951 AM/FM - \$25; TR-710 AM/SW - \$35; Juliette 10tr. true micro in presentation case - \$40. **WANTED:** Sonata TR-650 transistor name badge and pink Hoffman solar battery door. Jon Hall, 253 Spring Oaks Ln., Ruckersville, VA 22968. (804) 985-3827, 8:30-10:30 pm. Fax: (804) 984-3299. E-mail: jon@halls.com

**FOR SALE:** Altec #401A 8" speaker, 8 ohm - \$20 ea. Also other Altec equipment. T Gaida, Box 3328, Duluth, MN 55803. (218) 724-4131 Fax: (218) 728-0260

**FOR SALE:** 30s Scott Philharmonic Chippendale Grande, excellent condition, pictures - \$3,500; offers. R. M. Pierson, 154 W. Prospect St., Hudson, OH 44236. (216) 650-0585

## HIGHEST PRICES PAID FOR NEW and USED TUBES

**WANTED!**

**Western  
Electric**

VT25/A VT52 101D/F  
104D 205D/F 211D/E  
252A 262A/B 274A/B  
275A 300A/B 301A  
310A/B 311A/B 347A  
348A 349A 350B  
417A 421A 422A

**OTHER TUBES WANTED!**

2A3 5AR4/GZ34 6CA7/EL34

6L6GC(RCA) 10(GLOBE)

12AX7/ECC83 (Amperex/Mullard/RCA/Telefunken)

45(GLOBE) 50(ST & GLOBE) KT66 KT77

KT88 211/VT-4C 845

5691 & 5692 (Red Base) 6550(ST) etc.

**IF YOU HAVE ANY TUBES LISTED IN THIS AD,  
PLEASE Call or Fax DON SINGERHOUSE**

**SINGERHOUSE  
OUND**

**TEL/Fax: (715) 246-3899  
P.O. Box 321, New Richmond, Wisconsin 54017**



**FOR SALE:** (14) E.H. Scott consoles, including a rare Chippendale (not Chippendale Grande). Also, photocopies of E.H. Scott catalogs, laser or ? Some originals, also. Call for info. We accept Visa, Mastercard and Discover. Alan Jespersen, PO Box 17338, Minneapolis, MN 55417 (612) 727-2489, 8 am to 8 pm, 7 days. Fax only: (612) 727-1908

**FOR SALE:** Manuals, catalogs 1960s, 1970s, Fluke, HP Tektronix, Ballantine M412, M513, M881A - \$5 ea. More. James Wright, 4307 Hwy. 166N, Maynard, AR 72444. (870) 647-2913

**IF YOUR EXPIRATION DATE IS SEPTEMBER OR BEFORE, RENEW TODAY! EARLY RENEWALS RECEIVE AN EXTRA ISSUE!**

**FOR SALE:** Crosley JM-8BN hybrid book radio, excellent - \$150. Toshiba 8TM-294B transistor radio, excellent - \$100. Global GR-711 N.I.B., slight hairline - \$175. Suzanne Wyatt, HC67 Box 382, Ash Flat, AR 72513-9305. (870) 895-4757

**FOR SALE:** Zenith 6S322 - \$125. Bosch 66 Cruiser - \$125. Radiola 17 - \$75. Zenith 6S137 Zephyr - \$225. Crosley show box - \$35. Silvertone small metal radio - \$40. Freshman Masterpiece 3-dial battery set - \$75. Meteor cathedral cabinet - \$20. Scott service manuals from 1940s - \$12. **WANTED:** Chassis for Pilot Midget and Echophone S-10 cathedrals. Richard Haneline, 3600 Cuba Blvd., Monroe, LA 71201 (318) 323-9657 between 8 am & 6 pm

**FOR SALE:** Coronado 501CO cathedral, rare farm set, good condition, complete - \$85 OBO. Mike Lipke, 2177 Violet Ln., New Brighton, MN 55112. (612) 631-1644

**FOR SALE:** E.H. Scott including Napier 23, Wellington 15, Warrington 27, SG 9 N.I.B., literature. Jack Sacra, 1720 Solomon Rd., Charlottesville, VA 22901 (804) 293-9985

**NEW QUALITY CAPACITORS:**

Part Number	Value (UF)	*Price/25	Each
.001-630-AL	.001	\$ 6.00	24¢
.0047-630-AL	.0047	\$ 6.25	25¢
.01-630-AL	.01	\$ 6.50	26¢
.022-630-AL	.022	\$ 7.00	28¢
.033-630-AL	.033	\$ 7.25	29¢
.047-630-AL	.047	\$ 7.50	30¢
1-630-AL	1	\$ 8.00	32¢
.22-630-AL	.22	\$ 15.00	60¢

**Volt 630 Radial Leads**

1-630-RL	1	\$ 7.00	28¢
----------	---	---------	-----

**ELECTROLYTICS:**

**Volt 160 Axial Leads**

22-160-AL	22	\$ 16.00	64¢
33-160-AL	33	\$ 21.00	84¢
47-160-AL	47	\$ 24.00	96¢

**Volt 450 Axial Leads**

10-450-AL	10	\$ 18.75	75¢
22-450-AL	22	\$ 28.00	\$ 1.12
47-450-AL	47	\$ 45.00	\$ 1.80
47-450-AL10	47	\$ 20.00 (per 10)	\$ 2.00

To order, Send Check or Money Order to:

**BOB'S ANTIQUE RADIOS**  
111 East 29th Street La Grange Park, Illinois 60526  
Telephone: (708) 352-0648 / Fax: (708) 352-0647  
Ask About Super Bulk Rates/Sorry No Credit Cards or C.O.D.'s  
Shipping & Handling included in price  
\*Sold in 25 piece lots Wholesale Only No Minimum Order

**FOR SALE:** 78 rpm record collection. 1930s-1940s RCA, Decca(?), Columbia, Victor, Musicraft, Carillon, etc. Big Bands, Dixieland, Jazz, blues all in excellent condition, includes a master tape of all records and Sony combination turntable/amplifier in excellent shape - \$675. Steve Lazarian, 2645 Nina St., Pasadena, CA 91107 (818) 798-1230

**FOR SALE:** (3) Altec 1592B mixer amplifiers - \$100 ea. Altec 2454 AM/FM stereo tuner - \$100. TV-10 - \$200. Heathkits AJ21 AJ31 IT21 - \$75 ea. Multi Eimac Cili-Fone SS - \$75. Fisher 500C - \$375. All plus shipping. Bruce Bartoli, 414 Adams Dr., Mt. Shasta, CA 96067 (916) 926-3674

**FOR SALE:** Novelties: Kent flip-top cigarettes; Superman; Batman, all M.I.B. - \$65 ea. Pillsbury Doughboy, M.I.B., Sunoco gas pump M.I.B. - \$75 ea. Mercedes grille - \$125. Pepsi Cola dispenser - \$375. 110v Champion spark plug, M.I.B. - \$175. Treesweet orange, Bud beer bottle, Kraft Macaroni, all M.I.B. - \$35 ea. Tropicana orange, Beanie Weenie - \$20 ea. Frank Rose, 3701 Crownridge Dr., Sherman Oaks, CA 91403-4820. (818) 789-1106

**FOR SALE:** Zenith TO #3000-1, complete, clean, slight blistering, 120/12 volt adapter - \$95. Two Michael Jackson/Jacksons 12" picture disc records, 1983 - \$30. Plus UPS. C. Hill, 6934 Orion Ave., Van Nuys, CA 92406. (818) 787-0376

**FOR SALE:** Marconi paper maché bust, lifesize, excellent condition, made in the UK, circa 1935 - \$750. British Marconi Wireless and Telegraph Co., Type A, dual crystal set, very rare, original and in mint condition - \$2,800. Addison 2, mint, heavy marbledized (Sidell p. 28 bottom) - \$1,600. Crosley Pup, original bonzo mascot and matching headset, excellent - \$950. British Siemens and Sterling speakers - \$175 ea. A.R. Lof, 539 Kastelic Place, Burlington, Ontario, Canada L7N 3S9. (905) 333-4557 E-mail: arn@globalserve.net

## FREE POSTER!

( well, almost.)

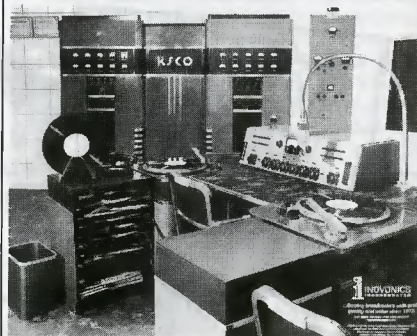

This 24" X 30" sepia-tone poster is a great shot of vintage broadcast gear at a 1940s, small-town radio station. We give these away at trade shows, and you're welcome to pick one up at our factory, free! But if you can't make it by, just send us \$4 (stamps OK) and we will mail it to you, first-class, rolled in a protective tube.

**Inovonics, Inc.** 1305 Fair Ave. Santa Cruz, CA 95060

**FOR SALE:** Surplus sale. SW-3 two pair coils - \$265; 1927 Browning-Drake Regenerformer - \$180; NC-98 - \$95; NC-109 - \$115; NC-125 - \$85; NCX-5 - \$75; NC-183D - \$100; Bud black 8-inch PM speaker - \$20. Plus UPS. Hank Bredehorst, 2440 Adrian St., Newbury Park, CA 91320. (805) 498-8907 E-mail: quailhill@aol.com

**FOR SALE:** Recapped working Philco cathedrals: 16 - \$300; 90 - \$350; 91 - \$225; 89 - \$150. Not working Philco 19, exc - \$225. Others. Mike Schwartzman, 10 Susquehanna Ave., Cooperstown, NY 13326. E-mail: schwartz@wpe.com

### HAS YOUR SUBSCRIPTION

## EXPIRED?

It has if your mailing label reads "EXP=SEP97" or earlier. Renew now!

**BONUS: Renew before your "EXP" month and receive 13 issues per year instead of 12!**

Renewal rates are:

\$38.95 for Periodicals Mailing

\$55.95 for First-Class Mailing

(Two-year renewals are twice above rates.)

**FOR SALE:** 1936 Philco console #645 - \$145. Oak tabletop Victrola #VV-IX - \$390. Both in nice working condition. Matthew Hinson, 1663 Bridge St., Merrick, NY 11566. (516) 379-3601

**FOR SALE:** Tektronix oscilloscopes Mod 7633 & 7633R, 100 MHz dual trace, CRT readout. Bob Lindahl, 10680 S.W. Wedgewood St., Portland, OR 97225-5127 (503) 644-9643

**FOR SALE:** WE #360 carbon horn mic - \$125. **WANTED:** WE carbon mic in 1B housing. Frank Hagenbuch, 1040 Bonair Dr., Williamsport, PA 17701 (717) 326-0932

**FOR SALE:** Vogues 713-32, 732-13 - \$300; 730 - \$75; 707 - \$40. Trade for windup phonographs. Larry Nelson, 1336 Howell, Cape Girardeau, MO 63701 (573) 334-8618. E-mail: a225bat@semovm.semo.edu

**FOR SALE:** Heathkit test equipment, Heathkit SSB, #HW101 Radiola III-A, AK-40, computers also. Bret Johnson, 13495 102nd Ter. N, Largo, FL 33774. (813) 595-9287 lv. message

**FOR SALE:** Spartan blue mirror Mod 557, nice condition, taking realistic offers. William Kalcik, 3714 S. Lombard, Berwyn, IL 60402. (708) 788-9022, please repeat phone # twice if leaving a message

**FOR SALE:** Truetone D2210 Art Deco metal, works - \$90. AK46 w/F2 speaker works, WT - \$80. Mitchell radio/bedlamp 1251 near mint - \$65. Morris coil winder - \$35. All plus shipping. Bill Lindley, 4265 Pont Dr., Bridgeton, MO 63044. (314) 739-0722

**FOR SALE:** Thorens portable gramophone Excelda with instructions, works, spring OK - \$400. Tom Murray, 3177 Latta Rd., #409, Rochester, NY 14612. Ph/Fax: (716) 723-1672. E-mail: tomvidtek@aol.com

**FOR SALE:** Batt: Zenith 3R, needs inside work - \$350. Heraldnye TRF "The Real Family Set" - \$200. Chelsea Regen Transcontinental ZR4 - \$150. Comm: Comet Pro - \$225. Circa 1940 Collins? tabletop xmtr w/813 Final (heavy-pickup) - \$300. Wireless: WSA Perikon detector - \$275. Rotary gap w/motor - \$150-\$175. Chelsea enclosed condenser - \$50. Blitzen enclosed condenser - \$100. AC: Zenith L cathedral (refin, top crack) - \$250. Scott 1931 console w/SW coils (pickup only) - \$850. Misc: Amrad 1920 Wavemeter - \$75; REL 1926 Wavemeter - \$75; DeForest DV-2 can - \$50. Richard Groshong, 3725 McGowan Blvd., Marion, IA 52302. (319) 377-3144

**FOR SALE:** Victor Electrola VE 9-25E serial #789, excellent original condition, 18K gold plate, working, 47 x 44 x 19" sold originally for \$1,200 in 1927 - \$6,000. Alan Jespersen, PO Box 17338, Minneapolis, MN 55417 (612) 727-2489, 8 am-8 pm, CDT Fax only: (612) 727-1908. E-mail: mte612@aol.com

**FOR SALE:** Philco 49-506 Deco plastic wedge - \$75. Emerson 547A, marbled green, slightly cracked - \$60. Olympic 6-501 slanted dial, very Deco - \$80. Halston 60M, nice wood, beautiful grille, tuning eye - \$160. Philco 42-345, nice wood w/push buttons - \$65. All prices plus shipping. **WANTED:** Philco 604, any interesting Deco Bakelite sets. Robert Carobene, PO Box 650206, Fresh Meadows, NY 11365. (718) 281-0504. E-mail: robertc894@aol.com

**FOR SALE:** Fada 711, restored - \$500. (3) crystal sets - \$50-\$300. Tube piano radio parts, music stands, pedals, etc. Geoff Shearer, 14101 Mesita Cliff Rd., NE, Albuquerque, NM 87112. (505) 293-8544. E-mail: GShea90278@aol.com

**FOR SALE/TRADE:** Table radios, consoles, tubes, needles. Ray Seppeler, Sunshine Radio (founded 1926), 8 Main, Sodus, NY 14551 (315) 483-8451 (315) 926-5696, evenings. E-mail: sunrad@aiausa.com

**VT DATA**

**A Complete Tube Manual on your Computer.**

Electrical specs for over 1200 tubes.

Includes Octals, Locals, Miniatures, Subminiatures, Metal Types, Compactrons, Acorns, Nuvistors, Historic "2-digit" and Hi-Fi Audio Types.

One or more service examples available for each tube.

Automatic searches: Enter the specs you need (Filament Voltage, Function, Base, etc.) and VTDATA searches its database for all tubes that meet your needs.

Find substitutes: VTDATA will search its entire database for all potential substitutes for the tube you specify.

Maintain your personal tube inventory: Add and delete tubes from your collection. Browse your inventory on screen.

Complete on-disk user's manual. Easy to use menus.

To Order, send \$29US (plus \$3 S&H) to: "EPS/Solutions", P.O. Box 862, Broomall, PA. 19008-0862. PA residents please add 6% sales tax. Please allow 2 weeks for delivery. IBM-PC and DOS 4.01 or higher required.

See our Web Site for more information:  
http://members.aol.com/EPsWeb/vtdata  
Email: EPsweb@AOL.com



**FOR SALE/TRADE:** Beautiful RCA (70 watt) movie theater power amps - \$1 100 for pair! Heathkit W-6M (70 watt) mono block "pure power" amplifiers - \$1,500 for pair! Grommes Mod 10-PG - \$200. Call: Larry Drago, 383 Lincoln Dr., Cheshire, CT 06410. (203) 272-6030. Fax: (203) 272-2002. E-mail: theradioman@webtv.net

**FOR SALE:** Radios for sale. All radios work! Prices do not include shipping. Prices are negotiable! Let's deal! Admiral Super 7 tan, exc - \$25. Admiral Y2272 red, exc, Comet - \$25. Admiral 42221 black, exc - \$30. AGS 88 aqua, exc - \$40. Aiwa AR160 black, good - \$20. Arvin 61R19 check mark, charcoal, exc - \$30. Bulova 890 ivory, reverse paint, exc - \$45. Bulova 672 black, fair, scratches, repaired chips - \$25. Channel Master 6506 black, M.I.B., case, nice reverse paint - Sold. Emerson 707 tan, mint - \$50. Emerson 888 red, excellent graphics, 1 small chip - \$50. Emerson 888 Titan, red, good - \$45. Emerson 888 no name, red, exc - \$90. Emerson 988 rambler black, exc, nice reverse paint, case - \$95. Everplay 1836A grey, mint, like new case - \$40. Fuji Denki RB804 red & black, HL in reverse, 2 chips, BK cor - \$35. GE 850B black, with display box, exc - \$50. GE 807C black, exc - \$30. GE P800A white, good - \$40. GE P830E grey, exc - \$30. Golden Shield 7100 tan & white, nice crest on front, exc - \$40. Hitachi 667 blue, small chips, nice reverse paint - \$35. Hitachi 627R black, mint, with case - \$40. Invicta 6TR black, horiz., CD marks, exc - \$25. Jewel 10TR white, M.I.B. - \$50. Jade J162 black, good - \$15. Juliette APR205 black, exc, in box - \$30. Kowa TRN80A ivory, exc, AM/SW, case, in box - \$55. Lafayette TR1660 blue, exc - \$20. Motorola X19A blue, good, nice reverse paint - \$45. Motorola X11B blue, exc - \$45. Motorola X11E black, exc - \$45. Motorola X23B blue, missing logo, with case - \$20. Motorola 8X26E Power 10, black, exc - \$45. Motorola X35B aqua, tiny chip, otherwise exc - \$30. Penney's 1130 black, good - \$35. Panasonic RL1880 grey, cigarette box radio, good - \$30. Penney's 1132 black, exc - \$40. Philco NT600BK black, mint, with case - \$35. RCA 3RH31 black & white, exc - \$40. RCA 3RH10 white, exc with case - \$50. Realtone 1843 black, good front, CD marks, exc - \$35. Sears 8TR white, chrome front, reverse dial, exc - \$15. Silvertone 4207 beige, exc, with case - \$40. Silvertone 4202 black, exc, with case - \$35. Silvertone 2203 mint green, good - \$25. Spica SP7D black, chipped corners, displays nice - \$40. Sony 2R21 green, good, hairline cracks - \$20. Sony 2R21 grey, exc, with case - \$40. Sony TR620 black, mint, with case - \$80. Starlite Skymate white, exc - \$30. Sylvania 4P19VD tan, exc, with case - \$40. Tempest HT6043 black, M.I.B. - \$45. Tempest HT8041 black, mint, with case - \$45. Trancel T11 white, exc - \$40. Westinghouse Escort black, good, watch radio - \$25. York TR8 black, N.I.B. with case - \$60. Zenith Royal 200 black, exc - \$45. Zenith Royal 250 white, exc - \$40. Zenith Royal 275 green two-tone, mint - \$40. Zenith Royal 285 black, exc - \$40. Zenith Royal 500H black, good, missing stand - \$90. Zenith Royal 20 yellow, exc - \$35. Zenith Royal 185 black & white, exc - \$30. Zenith Royal 50 black & white, exc, with case - \$35. Zenith Royal 50 brown & white, exc - \$35. Novelty radio, Coca-Cola large cooler repro, M.I.B. - \$99. Novelty radio, Coca-Cola wood with light up globe, M.I.B. - \$60. Novelty radio, Pepsi repro cathedral, M.I.B. - \$60. **WANTED:** Lloyd's Hippy, good condition. John Gardner 270 N. Main St., West Hartford, CT 06117 (860) 523-4145. E-mail: buggiecar@aol.com

**FOR SALE:** Rider's Radio, Volumes 7, 8, 10, 12, 13, 15 - \$20 each plus S/H. Also QST in volumes 1955, '56, '57 '61 BO. Herb Ellmers, 775 Howard St., Ft. Pierce, FL 34982. (561) 466-0926

**FOR SALE:** Dual 1209 turntable w/man. Has a Grado F3+ head - \$100 plus ship. Have others. Bill Miller, 3410 Hunnicutt Ln., Sacramento, CA 95821 (916) 489-1703

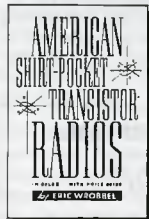

## NEW! Full Color Transistor Price Guide

**FOR SALE:** New book features (67) of the all-time greatest transistor radios made in the U.S. Featuring Zenith, Superex, Admiral, Emerson, Regency, Bell, and many more. Many shown life-size or larger, and all in full color. With model numbers, dates, notes, and current prices - \$19.95 includes postage. Eric Wrobbel, Dept. A, 20802 Exhibit Ct., Woodland Hills, CA 91367 (818) 884-2282

**FOR SALE/TRADE:** Western Electric LTD crystal set w/2 tube optional/attached WE amplifier in museum quality condition. Call: Larry Drago, 383 Lincoln Dr., Cheshire, CT 06410. (203) 272-6030. Fax: (203) 272-2002. E-mail: theradioman@webtv.net

**FOR SALE:** Vacuum tubes, all kinds, (15,000) on hand. Send want list & SASE for prompt response. Tom Ivas, 2932 W. 99th St., Evergreen Park, IL 60805. Phone/fax: (708) 423-0528. E-mail: tivas@ix.netcom.com

**FOR SALE/TRADE:** Scott Mod 4310 FM broadcast tuner in like-new condition w/cabinet - \$1,250; Scott 208 and 290 amps also available. Call: Larry Drago, 383 Lincoln Dr., Cheshire, CT 06410. (203) 272-6030. Fax: (203) 272-2002. E-mail: theradioman@webtv.net

**FOR SALE:** Superior Instrument Co. Model TV-50-A Genometer with manual - \$50 plus. Elwood Hunt, 308 Georgetown Rd., Carneys Point, NJ 08069-2512. (609) 299-5259

**FOR SALE:** Communication receivers: Hammarland HQ129X, Hallicrafters S-85, S-40B, or trade for Zenith radios. Frank J. Manzano, 82 Monhegon Ave., Oakland, NJ 07436. (201) 337-5263

**FOR SALE:** Fisher SA-1000 Stratakit, no cage or bottom cover - \$1 100. McIntosh MA-230, nice but no case - \$320. Altec 421A - \$80. Chuck Steika, 24 Frederick St., Johnson City, NY 13790. (607) 797-9573

**FOR SALE/TRADE:** Original RCA Victor radio, 12" x 6" plate glass sign, green and red against black background, absolutely beautiful. This would look great if illuminated - \$375. Call: Larry Drago, 383 Lincoln Dr., Cheshire, CT 06410. (203) 272-6030. Fax: (203) 272-2002. E-mail: theradioman@webtv.net

**FOR SALE:** RCA speaker 100?A. Radios: Lorenz (German) ZL6150, GE 409, Philco 38-38, Howard 225, Crosley 546-1228412, Eveready 3-W36703. Make offer. Kermit A. Muntman, 529 Spunky Ridge Rd., Meredosia, IL 62665. (217) 584-1780

**FOR SALE/TRADE:** Arvin 840-T - \$40. Novelties: Bert & Ernie - \$12; globe - \$35; owl - \$7. Manwich - \$6; Knights head - \$6; Firestone tire - \$30; mouse on cheese - \$20; STP oil treatment - \$15; tomato soup - \$15; car battery - \$6; Blabbermouth - \$20; Radio Shack - \$20; Statue of Liberty - \$30; cannon - \$25; phono w/ morning glory - \$25; Alka Seltzer basketball - \$10; GE P825A - \$12; Philco wood clock timer - \$25. **WANTED:** Wilcox Gay A-51 DeWald B401 Sentinel 314W, RCA 1X. Mike Anderson, 2040 Mittenwald Dr., #410, Colorado Springs, CO 80918. (719) 599-4208

## One Month Free!

### BONUS FOR EARLY RENEWALS

If you renew **before** the month shown on your mailing label (your expiration month), you will receive an extra month on your subscription: 13 months instead of 12! 26 months for an early 2-year renewal!

**FOR SALE:** National Model NC 109 and NC 190. Hoover Noonan, Rt. 1 Box 187 Pineland, SC 29934. (803) 726-5762

**FOR SALE:** Seco 1002 tube tester - \$95. John Kirby, 298 W. Carmel Dr., Carmel, IN 46032. (317) 843-2212

**FOR SALE:** Old battery eliminators. Willard Radiac B power unit - \$10. Balkite B current supply - \$15. Variac Type 200-C 0-135v at 5A and 150 volt panel meter - \$23. Mervyn Ellsworth, 2309 N. 25 St., Boise, ID 83702. (208) 385-6878

**FOR SALE/TRADE:** Kennedy 110 receiver, 525 amp. **WANTED:** Grebe CR6, ROKK Collins 30W, 32A, 32B, 4A 30FX, 32G or 32RA transmitters. Stuart Mount, W2AO, 35 Grand St., Highland, NY 12528. (914) 691-7957

# Tube Lore

## A REFERENCE FOR USERS AND COLLECTORS

By Ludwell Sibley

For serious tube enthusiasts, a new look into tubes from 1920 to the present: history of design trends, technical data, equivalencies, stocking-up hints, "where-used" information, even recent auction prices. Here's what it contains:

**Trends in Tube Design:** major styles that shaped the industry - acorns, metals, loktals, miniatures and subminis, lighthouse, nuvistors, compactrons. Odd design variants and special "reliable" types.

**Receiving and Audio Types:** "prehistoric" types from 25 tiny manufacturers as well as the big guys. Information on a lot of collectible tubes in one place. Basic data on lots of later types not found in ordinary tube handbooks, and early CRTs.

**Special-Purpose and Transmitting Tubes:** covers the familiar ones and lots of unknown types. "Regular" tubes, plus magnetrons, klystrons, thyratrons, ignitrons, camera tubes, etc. Capsulized characteristics on 2300 "specials" from 5512 to 9019. Helps identify that just-found "whatzit".

**Military Types:** a researched list of Signal Corps "VT" tubes; historic Navy types; coverage of Canadian "REL" tubes.

**Unique Tubes** from major makers: De Forest, Eimac, GE, Raytheon, RCA, Sylvania, Westinghouse. A 13-page chapter on Western Electric!

**User's Guide:** ideas on testing, adapting, repairing, reactivating, reading date codes, detecting the real maker of private-brand tubes, turning random bagfuls into usable repair stock.

**TV Sweep Types:** what tubes are used in eight audio amps and 78 amateur transmitters/linears; hints on substituting as the originals get scarcer and more expensive.

**Auction Prices:** for collectible and audio tubes, from six major tube-rich sales.

*Softbound, 186 pages, 8-1/2" x 11", \$19.95 postpaid in North America or \$24.95 air-PPD elsewhere. Orderable from:*  
Ludwell Sibley, 44C E. Main St., Flemington, NJ 08822.

Club discounts available; call (908) 782-4894.

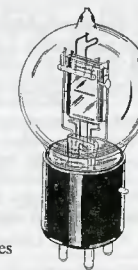



**SERVICES:** Rita's custom-made clear, plastic dial covers. **FOR SALE:** New/used tubes. Rita Hutchings, PO Box 382331, Germantown, TN 38183-2331 (901) 754-5565. E-mail: sally@netten.net

**SERVICES:** Loudspeaker repairs and reconing antique to modern; refoaming edges. Jackson Speaker Service, 217 Crestbrook Dr., Jackson, MI 49203. (517) 789-6400

**SERVICES:** Radio schematics, Rider/Sams 1920-70 - \$3 ppd. Send make/model to: Richard A. Lerche, 1561 Bluebell Ct., Livermore, CA 94550. (510) 447-9365. E-mail: lerche@aimgnet.com

**SERVICES:** Chuck's Radio is now rebuilding Atwater Kent power supplies. All new parts except transformer guaranteed - \$65 plus shipping and your old power supply. Chuck's Radio, 167 Lynn Dr., New Haven, WV 25265. (304) 882-2220

**SERVICES:** New dial scales: RCA, Philco, Zenith, many more. **SASE** for list. Rock-Sea Enterprises, 323 E. Matilija St. #110-241 Ojai, CA 93023. (805) 646-7362. E-mail: dials@Juno.com

**SERVICES:** Free book search, telegraph, wireless, radio, television. Send author and title to: Jerry Simkin, 10 Avalon Ln., Matawan, NJ 07747 E-mail: gsimkin@monmouth.com

**SERVICES:** Radio schematics & service info - **SASE** \$2.50. Steve Rosenfeld, PO Box 387 Ocean Gate, NJ 08740. (732) 269-2022. Fax: (732) 269-2897

**SERVICES:** Repair/replacement of meters before 1940. **WANTED:** Old meters before 1910, as is. Ye Olde Meter Cellar, Leonard W. Cartwright, 879 Russet Dr., Sunnyvale, CA 94087 (408) 739-6025

**SERVICES:** Schematics 1920-1960, mailed or faxed - \$3 - radios; \$4 - TVs ppd. Robert Schrantz, 610 E. Juanita Ave., San Dimas, CA 91773. Phone/fax: (909) 394-1194

**HELP:** Need rebuildable motor for Edison Home Mod D. Also rebuildable Edison and Victor reproducers - \$40 ea. Charles E. Callahan, 2717 Glendale Rd., Apt. B, Baltimore, MD 21234-5605. (410) 663-0767

**HELP:** I need a replacement tuning belt for a Zenith 7000-American. Walt Fleming, 182 Plain Hill Rd., Norwich, CT 06360. (860) 889-1957

**HELP:** Refurbishing AK Model 9 (4145) need info/source for paint on metal parts. Tips appreciated. Ted Biser, PO Box 2, Lorentz, WV 26229. (304) 472-4202

**HELP:** Looking for information on the Kennedy Radio Company, particularly Model #52A. Thanks. Mr. M. Bergman, 11 Kensington Heights, Worcester, MA 01602. (508) 754-8141

**HELP:** Business historian seeks contact with people who took correspondence courses in radio repair whether completed or not. Prof. A. Sabin, 315 Plymouth, Chicago, IL 60604. (312) 987-1441

**HELP:** Someone to repair my Pyramid Phase Three Model 25 power supply; have schematic. Greg Sheppard, KA3DBG, 4402 Jupiter St., Rockville, MD 20853-3255. (301) 946-6460

**HELP:** What was the connection between Emerson and International in 1931-32? Any info welcome. Alan Douglas, Box 225, Pocasset, MA 02559

**HELP:** Need copy of calibration portion of HM-102 Heath SWR meter manual. William Turner, W2WV 1243 Oakview Ave., Clearwater, FL 33756. (813) 447-7707

**HELP:** Need Zenith Model 970 console. Have only cabinet. Need radio chassis and speakers. Chuck Menard, WB9IFE, 232 N. Brashares Dr., Addison, IL 60101 (630) 543-4699

**HELP:** I just purchased a console radio in Plainfield, N.J. I'm looking for someone who is driving to Houston or Dallas, Tx. who can bring this radio to me. I will pay fee. Call or write to: Arnie Sanchez, 9615 Rockhurst, Houston, TX 77080. (713) 939-9221

**HELP:** Need name, address, telephone for the gentleman who makes and sells new cones for the Tower "Adventurer" ship speaker Carl R. Shirley, 824 Fairwood Dr., Columbia, SC 29209. (803) 776-6850. E-mail: shirleyc@garnet.cla.sc.edu

**SEND ALL A.R.C. MAIL TO**  
**Antique Radio Classified**  
**P.O. Box 2, Carlisle, MA 01741**

**FOR TRADE:** P 60, July 97 A.R.C., plus more for older BMW motorcycles. Scott Cavalari, 1258 Rt. 94, New Windsor NY 12553. (914) 561 7913. E-mail: araslub@aol.com

**FOR TRADE:** Rider's Vol. 10 (N.U. green), trade for Vol. 1-5, abr. in blue. Brad Winder, Box 160, Hay Lakes, Alberta, Canada T0B 1W0. (403) 878-3262. E-mail: gmwinder@telusplanet.net

**FOR TRADE:** My slide rules and associated books for small wooden table model radios or N.I.B. 6U5/6G5 tubes. A. Bruno, 24 Butternut Dr., New City, NY 10956. (914) 354-8899

**FOR TRADE:** My Zenith Spinet, 10H571 recapped for your two 1938 Zenith consoles. A. Bruno, 24 Butternut Dr., New City, NY 10956. (914) 354-8899

**FOR TRADE:** Crosley blue 11-101U, no cracks Airline 62-425, wood, nice condition. Peter Burnstad, 14508 Magdalen Cres., White Rock, British Columbia, Canada V4B 2X7 (604) 531-6882

**FOR TRADE:** Hallicrafters HCM261 CB radio, excellent. **WANTED:** S-120, Continental, or similar Jim Stoneback, K4AXF 5300 Holmes Run Pkwy., Alexandria, VA 22304. (703) 370-9857 E-mail: jstoneback@juno.com

**FOR TRADE:** DeForest D-10, in nice condition, taking best Catalin offer; Polyrod Capri transistor, nice - \$150, all plus shipping. Vern Shatwell, 13721 W. 86th, Sapulpa, OK 74066. (918) 224-4551 after 7pm

**MESSAGE:** Interested in other early electronics? How about pocket calculators of the '70s? Collect them while they're still inexpensive. Join the only organization for collectors and receive our quarterly newsletter - \$16/yr. Sample - \$3. International Association of Calculator Collectors, 14561 Livingston St., Tustin, CA 92780-2618

**MESSAGE:** Will the person who wrote me on making 1 3/4" pushbuttons for my Philco 39-25 write again. I lost your address. I want them. Richard Arnold, Box 275, Lone Grove, OK 73443. (405) 657-3319

**SERVICES:** SW-3, Super Wasp, 4-, 5-, 6-pin plug-in coil forms, WD-11 bases, adapters and WD-11 plug-in replacement tubes, battery boards being made as usual. James Fred, 5355 S. 275 W, Cutler, IN 46920. (765) 268-2214

**SERVICES:** Hickok, authorized contact person. Sales, service & calibration, most major makes, including military & kits. **FOR SALE:** Hickok, Precision, Triplett, Eico & Heath, sig. gen. tube testers VTVM, sig. tracers, cond. testers, etc. Manuals on most major makes, Hickok 500, 600, 6000 Series, TV7 118 w/cards. **WANTED:** Good used radio test equipment for repair & calibration & resale. **HELP:** Still need quality meter for Hickok 539B or parts unit. **MESSAGE:** Purging want list, please include your needs, name, address and phone number with all communications. Phone will be answered more hrs. for your convenience. Working to lessen backlog & improve turnaround time. Thanks for your patience. Wendell E. Hall, 3 Mockingbird Cir., Jeffersonville, IN 47130. Phone/fax: (812) 282-9709

**SERVICES:** Reproduction Philco cathedral cabinet parts, clock finials, reproduction 90 cabinets. **FOR SALE:** Schematics - \$2.75. Books and Rider's Radio and TV manuals - **SASE** for list. Dick Oliver, 28604 Schwalm Dr., Elkhart, IN 46517 (219) 522-4516

**SERVICES:** Do you need an old metal part electroplated? How about some Ping-Pong balls gold plated? Can plate with gold, silver, nickel, copper. Use submersible tank method. I'll help you bring that dull metal part back to life again! Reasonable rates. Mark Lang, 4601 Chelsea Ct., Titusville, FL 32796-1440. (407) 268-4697

**SERVICES:** Repair/replacement of meters before 1940. **WANTED:** Old meters/galvos before 1910, as is. Leonard W. Cartwright, Ye Olde Meter Cellar, 879 Russet Dr., Sunnyvale, CA 94087 (408) 739-6025

**HELP:** Will pay for close up photos, drawings and accurate size measurements for RCA Therman antennas. Ray Schmidt, 607 1st Ave. SW, Austin, MN 55912. (507) 433-0069 or (507) 433-3250

**HELP:** Need schematic diagram for Dahlberg pillow speaker radio. Thanks. Ted Hannah, K3CL, 11106 Bybee St., Silver Spring, MD 20902-3204. (301) 649-2319

**HELP:** I need instructions, manuals or any help on how to use a Century GT-1 condenser tester and a Knight generator to troubleshoot radio repairing. Norm Secor, 3333 Grand Ave., #361 Des Moines, IA 50312. (515) 277-4243

**HELP:** Still need brass Zenith Eagle insignia, (Bunis 3, p. 262). Thanks. David Spivey, #1 Rocky Valley Cove, Little Rock, AR 72212. (800) 505-0621 days

**CLASSIFIED AD NOTICE**  
**Please check your ads carefully before sending them in. Once ads are received, it is not always possible to refund the amount sent, pull the ad or make changes.**

**FOR TRADE:** Blue RCA curtains, RCA in black. **WANTED:** Catalins, tubed novelties, battery sets. Wayne Michiels, 7 Lowrie Cres., Tillsonburg, Ontario, Canada N4G 5L4. (519) 688-0964

**MESSAGE:** The business of Frontier Capacitor is no longer for sale, due to new products and orders. Everett Hoard, Owner, PO Box 218, 403 S. McIntosh St., Lehr, ND 58460. (701) 378-2341 Fax: (701) 378-2551

**MESSAGE:** I would like to correspond with anyone who can help provide information on the history of the National NC-100 series and variants. Please write, call or e-mail. Larry Ware, 7436 Fieldcrest Ave., Winter Park, FL 32792. (407) 679-6975. E-mail: lrware@pipeline.com

## ABBREVIATIONS USED IN CLASSIFIED ADS

### MISCELLANEOUS

amp = amplifier  
BC = broadcast  
BO = best offer  
ca. = circa (approx. date)  
ea. = each  
F.O.B. = free on board  
IB = instruction book  
LSASE = A Long SASE (see SASE)  
LW = long wave  
M.I.B. = mint in box  
MO = money order  
Mod = model  
N.I.B. = new in original box  
N.O.S. = new old stock (an original, unused vintage item)  
NT = no tubes  
OB = in original box  
OBO = or best offer  
P&H = postage & handling  
ppd = postage paid (shipping included)  
PS = power supply, also "pwr sup"  
PU = pick up only  
rcvr = receiver  
SASE = self-addressed stamped envelope (send a long, #10, envelope)  
spkr = speaker  
SW = shortwave  
UPS = United Parcel Service  
vol. = volume  
w/ = with  
w/o = without  
WT = with tubes  
xcvr = transceiver  
xfmr = transformer  
xmtr = transmitter  
xstr = transistor  
xtal = crystal

### BOOKS USED AS REFERENCES

(V.R., p 30) means *Vintage Radio*, page 30  
Blast = *Radio - A Blast From The Past*  
Bunis 1, 2, 3 or 4 = *Collector's Guide to Antique Radios, 1st, 2nd, 3rd or 4th editions*  
Collins = *Radios - The Golden Age*  
Douglas V1, V2 or V3 = *Radio Manufacturers of the 1920s, Volumes 1, 2 or 3*  
E.O.R. 1 or 2 = *Evolution of the Radio, Volumes 1 or 2*  
F.O.S. = *Flick of the Switch*  
Grinder/Fathauer = *Radio Collector's Directory and Price Guide*  
G.O.R. = *Guide to Old Radios*  
Johnson's A.R. = *Antique Radios - Restoration & Price Guide*  
M.A.J.A. = *Machine Age to Jet Age*  
O.T.B. = *Old Timer's Bulletin* published by Antique Wireless Association (AWA)  
Sideli = *Classic Plastic Radios*  
V.R. = *Vintage Radio*

### CONDITION

(If good or better mention non-original parts)  
p = poor f = fair  
g = good vg = very good  
exc = excellent

A.R.C. does not encourage abbreviations except those listed here. Please spell out all other words. Special note for hams - most subscribers are not hams so we do not recommend ham-type abbreviations.





### ALABAMA - Aug. 25

#### ALABAMA HISTORICAL RADIO SOCIETY MEETING

Birmingham, AL - Homewood Public Library  
1721 Oxmoor Road  
7 pm

Info: Earl Ridolphi, 2413 Old Briar Trail  
Birmingham, AL 35226 - (205) 823-3314

### OHIO - Aug. 26

#### SOCIETY FOR PRESERVATION OF ANTIQUE RADIO KNOWLEDGE - MEETING

Kettering, OH - Cassano's Pizza  
1680 E. Stroop Rd.

7:30 pm - WLW Stories  
Show & Tell: Mystery Night

Info: Richard Arter - (513) 932-7721, eves.

### IOWA - Aug. 31

#### IOWA ANTIQUE RADIO CLUB AND HISTORICAL SOCIETY - 4TH RADIOFEST

Dubuque, IA - Dubuque County Fairgrounds  
8 am-3 pm - Radiofest  
3-4 pm - IARCHS Meeting

Info: Doug Spyrison, 1295 Grove Ter.  
Dubuque, IA 52001 - (319) 588-2713

### VIRGINIA - Sep. 3

#### TIDEWATER ANTIQUE RADIO ASSN. MEETING

7 pm - Call for location & directions  
Info: Phil Stroud, 2328 Springfield Ave.  
Norfolk, VA 23523 - (757) 481-2561, eves.

### ARKANSAS - Sep. 4

#### ANTIQUERADIO COLLECTORS CLUB OF FORT SMITH CLUB MEETING

Fort Smith, AR - St. Luke Lutheran Church  
Waldron Road, at Free Ferry - 7:30 pm

Info: Paul Tucker, 4700 N. "N" Street  
Fort Smith, AR 72904 - (501) 782-8178

### SUBMISSION DEADLINE 5th OF MONTH

Please include date, time, place, directions,  
event details & information/contact person.

### NEW YORK - Sep. 3-6

#### ANTIQUERADIO WIRELESS ASSOCIATION 36th HISTORICAL RADIO CONFERENCE

Rochester, NY - Thruway Marriott  
Easy access from New York State Thruway  
(I-90), I-390 - (716) 359-1800

Theme: Television  
4-day, 3-Acre Antique Radio Flea Market

#### Sep. 3

6 am - Flea Market  
8 am-5 pm - Book Fair

1 pm - Prewar TV by Nat Pendelton  
3 pm - Farnsworth's Television, by Bart Lee  
4:30 pm - Key & Telegraph by Murray Willer  
7:30 pm - The War Emergency Radio  
Service (W.E.R.S.), by Robert Grindler  
7-9 pm - AWA Museum open

#### Sep. 4

6 am - Flea Market  
8 am-5 pm - Book Fair

9 am - Communication Equipment Auction  
10:30 am - Book & Magazine Seminar  
by John Terrey and Associates  
12 noon - Ladies' Lunch w/Magic Show  
1-6 pm - Television with demonstration  
of the Mirror Screw System  
8 pm - Robert von Lieben and the  
Electronic Tube by Dr. Franz Pichler  
7-10 pm - Main Auction Preview

#### Sep. 5

6 am - Flea Market; 8 am-5 pm - Book Fair  
8 am - Auction Preview

8:45 am - Sightseeing Excursion  
9 am - Vacuum Tube Auction  
10:30± am - Paper Collectibles Auction  
11± am-Noon - General Auction  
11 am-Noon- Equipment Contest viewing  
1-4:30 pm - General Auction continues  
1-5 pm - Equipment Contest viewing  
3:30 pm - The Story of the National SW-3  
7 pm - Historical and Top Awards Banquet  
Malcolm Baird on John Logie Baird  
9-11 pm - Equipment Contest viewing

#### Sep. 6

6 am - Flea Market; 8 am - Book Fair  
9 am - Tuska Radios by Dex Deeley  
10:30 am - Wireless w/Bruce Kelley  
Noon - Finale Luncheon w/Contest Awards  
2-4 pm - AWA Museum open

#### Sunday (Sep. 7):

2-5 pm - AWA Museum open  
Info: AWA, Box E, Breesport, NY 14816  
Secretary's phone - (607) 739-5443

*[If you can go to only one meet,  
make it to this one. Editor]*

### WASHINGTON - Sep. 6

#### RADIO ENTHUSIASTS OF PUGET SOUND MEETING

Seattle, WA - Queen Anne Library  
400 W. Garfield

2 pm

Info: REPS, 9936 NE 197th Street  
Bothell, WA 98011 - (206) 488-9518

### CALIFORNIA - Sep. 6

#### CALIF HISTORICAL RADIO SOCIETY MEET

Salinas, CA - St. Ansgars Lutheran  
Church, 72 San Joaquin

9 am

Info: CHRIS Hotline - (415) 821-9800

### MARYLAND - Sep. 6

#### GOLDEN RADIO BUFFS OF MARYLAND 25th ANNIVERSARY EVENT

Baltimore, MD - Bouni Temple Ballroom  
Charles Street and Homeland Ave.

7 pm-Midnight - Banquet, Show, & Awards

Info: Gene Leitner, 301 Jeanwood Ct.  
Baltimore, MD 21222 - (410) 477-3051

### CONNECTICUT - Sep. 6

#### VINTAGE RADIO & COMMUNICATIONS MUSEUM OF CONNECTICUT

Bob Steele - Radio personality at WTIC AM  
East Hartford, CT - 1173 Main Street

11 am - 12 pm

Info: John Elsworth (860) 675-9916  
Chris Watts (203) 757-3191

### NEW YORK - Sep. 7

#### GREATER NEW YORK VINTAGE WIRELESS ASSN. SWAP MEET

Lake Ronkonkoma, NY - 367 Hawkins Ave.  
N. of L.I. Expressway, lg. white house

9-12 am

Info: Chris Lieppert - (516) 471-9526, or  
Chris Bacon - (516) 821-7618

*NOTE: The Coming Radio Events  
pages are tabulated from the  
best information available to  
A.R.C. However, changes, can-  
cellations and errors do occur.  
To avoid disappointment, verify  
place, date and time especially  
for events which are new to you.*

### GEORGIA - Sep. 8

#### SOUTHEASTERN ANTIQUE RADIO SOCIETY MEETING

Norcross, GA - Picadilly Cafeteria  
3400 Holcomb Bridge Road

6:30 pm - Meeting with Show & Tell

Info: Gordon Hunter - (770) 475-0713, or  
SARS, PO Box 500025 - Atlanta, GA 31150

### ILLINOIS - Sep. 8

#### BELLEVILLE AREA ANTIQUE RADIO CLUB MEETING

Belleville, IL - Belleville Area College - 7 pm

Info: Karl Stegman, 4 Cresthaven Drive  
Belleville, IL 62221 - (618) 234-7992

### MISSOURI - Sep. 9

#### ANTIQUERADIO COLLECTORS & HISTORIANS OF GREATER ST. LOUIS - MEETING

St. Louis, MO - Kirkwood Community Center  
111 S. Geyer Rd., Room 201-A

7 pm - Meeting, Show & Tell, Swap Table

Info: Scott Teichmann, 103 Pleasant St.  
Jerseyville, IL 62052 - (314) 256-6263

### OHIO - Sep. 9

#### ANTIQUERADIO COLLECTORS OF OHIO MEETING

Kettering, OH - National City Bank Basement  
4100 Far Hills Ave., at Stroop Rd.

7:30 pm

Console & Tombstone Radios  
Info: Jim Cross - (513) 385-3855  
ARCO, PO Box 292292, Kettering, OH 45429

### ARKANSAS - Sep. 9

#### ARKANSAS ANTIQUE RADIO CLUB MEETING

Little Rock, AR - Books A Million  
Markam & Bowman Rd.

7 pm

Info: Tom Burgess - (501) 455-0773  
(Call to confirm details)

### PENNSYLVANIA - Sep. 9

#### DELAWARE VALLEY HISTORIC RADIO CLUB MEETING - SWAP MEET - AUCTION

Souderton, PA - 117 Main St. (Rt. 113)  
N. Penn Amusements Bldg.

7:30 pm

Info: DVHRC, PO Box 41031, Philadelphia,  
PA 19127 - Mike Koste - (215) 646-6488



## MARK YOUR CALENDAR

Aug. 25 - AL, Birmingham - ALHRS Meeting \$\*  
Aug. 26 - OH, Kettering - SPARK Meeting \$\*  
Aug. 31 - IA, Dubuque - IARCHS Radiofest\*  
Sep. 3 - VA, TBA - TARA Meeting \$\*  
Sep. 3-6 - NY, Rochester - AWA Conference\*  
Sep. 4 - AR, Fort Smith - ARCCFS Meeting \$\*  
Sep. 6 - WA, Seattle - REPS Meeting \$\*  
Sep. 6 - CA, Salinas - CHRS Meet\*  
Sep. 6 - MD, Baltimore - Radio Buffs Banquet\*  
Sep. 6 - CT, E. Hartford - Museum Program\*  
Sep. 7 - NY, Lake Ronkonkoma - GNYVWA Swap Meet \$\*  
Sep. 8 - GA, Norcross - SARS Meeting \$\*  
Sep. 8 - IL, Belleville - BAARS Meeting \$\*  
Sep. 9 - AR, Little Rock - AARC Meeting \$\*  
Sep. 9 - MS, Meridian - MHR&BS Meeting \$\*  
Sep. 9 - MO, St. Louis - ARCH Meeting \$\*  
Sep. 9 - OH, Kettering - ARCO Meeting \$\*  
Sep. 9 - PA, Souderton - DVHRC Meeting \$\*  
Sep. 10 - Ontario, Ottawa - OVRC Meeting\*  
Sep. 12 - NJ, Freehold - NJARC Meeting \$\*  
Sep. 13 - OK, Okla. City - OKVRC Meeting \$\*  
Sep. 13 - TX, Houston - HVRA Meeting \$\*  
Sep. 13 - Ontario, Guelph - LVRC Meet  
Sep. 13 - OR, Oregon City - NWVRS Meeting \$\*  
Sep. 13 - RI, E. Greenwich - Yankee Steam-up  
Sep. 14 - CO, Denver - CRC Auction\*  
Sep. 16 - CA, N. Highlands - CHRS Meeting \$\*  
Sep. 16 - TBA - Tri-State ARC Fall Swap Meet \$\*  
Sep. 17 - OH, Cincinnati - CARS Meeting \$\*  
Sep. 17 - OH, Columbus - COARA Meeting \$\*  
Sep. 18 - NY, Goshen - HARPS Meeting \$\*  
Sep. 20 - CA, Valencia - SCARF - Radio Fest\*  
Sep. 20 - PA, Pittsburgh - PARS - Meet\*  
Sep. 20 - NE, Lexington - NARCC Auction  
Sep. 21 - TX, San Antonio area - TARC Meeting \$\*  
Sep. 21 - MD, Burtonsville - MAARC Meeting \$\*  
Sep. 21 - NM, Albuquerque - NMRCC Meeting \$\*  
Sep. 21 - TN, Memphis - MARC Meeting \$\*  
Sep. 21 - WA, N. Seattle - PSARA Swap Meet\*  
Sep. 22 - AL, Birmingham - ALHRS Meeting \$\*  
Sep. 23 - OH, Kettering - SPARK Meeting \$\*  
† Sep. 26-27 - GA, Atlanta - SARS Mega Meet\*  
Sep. 27 - NJ, Freehold - NJARC - Swap Meet\*  
Sep. 27 - MO, W. St. Louis Co. - ARCH - Swap Meet\*  
Sep. 27 - CT, E. Hartford - Museum Swap Meet\*  
Sep. 28 - BC, Richmond - CVRS/BC Meeting\*  
Sep. 28 - NC, Charlotte - CC-AWA Meeting  
Oct. 4 - CA, Redding - CHRS Event  
Oct. 4 - KY, Lexington - MSARC Swap Meet\*  
Oct. 4 - MD, Arcadia - MAARC Picnic/Meet\*  
Oct. 4 - PA, Danville - CPARCC - Swap Meet\*  
Oct. 11 - CA, San Diego - SCARS Meeting  
Oct. 11 - IN, Greenfield - IHRS Fall Meet\*  
Oct. 11 - NC, Greensboro - Antique Radio Fest\*  
Oct. 12 - WI, Milwaukee - WARC - Swap Meet\*  
Oct. 17-19 - TX, Irving - VRPS/AWA '97\*  
Oct. 18 - CA, Fairfield - CHRS Picnic/Meet  
Oct. 18 - CA, San Diego - SCARS Swap Meet  
Oct. 18 - TN, Lebanon - MCVRPS Swap Meet  
Oct. 18 - WV, Huntington - Show/Auction  
Oct. 19 - IL, Elgin - ARCI Outdoor Meet  
Oct. 25 - NH, Nashua - NEARC Swap Meet  
Oct. 25-26 - OH, Cuyahoga Falls - BARPC - Mall Show\*  
Oct. 26 - IL, Olney - Eric's Auction\*  
Oct. 26 - UK, Birmingham - NVCF Fair\*  
Nov. 1 - CA, Los Altos Hills - CHRS Meet  
Nov. 1 - OR, TBA - NWVRS Swap Meet \$  
Nov. 1 - TX, Houston - HVRA Fall Swap Meet

(Continued at top of next column)

## MARK YOUR CALENDAR

(Continued from bottom left column)

Nov. 8 - OH, Huber Heights - SPARK Meet  
† Nov. 13-15 - CA, Van Nuys - SCARS Meeting\*  
Nov. 29 - Ontario, London - LVRC Meeting  
Dec. 6 - TX, Houston - HVRA Party \$  
Dec. 13 - OR, Oregon City - NWVRS Party \$  
Dec. 14 - IL, Elgin - ARCI Indoor Meet

\* See expanded listing this month. \$ Monthly Meeting  
† Date changed from original announcement

## MISSISSIPPI - Sep. 9

### MISSISSIPPI HISTORICAL RADIO & BROADCASTING SOCIETY MEETING

Meridian, MS - 2412 C Street - 7 pm  
Info: Randy Guttry, 2412 C. Street  
Meridian, MS 39301 - (601) 693-5958

## ONTARIO - Sep. 10

### OTTAWA VINTAGE RADIO CLUB MEETING

Ottawa, Ontario - Ottawa Citizen Conference Room, 1101 Baxter Rd.  
7 pm - Flea Market; 8 pm - Meeting  
Info: Lea Barker - (613) 829-1804  
OVRC, PO Box 84084, Pinecrest P.O.  
Nepean, Ontario, Canada K2C 3Z2

## NEW JERSEY - Sep. 12

### NEW JERSEY ANTIQUE RADIO CLUB SWAP MEET

Freehold, NJ - Grace Lutheran Church  
West Main St. & Park Ave. (old Rt. 33)  
7:30-9:30 pm - Meeting & Swap  
Info: Jim Whartenby - (908) 271-7701

## ONTARIO, CANADA - Sep. 13

### LONDON VINTAGE RADIO CLUB OF ONTARIO 9TH ANNUAL FLEAMARKET

Guelph, Ontario - Royal Canadian Legion  
919 York Rd.  
7:30 am - 2 pm  
Auction & Contest  
Info: Dave Noon, 19 Honeysuckle Cr., London,  
Ontario N5Y 4P3, Canada - (519) 453-2292

## OREGON - Sep. 13

### NORTHWEST VINTAGE RADIO SOCIETY MEETING

Oregon City, OR - Buena Vista Club House  
16th and Jackson Streets  
10 am  
Info: Ed Charman, PO Box 82379  
Portland, OR 97282-0379 - (503) 654-7387

## OKLAHOMA - Sep. 13

### OKLA. VINTAGE RADIO COLLECTORS MEETING

Oklahoma City, OK - Oklahoma Station BBQ  
Springdale Shopping Center, 4331 NW 50th  
6 pm - Meeting  
Info: Jim Collings - (405) 755-4139, after 6 pm  
Mike Lapuzza - (405) 745-3394, after 7 pm

## TEXAS - Sep. 13

### HOUSTON VINTAGE RADIO ASSN. MEETING

Houston, TX - Lai Lai Restaurant  
Tides II Hotel, Main at Holcombe  
(Medical Center area)  
9 am - Repair & Restoration Seminar  
1 pm - Auction; 2:30 pm - Program (TBA)  
Info: Bill Werzner - (713) 721-2242

## RHODE ISLAND - Sep. 13

### NEW ENGLAND WIRELESS & STEAM MUSEUM YANKEE STEAM-UP

E. Greenwich, RI - 1300 Frenchtown Rd.  
Info: Lea Barker - (401) 885-0545  
With Corliss Chapter #1 NAPE & Fidelity Amateur Radio Club  
Info: Bob Merriam - (401) 885-0545  
Fax: (401) 884-0683

## COLORADO - Sep. 14

### COLORADO RADIO COLLECTORS 6th ANNUAL AUCTION

Denver, CO - VectraBank Bldg.  
1380 South Federal Ave., rear  
11 am - Registration; 1 pm - Auction  
Radios, Televisions, Test Equipment, etc.  
Info: Rick Ammon - (970) 221-4001

## CALIFORNIA - Sep. 16

### CALIF HISTORICAL RADIO SOCIETY SACRAMENTO CHAPTER - MEETING

N. Highlands, CA - SMUD Foothill Service Center, Room D, corner of Elkhorn & Don Julio  
7-9 pm  
Info: CHRS, PO Box 162612, Sacramento, CA 95816, or Don Steger - (916) 929-8274

## N.Y./N.J./L.I./N.E. - Sep. 16

### TRI-STATE ANTIQUE RADIO CLUB FALL SWAP MEET

Call for Details  
Call for details: Bob Masterson, Box 172  
Valley Cottage, NY 10989 - (914) 353-3151

## OHIO - Sep. 17

### CENTRAL OHIO ANTIQUE RADIO ASSN. MEETING

Columbus, OH - DeVry Institute of Tech.  
1350 Alum Creek Rd., I-70 Exit 103B  
7:30 pm  
Info: Chuck/Sue Davis - (614) 792-6237

## OHIO - Sep. 17

### CINCINNATI ANTIQUE RADIO SOCIETY MEETING

Cincinnati, OH - Provident Bank  
8054 Reading Road  
7:30 pm  
Info: Ted Lewis - (937) 446-3898

## NEW YORK - Sep. 18

### HUDSON VALLEY ANTIQUE RADIO AND PHONO. SOCIETY/AWA - MEETING

7:30 10:00 pm - Meeting  
Info: Peter DeAngelo - (914) 496-5130  
(Call to confirm details)

## CALIFORNIA - Sep. 20

### SOUTHERN CALIF ANTIQUE RADIO FEST ANTIQUE RADIO FEST

Valencia, CA - Valencia Travel Village  
27946 Highway 126  
6 am 10:30 am  
Info: Byron Bernor - (805) 269-5459

## PENNSYLVANIA - Sep. 20

### PITTSBURGH ANTIQUE RADIO SOCIETY MEETING & DONATION AUCTION

Pittsburgh, PA - Westinghouse Recreation Center  
Parkway East, Exit 12, S. on Greensburg Pike  
10 am - Flea Market  
12 pm - Meeting & Auction  
Info: Sev Dvorsky - (412) 344-6633

## NEBRASKA - Sep. 20

### NEBRASKA ANTIQUE RADIO COLLECTORS CLUB - AUCTION & MEETING

Lexington, NE - Knights of Columbus Hall,  
6th and Taft Streets  
8 am Registration; 11 am Auction  
Info: Gary Reiss - (308) 263-3231

Although non-members are welcome at all events, joining may be required at some. Admission is charged at some events.



**TEXAS - Sep. 21**

TEXAS ANTIQUE RADIO CLUB  
NEW CLUB FORMING MEETING  
San Antonio area, TX - Shertz VFW Hall  
2 pm  
Info: Joe Koester, 7111 Misty Brook, San Antonio, TX 78250 - (210) 522-1662

**MARYLAND - Sep. 21**

MID-ATLANTIC ANTIQUE RADIO CLUB  
MEETING  
Burtonsville, MD - New Hope Seventh Day  
Adventist Church gym - 2 pm  
Info: Ed Lyon, 11301 Woodland Way  
Myersville, MD 21773-9133 - (301) 293-1773

**NEW MEXICO - Sep. 21**

NEW MEXICO RADIO COLLECTORS CLUB  
MEETING  
Albuquerque, NM - Desert Springs Bible  
Church, 7509 Paseo Del Norte  
1:30 pm - Tailgate Swap Meet  
2 pm - Program: Fada Products  
Followed by: Show & Tell & Auction  
Info: Bill Schultz, 7213 Donet Ct. NE  
Rio Rancho, NM 87124 - (505) 867-8178

**TENNESSEE - Sep. 21**

MEMPHIS ANTIQUE RADIO CLUB/MEETING  
Memphis, TN - St. Timothy United  
Methodist Church, 4105 St. Elmo Ave.  
2 pm  
Info: Mel Urban, 7190 Mimosa  
Germantown, TN 38138 - (901) 754-6307

**WASHINGTON - Sep. 21**

PUGET SOUND ANTIQUE RADIO ASSN.  
SWAP MEET & MEETING  
North Seattle, WA - Shoreline Museum  
Parking Lot, N. 175th & Linden Avenue  
12 pm - Meeting  
(Informal Swap Meet Prior to Meeting)  
Info: Al Atworth, PO Box 125  
Snohomish, WA 98291-0125 - (360) 568-2698

**ALABAMA - Sep. 22**

ALABAMA HISTORICAL RADIO SOCIETY  
MEETING  
Birmingham, AL - Homewood Public Library  
1721 Oxmoor Road - 7 pm  
Info: Earl Ridolphi, 2413 Old Briar Trail  
Birmingham, AL 35226 - (205) 823-3314

**OHIO - Sep. 23**

SOCIETY FOR PRESERVATION OF  
ANTIQUA RADIO KNOWLEDGE MEETING  
Kettering, OH - Cassano's Pizza  
1680 E. Stroop Rd.  
7:30 pm - Refinishing Materials  
Show & Tell: Pride Night  
Info: Richard Arter - (513) 932-7721, eves.

**GEORGIA - Sep. 26-27**

SOUTHEASTERN ANTIQUE RADIO  
SOCIETY FALL MEGA MEET  
Atlanta, GA - Howard Johnson Midtown  
(formerly Castlegate Hotel), new indoor  
location, 1750 Commerce Dr NW  
SARS rates: (404) 351-6100  
Sep. 26: 7 pm - Dinner  
8:30 pm - Atlanta Radio Theater Players  
Sep. 27: 7 am - Setup  
8 am - Flea Market, all day  
All day - Philco Display/Contests  
Info: Larry Smith, SARS, PO Box 500025  
Atlanta, GA 31150 - (770) 998-1964

**MISSOURI - Sep. 27**

ANTIQUA RADIO COLLECTORS & HISTORIANS  
OF GREATER ST. LOUIS  
SWAPMEET & PICNIC  
West St. Louis County, MO - Manchester Park  
Info: Scott Teichmann, 103 Pleasant St.  
Jerseyville, IL 62052 - (314) 256-6263

**NEW JERSEY - Sep. 27**

NEW JERSEY ANTIQUE RADIO CLUB  
SWAP MEET  
Freehold, NJ - National Guard Armory  
8 am 1 pm  
Info: Marv Beeferman, 2265 Emerald Pk. Dr.  
Forked River, NJ 08805 - (908) 693-9430

**CONNECTICUT - Sep. 27**

VINTAGE RADIO & COMMUNICATIONS  
MUSEUM OF CONNECTICUT  
OUTDOOR SWAP MEET  
E. Hartford, CT 1173 Main Street  
7:30 am  
Info: John Ellsworth (860) 675-9916

Attend a radio event near you,  
learn, meet others in the hobby,  
and perhaps find an item or two  
for your collection!

**N. CAROLINA - Sep. 28**

CAROLINAS CHAPTER OF THE ANTIQUE  
WIRELESS ASSOCIATION  
MEETING & RADIO STATION WBT TOUR  
Charlotte, NC - Pioneer Station WBT  
1 Julian Price Place  
2 pm - Meeting  
3 pm - Tour Studios  
Info: Ron Lawrence, PO Box 3015  
Matthews, NC 28106 - (704) 289-1166

**BRITISH COLUMBIA - Sep. 28**

CANADIAN VINTAGE RADIO SOCIETY  
BRITISH COLUMBIA CHAPTER - MEETING  
Richmond, BC - Steveston Hotel  
12 Noon - Informal Swap Meet  
2 pm - Meeting  
Info: Fred Tutt - (604) 275-2033

**PENNSYLVANIA - Oct. 4**

CENTRAL PENNSYLVANIA RADIO  
COLLECTORS CLUB  
OUTDOOR SWAP MEET & SHOW  
Danville, PA - Cloverleaf Barn Antique  
& Gift Village, 120 McCracken Rd. - 8 am  
Info: Frank Hagenbuch - (717) 326-0932  
Mike Heffner (717) 546-2907

**MARYLAND - Oct. 4**

MID-ATLANTIC ANTIQUE RADIO CLUB  
ANNUAL MAARC PICNIC  
Arcadia, MD - Arcadia Fairgrounds  
Info: Ed Lyon, 11301 Woodland Way  
Myersville, MD 21773-9133 - (301) 293-1773

**KENTUCKY - Oct. 4**

MID-SOUTH ANTIQUE RADIO  
COLLECTORS FALL SWAP MEET  
Lexington, KY - Holiday Inn South  
(502) 826-6600  
7:30 am - Swap Meet  
Noon - Old Equipment Contest  
1:00 pm - Auction  
Info: Allan Ferris - (502) 543-8233, or  
Lewis Owens - (606) 233-0376

**NORTH CAROLINA - Oct. 11**

GREENSBORO ANTIQUE RADIO FEST  
Greensboro N.C. The Gallery Antiques  
Cotton Mill Sq., Corner Merritt & Spring Garden  
8 am 4 pm  
Info: Brad Jones - (910) 547-1919

**INDIANA - Oct. 11**

INDIANA HISTORICAL RADIO SOCIETY  
FALL FOLIAGE MEET  
Greenfield, IN - Riley Park, Apple Street  
7:30 am - Swap Meet & Equipment Contest;  
Noon - Lunch  
Info: Glen Fitch - (765) 565-6911

**WISCONSIN - Oct. 12**

WISCONSIN ANTIQUE RADIO CLUB  
SWAP MEET  
Milwaukee, WI - 5722 W. North Ave.  
(Parking Lot) - Dawn 12 pm  
Info: Dale Boyce, 10230 W. Greenwood  
Terrace, Milwaukee, WI 53224 - (414) 353-0734

**TEXAS - Oct. 17-19**

VINTAGE RADIO & PHONO. SOCIETY  
ANTIQUA WIRELESS ASSOCIATION  
CONVENTION '97  
Irving, TX - Holiday Inn DFW Airport South  
4440 W. Airport Freeway  
VRPS Rates: (214) 399-1010  
Oct. 17  
9 am - Registration  
11 am - Bill Harris, Radio Servicing  
1 pm - Technical Session TBA  
? - 6 pm, Contest Viewing  
3 pm - Auction #1 - (\$10 min.)  
Tubes, Books/Literature  
4:10 pm - Silent Auction (Small Items)  
5 pm - Auction #2 - (\$10 min.)  
(Ham Equip., Transistors, Plastic,  
Test Equip., Signs, Etc.)  
Oct. 18  
8:30 am - Registration  
9 am - Viewing Contest Equipment  
10 am - Silent Auction (Small Items)  
11 am - Annual Meeting followed by  
Auction #3 (\$20 min.)  
(Radios, Consoles, TV, Phonographs,  
Wireless, Loudspeakers, etc.)  
6:30 pm - Reception (cash bar)  
7:30 pm - Annual Awards Banquet  
Guest Speaker Tyler Cox, WPAB  
Oct. 19  
8 am - 12 pm, Indoor Flea Market  
Info: VRPS, PO Box 165345, Irving, TX 75016

**OHIO - Oct. 25-26**

BUCKEYE ANTIQUE RADIO & PHONO CLUB  
CHAPEL HILL MALL SHOW  
Cuyahoga Falls, OH - Chapel Hill Mall  
Buchholzer Blvd., off Howe Ave., off Rt. 8  
Sat., Oct 25: 8:30 am-9 pm  
Sun., Oct 26: Noon 5 pm  
Info: Rich Bradley - (216) 842-5937



**UNITED KINGDOM - Oct. 26**

NATIONAL VINTAGE COMMUNICATIONS FAIR  
 NEC (Birmingham), UK - Hall 11  
 10:30 am-4 pm  
 Info: NVCF, 13 Belmont Rd., Exeter, Devon,  
 England - Phone: (01392) 411565

A free\* listing on these pages is available for each coming radio event. Sponsors should provide description of event, date, time, place, directions, & information/contact person. Since listings are on a "space available" basis, no guarantee of listing is made.

Submission Deadline - 5th of month.

\*Club/museum/non-profit events are listed free; other events are obtained from advertisements placed elsewhere in A.R.C.

**ILLINOIS - Oct. 26**

ERIC'S AUCTION BARN  
 8TH ANNUAL RADIO AUCTION  
 Olney, IL Eric's Auction Barn  
 Hwy. 130 S - (618) 392-2343 - 11 am  
 Info: Wayne Martin, 701 N. Dale  
 Perryville, MO 63775 (573) 547-4292

**CALIFORNIA - Nov. 14 - 15**

SOUTHERN CALIF. ANTIQUE RADIO SOCIETY  
 ANNUAL TWO DAY MEET  
 Van Nuys, CA Airtel Plaza Hotel, 7227  
 Valjean Ave. - (818) 979-7676  
 7 am Flea Market, Meetings and Programs  
 Info: Ricki Glassman, 19300 Roman St.,  
 Northridge, CA 91324 - (818) 993-4560

**BUSINESS CARD ADS - \$49.00 FOR 3 MONTHS****Looking for early, portable electronic calculators (1970-78)**

(Any that have LED or other "lighted" displays)

• Will Trade Transistor Radios (or buy outright) •  
 Especially: Busicom, Berkey/Keystone, Calfax, Columbia, Commodore, Decimo, Educalc, Garrett, Ian Jones, JCE, Kingspoint, M.I.T.S., Monroe/Litton, Olympia, Royal, Sanyo, Sinclair, Sperry Remington, Summit, Victor  
 Guy "Mr. Calculator" Ball Fax-(714) 730-6140  
 14561 Livingston St., Tustin, CA 92780

**Play Things of Past**

Sales Service Restoration of vintage radios, tv's, jukeboxes and electronics.

**Retail Sales Store**

3552 W. 105th St.  
 Cleveland, OH 44111  
 216-251-3714  
 Hours: 6-9PM Wed, 12-6PM Sat.  
 Other times by chance

**Mail Address**

Gary Schneider  
 Play Things of Past  
 9511 Sunrise Blvd., #J23  
 Cleveland, Ohio 44133  
 216-582-3094

**Memories on Main Antiques**

Open everyday  
 Multi-dealer  
 Quality antiques  
 Early Radios

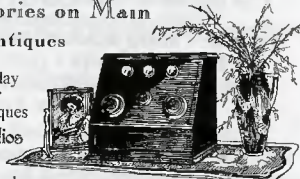

Visa/Mastercard  
 Main Street, Isanti, Minnesota 612-444-4488

**Atlanta, GA area ANTIQUE RADIO REPAIR**

JOHN PELHAM, W1 JA  
 1185 BEND CREEK TRAIL  
 SUWANEE, GA 30174  
 (770) 623-0533  
 E-MAIL: JOHN\_PELHAM@MSN.COM

♦ Vacuum tube radios only  
 ♦ Call, write or e-mail for information or to schedule a repair.

Collector, Historian, Seeker of  
 Stromberg Carlson Radio Apparatus

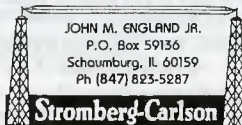

JOHN M. ENGLAND JR.  
 P.O. Box 59136  
 Schaumburg, IL 60159  
 Ph (847) 823-5287

Entrepreneur: Art Moderne,  
 Streamline, Machine Age Design

**The Bavarian Radio Works**

ROSS A. HOCHSTRASSER  
 (617) 447-4299

162 BEULAH ST.  
 WHEATMAN, MA 02082

**Antique Tube Type Radios**

Repairs - \$30.00 plus parts  
 Rebuilds - \$65.00 plus parts  
 Guaranteed to work well

**CHUCKS**

167 LYNN DR., NEW HAVEN, WV 25265  
 PHONE (304) 882-2220

1920-1970  
 SCHEMATICS + PAGES OF INFO  
 \$5.00 POSTPAID

MANUAL PRICES - SASE  
 RADIO/TV/HAM/MISC.

"IF I DON'T HAVE IT, YOU  
 PROBABLY DON'T NEED IT."

ALTON H. BOWMAN - 4172 EAST AVENUE  
 CANANDAIGUA, NY 14424-9564

**BUSINESS CARD ADS - \$49.00 FOR 3 MONTHS****BETA-TEK ANTIQUE RADIO SERVICE**

Repair of Radios, Communications  
 Receivers & Test Equipment  
 Power Supplies for Battery Sets

RAY BINTLIFF  
 2 Powder Horn Lane  
 Acton, MA 01720  
 508 263-7435



TEL: (972) 276-5458  
 FAX: (972) 272-1831

**THE RADIO MAN**  
 Buy-Sell-Trade  
 Antique Radios • Tubes • Parts

DICK MORGAN  
 RES: (972) 564-6464

P.O. BOX 461485  
 GARLAND, TX 75046-1485

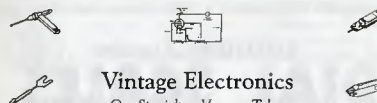
**Vintage Electronics**

Our Specialty Vacuum Tubes  
 Phono Cartridges / Needles

Ed Crockett

128 Buccaneer Drive  
 Hattiesburg, MS 39402

Phone (601) 264-4755  
 Fax (601) 264-0226

20 Years Experience Telephone/Fax 1-615-456-2529

**Specializing in Antique Speaker Repair**

- Very large stock of vintage parts
- Can repair most any cone-type speaker
- Field coils rewound • Fast turn-around
- Reasonable prices

Work Guaranteed

Hank Brazel  
 39 Lake Point Ct.  
 Crossville, TN 38555

**ANTIQUÉ RADIO RESTORATION**

Since 1936 Repair Buy Sell  
 Complete Restorations • Prompt Service

**COOPER'S RADIO SERVICE**

425 Court Street  
 Rockwell City, Iowa 50579

LARRY COOPER  
 712-297-7232

**Old Time Replications**

"TURN TO US WHEN YOU NEED KNOBS"  
 KNOBS PUSHBUTTONS ESCUTCHEONS  
 PLASTIC GRILLS HANDLES

LARRY BORDONARO  
 5744 TOBIAS AVE. VAN NUYS, CA 91411  
 PHONE (818) 786-2500 FAX (818) 909-0241

**VINTAGE RADIO SERVICES**

Ken Hubbard  
 KA9WRN

P.O. Box 792  
 Beloit, WI 53512-0792  
 (608) 362-1896  
 6 pm Evenings

Repair of  
 Tube and  
 Transistor Radios

Home-Auto

**412-837-5580 LOGANS TV-RADIO**

SINCE 1952

BUY • SELL • TRADE

100's of N.O.S. PARTS AND TUBES. SCHEMATIC  
 SERVICE AVAILABLE. RESTORATION AVAILABLE.

REAR 526 MT. PLEASANT ST., GREENSBURG, PA 15601

Free Estimates  
 Hrs. 10 AM - 7 PM EST.  
 Tues. Sat.

Tel./Fax(860) 928-2628  
 E-Mail: radiodoc@neca.com  
 http://www.neca.com/radiodoc/

**ANTIQUÉ RADIO RESTORATION & REPAIR**

1920 1960's

Buy & Sell



Reasonable Rates, Tubes, Professional  
 Overhauls, Cabinet Refinishing, Service  
 For All Antique Car, Table & Console  
 Radios, Communication Receivers &  
 Tube Amplifiers.

20 Gary School Road  
 Pomfret Center, CT 06259



(708) 383-1649  
 BY APPOINTMENT

DO YOU HAVE  
 A PROBLEM RADIO ?

**THE OLD RADIO SHOP**

SERVICE OF VACUUM TUBE ELECTRONICS  
 SCHEMATIC DIAGRAM SERVICE  
 RESTORATION OR REPAIR FREE ESTIMATES

ED HUETHER

1025 ERIE ST  
 DAN PARK, IL 60302

**WANTED ! JAPANESE MILITARIA**

any kind of WW-2 Japanese hardwares - aircraft instruments  
 radios, optics, ammunitions etc

**Takashi Doi**

Fax . 011-8145-301-8069  
 E-Mail : taka-doi@kk.ij4u.or.jp



1-21-4 Minamidai, Seyaku, Yokohama, 246 Japan.

**ANTIQUÉ RADIO REPAIR**

FRANK A. JOHNSON  
 530 ELFORD ROAD  
 FAIRLESS HILLS, PA 19030  
 (215) 943-8295

- ♦ VACUUM TUBE RADIOS ONLY
- ♦ BUY, SELL, RESTORE



**BUSINESS CARD ADS - \$49.00 FOR 3 MONTHS**



**TEST EQUIPMENT**

BUY SELL TRADE  
PARTS-ACCESSORIES-CABLES  
MILITARY SURPLUS-ELECTRONICS  
Illustrated Catalog Quarterly

**Boca Electro Magnetic Lab**  
21218-10 St. Andrews Blvd.  
Boca Raton, FL 33433  
(561) 750-8911



**WANTED**

Japanese Tubu Portable &  
Early Transistor Radio  
Unusual Shaped TV



Noriyoshi Tezuka  
1-11-2-403 Hiroo, Shibuyaku  
Tokyo 150 Japan  
Fax : 011-813-3440-8396

Replacements • Reproductions • Radio • Stereo • Ham • Auto • OEM

**Antique Radio  
DIAL SCALES**

Send an SASE for brochure and list

Rock-Sea Enterprises  
323 E. Matilija St. #110-241  
Ojai, CA 93023

Mike Tobin  
(805) 646-7362  
dials@juno.com

<http://members.aol.com/RockSeaEnt/>

**78 RPM Cartridges  
Repaired**



Dead cartridges rebuilt  
right. New crystals etc., as needed. Allow 3-4 weeks. Most  
crystal and "horseshoe" magnet types \$34.50  
100 hr. sapphire setscrew needles (list \$2.50 ea.) 4/\$5.50



Joe Smolksi  
855-A Pleasant Street  
Framingham, MA 01701

Inquiries: (508) 879-2778,  
evenings and weekends.  
Prices include return  
postage. Please include  
payment with order.

COMMNAV EQUIP  
RADIO SETS  
NAVAL AIR FIELD  
U.S. FOREIGN

CHARLES DIEBICA KAJ GON  
581 MYSTIC VALLEY PKWY  
MEDFORD, MASS. 02155  
PHONE: 617-396-9354



**MILITARY ELECTRONICS**

BUY WANTED TRADE

**PHILCO PREDICTAS WANTED:**



BUY SELL TRADE RENT RESTORE

DAVID WEDDINGTON  
(615) 890-7498

2702 Albany Ct.  
Murfreesboro, TN 37129

**INSTRUMENTS**

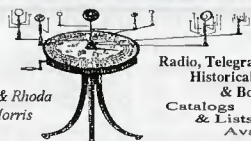

Jim & Rhoda  
Morris

Radio, Telegraph,  
Historical Instruments,  
& Books For Sale  
Catalogs & Lists  
Available

Antiques of Science & Technology  
A of ST Box 1852 Wakefield Ma. 01880 U.S.A.  
Tel 617 245 2897 Fax 617 245 3572

Carbon Resistors • Capacitors • Vacuum Tubes

**ALLTRONICS**

Electronic Component Supply

2300 Zanker Road • San Jose, CA 95131  
Voice (408) 943-9773 • Fax (408) 943-9776  
BBS (408) 943-0622 • 24 Hrs. • N-8-1

Call or Fax for Catalog

**SUNSHINE SOUNDS**

WANTED:



Hi Fi TUBE & COMMERCIAL AMPS | SPEAKERS & HORNS

McIntosh, Marantz, Dynaco, Heath,  
Altec, Scott, RCA, Fisher, Craftsman,  
Grommes, Fender, Ampex, W.E. Vox,  
Brook, Acro, Pultec, Fairchild

Altec, Jensen, RCA,  
E.V., Western Electric,  
JBL, Tannoy

Phone: 405-737-3312 or Fax: 405-737-3355  
Sonny - 1413 Magnolia Ln., Midwest City, OK 73110

**Modern Radio Laboratories**  
Since 1932

Crystal Set Instructions, Radio Parts, Supplies,  
Receiving Tubes. MRL Handbooks by Elmer G.  
Osterhoudt published by us.

Catalog \$2.00

MODERN RADIO LABS  
P.O. Box 14902  
Minneapolis, MN 55414-0902

**BUSINESS CARD ADS - \$49.00 FOR 3 MONTHS**

**Antique Radios**



David & Nancy Snow  
P.O. Box 6352  
Jackson, MI 49204  
(517) 787-2985

We Buy, Sell, Repair  
ARBE III Battery Eliminators

**ANTIQUÉ RADIO REPAIR**

Repair Restore Buy & Sell  
Schematic Service  
Radios \$2.<sup>50</sup>, TVs \$4.<sup>50</sup>

**DAMASKE ELECTRONICS**  
574-W16834 Janesville Road  
Muskego, WI 53150  
Phone: (414) 679-0838



K4GIT

1298 S.E. 5th Ave.  
Melrose, FL 32666  
E-mail: tubes@mindspring.com  
<http://www.mindspring.com/~tubes>

**RADIO ELECTRIC SUPPLY**

We Specialize In Receiving and Special Purpose Tubes  
Send For Price List

Dorothy and Don Gies  
Owners 352-475-1950  
Phone or Fax

**Wanted! (Top Paid)**

Tube type amps by Western Electric, McIntosh,  
Marantz, Ampex, RCA, Langvin, etc.

Vintage speakers, units, by W.E., Tannoy, Altec,  
Jensen, JBL, EV RCA, Goodman, etc.

Western Electric tubes & 6L6, 6550, 7591 KT66/77/88, etc

David Yo, Tel: (818) 441-3942  
PO Box 80371 San Marino, CA 91118-8371

Are You Looking For Antique Radios, Parts, Tubes,  
Schematics and Restoration Services?

For Free Flyer a 2-Stamp LSASE is required to  
insure a response to your request. Send to:

**Olde Tyme Radio Company**  
2445 Lyttonsville Road, Suite 317  
Silver Spring, MD 20910

Wish to contact us by phone or fax?  
Our number is (301) 587-5280.  
Please call 10 am to 10 pm (Local Time)

**Authentic Dial Reproductions**

Top quality material & workmanship.  
Finish your restoration with best dial available. Satisfied  
customers world-wide. A-K to Zenith.  
These are not copy machine plastic laminates.  
Telephone consultations welcome.

ANTIQUÉ RADIO RESTORATIONS  
109 So. Oak St.  
O'Fallon, IL 62269

Life Member I.E.E.E.  
AWA, ARCA, ARCI, MAARC

Clinton Blais, P.E.

**SPY EQUIPMENT  
WANTED!**

- Code Machines
- Secret Cameras
- Secret Radios
- OSS, SOE, CIA, KGB!
- Clandestine Weapons
- I Buy or Trade!

Keith Melton

880 Jupiter Park Dr., Suite 5, Jupiter, FL 33458  
(318) 747-9616 Days: Fax (318) 747-9010

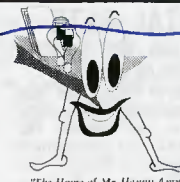

"The Home of Mr. Happy Amp"

**PR NOVELTY**

VACUUM TUBE SPECIALISTS  
Amplifier Rebuilding • Service  
Surplus Parts Brokerage  
(New Old Stock and Used)

PO Box 140 • Milwaukee • WI 53201

Paul Dargatzis Audio Technician  
Robin Richards General Manager

414 964 3302  
414 840 8812

RADIOS & STRANGE MISCELLANEA IF YOU VISIT THE BRIMFIELD FLEA MARKET... STOP BY FIRST!

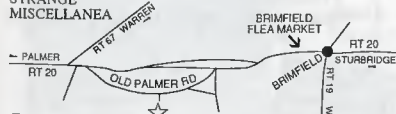

TEL: 413-245-7174  
COUNTRY ROAD BARN - BERNIE SAMEK  
OLD PALMER ROAD, BRIMFIELD, MASS.



**ESTES AUCTIONS**

Specializing in Vintage Radios

7404 Ryan Rd.  
Medina, Ohio 44256

Bus. Phone 330-769-4992  
Fax 330-769-4116  
Res. Phone 330-769-3987

WANTED  
PRE 1900  
ELECTRICITY  
MEDICAL • X-RAY  
TELEGRAPHY • TELEPHONE

PRE 1925  
RADIO • WIRELESS  
PRE 1940  
TELEVISION



**NEW WIRELESS  
PIONEERS**

BOOKS TUBES ARTIFACTS  
MAGAZINES AUTOGRAPHS  
CATALOGS EPHEMERA

P.O. BOX 398  
ELMA, NY 14059  
716-681-3186  
FAX: 716-681-4540

REPAIRS • BUY • SELL • TRADE  
PRE '65 AC SETS & CAR RADIOS

**FRED'S OLD RADIO EMPORIUM**  
1612 WEST 7TH AVENUE  
CORNICANA, TEXAS 75110

F.L. GORDON, PROPRIETOR  
BUSINESS (903) 874-5185 HOME (903) 874-7147



## BUSINESS CARD ADS - \$49.00 FOR 3 MONTHS



**WAVES**  
ANTIQUES  
EARLY RADIOS  
&  
PHONOGRAPHS  
BOUGHT - SOLD  
RENTALS - REPAIRS

MON - FRI 12-6  
SAT - SUN 10-6

FAX 201-461-7121  
e-mail: c1.wave@aol.com  
www.wavesradio.com

10 W 25TH ST., NY, NY 10001 SUITE 1005 212 986-9264  
PROPRIETORS Bruce and Charlotte Mager

**Two Day Antique Shop** / Fred Favour  
(Fridays & Saturdays Only) (803) 275-0202  
406 Calhoun Street or (803) 663-9878  
Johnston, SC 29832

**Always Over 150 Plastic & Bakelite,  
30's & 40's Table Radios For Sale  
In As-Found Condition.**

(No Lists)



**HAROLD C. BRAMSTEDT**  
C & N ELECTRONICS  
6104 Egg Lake Road North  
Hugo, MN 55038

Buy  
Sell  
Transmitting & Industrial Tubes

612-429-9397  
800-421-9397  
Fax 612-429-0292

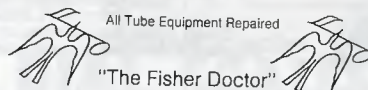

All Tube Equipment Repaired

"The Fisher Doctor"

Al Pugliese  
718-948-7489  
27 Daleham Street  
Staten Island NY 10308  
VINTAGE FISHER PRODUCTS  
Bought Sold Traded Repaired

(815) 235-8000

Specialty Batteries  
& Portable Lighting



1315 N. Bolton Rd.  
Freeport, IL 61032

36 years experience  
**Jackson Speaker Service**  
Expert Antique Loudspeaker Repairs  
(Cone Types) And Reconing A Speciality.  
Speaker Parts And Repair Service On  
Virtually Any Speaker Made Including  
Stereo, P.A., And Antique Auto Speakers.

217 Crestbrook Dr. Owner  
Jackson, Mich. 49203 Ron McGee

Ph. (517) 789-6400, Ans. 4th ring  
Wk-days 10am-7pm Wk-ends 9-5pm

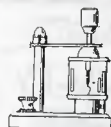

### CRYSTAL SETS

PARTS PLANS KITS BOOKS  
CATALOG \$2.00

Largest source of Vintage and New  
Variable Air Condensers, Variometers,  
Vario-Couplers, Tap Switches, Tap  
Points, Galena and Germanium  
Detectors, Detector Stands, Cat  
Whiskers, Terminals, Sliders,  
Headsets, Dial Knobs, Coil Forms,  
Magnetic Wire, etc.

**MIDCO**  
P.O. Box 2288  
Hollywood, FL 33022  
(954) 925-3670  
B.A. Turke, Ph.D.E.E.



If you buy, sell or like Jukeboxes you need  
**ALWAYS JUKIN' - THE MONTHLY JUKEBOX  
MAGAZINE!!** Subscribers in 25 countries,  
**ALWAYS JUKIN' LEADS THE WAY.** Articles,  
photos, show reports, ads, new products,  
price guides, restoration tips, repairs -  
everything you need to know about **JUKE-  
BOXES - the fastest appreciating collectible in  
the world!!!** Fun & a great investment.  
Sample copy, \$3. \$33 per year.  
**ALWAYS JUKIN', 221 YESLER WAY, AR,  
SEATTLE, WA. 98104. (206) 233-9460.**  
Master/Visa ok.

## PUT YOUR BUSINESS CARD HERE!

\$49 FOR 3 MONTHS \$84 FOR 6 MONTHS  
DON'T HAVE ONE? SEND AN EXTRA \$7 AND  
WE WILL TYPESET ONE FOR YOU.

Phono Needles/Styli  
1500 Types  
Magnetic Ceramic  
Crystal Cartridges



Rebuild Astatic  
and All Types  
of Crystal Cer-  
amic Cartridges



**West-Tech Services**

648 N. Ridgewood Dr. #2  
P.O. Box 1415  
Sebring, FL 33871

Rebuild Obsolete Idlers  
New Idlers and Belts  
Fabricate 78 RPM Needles

**STEVE KARPIAK C.E.T.**  
Phone (941) 471-0922  
Fax (941) 471-3817

### CAPACITORS - TUBES RADIO SERVICE ITEMS

Thousands in jam-packed illustrated  
24-page catalog No. 49

**INFORMATIVE  
INTERESTING  
FUN-TO-READ**

Send \$3 U.S./Canada  
\$5 overseas (U.S. funds)  
for a Heavy-Paper limited  
edition copy NOW!

**DON DIERS** 4276 North 50 St. Dept. A88  
Milwaukee, WI 53216-1313

### RADIO BOOKS FOR SALE

Large selection of books on Radio and Related Technology  
Call or write for our List of Catalogs.  
Always buying, single items or collections.

### RAINY DAY BOOKS

P.O. BOX 775, FITZWILLIAM NH 03447  
(603)-585-3448

## Books with Great Photographs

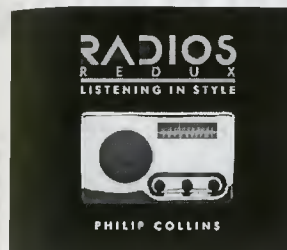

**Radios Redux** by Philip Collins. Subtitled "Listening in Style,"  
this book showcases the sleek lines and luscious colors of over 80  
gleaming sets from the collection of Philip Collins. 121 color  
photographs. 10" x 8 3/4" 120 pages.

Hardcover: \$29.95. Softcover: \$17.95

**Classic Plastic Radios of the 1930s and 1940s A Collector's  
Guide to Catalin Models**, by John Sideli. Over 200 models from 25  
manufacturers are illustrated in full color. 8 1/2" x 11" 127 pages.

Softcover: \$19.95

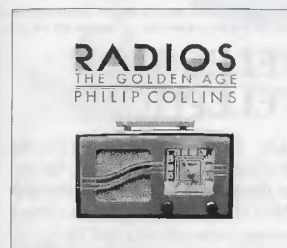

**Radios: The Golden Age** by  
Philip Collins. Collins' first  
book of the colorful Catalin  
and Bakelite radios from the  
late 1930s to the early 1940s.  
Over 100 color photographs.  
10" x 8 3/4" 128 pages.

Hardcover: \$29.95.  
Softcover: \$17.95  
Temporarily Out-of-Print

**Radio Art** by Robert Hawes. This book illustrates radio history.  
Although focusing primarily on British sets, this book also contains the  
following American sets: Addison, Airline, Atwater Kent, Bendix,  
Colonial, Country Belle, Dahlberg, E.H. Scott, Emerson, Fada, General  
Electric, Grunow, Majestic, Motorola, Philco, RCA, Sperton,  
Westinghouse, & Zenith. 250 photos, 150 in color. 9 1/4" x 12" 128 pages.

Hardcover only: \$9.95



**Radio! Radio! 3rd Edition** by Jonathan Hill.  
Comprehensive coverage of British radios from the 1920s  
to the 1970s. This expanded edition includes the previous  
versions plus 75 new pages and 50 new illustrations. A  
new section on transistor radios including a directory of  
nearly 3,000 different transistor models made in Britain or  
imported between 1956 and 1972.

Hardcover only: \$64.95

U.S. Orders Enclose \$3.00 per order for packing & book-rate shipping if total order is under \$35.00. If using VISA or  
MasterCard, include name on card, card number and expiration date. Send payment with order. Mass. residents add  
5% sales tax. Money back return policy. Softcover unless stated otherwise. Most orders shipped the same day received,  
but allow 2-4 weeks to receive order. Foreign orders - write for shipping costs, or use credit card and specify air or surface  
(allow 2-3 months for surface shipping).



**A.R.C., P.O. Box 2, Carlisle, MA 01741 Tel: (508) 371-0512**

Fax: (508) 371-7129

Web: <http://www.antiqueradio.com/>



(Jun-97)



# REPRINT BOOKS ON EARLY RADIO - WIRELESS - TELEVISION TELEGRAPH - TELEPHONE

## RADIO

Harvard Radio Research Laboratory Series, *Ultra High Frequency Propagation*. Reed, Henry R. and Russell, Carl M. 1966. Boston Technical Publishing Inc. Illustrations with diagrams 5 1/4" x 8" 562 pgs. \$24.95

Harvard Radio Research Laboratory Series, *Very High-Frequency Techniques*. 1965. Boston Technical Publishing Inc. Illustrations with diagrams 5 1/4" x 8" 1073 pgs. \$34.95

McNicol, D., *Radio's Conquest of Space*. 1946. A chronological treatment of the early days of radio, the scientists and their inventions. A few of the chapters: Spark Gaps & Oscillators, Wireless Spans the Atlantic, Regenerative Receivers, The Advent of Commercial Radio. 388 pgs. \$31.95

*Report of the Chief Signal Officer: 1919*. A record of the telegraph, telephone and radio in WWI. \$51.95

Schubert, Paul, *The Electric Word: The Rise of Radio*. 1928. Emphasis on economic and legal uses of radio from Marconi Maritime era and WWI to post-1920 popular use. 323 pgs. \$28.95

Summers, H.B., ed., *Radio Censorship*. 1939. Collection of excerpts from articles & books + brief bibliography. \$25.95

## THE FAMOUS M.I.T.

### RADIATION LAB. SERIES

#1 *Radar System Engineering*, 748 pgs. \$15.95

#2 *Radar Aids to Navigation*, 389 pgs. \$15.95

#5 *Pulse Generators*, 741 pgs. \$15.95

#7 *Klystrons and Microwave Triodes*, 533 pgs. \$15.95

#8 *Principles of Microwave Circuits*, 486 pgs. \$15.95

#9 *Microwave Transmission Circuits*, 725 pgs. \$15.95

#10 *Waveguide Handbook*, 428 pgs. \$15.95

#11 *Technique of Microwave Measurements*, 939 pgs. \$15.95

#13 *Propagation of Short Radio Waves*, 746 pgs. \$19.95

#15 *Crystal Rectifiers*, 457 pgs. \$15.95

#16 *Microwave Mixers*, 381 pgs. \$15.95

#17 *Components Handbook*, 640 pgs. \$19.95

#18 *Vacuum Tube Amplifiers*, 761 pgs. \$19.95

#19 *Waveforms*, 799 pgs. \$19.95

#20 *Electronic Time Measurements*, 546 pgs. \$24.95

#21 *Electronic Instruments*, 735 pgs. \$19.95

#22 *Cathode Ray Tube Displays*, 764 pgs. \$19.95

#23 *Microwave Receivers*, 618 pgs. \$15.95

#24 *Threshold Signals*, 400 pgs. \$19.95

#25 *Theory of Servomechanisms*, 383 pgs. \$19.95

#27 *Computing Mechanisms & Linkages*, 371 pgs. \$19.95

The above are quality reprints. Send for free list of over 70 reprints of books on early radio, television, broadcasting and telegraph available from A.R.C. Send payment with order. Mass. residents add 5% tax. Allow 2 to 4 weeks to receive books. Shipping and handling: add \$3.50 for first title and \$1.00 for additional titles. Foreign orders write for shipping costs, or use credit card. Specify air or surface (allow 2-3 months for surface shipping).



A.R.C., P.O. Box 2, Carlisle, MA 01741 Tel: (508) 371-0512

Fax: (508) 371-7129

Web: <http://www.antiqueradio.com/>



(Jun-97)

## TELEVISION

Abramson, A., *Electronic Motion Pictures: A History of the Television Camera*. Mechanical TV to Zworykin to 1940's. 228 pgs. \$26.95

Hess, G.N., *An Historical Study of the Du Mont Television Network*. 1960. Reviews the development of the Du Mont laboratories, network background, its development period, and its decline. A search for why the fourth television network failed. \$21.95

## TELEGRAPH TELEPHONE

Bennett, A.R., *The Telephone Systems of the Continent of Europe. 1895*; and Webb, Herbert *Laws, The Development of the Telephone in Europe. 1910*. In one volume - the development of European telephone networks near the turn-of-the-century plus a comparative study fifteen years later. Two vols. in one. \$40.95

*Electric Telegraph: An Historical Anthology*. The rise and progress of the electric telegraph from the late 19th century to recent times. A collection of early writings. 625 pgs. \$59.95

*Eyewitness to Early American Telegraphy*. Reprints of reports and letters of Alfred Vail from the 1830's and 40's. An invaluable primary resource. 288 pgs. \$34.84

Kingsbury, J.E., *The Telephone and Telephone Exchanges: Their Invention and Development*. \$44.95

Prescott, G.B., *Bells's Electric Speaking Telephone. It's Invention, Construction, Application, Modification and History*. \$42.95

*Signaling and Communicating at Sea*. A two-volume anthology of over 50 articles. Semaphores, pigeons, flashing lights, flags, radio, teletype. 2 vols., 480 & 524 pgs. \$121.90

Smith, Willoughby, *The Rise and Extension of Submarine Telegraphy*. An engineer's and designer's autobiographical account of cable laying in the mid-1900s including the 1856-66 Great Eastern missions. 409 pgs. \$35.95

# CRYSTAL CLEAR

By Maurice L. Sievers

## Volume 1



750 Illustrations - 570 Crystal Sets  
341 Detectors - 207 Crystals  
Perfect for the beginning collector!  
Useful for the experienced too!

*Crystal Clear* is the most comprehensive reference for collectors, historians and anyone interested in early radio. In addition to the many excellent photos and reproductions of ads, *Crystal Clear* includes lists showing all sets by manufacturer, set name, selling price and date of manufacture. 8 1/2" x 11", 282 pages.

\$29.95 - Softcover

## Volume 2

*Crystal Clear Vol. 2* supplements the first volume. It identifies an additional 172 crystal radio sets, 91 crystal detectors and 26 crystals by manufacturer, model, year produced, description and original selling price. Further research on many of the crystal sets covered in Volume 1. Detailed history on the Philmore Manufacturing Company and the Western Manufacturing Company. 8 1/2" x 11", 252 pages.

\$29.95 - Softcover



U.S. Orders Enclose \$3.00 per order for packing & book-rate shipping if total order is under \$35.00. If using VISA or MasterCard, include name on card, card number and expiration date. Send payment with order. Mass. residents add 5% sales tax. Money back return policy. Softcover unless stated otherwise. Most orders shipped the same day received, but allow 2-4 weeks to receive order. Foreign orders write for shipping costs, or use credit card and specify air or surface (allow 2-3 months for surface shipping).



A.R.C., P.O. Box 2, Carlisle, MA 01741 Tel: (508) 371-0512

Fax: (508) 371-7129

Web: <http://www.antiqueradio.com/>



(Oct-98)



# Radio Manufacturers of the 1920's

BY ALAN DOUGLAS



*"The definitive book on American broadcast receivers of the 1920s"*

**Volume 1:** A-C Dayton Adams Morgan Air-Way All-American Mohawk American Bosch Amrad Amrad S-Tube Apex Atwater Kent Bremer Tully Browning-Drake Clapp-Eastham Crosley Cutting & Washington Day-Fan DeForest Eagle ERLA FADA Federal Ferguson. 225 Pages.

**Volume 1 \$24.95 - Softcover Only**

**Volume 2:** Freed-Eisemann Eisemann Freshman Garod Gilfillan Grebe Howard Jones (Lester/Melco) Jones (Jos.) Kellogg Kennedy King Kodel Kolster Leutz Magnavox - Majestic - Marti - Metro Klitzen/Michigan Midwest - Mu-Rad Murdock - Music Master Neutrowound Operadio Ozarka Pfanstiehl Philco Pilot Priess. 266 Pages.

**Volume 2: \$29.95 - Softcover Only**

**Volume 3:** RCA Scott Silver-Marshall Slagle Sleeper Sonora Sparton Splitdorf Steinite Stewart-Warner Stromberg-Carlson Thermodyne R.E. Thompson Thorola Tri-City C. D. Tuska Ware Western Coil Western Electric Workrite Zenith. 292 Pages.

**Volume 3: \$29.95 - Softcover  
\$39.95 - Hardcover**

U.S. Orders Enclose \$3.00 per order for packing & book-rate shipping if total order is under \$35.00. If using VISA or MasterCard, include name on card, card number and expiration date. Send payment with order. Mass. residents add 5% sales tax. Money back return policy. Softcover unless stated otherwise. Most orders shipped the same day received, but allow 2-4 weeks to receive order. Foreign orders - write for shipping costs, or use credit card and specify air or surface (allow 2-3 months for surface shipping).

VISA A.R.C., P.O. Box 2, Carlisle, MA 01741 Tel: (508) 371-0512  
Fax: (508) 371-7129 Web: <http://www.antiqueradio.com/>



(Nov-96)

# Amateur Radio Books

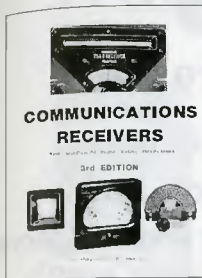

**Communications Receivers 3rd Edition** by Raymond S. Moore. A comprehensive guide to 732, 1932 to 1981, vacuum tube receivers by 66 manufacturers. New section on military receivers. 402 radios pictured! Sharper, clearer photographs 8 1/2" x 11" 115 pages. Softcover. **\$19.95**

**Heathkit, A Guide to the Amateur Radio Products** by Chuck Penson. Documentation of ALL Heathkit's amateur products. 200+ sharp photos. Most products are pictured with a full-page description. 8 1/2" x 11" 256 pgs. Softcover. **\$24.95**



**Radios by Hallicrafters** by Chuck Dachis. This book includes over a thousand photographs (b/w & color) of radio receivers, transmitters, electronics accessories and advertising material. Technical descriptions are provided for every known Hallicrafters model, including dates of production, model numbers, accompanying pieces and original prices. A current price guide is included. 8 1/2" x 11" 225 pages. Softcover. **\$29.95**

**Ham Price Guide** by Eugene Rippen. This book serves as a price guide and an identification guide. Handy index to help direct you from model numbers to the manufacturer. Small print. 8 1/2" x 11" 36 pages. Softcover. **\$9.95**

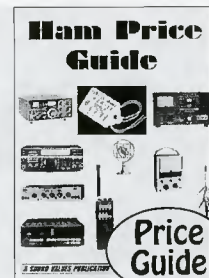

**The Pocket Guide to Collins Amateur Radio Equipment 1946-1980** by Jay Miller. A pictorial guide to Collins equipment and accessories. 90+ sharp photographs. 3 1/2" x 7" 108 pages. Softcover. **\$19.95**

**Tube Type Transmitter Guide** by Eugene Rippen. Provides a wealth of information on transmitters and transceivers. Includes ancillary items such as linear amplifiers, converters, modulators and VFOs. Over 500 illustrations. 8 1/2" x 11" 145 pages. Softcover. **\$17.95**

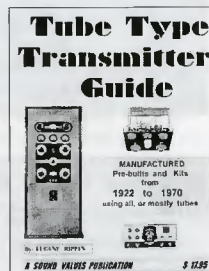

**Transmitters, Exciters & Power Amplifiers 1930-1980** by Ray Moore. Pictorial and descriptive guide to amateur high frequency transmitters and amplifiers manufactured in the U.S.A. Over 500 photos. 8 1/2" x 11" 144 pages. Softcover. **\$21.95**

**Shortwave Receivers Past & Present Communications Receivers 1945-1996, 2nd Edition** by Fred Osterman. This reference is designed for the radio collector, the informed receiver buyer or anyone interested in the history and development of shortwave radios. Over 500 receivers from 70 manufacturers. 8 1/2" x 11" 350 pages. Softcover. **\$19.95**



U.S. Orders Enclose \$3.00 per order for packing & book-rate shipping if total order is under \$35.00. If using VISA or MasterCard, include name on card, card number and expiration date. Send payment with order. Mass. residents add 5% sales tax. Money back return policy. Softcover unless stated otherwise. Most orders shipped the same day received, but allow 2-4 weeks to receive order. Foreign orders - write for shipping costs, or use credit card and specify air or surface (allow 2-3 months for surface shipping).

VISA A.R.C., P.O. Box 2, Carlisle, MA 01741 Tel: (508) 371-0512  
Fax: (508) 371-7129 Web: <http://www.antiqueradio.com/>



(Aug-97)



# Radios

of the Baby Boom Era

Six Volumes — 2000 pages — From Sams' Archives  
 1946 to 1960 — 274 Brands — 3494 Illustrations (B&W)  
 6769 Models — Catalin, Bakelite, Wood, Transistor Radios & More

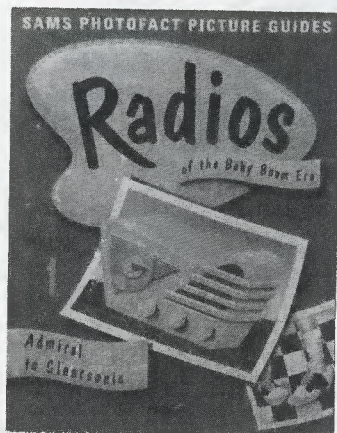

## All Volumes Available!

Vol.	Brands	Included
1	56	Admiral to Clearsonic
2	54	Co-op to Geloso
3	58	GE to Monitoradio
4	36	Motorola to RCA Victor
5	35	Realtone to Stratovox
6	35	Stromberg-Carlson to Zenith

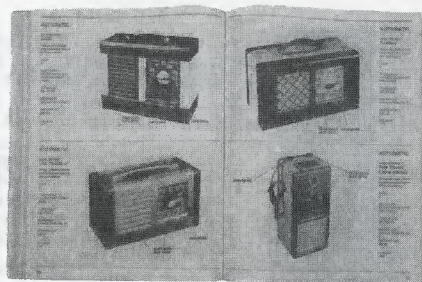

### 1/2 Page for each illustrated radio including:

- Large illustration of the radio including knob functions
- Short description of the radio
- Number of tubes
- Power supply type (AC, Battery, etc.)
- Tuning range
- Manufacturer
- Sams Photofact Set number & year Photofact published.

Each Volume: \$16.95 — Softcover  
 8 1/2" x 11" — Approx. 328 pages

U.S. Orders Enclose \$3.00 per order for packing & book-rate shipping if total order is under \$35.00. If using VISA or MasterCard, include name on card, card number and expiration date. Send payment with order. Mass. residents add 5% sales tax. Money back return policy. Softcover unless stated otherwise. Most orders shipped the same day received, but allow 2-4 weeks to receive order. Foreign orders - write for shipping costs, or use credit card and specify air or surface (allow 2-3 months for surface shipping).



A.R.C., P.O. Box 2, Carlisle, MA 01741 Tel: (508) 371-0512

Fax: (508) 371-7129

Web: <http://www.antiqradio.com/>



(Oct-96)

## Transistor Radio Books

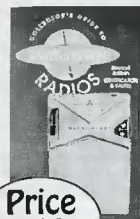

Price Guide

**The Collector's Guide to Transistor Radios 2nd Edition** by Marty & Sue Bunis. *This book will help you identify the most sought-after vintage transistor radios. Over 2,900 models listed, all with current prices. Includes radio club listing. 375 all new color photos. 5 1/2" x 8 1/2" 320 pgs. 1996.*

\$16.95 Softcover  
 (1st edition still available for \$15.95)

**The Portable Radio in American Life** by Michael Schiffer. *Approximately 50 pages on transistor radios, beginning with the Regency TR-1 through to the later sets made overseas. 450 photographs, 193 transistor radios pictured. 8 1/2" x 11" 259 pgs.*

\$24.95 Softcover  
 \$45.00 Hardcover

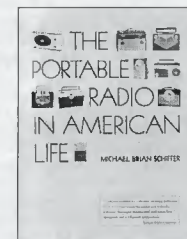

Price Guide

**Transistor Radios, A Collector's Encyclopedia and Price Guide** by David Lane & Robert Lane. *Identification & price guide to over 2,500 transistor and novelty radios. History & key to collecting chapters. 8 1/2" x 11" 170 pgs.*

\$19.95 Softcover

**Collector's Guide to Novelty Radios** by Marty Bunis & Robert Breed. *This book is the source for novelty transistor radios in all shapes and sizes. Radios are described in detail with current prices. Over 600 all new color photographs. 8 1/2" x 11" 224 pgs.*

\$18.95 Softcover



Price Guide

U.S. Orders Enclose \$3.00 per order for packing & book-rate shipping if total order is under \$35.00. If using VISA or MasterCard, include name on card, card number and expiration date. Send payment with order. Mass. residents add 5% sales tax. Money back return policy. Softcover unless stated otherwise. Most orders shipped the same day received, but allow 2-4 weeks to receive order. Foreign orders - write for shipping costs, or use credit card and specify air or surface (allow 2-3 months for surface shipping).



A.R.C., P.O. Box 2, Carlisle, MA 01741 Tel: (508) 371-0512

Fax: (508) 371-7129

Web: <http://www.antiqradio.com/>



(Feb-97)



# COLLECTOR BOOKS AVAILABLE FROM A.R.C.

BOOKS MARKED WITH "NEW" ARE THE MOST POPULAR AND ARE ESPECIALLY RECOMMENDED FOR NEW COLLECTORS!

- Antique Radio Restoration Guide, 2nd Ed., Johnson. *Beginner's introduction to troubleshooting and repairing AC table model radios.* 1992. 145 pgs. .... \$14.95
- The AWA Review. *Collections of articles.* Vol. 6: Hawaiian Wireless, U.K. TV, SCR-RC-BC Dir., NYC Wireless, etc. Vol. 7: Poldhu xmitters, Navy equipment, Arc xmitters, etc. Vol. 8: Keys, Federal Co., KFS-Federal-Mackay story, Nat'l Electrical Supply Co., Navy Electronics Dir., etc. .... Vol. 6-8, ea. \$10.00
- Vol. 9: Marconi, The Int'l Contest for Radar, Magnetron Story, F. Lowenstein, Ham Licensing. Vol. 10: Atwater Kent, Race for Radiotelephone, Radio Central 75th Anniversary, The Heintz and Kaufman Story, Collins Radio Co. Vol. 9-10, ea. \$19.00
- The Antique Radio Boys and the Garrulous Grebe, Dryer. *Thrilling adventure story written in the traditions of the '20s and '30s.* 5 1/2" by 8 1/2" 51 pgs. .... \$4.95
- The Auto Radio, Matteson. *Info, photos & ads of the auto radio through the 1950s.* 316 pgs. .... (hardcover) \$34.95
- Audio! Audio!, Hill. *A comprehensive directory of classic audio amplifiers and control units. Details of over 850 models from nearly 150 British manufacturers from the 1940s to the 1970s. Signed and numbered.* 95 pgs. .... \$19.95
- Behind the Front Panel, Rutland. *Reviews radio circuits and radio history. Easy descriptions.* 25 pics. 158 pgs. .... \$18.95
- Blast from the Past, A Pictorial History of Radio's First 75 Years, Rhoades. *The performers, programs, & technology that made radio a part of everyday life. 100s of never-before-published photos* .... (hardcover) \$39.95
- Broadcasting's Forgotten Father: The Charles Herrold Story, Adams. (Videotape, VHS). *One-hour documentary on this amazing inventor. Featuring his family, students, and photos to document his work* .... \$29.95
- Classic Plastic Radios of the 1930s and 1940s - A Collector's Guide to Catalin Models, Sidel. *Info on all aspects of this popular collecting field. 200+ models from 25 companies are illustrated in full color.* 127 pgs. .... \$19.95
- Classic TVs, 2nd Ed., Wood. *Prewar to 1950s. Price guide. 140+ color photos, reproductions of catalogs & ads.* 86 pgs. NEW \$18.95
- The Collector's Guide to Antique Radios, 4th Ed., Bunis. *This guide covers radios from 1920s to 1960s. Over 8,500 prices and many all new color photos are included.* 1996. .... \$18.95
- The Collector's Guide to Novelty Radios, Bunis & Breed. *Descriptions with prices. 600+ color photos.* 1994. 224 pgs. .... \$18.95
- The Collector's Guide to Transistor Radios, 2nd Ed., Bunis. *Identifies the most sought-after vintage transistor radios. Includes club listing. Over 2,900 models, 375 all new color photos, with current prices.* 1996. 320 pgs. .... \$16.95
- Communication Receivers, 3rd Ed., Moore. *Information on 738, 1932 to 1981, vacuum tube receivers by 66 manufacturers. 402 radios illustrated. New section: 3 pages of military receivers.* 125 pgs. .... \$19.95
- The Compleat Talking Machine, 2nd Ed., Reiss. *A guide to antique phonographs. Revised and expanded. Covers construction, cleaning and repairing of parts and cabinets. Over 700 pictures.* 236 pgs. .... \$29.95
- Crystal Clear - Vintage American Crystal Sets, Crystal Detectors and Crystals, Sievers. Vol. 1. *Comprehensive reference with 750 illustrations, 570 crystal sets, 341 detectors, 207 crystals.* 282 pgs. .... \$29.95
- Vol. 2. *479 All new & different illustrations, more crystal sets, detectors and crystals identified.* 252 pgs. .... \$29.95
- Crystal Radio: History, Fundamentals, and Design, Kinzie. *Plus crystals for detectors.* 121 pgs. .... \$10.95
- Crystal Set Projects: 15 Radio Projects You Can Build, The Xtal Set Society. *Various designs and difficulty for everyone. Step-by-step instructions so you can build and design your own xtal sets no matter what your background.* 160 pgs. NEW \$14.95
- E.H. Scott Radio Collectors Guide, 1925-1946, Clark. *The reference for collectors of Scott radios, cabinets and accessories. Lists original prices of cabinets and accessories. Over 200 photos with descriptions.* 88 pgs. .... \$29.95
- Early Radio, In Marconi's Footsteps, Jensen. *Realistic description of Marconi's work and his surroundings. Early construction projects with diagrams. Color and B&W photographs.* 170 pgs. .... (hardcover only) \$39.95
- Evolution of the Radio, L-W Books. *Radios pictured and priced, plus reproductions of catalog pages and ads.* Vol. 1. *Eight-hundred + radios.* 1991. 227 pgs., 118 pgs. in color. .... \$22.95
- Vol. 2. *Totally different from volume one with new photos, etc.* 1993. 654 color photos. 226 pgs. .... \$24.95
- Firco Radio Equipment, John Firth & Co., Inc. (reprint). *Twenty-six-page booklet of the Firth Co.* .... \$4.95
- Fixing Up Nice Old Radios, Romney. *Written by a retired radio instructor, this book covers Ohm's law, through battery sets, superhets and communications receivers.* 1990. 300+ figures, 185 pgs. .... \$29.00
- Flick of the Switch, McMahon. *The classic photo reference guide for '30s '50s radios. 1000+ photos.* 263 pgs. .... \$11.95
- Great Radio Personalities (reprint). *B&W pics of the golden days of radio - Abbott & Costello, etc.* 128 pgs. .... \$12.95
- Guide to Old Radios Pointers, Pictures & Prices, 2nd Ed., Johnson. *Introduction to radio collecting. Includes hundreds of photos and a price guide.* 1995. 272 pgs. .... \$19.95
- Hake's Guide to TV Collectibles. *Price guide and photos for 1600 TV shows, comic books, etc.* 1990. 185 pgs. .... \$14.95
- Ham Price Guide, Rippen. *This book serves as a price guide and an identification guide. Small print.* 36 pgs. .... \$9.95
- Heathkit, A Guide to the Amateur Radio Products, Penson. *Documentation of all Heathkit's amateur radio products, a complete history of the company.* 200+ sharp photos. 256 pgs. .... \$24.95
- International Directory of Antique Radio Collectors. *Lists collectors, clubs, museums, dealers.* 1996. 92 pgs. .... \$14.95
- Inventing American Broadcasting, Douglas. *A careful weaving of technology, social forces, and business decision making from the days of Marconi to broadcasting in the 1920s.* 1987. 363 pgs. .... \$14.95
- L. A. Radio Manufacturing, Paul. *Radio makers in L.A. from 1922-42. Echophone, Gilfillan & 10 others.* 88 pgs. .... \$10.50
- Supplement No. 1, Paul. *Coverage of additional manufacturers, people and sets.* 1993. 48 pgs. .... \$6.75
- The Magnetic Cone Speaker Notebook, Paul. *250+ cone speakers from 120+ companies. Photocopy.* 1995. 58 pgs. NEW \$10.90
- The Mechanics of TV, Yanczer. *Explanation of mechanical to, details for a working system.* 5 1/2" by 7 1/2" 170 pgs. .... \$24.95
- Most Often Needed 1926-38 Radio Diagrams and Servicing Information (reprint). *600+ diagrams for mostly AC radios from '26-'38.* 240 pgs. .... \$18.50
- Old Gramophones, Bergonzi. *The development of phonographs and gramophones.* 64 photos. 32 pgs. .... \$4.95
- Old Radio Sets, Hill. *The development of the radio from the late Victorian era until the late 60s.* 60 photos 32 pgs. .... \$4.95
- Old-Time Radios! Restoration and Repair, Carr. *How to repair vacuum-tube and transistor radios. A self-paced training guide. 200 illustrations.* 256 pgs. .... \$19.95
- Philco Radio: 1928-1942, Ramirez. *A reference book on Philco. Shows receivers and company history year-by-year.* 464 color photos, 364 black & white photos and drawings. 1993. 160 pgs. .... \$29.95
- Phono-Graphics: The Visual Paraphernalia of the Talking Machine, Schwartzman. *Shows the collection of products associated with the phonograph. Beautiful photos from Art Nouveau to Art Deco era.* 1996. 119 pgs. .... \$16.95
- The Pocket Guide to Collins Amateur Radio Equipment 1946-1980, Miller. *A pictorial guide to Collins equipment and accessories.* 90+ sharp photographs. 3 1/2" x 7" 108 pages. .... \$19.95
- Portable Radio In American Life, Schiffer. *Traces the development of the portable radio and how it affected American culture and society.* 450 photos and drawings, 253 pgs. .... (hardcover) \$45.00
- Price Guide to Plastic Collectibles, McNulty. *Describes types of plastics, etc. (Radio is 8 of 207 pgs.)* .... \$17.95
- RCA Radiolas, Radiotrons, and Accessories (reprint). *Twenty-page booklet summarizing RCA's 1926 product line including the Radiola III, 20, 25, 26, 28, etc.* .... \$4.50
- Radio Art, Hawes. *A chronological, illustrated history of the technical and stylistic progress of the radio. Mostly British, but American sets are featured as well.* 250 photos, 150 in color, 128 pgs. .... (hardcover only) Low Price \$9.95

# COLLECTOR BOOKS AVAILABLE FROM A.R.C.

BOOKS MARKED WITH "NEW" ARE THE MOST POPULAR AND ARE ESPECIALLY RECOMMENDED FOR NEW COLLECTORS!

- Radio Art Postcard Deck. *30 full-color photographs from Hawes' book.* ..... \$7.50
- Radio Collector. (Videotape, VHS). *The five-part Emmy-nominated PBS series combined on one 130-minute videotape. Meet collectors, see collections, attend swap meets, learn about radio restoration.* ..... \$29.95
- The Radio Collector's Directory and Price Guide, 1921-1965, 2nd Ed. Grinder. *Directory of over 20,000 radios by manufacturer, model number, year, etc., with prices. Radio history, cabinet styles, vacuum tube development chapters. Over 1,200 trade names listed. Thoroughly revised and expanded.* 500 pgs. .... \$26.95
- Radio Collector's Guide, McMahon. *Listing of 9,000+ radios made by some 1200 companies from 1921 to 1932. Gives manufacturer, year, model name and other info. No photos.* 264 pgs. .... \$11.95
- The Radio Collector's Guide to Philco Bakelite Block Condensers, 2nd Ed., Bintliff. *A detailed description of Philco Bakelite block condensers with illustrations and parts lists.* 1995. 57 pgs. .... \$9.95
- Radio Craft - 50 Years of Radio (reprint). *March 1938 issue of Radio Craft magazine. Numerous articles on the development of radio, then 50-years old, and on early radio pioneers.* 144 pgs. .... \$15.95
- Radio Diagram Sourcebook, Gray. *Valuable tool for identifying radios. Tubes used, replacement dial lamps, and I.F. frequency. Reprint of Sylvania's tube complement guide is included listing almost 10,000 radios.* 290 pgs. .... NEW \$18.95
- Radio Horn Speaker Encyclopedia, Paul. *Listing of horn speakers for 320+ manufacturers for the 1920s. Expanded info. on 10 companies.* 145+ photos, 80 pgs. .... \$14.90
- Radio Horn Speaker Notebook, Rev. H. Paul. *The companion to the Encyclopedia. Over 450 horn picture ads are shown, over 325 manufacturers are identified. Photocopy. New Index.* 1995. 72 pgs. .... \$15.90
- Radio Manufacturers of the 1920's, Douglas. *Three comprehensive volumes.* (softcover only) \$24.95
- Vol. 1 covers A-C Dayton thru Ferguson ..... (softcover only) \$29.95
- Vol. 2 covers Freed-Eisemann thru Priess. 266 pgs. .... (hardcover) \$39.95
- Vol. 3 covers RCA thru Zenith. 292 pgs. .... (hardcover) \$29.95
- Radio Redux, Collins. *Subtitled "Listening in Style." This book showcases the sleek lines and luscious colors of over 80 gleaming sets from the collection of Philip Collins.* 120 pgs. .... (hardcover) \$29.95
- Radio/Radio!, 3rd Ed., Hill. *Comprehensive coverage of British radios from the 1920s-70s. This expanded edition includes the previous versions plus 75 new pages and 50 new illustrations. New transistor radio section.* (hardcover only) NEW \$64.95
- Radio/TV Finder, Okolowicz. *Reference to nearly 7,000 radio and TV pics found in 24 books. No photos, 110 pgs.* .... \$13.95
- Radio & T.V. Collector's Guide Book, Biraud. *The "Vintage Radio" illustrated guide to European sets from early wireless to the 1930s (a few later). Text is in both French and English.* Vol. 1: History & Manufacturers A to P. 256 pgs. Vol. 2: P to Z & T.V., Speakers, Tubes, Loops, Parts & Novelties. 256 pgs. .... (Per Volume) \$49.95
- Radios by Hallcrafters, Dachis. *The most definitive book on the company. Over 600 photos (some color) on everything they made. An invaluable tool for anyone interested in Hallcrafters.* 220 pgs. .... \$29.95
- Radios of the Baby Boom Era. *Pictures and info from Sams Photofacts. 3,494 radios illustrated plus 3,275 additional radios listed.* 274 brands. 1946 thru 1960. Six volumes, 300+ pages per volume. Order by volume: Vol. 1: Admiral - Cleonsonic. Vol. 2: Co-op - Gelsoso. Vol. 3: GE - Monitoradio. Vol. 4: Motorola - RCA. Vol. 5: Realtone - Stratovox. Vol. 6: Stromberg-Carlson - Zenith. .... (Per Volume) \$16.95
- Refinishing Old Furniture, Wagoner. *Written by a furniture restoration instructor. A step-by-step guide to furniture (or radio) restoration, from removal of finishes right up to the final polish.* 178 pgs. .... \$14.95
- Saga of the Vacuum Tube, Tyne. *The development of vacuum tubes 1880 to 1930. From Edison, Thomson and Fleming to de Forest, Philips, Siemens and many more.* 100+ tube photos, 495 pgs. .... \$18.95
- Shortwave Receivers Past & Present, Communications Receivers 1945-1996, 2nd Ed., Osterman. *For the radio collector, the informed receiver buyer or anyone interested in the history of shortwave radios. 500+ receivers listed.* 350 pgs. .... NEW \$19.95
- Sound & Vision Yearbook 1995/96. *An annual directory of radio & TV collectors, primarily European.* \$6.95
- S. Gernsback Radio Encyclopedia (reprint). *1927 classic encyclopedia on radio. From "A" B 2 Yery to Zirconium, with 1000s of entries in between.* 100s of illustrations, 175 pgs. .... \$9.95
- 70 Years of Radio Tubes and Valves, Stokes. *The story of the radio tube from the lab to the public.* 247 pgs. .... \$25.95
- 75 Years of WE Tube Manufacturing, Magers. *A log book history 750+ WE tubes. Illustrated.* 133 pgs. .... \$16.95
- Tomart's Price Guide to Radio Premium and Cereal Box Collectibles, Tumbusch. *Includes comic character, pulp hero, TV and other premiums.* 1991. 3,000+ illustrations, 176 pgs. .... \$22.95
- Transistor Radios, A Collector's Encyclopedia and Price Guide, Lane. *Identification guide to over 2,500 transistor and novelty radios. History and key to collecting chapters.* 1994. 170 pgs. .... \$19.95
- Transmitters, Exciters and Power Amplifiers 1930 1980, Moore. *Pictorial and descriptive guide to amateur high frequency transmitters and amplifiers manufactured in the U.S.A. Over 500 photos.* 144 pgs. .... \$21.95
- Tube Lore, Sibley. *Trends in tube design, receiving and audio tubes, special-purpose and transmitting tubes, military types. tips on testing, repairing, adapting various tubes, auction prices from six major sales.* 186 pgs. .... NEW \$19.95
- Tube Type Transmitters, Rippen. *Provides a wealth of information on transmitters and transceivers. Includes ancillary items such as linear amplifiers, converters, modulators and VFOs.* Over 500 illustrations. 145 pgs. .... \$17.95
- The Weekend Refinisher, Johnson. *A complete guide to stains and finishes and tips for setting up your own workshop. A handy furniture "first aid" kit for quick repairs.* Illustrated. 296 pgs. .... \$12.00
- Westinghouse Catalog (reprint). *1920s catalog of the RA-DA and other early Westinghouse equipment.* 8 pgs. .... \$4.00
- Wireless Communication in the U.S., Mayes. *Early development of American radio operating companies. Alternators, coherers, stock promotions, unpublished letters, etc.* 160 illustrations, 240 pgs. .... \$29.95
- The Xtal Set Society Newsletter, Anderson. *Complete set of the Society's newsletter. Order by volume.* Vol. 1: 7/91 to 5/92
- Field Strength Meter, FM Xtal Set, Xtal Sets & Wireless, & more. Vol. 2: 7/92 to 5/93
- The Lead Pencil Detector, The Universal Xtal Set, etc. Vol. 4: 1/94 to 11/94
- Measuring Coil Capacitance, home-brew headphones and curve tracers, etc. Vol. 5: AM Receiver Design, Marconi Type 107 Radio Outfit in a Headset, & more. .... (Per Vol.) \$9.95
- The Xtal Set Handbook, Anderson. *Formulas for coil inductance, a procedure for measuring coil capacitance, circuit matching theory, & more. Also included is Vol. 3 of the Xtal Set Society Newsletter.* .... \$10.95
- Zenith Radio Corporation (reprint). *The instructions for installation and operation for Models 39-39A Models 392-392A, and Electric Zenith Receivers.* 3 schematics, 3 photos, 7 1/2" by 5" 16 pgs. .... \$4.50
- The Zenith Trans-Oceanic: The Royalty of Radios, Bryant and Cones. *Presents the fascinating story of the development and use of the Trans-Oceanic. Several photos, documents, ads, etc.* 160 pgs. .... \$24.95

U.S. Orders - Enclose \$3.00 per order for packing & book-rate shipping if total order is under \$35.00. If using VISA or MasterCard, include name on card, card number and expiration date. Send payment with order, Mass. residents add 5% sales tax. Money back return policy. Softcover unless stated otherwise. Most orders shipped the same day received, but allow 2-4 weeks to receive order. Foreign orders - write for shipping costs, or use credit card and specify air or surface (allow 2-3 months for surface shipping).



A.R.C., P.O. Box 2, Carlisle, MA 01741 Tel: (508) 371-0512  
 Fax: (508) 371-7129 Web: <http://www.antiqueradio.com/>







## ROCHESTER's COLOR TV SHOW & TELL

Correct time is **2:00 PM WEDNESDAY**  
in the Seneca Room (AWA meet).

See us there on **September 3rd**. We'll have CBS prototype color wheels, plus CBS color TV photos and info about their color TV systems from 1946-1954!

(Don't forget—it's **NOT Thursday**)

FOR SALE:  
Zenith  
Royal 7000  
chassis 18ZT40Z3

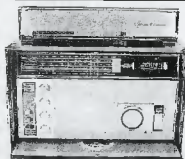

Marked: "Patented in Canada in 1961", this 18 transistor, 11 band radio is 15 lbs of quality. Nice cosmetics, and complete except the log is missing, and the plate that held the log is bend a bit. It seems to play on all bands but the volume control is scratchy, so we are selling it cheap...\$161

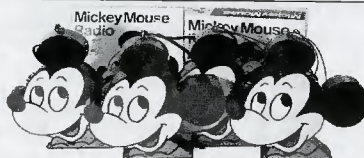

FOR SALE: Mickey Mice Transistor Radios, or at least that's what I think you call this many Mouses! A box full of these...but all are missing the battery cover. There are 5 of the regular Intoport Developments, plus 1 slightly different. This should make great trading stock! **6 Mices in all...\$59**



FOR SALE: Mickey Mouse Transistor Radio. This is an unusual variation which features Mickey's head without a collar. Seldom seen—but Anna found one in the pantry! No battery cover—\$22



FOR SALE: Male Chauvinist Pig transistor radio—his curly little tail is the volume control. A small brown pig with a brown bow, model #130 by Arrow in Hong Kong It's in excellent cond with tag instructions, and earphone, in the worn box...\$44

Please visit us at:  
[www.harryposter.com](http://www.harryposter.com)

MESSAGE: Bringing B&W or COLOR TVs to Rochester this year? Please call us so we can bring you some extra cash! We'd like to buy your pre-war TVs, your early or unusual B&W's from 1946 to 1975, and early color sets from 1946 to 1955. Plus color wheels, special CRTs, even empty television cabinets. Call or e-mail today...thanks!

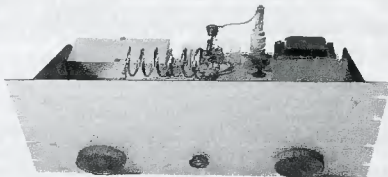

FOR SALE: Homebrew with Eimac 304-TL. This is either a kit or homebrew from a local ham shack. 19" wide, 10-1/2" high, and 14" deep, it sports two heavy transformers. It has 2 long air spaced condensers, and it comes with 2 plug-in coils by Barker and Williamson: 15TA and 10TEL. It weighs about 40 lbs ...and its yours for \$58

FOR SALE:  
Continental  
Model M-650.



This 1959 white Japanese bakelite portable is a 4-tube set. The face and tuner are reverse painted with gold and black. A nice set in good condition—except for a small corner crack. Continental Merchandise Co tube type portable in white bakelite! Only ...\$57



FOR SALE:  
Standard  
SR-100

This is an early and unusual Japanese 3 tube portable. Made of soft blue plastic with clear tuner, it's an earphone only set (no speaker)! It has a hand wired aluminum chassis, and it's in excellent condition, complete with earphones. Price...\$108

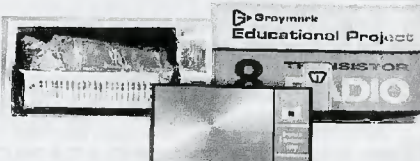

FOR SALE: Graymark 512 Transistor kit. This came from a local school 30 years ago! Kit includes pc board, parts, case, and schematic-parts layout. It has a bag of transistors—but I can't tell which goes where... Transistor radio kit...\$62

## CLASSIFIED ADVERTISING POLICY

ONE FREE 20-WORD AD for subscribers in each issue; additional words are 27¢ each. See details below. Classified ads sent by mail, fax or by any other method must be received (not just postmarked!) by Noon Eastern Time on the classified ad deadline date to guarantee inclusion in the current issue. Late ads are held for the following issue. Please enclose correct payment with all ads. Stamps or cash are OK for small amounts. (Canadian and other foreign advertisers, please see "Payment" on page 2 for methods.) "Free words" cannot be accumulated from month to month; free words must be requested when ad is submitted.

Faxed & e-mailed ads: Please see additional information on the inside front cover.

When including ads with other A.R.C. correspondence, write the ads on a separate piece of paper. Include SUB# with ad. Ads may be sent in advance; but, write each ad on a separate piece of paper and indicate the month (or successive two months) you want the ad to run.

To minimize our typing errors: Please write legibly. Use both capital and small letters. Do not use a dash between words. Carefully write the following numbers and letters (especially in model numbers) since some can look alike; for example 1, l and I (the number one, the capital l and the small L.) Also: 0, O, o, Q and D; r and n; 6, b and G; V, U, u, v and Y. A and R; 5, S and s; 2, Z and z. We try to correct spelling errors, so when using an uncommon word or manufacturer which we might mistake as a more common word or manufacturer, note it so that we do not "correct" it. Editor's annotations are in [brackets].

Advertising is accepted only for early items related to radio, communication, etc. All items must be described fairly; reproductions, reprints and not-original items must be so identified. Advertisers must agree to respond promptly to inquiries and orders, to resolve problems promptly if the buyer is not satisfied, and to comply with a buyer's refund request on unaltered returned items.

The publisher reserves the right to edit ads without notification to the advertiser and to reject ads for any reason. Names other than the advertiser will be edited out of ads. Ads with non-radio-related items will be returned or edited unless the non-radio-related items are for trade of radio-related items, or they are incidental to and appear at the end of an otherwise acceptable ad. The publisher is not responsible for errors due to illegibly written ads or for any other reason.

Clubs: Since club activities receive free coverage on the *Coming Radio Events* pages, the free 20 words may not be used for club activity ads. See inside front cover for additional information.

### CLASSIFIED AD DETAILS

Deadline: NOON ET—10th of the month!

Classified ads must have a standard heading such as WANTED, FOR SALE, FOR TRADE, FOR SALE/TRADE, SERVICES, MESSAGE, HELP AUCTION, MEET etc. This heading is the only bold or all-capitalized words allowed in the ad. Capitalize only manufacturer names, model names, etc. This standard ad format makes scanning the ads easier

Before writing your ad, please look over the ads in a recent issue of A.R.C., and try to write your ad in the same style. Full name (or company name) and address is required in all classified ads; we will add it if you forget.

To encourage varied content of the ads, the same classified ad may be run only once per issue and for only two consecutive months. (To run an ad longer use a boxed classified or display ad.)

### Classified Ad Rates per Month

Subscribers:

First 20 words: FREE\*  
27¢ per word for extra words over 20 plus  
10¢ per word for a shaded ad (count all words including free words).  
\* Subscribers may take 20 free words on only one ad each month.

Non-Subscribers:

45¢ per word plus  
10¢ per word for shaded ad.

Please do not forget to send in the extra 27¢ per word when your classified ad runs over the free 20 words; your payment will be appreciated, and it will help to keep A.R.C. healthy.

### BOXED CLASSIFIED AD DETAILS

Deadline: 1st of the month!

Boxed classified ads can run unchanged for three months or more. No words are free. Ads may be shaded and may include bold and all-capitalized words freely. The ad need not begin with "For Sale," etc. Minimum run is 3 months, prepaid. Discount: 10% for 6 months; 20% for 12 months.

### Boxed Classified Ad Rates per Month

Nonshaded ads:

38¢ per word for all words,\* none free, plus  
10¢ per word for each bold word plus  
10¢ per word for each all-caps word.  
Shaded Ads (All words are bold at no charge):  
48¢ per word for all words\* plus  
10¢ per word for each all-caps word.

Non-Subscribers:

Add 20¢ per word to above costs.

\*Three words can be bold-all-caps at no extra charge.

### PHOTO & DRAWING DETAILS

Deadline: 1st of the month

for all ads with drawings or photos!

Drawings and photos are encouraged as the response to your ad is much larger and the reader knows better what you want or are selling. Send in your drawing or photograph, and A.R.C. will reduce it or enlarge it as needed.

### Photo and Drawing Rates per Month

\$22.00 per month for each photo or drawing (if ad is canceled, this amount cannot always be refunded.)

### CHANGES & CANCELLATIONS

Please check your ads carefully before sending them in. Once ads are received, it is not always possible to refund the amount sent, pull the ad or make changes.

### IMPORTANT COUNTING WORDS IMPORTANT

The standard headings: WANTED, FOR SALE, etc., count as one word each time used in an ad. Name, address and (one) telephone number count as 6 words, regardless of length. Ham call letters and business name can be included in the 6 words and do not count extra. Full name (or company name) and address is required in all classified ads. Each additional word, abbreviation, model number or number group, extra telephone numbers, fax, e-mail, etc. count as one word each. Hyphenated words count as two words.





PERIODICALS

A.R.C., P O Box 2, CARLISLE, MA 01741  
RETURN POSTAGE GUARANTEED

3

9\*1\*\*\*\*\*3-DIGIT 064  
6-9H SUB#=22-18533  
GILBERT SIMPSON  
18 BEECHWOOD DR  
ANSONIA CT 06401

EXP=OCT97

**CLASSIFIED AD  
DEADLINE SEPT. 10th  
Noon Eastern Time**