



ANTIQUE RADIO CLASSIFIED



VOLUME 16

JUNE 1999

NUMBER 6

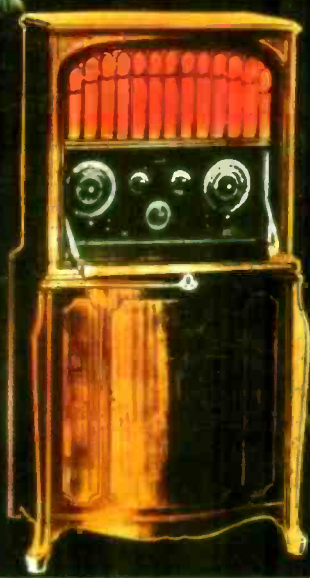

A RADIOLA
MASTERPIECE

Radiola SUPER VIII

*The last word
in selectivity,
range and quality
of tone.*



See and hear this great
radio achievement

HOYT'S DRUG STORE
RELIABLE RADIOS
EASY TO BUY ASK US

FIFTEENTH ANNIVERSARY ISSUE

A.R.C. — THE NATIONAL PUBLICATION FOR BUYERS AND SELLERS
OF OLD RADIOS AND RELATED ITEMS — PUBLISHED MONTHLY

ANTIQUE RADIO CLASSIFIED

Antique Radio Classified (ISSN:870-7547) is published monthly, 12 times per year, by John V. Terrey, One River Road, P.O. Box 2, Carlisle, MA 01741. Periodicals postage paid at Carlisle, MA, and additional mailing offices. Telephone: (978) 371-0512, 8:30 AM to 5:00 PM ET weekdays; machine answers phone at other times.

Annual subscription rates within the U.S. are \$39.49 by Periodicals mail and \$57.95 by First Class mail.

Annual foreign rates. By air: Canada - \$61.00; Mexico - \$67.00; Other foreign countries - \$105.00. Surface mail: Canada - \$51.00; Other foreign countries - \$58.00. (Surface delivery to countries other than Canada may take two or more months and cannot be guaranteed.)

Two-year subscriptions are twice these rates and receive an extra month. Sample issues are available free on request.

© Copyright 1999 by John V. Terrey.

POSTMASTER: Send address changes to Antique Radio Classified, P.O. Box 2, Carlisle, MA 01741.

Printed in U.S.A.

STAFF:

Publisher and Editor: John V. Terrey
Production & Advertising Manager: Cindie Bryan

Office Manager: Tammy DeGray

Managing Editor: Dorothy Schecter

Publishing & Editorial Staff:

Dave Crocker, Bobby Lyman

Founding Publisher/Editor: Gary B. Schneider

Contributing Writers & Consultants: Mike Adams, Richard L. Arnold, Richard Begbie, Ray Bintliff, Ron Boucher, Paul J. Bourbin, Norman S. Braithwaite, Dave Crocker, Dick Desjarlais, Alan S. Douglas, Richard C. Foster, Fred Geer, Jim Kreuzer, Ron Ramirez, Henry Rogers, Ian L. Sanders, Gary B. Schneider, Daniel Schoo, Frank R. White, Ralph Williams, Walter Worth

PURPOSE. Antique Radio Classified is published for people involved in the radio collecting hobby. Its purpose is to stimulate growth of the hobby through the buying, selling and trading of radios and related items, and to provide a monthly forum for the interchange of ideas and information.

CONTACTING ANTIQUE RADIO CLASSIFIED. All correspondence should be sent to:

A.R.C., P.O. Box 2, Carlisle, MA 01741.

Only UPS, Federal, etc. items to street address: One River Road.

Telephone: (978) 371-0512; Fax: (978) 371-7129

E-mail: ARC@antiqueradio.com - Web: www.antiqueradio.com

Please, no classified ads by telephone; thanks.

Your ads, renewals, letters, etc. can be handled faster and more efficiently if your name, address and SUB# are written on each.

Unfortunately, A.R.C. is not staffed to answer all letters with questions about antique radios or requests for advice. However, A.R.C. does solicit letters of interest to its readers and publishes them as space permits. (See "Publishing Rights" paragraph.)

GUARANTEE. You may cancel your subscription at any time and receive a pro rata refund for issues not yet mailed. If errors to ads are made by A.R.C., upon request a free correction will be run in the next available issue.

DISPLAY AND BUSINESS CARD ADS - DETAILS AND RATES

The deadline is the first of the month for display and business card ad artwork, payment and repeat requests.

Advertising is accepted only for early items related to radio, communication, etc. All items must be described fairly; reproductions, reprints and non-original items must be so identified. Advertisers must agree to respond promptly to inquiries and orders, to resolve problems promptly if the buyer is not satisfied, and to comply with a buyer's refund request on unaltered returned items.

Advertising must be prepaid, except as noted below; see "Payment" paragraph above for details. Late ads will be run only if space and time permit. Since artwork is reduced to 63% in the printing process, originals must be the artwork size listed below. Do not send in artwork on art board or send negatives. Ads should be typeset or typed neatly with a carbon ribbon, black ink (not pencil) on white. If used, reverse type must be limited to 25% of the ad. If you want us to prepare your ad, include the one-time cost below for A.R.C. to make up the ad.

Photos should be at an 85-line screen; otherwise, add \$16.00 per photo for screening. Do not cut or trim photos or glue photos to artwork; submit separately.

If you are confused by these requirements and terms, please

Page	ARTWORK SIZE (SEND IN THIS SIZE)		As Printed (size in magazine)		Cost for 1-month	Cost for 3-months	Cost for 6-months	Cost for 12-months	One Time to make up Ad
	H x W (inches)	H x W (inches)	H x W (inches)	H x W (inches)					
Full	12 7/16 x 7 1/2	7 3/4 x 4 3/4	7 3/4 x 4 3/4	7 3/4 x 4 3/4	\$289.00	\$769.00	\$1329.00*	\$2325.00**	\$69.00†
1/2 H	5 1/4 x 7 1/2	3 1/4 x 4 3/4	3 1/4 x 4 3/4	3 1/4 x 4 3/4	146.00	389.00	675.00*	1175.00**	37.00†
1/2 V	12 7/16 x 3 9/16	7 3/4 x 2 1/4	7 3/4 x 2 1/4	7 3/4 x 2 1/4	146.00	389.00	675.00*	1175.00**	37.00†
1/4	5 1/4 x 3 9/16	3 5/16 x 2 1/4	3 5/16 x 2 1/4	3 5/16 x 2 1/4	74.00	197.00	342.00*	595.00	19.00†
1/8	2 5/8 x 3 9/16	1 5/8 x 2 1/4	1 5/8 x 2 1/4	1 5/8 x 2 1/4	38.00	101.00	177.00	305.00	9.00†
Business Card (1st)	2 x 3 3/4	1 1/4 x 2 3/8	1 1/4 x 2 3/8	1 1/4 x 2 3/8	not avail.	53.00	90.00	159.00	7.00†
Business Card (2nd...)	2 x 3 3/4	1 1/4 x 2 3/8	1 1/4 x 2 3/8	1 1/4 x 2 3/8	not avail.	68.00	118.00	205.00	7.00†

* Full & 1/2 page, 6-mos.: 1/2 due with order; 1/2 due in 3 mos. ** Full & 1/2 page, 12-mos.: 1/2 due with order; 1/4 due at 3, 6 & 9 mos.

† For 6 and 12 month ads, no ad make-up charge if no change is made to ad for entire run.

PAYMENT. Please send in full payment with your order or ad. A.R.C. does not carry accounts; all subscriptions, ads, etc. must be prepaid (except for the 6 and 12 month display ads indicated below). Pay in U.S. funds. Checks drawn on a U.S. bank, money orders, VISA or MasterCard (\$10.00 min.) are preferred. Make check out to "A.R.C." U.S. stamps or cash are OK for small amounts. Canadian payers may send a Canadian check but specify U.S. funds. Subscriptions will be prorated to amount sent if amount is incorrect.

FAX & E-MAIL PROCEDURES/PAYMENT. Subscriptions, book orders, classified ads, display ads, etc. are welcome by fax or e-mail. Deadlines are the same as for ads received by mail. Please calculate the amount due. Payment by VISA or MasterCard is preferred if your order is over \$10. If under \$10, or if you prefer to send a check or money order, state the amount being sent and that the payment is in the mail. Do not send another copy of your ad with your payment; simply indicate that it is a fax or e-mail payment. If you want confirmation of our receipt of your fax, call immediately after sending your fax.

CHANGE OF ADDRESS. Please notify us 4 weeks in advance of a change of address. Send both your new and old addresses, and include your SUB# and effective date of your new address. Temporary address changes can be made also.

SUBMISSION OF MATERIAL. Antique Radio Classified welcomes and solicits information that pertains or relates to radio history or collecting. This may include articles, book reviews, photos, information on upcoming radio events, meetings, antique radio organizations, radio auctions, sources of old radio and restoration supplies, and other related and interesting material. All material submitted should be carefully researched, typed and accompanied by good photos, if appropriate. Computer disks are appreciated. Writing guidelines are available upon request.

PUBLISHING RIGHTS. Unless other arrangements are made: (1) All received materials (ads, articles, letters, correspondence, e-mail, photos, artwork, etc.) become the property of A.R.C., may be edited, combined with other material, published, and will not be returned. (2) For all received materials, A.R.C. is granted publishing and reprint rights in all forms of media including the monthly printed magazine, internet, etc. (3) Publication is subject to approval by A.R.C. and to time and space constraints.

MAILING OF ISSUES. U.S. subscribers can receive A.R.C. by First Class or Periodicals mail (Periodicals is the way most magazines are mailed). The mailing of First Class copies is staggered with faraway copies mailed before local copies. Non-U.S. copies are mailed on the first day. Periodicals copies are mailed on the last day. Mailing dates change each month, but mailing is usually completed by the 27th of the month. First Class copies usually are received by the 5th of the month; copies by Periodicals mail, by the 10th.

ETHICS. No person involved in the production of A.R.C. is to act on any information in the magazine until the first delivery day after local copies are mailed.

DISCLAIMER. The publisher is not responsible for any buying and selling transactions incurred, or for any other use of the contents of this publication.

Antique Radio Classified subscription rates, frequency of publication, content, policies, size and ad details, and rates are subject to change at any time by A.R.C.

contact A.R.C. before beginning to prepare your ad. We will be happy to advise you on your ad ideas, estimate how much the ad will cost, recommend an ad size, etc.

We assume that advertisers want all ads which are submitted to run without delay; therefore, we will run the ad and bill for any additional work required for the ad to meet these specifications. A late ad will run beginning with the next month. "Tear sheets" will be sent only for 1/8-page or larger ads and only if requested when the ad is submitted.

First business card per advertiser is at lower rate.

The 3-month rates represent about an 11% discount, the 6-month rates 23%, the 12-month rates 30%. Placement requests: add 15% but call first. Clubs: write for discount policy.



ANTIQUE RADIO CLASSIFIED

EDITOR'S COMMENTS

An anniversary always gives us pause. We take time to reflect on what's gone before and then move on. A.R.C.'s 15th anniversary is no exception — we pause, reflect — and marvel! We're still here doing what we set out to do!

We've become the largest print-publication for the radio-collecting community and our distribution is worldwide. In addition to being a conduit for buying and selling and for radio information, we have published numerous significant articles on a wide range of historical and technical subjects. Some of our contributing writers go back almost to the beginning; others are quite new but equally ready to share stimulating ideas.

Needless to say, we're proud of our accomplishments, but we know that we cannot be complaisant. We too must move on. The world is changing more rapidly than the early radio pioneers could have imagined, and we must meet that challenge. And so in this issue comes the announcement of a target date on which the A.R.C. Web site will expand to include classified ads and more.

Of course, this move into the technological future doesn't detract from our primary interest in the past. A good example is our lead article by John Wolkonowicz, which fills a knowledge gap — the mystery of why the set on our cover, part of the early 1924 RCA radio line, was not announced until after the lucrative 1923 Christmas selling season. John describes the original radio line planned for the 1923 Christmas season — a totally different group of Radiolas that were never produced and have been unknown to collectors until now.

We might call this article "a scoop." It certainly shows how the evolution of an A.R.C. article can be something like a labyrinth. This one started with a document your editor purchased at a radio meet. John Wolkonowicz, author of numerous RCA articles, was intrigued by the subject and agreed to write an article. He, in turn, contacted Alan Douglas, another RCA historian, who contributed photos from his collection. Then, your editor found the advertising slide of the related Radio a Super VIII in his archives.

Finally, Mike Brazil's chance *Photo Review* submission of his Radiola Super VIII in its crate rounds out the story. And so it went — one thing led to another until this exciting historical piece, like the recent ones on Atwater Kent and Cortlandt St., was complete.

Another bit of RCA history is described by Ray Bintliff in his story about the early days of television. Ray worked for the RCA Service Company converting pre-war sets to postwar standards, installing new sets, and responding to the need to receive the TV signal from farther and farther away. Ray describes some wild and crazy working conditions of the times.

Digging even more deeply into the past, Howard Stone writes about the restoration of the centerpiece of his collection — a Marconi Magnetic Detector. His find inspires all of us not to give up the chase for key pieces desired for our collections. A sidebar describes the operation of this early novel detector.

On the subject of our more recent past, our fifteenth

anniversary seemed to call for a retrospective article about A.R.C. Dorothy Schecter, our managing editor, rose to the task, though her inclination to "tell it like it is" around the office had to be constrained. Her article is accompanied by covers illustrating key milestones and the breadth of our coverage.

Radio history is always brought into the present by an auction. Once again, Ray Chase acts as our eyes and ears at another auction. Norm's Radio Auction in Hanover, Pennsylvania, sold the collection of Charles Mooney. This over 300-lot event drew a good crowd. Highlights included a Crosley grandfather clock radio, a Scott All-Wave, and a Zenith shutter-dial console.

Dick Desjarlais continues his trip into the future as he learns more about the Internet and WebTV. This month he makes his purchase decision and sets out to buy.

Photo Review is expanded by a page for this anniversary issue and includes quite a variety — crystal sets, a console, a desk set radio, a fireplace radio, and even a wind-up tape recorder.

Radio Miscellanea includes several letters on past A.R.C. articles and an enlightening letter regarding meets from one who runs them.

Internet. Finally we made it, or at least we have a target date — July 1. The article on page 31 describes the Web site enhancements, the most significant of which is searchable classified ads. There also will be a searchable data base of historic auction prices, and an easier-to-use A.R.C. store. The classifieds ads initially will not include photos, but very soon, photos will be added and display and business card ads will follow.

Support A.R.C.! All of this — the printed magazine you receive each month, the web site — all costs real money. We urge you to support A.R.C., not only with your subscriptions, but also with your orders for books, videos, etc. We stock what we sell and usually ship the day we receive the order.

Coming Radio Events. The *Coming Radio Events* calendar is filled with over 41 events in June alone. For this anniversary issue, we have included our full listing of radio clubs, U.S. and foreign. I encourage all of you to attend a meet near you or to go to one of the many major meets — meet other collectors, learn a great deal, and perhaps find an item or two for your collection!

Happy Collecting!

John V. Terrey, Editor

ON THE COVER

Our cover is the reproduction of a movie theatre advertising slide from your editor's collection. Such slides were projected in movie houses to advertise local businesses. In this one, Hoyt's Drugstore claimed to sell "Reliable Radios." The words "Easy to Buy — Ask Us" imply that people must have been apprehensive about radios — just as some are today about the Internet. The Radiola Super VIII pictured is a 6-tube, top-of-the-line superheterodyne, one of several sets that replaced the abandoned 1923-1924 line, the subject of our lead article.



RADIO IN THE TWENTIES

RCA's Intended Models for the 1923-1924 Season "What Might Have Been"

BY JOHN P. WOLKONOWICZ WITH ALAN DOUGLAS, JOHN V. TERREY AND RICHARD G. WOLVEN

Why RCA introduced its new line of radios in April 1924 rather than in time for the 1923 Christmas season has long been a mystery to radio historians. As a result of your Editor's find—a 1923 RCA document outlining the 1924 broadcast receivers — this article solves the mystery. (Editor)

This is an article I've wanted to write for more than 20 years but the necessary background information was unavailable. During the late 1970s, I wrote a series of articles for *Radio Age* entitled "The Radiola Superheterodyne Story." While researching this series, I learned that RCA's entire Christmas season model range for 1923 was canceled to allow all resources to be devoted to the perfection of the Radiola Superheterodyne.

This explained why RCA had introduced its new model range in April 1924 instead of in October 1923 which would have been in time for the lucrative Christmas selling season. The question is: Were the sets which were introduced in April 1924 — Radiolas III, IIIA, Regenoflex, X, Superheterodyne and Super VIII — simply delayed from fall 1923, or, was there a whole range of receivers planned but never manufactured? Now we know the answer.

At the New England Antique Radio Club (NEARC) Fall Swap Meet in October 1998,

John Terrey showed me a fascinating piece of literature that he had acquired at the meet. Bound in a General Electric binder, it was entitled "Specifications for Broadcast Receivers for 1924, Radio Corporation of America, Research Department, January 16, 1923."

In this document, RCA provided its initial thoughts on the 1923-1924 model range to its manufacturers — General Electric, Westinghouse and Wireless Specialty Apparatus (WSA). Note, until 1929, when RCA acquired the Victor Talking

Machine Company, 60 percent of RCA products were manufactured by GE, 40 percent by Westinghouse and the remaining shortfall by Wireless Specialty Apparatus.

A copy of the document was sent to Alan Douglas, historian and author of the classic, 3-volume, *Radio Manufacturers of the 1920's*. Alan was as excited as I was, since his collection included photographs from RCA engineer Arthur F. Van Dyck. Two of the sets in the proposed 1923-1924 line were there. As Alan said, "I always wondered what this monstrosity was." Here at last, was all the information necessary to complete the

story on what RCA had intended as its 1923-1924 model line.

HISTORIC BACKGROUND 1920-1923

To begin this story, let's dial the clock back to December 1922, at RCA's corporate offices at 233 Broadway in New York. The year 1922 had been frustrating for RCA. During the early part of the year, radio broadcasting and associated receiver sales seemed to defy gravity after a slow start in 1920-1921. But by summer, the radio boom had turned into a radio bust. Many critics proclaimed the radio "fad" to be over.

RCA saw the situation somewhat differently. The company believed that radio broadcasting was an essential service to the public, not a fad. It held out great hopes for the future of broadcasting, and the receiver sales which broadcasting would bring. But RCA was disappointed with its own performance in receiver sales in 1922. By the time its three manufacturing concerns had geared up to volume production in summer 1922, the radio boom had subsided.

Worse still, RCA's 1922-1923 model range was expensive, disjointed, and obsolete. Smaller competitors like Grebe, Kennedy, Paragon and Clapp-

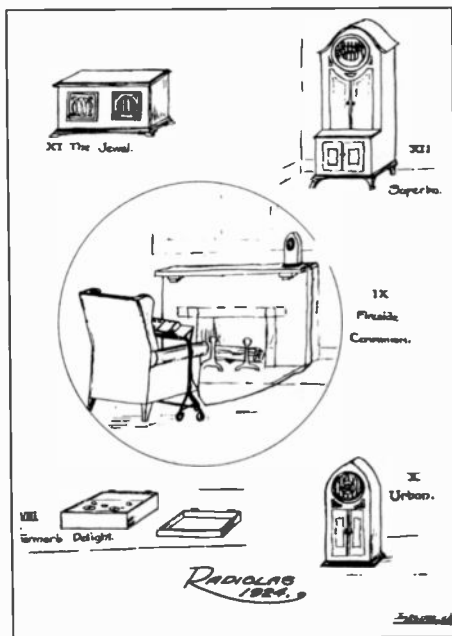

Eastham were running rings around the cumbersome RCA. Its 1922-1923 line was a conglomeration of what GE, Westinghouse and WSA had already designed. Products overlapped — for example, Westinghouse's Radiola RC with GE's Radiola V — and showed no coherent concept across the range. RCA's 1922-1923 model range looked like what it was — a collection of whatever was available from three formerly competing manufacturers.

But, the 1923-1924 season would be different. By December 1922, meetings were being held to plan the 1923-24 radio line. On January 16, 1923, detailed specifications and a schedule were finalized and were provided to GE, Westinghouse and WSA in the document titled: "Specifications for Broadcast Receivers for 1924."

The line would consist of five receivers of conservative electrical design, housed in innovative cabinets. Preliminary models would be submitted from the manufacturers by April 1, 1923, orders would be placed with the manufacturers by July 15, production samples would be provided by October 1, and final production approval given by RCA by October 15. A logically ascending price schedule of \$75 to \$420 was planned.

A description of the line of radios as described in the report is presented in this article. But a sequence of events was about to occur which would derail this product line and send RCA off in a completely new direction.

A NEW DIRECTION — THE SUPERHETERODYNE

The first of these events occurred in February, 1923, when Major Edwin Howard Armstrong visited RCA's General Manager David Sarnoff. Armstrong showed Sarnoff a self-contained portable

receiver of unusually high sensitivity and selectivity which contained a built-in loop antenna. In collaboration with Harry Houck, Armstrong had perfected a circuit, which he had invented earlier — the superheterodyne. Sarnoff wasted no time in recognizing that here was a true advancement of the state-of-the-art in radio. But could it be commercialized?

The second event occurred in April 1923 with the introduction of Hazeltine's Neutrodyne receiver — a nonradiating, tuned radio frequency circuit, which claimed equal gain across the broadcast band. Sales of the Neutrodyne took off immediately with Fada and Freed-Eisemann leading the charge. RCA would have to one-up the Neutrodyne and the proposed 1923-1924 product line was not up to the task.

In fact, the planned range lacked technical advancement and did not reach down low enough in price to match manufacturers like Crosley who were achieving great success by mid-1923. The only answer was to start again: (a) commercialize the superheterodyne as rapidly as possible, (b) design an innovative new midrange set (Regenoflex), and (c) complete the range with a price-leader set — Radiolas III and IIIA — starting at \$35. And so, the original plans for the 1923-1924 range were scrapped, never to be seen by radio collectors of future generations — until now!

THE ORIGINAL 1923-1924 RCA PRODUCT LINE

RCA had ambitious plans for its 1923-1924 range. As shown in Table I, in addition to five radio receivers — Radiolas VIII, IX, X, XI and XIII — there were plans for a hotel set, a motor vehicle set and a public entertainment set. But plans for the last three concepts were quickly dropped due to

(Text continues on page 7)

Table I — LIST OF CONTEMPLATED SETS

Radiola VIII.....	Cheapest set, 2 tubes, headset operation.
Radiola IX.....	Three tube set, in housing of distinctive character, separate loud speaker.
Radiola X.....	Same as the Model IX but in a different cabinet containing a loudspeaker and batteries.
Radiola XI.....	A 4- to 6-tube set of the same approximate quality as the Radiola IV and the Radiola Grand.
Radiola XII.....	A set of superior quality in all respects, with a cabinet generally similar to the Radio Corporation Research Department model.
Amplifier.....	2-stage audio amplifier arranged to work with Radiola VIII and give satisfactory loud speaker operation.
Hotel, Apartment, Hospital Set*.....	A set with the best performance features possible and with sufficient power output to feed a large number of loud speakers or headsets or both.
Motor Vehicle Set*.....	A set suitable for installation in automobiles as regular equipment.
Public Entertainment Set* ...	A set suitable for use in churches, auditoriums, clubs, restaurants, etc., with the best performance features possible.

* The last three items are included to make a complete picture of the apparatus requirements of the whole field. However, the Radio Corporation does not expect to push or to develop the fields covered by these three during the coming year, in the belief that the art is not yet ready for them, and it is therefore recommended that major development be concentrated on the first five items, Radiola VIII to XII inclusive, and particularly on Radiola XI.

Based on "Specifications for Broadcast Receivers for 1924," RCA Research Dept., Jan. 16, 1923.

Table II — GENERAL SPECIFICATIONS

The following general specifications applied to all sets, Radiolas VIII through XII.

A few radically new features are introduced, where technically justified, in order to give sales advantage and marked characteristics to the new line. These features are judged desirable after close study of experience to date and the trend of the art.

Appearance. Cabinets and all features affecting appearance shall be correct artistically, and it is recommended that artists expert in matters of form be consulted in the design.

Battery Space. All sets are to have self-contained battery space with easy replacement by the novice. If means for using lighting circuit power are discovered before development of this line is completed, the battery space in sets XI and XII should be so arranged as to make it possible to replace the batteries with the lighting circuit supply apparatus.

Battery Supply. This shall be such that one set of batteries will give satisfactory service for at least three months of average use, defined as one hour per day.

Tubes. Tubes shall be Model UV-199. This choice is made because it is necessary to settle upon one type, and at the time, the UV-199 tube is the better choice, for the following reasons. It is a patented device, requires less filament power, has less variation in production, has smaller size, and will have greater sales advantage on account of being a newer type.

In Radiola XII, UV-201A tubes may be used if lighting circuit supply is used.

No fewer than two tubes shall be used in any set, nor more than eight. The performance capabilities of these receivers is based upon transmitting stations of relatively low power ($\frac{1}{2}$ to 1 KW.)

Antenna. Open aerial and ground system will be used in Radiolas VIII to XI. Radiola XII may use either open aerial or closed coil aerial, if the circuits are such as to give the requisite sensitivity. Aerials from 20 to 100 feet in length are to be accommodated.

Selectivity. An interfering signal of frequency 15,000 cycles per second or more higher than the desired signal, or lower, and of five times the field strength of the desired signal, shall not emerge from background noises, when the desired signal is giving normal full tube output. Selectivity shall not cause serious attenuation of speech or music up to 3,000 cycles per second.

Quality of Reproduction. This factor will be approximately the same in all sets, except that it may be improved in some sets by balanced tube circuits or very special loud speakers. Radiola XI and XII may be improved by special means if such are discovered.

Regeneration. All sets except Radiola XII may utilize regeneration.

Radiation. No receiver shall be capable, under any condition of adjustments, of causing signals or interference in any other receiver within a distance of 15 feet.

Tuning Methods. The number of controls shall be the minimum consistent with operating requirements and once each control is set, it is not affected by later adjustment of other controls.

Controls. Major controls such as wavelength and regeneration shall have only fine adjustment. The pointer shall be double ended with one end indexing a scale and the other end on either a factory wavelength calibration scale or a space for marking station settings.

Shielding. Means shall be provided such that wave field action upon any part of the receiver shall not produce responses to decrease the effectiveness of the provisions for selectivity.

Panels. Wood panels, suitably finished, are preferred. Radiola XII will be wood only.

Terminals. Terminals are to be like those used on the Radiola Grand antenna.

Rheostats. Exceptional care shall be used in the design and construction of rheostats. Trouble of one kind or another has been experienced in the past with every design of filament rheostat, the most common being noise due to varying contact drop.

A form which is strongly recommended for consideration is one in which the resistance is adjusted in steps by means of a point switch, five or six points are probably sufficient with one for the off position. Also it is thought that some sales argument can be had from this arrangement as virtue in the tube is indicated by the freedom from critical adjustment. Careful consideration of this scheme is requested, as it is believed to be the logical and timely step toward the eventual and desirable condition of non-adjustable tubes.

At any rate, manipulation of the rheostat shall not produce noise if continuously variable, or more than single clicks if the switch method is used.

Dials. Where dials are used, flat on a panel surface, they shall be outlined by a raised brass ring, similar to the bezels used to cover edges of holes in panels, or equivalent effect.

Loud Speakers. Loud speakers will be judged separately by expert analytical measurement by the Radio Corporation, and by performance in conjunction with the amplifiers used.

(Continued)

GENERAL SPECIFICATIONS (CONTINUED)

Telephone Jack. A telephone jack for headset operation is to be provided in all sets. It shall be so placed in the circuit that the headset will have comfortable loudness when the loud speaker (with further amplification) has normal full load signals.

Automatic Switching. Consideration shall be given to methods for automatically switching off filaments when cabinets are closed, or devices to prevent closing of cabinets with filaments on. Still more desirable is a prominently visible indicator that the filaments are on, but no means seem available which take sufficiently small power. Radiola XII must have the automatic switching feature.

Mechanical Design. The mechanical form, detail and workmanship of this line must be above criticism. Radio apparatus as a household utility must be as reliable as the phonograph, the telephone, the automobile or the typewriter, and there is no reason why it cannot be. It is therefore expected and will be required that every model show mechanical design of high order.

Patents. Other things being equal, those circuits will be favored which afford patent protection.

Distinguishing Marks. Markings for identifying manufacturers will be decided upon later. They are to be such as not to be understandable to purchasers.

Antenna. For an indoor antenna, 100 feet of white double silk-covered copper wire, No. 28, shall be supplied with each set.

Based on "Specifications for Broadcast Receivers for 1924," RCA Research Dept., Jan. 16, 1923.

(RCA Continued)

the belief that the market was not yet ready for them. Table II lists the general specifications for the five receivers. There is interesting reading here, especially the sections on tubes, rheostats, automatic switching and distinguishing marks.

This article finally presents to the collector the RCA 1923 Christmas line. For each set, the specifications and a concept drawing are included. And, there also is interesting reading, showing RCA's thought processes in several of the specifications for

(Text continues on page 10)

Table III — 1923/24 RADIO PRICE ESTIMATES

Model No.	Cost to RCA	Est. List Price*
Radiola XIII	\$25-\$30	\$75-90
Radiola IX	\$35	\$105
Radiola IX	\$42 with stand	\$125
Radiola X	\$45-\$50	\$135-\$150
Radiola XI	\$70-\$80	\$210-\$240
Radiola XII	\$125-\$140	\$375-\$420

*Three-times RCA cost based on a cost to dealers of 2-times RCA cost and a 50% dealer markup.

Radiola VIII — "Farmer's Delight"

This set is the lowest cost of the line. It is not provided with or intended for loud speaker use, and in general replaces the Radiola II of the present line, although it should have superior performance by virtue of more efficient (for example, reflex) use of tubes.

VIII

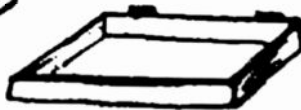

Farmer's Delight.

Cabinet. Similar in material and finish to the Type RS set and Radiola II. It should be possible to close the set when not in use to form a cabinet or box of good appearance. Operating panel is to be horizontal. Battery space to be provided.

Tubes. Two UV-199 tubes. Probably not more than 45 volts plate battery should be used to economize on battery space.

Circuit. To give an output equal or superior to the Radiola II or the Type RS set for both high and low signal field strengths and to work satisfactorily with an external two-stage amplifier for loud speaker operation.

Telephone Jack. Provided.

Wavelength Range (useful). At least 285-540 meters; 200-540 meters is desirable.

Volume Control. As described for the Radiola IX, unless undue complication is brought about.

Cost to Radio Corp. \$25 to \$30 including tubes but excluding batteries and headset.

Based on "Specifications for Broadcast Receivers for 1924," RCA Research Dept., Jan. 16, 1923.

Radiola IX — "Fireside Companion"

This set is the next higher class above the Radiola VIII. It is intended to be somewhat of a novelty set, and a tryout of the idea of greater convenience of operation.

Cabinet. Material and finish same as Radiola VIII. Operating panel is horizontal. The cabinet is to be shallow with batteries the determining factor.

Overall height being about 4 1/2" with the 2" cover removed. Battery compartment is on the right, operating panel on the left with tubes arranged at the back more or less as in the Radiola Sr. Overall dimensions about 18" x 11" x 4 1/2" with cover off.

The idea in this design is to make the set usable in at least two ways: first, resting upon a table; second, set upon a special stand for use beside a chair, bed, etc. It is felt that the exercise of design ingenuity will bring out a form with such possibilities. Both the height and angle of the panel should be adjustable.

The set is to extend over the lap of the operator when seated comfortably in a chair, the battery side of the case forming a book rest. Loud speaker is not included in the cabinet, but is separate.

Tubes. Three UV-199 tubes. Probably not more than 66 volts plate battery should be used to economize on battery space.

Circuit. To give an output equal or superior to the Radiola IV and Radiola Grand for both high and low signal field strengths.

Telephone Jack. Provided for headset or loud speaker.

Wavelength Range (useful). At least 285-540 meters; 200-540 meters is desirable.

Volume Control. Separate means of volume control shall be provided if no other circuit control which operates without affecting quality (such as antenna coupling) is provided. This control shall govern the input to the first tube.

Cost to Radio Corp. Not to exceed \$35 including tubes but excluding batteries, loud speaker and headset.

Loud Speaker. A separate device, connected with the set by flexible cord about 20 feet long, which is supplied with the receiver. Loud speaker as a separate device is to have a cost to Radio Corp. not exceeding \$7.00.

Stand. This shall be as cheap as possible consistent with good appearance. Wood or wrought iron may be used. Cost to Radio Corp. not to exceed \$7.00.

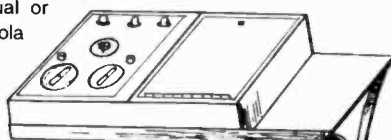
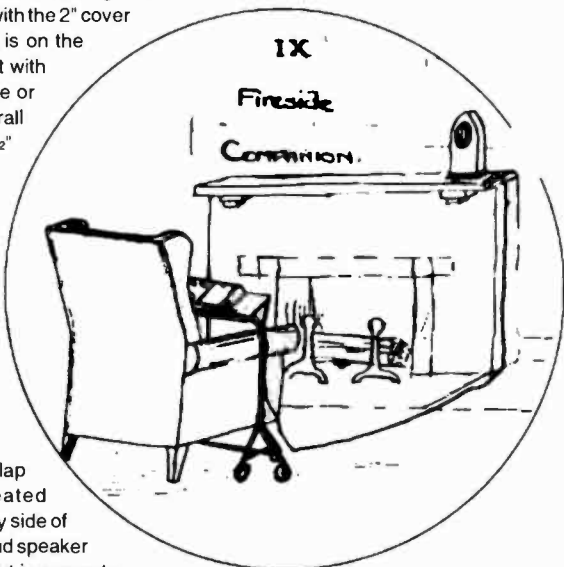

RADIOLA IX
Suggested form.
(Cover removed)

The Fireside Companion.
If possible the height
of stand and angle of table
should be adjustable to
fit any armchair.

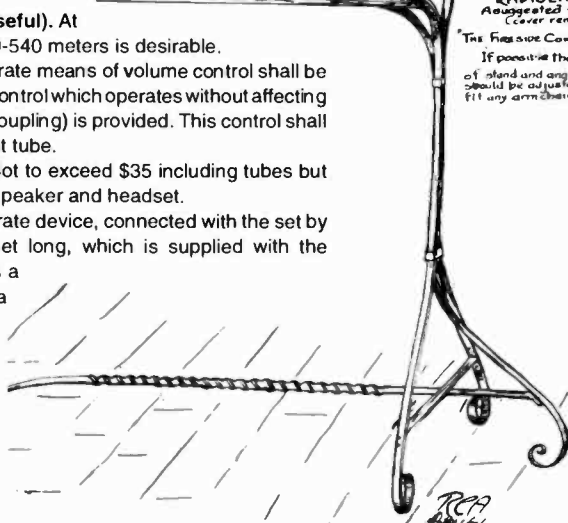

Based on "Specifications for Broadcast Receivers for 1924," RCA Research Dept., Jan. 16, 1923.

Radiola X — "Urban"

This set is to be identical with the Radiola IX in mechanism except tube mounting perhaps, but to be housed in different cabinet, which is to contain batteries and loud speaker.

Cabinet. It is desired to make this set as inexpensive as possible, and the cabinet can therefore probably not be as high quality as Radiola IV, Radiola Grand, etc. The operating panel is to be vertical with the horn grille opening above. Small doors like Radiola IV are preferred to large covers like Radiola Grand.

Tubes. Same as Radiola IX.

Circuit. Same as Radiola IX.

Telephone Jack. Same as Radiola IX.

Wavelength Range. Same as Radiola IX.

Volume Control. Same as Radiola IX.

Cost to Radio Corp. Between \$45 and \$50 including tubes but excluding batteries, and headset.



X
Urban.

Based on "Specifications for Broadcast Receivers for 1924," RCA Research Dept., Jan. 16, 1923.

Radiola XI — "The Jewel"

This receiver is to be intermediate in performance and in cost. It is to correspond in quality with Radiola IV and Radiola Grand except that performance should be somewhat superior to these.

Cabinet. Shall be similar to Radiola IV, except that internal appearance (when cover is lifted) shall be improved (perhaps by a secondary cover), and battery arrangements, especially from the replacement viewpoint, shall be improved. Cabinet houses batteries and loud speaker.

Tubes. Four to six UV-199 tubes.

Circuit. To be such as to give performance superior to Radiola IV and Radiola

Grand in both sensitiveness and quality of reproduction.

Telephone Jack. Provided and shall cut off circuit to loud speaker.

Wavelength Range. Same as Radiola IX.

Volume Control. Same as Radiola IX.

Stand. Although primarily a table set, a separate stand may be optional with the purchaser, and the set should be arranged to mount on a suitable stand when desired. Cost to Radio Corp. not to exceed \$10.00.

Power Output Capacity. Sufficient to suit the larger sort of residence rooms. Balanced tube (push-pull) circuit may be used.

Quality of Reproduction. Superior to all present day sets and to the Radiolas VIII, IX and X.

Antenna Leads. Silk covered leads, about 10 feet long, are to be supplied.

Cost to Radio Corp. Between \$70 and \$80 including tubes but excluding batteries, stand, and headset.

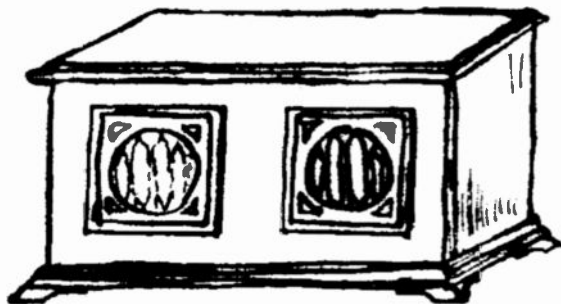

XI The Jewel.

Based on "Specifications for Broadcast Receivers for 1924," RCA Research Dept., Jan. 16, 1923.



An RCA photograph taken July 20, 1923, appearing to be the Radiola XI — The Jewel. The table designed for it is not shown here. (From the Alan Douglas collection of Arthur F. Van Dyck photos.)

(RCA Continued)

the receivers; for example, the cabinet and stand for the Radiola IX, the cabinets for the Radiolas XI and XII, and the wavelength range for the Radiola XII.

ANALYSIS

The sets show great design ingenuity and would most likely be quite desirable today — had they

been manufactured. But, it is quite likely that their desirability today would be enhanced by relative scarcity, since they would probably have been priced too high for their outdated performance and for the radio market in general. Table III shows the estimated list prices for the sets.

Compared to competitive receivers available for the Christmas season of 1923, these Radiolas

Radiola XII — "Superba"

This is the highest class set of the line and is to be "de luxe" in all particulars.

Cabinet. One style shall be the standard product, but the mechanism shall be such that it will be possible to install it without serious change in other cabinets ordered especially. The design of cabinet shall be similar to the model on hand at the Radio Corp. unless a superior one can be found. The floor cabinet is self-supporting and the operating panel is vertical. There is space for a loud speaker horn four feet long.

Tubes. Five to eight UV-199 tubes may be used with battery supply, or five to eight UV-201A tubes with lighting circuit supply.

Circuit. Performance at least equal to or better than the Radiola XI in sensitiveness and to give quality of reproduction superior to the Radiola XI.

Telephone Jack. Provided.

Storage Space. Provided for headset, spare tubes, etc.

Wavelength Range (useful). At least 285-540 meters; 200-1,000 meters is desirable to anticipate future broadcast wavelength developments if it can be obtained without too great complication.

Volume Control. Same as Radiola IX.

Power Output Capacity. To suit the largest sort of residence rooms without overloading tubes or loss of quality.

Automatic Switching. This set shall have a door switch in addition to the regular filament switch, both of which will open the filament circuit when the doors are closed.

Cost to Radio Corp. Between \$125 and \$140 including tubes but excluding batteries, and headset.

Based on "Specifications for Broadcast Receivers for 1924," RCA Research Dept., Jan. 16, 1923.

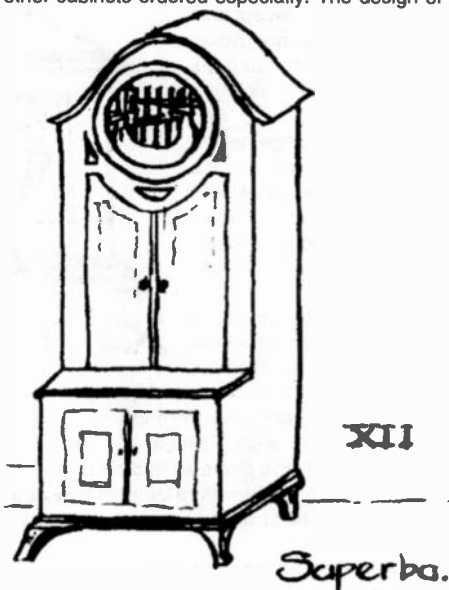

do not appear to offer competitive value. For example, the popular Freed-Eisemann NR-5, a Neutrodyne, had a list price of \$150. It is unlikely that the 3-tube, regenerative Radiola IX, at about the same price, would have come close to the NR-5 in performance.

It is interesting to note that RCA benchmarked performance goals for its new models against its old models; e.g. "Radiola XI to give performance superior to Radiola IV and Radiola Grand." This is a certain way to ensure obsolete design when products are introduced.

RCA did appear to be stretching a bit technically with the top of the line Radiola XII. However, except for the hope of AC operation, there was little substance behind the "hoped for" superiority.

But, if the mainly regenerative circuit designs for Radiolas VIII-XII were not exciting, the proposed cabinet designs were another matter. Here is some truly innovative thinking. With the exception of Radiola XI, which appears to be nothing more

than an improved Radiola IV, some very creative concepts are evident:

Radiola VIII — the beginning of miniaturized components yielding a shallow panel depth later used on Radiola VII, VII-B and IX; Radiola IX — the matching stand, while not practical, was very innovative; Radiola X — this would have been the first cathedral radio, seven years ahead of its time; Radiola XII — a very early attempt to create a console cabinet of unique design whose form is dictated by the requirements of radio (loudspeaker above, batteries below).

Having the benefit of 75 years of hindsight, we find it easy to be critical of RCA's plans for the 1923 Christmas season. Yet, RCA definitely made the correct decision in scrapping the original Radiolas VIII-XII in favor of the now familiar April 1924 line. The Radiola Superheterodyne portable was a smashing success, even at its original list price of \$286. This radio established RCA as a technology leader — a reputation maintained for many years. The expensive Radiola Super VIII became America's first successful console radio, judging from the number of surviving examples.

Radiolas III and III-A offered value-conscious customers a way to move up to the now prestigious RCA brand. Only the Regenoflex and the derivative Radiola X seem to have missed the mark with the consumer.

Although RCA was correct in scrapping the original 1923-1924 sets in favor of the April 1924 line, as a collector, I can't help but wish that the original Radiolas VIII-XII could have made it to production. They certainly would have made interesting and desirable collectibles today.

References:

- Douglas, Alan. *Radio Manufacturers of the 1920's, Vol. 3 — RCA to Zenith*. Vestal, N. Y.: Vestal Press, 1991.
- RCA Research Department. *Specifications for Broadcast Receivers for 1924*. Jan. 16, 1923.
- Wolkonowicz, John. "The Radiola Superheterodyne Story," *Radio Age*, 1977 to 1978.

Author's Acknowledgments:

Thanks to John Terrey for finding and sharing the RCA document upon which this article is based; to both Alan Douglas and Richard G. Wulven for their many years of stimulating discussion, which provided much of the background for this article; and to Alan Douglas for the photos, provided by John Milton Williams, who originally obtained them from the heirs of Arthur F. Van Dyck.

(John Wolkonowicz, 11 Hartford Rd., Worcester, MA 01606; Alan Douglas, P. O. Box 225, Pocasset, MA 02559; John Terrey, c/o A.R.C., P. O. Box 2, Carlisle, MA, 01741; Richard G. Wulven, 2614 Reno Rd., Castleton, NY 12033)

John Wolkonowicz has been interested in early radios and their related literature for over 30 years. His previous writing includes articles on Atwater Kent and RCA, as well as a 100-page analysis of the Philco Corp. Of significance to this article, John's professional life involves product development in the automobile industry.



An RCA photograph (probably taken October 10, 1922) of a cabinet appearing to be for the Radiola XII — Superba. (From the Alan Douglas Collection of Arthur F. Van Dyck photos.)



VINTAGE TELEVISION

Adventures in RCA TV Land

BY RAY BINTLIFF

In this article, Ray Bintliff, longtime A.R.C. staff member and prolific contributor of articles, describes the state of commercial television in 1946. He also relates some personal experiences that inspire a few chuckles, as well as a measure of incredulity — was it really that primitive? (Editor)

It is interesting to note the ease with which each new generation embraces current technology. Just think of all those youngsters clicking away on computer keyboards — they probably cannot imagine a world without computers, never mind without TV. When my grandchildren were very young, they were astonished to learn that their grandparents grew up in a world without TV. They assumed that TV had been around "forever."

Looking back in time, this same attitude may have prevailed with the introduction of the automobile, telegraph, telephone, wireless, radio and a host of other innovations. The early years of radio, for example, must have been an exciting time — an experience that most radio collectors can only imagine. However, I did have the good fortune to be on the scene when commercial television blossomed in the post-World War II period. The early steps were sometimes slow and halting, but with time, television swept the nation just as radio had in the 1920s.

HOW IT WAS

What was it like in early 1946? Well, World War II was over. Industry was busily converting from military to civilian production, and the public was hungry for those consumer products that were not available during wartime. The civilian population had deep pockets and was ready to spend.

In this environment, radio manufacturers were anxious to start selling radios and TV sets. RCA had produced some TV sets before the war — the TRK-series and the TT-5 TV adapters — but TV technology had changed so dramatically during the war years that the old designs were obsolete. In addition, the FCC had changed the frequency allocations for TV stations, as well as the standard for TV audio transmission from AM to FM. So it was back to the drawing boards.

Fortunately for RCA, it had developed a number of military applications for TV, and these circuits could be applied to commercial TV receivers. The initial product of the company's pre-war and wartime experience was the Model 630TS, shown in Figure 1. However, production of this famous set was still months away and there was a need to jump-start TV.



Figure 1. Model 630TS — RCA's first post-World War II TV set. This 30-tube set featured a 10" picture tube, 13-channel tuning, and FM sound. (From an RCA service manual)

Many, if not most, of RCA's prewar TV sets were sold in the metropolitan New York City area. Because of the changes imposed by the FCC, these sets were now useless. But RCA had a plan. It offered to convert these sets to the new frequencies, change the sound to FM, and make any necessary repairs — all for a flat fee. The response was overwhelming.

As a newly minted RCA TV Field Engineer, I was assigned to the TV service facility in New York City in February of 1946. For the next several months I saw TRKs in my sleep. When the Model 630TS sets came on the market, the workload and logistical problems escalated at an incredible rate.

The first RCA Service Company TV branch operation was located at 45-12 Skillman Avenue in the borough of Queens in New York City. This small and unimposing storefront building had previously housed a butcher shop. The office was located in the front, while the space in the rear was utilized for the shop and stock room. This facility soon proved too small, but we endured until other branch operations were established in the city and suburbs.

HANDICAPS AND SOLUTIONS

RCA is generally viewed as having been a monolithic corporate giant capable of destroying all in its path. In reality, the company was not without its foibles. Perhaps the demand for TV was underestimated. Certainly we faced logistical problems of major proportions. Hiring qualified personnel and setting up facilities were challenging tasks.

RCA was not alone in its multiple problems. In 1946, the demand for telephones far exceeded

IN THE SHOP

Ma Bell's abilities to string cables and install telephones. Consequently, our service branch had to get by with only two telephone lines, and a busy signal was the norm. But for some reason known only to AT&T, a teletype line was available. So, a teletype machine was installed for intra-company communications.

Customers were often frustrated by their inability to reach the branch by telephone, and they frequently showed up in person to inquire about the status of a repair or an antenna installation. On Monday mornings, it was hard to tell the new hires from the customers. Usually the customers' faces had deeper frowns.

Something had to be done, but not even the weight of corporate headquarters could squeeze out additional telephone lines. Then someone had an inspiration. The candy store next door had a pay phone in a booth, and a deal was cut with the store owner. The pay phone number was given to our customers, and a clerk was assigned to answer incoming calls with "RCA Service." Today, working in a cubicle is considered confining — how about eight hours in a telephone booth?

During the severe snow storm of 1947 — or was it 1948? — most of the streets of New York were impassable. And the service backlog was immense. So antenna crews were riding the subways to get to their jobs. They got some funny looks from other passengers as they boarded with 10' masts, antennas, and rolls of cable.

The service backlog was dutifully reported to Camden, New Jersey, on a weekly basis, but the backlog had grown so large that the office staff no longer counted it. They estimated the backlog after measuring the stacks of paper with a ruler.

To understand the scope of that early operation, you have to know the geographical area that we serviced. Simply stated, it was just about anywhere Channel 4 (WNBT) could be received: Northern New Jersey, parts of Connecticut, Long Island, and north to about Newburg, NY.

At the time, there were only three TV stations on the air in New York City: CBS on Channel 2, NBC on Channel 4 and DuMont on Channel 5. My recollection is that DuMont's signal pattern was somewhat smaller, and that NBC was the big gun.

Programming was limited so there was a lot of test pattern time. The test pattern transmissions, which allowed the technicians to make final adjustments to the sets being serviced, must have been a real bore to the viewers.

CONVERSIONS

Conversion and repair of the prewar sets, such as the TRK-12 shown in Figure 2, soon got to be a production-line operation with newly hired technicians joining our beleaguered force. Converting the sets to the new channels consisted of changing tuning slugs and pulling turns from one of the oscillator coils. Conversion from AM to FM sound was accomplished by retuning the last sound IF transformer to obtain slope detection.

The extent of repairs varied from set to set. But all of the necessary repairs were performed for the flat rate. I think the conversion program cost RCA a bundle, but it kept commercial TV rolling and made a lot of TV owners happy.

If OSHA had been around in those days, they would have shut down the whole operation. Fumes from melted solder and the acetone solvent in speaker glue were abundant. The AC-powered high voltage power supply used in the pre-war TV sets was potentially lethal. It delivered 7.3 kV. Hazards abounded, but I do not recall any accidents or personal injuries.

Although RCA service literature from that period warned "Always wear gloves and shatter-proof goggles when handling Kinescope (picture) tubes," such protective measures were never made available. (It is unlikely that we would have used them.) The 12-inch picture tubes sat unprotected on the test benches, usually supported by a block of wood. That same block of wood was frequently used as a mallet to locate intermittents. TRKs stacked two- or three-high awaiting the shop technicians' attention created an obstacle course.

The shop's test equipment was hardly high-tech. The sweep generators and oscilloscopes dated from 1938. The RCA Model 159 TV sweep generators use motor-driven variable capacitors. Waveform jitter was a common problem in those mechanically-swept instruments. Electronic sweep generators for TV frequencies were still several years away. The oscilloscopes' upper frequency response was about 500 kHz, a far cry from the wide-band scopes of today. On the plus side, VTVMs were standard shop equipment.

IN THE FIELD

Antennas and related installation material were of simple design and reflected late 1930s technology. One exception was the use of RCA's newly developed 300-ohm transmission line. This flat "twin-lead" cable soon became the industry standard. Until it became available, insulated, twisted-pair cable had been used in TV and FM antenna installations. Twisted-pair did not weather well and became lossy or open.

Some fussy customers complained that the twin lead was not properly installed because it had a few twists in it. Of course, it was very difficult to make long outdoor runs of the flat cable without getting some twists. Furthermore, the twists did no harm. Indoor runs could be made flat since they were usually secured to woodwork with fiber-headed tacks.

Some antenna installation crew came up with a bright idea. They purposely put more twists in the outdoor runs. Adding twists was an easier task than trying to remove all twists. In theory, transposing parallel conductors reduces the pick up of unwanted signals and noise. Who knows — it may have worked. In any event, another problem was solved.

The typical antenna installation, shown in Figure 3, consisted of a simple dipole and reflector element mounted on a 10' mast connected to the TV with the ribbon cable that RCA had chosen to call "Brite-Pix." The 2-element antenna was basic. The boom was made of varnished wood. The ends of the elements were threaded and fastened in place by nuts and washers.

Assembling the antennas was a time-consuming
(Continued on following page)

(RCA in TV Land, continued)

ing and challenging task, especially with cold fingers. Later, these antennas were replaced by the fold-out type that simplified assembly and saved time. Chimney mounts that simplified antenna installations were also a later development. But during those early years, the tools and materials available made antenna work slow and frustrating.

ENTER THE MODEL 630TS

Just as the backlog of conversions was being trimmed back, the 630TS hit the market. You may know how the model number was created, but I will repeat it here. The "6" indicates 1946, the "30" is the tube count and, naturally, "TS" stands for television set.

RCA was concerned that poor installation or service could affect the performance and reputation of the 630TS and subsequent models. RCA decreed that an installation and service contract had to be purchased with each new set. This action gave the RCA Service Company a monopoly on the installation and service of all RCA sets sold.

This policy was not popular with those RCA dealers that maintained their own service departments. But the company continued this position until about 1950. (I am uncertain of the exact date.) In retrospect, this policy was a good one. Even with the substantial resources and technical talent within RCA, it had a difficult time keeping up with demand. And many dealers lacked the facilities and technical know-how until several years after the introduction of the 630TS.

RCA had another worry. With its technical "leg up," the company was sure to beat most of the other manufacturers to market. Would the federal government take a dim view of RCA's dominance and intervene? RCA solved the problem by manufacturing and branding 630TS sets for other manufacturers.

It is probably not generally known, but the set was also available as a kit from some independent marketers. The critical parts, including a bare chassis, were of RCA manufacture. The resistors and paper capacitors were typical replacement parts available on the general market. The kit did not include a cabinet or picture tube. I built one of the kits and kept it in operation for about 10 years.

THE MODEL 630TS PERFORMANCE

The Model 630TS ran rings around the old TRKs because of its many technical improvements. While the old sets lacked an RF stage, the 630TS uses a



Figure 2. The prewar Model TRK-12 introduced by RCA at the New York World's Fair in 1939. (From an RCA service manual)

shielded tuner with three Type 6J6 miniature tubes as an RF amplifier, an oscillator and a mixer. The RF stage provides improved sensitivity and reduced local oscillator radiation — a problem in the TRKs. The high voltage power supply in the potentially lethal TRK-series was replaced by a safer supply using a fly-back transformer. The fly-back also became standard in the industry. The new set received all of the then-authorized FCC channels 1 through 13, a big jump on the 5-channel capability of the TRKs.

But there were problems. The 630TS uses a number of 1/2-watt resistors and paper bypass capacitors to decouple the IF stages. These capacitors began to fail after short term use. Depending on the location of the capacitor in the resistor string, one or more of the 1/2-watt resistors would go up in smoke when the capacitor shorted. Plumes of smoke and the odor of burning resistors did not make for happy customers.

Whenever a 630TS came into the shop all of the suspect capacitors were replaced. I'm not certain, but I'm inclined to believe that some well intentioned manufacturing parts buyer in Cam-

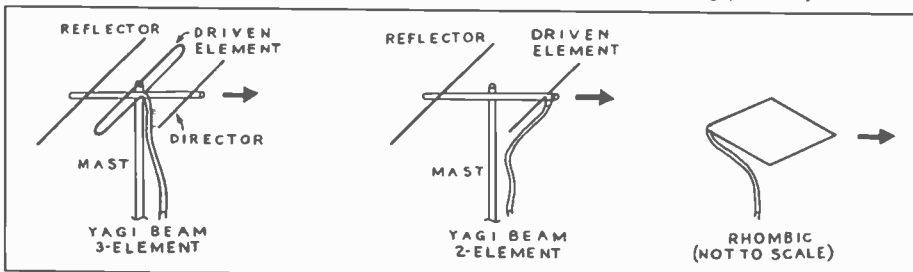

Figure 3. The 2- and 3-element yagis used for television reception. Also shown is an example of a rhombic wire antenna. Rhombics are large in size with wire elements several wavelengths long.



Figure 4. The Times Tower, located near Hartford, Connecticut, was the site of an early TV demonstration in that area. (From Colton: "The Story of the Times Tower.")

den went looking for a low bidder. He chose an obscure supplier for the capacitors. I recall that the manufacturer's name was O'Donnell. A quick switch to another manufacturer solved the problem in future production, but it took a while to purge the bad capacitors from the earlier sets.

(Speaking of lousy capacitors, in some future article I will describe how General Sarnoff shut down RCA's capacitor manufacturing operation.)

Another serious problem resulted from a bad run of tubes at the Harrison, New Jersey, tube plant. The set's vertical oscillator uses a Type 6J5 tube that is operated with the cathode running at about -100 volts. The defective tubes developed a filament to cathode short that resulted in the loss of the -100-volt supply and the complete loss of any display on the picture tube.

The field technicians were overwhelming the shop techs with chassis pulls diagnosed as "No Pix." It took awhile to get the bad Type 6J5s out of circulation and to convince the field techs to try a new 6J5 before pulling the chassis.

The only other failure of epidemic proportions that I can recall was the channel selector shaft. These shafts were made of cloth-reinforced phenolic, and they tended to break at the point where a drive pin secured the phenolic shaft to a metal shaft and detent assembly. The problem was solved by a redesign of the shaft assembly.

All in all, the 630TS was a nice piece of engineering.

PROMOTING TV

If the engineers were working hard, the "marketeers" weren't slackers either. RCA's interest in TV extended beyond TV sets. The company pro-

duced a wide range of associated products such as transmitters, antennas, studio equipment, picture tubes and replacement parts. So, RCA was eager to spread the gospel.

To help spread the word, either prewar or postwar TVs were placed in the homes of RCA and NBC executives as well as of some influential persons. As you can imagine, these individuals received preferential treatment. I began servicing many of these accounts after I had climbed out from under the avalanche of TRKs.

Covering these executive accounts provided me with some interesting personal contacts. As a radio collector, it is a special pleasure for me to recall meeting John Rider. Other contacts of note include Arturo Toscanini, Herbert Hoover, the Mayor of New York, some TV critics, and a host of RCA and NBC executives.

But one assignment was clearly a plum. In September 1946, I became responsible for maintaining the electronics in General Sarnoff's home and office. But that is another story for some future article.

While RCA was promoting TV, there were some eager prospects just salivating for the arrival of TV. A case in point was WTHT, an AM radio station, in Hartford, Connecticut, owned by the *Hartford Times* newspaper. About 100 air miles from New York, Hartford was well beyond the normal range of the New York television signal.

The Hartford station engineers were eager, but unsuccessful, in their attempts, to obtain satisfactory pictures from New York, even after installing an elaborate antenna — a rhombic. See Figure 3. Were these guys crazy? It might seem so, because they were trying to receive TV signals at such a great distance on a prewar TRK-12. Keep in mind that the TRK-12 was not renowned for its great sensitivity, and TV boosters were still a few years away.

Actually, the station engineers were clever fellows. They had a distinct advantage — their receiving location was superb. It was located in a 165-foot tower sitting on Talcott mountain outside of Hartford. But this was no ordinary radio tower. Built by G. F. Heublein as a residential retreat cum tower, it provided fantastic views and equally good radio reception.

The Story of the Times Tower, describes the view as follows: "The view from the tower includes a glimpse of Long Island on the south, the tip of Monadnock in New Hampshire, a great arc of the hills of Western Massachusetts, and of course the lovely Connecticut hills that rise on the west to the Berkshires, and those that lift their ridges east of the Connecticut River to the edge of Rhode Island." A photograph of the tower is shown in Figure 4.

The home office in Camden, New Jersey, served up another special assignment — go to Hartford and improve reception. Earl Hilburn from Camden was the lead engineer and he brought a secret weapon with him — a 3-element yagi antenna tuned to WNBT's Channel 4. A much better performer than the standard 2-element, it consisted of a reflector, driven element and director, as shown in Figure 3. The driven element was a

(Continued on following page)

(RCA In TV Land, continued)

folded dipole that more closely matched the transmission line and the TRK's antenna input.

I will spare you the details, but we installed the new antenna and it delivered a satisfactory signal.

SHOW TIME

Eager to demonstrate TV, the *Times* invited guests to view the Louis-Conn fight scheduled for June 19, 1946. Guests included executives of the *Times*, numerous state and city officials, superior court judges and station personnel. Obviously, there was a lot riding on the success of this demonstration.

Did I worry? You bet. We only had one TV set — what if it quit? Maybe a power failure would occur or even lightning might strike. Fortunately, the demo was a success and the quality of reception was acceptable. Had we demonstrated a high level of skill or were we just lucky? In retrospect, we had a lot of good luck. The antenna site was outstanding and signal propagation was good.

I got on the Web recently and located solar flux data for the month of June 1946 — sunspot activity had peaked just about the time of the demonstration. For readers unfamiliar with the relationship between sunspot activity and radio reception, a brief explanation may be in order. The subject is very complex, but simply stated, radio propagation at TV frequencies is usually better during periods

of high sunspot activity. Yes, we were lucky and we may have even established a DX record at the time for the reception of TV signals.

CONCLUSION

I hope that this article has given you some idea of the tenor of the times. The executives at RCA were determined to make TV a commercial success. The "grunts" in the factories and in the field made it happen without fully realizing the magnitude of their contributions. Although this article deals with TV in the New York City area, similar activities were occurring in other major cities such as Philadelphia, Pa., Schenectady, N. Y., and Washington, D.C.

The state-of-the-art as it existed in the late 1940s may seem pale by comparison to today's technology, but it was an exciting period.

Reference:

Coulton, John W. *The Story of the Times Tower*.
Hartford, Conn.: *The Hartford Times*.

(Ray Bintliff, 2 Powder Horn Lane, Acton, MA 01720)

Ray Bintliff holds an Amateur Extra Class license. A retired engineer, he enjoys repairing and restoring pre-1945 radios and test equipment. In addition to Amateur Radio, his interests include electronic equipment design and audio reproduction.

The RCA Radiola Super-VIII Receiver

CONTRIBUTED BY MIKE BRAZIL



Our cover shows the RCA Radiola Super-VIII, the top of the early 1924 receiver line, which replaced the abandoned 1923-1924 line described in this issue. The Radiola Super-VIII above was purchased at a garage sale for Mike Brazil of California by a friend in Greencastle, Pennsylvania, as he was on his way to his daughter's soccer game. Picking up the radio the next day, the friend found the shipping crate on the curb for rubbish pickup. Nice coincidence, don't you think? Also, great friend!



THE WIRELESS YEARS

Marconi Magnetic Detector

BY HOWARD STONE

This article places Howard Stone among the lucky ones who have found the radio items he wanted "most in the world." Here he shares with us the interesting process of restoring his rare Marconi magnetic detector, as well as information about its history and the theory of its operation. (Editor)

Most seasoned radio collectors spend hours helping antique dealers and others learn about radios. It is in our own interest to have more eyes looking for radio gear. We show them how to determine the age of radios and early wireless apparatus. Is it AC or battery? What type of battery is used? How many prongs do the tubes have? How many tubes? What is the shape of the cabinet? And so forth.

As a teacher at Texas Christian University, every seventh year I am on research leave — the last two times in Cambridge, England. In England, my wife and I have many friends, among them an antiques dealer who finds items of early

technology from time to time. On my last research leave (1992-93), he and I were poring over an early book on electrical and wireless technology while we waited for tea. I would point at a picture and say, "If you ever see this, please buy it for me."

When we came upon a picture of the Marconi magnetic detector and multiple tuner, I remember saying, "I want those two pieces more than any other radio items in the world." I told my friend more about them, and we moved on to other pictures. Tea came, and we put the book aside.

Nine months later, back in Fort Worth, Texas, I received a phone call from England. My friend had found a magnetic detector. Did I want it? My answer, obviously, was yes. When the magnetic detector arrived, it was a little scruffy, but all original. Figures 1 and 2 show my prize and its condition. The cover was missing, but that is true of many magnetic detectors. I was pleased to see that it had not been modified. It had a little woodworm damage on the bottom and a sliver of molding had been ripped off, but it was in better shape than I had expected.

With a piece of this value, both historical and financial, I was in no hurry to begin restoration. The first few weeks I just examined it, did some research, and slowly began to remove 80 or so years of dirt. After cleaning it, I sent the case to John Kegley for help in its restoration. John also made a cover for it.

The clock mechanism was hardly functioning and very dirty. A magnetic detector is wound up like a clock. I cleaned and oiled it, and it now works very well. The winding key is old, though not original, and came with the detector. It has a first rate mechanism; nothing was spared in quality. The wire loop tension adjustment, shown underneath the right pulley wheel in Figure 2, was frozen in position. After two weeks soaking in WD-40, it broke loose.

I reversed the side of the magnets that were facing out, and with some cleaning they looked good. Two wire connections had broken at the lug and had to be soldered. Fortunately, the coils had continuity and did not need

(Continued on following page)

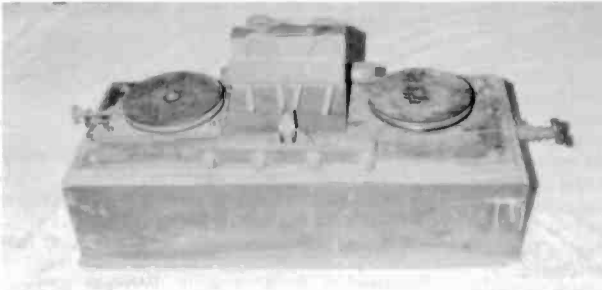

Figure 1. The Marconi magnetic detector as it appeared when Howard Stone received it from his antique dealer friend in England.

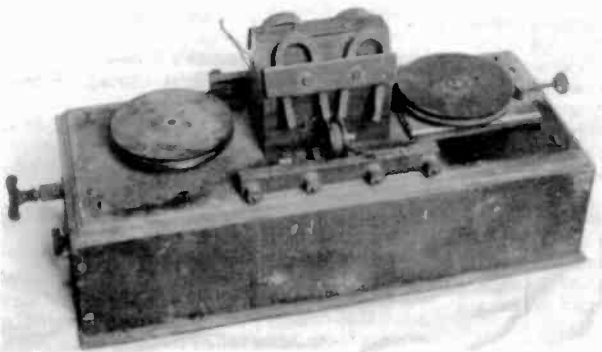

Figure 2. A view from the other side of the Marconi magnetic detector before Howard Stone began his restoration.

(*Marconi Magnetic Detector, continued*) rewinding. I replaced the iron wire loop that circles the two spools and goes through the small glass tubes; a short piece of the original wire was still with the detector and helped me in my search for a new piece of iron wire. The restoration was complete and the results can be seen in Figures 3 and 4.

MAGNETIC DETECTOR BACKGROUND

In 1895, Ernest Rutherford, a scientist in England, was able to detect signals transmitted a mile away, using a magnetometer, a device used for measuring the strength of magnetic fields. Rutherford's research was based on the prior work of Lord Rayleigh and other scientists studying oscillatory currents.

Rutherford attached an antenna to the magnetometer; the received signal deflected the needle of the magnetometer, and thus, an early "magnetic detector" had been discovered. Marconi further developed the work of Rutherford, and in 1902 he developed his magnetic detector. See the accompanying "Magnetic Detector Operation" for more information.

The first "Maggie" (the nickname widely used for the magnetic detector) was installed in the Italian Navy's warship the *Carlo Alberto* in 1903. Magnetic detectors were very reliable for ship-board communication and were the primary detectors installed on European vessels from 1903 to 1912, replacing coherer type detectors. In fact, because of their reliability, magnetic detectors were used as back-up detectors on many ships into World War I to supplement crystal and later valve detectors. Although wireless technology was developing at a very fast pace at this time in history, because of its dependability, the Maggie had a remarkably long period of usefulness.

Most of the magnetic detectors manufactured were made by Marconi Wireless in England. The ones built in the United States were produced in Aldene, New Jersey. Since the Aldene plant did not begin operations until 1912 when magnetic detectors were on their way out — being supplanted by valves and crystal detectors — not many were produced. Today, not more than a half a dozen American versions are known still to exist.

The magnetic detector was very important in the history of radio and most certainly was originally commissioned to a ship. Its reliability, a key to its longevity, and its use on ships at sea no doubt saved many lives.

The magnetic detector described in this article is serial number 31462. It is the pride of my collection. My fondest hope is to acquire a multiple tuner, which was used along with the magnetic detector, in order to complete a typical shipboard receiving set during the very early days of wireless.

Acknowledgment:

The author thanks Mel Bredehoeft, Jonathan Hill, Jim and Felicia Kreuzer, and John Terrey for

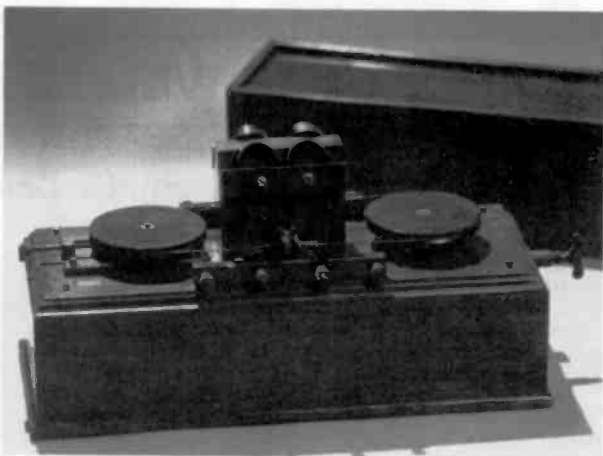

Figure 3. The fully restored Marconi magnetic detector complete with reproduction lid.



Figure 4. The name plate on the horseshoe assembly reads: "Marconi's Wireless Telegraph Co. Ltd. No. 31482 London"

assistance in the research, and Andy Anderson for the photographs in this article.

References:

- Baker, W. J. *History of the Marconi Company*. New York: St. Martin's Press, 1971.
- Blaine, Robert G. *Aetheric or Wireless Telegraphy*. London: Biggs & Sons, 1903.
- Blake, G.G. *History of Radio Telegraphy and Telephony*. London: Chapman & Hall, Ltd., 1928.
- Hammerton, A. *Harmsworth Wireless Encyclopedia*, Vol. 2. London: Fleetwood House, N. D.
- Hill, Jonathan. *Radio! Radio!* London: Sunrise Press, 1986.
- Kreuzer, James and Felicia. "Marconi — The Man and His Apparatus," *The AWA Review*, Vol. 9, 1995.
- Laughter, Victor H. *Operator's Wireless Telegraph and Telephone Hand-Book*. Chicago: Frederick J. Drake & Co., 1909.
- Rolfe-Martlin, A.B. *Wireless Telegraphy*. London: Adam and Charles Black, 1914.
- White, William J., *Wireless Telegraphy and Telephony*. London: Whittaker & Co., 1912.

(Howard Stone, 2825 6th Ave., Fort Worth, TX 76110)

Howard Stone is a professor of Pastoral Counseling at Texas Christian University, Fort Worth, Texas. A longtime collector, he is especially interested in wireless 1- and 2-tube battery sets of the early 1920s, as well as crystal sets. He has contributed several articles to A.R.C., including a series on British crystal sets and an article on round Ekcos.

MAGNETIC DETECTOR OPERATION

BY JOHN TERREY, HOWARD STONE AND RAY BINTLIFF

As shown below, a typical magnetic detector consists of an endless band of iron wires that is mounted on two grooved wooden pulleys, a clock-work mechanism, a pair of horseshoe magnets, two coils — an inner and outer one — and a telephone receiver.

A clock mechanism turns one of the wheels and moves the wire band at a slow steady pace. The wire band is composed of a flexible bundle of fine, soft iron wires that are individually insulated. The two coils are wound on concentric glass tubes through which the band of iron wires passes. The antenna and ground are attached to the inner coil. The outer coil is connected to the telephone receiver.

As the loop of soft iron wire passes through the magnetic field formed by the horseshoe magnets, it is magnetized. When a radio signal — a dot or dash — is picked up by the antenna, a pulsed current passes through the inner coil which reduces or demagnetizes the wire loop in the immediate vicinity of the coil. As this magnetic discontinuity in the wire band passes through the coil, it causes a slight current pulse to flow in the outer coil resulting in a sound that is audible as a click in the telephone receiver.

The magnetic detector is based on earlier work, ca. 1897, by E. Rutherford. He discovered that the magnetic properties of a magnetized needle were altered when exposed to a solenoid energized by an alternating current. The magnetic detector uses its band of iron wires as the magnetic medium, and horseshoe magnets are used to magnetize the band of wires. One coil of the magnetic detector functions like the solenoid in Rutherford's experiment, and the received radio signal is the alternating current which alters the magnetic state of the band of iron wires.

Literature from the period offers a number of explanations of the theory of operation for the magnetic detector. In his 1914 publication *Wireless Telegraphy*, A. B. Rolfe-Martin makes the candid statement, "Then, in some way not as yet satisfactorily explained the retentivity of the band of wires" is annulled, and its demagnetization and reverse magnetism follow at once."

Victor H. Laughter states in his 1909 edition of the *Operator's Wireless Telegraph and Telephone Hand-Book*, "The most commonly accepted theory of the working of the Magnetic Detector is that the magnetizing of the core lags behind the magnetic effects of the permanent magnet, and any changes in the field, such as would be produced by the incoming wave, would produce a second increased change in the secondary, resulting in the indication in the telephone receiver."

A somewhat different explanation is offered in

the *History of Radio Telegraphy and Telephony* by G. G. Blake published in 1928. Blake's explanation is, "In the absence of oscillations through the primary, the lines of magnetic force are, so to speak, pulled out of position by the moving band of iron, which by its steady progression, is being taken away from the poles before it has had time to become fully magnetized. If now the iron band is given a sharp blow, or if oscillations pass suddenly through the primary, the iron suddenly becomes fully magnetized and the lines of force move back into the position they would occupy were the band stationary. This sudden movement of the lines of force creates a momentary current in the secondary coil which causes a sound to be heard in the telephone."

A more contemporary source, *History of the Marconi Company* by W. J. Baker (1972) offers an explanation similar to that described by Blake, but goes on to say, "When an oscillation occurs in the primary winding, the hysteresis of the iron is annulled, the iron becomes fully magnetized, and the lines of force slip back to a point exactly opposite to the pole-pieces. As a consequence of this movement, a current is induced in the secondary winding and this creates a sound in the headphones."

Other early books offer such explanations as "The oscillatory current alters the number of lines of magnetic force in the iron and through the bobbin, causing a current and a click in the telephone" and "The requisite coercive force to annul the residual magnetism is supplied by the incoming waves, which set up oscillations in the primary circuit.... The magnetic field thus suddenly decays and builds up again, and in so doing causes the lines of force to cut the secondary winding, inducing an electro-motive force giving rise to a current which passes through the telephones...."

Robert G. Blaine in his *Aetheric or Wireless Telegraphy*, states the operation simply as, "The electrical oscillations from the aerial through the coil have the effect of demagnetizing the band... and the disturbance... of the magnetism in a portion of the band causes a sound to be heard in the telephone...."

While there is some disagreement on the exact theory of operation, it appears to your editor that the operation is similar to that of a wire audio recorder where an AC signal — which in the case of the magnetic detector is the radio signal — is used to erase the sound recorded on the wire — which in the case of the magnetic detector is the magnetism induced on the wire by the permanent magnets. Since the wire is moving, the sudden change in magnetism causes a current change in the telephone receiver circuit which is heard as a click.

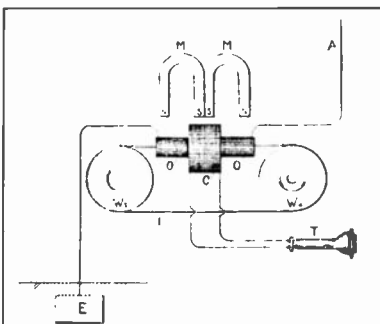

A simplified drawing of a magnetic detector. The pulleys W1 and W2 rotate the wire band I through the two coils O-O and C. The antenna A and earth E are attached to the coil O-O. The telephone receiver is attached to the coil C.

The Marconi magnetic detector has two sets of magnets and coils, which are connected in series to double the output signal.

(From White's "Wireless Telegraphy and Telephony.")



PHOTO REVIEW



This column presents in pictorial form many of the more unusual radios, speakers, tubes, advertising, and other old radio-related items from our readers' collections. The photos are meant to help increase awareness of what's available in the radio collecting hobby. Send in any size photos from your collection. Photos must be sharp in detail, contain a single item, and preferably have a light-colored background. A short, descriptive paragraph **MUST** be included with each photo. Please note that receipt of photos is not acknowledged, publishing is not guaranteed, and photos are not returned.



EMERSON MODEL 804A – This unusual desk set, in an Ingraham cabinet, probably dates from 1955. It measures 9½" w x 7" h x 7¼" d and features two pen holders, as well as a short shelf along the bottom front (for pencils?). The speaker is on the left side behind one of the two matching, graceful cutouts. The chassis is a Type AA5 with an appliance timer outlet in the back. The tuning indicator is a spot of light that travels behind the reverse-painted dial. Finding the right knob to replace the missing one from the center of the Telechron clock face took a long time, since apparently few clock/radios used this particular movement. (Chris Kocsis – Springfield, VA)



AMPLICORP TAPE RECORDER – This 1950s reel-to-reel tape recorder utilizes a spring-wound drive motor. It must be cranked up every 1½ minutes to maintain 3¾ IPS (inches-per-second) speed. Note the small hand crank on the left 5-inch reel for fast forward and rewind. Four 1½-volt miniature tubes supply amplification and frequency bias. Headphones are required for listening. The manufacturer was the Amplifier Corp. of America, New York. (Howard Goll – Glenview, IL)

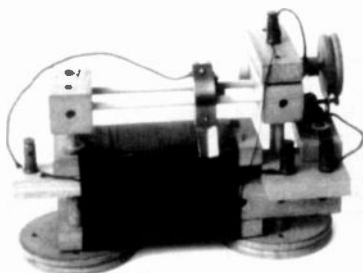

MATADOR CRYSTAL SET KITS – The founder of Matador Ing., Johann Korbuly of Vienna, was famous for his wooden radio kits for children. In 1924, he designed four different crystal set kits. After I had found his original plans, I constructed two sets with old wooden parts, and they work! (Erwin Macho – Vienna, Austria)

PHOTO REVIEW



STEWART-WARNER MODEL 91-513 – This table radio, ca. 1938, has a wooden triangular case with cutouts on all 4 sides. The end view resembles a spade in a deck of cards. It features a slide-rule dial, 4 pushbuttons, and a 5-tube chassis. It is in original mint condition and plays well. Has anyone else seen one like it? (Mr. & Mrs. L. M. Page – Mullins, SC)



AMERICAN BOSCH 205A – This 5-tube model is in a solid wood case typical of most 1934 radios. The simple string inlay was a trademark of American Bosch. (Wally Worth – Wollaston, MA)



EVEREADY MODEL 42 – This 8-tube AC console, produced in 1929, has the same cabinet and chassis as the Model 32, except for the use of Type 45 output tubes. The cabinet has very decorative Repwood in the center section. The set originally sold for \$180. (William Bourke – Swampscott, MA)



R.D.A. MODEL 1628 – This radio was ordered on Feb. 27, 1939. It has a fireplace mantle of asymmetric design with a large expanse of cobalt blue mirror across the top and down the right side. The piece is unusual in that fitted into the fireplace baffle are 13 glass rods, illuminated from behind by 2 red lights, giving it a very warm appearance in a darkened room. In keeping with the Art Deco Moderne design, I have placed a Sparton Model 557 radio on the mantle. R.D.A. apparently bought its electronics elsewhere, as this unit originally had a LeWinter radio included, but missing, so I have installed a period Zenith receiver in its place. Any information on this item or its designer would be appreciated. (Chris Kent – Sarasota, FL)

PHOTO REVIEW

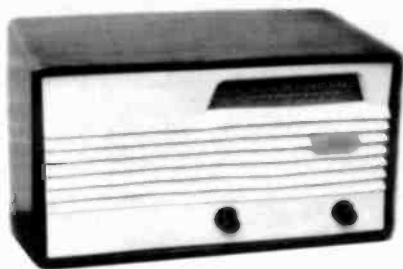

FREEDOM MODEL 571 – This 5-tube radio has a wooden cabinet with a removable plastic front. I presume it was manufactured around the World War II era. It features permeability tuning and the following loctal tubes: 14Q7, 14A7, 14B6, 50A5 and 35Y4. It will operate on 115 volts AC or DC. The dial tunes from right to left. It is quite similar to the Cherokee 571-X50-2A found on page 49 of *Bunis' 4th Edition*. Does anyone have a schematic or dial stringing instructions for this set? (*Bill Horn – Bealeton, VA*)



SIEMENS & HALSKE CRYSTAL SET – Little information is known about this unusual, metal-cased crystal receiver on a wooden board. It operates with an internal double-sliding tuner. (*Erwin Macho – Vienna, Austria*)



T.M.C. CONSOLE RECEIVER – This set is a 5-tube (valve) receiver in a console cabinet with lift top and built-in horn speaker. It was manufactured by the Telephone Manufacturing Co. in 1923. (*Jim Taylor – Bournemouth, England*)



ADVERTISING RADIO – This is a Philco Model 37-620 tombstone radio that has had its original front panel removed and replaced with the "Mail Pouch" advertising panel. The grille cloth is heavy material, and the rest of the cabinet appears to be a professional modification performed by a job shop or advertising agency, probably in 1937 or 1938. I've never seen another like it and I would be curious to know if any others exist. (*Robert W. Schmitz – Sykesville, MD*)

ANTIQUE RADIO CLASSIFIED

Antique Radio Classified — The First 15 Years

BY DOROTHY SCHECTER

Though 15 years is a short time in radio history, a 15th anniversary seems an appropriate time to look at a magazine's history. In fact, 15 years is a venerable age for a specialized publication like A.R.C., and we take justifiable pride in our growth in size and quality over the years.

Many of you longterm subscribers may do what we do on such an occasion — look back at early issues and realize how far A.R.C. has come since its 1984 beginnings. At that time, Gary Schneider, A.R.C.'s founder, had developed a mailing list from his own buying and selling activities and collector contacts. In June 1984, he sent out 1,000 16-page sample copies as a trial balloon to prospective subscribers, and little did he realize how rapidly his daring enterprise would take off.

The premier issue in September 1984 went to 440 subscribers. By August 1986, shortly before John Terrey took over the then 28-page publication, the number had grown to 1,800. A check of the fifth anniversary issue statistics shows that 4,500 subscribers were then in the fold, and in recent years, we have boasted of over 8,000.

What has accounted for this growth? Three factors come to mind: 1) More widespread advertising of A.R.C. in over a dozen collector publications; 2) Free samples to interested collectors and even to some who own only one radio, which, as a result, often ends up in the hands of a serious collector. Since 1986, we have sent out over 60,000 free samples; 3) A.R.C. booths at radio meets and ham gatherings from coast-to-coast — from the big states like California and Texas to the smallest, Rhode Island. We have even set up at the meet in Birmingham, England. As our subscriber list, ads and articles indicate, A.R.C. is known internationally.

In addition, we have tuned in to the "Information Age" and for three years have had a well designed Web site on the Internet — another way to widen the communication among collectors. In fact, one-third of our new subscribers each month can be attributed to the Internet. However, putting the classified ads on the Net has been a controversial issue, as many of you have come to realize through the pro and con

letters in *Radio Miscellanea*. Perhaps we have been overly cautious about taking this final step, in deference to those not yet computer-oriented.

But, the reality is that unless we find our niche in this new electronic world, we will not be able to continue to do what we do best — serve as *the* link between radio collectors. As we move toward the millennium, we hope to bring about a collaboration between those who want to use modern technology in their radio search and those who prefer the hard copy. We also want to continue to provide information not available anywhere else to the widest number of collectors.

THE HUMAN SIDE OF A.R.C. HISTORY

Growth and meeting the technical challenges of the modern world are not the only topics of a historical perspective. What is really interesting and meaningful is the human side of the story. Who and what twists of fate have made A.R.C. what is today?

Gary Schneider's idea that there was a need for a way to connect "collectors of old radios and related items for purposes of buying and selling" points directly to today's Internet exchanges for the same purposes. In those early days, collectors had few options. They searched out antique shops or other collectors, or perhaps found ads in a club publication. Then came A.R.C. — the first national marketplace for collectors.

By 1986, A.R.C. had grown so that Gary realized he could not give it the necessary full time, and he began to return renewal subscription money. Luckily, that process was stopped by a chance meeting with John Terrey at the 1986 Radiofest in Elgin, Illinois. A deal was finalized late one evening at the bar. Encouraged by many people at the meet, John announced at the banquet that he had agreed to purchase A.R.C.

Now why would a seemingly sane electrical engineer, who had worked for over 20 years for an aerospace company, make such a choice? Well, first the radiobug had bitten with a vengeance long ago in his teenage years. The disease has proved incur-

(Continued on following page)



Gary Schneider mailed 1,000, 16-page sample issues in June 1984. The cover says "Watch us grow," and that we have!

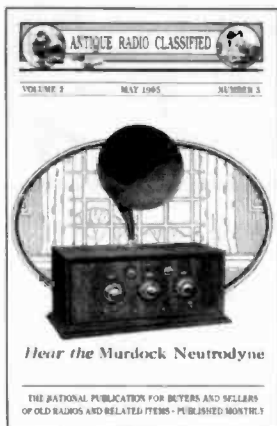

The May 1985 issue, with a 2-color cover, had grown to 24-pages. This cover was used for advertising A.R.C. for years.

(A.R.C., continued)

able. In addition, John had been considering a more technical publication and even had drafts of articles ready. His interest in early technological history had evolved into a plan for an antiquarian technical book business. But, the lure of a publication already established with a potential for growth was too compelling.

EARLY PRODUCTION

The purchase was the easy part. Then came the nuts and bolts of producing a monthly magazine out of the editor's house in the woods of rural Carlisle. The early staff was made up of townfolk who had "mother's hours." The first were Mary Annvedder and Betsy Dumka, both "stolen" from that well-known local newspaper, the *Carlisle Mosquito*. Others like Shirley Sauer and later, Jean Meldonian followed. Many of you will remember Chris Frederickson, our Radio Events Editor, who stayed for ten years before moving to California. Laura Katz, who has also



The 28-page October 1986 issue was the first issue published by John Terrey. Subscribers numbered 1,800.



The first full-color cover of June 1987 showed the Marconi Multiple Tuner restored by Art Albion for the Kreuzer collection.

moved on, took up Chris' tasks, among others.

John's next-door neighbor, Bobby Lyman, is still with us, and is a reminder of the days when Hurricane Bob struck in August 1991. A.R.C.'s "office" in the woods was one of the last to have power restored, and we were forced to transfer the operation, computers and all, to Bobby's basement. Other storms and dilemmas have stranded us at home or work, but we haven't missed a date with the printer yet.

A vivid memory of that early time is "Aerobic Day" when the entire press-run of magazines, weighing about 1/2 ton, was carried up a flight of stairs to John's kitchen. There the mailing process took place. How different from today when our Macintosh-produced pages go to a major printer of small circulation magazines where A.R.C. is printed, labeled, sacked, and mailed.

THE STAFF AND WRITERS

Within a few years, full-time help was required.

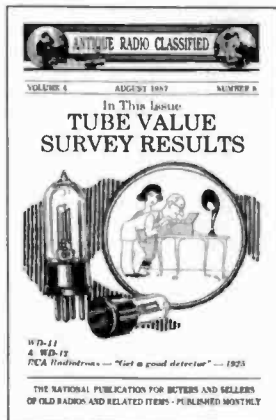

The August 1987 issue presented the results of the tube survey, one of several surveys conducted by A.R.C.

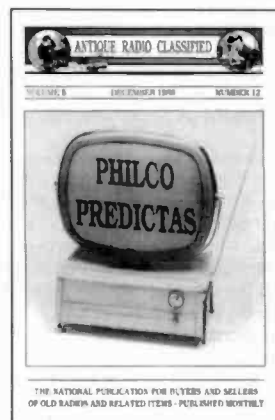

Television has not been neglected as indicated by this December 1988 cover showing a Philco Predicta TV.



Perhaps our most memorable cover is Bill Bell's "Ace Radio Repair," printed in full-color in June 1989.

Scott Young was hired and stayed for ten years as Production Manager. Lisa Friedrichs signed on as Office Manager and stayed for seven years. Now Cindie Bryan, Production and Advertising Manager, and Tammy DeGray, Office Manager, have taken their places.

Still others work on a regular part-time basis. Bobby Lyman holds up certain aspects of the business end of things. A managing editor (yours truly) is needed to keep the editor in line (or is it to correct his grammar?). Technical consultants and writers like Ray Bintliff and Dick Desjarlais have been indispensable. That role too is filled by collector Dave Crocker, who is also our layout artist. Dave's dedication to the cause is proved weekly by his long commute from Cape Cod.

In all, the staff is a good balance of engineers, collectors, business managers, and keepers of the King's English. And the longevity of our employment

shipping and storage space, and room for our computers, as well as for the old radio (or two or three) that inevitably keeps popping up. This move seemed to be a giant step in professionalizing the magazine — we were no longer a "cottage industry."

Incorporating color into the magazine once in awhile has brought us closer to the format of big-time publications. Although spot color had appeared on several covers — May 1985 and December 1986, for example — the first 4-color cover appeared in June 1987 portraying the Marconi multiple tuner. Since then we have used color whenever the occasion or the subject makes it irresistible. Unfortunately, cost has to be a factor in this decision.

No doubt the biggest milestone in our fifteen year history will be the expansion on the Internet — a new beginning, as we look to the advent of a new century. It was ironic that last year at the same table in the same bar in Elgin, Illinois, one of the same collectors

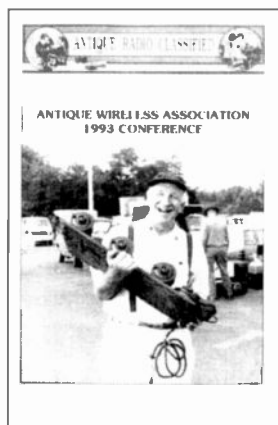

Reports on radio meets and auctions have been staples in A.R.C. This 100-page issue went to over 8,000 subscribers.



Many issues have featured a story or a historic manufacturer or personality, such as Charles Herrold.

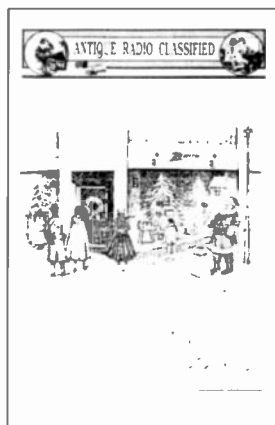

Seasonal covers have always been popular — Christmas, Valentine's Day, Halloween, and the baseball season.

is a testament to the fact that this is an interesting and fun place to work.

Another equally important dimension to the human side of producing this magazine is the contribution of many writers. Some bylines on series of articles in the early years still appear — Frank Heathcote, Dave Crocker, Jim Kreuzer, Ralph Williams, Frank White, Jim Fred, and Richard Foster. Other contributors appearing frequently on our pages are Ian Sanders, Howard Stone, Ray Bintliff, Dick Desjarlais, Alan Douglas, Paul Joseph Bourbon, Ray Chase, and Richard Arnold. Our apologies to others too numerous to list here. Each year, we're delighted to add more contributors to A.R.C., and our readers seem to take great pleasure in the diversity of their topics.

MILESTONES

Perhaps our first major milestone was the move out of the Terrey house. February 22, 1992, was the memorable day when we took over the first floor of one of the few commercial buildings in Carlisle. Though certainly not noted for its splendor or amenities, the building, originally a molasses factory, affords us plenty of space. We actually have offices,

who had urged John Terrey to buy A.R.C., said many, many times regarding the Net, "John, you're already too late." We hope not.

Instead, we are convinced that our plan for ads on the Net will make you subscribers feel more confident because transactions will be with fellow subscribers only. The ads will appear on the target date — the first day subscribers receive the hard copy — a process that is as fair to non-Net users as we can make it.

The fact is that for fifteen years our primary subscriber complaint has been about delivery of the magazine on time. But try as we may, there is no way to control the vagaries of the U.S. Postal system. Finally, there is a solution. All of you have the choice of signing on to modern technology.

Our goal is to extend Gary Schneider's vision of A.R.C. as the premier national publication for buyers and sellers of old radios well beyond the millennium. We're sure you will stay with us through the next fifteen years to make that goal a reality.

(Dorothy Schechter, c/o A.R.C., P.O. Box 2, Carlisle, MA 01741)



AUCTION REPORT

Norm's Radio Auction Hanover, Pennsylvania — March 19, 1999

REPORTED BY RAY CHASE

On March 19, 1999, Norm's Auction Service of Hanover, Pennsylvania, held a large radio auction largely consisting of the collection of Charles Mooney of Bowie, Maryland. There were 252 cataloged lots and over 65 uncataloged lots. Randy Dickensheets, assisted by Phil Dickensheets, called most of the auction.

Sets of the 1930s and later dominated the collection, but there was also a large selection of novelty radios. The radios by and large were in good to very good condition. Most were claimed to be working, although the auctioneer cautioned that they had been in storage and moved several times, so officially they were sold "as is." Highlights were a Crosley grandfather clock radio selling at \$350; a Scott All-Wave 2-chassis radio at \$450; even though the chrome chassis were rusty; and a Zenith shutter-dial console at \$600.

The auction hall was large with excellent viewing capabilities available for more than a week before the event. The catalog was well prepared and helped move the bidding along. The auction started at 5:30 P.M. and concluded at a few minutes after 10:00 P.M. A large crowd stayed for most of the auction. There was no buyer's premium so listed prices are net.

The following is a selection of items. Many items without model numbers and low values have been deleted. All prices are rounded down to the dollar.

e=excellent, vg=very good, g=good, f=fair, p=poor, WT=with tubes, NT=no tubes, wk=working, nwk=not working, ng=not good, PB=push buttons, PS=power supply

Admiral Palm Tree portable, alligator skin, g .. \$75
Airline 74 BR-150ZB metal midget, white 70
Airline AE-10, chassis only, 1931, vg 45

Airline phonograph, portable, green plastic, Deco, unusual, vg 77
Algene snakeskin vanity radio, (1) knob missing .. 50
Allied catalog, 1961 10
Americana cube radio, (2) 5, 7
Arbophone battery set, vg 140
Arvin 444A metal midget, g 60
Astatic table microphone 40
Atwater Kent 46 metal coffin 70
Atwater Kent 60C in Kiel table, top refinished darker, wk, vg 275
Atwater Kent 60C, no top lid, w/(2) globe 45s, g .. 60
Atwater Kent 856 tombstone, g 180
Atwater Kent hom speaker, g 115
Audels Radio Man's Guide, book, (2), g .. 10, 11
Audio Encyclopedia, book, g 24
Automatic 613X 85
Ball and Chain novelty radio, blue 12
BC-342 military receiver, no external modifications, vg 80
BC-348R military receiver, w/external PS and National speaker, no mount, g 130
Belmont A6D110, white Deco plastic, scratches & damaged PBs, g 70
Bendix 687A suitcase portable, g 37
Bendix 753M clock radio 35
Bendix radio in drop-leaf table, glass dial markings gone, g 75
Benrus clock radio 17
Big Bird novelty radio 24
Blaupunkt 2430 Virginia, medium size, g 90
Boom Box radio, small 6
Burger King novelty radio 9
Cabbage Patch Kids novelty radio, small 5
Cathedral transistor radio 27
Channel Master, w/leather case 5

A warning: Auction prices are not current values. Our selection of auction items is not necessarily complete. A listing such as this cannot adequately include the condition of cabinets, chassis, transformers, tubes, the operating status of the set, and the inclusion of incorrect, restored or replica components, etc. Auction prices are the result of the excitement of the auction process, the skill of the auctioneer and the specific interests of the participants. Nevertheless, auction prices serve as useful references and as another element in the value determining process. The possibility of error always exists, and if we are notified, corrections will be reported.



Everything from battery sets to Bakelites to plastics was offered in the auction.

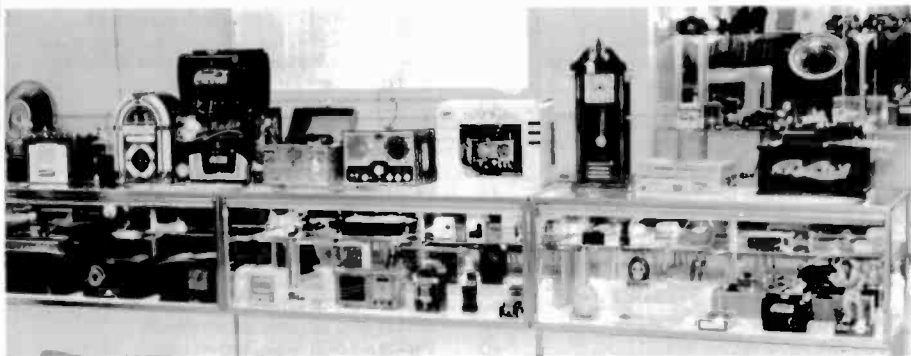

Some of the many novelty radios offered up for bids.

Coca Cola Bottle novelty radio	12
Coca Cola bottle novelty radio, in box	20
Coca Cola Cooler, large, in box	90
Coca Cola miniature cooler novelty radio	35
Coke Bottle transistor radio, w/box	15
Coke Machine novelty radio	30
Cornell Dubilier capacitor analyzer, wood case, g ..	35
Coronado table, wood	25
Coyne Radio Troubleshooting Manual	10
Coyne Troubleshooting Manual, electric and radio, f	12
Craftsman 800 AM-FM tuner, (5) knobs, chrome chassis & eye tube	27
Crosley 5V2 small tombstone, (3) knobs, g ...	80
Crosley 6H2 tombstone, (4) knobs, vg	140
Crosley 9-104W table, Deco, unusual plastic, vg ..	60
Crosley 14-AG wood table, (3) knobs, vg	55
Crosley 56 portable, plastic w/handle, g	57
Crosley 124M Playtime grandfather clock radio, g ..	350
Crosley 515 tombstone, small, g	140
Curtis-Mathis, AM-FM table, large, wood, 1950s, (6) knobs	14
Daltone 6 transistor radio, small	27
Detrola 342 table, white plastic, (2) knobs, g ..	40
DeWald C-800 table, plastic, 1948, g	15

Elco 315 signal generator	25
Electrolytic Capacitors, book, 1938	31
Elements of Radio Servicing, book, w/dust cover ...	4
Elvis Presley novelty radio	40
Emerson 8CW 334 13 table, plastic, (2) knobs ..	50
Emerson 8CW 334 table w/handle	35
Emerson 503 table	40
Emerson 510	37
Emerson 594A brown plastic, (2) knobs	30
Emerson 888 transistor radio, green, in case ..	45
Emerson table, small, wood, w/Ingraham cabinet, vg	260
Emerson transistor clock radio, g	2
Fada P80 flip-lid portable, with paper	170
Folded horn, papier mâché, large, no driver (for theatre?)	30
Freed-Eisemann 10, 3 dialer, NT	85
Freed-Eisemann AM-FM console, w/record player, late 1940s, g	10
GE A-53 tombstone, (4) knobs	75
GE Blue Police Light novelty radio	20
GE J-66 table, ornate wood, (3) knobs, g	42
GE L-650 table, plastic, (2) knobs, PB	55
GE M51 large tombstone, (4) knobs	100
GE S-22X tombstone, g	150
GE tube manual	5
GE TV & Radio metal lighted sign, 6" x 2'	140
GE TV & Radio Service metal and plastic lighted clock, 12" x 18"	110
General Radio output meter, small, wood case ..	27
Globe radio, vg	45
Grunow 670 tombstone, needs grille cloth, g ...	185
Guild 380T Town Crier, 1956	90
Guild Country Belle wall telephone radio	40
Hallicrafters S-20R, g	65
Hallicrafters S-38B, vg	65
Hallicrafters S-38D, g	45
Hallicrafters S-40B, (2) knobs missing, no speaker, g	60
Hallicrafters S-94	15
Hallicrafters S-81 Civic Patrol, black	45
Hallicrafters SX-24, f	110
Hallicrafters SX-28, f+	250
Hallicrafters SX-43, scratched	160
He-Man novelty radio	15
Heathkit HW-16 transceiver	30
Heathkit HW-29 6-meter transceiver, g	60
Heathkit IT-12 signal tracer	25

(Continued on following page)



Up for bids were a wide variety of communication receivers, sitting atop a Philco Model 511 and an RCA Radiola 60.

(Norm's Auction, continued)

Heathkit IT-17 tube tester	22	National NC-173, repainted, scratched	95
Heathkit portable 16-transistor radio, w/manual, g. 55	55	National NC-57, f	55
Heathkit SG-8 signal generator	15	<i>NRI Service Manual</i> , abridged, (like Rider's), g ...	25
Hickok 533A tube tester, g	140	Oil filter novelty transistor radio, p	3
High Heel Shoe novelty radio, red	27	Orioles "WCBM" novelty radio	11
Home brew battery radio, neutrodyne, NT	40	Peerless SM-305 portable, w/original box	70
Home brew 3-tube battery set, WT, g	42	Philco 38-10T table, wood, (4) knobs	75
Home brew crystal set, recent, g	45	Philco 38-12 table, wood, (2) knobs, holes in grille cloth, g	40
Home brew crystal set, slide-bar tuning, g	60	Philco 38-15 table, wood, (3) knobs, vg	50
Home brew, 1-tube, w/Remler tuning capacitor ..	65	Philco 40-130 table, wood, (4) knobs, g	25
Home brew, 1920s style, 2-tube, recent construction, but nice,	65	Philco 48-200 table, white plastic, (2) knobs, some paint chips	20
Howard 482 table	10	Philco 48-214 table	25
Jackson 106 RF signal generator	20	Philco 48-250 table, white plastic	37
Jewell 199 set analyzer	40	Philco 49-906 table, brown plastic, (4) knobs ..	25
Johnson Adventurer transmitter	80	Philco 60 tombstone, f	80
Kadette 66 table, wood, very clean	60	Philco 610 stepped tombstone, g	90
Knight Star Roamer	45	Philco 610 stepped tombstone, nice cabinet, chassis very rusty	85
Kolster 6D battery radio, pot metal problems ...	60	Philco 611, brown metal, p	80
Kolster K-110 cathedral, g	230	Philco 10664B "Bing Crosby" radio/phonograph ..	65
Kolster K-20 early AC radio	75	Philco Jr. cathedral, f-g	85
Lafayette TE-25 capacitor tester, metal case ...	20	Philco PT-3 table	20
Lincoln car, 1928, novelty radio	6	<i>Philco RMS Yearbooks</i> , 41 & 42	25
Longines Symphonette International Pathfinder 8000 portable, g	20	Philco, leather, w/oak roll-style top	45
Loud Mouth novelty radio	5	Philmore early transistor kit, w/paper, unusual ...	25
Magnavox AM-FM Grand Classic table	7	Piano radio, wood, g	37
Manhattan blue swirl, g	25	Pilotuner T601A FM tuner, wood	22
Meissner 8-C FM tuner, wood	10	Polaroid 600 Plus novelty radio	6
Meissner 8C-17 wood FM tuner, g	35	Pony telegraph relay radio, f	27
Mickey Mouse in chair novelty radio	15	Precise 630 TV marker generator	10
Mickey Mouse reclining on yellow radio, (2)	37, 45	Precision 10-12 tube tester	45
MJF World Band shortwave, small, modern, regenerative	25	Precision 920P tube tester, wood case, g	45
<i>Modern Radio Servicing</i> , book, g	12	<i>Radio Physics Course</i> , book, g	7
Money Talks novelty radio	21	<i>Radio Service Cyclopeda</i> , book	15
Motorola 62L2U portable, plastic, pop-out front ..	15	<i>Radio Servicing</i> , 3rd ed.	5
Motorola 71 7" TV, 1948, wk, g	210	Radio Shack catalog, 1963	5
Motorola 79XM table	50	Radio Shack CB set, base station and car unit ..	10
Motorola portable, 1950s	22	Ramsey 2-meter transceiver	20
Motorola portable, 1950s, midget, red, g	12	RCA Radiola 28, AC, on matching table, w/loop antenna, NT, g	225
Motorola Ranger 700 portable, 1940s	40	RCA Radiola 60, p	80
Mouse on Cheese novelty radio	10	RCA Radiola 100 drum speaker, f	45
Multimeter, military, ME9/HV-TS352 B/U	15	RCA Radiola 100A speaker, rear cloth gone, front cloth wrong	47
NAPA car battery novelty radio	19	RCA UZ-1320 horn speaker, w/replaced driver, f ..	120
National NC-125, g	85		



A view of some of the tombstones, early televisions, wooden table sets and plastics about to be offered.

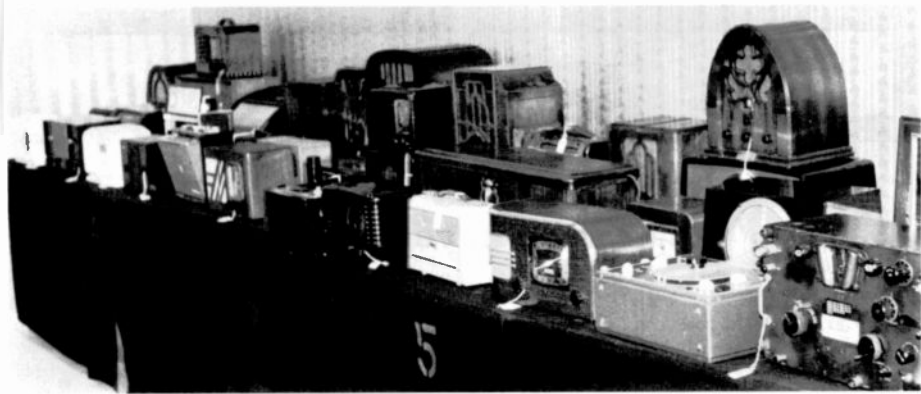

Typical of the variety of sets offered were radios like the early AC radios, tombstones, cathedrals, plastics, test equipment and communication receivers shown above.

RCA Victor "Radio/TV/HiFi/Tubes," end mounted metal sign, 10" x 15", g	120
RCA Victor 2-XF-933 table, green plastic, 1950s ..	30
RCA Victor 4XX1 table	55
RCA Victor 9-X-561	20
RCA Victor 14" TV on metal stand, white	40
RCA Victor 45-EY-2 45-rpm phono	30
RCA Victor AF 165A flush-mount wall speaker, g..	25
RCA Victor AR-8711 maritime receiver, w/large loop antenna on top	150
RCA Victor AR-8712 ship receiver, w/direction finding antenna	50
RCA Victor Braille radio, VHF & UHF TV, AM/FM solid-state, v/unusual	52
RCA Victor Brunswick 5KR, cabinet w/hood, g.	120
RCA Victor clock radio, black plastic	10
RCA Victor Golden Throat table, large, plastic, 1950s....	35
<i>RCA Victor Service Manual, 1947</i>	17
RCA Victor T-64 tombstone, g	160
RCA Victor T-64 table, 1940	95
RCA Victor table, "Golden Throat," 1950s	35
<i>Reference Data for Radio Engineering</i> , book ..	5
Regency DB-520 small TV signal booster	17
Rider's, 17 vols., 4 TV, plus mix of others ..	180
Rider's, National Union volume	27
Roadster novelty radio	8
Rolls Royce novelty radio, (2)	5, 5
Sam's, 5 box lots	62
Sansei table, white plastic	9
Satellite novelty transistor radio	20
Scott 800B AM/FM, w/15" speaker, fair chrome, no cabinet	300
Scott All-Wave 12, (2) chassis only with Atwater Kent speaker, rusted chrome	450
Sencore PS-148 scope	27
Silvertone 15 table, plastic, (3) knobs, g	25
Silvertone 132878 table	25
Sinclair Gas Pump novelty radio, in box	22
Spacta Junior 49161 M-4, 4-tube midget, g ...	55
Sparton 6A66, small metal case, SW & BC ...	45
Steinitz 102, 2-dial, 1929, w/internal AC supply, vg	200
Stewart-Warner PortoBaradio, w/all glassware, plastic front distorted	200
Stromberg-Carlson 228-8 table, large, (4) knobs & eye tube, vg	100
Superior 76 CR bridge and signal tracer	17

Superior TV-12 tube tester, wood case, g	40
Superman child's record player in carrying case, vg.	60
Swank Power Boat novelty radio	16
Temple 50 speaker, 1920s, g	60
Texaco #17 Indy Race Car novelty radio	16
Trav-Ler 500Z table	42
Triumph 420 countertop tube tester, old, looks like a Weston	65
Truetone D2210 table, wood, chrome trim and purple dial, warped dial, g	110
Tube(s): 833A transmitting tube on display stand, ng	30
TV clock, older mechanical digital type, (not a radio)....	12
Victor Victrola VVIX wind-up phonograph, vg	350
Westinghouse H-122A, brown plastic	27
Westinghouse H-476T5 clock radio	10
Westinghouse Tela-Dial table, wood, (2) knobs & eye tube, g	65
Weston 772 VOM, wood case, vg	35
Windsor Juke Box radio, small	15
Windsor transistor radio, small, in box,	20
WWV Time Receiver, small, modern, for ham use ..	10
Zenith 6S527	80
Zenith 12S265 shutter-dial console, Deco, e 600	600
Zenith AM-FM, wood, 1950s	2
Zenith B-724G AM-FM table	10
Zenith chairside, 1946, w/phono and cobra arm, wk, vg	125
Zenith K731 AM-FM TV-style radio	5
Zenith plastic lighted wall sign & clock, 1' x 3' 75	75
Zenith plastic sign, 2' x 4'	6
<i>Zenith Radio Circuits Manual, 1941</i>	45
Zenith service manual, 3 & 4 combined, g	42
Zenith table, AM-FM, wood, 1950s	6
Zenith Trans-Oceanic transistor radio, vg	130
Zenith Trans-Oceanic, g	85
Zenith Trans-Oceanic, g	90
Zenith Trans-Oceanic, vg	120
Zenith Y832 table, wood, 1950s	35

(Ray Chase, 1350 Marlborough Ave., Plainfield, NJ 07060)

(Norm's Auction Service, 4430 Hanover Rd., Rt. 116, W. of Hanover, Hanover, PA 17331. (717) 632-2035)



INTERNET

To WebTV or Not to WebTV — Part 2 (If I can do it, you can do it)

BY DICK DESJARLAIS

In Part I, I described how John Terrey had inveigled me into writing a series of articles on a topic I know nothing about, namely WebTV. That was the whole idea — to share with A.R.C. readers my experiences and observations in learning from scratch what WebTV is, and is not, what equipment is needed, how to set it up, operate it, and use it productively.

Sounds simple, but as I reported in Part 1, my first ventures into the WebTV marketplace left me almost where I had started — at point zero.

However, I doggedly headed to CompUSA, one of the nearest honest-to-goodness, nationally known computer stores within twenty miles of my home. Surely, this company would have everything a WebTV neophyte would need. Wrong again. CompUSA doesn't sell WebTV!

Now I began to wonder if perhaps computer stores didn't sell WebTV because WebTVs aren't computers! This suspicion was confirmed when I saw one manufacturer advertising WebTV as "Easy, affordable Internet access on your TV without a computer."

After trying Staples, the office supply store, with no success, I arrived at Circuit City, and lo and behold — there in all its mystery was a working Philips WebTV on display. There were three salesmen conversing in the aisle, so I approached them and asked if I could speak to the house expert on WebTV. Hesitating, they looked at each other, and finally, one said, "Well, I'll try to answer your questions."

FIRST LESSON

Through a brief explanation and a WebTV tour on the TV screen, I at least learned that WebTV is a device which uses your TV screen as a monitor. With the use of the WebTV Internet terminal and a wireless keyboard, you can access the Internet for e-mailing to family and friends and also access the World Wide Web (www). All this at a relatively low cost without having to purchase expensive computers, hardware and software.

Well, this much was a start, but I felt I needed more information before making any decision. Luckily, another store, Best Buy, was practically next door, so I gave it a try. As it turned out, Best Buy is where I got the best buy, not necessarily in terms of cost because prices at the stores I checked were very consistent.

What impressed me was the way the personable



Dick Desjarlais (right) and Best Buy super-salesman Jay Cayer discuss Dick's path to the Internet — the WebTV Internet terminal shown below the television set.

and attentive young salesman patiently answered my novice-type questions. After setting up his demonstration model with the WebTV tour, he even let me use the wireless keyboard, instructing me on which keys to push to gain access to the Internet.

A MINI-WORKSHOP

Incidentally, when I first agreed to write this series of articles, it happened that a mini-workshop titled, "Introduction to the Internet" was being offered at my church by two computer-savvy parishioners. At that workshop, with generous help, I searched my favorite topic — antique radios — what else? I even located A.R.C.'s Web site, and I was amazed to find myself reading articles in A.R.C. that I had written in the past. Here I was with my articles published on the Internet, and all this time, I hadn't even realized it was happening!

While I was at it, I searched for eBay, an Internet auction house, and with some guidance, found many radio items for sale, with bids for radios, including descriptions and photos. None of the salesmen at any of the stores I visited knew what eBay was. I, the computer illiterate, had to explain it to them!

I was thankful I had the timely good fortune to attend this workshop. It gave me not only some basics on how to use the Internet, but also a glimpse of what it has to offer. There was the added incentive that I knew I would soon be accessing the same information on the much simpler (for me) WebTV.

THE OPTIONS

Back to Best Buy which carries Sony as well as Philips. The salesman explained that there were

several WebTV options available with either manufacturer. In each case, an Internet terminal is needed, which must be hooked up to your telephone, using a signal splitter provided with the terminal, and to your TV.

The basic option is a WebTV Internet terminal with a remote control similar to your TV remote control. The cost is approximately \$100.

Another option is the WebTV Plus, an Internet terminal which also provides an expansion port for a printer, a remote control, and several other features to be described in Part 3. The cost is approximately \$200.

A desirable option for either of the above is the wireless keyboard used. The cost is approximately \$50. Whereas the remote control is very slow and limited in function — for example, to enter words, you have to use up/down/right/left buttons to select letters, one at a time, from a keyboard displayed on your TV set — with the keyboard in your lap, you can readily access Web sites and e-mail by typing.

The service fee for WebTV is approximately \$20 per month, and \$25 per month for WebTV Plus. Since

WebTV, an affiliate of Microsoft, is its own service provider, you do not have the choice of choosing another service provider, perhaps one without a monthly fee, as you could if you were using an ordinary computer.

CONCLUSION

With the above information at hand, I felt confident enough to buy the equipment that would be best for my purpose. I returned to Best Buy and sought out the salesman who was so helpful on my first visit. He and this prospective buyer are shown in Figure 1, flanking a TV screen and a Sony Internet terminal.

The next installment will focus on buying the equipment, lugging it home and opening the cartons with all their WebTV magic. Once everything is laid out, with the breathless anticipation of a 10-year old at Christmas, I will be committed to figuring out what goes where, setting everything up and making it work. Wish me luck!

(Dick Desjarlais, P.O. Box 629, Littleton, MA 01460-2629)

A.R.C.'s Web Site Expansion Target Date — July 1, 1999

BY JOHN V. TERREY, EDITOR

Hurrah! Yes, finally, at last, we can announce that A.R.C. will have its expanded web site up and operational on July 1, 1999. A.R.C. will be the web link to the world of the radio collecting.

The decision-making process has been multifold. First, we had to decide whether or not to do anything. If yes, numerous questions arose. What additional content, ads, articles, etc., should we add to our Web site? How do we balance the needs of both Web users and non-users? Should some of the information be restricted to subscribers only? Financially, how much should be budgeted for this project and where do we expect to recover these costs? Practically, does our own staff do the Web programming or do we hire outside consultants? These are only a few of the many issues we considered.

As we have discussed in these pages for months, expansion of the A.R.C. Web site is a necessity. However, at this time, we do not plan to put all of A.R.C. on the Web. As in the past, Web surfers will continue to see the cover, the Editor's page, one or more feature articles, radio club news and events pages, *Radio Miscellanea*, and links to related Web sites. New features will be searchable past auction prices and an improved searchable A.R.C. store. But, the most significant addition is the searchable classified ads, which will be accessible to subscribers only. For access, they will use their subscription number and a password.

Searching on the A.R.C. Web site through the classifieds, the auction listings and the books, videos, etc. for sale, has a key feature — you will be able to fine-tune your search by listing several words and include "AND" and "OR." The complexity of implementing this feature is a key reason why we have hesitated in taking this step to expand the Web site, and have chosen to utilize an outside consultant for the process.

For many of you collectors, a significant aspect of the expanded Web site will be the searchable listing of past auction prices. Although the popular price guides list thousands of sets, collectors still run across one that is not listed in any guide. Also, horns, tubes, etc., are hard to find in price guides. It is useful to see what a set sold for if it appeared in a recent auction.

The shopping features on the current Web site will be improved also. In order to purchase a book now, you must type in the book title. On the new site, you simply click the title to place it in your "shopping cart." And, for the final purchase, the credit card information will be transmitted using a secure method.

Although I hesitate to talk about the future additions to the site, our plans include classified photo ads, display ads, a searchable *Photo Review*, and a searchable index to the entire 15 years of A.R.C.

Of course, since all of A.R.C. will not be on the Web, the printed copy will still be desirable. And, I hope that as more web surfers see our expanded Web site, they will "want it all," and subscribe. In addition, I hope that surfers and subscribers alike will buy their radio-collecting books, etc., from A.R.C. — after all, we stock all of our items and usually ship the same day! This is where the payoff is for A.R.C.

We will keep you up-to-date on our progress via the printed A.R.C. But, also, star: checking out the Web site mid-June to find out the latest target date and the details on how to access the subscriber-only area — namely, the classified ads. By the way, keep your mailing label this month, as it includes your initial log-on password.

(John Terrey, c/o A.R.C., P.O. Box 2, Carlisle, MA 01741)



RADIO MISCELLANEA

"Radio Miscellanea" includes items of general interest selected from A.R.C.'s incoming correspondence. "In The Marketplace" items are based on information submitted by the businesses themselves. "From The Internet" items are obtained from internet newsgroups and other internet resources. Submitted items should be verified for accuracy; items may be edited by A.R.C. for publication, and publication is not guaranteed. See the masthead for more details.

From a "Crazy" Guy in Spain

Dear Editor:

First, I want to congratulate all the people that make it possible for a person like me who lives on the other side of the Atlantic to receive your magazine every month. Also, I find the different articles about the history of radio very interesting. I sometimes think that I am alone in my love for antique radios, and it is very important for me to know that there are more "crazy" people like me in this world!

Aitor de Elejabeita Garcia, Tenerife, Canary Islands, Spain

Atwater Kent Articles and Cover

Dear Editor:

Your Atwater Kent articles and the beautiful cover reminded me of the first antique radios I collected. Since I grew up in Philadelphia, the manufacturers were Atwater Kent, Philco and Music Master. A year ago, I tracked down Building No. 1; sadly, I missed Building No. 2.

I am wondering if the occupants in Building No. 1 realize where they are, and if the City of Philadelphia is going to make sure that this building is preserved.

Unfortunately, the article missed one important detail. How about the original site on Stenton Ave.? I believe that is where the early breadboards and other earlier gear were built.

I wonder if there is a chance of expanding this article. No book of the quality of the Dachis Hallicrafters book exists for Atwater Kent. Perhaps Ralph Williams will take on these projects.

Jeff Phillips, Kingston, NH

Alan Douglas, in his "Radio Manufacturers of the 1920's, Vol. 1," devotes over 20 pages to Atwater Kent. The "AWA Review" also contains much coverage written by Ralph Williams: Vol. 1 contains 26 pages; Vol. 2, 24 pages; Vol. 3, 28 pages; Vol. 10, 70 pages. Unfortunately, the AWA has not kept these valuable publications in print! However, Vol. 12, expected this fall, will be devoted solely to Atwater Kent. (Editor)

Kudos to Katz

Dear Editor:

I want to commend Laura Katz for the excellent job she has done with the A.R.C. Web page. Her article in the May 1999 issue clarifies how to use the Web site and get the most out of it. This opens a whole new world to collectors like me. I am new to the Internet and did not find much of value to me on it before reading her articles. Thanks for all the effort and hard work.

Jerry Mundel, Scottsdale, AZ

Likes A.R.C. Both Ways

Dear Editor:

I want to tell you that although I use the Internet to buy radios, I will still continue to buy A.R.C. Keep up the good work.

Marvin Nieman, W. Rapids, WI

The Other Side of the Meet Issue

Dear Editor:

In response to the letter in your May 1999 issue about radio meets, I thought your readers might be interested in hearing the other side of the issue from someone directly connected with a "meet," as I have been for over 20 years.

The Carolinas Chapter of the AWA has two kinds of meets: smaller swap meets and the "Spring Meet," of which I have been Chair for 15 years, and which is a conference, not just a swap meet.

There is a lot to this conference besides selling radios in the parking lot. It is a 3-day event offering many programs, a contest, an auction, a reception/open house, a luncheon, and it costs well over \$4,000 to put on. As for being "great for the chapter treasury," the profit has been about 10 percent — a little over \$400 — for a full year of work and hundreds of hours put in by club members. True, we are not a business, but we have to make enough to support the club and account for price increases that surely will come next year.

Much thought has been put into the subject of including the public in our events. During the year we host four swap meets fully open to the public. No admission is charged. At two of them we charge sellers a fee when we have to pay rent for a site to hold the swap meets. These swap meets are on Saturday mornings only, and typically have 30 to 60 vendors; 150 vendors show up for the Spring Meet.

My suggestion is that people try to understand the realities of what it takes to put a major meet together, or else stick with the smaller, 1-day, weekend meets.

Collectors travel from all over the country to attend the Charlotte event. To see how a meet is done right, come to the 2000 Spring Meet in Charlotte, N.C.

Ron Lawrence, Matthews, NC

As Ron relates, hundreds of hours are donated by dozens of collectors so that they and others can enjoy their collecting hobby. All collectors should find some way to participate in running a meet occasionally so that these events can continue. (Editor)

Down-Under Kudos for Leacock

Dear Editor:

The Leacock story was terrific! Bravo to Harry Schecter, who came across this treatise on love and the lazy Hertzian waves. As a lifelong fan of both Leacock and radio, I enjoyed their meeting in the pages of A.R.C. enormously. Such editorial thinking gives the magazine a great lift — as if our favorite periodical needs any elevation!

Another of Leacock's radio stories is "Broadcasting the Norman Conquest," which is also great fun. Leacock is my favorite Canadian and, along with good old Sam Clemens [Mark Twain], my favorite North American.

Thank you for the idea and the piece.

Richard Begbie, near Canberra, Australia

CLASSIFIED ADVERTISEMENTS

WANTED: Chassis for Addison 2A. Martin Lamonde, 394 St-Germain, Apt. 3, Quebec, Canada G1K 4N1. E-mail: mlamonde@exfo.com

WANTED: Federal Model 61 copy of schematic and manual. Thanks. John Pansing, 600 Tait Rd., Dayton, OH 45429. (937) 299-0210

WANTED: Excellent working original Majestic 906 Riviera console with manual/advertisement. Joseph DiCaro, 4155 Lastrada Hts., Mississauga, Ontario, Canada L5C 3V1. (905) 848-7759. E-mail: fox@globalserve.net

WANTED: The juvenile fiction book, Young Wireless Operator With U.S. Secret Service, by Theiss. Robert Stapleford, 1800 S.W. Randolph Ave., Topeka, KS 66604-3158

WANTED: Antique brass microscopes. Scientific and medical apparatus. Optical and electrical. Wissner, Box 102, Ardsley, NY 10502. (914) 693-4628. E-mail: wissner@bestweb.net

WANTED: Still looking for Philco antenna transformer #32-3248. Tracy Sands, 8850 Walker St., Cypress, CA 90630. (714) 527-5728

WANTED: WWII RCA aircraft radios. AVT-112 transmitter, AVR-20A receiver, AVA-126 power supply, and AVA-120 trailing wire antenna reel. Sam Taber, PO Box 601, East Troy, WI 53120. (414) 642-4515

WANTED: Fairbanks Morse console Model 9C or 12B preferred. Charles E. Patterson, 2621 Sweetwater Rd., SP #33, National City, CA 91950-7801. (619) 475-7141

WANTED: All types of crystal sets. Toy, old, rocket, novelty, pocket. And old advertising thermometers, Curta calculator. The Crystal Radio Guy, Galen Feight, 3104 S.E. 20, Portland, OR 97202. (503) 231-9708. E-mail: GFeight@aol.com

WANTED: Panasonic AM-FM radio Model RF 923. Joseph Argento, 10117 80 St., Ozone Park, NY 11416. (718) 843-5325

WANTED: Quack medical equipment. Dr. Albert Abrams E.R.A. devices (oscilloclasts, dynamizers). Radionics or Drown's Radiotherapeutic equipment. Spectrochromes (colored light projectors). Chromed cylinders with wires attached (electropoise, oxydonor, oxypathor). Magnetic belts, combs, brushes. Electrotherapy cabinets (Wappler, Thompson-Plaster, Fischer, Liebel Flarshiem, Victor), on books. Neurocalometers. Shock boxes. Tesla/oudin/induction coils. Send picture/description. Mr. David Rickert, 2107 5th St. S, Apt. 1, Arlington, VA 22204-1931. (703) 486-2782. E-mail: RickertD@gdls.com

WANTED: Old telegraph keys and related equipment, catalogs, signs, etc. Gerry Maira, 31 Prospect St., Fredonia, NY 14063. (716) 672-5389. E-mail: gm@netsync.net

WANTED: Philips-Norelco AM-FM Deluxe (AM-FM-SW) Type 6X3ST/54, 22LR798/44 with power-supply transformer, instruction booklet, aligned, working. Thanks. A. Sherry, PO Box 1051, Riverdale, NY 10471

WANTED: New collector wants transistor radios, working, excellent to mint condition. Bob Waskin, 9420 Kildare, Skokie, IL 60076. (847) 677-4620

A.R.C. Advertising Policy

Sellers and Buyers, Please Note!

- Advertising is accepted only for early items
- related to radio, communication, etc. All
- items must be described fairly; reproduc-
- tions, reprints and not-original items must be
- so identified. Advertisers must agree to re-
- spond promptly to inquiries and orders, to
- resolve problems promptly if the buyer is not
- satisfied, and to comply with a buyer's
- refund request on unaltered returned items.

WANTED: Allied Knight KN 400B 35DU814 transistor audio amplifier, diagrams, manuals. Jim Youngson, 6701 Melrose Ave., Louisville, KY 40216. (502) 448-6228

WANTED: Phono-related advertising items: Vogue picture records, original dealer advertising from Edison, Victor, Columbia. Needle tins and cutters, Nipper advertising items, calendars. Record brushes and dusters. Pocket advertising mirrors. Dealer lapel pins, posters, puzzles, fans, broadsides. Edison, Columbia, and any wax cylinder records. Phonograph toys, toy phonographs. Thanks. Bernie Seiberg, 714 Moredon Rd., Meadowbrook, PA 19046-1907. (215) 886-6124 or fax: (215) 638-2265. E-mail: phonoman-bernie@worldnet.att.net

WANTED: NRI radio kits, unbuilt from the 1940s-1950s #1, 2 & 3, with manuals preferred. Will consider built-up if complete. Art Sabin, 315 Plymouth, Chicago, IL 60604. (312) 427-2737. E-mail: 7sabin@jmls.edu

WANTED: Gonset G11 CB, RCA-CRM-P2B RadioPhone Deluxe, International crystal citizen bander, Argonne AR-57 microphone. Charles Zafonte, RR3, Box 2075, Fort Kent, ME 04743. (207) 834-6273, evs/weekends

WANTED: British crystal sets, detectors, crystal tins. Also looking for a supply of replacement glasses for detectors. Ian L. Sanders, 16725 Wild Oak Way, Morgan Hill, CA 95037. (408) 778-7547. E-mail: ilsande@ibm.net

WANTED: Stromberg-Carlson Model 925 chassis #33264. David Ketry, 3266 Glenn Eagle Ln., Kenner, LA 70065. (504) 469-4920. (504) 846-5623. (504) 441-4115

WANTED: Crosley 58 (BuddyBoy) chassis and speaker and CV6 tube. Aitor Elejabarrena Pedro J. Mendizabal 7 Urb, Tristan, S/C TFE 38009. Canary Islands, Spain

FOR SALE: Technical books. Visit: <http://cheshire.net/~rainyday> for list of catalogs and many books online. Rainy Day Books, PO Box 775, Fitzwilliam, NH 03447-0775. (603) 585-3448. E-mail: rainyday@cheshire.net

FOR SALE: Used tested tubes: (5) 6V6G, (1) 7025 - \$5 ea.; (2) 7027A - \$8 ea. Bob Curwin, 759 Jody Ln., Hoffman Estates, IL 60194. (847) 490-1414

**NOTICE TO ALL
CLASSIFIED ADVERTISERS!
OUR CLASSIFIED AD DEADLINE IS
12:00 NOON
ON THE 10th OF EACH MONTH**

FOR SALE: Radio list: battery to novelty. Literature list: books, magazines, service info, catalogs, miscellaneous ephemera. Dave Sutherland, PO Box 201, Spofford, NH 03462. (603) 363-4459. E-mail: echocove@cheshire.net

FOR SALE: Jukebox Collector Magazine - \$30/year (12 issues). 2 samples - \$5. Jukebox Collector, PO Box 624ARC, Altoona, IA 50009. (515) 265-8324

FOR SALE: Scott Philharmonic Gothic Grande - \$5,000. McMurdo Silver MPVI Norwich - \$4,000. Radio Bar Philco hand-painted Chinese figures on black laquer, stunning! - \$2,200. Mike Greene, 19113 Alpenglow Ln., Brookeville, MD 20833. (301) 774-3203

FOR SALE: Need attic space. Browning-Drake 5R. Samson 4 tube. Unidentified 6 tube TRF. Have schematics for first two. Any not totally unreasonable offer, especially for package deal and pick up. Tom Maier, W1EQG, 29 Bloomfield St., Lexington, MA 02421. (781) 861-8796

FOR SALE: General Radio Company test equipment, very large collection. SASE for list. John P. Tiedeck, WA2SDE, 212 Grandview Rd., Media, PA 19063. (610) 566-8049

THE TUBE SHOP

"Your one stop for new old-stock tubes"



Box 231160

Boston, MA 02123-1160

Phone: 617-369-0980

Fax: 617-262-0148

Fax: 617-353-1466

E-mail: tubeshop@quik.com

Hi-fi, antique radio, amateur
radio, guitar amps, jukeboxes

FOR SALE: Atwater Kent, Model 72, chassis only (completely stripped) front panel with dial, 2 controls and 2 switches (see Flick of the Switch page 63) - \$75 plus shipping. J. J. Papovich, 53 Magnolia Ave., Pitman, NJ 08071. E-mail: jjpapo@juno.com

FOR SALE: Tubes, parts, car radios! Can deliver to RadioActivity! SASE, e-mail for lists. Mitchell Thermionics, 211 Argosy Dr., Gaithersburg, MD 20878. E-mail: allenom@hotmail.com

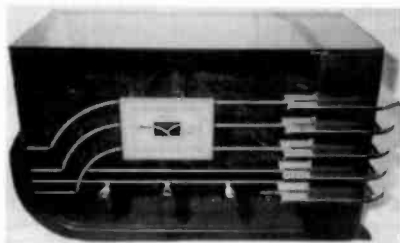

FOR SALE: This is a replication of one of the most beautiful radios ever produced, the 1936 Sparton Model 557 Sleigh. Now reproduced by Crosley. And what a wonderful job they have done, this Sparton classic has been carefully reproduced right down to the precision etching on the cobalt blue mirrored glass, its chrome wraparound fins and black hardwood cabinet with the bottom runners, hence the name "the Sled." This full-sized radio will make a stunning accent piece for your office or home. A colored picture can be seen on my website at <http://members.aol.com/bensradios/Classics/index.htm>. Price is - \$169 including S/H. Ben Martin, 18334 Pepper St., Castro Valley, CA 94546. (800) 595-0191. E-mail: bensradios@aol.com

FOR SALE: Dual electrolytic capacitors. 50-30 mFd at 160 Vdc - \$3.75 ea. for 4 or more, includes P&H. Many other types in stock. Also new manufacture stud mount, clamp mount, twist prong, and octal based capacitors. Call or write for free flyers. DH Distributors, PO Box 48623, Wichita, KS 67201-8623. (316) 684-0050, v/f

FOR SALE: Sams sets 116 thru 932 - \$2/set plus shipping. SASE for list. Leo Pedersen, 1881 Bradley Ln., Estes Park, CO 80517-6923. (970) 586-4576

FOR SALE: Clandestine WWII miniature comm. rec. Type M.C.R.I., complete in original tin box - \$650. B2 spy TX/RX, complete in original parachute drop containers. Two early German military comm. Rxs (1930, one 4 w/band, other 10 w/band). Jim Taylor, G4ERU, No. 5 Luther Rd., Boumemouth, England BH9 1LH. Tel/Fax: 44(0) 1202-510400

CATALIN

WANTED

WANTED

RADIOS



TOP
PRICES
PAID!

Michael Lawlor
P.O. Box 179
Santa Barbara, CA
93102
(805) 682-2336

WANTED: Old electrolytic condensers, stud mount type and nuts/washers. Need not be good. Also schematic/other information for 1940 Continental piano radio. Julian Brook, PO Box 130307, Birmingham, AL 35213. (205) 879-1191. Fax: (205) 870-9255

WANTED: Good 15GP22 color CRT for historic 1954 RCA. Leads or help appreciated. Mal Fuller, 624 N. Main St., Wolfeboro, NH 03894. (603) 569-1946, evenings

WANTED: Tubes: any USA brand 76, 6X5G and Western Electric 351A, 422A. John Birck, 458 E. 600 North, Orem, UT 84097. (801) 224-1216. E-mail: jbtubes@inquo.net

WANTED: 50s color 15" and 21" TVs, also odd brands, Trad, Videodyne, Starrett. Glenn Bubenheimer, 27851 Terrence, Livonia, MI 48154. (734) 421-5574. E-mail: gbuben@provide.net

WANTED: Tube with battery portable plastic radios. \$200 and up paid for many two-tone Japanese 1950s sets that fit in a big pocket. Damaged beauties also purchased. Mike Brooks, 7335 Skyline, Oakland, CA 94611. (510) 339-1751. E-mail: miniwave@aol.com

WANTED: Atwater Kent base for Model H or L horn speaker. Driver not necessary. Stan Marlin, Box 1035, Assiniboia, Saskatchewan, Canada S0H 0B0. (306) 642-3824

WANTED: Firestone 4-A-12 AM/FM Bakelite, Crosley, Airline other AM/FMs, old mics, TV cabinets. Steve Puryea, 1310 Osprey Ave., Orlando, FL 32803. (407) 894-7743

WANTED: Ghirardi's book Modern Radio Servicing, 3rd edition or later. Nick Terrence, 12 Eleanor Pl., Huntington, NY 11743. E-mail: nterrenc@suffolk.lib.ny.us

WANTED: Complete set of knobs and 12 push buttons for Crosley console Model 02CP-02CQ chassis 70. Alton A. DuBois, Jr., 67 Peggy Ann Rd., Queensbury, NY 12804. (518) 792-3130

WANTED: Arvin 517 tombstone chassis! Stein #1. Patrick Franzis, N10CJ, 235 Millville Ave., Naugatuck, CT 06770-3848. (203) 723-8976. E-mail: old_radios@yahoo.com

**PHONE NUMBER FOR
ANTIQUE RADIO CLASSIFIED
(978) 371-0512**

**Best time to call is weekdays:
9 am to 5 pm Eastern Time**

(Please no classified ads by phone. Thanks!)

WANTED: Trim pcs for an Addison 2A need anything in yellow. Wayne Michiels, 7 Lowrie Cres., Tillsonburg, Ontario, Canada N4G 5L4. (519) 688-0964. E-mail: michiels@oxford.net

WANTED: International crystal add on circuit kits from early 1960s. Also early superregenerative CBs. Harry Blesy, N9CQX, 9S 740 Clarendon Hills Rd., Hinsdale, IL 60521. (630) 789-1793

WANTED: Dial glass for McIntosh 1700 receiver. John Lendel, 13638 Cantaberry, South Lyon, MI 48178. (248) 486-0516

WANTED: Emerson Type: L-559, chest type 1932; 321-AW, oriental case design, 1933; 35, table, 1933. American Bosch: 200-A, treasure chest, 1932. General Electric K-51-P, 1932. Pla-Pal. Neutrowound very low metal blu case 1927. Jackson Bell Type: 62 cathedral 1930. Peter Pan cathedral, Swan cathedral. I need also urgently radios 1920s age and epoch, please send best prices, photo or e-mail. I purchase on quantity. Berti Benis, Via Franchini 60, Imola 40026, Italy. Ph./fax: 011-39-542-600108. E-mail: ED797@mail.crown-net.com

A. G. Tannenbaum

Electronic Service Data
PO Box 386, Ambler, PA 19092
Phone: (215) 540-8055
Fax: (215) 540-8327



FOR
Vintage Parts & Service Data
1920's - Present

Credit Cards Welcome

Browse our on-line catalog at
www.agtannenbaum.com

YARD SALE!

(GRILLE CLOTH)

~~\$20~~ per yard (51" x 36") for any quantity of yards of these patterns: #15, 16A, 17, 19A, 20, 21, 22, 23, 24, 25, 26, 27 until gone.

~~\$15~~ per yard for #11 - SOLD OUT

4 New Patterns!

#30 and 31 are not what I expected so I'm selling them cheap to recover my costs - \$12/yard! (36" x 44"). (If you can use a low cost generic look, this works.) #32 is a rust-colored Philco 90 type pattern for late 30's Zenith. #33 is for Buddy Boy, Kennedy tombstone and Temple speaker, and others.

Send 55¢ LSASE (4" x 10")
for full set of samples.

MICHAEL KATZ
3987 DALEVIEW AVENUE
SEAFORD, NY 11783
(516) 781-6202 (EVENINGS/WK-ENDS)

FOR SALE: Color poster depicting radio operators last S.O.S. from Titanic (April cover A.R.C.) - \$13. James J. McGrath, W2IOJ, 2 Centerview Ln., West Seneca, NY 14224-2124. (716) 675-0160. Pkt mail: w2ioj@ke2vw.#wny.ny.usa.noam

— WANTED —
PICTURES FOR PHOTO REVIEW OR TELEGRAPH REVIEW
PHOTOS MUST BE SHARP IN DETAIL
A SHORT DESCRIPTION IS A MUST!
SEE PHOTO REVIEW PAGES FOR ADDITIONAL INFORMATION

FOR SALE: Radiola III no tubes - \$185; GE K-64 cathedral orig finish exc working - \$575; Jackson Bell Swan cathedral - \$700; Atwater Kent Model 35, no tubes - \$135. Waves will be at the meets in Lansing, Elgin, and Rochester, we can transport radios for you to or bring them back to NYC from the above meets. Bruce will also be going to Brimfield in the spring, summer, and fall. We are always looking to purchase radios, phonographs, individual pieces or accumulations and collections. Contact: Waves, 110 W. 25 St., 10th fl., New York, NY 10001. (212) 989-9284. Fax: (201) 461-7121. E-mail: ct1wave@aol.com

FOR SALE: 1935 Scott Allwave 23, Warrington (?), Manuals - \$2,100 OBO. Atwater Kent Model 53, unworking - \$125. R. Shelar, 710 Columbia St., Leetonia, OH 44431. (330) 427-2303, 6-7 pm weeknights

FOR SALE: Philco Predicta TV Model H4730W, fully operational, excellent condition - \$500 or best bid. H.H. Scott Type 99D amp & Type 330-C AM-FM tuner, mint condition - Best Bid. Frank D. Atwood, Nostalgia Radio, 117 E. Main St., Unit 1, Merrimac, MA 01860. (978) 346-8100. Fax: (978) 374-1030. E-mail: atwoodtv@110.net, http://www.110.net/~pr2858

FOR SALE: Technical books, magazines, manuals. Send business SASE for a one page list to: Joseph Holstein, 1515 Sashabaw, Ortonville, MI 48462

FOR SALE: Heath DX-60B 90 W xmtr with VFO. Modified for 160m - \$60 plus shipping. C. Davis, W9CR, 201 E. West St., Georgetown, IL 61846

FOR SALE: Zenith Technical Reference Manual. A cross reference for parts, model numbers, chassis numbers, serial numbers, and dates from 1928 to 1942. A must for restorers and collectors. Write or call for free flyer. DH Distributors, PO Box 48623, Wichita, KS 67201-8623. (316) 684-0050, v/f

FOR SALE: Jukebox Price Guide (2000 edition) by Victory Glass - \$23.95 ppd. Jukebox Collector, PO Box 624ARC, Altoona, IA 50009. (515) 265-8324

FOR SALE: Must sell. Negotiable. Older speakers, amplifiers, receivers, books, more. List \$1 and SASE. Joseph Bedlovics, PO Box 139, Stratford, CT 06615

FOR SALE: Crystal radio kits, complete with face panel and base board, 365 variable capacitor, large prewound coil, and many other parts for an old style crystal radio, remit - \$19.50. Carl & Grace Ent., 5636 Romeyn, Detroit, MI 48209

FOR SALE: Exact reproduction glass dials for Sentinel 284 Catalins. Send - \$23 ppd. Radioart, PO Box 102, Centerbrook, CT 06409

FOR SALE: 24K vacuum tubes, new/used tested. Prices below AES! www.freeyellow.com/members5/tubes2000/index.html. Robert Taylor, PO Box 10503, Bradenton, FL 34282. (941) 751-1072

FOR SALE: Have 1,500 nice transistor radios. Will sell one or all. Doug Ferrero, WB8YNZ, 70173 Hillside Ct., Romeo, MI 48065. (810) 336-0120. E-mail: ynzdsd@bignet.net

VACUUM TUBES WANTED

(920) 208-0353

(All tubes are subject to testing and inspection)

WESTERN ELECTRIC:

VT-2 / 205A/B \$225 NOS, \$110 used
VT-25 \$50 NOS, \$25 used
VT-52 \$150 NOS, \$75 used
101D / 101F \$175 NOS, \$100 used (TB)
101D / 101F \$40 NOS (ST)
102D / 102F \$175 NOS, \$100 used (TB)
102D / 102F \$35 NOS (ST)
205D/E \$425 NOS, \$275 used (TB)
205F \$200 NOS, \$100 used
211A/D/E \$300 NOS, \$175 used
212A/D/E \$750 NOS, \$300 used
216A / 217A \$175 NOS, \$90 used
228A \$100 NOS, \$50 used
231D / 257A / 281A / 349A \$50 NOS
242A/B/C \$200 NOS, \$100 used
244A / 249A \$25 NOS
252A \$1100 NOS, \$650 used
261A \$150 NOS, \$75 used
262A Balloon / 275A \$90 NOS, \$50 used
262B \$40 NOS, \$15 used
264A/B/C \$30 NOS, \$15 used
274A / 274B \$210 NOS, \$110 used
274A / 274B \$250 NOS engraved base
276A \$100 NOS

300A / 300B \$850 NOS (engraved base)
300B \$550 NOS, \$275 used (1950-60's)
310A / 311A \$20 NOS, \$10 used
331A / 367A / 272A \$45 NOS
348A \$80 NOS, \$40 used
350B \$200 NOS, \$100 used
345A / 352A \$25 NOS, \$13 used
412A / 418A \$10 NOS
417A / 420A / 5755 \$10 NOS
421A / 422A \$35 NOS
347A / 437A \$75 NOS, \$38 used
US & EUROPEAN TUBES:
2A3 RCA \$42 NOS, \$20 used
2A3 Single-Plate \$175 NOS, \$100 used
10 Balloon \$70 NOS, \$35 used
10 Balloon "Meshplate" \$100 NOS

112A Balloon \$25 NOS, \$13 used
26/226 Balloon \$10 NOS, \$4 used
45/245 Balloon \$60 NOS, \$30 used
45 Balloon "Meshplate" \$110 NOS
50 Balloon \$200 NOS, \$110 used
50 Balloon "Meshplate" \$275 NOS
71A Balloon \$25 NOS, \$13 used
80/280 Balloon \$30 NOS, \$13 used
211 RCA / United \$110 NOS
800, 808 RCA \$40 NOS, \$20 used
845 RCA \$200 NOS, \$85 used
5691 Red Base \$18 NOS, \$10 used
5692 Red Base \$35 NOS, \$18 used
6550 Tungsol \$60 NOS (ST)
7189A US Brands \$10 NOS
7591A \$30 NOS, \$15 RCA used
616GC RCA Black Plate \$30 NOS
12AX7 Telefunken \$15 used
12AX7 RCA \$8 NOS
5AR4 Mullard \$35 NOS
EL34 Mullard \$60 NOS, \$30 used
EL37 Mullard \$60 NOS, \$30 used
KT66 Genalex / Mullard \$70 NOS
KT77 Gold Lion/GEC \$120 NOS
KT88 Gold Lion/GEC \$150 NOS

TUBE WORLD, Inc.

2712 Superior Ave.
Sheboygan, WI 53081
(920) 208-0353 Phone/Fax

Call, Fax, Write or Email for our
detailed "Want to Buy List"
Email: tekman@tubeworld.com

Announcing
A.R.C.'s Expanded Web Site Including
★ CLASSIFIED ADS ONLINE ★

www.antiqueradio.com

Target Date — July 1, 1999

Look for your password
on this month's address label.

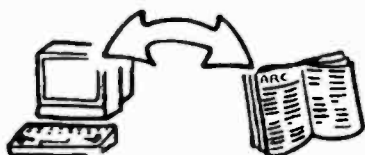

New Features!

Searchable Classified Ads for Subscribers Only
Searchable Past Auction Prices
An Improved Searchable A.R.C. Store

Standard Monthly Additions

The Cover, On The Cover, Editor's Page
One or More Feature Articles (Web Editions)
Book Reviews, Radio Miscellanea
Coming Radio Events & Mark Your Calendar
Radio Club Listing (over 80 clubs, worldwide)
Links to Over 200 Related Web Sites

Archives on the A.R.C. Web Site

Nearly Four Years of Web Editions of A.R.C.

The A.R.C. Web Store

Subscribe and Renew
Order From Over 90 Books and Videos
Request a Free Sample Copy

Also on the A.R.C. Web Site

Frequently Asked Questions (FAQ) about A.R.C.
E-mail A.R.C. With Your Ads and Comments

A.R.C., P.O. Box 2, Carlisle, MA 01741. Tel: (978) 371-0512
Fax: (978) 371-7129 – E-mail: arc@antiqueradio.com – Web: www.antiqueradio.com

FOR SALE: Tubes various types (n9tew tubes) web site <http://www.jorsm.com/~n9tew/tubes/tube-index.htm> or e-mail me at: n9tew@jorsm.com. Bob Bieker, 9528 Farmer Dr., Highland, IN 46322. (219) 641-5748

FOR SALE: Many N.O.S. and used radio tubes, very reasonable. Send or call with wants. Jim Lammers, RR1 Box 1675, Urbana, MO 65767. (417) 993-5802. E-mail: rainbow@positech.net

FOR SALE: Zenith transistor Model 500H chassis 8HT4022, white, works - \$100 plus. Zenith clock radio Model L520, brown, vg and works - \$30 plus. Philco Model 47-204 table radio, leatherette, nice, works - \$30 plus. Elwood F. Hunt, 308 Georgetown Rd., Cameys Point, NJ 08069. (609) 299-5259

FOR SALE: Audio gen. Eico 377, Heath AG-7 w/ manual, exc cond - \$30 ea. David Boardman, 10 Lemaistre, Sainte-Foy, Quebec, Canada G2G 1B4. (418) 877-1316. E-mail: davidboardman@sprint.ca

FOR SALE: Vintage radios, radio components, tubes, and cameras. Send SASE to: Bill Leggott, Box 501, Bowmanville, Ontario, Canada L1C 3Z2

FOR SALE: Tested globe/balloon shape tubes: 24-\$3; 26-\$9; 27-\$8; 45-\$40; 47-\$15; 56-\$12; 71A-\$26; 80-\$28. Jeff Arndt, 1215 Division St., Manitowoc, WI 54220-5734. (920) 684-8830

FOR SALE: Tube tester, U.S. Army ESPY 1-177A vg, works - \$75 plus UPS. Kenneth Miller, 10027 Calvin St., Pittsburgh, PA 15235. (412) 242-4701

FOR SALE: Wattmeter: Westinghouse Type PY-5; DC to 1000 CPS; 0-1500 W; max. ratings 7.5A & 400 V; 1/2% accuracy. Dan Kripe, 3750 Highgrove Ln., Nampa, ID 83687. (208) 888-9575

FOR SALE: Antique Mazda light bulbs - \$10 ea. plus postage. Joseph J. Jordan, 57 Waverly St., Jersey City, NJ 07306. (201) 963-4625

FOR SALE: Hopalong Cassidy, no back - \$400. Arborphone (round comers battery set) - \$100. Colin B Kennedy Model XV Type 430 - \$450. Tube tester TV-7D/U - \$200. Tube tester I-177B - \$75. Frank L. Brewster, 2020 W. 5th, Baxter Springs, KS 66713. (316) 856-3220, eves.

FOR SALE: Need speaker? We have them. Give size for price. Robert Haan, 2885 E. Beltline, Grand Rapids, MI 49525. (616) 364-5735

FREE - 20 WORD AD EACH MONTH
To get your free 20 words,
include your SUB# with your Ad.
Additional words are 29¢ each.
Read inside back cover for details.
MANY THANKS!!!!

FOR SALE: Samson copper plate variable condensers dated 1926 N.I.B. - \$12 ea. + shipping. Leroy Marshall, 1178 Foxboro Ln., Bartlett, IL 60103. (630) 483-8833

FOR SALE: Tube sale. All new old stock unless noted. Box TV and radio tubes mostly TV approx. (200) tubes for - \$75. Box of (22) one volt tubes for older portables - \$25. (2) boxes older radio tubes, each box - \$75 or both for \$125. Box of (35) older misc radio tubes - \$45. Box (200) or more used tubes - \$50. Add shipping to all. Maurer Television, 29 S. 4th St., Lebanon, PA 17042. E-mail: radiobks@aol.com

FOR SALE: My collection of tubes. About (300) two number types and (3,500) others. A deal for someone that can stop by on vacation to pick up. Call before 8 pm. Willie Carr, N4XE, 2739 Colonial Ave., Roanoke, VA 24015. (540) 343-5606

FOR SALE: Very small Emerson 201 two-tone Ingraham cabinet, vg, plays (M.A.J.A. 1, p. 82) - \$90. John Koop, 48 Wheelbarrow Ln., Wantagh, NY 11793. (516) 731-6711

I buy Western Electric

"What do you want to sell me today?"



Chong Ong

Tel : (703) 255-3218
Fax : (703) 255-3718
e-mail : ongkt88@erols.com

10223 Valentino Dr. # 7304
Oakton, VA 22124

WANTED: Stewart-Warner 525 radio. Need not work, cabinet fair, chassis all there. Ron Robinson, 2200 Ely Ave., Columbia, MO 65202. (573) 445-3772. E-mail: george11@earthlink.net

WANTED: Zenith Trans-Oceanic G-500 complete, 100% mint condition. Photo appreciated, will return. Kenneth F. Cervia, 3851 Harbor Heights Dr., Largo, FL 33774-1209. (727) 584-6471

WANTED: Schematics/data/parts for wire recorder Model 50 by Utah Radio Products of Chicago, Ill., device # 13-A-3b. Bryan Hodgson, 14 Evergreen Dr., Voorhees, NJ 08043-1504. (609) 424-0312

CLASSIFIED AD NOTICE

Please check your ads carefully before sending them in. Once ads are received, it is not always possible to refund the amount sent, pull the ad or make changes.

WANTED: H.H. Scott 333 tuner in good condition. Mal Fuller, 624 N. Main St., Wolfeboro, NH 03894. (603) 569-1946, evenings

WANTED: Knobs for Crosley D-25. Looking for both left and right (vol/tuner) front knobs and also one of the small setting knobs for clock. Need white color. Peter Aaron, PO Box 136, Cooper Station, New York, NY 10276. E-mail: ap4469@aol.com

WANTED: WWII walkie-talkies BC-611 and BC-721. Bill Jewell, 3800 Ridgehaven Rd., Fort Worth, TX 76116. (817) 377-4664. E-mail: OldRadios@aol.com

WANTED: For green Crosley dashboard radio D25CE, back cover dial pointer 2 knobs or buy junker. Maurer Television, 29 S. 4th St., Lebanon, PA 17042. E-mail: radiobks@aol.com

WANTED: Hallicrafters S-27B frequency coverage 36 MHz to 165 MHz, must be clean to mint. Thomas Dziadus, 2058 Fox Pointe Dr., #2D, Aurora, IL 60504. (630) 236-3965

WANTED: Detrola consoles, with phonograph and without. Detrola tabletops 120, 125, 126, 127. Scott Flaughner, 41100 Plymouth Rd., Plymouth, MI 48170. (734) 737-4221. E-mail: scott.flaugner@unisys.com

WANTED: Hickok Cardmatic tube tester, Model 123R or similar, with cards. Cash or trade. Steve Leffel, 1790 Edison St., Green Bay, WI 54302. (920) 465-1855, evenings

WANTED: Operating instructions for Wilcox Gay Model 8AJ10 Recordette. John Phipps, 1412 Navaho Tr., St. Charles, MO 63304

WANTED: UTC (A/H/ALS), WE111C, Triad RA6, Skully 280 electronics, old broadcast equipment, old product literature, catalogs, manuals (recording, broadcast), trades. Mark Hughes, 13500 Vandalia Dr., Rockville, MD 20853-3818. (301) 962-6823. E-mail: MarkHugh@aol.com

WANTED: Tube tester manuals: Weston 978, Weston OCL, and Hickock AC-51 or AC-51X. Radio Relics, Charles Kirsten, 15556 Sandra Ln., Sylmar, CA 91342. (818) 364-0491

WANTED: Crosley 527 radio, any cond., need knobs, spkr, etc. Ads showing these radios. Zenith T-O 7G605, 7000. Saba table radio. Clem Petrick, RR1 Box 79, Portland, ND 58274-9730

WANTED: Bendix Model 853 and 953 radios. Radios need not work. Aaron Mall, 903 Dropleaf Ct., Baltimore, MD 21208. (410) 486-8813

WANTED: WWII Japanese military radio of any kind; anything WWII Japanese military hardware, especially aircraft related. Takashi Doi, 1-21-4, Minamidai, Seyaku, Yokohama, 246 Japan. Fax: 011-8145-301-8069. E-mail: taka-doi@a2.ctktv.ne.jp

WANTED: Horn speaker bases with operational drivers for Magnavox M-1 and Atwater Kent M. John R. Crist, RR 1 Box 4, High Hill Rd., Earleton, NY 12058. (518) 731-9375

WANTED: Still looking for 4-tube chassis to fit Peter Pan/Jackson Bell. Also want speaker for Philco 89B. Byron Bemor, 33855 McEnery Cyn, Acton, CA 93510. (661) 269-5459. E-mail: rajo@prodigy.net

WANTED: Antique medical, scientific devices, fans, Deco clocks and radios, horn phonographs. Richard Cane, 1333 N.W. 127th Dr., Sunrise, FL 33323. (954) 846-7116. Fax: (954) 846-7973. E-mail: rbcane@m8.sprynet.com

TUBES BOUGHT & SOLD
INDUSTRIAL • POWER •
RECEIVING • SPECIAL PURPOSE
 Vast Inventory • Connectors
 Contact: Donna - Sales Manager
UNITED ELECTRONICS CO. (EST. 1934)
 1177 McCarter Highway, Newark, NJ 07104
 (973) 751-2591 • (800) 526-1275
 Fax (973) 481-1524 • E-mail: dloc111111@aol.com
Tube manufacturing equipment for sale. Engineering specifications, drawings & manufacturing data available for 100+ United Electronic Company's tube types.

NEW QUALITY CAPACITORS:

Volt 630 Axial Leads			
Part Number	Value (UF)	*Price/25	**Each
.001-630-AL	.001	\$ 6.00	24¢
.0047-630-AL	.0047	\$ 6.25	25¢
.0068-630-AL	.0068	\$ 6.35	25¢
.01-630-AL	.01	\$ 6.50	26¢
.022-630-AL	.022	\$ 7.00	28¢
.033-630-AL	.033	\$ 7.25	29¢
.047-630-AL	.047	\$ 7.50	30¢
.1-630-AL	.1	\$ 8.00	32¢
.22-630-AL	.22	\$ 15.00	60¢
.47-630-AL NEW	.47	\$ 20.00	80¢

ELECTROLYTICS:			
Volt 160 Axial Leads			
22-160-AL	22	\$ 16.00	64¢
33-160-AL	33	\$ 21.00	84¢
47-160-AL	47	\$ 24.00	96¢

Volt 450 Axial Leads			
10-450-AL	10	\$ 18.75	75¢
22-450-AL	22	\$ 28.00	\$1.12
47-450-AL	47	\$ 45.00	\$1.80
47-450-AL10	47	\$ 20.00 (per 10)	\$2.00

To order, Send Check or Money Order to:
BOB'S ANTIQUE RADIOS AND ELECTRONICS
 111 East 29th Street La Grange Park, Illinois 60526
 Telephone: (708) 352-0648 / Fax: (708) 352-0647
 Ask About Super Bulk Rates/Sorry No Credit Cards or C.O.D.'s
 Shipping & Handling included in price. **Comparison price only.
 *Sold in 25 piece lots - Wholesale Only - No Minimum Order

FOR SALE: IC 820H VHF-UHF all mode transceiver serial #02143. Frank L. Brewster, 2020 W. 5th, Baxter Springs, KS 66713. (316) 856-3220, eves.

FOR SALE: (1) Crosley cat Model 124, no chips or warps - \$380 + S/H. (1) Sprague TO6 - \$85 + S/H. (1) Sprague TO4 - \$75 + S/H. (1) Century Con. res. analyzer - \$50 + S/H. (1) Heathkit Model 1T28 - \$50 + S/H. (1) Eico Model 950B res-cap. bridge - \$40 + S/H. (1) Heathkit cap. tester Model CT1 - \$25 + S/H. All above testers are like new, working, with manuals. Carlos Gimenez, 15091 Shamrock Dr., Fort Myers, FL 33912. (941) 482-0198

**E-MAIL ADDRESS FOR
ANTIQUÉ RADIO CLASSIFIED
ARC@antiqueradio.com
Ads - Subscriptions - Book Orders
See inside front cover for details**

FOR SALE: Aims guitar amp with (4) speakers. (4) tube caddys and (600) N.O.S. tubes. Emerson 518 radio. High voltage probe. Heathkit: AR2 communication receiver; audio analyzer AA1; stereo hi-fi preamp AA141; hi-fi tuner AJ-31; FM multiplex stereo adaptor. Leslie speaker drum, motor. Bill Coolahan, 1450 Miami Dr. NE, Cedar Rapids, IA 52402-2933. (319) 393-8075

FOR SALE: Loewe Opta R158 radio; B-T Bakelite 1950s UHF converter; Radio Shack bicentennial radio; original 1958 manual for Heathkit XR1P, XR1L; WLS 194825th anniversary book; Cannon Chief headphones; Lionel 1014 transformer; used globe tubes, SASE. **WANTED:** Motorola 7VT1 or 9T1 TV. Also other 7-inch TVs. Charles Harper, 2000 Jackstown Rd., Paris, KY 40361. (606) 484-9393

FOR SALE: Microphone book, History of Identification and How They Work, 300 pp. - \$29.95 ppd. Victor Bang, Video Tech, 7520 S. Rural Rd. #3, Tempe, AZ 85283. (602) 491-1811

FOR SALE: Teac X10R tape deck with Dx2a DBX unit - \$435. Thomas Peters, PO Box 3925, McAllen, TX 78502. E-mail: oskimo@juno.com

FOR SALE: Hallicrafters SX 140 - \$120. Zenith Trans-Oceanic H500 - \$130. Marantz 23 tuner - \$95. William Dahlgran, 3095 Evelyn St., Roseville, MN 55113. (651) 639-0331. E-mail: dahlgran@net-info.com

FOR SALE: 25th edition 1961 Radio Master book, 1,598 pages - \$25 delivered. SASE list. Tom Tetzlaff, 23 Nelson Dr., Silver Bay, MN 55614. (218) 226-4192. E-mail: catt@lakenet.com

FOR SALE: RCA B&W TV Model 8PT7034, white/gold trim, tilt stand, case - \$175 + ship. Paul Harnetty, 4805 Parkmoor Dr., Westerville, OH 43082. (614) 882-1979

FOR SALE: Transmitting air capacitors, all sizes, variable, fixed. List, SASE. Bill Riley, W7EXB, 863 W. 38th Ave., Eugene, OR 97405-2375. (541) 345-2169

FOR SALE: Send SASE for Philco or AK radios. H.N. Felder, 7517 Granada Dr., Bethesda, MD 20817

FOR SALE/TRADE: Arvin portable transistor Mod 9562 with front, back dial - \$45 plus UPS. Paul Fulton, 711 Jacquelyn Rd., Westwood, NJ 07675. (201) 664-5260

FOR SALE: Books: Basic Electronics Training Course by U.S. Navy - \$20 plus; Ghirardi Radio Physics Course 2nd edition, hardback - \$20 plus; Radiotron Designers Handbook, 3rd Edition, hardback - \$20 plus. Elwood F. Hunt, 308 Georgetown Rd., Carneys Point, NJ 08069. (609) 299-5259

FOR SALE: Polydyne, Royal Radio Corp. 1924 small wood table, extra nice, all original, working - \$130. Metrodyne Super Six, table, nice condition, working, plays well - \$115. Precision signal generator E-200, nice case & front panel, working, 6-bands, kilocycles & megacycles - \$30. Russell Barker, 28 Franklin St., Holliston, MA 01746. (508) 429-5499

BUYING NEW AND USED TUBES

We desperately need the following tubes. They must be noted USA or European brands such as RCA, GE, Sylvania, Tungsol, Phillips etc... All new tubes must be in original boxes. *We pay shipping.* Payment will be made within 10 days of receipt. We also **SELL** tubes. Send for our **FREE** catalog at the address below.

NEW TUBES

11L6.....18.00	6BQ5(USA).....6.50	6JB6.....10.00	7G7.....1.75	76.....4.25
2A3(RCA).....30.00	6CA7(USA).....16.00	6JE6/6LQ6.....22.00	12A.....15.00	82.....6.50
2A6.....2.00	6D10.....2.00	6JS6C.....19.00	12AX7(USA).....2.50	83V.....3.50
2A7.....2.00	6DA6/EF89.....2.75	6KD6.....16.00	12AX7A(USA).....4.00	801A.....16.00
2B6.....5.00	6EM5.....1.50	6L6GC(USA).....15.00	12DW7.....9.00	866JR.....6.00
2DF4.....10.00	6F5G.....7.00	6LB6.....11.00	20L6F.....26.00	5692(RED).....30.00
5AR4/GZ34.....24.00	6F6.....2.00	6LF6.....22.00	26LX6.....6.00	6146B.....12.00
5Y3GT.....1.00	6F6GT.....2.50	6LR6.....15.00	26Z5W.....2.50	7025(RCA).....7.00
6A8G.....3.50	6G5/6U5.....16.00	6Q7G.....3.00	27.....3.50	7189A(USA).....8.75
6AD6G.....8.00	6GM5.....6.00	6SU7GT.....2.00	30.....3.00	7591A.....28.00
6AJ8.....2.50	6HR6.....2.75	6T5.....25.00	30MB6.....6.00	8417.....25.00
6B4G.....10.00	6HS6.....3.50	6V6G.....6.75	50A1.....16.00	8950.....35.00
6B5.....8.00	6HU6.....2.00	6V6GT/A(RCA).....6.00	56.....2.00	FM1000.....2.00

USED TUBES

01A.....6.00	6L66GC.....2.00	31.....1.00	240.....9.00	UX199.....13.00
2A3.....12.50	6Q7G.....1.00	59.....1.50	245(RCA).....30.00	UX201A.....6.50
2A6.....1.00	12A.....7.50	82.....2.75	247.....9.00	CX301A.....6.50
2A7.....1.00	26.....2.00	183/483.....11.00	282.....12.50	8417.....9.00
6A8G.....1.00	30.....1.00	210.....30.00	UV199.....15.00	8950.....13.00

ELECTRON TUBE ENTERPRISES 11 LINDEN LN BOX 8311 ESSEX, VT 05451



TEL: 802-879-1844

FAX: 802-879-7764

Manage Your Radio Collection the Smart, Fun Way with Collector's Choice Software



Three software packages in one

-  **Organize your collections:** Store all the important information about each item in your collection including make, model, style, year, condition, and color. Plus photographs that display automatically when you view your collection's entries. Create your own information or use pre-made templates.
-  **Maintain financial tracking:** Keep up with the purchase information — who, when, where and how much. Also market values and book values, selling dates and prices. You can manage up to ten different collections and still view a financial analysis for all at one time!
-  **Organize your contact information:** By *Business* or by *Person*. Either way, you'll have full contact information on everyone you sold to or purchased from.

Call today to get your copy of Collector's Choice
and get FREE support and upgrades for and entire year!

Low intro rate:
Only \$29⁹⁵



Visa and Mastercard accepted.
Orders ship within 48 business hours!

Shipping and handling: \$7.00

(407) 566-0677

Requirements:
Office97 and Windows 95/98

Collector's Choice • P.O. Box 470341 • Celebration, FL 34747-0341

FOR SALE: Grebe Synchrophase manual (copy), 74 pages, contains history, specifications, illustrations - \$15 + postage. Weltron 2001 space helmet radio, AM/FM, 8 track, nice - \$100. Realtone Globepacer, 11 bands - \$75. Radiola III - \$85. Ernie Nagy, PO Box 822, Elk Rapids, MI 49629-0822. (616) 264-9412. E-mail: elnag1599@webtv.net

FOR SALE: Meyers tube & base - \$70. (2) Catalin knobs, cream & beige, and (11) small push knobs - \$65. Kellogg 401 tubes - \$25. (7) National Union books, all - \$125. Carl Knipfel, 200 Langhorn, Morton, IL 61550. (309) 266-9440



FOR SALE: More Crosleys! Crosley Model 5-38, the early version with pointer dials. All there in very nice condition and with tubes - \$140. Crosley-DeForest Model C5, nice looking, unusual piece in excellent condition, with tubes - \$165. Crosley Model RFL-90 restoration project, small console version, missing the wooden legs, everything else there including the tubes - \$95. Kirkman (KE) horn speaker, nice, works - \$155. Dave Crocker, 4B Beechwood Point Dr., Mashpee, MA 02649. (508) 477-1578, before 9 pm please

FOR SALE: RCA 45 record player with amp Model 45EY3, very nice, does it all but sound is weak - \$100 plus. Elwood F. Hunt, 308 Georgetown Rd., Carneys Point, NJ 08069. (609) 299-5259

FOR SALE: Original manuals for Dynco PAS-2X and ST70 - \$25. (2) Eico 1060 battery eliminators/power supplies - \$25 ea. (2) EL34/6CA7 N.O.S., Los Gatos brand - \$30 ea. 6L6 quad matched Sylvania N.O.S. - \$80. Craig Huffman/Richard Mullen, 5020 West Ave., Ashtabula, OH 44004. (440) 992-0562 or (440) 998-1475. E-mail: huffmanc@usa.net or richardmullen@webtv.net

FOR SALE: If there is enough interest I will be starting production in the next few months on: Amrad screen - \$25 ea.; Emerson 520 ivory knob - \$30 ea.; a package of (2) cat's whiskers, (1) tapered and (1) straight wound for - \$5 pkg. Shipping approx. \$2 ea. Kevin Curley, 2932 Dwight Ave., Dayton, OH 45420-2610. (937) 256-1494. E-mail: kcurleyihs@compuserve.com

(818) 786-2500

Now Available
 1941 Phlco Eaculcheon Reproductions
 \$29.95 + \$3.00 Shipping & Handling (send a money order)
Injection Molded Marbleized Brown Plastic
 Fits Models: 41-250, 255, 256, 280, 285, 287, 290, 296

Old Time Replications 5744 Tobias Ave., Van Nuys, CA 91411
 CA Residents, please add 8.25% sales tax

FOR SALE: Zenith 511W - \$35. L515 - \$30. Webster wire player - Best Offer. Spools of wire - \$10 ea. Norman Landis, 1315 Marbendale Ct., Kirkwood, MO 63122-6932. (314) 821-7933

FOR SALE: Two DeForest training incl. binders with training lessons for radio & TV - \$110 postpaid lower 48. Darrell Combs, 6587 Pacheco Way, Citrus Heights, CA 95610. (916) 969-0635

FOR SALE: German WWII civil radios. G.W.H. Faassen, Heideweg 1, 5953 TL Reuver, Holland. Tel.: 0031-77-474-1316. Fax: 0031-77-474-6683

FOR SALE: Victrola 4 windup portable phonograph, Model 2-60, circa 1925, w/12 records - \$300; Hallicrafters S-94 Civic Patrol, nice, with bottom and back - \$65; Fisher Scientific Variac meter, 120 & 140 V - \$65; (2) Astatic D-104 mics, w/TUG8 stand and cord - \$70 ea.; (2) Zenith 500 transistors, (2) Zenith 200 transistors, all for - \$190 or make good offer or trade; Western Electric black rotary dial phone, has leather pads for feet - \$50; Majestic Model 130-A, 131 chassis - \$75, speaker, good cond. - \$65; Pakette Tiny Mite crystal radio with box and papers circa 1947 - \$75; Stromberg-Carlson AU 58 amp and PA, circa 1958, with cords - \$65; homebrew power supply with meter, 0-25 volts - \$35; Miller N.O.S., adjustable RF coils, RF chokes, transistor loops, 540-1650 KC adjustable, various others - \$10 - \$12 ea., or all (67) in original boxes - \$300; Western Electric headset, Model 52, nice - \$14 ea. or both for - \$25; Knight Star Roamer, needs work - \$55; Westinghouse 15-transistor, Model 5020, with owners manual and earphone, looks nice, not tested - \$45; Lafayette Dynacom, hand-held 23-channel CB, works - \$65; GE transceiver, Model Y7060, CB/CB, needs mic - \$40; Dumont Voltage Calibrator, Type 264B - \$35; Heath VOM, Model V7 - \$20; Knight cap checker, good eye tube - \$22; RCA Radiophone CB, needs works, Model CRMP3A5 - \$30; Sams Original CB Servicing and CB Radio Antenna books - \$14 ea. or both for - \$25; GE Transistor Manual, 660 pgs. - \$25; 1930 RCA Victor Service Notes Handbook - \$35; Hallicrafters SX-71, for parts, call; Hammarlund Superpro power supply, military type, heavy (64 lbs) not tested - \$55; IRL Brand FSK 1000 RTTY - \$65; old push-button tank radio, 27-39 MC, as is - \$45; Quam Alnico V, N.O.S. speaker, with box, make good offer or trade; Dentron Super Tuner, Model 160-10AT (1KW) - \$100; military mic, Model T-32 - \$45; Heathkit SB600 power supply - \$90; B&K Precision CB signal generator, Mod 2040, with manual - \$125; 1939 Emerson Strad, Mod CL256 - Best Offer over \$650. All above + UPS or U.S. mail. Also see ad pg. 74, in April A.R.C. Ron Crowe, PO Box 117, Handley, WV 25102. (304) 442-8179. E-mail: rgcrow@wvnet.wvnet.edu

12 BAND MINIATURE SHORTWAVE RADIOS

7 x 1 1/2 x 5 inches. AM/FM/LW and 9 shortwave bands: 5.9 to 26.6 MHz. Built in 3 inch speaker, two antennas. Operates on 4 AAs or AC. Very sensitive, brings in the entire world from "Australia to Zambia." Price break-through! Only \$40 postpaid!

Mail your check or money order to:
 R.G.B. Enterprises, Dept. 71
 P.O. Box 5367, Old Bridge, N.J. 08857, U.S.A.
 Call 732-607-0299, Fax 732-679-8524
 E-mail: RGBENT@AOL.COM

WANTED: Battery holder for Sony CRF-1 multiband radio Part # 3-887-792-00. Billy Ray Wilcox, 6501 Leffingwell Rd., Canfield, OH 44406. (330) 533-2478 or (330) 782-2086

WANTED: Radio maps, pre-1940. Jon Kummer, 20 Harbor Rd., Port Washington NY 11050. (516) 944-0963. E-mail: jon@pcnet.com

WANTED: Stancor power supply, CH2134 with 8412 transformer and 1411 choke, 9" x 7". John Bullock, 660 E. Robertson Rd., Castalian Springs, TN 37074. (615) 451-2268. E-mail: bullockj@epenergy.com

WANTED: Chassis for Crosley Model 59 (also not complete). G.W.H. Faassen, Heideweg 1, 5953 TL Reuver, Holland. Tel.: 0031-77-474-1316. Fax: 0031-77-474-6683

**FAX NUMBER FOR
ANTIQUÉ RADIO CLASSIFIED
(978) 371-7129 – 24 hours a day
Ads – Subscriptions – Book Orders
See inside front cover for details**

WANTED: McMurdo Silver Model 904 capacitance resistance bridge for parts. RCA Victor RE-57 door pull. Robert Blakesley, 5134 Garfield, Kansas City, KS 66104. (913) 287-9853

WANTED: To buy. Equipment and info related to AN/ARN-6 radio compass. Jim Cavan, 6 Timberline Dr., Norfolk, MA 02056. (508) 528-0908. E-mail: jcavan56@aol.com

WANTED: Front panel for Grebe CR-5, or junker set with unbroken panel. Dave Cheney, 338 Arlington Cres., Beaconsfield, Quebec, Canada H9W 2K3. (514) 694-3240. E-mail: cheney@total.net

WANTED: Manuals for AM demonstrators (receive, transmitter, power) made by Welch Scientific. Will pay for copy or original. Art Sabin, 315 S. Plymouth Ct., Chicago, IL 60604. (312) 987-1441. E-mail: 7sabin@jmls.edu

WANTED: Information on Merle Duston, Duston Radio Laboratories, Inc. Federal Radio Trade School. Richard Dzick, 31572 Juniper Ln., Warren, MI 48093. (810) 268-4671. E-mail: n8mq@aol.com

WANTED: Source for metal knob caps for H H. Scott beer barrel style knobs. Mal Fuller, 624 N. Main St., Wolfeboro, NH 03894. (603) 569-1946, evenings

WANTED: Original lamp hood Radiola Model 17, 3-prong. L.H. Baumlin, 129 Azalea Dr., Harwich, MA 02645-1721. (508) 430-0197

•••••
**• OLD TIME RADIO BROADCASTS
• ON CASSETTES**
•••••

• Many of your old time radio favorites are
• available on quality cassettes at a reasonable
• cost. You select the shows you want and purchase
• them by the hour. Fast, friendly service
• too. Send for our catalog listing over 5,400
• shows arranged by show category & title,
• many including original broadcast dates.

• Only \$2.00 (P & H). Send request to:

• **ERSTWHILE RADIO — P.O. BOX 2284**
• **PEABODY, MA 01960**
•••••

WANTED: Electron tubes, ball bearings, radio & aircraft receivers & transmitters, connectors, lamps, relays, switches, breakers. Hy Ness Company, 709B Delair Rd., Cranbury, NJ 08512-4212. (609) 395-1116. Fax: (609) 395-1117



WANTED: Motorola Catalins. I have been commissioned by the Almighty Himself to gather as many of these wonderful jewels for preservation before judgment day is upon us. For sake these worldly objects before it's too late! I pay cash. Please write or call collect: Rain Buttignol, 214 State St., #7, Portsmouth, NH 03801. (603) 427-1384

WANTED: Sony TR-63, Sony TR-52; any kind of Japanese-made transistor radio which used with oval transistor. Takashi Doi, 1-21-4, Minamidai, Seyaku, Yokohama, 246 Japan. Fax: 011-8145-301-8069. E-mail: taka-doi@a2.cktv.ne.jp

WANTED: Brook audio amplifiers. National: dog-house power supplies Mod 697, 5856, 5886-AB, 5886 version II. HRO-50 coils A, E, F, G, H, J. National 1-10 complete coil set. Will trade for above coil sets, National HFS and RAS complete coil sets. Sams: Audio Amplifiers AA-2, 3, 6, 7, 8; Servicing Hi-Fi, Vol. 1 and 2; Auto Radios AR-2, 7-10. Jack Ellis, 7607 Ensley Dr., Huntsville, AL 35802. (256) 881-6646. E-mail: rje@arnet.net



*Craig L. Graybar
Furniture Works Ltd.*

(414) 258-2390 or (888) 383-2390
SPECIALISTS IN RESTORING,
REPAIRING AND REPRODUCING
CLASSIC STYLED ANTIQUE TV,
RADIO & PHONOGRAPH CABINETS

Send us your plans or your project
via UPS for immediate price quotes



1535 S. 84th St.
West Allis, WI 53214



"We Turn Ideas Into Heirlooms"

Collector's Guide to Antique Radios Combined Edition – CD-ROM

By Marty & Sue Bunis and George Kaczowka

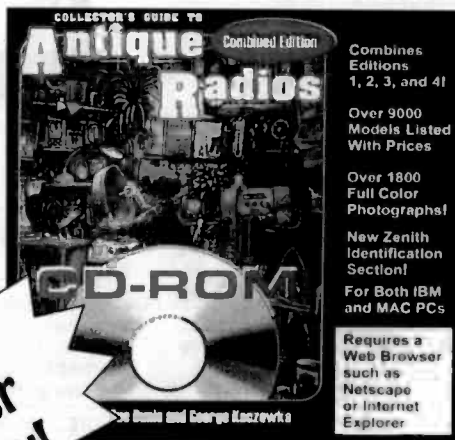

**NEW!
Order
Today!**

**Combines Book Editions 1, 2, 3, and 4!
Over 9,000 Models with Pricing
1,800 Full Color Photographs
Model Number Index for All Manufacturers
Photo Index by Category**

Runs on both IBM and Mac

Requires a Web Browser, such as Netscape Navigator or Internet Explorer

\$39.95

U.S. Orders - Enclose \$3.00 per order for packing & book-rate shipping if total order is under \$35.00. If using VISA or MasterCard, include name on card, card number and expiration date. Send payment with order. Mass. residents add 5% sales tax. Money back return policy. Softcover unless stated otherwise. Most orders shipped the same day received, but allow 2-4 weeks to receive order. Foreign orders - write for shipping costs, or use credit card and specify air or surface (allow 2-3 months for surface shipping).



A.R.C., P.O. Box 2, Carlisle, MA 01741. Tel: (978) 371-0512

Fax: (978) 371-7129 – E-mail: ARC@antiqueradio.com – Web: www.antiqueradio.com



(Mar-99)

The Collector's Guide To Antique Radios - 4th Edition

By Marty & Sue Bunis



**Order
Today!**

8,500+ Battery & AC sets from the '20s - '60s
400+ color photographs
Updated prices
\$18.95 - Softcover

There are no transistor radios listed in the fourth edition. You will find them in
The Collector's Guide to Transistor Radios available from A.R.C. for \$16.95.

U.S. Orders - Enclose \$3.00 per order for packing & book-rate shipping if total order is under \$35.00. If using VISA or MasterCard, include name on card, card number and expiration date. Send payment with order. Mass. residents add 5% sales tax. Money back return policy. Softcover unless stated otherwise. Most orders shipped the same day received, but allow 2-4 weeks to receive order. Foreign orders - write for shipping costs, or use credit card and specify air or surface (allow 2-3 months for surface shipping).



A.R.C., P.O. Box 2, Carlisle, MA 01741. Tel: (978) 371-0512

Fax: (978) 371-7129 - E-mail: ARC@antiqueradio.com - Web: www.antiqueradio.com



(Mar-99)

FOR SALE: Zenith Trans-Oceanic G500 made only one year - \$90. Crystal set, The Mighty Atom - \$19. Jim Montague, 1907 S. Stanley Ln., Spokane, WA 99212. (509) 535-9576

FOR SALE: Heathkit AR-2 - \$50. Fada P100 - \$30. Seminole 1101 - \$40. Universal PTR-62B - \$60. R. Allen, 399 Canterbury Tpke., Norwich, CT 06360. (860) 822-6096. E-mail: allens@99main.com

**HAVE YOU MOVED? ARE YOU MOVING?
PLEASE NOTIFY US A.S.A.P.**

SEND US YOUR...

OLD ADDRESS

NEW ADDRESS and

SUB #

MANY THANKS!!!!

FOR SALE: Radiodyne custom cabinets, mint in original shipping boxes, want - \$250 plus shipping. Frank Prince, 3316 10 Ave., Racine, WI 53402. (414) 639-9307. E-mail: radiolaman@pitnet.net

FOR SALE: Plastics technology, Swanson, Bakelite, Phenolics - \$25. AT&T telegraph, telephone operating manual, 1938 - \$18. Rich Yoch, 22410 Bartlett Dr., Rocky River, OH 44116. Phone/fax: (440) 331-9206

FOR SALE: Sams Transistor Manuals TSM, complete set of 159, all numbers, most unused and some shopworn - Best Offer. Can bring to Elgin, Lansing, Indianapolis, or Cincinnati meets or within a reasonable distance to your place. Bob Schaffbuch, 2811 Highland Ave., Carrollton, KY 41008. (502) 732-9650. E-mail: rjs@kih.net

FOR SALE: Watkins-Johnson WJ-8716, professional HF communications receiver, continuously tunable from 5 kHz to 29.99999 MHz, AM, CW, LSB, USB, and FM, beautiful condition with original owner's/service manual, asking - \$1,700. Steve Raycraft, 927 Fliggs Ave., Watertown, NY 13601. (315) 788-9323. E-mail: wb2kx@juno.com

FOR SALE: Stromberg Carlson 50 watt amp tube type, year 1950 - \$75. H. Eitz, WØJDT, 4265S Bladen, Juniata, NE 68955

FOR SALE: Three crystal detectors, MESCO spark coil, early MESCO catalog, Adams-Morgan slide tuner. Mike Heffner, 501 S. Market St., Muncy, PA 17756. (570) 546-2907. E-mail: jkmheff@aol.com

FOR SALE: Radio parts, books, radios, junk. Send SASE for 6 page list with photos. Phil Majewski, PO Box 92, Tamaqua, PA 18252

FOR SALE: Brown leather Trans-Oceanic A600L w/opp guide, brochure, extra 1L6, excellent - Offers til 6/17/99. Claude Chafin, NØFMO, 4223 E. 42nd Way, Independence, MO 64055. (816) 478-4518

FOR SALE: Clegg Zeus transmitter - \$300. Robert Braza, NIPRS, 23 Harvard St., Pawtucket, RI 02860. (401) 723-1603

FOR SALE: Emerson 250-AW, excellent cond, original - \$200. RCA Victrola 45-EY-3, Bakelite, excellent - \$50 plus shipping. Arthur Kreitner, 2013 East Belle Ave., Belleville, IL 62221. (618) 233-5610

FOR SALE: Riders radio volumes 1-13, volume 5 missing, some in fair shape, some in rough shape, all usable, all for - \$65 plus postage. Charles G. Phillips, Jr., 8607 Rembrandt Cir., Newark, DE 19702. (302) 832-9592

FOR SALE: Stancor Corporation Model P-6161 isolation transformer, 250 watts, good condition - \$25 plus shipping. Harry Cap, 190 Beech St., Bridgewater, MA 02324. (508) 697-8648

FOR SALE: Radiola IV, table, 1923, mahogany, rectangular case, left dial panel, inner right speaker, double door, (3) tubes, battery - \$850. Lemoyne Moulder, 1104 Indian Creek Dr., Lebanon, MO 65536-2021. (417) 532-5068

Tube Lore



A REFERENCE FOR USERS AND COLLECTORS

For the serious tube enthusiast, coverage of tubes from 1920 to today: tech data, history of design trends, equivalencies, stocking-up hints, "where-used" information, even auction prices on collectable types. Describes conventional gridded tubes used in radios, audio amplifiers, and communications gear, plus the unique types used in radar and other special applications. Contains 186 pages of material unavailable in conventional tube manuals: hints on identifying, dating, testing, reactivating, etc. It's softbound, 8-1/2" x 11" size.

Tube Lore is available from major antique-radio booksellers. It's also orderable directly, at \$19.95 postpaid in North America or \$24.95 postpaid elsewhere, from:

Ludwell Sibley
102 McDonough Rd.
Gold Hill, OR 97525

TUBE COLLECTORS ASSOCIATION FORMED!

This new group is now in operation. Started by dedicated collector-historians, it is international in scope, nonprofit, and noncommercial. It addresses tubes of all vintages and types. For a membership application and sample copy of *Tube Collector*, contact the club at PO Box 1181, Medford, OR 97501. Details are also available from Al Jones, W1ITX, on (707) 464-6470 or Ludwell Sibley on (541) 855-5207.



Cincinnati Antique Radio Society

Presents the Seventh Annual

RadioRama 99

A Show, Swap Meet, and Gathering for Antique Radio Enthusiasts
Cincinnati, Ohio - June 25 & 26, 1999

Host Hotel

Signature Inn

Turfway Road

Florence, KY 41042

(606) 371-0081

Continental Breakfast For Registered Guests

Exit 182 off I-75

10 minutes south of Cincinnati

2nd exit south of I-275

Turn Right Four Times To Hotel

A Block Of Rooms Is Reserved

Until June 11th Only !

Special Room Rate: \$55.00

Antique Radio Meet Must Be Mentioned

Within walking distance of many restaurants

Top Ten Reasons RadioRama is Better Than the Internet

10. Experience the fresh air and sunshine of the Mid-West
9. Handle and inspect each item in real time
8. Negotiate with a real human being
7. There is no shipping and handling charge
6. Instant fund transfers
5. No wooden splinters or broken glass in the shipping carton
4. No hunting for loose knobs in the styrofoam peanuts
3. No waiting to access a vendor
2. Experience fellowship with friends in the hobby
1. It is a mini-vacation with a free breakfast

Thursday

Hospitality Session 6:00 - 9:00 PM

In Lobby

Friday

Swap Meet Starts at Dawn

10:00 AM - Open Exhibition - "Pre-War RCA Radios"

2:00 PM - Caravan Tour - "Gray History of Wireless Museum"

7:00 PM - Seminar -

"Genuine Plastic Radios Of The Mid-Century"

Presented by Author

KEN JUPP

Saturday

Swap Meet Dawn Until Noon

Exhibition continues 10:00 AM - Noon

General Admission

\$5.00 per family (All one address)

Vendor Fee

\$15.00 per space which includes 2 general admissions.

Info: Bob Sands (513) 858-1755

FOR SALE: Hallicrafters R274D/FRR receiver (SX-73), 0.54 - 54 MHz; SX-96, Drake SSR-1, National: NC-183D, HRO-50T with AA, B, C, D coils. HP-331A distortion analyzer. Stoddard NM-30A. All good. **FOR TRADE:** Eddystone 830/4 for 830/1,2,3. **WANTED:** Brook audio amplifiers. Jack Ellis, 7607 Ensley Dr., Huntsville, AL 35802. (256) 881-6646. E-mail: rje@aimet.net

FOR SALE: Trade for breadboards or sell A.C. Dalton Model XL-5 gyro fan, nice, runs, all original - \$1,800. Plate glass radio, plays, all original - \$1,450. AK Model 20, small, ex-nice, plays - \$100. Lamp radio, American Chicago, black, lamp lg, red, shade, works - \$395. Trade for radios. Torpedo lamp radio, plays - \$150. Amateur light grey radio, 11-tube, like new - \$375. Transistor spark plug radio, plays, nice, AM - \$100. One AM-FM - \$125. (2) blue mirror clocks - \$200 both. (2) Catalin butterscotch - \$205. All clocks work. Edison Mabry, 402 Pearl Ave., Mansfield, OH 44907. (419) 525-0902

FOR SALE: Philco G4242 21" Predicta tabletop TV - \$135. Stromberg-Carlson 1243W Bakelite 40s telephone - \$40. Sam Mannino, PO Box 331, Villanova, PA 19085. (610) 353-6747

FOR SALE: Hicok 6000A tube tester, vg cond - \$130. Stromberg-Carlson 1105, parts - \$15. Thanks. Ed Kalpa, 4622 Melbourne Ave., Los Angeles, CA 90027. (323) 661-1221

FOR SALE: Two Lafayette citizen band walkie-talkies, nice with leather cases - \$30 pair plus. Elwood F. Hunt, 308 Georgetown Rd., Carneys Point, NJ 08069. (609) 299-5259

FOR SALE: New in box Thordarson transformer 1-24S50, 2-22S45 Greenlee chassis punch 5/8 7/8 1", all - \$100. Louis L. Veltre, 643A Sherwood Ct., Lakehurst, NJ 08733-4207. (732) 657-7592

ZENITH Philco
GOT
GRILLE CLOTH?

Check this out:

- ★ 12 Philco patterns
- ★ 8 Zenith patterns
- ★ Generic patterns
- ★ Majestic (Grigsby-Grunow)
- ★ Plus GE, RCA, Stromberg & Westinghouse

Send a 55¢ LSASE for samples and info to:
John Okolowicz, N3VSR
624 Cedar Hill Rd.
Ambler, PA 19002

or

See them on the web @
www.Grillecloth.com
E-mail: Grillecloth@compuserve.com

FOR SALE: Regency TR-1, black, no chips, minor scuffs, some wear on volume control near off position and around opening, complete but not playing - \$100 including shipping. Henry Loos, 210 Ingraham Ln., New Hyde Park, NY 11040. (516) 354-1943. E-mail: hcloos@webtv.net

FOR SALE: Seiko TV watch! Includes receiver and leather case, good condition, working - \$700. David Mednick, 10 Doe Dr., Wesley Hills, NY 10901-2302. (914) 354-5041. E-mail: davemed@acd-pc.com

RATE FOR ADDITIONAL WORDS:
29¢ per word
FIRST 20 WORDS FREE!

*Cash or stamps OK for small amounts.
Your payment helps to keep A.R.C. healthy!*

FOR SALE: Coronado wood table, AM/SW, 5 tubes plus eye, works - \$60 plus shipping. Jerry Wieland, 780 Charleston Ln., Hoffman Estates, IL 60195. (847) 934-1790. E-mail: Jerry_Wieland@email.mot.com

FOR SALE: Antique radio schematics plus data still only - \$3 postpaid. Joseph R. Forth, 321 Long Vue Acres, Wheeling, WV 26003. Ph/fax: (304) 277-3154. E-mail: wa2rt@juno.com

FOR SALE: Deforest Training Inc. 2" oscilloscope, RF signal generator, & box of test boards - \$200. Charles Bray, 1322 Ivy Rd., Bremerton, WA 98310. (360) 373-1013. E-mail: cbray@krl.org

FOR SALE: Zenith T/O D7000Y, 50MDR70, no cord or logs, charts & cord, works intermittently - \$100. Dick Stewart, 656 Squire St., Colorado Springs, CO 80911. (719) 392-9694. E-mail: stewartwcf@aol.com

FOR SALE: Philco #46-1201 - \$90. L-Tatro tombstone - \$85. Zenith 6G004Y portable - \$65. Ford #5MF - \$50. RCA WV-77E voltohmtr - \$10. Johnson Messenger #130A radio phone - \$15. Setchell Carlson #427 - \$65. Seco #107 mutual conductance tube tester - \$75. Zenith #A2A radionic hearing aid - \$35. Zenith phone magnet - \$45. Military #MEA multimeter - \$10. Philco D655 portable - \$10. Aiwa TP801 tape recorder - \$15. 1929 Radio News, 71 Lafayette Catalog, GE transistor manual & (2) CB books - \$20. New tubes: (5) 5U4s - \$10 ea.; (1) 6BQ5 - \$2.50; (1) 12BQ6 - \$1.50. Homebrew (1) tube - \$35. Gen. Elec. #GD60 - \$55. (2) Fisher Price phono, both - \$30. Sony #TC-123 recorder - \$20. Victor of Japan 6A2605 - \$45. Working chassis: AK #227 - \$75. Philco #20 - \$100. Philco #625 - \$80. Walt Wrabek, Rt. 4, Box 370, Menahga, MN 56464. (218) 564-4623

FOR SALE: Daven attenuation network, type VT795G, range to 111. Imp. 600 ohms - \$60 ppd. Carl Hackenson, 31 Hixson Farm Rd., Sharon, MA 02067. (781) 784-8834

FOR SALE: National FBX receiver, excellent condition, w/o tubes, 35-40 MC DET/OSC coils - \$50 + UPS. Martin Gottstine, 16 West Wind Dr., Topsham, ME 04086. (207) 729-7823

FOR SALE: Zenith T-O D7000Y, like new - \$400. Thanks. Ed Kalpa, 4622 Melbourne Ave., Los Angeles, CA 90027. (323) 661-1221

FOR SALE/TRADE: Manuals. Many out of print and hard to find amateur and test equipment manuals. Trade-sell-buy. A. J. Bernard, PO Box 690098, Orlando, FL 32869-0098. (407) 351-5536. E-mail: ni4q@juno.com

WANTED: Old headphones, headphone literature and phone plugs, one pair or entire collection. Bub Sukosky, 62 Strong St., Manchester, CT 06040. (860) 646-8857, 5-9:30 pm EST

WANTED: Hallicrafters SX-88, Hammarlund PPO-310, Lafayette HA-350. Takashi Doi, 1-21-4, Minamidai, Seyaku, Yokohama, 246 Japan. Fax: 011-8145-301-8069. E-mail: taka-doi@a2.ctktv.ne.jp

WANTED: Voice of Music parts, parts, parts! In the yellow envelope and boxes! Gary Stork, 37530 E. Meadowhill, Northville, MI 48167. (248) 478-099C

**IF YOUR EXPIRATION DATE IS
JUNE OR BEFORE, RENEW TODAY!
EARLY RENEWALS
RECEIVE AN EXTRA ISSUE!**

WANTED: Excellent original owner's manuals for 1942 Motorola portable, 61L11 & 61L12 and 1950 Crosley 10-135. Mike Hanke, PO Box 773, Wausau, WI 54402

WANTED: Loop antenna for Pries Straight 9 Nine or specifications for building one. Dale R. Johnston, 1305 Guadalupe Dr., Westminster, MD 21157. (410) 848-5279

WANTED: Philco 16 tombstone. Any King Kole paper mache Nippers. Phonograph horns and parts. John Yanalavitch, 153-19 75 Ave., Flushing, NY 11367. (718) 268-6413, leave message

WANTED: Grundig 97 WEI tabletop radio. Contact via e-mail. N. Ahmad, 34 Saccheri Ct., Staten Island, NY 10308. (718) 966-9018. E-mail: NA1050@aol.com

WANTED: Radio Boys books, Yaesu FRDX400SD, Knight T-50, Hammarlund HQ-145. Don Traves, PO Box 2114, Winter Haven, FL 33883-2114. E-mail: wb4cvh@ithink.net

WANTED: Adams Morgan Paragon open-frame audio transformer. Your price! Finalizing long-time restoration. Rick Ammon, 1249 Solstice Ln., Ft. Collins, CO 80525. (888) 473-2387. E-mail: wireless@verinet.com

WANTED: Your collection. If mostly pre-1927 items, it will pay you to contact me. Top prices also paid for scarce individual items. Receivers, transmitters, speakers, etc. Ed Bell, 5311 Woodsdale Rd., Raleigh, NC 27606. Fax/Ph: (919) 851-1517. E-mail: ekbell@mindspring.com

WANTED: Grunow 1541 teledial burlwood front folddown cover. John Mallery, 12309 W. 70th Ter., Shawnee, KS 66216. (913) 268-7135. E-mail: 73644.623@compuserve.com

WANTED: Payphones, 3 slot, Automatic Electric, Western Electric, any color. I pay highest prices. Stanley Schreier, 350 Hendrickson Ave., Lynbrook, NY 11563. (516) 887-4966. Fax: (516) 887-4780

WANTED: H.H. Scott TR13-2 power transformer as in most 299C amplifiers. Mal Fuller, 624 N. Main St., Wolfeboro, NH 03894. (603) 569-1946, evenings

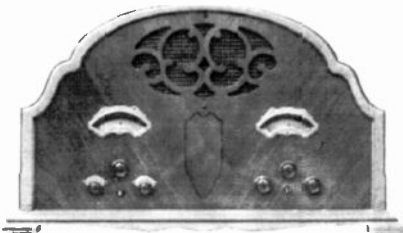

WANTED: The above Pilot radio, will pay up to \$1,500 or trade. Call. Bill Moore, 3049 Box Canyon Rd., Huntsville, AL 35803. (256) 880-1207

WANTED: Speaker for Zenith Model 9S262AT part no. 49-223 12". Charles A. Page, 7232 N. 26 Ln., Phoenix, AZ 85051. (602) 995-3867

WANTED: Hallicrafters TW1200/R1200 multiband portable and Panasonic RF8000, Braun T1000 MB and other high end SW portables, and Zenith Trans-Oceanic green military, like Model 600. And any Philips multiband SW. Thanks. Denis Burke, 308 Person St., PO Box 137, Runnells, IA 50237. (515) 966-2871. E-mail: Zeenith@msn.com

WANTED: Philco 41-81, 89C, portable w/strap. Ichiro Yamada, 10-21 Chiyodadai-cho, Kawachi, Nagano-shi, Osaka, Japan 586-0027. Ph/fax: 011-81-721-52-4695, mid/eve., local. E-mail: yamada1r@silver.ocn.ne.jp

BUY • SELL • TRADE

CATALIN RADIOS



I'll buy single pieces or
whole collections. Top prices paid.

RADIOART

Jim Meehan

P.O. Box 102 • Centerbrook, CT 06409

(860) 526-1762

E-mail: radioart@ntplx.net

S.A.R.S. SUMMER SWAP MEET

ATLANTA, GEORGIA

SATURDAY - JULY 17, 1999

Fairfield Inn - Alpharetta (same as last year)

11385 Haynes Bridge Road

(Exit 9, Ga. Hwy. 400)

From Dawn till 1:00 PM

Vendors - \$5.00

All others - Free!!!!

This is an outdoor, tailgate meet.

Info: Gordon Hunter (770) 475-0713

FOR SALE: Over forty tube radios and equipment. SASE for list. R.E. Versaw, 653 Peony Dr., Grand Junction, CO 81503. E-mail: rversaw@juno.com

FOR SALE: Lamp hood for your Radiola 18 - \$35. WRL Globe Scout transmitter, 680 - \$100. Mike Grimes, K5MLG, 3805 Appomattox Cir., Plano, TX 75023. (972) 867-6373

Classified Ad Deadline Noon

June 10 for July 1999 Issue

July 10 for Aug. 1999 Issue

Boxed, Photo, & Display Ads - 1st

FOR SALE: Tubes, parts, books/papers, radios. Sparton 417, GE GD-50, Graybar 310, others, 16 pp - 55¢ LSASE. **WANTED:** Chassis (pg. A.R.C. Sept. 98). W.F. Horn, 13110 Marsh Rd., Bealeton, VA 22712. (540) 439-9781. E-mail: wehcoll@tidalwave.net

FOR SALE: Stewart-Warner round end table radio, works - \$125. Mel-Tone cathedral radio, works - \$150. Drake SW8 shortwave radio - \$400. Canon EU-20V 8mm camcorder with case - \$400. Terma diathermy machine, large doctor's machine on wheels with pads, new tubes, works very well - \$175. Wayne F. Dimmler, 13 Midtown Rd., Carle Place, NY 11514. (516) 747-1325

FOR SALE: SW sale. Magnavox 4-band - \$75. Panasonic 4-band rare - \$75. GE 10-band - \$85. T-O 1000-1 - \$135. Sanyo SW/cassette - \$85. RCA 6-band - \$95. Ted Demski, 5806-225 Pl. SW, Mountlake Terrace, WA 98043. Ph./fax: (425) 778-7100

FOR SALE: Time and frequency receivers. Loran C, WWV, WWVB GPS - \$100 ea. Full measurement systems available with precision oscillators, software, etc. Please write indicating your interest. GS Electronics Co., 1270 Rock Creek Cir., Lafayette, CO 80026

Organize Your Basement!

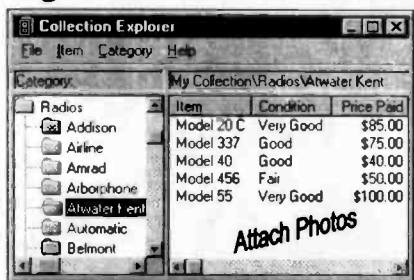

Collection Explorer: Track your radios, tubes, knobs, parts, and literature. *Windows Explorer* look and feel keeps things familiar. Organize your collection by category. Comes pre-loaded with many categories, and you can add unlimited categories of your own. Import/Export to/from other programs. **Print reports** by category or entire collection. You can even track multiple collections.

Also, create your own custom columns to hold text, dates, numbers, currency. Each item can also have its own memo to hold additional comments, and a photo attached.

For *Windows 95/98*. Send Check or Money Order for \$39US (plus \$3 S/H) to "EPS/Solutions", Radio Collection Software, PO Box 862, Broomall, PA. 19008-0862. Allow two weeks delivery. PA residents add 6% tax.

www.collectionexplorer.com/radios/

FOR SALE: Dynaco PAT-4 with ST-120 - \$175. Dynaco ST-120A - \$150. Fisher 600-T w/cabinet, horns - \$125. Walter Kiefner, 6233 51st Ave. NE, Seattle, WA 98115. (206) 526-1452

FOR SALE: Telephone, telegraph equipment, Victrola, longbox Zenith fair, Squires, Sanders, CB radio 23C. Paul Recupero, 265 Union, Ports, RI 02871. (401) 847-8589

FOR SALE: Ribbon microphone. Fostex 88RP bi-directional 40-18,000, new in box - \$700. Mark Schackow, 307 4th Ave. E, Lemmon, SD 57638

FOR SALE: Studebaker Philco Model S4627 radios for 47 thru 49 Champion and Commander cars - \$75 postpaid. Harry Schesnuk, Box 2162, Newport, WA 99156

FOR SALE: Over (30) Zenith radios from 1960s thru 1970s. Send SASE for list. Fala Electronics, PO Box 1376, Milwaukee, WI 53201

FOR SALE: Just off the press. Third and last book: Los Angeles Radio Mfg., 1920-1940 - \$10.90 plus \$3 shipping. Card game, Game of Radio - \$125. Four Frank Jones handbooks - \$40. Floyd A. Paul, 1545 Raymond Ave., Glendale, CA 91201. (818) 242-8961

FOR SALE: Drake SPR-4 comm. receiver, like new - \$200. Rod Galloway, 2220 Woodbury Rd., Melbourne, FL 32935. (407) 254-0280, after 5

FOR SALE: One box of old speakers for car radios & consoles, some are torn. Sams Photofacts cheap. Ann Bichanich (Jay's), 15 W. Lake St., Chisholm, MN 55719

FOR SALE: Hammarlund receiver, rare JX-21A. Last built with product detector - \$1,200. Also JX-21 - \$475. Excellent condition. Stuart T. Carter, II, W4NHC, 680 Fernwood Dr., Melbourne, FL 32904-1995. (407) 727-3015

FOR SALE: In beautiful Door County, Wisconsin, or will ship: My friend's antique and collectible tube and transistor radios, test equipment. Also hundreds of my own, plus televisions, military uniforms, radios, books, 1800s medical books. 1940s radio transcriptions. Tape recorders. For updated 17 page list send two-stamp LSASE to: John Enig, Sr., K9HJL, 5425 Cherry Ln., Egg Harbor, WI 54209. (920) 743-3672

FOR SALE: Ameco code practice oscillator with Rider manual - \$20 plus. Two Pilot wheel knobs for Pilot radio - \$15 plus. Elwood F. Hunt, 308 Georgetown Rd., Carneys Point, NJ 08069. (609) 299-5259

FOR SALE: A new report on the properties of minerals for crystal detectors. Sensitivity, drift, bias voltage and other information on 61 different minerals, based on recent test results. One of these is even more sensitive than a germanium diode. Much additional data on mineral peculiarities - \$11 ppd. in U.S.A. from our new address: Crys Tech, 530 Topeka St., Kingman, AZ 86401

FOR SALE: Reproduction loop antennas: DeForest plug-in for D7A etc. - \$140. Western Electric 1A, to spec - \$150; Radiola AG 1380 - \$125; Portabloop by Eagle Radio - \$65; Duo-Spiral collapsible - \$65; TOBE collapsible - \$75; Qualitone tension adjustment - \$85. Pair of Amphenol 2-way hand radios with base chargers O.B. - \$45. 8-band portable radio, AC or bat. - \$30. All plus S&H. Wally Worth, 2 W. Elm Ave., Wollaston, MA 02170. (617) 479-4512, please call before 9 pm

EXTRAVAGANZA '99

Hosted by the Michigan Antique Radio Club

July 8-11, 1999

Holiday Inn South Convention Center
6820 S. Cedar Street, Lansing, MI 48911

(517) 694-8123

Come join us for our 14th annual convention

CONVENTION THEME: "ON THE AIR"

A CELEBRATION OF THE HISTORY OF RADIO & TV BROADCASTING



FEATURES:

- EXPANDED 4-DAY EVENT
- FREE BUS TRANSPORTATION TO & FROM LOCAL MUSEUM'S "CN THE AIR" EXHIBIT ON THURSDAY ONLY!
- SAT. AUCTION WITH RICH ESTES
- 4 INFORMATIVE PROGRAMS
- INFORMAL SOCIAL HOUR FRIDAY
- EQUIPMENT CONTEST
- HUGE OPEN AIR FLEA MARKET

To mail check or to request a convention brochure, write: EXTRAVAGANZA '99, Suite 100, 3520 Okemos Rd. #6, Okemos, MI 48864. For additional information contact: Jim Clark @ (517) 349-7187 or E-mail: HGGW75A@PRODIGY.COM, or check out the MARC Homepage on the WWW at www.antiqueradios.com/marc

EXTRAVAGANZA '99 Registration

Note: Everyone attending EXTRAVAGANZA must register! The monies collected as a result of registration are a major source of revenue that help pay for this event. Your cooperation is appreciated.

Family Registration (All registrants must live at same address)		TOTAL
Current MARC member	\$ 12	\$
Non-MARC member	\$ 18*	\$
Outdoor Flea Market sellers		
1st outside Flea Market space (\$20)		\$
Additional outside spaces	[] # spaces x \$10 each	\$
8' table to rent	[] # tables x \$10 each	\$
Under Tent Flea Market sellers		
8' table with 2 chairs	[] # tables x \$20 each	\$
Make check out to MARC for this amount	TOTAL	\$

* Includes MARC membership from July-December 31, 1999.

FOR SALE: Up to (20) new 2C39A English tubes. (1) - \$8 ea., (5+) - \$6 ea. plus shipping cost. Marv Glassman, 19300 Romar St., Northridge, CA 91324-1136. (818) 993-4560. E-mail: m33412@concentric.net

FOR SALE/TRADE: Philco 20 cathedral looks and works well - \$110. GE GD60 looks and works well - \$45. Philco 920 car radio - \$20. Kadette 66X - \$49. Emerson small tombstone wood - \$65. King Model 82 less spkr - \$100. Consoles for pick up, others available call or write: Tom Guastella, 1633 W. 11th St., Brooklyn, NY 11223. (718) 256-8367

One Month Free!

BONUS FOR EARLY RENEWALS

If you renew before the month shown on your mailing label (your expiration month), you will receive an extra month on your subscription: 13 months instead of 12! 26 months for an early 2-year renewal!

FOR SALE: Original 1912 Western Union telegram form containing reproduced SOS from sinking Titanic - \$10. SASE. James J. McGrath, W2IOJ, 2 Centerview Ln., West Seneca, NY 14224-2124. (716) 675-0160. PKT Mail: w2ioj@kezwv.wny.ny.usa.noam

FOR SALE: Odds and ends sale: Radio misfits, mysteries, and broken Bakelites, 20s-30s-40s, and other stuff I forgot I had. Send SASE for list. Stephen Schaub, PO Box 1258, Peoria, IL 61654

FOR SALE: GE Superadio II - \$45. Sylvania tube manual, 1959 - \$20. + UPS. George Wright, 4181 Enders Way, Doylestown, PA 18901-5611. (215) 340-0413. E-mail: gwright@pennet.com

FOR SALE: Western Electric input trans #D163116 H-11-43 - Offers. Nipper salt & pepper - \$45. Tanny T225 (1) spkr - \$450. Data for Radio Eng 4th ed. by IT&T, 1957, 1,120 pp. - \$35. Other books avl. All + sh. Renee May, 1242 N. El Centro Ave., Los Angeles, CA 90038. Ph./fax: (323) 464-9179

FOR SALE: Majestic 161 chrome grille - \$400. Signal R-68 wireless practice set with box - \$45. Western Electric pole changer key 2-A and sounder - \$110. Leonard Aquino, 2 Somerset Ln., Putnam Valley, NY 10579. (914) 528-6857, 6:30-10 pm EST

FOR SALE: Tube manuals, RCA 1961, Sylvania 1949 - \$18 ea. Sams DC-1 Dial Cord Guide - \$20. Angelo Pallotta, W2TPW, 1367 D'Angelo Dr., N. Tonawanda, NY 14120. (716) 695-0329

ARBE-III - Universal Battery Eliminator

\$149.95 Shipped USA

Contact:

Antique Radios Inc.

Box 6352, Jackson, MI 49204

(517) 787-2985 or

Fax (517) 782-7422



FOR SALE/FOR TRADE: Partial set Radiobar glassware, Rider manuals & Philco remote control. A. Bruno, 24 Butternut Dr., New City, NY 10956. (914) 354-8899

FOR SALE: Catalin beautiful Bendix 526C - \$675. Another beauty Emerson 508 - \$65. Norman M. Landis, 1315 Marbendale Ct., Saint Louis, MO 63122-6932. (314) 821-7933

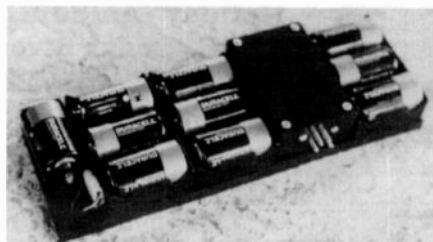

FOR SALE: Battery pack for Zenith Trans-Oceanic 7G605, 8G005, 600 Series, Universals, Hallicrafters Worldwide, and RCA Stratoworld. No modification to your set required. Also operates dial light on 600 Series. Months of use from one set of long-lasting alkaline D cells. The price of \$99.95 includes batteries and shipping. Without batteries \$89.95 includes shipping. James W. Poitvient, 3 Darby Circle East, Mount Holly, NJ 08060-3267. (609) 261-0059

FOR SALE: Electronics books, courses, magazines, parts, etc. List for stamp. Bob Eckert, 133 E. 7th St., Clifton, NJ 07011-1104

FOR SALE: 10 tubes, tested good, 7 or 9 pin - \$2 ppd. L. Gardner, 458 Two Mile Creek Rd, Tonawanda, NY 14150

FOR SALE: RCA poster Where Artists Become Legends (17 x 24 1/2) Toscanini, Reiner, Heifetz & Rubinstein, excellent. TCM, PO Box 363, Rotterdam Junction, NY 12150-0363

FOR SALE: Chassis and 15" speaker for Zenith 10S669 black dial radio - \$30. Also sweep tubes for color TV, used, tested, boxed - 50¢ ea. Call for your needs. John Martin, 111 Bancroft, Rochester, NY 14616. (716) 663-4182

FOR SALE: CB transceiver, Eico Model 760 - \$40 plus. CB Transceiver by Johnson Model Viking Messenger - \$40 plus. Elwood F. Hunt, 308 Georgetown Rd., Carneys Point, NJ 08069. (609) 299-5259

FOR SALE/TRADE: Heathkit SSB Mod NW101, Globe Scout Deluxe, Swan 500 transmitter, Hallicrafters SX-42, S-94, National NCX 5, NCL 2000, HRO-M, SW-3 w/PS, HRO 50, Collins 75A-4 w/3 filters serial #4936, Heathkit SB300, and SB 401, Hammarlund HQ 120, HQ 100, HX 50, National NC 300, NC-100A, Hallicrafters NC-46. Vintage Hallicrafters S-11 and S-15, SX-28, 390A, B&W 5100, 1930s BC-148, Johnson Viking II, Collins 75S-1, 30L1, 32S-3 and PS (will sell individually), Kenwood TS 930S w/spkr, Kenwood FM transceiver mobile unit TR 7400A, Collins 1939 6X2 gain unit with 40E exciter which came off radio stations. Collins 1000 watt transmitter, Knight T-60 transmitter. National 240-D w/speaker, pair of Federal military amplifiers. Call: Larry Drago, 383 Lincoln Dr., Cheshire, CT 06410. (203) 272-6030. Fax: (203) 272-2002. E-mail: theradioman@webtv.net

Radio Restoration Parts

Vacuum Tube Repair Wafers

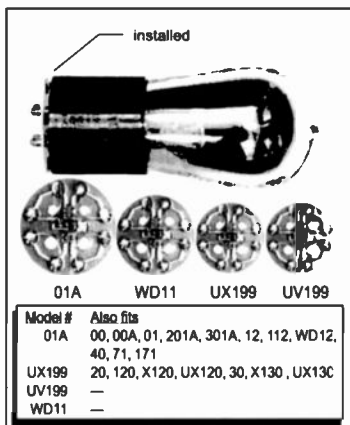

These tube repair wafers are solid-state devices for quick and easy repair of early vacuum tubes. The wafer is installed by simply sliding it over the tube pins and reinserting the tube into its socket. If the filament is intact, but there is little or no emission, the filament may be lit for best visual effect. However, the tube can be open filament.

No change in radio operating voltages is required. Any number of tubes may be repaired in a radio. If wafers are installed on all tubes, the B+ voltage may usually be reduced without sacrificing volume or sensitivity. Performance will vary between radio models.

\$10.00/each (\$7.50/ea. 3 or more)

Antique Radio Power Supply

The H15/ H16 power supplies operates most tube type battery radios from low cost batteries. The H15/H16 steps up the voltage from a 6V battery to provide 22.5V, 45V, and 90VDC for the "B" voltage requirements.

A very desirable feature of the H15/H16 is the method of switching power on and off. This function is provided by the switch on the radio. No radio modification required.

The "A" voltage required by the radio can be from "C" or "D" flashlight batteries or from a 6V gelled electrolyte battery when operating 5V tubes. When operating 1.5, 2, or 3V tubes the H15/H16 can be powered by 4 "C" or "D" flashlight batteries or from a 6V gelled electrolyte battery. The gelled electrolyte battery can operate both the H15/H16 and the 6V "A" supply for 5V tubes from one battery.

Order the H15 of parallel filaments or the H16 for series filaments.

The compact size, 4"X4"X3/4", allows the unit to be installed with batteries in the battery compartment of most radios.

H15 or H16: \$99.50. Accessories: "D" cell holders: \$6.00 per set. 6V 10AH battery \$31.00. Battery charger \$45.00. 1.5 - 90V socket \$9.50.

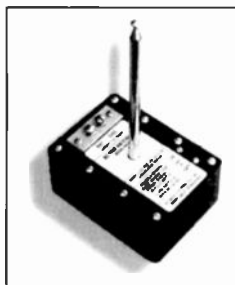

Active Antenna

Allows antique radios which were designed for a long wire outdoor antenna to operate on a 42" indoor whip antenna. Portable, operates from a 9 volt battery.

Only \$34.95

New Atwater Kent Breadboard Switch -

Only \$50

Order from: PT1, 7925 Mabelvale Cutoff, Mabelvale, AR 72103

Orders shipped UPS or Parcel Post, prepaid in continental U.S. Please allow 3 weeks for delivery.

Arkansas residents add 6.125% sales tax.

To Order: Call (501) 568-1995



Order These Popular Books From Antique Radio Classified



Price
Guide

The Collector's Guide to Antique Radios 4th Edition by Marty & Sue Bunis. 8,500+ Battery & AC sets from the '20s to the '60s. Updated prices. Many new photos. 1996. Shipping Now. — \$18.95
Combined Ed., CD-ROM by Bunis & Kaczowka. Available Now. — \$39.95

The Collector's Guide to Transistor Radios 2nd Edition by Marty & Sue Bunis. This book will help you identify the most sought-after vintage transistor radios. Over 2,900 models, all with current prices. Includes radio club listing. 375 all new color photos, 320 pages. 1996. — \$16.95



Price
Guide

NEW.....

The Collector's Guide to Antique Radios, Combined Ed., CD-ROM, Bunis & Kaczowka. Combines book editions 1-4. Over 9,000 models with pricing. 1,800 full color photos. Requires a web browser. Runs on both IBM & Mac. 1998. \$39.95

Genuine Plastic Radios of the Mid-Century, Jupp & Piña. Table radios made primarily of brightly covered plastics, with advertisements, vintage black and white photos, 439 color photos. Price guide. 208 pgs. Hardcover. \$39.95



Price
Guide

The Radio Collector's Directory and Price Guide, 1921-1965, 2nd Ed. by Robert Grinder. Over 20,000 radios by manufacturer, model number, year, etc. with prices. Radio history, cabinet style chapters. No photos, 264 pages. — \$26.95

Transistor Radios, A Collector's Encyclopedia and Price Guide by Robert Lane and David Lane. Identification guide to over 2,500 transistor and novelty radios. History and key to collecting chapters, 170 pages. — \$19.95

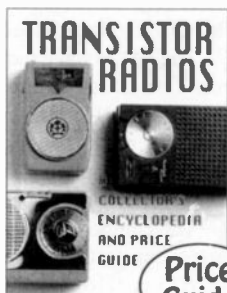

Price
Guide

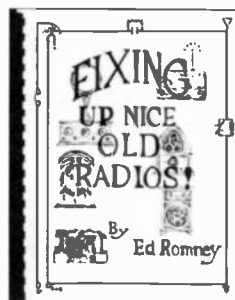

Fixing Up Nice Old Radios by Ed Romney. Written by a retired radio instructor. Plastic binding. 300+ figures, 185 pages. — \$29.00

Old Time Radios Restoration and Repair by Joseph J. Carr. A self-paced training guide. History, theory and practical operation of antique and classic radios. 200 illustrations, 256 pages. — \$19.95



U.S. Orders - Enclose \$3.00 per order for packing & book-rate shipping if total order is under \$35.00. If using VISA or MasterCard, include name on card, card number and expiration date. Send payment with order. Mass. residents add 5% sales tax. Money back return policy. Softcover unless stated otherwise. Most orders shipped the same day received, but allow 2-4 weeks to receive order. Foreign orders - write for shipping costs, or use credit card and specify air or surface (allow 2-3 months for surface shipping).



A.R.C., P.O. Box 2, Carlisle, MA 01741. Tel: (978) 371-0512

Fax: (978) 371-7129 - E-mail: ARC@antiqueradio.com - Web: www.antiqueradio.com



(Mar 99)

Order These Popular Books From Antique Radio Classified

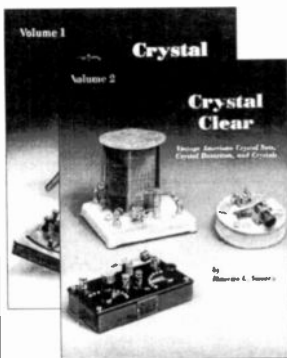

Crystal Clear Volume 1 and Crystal Clear Volume 2 by Sievers. *Comprehensive reference to crystal sets, crystal detectors, and crystals. Each volume contains different illustrations and information. Order by volume. — \$29.95*



Flick of the Switch by Morgan McMahon. *The classic photo reference guide for 1930s - 1950s radios. 1000+ photos of radios, 5" x 8", 263 pages. — \$11.95*

NEW TRANSISTOR BOOKS.....

Transistor Radios: 1954-1968, Smith. *Over 1,000 transistor radios identified by manufacturer, marketing organization, type, and style. Color photos and price guide. 1998. 160 pgs. Softcover. \$29.95*

Zenith Transistor Radios, Evolution of a Classic, Smith. *A complete listing of all transistor radio models created by Zenith during 1955-65.*

Color photos and price guide. 1998. 160 pgs. Softcover. \$29.95

Hams! We now have 7 ham books - See our full page ad

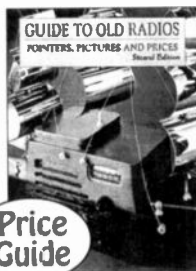

Guide to Old Radios, Pointers Pictures, and Prices, 2nd Ed. by Johnson. *Introduction to radio collecting. Includes hundreds of photos and a price guide. 272 pages. — \$19.95*

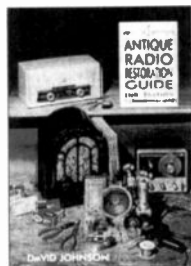

Antique Radio Restoration Guide, 2nd Ed. by Johnson. *Beginner's introduction to troubleshooting and repairing AC table model radios. 145 pages. — \$14.95*

Price Guide



The Zenith Trans-Oceanic: The Royalty of Radios by Bryant and Cones. *Presents the fascinating story of the development and use of the Trans-Oceanic. Several photos, documents, ads, etc. 160 pages. — \$24.95*

Communications Receivers, 4th Ed. by Ray Moore. *Information on vacuum tube receivers by 66 manufacturers. 448 radios illustrated. 136 pages. — \$19.95*

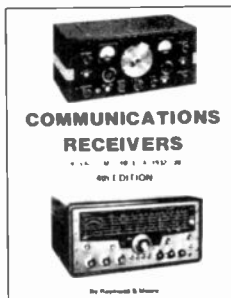

U.S. Orders - Enclose \$3.00 per order for packing & book-rate shipping if total order is under \$35.00. If using VISA or MasterCard, include name on card, card number and expiration date. Send payment with order. Mass. residents add 5% sales tax. Money back return policy. Softcover unless stated otherwise. Most orders shipped the same day received, but allow 2-4 weeks to receive order. Foreign orders - write for shipping costs, or use credit card and specify air or surface (allow 2-3 months for surface shipping).



A.R.C., P.O. Box 2, Carlisle, MA 01741. Tel: (978) 371-0512

Fax: (978) 371-7129 - E-mail: ARC@antiqueradio.com - Web: www.antiqueradio.com



(May-99)

FOR SALE: HP power supply #6286A 0-20V@10A no manual - \$90. Harry Pewowaruk, 1535 N. 8th Ave., St. Cloud, MN 56303. (320) 252-9910. E-mail: Hpewowaruk@aol.com

FOR SALE/TRADE: Items with no price are preferably for trade, but cash offers always considered. Altec 604-B #387, near perfect, cones exc, sounds beautiful; Heathkit W-4 AM tube amp kit N.I.B., never unpacked, w/manual, etc.; Heathkit AA-21D, solid-state stereo amp kit, same as above; two Heathkit AE-11 walnut cases N.I.B - Best Offer; Sony 2250 pro-3 speed w/ SME type tonearm; MacIntosh MC-225, exc; Lafayette 225 uses EL-86s, sweet, no case; Eico 668 tube checker - \$100; Grundig Mark V portable reel-to-reel dictating recorder in leather case, orig. mic, lots of tape, mint - \$50; Apolox RA-45, 3" reel-to-reel battery from 60s - \$20; Starlight RA-11 3" battery reel from 60s - \$20 or - \$30 for both; Webcor Model 80-1 wire recorder, rebuilt, runs fine; also, 228 wire recorder, case not too great, but inside fine, rebuilt, will trade one for Webster Ekotape recorder. Microphones for sale: Electro-Voice V2-A, very nice, works; Astatic D-104, several, nice to exc - \$75 and up; RCA MI-6225 carbon, mint. Several Shure 55 Elvis from mint to props. **WANTED:** Zenith Stratosphere 1000, must be all orig. and very good condition, serious reward for good lead and/or sale. Always looking for vintage mics; RCA, Neumann, Sony, Western Electric, what-have-you. Demand items sold to highest bidder, but don't be bashful! The more you buy, the cheaper it gets! Always make an offer. Ward Kremer, 5807 Papaya Dr., Ft. Pierce, FL 34982. Ph/ fax: (561) 468-7732. E-mail: WKremer798@aol.com

FOR SALE: Stromberg-Carlson tombstones, Models 60 and 61T, very good/excellent. **WANTED:** Zeniths: chrome front, Deco tombstone Model 834, 835 or 935; and 12A58 console, empty cabinet or complete. Chris Hicks, RR2 Box 342, Clinton Corners, NY 12514. (914) 266-4257

FOR SALE: Pilot T601 FM tuner - \$35. Zenith T-Os, clean & working: 8G005Y & H500 from - \$95. Bob Fuerderer, Holly Farm, 813 Rte. 12A, Surry, NH 03431. (603) 352-3005

FOR SALE: RCA Senior Volt Ohmyst Type WV98C, bench Type 110 volt - \$35 plus. Elwood F. Hunt, 308 Georgetown Rd., Carneys Point, NJ 08069. (609) 299-5259

**PHONE NUMBER FOR
ANTIQUE RADIO CLASSIFIED
(978) 371-0512**

**Best time to call is weekdays:
9 am to 5 pm Eastern Time**

(Please no classified ads by phone. Thanks!)

FOR SALE: Frontier Capacitor will be selling capacitors at these meets: Indianapolis, IN; Calverton, MD; Cincinnati, OH; Lansing, MI; Elgin, IL; & Rochester, NY Everett Hoard, PO Box 218, 403 S. McIntosh St., Lehr, ND 58460. (877) 372-2341, free

FOR SALE: Thompson cathedral Model R-81 mint, all original, with key. Lots of original paperwork. John DeLoria, 101 Doverbrook Rd., Chicopee, MA 01022. (413) 593-1180

FOR SALE/TRADE: Very rare Federal 159 (the gold plated version of the Model 59) in like new condition. This limited edition factory original radio looks and works beautifully! Pair of Altec 1570-B monoblock amps use 811s tubes, powerful and in great condition; 1929 Tyrman 10-tube Imperial 80, radio with PS; minisize Mod 4 Echophone cathedral; 1940s Radio Station WLOU-AM 1350 red, white and blue, neon clock from Louisville, Kentucky; it measures approx. 20" diameter; a pair of like new Western Elec. retro-fit second generation (8 watt) monoblock audio amps Mod KS-16617 (using 6V6 tubes), Neutrowound breadboard, Amrad key & spark gap, Paragon RA-10 tuner w/DA-2, Western Electric 7-A amp, Federal 61, Pederson Mod 15 Williamson amp; flawless Atwater Kent Mod 10C and Mod 12 breadboards, just beautiful! Radiola Grande, Clapp-Eastham Radak amp detector H2 w/HR tuner, Western Electric Mod 600A ring/spring mic w/WNBC flags on top; Crosley 51; large Signal loose coupler w/ white silk covered windings on slide coil, Hallicrafters SR-2000 hurricane receiver/transmitter w/PS, National NCX 5, National NCL 2000, 1-KW Fairchild turntable studio-style. Call: Larry Drago, 383 Lincoln Dr., Cheshire, CT 06410. (203) 272-6030. Fax: (203) 272-2002. E-mail: theradioman@webtv.net

FOR SALE: Rider #1 original format - \$75. Sams AA-4 & AA-6 - \$25 ea. Bunis #1 & 2, original Breed Novelty, LSASE with 2 stamps for expanded 12-page books and literature list. Ray Schmidt, 607 1 Ave., SW, Austin, MN 55912. (507) 433-0069

FOR SALE: Kadette 1936 Model 1019, 10 tubes, vg - \$100. Silvertone 7224-BC-SW-T.O., vg - \$100. Hallicrafters receiver 1951, R-10A, g - \$40. Gilbert Simpson, 18 Beechwood Dr., Ansonia, CT 06401. (203) 734-4085

FOR SALE: Seco 1002 tube tester - \$95. John Kirby, 298 W. Carmel Dr., Carmel, IN 46032. (317) 843-2212

FOR SALE: Heathkit tube tester Model TC2, has adapter cable for testing picture tubes - \$35 + UPS. Phil Guinan, 106 Page Rd., Litchfield, NH 03052. (603) 889-6213

Nipper Clock



Quality wall clock with full color "His Master's Voice" logo. Rugged, 3/8" wood grain case. Full-length glass front, hunter green and gold. Classic Roman numeral time dial. Battery operated, quartz movement. 100% made in USA, including movement. 5-1/4" x 12-3/4" x 2". \$39.95 delivered, continental USA. Massachusetts residents please add \$1.75 state sales tax.

Telephone:
508-879-2778

Send check with order or call with credit card, please!

Antique Radio

835-A Pleasant Street, Framlingham, MA 01701



RADIO CRAZE

John Sakas P O Box 4124 So. Hackensack NJ 07606-4124
 Phone (201)794-0437 ~ Fax 24 Hours (201)794-8359
 visit our web site at <http://www.radiocraze.com>

WANTED

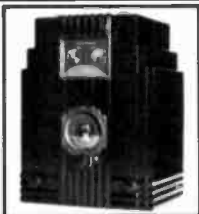

AIR KING SKYSCRAPERS

PAYING \$14,500.00+ for near mint condition red or blue
 \$10,000.00+ for green, lavender or yellow
 \$3000.00+ for black and \$2000.00+ for white or brown
ALSO WANTED ANY COLOR-ANY CONDITION
 COLLECTOR PAYING TOO MUCH, CALL ME LAST

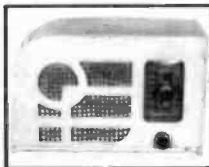

TOM THUMB CATALIN RADIOS WANTED

paying \$8,750.00+ for mint cond. red, green, orchid, blue
 \$2500.00+ for any mint one
ALSO WANTED ANY COLOR-ANY CONDITION

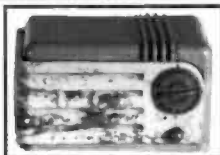

DETROLA PEE WEE & SUPER PEE WEE WANTED

paying \$600.00+ for mint cond. black, white
 \$1,250.00+ for beetle, gray, salt & pepper
 \$2000.00+ for red, blue \$3000.00+ for green or lavender
ALSO WANTED ANY COLOR-ANY CONDITION

WANTED ANY CATALIN RADIO

ADDISON 2 MAR. OR N. YELL. W \$100.00, YELL. W A RED \$1,500.00,
 ARVIN 532 ANY COLOR \$1,500.00, HENDIX 524 GREEN A HILL \$1,667.00,
 DeWAI D A501, A502 BR. W N \$375.00, YELL. W \$425.00, RED \$1,000.00
 EMERSON AU190 & BT 245 YELL. W \$1,300.00, GREEN \$1,350.00,
 DARK RED \$2,500.00, BLUE \$6,250.00, BRIGHT RED \$11,800.00,
 ENPEY MIDGEET, YOU NAME THE PRICE I WILL PAY IT!
 EMERSON BME28 YELL. W \$750, GREEN \$1,350, RED \$1,850, BLUE \$3,000
 EMERSON 544 BLACK \$500.00, GREEN \$900.00, RED \$1,250.00
 FADA 1.56, F55.53, F590, F590, 136, 53X, YELL. W \$900.00, LT GREEN \$1,350.00
 MARON & YELL. W \$1,500.00, YELL. W & BLUE \$1,700.00, YELL. W & RED \$2,650.00
 EMERALD GREEN & YELLOW \$6,250.00, BLUE & YELLOW \$6,450.00
 FADA 115, 116 & 1000 ALL YELLOW \$625.00, MAROON & YELLOW \$700.00,
 YELL. W & RED \$925.00, PEA GREEN \$1,000.00, BLUE & YELLOW \$2,150.00
 GAROD 6401 MAR. W N \$675.00, YELLOW & RED 1,250.00, RED & YELL. W \$1,400.00
 HALSON ANY COLOR \$1,500.00 TO \$5,000.00
 MOTOROLA 50X6 ALL YELL. W \$1,350, BR. W N & TORT \$2,500.00, RED & YELLOW
 \$5,000.00, GREEN & YELL. W \$5,250.00, MOTOROLA 52 YELL. W & TORT \$1,500.00,
 MARON & YELL. W \$1,750.00, GREEN & YELL. W \$2,900.00
 SONORA KM ANY COLOR \$1,400.00, SENTINEL 284 WAVY GRILL YELL. W \$700.00,
 SAND 800.00, RED 1,250.00, BLUE & 500.00
 SPARTAN CLOSURE ANY COLOR \$2,500.00 TO \$5,000.00, FMBRKN 520 \$60.00

always buying any catalin or pre-war colored bakelite radios
 We will buy one piece or entire collection
 watch out there's a new guy in town

FOR SALE

F
O
R

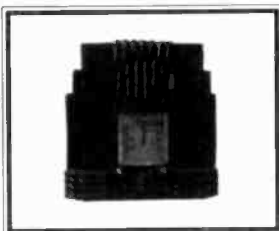

AWA

Brown Bakelite Radio, near-mint \$1095.00

S
A
L
E

F
O
R



Garod Peaktop

Maroon and Yellow Catalin Radio, Mint, \$2495.00

S
A
L
E

F
O
R

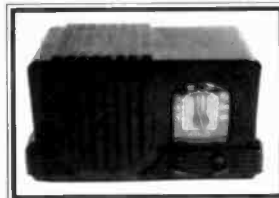

Small Addison model 2

All Brown Bakelite, Near-Mint \$395.00

S
A
L
E

F
O
R



Bendix 0526

Green and Black Catalin Radio, Mint, \$775.00

S
A
L
E

ALL PRICES ARE WITHOUT
 SHIPPING CHARGES

FOR SALE: Valves and radios for sale send IRC for list.
WANTED: Audio research SP6. Alan Cavender, 288 Hexham Rd., Throckley, Northumberland, England, NE15 9QX. E-mail: alcav@yahoo.com

FOR SALE: Plastic dial covers to fit Addison 2, Atwater Kent 145, Emerson 400, 520, Fada 1000, Hallicrafters S-38, National 240D, Zenith G-500, 8G005, and many more - \$15 ea. ppd. Doyle Roberts, HC 63 Box 236-1, Clinton, AR 72031. (501) 745-6690. E-mail: drob@artelco.com

SEND ALL A.R.C. MAIL TO
Antique Radio Classified
P.O. Box 2, Carlisle, MA 01741

FOR SALE: 1949 Philco combo 10" TV, AM/FM phono in a blond Deco cabinet, 50s TVs, Sylvania Silhouette, Sylvania Duelette, Philco Miss America, also Zenith, RCA, DuMont, Silvertone Panasonic Saucer, JVC Videosphere, Philco Safari. GE Model 45 in a custom blond signed cabinet by Brown-Saltman of California. Stromberg-Carlson Model 150-L, Philco Beam of Light console. Console radios from Zenith, RCA, GE, American Bosch, Philco 60 cathedral, N.O.S. phonograph needles. Anderson Electronics, 95 North Central Ave., Mechanicville, NY 12118. (518) 664-9555. E-mail: alcomm@ix.netcom.com

FOR SALE: Challenger Model CHA33 tube amplifier mfg by David Bogan Co., rated 33 watts - \$60 plus. Elwood F. Hunt, 308 Georgetown Rd., Carneys Point, NJ 08069. (609) 299-5259

FOR SALE: Radios, all kinds, table models, floor models, all conditions and parts sets, no lists. Let me know what you are looking for. Consoles, no shipping. Table models and consoles - \$25-500 + shipping, Zenith blk dial consoles 10 tubes and less. F. Vaillancourt, PO Box 726, Woodstock, VT 05091. (802) 457-3482

A.R.C. BACK ISSUES

April '87 to current issue: Originals available
32 to 100 pages each.

Oct. '86 to Mar. '87: Reprints available
Reprinted from original artwork; 28 to 32 pgs. ea.
Quality & appearance same as an original copy.

June '84 to Sept. '86: Photocopies available
Not original quality, useful for info.; 16 to 28 pages each.
Publication of *Antique Radio Classified* began in 1984 which had only five issues: June, Sept., Oct., Nov. & Dec. 1984, 1985 through current year have had 12 issues each.

**\$5.00 each - Postpaid to
U.S., Canada and Mexico.**

Orders of 6 issues or more may take a 10% discount. Orders for a full calendar year may take a 50% discount. 15th Year Special: 60% discount on orders for a full calendar year. Foreign orders other than Canada and Mexico: \$8.00 each by air. Mass. residents, please add 5% sales tax.

A.R.C. UN CUT, UN FOLDED COVERS

June '91 to present - 9.25" x 12.5" - \$9.95 each
Postpaid to U.S., Canada, & Mexico
Mass. residents, please add 5% sales tax.
A.R.C., P.O. Box 2, Carlisle MA 01741

Or Call (978) 371-0512

FOR SALE: Rare University Sound Model CMIL-T horn speaker, like new - \$65 + shipping. Leroy Marshall, 1178 Foxboro Ln., Bartlett, IL 60103. (630) 483-8833

FOR SALE: Novelty transistors; radio related items; woods, Bakelites, plastics; 6+ page list, state interest. Ripley, Box 9374, N. St. Paul, MN 55109

FOR SALE: Don Mc Gohan WA-325 mono tube amp with chromed output xformers and KT66s - \$300 + shipping. Scott Cohen, 930 W. Prince Rd., Tucson, AZ 85705. (520) 888-1316. E-mail: ahelper@flash.net

FOR SALE: Everything for construction: A dozen ham kilowatt linear amplifiers; tubes, roller coils, vacuum capacitors, cabinets. F. H. Yonker, P.E., W2IBH, 1229 Inverary Pl., State College, PA 16801. (814) 867-1400

FOR SALE: Radiola 67, in good working condition, asking - \$500, pick-up only. Herman Ebers, 2241 Palmer Ave., 1R, New Rochelle, NY 10801. (914) 235-0239

FOR SALE: Zenith Golden Triangle, Westinghouse 1113 Constellation, model tag on bottom chassis 2103-3, Grundig console 500, Silvertone 9 bands. F.H. Montgomery, 505 Congress Ave., Apt. 710, Hvre De Grace, MD 21078-3061. (410) 939-2099

FOR SALE: Some remaining tubes and parts for electronic organs. New and used. Retired serviceman. Marion L. Clemens, KC8KCP, 10129 Lapeer Rd., Davison, MI 48423

FOR SALE: Decals and dial scales for antique radios. SASE for list. Rock-Sea Enterprises, PMB 241, 323-110 E. Matilija St., Ojai, CA 93023. (805) 646-7362. E-mail: dials@juno.com

FOR SALE: Loewe Type OE 333 radio receiver using 3NF tube, 1926, very nice, original with coil and working - \$75 BO. 1+ VE 301V German WWII original and play, Bakelite box - \$190. R. Staffeldt, 72099 Berlin, Tempelhofer Damm 785, Germany. Tel./fax: 011-49-30 75704882

FOR SALE: Harman Kardon Citation 17S preamp, exc - \$95 includes UPS in 48 states. Aaron Krueger, 3719 Woodland Ridge Rd., Wausau, WI 54403. (715) 675-6674

FOR SALE: General Radio Co., Cambridge, Mass., 1935 & 1939, all products catalogs - \$30 ppd. Donald Sochurek, W191 S7500 Richdorf Dr., Muskego, WI 53150. (414) 679-0212

FOR SALE: Hallicrafters, HR40 - \$100; S40B - \$190; S53 - \$170; SX99 - \$175; S76 - \$290. Fisher 500 - \$100. Sams Auto Transistor Radios Series. Charles Seidel, PO Box 1500, Merlin, OR 97532. (541) 474-2596

FOR SALE: Philco wood radios, 1940 speaker (old) in wood cathedral cab., other old radios. Don J. Scher, 3705 57 Ave., Vero Beach, FL 32966. (561) 562-5149

FOR SALE: B/W Sony 6-inch TV Model TV-700U, wks - \$50 ppd. Wayne Himel, 1029 Cedre St., Westwego, LA 70094. (504) 347-3796

FOR SALE: 1939? Grunow allwave radio Type 11G, speaker 12G4-1, no cabinet. Silvertone radio AM-record player catalog no. 1040 chassis 528-194 sold by Sears, Browning Raven 23 ch AM CB w/pwr supply, no mic. John Volgyi, 308 Bryn Mawr, Unit K, Ravenna, OH 44266. (330) 296-3201

WANTED: Zenith 16A63 or 16A61 Stratosphere. Trade Zenith 15U272 Georgian for either one. Jim Choroszy, 764 E. Imperial Dr., Hartland, WI 53029. (414) 367-8367

WANTED: Atwater Kent 545 escutcheon; Stancor DY-1 deflection yoke; project Philco 16. John Hagman, 190 Park St., Burlington, VT 05401. (802) 865-1751

WANTED: Restoring Old Navy TCS12 pair. Needs source PS or PS plugs. Dennis Olmstead, WB9EMD, 431 Ridgewood, Glen Ellyn, IL 60137. (630) 469-0531

— WANTED —

CLUB CONTACT INFORMATION. A.R.C. IS UPDATING ITS CLUB LIST. PLEASE SEND US NAME OF CONTACT PERSON, ADDRESS, DUES, RATES, ETC.

WANTED: Bendix radios, ads, signs, etc. Radios need not work. Aaron Mall, 903 Dropleaf Ct., Baltimore, MD 21208. (410) 486-8813



WANTED: Fada Catalins. I like 'em perfect or in pieces — whatever you have to offer. Don't humiliate yourself by letting some other "big shot" collector take advantage of you. Go ahead and use me. Uh oh! Please write or call collect: Rain Buttignol, 214 State St., #7, Portsmouth, NH 03801. (603) 427-1384

WANTED: Buying Citizens Radio Callbooks, pre-50s Flying Horse Callbooks, pre-30s QSTs. Ron Allen, W3OR, PO Box 73, Bethel, DE 19931-0073. (302) 875-1100. E-mail: w3or@delanet.com

WANTED: Atwater Kent 356, RCA 143, Philco 90, Stewart-Warner R-1301-A excellent condition and original finish. Mark Murphy, 1400 Chicago Ave. #802, Evanston, IL 60201. (847) 328-5036. E-mail: PiscoCal@aol.com

WANTED: Tube type limiters, clippers. New or used Telefunken 6SN7GT. U.S.A. made 5Z4GT. 5931. Tom Miller, PO Box 20138, London Terrace Station, NY 10011. (212) 675-7704, eves.

WANTED: Aetna tombstone, small, must be in excellent condition. Larry M. Boshier, PO Box 193, Palo Pinto, TX 76484-0193. (940) 325-5333

WANTED: Marconi radios, advertising & related items, NBC chimes on a wooden board. Barry A. Janov, 2454 Dempster St., Ste. 416, Des Plaines, IL 60016. (847) 827-9100. E-mail: marconifon@aol.com

WANTED: Hopalong Cassidy radio Model 441T red or black in excellent condition. Frank Ramos, 5638 E. Bellaire Way, Fresno, CA 93727. (559) 291-7088

WANTED: Baradio, floor or table, preferably w th glass. Send picture & price. Michael Durand, 21 Le Grande Ave., Tarrytown, NY 10591. (914) 631-0493



GLASS AUDIO

*Vacuum tubes
for Audio are back ...
and they sound better
than ever!*

Glass Audio brings together
yesterday's tubes and today's
improved components,
making smooth sound possible
for your audio again.

Ask for your first issue FREE to
examine, without obligation!

Glass Audio

PO Box 176, Dept. ARC8
Peterborough, NH 03458-0176 USA
Phone: 603-924-9464

Fax: 603-924-9467 Email: custserv@audioxpress.com

Visit our website at www.audioxpress.com

Transistor Radios: 1954-1968

By Norman Smith



**Over 1,000 Transistor Radios
460+ Color Photographs
Price Guide**

\$29.95 - Softcover

U.S. Orders - Enclose \$3.00 per order for packing & book-rate shipping if total order is under \$35.00. If using VISA or MasterCard, include name on card, card number and expiration date. Send payment with order. Mass. residents add 5% sales tax. Money back return policy. Softcover unless stated otherwise. Most orders shipped the same day received, but allow 2-4 weeks to receive order. Foreign orders - write for shipping costs, or use credit card and specify air or surface (allow 2-3 months for surface shipping).



A.R.C., P.O. Box 2, Carlisle, MA 01741. Tel: (978) 371-0512

Fax: (978) 371-7129 - E-mail: ARC@antiqueradio.com - Web: www.antiqueradio.com



(Mar 99)

Radio Manufacturers of the 1920's

BY ALAN DOUGLAS



"The definitive book on American broadcast receivers of the 1920s"

Volume 1: A-C Dayton - Adams Morgan - Air-Way - All-American Mohawk - American Bosch - Amrad - Amrad S-Tube - Apex - Atwater Kent - Bremer Tully - Browning-Drake - Clapp-Eastham - Crosley - Cutting & Washington - Day-Fan - DeForest - Eagle - ERLA - FADA - Federal - Ferguson. 225 Pages.

Volume 1: \$24.95 - Softcover Only

Volume 2: Freed-Eisemann - Eisemann - Freshman - Garod - Gilfillan - Grebe - Howard - Jones (Lester/Melco) - Jones (Jos.) - Kellogg - Kennedy - King - Kodel - Kolster - Leutz - Magnavox - Majestic - Marti - Metro - Klitzen/Michigan - Midwest - Mu-Rad - Murdock - Music Master - Neutrowound - Operadio - Ozarka - Pfanstiehl - Philco - Pilot - Priess. 266 Pages.

Volume 2: \$29.95 - Softcover Only

Volume 3: RCA - Scott - Silver-Marshall - Slagle - Sleeper - Sonora - Sparton - Splitdorf - Steinite - Stewart-Warner - Stromberg-Carlson - Thermodyne - R.E. Thompson - Thorola - Tri-City - C. D. Tuska - Ware - Western Coil - Western Electric - Workrite - Zenith. 292 Pages.

**Volume 3: \$29.95 - Softcover
\$39.95 - Hardcover**

U.S. Orders - Enclose \$3.00 per order for packing & book-rate shipping if total order is under \$35.00. If using VISA or MasterCard, include name on card, card number and expiration date. Send payment with order. Mass. residents add 5% sales tax. Money back return policy. Softcover unless stated otherwise. Most orders shipped the same day received, but allow 2-4 weeks to receive order. Foreign orders - write for shipping costs, or use credit card and specify air or surface (allow 2-3 months for surface shipping).



A.R.C., P.O. Box 2, Carlisle, MA 01741. Tel: (978) 371-0512

Fax: (978) 371-7129 - E-mail: ARC@antiqueradio.com - Web: www.antiqueradio.com



(Mar-99)

FOR SALE: Zenith Universal Instructions Manual 6G501, chassis 6A19 - \$10. Zenith Universal 6G601 ML, nice - \$125. John Johnson, 276 N. Seymour Ave., Mundelein, IL 60060. (847) 566-5005

FOR SALE: Still have bargains in radio consoles and combos. Consider all offers. Malcolm D. Burdick, WINOO, 156 Station Rd., Hampton, CT 06247. (860) 455-9640, before 8:30 pm

FOR SALE: Tube and transistor radios. Send SASE for list. Dave Mock, 3 Larkspur Pl., Montpelier, OH 43543. (419) 485-3933

FOR SALE: T-3 Heathkit signal tracer w/magic eye tube, one lead missing - \$45. Early Philco tube tester, Art Deco cabinet with charts - \$45. Eico Model 145 signal tracer - \$45. Precision 1072 tube tester - \$50. RCA VTVM-WV77E, works - \$45. Heathkit VTVM, no leads - \$35. Add shipping all. Maurer Television, 29 S. 4th St., Lebanon, PA 17042. (717) 272-2481. E-mail: radiobks@aol.com

FOR SALE: Elenco electronic designer with power supply and voltmeter for experiments. Model XK-120 with manual. Daniel Seidler, 3721 W. 80 St., Chicago, IL 60652-2415. (773) 284-8221

FOR SALE: Vacuum tubes, all kinds, 40,000 on hand. Send want list & SASE for prompt response. Tom Ivas, 2932 W. 99th St., Evergreen Park, IL 60805. Ph/fax: (708) 423-0528. E-mail: tivas@xnet.com

FOR SALE: Radiola 8 Superhet panel, knobs, parts - \$35. Admiral 7" Bakelite TV with magnifier - \$200. Bill Rolf, 30131 Center Ridge, Westlake, OH 44145. (440) 871-4547

FOR SALE: Rare AC Delco wall mount radio, AM/FM, see-through case, N.I.B. - \$75 plus shipping. Steve Whited, 3637 W. 71st St., Indianapolis, IN 46268. (317) 298-9967

FOR SALE: Robot 800 plus monitor; manual and cables. Heath Model SW-717 receiver and manual. Collins TCS transmitter, receiver; remote control, dynamotor power unit cables, manuals; transformers, choke for AC power supply. Hallicrafters 8R 40 with manual. Central Electronics 20-A with instruction manual. Gosset G-50 with manual. Hickok tester Model OS 10. Bell & Howell 16mm film and sound projector, Model 1574, looks new. Will accept highest reasonable offer on any item. Pick up only. Paul D. Dillardi, WA8IBT, 1313 E. Wheeling St., Lancaster, OH 43130. (740) 653-5268

— WANTED —
PICTURES FOR PHOTO REVIEW OR TELEGRAPH REVIEW
PHOTOS MUST BE SHARP IN DETAIL
A SHORT DESCRIPTION IS A MUST!
SEE PHOTO REVIEW PAGES FOR ADDITIONAL INFORMATION

FOR SALE: Microphones (crystal): Brush Mod BL-2, lapel mounting and Tumer S22X with stand. Dan Knipe, 3750 Highgrove Ln., Nampa, ID 83687. (208) 888-9575

FOR SALE: RCA 45 record player Model 45-EY-2, does it all - \$60 plus. Etwood F. Hunt, 308 Georgetown Rd., Cameys Point, NJ 08069. (609) 299-5259

FOR SALE/TRADE: Just purchased a small collection of interesting radios and microphones from a New York gentleman who was the fussiest collector I think I have ever met. Everything he purchased had to be perfect. The following sets are one of a kind: AK-90 cathedral, Sparton 410 Junior, early Philco 60B cathedral, Philco 71B, Emerson 707B red, Silvertone 9000, Zenith 6D311, Truetone D2211, Western Electric microphone Mod 630-A, WE 600B Spring-ring, rare Western Electric Mod 1-B, RCA microphones, 77DX, 44BX, 74B. Call: Larry Drago, 383 Lincoln Dr., Cheshire, CT 06410. (203) 272-6030. Fax: (203) 272-2002. E-mail: theradioman@webtv.net



Antique Electronic Supply wants your tubes!

NEW TUBES

300A WE	\$300.00	845	\$125.00	5992-Red (Red Base)	\$30.00	V201A	\$24.00
300B WE	\$350.00	211AT/4C	\$75.00	6SN7GT-B (Full beam, USA only)	\$4.00	171-A	\$20.00
Engraved base on above adds	\$50.00	6CD7/EM34	\$24.00	6X4	\$12.00	282	\$14.00
274A WE	\$175.00	EM35	\$20.00	6X4	\$12.00	WD-11	\$70.00
274B WE	\$190.00	2A3	\$24.00	6R00 (Bendix)	\$10.00	01A (ST)	\$15.00
275A WE	\$75.00	2A3 Single Plate	\$75.00	12X7GT	\$3.50	30 (Must say 30)	\$5.00
310AB WE	\$15.00	5992 (Bendix)	\$10.00	6J5C/BL06	\$17.50	31	\$4.00
262AB WE	\$50.00	5AR4/GZ34 (European, USA)	\$25.00	6LF6/6BH6	\$25.00	864	\$12.00
348A WE	\$50.00	7868	\$18.00	20L F6	\$27.50	6A8	\$4.00
417A WE	\$15.00	6A3	\$12.00	6J59C	\$20.00	6AB8	\$5.00
420 WE	\$23.00	12AX7A-Tele (Smooth Plate)	\$30.00	6KD6	\$15.00	6ABGT	\$5.00
421A WE	\$15.00	12AX7A (Mullard)	\$30.00	6KRV6	\$15.00	6VGT	\$2.50
437A WE	\$30.00	12AX7A (Amperex, B B)	\$25.00	6LR6	\$14.00	8F6GT	\$5.00
412A WE	\$10.00	12AX7A (RCA)	\$10.00	21J96A/23J96	\$8.00	6VA/EZ20	\$2.00
9CA7, EL34-M (MULLARD)	\$40.00	12AT7	\$15.00	27L F6	\$18.00	41-ST	\$3.00
68Q5, EL84	\$8.50	(Tele, Mullard, Amperex, B B)	\$4.00	40K06A/PL519	\$3.00	5Y4G	\$2.50
68Q5, EL84 (Tele, Mullard, Amperex, B B)	\$12.00	12AT7 (RCA)	\$15.00	6JL6	\$5.00	6386	\$16.00
6V8GT	\$6.00	(Tele, Mullard, Amperex, B B)	\$15.00	8950	\$35.00	8072-A	\$4.00
6550 (Tung-Sol)	\$40.00	12AU7A (RCA)	\$5.00	M-2057	\$50.00		
6L9CC (RCA Black Plate)	\$25.00	6DU8	\$12.50	8968	\$35.00		
7189A	\$12.50	(Tele, Mullard, Amperex, B B)	\$12.50	42K96	\$3.00		
7027A	\$25.00	7308GP (Gold Pin)	\$6.00	31L06	\$7.00		
7591A	\$32.00	7025 (Can have only 7025 on glass)	\$10.00	6KN6	\$6.00		

USED TUBES

300A WE	\$150.00	437A WE	\$15.00	2A3 Single Plate	\$50.00	6KRV6	\$8.50	V201A	\$12.00
300B WE	\$175.00	6CA7/EL34 (Mullard only)	\$20.00	6A3	\$5.00	6LR6	\$7.00	171-A	\$10.00
Engraved base on \$50.00 above adds		8417	\$10.00	6J5C/BL06	\$6.00	21J96/23J96	\$4.00	282	\$12.00
275A WE	\$45.00	7591A	\$10.00	6LF6/6BH6	\$14.00	8950	\$25.00	WD-11	\$36.00
310AB WE	\$7.50	845	\$50.00	20L F6	\$14.00	M-2057	\$38.00	01A (ST)	\$8.00
421A WE	\$8.00	211AT/4C	\$15.50	6J96C	\$4.00	8008	\$17.50	30 (Must say 30)	\$3.00
		2A3	\$12.00	6KD6	\$4.00	X201A/301A	\$7.50		

B B - Bugle Boy
Tele - Telefunken

We need the following tubes. All must be well known brands (GE, RCA, Sylvania, Tung-Sol, Philips, etc. of U.S. or W. Europe manufacture). New tubes must be in original boxes. All tubes subject to inspection. Ship by UPS (ground); we'll send a check upon receipt and testing at prices shown plus your shipping charges. Call or fax for buying procedure and complete bid list. Call before sending more than 10 pieces of one type of tube.

CALL FOR OUR FREE 72 PAGE CATALOG!

6221 S. Maple Ave. • Tempe, AZ 85283 • (480) 820-5411 • FAX (480) 820-4643 or (800) 706-6789
 www.tubesandmore.com • E-MAIL: info@tubesandmore.com



Radio Era CD-ROM publications can add "sizzle" to your summer antique radio pursuits . . .

John F. Riders "Perpetual Troubleshooter's Manual".

All 23 Volumes with over 40,000 schematics for over 120,000 different models. Truly the work of a lifetime - if you are serious about your antique radio hobby, you owe it to yourself to buy this 6-set CD-Series. Find schematics "instantly" using our database search - - even if you don't know who made it or what the model number is, you can find it with a chassis number. Runs with Windows on PC. View, enlarge, rotate and print all schematics. An invaluable resource that will bring order to your life over and over again - thousands sold so try a set today.

Complete Set of 6-CD's \$ 450 postpaid USA

Individual sets (4-volumes) 1-4, 5-8, 9-12, 13-16, 17-20 & 20-23 available for \$ 85 per CD

Dial-Cord CD-ROM - Ever been stumped with re-stringing that old receiver and wasted hours? This CD is for you.

RCA HB-3 - Over 7,000 pages of great: tube data, graphs, diagrams on just about every kind of tube made!

RCA Radiotron Handbook - Over 1600 pages of design data, great tube radio & amplifier design data - 4th edition!

R390 & R390A Military CD-ROM - has all the technical manuals, history of these remarkable receivers and more!

Radiophile Vols 1, 2, and 3 CD-ROM's - have thousands of pages of books, history and reference materials.

Antique Radio Repair - Vol. 1 - a condensed version with what you will need to learn how to repair old radios.

Antique Radio Repair - Vol. 2 - More John Rider books and publications on radio theory and troubleshooting info

"Faster than a speeding bullet" - hilarious & informative book on the age of radio and old radio programs.

"Amos 'N Andy" on CD-ROM - Audio CD-ROM with lost 1940's episodes of this great old radio program.

"The Radio Boys" - first two books, "First Wireless" and "At Ocean Point" - great reading for young and old!

"80 Years of QST" - all magazines from the ARRL from 1915 through 1994 - truly the history of radio at its best!

Coming soon: - All of the Collins Radio equipment manuals on CD-ROM - keep tuned for new releases

Other services of REA include buying and selling old radios. We offer information, valuation and appraisal services for old radios. We run a schematic service bureau for those who need an occasional service and schematic diagram to fix an old radio. We have other resource information, old sales brochures and even complete manuals for old radio equipment. We do research to find who made "that" old radio, what its model number is and research on historical information about the maker. We buy & sell estates of radios and we offer written appraisals for insurance or estate purposes. We also have thousands of service manuals on amateur (ham) equipment available for fast shipment. We would invite all who are interested to browse our Internet web site at <http://www.radioera.com>. We think you will find something you may be looking for - so we hope you can drop in soon.

SCHEMATIC DIAGRAM SERVICE - over 150,000 schematics available and thousands of radio manuals are now available. MANY WITH ELECTRONIC DELIVERY BY EMAIL - We have thousands of satisfied customers for our old radio publications, try us today!

RADIO ERA ARCHIVES

2043 Empire Central
Dallas, Texas 75235
Inquiries: 214-358-5195
Email: tsm@radioera.com
Fax: 214-357-4693
Hours: 9-5 M-F CST

Visit us on the Internet:
<http://www.radioera.com>

FOR SALE: New antenna Hy-Gain multiband verticals - \$100 + \$35 shipping. Also new LGB passenger train set w/trans. Model 20301 - \$400 + \$35 shipping. John Nosbaum, W9BJP, 2743 Wilmette Ave., Wilmette, IL 60091. (847) 256-0547

FOR SALE: Radiola 18 W/T & RCA 100 speaker, nice - \$125. Crosley 51 W/T, nice - \$125. Heathkit Model DX-60 & manual - \$50. (21) Radio Craft 1944-1948 - \$17.50. (17) QST 1931-1952 - \$15. Robert Paul, 9150 Boone Rd., Yoder, CO 80864. (719) 478-5611

FREE - 20 WORD AD EACH MONTH

To get your free 20 words,
include your SUB# with your Ad.
Additional words are 29¢ each.
Read inside back cover for details.
MANY THANKS!!!!

FOR SALE: RCA Radiola III, NT - \$50. Kenwood KD-1033 turntable - \$45. Allied SX-190 receiver - \$30. Doug Fox, 603 S. 12th Ave., St. Charles, IL 60174. (630) 584-5915

FOR SALE: NC 60 special - \$55. Echophone commercial - \$55. Echophone EC1B - \$55. NC300 - \$85. Precision 912 - \$35. Tubes good test 280 - \$25. 245 - \$45. 5931 - \$10. 371A - \$20. 30 - \$3. 523 - \$3. (35) bulb - \$5. 6L6GC - \$8. 5U4G - \$5. Pete Putra, 1429 Lawndale Ave., Racine, WI 53403. (414) 632-2543

FOR SALE: Koronette, 1960s East German tube stereo. AM/FM multiplex, three SW bands, BSR turntable, six speakers, mirrored bar. 110 VAC, works - \$125 OBO. Jack Casey, 9905 Whitworth Way, Ellicott City, MD 21042. (410) 461-1141

FOR SALE: Capehart flipchanger console - \$200. Pick up only. **WANTED:** Phonograph for Magnavox Regency Symphony 455M. Steven Thompson, 504 Cardell Cir., Mableton, GA 30126. (770) 819-1743

FOR SALE: Hi-fi amps, speakers, microphones, radios, turntables, Sams, 1940s-1950s RCA tube manuals. LSASE. Norton Thompson, PO Box 422, Paonia, CO 81428. (970) 527-3017

FOR SALE: Heathkit catalogs 1969 and 1971 - \$8 ea. Toshiba late seventies service data, assorted - \$6 ea. Stewart-Warner R149A, Sparton 1167 chassis parts. Tram tube CB D201. Teletone TV-317 service sheet, instruction manual, original - \$10. Theoretical & Practical Electrical Engineering by Bliss Vol. 1 and 2 - \$20. DEF, CLX projector lamps - \$8 ea. RCA 58AV radio/phone whole or parts. Pilot T301 - \$35. Majestic 91 escutcheon - \$20. Zenith H665R chassis - \$10. **WANTED:** GM250 chassis. Brian Kurlle, 2222 Nodleigh Ter., Jarrettsville, MD 21084. (410) 692-0450

FOR SALE: FM-AM radio with 6 tubes plus 2 diode, AM is NW, made in Japan by Sansei, nice - \$30 plus. FM receiving system radio by KLF Research Corp, Model 21, NW - \$30 plus. Elwood F. Hunt, 308 Georgetown Rd., Carneys Point, NJ 08069. (609) 299-5259

FOR SALE: Big Stromberg-Carlson console w/phone, S-C 340-H, RCA 100A speaker, AK 60 chassis (poor, parts), Philco 116 console, 16 console, 610, 37-60 t-stones, Truetone D-2210 (killer Deco w/chrome trim and grille bars) - \$125. Emerson Ingrahams 131, 153, 271, Channel Master and Tung-Sol (small) tube caddies, telephone radio (not a Guild), Magnavox horn, no base; Firestone Air Chief port. w/strap, Philco dial shafts (planetary concentric centers), Hallicrafters S-94 - \$45. Plenty more, send wants. Wilbur Gilroy, PO Box 459, Lake Winola, PA 18625. (570) 378-2508. E-mail: wlbgr@aol.com

FOR SALE: Cotton-covered magnet wire, bus wire, loop wire, write SASE or visit site: <http://home.ici.net/~radiodaz/index.htm>. Charles A. Days, PO Box 80205, S. Dartmouth, MA 02748-0205. (508) 979-3758. E-mail: radiodaz@ici.net

Our Customers Say It Best: "You've Gotta Have an AM-100!"

Whether you are a novice collector with one radio or a seasoned veteran with a roomful, curious visitors always ask the question: "Does it still work?" What better way to prove the point than with a live old-time radio broadcast. With the Comtronics AM-100, you can entertain friends with authentic on-the-air radio demonstrations!

Will it Work for Me? *You be the Judge:*

"Big-band music all the time from any of my radios"

"I can't live without one!"

"The little transmitter works like a champ...the bass response is remarkable!"

"As I'm writing this, I am enjoying vintage Count Basie on my RCA 816K"

This is the Genuine Article. Call Now and
Enjoy the Music

Tusa Consulting Services
19 Augusta Drive, Covington, LA 70435
(504) 892-7348 (504) 892-2075 FAX



Make those old radios come alive
with an AM-100, today

Price: \$199.50

Includes antenna, power supply
and UPS delivery (48 States)
1yr warranty, 30day trial

WANTED: Atwater Kent 208, 255, 312, 412. 710. Info on AK 925. Jeff Aulik, 1708 Parkview Ave., Rockford, IL 61107. (815) 399-1902. E-mail: akent36@inwave.com

WANTED: Manufactured one tube sets with exposed tube. Ed Bell, 5311 Wooddale Rd., Raleigh, NC 27606. Fax/Ph: (919) 851-1517. E-mail: ekbell@mindspring.com

WANTED: Radiola 17 lamp hood and speaker. 1948 Motorola TV knobs. Mike Cutler, 2419 Ave. O, Galveston, TX 77550. (409) 763-0938

WANTED: Hallicrafters knob (function switch) power USB-LSB etc. from SX96 SX100. H.I. Stark, 3215 S. Meridian, Indianapolis, IN 46217. (317) 788-1210

VISIT A.R.C.'s WEB SITE
www.antiqeradio.com

Book Orders - Subscriptions - Articles
and more!

WANTED: General Radio type 1419k capacitor decade box. Type 1409 & 505 standard capacitors. Alan J. Kriss, 1872 Portsmouth Way, Union, NJ 07083. (908) 688-2092

WANTED: Radio chassis/speaker for Stewart-Warner console R1264A, or chassis R126. Mr. & Mrs. L.M. Page, 4138 N. Hwy. 41, Mullins, SC 29574-9359. (843) 464-6887. E-mail: Pagehaven@aol.com

WANTED: Crosley chassis for Dual Five or Model 167 cathedral. Will buy parts set. Alan Piorek, WB9RAD, 1050 N. Paulina, Chicago, IL 60622. (773) 235-1523

WANTED: Copy of Vacuum Tube Valley article concerning 6AR6 tubes. L. Schimmel, 17411 Yakima So., Spanaway, WA 98387

WANTED: 1940s televisions: Philco 48-1000, Motorola VT105, DuMont Club or Clifton (RA 102 chassis), others. Ed Dessau, 40 Verna Rd., Monroe, CT 06468. (203) 452-1981

WANTED: Western Electric 25A/B amplifier/parts units, 1920s cone speaker/parts, tubes: 101D, 205D/E/F, 216A, 217A. Westinghouse WL-787 tube. Transformers: UTC LS10X, LS20, HA105, LS63, Acrosound TO350. Ming Yang, 1995 University Ave., #119, Berkeley, CA 94704. (925) 376-4220. E-mail: yang1240@aol.com

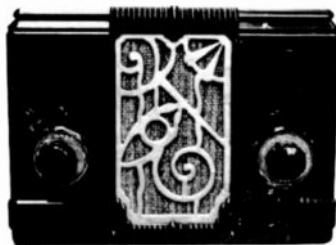

WANTED: Kadette pictured Detrola, RCA, Air King, etc. prewar plastics. I am new to the field of collecting but have plenty of money to live with big mistakes. Please write or call collect: Rain Buttignol, 214 State St., #7, Portsmouth, NH 03801. (603) 427-1384

WANTED: Junker Sony TC777 and Teac A3300 tape recorders; RCA 4X chassis. **FOR SALE:** Repaired Altec 604C speaker - Make Offer. Ray Barnes, 38 Woodmere Rd., Framingham, MA 01701

WANTED: One mint Hallicrafters tube 6SG7. John Volgyi, 308 Bryn Mawr, Unit K, Ravenna, OH 44266. (330) 296-3201

WANTED: EC-611 and accessories. Alan Burg, Forkland Ln., Dobbs Ferry, NY 10522. (914) 693-2564. E-mail: alanb@cloud9.net

WANTED: Lafayette HE-50 ten meter transceiver. Jeff Walden, 35 Sherwood Rd., Bristol, CT 06010. (860) 583-3751. E-mail: n1nin@webtv.net

HIGHEST PRICES PAID FOR NEW and USED TUBES

WANTED!

*Western
Electric*

VT25/A VT52 101D/F 104D
205D/E/F 211A/D/E 212A/D/E
231D 239A 252A 262A/B
264A/B/C 274A/B 275A 300A/B
301A 310A/B 311A/B 347A
348A 349A 350B 412A
417A 421A 422A 437A

OTHER TUBES WANTED!

2A3 5AR4/GZ34 6BQ5/EL64 6CA7/EL34
6DJ8/ECC88 6L6G/GC 6SN7GTB 6V6G/GT
10(GLOBE) 12AT7/ECC81 12AU7/ECC82
12AX7/ECC83 (Amperex/Mullard/RCA/Telefunken)
45(GLOBE) 50(ST & GLOBE) KT66 KT77 KT88
211 EF804S 845 5691 & 5692 (Red Base)
6267/EF86 6550 7025 7189 7199 7591/A, Etc.

IF YOU HAVE ANY OF THE TUBES LISTED IN THIS AD,
PLEASE Call, Fax or E-Mail DON SINGERHOUSE

Call TOLL-FREE (Tel / Fax) **(888) 715-8823**

E-Mail singtube@frontiernet.net



SINGERHOUSE

SOUND, LLC

PO Box 321, New Richmond, Wisconsin 54017

Est. 1994

FOR SALE: Crystal sets. Blue Bakelite Lil'wonder - \$75. Steinite - \$250. Detroit Radio Maxitone #1 - \$225. Dick Kowalski, KB8MR, 32823 Gloede Dr., Warren, MI 48093. (810) 294-6831

FOR SALE: Atwater Kent #48 with tubes - \$95 + UPS. Hugo Kann, 2320 King's Ct., Manion, IA 52302. (319) 377-1090. E-mail: hmkann@earthlink.net

FOR SALE: Lunafit, only one known! (Plate 612, Bunis & Breed novelty radios guide) - \$325. Gerald Schneider, 3101 Blueford Rd., Kensington, MD 20895-2726. (301) 929-8593

**E-MAIL ADDRESS FOR
ANTIQUE RADIO CLASSIFIED
ARC@antiqueradio.com**

**Ads - Subscriptions - Book Orders
See inside front cover for details**

FOR SALE: Hammarlund Comet Pro - \$425. Collins 75A-2 - \$425. RME DB-23 - \$40. RCA ACR-111 receiver - \$275. Richard Prester, 131 Ridge Rd., West Milford, NJ 07480. (973) 728-2454

FOR SALE: Zenith Trans-Oceanics, all original, working, complete, 100% restored to showpiece condition: L600 - \$275; H-500 - \$275; B600 - \$275. Frank J. Manzano, 82 Monhegon Ave., Oakland, NJ 07436. (201) 337-5263

FOR SALE: Hammarlund Super Pro 200 Series with power supply, beautiful condition - \$300. National NCX3 ham rig - \$200. Pilot TV37 with lens, restored - \$450. Many TV sets for sale. **MESSAGE:** Have liquidated radio and TV shop and have tons of tube radios and parts. Call or stop by or both. **SERVICES:** Repairs on vintage TVs and radios. Can repair all types of Predictas to work well. \$250 is the average overhaul price for Predictas. Call or write to: Vaughn Rudisill, 17 Pearsall Ave., Deer Park, NY 11729. (516) 667-5247

FOR SALE: Motorola 51X17 - \$35. Tumer crystal mic 22X - \$50. **WANTED:** 30s Zenith speaker, 6". Eric Miller, PO Box 778, Linn, MO 65051. (573) 897-4121

FOR SALE: Hallicrafters TW-1000 portable. Realistic DX-120 - \$50. GE Superadio III L.N. boxed - \$50. Sony MR-9100W portable FM stereo/AM - \$75. Zenith T-O Royal D7000Y - \$395. Grundig YB-400 PE L.N. boxed - \$150. All + shipping. Gerald Silver, 10863 W. Clairmont Cir., Tamarac, FL 33321. (954) 720-1972

FOR SALE: Pre-war Japanese cw xmtl with key, lifetime ringmount carbon mike with ring, Fiat Bank wound loop antenna, needs restoration. Photos of any item - \$1 ea. Jay McAlister, PO Box 1889, Costa Mesa, CA 92628-1889. (714) 963-1627

FOR SALE: General Electric L-660, wood, chrome, vg - \$75. General Electric H-639 R/P strong curve, vg - \$50. John Koop, 48 Wheelbarrow Ln., Wantagh, NY 11793. (516) 731-6711

FOR SALE: 45-tube adapter using a low cost output tube - \$16 ea. plus shipping. James Sinwell, 511 Newport Dr., Greensburg, PA 15601. (724) 834-0763

FOR SALE: Subwoofer, Jensen 12" dual coil JP12004-8 ohm, 375 watt peak - \$45 + ship. R.G. Purcell, 4473 W. 136th St., Cleveland, OH 44135. (216) 251-6511

FOR SALE: Heathkit IG-62 color bar generator, mint condition, untested - \$25 plus UPS. Onorio Lou Sabetto, 1717 Burgess Rd., Cleveland, OH 44112. (216) 481-1036

FOR SALE: N.O.S. tubes: 6MJ6 - \$30. 6LQ6, 6KD6, 6JS6, 6KV6 - \$25. Postage \$4. Bob Putnak, 1507 4th St., Monongahela, PA 15063. (724) 258-6236. E-mail: tubeaudio@home.com

FOR SALE: RCA 3-BX-671 Strato-World, no tubes - \$40 + shipping. George Fitzpatrick, 204 N.E. 17th Ave., Fort Lauderdale, FL 33301. (954) 467-7036

Join the
AWA

**ANTIQUE WIRELESS ASSOCIATION
THE ORIGINAL AND LARGEST HISTORICAL RADIO-COLLECTOR GROUP**

- Publishes *Old Timer's Bulletin* with:
 - Battery and AC receiver restoration
 - Vacuum-tube history and collecting
 - Old-time amateur-radio contests
 - Communications receivers
 - Free want-sell-swap ads
 - Early television
 - Horn loudspeakers
 - Reviews of current books
 - Keys and land-line telegraphy
 - News of U. S. and foreign clubs
 - Information on public radio museums.
- Maintains unique radio-TV museum.
- Produces the annual Rochester meet.
- Co-sponsors local meets.
- Publishes the annual **AWA Review**.



Membership is only \$15 per year (\$27 for two years, \$18 per year for overseas). Mail check to:

**Antique Wireless Association, Inc.
Box E, Breesport, NY 14816**



BUY/SELL

TUBES

NEW & USED

SEND FOR OUR "WANT LIST"
OR
OUR FREE CATALOG

**ELECTRON TUBE ENTERPRISES
P. O. BOX 8311
ESSEX, VT 05451-8311**

TEL: 802-879-1844

FAX: 802-879-7764

EMAIL: etetubes@vbimail.champlain.edu

Childers/Smith Auction Company
presents the
Frank Krantz
Estate Auction Continued

Sessions III and IV

Saturday, June 26 and Sunday, June 27, 1999

For the 200+ registered bidders that attended the Frank Krantz estate auction April 24th and 25th, 1999 when we held Sessions I and II, let this ad serve as a notification for the people who could not attend and would like to participate. Please join us for Sessions III and IV when we will attempt to sell the remainder of the most voluminous collection of electronics and related material we have ever encountered. (Refer to A.R.C. Volume 16 April Issue Number 4). When I say attempt to sell, I am referring to the fact that one additional auction may be required to liquidate Frank's inventory. We will make this assessment after Session IV and make an announcement at that time. In addition to the many categories of which Frank's collection was comprised, we will offer his parts inventory which most of A.R.C.'s classified readership would consider seemingly endless. Also, included in Session III and IV will be the entire tool inventory which under normal circumstances would be an auction in and of itself. Beginning at 10:00 AM on Saturday, June 26th, we will sell a cross section of all categories to be included and we will repeat the same process on Sunday, June 27th. Unlike Sessions I and II, Sessions III and IV will be sold uncataloged. There are sure to be many surprises.

When: Saturday, June 26th 10:00 AM and Sunday, June 27th 10:00 AM, 1999. Preview: Friday, June 25th 12:00 PM until 5:00 PM. On Saturday, June 26th and Sunday, June 27th inspection will begin at 8:30 AM.

Location: 100 Osage Ave., Somerdale, New Jersey.

Terms: Cash or local check, out of area checks require prior approval unless known to Childers/Smith. Absentee bids accepted with 25% deposit. There will be a 10% buyers premium applied to all purchases. No sales tax. No phone bidding. Address written inquiries to Dennis Childers, PO Box 126, Arcola, PA 19420 or call Dennis at (610) 489-0683. Phone number days of sale only (609) 783-0400. Visit our website at www.smithauctionco.com or e-mail us at harold@smithauctionco.com.

Auctioneers note: Sale conducted outdoors rain or shine. Limited space, bring your own chairs or stools. Food available.

Harold Smith
AU-002163-L

Annette Smith
AU-002706-L

Dennis Childers
AA-002303-L

FOR SALE: 1948-1952, dealer scrapbook, huge newspaper ads, radio/television, much more. SASE list. Bill Tucker, W4FXE, 1965 S. Ocean Dr., Apt. 15-G, Hallandale, FL 33009. (954) 456-1349

FOR SALE: Mallory BC-7 grid bias cells, Crosley 516 chassis w/speaker. William K. Seiler, 8819 S. State Rd. 135, Pekin, IN 47165. (812) 883-1453

FOR SALE: Rare RCA Model 96X13 in the brown and tan (Stein I, p. 168), perfect except for minor hairline on one side of dial cover, no back, otherwise all original and working - \$375 plus shipping. Stan Ward, 56 Third Ave., Berea, OH 44017. (440) 243-7197

**IF YOUR EXPIRATION DATE IS
JUNE OR BEFORE, RENEW TODAY!
EARLY RENEWALS
RECEIVE AN EXTRA ISSUE!**

FOR SALE: Pair of Krohn-Hite UF-101AR commercial amps, each unit 4-6550 Tung-Sol, 83 lbs. ea., rack mount, exc w/factory manual - \$700. George Schwarz, 18504 Arrowhead, Cleveland, OH 44119. (216) 486-6489

FOR SALE: Emerson 541 - \$60; 706B - \$70. GE GD-52 - \$75; L-652 - \$60. DuMont RA346, ivory - \$95. Grundig 97 - \$80. Guild Country Belle - \$60. Town Crier - \$100. Spica Chest - \$95. Sewing box - \$150. Farnsworth ET-269 - \$60. Westinghouse 579 - \$65. H-173 - \$70. Motorola 65X13 - \$55. RCA 15X - \$60. J. Gary Cameron, 824 Andrews St., Southington, CT 06489. (860) 276-9200

FOR SALE: Belmont 6D111B Art Deco - \$250.
WANTED: Chassis & speaker for AK 627 or Gloritone 99. Need not work if repairable. Maureen Martin, 1407 Memory Ln., Lutz, FL 33549. (813) 949-1835

FOR SALE: New, never used but slightly damaged, Kenwood SSB transceiver TS-5205, dial knob broken - \$200 + UPS. H. Andreoni, c/o 250-D So. Lyon Ave., Hemet, CA 92543

FOR SALE: Leeds & Northrup galvanometer No. 5430-A, oak box - \$250. Radio Electronics, 78 issues, 1960 thru 1977, not consistent issues. PF Reporter, 11 issues, 1963-65. Electronic Servicing, 11 issues 1973-77.
WANTED: Instruction book for using Pickett slide rule calculator electronic Mod N-515-T Cleveland Institute of Electronics. Ed Fifth, N20GZ, 123 Brannon Dr., #12, Dickson, TN 37055. (615) 446-6466, Sun. or after 8 pm

FOR SALE: Audio, radio & misc. Send for list. Roger & Mary Ellen Ruddick, 33 Emily Ln., Ft. Myers Beach, FL 33931. (941) 463-8887

FOR SALE: Fada 252 yellow on maroon - \$1,000. Addison #2 yellow on black, exquisite - \$1,500. Bendix 526C - \$600. 1939 World Fair - \$1,500. E-Mor world globe/pedestal blue metallic - \$2,000. Tom Thumb repro (2) red - \$750 ea. Tom Thumb camera radio - \$500. Extra camera; Radiolamp America (Chicago) (4) brass mushroom; white; brass; marble - \$600 ea. 1958 N.I.B. Hotpoint remote console TV - \$300. Crosley G1465 (24) yellow on black. David F. McMorran, 48 E. Central St., Natick, MA 01760

FOR SALE: General Radio 1650B RLC bridge, excellent - \$200. SASE for 5-page list. Chase Hearn, 104 Glenwood Dr., Williamsburg, VA 23185. (757) 229-7263

FOR SALE: Chassis only. Edison receiver Type 7R. Knobs, front panel & escutcheon, no tubes. Capehart Mod 115P2 with tubes, missing 1 knob. Baby Grand, broadcast & shortwave, knobs, tubes & speaker. All untested. Majestic service manuals, covers 28-29-30, hardbound. Best Offer by 15th of this month plus shipping & insurance. Bill Weber, 854 Southside Blvd. S, Melba, ID 83641. (208) 495-7849

FOR SALE: New: Toothed drive belt for the Zenith 7000 - \$5 plus \$1.50 shipping. Rescreened original dial masks for 1938 and 1939 Zenith shutter dials - Call. Rubber gasket for the dial glass for Zenith and other brands - \$3 per foot. Brass inserts for Zenith Transoceanics and 1942 Zeniths - \$5 each or 2 for - \$8. Also H500 and 600 knobs with inserts - \$15. We stock a large selection of quality repro grille cloth. Lucite dial lens for the 1942 Zeniths - \$16. Repro arms for your RCA chrome chair, pair - \$60. Call for details. Universal Dial Belt Kit - \$9.95 ppd. Complete speaker repair - Call. Send for free parts and supply catalog. Visa, Discover and Mastercard accepted. Alan Jespersen, PO Box 17338, Minneapolis, MN 55417. (612) 727-2489, 8 am-6 pm, Mon-Sat. Fax only: (612) 821-4821. E-mail: mte612@aol.com

FOR SALE: Copies of Majestic Grigsby-Grunow and Majestic General Household 1930s Service Bulletins. Gary A. Micanek, 226 Henry Ave., Manchester, MO 63011. (314) 227-7046. E-mail: micanek@aol.com

FOR SALE: Crosley E15WE nice - \$75. Emerson Moderne 517 - \$40, 547A - \$30. Mantola R664pvt 120 - \$30, Mantola wood, PB - \$40. Motorolas: 5X - \$75, 57X - \$45, 67X - \$25, 69X - \$35. Philcos: 48200 nice - \$35, 52548 - \$45, 52940, good - \$50. Silvertone 2002 - \$60. Zenith K616 - \$45. Many more, LSASE state choice. Pictures on individual basis. H. B. McMahan, 313 W. Shaw, Tyler, TX 75701-3029. (903) 593-5433. E-mail: hbmc@juno.com

Old Authors Bookshop

Wireless Telegraphy Telephony Radio Television Electricity

Books and Literature
Bought and Sold

PO Box 403 Morrisburg ON Canada K0C 1X0

Tel (613) 543-3337 Fax (613) 543-2380

e-mail: authors@mor-net.on.ca

Website <http://www.abebooks.com/home/oldauthors>



WANTED

Amrad 3670 as shown, any condition. Also a Type E crystal set, 3500-2 and other pre-1926 Amrad sets & parts.

Andrew Mooradian, 5 Priscilla Lane
Winchester, Massachusetts 01890
tel. 781-729-1873 after 7 pm

TUBES WANTED



Electron Valve

8430 COUNTRYWOOD FAIRWAY
CORDOVA, TN 38018

Phone: 901-382-9955

Fax: 901-382-9956

Email: cmagee@electron-valve.com



Western Electric

TB=Tennis Ball

VT-2 / 205A/B S250 NOS, S125 used

VT-52 S150 NOS, S80 used

101D / 101F (TB) S185 NOS, S100 used

101D / 101F / 101L (ST) S35 NOS

102D / 102F (TB) S180 NOS, S100 used

102D / 102F (ST) S35 NOS

205D/E (TB) S445 NOS, S285 used

211A/D/E S280 NOS, S150 used

212A/D/E S750 NOS, S250 used

2310 S65 NOS, S30 used

242A/B/C S300 NOS, S150 used

252A S1200 NOS, S700 used

261A S155 NOS, S80 used

262A/B S65 NOS, S35 used

274A / 274B S250 NOS, S180 used (Engraved Base)

274A / 274B S200 NOS, S130 used

275A S140 NOS, S65 used

300A S900 NOS, S675 used

300B S875 NOS, S525 used (Engraved Base)

300B S565 NOS (1950's and 1960's printed base)

310A / 310B S20 NOS, S12 used

331A S45 NOS, S23 used

348A / 349A S95 NOS, S45 used

350B S210 NOS, S95 used

417A / 420A / S755 S10 NOS

421A / 422A S35 NOS, S15 used

TRIODES:

2A3 RCA S44 NOS, S20 used

2A3 (Single Plate) S180 NOS, S100 used

10 Balloon S80 NOS, S35 used

45/245 Balloon S65 NOS, S28 used

50 Balloon S220 NOS, S120 used

VT-52 S120 NOS, S60 used

71A Balloon S28 NOS, S14 used

80/280 Balloon S32 NOS, S20 used

211 RCA / United S125 NOS

845 S200 NOS, S95 used

PENTODES:

6X50 Tungsol S65 NOS

7591A S34 NOS, S18 used

616GC RCA (Black-Plate) S40 NOS

EL34 Mullard S80 NOS, S35 used

EL37 Mullard S75 NOS, S35 used

KT66 Genalex / Mullard S80 NOS

KT77 Gold Lion S160 NOS, S90 used

KT88 Gold Lion S185 NOS, S80 used

PREAMP / DRIVERS:

5691 Red Base S18 NOS, S10 used

5692 Red Base S34 NOS, S20 used

65N7 Sylvania / RCA S6 NOS

6SL7 Sylvania / RCA S4 NOS

12AX7 / ECC83 Telefunken S38 NOS, S1's used

12AU7 / ECC81 Telefunken S34 NOS, S8 used

12AT7 / ECC82 Telefunken S30 NOS, S6 used

6BRCC Telefunken (Gold Pin) S40 NOS, S18 used

6FB6 / 6267 (ECC. Ampex, Tele) S20 NOS, S8 used

Genalex Z-729 S20 NOS, S14 used

Genalex Z-759 Gold Lion 12AX7 S100 NOS

Highest prices paid for NOS tubes in original boxes. If you have any other tubes that you think we might be interested in, please call.

We will meet or beat any written offer!

We would like to buy any of your Western Electric, H.H. Scott, Morantz, Fisher, or Dynaco amplifiers or preamplifiers.

Electron Valve is also seeking the following recording gear. If you have any of the following pieces or know anyone that does, please contact us.

MICROPHONES:

Neumann U-47

Neumann U-67

Neumann U-87

Neumann KM84

Neumann M-49

Neumann M-50 Omni

RCA 44

RCA 77

Sony C-37A

Telefunken ELAM 251



TUBES FOR MICROPHONES:

Telefunken VF-14 S600 NOS, S400 used

Telefunken AC701K S120 NOS



OUTBOARD / RACK GEAR:

Fairchild 660 / 670 Compressor

Neve T066, 1073, 1081, 1272 Mic Pre / EQ

Telefunken V72 / V76 Mic Pre

Pultec EQ's

RCA BA6A Compressor

Urei 1176 Compressor

Urei LA2A Compressor

**WE BID ON SMALL OR LARGE LOTS.
IF YOU HAVE ANY QUESTIONS OR IF YOU HAVE ANY OF THE ITEMS LISTED HERE, GIVE US A CALL!**

FOR SALE/WANTED: Buying/Selling: Minifons, mini reel tape and wire recorders. Jon Golden, Box 5077, Wayland, MA 01778. (508) 653-4166. E-mail: 3dman@ziplink.net

FOR SALE: Arvin 950T - \$20. RCA 35X - \$12. Beitman's Most Often Needed Radio Diagrams: '26-'38, '39, '40, '41, '42 - \$6 ea. Richard Haneline, 3600 Cuba Blvd., Monroe, LA 71201. (318) 323-9657, between 8 am & 6 pm

FOR SALE: Concord Model 444 (1964) reel-to-reel 3-speed stereo tape recorder - \$75. Goodmans (England) 15-inch woofer - \$75. GE box of TV knobs, over (35) N.O.S. knobs - \$20. Zenith console Model 9-H-081, 1946 9 tubes, has BC & (2) FM bands, but record player is missing, large black dial - \$75. Eico 40-D 5-inch oscilloscope - \$35. Heathkit oscilloscope IO-D-203 - \$50. Silvertone 7024 table radio - \$75. Garrard Type A-II 4-speed record changer - \$75. Sony Model TV-413, 3 1/2" B&W TV/AM/FM - \$75. Regency MR-10 radio, 152-174 MHz band - \$45. About (125) Sams AR (auto radio) books - \$6 ea. About (3,000) Sams Photofact folders - \$3 ea. Rotating Gyro speaker cabinet, takes 3 1/2" woofers & 3 tweeters - \$100. Boxes of mixed new, N.O.S. & used TV parts, RCA, Philco, Panasonic, Admiral, per box, per brand - \$30 per box. Mura CB SWR meter N.I.B. - \$15. Grab Bag Special: Hundreds of pounds of parts, mostly new, some in original packaging, including jacks, plugs, wires, cables, needles, lamps, controls, meters, relays, misc. hardware, and much more other stuff. A generous 5-pound box (no 2 alike) for - \$10 ea. All prices plus UPS. Bob Lynn, 26 E. Orchard St., Somerville, NJ 08876. (908) 685-9070

FOR SALE: Hallicrafters: SX10A & Heath Apache TX1. SX108. SX110. SX100. SX62. SX71. SX76. SX42 & SP. National: 240D & SP NC46 & SP. NC300. Military: 6 of R390A, all restored & correct. 10S1B & G restored & factory recons. Hammarlund: HQ180A & SP, HQ170. HQ145. HQ140X. HQ100A & SP. SP400 JX & PS, like new. HQ129X. HQ110. Teac X1000R reel-to-reel mint. Atwater Kent Model 40 & SP, very fine original. Lots more for sale, call. Alan Carpenter, 6850 N. Camino De Fray Marcos, Tucson, AZ 85718

FOR SALE: Philco cathedral cabinet rough, pair of Peerless cathedral speakers, good drives, rough cabinet - \$15. New book list available. SASE for radio and book list. Lots to sell. Matt Hussey, 8 Capital Cir., Rochester, NH 03867. (603) 332-9927

FOR SALE: I want to sell out. Send for 48 page list of old radios, magazines, tubes - \$2. Frank Brewster, 2020 W. 5th St., Baxter Springs, KS 66713. (316) 856-3220, eves.

FOR SALE: Philco tabletop radio, Model 38-620, 1938, cabinet is in nice shape, but small tear in grille cloth - \$125 or Best Offer. Jack Sheehan, Vintage Radio, 1334 Hanover St., Manchester, NH 03104

FOR SALE: Telefunken Jubilate 105, excellent cond., no dial pointer - \$35. Levy, 8 Waterloo, Morris Plains, NJ 07950. (973) 285-0233

FOR SALE: Tubes, parts, and books. Free list for two stamps on SASE #10 envelope. Andy Bruck, RR-1 Box 356, Cleveland, VA 24225

FOR SALE: Radio collection by lot. SASE for list. **WANTED:** Lid for TV-7A/U tube tester. Irv Sanders, 242 Hunter Ln., Harrisburg, PA 17112-8922

FOR SALE: Garmco Vintage Electronics. Check out the best internet website for old radios, microphones, phonos, etc. On the net since 1996 at: <http://www.garm.com/garmradio.htm>. Tommy C. Meers, 773 Carlisle Club Dr., Stone Mountain, GA 30083-4708

FOR SALE: Jackson Model 441-A RF-AF signal generator - \$30. Richard Zintek, KC8JWE, 11954 U.S. 31, Grand Haven, MI 49417. (616) 842-2211

SEND ALL A.R.C. MAIL TO
Antique Radio Classified
P.O. Box 2, Carlisle, MA 01741

FOR SALE: Realistic #DX160 w/sep spkr, 5 bands w/s-mtr, orig. works. 7" Motorola B&W 1947 parts set. VT-4-C GE Xmiltube. Trav-Ler 78 rpm radio/phone TBL. JVC white video sphere, working. Tubes (6) 6VT136, (2) VT236, (1) 5R4GY (new in box) Tung-Sol. Stewart-Warner #9000B w/ chrome metal grille, like new - \$60. Belmont #6DIII ivory, works - Offer. Crosby #10-135 ivory slt hairline, all original - Offer. Westinghouse 6-tube frig. cream, working - \$70. Philco #38-9 hums, needs rlnsh + 2 kn - Offer. Zenith Mod #6R 886 w/red cobra arm 78 changer - \$50. Garod blue and white radio - \$35. Philco Predicta barber pole complete, mahogany - Offer. Admiral Beetle exc cond. - Offer. 8" RCA B/W portable on 4 legs swivel stand, works, all original, exc cond. - Offer. Regency TR1 off white w/ leather case, exc cond., orig. - Offer. Bill Kalcik, 3714 S. Lombard, Berwyn, IL 60402. (708) 788-9022

FOR SALE: (5) Western Electric 300B, engraved base, new old stock - Best Serious Offer. Steve Harrell, 1179 Boylston St., #30, Boston, MA 02123. (617) 549-3962. Fax: (617) 236-5659 or fax: (617) 730-8449. E-mail: tubetown@quik.com

FOR SALE: Detrola SW metal - \$75. WWII German Militester - \$85. Trans-Oceanic B600 - \$125. Zenith G723 cathedral speaker - \$100. Sentinel 118BT - \$85. Zenith 275, 707 or 700 - \$35. Collins mech filter N.I.B. Ernest Odeneal, K5QJF, 2710 Lee St., Greenville, TX 75401. (903) 455-2113 or 5700

FOR SALE: Vintage electronic books, magazines, catalogs, manuals. List SASE or e-mail. Chuck Grossman, 825 Percy Warner Blvd., Nashville, TN 37205. E-mail: GrossmanCR@aol.com

FOR SALE: B&K TV analyst 1077B, with instruction manual - \$65. Herb Love, 6 Linda Ln., Pearl River, NY 10965. (914) 735-9172

FOR SALE: Tubes, examples; Used 6V6GT, 41 - \$3; 807, 6AS7G - \$5; 6SN7GT - \$1.50; Most miniatures N.O.S. - \$2; Send SASE for list, or e-mail. Radios: Stromberg-Carlson Model 1204, nice brown plastic - \$45. Zenith TM, plays, Model 6D030 - \$35. All prices plus S&H costs. Ted Babcock, 497 Long Island Dr., Moneta, VA 24121. Ph: (540) 721-1222. E-mail: tedshir1B@aol.com

FOR SALE/TRADE: Hallicrafters Sky Challenger II w/ speaker, \$72R, National NC46 - \$150 each plus UPS.

WANTED: D.A.V. B.F. Goodrich mini keychain license tags paying - \$1.50 each. John Williams, Jr., PO Box 1545, Scarborough, ME 04070-1545. (207) 775-4212

FOR SALE: 11-band Panasonic RF5000A - \$165; 8-band RF2200 - \$125. Shipping extra. Victor Marett, 3201 N.W. 18 St., Miami, FL 33125-1837. (305) 634-9569. E-mail: antonio1@gate.net

WANTED: Any 1920s Western Electric radio, one good WE217 tennis ball tube. Igor Golioto, 17 Addison Dr., Fairfield, NJ 07004. (973) 463-4973. E-mail: golioto@gdats.com

WANTED: Information related to Commodore PET-2001-personal computer. Joseph Wood, 6511 Chester, Hodgkins, IL 60525

HAS YOUR SUBSCRIPTION

EXPIRED?

It has if your mailing label reads
"EXP=JUN99" or earlier.
Renew now!

BONUS: Renew before
your "EXP" month and receive
13 issues per year instead of 12!

***15th Year Special!** Renewal rates are:

\$39.49* for Periodicals Mailing

\$57.95 for First-Class Mailing

(Two-year renewals are twice above rates.)

WANTED: Detroit: Commercephone, Etherphone, Powertone, Maxitone & TECLA. Michigan/Klitzen, Arborphone, International, Kadette & Cavac. Nevins Museum of Radio, Ken Nevins, 406 Jipson St., Blissfield, MI 49228. (517) 486-3019, evenings. E-mail: knevins@tc3net.com

WANTED: Collector tubes. Need good C301/UV201s and DL and DV types. Buying collector tubes of all types. Please send your list of tubes you want to sell for our offer. George H. Fathauer, 688 W. First St., Ste. 4, Tempe, AZ 85281. E-mail: fathauer@home.com

WANTED: Good cabinet for Stromberg-Carlson 325-J.
FOR SALE: Scott SLR12B shipboard receiver, working. Steve Hansman, 855 Anundel Dr. N, Arnold, MD 21012. E-mail: Shans01A@aol.com



WANTED: Emerson Catalin radios. Would you believe that my mother's last request is that I gather every known example of this radio ever made. I guess she wanted me to suffer a long time. Please write or call collect: Rain Buttignol, 214 State St., #7, Portsmouth, NH 03801. (603) 427-1384

WANTED: Rohde & Schwarz Type EK07 receiver. Harry Weber, 4845 W. 107th St., Oak Lawn, IL 60453-5252

WANTED: 1920s and 30s QSL cards, magazines, books on early radio and telegraph and wireless. Will pay a good price for good items and arrange pick-up at your door if necessary. Call: Larry Drago, 383 Lincoln Dr., Cheshire, CT 06410. (203) 272-5030. Fax: (203) 272-2002. E-mail: theradioman@webtv.net

WANTED: Manuals for military GRC-9 receiver and Heath QF-1. Bob Hand, W8WQS, 4775N 295W, Shipshewana, IN 46565. (219) 562-2318

WANTED: Speaker for Philco cathedral Model 20, 70, or 90. Edgar McBee, 114 S. Ashley Park, Wichita, KS 67209. (316) 729-2946

CALL FOR OUR FREE 72 PAGE CATALOG!

ANTIQUE ELECTRONIC SUPPLY 1999 CATALOG
TUBES PARTS BOOKS SUPPLIES



6221 SOUTH MAPLE AVE. TEMPE, AZ 85283

6221 SOUTH MAPLE AVE. TEMPE, AZ 85283

TUBES PARTS SUPPLIES

ANTIQUE ELECTRONIC SUPPLY

your complete source for...

Tubes:

Over 3500 receiving, transmitting, audio and industrial types in stock, including many foreign and early types.

Transformers:

Hard to find power, filament, and output transformers as well as filter chokes for tube equipment. We feature HAMMOND performance transformers as well as many new old stock transformers.

Capacitors:

High voltage electrolytic and mylar capacitors, multi-section capacitors and more for tube circuits.

Parts:

Resistors, tube sockets, potentiometers, knobs, dial belt lamps, diodes, speakers, wire, phonograph needles and much more.

Literature:

Extensive selection of literature and books on antique radios, tubes, circuit diagrams, communication gear, and hi-fi equipment. Some items not available elsewhere!

Supplies:

Grill cloth, cabinet restoration supplies, batteries, chemicals, tools, test meters, kits and gifts.

6221 S. Maple Ave. • Tempe, AZ 85283 • (480) 820-5411 • FAX (480) 820-4643 or (800) 706-6789

www.tubesandmore.com • E-MAIL info@tubesandmore.com

Collector's Guide to Novelty Radios Book II

By Marty Bunis & Robert Breed



**All New Second Volume
600+ Color Photographs
Price Guide**

\$19.95 - Softcover

Collector's Guide to Novelty Radios by Bunis & Breed, First Volume – \$18.95

U.S. Orders - Enclose \$3.00 per order for packing & book-rate shipping if total order is under \$35.00. If using VISA or MasterCard, include name on card, card number and expiration date. Send payment with order. Mass. residents add 5% sales tax. Money back return policy. Softcover unless stated otherwise. Most orders shipped the same day received, but allow 2-4 weeks to receive order. Foreign orders - write for shipping costs, or use credit card and specify air or surface (allow 2-3 months for surface shipping).



A.R.C., P.O. Box 2, Carlisle, MA 01741. Tel: (978) 371-0512

Fax: (978) 371-7129 – E-mail: ARC@antiqueradio.com – Web: www.antiqueradio.com



(Mar-99)

WANTED: Grille and tuning wheel for Penney's 6TP-408 transistor radio. Al Wirtenberg, 15 Wilson Rd., Weston, CT 06883. (203) 544-9270. E-mail: mswaw@mail.snet.net

WANTED: General Radio vacuum tube bridge Type 443, 561A or C, 1661A or B. Charles Brett, 5980 Old Ranch Rd., Colorado Springs, CO 80908. (719) 495-8660. E-mail: Brett3729@aol.com

WANTED: Zenith Trans-Oceanics, all models. Zenith military Trans-Oceanics R520/URR, R520A/URR, R1000M, ZX5. Frank J. Manzano, 82 Monhegon Ave., Oakland, NJ 07436. (201) 337-5263

WANTED: Jensen Alnico 5 concert series/special design speakers, magnet covers, bad cones are OK. George Weisel, 615 Pattee Canyon Dr., Missoula, MT 59803. (406) 549-2206

**HAVE YOU MOVED? ARE YOU MOVING?
PLEASE NOTIFY US A.S.A.P.
SEND US YOUR...
OLD ADDRESS
NEW ADDRESS and
SUB #
MANY THANKS!!!!**

WANTED: H.H. Scott 299B, 222C, LK48 tube amps for parts or repair. Ed Skilton, 517 Palmer Rd., Conshohocken, PA 19428. (610) 825-0557, 4 pm-10 pm, Mon.-Fri.

WANTED: Collector seeking deluxe floor radios, especially RCA Models 15K, HF-6, HF-8, U-134, D-22, 381. Send along SASE and I'll enclose photocopy to help identify specific models. Thanks. Dan Gutowski, 9753 Easton Rd., Dexter, MI 48130. (734) 433-1354

WANTED: Dial scale/printer and on-off-vol. switch for Stromberg-Carlson 1500 (BR). Set of knobs for Bendix 753W. L. Heath, 1708 Duffer Rd., Sebring, FL 33872. (941) 382-9535

WANTED: Knobs for Admiral television 24A12X. Need one inner metal and two outer Bakelite knobs. Robert Nicholson, General Delivery, Manila, Ontario, Canada K0M 2J0. (705) 357-1466

WANTED: Sutton transistor radio, black or green model. Also, Sutton UHF TV converter. Wayne King, 103 N. Main, Lawrenceburg, KY 40342. (502) 633-6564

WANTED: Left button pod for Zenith 10H573 console. E-mail for pictures. Robert Turcotte, 1890 Arlington Rd., Roanoke, VA 24015. (540) 342-8521. E-mail: turcotte@rev.net

WANTED MICROPHONES
BROADCASTING EQUIPMENT
Amplifiers, mixers, compressors, on-air lights, Mike flags, equalizers, literature, TV cameras, Disk, wire & tape recorders, 16" transcriptions, Turntables, arms, pickups, blank discs, speakers, Commercial, home & theater audio. Interesting, early or elaborate radio & TV sets. Buy & sell.



Robert Van Dyke, 2 Squires Ave., East Quogue NY 11942
Tel. 516 728 9835 Fax. 516 723 3538 vandyke@hamptons.com

WANTED: Atwater Kent early breadboards, 4052, 4120, 4066, 4205, etc. Please call or e-mail. Mike Fletcher, 1204 Cedar St., Niles, MI 49128-2636. (616) 684-2174. E-mail: fletchms@qtm.net

WANTED: Radios made in Seattle. Audio input, output transformers. Allied, Lafayette catalogs. V. Vogt, 330 S.W. 43rd St #247, Renton, WA 98055. (206) 295-4418. E-mail: v98055@webtv.net

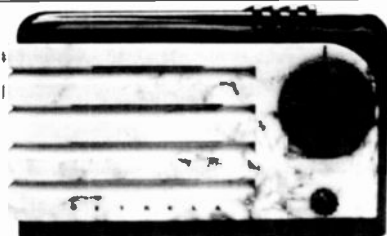

WANTED: Prewar plastics by Detrola, Kadette, RCA, Philco, etc. My cousin Vinny and I, we was thinking, "Hey, we got the cash," (a cool mil, to be exact), "so let's spend some before dem girls gets hold of it." You know what I'm saying? Please write or call collect: Rain Buttignol, 214 State St., #7, Portsmouth, NH 03801. (603) 427-1384

WANTED: Parts for otherwise nice radios. Station preset button assembly for Sparton 1068 console. Center potentiometer and knob for Fada 192A Neutrolette. Dial pointer and dial cover, if it had one, for a Crosley 6H2 tombstone. Gordon Ormsby, 1855 N.W. Circle Pl., Corvallis, OR 97330. (541) 753-6398

WANTED: Western Electric 4A and 5A rectifier units, Western Electric Model 41, 46, 47A, 59, 60A or 61A amplifiers any condition or completeness, Western Electric 247A, 247H & 247L input transformers, Western Electric 127D output transformers, Western Electric 239A, 244A, 247A, 264A, B, C and 262A, B, C tubes. Thanks. Eric Lenius, PO Box 685, Fort Orchard, WA 98366. (360) 871-5921. E-mail: lenius@tscnet.com

WANTED: Masterwork dual volume control 100K w/ 50K tap and switch. Reference Sams 1032-H. Don Mier, 4009 N. Foxdale Ave., Covina, CA 91722. (626) 338-9225

WANTED: Junker or Philco chassis Model 18 or 118. Need dial and drive. R.F. Haworth, 112 Tilford Rd., Somedale, NJ 08083. (609) 783-4175

WANTED: Military 2-volt lead acid cells, 2-volt vibrators, and 12-volt viabrapacks. Krajovic, N3DKS, 546 Sheridan Ave., Pittsburgh, PA 15206. (412) 665-0916

WANTED EARLY TUBES

Aecturus, DeForest and earlier uncommon types. Also buying balloon shape tubes of all types. Send your list for our offers.

For list of tubes for sale send SASE or e-mail fathauer@home.com

See <http://members.home.net/fathauer>

George H. Fathauer

688 W. 1st St., Ste 4, Tempe, AZ
480/921-9961 fax 921-9957

Genuine Plastic Radios of the Mid-Century

By Kenn Jupp & Leslie Piña



**NEW!
Order
Today!**

**55 Manufacturers from Admiral to Zephyr
Table Models – Portables
439 Color Photos – Price Guide
Advertisements**

\$39.95 - Hardcover

U.S. Orders - Enclose \$3.00 per order for packing & book-rate shipping if total order is under \$35.00. If using VISA or MasterCard, include name on card, card number and expiration date. Send payment with order. Mass. residents add 5% sales tax. Money back return policy. Softcover unless stated otherwise. Most orders shipped the same day received, but allow 2-4 weeks to receive order. Foreign orders - write for shipping costs, or use credit card and specify air or surface (allow 2-3 months for surface shipping).



A.R.C., P.O. Box 2, Carlisle, MA 01741. Tel: (978) 371-0512

Fax: (978) 371-7129 – E-mail: ARC@antiqueradio.com – Web: www.antiqueradio.com



(Mar-99)

WANTED: Working A-10 Type power supply, used in several all-American Mohawk models. Daniel Crowley, 61 Central Ave., E. Hartford, CT 06108. (860) 282-1309

WANTED: Will purchase entire collections and estates and will arrange for pick-up at your door anywhere. Call: Larry Drago, 383 Lincoln Dr., Cheshire, CT 06410. (203) 272-6030. Fax: (203) 272-2002. E-mail: theradioman@webtv.net

**NOTICE TO ALL
CLASSIFIED ADVERTISERS!
OUR CLASSIFIED AD DEADLINE IS
12:00 NOON
ON THE 10th OF EACH MONTH**

WANTED: Zenith Stratosphere 1000, must be exc and orig. Serious reward offered for lead and/or sale. Also, RCA/Western Electric broadcast industry catalogs, showing mics, preamps, other broadcast gear. Looking for Allied catalogs, '50, '51, '54, '57. Have dups from 60s and 70s for trade. The following gear is for a trade for above wants: EV V-2, exc.; 642 shotgun w/new rubber in shockmount, really cool; RCA 6225 carbon from 20s, near perfect w/embossed copper mesh screens: RCA BK-4; Astatic D-104 on stand, mint; Western Electric five foot shotgun on period tripod, near perfect: Electro-Voice 643, seven foot shotgun; Shure 55s, large and small from perfect to props; MacIntosh 225 amp, exc; Altec 604-B, exc. Always looking for: Western Electric, Neumann, other early bottle mics, RCA box camera 4-A, 77-A, 77-C, Shure 55-B. See For Sale or Trade ad this issue. Ward Kremer, 5807 Papaya Dr., Ft. Pierce, FL 34982. Ph./fax: (561) 468-7732. E-mail: WKremer798@aol.com

WANTED: Radio control model boats with vacuum tube transmitters and receivers. Louis L. D'Antuono, 8802 Ridge Blvd., Brooklyn, NY 11209. (718) 748-9612, call after 6 pm

WANTED: For RCA Radiola IV, horn and driver, interior cabinet parts or cabinet, condition not important. Willis Rudolph, 5608 Elmhurst Ave., Memphis, TN 38115. (901) 365-6166

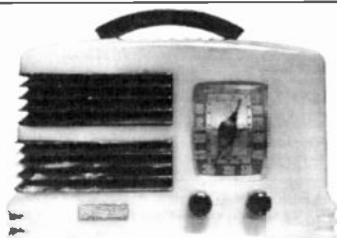

WANTED: Symphony and Detrola Catalins. If only you knew how necessary these radios are to my very existence. Gee, if you knew that you'd probably never call or hope I'd wither away ending once and for all these stupid ads. Please write or call collect: Rain Buttignol, 214 State St., #7, Portsmouth, NH 03801. (603) 427-384

WANTED: Pilot battery Super Wasp, junker or restorable. Bill Jelinek, 3985 Manor Loop Rd., Rhinelander, WI 54501. (715) 362-2909

WANTED: Tube & transistor cigarette advertising radios. Winston, Marlboro, Camel, Newport, etc. John DeLoria, 101 Doverbrook Rd., Chicopee, MA 01022. (413) 593-1180

WANTED: Emerson Model 560 portable in maroon plastic in near mint condition with no cracks. Chuck Davis, 7666 Aldridge Pl., Dublin, OH 43017. (614) 792-6237 E-mail: CDavis6237@aol.com

WANTED: Two knobs for a Crosley D-25WE clock radio, preferably white. Milt Margolis, 6500 Harwood Ct., Springfield, VA 22152. (703) 451-4507. E-mail: miltm@compuserve.com

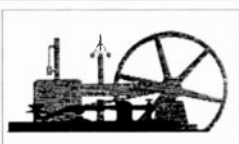

THE NEW ENGLAND MUSEUM OF WIRELESS AND STEAM, INC.

1300 Frenchtown Road, East Greenwich, Rhode Island 02818

Fax 401-884-0683 — Tel. 401-885-0545

See Our Web Page At: <http://users.ids.net/~newsm>
Coffee, donuts & soda available. Bring your own lunch.

STATIONS: PJ, WDH, W1NTE, W1MB, K1NQG calling:

YANKEE RADIO TUNE-UP

Saturday June 12, 1999 — 8:00 A.M. – 3:00 P.M.

Admission \$6.00 — Free Parking

*Antique Radio Flea Market & Tailgaters, Fidelity Amateur
Radio Club ~ K1NQG, Silent Auction Of Some Rare Items*

FOR SALE: Collector tubes. Send SASE or e-mail for list. George H. Fathauer, 688 W. First St., Ste. 4, Tempe, AZ 85281. E-mail: fathauer@home.com

FOR SALE: For El Loco's latest list send LSASE, stamp or e-mail. Stan Lopes, KB6LGV, 1201-74 Monument Blvd., Concord, CA 94520. (925) 825-6865. E-mail: splopes@aol.com

FOR SALE: 7591 - \$50. 6JB6 - \$25. 30KD6 - \$20. 6LF6 - \$30. More. John R. Tebeau, 2572 Oak Villa Rd., Thomson, GA 30824. (706) 595-8211. E-mail: TebeauJ@aol.com

FOR SALE: Knight 60 watt stereo, good chrome, has (2) Mullard EL34, (2) Valvo EL34, (2) Mullard GZ34, (2) Mullard ECC83, (2) Mullard 6267. All tubes test very good - Best Offer by 15th of this month. Radios: Air King 4607A, very nice - \$75. National NC300 - \$150. Plus shipping. Tony Rinaldo, 308 Lenox Ave., Oneida, NY 13421. Ph./fax: (315) 363-3644

FOR SALE: A large quantity of transmitters, receivers, transmitting tubes and parts from the estate of one of our pioneer hams. Lots of Collins equipment. Sell all at once, not piecemeal. Send \$2.50 for first-class postage to receive a 58-page inventory list. May be seen before bidding, call for an appointment. Serious bidders only, please. Edwin Rogers, 6938 E. Waco Dr., Syracuse, IN 46567. (219) 457-8886

FOR SALE: Zenith T-O, 8G005YT, all there, but wrong handle - \$80. Classic Radio & Television, 541 Riverside Dr., Box 61, Augusta, ME 04330. (207) 623-2059

WANTED: OUTSIDE HORN PHONOGRAPHS.

Mint, junkers or parts, horns, boxes, reproducers, etc. Johan L. Acciavatti, PO Box 806, Upton, MA 01568-0806. (508) 476-3229

WWII MILITARY TELEVISION WANTED. Army/Navy SCR, ATJ, ATK, ARK, ARJ, CEK, CRV. Receivers, cameras, monitor, transmitters, dynamotors. Maurice Schechter, 590 Willis Ave., Williston Park, NY 11596. Ph/fax: (516) 294-4416

Victrola Repair Service: Windup phonograph repairs, parts, springs, needles via U.P.S. Rod Lauman, 19 Cliff St., St. Johnsbury, VT 05819. (800) 239-4188, eves.

FOR SALE: 1941 PHILCO ESCUTCHEON REPRODUCTIONS. Beautiful injection molded marbled brown plastic - just like the originals. Fits Models 41-250, 255, 256, 280, 285, 287, 290 and 296. Cost - \$29.95 plus \$3 shipping. California residents please add 8.25% sales tax. Send a money order to Old Time Replications BA, 5744 Tobias Ave., Van Nuys, CA 91411. (818) 786-2500. Fax: (818) 909-0241. Guaranteed satisfaction or your money back.

PHONO NEEDLES & CARTRIDGES (magnetic/ceramic). Over 500 cartridges and 5,000 needles. J. J. Papovich, 53 Magnolia Ave., Pitman, NJ 08071. (609) 582-8279

BOXED CLASSIFIED ADS WORK! This is a boxed classified ad. These ads can be run more than two months. See the inside back cover for details. Boxed ad deadline: the 1st of the month.

FOR SALE: Stewart-Warner 950 Series, metal, AC - \$85. Wooden two unit desk intercom - \$40. Crosley 601 band box with original paper instructions - \$75. AK 33 - \$90. Wards Airline 05B-A, see A.R.C. April p. 53 - \$90. Speed Model 515 key - \$75. Steinite 2-knob, 4-tube, small cathedral - \$130. Stewart-Warner 3-position, wood - \$75. Vance Rayburn, 2718 Homestead Rd., Madison, WI 53711. (608) 274-3002

FAX NUMBER FOR

ANTIQUE RADIO CLASSIFIED

(978) 371-7129 - 24 hours a day

Ads - Subscriptions - Book Orders

See inside front cover for details

FOR SALE: Book, Radio Boys in Secret Service by Honeywell - \$20 ppd. RCA Receiving Tube Manual Series RC-20 - \$20 ppd. Elwood F. Hunt, 308 Georgetown Rd., Carneys Point, NJ 08069. (609) 299-5259

FOR SALE: Ghirardi's Modern Radio Servicing - \$35; and Radio Physics Course - \$35. Plus shipping. Send SASE for list of other books. Wini Reauveau, PO Box 73032, Las Vegas, NV 89170-3032. (702) 795-2613

FOR SALE: Rider's original index for radio, manuals volume 1 thru 19 - \$35. 12AU7 - \$3. James Wright, 4307 Hwy. 166 N, Maynard, AR 72444. (870) 647-2913

FOR SALE: Mac 5100 - \$265. MX-110 - \$475. C-24 - \$260. Scott 99D - \$65. 222-B - \$130. Yamaha C-65 pre - \$70. Altec 1592 - \$60. Nikko Alpha & Beta - \$185. Fender Champ - \$175. Supro amp - \$140. Carver M-500 - \$320. Tim Simpson, 915 Enright Ave., Cincinnati, OH 45205. (513) 471-6556

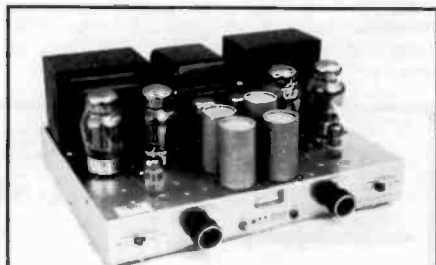

WANTED: Tube Hi-Fi components & commercial amplifiers by Marantz, McIntosh, Tannoy, Acrosound, Brook, Brociner, Fairchild, Hadley and others. Also want Western Electric theater amplifiers, speakers, tubes, & microphones. Richard Sharisky, PO Box 521, Belmont, MA 02478. Phone (617) 484-5784. Fax (617) 489-6592

WANTED: Vintage Electronic Music Synthesizers and modules by the following manufacturers, especially the listed models. Aires Modular, System III. ARP 2500. Buchia Modular, 100, 400. E-mu Modular. EML Electrocomp 100, 101, 200. EMS Synthi A, Synthi AKS, VCS3. Korg Modular PS-3100, PS-3200, PS-3300. Moog Theramin, Modular, Series 15, 35, 55. Oberheim SEM modules, 2-, 4- & 8-Voice Systems. Paia Modular 2700, 4700. Roland Modular Systems 100, 700. Serge Modulars, System 79. Synton Modular System. Call and surprise me; make my day! John V. Terrey, 498 Cross St., Carlisle, MA 01741. (978) 369-9770. Fax: (978) 371-7129

WANTED: Heathkit Mod AA-161 or AA-13, 14-watt mono integrated amplifier, Mod UA-2 mono amplifier, Mod AA-151 stereo integrated amplifier, Mod WA-P2 mono preamp. Jerry Cottingham, Box 251, Medina, TX 78055. (830) 966-3713

WANTED: 1970s LED calculators, all makes, models. Garage-sale pickers too! Erik Hedegaard, 1084 Washington Ave., Pelham Manor, NY 10803. (914) 738-9422. E-mail: floete@aol.com

WANTED: Radiola IIIA parts set, chassis, or tube sockets. Also, chassis for Aeriola Jr. Carl Steinberg, 5 Cannan Rd., Monsey, NY 10952. (914) 352-0701

WANTED: Calrad TK2500K meter, SA 30B stereo int. amp. Also Renco Tiny Tim crystal radio. Torr Farkas, 14847 Fremont Ave. N, Seattle, WA 98133

WANTED: Sony models: IC-8650, TFM-8600W, CRF-1, ICF-7760W, ICF-5900W, ICF-6500. Zenith 7000-1. Grundig 2260. Khushpal Singh, 1831 Gray Ave., Yuba City, CA 95991. (530) 671-3485

WANTED: Radios. Scott Shield Grid 9 or 9B or AC 10. Scott Napier. Zenith Super VII or Super 28. Zenith 33X. Crosley Gem Chests. Coloured Neutrowounds. AK breadboards. Metal framed speakers, especially Pathé Grecian. I will be at Lansing and Elgin swaps. I can be contacted prior to these meets at the below address up until 5th July. Richard Howarth, PO Box 9, Junortoun 3551, Victoria, Australia. Ph/fax: 61-3-54493207

WANTED: Three original or reproduction knobs for Philco Model 40-120. Patrick Colombo, 10091 S.W. 17th Ct., Davie, FL 33324. (954) 452-8944

WANTED: Telefunken Gavotte 5153W, 5253W, or 5353W table radio in exc/mint cond. Thanks. Ed Kalpa, 4622 Melbourne Ave., Los Angeles, CA 90027. (323) 661-1221

WANTED: SW3 #33A and #35 coils. I will trade my extra SW3 coils. Hank Bredehorst, 2440 Adrian St., Newbury Park, CA 91320. (805) 498-8907

WANTED: Examples of the following tube boxes: Bull Dog, Eagle, Kazoo, Goode, and Dixie. La try Daniel, 1758 Chennault Cir., San Antonio, TX 78226. (210) 923-2634. E-mail: LDaniel102@aol.com

WANTED: HALLICRAFTERS S-2, S-33, S-35; EP-132; HT-2, -3, -8, -12 (old series); AC p/s for HT-45; BC-669 or parts; complete BC-729. Chuck Dachis, WD5EOG, "The Hallicrafter Collector", 4500 Russell Dr., Austin, TX 78745. (512) 443-5027

WANTED: Collins Radio Company Catalogs, promotional literature, manuals 1933-1983. Jim Stitzinger, 23800 Via Irana, Valencia, CA 91355. 1-805-259-2011

ELECTRON TUBES: Over 1 Million Tubes in Stock. Buy & Sell. Daily Electronics, 10914 NE 39th St. #B-6, Vancouver, WA 98682. 800-346-6667. 360-896-8856. 360-896-5476, fax

WANTED: Broadcast-type MICROPHONES. Early carbon, condenser, ribbons, etc. Cash or trade. James Steele, P.O. Box 620, Kingsland, GA 31548-0620. (912) 729-2242. E-mail: JSteele@k-bay106.com. Microphone collectors Internet site: <http://www.k-bay106.com/mics.htm>.

WANTED: Manuals (copies OK). Realistic DX 160, Lafayette HA-230 receivers, Heathkit EK-1. Milton Fairve, K4EBT, 1445 2nd Rd. SW, Vero Beach, FL 32962

WANTED: Tube supplement, instructions Precision tube tester Series 10-22. Also push button Belmont Model 519. Robert Wheeler, 8341 Parker Rd., Orwell, OH 44076. (440) 437-6668

WANTED: Novar (nine) and Compactron (twelve) chassis mount tube sockets 1 1/2 inch mounting center. John Lomas, 253 Elm Ave., Glen Riddle, PA 19063-5739. (610) 459-0186

WANTED: Magnavox-Collaro 4-speed record changer. Turntable base is painted gold and has a round brass medallion in the upper-left corner with a Magnavox crest and the words Magnavox-Collaro-made in England. Under the turntable rubber pad are words MK V, Serial No. RC456 439463. This changer was installed in a hi-fi console cabinet Mod CP 291 CD which was a record player only. A similar model also contained an FM-AM radio. I would be interested in that. These items have sentimental value to a friend, please help and name your price. Thanks. Harold LaRoche, 16426 Heiden Cir., Spring, TX 77379-7026. (281) 370-3451

WANTED: Restorable Philco 90 cathedral, any condition, basket cases OK. James S. Fisher, 344 Harrison Ave., Manville, NJ 08835. (908) 725-7476. E-mail: y-r-less@juno.com

WANTED: Any of the Pilot Redi-block radio building components. Dick Bury, PO Box 25, Gurnee, IL 60031. (847) 623-7746. E-mail: pabury@aol.com



WANTED Wood Table Radios 40s. ZENITH 8H034, 6D030, 6R084 rec/player. EMERSON 578A, 578. Teletone 117. DETROLA 572 or Detrola's offbrands #572 Val-Keen, Aria, Freedom, Seiberling or Truetone. Detrola 532-tall rec/player. Thanks. Will buy parts sets if cabinets are good. Needing work is alright, my dad has projects he can use doubles for. Steve Cabella/modi, 500 Red Hill Ave., San Anselmo, CA 94960. (415) 461-6810

WANTED: 1930 to 1942 Police Radio communications equipment. Any 6 VDC mobile communication equipment. Raymond Miller, 953 N. 1st St., Albemarle, NC 28001. (704) 982-0228

WANTED: These Stromberg-Carlson radios Models 601, 633, 523, 524, 624 and 1A, also Stromberg-Carlson horn and cone type speakers. Must be excellent originals. Thanks. John M. Thomas, 253 W. Chestnut Hill Rd., Newark, DE 19713. (302) 368-9285. E-mail: jondel1651@aol.com

FOR SALE: Radio phonographs, untested, RCA U119 - \$30, Philco 46-1201 - \$25, plus shipping. Jim Clifford, KE4DSP, 108 Bayfield Dr., Brandon, FL 33511. (813) 654-7531. E-mail: j.c.clifford@juno.com

FOR SALE: Crosley CR-5 Limited Edition, needs checking - \$20 plus UPS. Mark Anderson, N2TWW, 207 Fiddlers Elbow Rd., Greenwich, NY 12834. E-mail: MAnder3345@aol.com

— WANTED —

CLUB CONTACT INFORMATION. A.R.C. IS UPDATING ITS CLUB LIST. PLEASE SEND US NAME OF CONTACT PERSON, ADDRESS, DUES, RATES, ETC.

FOR SALE: Book on the Royal 500 Owl Eyes radios - \$10 ppd. Eldon A. Horton, 8187 LaHabra Ln., Indianapolis, IN 46236. (317) 823-6374. E-mail: radio@inetdirect.net

FOR SALE: Selling at IHRS meet, Indianapolis, in June, large selection old radio knobs - \$1 ea., no list. Fred Schultz, 1246 Lincolnway S., Ligonier, IN 46767. E-mail: olradio@ligtel.com

FOR SALE: Zenith Trans-Oceanic 7000, has broken antennae plastic tip and one side of handle broken, plays - \$230; KustomX monaural amp, model XMPA - \$50 as is; digital to analog converter, Mod CD-47 as is - \$25; Truetone, Mod D3840, leatherette case, plays good, looks good - \$80; SX43 Hallicrafters - \$195. Ron Crowe, PO Box 117, Handley, WV 25102. (304) 442-8179. E-mail: rgcrow@wvnet.edu

FOR SALE: Copies of McMurdo & E.H. Scott schematics, brochures, literature, etc. Sorry no list, please call or e-mail what model you want info on. **WANTED:** McMurdo Silver, Scott radios, speakers, brochures, booklets. Don Hauff, Box 16351, Minneapolis, MN 55416. (888) OLD-RADIO. E-mail: DHauff@isd.net

WANTED



FILSON

METERS,
LIGHT BULBS,
ELECTRIC FANS,
STOCK TICKERS,
& OTHERS



STEREO

WESTERN ELECTRIC,
JENSEN, TONNOY,
SCOTT, McIntosh,
MARANTZ, FISHER,
& OTHERS

DECO STUDIO

8-10 WEST 36TH STREET, 3RD FLOOR
NEW YORK, NY 10018
TEL. (212) 563-8046 FAX. (212) 563-8051
E-MAIL: DECOSTUDIO@MSN.COM

FOR SALE: Wilcox-Gay Recordio tube, mono tape recorder, complete, working - \$50. Plus UPS. **WANTED:** Late 30s Zenith or Philco tombstone. Philco 37-116-122 owners manual (or copy). Dick Friedman, 1502 Elmwood, Wilmette, IL 60091. (847) 803-3050

FOR SALE/TRADE: Large 15-tube unknown military receiver. Cathedral, tombstone. John Gielczyk, 5456 Katherine, Saginaw, MI 48603. (517) 799-7233. E-mail: Faygoman@megsinet.net

FOR SALE: Wood table models: Zenith 6D029 - \$60. Sears 6124 PB, SW, eye - \$80. Sparton 5218 PB, SW - \$100. All working, good cabs. James R. Lopaz, 5467 S. 975 E, Ogden, UT 84405. (602) 684-2130

FOR SALE: Zenith brown leather T-O - \$350. Royal 3000 - \$155. Sony 5100, mint - \$175. Ron Fumival, 113 Konzier Dr., Pittsburgh, PA 15237. (412) 487-6643, after 7 pm

FOR SALE: Motorola 5T tombstone - \$45 plus UPS. Rich Stamer, Sound Remedy, 331 Virginia Ave., Collingswood, NJ 08108

FOR SALE: Radio schematics - \$2.50. Rider's Radio & TV manuals. Xerox copies of service manuals: Zenith, 942 pp. - \$65. Philco, 300 pp. - \$30. Crosley, 322 pp. - \$30. Atwater Kent, 463 pp. - \$35. Rider's Radio Index 1 through 23 - \$20. Books, SASE for list. All plus shipping. Dick Oliver, 28604 Schwalm Dr., Elkhart, IN 46517. (219) 522-4516

FOR SALE: Zenith Y-280A Aristocrat clock/radio as seen in TR Network mag. Nov. 1994, works - \$20. Ed Kalpa, 4622 Melbourne Ave., Los Angeles, CA 90027. (323) 661-1221

FOR SALE: Nice Bogen DB-10 tube amplifier - \$120; Sony 5F-90W FM/AM transistor - \$35. Add shipping. Preston Meeks, 13839 Aspen Cove Dr., Houston, TX 77077. (281) 531-0227

FOR SALE: (15) E.H. Scott consoles for sale. **WANTED:** Cabinet for 25-tube Zenith Stratosphere, or complete rough set, will pick up. **FOR SALE:** Owner's manuals and service manuals for most Scott radios. Call for info. Alan Jesperson, PO Box 17338, Minneapolis, MN 55417. (612) 727-2489 Mon-Sat, 8 am-6 pm. Fax: (612) 821-4821. E-mail: mte612@aol.com

FOR SALE: Philco cathedral Model 43. **WANTED:** Philco cathedrals Models 20 and 70. Tom Wagner, 392 State St. 3-F, North Haven, CT 06473. (203) 407-1832. E-mail: tomaswgnr@aol.com

FOR SALE: Heathkit SSB transmitter SB401 - \$100. Drake's 2-B Receiver with 2-AQ Q multiplier - \$110. Joseph B. Kelber, KB8GLD, 503 S. Scranton Ave., Scranton, KS 66537. (785) 793-2323

FOR SALE: Consoles: Sparton 1081, Philco 39-36 - \$95 ea. Supreme radio diagrams 1926-1942 - \$60. Richard Bednarcik, 28 Steele Ave., Lincoln Park, NJ 07035. (973) 694-6374

FOR SALE: Panasonic RQ-300S 120V R-R tape recorder, 7" x 8" x 4" - \$18; Sam's TV Test Instruments, 1953 - \$9. Dave Minchella, KE2GE, 80 N. Campfire Rd., Henrietta, NY 14467. (716) 359-3337. E-mail: djmradionut@juno.com

FOR SALE: A large number of radio and electronic books and magazines. Send LSASE for free list. Gerald Scott, N7WVY, PO Box 2731, Elko, NV 89803

WANTED: 2-tube amp for Tri-City W1 (Douglas Vol. 3, p. 196). Bob Breese, 50877 Deer Run Trl., E'khardt, IN 46514. (219) 262-9287. E-mail: bob@breese.com

WANTED: Pre-war television brochures: Television News, late '30s, Radio Retailing, RN TV issues. Ted Hutson, 11 1/2 Winthrop Ave., Beverly, MA 01915. (978) 922-3405. E-mail: tedhutson@yahoo.com

WANTED: Aircraft receivers, transmitters, wind generators, dynamotors, airport radios, light beacons, pre WWII. James Treherne, 11909 Chapel Rd., Clifton, VA 20124. (703) 830-6272. E-mail: treherne@erols.com

CLASSIFIED AD NOTICE

Please check your ads carefully before sending them in. Once ads are received, it is not always possible to refund the amount sent, pull the ad or make changes.

WANTED: Heathkit GR-10, GR-11 any condition. Emerson 602, 636 good to excellent condition. Andrew Mitz, WA3LTJ, 4207 Ambler Dr., Kensington, MD 20895. (301) 897-5531. E-mail: arm@serge.gnode.org

WANTED: Echophone Model 60 cabinet; Studebaker Wren; Admiral 551; Westinghouse WR-214; Giffillan 8C. Curt Schreiber, 3923 E. Latoka St., Springfield, MO 65809. (417) 887-5184, collect. E-mail: Curradio@aol.com

WANTED: GE floor radios, Model A-205 & E-155. These models were the deluxe models for 1935 & '36 respectively. They are quite large in size. Send along SASE for photocopy to help identify. Dan Gutowski, 9753 Easton Rd., Dexter, MI 48130. (734) 433-1354

WANTED: Western Electric 618 microphone. Have cash or trades. Dennis Schrank, 3129 S. Quiricy Ave., Milwaukee, WI 53207. (414) 744-3374. E-mail: radiohd@execpc.com

Visit the A.R.C. Web Site!

The URL to access the A.R.C. Web site is:
<http://www.antiqeradio.com/>

Our site includes highlights from current and recent issues:

- Editor's Comments
- Image of the Cover
- Feature Article
- Radio Miscellanea

- Plus:
- Photo Reviews
 - Book Reviews
 - Coming Radio Events
 - Complete Club Listing
 - List of Books For Sale
 - Subscription Information

While visiting our site, you may send e-mail and orders for books, videos and subscriptions.

Let us know what you think about A.R.C. on the Web!

WANTED: Wollensak T-1580 4-track stereo tape recorder. Need not operate but must be complete. Walt Heskes, 49 Marlin Ave. W, Edison, NJ 08820. (732) 205-9143

WANTED: Wood sets with metal grilles or trim, Climax radios, miniature cathedrals. Jay Malkin, 1250 Galapago #206, Denver CO 80204. (303) 623-6451



WANTED: Air King Skyscrapers, wealthy extraterrestrial seeks examples of this architectural marvel for new intergalactic communications museum. Please write or call collect: Rain Butignol, 214 State St., #7, Portsmouth, NH 03801. (603) 427-1384

WANTED: Single AR1 McIntosh all tuners, tube amps, preamps, cabinets, literature, parts, whole systems. Fisher 80 AZ amp, AM80 AM tuners, Eico HFT94 AM tuner, Altec333 amp, Thorens 121, 124 turntables, Pilot AA901 amp, Fairchild 260 amp, Karlson 15" factory speaker cabs, Scott 310 series tuners, Audiocyclopedia 1st, 2nd editions. Walt Fleming, 182 Plain Hill Rd., Norwich, CT 06360. (860) 889-1957/1937

WANTED: Early homebrew and commercial ham radios. Also early QSL cards, especially New Jersey QSL cards. John H. Dilks, K2QTN, 125 Warf Rd., Egg Harbor Twp., NJ 08234-8501, (609) 927-3873. Internet: <http://www.eht.com/oldradio/museum>

PUETT ELECTRONICS

PO BOX 28572 DALLAS TX 75228 U.S.A.
PHONES (214) 321-0927 OR (214) 327-8721

NEW CATALOG NO. 8B

OVER 88 PAGES
OVERALL SPECIAL PRICE REDUCTIONS!
CATALOG \$5.00 POSTPAID
\$5.00 DISCOUNT COUPON WITH CATALOG
APPLICABLE TO \$20.00 OR LARGER ORDER.
IF YOU HAVE CATALOG NO. 8 OR 8A, SEND
ONLY \$1.00 FOR ADDENDUM PAGES.

WE OFFER - MORE THAN 2,600 DIFFERENT ANTIQUE RADIO PUBLICATIONS FROM 1902 TO THE 1960'S REPRINTED BOTH SIDE OF THE PAGE AND BOUND. BOOKS, OPERATING AND SERVICE MANUALS FOR ANTIQUE RADIOS, TEST EQUIPMENT, COMMUNICATIONS RECEIVERS AND HAM GEAR, HISTORICAL BOOKS FOR NEARLY ANY MANUFACTURER. WE OFFER TUBES, OLD-TIME-RADIO PROGRAMS ON CASSETTES, SCHEMATIC DIAGRAMS AND MUCH MORE. RADIO CLUB - RECEIVE SPECIAL DISCOUNTS, PERIODICAL - THE NEW ACQUISITIONS LIST OFFERING ALL TYPES OF ANTIQUE RADIOS, TEST EQUIPMENT, RARE TUBES, OUT-OF-PRINT BOOKS, RADIO MAGAZINES, AND MUCH MORE.

**ORDER YOUR
CATALOG TODAY!**

FOR SALE: American Bosch 605 - \$90. Freed-Eisemann FE-15 - \$125. NR-5 - \$140. GE S22X tombstone - \$195. Hallicrafters SX-24 painted - \$75. Harvey Wells TBS-50 - \$75. Kolster K-20 - \$100; K-21 - \$110. Majestic 20, exc - \$200; 50 w/stand - \$195. Philco 84 cathedral - \$130; 511 brown - \$120; Grebe MU-1 chassis w/chain Bakelite front, no cabinet - \$140. Philco 18 chassis only - \$95. Radiola 60 - \$125. Westinghouse Aeriola Sr. - \$170. Westinghouse RA-DA, exc - \$285. Zenith 6S-52 console - \$150. National 109 - \$100. RCA AR 8505 marine receiver - \$95. Scotts marine receiver SLRM - \$200. J. Gary Cameron, 824 Andrews St., Southington, CT 06489. (860) 276-9200

VISIT A.R.C.'s WEB SITE
www.antiqueradio.com

**Book Orders - Subscriptions - Articles
and more!**

FOR SALE: RCA 140 chassis & speaker, untested, some rust, missing bottom cover - \$150 + UPS. Allen Jochem, 2205 Broadway, Quincy, IL 62301. (217) 223-6751

FOR SALE: Dual tubular capacitors, 33 uF + 47 uF @ 160 volts - \$144 ppd. Checks must accompany order to: Frontier Capacitor, Everett Hoard, Box 218, Lehr, ND 58460

FOR SALE: Meck 7-inch TV Model XA701, recapped, good CRT, plays, nice. Charles Harper, 2000 Jackstown Rd., Paris, KY 40361. (606) 484-9393

FOR SALE: Philco 71 cathedral; to reference our Zenith models, order our 60 page 11x17 Zenith Brochure Book for - \$28.95 ppd. The Story Of Zenith: I have a small quantity of this 32 page booklet Zenith originally put out as a promotional item in 1954 and reprinted about 10 years ago - \$9 ppd. Atwater Kent 612 console; Motorola neon clock, rescreened face - \$850; National Panasonic RF5000 - \$495. Stromberg-Carlson 231F mirror top chairside - \$895. Most Trans-Oceanics available, call. Many Rider's manuals available including low #s, call. Zenith consoles: Aviatrrix; 15S373; 15S372; 15U270; 15U269; 12H689; 12S568; 12S569; 12S471; 12S370; 12S371; 12S265; 12S268; 12U159; 12U158; 12A58; 980; 11S474; 10S470; 10S153; 10S155; 10S156; 10S160; 9S54; 9S55; 9S262; 9S264; 9S365; 9S367; 8S154; 8S463(5808); 8S359; 7S261 bookcase; 6S362; 7S363; 7S364; 775B and many others. Zenith chairside: 12S245; 10S147; 9S244; 9S344; 7S343; 7S342; 7S340; 6S147; 7S240; 5S327; 6S239; 6S238; 6S203 phono; 6S241 bar radio. Zenith table models: 4K535; 5S29; 5S126; 5S127; 5S228; 5S319; 6S321; 6S322; 6S528; 7S432; LH cathedral; L cathedral; 210 and 805 cathedrals; 6D029; 6D630; 7S323; 6S439; 6V27; 6S27; 6S128; 6S222; 6S229; 6J230; 8S443; 10S130; 12S445; 8S531; 288; 711; 807; and many others. Other radios available: Stromberg, Philco, GE, RCA, Fada. We can and do ship consoles and we do it right. All radios unrestored electrically unless noted. Satisfaction guaranteed, highest quality assured. Send for our free parts and supplies catalog. We offer complete chassis restoration service on all radios, call. Visiting Minneapolis? Visit our new store at 5200 Bloomington Ave, just 5 minutes from the airport. We accept Visa, MC and Discover. Alan Jespersion, PO Box 17338, Minneapolis, MN 55417. (612) 727-2489 or note new fax: (612) 821-4821, 8 am to 6 pm, Mon-Sat. E-mail: mte612@aol.com

WANTED: Chassis for Atwater Kent cathedral Model 82. Johnny Johnson, 7075 W. 32nd Ave., Wheat Ridge, CO 80033. (303) 274-5474

WANTED: NBC chimes, Raytheon radios. J. Finkelstein, 63 Cedar Hill Ln., Media, PA 19063

WANTED: Detrola grandfather clock, chairside, TV, FM, WWII military Detrola, anything unusual by Detrola!! Dennis Smith, KN8H, Box 113, Trenton, MI 48183. (734) 675-5847

WANTED: Hallicrafters SX71 in good working order; or SX71 parts set. C'mon! Help! (Please) and thank you. Noel S. Ilg, 228 Beck Rd., Avon Lake, OH 44012. (440) 933-5668. Fax: (440) 933-8864

WANTED: Bottom for Crosley Pup; brown back for GE H-510; information on 12-B Hartman. Dale Davenport, 622 S. 18th St., Ft. Smith, AR 72901. (501) 785-4929, eves.

WANTED: Catalin parts, paying \$20-\$100 per knob or grille, handle, chassis or damaged cabinet. Radio Ray Carroll, 158 Oakwood Dr., Wayne, NJ 07470. (973) 696-1149

WANTED: Amplifier: Western Electric 25A/25B, part units, 1920 cone speakers, parts units, tubes: 101D, 104D, 217A, 216A, 205D/E/F. Westinghouse WL-787 demo tube. Ming Yang, 1995 University Ave., #119, Berkeley, CA 94704. (925) 376-4220. E-mail: yang1240@aol.com

WANTED: Manual or operating instructions for Honeywell Rubicon Model 2745 potentiometer. Copy OK. Warren Sprague, 11855 Orlando Cir., Waynesboro, PA 17268. (717) 762-7283

WANTED: Glass dial to a RCA Catalin 66X7, 66X8, 66X9. Your postage returned. Gregory Sheppard, W3F5P, 4402 Jupiter St., Rockville, MD 20853. E-mail: moreradios@webtv.net

WANTED: On-off/volume knob for 1942 Zenith Console 10-S-669, black plastic with brass colored metal center insert. Ron Kudasik, 2235 Tanya Dr., Chambersburg, PA 17201. (717) 267-9468, 3-11 pm

WANTED: Arvin 517 tombstone chassis! See Stein #1. Patrick Franzis, 235 Millville Ave., Naugatuck, CT 06770-3848. (203) 723-8976. E-mail: old_radios@yahoo.com

WANTED: RCA NewVista HJ867(S) radio, tv, phono any condition and other 3-in-1 color consoles. Damon Vandehey, 18620 SW Aloha Ct., Aloha, OR 97006. (503) 259-9129

WANTED/TRADE: Broadcasting, theater, recording equipment & microphones. WE, RCA, Altec, etc. **FOR SALE:** Elaborate console radios. Robert Van Dyke, 2 Squires Ave., E. Quogue, NY 11942. (516) 728-9835

WANTED: Anything relating to this radio: Magnavox radio, Type T.R.F. #5, Model A #1392. This would include diagrams, tubes, case, speaker & power supply. Thanks, Harry MacMullan, 469A Garnet Mine Rd., Boothwyn PA 19061. E-mail: harry.macmullan@phl.boeing.com

WANTED: 2M2 ballast tubes, 1937 Midwest Radio Catalog. Jensen and Stephens 15 and 18-inch field coil speakers. Western Electric, Jensen and Magnavox field coil high frequency horn speakers. Thanks. Eric Lenius, PO Box 685, Port Orchard, WA 98366. (360) 871-5921. E-mail: lenius@tscnet.com

FOR SALE: RCA transistor radio Mod 9-BT-9H very good cosmetics, untested, uses 9v battery with oversized connectors - \$35 plus post. Robert Parke, 504 Essex St., Gloucester City, NJ 08030. (609) 742-8221. E-mail: Radiobob29@aol.com

FOR SALE: British GecoPhone battery receivers, with good tubes: Victor 3, 3-tube, near mint - \$325; BC 2820, 2-tube, excellent - \$600. Roger Hart, PO Box 403, Morrisburg, Ontario, Canada K0C 1X0. (613) 543-4255. E-mail: authors@mor-net.on.ca

FOR SALE/TRADE: Astatic/77A-studio m.c, TEAC/TD-102A tube deck. BSR/Lab-80 autochgr w/M7D. Pair 50s Midland Triumph-10HT. Sam Timberlake, K74TXQ, PO Box 161, Dadeville, AL 36853-0161. (256) 825-7305. E-mail: stimber@lakemartin.net

One Month Free!

BONUS FOR EARLY RENEWALS

If you renew **before** the month shown on your mailing label (your expiration month), you will receive an extra month on your subscription: 13 months instead of 12! 26 months for an early 2-year renewal!

SERVICES: Rider/Sams schematics, 1920-1970 - \$3 ppd. Send make/model to: Richard A. Lerche, 1561 Bluebell Ct., Livermore, CA 94550. (925) 447-9365. E-mail: lerche@home.com

SERVICES: Everett Hoard & Frontier Capacitor will not accept any cans for rebuilding until September 1999. Frontier Capacitor, PO Box 218, 403 S. McIntosh St., Lehr, ND 58460. Our toll free phone number is: (877) 372-2341

SERVICES: I will repair your antique car radios. Please contact: Tony LeDoux, PO Box 74, Schoenchen, KS 67667. (785) 625-6075

SERVICES: Reproduction Philco cathedral cabinet parts. Front panels, bottom moldings, rear arches. Reproduction 70, 90 or 20 (std) cabinets. Grandfather clock finials: Philco 570, GE H-91, Colonial clock top trim and finials. Other parts inquire. Tube shields, Philco 20, 70, or 90. All plus shipping. Dick Oliver, 28604 Schwalm Dr., Elkhart, IN 46517. (219) 522-4516

SERVICES: Hickok factory authorized contact person, providing affordable professional service, calibration and technical assistance. **WANTED:** Hickok radio test equipment for repair and resale. Special needs Model 156 traceometer, 118 A/B cardmatic and Supreme vedometer for display. **FOR SALE:** Rebuilt, calibrated and guaranteed test equipment. 4, 5, 6, 7 pin tube adapters for Hickok 6000 A/B tube testers, also octal socket savers. New calibration cells and card punches for 118 and 123 cardmatics. Socket extenders for voltage measurement. Test equipment data, tube tester chart update, to include obsolete, foreign and operators manual with schematic for most Hickok and military models. Wendell E. Hall, 3 Mockingbird Cir., Jeffersonville, IN 47130. Shop phone/fax: (812) 256-2090. Home phone: (812) 282-9709. E-mail: hickok@bellsouth.net

SERVICES: I make records. WANTED: Cutting machines, automotive record player, Precise 111 tube tester. Kim Gutzke, 7134 15th Ave. S, Minneapolis, MN 55423. (612) 869-4963

SERVICES: Repair/replacement meters prior 1935. **WANTED:** Meters before 1900, as is, your price! Ye Olde Meter Cellar, Leonard W. Carwright, 879 Russet Dr., Sunnyvale, CA 94087. (408) 739-6025. E-mail: lencarwright@msn.com

ABBREVIATIONS USED IN CLASSIFIED ADS

MISCELLANEOUS

amp = amplifier	PS = power supply, also "pwr sup"
BC = broadcast	PU = pick up only
BO = best offer	rcvr = receiver
ca. = circa (approx. date)	SASE = self-addressed stamped envelope (send a long, #10, envelope)
ea. = each	spkr = speaker
F.O.B. = free on board	SW = shortwave
IB = instruction book	UPS = United Parcel Service
LSASE = A Long SASE (see SASE)	vol. = volume
LW = long wave	w/ = with
M.I.B. = mint in box	w/o = without
MO = money order	WT = with tubes
Mod = model	xcvr = transceiver
N.I.B. = new in original box	xfmr = transformer
N.O.S. = new old stock (an original, unused vintage item)	xmtr = transmitter
NT = no tubes	xstr = transistor
OB = in original box	xtal = crystal
OBO = or best offer	
P&H = postage & handling	
ppd = postage paid (shipping included)	

BOOKS USED AS REFERENCES

(V.R., p 30) means *Vintage Radio*, page 30

Blast = *Radio - A Blast From The Past*

Bunis 1, 2, 3 or 4 = *Collector's Guide to Antique Radios, 1st, 2nd, 3rd or 4th editions*

Collins = *Radios - The Golden Age*

Douglas V1, V2 or V3 = *Radio Manufacturers of the 1920s, Volumes 1, 2 or 3*

E.O.R. 1 or 2 = *Evolution of the Radio, Volumes 1 or 2*

F.O.S. = *Flick of the Switch*

Grinder/Fathauer = *Radio Collector's Directory and Price Guide*

G.O.R. = *Guide to Old Radios*

Johnson's A.R. = *Antique Radios - Restoration & Price Guide*

M.A.J.A. = *Machine Age to Jet Age*

O.T.B. = *Old Timer's Bulletin* published by Antique Wireless Association (AWA)

Sideli = *Classic Plastic Radios*

V.R. = *Vintage Radio*

CONDITION

(If good or better, mention non-original parts)

p = poor	f = fair
g = good	vg = very good
exc = excellent	

A.R.C. does not encourage abbreviations except those listed here. Please spell out all other words. Special note for hams - most subscribers are not hams so we do not recommend ham-type abbreviations.

SERVICES: Radio schematics & service data U.S. & Canadian receivers. 1920s to 1960s - \$2.50 + SASE. Questions - SASE. Steve Rosenfeld, PO Box 387, Ocean Gate, NJ 08740. (732) 269-2022. Fax: (732) 269-2897. E-mail: srosenfeld@ems.att.com

SERVICES: New reproduction dial covers for over 500 different old radios - \$15 ea. ppd. Doyle Roberts, HC 63 Box 236-1, Clinton, AR 72031. (501) 745-6690. E-mail: drob@artelco.com

SERVICES: Repair of radios and other electronic equipment. John Osborne, W1KFY, Winthrop Electronics, 2 Lake St., Winthrop, ME 04364. (207) 377-2556, weekdays

SERVICES: Dial covers made-to-order! Over 250 in stock! Please note address change! Rita Hutchings, 2100 Pine Valley Cove, Germantown, TN 38138. (901) 754-5565. E-mail: radiorita@hotmail.com

HELP: Need horizontal grille bars & dial for Philco Model TP-10. Hood for Philco 2" portable Safari Model 2010 TV. Also radio knobs, hardware before 1950. By the bag or by the bushel. Larry Porter, 4115 Beam Rd., Crestline, OH 44827. (419) 683-2540

HELP: Need schematic, info on Akrodyne CR2. Ted Rogers, 6938 E. Waco Dr., Syracuse, IN 46567. (219) 457-8886

HELP: Looking for complete or incomplete Atwater Kent drivers for Models L horns. Mark Murphy, 1400 Chicago Ave. #802, Evanston, IL 60201. (847) 328-5036. E-mail: PiscoCal@aol.com

HELP: Still looking for Kodak Pageant 16mm parts for Models AV-085, AV126TR & AV256TR. Paul R. Moens, 6792 Miller Rd., Newark, NY 14513. (315) 331-6740. E-mail: PRMoens@aol.com

HELP: I need a schematic for a GE Model P2930A. May be in Sams TSM 113. Glad to pay the going rate. Andy Burnett, 9203 Lyndonway Dr., Richmond, VA 23229. E-mail: MABurn2@Juno.com

HELP: Need PYE schematic/service info for receiver Type 75. Alex Kaplan, 5347 Park Place Cir., Boca Raton, FL 33486. E-mail: alexlaw@gate.net

HELP: Need pair tuning knobs for Zenith Trans-Oceanic Model 8G005Y. Kenneth F. Cerva, 3851 Harbor Hts. Dr., Largo, FL 33774. (727) 584-6471

HELP: Need flyback for Philco 49-1040, part 32-8331 or replacement (e.g. Thordarson Fly 4). RCA R28P dial escutcheon. Many thanks. Bill Morse, 292 Pequot, 4C, New London, CT 06320. (860) 442-0233. E-mail: wsm@mixmail.com

HELP: Seeking original parts for 1926 Freshman Masterpiece Model 5-F tuning console series battery set: three tuning knobs to match mahogany Bakelite; two transformers; speaker driver; mahogany grille; matching console cabinet; owner's manual and radio log. Eric Scheck, 51 Adelaide St., Fairfield, CT 06430. (212) 210-7235, daytime. (203) 333-4799, evenings. E-mail: eric.scheck@jw.com

HELP: Need schematic for 10-tube Model 51 Packard Bell. Contact: Bill Homen, 1601 N. Rhododendron Dr., #592, Florence, OR 97439. (541) 997-1750. E-mail: homens@harmorside.com

HELP: Need original Radiola IIIA cabinet. Please write to: Orlandini Iginio, Via Lessing, 10 -00137 Roma, Italy

FOR TRADE: Zenith 12S265 and Stromberg-Carlson mirrored chairside 231R for quality battery sets. Jim Berg, 4261 Wilcox Rd., Box A, Northport, WA 99157. (509) 732-4047. E-mail: jimfberg@webtv.net

FOR TRADE: Hickok 539-A for sets of Early Radio Craft, News, QST, nice cathedral. Thanks. Roy Fortier, 1518 Dogwood Ln., Acworth, GA 30102. (770) 517-6549

FOR TRADE: My nice transistor radios, crystal sets, for your mini reel wire and tape recorders. Jon Golden, Box 5077, Wayland, MA 01778. (508) 653-4140. E-mail: 3dman@ziplink.net

FOR TRADE: Amrad 2575 xtal set, Radiola RS. **WANTED:** Grebe CR-13, KT-1. Joseph C. Woychowski, 81 Penn. Ave., Niantic, CT 06357. (860) 739-6579. E-mail: jc.woy@snet.net

MESSAGE: Transistor Network, International Magazine for Transistor Collectors - \$24.95; \$34.95 Canada; \$43.95 others. Free sample. PO Box 43, Live Oak, FL 32064-0043

MESSAGE: Repair antique radios, scopes, signal generators and test equipment. 30 years engineering in field of design prototype and calibration. Peter Hansen, 10238 Weber, Grass Valley, CA 95945. E-mail: oldtyme@jps.net

MESSAGE: Visit the Retrocom virtual CB museum, www.Retrocom.com. New Predicta pictures as well. Dave Mierzwinski, 13345 W. Dakota St., New Berlin, WI 53151

MESSAGE: Send now for the World's Premier 78 rpm & Cylinder Record Auction Catalog. Nauck's Vintage Records, 6323 Inway Dr., Spring, TX 77389. E-mail: nauck@78rpm.com

THANKS!

*Thanks for suggesting
A.R.C. to your friends.*

*Did you know that nearly 20% of
our new subscriptions come from
referrals from subscribers?*

So spread the word about A.R.C.!

*Give the center coupon to a
collector, or ask us to send a
friend a free sample copy.*

*Help A.R.C. and
radio collecting grow!*



BRITISH COLUMBIA - May 30

CANADIAN VINTAGE RADIO SOCIETY
ANNUAL GENERAL MEETING

Richmond, BC - Steveston Hotel
2 pm

Info: Fred Tutt - (604) 275-2033

CALIFORNIA - Jun. 5

CALIF. HISTORICAL RADIO SOCIETY
MEET

San Rafael, CA - Erik's Downtown Drive-In
8 am

Info: CHRS Hotline - (415) 821-9800

VIRGINIA - Jun. 2

TIDEWATER ANTIQUE RADIO ASSOC.
MEETING - 7 PM

Call for location & directions

Info: Vic Johnston - (757) 825-0757, eves.
Scott Balderston - (757) 549-0449, eves.

CALIFORNIA - Jun. 5

SOUTHERN CALIF. ANTIQUE
RADIO SOCIETY - SWAP MEET

Escondido, CA - Deer Park
8 am

Info: Mary Curry - (619) 461-9327

ARKANSAS - Jun. 3

ANTIQUERADIO COLLECTORS CLUB
OF FORT SMITH - MEETING

Fort Smith, AR - St. Luke Lutheran Church
Waldron Road, at Free Ferry
7:30 pm

Info: Paul Tucker, 4700 N. "N" St.
Fort Smith, AR 72904 - (501) 782-9178

CONNECTICUT - Jun. 5

VINTAGE RADIO & COMM. MUSEUM
TAILGATE SWAP

E. Hartford, CT - Vintage Radio & Comm. Mus.
1231 Main St. (Rte. 5)
Time TBA

Info: John Ellsworth - (860) 675-9916

INDIANA - Jun. 3-5

INDIANA HISTORICAL RADIO SOCIETY
28TH ANNUAL REGIONAL SPRING FLING
Indianapolis, IN

Signature Inn (East Washington St. at I-465)

Thu.: Noon-6:30 pm - Flea Market
8 pm - Movies/Videos

Fri.: 7:30 am-6 pm - Flea Market
9 am-1:30 pm - Old Equipment Contest
Noon - Luncheon - "When Radio Was Radio"
4 pm - Seminar - Technical Restoration
5:45 pm - Annual Awards Banquet
Live Music (The Charleston Chasers)

Sat.: 7:30 am-3 pm - Flea Market
10:30 am - Donation Auction
11:15 am - Auction

Info: Bob O'Friel - (317) 849-4328
Alex Whitaker - (317) 535-4174, after 6 pm

WASHINGTON - Jun. 5

RADIO ENTHUSIASTS OF PUGET SOUND
MEETING

Seattle, WA - Queen Anne Library
400 W. Garfield
2 pm

Info: REPS, 9936 N.E. 197th Street
Bothell, WA 98041 - (206) 488-9518

NEW YORK - Jun. 6

FREEPORT HISTORICAL SOCIETY
OLD TIME RADIO FESTIVAL

Freeport, NY - Freeport Recreation Center
Merrick Road
11 am-4 pm

Info: Robert Raynor, 10 Girard Pl.
Merrick, NY 11566 - (516) 623-5967

A free* listing on these pages is available for each coming radio event. Sponsors should provide description of event, date, time, place, directions, & information/contact person. Since listings are on a "space available" basis, no guarantee of listing is made. Submission deadline - 5th of month. *Club/museum/non-profit events are listed free; other events are obtained from advertisements placed elsewhere in A.R.C. Sorry, we don't have room for hamfests.

NEW YORK - Jun. 6

**GREATER NEW YORK VINTAGE
WIRELESS ASSOC. - SWAP MEET**
Lake Ronkonkoma, NY - 367 Hawkins Ave.

8 am-Noon

Info: Chris Lieppert - (516) 471-9526
Chris Bacon - (516) 821-7618

WISCONSIN - Jun. 6

**WISCONSIN ANTIQUE RADIO CLUB
SWAP MEET**

Hubertus, WI - Richfield Chalet
1271 Hwy. 175

7 am-Noon

Info: Dale Boyce, 10230 W. Greenwood Terr.
Milwaukee, WI 53224 - (414) 353-0734

MISSOURI - Jun. 8

**ANTIQUÉ RADIO COLLECTORS &
HISTORIANS OF GREATER ST. LOUIS
MEETING**

Kirkwood, MO - Kirkwood Community Center
111 S. Geyer Rd., Room 201-A

7:30 pm - Meeting (earlier for conversation)
Show & Tell, Swap Table

Info: Derek Cohn, 8141 Stratford Dr.,
Clayton, MO 63105 - (314) 725-2333

N. CAROLINA - Jun. 8

**EAST CAROLINA ANTIQUE RADIO CLUB
MEETING**

Greenville, NC - Western Sizzlin
2903 E. 10 St.

Info: Bill Engstrom - (252) 355-8732
Herman Schnur - (252) 752-2264

OHIO - Jun. 8

**ANTIQUÉ RADIO COLLECTORS OF OHIO
MEETING - 7:30 PM**

Kettering, OH - National City Bank Basement
4100 Far Hills Ave., at Stroop Rd.

Topic: Cathedrals & Tombstones

Info: John Heck - (937) 435-1571
ARCO, PO Box 292292, Kettering, OH 45429

INDIANA

**INDIANA HISTORICAL RADIO SOCIETY
HISTORICAL RADIO MUSEUM**

Ligonier, IN - Ligonier Visitors Center
2 blocks N. of US 6, US 33, & State Rd. 5

Open Tues., Wed. & Sat.: 10 am-3 pm

Info: Fred M. Schultz, 800 S. Lincolnway
Ligonier, IN 46767 - (219) 894-9000

PENNSYLVANIA - Jun. 8

**DELAWARE VALLEY HISTORIC RADIO CLUB
MEETING - SWAP MEET - AUCTION**

Telford, PA - Telford Community Bldg.
Corner of Hamilton & Madison

7:30 pm

Info: Bill Overbeck, PO Box 847,
Havertown, PA 19083 - (610) 789-8199

TEXAS - Jun. 8

**HOUSTON VINTAGE RADIO ASSOC.
MEETING**

Houston, TX - Lai Lai Rest., Tides II Hotel,
6700 S. Main St. at Holcombe

9 am - Seminar

1 pm - Meeting/Auction/Program

Info: Bill Werzner - (713) 721-2242

ARKANSAS - Jun. 10

**ARKANSAS ANTIQUE RADIO CLUB
MEETING - 7 PM**

Little Rock, AR - Books A Million
Markam & Bowmar Rd.

Info: Tom Burgess - (501) 455-0773
(Call to confirm details)

NEW JERSEY - Jun. 11

**NEW JERSEY ANTIQUE RADIO CLUB
MEETING - 7:30 PM**

Freehold, NJ - Grace Lutheran Church
West Main St. & Park Ave. (Old Rt. 33)

Info: Marv Beeferman - (609) 693-9430
Phil Vourtsis - (732) 446-2427

MARYLAND - Jun. 12

**RADIO HISTORY SOCIETY
MUSEUM PUBLIC OPENING**

Bowie, MD - Time TBA

Info: (301) 390-1020 - www.radiohistory.org
Ken Mellgren - (301) 929-1062

OKLAHOMA - Jun. 12

**OKLA. VINTAGE RADIO COLLECTORS
MEETING**

Oklahoma City, OK - Oklahoma Station BBQ
Springdale Shopping Center, 4333 N.W. 50th

6 pm - Dinner

7 pm - Meeting

Info: Jim Collings - (405) 755-4139, after 6 pm
Mike Lapuzza - (405) 745-3394, after 7 pm

**SUBMISSION DEADLINE
5th OF MONTH**

MARK YOUR CALENDAR

May 30 - BC, Richmond - CVRS Annual Gen. Mtg.
 Jun. 2 - VA, TBA - TARA Meeting
 Jun. 3 - AR, Fort Smith - ARCCFS Meeting
 Jun. 3-5 - IN, Indianapolis - IHRS/AWA Spring Fling
 Jun. 5 - CA, Escondido - SCARS Swap Meet
 Jun. 5 - CA, San Rafael - CHRSM Meet
 Jun. 5 - CT, Hartford - VRMC Swap
 Jun. 5 - WA, Seattle - REPS Meeting
 Jun. 6 - NY, Freeport - FHS Old Time Radio Festival
 Jun. 6 - NY, Lake Ronkonkoma - GNYVWA Swap
 Jun. 6 - WI, Hubertus - WARC Swap Meet
 Jun. 8 - MO, Kirkwood - ARCHGSL Meeting
 Jun. 8 - NC, Greenville - ECARC Meeting
 Jun. 8 - OH, Kettering - ARCO Meeting
 Jun. 8 - PA, Telford - DVHRC Meet & Auction
 Jun. 9 - TX, Houston - ECARC Meeting
 Jun. 10 - AR, Little Rock - AARC Meeting
 Jun. 11 - NJ, Freehold - NJARC Meeting
 Jun. 12 - MD, Bowie - RHM Museum Opening
 Jun. 12 - OK, Oklahoma City - OKVRC Meeting
 Jun. 12 - OR, Oregon City - NWVRS Meeting
 Jun. 12 - PA, Pittsburgh - PARS Meeting
 Jun. 12 - RI, Greenwich - Yankee Tune-up
 Jun. 13 - IL, Wheaton - Six Meter Club Hamfest
 Jun. 13 - NM, Albuquerque - NMRC Meet
 Jun. 14 - GA, Norcross - SARS Meeting
 Jun. 15 - CA, Sacramento - CHRSM Meeting
 Jun. 16 - OH, Cincinnati - CARS Meeting
 Jun. 16 - OH, Columbus - COARA Meeting
 Jun. 17 - Austria, Vienna - Dorotheum Auction
 Jun. 17 - NY, Hudson Valley - HARPS Meeting
 Jun. 17-19 - MD, Calverton - MAARC RadioActivity
 Jun. 19 - CA, Merced - CHRSM Meet
 Jun. 19 - TX, Belleville - HVRA Swap Meet & BBQ
 Jun. 19 - TX, Irving - VRPS Meet
 Jun. 20 - IL, Elgin - ARCI Meeting
 Jun. 20 - WA, Seattle - PSARA Swap Meet
 Jun. 22 - OH, Kettering - SPARK Meeting
 Jun. 25-26 - OH, Cincinnati - CARS Radiorama '99
 Jun. 25-26 - WA, Seattle - REPS Showcase VII
 Jun. 26 - Ontario - LVRC Meeting
 Jun. 26-27 - NJ, Somerdale - Krantz Estate Auction
 Jun. 27 - TX, Schertz - TARC Meeting
 Jun. 28 - AL, Birmingham - AHRM Meeting
 Jul. 1 - AR, Fort Smith - ARCCFS Meeting
 Jul. 3 - WA, Seattle - REPS Meeting
 Jul. 7 - VA, TBA - TARA Meeting
 Jul. 8 - AR, Little Rock - AARC Meeting
 Jul. 8-11 - MI, Lansing - MARC 14th Extravaganza '99
 Jul. 9 - NJ, Freehold - NJARC Meeting
 Jul. 10 - OK, Oklahoma City - OKVRC Meeting
 Jul. 11 - CO, Denver - CRC Meeting
 Jul. 11 - NM, Albuquerque - NMRC Meet
 Jul. 13 - MO, Kirkwood - ARCHGSL Meeting
 Jul. 13 - NC, Greenville - ECARC Meeting
 Jul. 13 - OH, Kettering - ARCO Meeting
 Jul. 17 - GA, Alpharetta - SARS Summer Swap Meet
 Jul. 17 - KY, Louisville - MSARC Swap Meet
 Jul. 23-25 - WV, Huntington - MRAT ACG Conference
 Jul. 24 - OH, Columbus - COARA Summer Meet
 Jul. 25 - British Columbia - CVRS Chapter Meeting
 Jul. 31 - NH, Nashua - NEARC Meet
 Aug. 4-7 - IL, Elgin - ARCI Radiofest XVIII
 Aug. 14 - NY, Amherst - NFWA Meet
 Aug. 20-21 - TX, Houston - HVRA Mega Auction
 Sep. 1-4 - NY, Rochester - AWA Meet
 Oct. 23 - NH, Nashua - NEARC Meet
 Oct. 23 - WV, Huntington - MRAT Fall Show/Auction
 See expanded listing for many of these events
 † = Changed Date

OREGON - Jun. 12

**NORTHWEST VINTAGE RADIO SOCIETY
 SPRING SWAP MEET - 10 AM**
 Oregon City, OR - Abernethy Grange Hall
 15745 S. Harley Ave
 Info: Ed Charman, PO Box 82379
 Portland, OR 97282-0379 - (503) 654-7387

PENNSYLVANIA - Jun. 12

**PITTSBURGH ANTIQUE RADIO SOCIETY
 MEETING**
 Pittsburgh, PA - Westinhouse Recreation
 Center, Parkway East (376) Exit 12
 10 am - Flea Market
 Noon - Meeting & Contest
 Info: Sev Dvorsky - (412) 344-6633

RHODE ISLAND - Jun. 12

**NEW ENGLAND WIRELESS &
 STEAM MUSEUM
 YANKEE RADIO TUNE-UP**
 E. Greenwich, RI - N.E. Wireless & Steam Mus.
 1300 Frenchtown Fd.
 8 am-3 pm
 Flea Market & Tailgaters
 Silent Auction
 Info: N.E. Wireless & Steam Museum
 (401) 885-0545

NEW MEXICO - Jun. 13

**NEW MEXICO RADIO COLLECTORS CLUB
 MEET**
 Albuquerque, NM - Anna Kaseman Hospital
 8300 Constitution Ave. (W. of Wyoming)
 1:30 pm - Tailgate Swap Meet
 2 pm - Program, Show & Tell and Auction
 Info: Chuck Burch, 39 Chaco Loop,
 Sandia Park, NM 87047 - (505) 286-9320

GEORGIA - Jun. 14

**SOUTHEASTERN ANTIQUE RADIO SOC.
 MEETING WITH SHOW & TELL**
 Norcross, GA - Picadilly Cafeteria
 3400 Holcomb Bridge Road
 6:30 pm
 Info: Gordon Hunter - (770) 475-0713
 SARS, PO Box 500025, Atlanta, GA 31150

NOTE: The "Coming Radio Events" pages are tabulated from the best information available to A.R.C. However, changes, cancellations and errors do occur. To avoid disappointment, verify place, date and time especially for events which are new to you.

CALIFORNIA - Jun. 15

CALIF. HISTORICAL RADIO SOCIETY
SACRAMENTO CHAPTER MEETING

Sacramento, CA - SMUD Building
Corner of Elkhorn & Don Julio

7 pm

Info: CHRS Hotline - (415) 821-9800

OHIO - Jun. 16

CENTRAL OHIO ANTIQUE RADIO ASSOC.
MEETING - 7:30 PM

Columbus, OH - DeVry Institute of Tech.
1350 Alum Creek Rd., I-70 Exit 103B

Info: Barry Gould - (614) 777-8534

Chuck Davis - (614) 792-6237

OHIO - Jun. 16

CINCINNATI ANTIQUE RADIO SOCIETY
MEETING - 7:30 PM

Norwood, OH - ITT Technical Institute
4750 Wesley Ave.

Info: Greg Tierney - (937) 732-1844

AUSTRIA - Jun. 17

AUCTIONHOUSE DOROTHEUM
HISTORICAL RADIO AUCTION - 2 PM

Vienna, Austria - Erlachgasse 90

Info: Dr. Gerti Draxler - +43-1/515 60-226
antiquitaeten@dorotheum.at

<http://www.dorotheum.com>

NEW YORK - Jun. 17

HUDSON VALLEY ANTIQUE RADIO
AND PHONO. SOCIETY - MEETING

7:30 pm - (Call to confirm details)

Info: Peter DeAngelo - (914) 496-5130

NEW YORK

ANTIQUE WIRELESS ASSOCIATION
ELEC. COMMUNICATION MUSEUM

Bloomfield, NY - Village Green

Rts. 5 & 20 - (716) 657-6260

May 1-Oct. 31 - Sunday, 2 pm-5 pm

Jun. 1-Aug. 31 - Saturday, 2 pm-4 pm

Jul. 1-Aug. 31 - Wednesday, 7 pm-9 pm
Closed Holidays

Info: Ed Gable, Curator, AWA Museum,
187 Lighthouse Rd., Hilton, NY 14468

Updating Club List

Please send A.R.C. the name, address, etc.
of your club's contact person.

MARYLAND - Jun. 17-19

MID-ATLANTIC ANTIQUE RADIO CLUB
RADIOACTIVITY '99

Calverton, MD - Holiday Inn
Powder Mill Rd. (Exit 29B off I-95)

Thu.: 4 pm - Flea Market

7 pm-10 pm - Beginner Radio Repair Class

Fri.: 6 am - Flea Market

10 am - Seminar: How To Make Replacement Parts

2:30 pm - Old Equipment Contest

7 pm - Awards Banquet

Sat.: 6 am - Flea Market

8:30 am-11 am - Bus Tour to RHS Museum

12:30 pm - Auction

Info: Brian Belanger, 5730 Avery Park Dr.,
Rockville, MD 20855 - (301) 258-0708

TEXAS - Jun. 19

HOUSTON VINTAGE RADIO ASSOC.
SWAP MEET & BAR B Q

Belleville, TX - John Schmitt's Ranch

9 am

Info: Bill Werzner - (713) 721-2242

TEXAS - Jun. 19

VINTAGE RADIO & PHONO SOCIETY
MEETING - 3 PM

Irving, TX - Senter East Bld.

Info: George Potter - (972) 353-4862

VRPS, PO Box 165345, Irving, TX 75016

CALIFORNIA - Jun. 19

CALIF. HISTORICAL RADIO SOCIETY
MEET - 9 AM

Merced, CA - Cliff's Radio Warehouse

Info: CHRS Hotline - (415) 821-9800

ILLINOIS - Jun. 20

ANTIQUERADIO CLUB OF ILLINOIS
MEET - 7 AM-NOON

Elgin, IL - Elgin Plaza Hotel

Swap Meet - Donation Auction

Info: Art Bilski, PO Box 1139,
La Grange Pk., IL 60526 - (630) 739-1060

WASHINGTON - Jun. 20

PUGET SOUND ANTIQUE RADIO ASSOC.
MEETING

North Seattle, WA - Shoreline Museum
N. 175th & Linden Avenue

9 am-Noon - Tailgate Swap Meet

Noon - Meeting, Program, Show & Tell

Info: Pete Petersen, PO Box 7251

Seattle, WA 98133 - (425) 747-1323

OHIO - Jun. 22

SOCIETY FOR PRESERVATION OF ANTIQUE RADIO KNOWLEDGE MEETING

Kettering, OH - Party Room at Cassano's
Pizza, 1700 E. Stroop Rd.

7:30 pm

Presentation: History of the Telephone

Info: PO Box 482, Dayton, OH 45449

E-mail: sparkinc@juno.com

OHIO - Jun. 25-26

CINCINNATI ANTIQUE RADIO SOCIETY RADIORAMA '99

Cincinnati, OH

Signature Inn (Exit 182 off I-75)

Thu.: 6 pm-9 pm - Hospitality Session

Fri.: Dawn - Swap Meet

10 am - Exhibition "Pre-War RCA Radios"

2 pm - Tour "Gray History of
Wireless Museum"

7 pm - Seminar

Sat.: Dawn-Noon - Swap Meet

10 am-Noon - Exhibition Continues

Info: Bob Sands - (513) 858-1755

WASHINGTON - Jun. 25-26

RADIO ENTHUSIASTS OF PUGET SOUND SHOWCASE VII

Seattle, WA - Seattle Center; Hotel:
Inn At Queen Anne - (206) 282-7357

Theme: Mystery at the Mike

Info: Mike Sprague, PO Box 723, Bothell,
WA 98041 - (425) 488-9518 - hrrmikes@aol.com

NEW JERSEY - Jun. 26-27

FRANK KRANTZ ESTATE AUCTION SESSIONS III AND IV

Somerdale, NJ - 100 Osage Ave.

Sat.: 8:30 am - Inspection

10 am - Auction

Sun.: 8:30 am - Inspection

10 am - Auction

Info: Dennis Childers - (610) 489-0683
www.smithauktionco.com

ONTARIO - Jun. 26

LONDON VINTAGE RADIO CLUB OF ONTARIO MEETING

London, Ontario - London Jaycees
317 Adelaide St. South

Noon - Doors Open

1 pm - Meeting Starts

Info: Lloyd Swackhammer, RR# 2, Alma
Ontario, Canada N0B 1A0 - (519) 638-2827

TEXAS - Jun. 27

TEXAS ANTIQUE RADIO CLUB MEETING

Schertz, TX - VFW Hall

2:30 pm

Info: Jim Moffett, 218 Shannon Lee, San
Antonio, TX 78216 - (210) 826-4938

ALABAMA - Jun. 28

ALABAMA HISTORICAL RADIO SOCIETY MEETING - 7 PM

Birmingham, AL - Homewood Public Library
1721 Oxmoor Road

Info: Julian Brook, PO Box 130307,
Birmingham, AL 35213 - (205) 879-1191

ARKANSAS - Jul. 1

ANTIQUERADIO COLLECTORS CLUB OF FORT SMITH MEETING - 7:30 PM

Fort Smith, AR - St. Luke Lutheran Church
Waldron Road, at Free Ferry

Info: Paul Tucker, 4700 N. "N" St.

Fort Smith, AR 72904 - (501) 782-8178

CALIFORNIA - Jul. 3

CALIF. HISTORICAL RADIO SOCIETY MEET/AUCTION

San Francisco, CA - St. Anne's Church of the
Sunset, Corner of Funston (13th Ave.) & Irving
8 am

Info: CHRS Hotline - (415) 821-9800

WASHINGTON - Jul. 3

RADIO ENTHUSIASTS OF PUGET SOUND MEETING - 2 PM

Seattle, WA - Queen Anne Library
400 W. Garfield

Info: REPS, 9936 N.E. 197th Street
Bothell, WA 98041 - (206) 488-9518

NEW YORK - Jul. 4

GREATER NEW YORK VINTAGE WIRELESS ASSOC. - SWAP MEET

Lake Ronkonkoma, NY - 367 Hawkins Ave.

8 am-Noon

Info: Chris Lieppert - (516) 471-9526
Chris Bacon - (516) 821-7618

Although non-members are
welcome at all events, joining
may be required at some.
Admission is charged at some.

VIRGINIA - Jul. 7

TIDEWATER ANTIQUE RADIO ASSOC. MEETING

Call for location & directions
7 pm

Info: Vic Johnston - (757) 825-0757, eves.
Scott Balderston - (757) 549-0449, eves.

ARKANSAS - Jul. 8

ARKANSAS ANTIQUE RADIO CLUB MEETING

Little Rock, AR - Books A Million
Markam & Bowman Rd.
7 pm

Info: Tom Burgess - (501) 455-0773

MICHIGAN - Jul. 8-11

MICHIGAN ANTIQUE RADIO CLUB EXTRAVAGANZA '99

Lansing, MI

Holiday Inn South Convention Center
6820 S. Cedar St. - (517) 694-8123

Thu.: Bus to MHM for Exhibit -
Registration - Program

Fri.: Flea Market - Women's Luncheon -
Contest - Social Hour - Programs - Raffle

Sat.: Flea Market - Auction - Raffle

Sun.: Donation Auction - Raffle

Theme: On The Air

Info: Extravaganza '99, Suite 100, 3520 Okemos
Rd. #6, Okemos, MI 48864 - (517) 349-7187

NEW JERSEY - Jul. 9

NEW JERSEY ANTIQUE RADIO CLUB MEETING - 7 PM

Freehold, NJ - Grace Lutheran Church
West Main St. & Park Ave. (Old Rt. 33)

Info: Marv Beeferman - (609) 693-9430
Phil Vourtsis - (732) 446-2427

OKLAHOMA - Jul. 10

OKLA. VINTAGE RADIO COLLECTORS MEETING

Oklahoma City, OK - Oklahoma Station BBQ
Springdale Shopping Center, 4333 N.W. 50th

6 pm - Dinner

7 pm - Meeting

Info: Jim Collings - (405) 755-4139, after 6 pm
Mike Lapuzza - (405) 745-3394, after 7 pm

**Attend a radio event near you,
learn, meet others in the
hobby, and perhaps find an
item or two for your collection!**

COLORADO - Jul. 11

COLORADO RADIO COLLECTORS MEETING - 1 PM

Denver, CO - VecraBank Bldg.
1380 South Federal Ave.

Info: Larry Weide - (303) 758-8382

NEW MEXICO - Jul. 11

NEW MEXICO RADIO COLLECTORS CLUB MEET

Albuquerque, NM - Anna Kaseman Hospital
8300 Constitution Ave. (W. of Wyoming)

1:30 pm - Tailgate Swap Meet

2 pm - Program, Show & Tell and Auction

Info: Chuck Burch, 39 Chaco Loop,
Sandia Park, NM 87047 - (505) 286-9320

MISSOURI - Jul. 13

ANTIQUÉ RADIO COLLECTORS & HISTORIANS OF GREATER ST. LOUIS MEETING

Kirkwood, MO - Kirkwood Community Center
111 S. Geyer Rd., Room 201-A

7:30 pm - Meeting (earlier for conversation)
Show & Tell, Swap Table

Info: Derek Cohn, 8141 Stratford Dr.,
Clayton, MO 63105 - (314) 725-2333

N. CAROLINA - Jul. 13

EAST CAROLINA ANTIQUE RADIO CLUB MEETING

Greenville, NC - Western Sizzlin
2903 E. 10 St.

Info: Bill Engstrom - (252) 355-8732
Herman Schnur - (252) 752-2264

OHIO - Jul. 13

ANTIQUÉ RADIO COLLECTORS OF OHIO MEETING - 7:30 PM

Kettering, OH - National City Bank Basement
4100 Far Hills Ave., at Stroop Rd

Parking Lot Swap Meet

Info: John Heck - (937) 435-1571
ARCO, PO Box 292292, Kettering, OH 45429

GEORGIA - Jul. 17

SOUTHEASTERN ANTIQUE RADIO SOC. SUMMER SWAP MEET

Alpharetta, GA - Fairfield Inn
11385 Haynes Bridge Rd. (Exit 9 off GA Hwy 400)

Dawn-1 pm

Info: Gordon Hunter - (770) 475-0713
SARS, PO Box 500025, Atlanta, GA 31150

KENTUCKY - Jul. 17

MID-SOUTH ANTIQUE RADIO COLLECTORS SWAP MEET

Louisville, KY - ITT Institute, 10509 Timberwood
Cir. (Off Hurshbourne Ln. near I-64)

7 am-1 pm

Theme: 78s & record players

Info: Allen Ferris - (502) 543-8233

W. VIRGINIA - Jul. 23-25

A.C. GILBERT HERITAGE SOCIETY 8TH ANNUAL NATIONAL CONFERENCE

Huntington, WV - Museum of Radio & Tech.

Fri.: 5 pm-7 pm - Founder's Welcoming Party
at Holiday Inn

7 pm-10 pm - Dinner "The River Cafe"

Sat.: 9 am-3 pm - Exhibits

6 pm-10 pm - Banquet, Awards Ceremony,
Guest Speakers, Entertainment

Sun.: 1 pm-4 pm - Heritage Farm Museum

Info: Museum of Radio & Technology
4204 Thornapple Ln., Charleston, WV 25313

OHIO - Jul. 24

CENTRAL OHIO ANTIQUE RADIO ASSN. SUMMER SALE & SWAP MEET

Columbus, OH - DeVry Institute of Tech.
1350 Alum Creek Dr. (I-70 exit 1C3B)

7:30 am-11 am

Info: Barry Gould - (614) 777-8534
Mike Keller - (614) 866-7725

BRITISH COLUMBIA - Jul. 25

CANADIAN VINTAGE RADIO SOCIETY BRITISH COLUMBIA CHAPTER MEETING

Richmond, BC - Steveston Hotel

Info: Fred Tutt - (604) 275-2033

NEW HAMPSHIRE - Jul. 31

NEW ENGLAND ANTIQUE RADIO CLUB SWAP MEET

Nashua, NH - Resurrection Center
Rt. 3 (Everett Turnpike) Exit 6

1 1/2 miles West on Rt. 130, 449 Broad St.

7:30-8 am - Real Early Admission

8-9 am - Early Admission

9 am-1 pm - General Admission

Over 100 tables - 50/50 Raffle - Catered
Old Equipment Contest
Reservations required to sell

Info: Gregg Thompson, PO Box 298
Newtonville, MA 02160 - NEARC: (617) 923-2665

MENTION A.R.C.
WHEN CONTACTING CLUBS!

ILLINOIS - Aug. 4-7

ANTIQUÉ RADIO CLUB OF ILLINOIS RADIOFEST XVII

Elgin, IL - Elgin Plaza Hotel, 345 River Rd
(847) 695-5000 - ask for Lori

Daily Open Air Flea Market

Zenith Display - 50/50 Raffle

Awards Banquet and Show

Radio Auction - Donation Auction

Free Admission to Muchow Museum

Info: A.R.C.I., PO Box 1139, LaGrange Park,
IL 60526 - E-mail: arci31280@aol.com

NEW YORK - Sep. 1-4

ANTIQUÉ WIRELESS ASSOCIATION 38TH HISTORICAL RADIO CONFERENCE

Rochester, NY - Thruway Marriott Hotel
Easy access from New York State Thruway
(I-90), I-390, or Rochester Airport
(716) 389-8300 - Theme: Philco

4-day, 3-acre Antique Radio Flea Market

Info: AWA, Box E, Breesport, NY 14816
Secretary's phone - (607) 739-5443

*[If you can go to only one meet,
make it to this one. Editor]*

RADIO CLUB LISTINGS

CLUBS: Send antique radio club and meet information to A.R.C. for free listing here, as space permits. Sorry, we don't have room for hamfests. Always send a SASE when writing to clubs!

NATIONAL CLUB

Antique Wireless Association (AWA). Box "E", Breesport, NY 14816. Pub: *The Old Timer's Bulletin*, quarterly. Dues: \$15. National annual conference and regional meets. Museum.

REGIONAL CLUBS

Alabama Historical Radio Society (ALHRS). PO Box 26452, Birmingham, AL 35226. Julian Brook, PO Box 130307, Birmingham, AL 35213. Pub: *The Superflex*, monthly. Dues: \$20. Meetings 4th Mon. evening each month but Dec., annual show/swap meet. Don Kresge Radio Museum, Fairfield Civic Center, 65C9 E.J. Oliver Blvd., Fairfield, AL.

Antique Radio Club of Illinois (ARCI). ARCI, PO Box 1139, La Grange Park, IL 60526. Carolyn Kniplfel, RR 3, 200 Langham, Morton, IL 61550. Pubs: *ARCI News*, semiannually, and "ARCI Update," periodically. Dues: \$12. Annual August Radiofest and bimonthly swap meets.

Antique Radio Collectors Club of Ft. Smith, Arkansas (ARCCFSA). Paul Tucker, 4700 N. "N" St., Fort Smith, AR 72904. Dues: \$10. Monthly meetings, annual show.

Antique Radio Collectors & Historians (ARCH) of Greater St. Louis. Derek Cohn, 8141 Stratford Dr., Clayton, MO 63105-3707. Dues: \$12. Monthly newsletter and meetings, annual picnic/swap meet.

Antique Radio Collectors of Ohio (ARCO). John Heck, ARCO, PO Box 292292, Kettering, OH 45429. Pub: *The ARCO Code*, quarterly. Dues: \$10. Monthly meetings, August show & auction.

Arkansas Chapter/AWA. Arkansas Antique Radio Club (AARC). Tom Burgess, PO Box 191117, Little Rock, AR 72219. Dues: \$5. Monthly meets.

Arizona Antique Radio Club (AARC). Bill Lettow, 2025 E. LaJolla Dr., Tempe, AZ 85282-5910. Pub: *The Arizona Antique Radio Club News*, quarterly. Dues: \$18. Monthly meetings, swap meets, Arizona Radio Roundup.

Belleville Area Antique Radio Club (BAARC). Karl Stegman, 4 Cresthaven Dr., Belleville, IL 62221. Monthly newsletter. Dues: \$10. Monthly meetings.

Buckeye Antique Radio and Phonograph Club (BARPC). Kevin Grimm, 1716 Chestnut Blvd., Cuyahoga Falls, OH 44223. Pub: *Soundings*, bimonthly. Dues: \$10. Monthly meetings, public mall show, March swap meet with PARS.

California Historical Radio Society (CHRS). CHRS, PO Box 31659, San Francisco, CA 94131. CHRS Hotline: (415) 821-9800. Steve Kushman, 4233 25th St., San Francisco, CA 94114. Pubs: *The Journal*, quarterly; *20 Years of CHRS, Hints & Kinks*, free w/membership. Dues: \$20. 13 events/yr.

Sacramento Chapter, CHRS. PO Box 162612, Sacramento, CA 95816-9998. Pub: *The Announcer*, quarterly. Dues: \$10. Special meets, monthly meetings.

Carolinas Chapter/AWA. Ron Lawrence, PO Box 3015, Matthews, NC 28106.

Central Ohio Antique Radio Association (COARA), Barry Gould, 3782 Mill Stream Dr., Hilliard, OH 43026. Monthly meetings, January Cabin Fever swap meet. Dues: \$12.

Central Pa. Radio Collectors Club. Frank Hagenbuch, 1440 Lafayette Parkway, Williamsport, PA 17701, or Mike Heffner, 501 S. Market St., Muncy, PA 17756.

Cincinnati Antique Radio Society Ted Lewis, 6 Indian Dr., Sardinia, OH 45171. Monthly meetings.

Colorado Radio Collectors (CRC). Riggs Smith, 7477 West Nichols Pl., Littleton, CO 80123. Pub: *The Flash!!*, bimonthly. Dues: \$12. Bimonthly meetings/swap meets. April Show & Swap Meet, July Family Picnic, and September Auction.

Delaware Valley Historic Radio Club (DVHRC). Mike Koste, PO Box 41031, Philadelphia, PA 19127-0031. Pub: *The Oscillator*, monthly. Dues: \$10. Monthly meetings with swap meets, quarterly tailgate swaps.

East Carolina Antique Radio Club. Bill Engstrom, 218 Bent Creek Dr., Greenville, NC 27834.

Florida Antique Wireless Group (FAWG). Paul Currie, Box 738, Chuluota, FL 32766. Pub: *FAWghorn News*, quarterly. Monthly tailgate swap meets, fall auction, & quarterly flea markets.

Greater Boston Antique Radio Collectors (GBARC). c/o A.R.C., PO Box 2, Carlisle, MA 01741. (978) 371-0512. Informal org. Write to be put on mailing list. Annual meet in Feb.

Greater New York Vintage Wireless Association (GNVWA). Chris Bacon, 52 Uranus Rd., Rocky Point, NY 11778. Pub: Meeting notices. Dues: \$4. Six meets/year and monthly meetings.

Houston Vintage Radio Association (HVRA). PO Box 31276, Houston, TX 77231-1276. Membership info: David Moore, 3213 Regal Oaks, Pearland, TX 77581. Pub: *The Grid Leak*, monthly. Dues: \$20. Monthly meetings and special regional events.

Hudson Valley Antique Radio and Phonograph Society-AWA (HARPS). PO Box 207, Campbell Hall, NY 10916. Peter DeAngelo, 25 County Route 51, Campbell Hall, NY 10916. Dues: \$15. Monthly meetings, annual Old Time Radio & Phono Show.

Indiana Historical Radio Society (IHRS). 245 N. Oakland Ave., Indianapolis, IN 46201-3360. Pub: *IHRS Bulletin*, quarterly. Dues: \$10. Quarterly swap meets in various areas of state.

International Antique Radio Club, World-Wide. New club forming. Richard G. Brill, PO Box 5367, Old Bridge, NJ 08857. No dues.

Illinois Historical Radio Society (IHRS). Paul Johnston, 8592 N. Creek Rd., Roscoe, IL 61073

Iowa Antique Radio Club and Historical Society (IARCHS). 790 Kane St., Dubuque, IA 52001. Pub: *IARCHS Newsletter*, quarterly. Dues: \$12. Annual Radiofest.

Louisiana & Gulf Coast Antique Radio Club. Phil Boydston, 750 Moore St., Baton Rouge, LA 70806.

Memphis Antique Radio Club (MARC). Mel Urban, 7190 Mimosas, Germantown, TN 38138. Pub: Newsletter, bimonthly. Dues: \$12. Monthly meetings and summer swap meet.

Michigan Antique Radio Club (MARC). Brenda Clark, MARC, Suite 100, 3520 Okemos Rd., #6, Okemos, MI 48864-5943. Pub: *The Michigan Antique Radio Chronicle*, quarterly. Dues: \$12. Annual Extravaganza and other quarterly meets.

Mid-America Antique Radio Club (MAARC). Gary Watkins, 8006 Greenwald, Belton, MO 64012. Pub: *The Broadcaster*, quarterly. Dues: \$12. Semi-annual auctions and swap meets.

Mid-Atlantic Antique Radio Club (MAARC). Barry Zimmerman, 5825 Woodwinds Cir., Frederick, MD 21703-7579. Pub: *Radio Age*, monthly. Dues: \$20. Monthly meetings.

Mid-South Antique Radio Collectors (MSARC). Joe Zahnen, 933 Venice Rd., Knoxville, TN 37923. Pub: *Old Radio Time's*, quarterly. Dues: \$10. Two meets per year.

Music City Vintage Radio & Phonograph Society. PO Box 22291, Nashville, TN 37202. Mary Evans, 713 Settiff Pl., Nashville, TN 37206. Pub: *Newsletter*, quarterly. Dues: \$15. Spring and fall swap meets.

Museum of Broadcast Communications. 78 E. Washington, Chicago, IL 60602. Dues: \$30

Nebraska Antique Radio Collectors Club (NARCC). Steve Morton, 905 W. First, N. Platte, NE 69101. Pub: Mountains 'N Plains newsletter, 6/year. Dues: \$12. Monthly meetings Apr. to Oct. in W. Nebraska, annual auction in Kearney.

New England Antique Radio Club (NEARC). Info: (617) 923-2665. Bob Andersen, PO Box 918, Melrose, MA 02176. Pub: *Escutcheon*, quarterly. Dues: \$10. Quarterly meets & auctions.

New Jersey Antique Radio Club (NJARC). Phil Vourtsis, 13 Cornell Pl., Manalapan, NJ 07726. Pubs: *New Jersey Antique Radio Club News*, quarterly; *The Jersey Broadcaster*, flyer. Dues: \$15. Monthly meetings, three swap meets/year.

New Mexico Radio Collectors Club (NMRCC). Charles Burch, 39 Chaco Loop, Sandia Park, NM 87047. Pub: *New Mexico Radio Collectors Club Newsletter*, quarterly. Dues: \$12. Annual Sale & Show and monthly meetings.

Niagara Frontier Wireless Association (NFWA). Gary Parzy, 135 Autumnwood, Cheektowaga, NY 14227. Pub: *NFWA Chronicle*, quarterly. Dues: \$9. Regional meets. Display at the Amherst Museum, Amherst, N. Y.

Northland Antique Radio Club (NARC). PO Box 18362, Minneapolis, MN 55418. Pub: *The NARC Newsletter*, four/year. Dues: \$10. 4 meets (including 2 swap meets) per year and Radio Daze event.

Northwest Vintage Radio Society (NWVRS). PO Box 82379, Portland, OR 97282-0379. Pub: *The Call Letter*, monthly. Dues: \$15. Monthly meetings.

Oklahoma Vintage Radio Collectors Club (OKVRC). Tom Laszynski, 7400 Sapphire Ln, Oklahoma City, OK 73150-8113. Pub: *OKVRC Broadcast News*, monthly. Dues: \$12. Monthly meetings, spring and fall swap meets.

Pittsburgh Antique Radio Society, Inc. (PARS). Seth Ward, 83 Ruthfred Dr., Pittsburgh, PA 15241. Pub: *The Pittsburgh Oscillator*, quarterly. Dues: \$12. Quarterly meetings, Spring Fever & March meet.

Puget Sound Antique Radio Association (PSARA). PO Box 7251, Seattle, WA 98133. Pub: *The Horn of Plenty*, monthly. Dues: \$20. Monthly meetings and swap meets, November show, and August swap meet.

Radio Enthusiasts of Puget Sound. (REPS). Bill Davies, 14911 Linden North, Seattle, WA 98133. Pub: *Air Check*, quarterly newsletter. Dues: \$18 (\$22 first year). Monthly meetings, annual REPS Radio Showcase.

Radio History Society, Inc. (RHS). Museum and library. Steve Snyderman, 4147 Lenox Dr., Fairfax, VA 22032. Dues: \$15 and up (various membership levels).

E. H. Scott Historical Society Inc. (EHSHS). 3712 N. Broadway #4450, Chicago, IL 60613. Pub: *Scott News*, quarterly. Dues: \$20. Manuals, parts and service, Scott Video.

Society for the Preservation of Antique Radio Knowledge (SPARK). Dan Gebhart, c/o SPARK, PO Box 482, Dayton, OH 45449. Pubs: *The Electronic Collector (TEC)*, quarterly; *SPARK Notes*, monthly. Dues: \$12. Monthly meetings, quarterly swap meets.

Society of Wireless Pioneers. PC Box 86, Geysville, CA 95441. *The World Wireless Beacon*, quarterly; *Register*, bi-annually. Dues: \$15.

South Florida Antique Radio Collectors. Thomas Valenti, 1717 N. Bayshore Dr., Apt. #1549, Miami, FL 33132. Dues: \$10.

Southeastern Antique Radio Society (SARS). Tom Atcheson, SARS, PO Box 500025, Atlanta, GA 31150. Pub: Newsletter, quarterly. Dues: \$12. Spring & fall swap meets. Monthly dinner meetings.

Southern California Antique Radio Fest (SCARF). c/o Jerry's Vintage Radio, 17665-1/4 Sierra Hwy., Canyon Country, CA 91351. Three swap meets a year — January, May and Sept.

Southern California Antique Radio Society (SCARS). Robert Schoenbeck, 9301 Texhoma Ave., Northridge, CA 91325-2330. Pub: *California Antique Radio Gazette*, quarterly. Dues: \$15. Quarterly meets in L.A. area and mini meets, two-day November meeting, annual auction.

Southern Vintage Wireless Association (SVWA). Earl Ridolphi, 2413 Old Briar Trail, Birmingham, AL 35226. Pub: *SVWA Newsletter*, 3/year. Dues: \$5. Three swap meets.

Texas Antique Radio Club (TARC). Jim Moffett, 218 Shannon Lee, San Antonio, TX 78216. Pub: *Lone Star Waveform*, monthly. Monthly meetings.

Tidewater Antique Radio Association (TARA). Vic Johnston, 7 Hillcrest Cir., Hampton, VA 23666

Tri-State Antique Radio Club. Close to N.Y.C., all of N.J., Ct., L.I., upstate N.Y. and Pa. Bob Masterson, Box 172, Valley Cottage, NY 10989. Swap meets and education.

Tube Collectors Association. PO Box 1181, Medford, OR 97501. Pub: *Tube Collector*, 6 times a year. Dues: \$20.

Vintage Radio & Phonograph Society (VRPS). George Potter, PO Box 165345, Irving, TX 75016. Pubs: *The Reproducer*, quarterly. *Soundwaves*, monthly between the quarterly. Dues: \$13.50. Monthly meetings, spring auction, annual convention, summer swap meet.

W. Va. Chapter, AWA (AWA-WVC). Geoff Bourne, 405 8th Ave., St. Albans, WV 25177. Newsletter, monthly. Dues: \$25 (includes museum membership). Quarterly meets, monthly meetings, classes.

Wisconsin Antique Radio Club (WARC). Dale Boyce, 10230 W. Greenwood Ter., Milwaukee, WI 53224-3716.

FOREIGN CLUB LISTINGS

(Dues, when listed, are for U.S. membership. A.R.C. would like to hear about other foreign antique radio clubs.)

Australia: Historical Radio Society of Australia (HRSA). Membership Secretary, PO Box 2283, Mt. Waverly, Victoria, 3149, Australia. Dues: \$25 Aus.

Australia: North East Vintage Radio Club. Monthly meetings at Wangaratta T.A.F.E. electronic unit. Info: Noel Meagher, 62 3149; Ian Milne, 62 5153; Rodney Champness, 62 1454 (all Benalla numbers).

Belgium: Belgische Radio Club. Francois Marschang, Kromvendreef 53, B-2900, Schoten, Belgium.

Belgium: Vlaamse Liefhebbers Van Der Historische Radiotechniek (VLHR). Rudi Sillen, Limberg 31, B-2230, Herselt, Belgium.

Canada: Canadian Vintage Radio Society (CVRS). CVRS, 4895 Mahood Dr., Richmond, British Columbia V7E 5C3. Pub: *Radio Waves*, bimonthly. Dues: \$17 U.S. (\$21 Canadian). Bimonthly meetings.

Alberta Chapter/CVRS, Rick Williams, Secretary CVRS Alberta, 9611 142 St., Edmonton, Alberta T5N 2M8. **British Columbia Chapter/CVRS,** Fred Tutt, 4895 Mahood Dr., Richmond, B.C. V7E 5C3.

Manitoba Chapter/CVRS, Bob Murray, 3216 Assiniboine Ave., Winnipeg, Manitoba R3K 0B1. **New Brunswick Chapter/CVRS,** W.H. Gentleman, 17 Maple Cresc., Rothesay, New Brunswick E2E 2A4. **Newfoundland Chapter/CVRS,** Tasker Squires, 11 Gulliver, St. John's, Newfoundland A1E 4K5.

Nova Scotia Chapter/CVRS, Brian McKeigan, 4 Baird St., North Sydney, Nova Scotia B2A 2B3. **Ontario Chapter/CVRS,** Bill Beaton, 79 Meadowlands Dr., Nepean, Ontario K2G 2R9.

Saskatchewan Chapter/CVRS, Roy Sawley, Box 174, Melfort, Saskatchewan S0E 1A0. **Yukon and NWT Chapter/CVRS,** Hoby Irwin, 21 Hyland Cres., Whitehorse, Yukon Y1A 4P6.

Canada: Society for the Preservation of Antique Radio in Canada (SPARC). Bruce C.E. Russell, 370 N. Hythe Ave., Burnaby, British Columbia, Canada V5B 1G5. Pub: Periodic newsletters. Dues: \$10. Annual open house and show, periodic shows and displays, and museum.

Canada, Ontario: London Vintage Radio Club (LVRC). Dave Noon, 19 Honeysuckle Cres., London, Ontario, Canada N5Y 4P3. Pub: *LVRC Newsletter "The Loudspeaker,"* bimonthly. Dues: \$15 Canadian. Six meetings yearly.

Canada, Ontario: Ottawa Vintage Radio Club (OVRC). Box 84084, Pinecrest PO, Ottawa, Ontario K2C 3Z2. Pub: *OVRC*, quarterly newsletter. Dues: \$10. Monthly meetings.

Canada, Quebec: Quebec Society for Vintage Radio Collectors (QSVRC). SQCRA, 224 Decelles, Brigham, Quebec, Canada J2K 4S5. Pub: *Radiophilie Quebec*, bimonthly.

Czech Republic: Historic Pardubicky Radioclub. Ivan Marek, Zapasazi 1342, CZ Pardubice, Czech Republic.

Czech Republic: Historic Radioclub Ceskoslovensky (HRCS). Dr. F. Perina, Prika 3495, CZ 76000 Zlin, Czech Republic.

England: British Vintage Wireless Society (BVWS). Mike Barker, 28 Cheney Manor Rd., Swindon, Wilts SN2 2NS, England. Pubs: *Vintage Wireless*, monthly; *BVWS Bulletin*, bimonthly. Dues: £20. Meetings and swap meets.

England: Eddystone User Group (EUG). C/O Graeme Wormaud, 15 Sabrina Dr., Bewdley, Worcestershire, DY12 2RJ, England. Pub: *EUG Newsletter*, 6 per year. Dues: £10 UK.

Finland: Radiohistorical Society of Finland. Jukka Heino, Viilarinkatu 5, FIN-87150, Kajaani, Finland. Pub: society magazine, quarterly. Meetings in October and March.

France: Club Histoire et Collection Radio (CHCR). Jean Le Galudec, 26 Rue de l'Oratoire, 54000 Nancy, France. Pub: *Telegraphie et Telephonie Sans Fil Electricite Ancienne*, quarterly. Dues: 195 francs. Library. Annual May event in Riquewihir, Sept. Bar Le Duc event, meetings.

France: French Antique Radio Association (Association des Amis du Musée de l'Electro-Acoustique). M. Kopito, Eric Trésorier A.E.A., 135, av. du Président Wilson, 93100 Montreuil, France. Pub: *Journal Officiel de L'Association*. Dues: 250 F.

Germany: German Society of Wireless History. Prof. Otto Künzel, Belm Tannenhof 55, 7900 Ulm 10, Germany. Pub: *Funkgeschichte*, bimonthly. Dues: DM 50 + DM 6 first registration.

Hungary: Hungarian Radio Collectors Club: Laszlo Koger, H-8900 Szekesfehervar Sajo U 9. Meetings twice a year, bi-monthly news.

Holland: Nederlandse Vereniging Voor Historisches Radio (NVHR). Paulus Pofferstr. 19, 6814 K.T. Arnhem, Holland. Swap meets quarterly.

Ireland: Irish Vintage Radio & Sound Society. Henry Moore, 9 Auburn Close, Killiney, Co. Dublin, Ireland. Quarterly newsletter. Dues: £10. 26 weekly and six monthly meetings.

Israel: Antique Radio and Broadcasting Museum. Museum in Tel-Aviv. Bruno Pinto, 24 Remez St., #7, Tel-Aviv, Israel 62192

Italy: Associazione Italiana Radio d'Epoca (AIRE). Nerio Neri, President, Via de Pellicceria 23, 52100 Arezzo, Italy. Pub: *Bollettino-Notiziario*, bimonthly. Dues: 60 Lire.

Japan: Antique Wireless Club (AWC). Noriyoshi Tezuka, JA1NTF, Secretary AWC, 1-11-2-403 Hiroo, Shibuyaku, Tokyo 150, Japan. Monthly meetings and newsletter.

New Zealand: New Zealand Vintage Radio Society (NZVRS). David Crozier, 154 Grey St. Onehunga, Auckland, New Zealand 1006. *NZVRS Bulletin*, quarterly, monthly meetings. Dues: \$15.50

Norway: Norsk Radiohistorisk Forening (NRHF). Maridalsvn. 256, 0872 Oslo, Norway. Pub.: *Hallo Hallo*, quarterly. Dues: \$40. Regular meetings every Tuesday and first Saturday of each month.

Spain: Spanish Vintage Wireless Club (Associacio Cultural Amicos de la Radio). Rei Jaume, 55, 08840 Cardedeu, Spain.

Sweden: The Radio-Historical Society in West-Sweden. Anders Carlssons, Gata 2, 417 55 Guteborg, Sweden. Pub: *Audionen*. Amateur radio station: SK6RM. Museum.

Switzerland: Club der Radio-und Grammosammler (CRGS). Claude Meylan, Muehleamtstrasse 25, CH-6004 Luzern, Switzerland. Quarterly newsletter.

BUSINESS CARD ADS - \$53.00 FOR 3 MONTHS

BETA-TEK

ANTIQUÉ RADIO SERVICE

- Quality Repair & Restoration of Vacuum Tube Radios
- Free Estimates • Radios Bought & Sold • Battery Eliminators

RAY BINTLIFF, W1RY
2 Powder Horn Lane
Acton, MA 01720-2014
☎ 978-263-7435

e-mail: w1ry@msn.com



(703) 283-1649
BY APPOINTMENT

DO YOU HAVE
A PROBLEM RADIO ?

THE OLD RADIO SHOP

SERVICE OF VACUUM TUBE ELECTRONICS
SCHEMATIC DIAGRAM SERVICE
RESTORATION OR REPAIR • FREE ESTIMATES

1325 ERIE ST
OAK PARK, IL 60302

ED HUETHER

Vintage Electronics

Phono

Cartridges/Needles
Center Post/Ilders
45 Adaptors

Fax Anytime

Phone: Mon-Fri.
9AM-5PM CST only

128 Buccaneer Drive
Hattiesburg, MS 39402

Ed Crockett

Phone (601) 264-4755
Fax (601) 264-0226

IF YOU VISIT THE BRIMFIELD FLEA MARKET...
STOP BY FIRST!

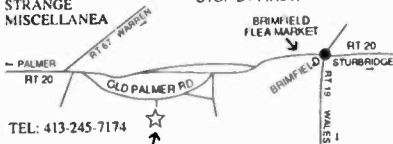

TEL: 413-245-7174

COUNTRY ROAD BARN - BERNIE SAMEK
OLD PALMER ROAD, BRIMFIELD, MASS.

ANTIQUÉ ELECTRONIC RESTORATION

35 Years Experience

Radios - Juke Boxes - Vintage TV's
Repair - Buy - Sell

Complete Restorations • Auto and Home • Prompt Service

COOPERS'S RADIO SERVICE

425 Court Street
Rockwell City, Iowa 50579

LARRY COOPER
712-297-7232



Old Time Replications

"TURN TO US WHEN YOU NEED KNOBS"
KNOBS • PUSHBUTTONS • ESCUTCHIONS
PLASTIC GRILLS • HANDLES

LARRY BORDONARO

5744 TOBIAS AVE. VAN NUYS, CA 91411
PHONE (818) 786-2500 • FAX (818) 909-0241

ANTIQUÉ RADIOS

Specializing in

Horn Speakers WANTED



DAVE CROCKER

4B Beechwood Point Dr.,
Mashpee, MA 02649 (508) 477-1578

PHILCO PREDICTAS WANTED:



BUY • SELL • TRADE • RENT • RESTORE
APPRAISALS/LECTURES GIVEN

DAVID WEDDINGTON
(615) 890-7498

2702 Albany Ct.
Murfreesboro, TN 37129

RADIOGALLERY.COM

QUALITY ANTIQUÉ RADIO SALES

"CLASSIC MODELS THAT WORK" / NEVER "as is" or "untested"

Big selection on the Internet at: www.RadioGallery.com

SCOTT STAMBAUGH

725 South 14th Street Lebanon, Pa. 17042

E-MAIL: Scott@RadioGallery.com

Free Estimates
Hrs. - 9 AM - 5 PM EST
Tues. - Sat

Tel./Fax (860) 926-2628
E-Mail: radiodoc@neca.com
<http://www.neca.com/~radiodoc>

ANTIQUÉ RADIO RESTORATION & REPAIR

1920 - 1960's

Buy & Sell



Reasonable Rates, Tubes, Professional
Overhauls, Cabinet Refinishing Service
For All Antique Car, Table & Console
Radios, Communication Receivers &
Tube Amplifiers

BOB ESLINGER

20 Gary School Road
Pomfret Center, CT 06259

WANTED !

JAPANESE MILITARIA

any kind of WW-2 Japanese hardwares - aircraft instruments
radios, optics.

Takashi Doi

Fax : 011-8145-301-8069

E-Mail : taka_doi@a2.ctktv.ne.jp

1-21-4 Minamidai, Seyaku, Yokohama, 246 Japan.



Cayce Vintage Sound Company

(803) 791-0733

Your complete source for

Leatherette

"Black Stag" style leatherette stocked
Others available by special order.

Scott McAwley
117 Sandy Lane
Cayce, S.C. 29033

LSASE for samples
cavisco@aol.com
Expert Vintage Electronic Repair

BUSINESS CARD ADS - \$53.00 FOR 3 MONTHS

TEST EQUIPMENT

BUY - SELL - TRADE
PARTS-ACCESSORIES-CABLES

Boca Electro Magnetic Lab
21218-10 St. Andrews Blvd.
Boca Raton, FL 33433
(561) 750-8911
bocalab@bellsouth.net



Collector, Historian, Seeker of
Stromberg-Carlson Radio Apparatus

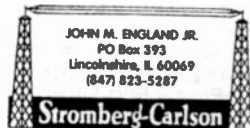

JOHN M. ENGLAND JR.
PO Box 393
Lincolnshire, IL 60069
(847) 823-5287

Entrepreneur: Art Moderne,
Streamline, Machine Age Design

INSTRUMENTS



Jim & Rhoda
Morris

Radio, Telegraph,
Historical Instruments,
& Books For Sale
Catalogs
& Lists
Available

Antiques of Science & Technology
A of ST Box 1852 Wakefield Ma. 01880 U.S.A.
Tel 781 245 2897 Fax 781 245 3572

Replacements - Reproductions • Radio - Stereo - Ham - Auto - OEM

Antique Radio DIAL SCALES

Send an SASE for brochure and list

Rock-Sea Enterprises
323 E. Matilija St. #110-241
Ojai, CA 93023

Mike Tobin
(805) 646-7362
dials @ juno.com
<http://members.aol.com/RockSeaEnt/>

Richard E. Desjarlais
(978) 486-9018

Antique Radios
Bought and Sold

DICK'S RADIO DAYS



Don't Trash - Get Cash!

P.O. Box 629, Littleton
Massachusetts 01460

Member AWA NEARC

ANTIQUE ELECTRONIC REPAIR

Radios ■ Hi Fi ■ Jukeboxes
Television ■ Test Equipment
...and other neat old stuff

since 1976

Mike Zuccaro
619 271-8294

8795 Corvus Pl
San Diego, CA 92126

Proud Member of *"The Early Soundman"* Satisfaction is Guaranteed
JOHN P. ANDOLINA JR.
AWA & MAPS

ANTIQUE

PHONOGRAPHS



COLLECTOR & EXPERT IN RESTORATION
OF SPRING WOUND CYLINDER & DISC
PHONOGRAPHS. SUPPLIER OF NEEDLES,
MAIN SPRINGS, ORIGINAL & REPRODUCTION
PARTS.
28 Glen Oaks Drive
Rochester, NY 14624
(716) 247-3056
Specialist in
Reproducer
Rebuilding

Honest, Friendly
Advice

78 RPM Cartridges Repaired



Dead cartridges rebuilt
right. New crystals etc., as needed. Allow 3-4 weeks. Most
crystal and "horseshoe" magnet types \$34.50
100 hr. sapphire setscrew needles (list \$2.50 ea.) ... 4/\$5.50



Joe Smolatz
835-A Pleasant Street
Frammingham, MA 01701

Inquiries: (508) 879-2778,
evenings and weekends.
Prices include return
postage. Please include
payment with order.

PUT YOUR BUSINESS CARD HERE!

\$53 FOR 3 MONTHS - \$90 FOR 6 MONTHS
DON'T HAVE ONE? SEND AN EXTRA \$7 AND
WE WILL TYPESET ONE FOR YOU.



All Tube Equipment Repaired



"The Fisher Doctor"

Al Pugliese
718-948-7489

27 Daleham Street
Staten Island N.Y. 10308

VINTAGE FISHER PRODUCTS
Bought • Sold • Traded • Repaired



Modern Radio Laboratories
Since 1932

Crystal Set and One Tube Radio Instructions. Exclusive source,
printing and publishing of all MRI. Handbooks & literature by
Elmer G. Osterhoudt. Tested instructions and plans.

Catalog \$2.00 ppd.

MODERN RADIO LABS
P.O. Box 14902-T
Minneapolis, MN 55414-0902

Atlanta, GA area ANTIQUE RADIO REPAIR



JOHN PELHAM, W1 JA
1185 BEND CREEK TRAIL
SUWANEE, GA 30024
(678) 778-7812



E-mail: repair@radiophile.com

I accept work from all states via USPS or UPS.
Write, call, e-mail, or surt to
<http://www.radiophile.com/arr.htm> for details!

1930s - 1960s Vacuum-tube radios only

BUSINESS CARD ADS - \$53.00 FOR 3 MONTHS

Antique Radios



David & Nancy Snow
P.O. Box 6352
Jackson, MI 49204
(517) 787-2985

We Buy, Sell, Repair
ARBE - III Battery Eliminators

ANTIQUÉ RADIO REPAIR

Repair - Restore - Buy & Sell

Schematic Service
Radios \$2.⁹⁹, TVs \$4.⁹⁹
DAMASKE ELECTRONICS
574-W16834 Janesville Road
Muskego, WI 53150
Phone: (414) 679-0838



1298 SE 5th Avenue
PO Box 1939
Melrose, FL 32666
(352) 475-1950 ph/fax

RADIO ELECTRIC SUPPLY

We Specialize in Recaving and Special Purpose Tubes

Buy and Sell

Don and Dorothy Gies

http://www.vacuumtubes.net
E-mail: tubes@mindspring.com

MESSAGE: Current flyer is **199.**

For details send **2-stamp LSASE**
for 20-page flyer to:

Olde Tyme Radio Company
2445 Lyttonsville Road, Suite 317
Silver Spring, MD 20910

Fax/phone: (301) 587-5280
Fax anytime, phone 10 am-10 pm local time
E-mail: oldetymeradio@juno.com



ELECTROMAGNETIC
RADIOS TUBES PARTS
P.O. BOX 1258 STEPHEN SCHAUB
PEORIA, IL. 61654-1258 309-681-8304

IN SOUTHERN CALIFORNIA GA RADIO SERVICE

TUBE - TRANSISTOR - LSI
SINCE 1950

SPECIALISTS IN COLLECTOR CAR RADIOS
PHONE/FAX 760-741-9660
140 N. ANDREASEN,
ESCONDIDO, CA 92029

SPY EQUIPMENT WANTED!

- Code Machines
- Secret Cameras
- Secret Radios
- OSS, SOE, CIA, KGB!
- Clandestine Weapons
- I Buy or Trade!

Keith Melton

880 Jupiter Park Dr., Suite 5, Jupiter, FL 33458
(561) 743-1143 Days; Fax (561) 743-7504
E-mail: hkmelton@adelphia.net



"The Home of Mr. Nappy Amp"

PR NOVELTY

Vacuum Tube Audio Specialists
Amplifier Rebuilding • Service
Surplus Parts Brokerage
(New, Old Stock and Used)

Paul Dorobialski Audio Technician
Robin Richards General Manager

PO Box 140 • Milwaukee • WI 53201
Office 413 964 3392
Cellular 414 440 8812



STEINMETZ ELECTRONICS
7519 MAPLEWOOD AVENUE
HAMMOND, INDIANA 46324
YES! "WE'RE STILL HERE"

TUBES

SCHEMATICS

SASE FOR LISTS

(219) 931-9316



ESTES AUCTIONS

Specializing in Vintage Radios

7404 Ryan Rd
Medina, Ohio 44256

Bus Phone 330-769-4992
Fax 330-769-4116
Res Phone 330-769-7987

WANTED

PRE 1900
ELECTRICITY
MEDICAL • X-RAY
TELEGRAPHY • TELEPHONE
PRE 1925
RADIO • WIRELESS
PRE 1940
TELEVISION



**NEW WIRELESS
PIONEERS**

P.O. BOX 338
ELMA, NY 14059
716-681 3186
FAX 716-681-4540

BOOKS • TUBES • ARTIFACTS
MAGAZINES • AUTOGRAPHS
CATALOGS • EPHEMERA

FRED GORDON

Fred's
OLD RADIO REPAIR • HOME • CAR

221 North Commerce
Corsicana, TX 75110

Bus 903-874-4531
Home 903-874-7147

BUSINESS CARD ADS - \$53.00 FOR 3 MONTHS



Antique Radio & Television

Buy - Sell - Repair
15 Green St., New London, CT 06320

Visit our shop in downtown New London

(860) 442-0233
Jack Armstrong

www.tuberadiorepair.com
William Morse



THE RADIO MAN

Buy-Sell-Trade
Antique Radios • Tubes • Parts

DICK MORGAN
RES: (972) 564-6464

P.O. BOX 461485
GARLAND, TX 75046-1485

TEL: (972) 276-5458
FAX: (972) 272-1831

Great Northern Antiques

We Buy and Sell
Antiques-Collectibles-Advertising
and Vintage Radios

Alan Jespersen
5200 Bloomington Ave. S
(4 blocks west of Cedar Ave)
Minneapolis, MN 55417

TEL (612) 727-2489
FAX (612) 821-4821
E-Mail: mt612@aol.com

* GRUNDIG • SABA • TELEFUNKEN • NORDMEND • PHILIPS • SIEHMEN •
- SPECIALIZING IN REPAIR OF EUROPEAN RADIO SETS -

The Bavarian Radio Works

Ross A. Hochstrasser
(781) 447-4299



162 BRULAN ST.
WITTMAN, MA 02382

Mel's Fix It Shop

Repairing tube amplifiers, stereo equipment,
antique radios, test equipment & other misc.

Well stocked with many tubes & parts.

266 LaSalle Ave., Buffalo, NY 14215

(716) 836-1200 or (716) 836-1148, lv. msg.

36 years experience

Jackson Speaker Service

Expert Antique Loudspeaker Repairs
(Cone Types) And Reconing A Speciality.
Speaker Parts And Repair Service On
Virtually Any Speaker Made Including
Stereo, P.A., And Antique Auto Speakers.

217 Crestbrook Dr. Owner
Jackson, Mich. 49203 Ron McGee

Ph. - (517) 789-6400, Ans. 4th ring
Wk-days 10am-7pm Wk-ends 9-5pm



CRYSTAL SETS

PARTS - PLANS - KITS - BOOKS
CATALOG \$2.00

Largest source of Vintage and New
Variable Air Condensers, Variometers,
Vario-Couplers, Tap Switches, Tap
Points, Galena and Germanium
Detectors, Detector Stands, Cat
Whiskers, Terminals, Sliders,
Headsets, Dial Knobs, Coil Forms,
Magnetic Wire, etc.

MIDCO
P.O. Box 222288
Hollywood, FL 33022
(954) 925-3670
B.A. Turke, Ph.D.E.E.

If you buy, sell or like jukeboxes you need
**ALWAYS JUKIN™ - THE MONTHLY JUKEBOX
MAGAZINE!!** Subscribers in 25 countries,
ALWAYS JUKIN LEADS THE WAY: Articles,
photos, show reports, ads, new products,
price guides, restoration tips, repairs -
everything you need to know about **JUKE-
BOXES** - the fastest appreciating collectible in
the world!!! Fun & a great investment.
Sample Copy, \$3. \$36 per year.

ALWAYS JUKIN, 1952 1st Ave. S, Ste. #6AR,
Seattle, WA 98134. (206) 652-4005.
Fax (206) 652-4007
Master/Visa OK

LOGANS RADIO SERVICE

412-837-5580

BUY • SELL • TRADE • WHEEL AND DEAL

N.O.S. BLACK/WHITE PICTURE TUBES

40's-70's

FOR SALE, CALL OR WRITE

PARTS, TUBES, SCHEMATICS FOR SALE

SCHEMATIC SERVICE - \$2.50 EA.

SERVICE AND RESTORATION SINCE 1952

REAR 526 Mt. PLEASANT ST., GREENSBURG, PA 15601

CAPACITORS - TUBES RADIO SERVICE ITEMS

Thousands in jam-packed illustrated
24-page catalog No. 49

INFORMATIVE
INTERESTING
FUN-TO-READ

Send \$3 U.S./Canada
\$5 overseas (U.S. funds)
for a Heavy-Paper limited
edition copy NOW!

DON DIERS 4276 North 50 St. Dept. AB9
Milwaukee, WI 53216-1313

Authentic Dial Reproductions

Top quality material & workmanship.
Finish your restoration with best dial available. Satisfied
customers world-wide. A-K to Zenith.

These are not copy machine plastic laminates.

Telephone consultations welcome.

ANTIQUE RADIO RESTORATIONS

109 So. Oak St.
O'FALLON, IL 62269
618-632-7423

Life Member I.E.E.E.
AWA, ARCA, ARCI, MAARC

Clinton Blais, P.E.

RADIO BOOKS FOR SALE

Large selection of books on Radio and Related Technology

Call or write for our List of Catalogs.

Always buying, single items or collections.

Visit our web site: <http://adam.cheshire.net/~rainyday>

RAINY DAY BOOKS

P.O. BOX 775, FITZWILLIAM NH 03447

(603)-585-3448

New Books for the Collector



Price
Guide

Zenith Radio: The Early Years 1919-1935 by John Bryant and Harold Cones. *The first of a planned 3-book series explains the Zenith story. Never published photos, documents, and information. 300 photos and illustrations, 120 in color. 8 1/2" x 11", 224 pages. Softcover. — \$29.95*

Genuine Plastic Radios of the Mid-Century by Ken Jupp and Leslie Piña. *Illustrates mid-century table radios made of plastic as examples of industrial design and pop-culture. Vintage B&W photos and advertisements. 439 color photos. 8 1/2" x 11 1/4", 208 pages. Hardcover. — \$39.95 NEW*



Price
Guide



Radios: The Golden Age by Philip Collins. *Colorful Catalin and Bakelite radios from the late 1930s to the early 1940s. Over 100 color photos. 10" x 8 1/4". 119 pages. Hardcover. — \$12.98*

The Golden Age of Televisions by Philip Collins. *An amazing collection of photos of these early machines that evoke a time when the television was more than merely a box or a screen: it was the center of every home. 10" x 8 1/4". Softcover. — \$15.95*

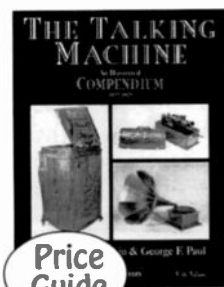

Price
Guide

The Talking Machine, An Illustrated Compendium, 1877-1929 by Timothy Fabrizio and George Paul. *Contains over 550 beautiful photos of external & internal horn phonographs. The authoritative text & value guide, complemented with a wealth of visuals, make this book a must in your library. 8 1/2" x 11", 256 pages. Hardcover. — \$69.95*

Radio Art by Robert Hawes. *Illustrated radio history. Although focusing primarily on British sets, this book also contains American sets: Airline, Atwater Kent, E.H. Scott, Emerson, Fada, GE, Majestic, Philco, RCA, Zenith, and others. 250 photos, 150 in color. 9 1/4" x 12", 128 pages. Hardcover. — \$9.95*



Radio! Radio! 3rd Edition by Jonathan Hill. *Comprehensive coverage of British radios from the 1920s to the 1970s. Includes a directory of nearly 3,000 different transistor models made in Britain or imported between 1956 and 1972. 8 1/2" x 12", 320 pages. Hardcover. — \$64.95*

U.S. Orders - Enclose \$3.00 per order for packing & book-rate shipping if total order is under \$35.00. If using VISA or MasterCard, include name on card, card number and expiration date. Send payment with order. Mass. residents add 5% sales tax. Money back return policy. Softcover unless stated otherwise. Most orders shipped the same day received, but allow 2-4 weeks to receive order. Foreign orders - write for shipping costs, or use credit card and specify air or surface (allow 2-3 months for surface shipping).



A.R.C., P.O. Box 2, Carlisle, MA 01741. Tel: (978) 371-0512

Fax: (978) 371-7129 - E-mail: ARC@antiqueradio.com - Web: www.antiqueradio.com



(Mar-99)

Transistor Radio Books



Price Guide

The Collector's Guide to Transistor Radios 2nd Edition by Marty & Sue Bunis. *This book will help you identify the most sought-after vintage transistor radios. Over 2,900 models listed, all with current prices. Includes radio club listing. 375 all new color photos. 5 1/2" x 8 1/4". 320 pgs. 1996. Softcover. - \$16.95*

Transistor Radios: 1954-1968 by Norman Smith. *Over 1,000 transistor radios identified by manufacturer, marketing organization, type, and style. 460+ color photographs and price guide. 8 1/2" x 11". 160 pgs. Softcover - \$29.95*



Price Guide

NEW



Price Guide

Transistor Radios, A Collector's Encyclopedia and Price Guide by David Lane & Robert Lane. *Identification & price guide to over 2,500 transistor and novelty radios. History & key to collecting chapters. 8 1/2" x 11". 170 pgs. Softcover. - \$19.95*

Collector's Guide to Novelty Radios by Marty Bunis & Robert Breed. *This book is the source for novelty transistor radios in all shapes and sizes. Radios are described in detail with current prices. Over 600 color photographs. 8 1/2" x 11". 224 pgs. Softcover - \$18.95*



Price Guide



Price Guide

Collector's Guide to Novelty Radios, Book II by Marty Bunis & Robert Breed. *All new second volume takes up where the first book left off. New radios are described with current prices. Over 600 all new color photographs. 8 1/2" x 11". 208 pgs. Softcover - \$19.95*

Zenith Transistor Radios, Evolution of a Classic by Norman Smith. *A complete listing of all transistor radio models created by Zenith during the Magic Years from 1955-65. 200+ color photographs and price guide. 8 1/2" x 11". 160 pgs. Softcover - \$29.95*



Price Guide

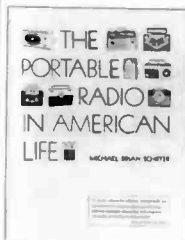

The Portable Radio in American Life by Michael Schiffer. *Approximately 50 pages on transistor radios, beginning with the Regency TR-1 through to the later sets made overseas. 450 photographs, 193 transistor radios pictured. 8 1/2" x 11". 259 pgs. Softcover - \$26.95 Hardcover - \$45.00*

U.S. Orders - Enclose \$3.00 per order for packing & book-rate shipping if total order is under \$35.00. If using VISA or MasterCard, include name on card, card number and expiration date. Send payment with order. Mass. residents add 5% sales tax. Money back return policy. Softcover unless stated otherwise. Most orders shipped the same day received, but allow 2-4 weeks to receive order. Foreign orders - write for shipping costs, or use credit card and specify air or surface (allow 2-3 months for surface shipping).



A.R.C., P.O. Box 2, Carlisle, MA 01741. Tel: (978) 371-0512

Fax: (978) 371-7129 - E-mail: ARC@antiqueradio.com - Web: www.antiqueradio.com



(Mar-99)

Amateur Radio Books



COMMUNICATIONS RECEIVERS
4th Edition



Communications Receivers 4th Edition by Raymond S. Moore. A comprehensive guide to 750, 1932 to 1981, vacuum tube receivers by 86 manufacturers. Three pages of military receivers. 448 radios pictured! Sharper, clearer photographs. 8 1/2" x 11", 136 pages. Softcover. — \$19.95

Heathkit, A Guide to the Amateur Radio Products by Chuck Penson. Documentation of ALL Heathkit's amateur products. 200+ sharp photos. Most products are pictured with a full-page description. 8 1/2" x 11", 256 pgs. Softcover. — \$24.95

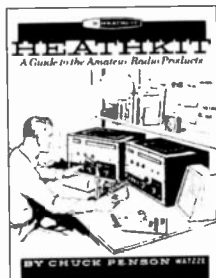

The Pocket Guide to Collins Amateur Radio Equipment 1946-1980 by Jay Miller. A pictorial guide to Collins equipment and accessories. 90+ sharp photographs. 3 1/2" x 7", 108 pages. Softcover. — \$19.95

Shortwave Receivers Past & Present Communications Receivers 1942-1997, 3rd Edition by Fred Osterman. This reference is designed for the radio collector, the informed receiver buyer or anyone interested in the history and development of shortwave radios. Over 770 receivers from 98 manufacturers. 8 1/2" x 11", 473 pages. Softcover. — \$24.95



TRANSMITTERS

EXCITERS & POWER AMPLIFIERS

1930-1980

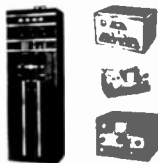

Transmitters, Exciters & Power Amplifiers 1930-1980 by Ray Moore. Pictorial and descriptive guide to amateur high frequency transmitters and amplifiers manufactured in the U.S.A. Over 500 photos. 8 1/2" x 11", 144 pages. Softcover. — \$21.95

Radios by Hallicrafters by Chuck Dachis. This book includes over a thousand photographs (b/w & color) of radio receivers, transmitters, electronics accessories and advertising material. Technical descriptions are provided for every known Hallicrafters model, including dates of production, model numbers, accompanying pieces and original prices. A current price guide is included. 8 1/2" x 11", 225 pages. Softcover. — \$29.95

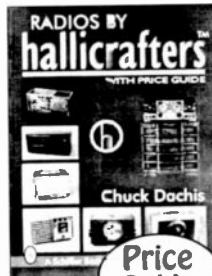

Price Guide

Tube Type Transmitter Guide



MANUFACTURED
Pre-built and Kit
from
1922 to 1970
using all or mostly tubes

Tube Type Transmitter Guide by Eugene Rippen. Provides a wealth of information on transmitters and transceivers. Includes ancillary items such as linear amplifiers, converters, modulators and VFOs. Over 500 illustrations. 8 1/2" x 11", 145 pages. Softcover. — \$17.95

U.S. Orders - Enclose \$3.00 per order for packing & book-rate shipping if total order is under \$35.00. If using VISA or MasterCard, include name on card, card number and expiration date. Send payment with order. Mass. residents add 5% sales tax. Money back return policy. Softcover unless stated otherwise. Most orders shipped the same day received, but allow 2-4 weeks to receive order. Foreign orders - write for shipping costs, or use credit card and specify air or surface (allow 2-3 months for surface shipping).

VISA

A.R.C., P.O. Box 2, Carlisle, MA 01741. Tel: (978) 371-0512

Fax: (978) 371-7129 - E-mail: ARC@antiqueradio.com - Web: www.antiqueradio.com

(May-99)

Shortwave Receivers Past & Present Communications Receivers 1942-1997

3rd Edition

By Fred Osterman



840 Photographs — 473 Pages
Features Over 770 Receivers from
98 American and International Manufacturers

NEW Edition

270 More Receivers!

28 More Manufacturers!

122 More Pages!

\$24.95 - Softcover

U.S. Orders - Enclose \$3.00 per order for packing & book-rate shipping if total order is under \$35.00. If using VISA or MasterCard, include name on card, card number and expiration date. Send payment with order. Mass. residents add 5% sales tax. Money back return policy. Softcover unless stated otherwise. Most orders shipped the same day received, but allow 2-4 weeks to receive order. Foreign orders - write for shipping costs, or use credit card and specify air or surface (allow 2-3 months for surface shipping).



A.R.C., P.O. Box 2, Carlisle, MA 01741. Tel: (978) 371-0512

Fax: (978) 371-7129 - E-mail: ARC@antiqueradio.com - Web: www.antiqueradio.com



(Mar-99)

Zenith Transistor Radios Evolution of a Classic

By Norman Smith



**NEW!
Order
Today!**

**Includes all Zenith Transistor Radio Models
from 1955 through 1965**

200+ Color Photographs — Price Guide

**Photographs, Documents & Original Drawings
from Zenith Archives**

\$29.95 - Softcover

U.S. Orders - Enclose \$3.00 per order for packing & book-rate shipping if total order is under \$35.00. If using VISA or MasterCard, include name on card, card number and expiration date. Send payment with order. Mass. residents add 5% sales tax. Money back return policy. Softcover unless stated otherwise. Most orders shipped the same day received, but allow 2-4 weeks to receive order. Foreign orders - write for shipping costs, or use credit card and specify air or surface (allow 2-3 months for surface shipping).



A.R.C., P.O. Box 2, Carlisle, MA 01741. Tel: (978) 371-0512
Fax: (978) 371-7129 - E-mail: ARC@antiqueradio.com - Web: www.antiqueradio.com



(Mar-99)

Radios

of the Baby Boom Era

Six Volumes — 2000 pages — From Sams' Archives
1946 to 1960 — 274 Brands — 3494 Illustrations (B&W)
6769 Models — Catalin, Bakelite, Wood, Transistor Radios & More

All Volumes Available!

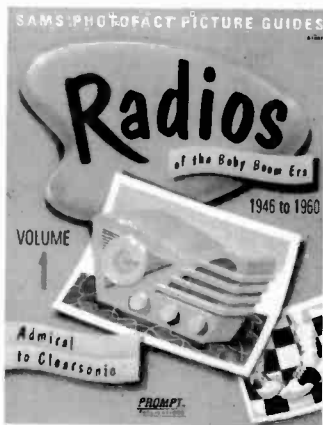

Vol.	Brands	Included
1	56	Admiral to Clearsonic
2	54	Co-op to Geloso
3	58	GE to Monitoradio
4	36	Motorola to RCA Victor
5	35	Realtone to Stratovox
6	35	Stromberg-Carlson to Zenith

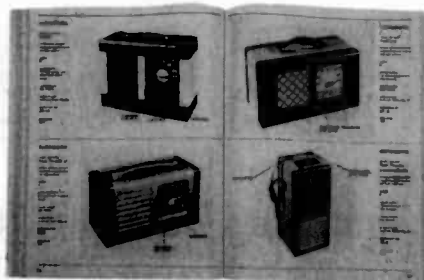

1/2 Page for each illustrated radio including:

- Large illustration of the radio including knob functions
- Short description of the radio
- Number of tubes
- Power supply type (AC, Battery, etc.)
- Tuning range
- Manufacturer
- Sams Photofact Set number & year Photofact published.

ALSO

- Index by model number listing tubes in radio
- List of similar radio models indexed to pictured radio
- List of manufacturers and suppliers indicating their brand names
- Basic trouble-shooting hints

Each Volume: \$16.95 – Softcover
8 1/2" x 11" – Approx. 328 pages

U.S. Orders - Enclose \$3.00 per order for packing & book-rate shipping if total order is under \$35.00. If using VISA or MasterCard, include name on card, card number and expiration date. Send payment with order. Mass. residents add 5% sales tax. Money back return policy. Softcover unless stated otherwise. Most orders shipped the same day received, but allow 2-4 weeks to receive order. Foreign orders - write for shipping costs, or use credit card and specify air or surface (allow 2-3 months for surface shipping).



A.R.C., P.O. Box 2, Carlisle, MA 01741. Tel: (978) 371-0512

Fax: (978) 371-7129 – E-mail: ARC@antiqueradio.com – Web: www.antiqueradio.com



(Mar-99)

15th Anniversary Special

Back Issues — 60% Off — \$2.00 Each

Full Calendar Years

A sampling of articles and topics is listed below.

(12 issues in all years except 1984. All originals except for June 1984 through March 1987)

- 1984 A.R.C.'s First Year. The June Sample Copy plus September-December. First Kreuzer's Value Guide,* Heathcote's Collectors' Corner, Crocker's Crosley Review,* With The Collectors* and Meet Reports.* (5 Issues. Photocopies; 16-20 pgs.) \$10
- 1985 First Photo Review,* Radio Novelties,* Collector Profile,* Telegraph Key Review,* Crystal Set Review* and Atwater Kent Breadboard Review.* Also Value Guide A-T, Penna Wireless, Marconi 106, WD-11. (Photocopies; 20-24 pgs.) \$24
- 1986 First Collecting British Crystal Sets.* Collectors' Corner, Value Guide S-Z, Horn Speaker Values, Speaker Review, Precision Ace, Quaker Oats Crystal Set, HQ-120X, First Issue Published by John Terrey. (Jan.-Sept. Photocopies; Oct.-Dec. reprints; 24-28 pgs.) \$24
- 1987 First full-color covers. First Foster's Restoration Topics,* Vintage Television,* Philco 38-3, EHScott 48-Tube Set, Marconi Multiple Tuner, Vacuum Tube Value Guide, Freed Eisemann, Crosley Pup, Fada Bullet, Vitus, Sparton Mirrored Radios. (Jan.-Mar. reprints; Apr.-Dec. originals; 32-36 pgs.) \$24
- 1988 First Old Tyme Radio Services Directory,* Jim Fred's Repairing AC Radios,* Vintage Test Equipment.* Also DuMont Clifton TV, Mechanical TV, Aeriola Senior, A-K Model 20, Kennedy 220, Philco Predictas, Martian and Gem Crystal Sets. (40-60 pgs.) \$24
- 1989 Automatic Radio, Clapp-Eastham HR/HZ, Mechanical TV,* Western Electric 1920-1927, Radiola 44, Ace Radio Repair on June cover, Arvin & the Hopalong Radio, Magnavox TRF-5, A-K Crystal Set, A-K 9A, Philco Block Capacitors, Marconi 106D, Patterson PR-10, Oriole 7B. (52-68 pgs.) \$24
- 1990 First Radio Adventures.* Also California Earthquake, Transistor Radios, Cleaning Bakelite, EH Scott Telematic, Ekko Round Radios, Radiola Grand, Horn Speaker Survey, Atlantic Radio, GE 901 TV, Philco Block Capacitors, Tuska 224, RCA 816K, RCA Theremin. (68-92 pgs.) \$24
- 1991 First Collecting Foreign Sets,* Out-Of-Sight Radios, Philco 20, 90, Wilcox-Gay Recordio, A.R.C. Index '84-'90, Westinghouse RC-RA-DA-DR-RT-AR, Radio Stock Certificates, German Radios, Subminiature Tube Radios, Early Navy Radio Equipment, Gonset. (84-100 pgs. Index Issue is 148 pgs.) \$24
- 1992 Vintage Microphones, Gonset, Early Navy Equipment, Superhets of the 20s,* The Neutrodyne, Telmaco, Atlantic Radio, Vintage Hi-Fi, Battery Eliminators, Radio Fans, A-K 35, RCA 648PTK TV, Repairing IF Transformers, Paragon RA-10/DA-2, A-K 21, 33, WLW, 1991 Index. (88-100 pgs.) \$24
- 1993 Arvin Metal Radios, Repairing RCA Catacombs, Philco Armchair Radios, Kenrad Crystal Set, Transistor Radios, A-K 52, Philco Cabinet Design,* Webster Electric Co., Kyletron Electrostatic Speaker, Vintage Guitar Amp, Tower Cone Speakers, EH Scott Allwave, 1992 Index. (100-104 pgs.) \$24
- 1994 Radiola I, Radiola 60 series, Pot Metal, Fada Neutrodyne, Clinton Mfg. Co., Kardon Radios, Philco Cabinet Designers, Palco, SCR-609 & 610, Philco Survey, Permeability Tuning, Weston, Regency TR-1, Charles Herrold, Nipper. 1993 Index. (100-116 pgs.) \$24
- 1995 Zenith Trans-Oceanic, Steinway Capehart, Ken-Rad, Radio Shop J, Freshman Master Speaker, Broadcast Equipment, Philco Survey, Power Transformers, Tube Testers,* Radio Apparatus Co., L.E. Knott Apparatus Co., Ford Museum Auction in color, Ozarka, 1994 Index. (108-116 pgs.) \$24
- 1996 Communications Receivers, KDKA, Philco Designers, Radiola IV, WJZ, Art Deco Radios, Herrold Microphone, Tuning Battery Sets, Paul Godley & Paragon, Soldering, Webb Microphone Collection, Mirrored Glass Radios, Samson Electric Co., Russian Red Star, Echophone EC-1. (100-116 pgs.) \$24
- 1997 Thompson Minuet, Marconi Archive Auction Saga, Frank Krantz, Emerson Multivalve Radios, De Forest Detectors & Tuners, Remote Control Radios, Ekko Stamps, Freshman Polydyne, Vintage Audio Recorders, Selenium Rectifiers, DeForest Reflex Sets, Early Zenith. (100-116 pgs.) \$24
- 1998 Sears Commentator, 300B Tube, Replica Nameplates, Australian Radios, WMAZ, Espey, Nipper, Early Wireless, Rider's Volume 1, Pilot Radio, Browning-Drake, Army-Navy Numbering System, Cortlandt Street Radio Row, Pooley Co., Transistor's Early History. (100-108 pgs.) \$24

* These articles continued for one or more years and some continue today.

15th Year Back Issue Special: U.S. Orders - Above prices include shipping. If using VISA or MasterCard, include name on card, card number and expiration date. Send payment with order. Money back return policy. Most orders shipped the same day received, but allow 2-4 weeks to receive order. Non-U.S. orders - write for shipping costs, or use VISA or MasterCard and specify air or surface (allow 2-3 months for surface shipping).



A.R.C., P.O. Box 2, Carlisle, MA 01741. Tel: (978) 371-0512
 Fax: (978) 371-7129 - E-mail: ARC@antiqueradio.com - Web: www.antiqueradio.com



(Feb-99)

COLLECTOR BOOKS AVAILABLE FROM A.R.C.

BOOKS MARKED WITH "R" ARE THE MOST POPULAR AND ARE ESPECIALLY RECOMMENDED FOR NEW COLLECTORS!

- Antique Radio Restoration Guide, 2nd Ed., Johnson. *Beginner's introduction to troubleshooting and repairing AC table model radios.* 1992. 145 pgs. \$14.95
- The AWA Review. *Collections of articles.* Vol. 6: Hawaiian Wireless, U.K. TV, SCR-RC-BC Dir., NYC Wireless, etc. Vol. 7: Poldhu xmitters, Navy equipment, Arc xmitters. Vol. 8: Keys, Federal Co., KFS-Federal-Mackay story, Nat'l Electrical Supply Co., Naty Electronics Dir., etc. Vol. 6-8, ea. \$10.00
- Vol. 9: Marconi, The Int'l Contest for Radar, Magnetron Story, F. Lowenstein, Ham Licensing. Vol. 10: Atwater Kent, Race for Radiotelephone, Radio Central 75th Anniversary, The Heinz and Kaufman Story, Collins Radio Co. Vol. 11: Scott Radio Products, National sliding coil receivers. Vol. 9-11, ea. \$20.00
- The Antique Radio Boys and the Garrulous Grebe, Dryer. *Thrilling adventure story written in the traditions of the '20s and '30s.* 5 1/2" by 8 1/2". 51 pgs. \$4.95
- The Auto Radio, Matteson. *Info, photos & ads of the auto radio through the 1950s.* 316 pgs. (hardcover) \$34.95
- Audio! Audio!, Hill. *A comprehensive directory of classic audio amplifiers and control units. Details of over 850 models from nearly 150 British manufacturers from the 1940s to the 1970s. Signed and numbered.* 95 pgs. \$19.95
- Behind the Front Panel, Rutland. *Reviews radio circuits and radio history. Easy descriptions.* 25 pics. 158 pgs. \$18.95
- Blast from the Past, A Pictorial History of Radio's First 75 Years, Rhoades. *The performers, programs, & technology that made radio a part of everyday life. 100s of never-before-published photos.* (hardcover) \$39.95
- Classic TVs, 2nd Printing, Wood. *Prewar to 1950s. Revised price guide. 140+ color photos, repros of catalogs & ads.* 86 pgs. \$18.95
- The Collector's Guide to Antique Radios, 4th Ed., Bunis. *This guide covers radios from 1920s to 1960s. Over 8,500 prices and many all new color photos are included.* 1996. \$18.95
- The Collector's Guide to Antique Radios, Combined Ed., CD-ROM, Bunis & Kaczowka. *Combines book editions 1, 2, 3, and 4. Over 9,000 Models with pricing, Model number index for all manufacturers, photo index by category. 1,800 full color photos. Requires a web browser. IBM & Mac.* 1998. NEW \$39.95
- The Collector's Guide to Novelty Radios, Bunis & Breed. *Descriptions with prices. 600+ color photos.* 1994. 224 pgs. \$18.95
- The Collector's Guide to Novelty Radios, Book II, Bunis & Breed. *New radios & prices. 600+ color photos.* 1998. 208 pgs. NEW \$19.95
- The Collector's Guide to Transistor Radios, 2nd Ed., Bunis. *Identifies the most sought-after vintage transistor radios. Includes club listing. Over 2,900 models, 375 all new color photos, with current prices.* 1996. 320 pgs. \$16.95
- Communication Receivers, 4th Ed., Moore. *Information on 750, 1932 to 1981, vacuum tube receivers by 66 manufacturers. 448 radios illustrated. 3 pages of military receivers.* 136 pgs. \$19.95
- The Compleat Talking Machine, 3rd Ed, Reiss. *A guide to antique phonographs. Revised price guide. Covers construction, cleaning and repairing of parts and cabinets. Over 700 pictures.* 249 pgs. NEW \$29.95
- Crystal Clear - Vintage American Crystal Sets, Crystal Detectors and Crystals, Sievers. Vol. 1 - *Comprehensive reference with 750 illustrations, 570 crystal sets, 341 detectors, 207 crystals.* 282 pgs. \$29.95
- Vol. 2 - *479 All new & different illustrations, more crystal sets, detectors and crystals identified.* 252 pgs. \$29.95
- Crystal Radio: History, Fundamentals, and Design, Kinzie. *Plus crystals for detectors.* 121 pgs. \$10.95
- Crystal Set Building and More, The Xtal Set Society. *Projects and information about crystal radios, mostly dealing with design and electronics issues. Also included are Vols. 6 & 7 of the Xtal Set Society Newsletter.* \$15.95
- Crystal Set Projects: 15 Radio Projects You Can Build, The Xtal Set Society. 160 pgs. \$14.95
- E.H. Scott Radio Collectors Guide, 1925-1946, Clark. *The reference for collectors of Scott radios, cabinets and accessories. Lists original prices of cabinets and accessories. Over 200 photos with descriptions.* 88 pgs. \$29.95
- 1940 E.H. Scott Catalog, King. *Quality reproduction of the custom built receivers. Includes radios & cabinet illustrations.* \$12.95
- Early Radio, In Marconi's Footsteps, Jensen. *Realistic description of Marconi's work and his surroundings. Early construction projects with diagrams. Color and B&W photographs.* 170 pgs. (hardcover only) \$39.95
- Evolution of the Audio Recorder, Van Praag. *Comprehensive guide to the audio recorder.* 1997. 518 pages. \$39.95
- Evolution of the Radio, L-W Books. *Radios pictured and priced, plus reproductions of catalog pages and ads.* Vol. 1 - *Eight-hundred + radios.* 1991. 227 pgs., 118 pgs. in color. \$22.95
- Vol. 2 - *Totally different from volume one with new photos, etc.* 1993. 654 color photos. 226 pgs. \$24.95
- Fixing Up Nice Old Radios, Romney. *Written by a retired radio instructor, this book covers Ohm's law, through battery sets, superhets and communications receivers.* 1990. 300+ figures, 185 pgs. \$29.00
- Flick of the Switch, McMahon. *The classic photo reference guide for '30s-'50s radios. 1000+ photos.* 263 pgs. \$11.95
- Genuine Plastic Radios of the Mid-Century, Jupp & Piña. *Overview of plastic table radios with advertisements, vintage black & white photos.* 439 color photos. 208 pgs. (hardcover) NEW \$39.95
- The Golden Age of Televisions, Collins. *Nice collection of photographs of these early machines.* \$15.95
- Guide to Old Radios - Pointers, Pictures & Prices, 2nd Ed., Johnson. *Introduction to radio collecting. Includes hundreds of photos and a price guide.* 1995. 272 pgs. \$19.95
- Hake's Guide to TV Collectibles. *Price guide and photos for 1600 TV shows, comic books, etc.* 1990. 185 pgs. \$14.95
- Heathkit, A Guide to the Amateur Radio Products, Penson. *Documentation of all Heathkit's amateur radio products, a complete history of the company, 200+ sharp photos.* 256 pgs. \$24.95
- International Directory of Antique Radio Collectors. *Lists collectors, clubs, museums, dealers.* 1996. 92 pgs. \$14.95
- Inventing American Broadcasting, Douglas. *From the days of Marconi to broadcasting in the 1920s.* 1987. 363 pgs. \$14.95
- L. A. Radio Manufacturing, Paul. *Radio makers in L.A. from 1922-42. Echophone, Gillfillan & 10 others.* 88 pgs. \$11.90
- Supplement No. 1, Paul. *Coverage of additional manufacturers, people and sets.* 1993. 48 pgs. \$6.75
- Supplement No. 2, Paul. *Coverage of additional manufacturers, people and sets.* 1999. 54 pgs. NEW \$10.90
- The Magnetic Cone Speaker Notebook, Paul. *250+ cone speakers from 120+ companies. Photocopy.* 1995. 58 pgs. \$11.90
- The Mechanics of TV, Yanczer. *Explanation of mechanical tv, details for a working system.* 5 1/2" by 7 1/2", 170 pgs. \$24.95
- Most Often Needed 1926-38 Radio Diagrams and Servicing Information (reprint). *600+ diagrams for mostly AC radios from '26-'38.* 240 pgs. \$18.50
- Old Gramophones, Bergonzi. *The development of phonographs and gramophones.* 64 photos. 32 pgs. \$4.95
- Old Radio Sets, Hill. *The development of the radio from the late Victorian era until the late 60s.* 60 photos. 32 pgs. \$4.95
- Old Television, Emmons. *The development of the television until the late 60s.* 50 photos. 32 pgs. \$4.95
- Old-Time Radios! Restoration and Repair, Carr. *How to repair vacuum-tube and transistor radios. A self-paced training guide. 200 illustrations, 256 pgs.* \$19.95
- Phico Radio: 1928-1942, Ramirez. *A reference book on Phico. Shows receivers and company history year-by-year.* 464 color photos, 364 black & white photos and drawings. 1993. 160 pgs. \$29.95
- Phono-Graphics: The Visual Paraphernalia of the Talking Machine, Schwartzman. 119 pgs. \$16.95
- The Pocket Guide to Collins Amateur Radio Equipment 1946-1980, Miller. *90+ sharp photos.* 3 1/2" x 7". 108 pages. \$19.95
- Portable Radio In American Life, Schiffer. *Traces the development of the portable radio and how it affected American culture and society.* 450 photos and drawings. 259 pgs. (hardcover) \$45.00
- RCA Radiolas, Radiotrons, and Accessories (reprint). *Twenty-page booklet summarizing RCA's 1926 product line.* \$4.50

- Radio Art, Hawes.** A chronological, illustrated history of the technical and stylistic progress of the radio. Mostly British, but American sets are featured as well. 250 photos, 150 in color, 128 pgs. (hardcover only) Low Price \$9.95
- Radio Art Postcard Deck.** 30 full-color photographs from Hawes' book. \$7.50
- Radio Collector.** (Videotape, VHS). The five-part Emmy-nominated PBS series combined on one 130-minute videotape. Meet collectors, see collections, attend swap meets, learn about radio restoration. \$29.95
- The Radio Collector's Directory and Price Guide, 1921-1965, 2nd Ed., Grinder.** Directory of over 20,000 radios by manufacturer, model no., year, etc., with prices. History, cabinet styles, vacuum tube development chapters. 500 pgs. \$26.95
- The Radio Collector's Foto-Finder, Bintliff.** An alphabetical index to illustrations in the four editions of the "Collector's Guide to Antique Radios" by Marty & Sue Bunis. 1997. 48 pgs. \$12.95
- Radio Collector's Guide, McMahon.** Listing of 9,000+ radios made by some 1200 companies from 1921 to 1932. Gives manufacturer, year, model name and other info. No photos. 264 pgs. \$11.95
- Radio Diagram Sourcebook, Gray.** Valuable tool for identifying radios. Tubes used, replacement dial lamps, and I.F. frequency. Reprint of *Sylvania's tube complement guide* is included listing almost 10,000 radios. 290 pgs. \$18.95
- Radio Horn Speaker Encyclopedia, Paul.** Listing of horn speakers for 320+ manufacturers for the 1920s. Expanded info. on 10 companies. 145+ photos. 80 pgs. \$15.90
- Radio Horn Speaker Notebook, Rev. H. Paul.** The companion to the Encyclopedia. Over 450 horn picture ads are shown, over 325 manufacturers are identified. Photocopy. New Index. 1995. 72 pgs. \$16.90
- Radio Manufacturers of the 1920's, Douglas.** 3 volumes. Vol. 1: A-C Dayton thru Ferguson (softcover only) \$24.95
Vol. 2: Freed-Eisemann thru Priess. 266 pgs. (softcover only) \$29.95
Vol. 3: RCA thru Zenith. 292 pgs. (hardcover: \$39.95) \$29.95
- Radio/Radio!, 3rd Ed., Hill.** Comprehensive coverage of British radios from the 1920s-70s. This expanded edition includes the previous versions plus 75 new pages and 50 new illustrations. New transistor radio section. (hardcover only) \$64.95
- Radios by Hallicrafters, Dachis.** The most definitive book on the company. Over 600 photos (some color) on everything they made. An invaluable tool for anyone interested in Hallicrafters. 220 pgs. \$29.95
- Radios of the Baby Boom Era.** Pictures and info from Sams Photofacts. 3,494 radios illustrated plus 3,275 additional radios listed. 274 brands. 1946 - 1960. 300+ pages per volume. Vol. 1: Admiral - Clearsonic. Vol. 2: Co-op - Genosol. Vol. 3: GE - Monitoradio. Vol. 4: Motorola - RCA. Vol. 5: Reatone - Stratovox. Vol. 6: Stromberg-Carlson - Zenith. (Per Vol.) \$16.95
- Radios: The Golden Age, Collins, (reprint).** Vintage table radios. 100+ color photos. 119 pgs. NEW \$12.98
- Rasco Radio Parts, (reprint).** Catalog No. 18 summarizing 1928's product line. 144 pgs. \$9.95
- Refinishing Old Furniture, Wagoner.** Written by a furniture restoration instructor. A step-by-step guide to furniture (or radio) restoration, from removal of finishes right up to the final polish. 178 pgs. \$14.95
- Saga of the Vacuum Tube, Tyne.** The development of vacuum tubes - 1880 to 1930. From Edison, Thomson and Fleming to de Forest, Philips, Siemens and many more. 100+ vacuum photos, 495 pgs. \$18.95
- Shortwave Receivers Past & Present, Communications Receivers 1942-1997, 3rd Ed., Osterman.** For the radio collector, the informed receiver buyer or anyone interested in the history of shortwave radios. 700+ receivers listed. 473 pgs. \$24.95
- S. Gernsback Radio Encyclopedia (reprint).** 1927 classic encyclopedia on radio. From "A" battery to Zirconium, with 1000s of entries in between. 100s of illustrations, 175 pgs. \$9.95
- 70 Years of Radio Tubes and Valves, 2nd Ed., Stokes.** The thermionic vacuum tube story from 1883 through 1960. New chapter on audio application tubes, more photos, magazine ads and a new index by tube number. 264 pgs. \$29.95
- 75 Years of WE Tube Manufacturing, Magers.** A log book history 750+ WE tubes. Illustrated. 133 pgs. \$16.95
- The Talking Machine, Fabrizio and Paul.** Contains over 550 photos of internal and external horn phonographs. The text and value guide, complemented with lots of visuals, make this book a must in your library. 256 pgs. (hardcover only) \$69.95
- Transistor Radios: 1954-1968, Smith.** Over 1,000 transistor radios identified by manufacturer, marketing organization, type, and style. Color photos and price guide, 1998. 160 pgs. NEW \$29.95
- Transistor Radios, A Collector's Encyclopedia and Price Guide, Lane.** Identification guide to over 2,500 transistor and novelty radios. History and key to collecting chapters. 1994. 170 pgs. \$19.95
- Transmitters, Exciters and Power Amplifiers 1930 - 1980, Moore.** Pictorial and descriptive guide to amateur high frequency transmitters and amplifiers manufactured in the U.S.A. Over 500 photos. 144 pgs. \$21.95
- Tube Data, Holm.** The most comprehensive list of vacuum tubes and data in an easy-to-use program for IBM compatibles. 27,000+ tubes, includes receiving and transmitting tubes. Lists function, manufacturer, technical data, & more. (3 1/2" disk). \$39.95
- Tube Lore, Sibley.** Trends in tube design, receiving and audio tubes, special-purpose and transmitting tubes, military types, tips on testing, repairing, adapting various tubes, auction prices from six major sales. 186 pgs. \$19.95
- Tube Type Transmitters, Rippen.** Provides a wealth of info on transmitters and transceivers. Includes ancillary items such as linear amplifiers, converters, modulators and VFOs. Over 500 illustrations. 145 pgs. \$17.95
- The Weekend Refinisher, Johnson.** A complete guide to stains and finishes and tips for setting up your own workshop. A handy furniture "first aid" kit for quick repairs. Illustrated. 296 pgs. \$12.00
- The Western Electric Loud Speaker and Horn Compendium, Nadel.** Vol. 2 in the Museum of Sound Series. 53+ Models covered. B&W illustrations, 58 pgs. NEW \$19.95
- Wireless Communication in the U.S., Mayes.** Early development of American radio operating companies. Alternators, coherers, stock promotions, unpublished letters, etc. 160 illustrations, 240 pgs. \$29.95
- The Xtal Set Society Newsletter, Anderson.** Complete set of the Society's newsletter. Order by volume. Vol. 1: 7/91 to 5/92 - Field Strength Meter, FM Xtal Set, Xtal Sets & Wireless, & more. Vol. 2: 7/92 to 5/93 - The Lead Pencil Detector, The Universal Xtal Set, etc. Vol. 1-2 \$9.95
Vol. 4: 1/94 to 11/94 - Measuring Coil Capacitance, home-brew headphones and curve tracers, etc. Vol. 5: AM Receiver Design, Marconi Type 107, Radio Outfit in a Headset, & more. Vol. 4-5 \$10.95
- The Xtal Set Handbook, Anderson.** Formulas for coil inductance, a procedure for measuring coil capacitance, circuit matching theory, & more. Also included is Vol. 3 of the Xtal Set Society Newsletter. \$11.95
- Zenith The Early Years, 1919-1935, Bryant and Cones.** The 1st of a planned 3-book series. Explains the Zenith story. Discover never published photos, documents and info. 300 photos and illustrations, 120 in color. 224 pgs. \$29.95
- Zenith Radio Corporation (reprint).** The instructions for installation and operation for Models 39-39A Models 392-392A, and Electric Zenith Receivers. 3 schematics, 3 photos. 7 1/2" by 5", 16 pgs. \$4.50
- The Zenith Trans-Oceanic: The Royalty of Radios, Bryant and Cones.** Presents the fascinating story of the development and use of the Trans-Oceanic. Several photos, documents, ads, etc. 160 pgs. \$24.95
- Zenith Transistor Radios, Evolution of a Classic, Smith.** A complete listing of all transistor radio models created by Zenith during the "Magic Years" from 1955-65. Color photos and price guide, 1998, 160 pgs. NEW \$29.95

U.S. Orders - Enclose \$3.00 per order for packing & book-rate shipping if total order is under \$35.00. If using VISA or MasterCard, include name on card, card number and expiration date. Send payment with order. Mass. residents add 5% sales tax. Money back return policy. Softcover unless stated otherwise. Most orders shipped the same day received, but allow 2-4 weeks to receive order. Foreign orders - write for shipping costs, or use credit card and specify air or surface (allow 2-3 months for surface shipping).



A.R.C., P.O. Box 2, Carlisle, MA 01741. Tel: (978) 371-0512
Fax: (978) 371-7129 — E-mail: ARC@antiqueradio.com — Web: www.antiqueradio.com

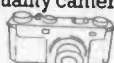
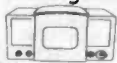

**Pre-War TV:
RCA TRK-120.**

This is the famous mirror-in-the-lid TV, premiered at the New York World's Fair. It is in good cosmetic condition but one of the power supply chassis is missing (we'll supply the schematic). A rare piece, only...\$5,235

**FOR SALE:
Philco Safari H2010.**

This portable TV was the first transistor television produced, circa 1959. A BLACK model H2010, it is working and complete with hood--a great collectible...\$245

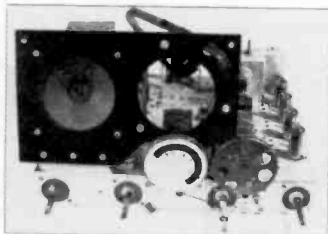

FOR SALE: Restored PILOT TV-37 chassis. This is from the always popular 3" table top from 1947, and it has been restored, and it's in good, working condition, ready to be put into your TV-37! \$218



FOR SALE: SHARP 3S111. This 10" high, working 1970s portable has a great space-age look. It actually comes off the base section so that it becomes smaller and more portable! Only....\$226

We BUY VINTAGE TVs!!!

We buy Radio-TV shops, Camera stores and Photo Studios!

Always buying **quality cameras, lenses & accs:** Leitz, Canon, Nikon, Zeiss, Bolex, Graflex, Alpa, Angenieux & more! **Please FAX or email.**

10" TVs from the 1940s

We need 10" table tops from the 1940s. Very clean cabinets wanted--but we can use them even if they're just empty cases!

Paying \$25 to \$200 each!

PRE-WAR TVs-- from the 1930s

We buy ANY television produced before 1942. Need not work or be complete! Look for GE's with push buttons below screen, RCA TRK's and TT5, DuMont 180s, and many others!

Paying \$500 to \$5,000 each!

2" - 5" Color TVs from the 1970s

We buy 1970s and 1980s television with color picture tubes in the small to very small size! Made by Panasonic, Sony, and others.

PAYING \$50 to \$200 each!

Weird or UNUSUAL TVs-any year!

You'll know them when you see them--strange TVs from the 1940s through the 1970s! We have plenty of square sets--so now we're looking for the really great odd-balls!

PAYING \$50 to \$500 each!

CLASSIFIED ADVERTISING POLICY

ONE FREE 20-WORD AD for subscribers in each issue; additional words are 29¢ each. See details below. Classified ads sent by mail, fax, e-mail or by any other method must be received (not just postmarked!) by **Noon Eastern Time** on the classified ad deadline date to guarantee inclusion in the current issue. Late ads are held for the following issue. Please enclose correct payment with all ads. Stamps or cash are OK for small amounts. (Canadian and other foreign advertisers, please see "Payment" on page 2 for methods.) "Free words" cannot be accumulated from month to month; free words must be requested when ad is submitted.

Faxed & e-mailed ads: Please see additional information on the inside front cover.

When including ads with other A.R.C. correspondence, write the ads on a separate piece of paper. Include SUB# with ad. Ads may be sent in advance; but, write each ad on a separate piece of paper and indicate the month (or successive two months) you want the ad to run.

To minimize our typing errors: Please write legibly. Use both capital and small letters. Do not use a dash between words. Carefully write the following numbers and letters (especially in model numbers) since some can look alike; for example 1, l and I (the number one, the capital i and the small L.) Also: 0, O, o, Q and D; r and n; 6, b and G; V, U, u, v and Y; A and R; 5, S and s; 2, Z and z. We try to correct spelling errors, so when using an uncommon word or manufacturer which we might mistake as a more common word or manufacturer, note it so that we do not "correct" it. Editor's annotations are in [brackets].

Advertising is accepted only for early items related to radio, communication, etc. All items must be described fairly; reproductions, reprints and not-original items must be so identified. Advertisers must agree to respond promptly to inquiries and orders, to resolve problems promptly if the buyer is not satisfied, and to comply with a buyer's refund request on unaltered returned items.

The publisher reserves the right to edit ads without notification to the advertiser and to reject ads for any reason. Names other than the advertiser will be edited out of ads. Ads with non-radio-related items will be returned or edited unless the non-radio-related items are for trade of radio-related items, or they are incidental to and appear at the end of an otherwise acceptable ad. The publisher is not responsible for errors due to illegibly written ads or for any other reason. See also Publishing Rights on page 2.

Clubs: Since club activities receive free coverage on the *Coming Radio Events* pages, the free 20 words may not be used for club activity ads. A discount on display advertising is available for clubs.

CLASSIFIED AD DETAILS

Deadline: NOON ET— 10th of the month!

Classified ads must have a standard heading such as **WANTED, FOR SALE, FOR TRADE, FOR SALE/TRADE, SERVICES, MESSAGE, HELP, AUCTION, MEET**, etc. This heading is the only bold or all-capitalized words allowed in the ad. Capitalize only manufacturer names, model names, etc. This standard ad format makes scanning the ads easier.

Before writing your ad, please look over the ads in a recent issue of A.R.C., and try to write your ad in the same style. Full name (or company name) and address is required in all classified ads: we will add it if you forget.

To encourage varied content of the ads, the same classified ad may be run only once per issue and for only two consecutive months. (To run an ad longer, use a boxed classified or display ad.)

Classified Ad Rates per Month

Subscribers:

First 20 words: **FREE***

29¢ per word for extra words over 20 plus

10¢ per word for a shaded ad (count all words including free words).

* Subscribers may take 20 free words on only **one** ad each month.

Non-Subscribers:

47¢ per word **plus**

10¢ per word for shaded ad.

Please do not forget to send in the extra 29¢ per word when your classified ad runs over the free 20 words; your payment will be appreciated, and it will help to keep A.R.C. healthy.

BOXED CLASSIFIED AD DETAILS

Deadline: 1st of the month!

Boxed classified ads can run unchanged for three months or more. No words are free. Ads may be shaded and may include bold and all-capitalized words freely. The ad need not begin with "For Sale," etc. Minimum run is 3 months, prepaid. Discount: 10% for 6 months; 20% for 12 months.

Boxed Classified Ad Rates per Month

Nonshaded ads:

40¢ per word for all words,* none free, **plus**

10¢ per word for each bold word **plus**

10¢ per word for each all-caps word.

Shaded Ads (All words are bold at no charge):

50¢ per word for all words* **plus**

10¢ per word for each all-caps word.

Non-Subscribers:

Add 20¢ per word to above costs.

*Three words can be bold-all-caps at no extra charge.

PHOTO & DRAWING DETAILS

Deadline: 1st of the month

for all ads with drawings or photos!

Drawings and photos are encouraged as the response to your ad is much larger and the reader knows better what you want or are selling. Send in your drawing or photograph, and A.R.C. will reduce it or enlarge it as needed.

Photo and Drawing Rates per Month

\$23.00 per month for each photo or drawing (If ad is canceled, this amount cannot always be refunded.)

CHANGES & CANCELLATIONS

Please check your ads carefully before sending them in. Once ads are received, it is not always possible to refund the amount sent, pull the ad or make changes.

IMPORTANT — COUNTING WORDS — IMPORTANT

The **standard headings:** WANTED, FOR SALE, etc., count as **one word** each time used in an ad. **Name, address** and (one) **telephone number**, count as **6 words**, regardless of length. Ham call letters and business name can be included in the 6 words and do not count extra. Full name (or company name) and address is required in all classified ads. Each additional word, abbreviation, model number or number group, extra telephone numbers, fax, e-mail, etc. count as one word each. Hyphenated words count as two words.

PERIODICALS

ANTIQUE RADIO CLASSIFIED

A.R.C., P.O. Box 2, CARLISLE, MA 01741
ADDRESS SERVICE REQUESTED

FDR ADC 780
EXP=JUN01

90*6*****ALL
6-6J SUB#-27-777 [3630]
JOE W MCCLUGHAN
PO BOX 310465
NEW BRAUNFELS TX 78131

**CLASSIFIED AD
DEADLINE JUNE 10th
Noon Eastern Time**