

OUR 15TH YEAR!

# ANTIQUE RADIO CLASSIFIED

VOLUME 15

DECEMBER 1998

NUMBER 12



A.R.C. — THE NATIONAL PUBLICATION FOR BUYERS AND SELLERS  
OF OLD RADIOS AND RELATED ITEMS — PUBLISHED MONTHLY

## ANTIQUE RADIO CLASSIFIED

Antique Radio Classified (ISSN:8750-7471) is published monthly, 12 times per year, by John V. Terrey, One River Road, P.O. Box 2, Carlisle, MA 01741. Periodicals postage paid at Carlisle, MA, and additional mailing offices. Telephone: (978) 371-0512, 8:30 AM to 5:00 PM ET weekdays; machine answers phone at other times.

Annual subscription rates within the U.S. are \$40.95 by Periodicals mail and \$57.95 by First Class mail.

Annual foreign rates. By air: Canada - \$61.00; Mexico - \$67.00; Other foreign countries - \$105.00. Surface mail: Canada - \$51.00; Other foreign countries - \$58.00. (Surface delivery to countries other than Canada may take two or more months and cannot be guaranteed.)

Two-year subscriptions are twice these rates and receive an extra month. Sample issues are available free on request.

© Copyright 1998 by John V. Terrey.

POSTMASTER: Send address changes to Antique Radio Classified, P.O. Box 2, Carlisle, MA 01741.

Printed in U.S.A.

### STAFF:

Publisher and Editor: John V. Terrey  
Production & Advertising Manager: Cindie Bryan  
Office Manager: Tammy DeGray  
Managing Editor: Dorothy Schecter  
Publishing & Editorial Staff:  
Dave Crocker, Laura Katz, Bobby Lyman  
Founding Publisher/Editor: Gary B. Schneider  
Contributing Writers & Consultants: Mike Adams, Richard L. Arnold, Richard Begbie, Ray Bintliff, Ron Boucher, Paul J. Bourbin, Norman S. Braithwaite, Dave Crocker, Dick Desjarlais, Alan S. Douglas, Richard C. Foster, Fred Geer, Jim Kreuzer, Ron Ramirez, Henry Rogers, Ian L. Sanders, Gary B. Schneider, Daniel Schoo, Frank R. White, Ralph Williams, Walter Worth

**PURPOSE.** Antique Radio Classified is published for people involved in the radio collecting hobby. Its purpose is to stimulate growth of the hobby through the buying, selling and trading of radios and related items, and to provide a monthly forum for the interchange of ideas and information.

**CONTACTING ANTIQUE RADIO CLASSIFIED.** All correspondence should be sent to:

A.R.C., P.O. Box 2, Carlisle, MA 01741.

Only UPS, Federal, etc. items to street address: One River Road.

Telephone: (978) 371-0512; Fax: (978) 371-7129

E-mail: A.R.C. @ antiqueradio.com - Web: www.antiqueradio.com

Please, no classified ads by telephone; thanks.

Your ads, renewals, letters, etc. can be handled faster and more efficiently if your name, address and SUB# are written on each.

Unfortunately, A.R.C. is not staffed to answer all letters with questions about antique radios or requests for advice. However, A.R.C. does solicit letters of interest to its readers and publishes them as space permits. (See "Publishing Rights" paragraph.)

**GUARANTEE.** You may cancel your subscription at any time and receive a pro rata refund for issues not yet mailed. If errors to ads are made by A.R.C., upon request a free correction will be run in the next available issue.

### DISPLAY AND BUSINESS CARD ADS - DETAILS AND RATES

The deadline is the first of the month for display and business card ad artwork, payment and repeat requests.

Advertising is accepted only for early items related to radio, communication, etc. All items must be described fairly; reproductions, reprints and non-original items must be so identified. Advertisers must agree to respond promptly to inquiries and orders, to resolve problems promptly if the buyer is not satisfied, and to comply with a buyer's refund request on unaltered returned items.

Advertising must be prepaid, except as noted below; see "Payment" paragraph above for details. Late ads will be run only if space and time permit. Since artwork is reduced to 63% in the printing process, originals must be the artwork size listed below. Do not send in artwork on art board or cend negatives. Ads should be typeset or typed neatly with a carbon ribbon, black ink (not pencil) on white. If used, reverse type must be limited to 25% of the ad. If you want us to prepare your ad, include the one-time cost below for A.R.C. to make up the ad.

Photos should be at an 85-line screen; otherwise, add \$16.00 per photo for screening. Do not cut or trim photos or glue photos to artwork; submit separately.

If you are confused by these requirements and terms, please

Page	ARTWORK SIZE (SEND IN THIS SIZE)		As Printed (size in magazine)		Cost for 1-month	Cost for 3-months	Cost for 6-months	Cost for 12-months**	One Time to make up Ad
	H x W (inches)		H x W (inches)						
Full	12 7/16 x 7 1/2		7 3/4 x 4 3/4		\$289.00	\$769.00	\$1329.00*	\$2325.00**	\$69.00†
1/2 H	5 1/4 x 7 1/2		3 5/16 x 4 3/4		146.00	389.00	675.00*	1175.00**	37.00†
1/2 V	12 7/16 x 3 9/16		7 3/4 x 2 1/4		146.00	389.00	675.00*	1175.00**	37.00†
1/4	5 1/4 x 3 9/16		3 5/16 x 2 1/4		74.00	197.00	342.00	595.00	19.00†
1/8	2 5/8 x 3 9/16		1 5/8 x 2 1/4		38.00	101.00	177.00	305.00	9.00†
Business Card (1st)	2 x 3 3/4		1 1/4 x 2 3/8		not avail.	53.00	90.00	159.00	7.00†
Business Card (2nd...)	2 x 3 3/4		1 1/4 x 2 3/8		not avail.	68.00	118.00	205.00	7.00†

\* Full & 1/2 page, 6-mos.: 1/2 due with order; 1/2 due in 3 mos. \*\* Full & 1/2 page, 12-mos.: 1/2 due with order; 1/4 due at 3, 6 & 9 mos.

† For 6 and 12 month ads, no ad make-up charge if no change is made to ad for entire run.

**PAYMENT.** Please send in full payment with your order or ad. A.R.C. does not carry accounts; all subscriptions, ads, etc. must be prepaid (except for the 6 and 12 month display ads indicated below). Pay in U.S. funds. Checks drawn on a U.S. bank, money orders, VISA or MasterCard (\$10.00 min.) are preferred. Make check out to "A.R.C." U.S. stamps or cash are OK for small amounts. Canadian payers may send a Canadian check but specify U.S. funds. Subscriptions will be prorated to amount sent if amount is incorrect.

**FAX & E-MAIL PROCEDURES/PAYMENT.** Subscriptions, book orders, classified ads, display ads, etc. are welcome by fax or e-mail. Deadlines are the same as for ads received by mail. Please calculate the amount due. Payment by VISA or MasterCard is preferred if your order is over \$10. If under \$10, or if you prefer to send a check or money order, state the amount being sent and that the payment is in the mail. **Do not** send another copy of your ad with your payment; simply indicate that it is a fax or e-mail payment. If you want confirmation of our receipt of your fax, call immediately after sending your fax.

**CHANGE OF ADDRESS.** Please notify us 4 weeks in advance of a change of address. Send both your new and old addresses, and include your SUB# and effective date of your new address. Temporary address changes can be made also.

**SUBMISSION OF MATERIAL.** Antique Radio Classified welcomes and solicits information that pertains or relates to radio history or collecting. This may include articles, book reviews, photos, information on upcoming radio events, meetings, antique radio organizations, radio auctions, sources of old radio and restoration supplies, and other related and interesting material. All material submitted should be carefully researched, typed and accompanied by good photos, if appropriate. Computer disks are appreciated. Writing guidelines are available upon request.

**PUBLISHING RIGHTS.** Unless other arrangements are made: (1) All received materials (ads, articles, letters, correspondence, e-mail, photos, artwork, etc.) become the property of A.R.C. may be edited, combined with other material, published, and will not be returned. (2) For all received materials, A.R.C. is granted publishing and reprint rights in all forms of media including the monthly printed magazine, internet, etc. (3) Publication is subject to approval by A.R.C. and to time and space constraints.

**MAILING OF ISSUES.** U.S. subscribers can receive A.R.C. by First Class or Periodicals mail (Periodicals is the way most magazines are mailed). The mailing of First Class copies is staggered with faraway copies mailed before local copies. Non-U.S. copies are mailed on the first day. Periodicals copies are mailed on the last day. Mailing dates change each month, but mailing is usually completed by the 27th of the month. First Class copies usually are received by the 5th of the month; copies by Periodicals mail, by the 10th.

**ETHICS.** No person involved in the production of A.R.C. is to act on any information in the magazine until the first delivery day after local copies are mailed.

**DISCLAIMER.** The publisher is not responsible for any buying and selling transactions incurred, or for any other use of the contents of this publication.

Antique Radio Classified subscription rates, frequency of publication, content, policies, size and ad details, and rates are subject to change at any time by A.R.C.



# ANTIQUE RADIO CLASSIFIED

## EDITOR'S COMMENTS

Although full of anticipation of good things to come, the holiday season also evokes memories of the past — a topic made-to-order for antique radio collectors. In this holiday issue, three articles fit readily into that category. We begin with Jack Ward's article on the history of the transistor. This article is not only interesting, but timely, because 1998 marks the 50<sup>th</sup> anniversary of the June 1948 public announcement of the transistor's invention. Communication, calculation, and all things electrical have not been the same since.

A serious collector of transistors themselves, Jack combines the history of early transistor manufacturing with suggestions for putting a transistor collection together. He describes transistor types and their advantages and disadvantages vs. those of vacuum tubes. Perhaps this first A.R.C. article on transistors may encourage others to join Jack in his pursuit.

Complementing Jack's article are reminiscences from Roy Blackshear about how he met John Bardeen, the transistor's co-inventor and Nobel Prize winner. Included are Bardeen's wife's enjoyable recollections of his casual mention one evening of the invention and of his appearance at the 1986 AWA conference.

Our history-memory theme continues with Fred Geer's story of his 1895 Berliner phonograph disc master. Fred's ten-cent purchase turned out to be every collector's fantasy-come-true — to find something rare. He subsequently contributed his treasure to the Smithsonian so that millions can enjoy it.

Frederick Ringwald's article on Cliff Gardner explores an aspect of television history. Gardner, who worked with Philo Farnsworth on early television, was the engineer who actually made the intricate television camera, picture, and other tubes for the Farnsworth image dissector television system.

Many of you may have thought that Ray Bintliff's additional articles on capacitors had been forgotten. But, "Capacitors in Old Radios, Part 2" is finally here. Ray continues his tutorial, focusing on paper capacitors. He shows their various types of construction and describes the manufacturers making them. He also suggests strategies for replacing paper capacitors. Ray assures us that the series will continue.

*Photo Review* offerings this month range from a tiny speaker and crystal set to a cardboard cabinet cathedral. *Radio Miscellanea* indicates that the internet issue is much on readers' minds, as we easily filled a page with your views. And our look back to A.R.C.'s first year

is a page from the December 1984 issue — "Collecting Radio Novelties" — showing vintage radio games. We also include one of Ron Boucher's "Gridley" cartoons to add a light touch to this seasonal issue.

**Classifieds on the Internet Soon.** Get ready for A.R.C.'s ads on the internet. Make sure that you are a subscriber because A.R.C. will soon be allowing access to the classified ads via the internet — for subscribers only. This is an excellent way for both groups of collectors — the hard copy devotees and the computer fans — to widen their buying and selling horizon. Currently, each group is missing the other's action. A.R.C.'s web site at <http://www.antiqueradio.com> will bring these two groups together. And, the paper version will continue!

**15th Year Specials.** Full-year packages of past A.R.C.s are being offered at a 60 percent discount. For only \$24, U.S. postpaid, you can get 12 original issues for an entire year. (Issues prior to April 1987 are reprints). Look back at what was collectible, what prices were, what articles you missed, etc. A super holiday gift for both the new and the seasoned collector.

**1999 — No Rate Increases!** As our holiday gift to our subscribers and as an effort to balance benefits to all readers in our expansion to the internet, our advertising rates will not increase for 1999. And in spite of the promised postal increases, our fifteenth-year special subscription rates will continue throughout 1999.

**Coming Radio Events.** Although December could be a quiet month for radio events, many radio clubs are having holiday gatherings for their members. This is a chance for you to share the holidays with your radio friends, and to introduce your family to them. Perhaps your family will then better appreciate your love for old radios and join you at the next collector gathering.

Thanks to all you supporters of A.R.C! Your ads, articles, and purchases have made A.R.C. the leading publication in the world for the radio-collecting community. We invite your support and participation as we embrace the technology of the internet, which, incidentally, was made possible by the invention of the transistor. With each new invention, our means of communicating among ourselves about the things we collect and love has improved. We continue to combine the best of two worlds — the old and the new.

All of us wish all of you the best of holiday seasons and a safe and fruitful New Year.

John, Cindie, Tammy, Laura,  
Dorothy, Bobby, and Dave

## OOPS!

With the millennium coming, we must be sure of our numbers! However, two numerical errors crept into our last issue. On page 19, although the information Don Hauff gave us at Radiofest clearly said, "McMurdo-Silver Masterpiece VI," we mistakenly printed "VI."

And the printer must have wanted to see if we could count when he swapped pages 80 and 81.

I'm sure the vigilant among you caught these errors.

## ON THE COVER

In keeping with the season and with our lead article, our cover shows two fine examples in red and green of the most collectible transistor radio — the Regency TR-1. Thanks to George Kaczowka, who lent us the radios for photographing, we show them as they might have been introduced in the stores for the 1954 holiday season. The TR-1 was the first commercially sold radio using the then new transistor technology.



# VINTAGE TRANSISTOR RADIOS

## The Transistor's Early History From 1947 to the 1960s

BY JACK WARD

*Jack Ward's carefully researched article reminds us that 1998 marks the 50<sup>th</sup> anniversary of the first public announcement of the invention of the transistor, which the April 1992 "Physics Today" said, "caused a revolution in technology and drastically altered society." The addition of Ron Blackshear's personal recollection of his friendship with John Bardeen, co-inventor of the transistor, gives us further insight into a remarkable 20<sup>th</sup> century event. (Editor)*

On Wednesday, June 29, 1948, at the Bell Labs West Street headquarters in New York City, a press conference was held to announce the invention by Bell Labs scientists of a new amplifying device — it was the transistor. The transistor had actually been invented 6 months earlier, December 1947, but the public announcement had been delayed to allow for filing of patents and disclosure to the military.

At the press conference, this new device was presented as an equivalent of the vacuum amplifier, except that it had desirable properties which overcame some of the fundamental drawbacks of tubes. For example, the transistor was small, lightweight, required no vacuum or filament current, and apparently had an unlimited lifetime. Although there were working demonstrations of the potential uses of the transistor presented to the audience (audio oscillator, audio amplifier, and radio receiver), no one present could have known or reasonably predicted the tremendous impact that this device would have on technology over the next 50 years.

### FROM PROTOTYPE TO PRODUCTION

The transistor developed by Bell Labs in 1947 was of the type known as "point contact." This term refers to the technique used to attach two fine wires as points of contact to a germanium block, as shown in Figure 1. While this technique allowed for the discovery of transistor action, the resulting device was not ideally suited for large scale commercial usage — the point contacts were erratic, mechanically unstable and yielded wide ranges of performance.

Nevertheless, Bell Labs continued to refine the techniques for point contact transistor development. By 1951, sufficient progress had been made to overcome some of the limitations of this type of transistor, and commercial production began at the Western Electric plant in Allentown, Pennsylvania.

By mid-1952, Western Electric was manufacturing 6,000 point contact transistors a month. This type of transistor was never in widespread commercial production, and found limited usage in the military, such as in the TRADIC airborne digital computer, and in Western Electric telephone switching equipment.

In July 1951, Bell Labs again made an announcement regarding transistors. This time a new type of transistor, called a "junction transistor," also shown in Figure 1, was made public. The junction transistor was constructed using a die or chip of germanium, with transistor action accomplished by any of several different manufacturing techniques, such as adding controlled amounts of impurities to the germanium — the point contacts, with their inherent drawbacks, had been eliminated.

This new type of transistor was the basis for a large scale increase in the quantities of transistors manufactured by a variety of companies. For example, see RCA's "bean-sized" transistor, shown in Figure 2. In 1953, approximately 1,000,000 units were manufactured. In 1955, over 3,500,000 transistors were manufactured, and in 1957 almost 29,000,000 units were made. In ten years, the transistor had grown from an exciting laboratory prototype to a mass-produced technology which found uses in all kinds of products.

### EARLY COMMERCIAL TRANSISTOR USES

The properties of the transistor — small size, very long life expectancy, and no filament heater, which meant longer battery life and low heat output — overcame the limitations of the vacuum tube. The transistor allowed for the rapid replacement of tubes in two very common electronic devices — hearing aids and portable radios. Each of these devices could be made better with transistors.

The first hearing aids to use transistors ap-

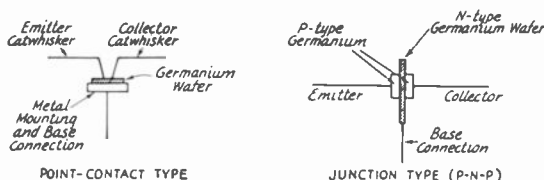

Figure 1. A simplified illustration of the construction of point-contact and junction-type transistors. (From "The Radio Amateur's Handbook" of the American Radio Relay League, 1956, p. 79.)

peared in 1953. Up to this point, hearing aids were manufactured with subminiature tubes, which were suitably small, but consumed expensive batteries at an alarming rate. The low-battery current requirements of transistors allowed for further size reductions in hearing aids (fewer batteries and those batteries lasted longer). Companies such as Maico and Sonotone introduced "all-transistor" or hybrid (transistor and tube) hearing aid models in 1953, as shown in Figure 3. Figure 4 shows a 1954 *Herald Tribune* photo of GE engineers with their experimental pocket radio.

The first commercial, all-transistor portable radio, the Regency TR-1, shown in Figure 5, was introduced by the I.D.E.A. Company in time for Christmas sales in 1954. The portable radio market capitalized on the same advantages of transistors that were important to hearing aids — small size and low battery consumption. Although the TR-1 was not an instant sales success (probably because of poor fidelity and high cost), the transistor radio market rapidly expanded. By 1957, almost 5 million portable radios were manufactured and sold by a large number of American companies, such as Admiral, Arvin, Emerson, GE, Raytheon, RCA, Westinghouse and Zenith.

#### IMPORTANT TRANSISTOR MANUFACTURERS

By the end of 1957 approximately 20 companies were involved in the commercial manufacture of transistors. Most of these were large, well established electronic manufacturers. Two of these companies, Western Electric and Raytheon, dominated the early transistor industry; several other companies (GE, Texas Instruments, and Fairchild) made major contributions throughout the decade.



*Figure 2. February 1952 — One of RCA's laboratory technicians gives a final inspection of the strengthened version of its new transistor. The device is about half the size of an ordinary paper clip. (United Press photo from the editor's collection.)*

Western Electric and its research organization, Bell Labs, was the company responsible for the invention of the transistor. William Shockley, Walter Brattain, and John Bardeen jointly shared the 1956 Nobel Prize for Physics for inventing the transistor at Bell Labs in 1947. This work was the result of a semiconductor research group established after World War II at Bell Labs specifically to create a solid-state replacement for the vacuum tube. Western Electric actively promoted the new transistor technology in a variety of ways, including supporting continued research that led to the invention of the junction transistor in 1951, licensing transistor manufacturing rights to more than 30 companies for \$25,000 each by 1952,

and fostering the early use of transistors in commercial products by removing any royalty charges on transistors used in hearing aids.

Raytheon was the early commercial transistor technology leader, beginning with the CK703 point contact introduced in 1948. Moving quickly to the new junction technology, Raytheon was able to mass produce in such quantities that unit prices became attractive for hearing aid use — the low-noise CK718, for example, was priced at \$8

*(Continued on following page)*

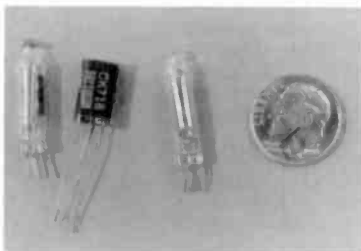

*Figure 3. Left: Front of the case of a Sonotone 1010 hearing aid, introduced in 1953. Above: 2 subminiature tubes, and 1 low-noise Raytheon CK718 transistor, shown next to a dime for size comparison. Hearing aids represented the first successful commercial use of transistors.*



Figure 4. GE engineers in 1954 demonstrate an experimental pocket radio, designed primarily for emergency broadcast use by civil defense workers, who could wear it like a hearing aid. ("Herald Tribune" photo, from the editor's collection.)

(The Transistor's Early History, continued)  
in volume quantities in 1953.

Having already established a leading role in the hearing aid market through the manufacture of subminiature vacuum tubes, Raytheon virtually created the transistorized hearing aid market, working closely with the established manufacturers to perfect product design. Raytheon continued to drive down costs, and the ever popular CK722 hobbyist type transistor dropped from \$5 in 1953 to 99¢ by the end of 1955, as shown in the ad in Figure 6.

The 1,000,000<sup>th</sup> Raytheon transistor was manufactured in 1954, nearly 4 times the output of all other manufacturers combined. Raytheon continued to be a major semiconductor manufacturer throughout the 1950s, supplying devices in a variety of markets including commercial, military and hobbyist.

General Electric was active in the manufacture of transistors during the early 1950s. By 1953, GE had perfected a form of transistor manufacturing, called alloy junction, which allowed for reliable unit operation as well as relative ease of manufacturing. Types 2N43/44/45 were introduced in 1953 and found widespread industrial and military acceptance. It is common to find these types in surplus military equipment.

GE continued to be a major manufacturer of transistors through the 1960s. In addition, GE pioneered the research and commercialization of several other unique semiconductor devices, introducing both tunnel diodes — a special type of diode which can be used as an oscillator — and silicon-controlled rectifiers or thyristors, which are bistable semiconductor devices designed in the late 1950s to be used as on/off switches.

Texas Instruments (TI) was responsible for several important early transistor developments. In May of 1954, TI announced the commercial availability of the first silicon transistors, Models

900, 901 and X-15. This was several years ahead of most industry estimates regarding when silicon units would be available. Silicon transistors had several advantages over the existing germanium type, most notably higher temperature stability. Silicon technology also was the basis for later semiconductor products, especially integrated circuits (IC) — a combination of interconnected transistors and other components formed on a single semiconductor element. TI used this expertise to market the first ICs, called "Solid Circuit," in March, 1960, for \$450 each.

Texas Instruments' other notable accomplishment was the TR-1 transistor radio mentioned earlier. Working with I.D.E.A. engineers, TI assisted in perfecting the radio design, initiating many new circuit and component innovations suitable for transistors.

The radio used four TI transistors.

Fairchild Semiconductor was founded in September, 1957, by a group of eight engineer/scientists who had resigned en masse from William Shockley's Semiconductor Laboratories, Division of Beckman Instruments. Fairchild quickly became a technology leader in silicon transistor manufacturing, introducing the first units in 1958. These were high-speed, computer-switching units (2N696, 2N697) selling for over \$100 each, as shown in Figure 7. Fairchild also invented a new manufacturing technique called planar, which became the



Figure 5. The Regency TR-1, the first all-transistor portable radio, manufactured by the I.D.E.A. Company in 1954. (From the George Kaczowka collection.)

# RAYTHEON CK722 TRANSISTORS

NOW 99c



Now you can buy a Raytheon CK722 Transistor for the price of a tube. The tremendous popularity of this Raytheon Transistor has made mass production possible, permitting Raytheon to substantially reduce the price to you.

#### Get This RAYTHEON TRANSISTOR APPLICATION BOOK!

116 pages — over 50 practical circuits including timers, receivers, oscillators, etc. all using low cost Raytheon Transistors. For your copy send 50¢ to Department P7.



## RAYTHEON MFG. CO.

Receiving and Cathode Ray Tube Operations  
Newton 58, Massachusetts

RELIABLE SUBMINIATURE AND MINIATURE TUBES  
SEMICONDUCTOR DIODES AND TRANSISTORS  
NUCLEONIC TUBES

RECEIVING AND PICTURE TUBES • MICROWAVE TUBES

Figure 6: Ad from a 1955 "Popular Electronics" showing a handful of Raytheon CK722 transistors priced at 99c each, the "price of a vacuum tube."

basic technique for the manufacture of ICs. Fairchild became an early IC leader, introducing the "Micrologic" series of logic ICs for \$120 each in 1961. Fairchild was also important in that most of

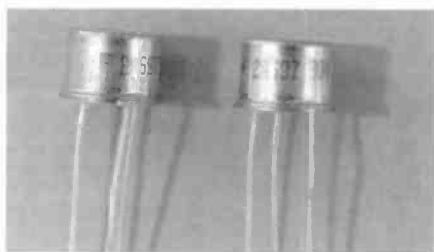

Figure 7: The 2N697 transistor, one of Fairchild's first products, developed in 1958 and sold for over \$100 each to IBM to be used as a computer core driver. Below, it is pictured the graphics that appeared on the Fairchild silicon transistor box.

the founding members of Fairchild left the company within a few years to start other successful semiconductor companies, the most notable of which is Intel.

### LOOKING AHEAD TO THE 1960s

Transistor technology had made tremendous progress throughout the 1950s. The decade had started with this new device seen as an unreliable oddity, difficult to manufacture, but offering great potential. By 1960, there were 42 different U.S. firms manufacturing transistors, with almost 1,000 distinct models. By the end of 1961, sales of diodes, transistors and rectifiers reached \$500 million, and the new integrated circuit technology, developed as a direct result of transistor research, was poised to achieve even higher unit and dollar levels.

### COLLECTING HISTORIC TRANSISTORS

The process of identifying key collectible categories of historic transistors has not received much attention until recently, and so will likely expand as more collectors enter the field. As a general rule, only transistors manufactured between 1948 and 1960 are collectible. Other types of semiconductor devices, such as silicon point contact radar diodes from the 1940s, tunnel diodes from the late 1950s, and integrated circuits from the early 1960s make interesting additions to a transistor collection. The following categories can form the basis for starting an interesting and historically significant transistor collection:

1. **Point Contact Types.** Any point contact type of transistor is collectible. This technology was in use only until about 1953, although a few replacement types were manufactured by West-

(Continued on following page)

(The Transistor's Early History, continued)

em Electric until the 1960s. Identifying a point contact unit can sometimes be difficult and requires comparing type numbers with historic reference lists. Some other types of point contact units are easily identified because there is a small hole on the unit to allow for manual adjustment of the point contacts during manufacture. Examples, some shown in Figure 8, include:

- a) Western Electric: 2N21, 2N23, 2N25, 2N26, 2N67, 2N110
- b) RCA: 2N32, 2N33
- c) CBS-HYTRON: PT-2A
- d) General Electric: G11
- e) Raytheon: CK703, CK716

**2. Early Bell Labs Units.** Since most of the very early transistor work was done at Bell Labs, any prototype or production unit up to about 1953 is collectible. Usually these can be identified by comparing type numbers (sometimes handwritten on the case or container) with Bell Labs literature from that time period. As a bonus, there are a few units which were presented in commemorative boxes to attendees of early transistor seminars and conferences. An example includes a 1729X (example with handwritten model number, 1952/53)

**3. Early Prototypes or Non-Standard Technologies.** Many companies experimented with the newly invented transistor technology by building prototype units. Most often the prototype units had handwritten identification. Additionally, a few companies experimented with "non-standard" technologies, such as 4-lead devices called "tetrodes" or light-sensitive units called "photo-transistors." Some of these types of devices were actually put into production. Examples, some shown in Figure 9, include:

- a) Western Electric: 3N22 (tetrode, 4-lead unit, 1956)
- b) General Transistor: GT66 (photo transistor, 1958)

**4. Early Manufacturers in the Transistor Business for a Limited Time.** Throughout the 1950s, a variety of companies entered commercial production of transistors, and then quickly exited within a few years. These were typically

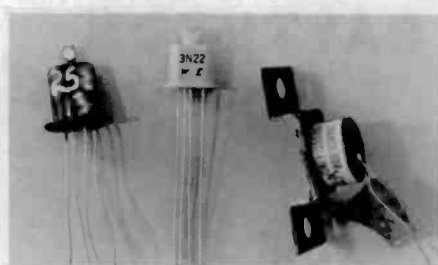

Figure 9. Unusual early junction transistors. Left to right: an experimental GE tetrode or 4-lead device, ca. mid-1950s; a Western Electric 3N22, a production tetrode, ca. 1958; and a Transistor Products power transistor, ca. mid-1950s.

small companies or small divisions of large companies. Units from the following companies are quite rare and collectible:

- a) Transistor Products, Inc. (Div. of Clevite)
- b) Germanium Products, Inc.
- c) National Union
- d) Marvelco
- e) Hydroaire
- f) Radio Receptor
- g) Federated Semiconductor

**5. First or Early Production Units.** As companies entered commercial production in the 1950s, specific model numbers or date codes can be identified as first or early production units. Examples include:

- a) Raytheon: CK718 (1<sup>st</sup> Raytheon junction type; production started in late 1952)
- b) General Electric: 2N43/44/45 (1<sup>st</sup> GE junction types; production started in 1953)
- c) Western Electric: A1858 (early junction type; production started in 1953)
- d) Western Electric: 1689, 1760, 1768 (production point contact units, 1953/54)

**6. Important Types Based On Underlying Unique Technology Or Intended Use.** Some transistor types are collectible because the unit represents a unique technology — early silicon units, for example — or the unit was intended for

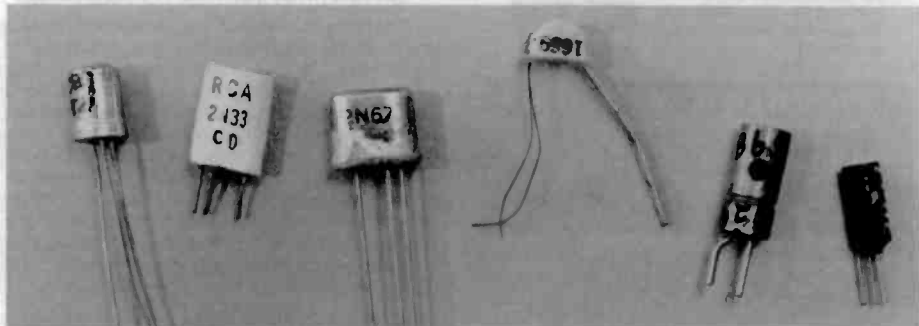

Figure 8: These are somewhat rare point contact transistor types. From left to right: a CBS Hytron, CHY PT-2A of 1954; an RCA 2N33 of 1953; a Western Electric 2N67 of 1954; a Western Electric 1689 of 1953; a Western Electric A1729X; and a General Electric G11. Note the evidence of a small hole in the case of each of the last two units. This hole allowed for adjustment of the fine point contact wires during manufacturing.



a unique application, such as low-cost, experimenter usage. Examples include:

- Texas Instruments: 900/901/X-15 (First commercially available silicon units, 1954)
- Raytheon: CK722/721 (low-cost units aimed toward experimenter market, 1953)
- Western Electric: 2N559 (very high reliability switching unit for Nike/Zeus missile computer and communication systems, 1957)
- Philco: SB100 (early high frequency unit, Surface Barrier technology, 1955)

**7. Units With Unique Packaging, Text or Graphics.** The external packaging (usually cardboard "matchbook-like" containers) used by several early transistor companies have collectible interest based on the uniqueness of the packaging or markings on the packaging. Examples, some shown in Figure 10, include:

- Raytheon: (classic red/white/blue foldover cardboard package, 1954)
- General Transistor: (brilliant orange/black/white cardboard package, 1958)
- Western Electric: (early transistor terminology, "Crystal Unit, Amplifying" printed on white cardboard package, 1954)

#### REFERENCES AND FURTHER READING

*Bell Labs Technical Journal*, Vol. 2, No. 4, Commemorative Issue, "The Transistor — 50th Anniversary: 1947-1997."

*This is a collection of fairly technical articles describing early transistor developments and subsequent semiconductor engineering.*

*Electronic News*, January, 25, 1982.

*This issue celebrated 35 years of industry development following the invention of the transistor. It is full of interesting ads and short news pieces on various companies and products.*

*Physics Today*. "John Bardeen." Special Issue, April 1992.

*A series of informative talks about John Bardeen and his work given at the March 1992 American Physical Society meeting in Indianapolis, Indiana.*

*Proceedings of the IEEE*, Vol. 86, No. 1. Special Issue. "50<sup>th</sup> Anniversary of the Transistor!"

*This is a great issue, with almost 300 pages of a variety of articles describing the invention of the transistor, with references. Also includes data on early ICs and 100-year-old, solid-state devices.*

Riordan, M. and L. Hoddeson. *Crystal Fire — The Birth of the Information Age*. New York: W.W. Norton, 1997.

*An excellent overall history of the technology and the people associated with the invention of the transistor. A detailed account of the research done at Bell Labs leading up to and following the invention of the transistor.*

Rostky, G. *EE Times*. "The Transistor — A Biography," Oct 30, 1997.

*This is an excellent, detailed article covering the technology and people associated with semiconductor technology. Mr. Rostky captures invaluable information by interviewing many of the key players from the 1950s and 1960s semiconductor industry.*

Wolff, M. 1985. *IEEE Spectrum*. "The Secret Six Month Project."

*The story of Texas Instruments and the TR-1 radio. An interesting account of the development of the first all-transistor radio.*

(Jack Ward, 20 Elm St., Brookline, MA 02146. Email: wardwardj@aol.com)

*Jack Ward is a Quality Assurance Manager in the electronics industry. He collects historic semiconductors, especially point contact transistors, Tunnel Diodes, and early ICs, and welcomes inquiries, trades or additional information about this topic.*



Figure 10: Several unusual package graphics. Highly stylized graphics or text on packages add interest to a transistor collection. Note the phrase "Crystal Unit, Amplifying" on the Western Electric package — this was early wording for the new transistor technology.

# How I Met John Bardeen

## Co-Inventor of the Transistor — Nobel Prize Winner

BY ROY S. BLACKSHEAR

*As fate would have it, when we were preparing the Ward article on the transistor, Roy Blackshear happened to talk with your editor at the AWA Conference about his meeting and subsequent friendship with John Bardeen, co-inventor of the transistor. The following article is Roy's response to our request to write about this meeting and to provide copies of the autographed patent filed June 17, 1948. (Editor)*

How did I get to meet John Bardeen, the distinguished physicist, many people ask. Well, some time in the late 1970s, when I was in management at Hawaiian Telephone Co. in Hilo, Hawaii, I received a phone call from a good friend in Honolulu, Roger Monsaratt, who asked, "What are you doing next Tuesday?"

After checking my calendar, I said I was free. Roger said he would like to bring over an elderly couple because the man wanted to go up to the Volcanoes National Park to see the seismographs.

"No problem. I'll meet you at the airport and will be glad to take you up there."

Tuesday arrived, and it had to be one of the stormiest, wettest days in Hilo's history. At any rate, the planes were flying, and I met Roger and the "elderly couple" at the airport as planned. I was introduced to the Bardeens and away we went.

However, I kept wondering why the name "Bardeen" was so familiar. Along the way, John Bardeen asked many pointed questions about Hawaii, but our conversation was interrupted by a large tree across the highway. This gave me a chance to question Roger. It was then that I learned that John Bardeen was one of the inventors of the transistor.

"Holy Mackerel, I've got Edison in the backseat!" I exclaimed.

Well, we finally made it to the Volcano Observatory. I knocked on the door and said that we would like a tour. "No tours today!" was the curt reply, and the door was slammed in my face.

I knocked again and asked to see the boss, whom I knew. He arrived at the door and invited me in because I was getting all wet. I told him that I had a very distinguished visitor in the car who was co-inventor of the transistor. That changed the picture fast.

So, John, Jane, and Roger came in and, after introductions, John got the "royal" tour of the observatory, including the bank of seismographs, which were all working. John was impressed and asked many questions, all of which were answered to his satisfaction. We returned to Hilo after visiting my home at Keaau Beach.

Over the next ten years, John Bardeen and his biologist wife Jane were my house guests three times here in Hawaii. Each time he visited, John wanted to see my "Junque Room" where I have my collection of antique radios, telephones, cameras, and phonographs on display. I also have my ham station, KH6BAI, in this room.

On one visit, I asked John what he had told Jane on the night he came home from Bell Labs and knew that the invention of the transistor would replace radio tubes. Jane was within earshot and said, "I'll tell the story, Roy."

Jane said that she had had a rough day with their two young sons. In fact, she'd "had it up to here," indicating her chin. When John came home, took off his heavy cap, hung up his overcoat, and kissed her, he said, "Well, Dear, we discovered something today."

Jane replied, "That's fine. Now, wash your hands because dinner is ready."

Following dinner, where nothing more was said, she put the boys to bed, finished doing the dishes, walked into the living room and said, "OK, John, what did you discover today?"

John corrected her and said, "What did we discover today?" [He shared the Nobel Prize for this discovery with William Shockley and Walter Brattain in 1956.]

It was then that she learned that the transistor

### At AWA in 1986

*The following is an excerpt from a 1986 letter written to me by Jane Bardeen, telling of their trip that year to AWA in Canandaigua, New York.*

"John had a great time at the meeting of the Antique Wireless Association at the end of September. They had the biggest crowd ever — over 800 registered and about 300 at the banquet. There was a very receptive audience for John's talk — they must have thought that he was an antique tool!

"Among the demonstrations was a music box dating from about 1950 with two point-contact transistors, one as an oscillator that could be tuned to various frequencies, and the other acting as an amplifier. It is still

operating after all these years, with only a condenser and a switch replaced. There were only three made at Bell Labs for lecture demonstrations, and this is the only one that has survived.

"Another was a radio built into a golf ball — antenna, rechargeable battery, and speaker, all inside a standard golf-ball cover. Made by Sony, again one of three, it had been presented to John on his 60th birthday by the Sony Director of Research.

"Still another was a Regency radio, the first pocket transistor radio, dating from 1954. There is now a place in the AWA for transistors and transistor radios. John is now a proud honorary member."

would probably replace radio tubes as we knew them. When she asked if the transistor used electricity, he told her that it used minute bits of electricity — some transistors used more than others — and that it was small, rugged and unbreakable if dropped. It was then that Jane realized that this had to be a great invention.

On another visit, John promised to send me a copy of the first patent on the transistor. The autographed patent file, dated June 17, 1948, appears below. Along with the patent copy was a copy of a speech given to an assembly of engineers on the early days of the transistor. On the cover of the speech, I learned that John was the recipient of a second Nobel Prize in 1972 as co-developer of the theory of superconductivity at low temperatures.

An avid golfer, John once shot a hole-in-one. When his colleagues asked which accomplishment he considered more important — the hole-in-one or the two Nobel Prizes, he had to think about it a bit. Finally, he responded, "Well, two Nobel Prizes are perhaps better than one hole-in-one."

On another visit, John asked to see all my transistor radios. I produced about 15, and then he asked for a screw driver. He removed the back of each radio to see what kind of transistor was used. He could name each type in the various radios. Of special interest to him was the small Heathkit transistor radio which I had built in the mid-1960s, and he pulled out each of the Texas Instrument transistors.

That was the last visit of a very good friend who died in Boston, Massachusetts, on January 30, 1991, at age 82.

(Roy Blackshear, P.O. Box 950, Keaau, Hawaii 96749)

Roy Blackshear, a Hawaii native, received his first amateur radio license in 1953. His wide-ranging interests include photography, raising Nene — a rare type of goose and the state bird of Hawaii — and collecting antique radios, phonographs, and cameras. He has the largest collection of antique telephones in the state.

Oct. 3, 1950

J. BARDEEN ET AL  
THREE-ELECTRODE CIRCUIT ELEMENT UTILIZING  
SEMICONDUCTIVE MATERIALS

2,524,035

Filed June 17, 1948

3 Sheets-Sheet 1

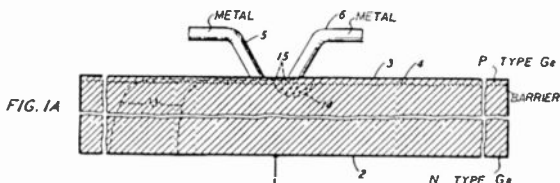
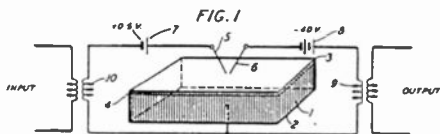

FIG. 2

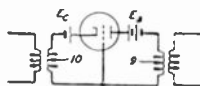

FIG. 12

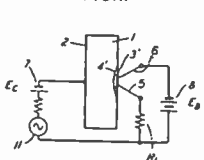
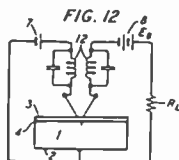
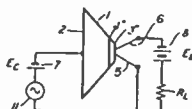

FIG. 10



To Roy Blackshear  
Compliments of  
John Bardeen  
June 1, 1982

INVENTORS J. BARDEEN  
W. H. BRATTAIN  
BY Harry C. Hart  
ATTORNEY

Autographed copy of the first patent on the transistor, courtesy of Roy Blackshear.



# VINTAGE RECORDING

## A Berliner First Flat Disk Ten Cents' Worth of History

BY FRED GEER

*The RCA/Nipper/Camden saga (A.R.C., April and August, 1998) is a good backdrop to Fred Geer's story about the thrill of finding a rare item — a Berliner flat disk. Nipper, after all, listened to a Berliner gramophone early in his advertising career. Fred shares this experience with us, along with a little history of early recording. How many of us would make the choice he did for the future of his disk? (Editor)*

Every day after teaching school, I used to stop at Goodwill's outlet store, hoping to find a treasured radio or something. In 1963 flea markets did not exist, and Goodwill had many fine cast-offs.

A Modcan heater pumped balmy warm air in my face as I entered from the cold gray February wind. I wondered what fate had in store for me today. The many warm objects scattered on tables felt good to my cold hands. Rum-maging through the junk, I uncovered an interesting ugly metal disk.

It was very dirty, but without question, it was a phonograph record unlike any I had ever seen before. I looked at it with a critical eye. The label was embossed in the metal disk and read: "E. BERLINER." The title was engraved saying: "Piano and singer, Washington, D.C., December 5, 1895."

At that moment, little did I realize that I held an "original" — one of the first five, lateral cut, flat phonograph disks ever made. My heart raced as I read the label slowly the second time. What it was sank in. It wasn't junk but something with real historical significance. Its 68-year trip from that wonderful night in 1895 to a junk table in Jacksonville, Florida, would be interesting to think about.

I took the treasure to the counter and asked "How much?" The clerk took the crusty disk and looked at it replying, "Little records are a dime." Reaching into my pocket for some change, I discovered all I had was a nickel and three pennies, and my billfold was empty. (Teachers live

like that.) I know the look on my face was one of loss. Being a proud person, I did not ask for any favors from the clerk. I took the record from her hand and put it back on the table.

Leaving the store, I looked back at the dirty little disk on the warm table. I felt bad because its fate was now in an uncaring world. A gust of cold wind slammed the door behind me. A car pulled in and a man got out. That's when I heard the beautiful ring of a coin hitting the pavement. I watched the man. He did not pick up the coin, but I did! It was a nickel.

In a flash, I rescued the record from the table. I passed the man who had lost the coin, and for some strange reason said, "Thanks to you a very important part of history

has been saved." He gave me a bewildered look and said, "If you say so, Mister." I gave the clerk two nickels and a penny. She rang it up and put the little disk in a used paper bag.

All the way home E. Berliner's disk occupied my thoughts. My oldest record was a 1905 Victor. The 10-cent disk was a full ten years older. Had destiny put that disk in my care knowing that I would do the right thing with it?

It was natural to give the record a bath. Now that it was clean, I could see that the surface looked like a 1943 penny made from zinc and that it would never look any better. The disk was not flat; it had a slight bend, but I could fix that.

I had to play it but felt sorry for my phonograph needle. The record's surface was all pitted. Lowering the stylus into the groove blasted my ears with surface noise as the tone arm bobbed up and down.

Just above the surface noise, I heard a piano playing a nameless tune and a lady singing unidentifiable words. It played less than 60 seconds — 60 seconds that I will always remember. After having 10 cents' worth of exciting entertainment, I put the disk with the other old records and forgot it.

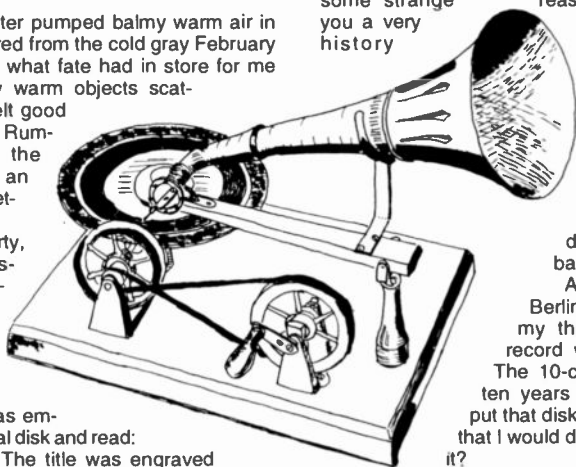

## THE SMITHSONIAN CONNECTION

Years later a magazine article that told about E. Berliner and the first flat disk caught my eye. From the description of the disk, mine had to be one of his first flat disks. That evening I put the Berliner disk on display.

It was worth 10 cents to me, but some collector might pay thousands. I did a rubbing and sent that image to the Smithsonian. Their experts would know what it was. A year passed before I got an answer. The Smithsonian's letter said that the disk would complete its collection of the five original Berliner disks. I put the letter with the disk aside and thought about it for a year. Then I wrote saying they could have it.

Months later, they answered and said that a special box would be provided for shipment. Weeks later a handmade case arrived, and all I had to do was slip the disk in and drop it in my mail box. The big decision was at hand. Sell it or give it away so that millions could enjoy it at the Smithsonian. I chose the millions.

## EARLIEST RECORDINGS

Berliner's disk sprang from the earlier inventions of other scientists. The first recording was done by the French scientist Leon Scott de Martinville, who in 1857 designed the Phonautograph, which traces the wave from sound on a cylinder in a visual form.

Another Frenchman, Charles Cros, submitted drawings for a recording/playback machine in early 1877. He requested that the drawings not be shown until December. In August 1877, American Thomas Edison showed a working recording/playback machine using a tin foil cover cylinder. Edison filed a patent on Dec. 24, 1877, and received U.S. patent #200,521 on Feb. 19, 1878. He called it a "Phonograph" or "Speaking Machine." Edison's machine recorded the sound at the bottom of the groove in hill-and-dale fashion.

An improved version was patented in 1886 by Chichester Bell and Charles S. Tainter at the Volta Labs in Washington, D.C. Their invention made a hill-and-dale recording on a hard wax cylinder. It was called the "Graphophone" cylinder record and had one drawback — it had to be recorded live and could not be mass-produced.

## BERLINER AND THE GRAMOPHONE

In 1887, Emile Berliner had a better idea. His machine was called the "Gramophone" and played

### Nipper and The Gramophone

William Barry Owen, managing director of the Gramophone Co., first saw Nipper looking into a British Edison Bell phonograph horn. He liked the whimsical look on the dog's face and offered to buy the painting if artist Francis Barraud painted out the Edison machine and painted in a Berliner "Improved Gramophone." In 1899, Berliner acquired one of the world's most famous trademarks — "His Master's Voice."

### from "On the Gramophone" by George Graham

"I am known far and wide as the  
'Berliner Gramophone.'  
And as a talking machine, I am standing  
quite alone..."

My records are indestructible; you will  
find them never wrong;  
and they produce properly music, speech  
and song..."

(Recorded December 2, 1896, as a self-  
advertisement by the Berliner Gramophone  
Company.)

a flat disk for which he received patent #372,786 on Nov. 8, 1887. Berliner's system included a method for duplicating the original recording.

Berliner's disk did not need a drive mechanism to propel the sound box across the record's surface as the cylinder machines required. His disk was recorded with a lateral cut, meaning the sound was stored on the grooves' side walls. His toughest job was solving the duplication process or "matrices."

By 1895, Berliner had devised a way to make copies of the original recordings efficiently. Here is the process: A 20-gage zinc disk was coated with a soft, low melting-point wax. A worm gear drove the stylus across the disk. The sound-powered stylus cut the wax, exposing a tiny groove that conformed to the sound wave exposing the zinc surface. Once the recording was finished, the disk was suspended in an acid bath where its exposed zinc surface was etched away by the acid.

After that process, the disk was a "master" that could be played back or used to make a stamper. From a molder's standpoint, the master is a positive. My disk is a master.

By matrixing the master's surface, a negative mold can be formed. This negative mold, or stamper, is strong enough to stamp a positive copy of the master using a heated composition material to produce the finished record. That was the birth of the one-sided 78-rpm record.

#### References:

Barnum, Frederick O. *His Master's Voice in America*. Camden, N. J.: General Electric Co., 1991, pages 7-11.

Fabrizio, Timothy C. & George F. Paul. *The Talking Machine*. Atglen, Pa.: Schiffer Publishing, Ltd., 1997.

Drawing by Fred Geer: E. Berliner's Gramophone, February 19, 1895, patent # 534,543.

(Fred Geer, 6042 Brookridge Rd., Jacksonville, FL 32210)

Fred Geer's radio collecting began in 1953 with a Shure microphone and an RCA R-32. In addition to his 300-plus collection, he owns around 2,000 old-time radio shows, which he can broadcast to any radio in his house. Through his articles, he enjoys sharing various aspects of radio collecting and history.



# PHOTO REVIEW



This column presents in pictorial form many of the more unusual radios, speakers, tubes, advertising, and other old radio-related items from our readers' collections. The photos are meant to help increase awareness of what's available in the radio collecting hobby. Send in any size photos from your collection. Photos must be sharp in detail, contain a single item, and preferably have a light-colored background. A short, descriptive paragraph **MUST** be included with each photo. Please note that receipt of photos is not acknowledged, publishing is not guaranteed, and photos are not returned.



**EKCO MODEL 312** – This 2-tube AC radio is of 1930 vintage. The cabinet is completely made of Bakelite material. (Jim Taylor – Winton, Bournemouth, England)



**SCHNEIDER-OPEL CRYSTAL SET** – This crystal set was manufactured in Frankfurt Germany by the F. Ehrenfeld Company. The detector has been missing since I acquired it in the early 1950s. Otherwise, it is complete. (Norman Hart – Clearwater, FL)



**ZENITH "LONG DISTANCE"** – This solid wood, AM only portable, ca. 1948, has a 5-tube chassis and the usual plug-in loop antenna similar to the Trans-Oceanics. (Wally Worth – Wollaston, MA)

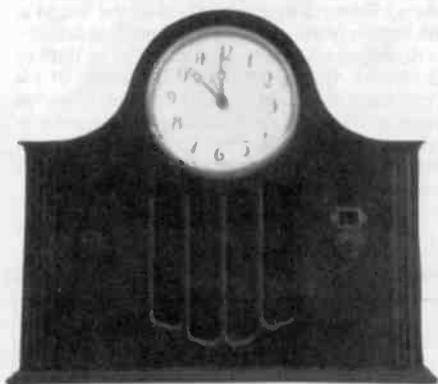

**INGRAHAM CLOCK/RADIO, MODEL UNKNOWN** – This clock/radio was recently purchased at a local antique shop. The clock and cabinet bear an Ingraham label, but the label is missing from the radio chassis. It appears to be of an early to mid-1930s vintage and has a complement of 5 tubes — Types 224 (3), 47, and an 80 rectifier. (Craig Tipton – Perry, OH)

## PHOTO REVIEW



**ATWATER KENT MODEL 768Q** – When found in a stockpile of 500 radios, this 1933 tombstone needed its battery wires replaced. It is similar in cabinet design to the Atwater Kent Model 447, except that this model is a 6V DC receiver. It has 2 non-original knobs. (*Mark Minks – Liberal, KS*)



**MIDGET CELLULOID SPEAKER, MODEL AND MANUFACTURER UNKNOWN** – This tiny hom speaker is only 5 1/2 inches tall and is made of black celluloid. The base is similar to that of the familiar Tower Midget celluloid speaker, and the internal driver is manufactured by Tower as well. If anyone has information about its identification, please write A.R.C. (*Dave Crocker – Mashpee, MA*)



**AUDIOLA 4P** – The cardboard case for this 4-tube set is 1/8" thick, except for the front panel, which is doubled up to 1/4" to support the heavy speaker. The label says, "made in Plant A Chicago under RCA patents, ca. 1934." (*Wally Worth – Wollaston, MA*)



**ROLL-O 1-TUBE RECEIVER** – This 1-tube, 6" x 8" receiver with a slant front was made by Roll-O Radio Co., Cincinnati, Ohio. Does anyone have information about this company? (*Ed Bell – Raleigh, NC*)



# RESTORATION TOPICS

## Capacitors in Old Radios - Part 2 Paper Capacitors

BY RAY BINTLIFF

*In this second of a series of articles on capacitors, Ray Bintliff describes and illustrates some typical capacitors that the reader may encounter while restoring and repairing old radios. Part 1 appeared in the December 1997 issue. Future articles on this subject are promised. (Editor)*

My original plan was to describe commercial capacitor testers in Part 2 of this series. However, it now seems more appropriate to take a detour and describe some types of capacitors that you may encounter when working on old radios. So let's start with paper capacitors.

### EARLY PAPER CAPACITORS

Some early battery sets use paper capacitors as bypass capacitors in the B+ circuit with values in the order of 0.1 to 0.5 mF. Two examples are shown in Figure 1. The example on the left was "cooked out" of a flat rectangular metal can — some of the paraffin used to pot the capacitor is still present. A number of these capacitors that I have replaced carried internal markings of "Made in Germany." Figure 2 depicts some paper capacitors produced by Sprague. These flat-wound types were phased out in favor of the tubular type with pigtail leads.

### TUBULAR PAPER CAPACITORS

Figure 3 shows some capacitors removed from an Atwater Kent radio that are representative of early tubular types of paper capacitors. The capacitor at the bottom is a single 0.25mF unit. Above it is a dual unit that contains two capacitors with a common ground lead. At the top is a triple-unit capacitor with a common lead. Atwater Kent may have pioneered the use of multisection tubular paper capacitors. What say A.R.C. readers?

Another example of a dual capacitor is shown in Figure 4. This unit consists of a 0.03 mF coupling capacitor and a 0.001 mF plate bypass capacitor. The pigtail leads are connected to the coupling capacitor. Connections to the bypass capacitor are made by one pigtail lead and the mounting/grounding strap.

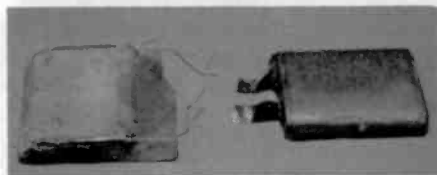

Figure 1. Two examples of paper-dielectric, flat-wound bypass capacitors, each with different types of leads.



Figure 2. Early paper capacitors from Sprague. Their values, left to right, are 0.25, 0.02, 0.02 and 0.01 mF. All are rated at 400 vdc, except for the 0.01 mF, which is rated at 500 vdc. Note the flat tinned-copper, solder-lug type of leads.

### CAPACITOR STYLES

Depending on the vintage of your radio, you are apt to find a broad range of paper capacitor styles, as Figure 5 illustrates. At the top is a paper capacitor used as a phone condenser in an early battery set. Below it is another example of an Atwater Kent capacitor from the early 1930s. Next is an RCA-made 0.1 mF capacitor from the mid- to late-1930s followed by a Comell-Dubilier "Blue Tiger." At the bottom is an Astron 0.005 mF capacitor in a molded case, probably from the 1950s.

### PHILCO BAKELITE BLOCKS

Philco used a very distinctive style of capacitor in its radios during the 1930s and to a limited degree until 1948. Some examples of these unique capacitors are shown in Figure 6. The Bakelite block capacitors consist of a black Bakelite case, or shell, in which one or two capacitors are installed, and then wired to the appropriate terminals and sealed in place with a tar mixture. In addition to the terminals used for capacitor connections, the cases used dummy terminals that served as tie points for other components. Curiously, Philco reverted to the flat-wound type of construction for the capacitors used in these blocks. A detailed description of these unusual capacitors may be found in my book *The Radio Collector's Guide to Philco Bakelite Block Capacitors*.

### SEALING AND IMPREGNATION

The manufacturers of paper capacitors must have recognized early on that it was necessary to protect capacitors from contaminants and moisture. The man-



ufacturer of the phone condenser, shown in Figure 5, made no attempt to seal that device. The Atwater Kent capacitor, also shown in Figure 5, is sealed with wax. In production the capacitor was assembled in a cardboard tube, its open ends sealed with wax, and then the completed unit dipped in hot wax.

The Philco Bakelite blocks were sealed by pouring molten tar into the inverted case. While such a process sounds like a good one, in actual practice it turned out to be ineffective because the tar shrank over time and the seal was broken.

Figure 7 shows the type of construction used in the RCA capacitors. The capacitor is wax impregnated and mounted in a cardboard tube, but the ends are not filled with wax to retain the capacitor. Instead, fiber

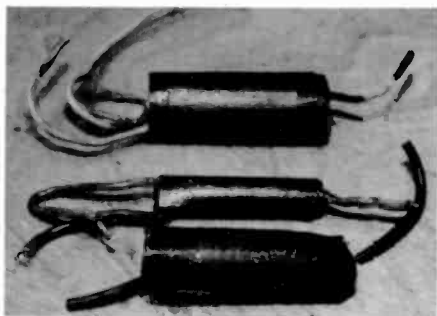

Figure 3. Examples of Atwater Kent tubular capacitors from the early 1930s.

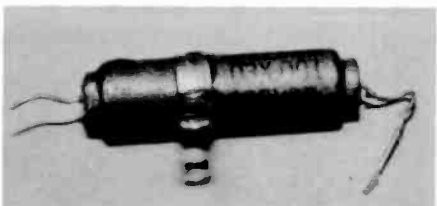

Figure 4. A dual-section tubular capacitor that performs both coupling and bypass functions.

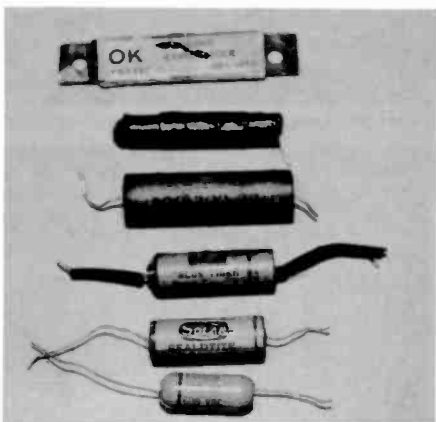

Figure 5. Some typical tubular paper-dielectric capacitors spanning the period from the 1920s to the 1950s.

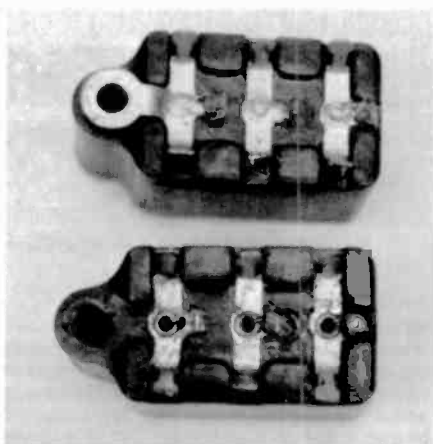

Figure 6. Two examples of the Philco Bakelite block capacitor.

discs (with a center hole) are slipped over the wire leads and then the ends of the cardboard tube are crimped. This arrangement works well unless the leads are stressed – then the soldered leads will separate from the capacitor resulting in an open or intermittent capacitor. This failure mode was common in the IF strip of RCA's pre-World War II TRK-12 and -120 TV sets.

The capacitor in the Cornell-Dubilier Blue Tiger is wax impregnated and mounted in a cardboard tube with wax-filled ends. However, the wax is much harder than that used in the Atwater Kent capacitors.

A number of manufacturers produced capacitors housed in molded cases. The Astron unit is only one example of a molded tubular capacitor. Sprague must have made millions of those capacitors in the molded black plastic cases with the colored stripes that identified the capacitance value, voltage rating and tolerance. To promote its color-coded tubulars, Sprague furnished a plastic decoder to assist the user in determining the characteristics of these capacitors. A front view of the decoder is shown in Figure 8. Turning each of the six dials to their appropriate color setting gave the user a direct readout of the capacitance, tolerance and voltage rating.

The construction of a Sprague molded tubular can be seen in Figure 9. This exploded view is *really* an

*(Continued on following page)*



Figure 7. Type of construction used in the RCA capacitors.

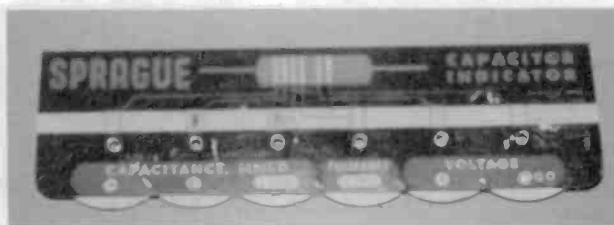

Figure 8. A front view of a Sprague Capacitor Indicator.

(Capacitors in Old Radios - Part 2, continued)

exploded view. This capacitor was taken from a radio in which it was used as an AC line bypass. Obviously, the radio took a power line surge and the excessive voltage caused the capacitor to explode. The message here is that when you replace a line bypass capacitor be sure to use an AC-rated capacitor or a ceramic capacitor with a voltage rating of at least 1KV.

Some of the methods used in capacitor production are illustrated in Figure 10. Shown from left to right are the crimped method used by RCA, a solar capacitor with an extremely hard wax compound as its sealing material, and the soft wax seal on a CD Blue Tiger.

#### WHAT'S IN A NAME?

Capacitor manufacturers gave fanciful names to some of their capacitor lines - such as Cornell-Dubilier's Dwarf Tiger, Blue Tiger, Blue Beaver; Solar's Red-Cap, Little Giant, Sealclite, Domino and Tom Thumb; and Sprague's Atoms, and Pinheads.

#### CAPACITORS IN A CAN

Multiple paper capacitors used in filter and bypass applications were sometimes mounted in metal cans and sealed with wax or that nasty black tar. Used extensively in the 30s, these multisection capacitors (frequently called "capacitor blocks") were abandoned in favor of individual capacitors in later radios. Figure 11 shows three can-type paper capacitor blocks. All are multisection capacitors, two with wire leads and one with solder lugs. The block on the right is designed for mounting on the top of the chassis. The other two are under the chassis types.

#### REBUILD OR REPLACE

What do you do when you discover that your nice old radio has bad capacitors buried in that tar-filled can. You can rebuild the can using new capacitors or use point-to-point wiring to solder in new capacitors. Rebuilding requires that the old capacitors and potting

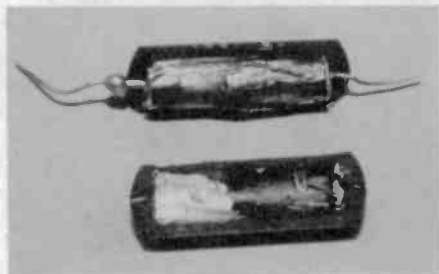

Figure 9. An exploded view of a AC line bypass capacitor that was subjected to excessive voltage.

material be removed — a very messy procedure. Removal can be accomplished by heating the metal can until the potting material melts and releases the capacitors. This is a subject that we will explore in some future article.

A simpler method is to cut all leads to the capacitors in the can and then solder in the new capacitors under the chassis. Unfortunately this approach is not always possible because of under chassis

space limitations.

Rebuilding has the advantage of preserving the original appearance of the radio both above and below the chassis.

#### MORE STYLES THAN CARTER HAS PILLS

The capacitors described in this article are presented as examples only. Obviously, there are many configurations of paper capacitors that cannot be included because of space limitations. In some future article, I will describe some paper capacitors that may be mistaken for mica capacitors and some other capacitor oddities. If you have a really weird paper capacitor, please send me a picture along with a brief description

(Ray Bintliff, 2 Powder Horn Ln., Acton, MA 01720)

Ray Bintliff, W1RY, holds an amateur Extra Class license. A retired engineer, he enjoys repairing and restoring pre-1945 radios and test equipment. In addition to Amateur Radio, his interests include electronic equipment design and audio reproduction.

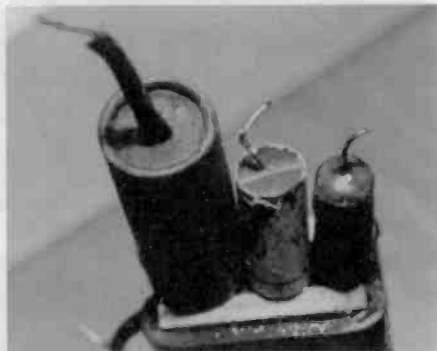

Figure 10. Examples of paper capacitor construction.

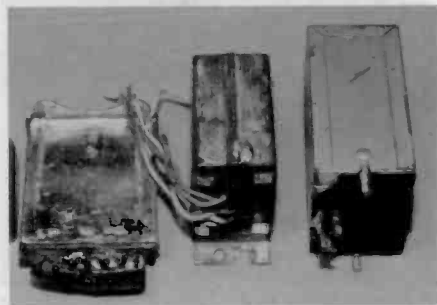

Figure 11. Examples of multisection capacitor blocks housed in metal cans.

DECEMBER 1984

# COLLECTING RADIO NOVELTIES

As Christmas is rapidly approaching, I thought you might be interested in seeing what the radio fans of the 1920's had on their Christmas shopping list. The photos below show board games with the themes all being radio related. As a collector who specializes in radio related novelties, I found collecting this series of board games quite a challenge. Perhaps there is a "Santa" out there who has a different one to put in my stocking (collection)!

## MERRY CHRISTMAS TO ALL!

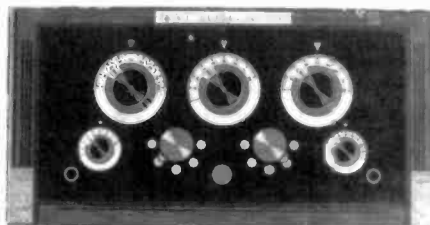



# VINTAGE TELEVISION

## Cliff Gardner — Electronics Pioneer

BY FREDERICK W. RINGWALD

November 1994 saw the passing of Bernard "Cliff" Gardner, electrical engineer, inventor, and electronics pioneer who helped develop the first all-electronic television system. Mr. Gardner held 28 patents for electronic tube devices and was first assistant to Philo T. Farnsworth who was the inventor of electronic television. Cliff began his long career in 1926, when electronic television was challenging mechanical television systems.

Gardner and Farnsworth were setting about to be the first to send "pictures through the air" in the manner we are familiar with today. Philo T. Farnsworth, or "Phil" as he preferred, was ready to prove that his idea about electronic television transmission, conceived years earlier as a teenager, was practical. Phil quite naturally chose as his right-hand man his new brother-in-law, Cliff Gardner, a friend he'd known for several years. Their previous professional relationship had dealt with the repair and home installation of radios in the Salt Lake City area.

By late 1926, Phil and Cliff had decided to relocate to the San Francisco area where financial backers and a ready supply of electronics parts and equipment were more readily available. Suitable laboratory accommodations were soon found at 202 Green Street. The original two-story structure still stands today and bears a historical marker.

### EARLY MECHANICAL TELEVISION

Sending "pictures through the air" was at this time accomplished by mechanical means using synchronized spinning disks as both a sending and a receiving device. A spiral of small holes in the disk would consecutively "scan" a swath of an illuminated image and thus modulate the electrical output of a photoelectric cell. A similar scanning disk system produced a recognizable although crude image at the receiving end.

Achieving the required synchronization of both disks was, however, often quite difficult. The limitations of mechanical television systems of the day seem obvious to us today, but great effort



Figure 1. Cliff Gardner creating a replica of the earliest "image dissector."

was being expended at the time to improve this technology.

### THE FARNSWORTH ELECTRONIC THEORY

Phil's fundamental idea, contrary to mechanical television, was to focus an optical image on a charged surface and then scan the image with a beam of electrons. The differing electrical charge at each point in the image would cause the strength of the resultant and returning electron beam to vary accordingly. Electron beam strength could then be ultimately used to modulate radio waves and control brightness line-by-line and to create an image at the receiver.

Accomplishing this task would require the design and construction of devices and parts that simply did not exist. Working at the lab's workbenches, often late into the night, Phil and Cliff created whatever they needed by hand. Cliff would soon become an expert glassblower, a skill essential to the creation of the world's first cathode ray tube for television.

Cliff also made the first "image dissectors," used to pick off the focused image, and tetrode tubes designed to handle the unique amplification requirements of the new television system. Phil and Cliff continued to invent, reinvent and perfect their devices, and the final product bore little resemblance to that of earlier and often frustrating efforts. Near tragedy struck when fire engulfed the laboratory one night causing much damage. Luckily a great deal of equipment was salvaged, and they were soon back on track.

Cliff's first truly successful television cathode-ray tube was about 7 inches in length with a 3-inch face displaying an image not more than an inch wide.

Finally, after nearly a year of intense effort, their first all-electronic television transmission displayed a simple horizontal line. A week later on September 7, 1927, with a small but full raster and a cardboard cutout, the first two-dimensional image was formed.

A few months later, in May of 1928, Phil and Cliff's financial backers and other interested par-

ties were invited to a demonstration of the world's first functioning all-electronic television system. Earlier, Phil had asked Cliff to make up a few slides or silhouettes and use them to transmit 2-dimensional images. As a joke, Cliff crafted a slide that resembled a dollar sign or "\$." It seems the bankers had often asked when they would "finally see some money in this venture," and Phil wasn't about to let them down. All those attending appreciated the joke.

The exhibition was set up with the transmitting equipment in one room and the receiving equipment in another. While Cliff was changing slides in front of the image dissector located in the sending room, someone in the receiving room noticed what seemed like clouds floating through the image. It turned out that Cliff was the cause of these mysterious clouds. He was creating electronic television's first moving image when he blew puffs of cigarette smoke into the television camera's field of view!

### FIFTY YEARS LATER

Exactly fifty years after the original event, on September 7, 1977, a re-creation of the exhibition was held at the Foothill College in Los Altos Hills, California. At the last minute, Cliff had to fabricate an image dissector since no working original could be found. He successfully produced a fully functioning replica, as shown in Figure 1.

Mrs. Philo T. Farnsworth was present at the anniversary events and has the distinction of being the first person ever televised via an electronic television system. Mrs. Farnsworth, now a resident of Fort Wayne, Indiana, is active in furthering the public's awareness of what Phil and Cliff accomplished. She is also involved as a consultant for the upcoming motion picture featuring the career of Philo T. Farnsworth.

Cliff Gardner would eventually hold 28 U.S. patents for his television-related inventions and other innovations concerned with electron tubes.

Together Phil and Cliff won the court fight with rival television pioneer Vladimir Zworykin over the invention of the iconoscope, a later form of image dissector. Unfortunately the U.S. Patent Office never found the time to change its own records.

Cliff Gardner was a Life Fellow of the IEEE and after an extremely productive career, retired as vice-president of Varian/EMI. The *Who's Who of Engineering* amply lists his accomplishments. Sixty-seven years after helping to create all-electronic television, Cliff Gardner died at his home in Colorado Springs, Colorado, November 20, 1994.

(Frederick W. Ringwald, 2909A Mesa Rd., Colorado Springs, CO 80904)

### References:

*Colorado Springs Gazette Mercury*, April, 22, 1991; November 21, 1994.  
 Farnsworth, Elma G. *Distant Vision, Romance and Discovery on an Invisible Frontier*. Salt Lake City: Pemberykent Publishers, Inc., 1990.  
*San Jose Mercury*, September 8, 1977.  
*Who's Who in Engineering*.

**Credits:** Jill Gardner Hoover (Gardner's daughter) — recollections, photo, and patent papers; and Elma G. Farnsworth (Gardner's sister).

*Frederick Ringwald has been a collector of radios and especially of pre-1950 televisions for almost twenty years. His interest in early pioneers began after he had restored an early Farnsworth 651P TV. He then got to know Cliff Gardner and his family, all living in his hometown of Colorado Springs. For a time, Fred worked on Shemya Island, Alaska, for Raytheon, a company that once employed Cliff Gardner to head its tube department. Shemya Island was also once the site of a communications system built during the 1950s by personnel employed by none other than Philo T. Farnsworth.*





# RADIO MISCELLANEA

"Radio Miscellanea" includes items of general interest selected from A.R.C.'s incoming correspondence. "In The Marketplace" items are based on information submitted by the businesses themselves. "From The Internet" items are obtained from internet newsgroups and other internet resources. Submitted items should be verified for accuracy; items may be edited by A.R.C. for publication, and publication is not guaranteed. See the masthead for more details.

## Against "Webizing"

Dear Editor:

I am not happy about your decision to "webize." The push for the web is by people mainly interested in quick sales, the buck. There is nothing wrong with making a buck — I do it myself, and I use A.R.C. I am also familiar with the tone of radio web sites. The people who want the internet already have websites anyway. So what's the point?

This is my point: Who is going to bother to read the ads in A.R.C. when you can surf the web like a gerbil on crack? I don't have a computer. What are my chances of finding something in the A.R.C. classifieds when I get it second class? Surely, you must be getting more mail against the web than for the web. It's my opinion that you print more pro-web letters than anti-web letters.

Vaughn Rudisill, Deer Park, NY

*Adapting to the concept of "webizing" is not easy. What needs to be understood is that people who read the web are no different from people who read the magazine — both are readers. The web is just another way to distribute the magazine, and also to provide an avenue for both groups to participate in a single market place.*

*As for letters pro and con the web, we have done our best to present both sides of the argument, and some months, we have to search deeply into our mail pile to find a letter against the web. The fact is that the computer, like the telephone, has become a way of life. (Editor)*

## The Perennial Mailing Problem

Dear Editor:

FYI: One of the reasons I dropped my subscription was that even by First Class mailing, most of the good deals were gone. I even went home early from my office to get my copy to call and heard mostly "sold."

I honestly think that internet plus hard copy would increase your subscriptions. I would subscribe via the net for less, with a later date for the hard copy.

Lee Rhoden, Dallas, TX

Dear Editor:

I have debated whether to continue my subscription of A.R.C. The problem is not with the publication itself, but the mailings. I subscribe by First Class and have called minutes after receiving my issue, only to find the item sold. I find this situation unacceptable, and I hope that you will renew your efforts to make it a level playing field for all your subscribers.

Lee McGough, Medina, OH

*The internet is a way to level the playing field! Finally the mail delivery problems can be wished away. Modem technology offers the ultimate solution to the perennial problem of late delivery by the U.S. Postal Service.*

*However, regardless of how you receive the magazine — by First Class mail, by Periodical mail, or via the internet — only one person can be the first caller. The internet will just shorten the length of the receipt time from days to minutes — it still will not guarantee that the item will be there when you call. (Editor)*

## A Gem Web Site

Dear Editor:

I am relatively new to the internet, and it seems that 'round every corner there is a gem web site and yours is no exception. Old radio has been an interest of mine for many years, and to find a fact-filled web page like yours is a dream come true. I congratulate you on an excellent page.

Paul J. Jarvis, Near Winsor, U.K.

## The Internet Issue

Dear Editor:

In response to some comments in the September issue about my July letter to the editor concerning the internet, I have never concluded that all folks who do not use the internet are "troglodytes." I would never paint with such a broad brush. Some people, for whatever reason, simply aren't comfortable with the internet. I accept that and am saying only that there is much to be gained from using the net, as I and other subscribers have outlined in A.R.C.

Thanks to A.R.C. for providing a forum where all can voice their opinions.

Tom Neeley, Cumming, GA

## No "Foot-dragging" on the Net

Dear Editor:

Glad to hear you are close to putting A.R.C. ads on the internet. One point to make with the detractors: some of us are not online yet, but this would hasten our doing so. Meantime, when each edition hits the net, I for one will just plan an hour or so at a friend's house, and I expect others can do the same. Don't let the "foot-draggers" delay your implementation.

Dave Davies, Nokomis, FL

## Computer Limitations

Dear Editor:

Thumbs up on the September '98 issue. The photos of "Radio Row" were awesome and O.T. Andy Anderson's article was filled with much common sense. As for the ongoing debate about the magazine vs. the internet — nothing will ever replace the book form, as I cannot take my computer into the bathroom!

Robert Gardner, Fort Pierce, FL

*Not yet, but just wait. (Editor)*

## The Internet Will Not Help

Dear Editor:

Just my 2¢ worth. I don't think that putting A.R.C. ads on the internet will help you in any way. You have a unique market niche, and it seems as if it is about to be vaporized as A.R.C. becomes "just another" one of the many classified lists on the net.

Harry White, New Haven, CT

Dear Editor:

You are doing a fine job. Please no internet!  
Norton Thompson, Paonia, CO



**WANTED:** Antique brass microscopes. Scientific and medical apparatus. Optical and electrical. Wissner, Box 102, Ardsley, NY 10502. (914) 693-4628. E-mail: [wissner@bestweb.net](mailto:wissner@bestweb.net)

**WANTED:** Pierson-Holt communications receiver, Model KE-93, also Gonset communications receiver Model G-66. Gus Muchitsch, PO Box 487, Tivoli, NY 12583. (914) 757-5271, after 4 pm

**WANTED:** The juvenile fiction book, *The Hidden Aerial* by Theiss. Robert Stapleford, 1800 S.W. Randolph Ave., Topeka, KS 66604-3158

**WANTED:** Dead record cutting heads, and home disc recorders. West-Tech, PO Box 1415, Sebring, FL 33871

**WANTED:** Phonograph related items: Vogue picture records, Edison, Columbia, and any wax cylinder records, toy phonographs, needle tins and cutters, Nipper record dusters, puzzles, fans, calendars, pocket advertising mirrors, dealer lapel pins, phonograph toys, posters, broadsides, original dealer advertising items from Edison, Victor, and Columbia. Thanks. Bernie Seiberg, 714 Moredon Rd., Meadowbrook, PA 19046-1907. (215) 886-6124. E-mail: [phonoman-bernie@worldnet.att.net](mailto:phonoman-bernie@worldnet.att.net)

**WANTED:** RCA (or other) AM demonstrator, wall size, with functioning components. Tube, not transistor. Art Sabin, 315 Plymouth, Chicago, IL 60604. (312) 987-1441

**WANTED:** Copy of QST covers (front, back, inside) December 1916, June 1920, magazine issues. James J. McGrath, W210J, 2 Centerview Ln., West Seneca, NY 14224-2124. (716) 675-0160

**WANTED:** Hi-fi/commercial tube equipment, amps, preamps, tuners, etc. Marantz, Altec, McIntosh, Fisher, Scott, Dynaco, Western Electric, Leak, Quad, etc. Sonny Goldson, 1413 Magnolia Ln., Midwest City, OK 73110. (405) 737-3312. Fax: (405) 737-3355

**WANTED:** Gas-type open X-ray tubes, early Coolidge open x-ray tubes, no rotating anodes, one or a collection. J. Grady, 300 Foster St., Littleton, MA 01460

**WANTED:** Quack medical equipment, especially early shock/electronic stuff, any Abrams E.R.A. equipment such as oscilloclasts, dynamizers, etc. Tesla/Oudin induction coils. Magnetic therapy or any other scary or interesting stuff. Send picture/description or call David G. Rickert, 2107 5th St. Apt. 1, Arlington, VA 22204-1931. (703) 486-2782

**WANTED:** Super weird rabbit ears from 50s and 60s. Please send pictures and price. Mr. Alceu Massini, Av. Dom Pedro II 1804/111, Santo Andre, SP, Brazil, CEP 09080-001. Tel/fax: 011-5511-4997-6228

**WANTED:** Bogen M0100 or M0200 PA amplifiers, 8417 tubes, tube list for TV-7D/U tube checker that includes 8417, N.O.S. Electrolytics, 450V or more, useable guitar amp, 100w or more. Chip Schmidt, 2024 Hilton Dr., Cedar Falls, IA 50613. (319) 277-8504, evenings or weekends

**WANTED:** Vintage 9-volt batteries. Please write with make (logo) and price (shipped). Harry Schools, 8566 Glen Campbell Rd., Philadelphia, PA 19128

**WANTED:** A pinch roller for an Akai Crossfield M8 reel recorder, bad rubber OK. Anton Johannes, 3503 Rt. 52, Pine Bush, NY 12566

**WANTED: Crystal sets, diode radios & rocket radios. Toy crystal sets collection at 165 & growing. The Crystal Radio Guy, 3104 S.E. 20th, Portland, OR 97202. (503) 231-9708**

**WANTED:** Chassis only for Emerson BT245 or AU190. Dial must be good. Bruce Phillips, 127 Bunker Hill Ave., Stratham, NH 03885. (603) 772-7516. E-mail: [gxxL02A@prodigy.com](mailto:gxxL02A@prodigy.com)

.....  
 • A.R.C. Advertising Policy  
 • Sellers and Buyers, Please Note!  
 • Advertising is accepted only for early items  
 • related to radio, communication, etc. All  
 • items must be described fairly; reproduc-  
 • tions, reprints and not-original items must be  
 • so identified. Advertisers must agree to re-  
 • spond promptly to inquiries and orders, to  
 • resolve problems promptly if the buyer is not  
 • satisfied, and to comply with a buyer's  
 • refund request on unaltered returned items.  
 • .....

**WANTED:** Old telegraph keys and related equipment, Western Union items, etc. Gerry Maira, 31 Prospect St., Fredonia, NY 14063. (716) 672-5389

**WANTED:** For Zenith 10S567, tone control plastic pushbutton and bezel assembly for left side, also plastic station pushbutton and bezel for right side. Will buy entire chassis if necessary. Robert Pote, 766 Ashford Ln., Greenwood, IN 46143. (317) 881-5721

**WANTED:** Service info for stereo 5501 hi-fi radio/cassette made by ITT Schaub-Lorenz. John Phipps, 1412 Navaho Trl., St. Charles, MO 63304-7325

**WANTED:** Motorola '30s/'40s console, lazy boy, chairside, other interesting radios. Robert M. Sonnicksen, 242 Albion Ave., Park Ridge, IL 60068

**WANTED:** Transistor Zenith Trans-Os, German table radios (especially SABA) will buy in Germany in U.S. currency und ich kann auf Deutsch entsprechen, USA 6973s N.O.S. the old configuration that feeds pin 8 into the grid, Hickcock 850As and forward. Always happy to get your for sale list of anything by fax at (770) 492-1177. Almost always buying, pay a fair price in cash. Thanks for reading. Ed Saunders, 2156 Hanfred Ct., Tucker, GA 30084. (770) 492-1025, anytime; (770) 938-8606, home. Fax: (770) 492-1177. E-mail: [ed@acitydiscount.com](mailto:ed@acitydiscount.com)

**WANTED:** International crystal/citizen bander A2 icebox; Radson telephone Type CB. C. Zafonte, RR3 Box 2075, Fort Kent, ME 04743. (207) 834-6273, eves./weekends

**FOR SALE:** Accurate Instrument signal gen. & tracer Model 153 - \$25. B&K Model 960 transistor radio analyst - \$25. B&K Model 970 radio analyst - \$40. EICO Model 232 VTVM - \$15. TEC Model TOT 200A transistor analyst tester - \$25. EICO 147A signal tracer - \$15. Precision Series 912 electronic tube tester - \$25. Precision E-200-C signal gen. - \$15. Dynaco Model SCA-80Q stereo amp, as is - \$30. Tech Master mono power amp, as is - \$30. (20) 10.5 audio tape 1/4 x 2,500 feet on 1 1/2 mil mylar professional tapes on aluminum reel-to-reel - \$100. Craftsmen 10 FM/AM tuner - \$30. Heathkit sine square audio gen. Model IG18, as is - \$20. Old new stock Peerless audio output transformer S-265-Q. Best offer still in the box. EICO 378 audio gen., mint - \$40. Heathkit Model G-5 signal gen. - \$15. Heathkit Model T-2 signal tracer - \$15. (1) pr. JBL Le8T woofers, need re-cone - \$40. Sencore LC53\*Z meter cap-ind analyzer - \$150. Fisher 80 tuner & MPX 200 stereo all - \$80. Akai 1730 DSS 4-channel reel-to-reel - \$50. (1) pr. Carvin PS10 pro series 200W8 ohms speakers - \$100. SAE Mark XXXIB stereo power amp, as is - \$30. Phase Linear 400 stereo power amp, as is - \$60. Admiral TV chassis 19A1 with Sam's schematic and open to offer, it needs to be restored. On ppd order we pay shipping under 65 lb. Open to offer. Dale Shuler, 1208 Greenwood Ave., Akron, OH 44320. (330) 865-4685. Fax: (330) 535-5756

**FOR SALE:** Working Scott Phantom in refinished Warrington cabinet, chrome is fair - \$1,500. Gary Glazier, 3031 El Caminito, La Crescenta, CA 91214. (818) 248-1693

**FOR SALE:** Lists on following, each a LSASE. Sets TVs test eqpt. mil sets on pick up only. Tubes - close out. Tuners/amps AM-FM. Large blade knife throw switches. Large insulators. Books, service data catalogs, other paper. F. Krantz, 100 Osage Ave., Somerdale, NJ 08083-1136

# Notice

## Play Things of Past

mail order customers please note:

We will be doing a limited business during the month of December while we move into a new building. Please call before placing any orders.

Gary B. Schneider

Play Things of Past  
9511-23 Sunrise Blvd.  
Cleveland, OH 44133

(216) 251-3714

**FOR SALE:** Must sell, negotiable. Radios, amplifiers, ham, parts, more. Large list - \$1 and SASE. Joseph Bedlovics, PO Box 139, Stratford, CT 06497

**FOR SALE:** Stromberg-Carlson Radio Apparatus Catalog, 1930 (receivers, speakers); 6-page (copy) - \$4 ppd. Gary A. Micanek, 226 Henry Ave., Manchester, MO 63011. (314) 227-7046

**FOR SALE:** Have many many transistor radios for sale. Will sell one or all. Douglas Ferrero, WB8YNYZ, 70173 Hillside Ct., Romeo, MI 48065. (810) 336-0120. E-mail: ynzdsd@bignet.net

### RATE FOR ADDITIONAL WORDS:

29¢ per word

### FIRST 20 WORDS FREE!

Cash or stamps OK for small amounts.

Your payment helps to keep A.R.C. healthy!

**FOR SALE:** Jerrold: 5100 Logarithmic tic amplifier, 1015 sweep generator. Texas Inst. calculator, older. Military PRC-9. Krajovic, N3DKS, 546 Sheridan, Pittsburgh, PA 15206. (412) 665-0916

**FOR SALE:** Check any TV w/Anchor Chek-Tube converter, includes test tube and adaptors, 6 different current and voltage settings, especially good for those Philco Predictas - \$40. Cathode Ray Tubes #906-#910-#3AP1-#3BP1-#1802-#5BP1-TP400 all good filaments - \$10 ea. RCA yokes and flybacks - \$10 to \$20 ea. We need part numbers not drawing numbers. Big Table Radio Sale (30% off Bunis prices), send LSASE for list. Plus postage. J.J. Papovich, 53 Magnolia Ave., Pitman, NJ 08071. (609) 582-8279. E-mail: jjpapo@juno.com

**FOR SALE:** Original Zenith stock certificates - \$20 + ship. Barry S. Dagestino, 620 W. Wedgewood Ln., La Habra, CA 90631. (714) 526-5371

**FOR SALE:** Transistor: radios, books, regular, novelty, LPs, clocks, watches, advertising goodies. List: SASE. Douglas Low, PO Box 452, West Street, Annandale, NJ 08801

**FOR SALE:** Guild Country Belle wood telephone radio - \$75. RCA Strato-World S/W portable leather case #3BX671 - \$150. Hallicrafters HT-18 transmitter - \$175. Frank J. Manzano, 82 Monhegon Ave., Oakland, NJ 07436. (201) 337-5263

**FOR SALE:** Dual electrolytic capacitors. 50-30 mF. at 160Vdc - \$3.75 ea. for 4 or more. Includes P&H. Many other types in stock. Write, phone, or fax for free flyer. DH Distributors, PO Box 48623, Wichita, KS 67201-8623. (316) 684-0050, v/f

### OLD TIME RADIO BROADCASTS ON CASSETTES

Many of your old time radio favorites are available on quality cassettes at a reasonable cost. You select the shows you want and purchase them by the hour. Fast, friendly service too. Send for our catalog listing over 5,400 shows arranged by show category & title, many including original broadcast dates.

Only \$2.00 (P & H). Send request to:

ERSTWHILE RADIO — P.O. BOX 2284  
PEABODY, MA 01960



**WANTED:** Atwater Kent 447. Fairbanks-Morse Semaphore dial tombstone. Large Pilot, Fada tombstones. Curt Schreiber, 3923 E. Latoka St., Springfield, MO 65809. (417) 887-5184, collect. E-mail: Curtradio@aol.com

**WANTED:** Cabinet for Majestic 5A430 table model, wood. Jim Bumstead, 87 Sherman Ave., Williston Park, NY 11596. (516) 746-3811. Fax: (516) 873-1698

**WANTED:** Doerle, Haynes or similar regen. rcvrs, late 30s. Popular Science mags. 1936-1940. Carl Davis, 201 E. West St., Georgetown, IL 61846

**WANTED:** Need badly front door latch for 8G005 or any other latch at all. Will trade other T-O parts. Jim Montague, 1907 S. Stanley Ln., Spokane, WA 99212. (509) 535-9576

**WANTED:** Chrome/fo-noise switch for Akai GXC-75D stereo cassette deck. Roland Jennings, 1907 Seneca, Leavenworth, KS 66048. (913) 682-8281

**WANTED:** Klitzen radio from Racine, Wisc. Also, any Radiodyne items. Jim Mercier, 3911 Lathrop. Racine, WI 53405. (414) 554-0488

**WANTED:** Zenith Trans-Oceanics, all models. Zenith military Trans-Oceanics R520/JRR, R520A/JRR, R-1000M, ZX5. Zenith military metal cased receivers and transmitters. Frank J. Manzano, 82 Monhegon Ave., Oakland, NJ 07436. (201) 337-5263

**WANTED:** Theatre/hi-fi/commercial speakers: coax, woofers, horns, cabinets, drivers, etc. Altec, Electro-Voice, JBL, Tannoy, Western Electric, Jensen, Goodman, etc. Sonny Goldson, 1413 Magnolia Ln., Midwest City, OK 73110. (405) 737-3312. Fax: (405) 737-3355

**WANTED:** Tuning capacitor drive from Philco 70 or 90 including disc. J. Grady, 300 Foster St., Littleton, MA 01460

**WANTED:** Trying to complete set of old Popular Electronics Annual Communications Handbook and Semi-Annual Communications World. Can you help? Harry Schoels, 8566 Glen Campbell Rd., Philadelphia, PA 19128

**WANTED:** Philco Model 111 Highboy. Also looking for speaker and cabinet for Grebe M1-2 or HS-7. Junker OK. Also need RCA phono Model RP158 to complete restoration of GE LFC 1128 radio-phono console. Alan Kalivas, 7 Anderson St., Peabody, MA 01960-3713. (978) 535-8175

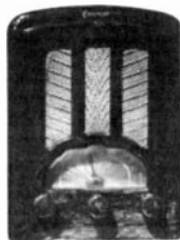

**WANTED:** Emerson Catalin radios. Nobody pays more than I. What an arrogant and inaccurate thing to say. I mean, like there isn't anyone wealthy enough, dumb enough, desperate enough – or any combination of the three – to pay even a dollar more than I would pay. I mean, c'mon, who am I trying to kid! Please write or call collect: Rain Buttignol, 214 State St., #7, Portsmouth, NH 03801. (603) 427-1384

**WANTED:** Transistors. Sony TR-55, TR-63 red, TR-66, Toshiba 3TP-315, Hitachi TH-668 and others. Toshiya Abiko, Safuran Heights 202, 2254-1 Goi, Ichihara-city, Chiba Prefecture, 290-0056, Japan. Tel.: 011-81-436-24-5510. E-mail: JDN06224@nifty.ne.jp

## A. G. Tannenbaum

Electronic Service Data  
PO Box 386, Ambler, PA 19002  
Phone: (215) 540-8055  
Fax: (215) 540-8327



FOR

Vintage Parts & Service Data  
1920's - Present

Free Catalog  
Credit Cards Welcome  
Browse our web page at  
[www.agtannenbaum.com](http://www.agtannenbaum.com)

## YARD SALE!

(GRILLE CLOTH)

~~\$20~~ per yard (51" x 36") for any quantity of yards of these patterns: #15, 16A, 17, 19A, 20, 21, 22, 23, 24, 25, 26, 27 until gone.

~~\$15~~ per yard for #11 - SOLD OUT

### 4 New Patterns!

#30 and 31 are not what I expected so I'm selling them cheap to recover my costs - \$12/yard! (36" x 44"). (If you can use a low cost generic look, this works.) #32 is a rust-colored Philco 90 type pattern for late 30's Zenith. #33 is for Buddy Boy, Kennedy tombstone and Temple speaker, and others.

Send 55¢ LSASE (4" x 10")  
for full set of samples.

MICHAEL KATZ  
3987 DALEVIEW AVENUE  
SEAFORD, NY 11783

(516) 781-6202 (EVENINGS/WK-ENDS)

**FOR SALE:** (6) RCA 44 flags, original condition, all black and white call letters - \$225 ea. Mike Dupuis, 116 First Ave., Tuckerton, NJ 08087. (609) 296-4883

**FOR SALE:** Sams TSMs, transistor manuals. All 159, set only - \$350. Heavy, pickup only. Bob Schafbuch, 2811 Highland Ave., Carrollton, KY 41008. (502) 723-9650. E-mail: rjs@kih.net

**FOR SALE/TRADE:** Warfedale sand-filled baffles, six speakers each, beautiful. **WANTED:** International Allwave duo cathedral. Nevins Museum of Radio, Ken Nevins, 406 Jipson St., Blissfield, MI 49228. (517) 486-3019, evenings please

**FOR SALE:** 30K + vacuum tubes, new/used tested. Prices below AES! Send 2 stamps for list. Robert Taylor, PO Box 10503, Bradenton, FL 34282-0503. (941) 751-1072

**FOR SALE:** National HRO-50T collection, 6 units, ABCD coils for each, some spare parts, all need cosmetic restoration - \$500 for all. John P. Tiedeck, WA2SDE, 212 Grandview Rd., Media, PA 19063. (610) 566-8049

**FOR SALE:** Rubber gasket for Zenith/other dial glasses, 3 ft. - \$6; 6 ft. - \$11 ppd. Curt Lutz, 1021 N. Hickory Pl., Broken Arrow, OK 74012. (918) 251-4915. E-mail: antiqradio@aol.com

**FOR SALE:** Radio News and other magazines - \$2 ea. plus shipping. Contact for list. Richard Lang, 43 Nottingham Cir., Lebanon, NH 03766. (603) 448-0277. E-mail: RHL003@aol.com

**FOR SALE:** N.O.S. tubes. 31s - \$5. 35/51s - \$3. 46s - \$10. 71As - \$15. Plus shipping. Willie Carr, N4XE, 2739 Colonial Ave., Roanoke, VA 24015-3835. (540) 343-5606, call before 8 pm

**FOR SALE/TRADE:** Bogen tube receiver MD SRB-40 AM/FM for your pocket/novelty or - \$40. Paul Fulton, 711 Jacquelyn Rd., Westwood, NJ 07675. (201) 664-5260

**FOR SALE/TRADE:** Green Addison A2, Puglarcito (smallest Bakelite/Plaskon ever made), AWAs, circular Ekcos. Check October's A.R.C.! Simon Wade, Finchcroft, Broadwater Down, Royal Tunbridge Wells, Kent TN2 5PE, United Kingdom. Telefax: (44) 1892 543505. Images on e-mail: Simonwade@aol.com

**FOR SALE:** Stud mount, clamp mount, twist prong, and octal based capacitors. New manufacture. Call or write for free flyers. DH Distributors, PO Box 48623, Wichita, KS 67201-8623. (316) 684-0050, v/f

**NOTICE TO ALL  
CLASSIFIED ADVERTISERS!  
OUR CLASSIFIED AD DEADLINE IS  
12:00 NOON  
ON THE 10th OF EACH MONTH**

**FOR SALE:** Novelty transistors, Radio Shack battery, works - \$25. Windsor cathedral radio (works on low volume) - \$15. Wood table sets: Airline DC, Model 64BR-1208A, NT - \$20. Silvertone Model 6421, works, excellent original finish - \$45. Philco 48-461, NT - \$15. All sets plus UPS. James M. Seal, 3309 Boatman's Mountain Rd., Morristown, TN 37814. (423) 581-8269, after 4 pm

**FOR SALE:** Tubes 6CW4, 6FQ7, 6JB6, 5823, 7586, all 6Y6, 6EJ7, (2) Heath VTM meters new, 8GJ7, 9GH8, some in wholesale box. Frank H. Montgomery, 505 Congress #710, Havre de Grace, MD 21078. (410) 939-2099

**FOR SALE:** Bird dummy load RF wattmeter DA 140/AP; Cornell-Dublier decade capacitors, CDA, CDC - \$20 ea. R. Allen, 399 Canterbury Tpke., Norwich, CT 06360. (860) 822-6096

**FOR SALE:** Zenith Trans-Oceanic 7000 no AM - \$99. Zenith T-O R7000 - \$199. Plus shipping. Jim Montague, 1907 S. Stanley Ln., Spokane, WA 99212. (509) 535-9576

**FOR SALE:** Tubes galore! Send SASE for latest list X. **WANTED:** M.S. military green connectors; and door knob capacitors. Fred Schmitt, N4TT, Typetronics, PO Box 8873, Ft. Lauderdale, FL 33310-8873. (954) 583-1340. Fax: (954) 583-0777

**FOR SALE:** (2) Collins R-388/URR military receivers, one works, one doesn't but complete - \$400 both OBO. Danny Brou, 212 Wainwright Rd., Pineville, LA 71360-5944. (318) 445-4843

**FOR SALE:** Zenith Trans-Oceanics: all original, complete, working, 100% cosmetically restored to showpiece condition: H-500 - \$225; L600 - \$225; 8G005Y - \$225. Frank J. Manziano, 82 Monhegon Ave., Oakland, NJ 07436. (201) 337-5263

**ANTIQUE  
RADIO DIAL SCALES**

We thank the readers of ARC and our many good friends around the world for your support and we extend to you our sincere best wishes for a happy holiday season.

# Seasons Greetings!

Now over 500 radio models included in our line of fine quality reproductions.

## Rock-Sea Enterprises

323 E. Matilija St., #110-241  
Ojai, CA 93023

BASE FOR LIST

(805) 646-7362 - dials@juno.com

<http://members.aol.com/RockSeaEnt/>

## WANTED ANTIQUETUBES

Arcturus, DeForest and earlier uncommon types. Send list for our offers.

See <http://members.home.net/fathauer>  
**George H. Fathauer**  
688 W. 1st St., Ste 4, Tempe, AZ  
602/921-9961  
e-mail [fathauer@home.com](mailto:fathauer@home.com)

# This Holiday Season, Give a Gift To a Friend... Or Treat Yourself !!



- Subscriptions..... Center Coupon
  - Books & Videos ..... pgs. 42, 43, 47, 50, 51, 75, 90-97
  - Gift Subscriptions ..... pg. 63
  - New Books: Check Them Out! ..... pgs. 31, 39, 65
  - Back Issues (*Great for new subscribers*)..... pg. 35
- Full Calendar Year of Back Issues - only \$24!*



## Antique Radio Classified *Is Your* **Gift Source !!**



Order From Our Web Site At "[www.antiqueradio.com](http://www.antiqueradio.com)"  
 ...Or, Call Us At (978) 371-0512  
 ...Or, Fax Us At (978) 371-7129



**FOR SALE:** (94) tube sets. Majority electrically restored. Beautifully refinished. Consoles, cathedrals, tombstones, table models. Absolutely no junk. LSASE. Doug McIntosh, 30062 Fox Run Trl., Granger, IN 46530. (219) 264-4658

**FOR SALE:** Gulbransen chassis 37223 with speaker, face plate and knobs, works - \$45 plus shipping. Phil C. Baker, 35 Topaz Dr., Chambersburg, PA 17201-8660. (717) 267-0632

**FOR SALE:** Zenith Trans-Oceanic Royal 3000-1 needs knob, etc. - \$50. Round dial Zenith - \$165. Renee May, 1242 N. El Centro Ave., Los Angeles, CA 90038. Ph/fax: (323) 464-9179

**FREE - 20 WORD AD EACH MONTH**

To get your free 20 words, include your SUB# with your Ad. Additional words are 29c each. Read inside back cover for details. **MANY THANKS!!!!**

**FOR SALE:** N.I.B. tubes priced each: (2) CX350 - \$235; (3) CX381 - \$25; (2) CX326 - \$15; (1) CX301A - \$22.50; (1) C335 - \$12; (4) X199 - \$25; (4) VT5 - \$40; (1) RCA 2A3 - \$50; (1) GE 6550 - \$15; (2) 1622 - \$6; (3) 6B4G - \$18; (8) 5U4GB - \$5.50; (1) 6JE6 - \$25; (12) 6SJ7 - \$1. Joe Svihel, 17227 Co. Rd. 54, Avon, MN 56310. (320) 356-7601

**FOR SALE:** Fada bullet replica radios, 3 colors available. See March 1997 A.R.C. p. 29 - \$20 shipped. Henry Trabold, 2058 Nakiska Ct., Toms River, NJ 08755. (732) 244-2345. E-mail: trabold@exit109.com

**FOR SALE:** Small collection. 20s, 30s, 40s, 50s plus few novelty. Includes AK-35, Radiola 18, Zenith 5R 337 chairside, Majestic Grigsby Grunow horn speaker. Tube testers. SASE for list. Gene Lightel, 24 Burrows Rd., West Middlesex, PA 16159

**FOR SALE:** (10) radio electronics from 1950s +4UR 1960 - \$15/all. 2,500 to 3,000 brand new and used audio radios, TVs, vacuum tubes - \$150/all. No list. Dale Shuler, 1208 Greenwood Ave., Akron, OH 44320. (330) 865-4685. Fax: (330) 535-5756



**FOR SALE:** 12" Zenith porthole television with original box, working - \$975. 5" Zenith television - \$275. 10" Admiral television with channel one working - \$675. 4" Sony watchman - \$425. Old radios: twelve cathedrals, tombstones, gothics - \$75 up. Thirty wood table models - \$45 up. Ten Bakelites - \$25 to \$275 ea. Hallicrafters: SX-28, S-40B, S-53, S-41G, SX105, S-94 - \$35; S-38 - \$30; S-81 - \$25. Echophone 102. Western Electric tube amplifier, exceptional #KS16617 - \$475. Pioneer SX-880 stereo receiver. Fisher 500 - \$125. Dynacast stereo 70 kit. PAS-2 factory. Manual. Simulcast tube tuner - \$120. Fifty VCRs video and audio tape recorders - \$35 up. Morninglory radio horn - \$975. Thermometer 38" high - \$275. 65 pieces of test equipment. Everything sold as is, no refunds. Charles Seidel, PO Box 1500, Merlin, OR 97532. (541) 474-2596

**FOR SALE:** After 65 years in radio repair I have a garage and house full of stuff. Too much to list. Write or call your wants. Joe Merti, 2003 Bellevue Ave., Bettendorf, IA 52722. (319) 355-0498

**NEW AND USED TUBES WANTED**

We urgently need the following tubes. All tubes must be well known brands such as GE, RCA, Sylvania, Tung-Sol, Phillips, etc. of U.S. or W. Europe manufacture. New tubes must be in their original boxes. All tubes are subject to inspection. Ship by UPS (ground); we'll mail a check to you upon receipt and testing at prices shown plus your shipping charges. Call or fax for buying procedures and complete bid list. Call before sending more than 10 pieces of one type of tube.

**NEW TUBES**

01A	\$9.00	6F6G	\$5.20	12BH7A	\$5.10	274B(WE)	\$85.00	6146B/8298A	\$12.00
1L6	8.50	6GS/6U5	8.00	12DW7/7247	9.00	275A(WE)	85.00	6267/EF86	6.00
2A3	24.00	6K5G	5.00	20LF6	16.00	300B(WE)	250.00	6550/A	12.00
2B6	6.00	6KD6	15.00	26LX6	6.00	350B(WE)	100.00	6550 (ST)	34.00
5R4GY/A/B	3.40	6L6GC	8.40	35L6G	6.00	623	35.00	7189/A	5.30
5U4G	6.70	6LB6	7.50	45	30.00	808	16.00	7591/A	20.00
5V4G	4.70	6LF6/GMH6	18.60	50	110.00	805/331A	32.00	8005	50.00
5Y3G	3.80	6V6	6.00	71A	8.20	845	80.00	8068	27.00
6BK4C/6EL4A	8.00	6V6G	6.50	80(ST)	5.60	864	5.00	8908	20.50
6CA7/EL34	11.00	10	25.00	211(VT-4C)	35.00	5691	15.00	8950	25.00
6F5G	5.80	12A	11.00	274A(WE)	110.00	5692	18.00	M-2057	32.00

**USED TUBES**

01A	\$5.00	10	\$16.00	171/A	\$7.00	245	\$23.00	845	\$31.00
2A3	12.00	12A	7.00	183/483	9.30	246	11.00	7591	8.60
5AR4/GZ34	6.00	20LF6	7.30	210	20.00	247	8.00	8417	8.50
6B4G	6.50	42(GLOBE)	8.00	211(VT-4C)	14.50	250	65.00	8950	12.30
6LF6/GMH6	9.20	45(VT-52)	25.00	230	6.20	280	12.00	V201A	6.50
6V6G	2.10	45	11.00	237	8.50	282	8.00	WD-11	35.00
		50	60.00	240	8.50	401-CARDON	9.60	WD-12	24.00

**ANTIQUE ELECTRONIC SUPPLY™**

LIMITED PARTNERSHIP

6221 S. MAPLE AVE. • TEMPE, AZ 85283 • (602) 820-5411 • FAX (602) 820-4643 or (800) 706-6789

**WANTED:** Cloth cords for old headphones, also old headphones working or not. Scott Balderston, 707 Watch Island Reach, Chesapeake, VA 23320. (757) 549-0449. E-mail: scottswim@aol.com

**WANTED:** Telefunken Hymnus, Roland radios from 1950s. Roland Frölund, 2060 Carrigan St., Turlock, CA 95380. (209) 668-1959. E-mail: Rfrolund@aol.com

**WANTED:** Older guitars/amps: Vox, Ampeg, Fender, Selmer, Gibson, National, Marshall, Gretsch, Rickerbacker, etc. Sonny Goldson, 1413 Magnolia Ln., Midwest City, OK 73110. (405) 737-3312. Fax: (405) 737-3355

**WANTED:** Antique medical, scientific devices, fans, Deco clocks and radios, horn phonographs. Richard Cane, 1333 N.W. 127th Dr., Sunrise, FL 33323. (954) 846-7116. Fax: (954) 846-7973. E-mail: rbcane@m8.sprynet.com

### Classified Ad Deadline Noon

Dec. 10 for Jan. 1999 Issue

Jan. 10 for Feb. 1999 Issue

Boxed, Photo. & Display Ads - 1st

**WANTED:** Clarion AC85 (Model 85) chassis, speaker Ron Boucher, 271 Tirrell Hill Rd., Goffstown, NH 03045-2827. (603) 497-2988. Fax: (603) 497-3244. E-mail: ronboucher@aol.com

**WANTED:** Sony TR-63, Sony TR-52; any kind of Japanese made transistor radio which is used with oval transistor. Takashi Doi, 1-21-4, Minamida, Seyaku, Yokohama, 246 Japan. Fax: 011-8145-301-8069. E-mail: taka-doi@kk.ij4u.or.jp

**WANTED:** Crosley cathedral 171 cabinet or complete. Ronnie Kaczmar, 5747 Williamson, Dearborn, MI 48126. (313) 582-4348

### A.R.C. BACK ISSUES

April '87 to current issue: Originals available  
32 to 100 pages each.

Oct. '86 to Mar. '87: Reprints available  
Reprinted from original artwork; 28 to 32 pgs. ea.  
Quality & appearance same as an original copy.

June '84 to Sept. '86: Photocopies available  
Not original quality, useful for info.; 16 to 28 pages each.

Publication of *Antique Radio Classified* began in 1984 which had only five issues: June, Sept., Oct., Nov. & Dec. 1984. 1985 through current year have had 12 issues each.

**\$5.00 each – Postpaid to  
U.S., Canada and Mexico.**

Orders of 6 issues or more may take a 10% discount. Orders for a full calendar year may take a 50% discount. 15th Year Special: 60% discount on orders for a full calendar year. Foreign orders other than Canada and Mexico: \$8.00 each by air. Mass. residents, please add 5% sales tax.

### A.R.C. UNCUT, UNFOLDED COVERS

June '91 to present - 9.25" x 12.5" - \$9.95 each  
Postpaid to U.S., Canada, & Mexico

Mass. residents, please add 5% sales tax.

A.R.C., P.O. Box 2, Carlisle MA 01741

Or Call (978) 371-0512

**WANTED:** Ham radio license plates from all 50 states with extra class (1x2 or 2x1) call signs. Write with license number (call sign) and price (shipped). Harry Schools, 8566 Glen Campbell Rd., Philadelphia, PA 19128

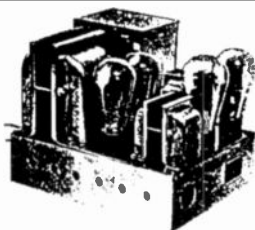

**WANTED:** E.H. Scott 150/250 power amplifier uses (2) Type 81 and (2) Type 50 tubes, or whole radio. Top cash. Joseph Halser, III, c/o Landmark 1850 Inn, 5905 S. Howell Ave., Milwaukee, WI 53207. (414) 769-1850

**WANTED:** Assembly instructions, operator's manual, or charts for Heathkit tube checker Model IT-21. Bill Kellogg, 104 Ministerial Dr., Concord, MA 01742-4030. (978) 369-7769. E-mail: kellbilge@aol.com

**WANTED:** Coronado wood console radio with Gamble-Skogmo 807-B chassis. Steve Danielson, 7630 Grand Oaks Cir., Lincoln, NE 68516. (402) 472-8693. E-mail: sdanielson1@unl.edu

**WANTED:** Philco 37-116 original grille cloth Michael Harrington, PO Box 250995, Little Rock, AR 72225

**WANTED:** Accurate Instrument Co. Model 161 utility tester, working or restorable. Gene Ray, WD4GUA, 2388 Hwy. 36E, Milner, GA 30257

**WANTED:** Robert Lawrence radio for sentimental reasons. Richard Brewster, 145 Little Peconic Bay Rd., Cutchogue, NY 11935

## **PUETT ELECTRONICS**

PO BOX 28572 DALLAS TX 75228 U.S.A.  
PHONES (214) 321-0927 OR (214) 327-8721

### **NEW CATALOG NO. 8B**

OVER 88 PAGES

OVERALL SPECIAL PRICE REDUCTIONS!  
CATALOG \$5.00 POSTPAID

\$5.00 DISCOUNT COUPON WITH CATALOG  
APPLICABLE TO \$20.00 OR LARGER ORDER.  
IF YOU HAVE CATALOG NO. 8 OR 8A, SEND  
ONLY \$1.00 FOR ADDENDUM PAGES.

WE OFFER - MORE THAN 2,600 DIFFERENT ANTIQUE RADIO PUBLICATIONS FROM 1902 TO THE 1960'S REPRINTED BOTH SIDE OF THE PAGE AND BOUND. BOOKS, OPERATING AND SERVICE MANUALS FOR ANTIQUE RADIOS, TEST EQUIPMENT, COMMUNICATIONS RECEIVERS AND HAM GEAR, HISTORICAL BOOKS FOR NEARLY ANY MANUFACTURER. WE OFFER TUBES, OLD-TIME-RADIO PROGRAMS ON CASSETTES, SCHEMATIC DIAGRAMS AND MUCH MORE. RADIO CLUB - RECEIVE SPECIAL DISCOUNTS, PERIODICAL - THE NEW ACQUISITIONS LIST OFFERING ALL TYPES OF ANTIQUE RADIOS, TEST EQUIPMENT, RARE TUBES, OUT-OF-PRINT BOOKS, RADIO MAGAZINES, AND MUCH MORE.

**ORDER YOUR  
CATALOG TODAY!**

**FOR SALE:** Used tubes, 27, 32, 34, 35, 41, 78 - \$2.50 ea. Jeff Arndt, 1215 Division St., Manitowoc, WI 54220-5734. (920) 684-8830

**FOR SALE:** 1963 McIntosh MC225 stereo amp and MX110 tuner/preamp, near mint - \$2,000. Chuck Sundgren, 1818 Alder Ave., Richland, WA 99352-2424. (509) 943-2753

## HAS YOUR SUBSCRIPTION

### EXPIRED?

It has if your mailing label reads  
"EXP=DEC98" or earlier.  
Renew now!

**BONUS: Renew before  
your "EXP" month and receive  
13 issues per year instead of 12!**

**\*15th Year Special!** Renewal rates are:  
\$39.49\* for Periodicals Mailing  
\$57.95 for First-Class Mailing  
(Two-year renewals are twice above rates.)

**FOR SALE:** German WWII radios with sign, can ship. G. Faassen, Heideweg 1, 5953 T.L. Revver, Holland. Tel: 031-77-474-1316. Fax: 031-77-474-6683

**FOR SALE:** Electronics books, courses, instruction manuals, kits, magazines, parts, etc. Stamp for list. Bob Eckert, 133 E. 7th St., Clifton, NJ 07011-1104

**FOR SALE:** Wards SC-6 auto antenna, new in original box - \$50 plus shipping. Thanks. William K. Seiler, 8819 S. State Rd., 135, Pekin, IN 47165. (812) 883-1453

**FOR SALE:** Used tubes: USN CG-81A - \$15. UX245 globe - \$45. USN GL-451 - \$35. Amperex 841 - \$20. Radiotron 280 - \$15. United UX-CV11 - \$25. 6550 - \$25. RCA 813 - \$25. Bogen 7199 - \$10. WE JAN 725A - \$75. Amperex 6146A - \$20. D-227 globe - \$40. CX-326 globe - \$40. Norelco JAN-CNY-813 (VT-144) looks new - \$65. Mullard EL34/GCA7 in box - \$75. United Electronics 311-CH - \$65. Zenith tube Trans-Oceanic chassis 5G40, batt. 2985 (all there, not tested) - \$100. Zenith long distance, 11-tube chassis R24388A (appears complete, not tested, chassis only, no speaker but has moveable plate dial assembly) - \$175. (10) boxes of N.O.S. GE PR-2 pointed flashlight bulbs, 10/box - \$25. Old Rosin core solder spool w/solder - \$10. Square D overload thermal relay in box - \$10. All plus UPS. H. Andreoni, c/o 250-D So. Lyon Ave., Hemet, CA 92543. (909) 849-7539

## (818) 786-2500



### Now Available

1941 Philco Escutcheon Reproductions  
\$29.95 + \$3.00 Shipping & Handling (send a money order)  
Injection Molded Marbleized Brown Plastic  
Fits Models: 41-250, 255, 258, 280, 285, 287, 290, 296

Old Time Replications 5744 Tobias Ave., Van Nuys, CA 91411  
CA Residents, please add 8.25% sales tax

**FOR SALE:** Two cabinets of phonograph needles, some old timers and some plug-in types for newer cartridges. These cost \$20 or more each. Will sell lot for \$175 plus shipping. Include reference guide, mostly Pfanstiehl needles. Maurer Television, 29 S. 4th St., Lebanon, PA 17042. (717) 272-2481. E-mail: radiobks@aol.com

**FOR SALE:** DAK X w/box, original mike, manual; mint - \$750. SBE console II, as N.I.B. - \$250. Royce 1-650 N.I.B. - \$100. Shipping extra. Many other vintage CBs, collection for sale. List - SASE. Charles Zafonte, RR3, Box 2075, Fort Kent, ME 04743. (207) 834-6273, eves.

**FOR SALE:** Zenith T-O 3000-1, excellent with original 12V metal adapter - \$225 includes shipping. Thank you. Ed Kalpa, 4622 Melbourne Ave., Los Angeles, CA 90027. (323) 661-1221

**FOR SALE:** Tubes, N.I.B. 5V3A - \$2. 6L6 - \$5. Used tubes, test good: (5) 6V6G - \$7 ea. (2) 7027A - \$10 ea. 7025 - \$7. 5V4GA - \$2. Bob Curwin, 759 Jody Ln., Hoffman Estates, IL 60194. (847) 490-1414

**FOR SALE:** Photocopies: Radiola III, 18, 60, 100A, Hallicrafters S-22, other radio, tube, T.E. manuals. LSASE list. Herman Gross, 1705 Gordon Dr., Kokomo, IN 46902. E-mail: w9itt@juno.com

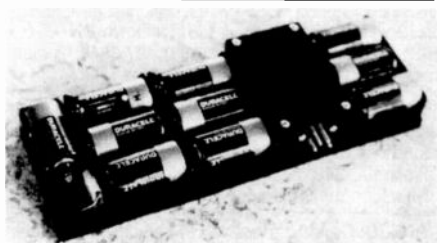

**FOR SALE:** Zenith Trans-Oceanic battery pack for tube models. Ready to plug in and use. No extra plugs or wiring needed. Easily moved from one set to another. Months of use from one set of batteries. Also powers 600 Series dial light - \$99.95 includes batteries and shipping. James W. Poitvient, 3 Darby Cir. E, Mt. Holly, NJ 08060. (609) 261-0059

**FOR SALE/TRADE:** My extra ARs, Photofacts and service literature. Send SASE for list or call. Lois Rasmussen, 1107 W. Jefferson St., Joliet, IL 60435. (815) 744-4565. E-mail: L.E.Rasmussen@juno.com

**FOR SALE/TRADE:** Butterscotch AU190 - \$1,450. Red Patriot - \$900. Yellow Aristocrat bm trim, crack - \$275. Majestic Charlie - \$950. Don't be misled by the low prices. These are all in excellent condition! Joe Svihel, 17227 Co. Rd. 54, Avon, MN 56310. (320) 356-7601

**FOR SALE:** Philco Predicta, pedestal Model, 1956 or 1958, I am told. Looks like the one pictured on page 70, July 1998 issue of Antique Radio Classified. Excellent condition, running, middle knob broken, asking - \$1,000. Horton's Antique Clocks, 3864 Wyse Sq., Lexington, KY 40510. (606) 381-8633

**FOR SALE:** Radioparts, books, magazines, junk. Send SASE for 6-page list. Phil Majewski, PO Box 92, Tamaqua, PA 18252

**FOR SALE:** Philcos: 1931 Model A clock timer - \$60; 175-124 transistor - \$12. Sam Mannino, Box 331, Villanova, PA 19085. (610) 353-6747

# Collector's Guide to Novelty Radios Book II

By Marty Bunis & Robert Breed



**All New Second Volume  
600+ Color Photographs  
Price Guide**

**\$19.95 - Softcover**

Collector's Guide to Novelty Radios by Bunis & Breed, First Volume – \$18.95

*U.S. Orders - Enclose \$3.00 per order for packing & book-rate shipping if total order is under \$35.00. If using VISA or MasterCard, include name on card, card number and expiration date. Send payment with order. Mass. residents add 5% sales tax. Money back return policy. Softcover unless stated otherwise. Most orders shipped the same day received, but allow 2-4 weeks to receive order. Foreign orders - write for shipping costs, or use credit card and specify air or surface (allow 2-3 months for surface shipping).*



**A.R.C., P.O. Box 2, Carlisle, MA 01741. Tel: (978) 371-0512**

**Fax: (978) 371-7129 – E-mail: [ARC@antiqueradio.com](mailto:ARC@antiqueradio.com) – Web: [www.antiqueradio.com](http://www.antiqueradio.com)**



(Dec-98)

**FOR SALE:** 1933 Fada Model RG55, plays - \$110. Battery set, (3) 199s tubes, new interstages, plays - \$125. 1938 RCA Model 95T5, 6 pushbuttons, plays - \$55. 1933 Crosley Model 5M-3 (Fiver), plays - \$90. 1924 Fada Neutrodyne, 3 large dials & 2 small dials, plays - \$135. Crosley Model 51, all tags & w/2 B.B. tipped tubes, plays - \$200. Philco Model 45C, butterfly, plays - \$175. 1924 or 25 Airline one tube with matching headphones - \$155. Plus UPS. George Jones, 1943 Palm Dr., Fernandina Bch., FL 32034. (904) 261-6533. E-mail: gjones@leading.net

**FOR SALE:** Atwater Kent Model 5, parts are mint - \$4,995. American Bosch treasure chest Model 200A, mint original - \$495. Sparton Junior Model 410, mint original - \$395. Zenith 9-tube Walton, super mint - \$2,000. Philco grandfather clock Model 570 - \$675. Philco console Model 16 anniversary, beautifully restored - \$325. RCA console Model 19K, nice - \$275. Philco console Model 40-190 - \$350. Atwater Kent Model 447 - Call for price. KLH Model one with Janszen amp, top model - \$275. Call for free pictures. Harvey Daniel Rieff, PO Box M-372, Hoboken, NJ 07030. (201) 659-0401, work or (201) 262-9466, home, ask for Harvey

## One Month Free!

### BONUS FOR EARLY RENEWALS

If you renew before the month shown on your mailing label (your expiration month), you will receive an extra month on your subscription: 13 months instead of 12! 26 months for an early 2-year renewal!

**FOR SALE:** Old car radios 1936-1949, meters of all kinds, about 100, Philco mystery control sets, other Philcos, Hickok #539A, tubes. Joe Merti, 2303 Bellevue Ave., Bettendorf, IA 52722. (319) 355-0498

**FOR SALE:** Meissner AM/FM tuner Model 9-1091. Very good all original condition, with papers - \$50. Kevin Kuehn, 1615 13 1/2 Ave., Barron, WI 54812. (715) 537-3225, 9-5; or (715) 637-9395 later

**FOR SALE:** Diagrams, schematics, magazines, radios, speakers, radio TV parts. Florian A. Rogowski, 25103 Cunningham, Warren, MI 48091

**FOR SALE:** Fada #652s: butterscotch/red - \$700; butterscotch, hairline - \$525. Emerson #AX235 butterscotch - \$1,050. Ripley, Box 9374, N. St. Paul, MN 55109. (651) 777-6791

**FOR SALE:** Sparton Bluebird replica, factory sealed box, gorgeous cobalt glass 16" mirror, lighted dial - \$125 shipped, U.S. C. Zafonte, RR3 Box 2075, Fort Kent, ME 04743. (207) 834-6273, eves

**FOR SALE:** Silvertone Portola windup phono, good; Stewart-Warner 9180H black and red plastic; Advent 300 receiver, good; Carver M400 amp; Hafler DH-10 preamp; Westclox N.O.S. 80154 transistor; Cannon Chief headphones; Lionel 1014 transformer; CCD video player and 100 plus video discs. **WANTED:** Motorola 7-inch TV set, Model 7VT1, chassis TS18. Charles Harper, 2000 Jackstown Rd., Paris, KY 40361. (606) 484-9393

**FOR SALE:** Perfect replica Atwater Kent Type 2A twin crystal detector - \$95 includes certified mail. Roland Matson, PO Box 956, Lake Panasoffkee, FL 33518

**FOR SALE:** Hallicrafters, Drake, Heathkit, Military, etc. Send e-mail request or SASE for list #2. Fenton Wood, 109 Shoreline Dr., Star Harbor, Malakoff, TX 75148. E-mail: fenton@tvec.net

**FOR SALE/TRADE:** Zenith R7000-1 (Taiwan), needs repair, shortwave bands very weak, has RV adapter - \$170 or trade for R3000-1. Andy Bedoian, 6017 Encino, Encino, CA 91316. (818) 705-1114

**FOR SALE:** Used tubes: Tung-Sol 6550 - \$30 ea. Sylvania 811 - \$25. Blue Arcturus Wunderlich globe 27 - \$75. 6A5 - \$20. National Union 75 ST shape - \$20. UX-245 - \$60. Radiotron UX-226 globe - \$50. Eveready Raytheon ER-201A - \$85. Cunningham CX-301-A - \$45. Cunningham C336 globe - \$45. Majestic G-27-S globe - \$40. Tung-Sol 26 globe - \$25. GE 6014/UK - \$50. Realistic 8 transistor pocket radio, not tested - \$30. Chrome precision Radiotron instr. geiger counter Mod 107C w/case and original instr. booklet - \$85. Johnson Viking messenger, unknown status - \$25. (100) assorted old radio potentiometers, used - \$30. Old GE tungar battery charger, 3 cell, 2 amp, not tested, appears, complete - \$45. Amperite 10-4C ballast tube N.O.S. - \$40. All plus UPS. H. Andreoni, c/o 250-D So. Lyon Ave., Hemet, CA 92543. (909) 849-7539

**FOR SALE:** Philco 53-958, large wood table radio w/ unusual 2 scale & pointers am/fm. excellent condition - \$40 + s/h. Electronic Books, LSASE. Mike Korsower, 34 Cromwell Rd., Monroe, NY 10950

**FOR SALE:** Book: A Microphone For David (c) 1942 - \$15 delivered. SASE list. Tom Tetzlaff, 23 Nelson Dr., Silver Bay, MN 55614. No phone. E-mail: wl7aec@w8yy.ampr.org

**FOR SALE:** Triplett sweep generator 3434-A, exc. working & cosmetic condition - \$70. David Boardman, 10 Lemaistre, Sainte-Foy, Quebec, Canada G2G 1B4. (418) 877-1316

**FOR SALE:** Wrist watch radio Sanyo - \$25 ppd. Bearcat thin scan - \$25 ppd. Al N.I.B. Ed Crockett, 28 Buccaneer Dr., Hattiesburg, MS 39402. Fax: (601) 264-0226

**FOR SALE:** Antique radio schematics 1920-1960 - \$3, TV - \$4 postpaid. One day turnaround. Joseph R. Forth, 321 Long Vue Acres, Wheeling, WV 26003. Phone or fax: (304) 277-3154. E-mail: Schematic1@aol.com

**FOR SALE:** General Radio Experimenters, approximately 100 different issues beginning 1937 - 75¢ each. Frank White, PO Box 3283, Olathe, KS 66063. E-mail: frw@gvi.net

**FOR SALE:** Grommes custom tube type high fidelity amplifier by Precision Electronics, Inc., nice - \$40 plus. Elwood F. Hunt, 308 Georgetown Rd., Carneys Point, NJ 08069. (609) 299-5259

**FOR SALE:** (16) issues of Wireless Age Jan. 1919 to June 1921, a wealth of info history, circuits, etc., bargain priced at - \$200. (3) Science & Invention 1925-26 - \$25. (2) Radio Service News, 1935 by RCA - \$3. (33) Acrovex Research Worker, April 42 to Dec. 46 - \$15. (5) QST, (4) 1920, (1) 1930 - \$7.50. 1935 1st ad Modern Radio Servicing by Ghirardi - \$15. 1936 AVC by Rider - \$5. Rider's #20 - \$45; #21 - \$50; #22 - \$65, 1938 Thordarson Amp Guide - \$8. Hammarlund HQ-110 & HQ-160 sales lit. - \$2. Delco 1938 to 1941 sales lit., 13 sheets - \$7. Joe Svihel, 17227 Co. Rd. 54, Avon, MN 56310. (320) 356-7601



**WANTED:** WWII Japanese military radio of any kind; anything WWII Japanese military hardware, especially aircraft related. Takashi Doi, 1-21-4, Minamidai, Seyaku, Yokohama, 246 Japan. Fax: 011-8145-301-8069. E-mail: taka-doi@kk.ij4u.or.jp

**WANTED:** Philco 90 cathedral cabinet, any condition, basket cases OK or junker set. James S. Fisher, 344 Harrison Ave., Manville, NJ 08835. (908) 725-7476

**WANTED:** Instruction manual and servicing data for Fada 799 television. J. Finkelstein, 63 Cedar Hill Ln., Media, PA 19063

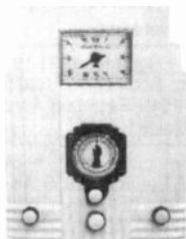

**WANTED:** Air King Skyscraper radios, except for that unbearably ugly model with the third (tuning) eye at the top that bears better resemblance to a flounder than to the face of a building. Please write or call collect: Rain Buttignol, 214 State St., #7, Portsmouth, NH C3801. (603) 427-1384

**WANTED:** Auto radio for 1940 Ford sedan. John Webb, 12736 Erin Dr., Auburn, CA 95603. (530) 885-9556. E-mail: WEBB@neworld.net

**WANTED:** J.W. Miller 100kHz. IF transformers 1709 or 1710. Harry Weber, 4845 W. 107th St., Oak Lawn, IL 60453-5252

**WANTED:** Arvin metal radios, please write to: Patrick Franzis, 235 Millville Ave., Naugatuck, CT 06770-3848. (203) 723-8976

**WANTED:** Remote aligning information, not Riders, Philco 40-216 or similar. Also adaptor P/N 45-2769. Chris Williams, 6985 Dunnview Ct., Mississauga, Ontario, Canada. (905) 785-0322

**WANTED:** Giffilan Model 43-A. Will consider Model 4T or 30 or 410. Mel George, PO Box 24934, San Jose, CA 95154. (408) 267-0697

**WANTED:** Philco tombstone with 11 tubes such as Model 116B, 37-670 or 38-2670. Mark Hewitt, 6659 Tipperary Trl., Roscoe, IL 61073. (815) 623-8729

**WANTED:** Tube socket for Crosley Pup. Will buy part alone or junker. Sam Beale, 28 Deer Run, Hope, RI 02912. (401) 821-4868. E-mail: radio1@brown.edu

**WANTED:** A few N.O.S. N.I.B. Type 42 and Type 6H6 G tubes. Gregg Humanic, 540 Wicklow Ln., Monroeville, OH 45050. (513) 539-8926

**WANTED:** Crosley 53F chassis and speaker. Zenith 67 working tuning capacitor. Arvin 1247 instructions book. Tony Parjus, 816 Richard Ln., Gretna, LA 70056. (504) 393-0099

**WANTED:** Old 3 slot payphones. Western or Automatic Electric, any color or condition. Stanley, Schreier, 350 Hendrickson Ave., Lynbrook, NY 11563. (516) 887-4966. Fax: (516) 887-4780

*Premium Prices*

## Paid For Western Electric Tubes

**WESTERN ELECTRIC TUBES WANTED:**

VT-1, VT-2, VT-25, VT-52, 101D/F, 102D/F, 104D, 205B/D/E, 211D/E, 212D/E, 252A, 262A/B, 274A/B, 275A, 300A/B, 310A/B, 417A, 421A, 422A  
And any Western Electric amplifiers such as the 25B or the 96A.

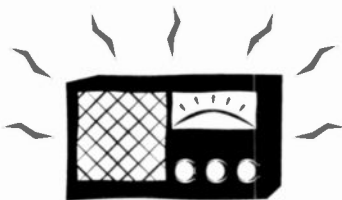

Many other audio tubes wanted such as 5AR4, GZ37, 5691, 5692.

**We are also interested in:**

**TRIODES:**

2A3, 10, 45, 50, 211, 845

**PENTODES:**

EL34, EL37, KT66, KT77, KT88, 7591, 6L6GC RCA

**PREAMP/DRIVERS:**

12AX7 (EURO-ECC83), 6Z76 (EURO-EF86), 12AT7 (EURO ECC81), 12AU7 (EURO ECC82), 6BQ5 (EURO-EL84), 6DJ8 (EURO-E88CC)

**Highest Prices paid for NOS tubes in original boxes. We will meet or beat any written offer!**

We buy and bid on small or large lots. If you have any questions or if you have any of the items listed here, give us a call!

Phone: 901-382-9955 Fax: 901-382-9956  
Email: cmagee@electron-valve.com

**Electron Valve Enterprises**

**FOR SALE:** Wards Airline 62-290 Series A with eye urea case, 6 push buttons – \$150. National NG300 – \$150. Johnson matchbox – \$200. Books: Radio Amateur, a handbook, 1961 & 62 – \$15 ea. Radio Theory and Operating Mary Texanna Loomis – \$25. Understanding Radio – \$20. Audels #2 – \$15. Repairing Home Audio Systems, 1962, Ecklund – \$10. Fundamentals, 1942 – \$15. How To Make the Peridyne Five Gernsback – \$10. Tubes used balloon types 01-A – \$10. 200A – \$15. 226 & 227 – \$7. 236 – \$5. 237 – \$15. 230 – \$17. 171 – \$20. 280 – \$20. 281 – \$15. 245 – \$40. 56 – \$10. Other new and used tubes. Tony Rinaldo, 308 Lenox Ave., Oneida, NY 13421. Ph/fax: (315) 363-3644

**SEND ALL A.R.C. MAIL TO**  
**Antique Radio Classified**  
**P.O. Box 2, Carlisle, MA 01741**

**FOR SALE:** B&K 1243 digital IC color and manual generator – \$20. B&K Model 600 Dyna-Quik tube tester – \$35. Sencore Model TF17 transistor FET tester, the case is rusty, as is – \$25. Adjust-A-Volt variable transformer with AC volt meter, all for – \$40. Sola constant voltage transformer – \$40. Hickok Model 620 crystal controlled linearity-pattern generator and manual – Best Offer. Sprague Tel-Ohmike Model TO-4 capacitor-resistor analyzer – \$25. HK Citation I, III, preamp & tuner need work – Best Offer. 1 pr. Eico HF20 hi-fi amps – Best Offer. Hickok Model 630 television voltage calibrator, peak to peak, AC voltage meter – Best Offer. Eico 944 flyback xfmr and yoke tester – \$15. Dale Shuler, 1208 Greenwood Ave., Akron, OH 44320. (330) 865-4685. Fax: (330) 535-5756

**FOR SALE:** Our new 54 page 1999 catalog of WWII military communications items – \$3. Sam Hevener, W8KBF, The Signal Corps, 3583 Everett Rd., Richfield, OH 44286-9723. (330) 659-3244



*Craig L. Graybar*  
**Furniture Works Ltd.**

(414) 258-2390 or (888) 383-2390  
**SPECIALISTS IN RESTORING,  
 REPAIRING AND REPRODUCING  
 CLASSIC STYLED ANTIQUE TV,  
 RADIO & PHONOGRAPH CABINETS**

Send us your plans or your project  
 via UPS for immediate price quotes



**1535 S. 84th St.  
 West Allis, WI 53214**



*"We Turn Ideas Into Heirlooms"*

**FOR SALE:** Atwater Kent tombstone 456, vg – \$225. Philco cathedrals, 60 recapped, vg – \$200. 37-84, vg – \$100. Crosley 637 Super Six, vg – \$95. German field relay station K10-4/3, vg – \$75. U.S. Army field relays, ACR RT-10, need batteries – \$40/pr. Motorola portables, 5M1U, vg – \$35. 5P33VV, vg – \$25. 5P31A, vg – \$25; all 3 – \$75. Buzz Miller, 725 Mt. Rock Rd., Carlisle, PA 17013. (717) 776-3279. E-mail: buzzm@sprintmail.com

**FOR SALE:** Temple Superhet G419/G4108, nice metal case, good handle, back, paint chipped. 4-tube (2 missing), right front dial, left graduated louvers – \$50. Gary Nitkin, 102 Long Highway, Little Compton, RI 02837. (401) 635-2816. E-mail: talkingmachine@webtv.net

**FOR SALE:** (48) magazines 1933-1940, Radio World, Communications, Short Wave Radio & Electronics. Floyd A. Paul, 1545 Raymond Ave., Glendale, CA 91201. (818) 242-8961

**FOR SALE:** Many tubes, parts, books, radios, Scott SLRM, Philco 87, Day-Fan #5050, AK 55C chassis, 16 pp. – 55c LSASE. W.F. Horn, 13110 Marsh Rd., Bealeton, VA 22712. (540) 439-9781

**FOR SALE:** Rubber gasket for Zenith/other dial glass, 3 ft. – \$6; 6 ft. – \$11 ppd. Curt Lutz, 1021 N. Hickory Pl., Broken Arrow, OK 74012. (918) 251-4915. E-mail: antiqradio@aol.com

**FOR SALE:** Trans-Oceanic 3000-1, exc working w/charts – \$150. Also some misc. old table tops, portables & 10 Zenith collector record albums, call. Marvin Harris, 1641 N. Spyglass Way, Flagstaff, AZ 86004. (520) 526-9399

**FOR SALE:** Wood knobs for Fada Model 50, 50Z, 70, 70Z, two large and one small – \$16 ppd. Elwood F. Hunt, 308 Georgetown Rd., Carneys Point, NJ 08069. (609) 299-5259

**FOR SALE:** Heavy duty equipment rack on casters, with rear door, 86"H x 23"W x 34"D – \$100. Floyd Stahl, 110 N. Adams St., New Carlisle, OH 45344-1801. (937) 845-8169

**FOR SALE:** Hallicrafters HT-37, Heathkit Apache & National NC-155. Robert Braza, N1PRS, 23 Harvard St., Pawtucket, RI 02860. (401) 723-1603

**FOR SALE:** Microphone book, 300 pages, History of Identification, How They Work – \$29.95, includes shipping. Victor Bang, Video Tech Service, 7520 S. Rural Rd., #3, Tempe, AZ 85283. (602) 491-1811

**FOR SALE:** Rider's 6-9 – \$75 for set. Crosley 51 with WD-12 tubes – \$150. Dwight Hill, 1209 Royal Pointe Dr., Bloomington, IL 61704. (309) 663-7599

<b>CATALIN</b>	<b>WANTED</b>
<b>WANTED</b>	<b>RADIOS</b>



**TOP PRICES PAID!**

**Michael Lawlor**  
 P.O. Box 179  
 Santa Barbara, CA  
 93102  
 (805) 682-2336

# 15th Anniversary Special

## Back Issues — 60% Off — \$2.00 Each

### Full Calendar Years

*A sampling of articles and topics is listed below.*

*(12 issues in all years except 1984. All originals except for June 1984 through March 1987)*

- 1984 A.R.C.'s First Year. The June Sample Copy plus September-December. First Kreuzer's Value Guide,\* Heathcote's Collectors' Corner, Crocker's Crosley Review,\* With The Collectors\* and Meet Reports.\* (5 Issues. Photocopies; 16-20 pgs.)..... \$10
- 1985 First Photo Review,\* Radio Novelties,\* Collector Profile,\* Telegraph Key Review,\* Crystal Set Review\* and Atwater Kent Breadboard Review.\* Also Value Guide A-T, Penna Wireless, Marconi 106, WD 11. (Photocopies; 20-24 pgs.) ..... \$24
- 1986 First Collecting British Crystal Sets.\* Collectors' Corner, Value Guide S-Z, Horn Speaker Values, Speaker Review, Precision Ace, Quaker Oats Crystal Set, HQ-120X, First Issue Published by John Torrey. (Jan.-Sept. Photocopies; Oct.-Dec. reprints; 24-28 pgs.)..... \$24
- 1987 First full-color covers. First Foster's Restoration Topics,\* Vintage Television.\* Philco 38-3, EHScott 48-Tube Set, Marconi Multiple Tuner, Vacuum Tube Value Guide, Freed Eisemann, Crosley Pup, Fada Bullet, Vitus, Sparton Mirrored Radios. (Jan.-Mar. reprints; Apr.-Dec. originals; 32-36 pgs.) ..... \$24
- 1988 First Old Tyme Radio Services Directory,\* Jim Fred's Repairing AC Radios,\* Vintage Test Equipment.\* Also DuMont Clifton TV, Mechanical TV, Aeriola Senior, A-K Model 20, Kennedy 220, Philco Predictas, Martian and Gem Crystal Sets. (40-60 pgs.)..... \$24
- 1989 Automatic Radio, Clapp-Eastham HR/HZ, Mechanical TV,\* Western Electric 1920-1927, Radiola 44, Ace Radio Repair on June cover, Arvin & the Hopalong Radio, Magnavox TRF-5, A-K Crystal Set, A-K 9A, Philco Block Capacitors, Marconi 106D, Patterson PR-10, Oriole 7B. (52-68 pgs.) ..... \$24
- 1990 First Radio Adventures.\* Also California Earthquake, Transistor Radios, Cleaning Bakelite, El-Scott Telematic, Ekko Round Radios, Radiola Grand, Horn Speaker Survey, Atlantic Radio, GE 901 TV, Philco Block Capacitors, Tuska 224, RCA 816K, RCA Theremin. (68-92 pgs.) ..... \$24
- 1991 First Collecting Foreign Sets,\* Out-Of-Sight Radios, Philco 20, 90, Wilcox-Gay Recordio, A.R.C. Index '84-'90, Westinghouse RC-RA-DA-DR-RT-AR, Radio Stock Certificates, German Radios, Subminiature Tube Radios, Early Navy Radio Equipment, Gonset. (84-100 pgs. Index issue is 148 pgs.) ..... \$24
- 1992 Vintage Microphones, Gonset, Early Navy Equipment, Superhets of the 20s,\* The Neutrodyne Telmaco, Atlantic Radio, Vintage Hi-Fi, Battery Eliminators, Radio Fans, A-K 35, RCA 648PTK TV, Repairing IF Transformers, Paragon RA-10/DA-2, A-K 21, 33, WLW, 1991 Index. (88-100 pgs.) ..... \$24
- 1993 Arvin Metal Radios, Repairing RCA Catacombs, Philco Armchair Radios, Kenrad Crystal Set, Transistor Radios, A-K 52, Philco Cabinet Design,\* Clinton Mfg. Co., Webster Electric Co., Kyletron Electrostatic Speaker, Vintage Guitar Amp, Tower Cone Speakers, EH Scott Allwave, 1992 Index. (100-104 pgs.) ... \$24
- 1994 Radiola I, Radiola 60 series, Pot Metal, Fada Neutrodyne, Kardon Radios, Philco Cabinet Designers, Palco, SCR-609 & 610, Philco Survey, Permeability Tuning, Weston, Regency TR-1, Charles Herold, Nipper, 1993 Index. (100-116 pgs.)..... \$24
- 1995 Zenith Trans-Oceanic, Steinway Capehart, Ken-Rad, Radio Shop J, Freshman Master Speaker, Broadcast Equipment, Philco Survey, Power Transformers, Tube Testers,\* Radio Apparatus Co., L.E. Knott Apparatus Co., Ford Museum Auction in color, Ozarka, 1994 Index. (108-116 pgs.)..... \$24
- 1996 Communications Receivers, KDKA, Philco Designers, Radiola IV, WJZ, Art Deco Radios, Herold Microphone, Tuning Battery Sets, Paul Godley & Paragon, Soldering, Webb Microphone Collection, Mirrored Glass Radios, Samson Electric Co., Russian Red Star, Echophone EC-1. (100-116 pgs.) ..... \$24
- 1997 Thompson Minuet, Marconi Archive Auction Saga, Frank Krantz, Emerson Multivalve Radios, De Forest Detectors & Tuners, Remote Control Radios, Ekko Stamps, Freshman Polydyne, Vintage Audio Recorders, Selenium Rectifiers, DeForest Reflex Sets, Early Zenith. (100-116 pgs.) ..... \$24
- 1998 Sears Commentator, 300B Tube, Replica Nameplates, Australian Radios, WMAZ, Espey, Nipper, Early Wireless, Rider's Volume 1, Pilot Radio, Browning-Drake, Army-Navy Numbering System, Cortlandt Street Radio Row, Pooley Co., Transistor's Early History. (100-108 pgs.)... \$24

\* These articles continued for one or more years and some continue today.

*15th Year Back Issue Special: U.S. Orders - Above prices include shipping. If using VISA or MasterCard, include name on card, card number and expiration date. Send payment with order. Money back return policy. Most orders shipped the same day received, but allow 2-4 weeks to receive order. Non-U.S. orders - write for shipping costs, or use VISA or MasterCard and specify air or surface (allow 2-3 months for surface shipping).*



**A.R.C., P.O. Box 2, Carlisle, MA 01741. Tel: (978) 371-0512**

**Fax: (978) 371-7129 - E-mail: ARC@antiqueradio.com - Web: www.antiqueradio.com**



(Dec-98)

**FOR SALE:** WE 7A amp with tubes - \$550. Thompson Neutrodyne NT - \$75. AK 20 with book NT - \$70. AK60 & spkr for parts - \$20. Crosley 124 cathedral - \$190. Majestic Treasure Chest - \$150. Joe Svihel, 17227 Co. Rd. 54, Avon, MN 56310. (320) 356-7601

**FOR SALE:** HP 400H AC VTVM, 1% accuracy, 10Hz-4MHz range, with manual, calibrated, excellent - \$55. Alan J. Kriss, 1872 Portsmouth Way, Union, NJ 07083. (908) 688-2092

**HAVE YOU MOVED? ARE YOU MOVING?  
PLEASE NOTIFY US A.S.A.P.  
SEND US YOUR...  
OLD ADDRESS  
NEW ADDRESS and  
SUB #  
MANY THANKS!!!!**

**FOR SALE:** Zenith H500T-O - \$85. Sterling LS4 miniature tube port. red - \$65. Crosley 5M3 tombstone - \$75. Grunow 1291 teledial console, 12-tube, cabinet damage, part out? Magnavox audio freq. amplifier, Model C, exposed 2 tube, 1920s? neat decal - \$150. Howard Bakelite - \$30. RCA 14X Bakelite AM-SW - \$40. Crosley 140 chassis & speaker, works - \$50. Crosley 124 chassis and speaker - \$30. Stewart-Warner 801 - \$65. SW reproducer - \$35. AK 30 - \$85. RCA 100 speaker - \$40. RCA 103 tapestry - \$75. Majestic 20 grandfather clock, needs extensive cabinet restoration. Small Eico tube tester - \$20. Guy Forstrom, PO Box 159, Quinnesec, MI 49876. (906) 774-8116

**FOR SALE:** All includes S&H; Rider's 6 - \$19; Heath IM-10 VTVM - \$32; (2) 6L6 and (2) 1622 tubes, all - \$33; (10) 6SJ7 - \$23. William L. Clark, 15476 Wellington Pl. Dr., Basehor, KS 66007. (913) 724-1203

**FOR SALE:** Geochron clock, rare, excellent for the ham shack - Best Offer. Claude Chafin, 4223 E. 42nd Way, Independence, MO 64055. (816) 478-4518

**FOR SALE:** Stromberg-Carlson 240R, excellent, half-round console, restored - \$600. Also 231F Deco mirror butler table, excellent - \$600; or trade for S-C 180L console. John England, PO Box 393, Lincolnshire, IL 60069. (847) 823-5287

**FOR SALE:** Unique tuners. Kenwood FM converter FC-1 - \$100. Heathkit AJ-11, for AM-FM simulcast stereo - \$200. Chuck Bray, 1322 Ivy Rd., Bremerton, WA 98310. (360) 373-1013. E-mail: cbray@krl.org

**FOR SALE/TRADE:** HQ-145A. SB-301/SB-401, DX-40, QF-1, HR-10B. TR4C. Mics: WRL/SB-44, Astatic/77-A. SASE. WANTED: Hamband FT-243. Sam Timberlake, KF4TXQ, PO Box 161, Dadeville, AL 36853-0161. (256) 825-7305. E-mail: stimber@lakemartin.net

## RadioGallery.com

"A New Way to Buy & Sell Old Radios"

Advertise your radios on the Internet with full-color photographs. We can scan your photos free. "Wanted" ads & club event announcements free.

RadioGallery.com  
PO Box 90, Moody, AL 35004

http://www.radiogallery.com  
e-mail: ads@radiogallery.com  
Phone: (205) 640-2701

**FOR SALE:** Temple G-515/National Union wood table model - \$35. RCA 100-A speaker - \$35. Jim Ligouri, 7 Sycamore Ct., Atkinson, NH 03811. (603) 362-5712. E-mail: Jligouri@aol.com

**FOR SALE:** N.O.S. tubes 1625 - \$4 ea.; 10 or more - \$3 ea. 4D32 - \$50 ea.; 10 or more - \$40 ea. 8532-W/6J4W - \$1 ea. 0D3 - 6AC7 - 6AX4 GTB - 5643-H, 6088, 6418, 9001 - 50¢ ea. 7571 storage tube - \$20. 8602/CK 1383-A storage radechon type - \$40. Micro pix Litton L-4365 x-ray tube - \$100. Many others avail. Kirk Cline, PO Box 9462, Greensboro, NC 27429-0462. (336) 288-6903. V-mail/fax: (336) 282-8366

**FOR SALE:** Electronic books, radios, tubes, misc. Send SASE. HELP: Need Silverstone Model 1955 chassis. Rich Yoch, 22410 Bartlett Dr., Rocky River, OH 44116. Ph/fax: (440) 331-9206

**FOR SALE:** Large grandfather clock radio by Davison Haynes (Los Angeles). No chassis. Gordon Wilson, 11108-50, Edmonton, Alberta, Canada T6H 0H9. (403) 434-6257

**FOR SALE:** Saba studio 2A, exc - \$350. Grundig studio 260 - \$75. Bulova 840, exc, NW - \$35. Ed Kalpa, 4622 Melbourne Ave., Los Angeles, CA 90027. (323) 661-1221

**FOR SALE:** Radiola 20, 1925 battery table, slant panel, nice condition, all original, plays fine - \$175. Small Bakelite RCA 45 rpm record player, Model 45-EY-3, new cartridge, return mech. works, sounds fine - \$80. 1950 Zenith portable, BC chassis #5G41, light brown leatherette, flip-up dial, nice condition, plays OK, has small hum, needs new filters - \$65. Russell Barker, 28 Franklin St., Holliston, MA 01746. (508) 429-5499

**FOR SALE:** Airline 62-445 - \$45. Amateur Handbook, 1969 - \$20. QST (20) issues, 1942-1963 - \$10/all. Crosley 52TA - \$40. Crosley 5529B - \$50. Crosley 148 cathedral - \$125. Blue glass Crosley (Arcturus) 551 tube, good filament - \$25. Majestic Zephyr, 4501 - \$55. Philco 89 cathedral - \$265; RCA Selectovision/8 discs - \$75. Bendix 526A - \$45; National TVB-2, rare TV booster made by ham eqpt mfr - \$60. GE TV-radio service clock - \$135. Westinghouse refrigerator Model H126 - \$75. All + ship. Willard Smith, 1802 13th St., Bedford, IN 47421. (812) 275-5760, eves.

**FOR SALE:** Freed-Eisemann FM52, Luxman L80V amplifier, Dynaco PAT4 preamp, Sony SL5800 Betamax, Sony STR 6055 receiver - \$50 ea. Charles Voigt, RR4 Box 60, Belfast, ME 04915. (207) 338-6355

**FOR SALE:** Eico Sentinel 23 channel CB, with mic, nice and working - \$45 plus. Elwood F. Hunt, 308 Georgetown Rd., Carneys Point, NJ 08069. (609) 299-5259

**FOR SALE:** Hickok tube testers, Model 6000A - \$150. Model 633 - \$125. Rider's manuals in good condition, Vols. 6, 7, 8, 9, 10, 11, 12, 13 - \$12 ea. Vols. 3, 4, 5 - \$18 ea. In bad condition Vols. 14, 17 - \$6 ea. Two SG44 signal generators (equivalent to HP 608D) - \$50 ea. Model 707 Jerrold sweep generator - \$45. All items working and in vg condition. All items plus shipping. Gary R. Giedd, 1929 Airport Rd., PO Box 556, Mansfield, MO 65704. (417) 924-8649. E-mail: GRGiedd@email.msn.com

**FOR SALE:** Akai M-8 stereo tape recorder, crossfield w/tubes, very clean and working - \$85 plus shipping. Rudy G. Purcell, 4473 W. 136th St., Cleveland, OH 44135. (216) 251-6511

**WANTED:** To buy/trade/sell surplus telegraph relateds. Dr. Joe Jacobs, 5 Yorktown Pl., Northport, NY 11768. (516) 261-1576. E-mail: joekey@aol.com

**WANTED:** Amplion AR-114 driver or entire speaker. Any other Amplions except AR-19. Greg Farmer, 71 Rice Creek Way, Fridley, MN 55432. (612) 571-6062. E-mail: farme007@tc.umn.edu

**WANTED:** Early telegraph sounders, relays and apparatus. John Casale, W2N1, 3 Pickering Ln., Troy, NY 12180. (518) 272-3631. E-mail: jcs1@global2000.net

**WANTED:** RCA 143, Philco 90, Atwater Kent 356, and Stewart-Warner R-1301-A, excellent condition and original finish. Philco 70 chassis. Mark Murphy, 1400 Chicago Ave. #802, Evanston, IL 60201. (847) 328-5036. E-mail: PiscoCal@aol.com

**WANTED:** 3-tube earphone-only radios, point contact transistors, German transistor radios, advertising. Rudi Herzog, PO Box 140 108, 30959 Hemmingen, Germany. Ph: 011-49-5045-7464. Fax: 011-49-5101-5100

**WANTED:** DeForest D10 Radiophone chassis, or would sell my cabinet. Sherwood Morse, 770 Cummings Rd., Montpelier, VT 05602 (802) 223-7702. E-mail: ticmorse@aol.com

**WANTED:** Need escutcheon for Craftsmen (Radio Craftsmen) Model 10 tuner. Gary Royal, PO Box 302, Millers Creek, NC 28651. (336) 838-8499

**WANTED:** Pre-war Collins goods. Vibroplex Zaphyr bug. McElroy bug. B&W jel coils, 4CX1000. Brian Roberts, K9VKY, 130 Tara Dr., Fombell, PA 16123. (724) 758-2688

**WANTED:** Early wireless related like spark transmitter, loose coupler type crystal receiver, etc. Takashi Doi, 1-21-4, Minamidai, Seyaku, Yokohama, 246 Japan. Fax: 011-8145-301-8069. E-mail: taka-doi@kk.ij4u.or.jp

**WANTED:** HP400H VTVM AC or the meter alone. Heathkit VTVM V7A, meter and manual, copy OK. Manual for Hickok tube tester 534B. Manual for HP 8443 A tracking gen. nixie tube readouts. Charles W. Rhodes, 10105 Howell Dr., Upper Marlboro, MD 20774. (301) 574-0214

**WANTED:** Original butterscotch knobs for Fada 115 Catalin. Rod Galloway, 2220 Woodbury Rd., Melbourne, FL 32935. (407) 254-0280, after 5

— WANTED —  
**PICTURES FOR PHOTO REVIEW OR TELEGRAPH REVIEW PHOTOS MUST BE SHARP IN DETAIL A SHORT DESCRIPTION IS A MUST! SEE PHOTO REVIEW PAGES FOR ADDITIONAL INFORMATION**

**WANTED:** Eleton tubes, ball bearings, radio & aircraft receivers & transmitters, connectors, lamps, relays, switches, breakers. Hy Ness Company, 709B Delair Rd., Cranbury, NJ 08512-4212. (609) 395-1116. Fax: (609) 395-1117

**WANTED:** Schematics, manuals for Electronic educational electronic building sets. Call anytime, leave message. Richard Tabler, 24 Thorndike St., Arlington, MA 02474. (781) 641-1089

**WANTED:** 1941 Zenith chassis 12A1 or 12A2 as found in Models: 12S550Z, 12S58E, 12S568Z, 12S569E, 12S569Z, 12S595Z. Gino Lombardo, 10 Edgemont Ln., Bedminster, NJ 07921. (908) 781-6726

**WANTED:** Browning-Drake coil sets, RF & detector with DX tuning capacitors, see pictures: <http://home.ici.net/~radiodaz/wanted/wanted.htm>. Charles A. Days, PO Box 80205, S. Dartmouth, MA 02748-0205. (508) 979-3758. E-mail: radiodaz@ici.net

## TUBES • PARTS • SUPPLIES YOUR COMPLETE SOURCE FOR...

### TUBES:

Over 3500 receiving, transmitting, audio and industrial types in stock, including many foreign and early types.

### TRANSFORMERS:

Hard to find power, filament and output transformers as well as filter chokes for tube equipment. We feature HAMMOND performance transformers as well as many new old stock transformers.

### CAPACITORS:

High voltage electrolytic and mylar capacitors, multi-section capacitors and more for tube circuits.

### PARTS:

Resistors, tube sockets, potentiometers, knobs, dial belt lamps, diodes, speakers, wire, phonograph needles and cartridges and much more.

### LITERATURE:

Extensive selection of literature and books on antique radios, tubes, circuits diagrams, communication gear and hi-fi equipment. Some items not available elsewhere!

### SUPPLIES:

Grill cloth, cabinet restoration supplies, batteries, chemicals, tools, test meters, gifts and kits.



CALL OR FAX FOR OUR NEW 40 PAGE CATALOG!

**ANTIQUE ELECTRONIC SUPPLY™**

LIMITED PARTNERSHIP

6221 S. MAPLE AVE. • TEMPE, AZ 85283 • (602) 820-5411 • FAX (602) 820-4643 or (800) 706-6789

**FOR SALE:** Matched pair, N.I.B. globe 10s - \$185 pr. N.I.B. RCA 2A3 - \$110 pr. Used globe 10 - \$45. Igor Goloto, 17 Addison Dr., Fairfield, NJ 07004. (973) 463-4973. E-mail: goloto@gdats.com

**FOR SALE:** Fada 1000 mint - \$950. Sentinel 284 - \$625. Stewart Warner 62T36 - \$600. Bendix 526C - \$685. RCA 3BX671 - \$185. Zenith H600 - \$95. Northern Electric 5000, tan - \$150. Northern Electric 5000, brown/ivory - \$60. Northern Electric Midge - \$95. Silvertone 7000 - \$150. Emerson AX235, damaged - \$425. RCA 66X7 - \$500. Zenith K412R - \$100. Fada 263 - \$125, \$225. Fada 254 - \$225. Crosley 10-136 - \$60. Crosley 515 - \$110. Farnsworth 051 - \$95. Transistors: Zenith 500, tan - \$195; white - \$50; GE 676, red - \$75. Large photo list - \$1 LSASE, 2 stamps. **WANTED:** Kadette, Detrola, Fada, Catalins, Beetle, Plaskon transistors. Bob Masterson, Box 172, Valley Cottage, NY 10989. (914) 353-3151. E-mail: BMradio@aol.com

**FOR SALE:** New 2C39A made in England - \$7 ea + ship up to 22 pieces. Marv Glassman, 19300 Romar St., Northridge, CA 91324-1136. (818) 993-4560. Fax: (818) 886-0355

**FOR SALE:** 500+ radios, TVs & mics. Blue Fada Bullet - \$2,500. Blue Patriot - \$1,250. Fada 260, black & brass - \$450. Fada 260, white & brass - \$550. Fada 711, maroon - \$850. Panasonic TR005 - \$795. JVC Vsphere, white - \$375. JVC Vcapsule, white - \$450. RCA 44 mic - \$1,950. RCA 88 mic - \$375. Call me or e-mail with your needs. Tom Meers, 773 Carliste Club Dr., Stone Mountain, GA 30083-4708. (404) 297-0557, leave message. E-mail: garmco@mindspring.com

**FOR SALE:** WWII Deluxe Vibroplex original bug with the gray base and red paddles - \$225. All chrome version - \$125. Sounders and relays - \$50 ea. Dave Pennes, WA3LKN, 4607-C Santa Cruz Dr., Indianapolis, IN 46268-5354. (317) 471-9605

**FOR SALE/TRADE:** Sams CB manuals CB1 through CB77, (3) for - \$25, or trade for ham manuals, catalogs, magazines, handbooks. Al Bernard, PO Box 690098, Orlando, FL 32869-0098. (407) 351-5536. E-mail: ni4q@juno.com

**FOR SALE:** 100 boxes of loose radio tv tubes: 7-9 pin - \$5; loctals - \$8; octals - \$9; compactrons - \$15. Prices per box. Pick up. Cash in Somerdale. F. Krantz, 100 Osaige Ave., Somerdale, NJ 08083-1136

**FOR SALE:** Radio Shack Golden-U UHF indoor antenna #15-623, used, original box - \$10, includes shipping. Louis L. D'Antuono, 8802 Ridge Blvd., Brooklyn, NY 11209. (718) 748-9612

**FAX NUMBER FOR  
ANTIQUE RADIO CLASSIFIED  
(978) 371-7129 - 24 hours a day  
Ads - Subscriptions - Book Orders  
See inside front cover for details**

**FOR SALE:** N.I.B. 6CA7, 6LF6, 6BQ5, 6BR7, 6JE6, 6JG6, 6JS6, 6JT6, 6KM6. N.O.S. Mallory vibrators. Thank you. Louis L. Veltre, 643A Sherwood Ct., Lakehurst, NJ 08733-4207. (732) 657-7592

**FOR SALE:** High end tomato red Sony TR-86 in original gold box plus instruction manual originally purchased Nov. 5, 1962, no chips, cracks or scratches and it plays - BO. S. Volpini, 178 Cecil St., Samia, Ontario, Canada N7T 6W5. E-mail: ivolpini@xcelco.on.ca

**FOR SALE:** TSM 24-159 complete. Will include a TSM-1 - \$150 OBO plus shipping. Ray Schmidt, 607 1 Ave. SW, Austin, MN 55912. (507) 433-0069

**FOR SALE:** Bietman Most Often Needed Radio Diagrams, 1926-1938. Also for years 1939, 1940, 1941 and 1942 - \$15 ea. or \$60 plus. Elwood F. Hunt, 308 Georgetown Rd., Carneys Point, NJ 08069. (609) 299-5259

## Our Customers Say It Best: "You've Gotta Have an AM-100!"

Whether you are a novice collector with one radio or a seasoned veteran with a roomful, curious visitors always ask the question: "Does it still work?" What better way to prove the point than with a live old-time radio broadcast. With the Comtronics AM-100, you can entertain friends with authentic on-the-air radio demonstrations!

Will it Work for Me? *You be the Judge:*

"Big-band music all the time from any of my radios"

"I can't live without one!"

"The little transmitter works like a champ...the bass response is remarkable!"

"As I'm writing this, I am enjoying vintage Count Basie on my RCA 816K"

This is the Genuine Article. Call Now and  
Enjoy the Music

**Tusa Consulting Services**

19 Augusta Drive, Covington, LA 70435  
(504) 892-7348 (504) 892-2075 FAX



Make those old radios come alive  
with an AM-100, today

**Price: \$199.50**

Includes antenna, power supply  
and UPS delivers (48 States)  
1 yr warranty, 30day trial

# Transistor Radios: 1954-1968

By Norman Smith

**Super Holiday Gift!**



**Over 1,000 Transistor Radios  
460+ Color Photographs  
Price Guide**

**\$29.95 - Softcover**

U.S. Orders - Enclose \$3.00 per order for packing & book-rate shipping if total order is under \$35.00. If using VISA or MasterCard, include name on card, card number and expiration date. Send payment with order. Mass. residents add 5% sales tax. Money back return policy. Softcover unless stated otherwise. Most orders shipped the same day received, but allow 2-4 weeks to receive order. Foreign orders - write for shipping costs, or use credit card and specify air or surface (allow 2-3 months for surface shipping).



**A.R.C., P.O. Box 2, Carlisle, MA 01741. Tel: (978) 371-0512**

**Fax: (978) 371-7129 - E-mail: ARC@antiqueradio.com - Web: www.antiqueradio.com**



(Dec-98)

**FOR SALE:** RCA 20LF6 tubes, N.I.B. - \$50 ea., 7 for - \$300. Used 20LF6 tubes - \$30 ea. Glenn Hendrix, HC70, Box 117, Ardmore, OK 73401. (580) 226-4644

**FOR SALE:** (4) N.I.B. vibrator transformers - \$10 ea. plus shpg. N.I.B. Midland Model 23-160 RF signal generator with leads and papers - \$35 plus shpg. Jackson Audio, Model 555 signal generator - \$25 plus shpg. Copy of users manual - \$5. Carter Dynamotor, 12V at 14A DC in and 600V, 170 ma DC out - \$50 plus shpg. James Fred, 5355 S. 275 W, Cutler, IN 46920. (765) 268-2214

**E-MAIL ADDRESS FOR  
ANTIQUE RADIO CLASSIFIED**

**ARC@antiqueradio.com**

**Ads - Subscriptions - Book Orders**

**See inside front cover for details**

**FOR SALE:** Electrician London bound volumes dated early 1900; great articles, photos on wireless - \$75 ea. Bob Fuschetto, 1758 Michael Dr., Whitehall, PA 18052. (610) 435-8944, call bet. 7 pm & 9 pm

**FOR SALE:** At Bradenton, Fla. meet, Dec. 5th. Hallicrafters SX-99 - \$125. Hammarlund HQ 100C - \$150. Motorola 56T1 - \$225. Coral TR1G, no back - \$210. TR1 red back only - \$50. Green Emerson 888 - \$95. Radio tubes - \$1 to \$2. White Royal 500E - \$75. Maroon Toshiba 7TP30, in presentation case - \$110. Old catalogs - \$18 up. Old mics - \$75 & \$45. 1930 ARRL - \$28. Boy Radio Bug. Davies' Radio-Television, 701 W. Albee Rd., Nokomis, FL 34275. (941) 484-6786

**FOR SALE:** Browning & Drake 4-tube - \$65. Philco cathedral Mod 38 - \$60. Bristol Model C cabinet horn sprk - \$50. Western Electric 1A loop repro - \$150. Pair of 2-way radios Mod 80 Commander with chargers, vg - \$40. L&N galvanometer in pak box - \$30. All plus S&H. Wally Worth, 2 W. Elm Ave., Wollaston, MA 02170. (617) 479-4512, please call before 9 pm

**Call the CHRS Hotline: 415/821-9800**

**CHRS IS ON  
THE WEB**  
<http://www.wp.com/chrs>  
**JOIN NOW!**

- Four Journals per year. "The finest radio club magazine in the nation."
- Join now and receive *Hints & Kinks*, a valuable collection of restoration articles from 20 years of CHRS.
- 14 collector's events scheduled for 1997 all over Northern and Central California.
- Members receive access to the CHRS technical reprint service.
- All this and more for \$20 per year.



California Historical Radio Society  
PO Box 31659  
San Francisco, CA 94131  
<http://www.wp.com/chrs>

**FOR SALE:** GE GD-600 - \$45. AR turntable. J. Finkelstein, 63 Cedar Hill Ln., Media, PA 19063

**FOR SALE:** Rubber gasket for Zenith/other dial glass, 3-ft - \$6; 6-ft - \$11; ppd. Curt Lutz, 1021 N. Hickory Pl., Broken Arrow, OK 74012. (918) 251-4915. E-mail: antiqradio@aol.com

**FOR SALE:** GE 608 portable - \$10. GE Model 50 - \$15. Knight 93-320 6V6 amplifier - \$15. All items plus UPS. Jon Andreasen, PO Box 22, Newton, NJ 07860. (973) 579-6261, 7 to 10 pm Eastern. E-mail: jda@nac.net

**FOR SALE:** Communications equipment: Hammarlund HQ100A - \$150; Hammarlund HQ170 - \$185; Hallicrafter SX71 - \$175; Hallicrafter S40B - \$50; Hallicrafter S20R - \$75; Hallicrafter speaker R-46 - \$75; Knight T-150A transmitter - \$125. Norton Thompson, PO Box 422, Paonia, CO 81428. (970) 527-3017

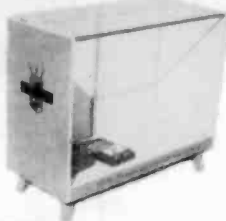

**FOR SALE:** Early 1960s Zenith transistor radio dealer display case, similar to one on page 140 of Smith's Zenith Transistor Radios book, approx. size: 30"H x 38"W x 16"D, glass top and front - \$185. Please arrange pick up or shipping. Also, 1920s Jefferson tube revitalizer, for 01-A and 199 Type tubes, complete, nice condition - \$25. Dave Crocker, 4B Beechwood Point Dr., Mashpee, MA 02649. (508) 477-1578

**FOR SALE:** 10K gold, 23.4 gr. executive's ring, World Radio Company, from mid 20s - Best Offer. Stafford Kaplan, 520 Sumter Ave. S, Minneapolis, MN 55426. Or call: (612) 545-2357. Fax: (612) 938-6395

**FOR SALE:** Philco cathedrals, all excellent condition. Models 20B - \$325; 21 - \$375; rare 43 - \$375; rare 52 - \$225; 60 - \$175; 91 - \$325; plus UPS. Frank Connors, 3 Rockingham Ct., Bedford, NH 03110. (603) 647-1981

**FOR SALE:** Zenith Deluxe Royal 500H, eight transistor radio, chassis 8HTU22 - \$80 plus. Zenith Royal 500 seven transistor radio, chassis 7Z140Z1, needs work - \$40 plus. Elwood F. Hunt, 308 Georgetown Rd., Carneys Point, NJ 08069. (609) 299-5259

**FOR SALE:** Two Vibroplex brass racer keyers eky, need adjustment - \$35/\$65. Levy, 8 Waterloo Dr., Morris Plains, NJ 07950. (973) 285-0233

**FOR SALE:** Galina crystal radios and parts, 304TL, unused - Make Offer. L. Gardner, 458 Two Mile Creek Rd., Tonawanda, NY 14150. (716) 873-0447

**FOR SALE:** Tube tester, test equipment, 1920s radio parts, literature, tubes. Send SASE for list. Harry Cap, 190 Beech St., Bridgewater, MA 02324. (508) 697-8648

**FOR SALE:** Eico Model 368 sweep generator and marker 1500KC xtal - \$20 plus UPS. Ed Povraznik, 9606 Biddulph Rd., Brooklyn, OH 44144-3015. (216) 661-0032



**WANTED:** Deluxe Morris coil winder with instructions. Radiojac chassis stand. Battery eliminators: AK, Majestic, Sterling, etc. 1929-1935 Allied catalog. Del Fankhauser, 6 Don's Dr., Mission, TX 78572. (956) 585-3209. E-mail: Delfish@Hiiline.net

**WANTED:** Pilotron Pilot tubes Types P-227 and P-224. Must test good. David Kechkaylo, 624 Shady Glen Cir., Webster, NY 14580. (716) 872-6683

**WANTED:** Information, schematic or finishec unit for Antique Electronic Supply kit K-167 or P-M167. Battery Powered Wireless Transmitter. Richard Dzick, 31572 Juniper Ln., Warren, MI 48093. (810) 268-4671. E-mail: n8mq@aol.com

**VISIT A.R.C.'s WEB SITE**  
[www.antiqueradio.com](http://www.antiqueradio.com)

**Book Orders – Subscriptions – Articles  
and more!**

**WANTED:** RCA television antennas. 7" & 10" TVs N.O.S. 201 & 401 tubes. Banks that look like TVs or radios. Tony DeMara, 40231 Day Dr., Clinton Twp., MI 48038. (810) 263-0325. E-mail: oldtvsandtoys@ameritech.net

**WANTED:** Large knob for Crosley 51, need 2. Steve Imms, 51a Old Shannock Rd., Wakefield, RI 02879. (401) 783-5387. E-mail: imms@brainiac.com

**WANTED:** UTC input, interstage, output transformers. Western Electric: 7A and 2A power supply; 10D, 540, 560 radio speakers. Tubes: 216A, 217A, 262A, 274A, 239A, 212D, 437A, etc. Mesh plate 50, 585. Ming Yang, 346 Donald Dr., Moroga, CA 94556. (925) 376-4220

**WANTED:** Military BC-221 freq. meter, ARC-5 items & special wrench BC-721 pogostick, GRC-9. Jim Krajovic, N3DKS, 546 Sheridan, Pittsburgh, PA 15206. (412) 665-0916

**WANTED:** Will pay your price for Crosley Audion, Harko senior non-regenerative Model 50 amplifier, Model VI, Model 50 portable, Model XV, Model XII. Bill Moss Settle, 120 Clarksdale Cir., Glasgow, KY 42141. (502) 651-6525

**WANTED:** Chassis and speaker for Crosley Elf cathedral and Majestic 15. Gary Milner, 106 Henry Little, Pea Ridge, AR 72751. (501) 451-1343

**WANTED:** Matching speaker for National NC46. Tom Mooningham, PO Box 487, Maugansville, MD 21767-0487. (301) 791-0834. E-mail: lunarpig@aol.com

**WANTED:** Horn speakers: Atwater Kent Model R, Stromberg-Carlson 2A base. John Crist, RRT1 Box 4, High Hill Rd., Earlton, NY 12058. (518) 731-9375

**WANTED:** Microphones Wanted: Will pay cash or trade for other vintage mics: Western Electric 53-A, Neumann CMV-3, other early bottle type condenser mics; also, RCA 4-A box camera, other box cameras; Shure 556-A, B, and C. these are large Elvis-type mics with cylinder-shaped shock mounts on the bottom, cord will come out of the shock mount; also, Shure 55-B, medium impedance model, same size, but w/shoulder mount, connector comes out of bottom mount; Shure 546 cigar-shaped mic, w/cylinder shock mount on bottom, has XLR connector coming out of mount; Electro-Voice V-4; Astatic 600-S 'ocket; Shure 737 monoplex crystal. Also, looking for 3-legged and tripod-type early mic stands, other oddball mic stands. Also, all Allied radio catalogs from the 50s. Also, mic-related memorabilia, sales lit., interesting pictures, accessories, parts. Have several vintage mics to trade, both broadcast/recording and ham-type, etc. Merry Christmas! Ward Kremer, 5807 Papaya Dr., Ft. Pierce, FL 34982, Ph/fax: (561) 468-7732. E-mail: WKremer798@aol.com

**WANTED: Japanese tube portable radios and information about them: ads, articles, company info, etc. Larry Gilbert, 2602 Amapola Dr., Davis, CA 95616. (530) 758-5025. E-mail: l.gilbert@thegrid.net**

**WANTED:** Ham QSL cards. Don Swanson, 8070 BriarOak Dr., Pensacola, FL 32514-7830

**WANTED:** Hallicrafters TW1200/R1200 multiband portable and Panasonic RF8000 or RF9000 multiband portable. Sony CRF320 and Zenith Trans-Oceanic green military, like Model 600. Zenith Royal 1000 6-band and any Philips multiband SW. Thanks. Denis Burke, 308 Person St., PO Box 137, Runnells, IA 50237. (515) 966-2871. E-mail: zeenith@msn.com

**WANTED:** Nice examples of 1935 Crosley tombstones: 915 (Clipper), 855 (Merrimac), 715 (Corsair). Paul Froehlich, W13562 Rausch Rd., Lodi, WI 53555. (608) 592-2142. E-mail: pafroehl@facstaff.wisc.edu

## RADIO XXX

OUR 30th  
GET-TOGETHER

An Indoor Old Radio  
Flea Market

6500 square feet — 90+ tables available

Sunday, February 21, 1999

8:00 A.M. 'til 1:00 P.M.

Westford Regency Inn — Regency Room  
Westford, Mass. (I-495 at Exit 32)

Look for additional information  
Jan. & Feb. A.R.C.

Sponsored by:

The Greater Boston  
Antique Radio Collectors

*Not a club, no dues, no newsletter...  
just a great group of collectors!*

Thanks to Antique Radio Classified for  
organizing this meet.

## Old Authors Bookshop

Wireless Telegraphy Telephony Radio  
Television Electricity

Books and Literature  
Bought and Sold

PO Box 403 Morrisburg ON Canada K0C 1X0

Tel: (613) 543-3337 Fax: (613) 543-2380

e-mail: [authors@mor-net.on.ca](mailto:authors@mor-net.on.ca)

Website <http://www.abebooks.com/home/oldauthors>

# *The Collector's Guide To Antique Radios - 4th Edition*

By Marty & Sue Bunis



**Order  
Today!**

**8,500+ Battery & AC sets from the '20s - '60s**  
**400+ color photographs**  
**Updated prices**  
**\$18.95 - Softcover**

There are no transistor radios listed in the fourth edition. You will find them in *The Collector's Guide to Transistor Radios* available from A.R.C. for \$16.95.

*U.S. Orders - Enclose \$3.00 per order for packing & book-rate shipping if total order is under \$35.00. If using VISA or MasterCard, include name on card, card number and expiration date. Send payment with order. Mass. residents add 5% sales tax. Money back return policy. Softcover unless stated otherwise. Most orders shipped the same day received, but allow 2-4 weeks to receive order. Foreign orders - write for shipping costs, or use credit card and specify air or surface (allow 2-3 months for surface shipping).*



**A.R.C., P.O. Box 2, Carlisle, MA 01741. Tel: (978) 371-0512**

**Fax: (978) 371-7129 - E-mail: [ARC@antiqueradio.com](mailto:ARC@antiqueradio.com) - Web: [www.antiqueradio.com](http://www.antiqueradio.com)**



(Jul-98)

# **Collector's Guide to Antique Radios Combined Edition - CD-ROM**

By Marty & Sue Bunis and George Kaczowka

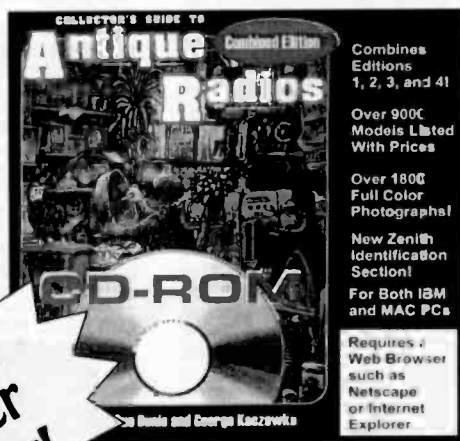

**NEW!  
Order  
Today!**

Combines Editions 1, 2, 3, and 4!

Over 9000 Models Listed With Prices

Over 1800 Full Color Photographs!

New Zenith Identification Section!

For Both IBM and MAC PCs

Requires a Web Browser such as Netscape or Internet Explorer

**Combines Book Editions 1, 2, 3, and 4!  
Over 9,000 Models with Pricing  
1,800 Full Color Photographs  
Model Number Index for All Manufacturers  
Photo Index by Category**

Runs on both IBM and Mac

Requires a Web Browser, such as Netscape Navigator or Internet Explorer

**\$39.95**

*U.S. Orders - Enclose \$3.00 per order for packing & book-rate shipping if total order is under \$35.00. If using VISA or MasterCard, include name on card, card number and expiration date. Send payment with order. Mass. residents add 5% sales tax. Money back return policy. Softcover unless stated otherwise. Most orders shipped the same day received, but allow 2-4 weeks to receive order. Foreign orders - write for shipping costs, or use credit card and specify air or surface (allow 2-3 months for surface shipping).*



**A.R.C., P.O. Box 2, Carlisle, MA 01741. Tel: (978) 371-0512**

**Fax: (978) 371-7129 - E-mail: [ARC@antiqueradio.com](mailto:ARC@antiqueradio.com) - Web: [www.antiqueradio.com](http://www.antiqueradio.com)**



(Jul-98)

**FOR SALE/TRADE:** Would rather trade for vintage mics, stands, etc., but cash offers will be considered. RCA SW-5 cartridge wire recorder, black deco Bakelite, rare, cartridge is heavy as a brick, from 40s, exc condition, works great, have copy of orig. lit; Bozak B-300 square, medium size enclosures, 50s deco, w/12" woofers and 2 tweeters inside ea., sound great, lots of bass; Fisher 400 receiver, exc, sounds real nice, near mint, no case - \$135; pair MacIntosh 30-tube amps, medium haze/rust, sound fine; Pioneer 3-way stereo crossover - \$125 OBO; U-Test-Em color TV tube checker, drug store type, interesting piece from 50s, very colorful - \$70 OBO; RCA 15 GP 22, round prototype picture tube w/no gun in neck, used for sizing, serial #153 chalked on side of tube, this would make it less than 200 out of a run-to-date of over a billion tri-color CRTs, very nice collectible. Still looking for offers of trade for tube hi-fi Marantz system. These pieces all came together, are near mint, w/all orig. lit, warranties, etc.: 10-B tuner, 7-C preamp, 8-B amp, SLT-100 linear tracking turntable. Have the following mics for trade, preferably for other vintage mics, will consider cash offers: RCA BK-4; BK-5; Varicoustic pancake; EV 342 shotgun in shock mount; EV V-1, V-2, several Shure, EV, some great ham mics. Always looking for: RCA, Neumann, Telefunken, Sony, Western Electric, broadcast and film mics; also, RCA memob., esp. curtains, clocks, chairs, signs, thermometers, what-have-you; all Allied catalogs from the 50s. Merry Christmas and good hunting! Ward Kremer, 5807 Papaya Dr., Ft. Pierce, FL 34982, Ph/fax: (561) 468-7732. E-mail: WKremer798@aol.com

**FOR SALE:** RCA 45 record player with amp Model 45EY2 - \$40 plus. Elwood F. Hunt, 308 Georgetown Rd., Carneys Point, NJ 08069. (609) 299-5259

**FOR SALE:** Philco 20 and 90 tube shields - \$20 ea. Emerson 231 Ingraham cabinet - \$225. Send SASE for list of radios, crystal sets, speakers, books, Edison phonograph parts, cases and horns. Leonard Aquino, 2 Somerset Ln., Putnam Valley, NY 10579. (914) 528-6857, after 7pm EST

**FOR SALE:** Optonica dual-motor tape deck - \$30 plus UPS. **WANTED:** Turntable mechanism for Victrola, mid to late 30s Zenith or Philco tombstone radio, Philco 37-166-122 owners manual, or copy. Dick Friedman, 1502 Elmwood, Wilmette, IL 60091. (847) 803-3050

**FOR SALE:** Zenith M722, FM only - \$15. Majestic 91 escutcheon - \$25. RCA 813K chassis, tubes, knobs - \$40. Philco 41-260 chassis speaker, not positive, unmarked - \$20. ARRL 1952 handbook, stained - \$12.

**WANTED:** Chassis for Fada Seven. Brian Kurlle, 2222 Nodleigh Ter., Jarrettsville, MD 21084. (410) 692-0450

**FOR SALE:** Books: Elements of Radio, Marcus 1st Edition - \$15; 3rd Edition - \$12. Scientific Apparatus, Thomas Co., exc cond., over 1,000 pp. - \$20. All hardcovers. Radios Redux, Collins, exc cond. - \$15. Flick of the Switch 1930-50, McMahon, fair - \$6. Maureen Martin, 1407 Memory Ln., Lutz, FL 33549. (813) 949-1835

**FOR SALE:** Zenith 3000-1 T/O with log and AC adaptor - \$55. Bendix 55X4, maroon, works - \$40. Reel-to-reels: MINY 3", vg+ - \$25; Grundig TK20, 6", works - \$40; OKI555, vg+ case - \$40. Lafayette HA230 radio - \$45. Zenith J733, works - \$10. Zenith R520W, works - \$10. Regency FM monitor radio MR33 - \$25. Heathkit AA181 stereo amplifier and AJ11 receiver with tubes, both for - \$85. All plus shipping. Charles Phillips, 8607 Rembrandt Cir., Newark, DE 19702. (302) 832-9592

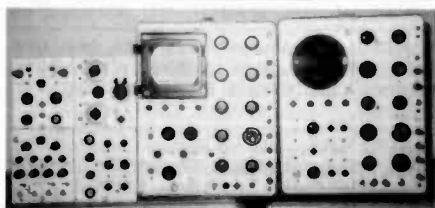

**FOR SALE/TRADE:** Tektronix 535 and 545B oscilloscopes, four extra plug-in units, complete, untested, good to excellent. Jim Van Valkenburg, PO Box 81554, Las Vegas, NV 89180-1554. (702) 221-9956

**FOR SALE:** tubes: 45s 10, 310, 01A, 301A, 201A, 6B4s, 76, 47, 6LF6, 5556, 281, 199, 499, 171A, 112, 813, 6146, 12AU7, 12AX7, 6973, 1614, 6L6, and many other tubes. Send want list. Tony DePasquale, 186 Randolph Ave., Emerson, NJ 07630. (201) 262-4970

**FOR SALE:** Sonora, small table model wooden cabinet horn speaker, good driver - \$120. Motorola Model 51x12 radio, same chassis and dial as S-grille catalin - \$45. Eric Miller, PO Box 778, Linn, MO 65051. (573) 897-4121. E-mail: miller@linnstate.edu

**FOR SALE:** Westinghouse Model CB loading coil - \$150. Mint Collins KWM1+516F1 transceiver. **WANTED:** Pre-1940 Collins ham transmitters. Stuart Mount, W2AO, 35 Grand, Highland, NY 12528. (914) 691-7957

**FOR SALE:** Admiral 5X12N - \$20; 17TM-N - \$25. Goodrich Esquire clock radio - \$30. Crosley 66TC - \$45. Detrola metal, AM/SW - \$25. GE 542 C/R - \$30. Hallicrafters: S38B, fair - \$35; S38D, dial scale not original, works exc - \$45. Philco 66, refinished - \$75. RCA 45X13 - \$35. Others plus transistor regular and novelty. LSASE. H. B. McMahan, 313 W. Shaw, Tyler, TX 75701-3029. (903) 593-5433. E-mail: hbmc@juno.com

**FOR SALE:** AK-40 with accessory unit, tubes - \$25 plus UPS. **WANTED:** RCA 5T4 tableset. Dave Smith, PO Box 81, Olney, IL 62450. (618) 392-6601

**FOR SALE:** All Zenith sale #4 Trans-Oceanics, all working 8G005 vg, complete - \$195. (2) G-500s vg - \$195, g - \$100, B600L tan, leather vg - \$395. 1000 leather - \$185. 1000-1 vg - \$135. 3000-1 exc - \$195. 3000-1 rough - \$75. R-7000 - \$350. Royal 500 - \$50. 7S633 vg wood - \$165. Panasonic RF-4900 10 band SW, vg - \$375. Ted Demski, 5806 225 Pl. SW, Mountlake Terrace, WA 98043. Phone/fax: (425) 778-7100

## WANTED

# Old Computers

Would love to discuss purchasing your pre-80's computers and related items.

<p>Please contact:</p> <p>Steve Gabaly 128 McFall Rd Apalachin NY 13732 (607) 625-5221</p>	<ul style="list-style-type: none"> <li>• MITS      • IMSAI</li> <li>• Apple I   • Scelbi</li> <li>• SWTPC   • Sol-20</li> <li>• JOLT     • Mark-8</li> <li>• Heath EC-1</li> </ul>
--	--

**old\_computers@yahoo.com**

# Gift Ideas for the Holidays



Price Guide

**Zenith Radio: The Early Years 1919-1935** by John Bryant and Harold Cones. *The first of a planned 3-book series explains the Zenith story. Never published photos, documents, and information. 300 photos and illustrations, 120 in color. 8 1/2" x 11", 224 pages. Softcover. — \$29.95*



Price Guide

**Genuine Plastic Radios of the Mid-Century** by Ken Jupp and Leslie Piña. *Illustrates mid-century table radios made of plastic as examples of industrial design and pop-culture. Vintage B&W photos and advertisements. 439 color photos. 8 1/4" x 11 1/4", 208 pages. Hardcover. — \$39.95 NEW*

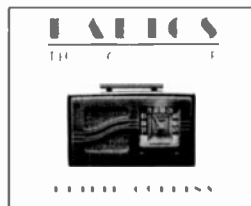

**Radios: The Golden Age** by Philip Collins. *Colorful Catalin and Bakelite radios from the late 1930s to the early 1940s. Over 100 color photos. 10" x 8 3/4", 119 pages. Hardcover. — \$12.98*



**The Golden Age of Televisions** by Philip Collins. *An amazing collection of photos of these early machines that evoke a time when the television was more than merely a box or a screen: it was the center of every home. 10" x 8 1/4". Softcover. — \$15.95*

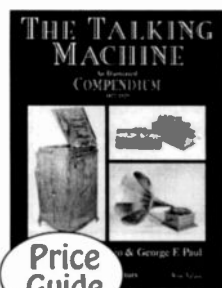

Price Guide

**The Talking Machine, An Illustrated Compendium, 1877-1929** by Timothy Fabrizio and George Paul. *Contains over 500 beautiful photos of external & internal horn phonographs. The authoritative text & value guide, complemented with a wealth of visuals, make this book a must in your library. 8 1/2" x 11", 256 pages. Hardcover. — \$69.95*



**Radio Art** by Robert Hawes. *Illustrated radio history. Although focusing primarily on British sets, this book also contains American sets: Airline, Atwater Kent, E.H. Scott, Emerson, Fada, GE, Majestic, Philco, RCA, Zenith, and others. 250 photos, 150 in color. 9 1/4" x 12", 128 pages. Hardcover. — \$9.95*



**Radio! Radio! 3rd Edition** by Jonathan Hill. *Comprehensive coverage of British radios from the 1920s to the 1970s. Includes a directory of nearly 3,000 different transistor models made in Britain or imported between 1956 and 1972. 8 1/4" x 12", 320 pages. Hardcover. — \$64.95*

U.S. Orders - Enclose \$3.00 per order for packing & book-rate shipping if total order is under \$35.00. If using VISA or MasterCard, include name on card, card number and expiration date. Send payment with order. Mass. residents add 5% sales tax. Money back return policy. Softcover unless stated otherwise. Most orders shipped the same day received, but allow 2-4 weeks to receive order. Foreign orders - write for shipping costs, or use credit card and specify air or surface (allow 2-3 months for surface shipping).



A.R.C., P.O. Box 2, Carlisle, MA 01741. Tel: (978) 371-0512

Fax: (978) 371-7129 - E-mail: ARC@antiqueradio.com - Web: www.antiqueradio.com



(Dec-98)

**FOR SALE:** Delco auto radio 10BFMT1 with 8-track player, stereo - \$35. Paul E. Ares, 275 Massapoag Ave., Sharon, MA 02067. (781) 784-3067

**FOR SALE:** Manual of Radio Telegraphy and Radio Telephony by J. A. Fleming, 1908, signed and dated by wireless operator on R.M.S. Lusitania - Offers. French postal telegraphy, 4 pieces, tape inker, twin relay repeater, code key, CI spool stand, dated 1898. Also have H. W. Sullivan tape inker, photos available. Jim Taylor, G4ERU, No. 5, Luther Rd., Winton, Boumemouth, BH9 1LH, UK. Tel/fax: +44-1202-510400

**FOR SALE:** EC1-B, please call again, 2-245s, both - \$80. Good used Riders #12 - \$15. 6ST6, new - \$15. 280 good used - \$25. Regency WT-4 - \$65. National NC60 special - \$65. Realistic DX-120 - \$65. SX24 - \$75. Pete Putra, 1429 Lawndale Ave., Racine, WI 53403. (414) 632-2543

**FOR SALE:** Journals: Proceedings of the Institute of Radio Engineers from 1927-1939, Radio, Radio Television News. Emil Socher, 135 Brinkworthy Rd., 2-114 SaltSpring Tsl., British Columbia, Canada V8K 1S3. (250) 537-5947

**FOR SALE:** A heavy AK F4 speaker for - \$35 + \$10. Earle Drake, PO Box 1808, Hyannis, MA 02601

**FOR SALE:** Fisher 500C, no case, AR turntable, Fisher XP18 speakers, exc - \$300. Tom Mooningham, PO Box 487, Maugansville, MD 21767-0487. (301) 791-0834. E-mail: lunarpig@aol.com

**FOR SALE:** Brush Soundmirror, KLH21, AK33, Radiola 3, N.O.S. scarce phono cartridges. Gerald Shirley, 133 Sagamore Rd., Tuckahoe, NY 10707. (914) 779-2436

**FOR SALE:** Panasonic 8TK stereo cartridge tape deck. Sams Photofacts - cheap. Ann Bichanich, Jay's, 15 W. Lake St., Chisholm, MN 55719

**FOR SALE:** RCA 100B - \$50. Shure 51 - \$50. EV LS-15 - \$100/pr. JBL D-123 - \$100. Jack Smith, 288 Winter St., N. Andover, MA 01845. (978) 686-7250

**FOR SALE:** Allied radio cat. 1941 - \$12. Radio & TV news, 1957-1958, 11 copies - \$15. All items plus shipping. Phone or write. Samuel T. Burnside, 4838 S. Westhaven Dr., Jackson, MS 39209-4711. (601) 922-2235

**FOR SALE/TRADE:** (One) 1930s large "Zenith Radio" neon sign, approx. size 29" x 18". Larry Drago, 383 Lincoln Dr., Cheshire, CT 06410. (203) 272-6030. Fax: (203) 272-2002. E-mail: theradioman@webtv.net

**FOR SALE:** Antique and collectibles in Door County, WI, or will ship: hundreds of tube and transistor radios; television; tape recorders; multibands; telephones; high fidelity equipment; test equipment; amateur, military radios; uniforms; antique medical, radio, other books; unusual electronic devices; antique hearing aids. For 16 page list, send two-stamp LSASE to: John Enigl, K9HJL, 5425 Cherry Ln., Egg Harbor, WI 54209. (920) 743-3672

**FOR SALE:** Aluminum tube caddy - \$15. Telematic TV: analyzer (no book) - \$10. Both plus shipping. Bill Riley, W7EXB, 863 W. 38th Ave., Eugene, OR 97405-2375. (541) 345-2169

**FOR SALE:** Vacuum tubes, all kinds, 35,000 on hand. Send want list & SASE for prompt response. Tom Ivas, 2932 W. 99th St., Evergreen Park, IL 60805. Ph/fax: (708) 423-0528. E-mail: tivas@xnet.com

**FOR SALE:** Harman Kardon T224 tuner, A224 amp, good, working - \$10 each. Ted Hutson, N1GTP, 11 1/2 Winthrop Ave., Beverly MA 01915. (978) 922-3405. E-mail: tedhutson@yahoo.com

**FOR SALE:** New Johnson Viking II, Johnson Viking UFO Model 122 with manual - \$900 plus UPS shipping charge. John Nosbaum, W9BJP, 2743 Wilmette Ave., Wilmette, IL 60091. (847) 256-0547

# ARBE-III

## Universal Battery Eliminator

*Ideal Christmas gift for the radio collector!*

A gift that will give years of service  
Completely assembled and tested  
Can be used Christmas morning  
Professional quality and construction

Comes with five-year warranty,  
owners manual and instructions

**\$149.95 Shipped USA**

Contact:

Antique Radios Inc.

Box 6352, Jackson, MI 49204

(517) 787-2985 or

Fax (517) 782-7422



CLASSIC RADIO

## WALL CLOCK

Big, 10 inch wall clock with black "radio" dial face and brass colored bezel. Quartz controlled movement, sweep second hand, acrylic dial crystal and bezel. Battery included. \$19.95 includes shipping anywhere in the U.S. via Priority Mail. Massachusetts residents please add \$1 sales tax. Send check with order, please.

Antique Radio

635-A Pleasant Street  
Frammingham, MA 01701  
Tel. 508-879-2778

**WANTED:** Working driver for Tower horn speaker, 2 1/2 in. diameter. Stan Marlin, Box 1035, Assiniboia, Saskatchewan, Canada S0H 0B0. (306) 642-3824

**WANTED:** Conar Model 400 transmitter and Model 500 receiver. Matt Kachmarchi, RD2, Box 150, Cherry Tree, PA 15724. (814) 948-7526

**WANTED:** A copy of From CB to Ham Beginner, by J.A. Stanley, published by Howard W. Sams, FT-234 crystals, 7050-7140 kHz. R.C. Yingling, 2 S. Locke Ave., Yeagertown, PA 17099

**WANTED:** Catalan radios and colored Plaskons. Any make or model. I am willing to pay top prices for radios that I need. I will also purchase whole collections. Please write, call or e-mail. Jean-Claude Reboil, 7010 S.W. 48th Ln., Miami, FL 33155. (305) 662-1986. E-mail: jcreboul@aol.com

**HAVE YOU MOVED? ARE YOU MOVING?  
PLEASE NOTIFY US A.S.A.P.  
SEND US YOUR...  
OLD ADDRESS  
NEW ADDRESS and  
SUB #  
MANY THANKS!!!!**

**WANTED:** Atwater Kent Model 206 parts, need chassis, speaker, dial escutcheon. What do you have? Maybe you have all in shabby cabinet. Please advise. Thanks. Ed Adrian, 4735 Thornhill Ave., Shreveport, LA 71106-1523. (318) 868-5729

**WANTED:** Emerson chassis to fit 1933 Mickey Mouse radio, #409-410 or 411. Herman Fothe, 5292 Tiffany Ann, West Palm Beach, FL 33417. (561) 688-3794

**WANTED:** E.H. Scott amplifier chassis for 19-tube Phantom, I have amplifier chassis for AM/FM Phantom (I think) for trade, also need speaker for 19-tube Phantom. Eric Lenius, PO Box 685, Port Orchard, WA 98366. (360) 871-5921. E-mail: lenius@tscnet.com

**WANTED:** Speakers for Gloritone 26, 27; Crosley 53, 54; Grunow 660; Zenith 6-S 27, part no. 49-117-8 in. 5-S 27, part no. 49-143-6 in. Cones do not have to be perfect. Smokehouse Antiques, Ralston Bailey, R#1, Box 479, Benton, TN 37307. (423) 338-5923

**WANTED:** Western Electric amps, horn, spkr, xfmr, wire, socket, caps and datasheet, etc. 101 102, 104, 205, 211, 212, 216, 217, 242, 252, 253, 262, 271, 274, 275, 276, 284, 300, 310, 339, 347, 348, 349, 350, VT2, VT25A, VT52. Others: KT66, 77, 88, RCA50, 250, 350, 245, 345, 845, Telefunken ECC81, 82, 83. Jun Mizuno, 933 Portwood Cir., San Jose, CA 95120. Tel./fax: (408) 268-4016. E-mail: jmizuno@usa.net

**WANTED:** Owners manual for a Radiola Super VIII console, escutcheon for a Radiola 48 & a Fada 480-A. Ken Martin, 12667 Eckard Way, Auburn, CA 95603. (530) 885-C243

**WANTED:** Any condition Radiola VII-B cabinet or horn speaker. William Boyd, 74 Atsion Ct., Medford, NJ 08055. (609) 722-2369

**WANTED:** Assembly/service manual or schematic for Heath AA11 preamp. John Lomas, 253 Elm Ave., Glen Riddle, PA 19063-5739. (610) 459-0186

**WANTED:** Bendix radios, ads, signs, etc. Radios need not work. Aaron Mall, 903 Dropleaf Ct., Baltimore, MD 21208. (410) 486-8813

**WANTED:** Gold Airline 01-As. RCA Selectavision player and movies. Charlie Poulton, 25626 Oaks Blvd., Land O'Lakes, FL 34639. (913) 973-7030

**WANTED:** Crosley 148 cathedral case, usable condition, reasonably priced, finish of secondary importance. Thanks! Art Eberhardt, 307 Hackamore Dr., Florissant, CO 80816. (719) 689-2026

**WANTED:** To double the size of my private museum collection of communication & ham equipment, cash waiting for Hallicrafters, Hammarlund, National, Collins, Scott, Racal, Howard, RCA, Viking, RME, TMC, military receivers, etc. Large collections. Estates or single items. Call: Alan Carpenter, 6850 N. Camino de Fray Marcos, Tucson, AZ 85718. (520) 575-1960

**WANTED:** BC-611 and accessories; command sets. Alan Burg, Forkland Ln., Jobbs Ferry, NY 10522. (914) 693-2564. E-mail: alarb@cloud9.net

**WANTED:** An example of Rawls Yellow-Base tube for display and CK 716 semiconductor. Larry Daniel, 1758 Chennault Cir., San Antonio, TX 78226. (210) 923-2634. E-mail: LDaniel102@aol.com

## Visit the A.R.C. Web Site!

The URL to access the A.R.C. Web site is:  
<http://www.antiqueradio.com/>

Our site includes highlights from  
current and recent issues:

- Editor's Comments
- Image of the Cover
- Feature Article
- Radio Miscellanea

- Plus:
- Photo Reviews
  - Book Reviews
  - Coming Radio Events
  - Complete Club Listing
  - List of Books For Sale
  - Subscription Information

While visiting our site, you may  
send e-mail and orders for  
books, videos and subscriptions.

Let us know what you think  
about A.R.C. on the Web!

### 10 BAND MINIATURE SHORTWAVE RADIOS!

Listen to the entire world! This unusual shortwave radio, 7 x 1 1/4 x 3 1/2 inches, is one of the smallest and most sensitive radios ever built. It has AM/FM/MV and 7 shortwave bands. It uses only two AA batteries or 3-volt adapter (not included). The cost including shipping and insurance is: Only \$35.00 per set N.I.B. 12, 8 bands also available. E-mail: RGBENT@AOL.COM.

Call 732-607-0299, Fax 732-679-8524.

Mail your check or money order to:

R.G.B. Enterprises, Dept. 71

P.O. Box 5367, Old Bridge, N.J. 08857, U.S.A.

# Our Most Popular Titles Make Great Gifts This Holiday Season

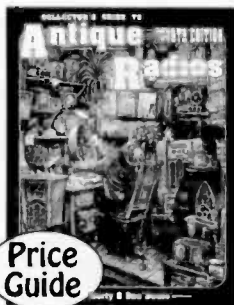

Price Guide

**The Collector's Guide to Antique Radios 4th Edition** by Marty & Sue Bunis. 8,500+ Battery & AC sets from the '20s to the '60s. Updated prices. Many new photos. 1996. Shipping Now. — **\$18.95**  
**Combined Ed., CD-ROM** by Bunis & Kaczowka. Available Now. — **\$39.95**



Price Guide

**The Collector's Guide to Transistor Radios 2nd Edition** by Marty & Sue Bunis. This book will help you identify the most sought-after vintage transistor radios. Over 2,900 models, all with current prices. Includes radio club listing. 375 all new color photos, 320 pages. 1996. — **\$16.95**

**NEW.....**

**The Collector's Guide to Antique Radios, Combined Ed., CD-ROM**, Bunis & Kaczowka. Combines book editions 1-4. Over 9,000 models with pricing. 1,800 full color photos. Requires a web browser. Runs on both IBM & Mac. 1998. — **\$39.95**

**Genuine Plastic Radios of the Mid-Century**. Jupp & Piña. Table radios made primarily of brightly covered plastics, with advertisements, vintage black and white photos, 439 color photos. Price guide. 208 pgs. Hardcover. — **\$39.95**



Price Guide

**The Radio Collector's Directory and Price Guide, 1921-1965, 2nd Ed.** by Robert Grinder. Over 20,000 radios by manufacturer, model number, year, etc. with prices. Radio history, cabinet style chapters. No photos, 264 pages. — **\$26.95**

**Transistor Radios, A Collector's Encyclopedia and Price Guide** by Robert Lane and David Lane. Identification guide to over 2,500 transistor and novelty radios. History and key to collecting chapters, 170 pages. — **\$19.95**

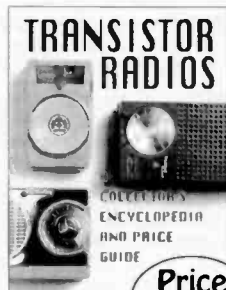

Price Guide

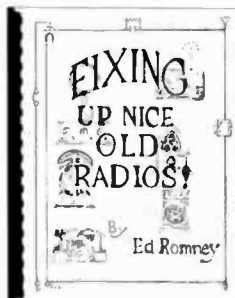

**Fixing Up Nice Old Radios** by Ed Romney. Written by a retired radio instructor. Plastic binding. 300+ figures, 185 pages. — **\$29.00**

**Old Time Radios Restoration and Repair** by Joseph J. Carr. A self-paced training guide. History, theory and practical operation of antique and classic radios. 200 illustrations, 256 pages. — **\$19.95**

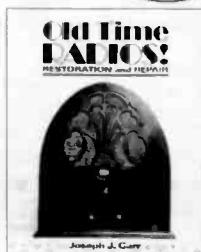

U.S. Orders - Enclose \$3.00 per order for packing & book-rate shipping if total order is under \$35.00. If using VISA or MasterCard, include name on card, card number and expiration date. Send payment with order. Mass. residents add 5% sales tax. Money back return policy. Softcover unless stated otherwise. Most orders shipped the same day received, but allow 2-4 weeks to receive order. Foreign orders - write for shipping costs, or use credit card and specify air or surface (allow 2-3 months for surface shipping).



**A.R.C., P.O. Box 2, Carlisle, MA 01741. Tel: (978) 371-0512**

Fax: (978) 371-7129 - E-mail: [ARC@antiqueradio.com](mailto:ARC@antiqueradio.com) - Web: [www.antiqueradio.com](http://www.antiqueradio.com)



(Oct-98)



# Our Most Popular Titles Make Great Gifts This Holiday Season

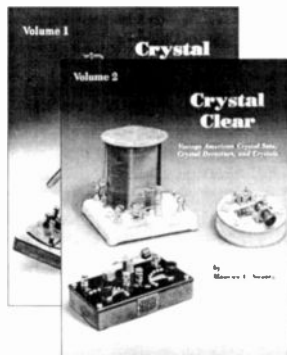

**Crystal Clear Volume 1 and Crystal Clear Volume 2** by Sievers. *Comprehensive reference to crystal sets, crystal detectors, and crystals. Each volume contains different illustrations and information. Order by volume. — \$29.95*

**Flick of the Switch** by Morgan McMahon. *The classic photo reference guide for 1930s - 1950s radios. 1000+ photos of radios, 5" x 8", 263 pages. — \$11.95*



**Hams! We now have 8 ham books - See our full page ad**

## NEW TRANSISTOR BOOKS.....

**Transistor Radios: 1954-1968**, Smith. *Over 1,000 transistor radios identified by manufacturer, marketing organization, type, and style. Color photos and price guide. 1998. 160 pgs. Softcover. .... \$29.95*

**Zenith Transistor Radios, Evolution of a Classic**, Smith. *A complete listing of all transistor radio models created by Zenith during 1955-65. Color photos and price guide. 1998. 160 pgs. Softcover. .... \$29.95*



**Guide to Old Radios, Pointers Pictures, and Prices, 2nd Ed.** by Johnson. *Introduction to radio collecting. Includes hundreds of photos and a price guide. 272 pages. — \$19.95*



**Antique Radio Restoration Guide, 2nd Ed.** by Johnson. *Beginner's introduction to troubleshooting and repairing AC table model radios. 145 pages. — \$14.95*

**Price Guide**



**The Zenith Trans-Oceanic: The Royalty of Radios** by Bryant and Cones. *Presents the fascinating story of the development and use of the Trans-Oceanic. Several photos, documents, ads, etc. 160 pages. — \$24.95*

**Communications Receivers, 4th Ed.** by Ray Moore. *Information on vacuum tube receivers by 66 manufacturers. 448 radios illustrated, 136 pages. — \$19.95*



U.S. Orders - Enclose \$3.00 per order for packing & book-rate shipping if total order is under \$35.00. If using VISA or MasterCard, include name on card, card number and expiration date. Send payment with order. Mass. residents add 5% sales tax. Money back return policy. Softcover unless stated otherwise. Most orders shipped the same day received, but allow 2-4 weeks to receive order. Foreign orders - write for shipping costs, or use credit card and specify air or surface (allow 2-3 months for surface shipping).



A.R.C., P.O. Box 2, Carlisle, MA 01741. Tel: (978) 371-0512

Fax: (978) 371-7129 - E-mail: ARC@antiqueradio.com - Web: www.antiqueradio.com



(Oct-98)

**FOR SALE:** Home-brew antenna tuner for 80, 40, 15, SWR meter – \$20 + UPS. R. J. Eastwick, N2AWC, Unit 109, The Commons, 400 N. Haddon Ave., Haddonfield, NJ 08033. (609) 429-2477

**FOR SALE:** Philcos, T700 tan leather portable – \$59. D664 tube AC/DC portable – \$35. 51-532 transitone TM – \$49. All vg. SASE list. Frank Sheldon, PO Box 297, Arkport, NY 14807. (607) 324-6646

**FOR SALE:** HRO-60 – \$450. HQ150 – \$285. 75A-1 – \$395. Hallicrafters S-119, collector grade – \$115. Free list. Richard Prester, 131 Ridge Rd., W. Milford, NJ 07480. (973) 728-2454

**RATE FOR ADDITIONAL WORDS:**

29¢ per word

**FIRST 20 WORDS FREE!**

*Cash or stamps OK for small amounts.*

*Your payment helps to keep A.R.C. healthy!*

**FOR SALE:** Zenith-published original 30-page Zenith's History (1918-1954) booklet – \$8 ppd. Gerald Schneider, 3101 Blueford Rd., Kensington, MD 20895-2726. (301) 929-8593

**FOR SALE:** RCA 8-X-541, very nice case, works – \$20. Bob Puttre, 637 Stratford Rd., Baldwin, NY 11510. (516) 223-9667

**FOR SALE:** German multiband Tonfunk GMBH 286/ USA wooden tabletop, plays – \$85. John Koop, 48 Wheelbarrow Ln., Wantagh, NY 11793. (516) 731-6711

**FOR SALE:** Riders Radio Vol. IX – \$15. Wilcox Gay recordio tape recorder – \$15 plus UPS. James S. Fisher, 344 Harrison Ave., Manville, NJ 08835. (908) 725-7476

**FOR SALE:** Motorola SK14B tube stereo hi-fi, eight speakers, blond cabinets, working – \$50, deliver Elgin. Bill Allen, 505 S. 8th St., Eldridge, IA 52748. (319) 285-6472

**FOR SALE:** Transistor radio photo guides showing all collectible models of each brand. Most models not shown in any other book. With model numbers and notes. Five different guides available: Sony, Toshiba, Realtone, Standard or Global/Zephyr – \$7 each includes postage. Eric Wrobbel, Dept. A, 20802 Exhibit Ct., Woodland Hills, CA 91367. (818) 884-2282. E-mail: ewrobbel@aol.com

**FOR SALE:** Quality reprint operator's manual for Zenith Trans-Oceanic H500. Black leatherette stock paper, gold printed cover, 32 gloss pages. Clear, crisp pictures. Includes copy of original Zenith schematic and copy of station log card – \$17 plus \$1 postage. G500, tan cover, and R600-R600L manuals and Zenith schematics for – \$15 plus 75¢. Includes "This Radio Belongs To" sticker. Replacement battery eliminator for Zenith 1000-1, 2000-1, 3000-1, electronically correct – \$12 plus \$3 priority mail. Mike Koch, 17355 Golden Maple Ln., Yorba Linda, CA 92886. (714) 961-0261. E-mail: rkoch17355@aol.com

**FOR SALE:** Silvertone tombstone – \$75. Atwater Kent tombstone – \$135. Zenith Royal 3000 Trans-Oceanic, N.I.B. – \$125. Temple G419 metal – \$50. Meck DB602 – \$25. Vibroplex key – \$50. Dictograph loudspeaker – \$150. Tom Thumb bike radio – \$75. Three coin-op radios – \$25 ea. RCA Victor Eye Witness television sign – \$85. Eskimo #35 fan – \$35. A.M.I. Model C jukebox. Rockola Empress jukebox. Several televisions. Several transistor radios. Assorted literature. Dave Petrozello, 80 Lincoln Ave., Johnson City, NY 13790. (607) 770-4026

**FOR SALE:** Radio City VOM Mod 448A, old – \$30. Hallicrafters S-85 receiver, works great – \$100. Sportcat scanner, blk., In. – \$130. Spica ST-800, red, In. – \$40. Weller soldering kit 8200 – \$18. Masco 35w PA amp In. – \$40. Eveready weather radio, rare – \$15. + shipping. Gus Nianouris, 1316 Richard St., Miamisburg, OH 45342. (937) 866-1865

## HIGHEST PRICES PAID FOR NEW and USED TUBES

**WANTED!**

*Western  
Electric*

VT25/A VT52 101D/F  
104D 205D/F 211D/E  
252A 262A/B 274A/B  
275A 300A/B 301A  
310A/B 311A/B 347A  
348A 349A 350B  
417A 421A 422A

### OTHER TUBES WANTED!

2A3 5AR4/GZ34 6CA7/EL34  
6L6GC(RCA) 10(GLOBE)

12AX7/ECC83 (Amperex/Mullard/RCA/Telefunken)  
45(GLOBE) 50(ST & GLOBE) KT66 KT77  
KT88 211/VT-4C 845

5691 & 5692 (Red Base) 6550(ST) etc.

IF YOU HAVE ANY TUBES LISTED IN THIS AD,  
PLEASE Call or Fax *DON SINGERHOUSE*

**S**

**INGERHOUSE  
OUND**

P.O. Box 321, New Richmond, Wisconsin 54017

Toll Free Tel/Fax: (888) 715-TUBE  
(8823)

# RADIO CRAZE

John Sakas P.O. Box 4124 So. Hackensack NJ 07606-4124  
 Phone (201)794-0437 ~ Fax 24 Hours (201)794-8359  
 visit our web site at <http://www.radiocraze.com>

## WANTED

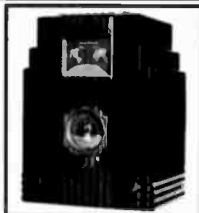

### AIR KING SKYSCRAPERS

PAYING \$14,500.00+ for near mint condition red or blue  
 \$10,000.00+ for green, lavender or yellow  
 \$3000.00+ for black and \$2000.00+ for white or brown  
**ALSO WANTED ANY COLOR-ANY CONDITION**  
 COLLECTOR PAYING TOO MUCH, CALL ME LAST

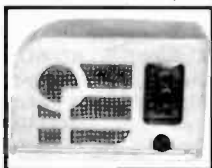

### TOM THUMB CATALIN RADIOS WANTED

paying \$6,750.00+ for mint cond. red, green, orchid, blue  
 \$2500.00+ for any mint one  
**ALSO WANTED ANY COLOR-ANY CONDITION**

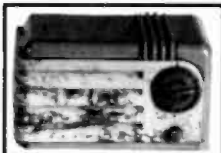

### DETROLA PEE WEE & SUPER PEE WEE WANTED

paying \$600.00+ for mint cond. black, white  
 \$1,250.00+ for beetle, gray, salt & pepper  
 \$2000.00+ for red, blue \$3000.00+ for green or lavender  
**ALSO WANTED ANY COLOR-ANY CONDITION**

### WANTED ANY CATALIN RADIO

ADDISON 2 MARKOVN & YELLOW \$900.00, YELLOW & RED \$3,500.00,  
 ARVIN 52 ANY COLOR \$1,500.00, BENDIX 526 GREEN & BLACK \$675.00,  
 DeWALD A501, A502 BROWN \$375.00, YELLOW \$425.00, RED \$7,000.00,  
 EMERSON AU 190 & BT 245 YELLOW \$1,300.00, GREEN \$1,850.00,  
 DARK RED \$2,500.00, BLUE \$6,250.00, BRIGHT RED \$11,000.00,  
 ESPEY HINGEEL, YOU NAME THE PRICE (WE'LL PAY IT)  
 EMERSON BM 159 YELLOW \$750, GREEN \$1,350, RED \$1,850, BLUE \$3,000  
 EMERSON 544 BLACK \$1,500.00, GREEN \$900.00, RED \$1,250.00  
 FADA L56, 556, 52, 5F50, 5F60, 136, 53X, YELLOW \$900.00, LT GREEN \$1,350.00  
 MAROON & YELLOW \$1,500.00, YELLOW & BLUE \$1,700.00, YELLOW & RED \$2,650.00,  
 EMERALD GREEN & YELLOW \$6,250.00, BLUE & YELLOW \$6,650.00  
 FADA 115, 116 & 1000 ALL YELLOW \$625.00, MAROON & YELLOW \$700.00,  
 YELLOW & RED \$625.00, PEAK GREEN \$1000.00, BLUE & YELLOW \$2,150.00  
 GAROD 64TH MARKOVN \$675.00, YELLOW & RED 1,250.00, RED & YELLOW \$1,400.00  
 HALLSON ANY COLOR \$1,500.00 TO \$5,000.00  
 MOTOROLA 40XC ALL YELLOW \$1,350, BROWN & TORT \$2,500.00, RED & YELLOW  
 15,000.00, GREEN & YELLOW \$5,250.00, MOTOROLA 52 YELLOW & TORT \$1,500.00,  
 MAROON & YELLOW \$1,750.00, GREEN & YELLOW \$2,500.00,  
 MONORA KM ANY COLOR \$1,300.00, SENTINEL 184 WAVY GRILL YELLOW \$700.00,  
 SAND 800.00, RED 1,250.00, BLUE & 650.00  
 SPARTAN CLOISONNE ANY COLOR \$2,500.00 TO \$5,000.00, EMERSON 520 \$600.00

always buying any catalin or pre-war colored bakelite radios  
 We will buy one piece or entire collection  
 watch out there's a new guy in town

## FOR SALE

### Chassis for Catalins { Everything Must Go Sale }

- Addison 2A Untested \$70
- Air king A-600 Untested \$60
- Bendix 526C Restored \$110
- Bendix 526C Untested \$60
- DeWald 561 Restored \$120
- DeWald 561 Untested \$65
- DeWald A-501 Untested \$75
- DeWald A-502 Restored \$95
- DeWald a-502 Untested \$65
- Emerson AX-235 Restored \$125
- Emerson AX-235 Untested \$55
- Emerson EP-375 (5+1) Restored \$150
- Emerson 400 Untested \$75
- Emerson 400 Pat Restored \$175
- Garod 1450 (Peak Top) Restored \$350
- Garod 6AU1 (Commander) Restored \$100
- Garod 6AU1 (Commander) Untested \$50
- G.E. L-570 Restored \$105
- G.E. L-570 Untested \$50
- General TV 591 Untested \$50
- R C A Large 66X Untested \$50
- Sentinel 284 (Wavy Grill) Restored \$100
- Sentinel 284 (Wavy Grill) Untested \$ 50

### Chassis for Bakelites

- Crosley 11-115U Restored \$100
- Crosley 11-105U Untested \$50
- Detrola Super PeeWee Untested \$125
- Detrola PeeWee Untested \$125
- Charlie McCarthy Restored \$200
- New World Globe Untested \$250

### Dial Glasses

Original RCA 66X \$65.00.

SORRY NO CHASSIS For FADA 1000,  
 115, L56, 5F50, 5F60, Emerson AU-190,  
 BT-245 or Motorola 51X15, 50XC

**ALL PRICES ARE  
 WITHOUT SHIPPING CHARGES**

**FOR SALE:** Blue Arcturus 127 good fil. - \$9. Brass base 201-A, 301-A short pins, good fil - \$15 ea. 201-A good fil. - \$8 ea. 201-A duds - \$2. 199 Type duds - \$2. 71 good fil - \$15. 71-A - \$10. 2A3 dual plate - \$20. 26-A, 27-A - \$3 ea. 80ST - \$6. 45-A ST - \$22. Roll 3 1/2 pounds 21/22 ga. copper enamel wire - \$18. Other small coils, rolls wire. Astatic D104 desk CB mikes with base amp - \$40. Less amp - \$35. Morse code practice oscillator and key - \$15. Lot of desk. Hand CB mics parts or repair, 8 mics, all - \$40. Coils 4-5 pins plug in 18 all - \$45. Hallicrafters T0 keyer less case - \$25. Lot of 5 AM-transistor small sets, all - \$24. Line voltage regulator LR-10 350 watts - \$12. RCA red cover Vol. #4 Radiotron Designer's Book - \$55. RCA RC16 tube manual - \$10. RCA triple pindex - \$12. RCA air cooled transmitting tubes TT3 - \$15. Howard Sams Red Book parts - \$15. Electronics for Everyone - \$5. Electronics for Everybody - \$7.50. RCA RC30 tube manual - \$15. Modern metal working - \$9. General Electric Supply Corp catalog #31 - \$15. TV Test eqpt. and guide to scopes, both - \$7. Hamradio circuits - \$9. CB Dictionary - \$8.50. Hawkins Elect. guides, 5 books - \$15. Maser Guide to Electronic Circuits, 616 pages - \$10. Bundles of old org. service data, Philco, RCA, GE, Motorola, Supreme, Tel Aids, Emerson, plus for sale. Model airplanes tube wireless controls (2) plus other parts, all - \$20. Realistic 9-tube stereo amp - \$34. Base mate amp (tubes) YBA-2 - \$35. Emerson portable 4-speed manual record player and AM radio - \$39. Silvertone Medalist 7-tube amp and AM-FM stereo tuner, both - \$40. Output transformer 120 watt pullout - \$28. Philco and mix of dial drive parts, lot - \$10. Assd. AC line meters 0-150 VAC - \$6. Solder guns and irons, other tools. Radio test eqpt. as removed from closed repair shops. Roller Smith circuit ohm tester - \$10. Jackson 630 port tube tester - \$20. Jackson 49 port. tube tester roll chart - \$25. Eico 625 port tube test rollchart - \$25. Some B&K Sencore TV pix tube testers, also other TV test eqpt. RCA WO55-A 3" scope - \$22. Dumont 164 3" scope - \$20. Simpson 466 5" scope - \$20. Precision E200 signal gen. - \$18. Test box AC-DC 1 to 30 volts output and bulb tester - \$18. Sencore F160 Senior field effect meter VOM - \$20. Heath IM104 VOM - \$10. Precise AM/FM sig. gen. - \$12. Precise radio audio signal gen. - \$10. General Elect. SG-3 signal gen. - \$18. Signal Corps 1-72 J signal gen. - \$20. Wintronix condition analyzer signal tracer - \$20. Philco 070 signal gen. panel fair - \$18. Heath signal gen(s) each - \$15. Assd. test eqpt. TV service transistor radios. Mercury 501 component substitutor res-cons - \$18. Heath VTVMs Models V4-V6-V7-IM-11 - \$8 ea. Hewlett-Packard VTVM 410-P parts unit - \$9. RCA WV-77E VTVM (have 15) - \$10 ea. DeVry Tech VTVM 1514 - \$10. PACO VTVM V70 - \$9. Heath audio VTVM parts - \$6. Heath IM21 AC meter - \$8. Some transistorized VOM - \$10. RCA tube and tool case 21" x 13" x 8" - \$18. Eico 377 audio signal tester sine square wave (tested) - \$35. Superior C-R bridge and signal tracer - \$29. Sylvania 140 tube tester port case roll chart (tested) - \$45. Eico 950 A/B resistor cond. tester - \$30. Have quantity of small AC/DC power supplies. 1 pound mix resistors - \$6.50. 1 pound mix small condensers - \$7. 1/2 pound radio thin solder - \$3.50. Have early type carbon resistors. Watch case meters, list SASE. NRI Radio TV late booklets, 19 all - \$6. 1,000s of other old radio parts. Write wants, SASE. All plus hand and ship costs. Min parts orders - \$8. Have a list of lab type test eqpt. floor model radios. German table radios. Tombstones, shortwave sets. Mil radios.

**CONTINUED AT TOP OF NEXT COLUMN**

**CONTINUED FROM BOTTOM LEFT**

Plus more L5ASE. These are pick up only, cash. Boxes and boxes of loose radio tubes \$3 to \$6 box pick up. F. Krantz, 100 Osage Ave., Somerdale, NJ 08083-1136. (609) 783-0400

**FOR SALE:** Philco 20 chassis only, no tube, no knobs - \$40 plus. Elwood F. Hunt, 308 Georgetown Rd., Carneys Point, NJ 08069. (609) 299-5259

**FOR SALE:** Reproduction audio and historic tubes manufactured by KR Enterprise s.r.o. of Prague, Czechoslovakia. 300B improved replacement for the famous W.E. tube, guaranteed life, lower cost - \$500 per matched pair. PX25, an exact copy of the balloon shaped G.E.C. original - \$400 per matched pair. 2A3 copy of the RCA single plate version - \$400 per matched pair. Working historic tubes. R Type spherical pip top bright emitter, copper base, yellow glass, also available with nickel plated base and with clear glass - \$120 ea. WD11, an exact replica of this popular tube, with copper base - \$120 ea. In the U.S.A. contact: John Wiesner, 31 Haystack Rd., Clifton Park, NY 12065. (518) 371-9902. E-mail: jwandr@aol.com. Rest of world contact: Valve & Tube Supplies. E-mail: rod@pascall.co.uk

**FOR SALE:** Zenith 12S265 - \$800. Rider's 1-5 abridged, 6-17 - \$200. General TV, brown w/white trim - \$150. Robert Lutz, 9100 Noland Rd., Lenexa, KS 66215. (913) 894-1327

**CLASSIFIED AD NOTICE**

**Please check your ads carefully before sending them in. Once ads are received, it is not always possible to refund the amount sent, pull the ad or make changes.**

**FOR SALE:** Crosley Model 124 grandfather clock radio - \$550. Heathkit W5M amp with cage, NR - \$75. Dynaco FM-1 tuner, mint - \$100. Eico HF 52 hi-fi amp - \$100. Eico 2200 tuner - \$100. Eico tuner 2510 for parts - \$50. Pilotone hi-fi amp AA-904 - \$175. Sterling radioe and tube tester - \$75. EV915 and Astatic T-3 mics - \$35 ea. Craig Huffman, c/o Richard Mullen, 3470 Austinburg Rd., Ashtabula, OH 44004. (440) 998-1475. E-mail: huffmanc@usa.net

**FOR SALE:** Console radios: 1936 Grunow 1291; c. 1934 Airline console, cabinet with full-length doors; 1935 Philco 16X; 1940 GE J-805; 1942 GE LF-115; 1942 Philco 42-390. Also 1958 Zenith two-piece stereo console SRS20M. Al Anderson, 510 Park Ave., Mechanicville, NY 12118. (518) 664-2189. E-mail: alcomm@ix.netcom.com

**FOR SALE:** EICO 667 tube tester, like new with manual - \$100 + UPS. Martin Gottstine, 16 West Wind Dr., Topsham, ME 04086. (207) 729-7823

**FOR SALE:** Philco 41-280; Admiral transistor, mint 237; Grebe CR9 mint; (1) blue Cambridge tube no. 80. Joe Duell, Box 333 County Rd. 76, Stillwater, NY 12170. (518) 664-4951

**FOR SALE:** Small brass blade fan, runs, no cage - \$35. Webcor reel-reel tape recorder, good - \$50. Hoffman solar radio, wrong calls - \$60. More radios for sale on my web site <http://members.aol.com/dmradios/index.html>. **WANTED:** Early unbroken transistor radios, especially Global GR711, Crestline 6T220. Donald M. Maurer, 29 S. 4th St., Lebanon, PA 17042. (717) 272-2481. E-mail: DMradios@aol.com

**WANTED:** Philco 41-81, 89C, portable w/strap. Ichiro Yamada, 10-21 Chiyodadai-cho Kawachi Nagano-shi, Osaka, Japan 586-0027. Ph/fax: 011-81-721-52-4695, mid/eve., local. E-mail: yamada1r@silver.ocn.ne.jp

**WANTED:** Radio Boys books: To the Rescue (Chapman) and With the Air Patrol (Breckenridge). Mike O'Brien, 1031 E. University St., Springfield, MO 65807. (417) 887-0373

**WANTED:** RCA R/RP mahogany console Model A-101, nice cabinet desired with working or restorable electronics. Buyer located in NE Texas will pay shipping. Contact: Brian Kurrle, 2222 Nodleigh Ter., Jarrettsville, MD 21084. (410) 692-0450

**WANTED:** 16GP4 16" metal B&W picture tube. Alvin Abramowitz, 11218 Liberty Rd., Owings Mills, MD 21117. (410) 496-1117

**WANTED:** 45 rpm automotive underdash record players, record mastering lathes, turntables, tonearms, hi-fi tube amplifiers. Kim Gutzke, 7134 15th Ave. S, Minneapolis, MN 55423. (612) 869-4963

**WANTED:** Good used Airline brand NO 47 knobs for R35 Victor radio. Jack Ghery, 1753 Community Beach Rd., Odin, IL 62870. (618) 532-5548

**WANTED:** IF transformers JW Miller 100 Kc. 1710-1709-1711. Harry Weber, 4845 W. 107th St., Oak Lawn, IL 60453-5252

**WANTED:** Two WE217A, tennis ball diodes, paying \$135 each for good ones. Igor Golioto, 17 Addison Dr., Fairfield, NJ 07004. (973) 463-4973. E-mail: golioto@gdats.com

**WANTED:** National S-101 impedance coupler, SW3 coils, HRO black wrinkle speakers. I love National. Sylvia K. Thompson, N1WVJ, 33 Lawton Foster Rd., Hopkinton, RI 02833. (401) 377-4912

**WANTED:** Any Navy tubes with 3800C series numbers. CRC-38027, CRP-38041, CWL-38160, etc. William Donzelli, 15 Gen. MacArthur Dr., Ca mel, NY 10512. (914) 225-2547. E-mail: william@ans.net

**WANTED:** Detrola or Truetone console (chassis 163) with 15 tubes and 2 speakers. Scott Flaughter, 41100 Plymouth Rd., Plymouth, MI 48170. (734) 737-4221. E-Mail: scott.flaugher@unisisys.com

**WANTED:** Knob for Atwater Kent 217. Also project Philco 16 cathedral or tombstone, or any high tube count cat. or tomb. which is inexpensive considered. John Hagman, 190 Park St., Burlington, VT 05401. (802) 865-1751. E-mail: yonny@worldnet.att.net

— WANTED —

**CLUB CONTACT INFORMATION. A.R.C. IS UPDATING ITS CLUB LIST. PLEASE SEND US NAME OF CONTACT PERSON, ADDRESS, DUES, RATES, ETC.**

**WANTED:** RCA & Silvertone wire recorders. Mic for GE Mod 22D by Turner Co. Dick Baker, 8319 Hemlock Ave., Fontana, CA 92335. (900) 822-3159. E-mail: paula@access1.net

**WANTED:** CQ September 1945 and Radio News March 1944. John A. Benyo, 25 Schley St., Garfield, NJ 07026

**WANTED:** RCA Radiomarine Direction Finder Model AR-8712 service manual. Al Kaiser, 713 Marlowe Rd., Cherry Hill, NJ 08003-1551. (609) 424-5387

**WANTED:** Band/tuning knob and bass push-pull for Zenith Model 5678. George Glann, 4440 N. Creek Rd., Palmyra, NY 14522. (315) 597-4438

**WANTED:** I am buying or trade theater tube amps, theater horn, tubes, mic. Wen Hsin, 1560 Via Leon, Palos Verdes CA 90274. (310) 377-0056. E-mail: wenh@jps.net

## I'm Buying Tubes !! New or Used

New tubes must be well known U.S. brands or W. Europe in original boxes. Used tubes need clear numbers & good silver color flashing. All must test good, one week turnover, shipping refunded.

**Buying the following Western Electric tubes. New and used, N.O.S. \$420, 205D/E, used \$275. (TB), 252A, \$1,100., \$650., used 274A/B, \$220., used \$110., 300A, engraved base, \$850., used 300B, engraved \$350. 310A, \$20., N.O.S. Also buy 12AX7A, European types only, Telefunken, Mullard, Amperex Bugle Boy only.**

Call, write or fax to:  
George Stagakis, 1714A 41st St., North Bergen, NJ 07047.  
Owner of George's Antique TV & Radio Repair  
(201) 867-9136. Fax: (201) 867-4044

**FOR SALE:** Collection: high-quality military specification, oil filled capacitors, N.O.S. filters/bypass/coupling, approx. 100 pieces - \$30, 25 pounds shipping. 3inch R-R Webcor microcorder 300, Model EP2404, cosmetically like new - \$25. Collection: N.O.S. 1950s grille cloth, 6 square yards, 4 patterns - \$15. Garrard Lab 70, restorable - \$15. Original sales brochure, 1960s, Grundig, Sony, Garrard, 5 for - \$10. Ellsworth O. Johnson, 364 S. Coeur d'Alene St., Spokane, WA 99204-1063. (509) 838-2161. E-mail: eojohnsonww2@worldnet.att.net

**FOR SALE/TRADE:** 1950s Charlie McCarthy style ventriloquist's dummy in near mint condition. Handmade of balsam wood by famous puppet carver. This Charlie measures 42" tall and is fully outfitted in expensive full-length tuxedo, top hat, shirt, tie, shoes, etc. Also comes with travel steamship trunk. In addition, there are several items separately available such as a collection of Edgar Bergen ventriloquist record albums, books, radio premiums, autographed photos by Edgar, this would make an exc. Christmas gift for any radio enthusiast or collector of Charlie McCarthy memorabilia. Call: Larry Drago, 383 Lincoln Dr., Cheshire, CT 06410. (203) 272-6030. Fax: (203) 272-2002.

**FOR SALE:** The best reproduction of a Federal 61 Instruction card you have ever seen. Not reproduced on a color copier but professionally printed on heavy stock - \$11.95 plus \$3 priority mail; RCA CTC-4 (1956) color set, works, near mint, new tube, manuals, pickup only - \$350. Fada 799 10" TV recapped - \$250 plus ship. Motorola TS 141 Bakelite 14" rect TV, recapped, works great - \$200 plus ship. Don Patterson, 636 Cambridge Rd., Augusta, GA 30909. E-mail: patters@mindspring.com

**FOR SALE:** Hammarlund: SP210 SX & P/S. SP600 JX-21, HQ180 & SP. HQ129X. National: NC300, NC57, NC54, NC240-D & SP. Hallicrafters: S20R, S22 marine, SX24, S40B, S76, SX42 & SP. SX101A, SX100, SX110, S120 WR 4000, Knight 100A, Allied transx A2517 & A2518, Lafayette HA350, Heath SB 300. AR3 military R390A complete & restored. 1051B, 1051G, restored. Philco Sierra 128A & spectrum display. Scott 800BC chassis complete with SP fair chrome, 20+ Zenith Trans-O tube type sold as one lot, Nordmend Fidelity Sony CRF 160. Wharfedale 70 (1961), speakers nice. Marantz, classic SR7000G & SD8020+AT-6+ TT1080. Teac X-10R reel-to-reel, nice. Crosley Dynatrol 11 + much more. Call: Alan Carpenter, 6850 N. Camino de Fray Marcos, Tucson, AZ 85718. (520) 575-1960

**FOR SALE:** Peruse my six-page list for a stamp, LSASE or e-mail to: Stan Lopes, KB6LGV, 1201-74 Monument Blvd., Concord, CA 94520. (925) 825-6865. E-mail: splopes@aol.com

**FOR SALE:** Zenith Trans-Oceanics 7G605 bomber, fair parts - \$45. (2) ea. 8G005YT one for parts - \$40. G500, good - \$35. A600L parts - \$20. 6G001Y AM portable, fair - \$18. Mervyn Ellsworth, 2309 N. 25 St., Boise, ID 83702. (208) 345-6878

**FOR SALE:** Stromberg-Carlson amplifier Model AU-36B with (4) 6L6 output tubes, works - \$150 plus shipping. Andy Shackelford, 702 Brandywine Blvd., Wilmington, DE 19809. (302) 764-7502

**FOR SALE:** Plastic dial covers. I have covers for over 500 different old radios, including some amateur - \$15 ea. ppd. Doyle Roberts, HC63 Box 236-1, Clinton, AR 72031. (501) 745-6690. E-mail: drob@artelco.com

**FOR SALE:** Mono amplifiers. David Bogen CHA33 Challenger 33 watt 6L6GBs - \$75. Stromberg-Carlson 5AU33 signet 25 watt 6L6s - \$60. Heathkit 06 scope with manual - \$50. Above plus UPS. Onerio Sabetto, W8PIU, 1717 Burgess Rd., Cleveland, OH 44112

**FOR SALE:** Specialty N.O.S. tubes: Amperite delay relay miniature glass tubes 115 NO60T and 6N030T - \$20 ea. WE 6167 - \$40. Metal, miniature base tube GV, thermal relay - \$25. Amperite tubular ballast tube TJ6D1K01 - \$35. Sylvania VT-215/6E5 - \$20. Amperite 10-AC ballast GT shape tube - \$40. JAN-CRC 5R4 GY (brown base) - \$15. Amperite automatic regulator 3-14 ballast tube - \$35. ECC 82 telefunken - \$25. JAN CRC 83 ST tube - \$35. EF86/6267 Mullard - \$20. EM34/6CD7 Mullard, red - \$100. 6AC7 Arcturus - \$100. Used tubes: GE7868 - \$15. Sylvania ST No. 15 - \$20. Radiotron UX-281 globe - \$50. Amperex 6146 - \$25. Philco 755T - \$15. RCA red base 5691 - \$25. RCA red metal 5693 - \$20. ECC81 Telefunken - \$20. ECC 84 Mullard - \$25. Radiotron Cunningham metal 6C5 - \$20. 6BQ5, ECC83/12AX7 Fisher - \$10. Cardon C484 globe - \$40. Radiotron 247 globe - \$35. Other: two dozen assorted, very small and unusual variable condensers. Drake's Radio Cyclopeda 1929, 3rd - \$25. ERLA 110 VAC/batt. portable radio - \$75. Radiola wooden radio Mod 61-5 (no knobs) - \$85. CB transceivers (not tested): Lafayette HB-333, Realistic Navaho TRG-30A - \$35 ea. H. Andreoni, c/o 250-D S. Lyon Ave., Hemet, CA 92543. (909) 849-7539

— WANTED —  
**PICTURES FOR PHOTO REVIEW OR  
TELEGRAPH REVIEW  
PHOTOS MUST BE SHARP IN DETAIL  
A SHORT DESCRIPTION IS A MUST!  
SEE PHOTO REVIEW PAGES FOR  
ADDITIONAL INFORMATION**

**FOR SALE:** CB Sams 16, 19, 33, 39 - \$18. Federal 141 - \$500 OBO. Hallicrafters S20R - \$85. Tube portables: Zenith 4G903 - \$30. GE 614 - \$25. RCA 8BX63, 7BX8J, 7BX8L - \$20 ea. Airline 62-1052 - \$18. Philco 53-656 - \$18. Bogen amp M060A - \$75. Monarch FM tuner (FM100) - \$25. Kevin L. Moe, 932 Adams St., Ottawa, IL 61350. (815) 433-4598

**FOR SALE/TRADE:** Federal Mod 110 - \$800. Hanscom Junior 5-tube battery set - \$500. Fada Mod 460-A with built-in loop antenna, also in remarkable condition - \$550. Collins KWM-1 w/p/s works great, very nice condition - \$975. RCA microphone banquet stand w/ exc chrome racing stripe and chrome concealed and retractable chrome feet - \$475. Westinghouse/Radiola Mod 53, Canadian version, 3-exposed-tube battery set - \$475. Westinghouse RA - \$400. Ariola SR w/tube - \$400. Federal 58 with custom black wood cabinet - \$700. Silver-Marshall shield six Mode 630 in beautiful condition - \$550. BC 148 made in 1935 by Fairbanks & Morse w/tubes in exc cond - \$1,450. Amrad Mod neutrodyne 5-tube set - \$350. DeForest Mod F-5-AW - \$300. Call: Larry Drago, 383 Lincoln Dr., Cheshire, CT 06410. (203) 272-6030. Fax: (203) 272-2002. E-mail: theradioman@webtv.net

**FOR SALE/TRADE:** Hallicrafters Sky Challenger II, SX110, SX133 w/speakers - \$200 ea. S72R - \$150. Sams CB repair books 1/262 - \$8 ea. plus UPS. **WANTED:** Cast iron advertising ash trays shaped like little frying pans, paying \$8 ea. John Williams, Jr., PO Box 1545, Scarborough, ME 04070-1545. (207) 775-4212

**WANTED:** In 1938 Zenith Robotdial sets were supplied new with ten station locator tabs attached to the dial bezel. These were slid around the circumference of the dial, labeled with call letter tabs and left to mark your favorite stations. I'd like to find some of these. Ron Kudasik, 2235 Tanya Dr., Chambersburg, PA 17201. (717) 267-9468, 3-11 pm

**WANTED:** Someone please help me out. Looking for a junker or just the chassis for a Philco Junior Model 81 or 81B with 3 knobs. Al Undheim, 1055 Mullen Way, Vista, CA 92083. E-mail: AUndheim@aol.com

**IF YOUR EXPIRATION DATE IS  
DECEMBER OR BEFORE, RENEW TODAY!  
EARLY RENEWALS  
RECEIVE AN EXTRA ISSUE!**

**WANTED:** McMurdo-Silver VI alignment/ schematic information. Photocopy is just fine. Any help would be much appreciated! Paul Currie, KE4TTH, PO Box 738, Chuluota, FL 32766-0738. E-Mail: yrless@maginnet.net

**WANTED:** Philco Model 42-321, playing condition. Cabinet may be rough. John N. Evans, 8511 Thompson Rd., Highlands, TX 77562. (281) 426-3952. E-mail: jevans35@juno.com

**WANTED:** Radio Boy Books, HQ-145, HW-16, Letterpress cuts/type. Don Traves, WB4CVH, PO Box 2114, Winter Haven, FL 33883-2114. E-mail: wb4cvh@juno.com

**WANTED:** Heathkit GR10 or GR11 table radios in any condition, or parts. Andrew Mitz, WA3LTJ, 4207 Ambler Dr., Kensington, MD 20895. (301) 897-5531. E-mail: arm@serge.gnode.org

**WANTED:** Emerson AU190 chassis; Fada 659 dial glass; Chelsea ZR-4 audio transformers. Frank Johnson, 530 Elford Rd., Fairless Hills, PA 19030. (215) 943-8295

**WANTED:** Information, schematic or finished unit for Antique Electronic Supply kit K-167 or P-M167, Battery Powered Wireless Transmitter. Richard Dzick, 31572 Juniper Ln., Warren, MI 48093. (810) 268-4671. E-mail: n8mq@aol.com

**WANTED:** Crystal sets, collection now at 434 pieces; seeking more. Erwin Macho, Ambrosweg 17/A/8, A-1230 Vienna, Austria. Fax: 431/8874355



**WANTED:** Motorola Catalin #s 50XC, 51X15, and 52, as complete or "parts" sets. I am a very serious collector seriously looking for serious stuff (leaving all kidding aside, of course)! Please write or call collect: Rain Buttignol, 214 State St., #7, Portsmouth, NH 03801. (603) 427-1384

**WANTED:** Maroon left trim for Addison A2; Canadian GE C-400 ridget sets any colors. David Katz, PO Box 359, Ste. 920, 1 First Canadian Pl., Toronto, Ontario, Canada M5X 1E1. (416) 869-8429. E-mail: dkatz@tor.lafleurbrown.ca

**WANTED:** Atwater Kent Model 40 belt set. Alex Kaplan, 5347 Park Place Cir., Boca Raton, FL 33486. (561) 338-0858

**WANTED:** E.H. Scott 30-tube Philharmonic radio, complete or chassis. P. Heim, PO Box 04765, Milwaukee, WI 53204. (414) 671-5689

# Tube Lore

A REFERENCE FOR USERS AND COLLECTORS

For the serious tube enthusiast, coverage of tubes from 1920 to the present: history of design trends, tech data, equivalencies, stocking-up hints, "where-used" information, even auction prices on collectable types. Describes conventional "gridded" tubes used in radios, audio amplifiers, and communications gear, plus the unique types used in radar and other special applications. Contains 186 pages of material unavailable in conventional tube manuals: hints on identifying, dating, testing, reactivating, etc. It's softbound, 8-1/2" x 11" size.

**Tube Lore** is available from:

- Angela Instruments, (301) 725-0451
- Antique Electronic Supply, (602) 820-5411
- Antique Radio Classified, (978) 371-0512
- Old Colony Sound Lab, (603) 924-6371
- A. G. Tannenbaum, (215) 540-8055
- W7FG Vintage Manuals, (800) 807-6146

It's also orderable directly, at \$19.95 postpaid in North America or \$24.95 postpaid elsewhere, from:

**Ludwell Sibley**  
102 McDonough Rd.  
Gold Hill, OR 97525

Discounts available to clubs on group orders; call (541) 855-5207 for details.

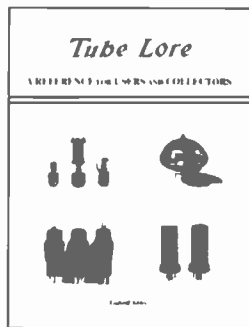

**FOR SALE:** Majestic 161 - \$150. Zenith X347 - \$35. Emerson Vanguard - \$20. Scott 1510 chassis - \$65. Zenith T-O H500 - \$150. Zenith T-O B600 - \$125. Zenith T-O L600 - \$125. Coronado 2056 cathedral - \$120. Philco 20 chassis - \$80. (2) Turner 251 mikes - \$15 ea. Superior CA-12 signal tracer - \$8. Victor 6A-2605 - \$30. Grunow 470 - \$125. Air Master 73-B radio - \$50. Zenith L-569 chassis - \$20. Star-O-Tone horn - \$65. Riders 9 & 11 - \$12 ea. AK 70 & L chassis, ea. - \$20 & \$35. Peavey PA-300 amp - \$25. SA-39 Hudson auto radio - \$40. Shakespeare fish locator - \$25. Zenith 4 B131 - \$100. Phillips 5" tape recorder - \$15. Knight 5" oscilloscope - \$20. Walt Wrabek, Rt. 4, Box 370, Menahga, MN 56464. (218) 564-4623

**FOR SALE:** National HRO, coils, manual, works excellent - \$750+. BC-191, tuning units, manual - \$500+. Chris Cross, PO Box 68, Cedarville, IL 61013. (815) 868-2323

**E-MAIL ADDRESS FOR  
ANTIQUERADIO CLASSIFIED  
ARC@antiqueradio.com**

**Ads - Subscriptions - Book Orders  
See inside front cover for details**

**FOR SALE/TRADE:** Radio related novelty and collectable items: include vintage plaster Charlie McCarthy statue 13" tall w/tux, high hat and monocle - \$250. Early RCA chalk Nipper 4" ≠ \$110. A. C. Gilbert radio tube handheld puzzle game - \$50. RCA Victor radio 12" x 6" glass advertising sign w/reverse painted letters and background - \$200. Zenith radio neon sign, circa 1930s, 29" x 18" - \$725. Edison concert cylinder in original box, never used, title "I live underneath" - \$350. RCA N.I.B. finger wrench - \$100, and vintage light bulb w/old RCA logo that illuminates inside - \$125. Call: Larry Drago, 383 Lincoln Dr., Cheshire, CT 06410. (203) 272-6030. Fax: (203) 272-2002. E-mail: theradioman@webtv.net

**FOR SALE:** National NC-173 receiver w/chipped tuning knob and original manual - \$175. National 10" speaker, w/173 only - \$50. Pickup only. Earl Ladendorf, N9L1K, 208 S. Columbia St., New Auburn, WI 54757. (715) 237-2633

**FOR SALE:** Telequipment scopes (div of Tektronix) S-54 0-10MHz no probes, have several - \$65. Also D-54 - \$85. SASE for test equipment list. Harry Pewowaruk, 1535 N. 8th Ave., St. Cloud, MN 56303. (320) 252-9910. E-mail: HPewowaruk@aol.com

**FOR SALE/TRADE:** Vintage guitar amp made by Multivox Co. in New York called Premier 76. It has built-in speaker and tube amp, 6 Catalin colored knobs, in leatherette trapezoid carrying case. Sounds as good as it looks - \$750. Call: Larry Drago, 383 Lincoln Dr., Cheshire, CT 06410. (203) 272-6030. Fax: (203) 272-2002. E-mail: theradioman@webtv.net

**FOR SALE:** Emerson 546, R/P, wood - \$30. GE, year 1965, wood, TM, looks like miniature console, model unknown - \$40. Motorola B-100W, multiplex - \$75. Philco cathedral, 37-84 - \$90. Philco 40-130, needs cabinet work - \$35. All radios play. George Stagakis, George's Antique Radio & TV Repair, 1714A 41st St., North Bergen, NJ 07047. (201) 867-9136. Fax: (201) 867-4044

**FOR SALE:** A rare piece, 9-54 Victor cabinet, Electrola player with home recording head and mike, and RCA RE-52 chassis and speaker, an excellent performer, cabinet needs restoration, just under \$1,000 invested, take the parcel for - \$500. Sid Greenspan, #1808, 500 S. Ocean Blvd., Boca Raton, FL 33432. (561) 368-2019

**FOR SALE:** Revox A77 10" R-R - \$275. Sony TC-366-4 7" quadracial R-R - \$135. Teac A-6010 7" auto reverse R-R - \$135. Teac A-1200 7" R-R - \$75. Trio W-38 tube receiver - \$60. Sony SRA-3 tube recording amp - \$25. SRA-2 - \$25. Walter Kiefner, 6233 51st Ave. NE, Seattle, WA 98115. (206) 526-1452



**NEW QUALITY CAPACITORS:**



**Volt 630 Axial Leads**

Part Number	Value (UF)	Price/25	**Each
.001-630-AL	.001	\$ 6.00	24¢
.0047-630-AL	.0047	\$ 6.25	25¢
.0068-630-AL	.0068	\$ 6.35	25¢
.01-630-AL	.01	\$ 6.50	26¢
.022-630-AL	.022	\$ 7.00	28¢
.033-630-AL	.033	\$ 7.25	29¢
.047-630-AL	.047	\$ 7.50	30¢
.1-630-AL	.1	\$ 8.00	32¢
.22-630-AL	.22	\$ 15.00	60¢
.47-630-AL NEW	.47	\$ 20.00	80¢

**ELECTROLYTICS:**

**Volt 160 Axial Leads**

22-160-AL	22	\$ 16.00	64¢
33-160-AL	33	\$ 21.00	84¢
47-160-AL	47	\$ 24.00	96¢

**Volt 450 Axial Leads**

10-450-AL	10	\$ 18.75	75¢
22-450-AL	22	\$ 28.00	\$1.12
47-450-AL	47	\$ 45.00	\$1.80
47-450-AL10	47	\$ 20.00 (per 10)	\$2.00

To order, Send Check or Money Order to:

**BOB'S ANTIQUE RADIOS AND ELECTRONICS**

111 East 29th Street La Grange Park, Illinois 60526  
Telephone: (708) 352-0648 / Fax: (708) 352-0647

Ask About Super Bulk Rates/Sorry No Credit Cards or C.O.D.'s  
Shipping & Handling Included in price. \*Companion price only.

\*Sold in 25 piece lots - Wholesale Only - No Minimum Order

Join the

**AWA**

**ANTIQUERADIO ASSOCIATION**

**THE ORIGINAL AND LARGEST HISTORICAL RADIO-COLLECTOR GROUP**

- \* Publishes *Old Timer's Bulletin* with:
  - Battery and AC receiver restoration
  - Vacuum-tube history and collecting
  - Old-time amateur-radio contests
  - Communications receivers
  - Free want-sell-swap ads
  - Early television
  - Horn loudspeakers
  - Reviews of current books
  - Keys and land-line telegraphy
  - News of U. S. and foreign clubs
  - Information on public radio museums.
- \* Maintains unique radio-TV museum.
- \* Produces the annual Rochester meet.
- \* Co-sponsors local meets.
- \* Publishes the annual *AWA Review*.



Membership is only \$15 per year (\$27 for two years, \$18 per year for overseas). Mail check to:

**Antique Wireless Association, Inc.  
Box E, Breesport, NY 14816**





# Christmas is coming !

*Santa's Got Lot's of CD-ROM Goodies This Year. Order your Radio Era Christmas Catalog early with discount coupon. Write, Fax, Email us or order our all new Christmas Catalog via the web.*

Did you know that Radio Era . . .

- Buys & Sells & Restores antique radios?
- Is the only producer of antique radio resources on CD-ROM?
- Has over 50 titles of CD's on old radio schematics, books, & resources?
- Produced all 80 years of QST for the American Radio Relay League?
- Is electronically publishing "The Radio Boys" on CD-ROM?
- Has sold over 30,000 CD's world-wide in the past 3 years?
- Has hundreds of Edison 4 minute cylinders in stock?
- Has over 150,000 schematics and over 5,000 manuals available?
- Has a research bureau to dig out hard to find radio information?
- Can Email schematics directly to you in just minutes?

While all of this is true, it probably won't mean anything to you unless you try us out. So do it today, we think you will be pleased that you did. We pride ourselves in *taking the time* to *spend the time* to research the right schematics and to sell you the correct CD's that will help you with your hobby or endeavors. Anyhow, thanks for making Radio Era Archives a successful venture with your purchases. We would like to take the time this Christmas season to wish each and every one of ARC's readers and our customers a very merry Christmas and a Happy New Year.

**Complete 6-CD sets for Riders Vol. 1-23 ONLY \$ 450 postpaid USA**  
**6 Volume sets, ie V1-4, V5-8 available individually for only \$ 85 per CD postpaid**

## NEW CD-ROM RADIO PUBLICATIONS - Fall 1998

- Antique Radio Repair - Vol. 2 - More John Rider books and publications on radio theory and troubleshooting info
- Dial-Cord CD-ROM - Ever been stumped with re-stringing that old receiver and wasted hours? This CD is for you.
- RCA HB-3 - Over 7,000 pages of great tube data, graphs, diagrams on just about every kind of tube made
- RCA Radiotron Handbook - Over 1600 pages of design data, great tube radio & amplifier design data - 4th edition!
- R390 & R390A Military CD-ROM - has all the technical manuals, history of these remarkable receivers and more!
- Radiophile Vols 1, 2, and 3 CD-ROM's - have thousands of pages of books, history and reference materials.
- Antique Radio Repair - Vol. 1 - a condensed version with what you will need to learn how to repair old radios.
- "Faster than a speeding bullet" - hilarious & informative book on the age of radio and old radio programs.
- "Amos 'N Andy" on CD-ROM - Audio CD-ROM with lost 1940's episodes of this great old radio program.
- "The Radio Boys" - first two books, "First Wireless" and "At Ocean Point" - great reading for young and old!

## SCHEMATIC DIAGRAM & SERVICE MANUALS

*Over 150,000 schematics available and thousands of radio manuals are now available. REA has digitized these into digital masters for fast & accurate reproduction. NOW WITH ELECTRONIC DELIVERY BY EMAIL - We have thousands of satisfied customers for our old radio publications, give us a try today. Call, Write, Fax, or Email us at the below new old radio web-site!!*

## RADIO ERA ARCHIVES

2043 Empire Central  
Dallas, Texas 75235  
Inquiries: 214-358-5195  
Fax: 214-357-4693  
Email: tsm@radioera.com  
Hours: 9-5 M-F CST

**Visit us on the Internet:**  
**<http://www.radioera.com>**

**FOR SALE:** Eico 460 oscilloscope - \$35. Heathkit scope IO-D-203 - \$50. RCA 16mm sound movie projector Mod 1600 - \$75. Utah 12" woofers G12P, pair - \$50. GE compartment box of TV channel selector knobs, contains over (35) N.O.S. knobs - \$20. Bogen 250 watt amps, solid-state Model MT-250 - \$250 ea. Bogen 4-channel preamps Model CSM - \$50 ea. Zenith console Mod 9H081 (1946) 2 FM bands but record player missing, has 9 tubes, large black dial - \$75. Silvertone Model 1965 console radio (about 1936) - \$100. (125) Sams AR (auto radio) books - \$8 ea., or entire lot - call. About (3,000) Sams folders, want to sell the entire lot, call. Box of Zenith sales aids, brochures, etc. circa 1970s - \$30. Grab bag special: Hundreds of pounds of parts, mostly new, some in original packaging, including jacks, plugs, wires, cables, needles, lamps, controls, meters, relays, misc hardware, and much more other stuff. A generous 5 pound box (no 2 alike) for - \$10 ea. All prices plus UPS. Bob Lynn, 26 E. Orchard St., Somerville, NJ 08876. (908) 685-9070

**FOR SALE:** New! Rare! Xerox copy of a 1936 Atwater Kent newspaper - \$20! New! Rubber gasket for dial glass for Zenith and other brands - \$3 per foot. New! Brass inserts for 1942 Zenith knobs and Trans-Oceanics - \$5 each or 2 for \$8. Also 600 T-O knobs with inserts. Lucite dial lens for the 1942 Zeniths - \$16. New! Reprints of (2) McMurdo Silver cabinet catalogs, Masterpiece III and IV period - \$20 each, ppd. Repro arms for your RCA chrome chair, pair - \$60. Call for details. Universal Dial Belt Kit - \$8.95 ppd. Complete speaker repair, call. Send for free catalog. Visa, Discover and Mastercard accepted. Alan Jesperson, PO Box 17338, Minneapolis, MN 55417. (612) 727-2489. E-mail: mte612@aol.com.

**FOR SALE:** Wireless Telegraph & Telephone Handbook by Victor Laughter, exc condition, copyright 1909 - \$50. Carleton Rand, W1PZI, 85 Black Hall Rd., Epsom, NH 03234. (603) 736-9695

**FOR SALE/TRADE:** Green Addison A2, ivory AK771, Puglarcito (smallest Bakelite ever), AWAs, circular Ekcos. Check October's A.R.C.! Simon Wade, Finchcroft, Broadwater Down, Royal Tunbridge Wells, Kent TN2 5PE, UK. Telefax (44) 1892 543505. Images on e-mail: Simonwade@aol.com

**FOR SALE:** Magnecord 814CK tape deck auto, five 14" reels, and manual, playback only - \$125 plus shipping. James Smith, 1228 S. 40th Dr., Yuma, AZ 85364

**FOR SALE:** Spartan blue mirror #557 excellent - \$2,800. Philco 16B cathedral, mint restored - \$495. Richard Bednarick, 28 Steele Ave., Lincoln Park, NJ 07035. (973) 694-6374

**VISIT A.R.C.'s WEB SITE**

[www.antiqradio.com](http://www.antiqradio.com)

**Book Orders - Subscriptions - Articles and more!**

**FOR SALE/TRADE:** McMurdo Silver masterpiece II, all chrome with chrome-plated chassis cage/cover and chrome power supply, absolutely beautiful - \$1,585. Larry Drago, 383 Lincoln Dr., Cheshire, CT 06410. (203) 272-6030. Fax: (203) 272-2002. E-mail: theradioman@webtv.net

**FOR SALE:** Atwater Kent 145 tombstone - \$125; 20 Big Box - \$100. Bremer-Tully counterphase - \$195. Browning-Drake 4R - \$130; 5R - \$130. Freshman Masterpiece - \$130. Freed-Eisemann FE-15 - \$140; NR-6 - \$90; NR-20 - \$190. Grundig/Majestic 1060 S/W - \$100. Magnavox T - \$150. Majestic 20 cathedral - \$225; 50 cathedral w/stand - \$240; 50 cathedral - \$110; Philco 38-7 chairside - \$125; 70 cathedral - \$310. RCA 118 tombstone - \$110. Concert Master by Stanley Radio Corp. - \$85. Stewart-Warner 325 - \$120; 705 - \$130. Stromberg-Carlson 523/524 - \$160. Telefunken Garotte 7 - \$120. Thompson V-50 - \$140. Zenith FDR chairside - \$190. J. Gary Cameron, 824 Andrews St., Southington, CT 06489. (860) 276-9200

• WANTED •

# CATALIN RADIOS



I'll buy single pieces or whole collections. Top prices paid.

## RADIOART

Jim Meehan

P.O. Box 102 • Centerbrook, CT 06409  
(860) 526-1762



## BUY/SELL

## TUBES

## NEW & USED

SEND FOR OUR "WANT LIST"  
OR  
OUR FREE CATALOG

## ELECTRON TUBE ENTERPRISES

P. O. BOX 8311

ESSEX, VT 05451-8311

TEL: 802-879-1844

FAX: 802-879-7764

EMAIL: [etetubes@vbmail.champlain.edu](mailto:etetubes@vbmail.champlain.edu)

**WANTED:** Radione R2, R3. Pencil tube Hoffman Nugget. R520/URR Zenith military. John A. Miner, Suite 1000, 700 Broadway, Denver, CO 80203. (800) 873-8500 ext. 5252. Fax: (303) 759-5438. E-mail: hohum@uswest.net

**WANTED:** Music Master 21" bell horn, can trade early radio/wireless items or purchase. **FOR SALE:** Victor RE45 radio/phonograph, great condition - \$125. HP 608D 10 to 420 MHz VHF signal generator - \$90. Sev Dvorsky, 380 Morrison Dr., Pittsburgh, PA 15216. (412) 344-6633

**FREE - 20 WORD AD EACH MONTH**

To get your free 20 words,  
include your SUB# with your Ad.  
Additional words are 29¢ each.  
Read inside back cover for details.  
**MANY THANKS!!!!**

**WANTED:** Power supply chassis for Zenith TV Mod 28T925-E with chassis 28F22. The chassis I need is separate unit with (2) 5U4 tubes, a power transformer, capacitors & chokes. Andy Shackelford, 702 Brandywine Blvd., Wilmington, DE 19809. (302) 764-7502

**WANTED:** Amrad. Most anything before 1926. Ed Bell, 5311 Woodsdale Rd., Raleigh, NC 27606. Fax/ph.: (919) 851-1517. E-mail: ekbell@mindspring.com

**WANTED:** Transformer for a Scott Stradivarius large power type, chrome cased. Paul Recupero, 265 Union St., Portsmouth, RI 02871-2209

**WANTED:** B&K Model 747 tube tester. Charlie Poulton, 25626 Oaks Blvd., Land O' Lakes, FL 34639. (813) 973-7030

**WANTED:** Lackner Neon Glo clocks. Catalin, Bakelite or wood. Working or not and in any condition, I will buy clocks for parts. With or without neon. Please write, call or e-mail. Jean-Claude Reboul, 7010 S.W. 48th Ln., Miami, FL 33155. (305) 662-1986. E-mail: jcreboul@aol.com

**WANTED:** Dial pointer and glass for Zenith Model 6V27 tombstone. Paul Harnetty, 4805 Parkmoor Dr., Westerville, OH 43082. (614) 882-1979



**WANTED:** Early (prewar II) plastic radios. I collect these objects of beauty to enhance my otherwise dull and uneventful life to which I am forever bound by my sad-but-true unworthiness and shortcomings: physical, emotional, and intellectual. Please write or call collect: Rain Buttignol, 214 State St., #7, Portsmouth, NH 03801. (603) 427-1384

**WANTED:** Acro, Dynaco, Peerless, UTC, WE xfrs, tube sockets, IPC/Simplex 1029, 1133. Takshi Otsuka, 6701 Arlington Blvd., Richmond, CA 94805. (510) 236-9476

**WANTED:** Amplion driver for my Amplion AR19 wood petal horn or a complete damaged one. Don Hovde, 1000 Ashland Ave. Apt. 2, St. Paul Park, MN 55071. (651) 459-9135

**WANTED:** Raytheon RK Series tubes. RK15, RK16, RK25A, RK25B, RK30, RK32, RK41, RK44, RK45, RK46, RK56, RK58, RK63A, RK100. John H. Walker, Jr., 11015 W. 126th Ter., Overland Park, KS 66213. (913) 782-6455. E-mail: johnh.walker@alliedsignal.com

**WANTED:** Grundig Heinzelmann radio. Sam Giansante, 4255 West Ave., Elba, NY 14058-9769

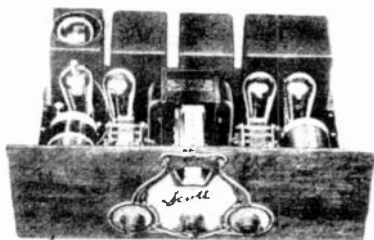

**WANTED:** E.H. Scott AC and DC Symphony. Arvin Model 1427 console. Top cash or trade. Joseph Halser, III, c/o Landmark 1850 Inn, 5905 S. Howell Ave., Milwaukee, WI 53207. (414) 769-1850

**WANTED:** Zenith Trans-Oceanics, all original, complete. Working, 100070 cosmetically restored to showpiece condition. G-500, Y-600 leather version. Kenneth F. Cerva, 3851 Harbor Heights Dr., Largo, FL 33774. (727) 584-6471

**WANTED:** Early home-brew and commercial Ham radios. Also early QSL card, especially New Jersey QSL cards. Internet: <http://www.eht.com/oldradio/museum>. John H. Dilks, K2TQN, 125 Warf Rd., Egg Harbor Twp., NJ 08234-8501. (609) 927-3873.

**WANTED:** Quality reproductions of my antique electronic catalogs, also audio input, output transformers. V. Vogt, 2311 Pimmit Dr. #114E, Falls Church, VA 22043. (206) 295-4418. E-mail: vcv mav@webtv.net

**WANTED:** Bendix 114, Belmont 6D111, Crosley Bullseyes, Emerson 744B, Sterling Deluxe, Sonora Sonerette and Excellence, Detrola Pee Wee, Round British Echo radio. Raytheon T-100, NECNT-61, Global GR900, any crown, any oceana, any coat-pocket tube radio. Bruce Phillips, 127 Bunker Hill Ave., Stratham, NH 03885. (603) 772-7516. E-mail: gxxl02a@prodigy.com

**WANTED:** Pilct variable condensers part #1613 250pf. and J5 15pf. Joseph G. Kelber, KB8GLD, 503 S. Scranton Ave., Scranton, KS 66537. (785) 793-2323. E-mail: ble17@juno.com

**WANTED:** Philco station stop wrench, Part #45-2475, for cone-centric tuning. Jim Regan, PO Box 880752, San Francisco. CA 94188. (415) 397-4134

**WANTED:** Will pay \$6.50 for 24JE6, \$8 for RCA 12AX7A and 12BH7A, \$5.50 for 21JS6/23JS6. Leeds Electronics, 68 N. 7th St., Brooklyn, NY 11211. (718) 963-1764. Fax: (718) 963-1963

**WANTED:** Braun SK-22u small table radio. Non-working is OK. Daryl Jorud, R#1 Box 180, Battle Lake, MN 56515. (218) 864-5725. E-mail: djorud@prtcl.com

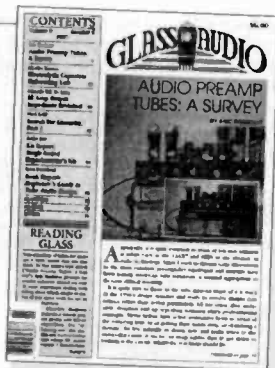

# GLASS AUDIO

*Vacuum tubes  
for Audio are back ...  
and they sound better  
than ever!*

Glass Audio brings together  
yesterday's tubes and today's  
improved components,  
making smooth sound possible  
for your audio again.

Ask for your first issue FREE to  
examine, without obligation!

**Glass Audio**

PO Box 176, Dept. ARC8

Peterborough, NH 03458-0176 USA

Phone: 603-924-9464

Fax: 603-924-9467 Email: [custserv@audioexpress.com](mailto:custserv@audioexpress.com)

Visit our website at [www.audioexpress.com](http://www.audioexpress.com)

**FOR SALE:** Speakers: AK H horn - \$150; L - \$150; G - \$200. Farrand Junior cone - \$60. Manhattan 2551 - \$60. RCA 103 tapestry - \$150. Liberty Bell horn by Metalcraft - \$140. Symphony Grand horn by Saal - \$140. Ultra Tone small cathedral speaker - \$65. Western Electric 521CW horn - \$125. J. Gary Cameron, 824 Andrews St., Southington, CT 06489. (860) 276-9200

— WANTED —

**CLUB CONTACT INFORMATION. A.R.C. IS  
UPDATING ITS CLUB LIST. PLEASE SEND  
US NAME OF CONTACT PERSON,  
ADDRESS, DUES, RATES, ETC.**

**FOR SALE/TRADE:** Under dash 45 rpm automobile record player parts and accessories, includes chrome doors and escutcheons, motors, cam wheels, switches, coils for solenoids, platters, etc. Let me know what you need. Call: Larry Drago, 383 Lincoln Dr., Cheshire, CT 06410. (203) 272-6030. Fax: (203) 272-2002. E-mail: [theradioman@webtv.net](mailto:theradioman@webtv.net)

**FOR SALE:** To reference our Zenith models, order our 60 page 11x17 Zenith Brochure Book for \$28.95 ppd. 4 tube Steinite Mini cathedral - \$295; Philco Transitone PT43, complete with back, original finish - \$175; Black Burns celluloid horn, no cracks in horn, some paint rubbed off side of neck, driver good - \$525; Rada-Cron cathedral clock radio - \$345; Squat peak-topped Cheney clock radio - \$395; Fabulous original rare Balkeit (not Bakelite) Globe Radio - \$1,350; 7G605 Bomber Clipper in very nice original condition; Very nice Leather 600 Series Zenith Trans-Oceanic; Rosewood Stromberg-Carlson 225H - \$275; rare Zenith 6B107 boat and trailer radio and speaker; 2 RCA chrome chairs in excellent condition - \$475/pair; Most Trans-Oceanics available. Call. Many Rider's manuals available, including early #s, call. Zenith Consoles: Aviatrux; 15S373; 15S372; 15U270; 12H689; 12A58; 12A57; 12S569; 12S568; 12S471; 12U159; 12U158; 12S370; 12S371; 12S265; 12S268; 11S474; 10S470; 10S491 phono; 10S153; 10S155; 10S156; 10S160; 9S54; 9S55; 9S262; 9S264; 9S365; 9S367; 8S154; 8S463(5808); 8S359; 7S261 bookcase; 6S362; 6S306 w/phono; 7S363; 7S364; 7S260; 7S258; 775B and many others. Zenith chairs: 12S245; 10S147; 9S244; 9S344; 7S343; 7S342; 7S340; 6S147; 7S240; 5S237; 6S239; 6S238; 6S203 phono; 6S241 bar radio. Others radios available: Zenith, Stromberg, GE, RCA, Fada, Philco. We can and do ship consoles anywhere and we do it right. Zenith table models: 4K535; 5S29; 5S228; 5S319; 6S321; 6S322; 6S528; 7S432; LH cathedral; L cathedral; 210 and 805 cathedrals; 6D029; 6D630; 6D525; 6S229; 6S330; 7S323; 6S439; 6V27; 6S27; 6S128; 6S222; 8S443; 10S130; 12S445; 8S531; 288; 711; 807 and many others, call. All radios unrestored electrically unless noted. Shipping extra unless noted. Satisfaction guaranteed, highest quality possible assured. Send for our free parts and supply catalog. Visiting Minneapolis? Visit our new store, Great Northern Antiques, 5200 Bloomington Ave., across from our old store, just five minutes from the airport. We accept Visa, Discover and Mastercard. Alan Jespersen/Mike Emery, PO Box 17338, Minneapolis, MN 55417. (612) 727-2489 or Fax only: (612) 727-1908, ans. mach. after 4 rings, 8 am to 6 pm, 7 days. E-mail: [mte612@aol.com](mailto:mte612@aol.com).

**FOR SALE:** Special for the month of December only; any remaining unsold items in my July '98 issue of A.R.C. will be 1/2 price. See ad in July issue page 66. Bob Lynn, 26 E. Orchard St., Somerville, NJ 08876. (908) 685-9070

**WANTED:** Any type DeForest unit panels to make up a unit receiving set. Richard Bury, PO Box 25, Gurnee, IL 60031. (847) 623-7746. E-mail: pabury@aol.com

**WANTED:** Adams Morgan (Paragon) open-frame audio transformer. Your price! To finish ancient restoration. Rick Ammon, 1249 Solstice Ln., Ft. Collins, CO 80525-1239. (970) 221-4001. E-mail: wireless@verinet.com



**WANTED:** Symphony and Detrola Catalin radios. I am not a human being: I am a radio collector. God forbid! Pity me the lost soul that I am and fulfill my humble needs. Please write or call collect: Rain Buttignol, 214 State St., #7, Portsmouth, NH 03801. (603) 427-1384

**WANTED:** Escutcheon cable for AK 20 C small. Gwen Cathcart, 410 Georgetown Dr., Kenner, LA 70065-4106. (504) 466-9992.

**WANTED:** Simplex Model R chassis, any condition will be considered if restorable. Dennis Smith, KN8H. Box 113, Trenton, MI 48183. (734) 675-5847

**FAX NUMBER FOR  
ANTIQUE RADIO CLASSIFIED  
(978) 371-7129 - 24 hours a day  
Ads - Subscriptions - Book Orders  
See inside front cover for details**

**WANTED:** COL-R-TEL color wheel converter manual. Amplifier for Tri-City W1. Bob Breese, 50877 Dee Run Trail, Elkhart, IN 46514. (219) 262-9287, E-mail: Bob@Breese.com

**WANTED:** Filmstrips about early radio. **FOR SALE:** Filmstrip projectors - \$3 & up + shipping. Paul Moens, 6792 Miller Rd., Newark, NY 14513. (315) 331-6740. E-mail: PRMoens@aol.com

**WANTED:** Zenith Walton cabinets. Johnny Johnson, 7075 W. 32nd Ave., Wheat Ridge, CO 80033. (303) 274-5474

**WANTED:** One yellow or two red knobs for Sentinel 284 wavy grille. Ron Stoner, 5341 High St., Lincoln, NE 68506. (402) 489-9259

**WANTED  
MICROPHONES**  
**BROADCASTING EQUIPMENT**  
Amplifiers, mixers, compressors, on-air lights, Mike flags, equalizers, literature, TV cameras, Disk, wire & tape recorders, 16" transcriptions, Turntables, arms, pickups, blank discs, speakers, Commercial, home & theater audio. Interesting, early or elaborate radio & TV sets. Buy & sell.

Robert Van Dyke, 2 Squires Ave., East Quogue NY 11942  
Tel. 516 728 9835 Fax. 516 723 3538 vandyke@hamptons.com

**WANTED:** Transistors: Sony TR-55, TR-63 red, TR-66, Toshiba 3TP-315, Hitachi TH-668, and others. Toshiya Abiko, Safuran Heights 202, 2254-1 Goi, Ichihara-City, Chiba Prefecture, 290-0056, Japan. Tel: 011-81-436-24-5510. E-mail: jdn06224@nifty.ne.jp

**WANTED:** Any Zenith Royal 500, especially handwired, in excellent condition. John A. Miner, 700 Broadway, Ste. 1000, Denver, CO 80203. (800) 873-8500, ext. 5252. Fax: (303) 759-5438. E-mail: hohum@uswest.net

**WANTED:** Chrome front radios, Catalin, colorful Plaskon, any killer Deco style sets. Top \$\$\$ paid. Adam Schoolsky, PO Box 23162, Portland, OR 97281. E-mail: Radios@ArtDeco.com. URL: http://www.ArtDeco.com

**WANTED:** Chrome leg model radio. Ex: RCA 6T10 or 8T10. Darwin Lee, 125 Monroe St., Santa Clara, CA 95050. E-mail: Rubarombic@aol.com

**WANTED:** DeForest 433 through 440 tubes, Westinghouse WL-461, Taylor 833, duds OK. John H. Walker, Jr., 11015 W. 126th Ter., Overland Park, KS 66213. (913) 782-6455. E-mail: johnh.walker@alliedsignal.com

**WANTED:** Ryder Radio index vol. 21, 22, 23; will trade index 1-10 inclusive. John Uscinowski, 95 Vly Summit Rd., Greenwich, NY 12834. E-mail: Mander3345@aol.com

**WANTED:** Panel and dial for AK breadboard coupled circuit tuner part #3752. Mark S. Cowart, N4FBL, PO Box 550766, Jacksonville, FL 32255-0766. (904) 724-1364

**WANTED:** 2, 3, & 4 tube AK breadboards. Thanks. Mike Fletcher, 1204 Cedar St., Niles, MI 49120. (616) 684-2174

**WANTED:** Any information on Garrard phonograph Model #RC80M from Fisher hi-fi. Robert Gardner, 2629 S. 27th St., Fcrt Pierce, FL 34981. (561) 466-8857. E-mail: LocNKey@aol.com

This Holiday Season...  
Give A Gift Subscription to  
Antique Radio Classified

**BONUS: December 1998 Free!**  
All gift subscriptions received before  
December 31 will be sent the December  
1998 issue free!\*

To Order:

1. Fill out the card in this issue with the recipient's name and address.
2. Enclose a gift card which we will send along with the bonus issue. (We will enclose our card with your name if you wish.)
3. Include payment or charge to VISA or MasterCard, and send to:  
A.R.C., PO Box 2, Carlisle, MA 01741

Or Call (978) 371-0512.

P.S. There are more gift ideas from  
A.R.C. on page 27.

\* If already a subscriber, a 13-month extension  
will be made to the recipient's subscription.

**FOR SALE:** Philco 89 cathedral, some irregular finish on top, appears complete – \$150 plus ship. Robert Turcotte, 1890 Arlington Rd., Roanoke, VA 24015. (540) 342-8521. E-mail: turcotte@rev.net

**FOR SALE:** Webcor Mod A-2945-1 crystal hand microphone new in box – \$10. 45EY3 needs amp repair – \$30. Robert Parke, 504 Essex St., Gloucester City, NJ 08030-1015. (609) 742-8221

**PHONE NUMBER FOR  
ANTIQUE RADIO CLASSIFIED  
(978) 371-0512**

**Best time to call is weekdays:  
9 am to 5 pm Eastern Time**

(Please no classified ads by phone. Thanks!)

**FOR SALE:** RCA 816K with remote, circuit modified – \$450. Norden Hauck Admiralty Super 15, AC, uses #50 output tubes – \$950. E.H. Scott AW23 in Windsor cabinet, complete, exc chrome, some damage to cabinet – \$1,100. 800B chassis – \$150. Capehart Panamuse G2 chassis, speaker, and turntable, vg – \$275. Zenith 7G605, Trans-Oceanic, airplane, complete – \$350. 6S532, table – \$75. 1000-D – \$100. 7S363 chassis, f – \$55. Chassis, 8A02, f – \$40. Trans-Oceanic 5H40, painted cabinet, parts – \$20. Zenith 1968 50th Anniversary sign, vg – \$40. Atwater Kent Model 84Q with storage battery base – \$450. Model E speaker – \$65. Type L chassis, vg – \$55. Type N speaker, vg – \$25. Airline 62-403, 13 tube movie dial – \$450. Airline Screen Grid chassis #31, vg – \$35. RCA BP-10, with case – \$80. Dumont RA346, clock radio – \$150. Temple G-418, brown, missing handle – \$50. G-419, white – \$65. Silvertone 1, brown – \$75. Sentinel Model 560, see Oct. photo review – \$95. Mitchell Lullaby Model 1250, brown – \$65. Philco Transitone 3, Philco's first auto radio, uses 01-As – \$350. Majestic Model 20 grandfather clock – \$200. Crosley 52 – \$95. 51 – \$95. Guild Country Bell – \$85. Ansonia Model 911, cathedral speaker – \$55. Bremer Tully, cathedral speaker – \$55. Philco Predicta, tabletop, mahogany, works – \$400. Hi-fi: Craftsman 10 tuner, no tubes – \$45. RC-10 tuner – \$45. C-400, 6V6 mono amps – \$175 pair. RC-2, 6V6 mono amps – \$200/pair. HH Scott model 240 amplifiers, vg – \$450 pair. Citation V – \$425. 232B mono amp – \$175. Leak TL25 w/point 1 preamp, single, vg – \$450. Eico HF22 mono amps – \$75/pair. Pickering electrostatic speaker power supply and 402 Woofer Network – \$50. RCA MI-12235 amplifier, vg – \$90. Brian Dunlop, 314 Stetson Dr., Cheyenne, WY 82009. (307) 778-4101. E-mail: Zgap@Sprintmail.com.

**FOR SALE:** Sony ICF-SW55, like new, all accessories, hard system case – \$225 plus shipping. Nils Hardin, 220-B W. Sola St., Santa Barbara, CA 93101. (805) 963-0116

**FOR SALE:** Zenith T-Os. Royal 7000YD, G500, brown leather 600, giant Panasonic RF5000 multiband. Ron Furnival, 113 Konzier Dr., Pittsburgh, PA 15237. (412) 487-6643

**FOR SALE:** Vintage Triplett meter #325 adjustable angle on base, binding posts – \$25. Ramsey VOM N.I.B. – \$25. Much more, SASE list. Bill Tucker, W4FXE, 1965 S. Ocean Dr., Apt. 15-G, Hallandale, FL 33009. (954) 456-1349

**FOR SALE:** Shure Carbon Microphone Chrome Model 3B – \$90. 20" Wall Clock KWDM 1150 K.C. – \$180. Mike Grimes, K5MLG, 3805 Appomattox Cir, Plano, TX 75023. (972) 867-6373.

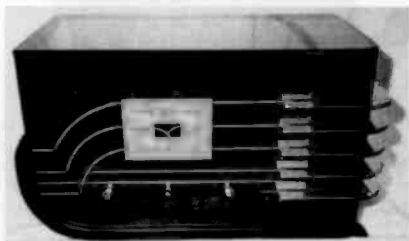

**FOR SALE:** 1936 Sparton 557 (replica). A beautiful recreation of one of the Art Deco periods most elaborate radios. This recreation by the Crosley Co. is so close to the original you will find it difficult to tell the difference, right down to the precision etching on the cobalt blue mirrored glass, the five wrap around chrome fins and knobs. A true Art Deco experience and a great addition to any radio collection. Model CR38 Crosley Sleigh – \$169 inc. delivery. See color photo on my web site. <http://www.radiogallery.com/galleries/0285/0285.htm>. Ben Martin, 18334 Pepper St., Castro Valley, CA 94546. (800) 595-0191. E-mail: bensradios@aol.com

**FOR SALE:** Pilot TV37 w/magnifier restored – \$475. Philco cathedral Model 71B Baby Grand in original box – \$700 firm. RCA TV Model 8TS30 – \$250 as is clean cosmetically or \$450 working. Western Electric Langevin #728 – \$550. Eico HF60 w/preamp – \$450. Admiral 1948 TV phono AM/FM blond combo. Rare 1948 Majestic 7" TV, phono radio combo, completely restored. I'm offering this set only once for – \$1,200. Dynaco 120 power amp – \$150. Clean Dynaco PAT4 preamp – \$150. Several reel-to-reel tape recorders, as is – \$50 ea. Sony, Grundig, Revere, Webster. Vaughn Rudisill, 17 Pearsall Ave., Deer Park, NY 11729. (516) 667-5247, evens. (516) 822-4501, days

**FOR SALE:** CRTs: 3ADP1, 5ABP7, 5UP7, 5VAHP4, 3AP1, 5AXP4A univ. test tube, 16KP4, TP4, Orion 3 1/2 x 4 1/2 rectangle #140ANB4, 100s of J.W. Miller coils, 1,000s phono cartridges & needles. Ed Crockett, Vintage Electronics, 128 Buccaneer Dr., Hattiesburg, MS 39402. (601) 264-4755. Fax: (601) 264-0226

**FOR SALE:** Used tubes: 6AS7/6080, 6Y6G, 5R4G, 5Y3GT, 5V4G, 5U4GB, many other new and used in stock. Angelo Pallotta, W2TPW, 1367 D'Angelo Dr., N. Tonawanda, NY 14120. (716) 695-0329

**FOR SALE:** Panasonic B-45 LN, boxed – \$75. Sony MR-9100 FM stereo, AM radio – \$75. Sony ICF-TR40 40th anniversary pocket radio, boxed – \$125. All + shipping. Gerald Silver, 10863 W. Clairmont Cir., Tamarac, FL 33321. (954) 720-1972

## WANTED Old Computers

Prices are for basic units, fair condition, working or not.

Please contact:  
Steve Gabaly  
128 Mcfall Rd  
Apalachin NY 13732  
(607) 625-5221

Apple I	\$10,000
Altair 8800	\$700+
Altair 8800b	\$400
IMSAI	\$400
Heath EC-1	\$500
Sol-20	\$400
Scelbi-8H	\$2,500
Mark-8	\$2,500

**old\_computers@yahoo.com**

# *Genuine Plastic Radios of the Mid-Century*

By Kenn Jupp & Leslie Piña

**Super Holiday Gift!**



**NEW!  
Order  
Today!**

**55 Manufacturers from Admiral to Zephyr  
Table Models – Portables  
439 Color Photos – Price Guide  
Advertisements**

**\$39.95 - Hardcover**

*U.S. Orders - Enclose \$3.00 per order for packing & book-rate shipping if total order is under \$35.00. If using VISA or MasterCard, include name on card, card number and expiration date. Send payment with order. Mass. residents add 5% sales tax. Money back return policy. Softcover unless stated otherwise. Most orders shipped the same day received, but allow 2-4 weeks to receive order. Foreign orders - write for shipping costs, or use credit card and specify air or surface (allow 2-3 months for surface shipping).*



**A.R.C., P.O. Box 2, Carlisle, MA 01741. Tel: (978) 371-0512**

**Fax: (978) 371-7129 – E-mail: [ARC@antiqueradio.com](mailto:ARC@antiqueradio.com) – Web: [www.antiqueradio.com](http://www.antiqueradio.com)**



(Oct-98)

**FOR SALE:** Crosley radios: Pup - \$425. Super Buddy Boy - \$375. Buddy Boy Repwood cabinet - \$45. James J. McGrath, W2IOJ, 2 Centerview Ln., W. Seneca, NY 14224-2124. (716) 675-0160

**FOR SALE:** 300+ antique radios + electronics, parts, huge photolist - \$2. Pre-order 99 photolist - \$2. Radio Ranch, 10745-255th Ave. NE, Belgrade, MN 56312

**FOR SALE:** Zenith 5S29 tombstone, nice and working - \$285. Rare Admiral 551 tombstone, nice, needs some restoration - \$125. Gerry Harmon, 10704 Callanish, Austin, TX 78750. (512) 219-0499. E-mail: texaswaves@cms.net

**FOR SALE:** Collection books, catalogs, magazines, manuals. Military radios. List SASE, e-mail. Chuck Grossman, 825 Percy Warner Blvd., Nashville TN37205. E-mail: GrossmanCR@aol.com

**HAVE YOU MOVED? ARE YOU MOVING?  
PLEASE NOTIFY US A.S.A.P.  
SEND US YOUR...  
OLD ADDRESS  
NEW ADDRESS and  
SUB #  
MANY THANKS!!!!**

**FOR SALE:** Stromberg-Carlson multi-band portable radio AWP-8. Has panel mounted weather instruments. Great reception, good condition. Contact: Sheldon Kane, 360 Rhinecliff Dr., Rochester, NY 14618, or call (716) 442-6338. E-mail: Auxch@aol.com

**FOR SALE:** Tubes N.O.S.: 6LQ6/6JE6C, 6JS6C, 6KD6 - \$25. 6JB6 - \$14. Quantities avail. Postage \$4. Bob Putnak, 1507 4th St., Monongahela, PA 15063. (724) 258-6236. E-mail: tubeaudio@home.com

**FOR SALE:** Transistors: Standard Micronic Ruby SR-H437 - \$60. 1956 Westinghouse H617P7 - \$60. 1956 Westinghouse H610P5 - \$90. Emerson 988 Rambler - \$80. Silvertone 8206, coral - \$80. Global GR711, white N.I.B. - \$175. Global GR-711, black N.I.B. tiny hairline - \$125. Suzanne Wyatt, HC67 Box 382, Ash Flat, AR 72513-9305. (870) 895-4757

**FOR SALE:** WRL Globe King transmitter - \$200. Johnson Viking Valiant transmitter - \$200. Hammarlund 129X receiver - \$100. Pick up only. Jim Roper, W4NJM, 3402 B.C. Grant Rd., Cornelia, GA 30531. (706) 778-6222

**FOR SALE:** Zenith 10S571 Spinnet, exceptionally mint original, cosmetically and electrically with original owner's instructions - \$425. RCA T6-1 tombstone, restored, excellent - \$125. Chris Hicks, RR2, Box 342, Clinton Corners, NY 12514. (914) 266-4257

**FOR SALE:** HQ 145C, manual, advertising, HQ S200 speaker. FRG7 communication receiver. N.I.B. Collins rubber feet with washers - 50¢ ea. 514S1 manual. HF80 binders. Bill Coolahan, 1450 Miami Dr. NE, Cedar Rapids, IA 52402-2933. (319) 393-8075

**FOR SALE:** Viking II AM transmitter with VFO, p/u only - \$200. Howard Felder, 7517 Granada Dr., Bethesda, MD 20817. (301) 320-3028

**FOR SALE:** Spartan 104 Jr. - \$225. GE A-64 - \$110. Gloritone 27 - \$165. Delco tombstone - \$75. John Lyle, 1161 S.W. Mulvane, Topeka, KS 66604-1456. (785) 232-0128

**FOR SALE:** Seco 1002 tube tester - \$95. John Kirby, 298 W. Carmel Dr., Carmel, IN 46032. (317) 843-2212

**FOR SALE:** Morrow receiver CM-1; RME converter MC55 80/10 - \$20 ea. + shpg. **WANTED:** Cabinet for RME 84. H. Mohr, 1005 Wyoming, Allentown, PA 18103

**FOR SALE:** Swan readout FC-76 - \$25. Autek filter QF-1 - \$15. James Wright, 4307 Hwy. 166 N, Maynard, AR 72444. (870) 647-2913

**FOR SALE:** Eimac 4-400A, Sylvania 250TH - \$75 ea. Factory-sealed, Tri-City 99 tube receiver - \$165. William Harder, 911 W. Northrup St., Lansing, MI 48911-3640. (517) 882-2303

**FOR SALE:** National SW-54 comm. rcvr. works AM, untested SW, needs some repair - \$30. Donald Sochurek, W191 S7500 Richdorf Dr., Muskego, WI 53150. (414) 679-0212

**FOR SALE:** Atwater Kent Model 20 little box w/o tubes, very nice - \$80. Panasonic RF4800 - \$250. Vance Rayburn, 2718 Homestead Rd., Madison, WI 53711. (608) 274-3002

**FOR SALE:** Pilot 3" TV - \$100. Pocket transistor radios, many different types; Tektronix scope manuals; Channel Master radio with shortwave. **WANTED:** Old Supreme test equipment in wood cases. Richard Oglebay, 164 S. Tropical Trl., Merritt Island, FL 32952. (407) 454-3466

**FOR SALE:** Wattmeter: Westinghouse Type PY-5; DC to 1000CPS; 0-150W; max. ratings: 7.5A & 400V; 1/2% accuracy. Dan Knipe, 3750 Highgrove Ln., Nampa, ID 83687. (208) 888-9575

**FOR SALE:** Carron crystal set - \$175. Radacron cathedral radio with clock - \$500. Crosley 51 - \$95. Air Queen - \$40. Federal box camera radio - \$150. Philco 118B cathedral - \$295. Zenith pop up - \$40. Buddy Boy cabinet - \$50. Acousticon hearing aid, boxed - \$35. Zenith 5L41 - \$10. Philco 48-472 - \$40. Wooden Zenith 5D027 - \$25. Riders 17 - \$40. Large list - SASE. Bill Rolf, 30131 Center Ridge, Westlake, OH 44145. (440) 871-4547

**FOR SALE:** Eveready #3, 1928 - \$80. Admiral 29-6S Bantam, 1941 - \$60. Hallicrafters SR10A-S1-S3 - \$40. Hallicrafters SW500 - \$95. Gilbert Simpson, 18 Beechwood Dr., Ansonia, CT 06401. (203) 734-4085

**FOR SALE:** McMillan Tel-O-Air partial chassis - \$10. Atwater Kent 52 partial chassis - \$10. Richard Zintek, 11954 U.S. 31, Grand Haven, MI 49417. (616) 842-2211

**FOR SALE:** Husberg & Compagnio German phonograph - \$225. Perfectone horn speaker GD - \$75. Crosley Bell advertisement 1928-1929 - \$75. Alladin Big Four - \$100. Alladin Super Five - \$100. Homebrew battery 20s set out of Murad parts - \$75. Stewart-Warner Model 300 LT - \$65. Day-Fan Model 5106 LT - \$75. Plus UPS. Larry Chambers, 5026 Suter Dr., Nashville, TN 37211. (615) 833-2448

**FOR SALE:** Regency TR-1G, turquoise, w/leather case in good condition - \$250. Dale Johnston, 1305 Guadalupe Dr., Westminster, MD 21157. (410) 848-5279

**FOR SALE:** (3) radios and parts (tubes) - Make Offer. Ed Schmidt, PO Box 247, Richfield, WI 53076. (414) 628-4632

**FOR SALE:** Hallicrafters S38C - \$60 includes shipping. Leroy Neal, 603 Butterworth Ave., Dyersburg, TN 38024. (901) 285-5120, after 8 pm CST



**WANTED:** 2 knobs and 1 tube shield for Echophone S-5. James W. Tills, 4766 County Rd. P43, Fort Calhoun, NE 68023. (402) 468-5181. E-mail: jtills@hurltel.net

**WANTED:** Dial pointer for Crosley 11-105U. Don Sturzenbecher, 26990 Marion Rd., Sioux Falls, SD 57108. (605) 368-2135

## One Month Free!

### BONUS FOR EARLY RENEWALS

If you renew before the month shown on your mailing label (your expiration month), you will receive an extra month on your subscription: 13 months instead of 12! 26 months for an early 2-year renewal!

**WANTED:** Operation manuals and schematics for the following: Eico Mod 950 resistance and capacitance bridge, Hickok Mod 288E signal generator, Clough-Brengle Mod 210A signal generator. Reprints are OK. Austin R. Salmon, 3039 Old State Rd. E, Scherectady, NY 12303. (518) 355-8708

**WANTED:** Western Electric Model 46, 60A and 61A amplifiers in any condition. Western Electric Model 4A and 5A rectifiers, Western Electric 203B meter panel. Eric Lenius, PO Box 685, Port Orchard, WA 98366. (360) 871-5921. E-mail: lenius@tscnet.com

**WANTED:** Swan 160-X with power supply and manual. Fred Ellis, 1040 Ebony Dr., Edinburg, TX 78539. (956) 383-5223

**WANTED:** Faceplate, case for Harman Kardon citation 2, will pay cash. Call: Lee M. McGough, 463 Lafayette Rd., Medina, OH 44256. (330) 722-3780

**WANTED:** Capehart radio phonograph with flp over changer in good restorable condition. Bruce Mercer, 1226 S.E. Second St., Evansville, IN 47713. (812) 423-9706

**WANTED:** Chassis & speaker for Philco Model 551 & GE Model K-53-M. Cabinet for Wilcox-Gay Model A-46. Knobs, dial glass & hardware, by the box or bushel. Larry Porter, 4115 Beam Rd., Crestline, OH 44827

**WANTED:** Bandsread knob for Howard 435. Chassis for Colonial 39, 41 or 42. Claude J. Dellevar, Jr., 13009 Maclay St., Sylmar, CA 91342. (818) 365-1629

**WANTED:** Radiola IV in good cond. Vincent Cormier, 6096 Pine Hill, Kountze, TX 77625-7218. (409) 246-4318. E-mail: vincecorm@worldnet.att.net



**WANTED:** Seiko, Sony, Panasonic vintage TVs. 1" up to 5". Transistor radios also wanted. Please fax or write: Tom Christopher, 45 Boway Rd., South Salem, NY 10590. Fax: (914) 763-5936

**WANTED:** Entire collections. Want mainly equipment prior to 1926. It will pay you to contact me. Ed Bell, 5311 Woodsdale Rd., Raleigh, NC 27606. Fax/ph.: (919) 851-1517. E-mail: ekbell@mindspring.com

**WANTED:** Crosley 52 case, Radiola FH horn only, chassis for each of the following: Echophone S-3, AK20 and 30, Radiachron, Eveready 33, Crosley 51 and 148, Radiola 100 or GE K-43-C, Tricity W-2, Stewart-Warner 300 and Companion, Century of Progress. Richard B. Jehlik, 14441 N. River Rd., Omaha, NE 68112. (402) 457-4604, after 7 pm CST

## VACUUM TUBES WANTED

(920) 208-0353

(All tubes are subject to testing and inspection)

### WESTERN ELECTRIC:

VT-2 / 205A/B \$225 NOS, \$110 used  
VT-52 \$140 NOS, \$75 used  
101D / 101F \$175 NOS (TB)  
101D / 101F \$45 NOS (ST)  
102D / 102F \$175 NOS (TB)  
102D / 102F \$45 NOS (ST)  
205D/E \$420 NOS, \$275 used (TB)  
211A/D/E \$275 NOS, \$140 used  
212A/D/E \$400 NOS, \$175 used  
231D / 349A \$50 NOS  
242A/B/C \$200 NOS, \$100 used  
252A \$1100 NOS, \$650 used  
261A \$150 NOS, \$75 used  
262A/B \$30 NOS, \$15 used  
264A/B/C \$25 NOS, \$13 used  
274A / 274B \$220 NOS, \$110 used  
275A \$90 NOS

300A / 300B \$850 NOS (engraved base)  
300B \$550 NOS (1950-60's)  
310A / 311A \$20 NOS  
331A / 272A \$45 NOS  
348A \$75 NOS, \$35 used  
350B \$200 NOS  
352A \$25 NOS, \$13 used  
412A / 418A \$8 NOS  
417A / 420A / 5755 \$10 NOS  
421A / 422A \$35 NOS  
437A \$15 NOS

### US & EUROPEAN TUBES:

2A3 RCA \$42 NOS, \$20 used  
2A3 (Single Plate) \$175 NOS, \$90 used  
10A Balloon \$70 NOS, \$35 used  
12A/112A Balloon \$25 NOS, \$13 used  
26/226 Balloon \$10 NOS, \$4 used

45/245 Balloon \$60 NOS, \$30 used  
50 Balloon \$200 NOS, \$110 used  
71A Balloon \$25 NOS, \$13 used  
80/280 Balloon \$28 NOS, \$13 used  
211 RCA / United \$110 NOS  
800, 808 \$40 NOS  
845 \$160 NOS, \$80 used  
5691 Red Base \$18 NOS, \$10 used  
5692 Red Base \$35 NOS, \$18 used  
6550 Tungsol \$60 NOS (ST)  
7591A \$30 NOS, \$15 used  
6L6GC RCA \$21 NOS  
12AX7 Telefunken \$15 used  
EL34 Mullard \$60 NOS, \$30 used  
EL37 Mullard \$60 NOS, \$30 used  
KT66 Genalex / Mullard \$70 NOS  
KT77 Gold Lion/GEC \$120 NOS  
KT88 Gold Lion/GEC \$150 NOS

NOS= New Old Stock  
in original boxes

Write, Call, Fax or Email for a  
detailed  
"WANT TO BUY" tubes list

## TUBE WORLD

2712 Superior Ave.  
Sheboygan, WI 53081  
(920) 208-0353 Phone/Fax  
E-mail: tekman@execpc.com

Always wanting to bid on  
LOT SALES!

Please write or call if you  
have any questions

**FOR SALE:** Altec 287W—\$1K ea. Altec 260A—\$1K ea. Teac A-3300SX 2-track—\$600. 4 pcs. Dell 486-66MHz, 333MD, 1.44M floppy, video graphics array—\$130 ea. 4 pcs. Dell 486-80MHz, 264MB, 1.44M floppy, video graphics array—\$130 ea. Weco 274B engraved—\$200. Bird 43 wattmeter with 400MHz-1GHz 100 watt slug, 25 watt slug, case—\$200. B&O beocenter 3500 needs needle—\$350. Unisync Mod 50 amp with balanced inputs—\$200. Hickock WE KS-15874-L2 cardmatic tube tester—\$400. Alnor chrome velometer in case, world's biggest VOM-Hickock 209A with 6 x 8" analog meter—\$150. Onkyo Integra T-4017 tuner—\$150. Antique Millen o'scope 90902-523—\$150. JBL 2470 16 ohm with 2307 horn—\$250. 4X150G tubes N.I.B. Collins mechanical filters F455N20, N40, N40, N80, F455FA216929—\$100 ea. Shure Audiomaster M63 with locut, hicut, bass, treble, 120Vac or 30Vdc—\$100/pr. Technics SH9020 peak/average meter unit—\$200. Crosley 5-38 battery set—\$100. Rockland 1020F hi/lo electronic xover—\$100. Akai professional midi sampler S-1000PB—BO. Marantz 15 amp made in N.Y.—\$300. HP 478A thermistor—\$100. Altec Valencias—\$1,500/pr. Altec 416-8A 8ohm woofers—\$400/pr. Nakamichi CM-300 mics with CP1, CP2—\$600. Jensen P15LL—\$200. Motorola PB501A FM communications-audio test set—\$200. TV-7 tube tester—\$150. B&K 747 tube tester—\$200. TEK 454 o'scope—\$200. McIntosh 1700 receiver cracked face—\$300. 1894 Stromberg-Carlson candlestick phone with post 1900 rotary dial—\$1K. Huge Bozak B4000 speakers—\$1K/pr. Lee Corner horns, all Jensen inside—\$1K/pr. Brociner transcendent corner horn, rare—\$2K ea. CM Labs CC-50s amp, cost \$500 in 1970, computer grade construction throughout, made in U.S.A.—\$300. HK Citation 5 amp, rebuilt—\$600. Danish sailor radio 16T—\$200. Matsushita P8T1 TV with box 50s?—\$200. 50 pcs. used UTC S-15 output trans.—\$30 ea. Pair UTC S-14 single-ended outputs—\$150. Pair Leak TL-10—\$750. AK breadboard 4566—\$1K. Many pre-1970 Allied, Lafayette catalogs—\$30 ea. 1972, 1973 HP catalogs—\$25 ea. Many Radiotron 4th editions—\$100 ea. A couple Tremaine Audiocyclopedias, 2nd ed.—\$100. Leslie 51C amp, no tubes—\$200. HP 331A distortion meters, good enough for any tube amp—\$125 ea. 50 pcs. mint in sleeves armed forces radio 16" transcription LPs—\$500 no list. Jensen RP201 mid horn—\$150 ea. Dynaco stereo 120—\$125. Dynaco PAT 4—\$75. McIntosh MR78—\$1K. Pair Tung-Sol 7241 triodes—BO. RC27 tube manuals—\$25. TEK T922 scope—\$200. Eimac 4CX1000A, used—\$100. Scott 370 wideband tuner—\$125. Bird 74 coax switch—\$75. Huge UTC LS-34 line-to-line and voicecoil audio trans. new—\$200/pr. Harvey Wells T-90 bandmaster—\$200. Marantz 1200—\$300. Counterpoint SA7 tube preamp—\$250. Technics SP10MK2 turntable—\$500. Leak stereo 20—\$600. Fisher K1000 tube amp—\$1,500. Rare black Tannoy 15"—\$2K. Pair 12" Tannoy in orbitus cabinets—\$1,500. Marantz Model 4 power supply for console/ette—\$500. Fluke 97 scopemeter—\$1K. Pair Leak TL12 plus—\$600. Garard 301 oil bearing, on base—\$500. Leak stereo 50—\$750. Pair Weco KS12025 horns—BO. HK Citation 4 tube preamp, no case—\$250. Walnut enclosure for Citation 1, 3, 4 in box—\$50. RCA 74 mic—\$450. Marconi stock certificate dated 1912—\$100. Jensen P8 8" woofers—\$25 ea. Rare GR Toroid output transformer 942A—\$200. Jensen 12" field coil woofers—\$200 ea. RCA 15" field coil woofers—\$300 ea. McIntosh MX110—\$800. Thorens

**CONTINUED AT TOP OF NEXT COLUMN**

**CONTINUED FROM BOTTOM LEFT**

TD124—\$350. Telefunken smoothplate 12AX7 look & test, new—\$30 ea. Collins KWM2A—\$1K. WWII British receiver R1147A in box—BO. 20uF-20uF-20uF at 450Vdc octal plug in caps—\$10 ea. RCA field coil compression drivers—\$600/pr. Ceramic Studio mags, 36 issues 1905-1912—\$30 ea. Sought by pottery collectors, Pilot TV37 untested missing one Bakelite slat—\$300. 3 pcs. Acrosound TO-600 output trans. plus 3 pcs. TP590 power trans, for UL 2 amp, need paint—\$600 all. EICO 730 modulator with case—\$200. Haven't even scratched the surface. V. Vogt, 2311 Pimmit Dr., #114E, Falls Church, VA 22043. (206) 295-4418, no detailed message=no returned call. E-mail: vcv mav@webtv.net

**FOR SALE:** Complete 1939 NRI Practical Radio Course in leatherette binders. Good condition—\$50 + UPS. Lloyd Noel, 494 Clark St., Galesburg, IL 61401. (309) 342-2825

**FOR SALE:** PACO Signal Tracer Z-80, works well—\$40. **WANTED:** Old headphones. Scott Balderston, 707 Watch Island Reach, Chesapeake, VA 23320. (757) 549-0449. URL: <http://members.aol.com/scottswim/index.html>

**FOR SALE:** Rider Electricity Vols. 1 to 5—\$15; Electronics Vols. 1, 3, 5—\$15. J. Ambos, 754 Carleton Rd., Westfield, NJ 07090. (908) 232-7762. E-mail: jambos@home.com

**FOR SALE:** National SW-54, Zenith chassis, dial bezel and lens from 7-S-53, Zenith 7H820-Z (one FM)—\$65. G503-Y—\$35. Stromberg-Carlson 1500-H, white paint, fair—\$45. Bendix 526A, 300, Arvin 664 (good cond)—\$50. Majestic Mighty Monarch, Gonset FM communicator G-151, Philco 38-12 (nice, working)—\$100. Clamp-on antenna AN-75, 9 ft. telescoping—\$30. Admiral 16D25, brn Bakelite, fixed grille—\$35. Garrard Synchro Lab 750 record changer. ARRL handbook, 1946, hardcover, fair cond, RCA receiving tube manual RC-23, 1964—\$25 both. American Bosch 505, nice cond—\$90. \$\$\$ negotiable, have pix, send wants to: Wilbur Gilroy, PO Box 459, Lake Winola, PA 18625. (717) 378-2508. E-mail: wlbgr@aol.com

**FOR SALE:** RCA AM-FM tuner, Mod. MI12116, Bogen AM-FM tuner preamp, Mod. R756, both commercial grade, Heathkit Mod. PT1 AMFM tuner, all good—\$150 for all, plus shipping, OBO. Irv Sanders, 242 Hunter Ln., Harrisburg, PA 17112. (717) 469-2185

**FOR SALE:** Radio schematics—\$3. Rider's radio & TV manuals. Xerox copies of service manuals: Zenith, 942 pp.—\$65. Philco, 300 pp.—\$30. Crosley, 322 pp.—\$30. Atwater Kent, 463 pp.—\$35. Rider's Radio Index 1 through 23—\$25. Dec. special 25% discount all above. Dec. special 30% discount all books from book list—SASE for list. All plus shipping. Dick Oliver, 28604 Schwalm Dr., Elkhart, IN 46517. (219) 522-4516

**FOR SALE:** Catalan radios. General Electric Jewelry Box in translucent tortoiseshell. Kadette Clockette in Chinese red. Fada Bullet Model 1000 in highly marbled blue with yellow trim. Bendix 526C in green and black. Fada Model 52 in all yellow. General Television in emerald green and white swirl Temite with white trim. Kadette Classic in black with red. Please call or e-mail. Jean-Claude Reboul, 7010 S.W. 48th Ln., Miami, FL 33155. (305) 662-1986. E-mail: jcreboul@aol.com

# Radio Restoration Parts

## Vacuum Tube Repair Wafers

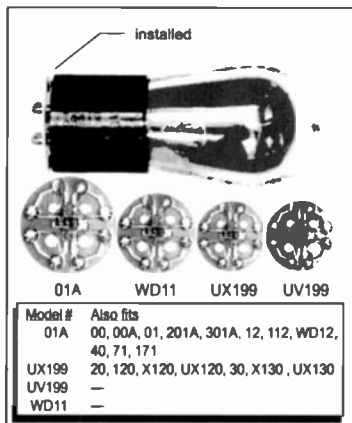

These tube repair wafers are solid-state devices for quick and easy repair of early vacuum tubes. The wafer is installed by simply sliding it over the tube pins and reinserting the tube into its socket. If the filament is intact, but there is little or no emission, the filament may be lit for best visual effect. However, the tube can be open filament.

No change in radio operating voltages is required. Any number of tubes may be repaired in a radio. If wafers are installed on all tubes, the B+ voltage may usually be reduced without sacrificing volume or sensitivity. Performance will vary between radio models.

\$10.00/each (\$7.50/ea. 3 or more)

## Antique Radio Power Supply

The H15/ H16 power supplies operates most tube type battery radios from low cost batteries. The H15/H16 steps up the voltage from a 6V battery to provide 22.5V, 45V, and 90VDC for the "B" voltage requirements.

A very desirable feature of the H15/H16 is the method of switching power on and off. This function is provided by the switch on the radio. No radio modification required.

The "A" voltage required by the radio can be from "C" or "D" flashlight batteries or from a 6V gelled electrolyte battery when operating 5V tubes. When operating 1.5, 2, or 3V tubes the H15/H16 can be powered by 4 "C" or "D" flashlight batteries or from a 6V gelled electrolyte battery. The gelled electrolyte battery can operate both the H15/H16 and the 6V "A" supply for 5V tubes from one battery.

Order the H15 of parallel filaments or the H16 for series filaments.

The compact size, 4"X4"X3/4", allows the unit to be installed with batteries in the battery compartment of most radios.

H15 or H16: \$99.50. Accessories: "D" cell holders: \$6.00 per set. 6V 10AH battery \$31.00. Battery charger \$45.00. 1.5 - 90V socket \$9.50.

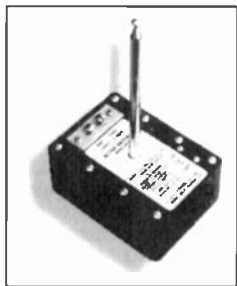

## Active Antenna

Allows antique radios which were designed for a long wire outdoor antenna to operate on a 42" indoor whip antenna. Portable, operates from a 9 volt battery.

Only \$34.95

## New Atwater Kent Breadboard Switch -

Only \$50

Order from: PTI, 7925 Mabelvale Cutoff, Mabelvale, AR 72103

Orders shipped UPS or Parcel Post, prepaid in continental U.S. Please allow 3 weeks for delivery.

Arkansas residents add 6.125% sales tax.

To Order: Call (501) 568-1995



**FOR SALE:** RCA Radiola 33 in metal case, fair, no lid or tubes - \$35. (2) output transformers for single-ended class A 6BQ5s - \$25/pr. Realistic 24B stereo integrated 6BM8s, gold face, fair cosmetics, needs coupling caps - \$45. (2) Heath WAP2 preamps, very clean - \$18 ea. (2) Bogen DB-110 mono integrateds 6V6s - \$25 ea. E.H. Scott mono tuner/preamp with matching chrome amp 6L6s - \$100. The Fisher mono tuner/preamp - \$35. Altec 1211A PA columns with (3) 8", horn tweeter, exc - \$135/pr. Vintage Realistic 15" musical instrument speaker, possibly JBL? - \$35. EV, Brush, Astatic mics, misc. tube power supplies, many N.O.S. tubes, sockets, capacitors, connectors, trannies, pots, vibrators, ammeters, Meissner coils, etc., call with wants or **SASE**, extra postage, for a 10-page list. **WANTED:** Additional roll charts/supplements for Triplett 3444/Westmore T-501 tube tester. C.J. Poulos, 29 Doubleday Rd., Columbia, CT 06237. (860) 228-7680, to 9 pm. Fax: 228-7681, anytime

**IF YOUR EXPIRATION DATE IS  
DECEMBER OR BEFORE, RENEW TODAY!  
EARLY RENEWALS  
RECEIVE AN EXTRA ISSUE!**

**FOR SALE:** Tube HF amps, tuners, PA amps, mics, RCA clock sign, N.O.S. 12AT7 tubes. **SASE** for list. Gordon Van Allen, 5822 Knollwood Dr., Ashtabula, OH 44004. Ph/fax: (440) 998-0723

**FOR SALE:** Telefunken 5083-W AM/FM/SW, beautiful, original, untouched condition - \$475+ shipping. George Wright, 4181 Enders Way, Doylestown, PA 18901. (215) 340-0413

**FOR SALE:** TV-10 tube tester - \$65. **WANTED:** 1276 and 2A3 SP tubes, RCA tube manuals before RC-13. John Birk, 458 E. 600 North, Orem, UT 84097. (801) 224-1216. E-mail: jbtubes@inquo.net

**WWII MILITARY TELEVISION WANTED.** Army/Navy SCR, ATJ, ATK, ARK, ARJ, CEK, CRV. Receivers, cameras, monitor, transmitters, dynamotors. Maurice Schechter, 590 Willis Ave., Williston Park, NY 11596. Ph/fax: (516) 294-4416

**Victrola Repair Service:** Windup phonograph repairs, parts, springs, needles via U.P.S. Rod Lauman, 19 Cliff St., St. Johnsbury, VT 05819. (800) 239-4188, eves.

**FOR SALE: 1941 PHILCO ESCUTCHEON REPRODUCTIONS.** Beautiful injection molded marbled brown plastic - just like the originals. Fits Models 41-250, 255, 256, 280, 285, 287, 290 and 296. Cost - \$29.95 plus \$3 shipping. California residents please add 8.25% sales tax. Send a money order to Old Time Replications BA, 5744 Tobias Ave., Van Nuys, CA 91411. (818) 786-2500. Fax: (818) 909-0241. Guaranteed satisfaction or your money back.

**PHONO NEEDLES & CARTRIDGES** (magnetic/ceramic). Over 500 cartridges and 5,000 needles. J. J. Papovich, 53 Magnolia Ave., Pitman, NJ 08071. (609) 582-8279

**BOXED CLASSIFIED ADS WORK!** This is a boxed classified ad. These ads can be run more than two months. See the inside back cover for details. Boxed ad deadline: the 1st of the month.

**FOR SALE:** N.O.S. industrial tubes, 100s available - Best Offer. Thank you. Audio Imports, 663 Fairview, Arcadia, CA 91007. (626) 447-3117

**FOR SALE:** AK speakers: F-2, F-4, J, 85, 87-89, and N. AK 246, cabinet only. **WANTED:** Front panel for Grebe CR-5. Bob Nicholson, 2745 S.W. Villa West Dr. #1308, Topeka, KS 66614-5236. (785) 271-5604

**FOR SALE/TRADE:** Motorola metal sandwich style sign w/wheels used to display 1930s Motorola radios and speakers, very colorful - \$375. RCA Radiotron display & advertising cabinet. It resembles a large cash register 36"H x 24W x 24D. There is a reversed painted glass sign built-in front that is illuminated from rear, inside cabinet. You can display your balloon/globe style Radiotron tubes in special holder in front & store other in rear of cabinet. Color is dark teal w/colorful red and orange tube boxes & lettering all around, very striking - \$500. Call: Larry Drago, 383 Lincoln Dr., Cheshire, CT 06410. (203) 272-6030. Fax: (203) 272-2002

**FOR SALE:** Pair EICO HF-60 amps, sound great, cosmetic fair/good, with cages. Have Acro TO330 O/T - \$1,100. **WANTED:** UTC LS output & LS-19 & 21 interstage trans. Dave Barth, 8320 Bevan St., San Gabriel, CA 91775. (818) 286-6503

**FOR SALE:** Supreme 1926-38 Radio Diagrams; Sam's TV Test Instruments, 1953; 1977 U.S. Callbook - \$10 ea. Dave Minchella, KE2GE, 80 Campfire Rd. N, Henrietta, NY 14467. (716) 359-3337

**FOR SALE:** Crosley bullseye Model 11-102U - \$150. General Television Model 534 grand piano, nice - \$300. Richard Sage, 1400 S.E. 2nd Ave., Aledo, IL 61231. (309) 582-2967



**WANTED:** Tube Hi-Fi components & commercial amplifiers by Marantz, McIntosh, Tannoy, Acrosound, Brook, Brociner, Fairchild, Hadley and others. Also want Western Electric theater amplifiers, speakers, tubes, & microphones. Richard Sharisky, PO Box 521, Belmont, MA 02478. Phone (617) 484-5784. Fax (617) 489-6592

**WANTED: Vintage Electronic Music Synthesizers** and modules by the following manufacturers, especially the listed models. **Aires** Modular, System III. **ARP** 2500. **Buchia** Modular, 100, 400. **E-mu** Modular. **EML Electrocomp** 100, 101, 200. **EMS** Synthi A, Synthi AKS, VCS3. **Korg** Modular PS-3100, PS-3200, PS-3300. **Moog** Theramin, Modular, Series 15, 35, 55. **Oberheim** SEM modules, 2-, 4- & 8-Voice Systems. **Paia** Modular 2700, 4700. **Roland** Modular Systems 100, 700. **Serge** Modulares, System 79. **Synton** Modular System. Call and surprise me; make my day! John V. Terrey, 498 Cross St., Carlisle, MA 01741. (978) 369-9770. Fax: (978) 371-7129

**WANTED:** Jones Radio Handbook 1937; RCA 151 oscilloscope; T-O 1000 battery box. Robert Pe'stein, PO Box 642, Old Orchard Beach, ME 04064. (207) 934-9206. E-mail: Perfs@compuserve.com

**WANTED:** Zenith chassis (5516) and speaker (49-43) for Model 5S127. Dennis Schrank, 3129 S. Quincy Ave., Milwaukee, WI 53207

**WANTED:** One (or possibly two depending on shading) dark blue/green? knob for blue Catalin Emerson Patriot (knob and handle there look like some dark blue/green color); a base for a Music Master wood radio cygnet horn (correct or close to correct base OK). **FOR SALE:** HH Scott 399 amp/tuner in nice shape - \$300 plus shipping. R. Carobene, PO Box 650206, Fresh Meadows, NY 11365. (718) 281-0504. E-mail: cphobia@bway.net

**WANTED:** Philco Service Manuals, Vol. I 1926-36; Vol. II 1937-38, or any other Philco service manuals or parts catalogs. Ray Bintliff, 2 Powder Horn Ln., Acton, MA 01720. (978) 263-7435

**WANTED:** Western Electric loudspeaking telephone, any models and condition. Jun Mizuno, 933 Portswood Cir., San Jose, CA 95120. Tel./fax: (408) 268-4C16. E-mail: jmizuno@usa.net

**WANTED:** Factory issued service books and dealer brochures of 1930s: Fada, Sparton, Arvin, whatever. Mark Oppat, Antique Audio, 253 Blanche St., Plymouth, MI 48170. (734) 455-4169

**WANTED:** Stromberg-Carlson AWP-8 knob, crystal detector assembly for Radiola V, Riders volume 23. Charles Combs, 508 E. Daniel, Albany, MO 644C2. Ph/fax: (660) 726-3038



**WANTED:** 40s WOOD RADIOS. My Dad wants to buy some of these, pictured, late forties wooden radios. Needing work is OK. Zenith 6D030, 6DC3CE, 8H034 or 6D029. EMERSON small wood 587. VAL-KEEN 572. DETROLA 572, 576 or 579. TELE-TONE 117 with holes. Your price based on condition. It's my dad's hobby, so please call (415) 461-6810, or write Steven Cabella/modi, 500 Red Hill Ave., San Anselmo, CA 94960

**ELECTRON TUBES:** Over 1 Million Tubes in Stock. Buy & Sell. Daily Electronics, 10914 NE 39th St. #B-6, Vancouver, WA 98682. 800-346-6667. 360-896-8856. 360-896-5476, fax

**WANTED:** Broadcast-type MICROPHONES. Early carbon, condenser, ribbons, etc. Cash or trade. James Steele, P.O. Box 620, Kingsland, GA 31548-0620. (912) 729-2242. E-mail: JSteele@k-bay106.com. Microphone collectors Internet site: <http://www.k-bay106.com/mics.htm>.

**WANTED:** 1925 Amrad Model radio as shown in Radio Mfg. 20s book. Andrew Mooradian, 5 Priscilla Ln., Winchester, MA 01890

**WANTED:** RCA transistor Strato-World model 1-MBT-6, circa late 50s. Seeking great original condition unit. Gilbert Smith, 248 S. 36th St., San Diego, CA 92113-1613. (619) 236-7990. E-mail: radioman63@juno.com

**WANTED:** Coils for Unelco receiver. 8 pins, marked SATO. Tops have silver label indicating ant or osc number. I need #2 thru #6. Harry Blesy, N9CQX, 9S740 Clarendon Hills Rd., Hinsdale, IL 60521. (630) 789-1793

**WANTED:** Outside horn phonographs, by Victor, Columbia and all others. Mint, junkers or parts. Jahaar L. Acciavatti, PO Box 806, Upton, MA 01568. (508) 476-3229

**WANTED:** Crosley center bullseye or left bullseye. David Spivey, #1 Rocky Valley Cove, Little Rock, AR 72212. (800) 505-0621, days

**WANTED:** Western Electric Model 555, 594 and 597 loud speaking telephones, drivers. Also want 18-inch Jensen field coil speakers. Eric Lenius, PO Box 685, Port Orchard, WA 98366. (360) 871-5921. E-mail: lenius@tscnet.com

**WANTED:** Mae West radio cabinet, have chassis. Robert F. Wheeler, 8341 Parker Rd., Orwell, OH 44706. (440) 437-6668, evenings

**WANTED:** For RCA Model 88K dial pointer and the dark brown plastic escutcheons. Will buy junker to get these parts. Will send photo to confirm, Charlie Rhodes, 10105 Howell Dr., Upper Marlboro, MD 20774. (301) 574-0214. Fax: 1978

**WANTED:** All-American tube series. Paying \$2 each used subject to my testing. Ship. Milt Faivre, K4EBT, 1445 2nd Rd. SW, Vero Beach, FL 32962

**WANTED:** Information, correspondence, conversation; anything on 1920s Hartman sets from Mansfield, Ohio. Particularly B-12. Dale Davenport, 622 S. 18th St., Fort Smith, AR 72901. (501) 785-4929, eves

**WANTED:** Small and mid-size cathedrals reasonably priced. Contact: Chester Michalowski, 820 Elder Rd., #404, Homewood, IL 60430. (708) 799-7046

**WANTED:** Collins Radio Company Catalogs, promotional literature, manuals 1933-1983. Jim Stitzinger, 23800 Via Irana, Valencia, CA 91355. 1-805-259-2011

**WANTED: Late 1940s to early 1950s ZENITH Porthole Console Televisions, working or fixable sets. Call or write: Joe St. Cyr, 200 Carolina Ave., 407A, Winter Park, FL 32789. (407) 599-7450. E-mail: jstcyr@peganet.com**

**WANTED:** 1930 to 1942 Police Radio communications equipment. Any 6 VDC mobile communication equipment. Raymond Miller, 953 N. 1st St., Albemarle, NC 28001. (704) 982-0228

**FOR SALE:** Campbells Soup can radios - \$30. Coca-Cola vending machine "Neat-O" radio - \$45. Coke vending machine "Breed" plate 390 - \$35. All N.I.B. Add \$3 shipping. Also, large 14-inch Coke "Neat-O" radio with cassette deck - \$75, plus \$5 shipping. Visa/MC. House of Radio, 3508 Florence Rd., Killeen, TX 76542. (254) 526-8677. E-mail: tiqradio@aol.com

**FOR SALE:** Heathkit SB-310 receiver, with speaker and manuals - \$150. Heathkit SB-610 monitor scope, with manual - \$75. Heathkit SB-630 station console, with manual - \$65. Bendix MT-11B key - \$75. British A-M type 10F/2533 key - \$35. New 1L6 tubes - \$20 ea. Raytheon CK-722 transistor, in original packet - \$20. Dynaco PAS3 preamp, factory wired, clear - \$125. Add UPS, call for details. Rick Weibezahl, 305 Belvidere Ave., Washington, NJ 07882. (908) 689-3276

**FOR SALE:** N.O.S. tubes. (22) Kenrad 6B4G - \$20 ea. (6) RCA 6973 - \$25 ea. (20) RCA 7027A - \$35 ea. (5) Sylvania 7591A - \$50 ea. Sylvania #45 - \$40 ea. (4) various brand (Sylvania) 8417 - \$35 ea. Radiotron 4th - \$100. Great shape Radiotron 4th - \$50 & \$60. Fair Audiocyclopedia - \$100. Craftsmen 500 amp - \$300. Craftsmen CR-10 tuner - \$150. Eico ST-70 - \$175. Radiotron 3rd - \$35. Used/tested tubes, (25) RCA 7027A - \$15 ea. (15) 6E5 - \$6 ea. (20) EL-34 - \$20-\$30 ea. All + shipping. Steve Harrell, 1179 Boylston St., #30, Boston, MA 02215. (617) 549-3962. Fax: (617) 236-5659. E-mail: tubetown@quik.com

**FOR SALE:** Scott 222C amp - \$125. Pr. University 312 spkrs - \$95. Pr. EV SP12 & T-35 spkrs - \$275. Pr. E-V LS 12" w/matching mid-horns tweeters & orig. covers - \$165. Dyna stereo 120 amp - \$75. Sony 5" 5307UW TV in box w/paper - \$49. Panasonic 5" TV TR555 - \$35. (2) Hallicrafters S-38A - \$50 both. (1) Altec 604-B w/cover, black, orig - \$550. (15) transistor radios - \$100/all. Roger & Mary Ellen Ruddick, 33 Emily Ln., Ft. Myers Beach, FL 33931. (941) 463-8887

**FOR SALE:** Fada Temple open grille, yellow w/red trim, restored, 2 in. stress crack on bottom screw - \$795 ppd. **WANTED:** New Buddy chassis/knobs/spkr for my good cabinet or sell? Mike Biddison, 15 Palomino Ct., Chico, CA 95928. (530) 894-2800

**FOR SALE:** Price reduced! Approx. 350 Sams Photofact Manuals, 1960s-70s, mostly TV - \$295 for all or \$3 ea. Realistic and Monarch VOMs - \$5 ea. Misc. TV tubes - \$2 ea. Misc. tools - \$2 ea. All untested, all plus shipping. Lee Kuntz, 3627 Keystone Ave. #2, Los Angeles, CA 90034. (310) 839-4378. Fax: (310) 204-4290. E-mail: Iskassociates@compuserve.com

**FOR SALE:** Sony TR-72, TR-609, TR-608. DeForest and Marconi signs. Mercury Super 10. A.R. Nolf, 539 Kastelic Pl., Burlington, Ontario, Canada L7N 3S9. (905) 333-4557. E-mail: am@globalserve.net

**FOR SALE:** RCA Redbooks Vol. 1 1923-1937 - \$50. Vol. 2 1938-1942 - \$35. N.O.S. Majestic ballasts for 70 & 90 chassis - \$20 ea. British sets: Philips 353A, no back - \$75. No name tombstone (circa 1936), oak cabinet, plays! - \$150. Need those hard to find knobs or spray shield tubes for your Majestic? Give me a call. **WANTED:** Issues of The Radio Weekly magazine, Radio & Electrical Appliance Journal, Talking Machine, Radio Retailing 1933-1937. Grunow Majestic & Grunow advertising/promotional items. Radios: Majestic Models 54A, Mayfair, M204, 422, 521. Grunow Models: 410, 502A, 510, 592, 594, 654, 1541. Any Majestic International sets, Grunow chassis 4A, 4C, 5A & 11C. Chip Taylor, 2223 53rd St., Sarasota, FL 34234. (888) 526-5566, toll free. Fax: (941) 359-6778

**FOR SALE/TRADE:** Bozak, Stentoran, Warfedale speakers. **WANTED:** Cavac, Courier, Peerless radios with/and flat electrostatic speakers. Nevins Museum of Radio, Ken Nevins, 406 Jipson St., Blissfield, MI 49228. (517) 3019, evenings please

**FOR SALE:** Cathedrals: AK 627, excellent original condition - \$525; AK 80, good original finish - \$500; AK 944, very good cond. - \$295. AK 246, exc cond. - \$385. Sid Stivland, 17725 6th Ave. N., Plymouth, MN 55447. (612) 475-1332

**FOR SALE:** Stromberg-Carlson 1A with tubes, nice - \$95. Unusual Crosley 567 small metal chairside - \$55. Hallicrafters SX-99 good but doesn't work - \$75. Spencer Kennedy Labs 302 tube type electronic audio filter - \$145. Shure 737A monoplex crystal microphone, works - \$85. Jon Hall, 253 Spring Oaks Ln., Ruckersville, VA 22968. (804) 985-3827, 8:30-10:30 pm. Fax: (804) 984-3299. E-mail: jon@halls.com

**Classified Ad Deadline Noon  
Dec. 10 for Jan. 1999 Issue  
Jan. 10 for Feb. 1999 Issue  
Boxed, Photo, & Display Ads - 1st**

**FOR SALE:** Radiola 103 speaker - \$165. Stewart-Warner 206FA brown Bakelite - \$110. Zenith 7S461 console - \$175. Zenith 6S229 needs some veneer work - \$95. Emerson sunburst with wooden cabinet - \$100. Atwater Kent 856 tombstone, needs dial glass cover - \$150. RME 84 with VFO - \$165. Philco 16B cathedral, needs veneer repairs on back - \$265. AK 60 chassis & speaker - \$75. Radiola 60, refinished w/103 speaker, needs refinished, everything works - \$235. Transportation additional. Joseph Szabat, 1019 Hiland Ave., Coraopolis, PA 15108. (412) 264-7498

**FOR SALE:** Detrola Pee Wee chassis - \$40. Crosley 10-135 parts set - \$50. Grundig RF26OU table - \$50. KHL sixes - \$100/pr. Wheatstone bridge, oak box - \$30. Hallicrafters S-240, nice - \$60. Silvertone 8003 midget, nice - \$75. Technics 631 and Sankyo cassette decks - \$40 ea. Sam's TV tube location guides, vols. 1, 2, 4, 5, 6, 7, 9, 10 - \$25. Classic Radio & Television, 541 Riverside Dr., Box 61, Augusta, ME 04330. (207) 623-2059

**FOR SALE:** Seldom offered horn speakers: RCA UZ-1320, not the common 1325, rarely seen in this condition, exc working condition, hate to use "near mint" - \$265. Standard Metal Mfg. Co. straight neck horn, complete, nice decal - \$220. Atwater Kent Model R, the elusive small one, good pot metal, nice looking - \$250. Dave Crocker, 4B Beechwood Point Dr., Mashpee, MA 02649. (508) 477-1578, before 9 pm please

**FOR SALE:** Working tube testers: Sencore TC 136 - \$45. Heathkit TC 1 - \$25. Philco 9200 - \$25. D. Cox, Box 415, Kiefer, OK 74041. (918) 321-5945

**FOR SALE:** Charlie McCarthy ventriloquist doll, lips move, old, as-is, needs a home - \$40! Bret Johnson, 13495 102nd Ter. N., Largo, FL 33774. (813) 595-9287. E-mail: bjoh1972@aol.com

**FOR SALE:** Used tube specials. (9) 12AX7 - \$3.50 ea. or \$25/all. 12AT7, 12AU7, others at reduced prices. Arcturus 124 blue globe, good - \$25 OBO. Other 224 globes - \$6 ea. Find additional tubes and other antique radio pages at [www.terracom.net/~john\\_b/antique.htm](http://www.terracom.net/~john_b/antique.htm). John Burdick, 5406 N. Cook St., McFarland, WI 53558. (608) 838-7076. E-mail: john\_b@terracom.net

**FOR SALE:** Old laboratory meters. **WANTED:** Instruments by James Biddle Co. wood telechron wall clock. Henry Weiland, 8946 W. Grantosa Dr., Milwaukee, WI 53225. (414) 463-4681

**WANTED:** Wood sets with metal grilles, Climax radios, miniature cathedrals. Jay Malkin, 1250 Galapago #206, Denver, CO 80204. (303) 623-6451

**WANTED:** Zenith Stratosphere and other high tube count radios. I need for my collection an empty 25-tube Stratosphere cabinet in any condition, or a complete set with a nasty chassis. Also Zenith and other pre-1950 radio advertising. I will buy or trade. Alan Jespersen, PO Box 17338, Minneapolis, MN 55417. (612) 727-2489. E-mail: mte612@aol.com

**WANTED:** Sony ICF-8650, ICF5900 JVCs RC-838, RC-550, Panasonic RX-7700. **FOR SALE:** Sony ICF-5500. Khushpal Singh, 1831 Gray Ave., Yuba City, CA 95991. (530) 671-3485, or (530) 671-4607

**WANTED:** Parts for Zenith T-O7G605, need rod antenna and speaker w/xfmr. Frank Cooper, 1016 Ulterback Rd., Great Falls, VA 22066. (703) 430-8041. E-mail: cooperf@erols.com

**WANTED:** Radio chassis R126 and speaker for Stewart-Warner console R1264A. Please help! Mr. & Mrs. L. M. Page, 4138 North Hwy. 41, Mullins, SC 29574-9359. (843) 464-6887. E-mail: pagehaven@aol.com

**WANTED:** In desperate search for an Atwater Kent Model 82 in excellent condition. Rob DeHart, 17325 N.E. 85th Pl. #O-129, Redmond, WA 98052. (425) 602-5070 ext. 6375. E-mail: rdehart@uascwa.com.

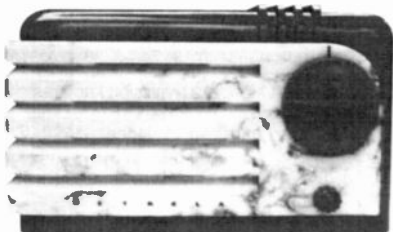

**WANTED:** More prewar plastics by Detrola, RCA, Kadette, Air King, et al. Take all my money before the relatives do. They are trying to hurry my already imminent demise. Please write or call collect: Rain Buttignol, 214 State St., #7, Portsmouth, NH 03801. (603) 427-1384

**WANTED:** Klipschorn information (speakers used: 1948-1968?), brochures needed: originals or copies. Hal Layer, KK6HY, PO Box 27676, San Francisco, CA 94127. (650) 366-5060. E-mail: hl@sfsu.edu

**WANTED:** (2) meters and (2) nameplates for WE SCR67A. Merrill Bancroft, 169 S. Row Rd., Townsend, MA 01469

## REPLACEMENT DRIVERS FOR ATWATER KENT HORNS

Driver w/housing for Model M & Pooley horns (this assembly replaces all pot metal) \$65.75 + \$4.75 s&h

Driver w/repair ring for Models G, H, & L (repair ring replaces threads in base) \$59.85 + \$4.75 s&h

All drivers above include diaphragm, gaskets, spacer, and spring. All parts are also sold separately. Send SASE for price list.

M. Harold Ezzone, 4901 Park Drive  
West Des Moines, IA 50265 — (515) 221-9447

**WANTED:** McMurdo Silver radios, brochures, booklets. **FOR SALE:** Copies of McMurdo schematics, manuals. Making repro parts also. Don Hauff Box 16351, Minneapolis, MN 55416. (888) OLD-RADIO. E-mail: DHauff@isd.net

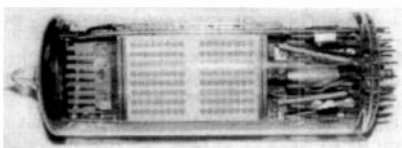

**WANTED:** This large RCA Selectron tube. Approximately 8" x 3". V. Vogt, 330 S.W. 43rd St., #247, Renton, WA 98055. (206) 295-4418

**WANTED:** U.S.A. manufactured pre-1930 crystal sets, detectors, one tube sets. Ed Bell, 5311 Woodsdale Rd., Raleigh, NC 27606. Fax/ph.: (919) 851-1517. E-mail: ekbell@mindspring.com

**WANTED:** Swan Mark II linear with power supply and manual. Trying to reassemble my all Swan station and get back on the air. TKS. Fred Ellis, EX-W5PTZ, 1040 Ebony Dr., Edinburg, TX 78539. (956) 383-5223

**WANTED:** Large Ampere tube manual from the late 1960s. Also odd or unusual tube types. Will pay \$200 for Eimac 500T tube. John H. Walker, Jr., 11015 W. 126th Ter., Overland Park, KS 66213. (913) 782-6455. E-mail: johnh.walker@alliedsignal.com

**WANTED:** Will pay \$20 for 6CA7, \$25 for 8417, \$50 for 4-400A (U.S.), \$30 for GE 6LF6. Leeds Electronics, 68 N. 7th St., Brooklyn, NY 11211. (718) 963-1764. Fax: (718) 963-1963

**WANTED:** Remote speaker for Philco chairside pictured on pg. 20 Sept. 98 A.R.C. Fred Watson, 581 W. Summit St., McClure, OH 43534. (419) 748-8798

## ANNOUNCING ZENITH and Philco Grille Cloths

N GE/RCA Aztec N  
E Pattern #44 E  
W for sets of the 1930s W  
also

- ★ Generic console patterns for Philco, Zenith and others
- ★ 2 silver/black deco patterns
- ★ 12 Philco patterns
- ★ 8 Zenith patterns
- ★ Plus GE, RCA, Stromberg & Westinghouse

Send a 55¢ LSASE for samples and info to:  
John Okolowicz, N3VSR  
624 Cedar Hill Rd.  
Ambler, PA 19002

or  
SEE THEM ALL ON THE WEB @  
www.Grillecloth.com

E-mail: Grillecloth@compuserve.com

**FOR SALE:** Help! Overstocked on N.O.S. common tubes. Many under \$1. Sweeps 6LQ6 – \$15. 6LF6 – \$25; 24LQ6 – \$9; many more. Test equip., radios, Sams, books, parts. Much more. 78¢ SASE for 28-page list. **WANTED:** Your excess or surplus N.O.S. tubes. Small lots OK. Charles D. Blair, 815 N. 5th St., Cambridge, OH 43725. (740) 432-4453, 9 to 5

**FOR SALE/TRADE:** Just spured a nice collection of early 1930s magazines, books, radio courses, etc. They include the following: five RCA service manuals 1923-1938, the complete set of ten Hawkins Guides 1920, sixty Radio News 1930-1935, ten Radio Shortwave magazines, 1930s, five radio callbooks, 1930s, seventy-three Service magazines 1930s, eighteen Rider's indexes, twenty-five Radio Engineers magazines 1930s, three experimental booklets, 1920s and several other wireless books dated 1912 & up. Call: Larry Drago, 383 Lincoln Dr., Cheshire, CT 06410. (203) 272-6030. Fax: (203) 272-2002

**FOR SALE:** EPI Model 60 speakers, woofers need repair – \$25 + UPS. Allen Jochem, 2205 Broadway, Quincy, IL 62301. (217) 223-6751

**FOR SALE:** Philco 45-1713 booster. UHF converters: Regency, Granco, Mallory, others. See <http://members.aol.com/aj2x/forsale>. Mark Nelson, 17 Wentworth Rd., Natick, MA 01760-1736. E-mail: aj2x@aol.com

**FOR SALE:** Holiday specials: \$25 – Emerson 813B, EC-301, RCA 1X53, 2BX63, Silvertone 2016. \$55 – RCA 9X571 bullhorn, Delco R-1238 (See Bunis 4 or Collins Redux p. 72). \$95 – RCA ST, Airline 62-177. \$125 – Zenith 7S363, Telefunken 5093W Concertino. Shipping extra. Lots more on list holiday priced SASE. Will listen to offers. Matt Hussey, 8 Capitol Cir., Rochester, NH 03867. (603) 332-9927

**FOR SALE:** Write for our lists: old tube list, tubes from the 1920s and later; phonograph parts; early technical books; table and portable radios; tube tester list – \$10 and up; test equipment; old wind up phonographs; CRT tube testers; stock certificates; we have almost anything you need. Send LSASE with 55¢ postage for each list. Cartridges and needles for all phonographs. J.J. Papovich, 53 Magnolia Ave., Pitman, NJ 08071. (609) 582-8279. E-mail: jipapo@juno.com

**FOR SALE:** Firesign Theatre's Don't Crush That Dwarf... N.O.S. album – \$7; Sidelii's Classic Catalin book, out of print – \$25; (add \$3 shipping on previous items); Zenith 15U269, professionally refinished, call; Bendix 526 brown Bakelite – \$45; CBS T204, black plastic & pink (like Traver in Machine Age 2) – \$60; Chevrolet radio test bench, 4 pieces – \$120; Riders: Vol. 6 – \$25; Vol. 7 – \$20; Vol. 11 & 13 – \$15 ea.; TV Vol. 1 – \$45. Prices do not include shipping. Vintage TV & Radio, 3498 West 105 St., Cleveland, OH 44111. (216) 671-6712. E-mail: vintageradio@ameritech.net

**FOR SALE:** RCA Radiola 20 cabinet nice w/good plate, label – \$30. **WANTED:** McIntosh mint tuners, tube preamps, amps, cabinets, literature, whole systems. Fisher 50C, 80AZ, AM80, mono amps: Pilot 901, Fairchild 260, Altec 333. Turntables: Garrard 301, Thorens 121, 124, speaker cabinets: Altec Voice of Theater, factory Karlson cabinets especially Formica; Altec, Western Electric relay racks. Walt Fleming, 182 Plain Hill Rd., Norwich, CT 06360. (860) 889-1957, 1937

**FOR SALE/TRADE:** Silvertone 4500 Commentator, black – \$145. RCA 103 speaker, nice, needs coverings – \$75. Crosleys: 5M3, plays – \$110; 58TW – \$39; D-25BE, plays – \$150; B548A – \$65. Kolster K-6 no-name speaker, nice – \$85. Detrola 342 – \$80. Belmont 6D636 – \$75. Zenith Royal 1000-D, very nice, plays – \$150. Majestic Royal 5LA5 – \$60. Bendix 753M – \$55. Silvertone 8217 beater – \$33. Zenith 5G401, nice – \$70. 1930-1950 WICO Magneto factory manual – \$55. Large coke cooler reproduction N.I.B. – \$110. Microphones: Astatic 22X crystal – \$70. Shure 777 in box – \$50. All plus shipping. No shipping items; GE H-64 Grunow 654, Zeniths; 6S152, 5R236W white chairside. **WANTED:** 1950s Crosley metal knobs. Bill Timoszyk, 35283 Leon, Livonia, MI 48150. (734) 421-2076, 10-12 am or pm

**E-MAIL ADDRESS FOR  
ANTIQUERADIO CLASSIFIED  
ARC@antiqueradio.com**

**Ads – Subscriptions – Book Orders  
See inside front cover for details**

**FOR SALE:** Collins 75A1 – \$465; 7553 – \$400; 3251 W/516F2 – \$350. Drake TR4 W/MS4+AC4 – \$265. TR4CW W/MS4-AC4 – \$365; R4C – \$250; T4XC W/MS4-AC4 – \$225. Hammarlund HX50 – \$125. HQ105 – \$125. BC779 in rack w/original sprk & PS – \$350. Hallicrafters SX117 w/HA10 – \$250. HT44 w/PS – \$200. SR500 w/PS – \$300. HT45 w/PS – \$400. Lots of Millen stuff – Call. R729 w/TMC SSB adapter – Offers. Johnson Thunderbolt – \$400. Some items pickup only. Offers always considered. Fred Watson, K18BP, 581 W. Summit St., McClure, OH 43534. (419) 748-8798

**FOR SALE:** RCA Model 121, missing knob restored – \$345. Zenith 4B131 with Zenith box – \$145. Zenith 4T26 with repro knobs and chip in veneer – \$90. Zenith 5F134, no knobs, rough cabinet – \$75 plus UPS. Steve Rudberg, 8812 Rainier Bay, Woodbury, MN 55125. (651) 735-1882

**FOR SALE:** Altec vintage broadcast mics in good working condition. 639A birdcage – \$800 and 633 saltshaker – \$80 plus shipping. Mike Lewis, 5549 Holmes Run Pkwy., Alexandria, VA 22304. (703) 823-3364. E-mail: mikephoebe@msn.com

**FOR SALE:** RCA 65U table – \$25. 56X3 w/phono table – \$35. 9-BT9-J early pocket port, plug in transistors – \$75. Dave Schmidtko, PO Box 462, Faribault, MN 55021. (800) 500-8055

**FOR SALE:** Two stamp LSASE for large list: old electronics books, radios, amplifiers, parts, misc. Japanese transistor radios: Toshiba 6TP-309, Excel 6T-2, Mars boys radio, Melson boys radio, holiday OLM6P, Magnavox AM-60, Channel Master 6512. Bob Warren, PO Box 643, Dalton, PA 18414. (717) 587-2405

**FOR SALE:** 1941 Zenith 8S563. Plays good & looks good – \$225. Fred Schultz, 1246 Lincolnway S, Ligonier, IN 46767. (219) 894-3779. E-mail: olradio@ligtel.com

**FOR SALE:** 5S319 – \$185 and 5S327 – \$225. Black dial Zenith 1939, both radios work. Call or write. Arnie Sanchez, 9615 Rockhurst, Houston, TX 77080. (713) 939-9221

**FOR SALE:** SX15, SX11, SX42, SX24, SX28, S-76, S-38B, – \$400 ea. or Best Offer. Donald Foster, 1754 Baywood Dr., Sarasota, FL 34231. (941) 924-5783. E-mail: djs7@gte.net



# *Shortwave Receivers Past & Present Communications Receivers 1942-1997*

## *3rd Edition*

By Fred Osterman



**840 Photographs — 473 Pages**  
**Features Over 770 Receivers from**  
**98 American and International Manufacturers**

**NEW Edition**  
**270 More Receivers!**  
**28 More Manufacturers!**  
**122 More Pages!**

**\$24.95 - Softcover**

*U.S. Orders - Enclose \$3.00 per order for packing & book-rate shipping if total order is under \$35.00. If using VISA or MasterCard, include name on card, card number and expiration date. Send payment with order. Mass. residents add 5% sales tax. Money back return policy. Softcover unless stated otherwise. Most orders shipped the same day received, but allow 2-4 weeks to receive order. Foreign orders - write for shipping costs, or use credit card and specify air or surface (allow 2-3 months for surface shipping).*



**A.R.C., P.O. Box 2, Carlisle, MA 01741. Tel: (978) 371-0512**

**Fax: (978) 371-7129 - E-mail: [ARC@antiqueradio.com](mailto:ARC@antiqueradio.com) - Web: [www.antiqueradio.com](http://www.antiqueradio.com)**



(Jul-98)

**FOR SALE:** Reslo ribbon mics, minifon wire recorders and accessories. Jon Golden, Box 205, Waban, MA 02468. (617) 332-5460. E-mail: 3dman@ziplink.net

**FOR SALE:** Zenith tombstone 5F134 - \$95. Crosley Fiver tombstone - \$50. Revere Junior cathedral - \$250. Books: Radios The Golden Age, Collins - \$25; Bakelite Radios, Hawes - \$25; both hardcover. Dale Raduege, 411 N. Greenfield Ave., Waukesha, WI 53186. (414) 547-0742

**FOR SALE:** Heath signal tracer. **WANTED:** Hallicrafters F72 portable reasonable. Hoover Noonan, Rt. 1, Box 187, Pineland, SC 29934. (843) 726-5762

**FOR SALE:** Porcelain tube sockets: Crosley; other receivers; transmitters. Arthur Harrison, 20 Suttlers Row, Hilton Head, SC 29928. (843) 689-3760

**FOR SALE:** Fada bullets; Commander; several cathedrals incl. AK, Philco 90, Lyric, several Trans-Oceanics, urea candy-cane, metal Silvertones, large Nordmende Parsifal, cool Nordmende stereo system/speakers; also Emerson 888s, red Kowa, Realtone; catalins/p, poker chips, checkers, more. Ted Chronister, 7073 Carlisle Pike #26, Carlisle, PA 17013. (717) 766-6436. E-mail: shorty@ezonline.com

**FOR SALE:** Tombstones: RCA R-7A - \$175, GE E-71 - \$150. Radios: Emerson atlas 888 - \$50; Zenith radios; Royal 820 - \$30; Royal 710 - \$25; Royal 755, knob short - \$40; J-615 - \$30; 49CZ843 - \$25; 4F-40 - \$40; 5Y01 - \$30; R514 - \$45; 7H9Z1Z - \$40; 7492L - \$40; Continental B-5400 - \$35; Traveler 5015 - \$35; Lang 406 - \$50; Sears 132.878 and 132.818-1 - \$50 ea. Capehart 3T55BN - \$25. RCA 66BX - \$40. Minerva W119 - \$50. All above plus UPS/U.S. mail. Charles R. Boller, 3108 NW 91st, Seattle, WA 98117. (206) 782-8318

**FOR SALE:** 1 lot CB. Parts from repair shop estate, write for list, SASE. (3) old 23 ch. CB sets. Like new operator's manuals for Simpson #260 meters 1 series 6 & 6M 1 series 5P. Don Miklasz, 7312 Chesterfield Rd., Crystal Lake, IL 60012. (815) 459-8198

**FOR SALE:** Microphone Shure 588 SA, unisphere B, 15' cord, excellent - \$50. Don Carver, 174 84th Ave. N, St. Petersburg, FL 33702. (727) 577-5355

**FOR SALE:** Grunow 500 - \$225. Spica D600 transistor - \$60. Philco vanity case radio D665-124 - \$60. Joe Holoner, 443 2nd St., Brooklyn, NY 11215. (718) 768-6212

**FOR SALE:** Philco 70 - \$325 plus shipping. Emerson EP405 - \$100 plus shipping, GE F40 - \$100 plus shipping. James W. Poitviant, 3 Darby Cir. E, Mt. Holly, NJ 08060. (609) 261-0059

**FOR SALE:** Panasonic flying saucer shaped speaker - \$20. Bud can AM/FM - \$20. Al Varga, 2120 School St., Two Rivers, WI 54241. (920) 793-1993

**FOR SALE:** (2) Edison cylinder phonographs. Early home 2/4 min., banner decal, 2 horns and 6 records, exc - \$1,295 + S/H. Early standard 2/4 min., banner decal, horn and 2 reproducers, exc - \$995 + S/H. Also available, assorted horns - \$60 and up + S/H. Photos - \$2 w/ SASE. Happy holidays to all! The Early Soundman, John P. Andolina, Jr., 28 Glen Oaks Dr., Rochester, NY 14624. (716) 247-3056

**FOR SALE:** Crystal sets. Martian Big 4 - \$600. Howe - \$160. Henry Hyman Bestone - \$180, Stanford - \$275. Dick Kowalski, KB8MR, 32823 Gloede Dr., Warren, MI 48093. (810) 294-4117

**FOR SALE:** Radio physics course neck ties. Covered with tubes & circuit designs. Handmade silk, blue, black & cream. A must for collectors. Ready for X-mas, only - \$25 each, includes S&H. In U. S., call: Walt Murray, PO Box 2100, Lakeside, CA 92040. (800) 878-1308. Fax: (619) 596-8403

**FOR SALE:** Philco 39-116 with correct remote, original, as found - \$200. 70 cathedral, needs work - \$190. 80JR, cathedral, nice, works - \$130. Zenith 6-S-52, recapped, nice - \$200. 9-S-369, robot-dial, restored, unusual & beautiful - \$900, available in mid December '98. Bob Snively, 516 S. 16th St., Richmond, IN 47374. (765) 935-3746

**FOR SALE:** Atwater Kent 90 cathedral - \$400. Philco 38-9 - \$65. Radio Shack pro 2035 1000 channel scanner - \$200. All radios working. Shipping extra. Wayne F. Dimmler, 13 Midtown Rd., Carle Pl., NY 11514. (516) 747-1325

**FOR SALE:** Roland W100 port., vg - \$100 OBO Steinite xtal set - \$200 OBO. RCA TX1HE xstr - BO. Zenith Royal 16, exc - BO. Randy Seifert, Box 45, Middle, IA 52307. (319) 622-3568. Fax: (319) 622-3461

## HAS YOUR SUBSCRIPTION

### EXPIRED?

It has if your mailing label reads  
"EXP=DEC98" or earlier.  
Renew now!

*BONUS: Renew before  
your "EXP" month and receive  
13 issues per year instead of 12!*

\*15th Year Special! Renewal rates are:  
\$39.49\* for Periodicals Mailing  
\$57.95 for First-Class Mailing  
(Two-year renewals are twice above rates.)

**FOR SALE:** Test equipment, variacs, scopes sig. gens, frequency counters, etc. Checked/guaranteed. List - LSASE. Kirk Ellis, KK4YP, 203 Edgebrook Dr., Pikeville, NC 27863. (919) 242-6000, evenings

**FOR SALE:** GR1001A AM signal generator 10 kHz - 50 MHz, vg - \$125. Chase Hearn, 104 Glenwood Dr., Williamsburg, VA 23185. (757) 229-7263

**FOR SALE/TRADE:** Kemser D64AC ext. spkr wood, vg - \$95. Kolster K30 TM - \$95. Zenith 6S511 PBTM, vg - \$59. Bob Fuerderer, Holly Farm, 813 Rt. 12A, Surry, NH 03431. (603) 352-3005

**FOR SALE:** Books by Tremaine, Kraus, Collins, Chapman, Dunlap, etc. - LSASE for list. Steve Russell, 121 Horseshoe Dr., Kalispell, MT 59901. (406) 755-3321. E-mail: imbio2@digisys.net

**FOR SALE:** Hallicrafters SX110 and speaker, e - \$200. T-O 8G005Y - \$125. 6A40 - \$35. John Livingston, 237 St. Charles St., Johnson, City, NY 13790. (607) 729-6574

**FOR SALE:** German People radio WWII, VE 301W, C230S, VE 301 G (240S) vg, WE 301 Dyn with symbol, all vg and working, original, shipping extra. R. Staffeldt, Tempelhofe Damm 785 Germany. Fax 011-49-30-450 78909

**FOR SALE:** Pristine 33-tube AM/FM Philharmonic with 3 speakers. (15) EH Scott consoles for sale including a fabulous all original pointer dial Philharmonic in a Warrington. **FOR TRADE:** High fidelity speakers for the Phantom and also for Philharmonic. Call for info. We accept Visa, Mastercard and Discover. Alan Jesperson, PO Box 17338, Minneapolis, MN 55417. (612) 727-2489, 8 am to 8 pm, 7 days. Fax only: (612) 727-1908

### CLASSIFIED AD NOTICE

Please check your ads carefully before sending them in. Once ads are received, it is not always possible to refund the amount sent, pull the ad or make changes.

**FOR SALE/TRADE:** Just acquired a new collection of various size tubular audions w/wire ends, also many interesting tubes made by Radiotron, DeForest, Marconi, Voltron, Van Dyke, Fleming, Daven, Audiotron, Moorehead, Western Electric, Sonatron, Sodian, CT Tel. & Te. Co., etc. Let me know what you're looking for in old tubes. Also over 200 rare duds for display purposes - \$25 each. Call: Larry Drago, 803 Lincoln Dr., Cheshire, CT 06410. (203) 272-6030. Fax: (203) 272-2002

**FOR SALE:** National HRO7 w/speaker & doghouse supply & coils, look good, untested - \$350; Zenith T-O 1000 in original boxes, near mint - \$275; Heathkit 20-watt power amplifier w/book - \$70; Air King Mod 828 w/eye - \$70; National NC60 - \$70; RCA 56X3 - \$55; Teletone circa 1948 - \$30; Crosley, 11-106U - \$45; Teddy Ruxpin answer boxes w/cassette, N.O.S. - \$15; also, Teddy Ruxpin Bear, not working - \$50; DeWald catalin radio Model B512 - \$675, firm; National NC-98, great condition - \$120; Great Britain radio w/eye - \$45; Hallicrafters EC I Echophone - \$65; NC-300 National, complete, needs work - \$215; Scott 800B - \$400, pick up only; RCA 65X1 12,000 miler - \$45; Stewart-Warner SW converter, Model 301A - \$65; Arvin Mod 68 & 622 - \$45; Zenith G503Y - \$35; Aircastle 162F1, 8-band - \$25; Philco 40-155, gc - \$75; American-Bosch 610 & 515 - \$70; Ward's hand-held portable circa 1947, Model 84GCB/1062A - \$75; Firestone 4A24 w/old battery - \$65; Zenith 850 console - \$90; Motorola 61T21 - \$35; Westinghouse H307T7 - \$35; Philips Radio, B5X43A, West Germany - \$65; parting out two Zenith 10-tube chassis, (1st) #1005, (2nd) 10S599, chassis 10A2R, call; also, parting out: Hammarlund HQ145X; Silvertone 4790; Philco 41295; Silvertone 4565; Philco 48-482; Philco 42PT7; S40 Hallicrafters cabinet; Firestone Air Chief working chassis - \$65; GE transistor P800A, complete - \$25; all above + UPS/U.S. mail. Ron Crowe, PO Box 117, Handley, WV 25102. (304)442-8179. E-mail: rgcrow@wvnet.edu

**FOR SALE:** 55c LSASE for list of new/used receiving/transmitting tubes. Sell or trade for old or unusual tubes or related material for my collection. John H. Walker, Jr., 11015 W. 126th Ter., Overland Park, KS 66213. (913) 782-6455. E-mail: johnh.walker@alliedsignal.com

**FOR SALE:** We buy and sell tubes of all types. Leeds Electronics, 68 N. 7th St., Brooklyn, NY 11211. (718) 963-1764. Fax: (718) 963-1963

**FOR SALE:** Unbuilt kits, N.I.B. Knight kit audio generator 83YX137 - \$85. EICO RC bridge & RCL comparator 950B - \$85. N.I.B. Eimac tubes, 4-125A(4) - \$85 ea., 4X150A - \$23; Penta Labs 5D22(1) (4-250A) - \$95, 813(6) - \$35 ea.; Used tubes, 805(4) - \$30 ea. George Shute, 2910 Virginia St., NE, Albuquerque, NM 87110. (505) 298-7347

**FOR SALE:** Admiral 8A, Emerson 336 white plastic, Melody Cruiser, metal Spartan with chrome trim, grille. Philco 650, 665 chassis, (2) Crosley Fivers, GE World Monitor, Zenith R511R for parts - \$20. 6D015. Auto radios: Philco 807 Transitone, Motorola 9-29. Wilbur Gilroy, PO Box 459, Lake Winola, PA 18625. (717) 378-2508. E-mail: wbrg@aol.com

**FOR SALE:** Admiral 4203BG - \$60. Emerson 512 - \$60. GE 203 - \$50. 541 - \$60. JMF-90 - \$60. GD-52 - \$95. Guild Town Crier - \$110. Hamilton-Lloyd wood Treasure Chest cabinet, no chassis - \$60. Kent 423 - \$60. Philco 39-7 - \$65; 39-2E - \$80; 42-322 - \$55; 48-461 - \$55; 49-607 - \$70; PT-30 - \$55. RCA 18T - \$75; 28T - \$75; T65 - \$75; 45X3 - \$60; 45X11 - \$60; 75X11 - \$80; 97X - \$60; 66X3 - \$50; 66X12 - \$50. Sonora RCU-208 - \$70. Stromberg-Carlson 500J - \$60; 1100 - \$55; 430-H - \$80; Zenith G503 - \$55. J. Gary Cameron, 824 Andrews St., Southington, CT 06489. (860) 276-9200

**FOR SALE:** Collins 75S3 rcvr, 32S1 xmtr, 32S3 xmtr, 312B4 stn. controller. Barry Hawkes, 87 Summer St., Watertown, MA 02472. (617) 924-2569, eve, weekend

## DECO STUDIO

### WANTED

Altec,  
Heath,  
JBL,  
Marantz,  
McIntosh,  
RCA,  
Scott,  
Tannoy,  
Western Electric,  
Also, Early Light  
Bulbs & Electrics

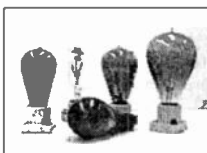
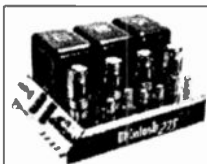

(Specially Edison Bulbs & Sockets)

8-10 West 36th Street, 3rd Floor  
New York, NY 10018  
Tel. (212) 563-8046  
Fax. (212) 563-8051  
E-Mail: decostudio@msn.com

I am a serious collector and historian interested in all aspects of E. H. Scott.

Please contact me first if you are selling your E. H. Scott Radio, Seleco L.H. RADIOTONE Coils, World's Record Superhet, or Scott Transformsmer Co. items.



Always interested in any E. H. Scott stock certificates, literature, and military sets.

John T. Meredith  
2462 Statonsburg Rd., Suite 152  
Greenville, NC 27834 - (919) 551-1882

**MESSAGE:** Treasures are still being sold at King's Attic on-Line Vintage Radio Auctions! James Fraley (Radio King), PO Box 2846, Wilmington, NC 28402. E-mail: scribe@kingsattic.com

**MESSAGE:** Visit my web. It will trap you with a collection of beautiful radio related items always updated. Type in www.Drago-net.com. P.S. Thank you for all of your nice comments. Soon I will be adding photos per so many requests. Larry Drago, 383 Lincoln Dr., Cheshire, CT 06410. (203) 272-6030. Fax: (203) 272-2002

**MESSAGE:** "For The Love Of Mike" microphones that is! That's the title of our long-awaited mic book. 1998 has been a most exciting year, with great feedback (pun intended) from microphone design engineers, recording engineers, soundmen, collectors, videographers, general enthusiasts, even interior decorators! Some have suggested including a list of collectors and a price list in the book. If you are interested in contributing to this subject, please send us, either by letter or e-mail, the types of microphones that you have, condition, the quantities of microphones, the purchase price and year. This will help us establish an information base and network between all the various types of collectors. I have been using microphones since I was a child and have had a lifetime of adventures recording and doing sound reinforcement (and singing through them), but nothing like the excitement of getting this book together. I would like to think this is a very worthwhile cause and definitely a labor of love! This book should be completed and on the market before the end of 1999. We used to joke and say we would get it out before the year 2000, but now that is our practical goal! Kindest regards, thanks again for all your input and enthusiasm, happy holidays, from: Ward Kremer & Kremer Kraft, 5807 Papaya Dr., Ft. Pierce, FL 34982. Ph/fax: (561) 468-7732. E-mail: WKremer798@aol.com

**MESSAGE:** Send now for the World's Premier 78 rpm & Cylinder Record Auction Catalog. Nauck's Vintage Records, 6323 Inway Dr., Spring, TX 77389. E-mail: nauck@78rpm.com

**MESSAGE:** Visit our web site for list of radio reprints and catalogs. <http://cheshire.net/~rainyday/>. Rainy Day Books, PO Box 775, Fitzwilliam, NH 03447. (603) 585-3448

**MESSAGE:** Visit Radiotique at <http://oldradios.home.ml.org>. View my collection. For sale, wanted, and trades also. Thanks. Jeffrey Goldstein, 4 Curry Ct., Wilmington, DE 19810. (302) 886-8071. E-mail: Jeffrey.Goldstein@phwilm.zeneca.com

**MESSAGE:** A wonderful site to behold. Visit my web site at www.Drago-net.com and see latest additions, always updating it. Soon I will be adding 200 photos, be patient. Thanks for all the great compliments on my site. Larry Drago, 383 Lincoln Dr., Cheshire, CT 06410. (203) 272-6030. Fax: (203) 272-2002

**MESSAGE:** Model 28 Teletype with tape accessories. Free, you haul from LA suburb. Gary D. Barry, 1933 Sunny Heights Dr., Los Angeles, CA 90065. (323) 223-1893. E-mail: garylois@aol.com

**MESSAGE:** Attention vintage CB radio collectors! You now have a web site to call home. Ads, pictures, for sale. Set your browser to: <http://www.retocom.com>. Enjoy! Dave Mierzwinski, 13345 W. Dakota, New Berlin, WI 53151

**MESSAGE:** Frontier Capacitor will not be open from December 13 thru New Years weekend. Everett Hoard, PO Box 218, Lehr, ND 58460

**MESSAGE:** Would the gentleman from Chicago who telephoned me re: ARB/ CRV46151 receiver please contact me again. W.J. Williamson, Leeskol, Camb, Yell, Shetland, ZE2 9DA, United Kingdom. Tel.: 44 0 1957 702384

— WANTED —  
**PICTURES FOR PHOTO REVIEW OR TELEGRAPH REVIEW  
PHOTOS MUST BE SHARP IN DETAIL  
A SHORT DESCRIPTION IS A MUST!  
SEE PHOTO REVIEW PAGES FOR  
ADDITIONAL INFORMATION**

**HELP:** I need a dial pointer for a Crosley 10-136. Andy Bruck, RR-1 Box 356, Cleveland, VA 24225. E-Mail: andyb@naxs.com

**HELP:** Raven Superheterodyne kit, need any information available. **FOR SALE:** Hotpoint portable TV, working, '60?, MDL#17S301-\$10. Gerald Huelsbeck, 323 Cherry Ln., Little Chute, WI 54140. (920) 788-3104. E-mail: kpru13c@prodigy.com

**HELP:** Schematics for HP200 CD audio signal generator and Jackson Model #650A condenser tester. Hugo Kann, KOHBN, 2320 King's Ct., Marion, IA 52302

**HELP:** Restoring Arvin Model 818. Need photo or description of grille cloth, knobs and cabinet color. As found left half of front face is very cherry like in color while the right is very dark walnut. Doubt that is correct. Ged Bryon, 194 N. Valley Rd., Pelham, MA 01002. (413) 253-3984. E-mail: gbryon@k12s.phast.umass.edu

**HELP:** Need second IF transformer for GE Model S-22 or will buy junker chassis. Ed Frezon, 2 William Terr., Rensselaer, NY 12144. (518) 286-3791

**HELP:** If you or someone you know is knowledgeable on the Admiral 1956 television product line or has 1956 Admiral TV sales literature or have any Admiral TVs made around 1956, please contact me. I am also looking for anybody that may have worked at the Admiral television manufacturing plant in Bloomington, Ill. in 1956 or has information related to plant and Admiral's 1956 TV product line. Thank you. A. Tobia, 5692 Abington Dr., Newark, CA 94560

**HELP:** Zenith Model 280 Jr. clock/radio need a tracing or drawing of the top wood piece and the three decorative finials. Chuck Davis, 7666 Aldridge Pl., Dublin, OH 43017. (614) 792-6237

**HELP:** Need Centralab dual volume control part no. F59-100K and R59-100K with switch SSK106 or CTS-IRC part no. CF106TT and CR71TT with switch SS1 or SS7A reference Sams 1032-4. Thanks. Don Mier, 4009 N. Foxdale Ave., Covina, CA 91722. (626) 338-9225

**HELP:** Need cabinet for Radiola IIIA. Please write to: Orlandini Iginio, Via Lessing, 10 - 00137, Roma, Italy

**HELP:** Need following Crosley parts: Light lime green knobs Model 11-105-U; SW/Vol. control Part B-151845-C Model E15TN. George Neumeister, 565 Belmont N.E., Warren, OH 44483. E-mail: mnmradio@aol.com

**HELP:** Would like a picture of a Crosley 124 Playtime grandfather clock radio. Joe DeBari, 194 Ramah Church Rd., Barnesville, GA 30204

**HELP:** Information required by relative on C.H. Thordarson or Thordarson Transformer Co. Historical items, biography, etc. Would be most appreciated. How can I help you? H.K. Fredrickson, RR2, Kemble, Ontario, Canada N0H 1S0. (519) 371-9814

**HELP:** Photocopy or original dial face of Stromberg-Carlson 231-F. Joseph Di Caro, 4155 Lastrada Hts., Mississauga, Ontario, Canada L5C 3V1. (905) 848-7759. E-mail: fox@globalseve.net

**HELP:** Need sensitivity coil and 2-lube peephole screens for Federal 59. J. Lowe, 3025 Harpers Ferry Rd., Sharnsburg, MD 21782. (301) 432-2420

**HELP:** Need Crosley Musicone speaker designed to fit in a console cabinet. Also need cabinet for Crosley 167. Thanks. Jimmy Heath, 2818 Oakland Ave., New Bern, NC 28560. (252) 633-1716

## One Month Free!

### BONUS FOR EARLY RENEWALS

If you renew **before** the month shown on your mailing label (your expiration month), you will receive an extra month on your subscription: 13 months instead of 12! 26 months for an early 2-year renewal!

**SERVICES:** Happy Holidays! Rider/Sams schematics 1920-70 - \$3 ppd. Send make/model. Richard A. Lerche, 1561 Bluebell Ct., Livermore, CA 94550. (925) 447-9365. E-mail: lerche@home.com

**SERVICES:** Any dial cover - \$12 ppd. Send bezel, tracing or old dial cover. Bill Turner, WA0ABI, 1117 Pike St., Saint Charles, MO 63301. (314) 949-2210. E-mail: dialcover@webtv.net.

**SERVICES:** Dial scales. Over 500 different models in stock. SASE for list. Rock-Sea Enterprises, 323 E. Matilija St. #110-241, Ojai, CA 93023. (805) 646-7362. E-mail: dials@juno.com

**SERVICES:** Reproduction Philco cathedral cabinet parts. Front panels, bottom moldings, rear arches. Reproduction 70, 90 or 20 std. cabinets. Grandfather clock finials, colonial clock top trim and finials. Other parts, inquire. Tube shields, Philco 20, 70 & 90 - \$35. Dec. special all postpaid. Dick Oliver, 28604 Schwalm Dr., Elkhart, IN 46517. (219) 522-4516

**SERVICES:** Hickok factory authorized person, providing affordable, professional service and calibration on Hickok, military, kit and other makes of radio and electronic service equipment. Services, tech hint #02, always place none test card in all cardmatics before turning off tube tester. **FOR SALE:** Affordable, refurbished, guaranteed test equipment. Manuals, schematics, tube chart update, obsolete, foreign, data, technical assistance. Calibration cells, Hickok 6000A 4, 5, 6, 7 pin adapters. **WANTED:** Complete, repairable electronic test equipment. **MESSAGE:** Profit by our 55+ years experience providing service that satisfies. Happy Holidays. Thanks for your continued support. Wendell E. Hall, 3 Mockingbird Cir., Jeffersonville, IN 47130. (812) 282-9709, home; (812) 256-2090, shop phone, fax, answering machine

**SERVICES:** I have or can make you a plastic reproduction dial cover for your radio - \$15 ppd. Doyle Roberts, HC63 Box 236-1, Clinton, AR 72031. (501) 745-6690. E-mail: drob@artelco.com

**SERVICES:** Schematics 1920-1960, mailed or faxed. \$3 radios, \$4 TVs ppd. Robert Schrantz, 610 E. Juanita Ave., San Dimas, CA 91773. Phone/fax: (909) 394-1194. E-mail: schrantz@prodigy.net

**SERVICES:** Repair/replacement meters prior 1935. **WANTED:** Meters before 1900, as is, your price! Ye Olde Meter Cellar, Leonard W. Cartwright, 879 Russet Dr., Sunnyvale, CA 94087. (408) 739-6025.

**SERVICES:** Radio schematics 1920 to 1960 - \$2.50 + SASE. Steve Rosenfeld, PO Box 387, Ocean Gate, NJ 08740. (732) 269-2022. Fax: (732) 269-2897. New e-mail: srosenfeld@ems.att.com

**SERVICES:** Dial covers, custom-made, over 200 in stock. Satisfaction guaranteed - \$15 up. Rita Hutchings, PO Box 382331, Germantown, TN 38183. (901) 754-5565. E-mail: sally@natten.net

**SERVICES:** Hand-wound plug-in coils for SW-3s, Wasp, and Super Wasp. Contact Tony LeDoux, PO Box 74, Schoenchen, KS 67667. (785) 625-6C75

**FOR TRADE:** Addison 2 for chassis Emerson Model AU-190. Robert Rouette, 4000 Cardinal Leger #14, Trois-Rivieres, Quebec, Canada G8Y 2H2

**FOR TRADE:** Mirrored half-round Stromberg-Carlson 231-F chairside for quality battery sets. Jim Berg, 4261 Wilcox Rd. Box A, Northport WA 99157. (509) 732-4047

**FOR TRADE:** Working Paragon DA-2 for Paragon 10R-1 RF amplifier unit. Pat Stewart, W7GVC, 1404 Ruth Ave., Walla Walla, WA 99362-3558. (509) 525-1699

**FOR TRADE:** My beautiful recapped Sentinel 284-NR Catalin for your SX-88 & spkr. A. Bruno, 24 Butternut Dr., New City, NY 10956. (914) 354-8899

# THANKS!

*Thanks for suggesting  
A.R.C. to your friends.*

*Did you know that nearly 20% of  
our new subscriptions come from  
referrals from subscribers?*

*So spread the word about A.R.C.!*

*Give the center coupon to a  
collector, or ask us to send a  
friend a free sample copy.*

*Help A.R.C. and  
radio collecting grow!*



# COMING RADIO EVENTS

## MINNESOTA - Nov. 28

### BASEMENT RADIO OPEN HOUSE SALE

Maplewood, MN - 2276 Holloway Ave.  
8 am-8 pm

Info: Ed Ripley - (651) 777-6791

## ONTARIO - Nov. 28

### LONDON VINTAGE RADIO CLUB OF ONTARIO MEETING

London, Ontario - London Jaycees  
317 Adelaide St. South

1 pm - Doors open at Noon

Info: Lloyd Swackhammer, RR# 2, Alma  
Ontario, Canada N0B 1A0 - (519) 638-2827

## BRITISH COLUMBIA - Nov. 29

### CANADIAN VINTAGE RADIO SOCIETY BRITISH COLUMBIA CHAPTER MEETING

Richmond, BC - Steveston Hotel

Info: Fred Tutt - (604) 275-2033

## VIRGINIA - Dec. 2

### TIDEWATER ANTIQUE RADIO ASSOC. MEETING

Call for location & directions

7 pm

Info: Vic Johnston - (757) 825-0757, eves.  
Scott Balderston - (757) 549-0449, eves.

## ARKANSAS - Dec. 3

### ANTIQUA RADIO COLLECTORS CLUB OF FORT SMITH - MEETING

Fort Smith, AR - St. Luke Lutheran Church  
Waldron Road, at Free Ferry

7:30 pm

Info: Paul Tucker, 4700 N. "N" St.  
Fort Smith, AR 72904 - (501) 782-8178

## ARIZONA - Dec. 5

### ARIZONA ANTIQUE RADIO CLUB MEET

Glendale, AZ - Mark Toppo's residence  
5127 W. Kings Ave.

8 am

Info: Dave Lambert - (602) 963-0262

## FLORIDA - Dec. 5

### ANTIQUA WIRELESS ASSOCIATION SWAP MEET

Bradenton, FL, Stuart Elementary School  
7905 15th Ave. NW

8 am

Info: Norm Smith - (941) 782-0003 (After 6 pm)

## OREGON - Dec. 5-6

### MASON AUCTION

Beaverton, OR - 90 N.W. 150th Ave.  
James Mason's estate (charter member of NVR5)

Dec. 4: Preview 9 am-5 pm

Dec. 5 & 6: 9 am Auction Opens

Send \$6 for an item list to:

Info: Jerry Talbott, 1440 S.W. 239th St.  
Hillsboro, OR 97123, or see web site:  
[www.radiolaguy.com/JMauktion.htm](http://www.radiolaguy.com/JMauktion.htm)

## PENNSYLVANIA - Dec. 5

### PITTSBURGH ANTIQUA RADIO SOC. MEETING

Pittsburgh, PA - Westinghouse Rec. Center  
Parkway East (376), Exit 12

S. on Greensburg Pike (on right)

10 am - Flea Market

Noon - Meeting & Luncheon

Info: Sev Dvorsky - (412) 344-6633

## TEXAS - Dec. 5

### HOUSTON VINTAGE RADIO ASSOC. CHRISTMAS PARTY

Houston, TX - Lai Lai Suites, Tides II Hotel,  
6700 S. Main St. at Holcombe

Info: Bill Werzner - (713) 721-2242

## TEXAS - Dec. 5

### VINTAGE RADIO & PHONO SOCIETY CHRISTMAS PARTY

6-11 pm

Irving, TX - Jaycee Arts Building

Info: George Potter - (972) 353-4862  
VRPS, PO Box 165345, Irving, TX 75016

**SUBMISSION DEADLINE: 5th OF MONTH**

## WASHINGTON - Dec. 5

### RADIO ENTHUSIASTS OF PUGET SOUND MEETING - 2 pm

Seattle, WA - Queen Anne Library  
400 W. Garfield

Info: REPS, 9936 N.E. 197th Street  
Bothell, WA 98041 - (206) 488-9518

## WEST VIRGINIA - Dec. 8

### MUSEUM OF RADIO & TECHNOLOGY ANNUAL BANQUET

1640 Florence Ave., Huntington, WV 25701  
Info: Jack Woodrum - (304) 525-4546  
Donnie Setliff - (304) 576-2705

## NEW YORK - Dec. 6

### GREATER NEW YORK VINTAGE WIRELESS ASSOC. - SWAP MEET

Lake Ronkonkoma, NY - 367 Hawkins Ave.  
8 am-Noon

Info: Chris Lieppert - (516) 471-9526  
Chris Bacon - (516) 821-7618

## ONTARIO - Dec. 9

### OTTAWA VINTAGE RADIO CLUB MEETING

Ottawa, Ontario - Ottawa Citizen  
Conference Room, 1101 Baxter Rd.

7 pm - Flea Market  
8 pm - Meeting  
Auction

Info: OVRC, PO Box 84084, Pinecrest P.O.  
Ottawa, Ontario, Canada K2C 3Z2 - (613) 832-0397

## MISSOURI - Dec. 8

### ANTIQUA RADIO COLLECTORS & HISTORIANS OF GREATER ST. LOUIS - MEETING

Kirkwood, MO - Kirkwood Community Center  
111 S. Geyer Rd., Room 201-A

7:30 pm - Meeting (earlier for conversation)  
Show & Tell, Swap Table

Info: Derek Cohn, 8141 Stratford Dr.,  
Clayton, MO 63105 - (314) 725-2333

## ARKANSAS - Dec. 10

### ARKANSAS ANTIQUA RADIO CLUB MEETING

Little Rock, AR - Books A Million  
Markam & Bowman Rd.

7 pm

Info: Tcm Burgess - (501) 455-0773  
(Call to confirm details)

## OHIO - Dec. 8

### ANTIQUA RADIO COLLECTORS OF OHIO MEETING

Kettering, OH - National City Bank Basement  
4100 Far Hills Ave., at Stroop Rd.

7:30 pm

Theme: Open Elections/Pizza Party

Info: John Heck - (937) 435-1571  
ARCO, PO Box 292292, Kettering, OH 45429

## NEW JERSEY - Dec. 11

### NEW JERSEY ANTIQUA RADIO CLUB FALL SWAP MEET

Freehold, NJ - National Guard Armory  
7:30 pm

Info: Marv Beeferman - (609) 693-9430  
Phil Vourtsis - (732) 446-2427

## PENNSYLVANIA - Dec. 8

### DELAWARE VALLEY HISTORIC RADIO CLUB MEETING - SWAP MEET - AUCTION

Telford, PA - Telford Community Bldg.  
Corner of Hamilton & Madison

7:30 pm

Info: Bill Overbeck, PO Box 847,  
Havertown, PA 19083 - (610) 789-8199

## OKLAHOMA - Dec. 12

### OKLA. VINTAGE RADIO COLLECTORS ANNUAL CHRISTMAS PARTY

Oklahoma City, OK - Oklahoma Station BBQ  
Springdale Shopping Center, 4333 N.W. 50th

6 pm - Dinner

7 pm - Meeting

Info: Jim Collings - (405) 755-4139, after 6 pm  
Tom Laszynski - (405) 741-1176

## OREGON - Dec. 12

### NORTHWEST VINTAGE RADIO SOCIETY MEETING - 10 am

Oregon City, OR - Buena Vista Club House  
16th & Jackson St.

Info: Ed Charman, PO Box 82379  
Portland, OR 97282-0379 - (503) 654-7387

A free\* listing on these pages is available for each coming antique radio event. Sponsors should provide description of event, date, time, place, directions, & information/contact person. Since listings are on a "space available" basis, no guarantee of listing is made. \*Club/museum/non-profit events are listed free; other events are obtained from advertisements placed elsewhere in A.R.C. Sorry, we don't have room for hamfests.

## MARK YOUR CALENDAR

Nov. 28 - MN, Maplewood - Open House  
Nov. 28 - London, Ontario - LVRC Meeting  
Nov. 29 - British Columbia - CVRS Chapter Meeting  
Dec. 2 - VA, TBA - TARA Meeting  
Dec. 3 - AR, Fort Smith - ARCCFS Meeting  
Dec. 5-6 - OR, Beaverton - Mason Auction  
Dec. 5 - AZ, Glendale - AARC Meeting  
Dec. 5 - FL Bradenton - AWA Swap Meet  
Dec. 5 - PA, Pittsburgh - PARS Meeting  
Dec. 5 - TX, Houston - HVRA X-mas Party  
Dec. 5 - TX, Irving - VRPS X-mas Party  
Dec. 5 - WA, Seattle - REPS Meeting  
Dec. 6 - NY, Lake Ronkonkoma - GNYVWA Swap  
Dec. 8 - MO, Kirkwood - ARCHGSL Meeting  
Dec. 8 - OH, Kettering - ARCO Meeting  
Dec. 8 - PA, Telford - DVHRC Meet & Auction  
Dec. 8 - WV, Huntington - MRAT Banquet  
Dec. 9 - Ottawa - OVRC Meeting  
Dec. 10 - AR, Little Rock - AARC Meeting  
Dec. 11 - NJ, Freehold - NJARC Fall Swap Meet  
Dec. 12 - OK, Oklahoma City - OKVRC X-mas Party  
Dec. 12 - OR, Oregon City - NWVRS Meeting  
Dec. 13 - IL, Elgin - ARCI Indoor Meet  
Dec. 13 - MS, Meridian - MHRBS Meeting  
Dec. 13 - NM, Albuquerque - NMRC Meet  
Dec. 13 - TX, TBA - TARC Meeting  
Dec. 13 - WA, Seattle - PSARA Swap Meet  
Dec. 14 - GA, Norcross - SARS Meeting  
Dec. 14 - IL, Belleville - BAARC Meeting  
Dec. 15 - CA, Sacramento - CHRIS Sac. Meeting  
Dec. 16 - OH, Cincinnati - CARS Meeting  
Dec. 16 - OH, Columbus - COARA Meeting  
Dec. 17 - NY, Hudson Valley - HARPS Meeting  
Dec. 20 - MD, Burtonsville - MAARC Meeting  
Dec. 22 - OH, Kettering - SPARK Meeting  
Dec. 28 - AL, Birmingham - AHRM Meeting

1999

Jan. 2 - WA, Seattle - REPS Meeting  
Jan. 3 - NY, Lake Ronkonkoma - GNYVWA Swap  
Jan. 6 - VA, TBA - TARA Meeting  
Jan. 7 - AR, Fort Smith - ARCCFS Meeting  
Jan. 8 - NJ, Freehold - NJARC Meeting  
Jan. 9 - AZ, Sun City - AARC Meeting  
Jan. 9 - OR, Oregon City - NWVRS Meeting  
Jan. 10 - CO, Denver - CRC Meeting  
Jan. 10 - MS, Meridian - MHRBS Meeting  
Jan. 10 - NM, Albuquerque - NMRC, Meet  
Jan. 12 - MO, Kirkwood - ARCHGSL Meeting  
Jan. 14 - AR, Little Rock - AARC Meeting  
Jan. 20 - OH, Columbus - COARA Meeting  
Jan. 23 - NH, Nashua - NEARC Winter Meet  
Jan. 25 - AL, Birmingham - AHRM Meeting  
Jan. 29-31 - TX, Houston - HVRA/AWA Convention  
Jan. 30 - OH, Columbus - COARA Swap Meet  
Jan. 31 - British Columbia - CVRS Chapter Meeting  
Feb. 5-6 - TX, Houston - HVRA Annual Convention  
Feb. 6 - MI, Dearborn - MARC Winter Swap Meet  
Feb. 6 - PA, Havertown - DVHRC Super Winter Meet  
Feb. 13 - IN, Indianapolis - IHRS Winter Meet  
Feb. 20 - CA, Van Nuys - SCARS Auction  
Feb. 21 - MA, Westford - GBARC Radio XXX  
Feb. 27-28 - CA, Buena Park - VTV Swap Meet  
Jul. 9-10 - MI, Lansing - MARC 14th Extravaganza  
Jun. 25-26 - WA, Seattle - REPS Showcase VII  
Aug. 4-7 - IL, Elgin - ARCI Radiofest XVIII

See expanded listing for many of these events

Attend a radio event near you,  
learn, meet others in the hobby.

## ILLINOIS - Dec. 13

### ANTIQUE RADIO CLUB OF ILLINOIS MEET

Elgin, IL - Holiday Inn, 345 River Rd., Rt. 31 & I-90  
Swap Meet - Donation Auction  
7 am-Noon

Info: Bob Piekarz, PO Box 1139,  
La Grange Pk., IL 60526 - (708) 352-0648

## MISSISSIPPI - Dec. 13

### MISSISSIPPI HISTORICAL RADIO & BROADCASTING SOCIETY - MEETING

Meridian, MS - 2412 C Street

Info: Randy Guttery - (601) 482-4534  
Bill Gerk - (601) 268-6059

## NEW MEXICO - Dec. 13

### NEW MEXICO RADIO COLLECTORS CLUB MEET

Albuquerque, NM - Anna Kaseman Hospital  
8300 Constitution Ave. (W. of Wyoming)

1:30 pm - Tailgate Swap Meet  
2 pm - Program, Show & Tell and Auction  
Topic: Atwater Kent & History

Info: Bill Schultz, 7213 Donet Ct. NE  
Rio Rancho, NM 87124 - (505) 867-8178

## TEXAS - Dec. 13

### TEXAS ANTIQUE RADIO CLUB MEETING

Call for further info, location TBA

Info: Joe Koester, 7111 Misty Brook, San  
Antonio, TX 78250 - (210) 522-1662

## WASHINGTON - Dec. 13

### PUGET SOUND ANTIQUE RADIO ASSOC. SWAP MEET

North Seattle, WA - Shoreline Museum  
Parking Lot, N. 175th & Linden Avenue  
9 am-1 pm

Info: Pete Petersen, PO Box 7251  
Seattle, WA 98133 - (425) 747-1323

## GEORGIA - Dec. 14

### SOUTHEASTERN ANTIQUE RADIO SOCIETY MEETING WITH SHOW & TELL

Norcross, GA - Picadilly Cafeteria  
3400 Holcomb Bridge Road - 6:30 pm  
Topic: Anything Goes

Info: Gordon Hunter - (770) 475-0713  
SARS, PO Box 500025, Atlanta, GA 31150

MENTION A.R.C. WHEN CONTACTING CLUBS!



## **ILLINOIS - Dec. 14**

### **BELLEVILLE AREA ANTIQUE RADIO CLUB MEETING - 7 pm**

Belleville, IL - Belleville Area College  
Topic: Novelty & Transistors

Info: Karl Stegman, 4 Cresthaven Drive  
Belleville, IL 62221 - (618) 234-7992

## **CALIFORNIA - Dec. 15**

### **CALIF. HISTORICAL RADIO SOCIETY SACRAMENTO CHAPTER MEETING - 7 pm**

Sacramento, CA - SMUD Building  
Corner of Elkhorn & Don Julio

Info: CHRIS Hotline - (415) 821-9800

## **OHIO - Dec. 16**

### **CENTRAL OHIO ANTIQUE RADIO ASSOC. MEETING**

Columbus, OH - DeVry Institute of Tech.  
1350 Alum Creek Rd., I-70 Exit 103B

7:30 pm

Info: Chuck/Sue Davis - (614) 792-6237

## **OHIO - Dec. 16**

### **CINCINNATI ANTIQUE RADIO SOCIETY MEETING**

Cincinnati, OH - Eastgate Mall  
Community Room; Rt. 32 & I-275

7:30 pm

Info: Ted Lewis - (937) 446-3898

## **NEW YORK - Dec. 17**

### **HUDSON VALLEY ANTIQUE RADIO AND PHONO. SOCIETY- MEETING**

7:30 pm - (Call to confirm details)

Info: Peter DeAngelo - (914) 496-5130

## **MARYLAND - Dec. 20**

### **MID-ATLANTIC ANTIQUE RADIO CLUB MEETING**

Burtonsville, MD, New Hope Seventh Day  
Adventist Church, 15121 McKnew Rd.  
(Between Rt. 29 & I-95, off Rt. 19E) - 2 pm

Info: Ed Lyon, 11301 Woodland Way,  
Myersville, MD 21773 - (301) 293-1773

## **OHIO - Dec. 22**

### **SOCIETY FOR PRESERVATION OF ANTIQUE RADIO KNOWLEDGE MEETING - 7:30 pm**

Kettering, OH - Cassano's Pizza  
1700 E. Stroop Rd.

Program: Pizza party/ Business mtg.  
Show & Tell: Gramophones, discs, wire re-  
corders, victrolas, record players & records

Info: SPARK, PO Box 482, Dayton,  
OH 45449 - sparkinc@ju.no.com

## **ALABAMA - Dec. 28**

### **ALABAMA HISTORICAL RADIO SOCIETY GET-TOGETHER**

Birmingham, AL - Homewood Public Library  
1721 Oxmoor Road

7 pm

Info: Earl Ridolphi, 2413 Old Briar Trail  
Birmingham, AL 35226 - (205) 823-3314

## **WASHINGTON - Jan. 2**

### **RADIO ENTHUSIASTS OF PUGET SOUND MEETING**

Seattle, WA - Queen Anne Library  
400 W. Garfield

2 pm

Info: REPS, 9936 N.E. 197th Street  
Bothell, WA 98041 - (206) 488-9518

## **NEW YORK - Jan. 3**

### **GREATER NEW YORK VINTAGE WIRELESS ASSOC. - SWAP MEET**

Lake Ronkonkoma, NY - 367 Hawkins Ave.  
8 am-Noon

Info: Chris Lieppert - (516) 471-9526  
Chris Bacon - (516) 821-7618

## **VIRGINIA - Jan. 6**

### **TIDEWATER ANTIQUE RADIO ASSOC. MEETING**

Call for location & directions

7 pm

Info: Vic Johnston - (757) 825-0757, eves.  
Scott Balderston - (757) 549-0449, eves.

## **ARKANSAS - Jan. 7**

### **ANTIQUE RADIO COLLECTORS CLUB OF FORT SMITH - MEETING**

Fort Smith, AR - St. Luke Lutheran Church  
Waldron Road, at Free Ferry - 7:30 pm

Info: Paul Tucker, 4700 N. "N" St.  
Fort Smith, AR 72904 - (501) 782-8178

*NOTE: The "Coming Radio Events" pages are tabulated from the best information available to A.R.C. However, changes, cancellations and errors do occur. To avoid disappointment, verify place, date and time especially for events which are new to you.*

### **NEW JERSEY - Jan. 8**

#### **NEW JERSEY ANTIQUE RADIO CLUB FALL SWAP MEET**

Freehold, NJ - National Guard Armory  
7:30 pm

Info: Marv Beeferman - (609) 693-9430  
Phil Vourtsis - (732) 446-2427

### **ARIZONA - Jan. 9**

#### **ARIZONA ANTIQUE RADIO CLUB MEETING AND WORKSHOP**

Sun City, AZ - 9980 Willow Point  
Dick Stout's residence  
1 pm

Info: Dave Lambert - (602) 963-0262

### **OREGON - Jan. 9**

#### **NORTHWEST VINTAGE RADIO SOCIETY MEETING**

Oregon City, OR - Buena Vista Club House  
16th & Jackson St. - 10 am

Info: Ed Charman, PO Box 82379  
Portland, OR 97282-0379 - (503) 654-7387

### **COLORADO - Jan. 10**

#### **COLORADO RADIO COLLECTORS ANNUAL MEETING - 1 pm**

Denver, CO - VectraBank Bldg.  
1380 South Federal Ave.

Info: Larry Weide - (303) 758-8382

### **MISSISSIPPI - Jan. 10**

#### **MISSISSIPPI HISTORICAL RADIO & BROADCASTING SOCIETY - MEETING**

Meridian, MS - 2412 C Street

Info: Randy Guttery - (601) 482-4534  
Bill Gerk - (601) 268-6059

### **NEW MEXICO - Jan. 10**

#### **NEW MEXICO RADIO COLLECTORS CLUB MEET**

Albuquerque, NM - Anna Kaseman Hospital  
8300 Constitution Ave. (W. of Wyoming)

1:30 pm - Tailgate Swap Meet  
2 pm - Program, Show & Tell and Auction  
Info: Bill Schultz, 7213 Donet Ct. NE  
Rio Rancho, NM 87124 - (505) 867-8178

### **SUBMISSION DEADLINE**

**5th OF MONTH**

Please include date, time, place, directions,  
event details & information/contact person.

### **MISSOURI - Jan. 12**

#### **ANTIQUÉ RADIO COLLECTORS & HISTORIANS OF GREATER ST. LOUIS - MEETING**

Kirkwood, MO - Kirkwood Community Center  
111 S. Geyer Rd., Room 201-A

7:30 pm - Meeting (earlier for conversation)  
Show & Tell, Swap Table

Info: Derek Cohn, 8141 Stratford Dr.,  
Clayton, MO 63105 - (314) 725-2333

### **ARKANSAS - Jan. 14**

#### **ARKANSAS ANTIQUE RADIO CLUB MEETING**

Little Rock, AR - Books A Million  
Markam & Bowman Rd.

7 pm

Info: Tom Burgess - (501) 455-0773

### **OHIO - Jan. 20**

#### **CENTRAL OHIO ANTIQUE RADIO ASSOC. MEETING**

Columbus, OH - DeVry Institute of Tech.  
1350 Alum Creek Rd., I-70 Exit 103B

7:30 pm

Info: Chuck/Sue Davis - (614) 792-6237

### **NEW HAMPSHIRE - Jan. 23**

#### **NEW ENGLAND ANTIQUE RADIO CLUB SWAP MEET**

Nashua, NH - Resurrection Center  
Rt. 3 (Everett Turnpike) Exit 6  
1 1/2 miles West on Rt. 130, 449 Broad St.

7:30-8 am - Real Early Admission

8-9 am - Early Admission

9 am-1 pm - General Admission

Over 100 tables - 50/50 Raffle - Catered  
Old Equipment Contest

Reservations required to sell

Info: Gregg Thompson, PO Box 298  
Newtonville, MA 02160 - NEARC: (617) 923-2665

### **ALABAMA - Jan. 25**

#### **ALABAMA HISTORICAL RADIO SOCIETY MEETING**

Birmingham, AL - Homewood Public Library  
1721 Oxmoor Road - 7 pm

Info: Julian Brook, PO Box 130307,  
Birmingham, AL 35213 - (205) 879-1191

Although non-members are  
welcome at all events, joining  
may be required at some.  
Admission is charged at some.

## OHIO - Jan. 30

### CENTRAL OHIO ANTIQUE RADIO ASSOC. 6th ANNUAL CABIN FEVER INDOOR SWAP MEET

Columbus, OH - DeVry Institute  
1350 Alum Creek Dr. (Exit 103B off I-70)

7 am - Set Up  
8 am - Open to Public  
10 am - Silent Auction

Info: Barry Gould - (614) 777-8534  
Chuck Davis - (614) 792-6237

## CALIFORNIA - Feb. 20

### SO. CALIF. ANTIQUE RADIO SOCIETY INDOOR AUCTION

Van Nuys, CA - St. Andrews Lutheran  
Church, 15520 Sherman Way

7:30 am - Registration  
9 am - Preview/10 am - Auction  
Info: Dale Donaldson - (818) 839-3353 or  
Thurston Armstrong - (310) 822-8382

## PENNSYLVANIA - Feb. 6

### DELAWARE VALLEY HISTORIC RADIO CLUB SUPER WINTER MEET

Havertown, PA - Indoors at Grimes Center  
From PA Turnpike, I-476 or I-95

7 am

Info: DVHRC, PO Box 847, Haverstown,  
PA 19083; Bill Overbeck - (610) 789-8199

## INDIANA - Feb. 13

### INDIANA HISTORICAL RADIO SOCIETY WINTER MEET

Indianapolis, IN - Holiday Inn Southeast  
5120 Victory Ln. (I-465 at Emerson, Exit 52)

7:30 am

Info: Dr. Mike Clark (317) 738-4649 or  
Alex Whitaker - (317) 535-4174, after 6 pm

*Attend a radio event near you,  
learn, meet others in the hobby,  
and perhaps find an item or  
two for your collection!*

## MASSACHUSETTS - Feb. 21

### GREATER BOSTON ANTIQUE RADIO COLLECTORS - RADIO XXX

Westford, MA - Westford Regency Inn  
I-495, Exit 32; West on Rt. 113 for .4 mi.  
Same giant (6500 sq. ft.) and warm location!  
8 am-1 pm

Coffee, Doughnuts, Sandwiches, etc. avail.  
For hotel reservations: 800-543-7801 (in  
Mass. 800-543-7802) - Mention Radio XXX  
Seller Preregistration Suggested!

Info: A.R.C., PO Box 2,  
Carlisle, MA 01741 - (978) 371-0512  
E-mail: ARC@antiqueradio.com

## CALIFORNIA - Feb. 27-28

### VACUUM TUBE VALLEY SWAP MEET

Buena Park - Sequoia Conference Center  
7530 Orangethorpe Ave. - (714) 670-9252

Feb. 27: 7:30 am-4 pm - Class

Feb. 28: 9 am-2 pm - 2 Swap Meets  
(Tube, Audio & Hi-Fi or Record Collections)

Info: VTV, PO Box 691, Belmont, CA 94002  
(650) 631-6550 or triode@vacuumtube.com

## BUSINESS CARD ADS - \$53.00 FOR 3 MONTHS



**ELECTROMAGNETIC**  
RADIOS TUBES PARTS  
P.O. BOX 1258 STEPHEN SCHAUB  
PEORIA, IL. 61654-1258 309-681-8304

### Play Things of Past

Sales - Service - Restoration of vintage  
radios, tv's, jukeboxes and electronics.



#### Retail Sales Store

3552 W 105th S  
Cleveland, OH 44111  
216-251-3714  
Hours: 6-9PM Wed. 12-6PM Sat  
Other times by chance

#### Mail Address

Gary Schneider  
Play Things of Past  
9511 Sunrise Blvd., #J23  
Cleveland, Ohio 44133  
216-582-3044

784-9417

206-784-9417



### COSMOS TV

• Low Prices  
• TV Repair

• Quality Used TV's  
• Antique Radio Repair

Buy, Sell, Trade

Free Estimates  
784-9417

5919 15th Ave. N.W.  
Seattle, WA 98107



### STEINMETZ ELECTRONICS

7519 MAPLEWOOD AVENUE  
HAMMOND, INDIANA 46324  
YES! 'WE'RE STILL HERE'

TUBES:

schematics.

SASE for lists.

(219) 931-9316

**BUSINESS CARD ADS - \$53.00 FOR 3 MONTHS**

**TEST EQUIPMENT**

**BUY - SELL - TRADE**  
**PARTS-ACCESSORIES-CABLES**

**Boca Electro Magnetic Lab**  
21218-10 St. Andrews Blvd.  
Boca Raton, FL 33433  
(561) 750-8911

#10 SASE FOR OUR LATEST FLYER



Collector, Historian, Seeker of  
Stromberg-Carlson Radio Apparatus

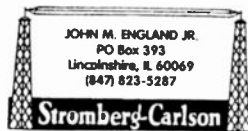

Entrepreneur: Art Moderne,  
Streamline, Machine Age Design

**78 RPM Cartridges  
Repaired**



Dead cartridges rebuilt  
right. New crystals etc., as needed. Allow 3-4 weeks. Most  
crystal and "horsehoe" magnet types ..... \$34.50  
100 hr. sapphire setscrew needles (list \$2.50 ea.) ... 4/\$5.50



Joe Smolksi  
835-A Pleasant Street  
Framingham, MA 01701

Inquiries: (508) 879-2778,  
evenings and weekends.  
Prices include return  
postage. Please include  
payment with order.

Replacements • Reproductions • Radio • Stereo • Ham • Auto • OEM

**Antique Radio  
DIAL SCALES**

Send an SASE for brochure and list

Rock-Sea Enterprises  
323 E. Matilija St. #110-241  
Ojai, CA 93023

Mike Tobin  
(805) 646-7362  
dials @ juno.com

<http://members.aol.com/RockSeaEnt/>

**WANTED TO BUY CRT'S**

**5BP4, 1802-P4, ETC.**

800-331-8478 or E-mail: [bhagen@msn.com](mailto:bhagen@msn.com)

**ANTIQUÉ ELECTRONIC REPAIR**

Radios ■ Hi Fi ■ Jukeboxes  
Television ■ Test Equipment  
...and other neat old stuff

since 1976

Mike Zuccaro  
619 271-8294

8795 Corvus Pl  
San Diego, CA 92126

member MAPS

*"The Early Sound Man"*

Mr. John P. Andolina, Jr.

*Antique Phonographs*



NEEDLES  
springs-  
rebuids

Collect • Repair • Restore  
Edison, Victor, Columbia  
Cylinder • Disc Records  
Phonograph Advertising  
Quality Repairs Since 1973



Satisfaction  
guaranteed.



(716) 247-3056

\* Reasonable prices

28 GLEN OAKS DR  
ROCHESTER, NY 14624 Prompt Service



*Tom's Antique Radio & TV*

REPAIRS & RESTORATION ON ALL  
PRE-1960's — RADIOS & TV's  
ANY MAKE OR MODEL  
2 WEEK TURNOVER

THOMAS ROMANO  
508-865-6293

8 HOWE LANE  
MILLBURY, MA 01527

**Wanted**

★★★★★★★★



TV GUIDES, newspaper TV maga-  
zines, 1948-1997. Highest prices paid.



*TV GUIDE  
Specialists*

BOX 20  
MACOMB, IL 61455  
(309) 833-1809

**GEORGE H. FATHAUER**

DEALER IN COLLECTOR TUBES

REPAIR OF RADIOS, HI-FI AND TEST EQUIPMENT  
HEWLETT-PACKARD AND TEKTRONIX LAB.  
EQUIPMENT USED FOR TEST AND ALIGNMENT

PHONE 602/921-9961  
FAX 602/921-9957  
e-mail [fathauer@home.com](mailto:fathauer@home.com)

688 W. FIRST ST. STE 4  
TEMPE, AZ 85281  
<http://members.home.net/fathauer>



**Modern Radio Laboratories**  
Since 1932

Crystal Set and One Tube Radio Instructions. Exclusive source,  
printing and publishing of all MRL Handbooks & literature by  
Elmer G. Osterhoudt. Tested instructions and plans.

Catalog \$2.00 ppd.

MODERN RADIO LABS  
P.O. Box 14902-T  
Minneapolis, MN 55414-0902

**TUBES WANTED**

**I pay cash or trade for  
transmitting or special  
purpose tubes**

Mike Forman  
1472 Macarthur Blvd.  
Oakland, CA 94602

(510) 530-8840  
Fax (510) 530-0858

## BUSINESS CARD ADS - \$53.00 FOR 3 MONTHS

### BETA-TEK ANTIQUE RADIO SERVICE



- Quality Repair and Restoration of Radios & Communications Sets
- Power Supplies for Battery Radios

**RAY BINTLIFF**  
2 Powder Horn Lane  
Acton, MA 01720  
**978 263-7435**



(708) 383-1848  
BY APPOINTMENT

DO YOU HAVE  
A PROBLEM RADIO ?

### THE OLD RADIO SHOP

SERVICE OF VACUUM TUBE ELECTRONICS  
SCHEMATIC DIAGRAM SERVICE  
RESTORATION OR REPAIR • FREE ESTIMATES

ED HUEYER

1025 ERIE ST  
OAK PARK, IL 60302

**Vintage Electronics**

**Phono**  
*Cartridges/Needles*  
*Center Post/Idlers*  
**45 Adaptors**

128 Buccaneer Drive  
Hattiesburg, MS 39402      Ed Crockett      Phone (601) 264-4755  
Fax (601) 264-0226

### THE TUBE SHOP

"Your one stop for new old-stock tubes"



Box 231160, Boston, MA 02123-1160  
phone: 617-369-0980    fax: 617-262-0148  
e-mail: tubeshop@quik.com  
Hi-Fi, antique radio, amateur radio, guitar amps, jukeboxes

### ANTIQUE ELECTRONIC RESTORATION

35 Years Experience  
Radios • Juke Boxes • Vintage TV's  
Repair • Buy • Sell  
Complete Restorations • Auto and Home • Prompt Service



### COOPERS'S RADIO SERVICE

425 Court Street  
Rockwell City Iowa 50579

**LARRY COOPER**  
712-297-7232

### Old Time Replications

"TURN TO US WHEN YOU NEED KNOBS"  
KNOBS • PUSHBUTTONS • ESCUTCHEONS  
PLASTIC GRILLS • HANLES

**LARRY BORDONARO**  
5744 "OBIAIS AVE. VAN NUYS, CA 91411  
PHONE (818) 786-2500 • FAX (818) 909-0241

### VINTAGE RADIO SERVICES

Ken Hubbard  
KA9WRN

P.O. Box 792  
Beloit, WI 53512-0792  
(608) 362-1896  
6 pm Evenings

Repair of  
Tube and  
Transistor Radios

Home-Auto

### PHILCO PREDICTAS WANTED:

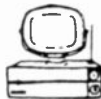

BUY • SELL • TRADE • RENT • RESTORE  
APPRAISALS / LECTURES GIVEN

DAVID WEDDINGTON  
(615) 890-7498

2702 Albany Ct.  
Murfreesboro, TN 37129

### CONCERTONE

#### WANTED

- Reel to reel tape recorders (any condition)
    - Sales brochures
  - Dealer display material and related items
- Contact Stuart Dunis

18095 Westview Dr. Lake Oswego, OR 97034  
(503) 638-3322/638-5823 anytime

Free Estimates  
Hrs : 9 AM - 5 PM EST  
Tues - Sat

Tel / Fax (860) 928-2628  
E-Mail radiodoc@nwa.com  
<http://www.neca.com/~radiodoc/>



BOB ESLINGER

### ANTIQUE RADIO RESTORATION & REPAIR

1920 - 1960's

*Buy or Sell*

Reasonable Rates, Tubes, Professional  
Overhauls, Cabinet Refinishing Service  
For All Antique Car, Table & Console  
Radios, Communication Receivers &  
Tube Amplifiers

20 Gary School Road  
Pomfret Center, CT 06259

### WANTED ! JAPANESE MILITARIA

any kind of WW-2 Japanese hardware - aircraft instruments  
radios, optics, etc .

### Takashi Doi

Fax : 011-8145-301-8069

E-Mail : [taka-doi@kk.iij4u.or.jp](mailto:taka-doi@kk.iij4u.or.jp)

I-21-4 Minamidai, Seyaku, Yokohama, 246 Japan.



### ANTIQUE RADIO REPAIR

**FRANK A. JOHNSON**  
530 ELFORD ROAD  
FAIRLESS HILLS, PA 19030  
(215) 943-8295

- ◆ VACUUM TUBE RADIOS ONLY
- ◆ BUY, SELL, RESTORE

## BUSINESS CARD ADS - \$53.00 FOR 3 MONTHS



**WAVES**  
ANTIQUE  
EARLY RADIOS  
&  
PHONOGRAPHS  
BOUGHT • SOLD  
RENTALS • REPAIRS

MON-FRI 12-6  
SAT-SUN 10-6  
FAX 201-461-7121  
e-mail: c1waves@aol.com  
www.wavesradio.com

110 W 25TH ST., NY, NY 10001 SUITE 1005 212 669-9264  
PROPRIETORS Bruce and Charlotte Mager

## We Buy and Sell Radios Great Northern Antiques

Free catalog of apparel, reproduction parts, grille cloth, owners manual reprints, dial belt kits, reproduction knobs, and Zenith Radio Brochure Book

**Alan Jespersion, 5200 Bloomington Ave. So.,  
Minneapolis, Minnesota 55417**

(612) 727-2489 • 8AM to 6PM • Fax (612) 727-1908



### THE RADIO MAN

Buy-Sell-Trade  
Antique Radios • Tubes • Parts

DICK MORGAN  
RES: (972) 564-6464

P.O. BOX 461485  
GARLAND TX 75046-1485

TEL: (972) 276-5458  
FAX: (972) 272-1831

• GRUNDIG • SABA • TELEFONEN • NORDMEND • PHILIPS • SIEMENS •  
- SPECIALIZING IN REPAIR OF EUROPEAN RADIO SETS -

## The Bavarian Radio Works

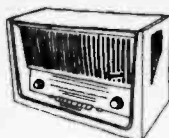

ROSS A. HOCHSTRASSER  
(781) 447-4299

162 BELLEVUE ST.  
WHITMAN, MA 02382

Crystal Radios  
Reproductions • Kits • Parts  
Send for Free Catalog

### RogRadCo

[www.crystalrad.com](http://www.crystalrad.com)

PO Box 813

Dearborn Heights, MI

48127

Phone:

313-561-1421

36 years experience

### Jackson Speaker Service

*Expert Antique Loudspeaker Repairs  
(Cone Types) And Reconing A Speciality.  
Speaker Parts And Repair Service On  
Virtually Any Speaker Made Including  
Stereo, P.A., And Antique Auto Speakers.*

217 Crestbrook Dr. Owner  
Jackson, Mich. 49203 Ron McGee

Ph. - (517) 789-6400, Ans. 4th ring  
Wk-days 10am-7pm Wk-ends 9-5pm



### CRYSTAL SETS

PARTS - PLANS - KITS - BOOKS  
CATALOG \$2.00

Largest source of Vintage and New Variable Air Condensers, Variometers, Vario-Couplers, Tap Switches, Tap Points, Galena and Germanium Detectors, Detector Stands, Cat Whiskers, Terminals, Sliders, Headsets, Dial Knobs, Coil Forms, Magnetic Wire, etc.

**MIDCO**  
P.O. Box 222288  
Hollywood, FL 33022  
(954) 925-3670  
B.A. Turso, Ph.D.E.E.



If you buy, sell or like Jukeboxes you need **ALWAYS JUKIN--THE MONTHLY JUKEBOX MAGAZINE!** Subscribers in 25 countries, **ALWAYS JUKIN LEADS THE WAY:** Articles, photos, show reports, ads, new products, price guides, restoration tips, repairs--everything you need to know about **JUKEBOXES--the fastest appreciating collectible in the world!!! Fun & a great investment.** Sample Copy, \$3. \$36 per year.

**ALWAYS JUKIN, 1952 1st Ave. S, Ste. #6AR, Seattle, WA 98134. (206) 652-4005. Fax (206) 652-4007 Master/Visa OK**

## LOGANS RADIO SERVICE

412-837-5580

**BUY • SELL • TRADE • WHEEL AND DEAL**  
N.O.S. BLACK/WHITE PICTURE TUBES

40's-70's

**FOR SALE, CALL OR WRITE**

PARTS, TUBES, SCHEMATICS FOR SALE

SCHEMATIC SERVICE - \$2.50 EA.

SERVICE AND RESTORATION SINCE 1952

**REAR 526 Mt. Pleasant St., Greensburg, PA 15601**

## CAPACITORS - TUBES RADIO SERVICE ITEMS

Thousands in jam-packed illustrated  
24-page catalog No. 49

**INFORMATIVE  
INTERESTING  
FUN-TO-READ**

Send \$3 U.S./Canada  
\$5 overseas (U.S. funds)  
for a Heavy-Paper limited  
edition copy NOW!

DON DIERS 4276 North 50 St. Dept. AB9  
Milwaukee, WI 53216-1313

### Authentic Dial Reproductions

Top quality material & workmanship. Finish your restoration with best dial available. Satisfied customers world-wide. A-K to Zenith. These are not copy machine plastic laminates. Telephone consultations welcome.

ANTIQUE RADIO RESTORATIONS  
109 So. Oak St.  
O'FALLON, IL 62269  
618-632-7423

Life Member I.E.E.E.  
AWA, ARCA, ARCI, MAARC

Clinton Blais, P.E.

## RADIO BOOKS FOR SALE

Large selection of books on Radio and Related Technology

Call or write for our List of Catalogs.

Always buying, single items or collections.

Visit our web site: <http://adam.cheshire.net/~rainyday>

### RAINY DAY BOOKS

**P.O. BOX 775, FITZWILLIAM NH 03447**

**(603)-585-3448**

**BUSINESS CARD ADS - \$53.00 FOR 3 MONTHS**

**Antique Radios**



David & Nancy Snow  
P.O. Box 6352  
Jackson, MI 49204  
(517) 787-2985

We Buy, Sell, Repair  
ARBE - III Battery Eliminators

**ANTIQUE RADIO REPAIR**  
*Repair - Restore - Buy & Sell*

Schematic Service  
Radios \$2.<sup>50</sup>, TVs \$4.<sup>50</sup>

**DAMASKE ELECTRONICS**  
574-W16834 Janesville Road  
Muskego, WI 53150  
Phone: (414) 679-0838



K4GIT

1298 S.E. 5th Ave.  
Melrose, FL 32666  
E-mail: tubes@mindspring.com  
http://www.vacuumtubes.net

**FOR SALE:** Just released, Flyer 198.

For details send 2-stamp LSASE  
for 20-page flyer to:

**Old Tyme Radio Company**  
2445 Lyttonville Road, Suite 317  
Silver Spring, MD 20910

Fax/phone: (301) 587-5280  
Fax anytime, phone 10 am-10 pm local time  
E-mail: oldtymradio@juno.com

**RADIO ELECTRIC SUPPLY**

We Specialize In Receiving and Special Purpose Tubes

Send For Price List

Dorothy and Don Gies Owners  
352-475-1950  
Phone or Fax

Phono Needles/Style  
1500 Types  
Magnetic - Ceramic -  
Crystal Cartridges



Rebuild Astatic  
and All Types  
of Crystal Ceram-  
ic Cartridges



*West-Tech Services*

643 N. Ridgewood Dr #2  
P.O. Box 1415  
Sebring FL 33871

Rebuild Obsolete Idlers  
New Idlers and Belts  
Fabricate 78 RPM Needles

STEVE KARPIAK C E T  
Phone (941) 471-0922  
Fax (941) 471-3817

**IN SOUTHERN CALIFORNIA  
GA RADIO SERVICE**

**TUBE - TRANSISTOR - LSI**  
SINCE 1950

**SPECIALISTS IN COLLECTOR CAR RADIOS**  
PHONE/FAX 760-741-9660

140 N. ANDREASEN,  
ESCONDIDO, CA 92029

**SPY EQUIPMENT  
WANTED!**

- Code Machines
- Secret Radios
- Clandestine Weapons
- Secret Cameras
- OSS, SOE, CIA, KGB!
- I Buy or Trade!

Keith Melton

880 Jupiter Park Dr., Suite 5, Jupiter, FL 33458  
(561) 743-1143 Days Fax (561) 743-7504  
E-mail: hkmelton@adelphia.net



"The Home of Mr. Happy Amp"

**PR NOVELTY**

Vacuum Tube Audio Specialists  
Amplifier Rebuilding • Service  
Spare Parts Brokerage  
(New, Old Stock and Used)

Paul Dorobalski: Audio Technician  
Robin Richards: General Manager

P.O. Box 140 • Miltonville • WI 53021  
Office 414 964 3392  
Cellular 414 840 8812

RADIOS &  
STRANGE  
MISCELLANEA

IF YOU VISIT THE BRIMFIELD FLEA MARKET...  
STOP BY FIRST!

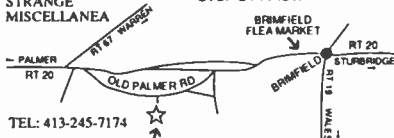

TEL: 413-245-7174

COUNTRY ROAD BARN - BERNIE SAMEK  
OLD PALMER ROAD, BRIMFIELD, MASS.



**ESTES AUCTIONS**

Specializing in Vintage Radios

7414 Ryan Rd  
Medina, Ohio 44256

Bus Phone 330-769-4992  
Fax 330-769-4116  
Res Phone 330-769-3987

**WANTED**

PRE 1900  
**ELECTRICITY**  
MEDICAL • X-RAY  
TELEGRAPHY • TELEPHONE  
PRE 1925  
RADIO • WIRELESS  
PRE 1940  
TELEVISION



**NEW WIRELESS  
PIONEERS**  
P.O. BOX 396  
ELMA, NY 14059  
716 681 3795  
FAX 716-681-4540

BOOKS • TUBES • ARTIFACTS  
MAGAZINES • AUTOGRAPHS  
CATALOGS • EPHEMERA

FRED GORDON

Fred's  
OLD RADIO REPAIR • HOME • CAR

221 North Commerce  
Corsicana, TX 75110

Bus 903-874-4531  
Home 903-874-7147

# Radios

of the Baby Boom Era

Six Volumes — 2000 pages — From Sams' Archives  
 1946 to 1960 — 274 Brands — 3494 Illustrations (B&W)  
 6769 Models — Catalin, Bakelite, Wood, Transistor Radios & More

**All Volumes Available!**

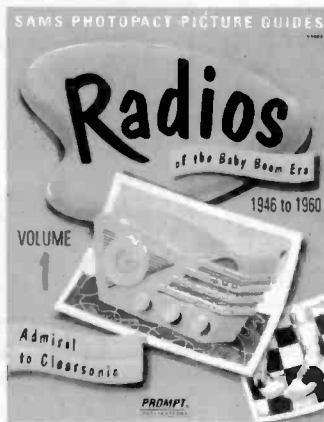

Vol.	Brands	Included
1	56	Admiral to Clearsonic
2	54	Co-op to Geloso
3	58	GE to Monitoradio
4	36	Motorola to RCA Victor
5	35	Realtone to Stratovox
6	35	Stromberg-Carlson to Zenith

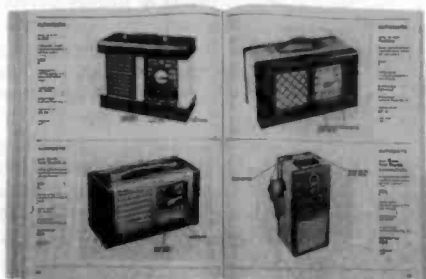

## 1/2 Page for each illustrated radio including:

- Large illustration of the radio including knob functions
- Short description of the radio
- Number of tubes
- Power supply type (AC, Battery, etc.)
- Tuning range
- Manufacturer
- Sams Photofact Set number & year Photofact published.

## ALSO

- Index by model number listing tubes in radio
- List of similar radio models indexed to pictured radio
- List of manufacturers and suppliers indicating their brand names
- Basic trouble-shooting hints

**Each Volume: \$16.95 – Softcover**  
**8 1/2" x 11" – Approx. 328 pages**

*U.S. Orders - Enclose \$3.00 per order for packing & book-rate shipping if total order is under \$35.00. If using VISA or MasterCard, include name on card, card number and expiration date. Send payment with order. Mass. residents add 5% sales tax. Money back return policy. Softcover unless stated otherwise. Most orders shipped the same day received, but allow 2-4 weeks to receive order. Foreign orders - write for shipping costs, or use credit card and specify air or surface (allow 2-3 months for surface shipping).*



**A.R.C., P.O. Box 2, Carlisle, MA 01741. Tel: (978) 371-0512**

**Fax: (978) 371-7129 – E-mail: ARC@antiqueradio.com – Web: www.antiqueradio.com**



(Jul-98)



# Radio Manufacturers of the 1920's

BY ALAN DOUGLAS



*"The definitive book on American broadcast receivers of the 1920s"*

**Volume 1:** A-C Dayton - Adams Morgan - Air-Way - All-American Mohawk - American Bosch - Amrad - Amrad S-Tube - Apex - Atwater Kent - Bremer Tully - Browning-Drake - Clapp-Eastham - Crosley - Cutting & Washington - Day-Fan - DeForest - Eagle - ERLA - FADA - Federal - Ferguson. 225 Pages.

**Volume 1: \$24.95 - Softcover Only**

**Volume 2:** Freed-Eisemann - Eisemann - Freshman - Garod - Gilfillan - Grebe - Howard - Jones (Lester/Melco) - Jones (Jos.) - Kellogg - Kennedy - King - Kodel - Kolster - Leutz - Magnavox - Majestic - Marti - Metro - Klitzen/Michigan - Midwest - Mu-Rad - Murdock - Music Master - Neutrowound - Operadio - Ozarka - Pfanstiehl - Philco - Pilot - Priess. 266 Pages.

**Volume 2: \$29.95 - Softcover Only**

**Volume 3:** RCA - Scott - Silver-Marshall - Slagle - Sleeper - Sonora - Sparton - Splitdorf - Steinite - Stewart-Warner - Stromberg-Carlson - Thermodyne - R.E. Thompson - Thorola - Tri-City - C. D. Tuska - Ware - Western Coil - Western Electric - Workrite - Zenith. 292 Pages.

**Volume 3: \$29.95 - Softcover  
\$39.95 - Hardcover**

*U.S. Orders - Enclose \$3.00 per order for packing & book-rate shipping if total order is under \$35.00. If using VISA or MasterCard, include name on card, card number and expiration date. Send payment with order. Mass. residents add 5% sales tax. Money back return policy. Softcover unless stated otherwise. Most orders shipped the same day received, but allow 2-4 weeks to receive order. Foreign orders - write for shipping costs, or use credit card and specify air or surface (allow 2-3 months for surface shipping).*



**A.R.C., P.O. Box 2, Carlisle, MA 01741. Tel: (978) 371-0512**  
Fax: (978) 371-7129 - E-mail: [ARC@antiqueradio.com](mailto:ARC@antiqueradio.com) - Web: [www.antiqueradio.com](http://www.antiqueradio.com)



(Jul-98)

# CRYSTAL CLEAR

By Maurice L. Sievers

## Volume 1

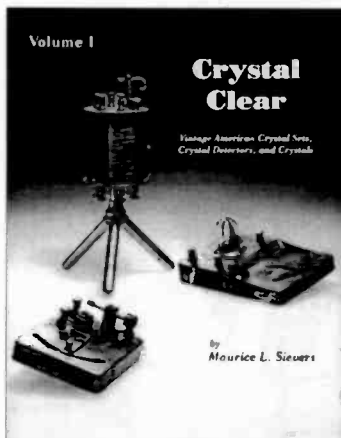

750 Illustrations – 570 Crystal Sets  
341 Detectors – 207 Crystals  
Perfect for the beginning collector!  
Useful for the experienced too!

*Crystal Clear* is the most comprehensive reference for collectors, historians and anyone interested in early radio. In addition to the many excellent photos and reproductions of ads, *Crystal Clear* includes lists showing all sets by manufacturer, set name, selling price and date of manufacture. 8 1/2" x 11", 282 pages.

**\$29.95 – Softcover**

## Volume 2

*Crystal Clear, Vol. 2* supplements the first volume. It identifies an additional 172 crystal radio sets, 91 crystal detectors and 26 crystals by manufacturer, model, year produced, description and original selling price. Further research on many of the crystal sets covered in Volume 1. Detailed history on the Philmore Manufacturing Company and the Western Manufacturing Company. 8 1/2" x 11", 252 pages.

**\$29.95 – Softcover**

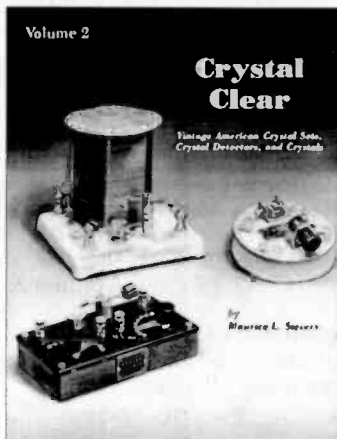

*U.S. Orders - Enclose \$3.00 per order for packing & book-rate shipping if total order is under \$35.00. If using VISA or MasterCard, include name on card, card number and expiration date. Send payment with order. Mass. residents add 5% sales tax. Money back return policy. Softcover unless stated otherwise. Most orders shipped the same day received, but allow 2-4 weeks to receive order. Foreign orders - write for shipping costs, or use credit card and specify air or surface (allow 2-3 months for surface shipping).*



**A.R.C., P.O. Box 2, Carlisle, MA 01741. Tel: (978) 371-0512**

**Fax: (978) 371-7129 – E-mail: [ARC@antiqueradio.com](mailto:ARC@antiqueradio.com) – Web: [www.antiqueradio.com](http://www.antiqueradio.com)**



(Jul-98)

# Zenith Transistor Radios Evolution of a Classic

By Norman Smith



**NEW!  
Order  
Today!**

**Includes all Zenith Transistor Radio Models  
from 1955 through 1965**

**200+ Color Photographs — Price Guide**

**Photographs, Documents & Original Drawings  
from Zenith Archives**

**\$29.95 - Softcover**

*U.S. Orders - Enclose \$3.00 per order for packing & book-rate shipping if total order is under \$35.00. If using VISA or MasterCard, include name on card, card number and expiration date. Send payment with order. Mass. residents add 5% sales tax. Money back return policy. Softcover unless stated otherwise. Most orders shipped the same day received, but allow 2-4 weeks to receive order. Foreign orders - write for shipping costs, or use credit card and specify air or surface (allow 2-3 months for surface shipping).*



**A.R.C., P.O. Box 2, Carlisle, MA 01741. Tel: (978) 371-0512**

**Fax: (978) 371-7\*29 - E-mail: ARC@antiqueradio.com - Web: www.antiqueradio.com**



(Jul-98)

# COLLECTOR BOOKS AVAILABLE FROM A.R.C.

☞ BOOKS MARKED WITH "☞" ARE THE MOST POPULAR AND ARE ESPECIALLY RECOMMENDED FOR NEW COLLECTORS!

- Antique Radio Restoration Guide, 2nd Ed., Johnson. *Beginner's introduction to troubleshooting and repairing AC table model radios.* 1992. 145 pgs. \$14.95
- The AWA Review. *Collections of articles.* Vol. 6: Hawaiian Wireless, U.K. TV, SCR-RC-BC Dir., NYC Wireless, etc. Vol. 7: Polihu xmitters, Navy equipment, Arc xmitters. Vol. 8: Keys, Federal Co., KFS-Federal-Mackay story, Nat'l Electrical Supply Co., Navy Electronics Dir., etc. Vol. 6-8, ea. \$10.00
- Vol. 9: Marconi, The Int'l Contest for Radar, Magnetron Story, F. Lowenstein, Ham Licensing. Vol. 10: Atwater Kent, Race for Radiotelephone, Radio Central 75th Anniversary, The Heintz and Kaufman Story, Collins Radio Co. Vol. 11: Scott Radio Products, National sliding coil receivers. Vol. 9-11, ea. \$20.00
- The Antique Radio Boys and the Garrulous Grebe, Dryer. *Thrilling adventure story written in the traditions of the '20s and '30s.* 5 1/2" by 8 1/2". 51 pgs. \$4.95
- The Auto Radio, Matteson. *Info, photos & ads of the auto radio through the 1950s.* 316 pgs. (hardcover) \$34.95
- Audio! Audio!, Hill. *A comprehensive directory of classic audio amplifiers and control units. Details of over 850 models from nearly 150 British manufacturers from the 1940s to the 1970s. Signed and numbered.* 95 pgs. \$19.95
- Behind the Front Panel, Rutland. *Reviews radio circuits and radio history. Easy descriptions.* 25 pics. 158 pgs. \$18.95
- Blast from the Past, A Pictorial History of Radio's First 75 Years, Rhoades. *The performers, programs, & technology that made radio a part of everyday life. 100s of never-before-published photos.* (hardcover) \$39.95
- Classic TVs, 2nd Printing, Wood. *Prewar to 1950s. Revised price guide.* 140+ color photos, repros of catalogs & ads. 86 pgs. \$18.95
- ☞ The Collector's Guide to Antique Radios, 4th Ed., Bunis. *This guide covers radios from 1920s to 1960s. Over 8,500 prices and many all new color photos are included.* 1996. \$18.95
- ☞ The Collector's Guide to Antique Radios, Combined Ed., CD-ROM, Bunis & Kaczowka. *Combines book editions 1, 2, 3, and 4. Over 9,000 Models with pricing. Model number index for all manufacturers, photo index by category.* 1,800 full color photos. Requires a web browser. IBM & Mac. 1998. NEW \$39.95
- The Collector's Guide to Novelty Radios, Bunis & Breed. *Descriptions with prices.* 600+ color photos. 1994. 224 pgs. \$18.95
- The Collector's Guide to Novelty Radios, Book II, Bunis & Breed. *New radios & prices.* 600+ color photos. 1998. NEW \$19.95
- The Collector's Guide to Transistor Radios, 2nd Ed., Bunis. *Identifies the most sought-after vintage transistor radios. Includes club listing. Over 2,900 models, 375 all new color photos, with current prices.* 1996. 320 pgs. \$16.95
- ☞ Communication Receivers, 4th Ed., Moore. *Information on 750, 1932 to 1981, vacuum tube receivers by 66 manufacturers.* 448 radios illustrated. 3 pages of military receivers. 136 pgs. \$19.95
- The Compleat Talking Machine, 2nd Ed., Reiss. *A guide to antique phonographs. Revised and expanded. Covers construction, cleaning and repairing of parts and cabinets.* Over 700 pictures. 236 pgs. \$29.95
- ☞ Crystal Clear - Vintage American Crystal Sets, Crystal Detectors and Crystals, Sievers. Vol. 1 - *Comprehensive reference with 750 illustrations, 570 crystal sets, 341 detectors, 207 crystals.* 282 pgs. \$29.95
- Vol. 2 - *479 All new & different illustrations, more crystal sets, detectors and crystals identified.* 252 pgs. \$29.95
- Crystal Radio: History, Fundamentals, and Design, Kinzie. *Plus crystals for detectors.* 121 pgs. \$10.95
- Crystal Set Building and More, The Xtal Set Society. *Projects and information about crystal radios, mostly dealing with design and electronics issues. Also included are Vols. 6 & 7 of the Xtal Set Society Newsletter.* \$15.95
- Crystal Set Projects: 15 Radio Projects You Can Build, The Xtal Set Society. 160 pgs. \$14.95
- E.H. Scott Radio Collectors Guide, 1925-1946, Clark. *The reference for collectors of Scott radios, cabinets and accessories. Lists original prices of cabinets and accessories. Over 200 photos with descriptions.* 88 pgs. \$29.95
- 1940 E.H. Scott Catalog, King. *Quality reproduction of the custom built receivers. Includes radios & cabinet illustrations.* \$12.95
- Early Radio, In Marconi's Footsteps, Jensen. *Realistic description of Marconi's work and his surroundings. Early construction projects with diagrams. Color and B&W photographs.* 170 pgs. (hardcover only) \$39.95
- Evolution of the Audio Recorder, Van Praag. *Comprehensive guide to the audio recorder.* 1997. 518 pgs. \$39.95
- Evolution of the Radio, L-W Books. *Radios pictured and priced, plus reproductions of catalog pages and ads.* Vol. 1 - *Eight-hundred + radios.* 1991. 227 pgs., 118 pgs. in color. \$22.95
- Vol. 2 - *Totally different from volume one with new photos, etc.* 1993. 654 color photos. 226 pgs. \$24.95
- ☞ Fixing Up Nice Old Radios, Romney. *Written by a retired radio instructor, this book covers Ohm's law, through battery sets, superhets and communications receivers.* 1990. 300+ figures, 185 pgs. \$29.00
- ☞ Flick of the Switch, McMahon. *The classic photo reference guide for '30s - '50s radios.* 1000+ photos. 263 pgs. \$11.95
- Genuine Plastic Radios of the Mid-Century, Jupp & Piña. *Overview of plastic table radios with advertisements, vintage black & white photos.* 439 color photos. 208 pgs. (hardcover) NEW \$39.95
- ☞ The Golden Age of Televisions, Collins. *Nice collection of photographs of these early machines* \$15.95
- ☞ Guide to Old Radios - Pointers, Pictures & Prices, 2nd Ed., Johnson. *Introduction to radio collecting. Includes hundreds of photos and a price guide.* 1995. 272 pgs. \$19.95
- Hake's Guide to TV Collectibles. *Price guide and photos for 1600 TV shows, comic books, etc.* 1990. 185 pgs. \$14.95
- Ham Price Guide, Rippen. *This book serves as a price guide and an identification guide.* Small print. 36 pgs. \$9.95
- ☞ Heathkit, A Guide to the Amateur Radio Products, Penson. *Documentation of all Heathkit's amateur radio products, a complete history of the company.* 200+ sharp photos. 256 pgs. \$24.95
- International Directory of Antique Radio Collectors. *Lists collectors, clubs, museums, dealers.* 1996. 92 pgs. \$14.95
- Inventing American Broadcasting, Douglas. *From the days of Marconi to broadcasting in the 1920s.* 1987. 363 pgs. \$14.95
- L. A. Radio Manufacturing, Paul. *Radio makers in L.A. from 1922-42. Echophone, Gilfillan & 10 others.* 88 pgs. \$11.90
- Supplement No. 1, Paul. *Coverage of additional manufacturers, people and sets.* 1993. 48 pgs. \$6.75
- The Magnetic Cone Speaker Notebook, Paul. *250+ cone speakers from 120+ companies. Photocopy.* 1995. 58 pgs. \$11.90
- The Mechanics of TV, Yanczer. *Explanation of mechanical tv, details for a working system.* 5 1/2" by 7 1/2", 170 pgs. \$24.95
- Most Often Needed 1926-38 Radio Diagrams and Servicing Information (reprint). *600+ diagrams for mostly AC radios from '26-'38.* 240 pgs. \$18.50
- Old Gramophones, Bergonzi. *The development of phonographs and gramophones.* 64 photos. 32 pgs. \$4.95
- Old Radio Sets, Hill. *The development of the radio from the late Victorian era until the late 60s.* 60 photos 32 pgs. \$4.95
- Old Television, Emmerson. *The development of the television until the late 60s.* 50 photos. 32 pgs. \$4.95
- ☞ Old-Time Radios! Restoration and Repair, Carr. *How to repair vacuum-tube and transistor radios. A self-paced training guide.* 200 illustrations. 256 pgs. \$19.95
- ☞ Philco Radio: 1928-1942, Ramirez. *A reference book on Philco. Shows receivers and company history year-by-year.* 464 color photos, 364 black & white photos and drawings. 1993. 160 pgs. \$29.95
- Phono-Graphics: The Visual Paraphernalia of the Talking Machine, Schwartzman. 119 pgs. \$16.95
- The Pocket Guide to Collins Amateur Radio Equipment 1946-1980, Miller. *90+ sharp photos.* 3 1/2" x 7". 108 pages. \$19.95
- Portable Radio In American Life, Schuffer. *Traces the development of the portable radio and how it affected American culture and society.* 450 photos and drawings, 259 pgs. (hardcover) \$45.00 \$26.95
- RCA Radiolas, Radiotrons, and Accessories (reprint). *Twenty-page booklet summarizing RCA's 1926 product line.* \$4.50

- Radio Art, Hawes.** A chronological, illustrated history of the technical and stylistic progress of the radio. Mostly British, but American sets are featured as well. 250 photos, 150 in color, 128 pgs. (hardcover only) Low Price \$9.95
- Radio Art Postcard Deck.** 30 full-color photographs from Hawes' book. \$7.50
- Radio Collector.** (Videotape, VHS). The five-part Emmy-nominated PBS series combined on one 130-minute videotape. Meet collectors, see collections, attend swap meets, learn about radio restoration. \$29.95
- The Radio Collector's Directory and Price Guide, 1921-1965, 2nd Ed., Grinder.** Directory of over 20,000 radios by manufacturer, model no., year, etc., with prices. Historical, cabinet styles, vacuum tube development chapters. 500 pgs. \$26.95
- The Radio Collector's Foto-Finder, Bintliff.** An alphabetical index to illustrations in the four editions of the "Collector's Guide to Antique Radios" by Marty & Sue Bunis. 1997. 48 pgs. \$12.95
- Radio Collector's Guide, McMahon.** Listing of 9,000+ radios made by some 1200 companies from 1921 to 1932. Gives manufacturer, year, model name and other info. No photos, 264 pgs. \$11.95
- Radio Diagram Sourcebook, Gray.** Valuable tool for identifying radios. Tubes used, replacement dial lamps, and I.F. frequency. Reprint of Sylvania's tube complement guide is included listing almost 10,000 radios. 290 pgs. \$18.95
- Radio Horn Speaker Encyclopedia, Paul.** Listing of horn speakers for 320+ manufacturers for the 1920s. Expanded info. on 10 companies. 145+ photos, 80 pgs. \$15.90
- Radio Horn Speaker Notebook, Rev. H. Paul.** The companion to the Encyclopedia. Over 450 horn picture ads are shown, over 325 manufacturers are identified. Photocopy. New Index. 1995. 72 pgs. \$16.90
- Radio Manufacturers of the 1920's, Douglas.** 3 volumes. Vol. 1: A-C Dayton thru Ferguson (softcover only) \$24.95  
Vol. 2: Freed-Eisemann thru Pries. 266 pgs. (softcover only) \$29.95  
Vol. 3: RCA thru Zenith. 292 pgs. (hardcover: \$39.95) \$29.95
- Radio! Radio!, 3rd Ed., Hill.** Comprehensive coverage of British radios from the 1920s-70s. This expanded edition includes the previous versions plus 75 new pages and 50 new illustrations. New transistor radio section. (hardcover only) \$64.95
- Radios by Hallcrafters, Dachs.** The most definitive book on the company. Over 600 photos (some color) on everything they made. An invaluable tool for anyone interested in Hallcrafters. 220 pgs. \$29.95
- Radios of the Baby Boom Era.** Pictures and info from Sams Photofacts. 3,494 radios illustrated plus 3,275 additional radios listed. 274 brands. 1946 - 1960. 300+ pages per volume. Vol. 1: Admiral - Clarsonic. Vol. 2: Co-op - Gelsco. Vol. 3: GE - Monitoradio. Vol. 4: Motorola - RCA. Vol. 5: Realtone - Stratovox. Vol. 6: Stromberg-Carlson - Zenith. (Per Vol.) \$16.95
- Radios: The Golden Age, Collins, (reprint).** Vintage table radios. 100+ color photos. 119 pgs. NEW \$12.98
- Rasco Radio Parts, (reprint).** Catalog No. 18 summarizing 1928's product line. 144 pgs. \$9.95
- Refinishing Old Furniture, Wagoner.** Written by a furniture restoration instructor. A step-by-step guide to furniture (or radio) restoration, from removal of finishes right up to the final polish. 178 pgs. \$14.95
- Saga of the Vacuum Tube, Tyne.** The development of vacuum tubes - 1880 to 1930. From Edison, Thomson and Fleming to de Forest, Philips, Siemens and many more. 100+ tube photos, 495 pgs. \$18.95
- Shortwave Receivers Past & Present, Communications Receivers 1942-1997, 3rd Ed., Osterman.** For the radio collector, the informed receiver buyer or anyone interested in the history of shortwave radios. 700+ receivers listed. 473 pgs. \$24.95
- S. Gernsback Radio Encyclopedia (reprint).** 1927 classic encyclopedia on radio. From "A" battery to Zirconium, with 1000s of entries in between. 100s of illustrations. 175 pgs. \$9.95
- 70 Years of Radio Tubes and Valves, 2nd Ed., Stokes.** The thermionic vacuum tube story from 1883 through 1960. New chapter on audio application tubes, more photos, magazine ads and a new index by tube number. 264 pgs. \$29.95
- 75 Years of WE Tube Manufacturing, Magers.** A log book history 750+ WE tubes. Illustrated. 133 pgs. \$16.95
- The Talking Machine, Fabrizio and Paul.** Contains over 550 photos of internal and external horn phonographs. The text and value guide, complemented with lots of visuals, make this book a must in your library. 256 pgs. (hardcover only) \$69.95
- Transistor Radios: 1954-1968, Smith.** Over 1,000 transistor radios identified by manufacturer, marketing organization, type, and style. Color photos and price guide. 1998. 160 pgs. NEW \$29.95
- Transistor Radios, A Collector's Encyclopedia and Price Guide, Lane.** Identification guide to over 2,500 transistor and novelty radios. History and key to collecting chapters. 1994. 170 pgs. \$19.95
- Transmitters, Exciters and Power Amplifiers 1930 - 1980, Moore.** Pictorial and descriptive guide to amateur high frequency transmitters and amplifiers manufactured in the U.S.A. Over 500 photos. 144 pgs. \$21.95
- Tube Data, Holm.** The most comprehensive list of vacuum tubes and data in an easy-to-use program for IBM compatibles. 27,000+ tubes, includes receiving and transmitting tubes. Lists function, manufacturer, technical data, & more. (3 1/2" disk). \$39.95
- Tube Lore, Sibley.** Trends in tube design, receiving and audio tubes, special-purpose and transmitting tubes, military types, tips on testing, repairing, adapting various tubes, auction prices from six major sales. 186 pgs. \$19.95
- Tube Type Transmitters, Rippen.** Provides a wealth of info on transmitters and transceivers. Includes ancillary items such as linear amplifiers, converters, modulators and VFOs. Over 500 illustrations. 145 pgs. \$17.95
- The Weekend Finisher, Johnson.** A complete guide to stains and finishes and tips for setting up your own workshop. A handy furniture "first aid" kit for quick repairs. Illustrated. 296 pgs. \$12.00
- The Western Electric Loud Speaker and Horn Compendium, Nadel.** Vol. 2 in the Museum of Sound Series. 53+ Models covered. B&W illustrations. 58 pgs. NEW \$19.95
- Wireless Communication in the U.S., Mayes.** Early development of American radio operating companies. Alternators, coherers, stock promotions, unpublished letters, etc. 160 illustrations, 240 pgs. \$29.95
- The Xtal Set Society Newsletter, Anderson.** Complete set of the Society's newsletter. Order by volume. Vol. 1: 7/91 to 5/92 - Field Strength Meter, FM Xtal Set, Xtal Sets & Wireless, & more. Vol. 2: 7/92 to 5/93 - The Lead Pencil Detector, The Universal Xtal Set, etc. Vol. 1-2 \$9.95  
Vol. 4: 1/94 to 11/94 - Measuring Coil Capacitance, home-brew headphones and curce tracers, etc. Vol. 5: AM Receiver Design, Marconi Type 107, Radio Outfit in a Headset, & more. Vol. 4-5 \$10.95
- The Xtal Set Handbook, Anderson.** Formulas for coil inductance, a procedure for measuring coil capacitance, circuit matching theory, & more. Also included is Vol. 3 of the Xtal Set Society Newsletter. \$10.95
- Zenith The Early Years, 1919-1935, Bryant and Cones.** The 1st of a planned 3-book series. Explains the Zenith story. Discover never published photos, documents and info. 300 photos and illustrations, 120 in color. 224 pgs. \$29.95
- Zenith Radio Corporation (reprint).** The instructions for installation and operation for Models 39-39A Models 392-392A. \$4.50
- The Zenith Trans-Oceanic: The Royalty of Radios, Bryant and Cones.** Presents the fascinating story of the development and use of the Trans-Oceanic. Several photos, documents, ads, etc. 160 pgs. \$24.95
- Zenith Transistor Radios, Evolution of a Classic, Smith.** A complete listing of all transistor radio models created by Zenith during the "Magic Years" from 1955-65. Color photos and price guide, 1998. 160 pgs. NEW \$29.95

U.S. Orders - Enclose \$3.00 per order for packing & book-rate shipping if total order is under \$35.00. If using VISA or MasterCard, include name on card, card number and expiration date. Send payment with order. Mass. residents add 5% sales tax. Money back return policy. Softcover unless stated otherwise. Most orders shipped the same day received, but allow 2-4 weeks to receive order. Foreign orders - write for shipping costs, or use credit card and specify air or surface (allow 2-3 months for surface shipping).



**A.R.C., P.O. Box 2, Carlisle, MA 01741. Tel: (978) 371-0512**

**Fax: (978) 371-7129 — E-mail: ARC@antiqueradio.com — Web: www.antiqueradio.com**



Vintage TVs & radios



# HARRY POSTER

Stereo 3D & quality cameras

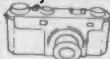

PO Box 1883 S.Hackensack, NJ 07606

hposter@harryposter.com

[FAX: (201)794-9553]

24 Hr Phone: (201)794-9606

For the Holidays: *PRESENTS* for yourself (or others)!



**FOR SALE: Crosley with New, Color TV!** Ready for the Holidays, this set is an original 1948 vintage television--with a modern color TV (with remote control) inside! This and about 20 other conversions are listed on our site! **Color-Crosley \$495**

[www.harryposter.com](http://www.harryposter.com)



**FOR SALE: 7" Crosley 9-425.** This early "portable" features a handle and lid, but it's heavy! As found, with back, knobs and trim, but the fabric is ripped in a few spots and the handle is broken. **\$184**

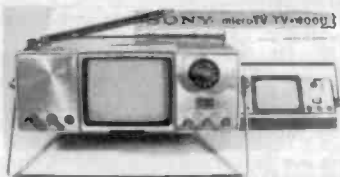

**FOR SALE: SONY TV-400.** This B&W Mini-TV from 1978 comes in the original packaging-but I spotted 2 flaws. The antenna tip is broken off and the battery compartment has damage from old, leaky batteries. Includes original booklet **\$57**

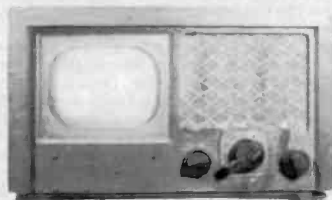

**FOR SALE: Admiral 7" Wooden TV!** This 7" wooden television is from 1948, and it's Model 19A15S. There are some marks and stains on the wood, but it's in good condition, with back. **\$168**

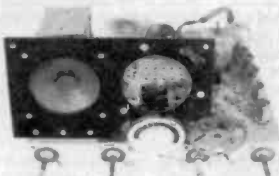

**FOR SALE: Pilot TV-37 Chassis!** We have several extra chassis from the 3" Pilot TV set, clean, complete, restored and working. Available:

**Working (you supply the CRT) ... \$211**

**Working with white 3" CRT ..... \$307**

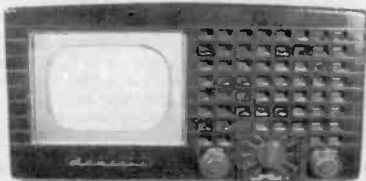

**FOR SALE: Admiral BAKELITE 19A11SN.** This 7" brown bakelite television, circa 1949, is as found but in very good condition. No chips or breaks, it's nice and will make a great display! Only **\$166**

## WANTED VINTAGE TVs!!!

**TYPICAL 10" TVs...**we need 10" table top television sets from the 1940s. Very clean cabinets--but we can use them regardless of chassis/CRT condition--even empty cases!  
**Paying \$25-\$200 each!!**

**15" COLOR TVs, pre 1956.** We buy color sets with 15" and 16" round CRTs! Clean and complete, but need not work. Also: color wheels and adapters, plus color drums--even literature!  
**Paying up to \$2,000!**

**WANTED: SONY 13" and 20" TVs.** We need some modern Sony televisions to replace a display. Model numbers are: 13M10, 20M10 and 20S10 (model number must end in "10").  
**PAYING \$175-\$300 each!**

**WANTED: Hotpoint and GE 14" Metal portables.** We need these metal portable TV sets from the 1950s, and they need not work! (Most of the model numbers start with "14")  
**PAYING \$50 each!**

# CLASSIFIED ADVERTISING POLICY

**ONE FREE 20-WORD AD** for subscribers in each issue; additional words are 29¢ each. See details below. Classified ads sent by mail, fax, e-mail or by any other method must be received (not just postmarked!) by **Noon Eastern Time** on the classified ad deadline date to guarantee inclusion in the current issue. Late ads are held for the following issue. Please enclose correct payment with all ads. Stamps or cash are OK for small amounts. (Canadian and other foreign advertisers, please see "Payment" on page 2 for methods.) "Free words" cannot be accumulated from month to month; free words must be requested when ad is submitted.

**Faxed & e-mailed ads: Please see additional information on the inside front cover.**

When including ads with other A.R.C. correspondence, write the ads on a separate piece of paper. Include SUB# with ad. Ads may be sent in advance; but, write each ad on a separate piece of paper and indicate the month (or successive two months) you want the ad to run.

To minimize our typing errors: Please write legibly. Use both capital and small letters. Do not use a dash between words. Carefully write the following numbers and letters (especially in model numbers) since some can look alike; for example 1, I and l (the number one, the capital i and the small L.) Also: 0, O, o, Q and D; r and n; 6, b and G; V, U, u, v and Y; A and R; 5, S and s; 2, Z and z. We try to correct spelling errors, so when using an uncommon word or manufacturer which we might mistake as a more common word or manufacturer, note it so that we do not "correct" it. Editor's annotations are in [brackets].

Advertising is accepted only for early items related to radio, communication, etc. All items must be described fairly; reproductions, reprints and non-original items must be so identified. Advertisers must agree to respond promptly to inquiries and orders, to resolve problems promptly if the buyer is not satisfied, and to comply with a buyer's refund request on unaltered returned items.

The publisher reserves the right to edit ads without notification to the advertiser and to reject ads for any reason. Names other than the advertiser will be edited out of ads. Ads with non-radio-related items will be returned or edited unless the non-radio-related items are for trade of radio-related items, or they are incidental to and appear at the end of an otherwise acceptable ad. The publisher is not responsible for errors due to illegibly written ads or for any other reason. See also Publishing Rights on page 2.

**Clubs:** Since club activities receive free coverage on the *Coming Radio Events* pages, the free 20 words may not be used for club activity ads. A discount on display advertising is available for clubs.

## CLASSIFIED AD DETAILS

### Deadline: NOON ET—10th of the month!

Classified ads must have a standard heading such as **WANTED, FOR SALE, FOR TRADE, FOR SALE/TRADE, SERVICES, MESSAGE, HELP, AUCTION, MEET**, etc. This heading is the only bold or all-capitalized words allowed in the ad. Capitalize only manufacturer names, model names, etc. This standard ad format makes scanning the ads easier.

Before writing your ad, please look over the ads in a recent issue of A.R.C., and try to write your ad in the same style. Full name (or company name) and address is required in all classified ads; we will add it if you forget.

To encourage varied content of the ads, the same classified ad may be run only once per issue and for only two consecutive months. (To run an ad longer, use a boxed classified or display ad.)

### Classified Ad Rates per Month

#### Subscribers:

First 20 words: **FREE\***

29¢ per word for extra words over 20 **plus**

10¢ per word for a shaded ad (count all words including free words).

\* Subscribers may take 20 free words on only **one** ad each month.

#### Non-Subscribers:

47¢ per word **plus**

10¢ per word for shaded ad.

Please do not forget to send in the extra 29¢ per word when your classified ad runs over the free 20 words; your payment will be appreciated, and it will help to keep A.R.C. healthy.

## BOXED CLASSIFIED AD DETAILS

### Deadline: 1st of the month!

Boxed classified ads can run unchanged for three months or more. No words are free. Ads may be shaded and may include bold and all-capitalized words freely. The ad need not begin with "For Sale," etc. Minimum run is 3 months, prepaid. Discount: 10% for 6 months; 20% for 12 months.

### Boxed Classified Ad Rates per Month

Nonshaded ads:

40¢ per word for all words,\* none free, **plus**

10¢ per word for each bold word **plus**

10¢ per word for each all-caps word.

Shaded Ads (All words are bold at no charge):

50¢ per word for all words\* **plus**

10¢ per word for each all-caps word.

Non-Subscribers:

Add 20¢ per word to above costs.

\*Three words can be bold-all-caps at no extra charge.

## PHOTO & DRAWING DETAILS

### Deadline: 1st of the month

#### for all ads with drawings or photos!

Drawings and photos are encouraged as the response to your ad is much larger and the reader knows better what you want or are selling. Send in your drawing or photograph, and A.R.C. will reduce it or enlarge it as needed.

### Photo and Drawing Rates per Month

\$23.00 per month for each photo or drawing

(If ad is canceled, this amount cannot always be refunded.)

## CHANGES & CANCELLATIONS

Please check your ads carefully before sending them in. Once ads are received, it is not always possible to refund the amount sent, pull the ad or make changes.

## IMPORTANT — COUNTING WORDS — IMPORTANT

The standard headings: **WANTED, FOR SALE**, etc., count as **one word** each time used in an ad. **Name, address** and (one) **telephone number**, count as **6 words**, regardless of length. Ham call letters and business name can be included in the 6 words and do not count extra. Full name (or company name) and address is required in all classified ads. Each additional word, abbreviation, model number or number group, extra telephone numbers, fax, e-mail, etc. count as one word each. Hyphenated words count as two words.

PERIODICALS

ANTIQUE RADIO CLASSIFIED



A.R.C., P.O. Box 2, CARLISLE, MA 01741

ADDRESS SERVICE REQUESTED

89\*6\*\*\*\*\*ALL FOR ADC 780  
G-CI SUB#-27-777 EXP=APR99  
JOE W MCCLUGHAN

PO BOX 310465  
NEW BRAUNFELS TX 78131

**CLASSIFIED AD  
DEADLINE DEC. 10th  
Noon Eastern Time**