



ANTIQUE RADIO CLASSIFIED



VOLUME 14

JULY 1997

NUMBER 7

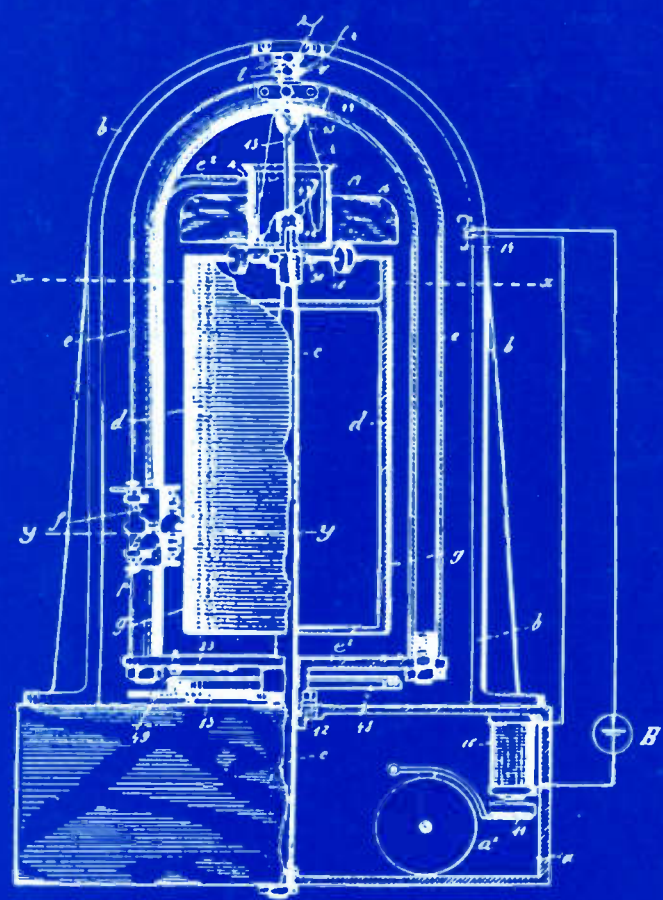

Poulsen's 1900 Telegraphone

A.R.C. — THE NATIONAL PUBLICATION FOR BUYERS AND SELLERS
OF OLD RADIOS AND RELATED ITEMS — PUBLISHED MONTHLY

ANTIQUE RADIO CLASSIFIED

Antique Radio Classified (ISSN: 8750-7471) is published monthly, 12 times per year, by John V. Terrey, One River Road, P.O. Box 2, Carlisle, MA 01741. Periodicals postage paid at Carlisle, MA, and additional mailing offices. Telephone: (508) 371-0512, 8:30 AM to 6:00 PM ET weekdays; machine answers phone at other times.

Annual subscription rates within the U.S. are \$38.95 by Periodicals mail and \$55.95 by First Class mail.

Annual foreign rates. By air: Canada - \$59.00; Mexico - \$65.00; Other foreign countries - \$100.00. Surface mail: Canada - \$49.00; Other foreign countries - \$55.00. (Surface delivery to countries other than Canada may take two or more months and cannot be guaranteed.)

Two-year subscriptions are twice these rates and receive an extra month. Sample issues are available free on request.

© Copyright 1997 by John V. Terrey.

POSTMASTER: Send address changes to Antique Radio Classified, P.O. Box 2, Carlisle, MA 01741. Printed in U.S.A.

STAFF:

Publisher and Editor: John V. Terrey
Production Manager: Scott J. Young
Office Manager: Lisa A. Friedrichs
Advertising Manager: Cindie P. Bryan
Managing Editor: Dorothy Schecter
Radio Events Editor: Chris Frederickson
Publishing & Editorial Staff: Ray Bintliff, Dave Crocker, Dick Desjarlais, Bobby Lyman, Jean Meldonian
Founding Publisher/Editor: Gary B. Schneider
Contributing Writers: Mike Adams, Richard L. Arnold, Ray Bintliff, Ron Boucher, Paul J. Bourbon, Norman S. Braithwaite, Dave Crocker, Alan S. Douglas, Richard C. Foster, Fred Geer, Jim Kreuzer, Ron Ramirez, Henry Rogers, Ian L. Sanders, Gary B. Schneider, Daniel Schoo, Dwane Stevens, Frank R. White, Ralph Williams

PURPOSE. Antique Radio Classified is published for people involved in the radio collecting hobby. Its purpose is to stimulate growth of the hobby through the buying, selling and trading of radios and related items, and to provide a monthly forum for the interchange of ideas and information.

CONTACTING ANTIQUE RADIO CLASSIFIED. All correspondence should be sent to:

A.R.C., P.O. Box 2, Carlisle, MA 01741.

Only UPS, Federal, etc. items to street address: One River Road.

Telephone: (508) 371-0512; Fax: (508) 371-7129

E-mail: ARC@antiqueradio.com - Web: www.antiqueradio.com

Please, no classified ads by telephone; thanks.

Your ads, renewals, letters, etc. can be handled faster and more efficiently if your name, address and SUB# are written on each.

Unfortunately, A.R.C. is not staffed to answer letters with questions about antique radios or requests for advice. However, A.R.C. does solicit letters of interest to its readers and publishes them as space permits. A.R.C. assumes that permission is given to edit and to publish all correspondence and articles received unless otherwise indicated.

DISPLAY AND BUSINESS CARD ADS - DETAILS AND RATES

The deadline is the first of the month for display and business card ad artwork, payment and repeat requests.

Advertising is accepted only for early items related to radio, communication, etc. All items must be described fairly; reproductions, reprints and not-original items must be so identified. Advertisers must agree to respond promptly to inquiries and orders, to resolve problems promptly if the buyer is not satisfied, and to comply with a buyer's refund request on unaltered returned items.

Advertising must be prepaid, except as noted below; see "Payment" paragraph above for details. Late ads will be run only if space and time permit. Since artwork is reduced to 63% in the printing process, **originals must be the artwork size listed below.** Do not send in artwork on art board or send negatives. Ads should be typeset or typed neatly with a carbon ribbon, black ink (not pencil) on white. If used, reverse type must be limited to 25% of the ad. If you want us to prepare your ad, include the one-time cost below for A.R.C. to make up the ad.

Photos should be at an 85-line screen; otherwise, add \$15.00 per photo for screening. Do not cut or trim photos or glue photos to artwork; submit separately.

If you are confused by these requirements and terms, please

Page	ARTWORK SIZE (SEND IN THIS SIZE)		As Printed (size in magazine)	
	H x W (inches)		H x W (inches)	
Full	12 7/16 x 7 1/2		7 3/4 x 4 3/4	
1/2 H	5 1/4 x 7 1/2		3 5/16 x 4 3/4	
1/2 V	12 7/16 x 3 9/16		7 3/4 x 2 1/4	
1/4	5 1/4 x 3 9/16		3 5/16 x 2 1/4	
1/8	2 5/8 x 3 9/16		1 5/8 x 2 1/4	
Business Card (1st)	2 x 3 3/4		1 1/4 x 2 3/8	
Business Card (2nd...)	2 x 3 3/4		1 1/4 x 2 3/8	

* Full & 1/2 page, 6-mos.: 1/2 due with order; 1/2 due in 3 mos. ** Full & 1/2 page, 12-mos.: 1/2 due with order; 1/2 due at 3, 6 & 9 mos.

† For 6 and 12 month ads, no ad make-up charge if no change is made to ad for entire run.

GUARANTEE. You may cancel your subscription at any time and receive a pro rata refund for issues not yet mailed. If errors to ads are made by A.R.C., upon request a free correction will be run in the next available issue.

PAYMENT. Please send in full payment with your order or ad. A.R.C. does not carry accounts; all subscriptions, ads, etc. must be prepaid (except for the 6 and 12 month display ads indicated below). Pay in U.S. funds. Checks drawn on a U.S. bank, money orders, VISA or MasterCard (\$10.00 min.) are preferred. Make check out to "A.R.C." U.S. stamps or cash are OK for small amounts. Canadian payers may send a Canadian check but specify U.S. funds. Subscriptions will be prorated to amount sent if amount is incorrect.

FAX & E-MAIL PROCEDURES/PAYMENT. Subscriptions, book orders, classified ads, display ads, etc. are welcome by fax or e-mail. Deadlines are the same as for ads received by mail. Please calculate the amount due. Payment by VISA or MasterCard is preferred if your order is over \$10. If under \$10, or if you prefer to send a check or money order, state the amount being sent and that the payment is in the mail. Do not send another copy of your ad with your payment; simply indicate that it is a fax or e-mail payment. If you want confirmation of our receipt of your fax, call immediately after sending your fax.

CHANGE OF ADDRESS. Please notify us 4 weeks in advance of a change of address. Send both your new and old addresses, and include your SUB# and effective date of your new address. Temporary address changes can be made also.

SUBMISSION OF MATERIAL. Antique Radio Classified welcomes and solicits information that pertains or relates to radio history or collecting. This may include articles, book reviews, photos, information on upcoming radio events, meetings, antique radio organizations, radio auctions, sources of old radio and restoration supplies, and other related and interesting material. All material submitted should be carefully researched, typed and accompanied by good photos, if appropriate. Computer disks are appreciated. Writing guidelines are available upon request. Unless prior arrangements are made, all submitted materials may be edited, become the property of Antique Radio Classified and will not be returned. Publication is subject to approval by A.R.C. and to time and space constraints.

MAILING OF ISSUES. U.S. subscribers can receive A.R.C. by First Class or Periodicals mail (Periodicals is the way most magazines are mailed). The mailing of First Class copies is staggered with faraway copies mailed before local copies. Non-U.S. copies are mailed on the first day. Periodicals copies are mailed on the last day. Mailing dates change each month, but mailing is usually completed by the 27th of the month. First Class copies usually are received by the 5th of the month; copies by Periodicals mail, by the 10th.

ETHICS. No person involved in the production of A.R.C. is to act on any information in the magazine until the first delivery day after local copies are mailed.

DISCLAIMER. The publisher is not responsible for any buying and selling transactions incurred, or for any other use of the contents of this publication.

Antique Radio Classified subscription rates, frequency of publication, content, policies, size and ad details, and rates are subject to change at any time by A.R.C.

contact A.R.C. before beginning to prepare your ad. We will be happy to advise you on your ad ideas, estimate how much the ad will cost, recommend an ad size, etc.

We assume that advertisers want all ads which are submitted to run without delay; therefore, we will run the ad and bill for any additional work required for the ad to meet these specifications. A late ad will run beginning with the next month. "Tear sheets" will be sent only for 1/8-page or larger ads and only if requested when the ad is submitted.

First business card per advertiser is at lower rate.

The 3-month rates represent about an 11% discount, the 6-month rates 23%, the 12-month rates 30%. Placement requests: add 15% but call first. Clubs: write for discount policy.

Cost for 1-month	Cost for 3-months	Cost for 6-months	Cost for 12-months	One Time to make up Ad
\$269.00	\$719.00	\$1239.00*	\$2159.00**	\$69.00†
136.00	363.00	629.00*	1095.00**	37.00†
136.00	363.00	629.00*	1095.00**	37.00†
69.00	184.00	319.00	555.00	19.00†
35.50	95.00	165.00	285.00	9.00†
not avail.	49.00	84.00	147.00	7.00†
not avail.	64.00	110.00	191.00	7.00†



ANTIQUE RADIO CLASSIFIED



EDITOR'S COMMENTS

The sheer joy of collecting — this is a feeling all of you readers know well. Certainly it is the sentiment conveyed by Phil Van Praag in our lead article about the writing of his book, *Evolution of the Audio Recorder*, testifying to his passion for “these electro-mechanical marvels.” Joseph Esdale, reviewer of the book in this issue, generates the same enthusiasm both for the subject and for Phil’s engaging writing style. As an audio and tape recorder enthusiast for over 40 years, Joe reports that this book is a “terrific reference guide.”

It is interesting to note that Poulsen’s telegraphone was developed at about the same time as Marconi’s wireless telegraph. However, although the wireless telegraph was in use only a few years later, and radio had become a household necessity for information and entertainment by the mid-1930s, the magnetic recorder did not “take off” for consumers until after World War II. Still, the difference in time frames is understandable when we think that, as Tom Lewis says in *Empire of the Air*, “Radio was the first national medium Americans knew, and it brought them the world.”

“I found a radio in a box” could be the subtitle of Dave Crocker’s article on the 1-tube, 1920s Splendid receiver. After a little research, Dave found four variations of this otherwise rather simple set. Collectors are reminded once again to look inside every old box you see on an antique store shelf or at a flea market. There, you might find a 1-tube set like the Splendid, or even a highly collectible Sodian receiver worth over \$1,000.

Ship speakers — early cone speakers sporting a design of a ship — are unusual. Alan Douglas sent in a couple of fine photos of four of these speakers, and A.R.C. staff members added their combined knowledge to describe these “nautical wonders” for this issue.

Photo Review this month shows several unusual items — a round speaker-shaped lamp, a skyscraper-styled, Bakelite intercom set, a space satellite novelty crystal set, and a rather short — under 5 feet — grandfather clock radio.

How often have you seen an early 1-tube tester on a flea market table and just passed it by? Phil MacArthur saw one, but did not pass it by. He bought a Hoyt Model 100 and then decided to find out more about the company. His curiosity led him from Florida to the New Hampshire town where the Hoyt Works is still alive and well and very much in the business of making electrical instruments.

A report on the Findley Estate Auction held by the Smith Auction Co. combines information provided by Ludwell Sibley and Ray Chase. Over 500 lots were sold covering almost any radio collecting interest — home brew sets, battery

sets, breadboards, cathedrals, Trans-Oceanics, transistor radios, and Catalins. The surprise of the auction was a DeForest D-12, a 4-tube, reflex set with a crystal detector, which sold for \$2,600.

As always *Radio Miscellanea* contains good advice, responses to inquiries and earlier articles, as well as the pleasant sense that folks from as far away as Australia are tuning in to A.R.C.

International Collector Reception at Radiofest XVI. Come one; come all! Collectors from all parts of the globe are invited to an A.R.C.-sponsored informal reception poolside at the Holiday Inn on Wednesday, August 6, at 5:00 P.M. Among the first to sign the special guest book will be collector/author Jonathan Hill and two of his fellow collectors from England, John Howes and Phil Taylor. We’re hoping that others from abroad will consider this an open invitation to come and enjoy a chat with their American counterparts. To add to the festivities, A.R.C. will have prize drawings. We look forward to seeing all Radiofest XVI attendees for a relaxing hour and some good old-fashioned talk about radios — national and international.

Coming Radio Events. Extravaganza '97 and Summer Heat are the big ones for July. The Michigan Antique Radio Club’s Extravaganza '97 always yields good programs, a great flea market, an exciting auction, and an informal and informative social hour. “Radios of the World” is the theme this year. And in West Virginia, the Museum of Radio and Technology’s Radio Heat includes a 2-day flea market, an equipment contest, museum tours, and programs, plus a Dixieland band.

And, plan for the next big ones in the lineup — the August Radiofest in Elgin, Illinois, and the September AWA Conference in Rochester, New York. A.R.C. will be at these two events, so I hope that you will look us up and say “Hi.”

Happy Collecting!

John V. Terrey, Editor

ON THE COVER

Our cover this month depicts the patent drawing of a device called a telegraphone, issued on November 13, 1900, to Valdemar Poulsen, a Danish telephone engineer credited as the first to build a magnetic recorder. In his book *Evolution of the Audio Recorder*, the subject of our lead article, Phil Van Praag warns that we are not likely to find a telegraphone at a local flea market or hamfest. He also says that the word “telegraphone” is presumably pronounced with the accent on the second syllable — “presumably” because, oddly enough, Poulsen doesn’t appear to have made recordings containing that word. Some might call this omission a bit of a blunder on his part!

VINTAGE RECORDING

Vintage Audio Recorders The Evolution of a Book

BY PHIL VAN PRAAG

Phil Van Praag is the author of "Evolution of the Audio Recorder," now available from the publisher, EC Designs, Inc. The following article provides a small sampling of the history of the tape recorder covered in the book, as well as an account of the evolution of the book itself. Phil's article gives us the rare opportunity to feature a new book and connect it with the cover, an article, and a book review. (Editor)

Evolution of the Audio Recorder provides simplified theory, descriptions of unusual and specialized recorders, extensive service and restoration material, an identification and price guide for used machines, plus buying tips and more. This 540-page landmark book contains over 500 photos and illustrations, including 125 color pages.

In a sense, I actually set out to write the history of the audio recorder many years ago, with my first personal involvement during the 1950s. It was love at first sight; and, although my "collectibles" interests have broadened considerably over the years, my first love has always been the recorder. Through the years, I have acquired or, as my wife prefers to say, amassed a number of recorders and a quantity of literature, along with the knowledge and experience gained through use, observation, engineering, and maintenance.



Figure 1. The Webster Chicago Model 80 single-channel, tube-type wire recorder, ca. 1947-1952, is AC-operated and uses a single motor to run the wire at 24 ips.

Thus, the task of writing a book on recorders turned out to be much less a writing task, per se, and more a labor of love. I do hope that the book *Evolution of the Audio Recorder* conveys that same sense of joy that I have felt in working with these electro-mechanical marvels.

Most of us can still remember that first time we heard our own recorded voices. Many of us used recorders during our school years — perhaps while practicing a musical instrument or recording lectures or "Top 40" tunes from the radio. Many more of us used them at home to record baby's first words, or at family reunions. Some used them professionally — remember, for one example, Sun Record's first recordings by Sam Phillips of a youthful Elvis Presley in Memphis?

THE BEGINNINGS

Evolution of the Audio Recorder traces the evolution of the audio recorder from its beginnings around the turn of the century. Valdemar Poulsen, a Danish telephone engineer, is credited as the first to build a magnetic recorder. Details of his 1900 patent for a telegraphone are shown on the opposite page. However, my new book focuses primarily on what I call the "vintage years" — from post World War II to the early 1970s. It was during this quarter century that tremendous advances occurred in terms of producing practical recording machines to fit the many real world application needs.

While the book provides a detailed account of



Figure 2. The transistorized, battery-operated Minifon Model 360S wire recorder, ca. 1961-1963, is a single-motor, single-channel recorder. Produced in Germany and used for surveillance, it operates at 13.4 ips.



Figure 3. This 2-channel, tube-type Voice of Music tape recorder, Model 714, ca. 1955-1957, operates on AC at 7½ or 3¼ ips and accepts 7" reels.

this evolution, along with theory, restoration tips, identification, and pricing guides, here I'll limit the discussion to a few of my personal experiences with tape recorders. Since I am a member of the "Baby Boomer" generation, however, I can't tell any personal stories of the 1940s. What does come to mind, however, is a story recently related to me about a Nebraska farmer who, beginning in 1947, had tried unsuccessfully for two years to obtain a tape recorder from one of the mail order houses. Finally successful in 1949, he received a Masco D37; but then, he had to go to town to use it since the only power available on the farm was 32 volts. Now there's determination!

WIRE vs. TAPE

While, indeed, there were relatively few models available immediately after World War II, a number of recorders based on wire format, as opposed to tape, were around. Figure 1 shows an early wire recorder — the Webster Chicago Model 80 — designed in 1947 but sold well into the early 1950s.

It was not a case of one type preceding the other as much as both being available at the same time. What happened during the early 1950s was a show of clear superiority on the part of tape-based units for most applications. This led to the gradual demise of the wire recorder, although it did continue to appear in specialized applications even into the early 1960s! One example is the Minifon Model 360S, as shown in Figure 2.

My first experiences with a recorder came in the late 1950s, with a second-hand Voice of Music recorder (similar to the Model 714 shown in Figure 3). Unfortunately, this set didn't last long due to my persistent *need* to disassemble it. (I used to do the same thing with clocks; at least the tape recorder still worked after the first few tear-downs; which is more than I can say for the clocks.)

TRANSISTORIZED MODELS

By the early 1960s, I was really into tape recorders. With the advent of transistorized models in these years, two extremely important events occurred: first, smaller recorders became possible, leading to a number of specialized models never before practical; second, and perhaps of even greater significance, very inexpensive recorders became possible. Thus, for the first time

(Continued on following page)

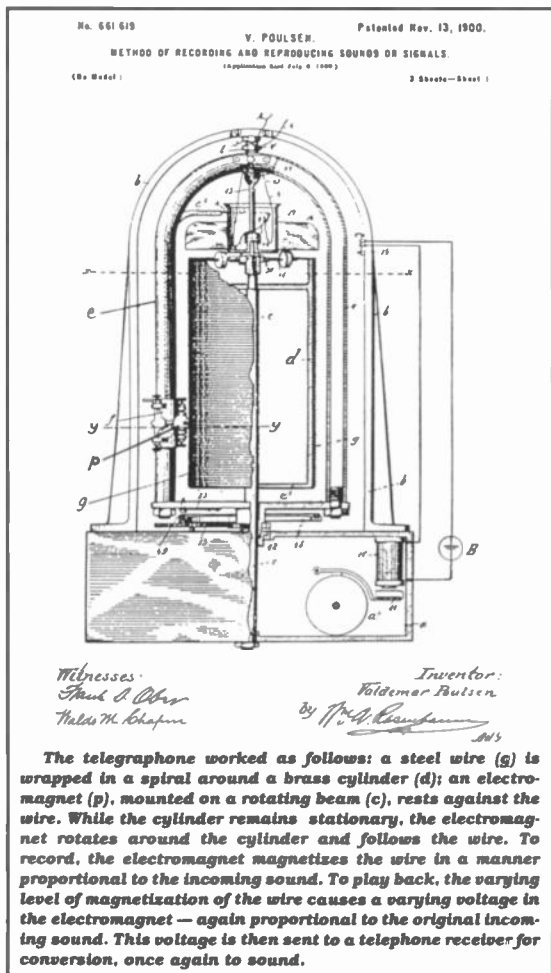



Figure 4. The single-channel Apollo Model Apolec tape recorder, ca. 1962-1964, is transistorized and battery-operated. It accepts 3" reels.

(Tape Recorder Story, continued)

in history, just about anyone could own a tape recorder.

Figure 4 pictures one such \$15 bargain — the Apollo Apolec recorder. Using a very simple "rim drive" mechanism, and with shortcuts, such as a

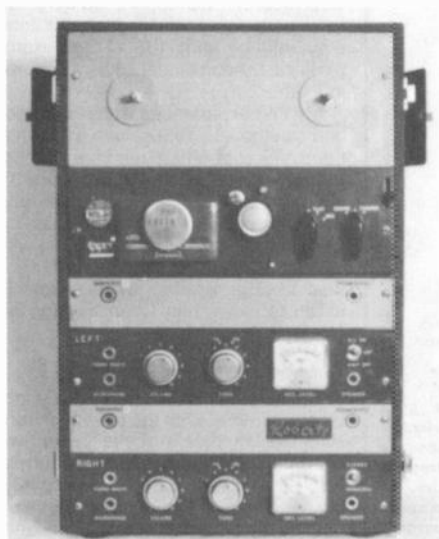

Figure 5. The dual-channel Roberts Model 990, ca. 1961-1962, is an AC-operated, tube-type tape recorder, using 7" reels and running at 15, 7½, and 3¼ ips.

swing-out, permanent magnet as an erase head, the technical specifications were not very good, but the Apollo worked, and it was cheap.

Anyway, as I had become involved with a dance band in 1963, I began looking for a nearly professional quality recorder to make demo tapes and to use as a practicing aid. I could not afford an Ampex, but instead settled for a Roberts Model 990, as shown in Figure 5. It had excellent specs, including a 15 ips (inches per second) speed, plus the portability I needed.

By the second half of the 1960s, I began repairing tape recorders as a vocation (as opposed to just an avocation harking back to those days at the kitchen table with my VM machine strewn all over). It was during these years that I became exposed to almost all the tape recorder manufacturers and models, not just those of the industry leaders, such as Ampex, Concertone, Crown, Magnecord, and Revox, but also the scores of mid-priced and economy models. One of my personal

favorites is the Concertone Model 800 (Figure 6). With its heavy chromed accents, its oversized transport buttons and its six heads, it creates every bit as much excitement today as it



Figure 6. The Concertone Model 800 "Revers-O-Matic," ca. 1966-1967, features 6 heads and is an AC-operated hybrid. It uses 3 motors and operates at tape speeds of 7½ and 3¼ ips.

did 30 years ago. It even made the list of my personal "Top 10" tape recorder models, as described in the book.

Later in the '70s, I worked for Ampex Corporation in the audio/video systems division. I wrote technical manuals and served as an instructor. I felt truly honored to be working for the company that had produced such great recorders as the Ampex 350 series, shown in Figures 7A and 7B, which had basically set the standard for professional studio machines in the 1950s.

Since that time, I have been vigorously pursuing the advancement of my personal collection, which now affords (finally!) the opportunity to do more research and technical analysis (my educational background is in electrical engineering). In *Evolution of the Audio Recorder*, I have attempted to provide a balanced presentation, with separate chapters on simplified theory, a rather detailed evolution spanning 175 pages, specialized machines, repair and restoration information, plus an identification/description/price guide. In addition, buying tips, a corporate close-up, and sample schematic diagrams are included; plus, of course, my "Top 10" favorite recorders.

If I am successful in rekindling the excitement, the curiosity, the fascination so many of us felt in those early years with these great "talk-back" machines, then my purpose in writing this book will have been accomplished.

Evolution of the Audio Recorder is available from the publisher EC Designs, Inc., P.O. Box 33, Genesee Depot, WI 53127-0033 at a cover price of \$39.95. However, for a limited time it is being offered at a discount. Be sure to check with the publisher for ordering information.

Photo credits: Cindy Van Praag.

(Philip Van Praag, P.O. Box 33, Genesee Depot, WI 53127-0033)

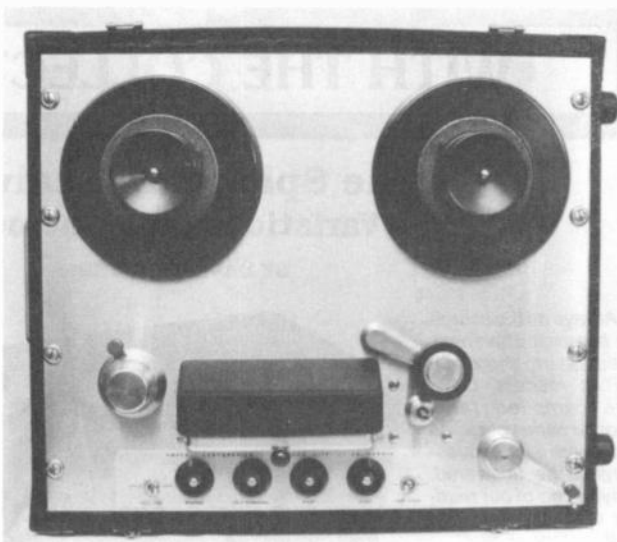

Figure 7A. The tape transport of the Ampex Model 350 series, ca. 1953-mid 1960s. A studio quality, 3-motor, 3-head transport, it operated at 15 and 7½ ips or 7½ and 3¾ ips and accepted reels up to 10½".

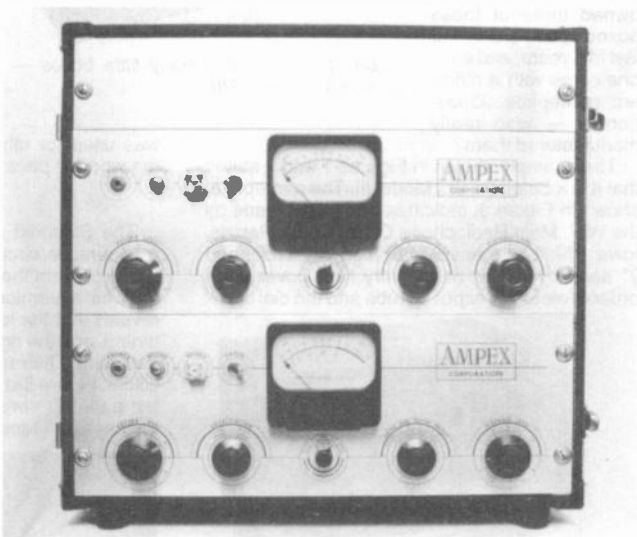

Figure 7B. The dual-channel, tube-type electronics of the Ampex Model 350 series.

Phil Van Praag's collection of radios, recorders, jukeboxes, TVs, and record players spans 35 years of collecting. As an electrical engineer, he has serviced consumer and professional products and has combined teaching and writing into his professional career. Having held an FCC General Radiotelephone Operator License for 20 years, he has also serviced commercial radio stations. Currently assembling a '50s recording studio, he intends to resume guitar playing "any day now."

WITH THE COLLECTORS

The Splendid Receiver Variations on a Theme

BY DAVE CROCKER

Always on the search for interesting radio-related items to share with A.R.C. readers, Dave has compiled facts about a series of radios that leave a lot of questions to be answered. Maybe one of our readers can help us to add to this story. (Editor)

Little boxes . . . little boxes . . . just who made all those little boxed radios anyway? I've owned three of these boxed receivers in the last few years, and each one came with a different nameplate. Question is — who really manufactured them?

The example shown in Figures 1 and 2 states that it is a Splendid Sr., Model III. The nameplate, shown in Figure 3, indicates that it was made by the W.F. Main Radiophone Co. of Cedar Rapids, Iowa. This box measures 8" high, 10" wide, and 7" deep overall. It has a very high cover lid in order to clear the exposed tube and the dial crank



Figure 1. One of the many little boxes — the Splendid Sr. Model III.

lever, two of the set's unique features.

In a close-up of the set, as shown in Figure 4, you can see that there are two Bakelite panels separated by a wooden strip, but connected by two flat metal strips. The bottom metal strip connects a tapped coil under the left-hand panel to the grid of the tube socket on the right-hand panel. The top strip connects the variable tuning condenser under the left panel to the fixed condenser under the right panel. In addition to the above-panel strips connecting the panel sections, conventional wiring connects the panel sections, conventional wiring

was used for other connections crossing under the wooden panel separator.

CIRCUITRY

The Splendid receiver operates on a simple regenerative circuit. The odd-ball dial crank exists to prevent the hand capacity effect, and doubles as a vernier for finer tuning. Observation reveals that the left-hand panel section is for the tuning, and the right-hand panel section does the detecting. The regenerative detector uses a fixed tickler. Figure 5 shows the underneath view of the left panel. It consists of a variable tuning condenser and a tapped double coil. The fixed tickler



Figure 2. The Splendid Sr. Model III with the cover lid open.



Figure 3. The Splendid Sr. Model III nameplate.

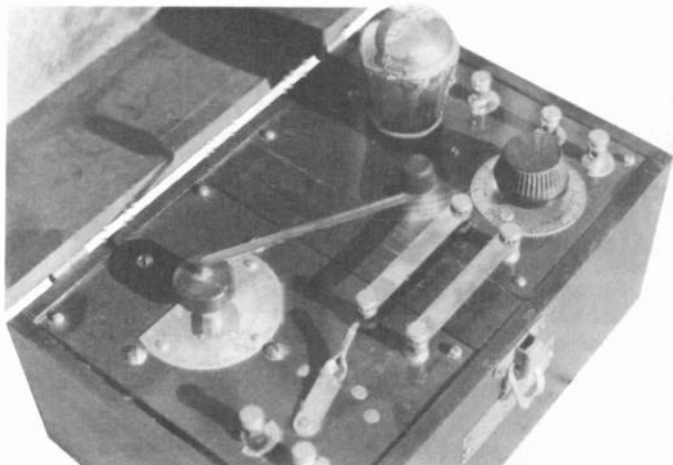

Figure 4. A close-up of the Splendid Sr. Model III panels. Note the long crank handle on the dial knob.

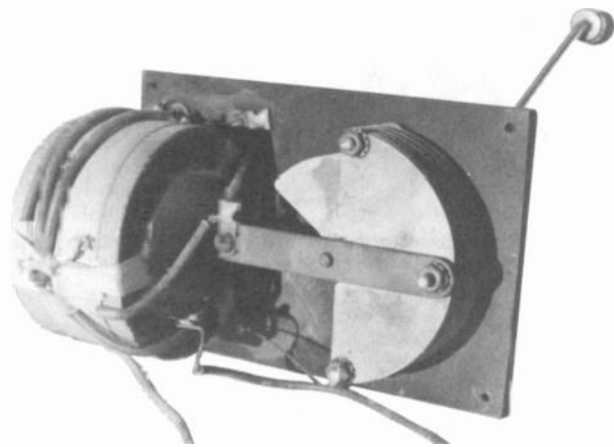

Figure 5. An underpanel view of the Splendid's left-hand tuning panel.

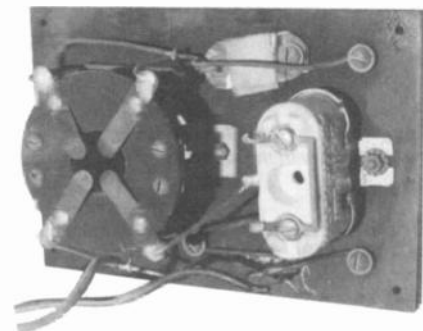

Figure 6. An underpanel view of the right-hand detector panel.

coil is mounted concentrically inside the larger tuning coil.

The underneath view of the right panel is shown in Figure 6. Visible is a Bradleystat (which controls the regeneration), a Type 01-A tube socket, and a fixed condenser. The absence of a grid-leak resistor is evident. Perhaps a graphite pencil line drawn on the fixed capacitor served as a high resistance grid leak. Note the trailing wires that connect both sections under the panels. Because these are soldered wires, removal of the panels is difficult, but possible. A schematic of the Splendid's circuit is shown in Figure 7.

CONFUSING NAMEPLATES

I've just described the Splendid Sr. Model III receiver. Now comes the mystery. Another set I came across is virtually identical in circuitry and design but carries the nameplate shown in Figure 8. It's called the "Masterphone," manufactured in Iowa City, Iowa. Now if you turn to page 48 of *Guide To Old Radios*, (page 52 of the second edition), by David and Betty Johnson, you will see the same Masterphone radio, but credited to the Boston Radio Manufacturing Co. in Massachusetts. Research revealed that there was a company in Boston by that name listed at 28 State Street during the mid-1920s, but I've never discovered any advertising by this company.

Then I found a third similar receiver, again with the W.F. Main of Cedar Rapids, Iowa, (Continued on following page)

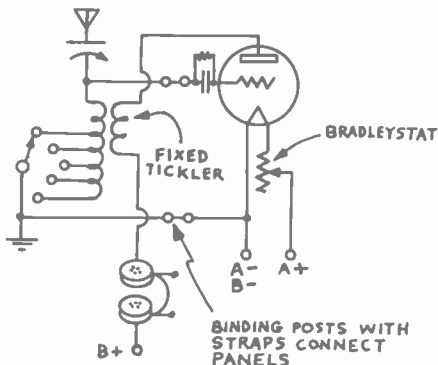

Figure 7. Schematic diagram of the Splendid Sr. regenerative circuit.



Figure 8. The Masterphone receiver's nameplate.



Figure 9. The Splendid Jr. receiver's nameplate.

(Splendid Receivers, continued)

nameplate, but called the Splendid Jr.; see Figure 9. This set is again identical in layout except for two obvious design changes — it has no dial crank (did they solve the hand capacitance problem or was it simply economics?), and there is no tap switch mechanism. Both features are gone from the left-hand panel.

However a not-so-obvious difference is the material comprising the two panels. See Figure 10. Instead of the usual Bakelite, this unit has panels made of a very hard graphite-like material which is extremely difficult to work with when drilling, etc. One more thing — instead of the half-moon-shaped aluminum dial on the left, it has a fully round dial plate. Imprinted on this plate is the Splendid name.

STILL MORE

Checking through John Terrey's collection revealed still another version. His set carries the similar Masterphone name of Iowa City, Iowa, but big changes are on the panel; see Figure 11. Instead of two control panels, this one has only one large Bakelite panel. The small dial knob and aluminum plate have been replaced with a standard larger, molded dial. Also, the configuration of the coils has been changed to the "pancake" type of construction, and the right-hand rheostat knob has no metal dial.

Overall, it is kind of a "plain Jane" receiver, and probably the company's last. Last seems to be the case for gone are the names "Masterphone" and "Splendid" from the radio directory lists. So ended the little boxes, but if you ever find one, take a good look inside the box — you may find still another version and still another nameplate. If you do, let A.R.C. know, as we would like to share the information.

Reference:

Johnson, David and Betty. *Guide To Old Radios, Painters, Pictures And Prices*. Radnor, Pennsylvania: Wallace-Homestead Book Co., 1989.

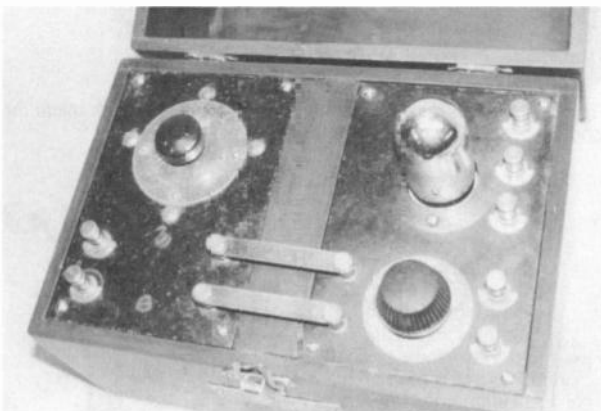

Figure 10. The two panels of the Splendid Jr. Note that the dial crank, as well as the tap switch, used in the Sr. are not used in the Jr. version.



Figure 11. One of the last of the series — the Masterphone with the simplified panel.

(Dave Crocker, 4B Beechwood Point Dr., Mashpee, MA 02649)

Dave Crocker, a member of the A.R.C. staff, lends his skills as a graphic artist to the layout of the magazine. He has been actively collecting radios for over 25 years. Many of these years have been spent researching and collecting radios manufactured by the Crosley Radio Company.

COLLECTOR'S CORNER

Cone "Ship Speakers"

BY DICK DESJARLAIS WITH INPUT FROM ALAN DOUGLAS AND DAVE CROCKER

Alan Douglas recently sent in the excellent photos of the ship speakers shown here. They inspired a little research on our part and perhaps will bring in more information from readers. (Editor)

Cone "ship speakers" came into prominence in 1926-1927. The four examples shown here are representative of this popular style. Although there were numerous manufacturers of cone ship speakers, Pathé and Tower are among the most commonly known.

Alan Douglas identified the cast iron-frame speaker at left in Figure 1 as a Vitalitone, made by Vitalis Himmer in New York City and advertised in 1927. Before this, Himmer had been making horns (Magnavox look-alikes) as far back as 1922.

The Tower "Pirate Ship," shown at right in Figure 1, was made by the Tower Manufacturing Co., Boston, Mass., according to Dave Crocker. In 1927, this speaker, also cast iron, sold for \$8.95. Measuring 14" in diameter, it is the mid-sized version of three different sizes manufactured by Tower.

At left in Figure 2 is a cone with a wooden octagon frame. The ship design is painted on the speaker's paper cone. This unit, which Dave Crocker surmises is a Na-Ald speaker, has a cord for hanging it on the wall. It was manufactured by the Alden Mfg. Co. of Springfield, Mass.

The speaker on the right in Figure 2 is the Tower "Adventurer." It has a cast iron frame and is 17" in diameter. Dave Crocker reports that, in 1927, it sold for \$11.95. Readers will remember that this speaker is pictured in A.R.C.'s AWA auction report on page 12 of the November 1996 issue. The Adventurer sold for \$500.

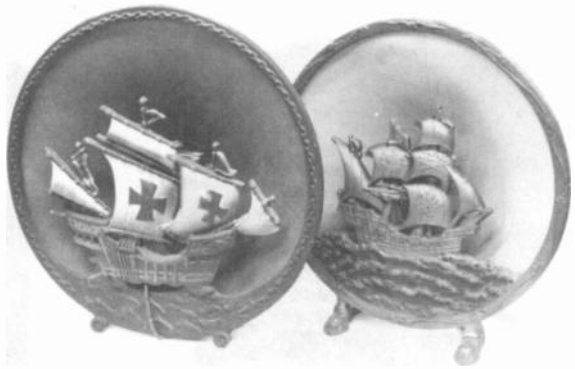

Figure 1. A Vitalitone (left) and a Tower "Pirate Ship" (right).



Figure 2. A Na-Ald (left) and a Tower "Adventurer" (right).

A.R.C. would certainly welcome an offer from a collector of ship speakers to write a more complete article on these nautical wonders.

Photos by Alan Douglas.

(Dick Desjarlais, Box 629, Littleton, MA 01460)



PHOTO REVIEW



This column presents in pictorial form many of the more unusual radios, speakers, tubes, advertising, and other old radio-related items from our readers' collections. The photos are meant to help increase awareness of what's available in the radio collecting hobby. Send in any size photos from your collection. Photos must be sharp in detail, contain a single item, and preferably have a light-colored background. A short, descriptive paragraph **MUST** be included with each photo. Please note that receipt of photos is not acknowledged, publishing is not guaranteed, and photos are not returned.



PHILCO LAMP - This lamp, shaped like a speaker, is inscribed, "Merry Christmas - 1944 - Radio Division" on its back. The case is made of highly polished, marbled plastic. When turned on, the frosted lens casts a direct, bright light. The lamp may have been a "blackout lamp" for use in air raids. (*Marilyn Fletcher - Spring Hill, FL*)



TELEVIAN MODEL UNKNOWN - This 4-tube Japanese tombstone has a fine-tuning knob. The cabinet is solid wood with an oriental style grille cutout. (*R. Suslovich - McLean, VA*)

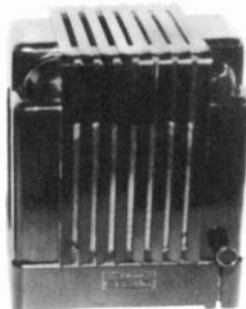
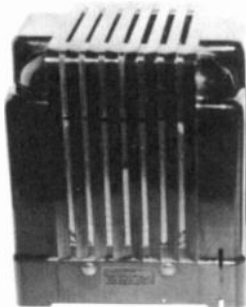

ERPI/WE INTERCOM SET - This skyscraper-styled, 2-way, wired intercom set was manufactured in the 1930s by Electrical Research Products Inc. (ERPI) under patents of its sister companies Western Electric (WE) and ATT. The Bakelite cabinets are 6½" tall and contain a 4½-inch permanent magnet, high impedance speaker, which doubles as a microphone. One of the two units contains the electronics which serves both units and which consists of a 3-tube chassis (Types 6C6G, 25A7G, and a K90A ballast tube). The distinctive styling is reminiscent of the Air King tombstones. (*Al Wirtenberg - Weston, CT*)

PHOTO REVIEW



OLYMPIC MODEL 447 – This 1956 AM battery transistor radio is the size of a lunch box. The transistors were installed in tube sockets. (*Kurt Henriksen – Peotone, IL*)

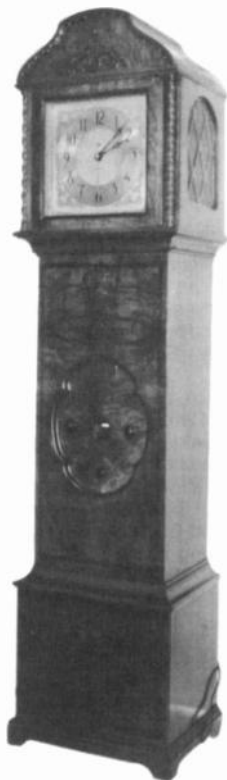

GILFILLAN GRANDFATHER CLOCK RADIO MODEL UNKNOWN – This unusual radio, circa mid-1930s, is only 4' 10" tall. Built on an even more unusual, large aluminum chassis, the radio uses the following tube types: (2) 47, (1) 80, (2) 35, (2) 27. It was designed so that the two Type 47 tubes and the Type 80 are mounted vertically, and the rest of the components are mounted horizontally. A chassis tag reads, "Manufactured by Gilfillan Brothers." (*Jerry DeWitt – Simi Valley, CA*)

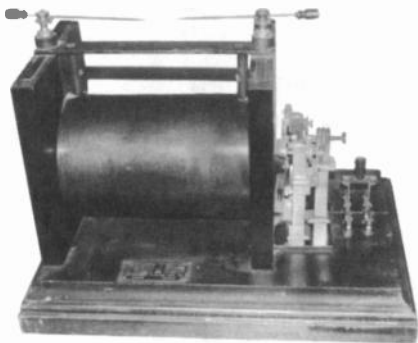

THORDARSON MODEL 8508.6 – This unique spark coil mounted on its original board measures 18" x 12½" x 14". The coil is 8½" in diameter. (*Steve Lange – Milwaukee, WI*)



SPACE RADIO MODEL GR-150 – Using an 1N34 germanium diode, this model is tuned by pulling up and down on the center rod. The plastic housing could be used for a bobber when the diode goes bad! (*Kurt Henriksen – Peotone, IL*)



VINTAGE TEST EQUIPMENT

Hoyt Electrical Instrument Works

BY PHIL MACARTHUR

Phil MacArthur made quite a "swing" from Florida to New Hampshire to visit the Hoyt Works. In this article, he shares his pleasure in finding a company still steeped in the tradition of Yankee ingenuity and pride in products perfected over the past century. (Editor)

Last March, at the AWA spring meet in Charlotte, North Carolina, I bought the old Hoyt Model 100 tube tester, shown in Figure 1. The brass plate on the cherry base read "HOYT Electrical Instrument Works, Penacook, N.H., U.S.A." This 1920s device has A, B and C battery binding posts allowing it to test Types UV-201A, C-301A, C-299, UV-199, WD-11, WD-12, C-301, UV-201, DV-3, W.E. 216A and UV-200 tubes. The Model 100, as well as other meters, were often sold through the Burton-Rogers Company, which had a sales office in Boston, Mass. Another instrument, an AC ammeter, shown in Figure 2, is typical of Hoyt products of this era.

One day, on a whim, I dialed information and asked if there was a listing for Hoyt, and soon I was talking with Douglass Hoyt, grandson of the founder.

With all the bankruptcies, buy-outs, mergers and breakups in today's marketplace, I was astounded that I could read an 80-year-old ID plate and contact the same company in the same city on the same grounds with the same name making the same products! Can any other outfit make a similar claim?

The conversation was so interesting that I decided to swing by New Hampshire (from Key West, Florida!) and interview Mr. Hoyt in person.

PHYSICAL PLANT AND WORKERS

The original Hoyt building is a typical New England "add-on"—and on and on, as shown in Figure 3. With each new contract, another two or three hundred square feet were added. Finally, in the 1970s, Hoyt put up a sep-

arate, modern 30,000 sq. ft. building behind the original one. There, about 100 employees create a broad line of analog meter products, like the example shown in Figure 4. The many employees wind the coils, silk screen the dials, form cases, and calibrate, in-house. As a Hoyt brochure says, "It takes good people to make good meters."

HISTORY

In the 1950s, Douglass Hoyt took over from his father, who had succeeded the founder, Adrian

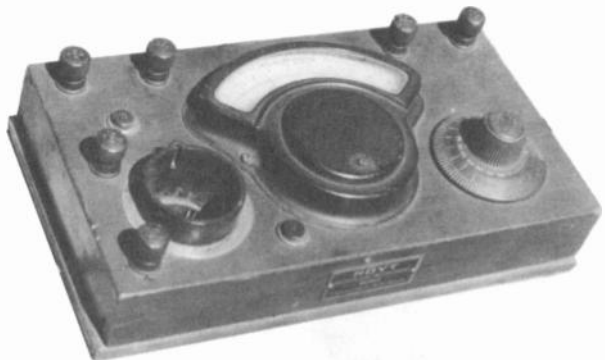

Figure 1. The Hoyt Model 100 for testing tubes of the 1920s.



Figure 2. An AC ammeter manufactured by Hoyt about the same time as the Model 100 tube tester.

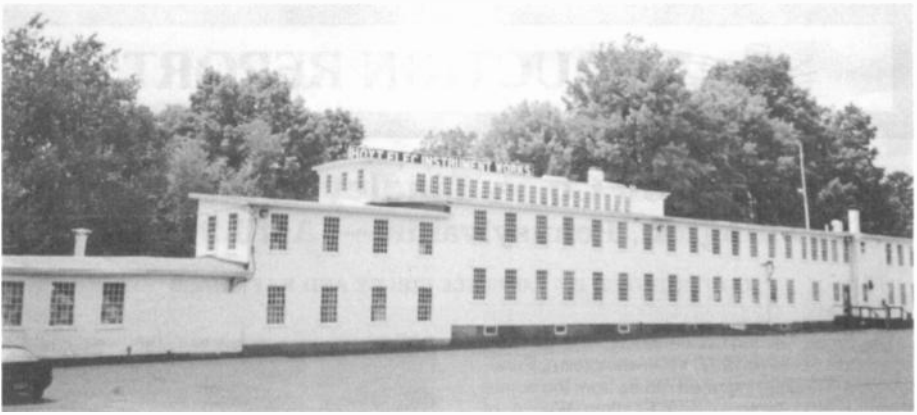

Figure 3. The original Hoyt building in Penacook, New Hampshire, showing its add-on construction.

Hoyt, in the 1920s. Adrian started with a degree in medicine, but had an early interest in electricity. At that time — the 1880s — what came to be called electronics was in its infancy. By 1888, Hoyt was building meters with the Whitney Company, maker of some of those ornate, brass-cased station meters. This meter works moved from Manchester to Penacook, N. H., in 1892.

In 1904, Hoyt started his own company in Penacook, and Whitney merged with Roller-Smith in Bethlehem, Pennsylvania. During this time, Ed Weston, originally a manufacturer of motor generators, was manufacturing his own line of well known "direct reading" meters.

At one point, Triplett, Hickok, and Simpson all worked for Jewell, another manufacturer of electrical testing instruments, located in Chicago. Triplett left Jewell and started up in Bluffton, Ohio, while Hickok later started up in Cleveland. Jewell's company was purchased by Weston in 1928, and Simpson agreed not to compete with Weston for five years.

About this time, Weston offered Hoyt so much money to sell that Hoyt decided that there must

be more to the business than he realized, and he decided to stay on and compete!

I have purchased a couple of meters from a Hoyt distributor, and they are superb examples of today's state-of-the-art. Anyone who sends for a catalog will probably find one or two meters to add to his inventory. Among the offerings is a complete line of ammeters, milliammeters, voltmeters, millivoltmeters, VU meters, and accessories. Standard Hoyt meters offer a choice of self-shielded Accu-Ring, external magnet, 250° movements with accuracy ranges of one to five percent. The Hoyt custom meters product line includes rectifier type AC meters, 50-2000 cycle calibrated AC meters, and suppressed zero DC meters.

Hoyt also offers a wide selection of case styles, colors and materials, including metal, phenolic, noryl, polystyrene, high impact polycarbonate and acrylic. Special dial colors and layouts for non-standard range dials are also available on quantity orders.

If you're in New Hampshire or want to make an interesting trip from wherever you are, stop by to say hello and take a walk through the visual history of an interesting facet of our hobby. Hoyt prides itself on quick customer assistance in meeting special performance or appearance requirements. The address for Hoyt Electrical Instrument Works, Inc., is 19 Linden St., P.O. Box 6183, Penacook, NH 03303, (603) 753-6321.

Reference:

Hoyt Electrical Instrument Works, Inc., Bulletin 300M © 1977.

Figures 1 and 2 photos by Dave Crocker.

(Phil MacArthur, 701 Spanish Main Dr. #7, Summertand Key, FL 33042)

Phil MacArthur teaches mathematics and electronics at the Florida Keys Community College in Key West, Florida. The school houses a growing collection of old test equipment and radios, and is currently seeking a Hoyt Model 200 tube tester.



Figure 4. One of the many modern meters now offered by the Hoyt Electrical Instrument Works.



AUCTION REPORT

Smith Auction Co. — Findley Estate Auction Downington, Pennsylvania — April 26, 1997

CONTRIBUTED BY LUDWELL SIBLEY AND RAY CHASE

The Smith Auction Co. conducted a large cataloged sale April 26, 1997, in Downington, Pennsylvania. The sale included radios from the estate of long-time collector William Findley, W3FEA, of Parkesburg, Pennsylvania, plus selected other items. Widely advertised via the newsletters of the Delaware Valley, Mid-Atlantic, and New Jersey Antique Radio Clubs, and also in A.R.C. and posted on the World Wide Web, the catalog enjoyed 600+ "hits" by sale day. As a result, over 200 people attended.

Auctioneers Harold Smith and Dennis Childers kept the 448 cataloged lots, along with 124 uncataloged lots, moving along. New Jersey Antique Radio Club members assisted in cataloging and setting up the sale.

Material offered covered a wide spectrum, from "wireless" (a Signal Corps pigeon cage) to transistor sets and modern audio gear. Highlights of the sale included a massive Western Electric theater-speaker driver that sold for \$1,050 and a charming Turner 1930s condenser microphone that brought an impressive \$1,600. A pair of DeForest D-12 receivers, one with a crystal detector, brought \$2,600 and \$800.

Other significant sales included an Atwater Kent 10B at \$900, a Kennedy XV at \$975 and a Radio Shop Paramount-Echophone at \$950. Battery sets, unless noted otherwise, were fully equipped with tubes having good filaments.

Prices listed here are rounded up to the nearest dollar. The auction house charged a 10 percent buyer's premium in addition.

e=excellent, vg=very good, g=good, f=fair, p=poor, BBT=brass-based/tipped, N.I.B.=new in box, NT=no tubes, WT=with tubes, nwk=not working, wk=working

Air Castle 831SP, g	\$45
Air Castle table, AM-SW, wooden, 1930s, vg	35
Airline 115445, repainted Bakelite case	40
Airline AC8C Neutrodyne, refinished,	80
Akai M7SP reel-to-reel stereo tape recorder, g ..	40
Altec W-5M amp, vg	110
Ambler-Holman TR5, 3-dialer, p	80
American Bosch 5A table, TRF, wooden, vg ..	40
American Bosch 80 auto radio.....	20
American Bosch 575 tombstone, f.....	50
American Bosch console, f	30
American D44W mike, spring-mounted, in case w/screen, e	300
AN/URM-25F signal generator, g	25
Antenna insulators, vintage Pyrex, etc.	20

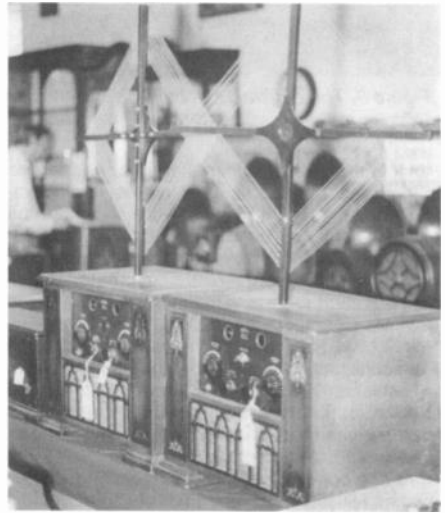

One of these DeForest D-12 receivers in leatherette cabinets sold for \$2,600 (with original crystal detector); the other for \$800 (with tube detector).

Antique DC electric motor and water pump, 1890s-1900s, g	120
Apex Electric Mfg. Co. 36 table, WT, g	20
Arcturus blue tubes, (6)	50
Astatic D-104 mike, (early), Shure 60N stand, f ...	20
Astatic D-104 mike (late), on UG8 stand, g	25
Atwater Kent 10B breadboard, w/book, tags, e	900
Atwater Kent 20(?), in Pooley cabinet, vg	65
Atwater Kent 20 big box, (2)	70, vg, 110
Atwater Kent 20, compact, 3-dialer, g	110
Atwater Kent 30, TRF, g	80
Atwater Kent 35, TRF, vg	50
Atwater Kent 36 table, no power unit, cable cut, p. 120	
Atwater Kent 36, in Red Lion desk, vg	160
Atwater Kent 40 console, TRF, e	140
Atwater Kent 42 table, metal, TRF, vg	40
Atwater Kent 44 table, TRF, vg	45
Atwater Kent 52 consolette, TRF, vg	55
Atwater Kent 55, TRF, in Kiel table, vg	275
Atwater Kent 55 metal table, vg	35
Atwater Kent 89 console, g	65
Atwater Kent 376 console, AM-SW, Deco, vg ..	150
Atwater Kent 511 Tune-O-Matic console, w/service manual, disassembled, g	200



This Rada Cron cathedral in excellent condition brought a bid of \$200.

Atwater Kent 711 AM-SW console, e200
 Atwater Kent 854 tombstone, Deco, restored... 170
 Atwater Kent Bakelite variometers, (2), vg40
 Atwater Kent E cone speaker, driver g60
 Atwater Kent E cone speaker, nwk, p30
 Atwater Kent E2 cone speaker, less driver.....30
 Atwater Kent F4A cone speaker, driver open, e..40
 Atwater Kent factory service manuals, (4), g 200
 Atwater Kent H hom speaker, nwk45
 Battery kit, 3-dialer, square-toroid coils80
 Battery kit, TRF, in commercial cabinet, NT ...45
 Bendix 111W table, e60
 Bino-Dio Japanese novelty binocular radio, e 45
 Book(s): Amateur handbooks and servicing, (15) ...35
 Book(s): Atwater Kent 1931 service manual, g ...25
 Book(s): *Consolidated Radio Call Book*, July 1920, e 35
 Book(s): GE 6-binder tube manual, g 120
 Book(s): Grinder, Greenberg, etc., (14)30
 Book(s): *Most Often Needed Radio Diagrams*, 1926-38, (2), g10
 Book(s): NA(RT)B Engineering Handbook, 4th ed., 1949, vg35
 Book(s): Philco 1937 factory catalog, 11" x 14" leatherette case, 50 pp., e75
 Book(s): *Practical Radio*, Williams, 3rd ed., 1922, w/dust cover, vg25
 Book(s): *Principles Underlying Radio Communication*, Signal Corps, 1921 ed., vg35
 Book(s): *Radio Broadcast* magazine, Sept. 1927, g 20

A warning: Auction prices are not current values. A listing such as this cannot adequately include the condition of cabinets, chassis, transformers, tubes, the operating status of the set, and the inclusion of incorrect, restored or replica components, etc. Auction prices are the result of the excitement of the auction process, the skill of the auctioneer and the specific interests of the participants. Nevertheless, auction prices serve as useful references and as another element in the value determining process. The possibility of error always exists, and if we are notified, corrections will be reported.

Book(s): *Hom Speaker Encyclopedia* (Floyd Paul) and Radio Supply Catalog 1922 (reprint)35
 Book(s): *Radio's Master* 1952, '53, '54, '56, e...55
 Book(s): Tube manual: RCA-Cunningham RC-11 ...15
 Book(s): Zenith service manual, ca. 1940,20
 Book(s): Stromberg-Carlson equipment40
 Bosch Ambotone 16" cone speaker, wk, vg .100
 Bose bookshelf speakers (pair)150
 Brewster B10 FM tuner (prewar band), e90
 Browning-Drake Junior kit, battery, in cabinet, w/construction drawings, WT, g55
 Bunnell Western Union telegraph sounder25
 Burton-Rogers tube tester, ca. 193023
 Calrad mike in box13
 Coca-Cola bottle transistor radio, w/box, g13
 Columbia dry cell batteries (5), and B batteries, (3), old8
 Confidence Automatic tube tester, g55
 Control Products GMS401 Ni-Cad charger, vg...20
 Craig 602 transistor radio, vg130
 Crosley 4-29, 4-tube, (3) good tubes, vg35
 Crosley 50, 1-tuber, holes in cabinet, WT, g.140
 Crosley 51, 2-tube receiver, WT, f80
 Crosley 52, (1) audio transformer missing, vg...70
 Crosley 58 Buddy Boy, Repwood cathedral, no knobs, needs speaker cone, g80
 Crosley 167 cathedral, small, vg.....100
 Crosley 305 table, AC, TRF, f-g.....60
 Crosley 517 tombstone, e110
 Crosley 527 2-volt "battery five" table, f23
 Crosley chassis, w/book condenser15
 Crosley M45 Dynacoil speaker, trim broken ...13
 Crosley Super Eleven #1117 console, vg75
 Crystal detectors, incl. Philmore 40
 Day-Fan 5046, w/built-in speaker, vg60
 Day-Fan 5106 (OEM7) 4-tube, NT, f-g50
 DeForest D-12 receiver, w/crystal detector and loop, complete, wk2,600
 DeForest D-12, w/tube detector and loop, complete, wk800
 Detrola 4-tube,TRF, AC, g50
 Detrola 216 Pee Wee table, bottom cracked, vg..90
 DeWald C-800, AM-FM, vg20
 Distantone Model B 3-dialer, w/card, cabinet f....40
 DuMont 304A oscilloscope, g10
 DuMont RA346 Chinese style clock radio, brown/gold, (2).....30, vg 70
 Early mike, double button carbon, desk stand 45
 Early resistor decade, lots of brass25
 Edison 7R, AC, TRF, chassis and tubes only, g ..35
 Edison SRC3R1 console, TRF, w/book, vg ..200
 Eico 232 VTVM, g15
 Eico 377 sine/square-wave audio generator, e ..15
 Eico 950B resistance-capacitor bridge, w/book, vg ..20
 Eico 2080 stereo amp50
 Electro-Voice Aristocrat speakers, (pair)100
 Emerson "Universal Compact" table, TRF, f...70
 Emerson 3-dialer, w/(1) BBT25
 Emerson 415 table, g.....55
 Emerson 502 table, marbled cabinet, f80
 Emerson 520 Catalin, black/butterscotch, vg ..100
 Emerson 540 Emersonette table, world's smallest superhet, crack in rear, g90
 Emerson 555 transistor radio, e70
 Emerson 652 table, vg15
 Emerson, Catalin/plastic, like 520, vg160
 Erla S-50 Monodic, vg55

(Continued on following page)

(Findlay Estate Auction, continued)

Evershed resistance decade (English), distributed by S. G. Biddle of Phila., vg	35
Farrand 15" cone speaker, g	25
Federal '40s portable disc recorder/radio in field case, w/speaker, f-g	25
Federal 110, 3-tube, w/instruction card, vg	625
Federal 1540T Chinese style, tilt-down panel, vg ..	100
Firestone 4-C-26 plaid-cloth portable, vg	15
Firestone 4-V-24 clock-radio, g	10
Firestone Air Chief mini-table, f	55
Fisher 600 tube stereo receiver, vg	65
Fisher CA-40 amps, (2), g	35
Franklin Big Five, 3-dialer	50
Freed-Eisemann 48, g	120
Freed-Eisemann 147 cone speaker, nwk, g	55
Freed-Eisemann FE-15, 3-dialer, e	80
Freshman B eliminator, WT, g	20
Freshman Masterpiece 3-dialer, early, g	60
Freshman Masterpiece 3-dialer, vg	70
Freshman Masterpiece, single dial, WT	35
Frost Musette mini-horn speaker, driver g	60
Gates Radio & Supply Co. broadcast remote board, w/3 carbon-mic inputs, some internal modifications, from WDAE (W. Palm Beach, Fla.), NT, vg	225
GE (by RCA) M-40 table, AC, TRF, g	28
GE 160 2-volt portable, f-g	13
GE 636 farm table, vg	8
GE Coke-can novelty transistor radio, vg	13
GE DP12 ammeter, 10/100 mA	5
GE H634 table, AM-SW, vg	15
GE LC638 radio-phonograph, f	5
GE P761A transistor radio, g	5
General Electric GD-52, g	15
General Radio 650A impedance bridge, vg	70
General Radio audio oscillator, 1930s, g	10
Golden-Leutz PL10-6, 2-dialer, NT, wk	275
Grebe MU-1 Synchrophase, w/orig. book, card, and QSLs, WT, g	200
Grigsby-Grunow 572 table, less bezel, g	50
Grundig Mini-Boy transistor radio, N.I.B.	75
Grundig transistor radio, in box w/accessory speaker	75
Halicrafters plug-in tuning units, for HT-9 or similar, g	50
Hand telegraph keys, (2)	45
Headphones: pairs, (21)	100
Heathkit AM-FM mono tuners, 1950s, (2), 13, 13	
Heathkit HWA-2036-3 12-V supply, wks, vg	10
Heathkit IM-11 VTVM, g	10
Heathkit IT-12 signal tracer, g	30
Hoffman Solar transistor radio, e	120
Home-brew loop tuner/wavemeter, w/loop antenna, General Radio parts	60
Home-built amplifier for Shamrock set, Crosley parts, unfinished	30
Home-built battery set, National dials	60
Home-built crystal set, 1920s, oatmeal-box slider coil, vg	90
Home-built Litz-wire loop antenna,	60
Home-built (?) crystal receiver, w/plug-in coils (2), Kilbourne & Clark(?), e	150
Homemade regenerative, NT	25
Howard FM tuner (postwar band), vg	23
IBM desk mike in box	40
Instructograph code-practice tape senders, (2), 1 wind-up, 1 AC-powered, w/tapes, g	90
Jackson 103 vintage tube tester, vg	25
Jewett horn speaker, good driver, e	150
Kellogg 70A horn speaker, good driver, vg ..	100
Kellogg 505 B eliminator, g	15
Kennedy horn speaker, good driver, e	25
Kennedy XV Type 430, TRF, WT, g, e	975
Kenwood KC-6060A solid-state "audio lab-scope"	45
Keystone Elect. Inst. Co. 300-V DC voltmeter, w/case f, e	18
King (?) highboy console, e	45
King 80A, WT, vg	60
Knight SW receiver	15
Knight-Kit Space Spanner, BC-SW, vg	30
Kolster (Brandes) 6J table, TRF, vg	45
Kuhn VHF receiver, 8 bands, e	25
Lafayette J16 table, refinished, vg	75
Lafayette tube tester, w/case	8
Lorgnette hand-held ear pieces (hearing aids?), (2), 20	
Machado & Roller Sage telephone-telegraph tone-bridge ohmmeter	30
Maggard-Bradley Cosmograph portable 35mm projector, w/oak case, g	110
Magnavox Model D, TRF, vg	170
Magnavox R3 horn speaker, driver g, e	110
Magnavox R3 Model B horn speaker, driver g	90
Magnavox Telemegaphone 1153 Type L-2 horn speaker, w/MC-1 control box, e	140
Majestic 50 TRF console, restored	100
Majestic 461 table, Deco, vg	80
Majestic GTS-33 transistor radio, w/case, vg ..	30
Mallory UHF TV converter, e	80
Mellow-Tone NR23 boy's radio, w/box, g	35
Microphone ribbon-type built into 3" aluminum sphere, Navy inspection stamp	275
Mike on desk stand	75
Military key w/knee clamp	35
Millen wavemeter set (Signal Corps I-129B), (4), e ..	18
Military HF-VHF transceiver No. 19 MK II, Russian/English marking, mfd. by Zenith	60
Minerva W119 table, AC, p-f	10
Mirrortone 4B7, Bakelite, ivory	35
Morris coil winder, complete, w/instructions ..	50
Motorola 5J1U Jewel Box, portable, AC/DC, f	45
Motorola VHF land-mobile base station, g ..	100
Motorola VT-71 TV set, 7", e	60
Murdock variable capacitor, Mesco telegraph sets (2), (1) g, (1) missing coils, Federal switches, nicked panel labels, etc.	100
NESCO (National Electrical Supply Co.) CGR-5A Coast Guard 1-tube regenerative, metal-cased version of IP-500, 40-1200 kHz, S/N 48, w/descriptive book, e	1,050
Newcomb-Hawley B3 cone speaker, f	25
Norelco Protelgram projection unit, w/Emerson 637 TV set, w/Norelco book, g	90
NSK 6" vernier caliper w/dial readout, wooden case, e	30
"On Air" sign, 4" x 16" lighted, modern	40
Parts: Box lot, antique knobs and vernier dial, 3-gang variable cap. w/vernier drive	30
Peerless cone speaker, driver, (2), g	20, 25
Peerless horn speaker, wk	85
Peerless R-1581 Gothic cone speaker, f	23
Philco 20 cathedral, AC, f	80
Philco 38-7 table, AM-SW, vg	100
Philco 38-14 table	30
Philco 38-15 table, AM-SW, f	25
Philco 40-115 table, superhet, wooden, vg	35
Philco 41-250 table, AM-SW, f	20

Philco 42-34 table, AM-SW, g	20
Philco 42-321 table, g, vg	20, 35
Philco 46-350 tambour-door portable, vg	40
Philco 46-1201 "Bing Crosby" radio-phonograph, vg	35
Philco 49-350 table, superhet, g	40
Philco 49-1405 table, radio-phonograph, vg	45
Philco 51-631 portable, g	13
Philco 60 cathedral, BC-SW, vg	75
Philco 84 cathedral, refinished, g	50
Philco 95 console, g	65
Philco 220 BC-police table, g	23
Philco 610 console, f-g	20
Philco 610 tombstone, AM-SW, f-g	220
Philco 7001 VTVM, g	35
Philco console	30
Philco E-60 cathedral, f	70
Philco factory service manuals, 1928-38 sets	30
Philco TH4 Transitone, g	45
Philco tombstone pair: 620, cabinet g, no speaker; 37-610, discolored cabinet,	120
Philips BX-326A receiver, 6-band, AM, SW, e	140
Philmore diode crystal-set kit, w/instructions	15
Philmore Little Wonder crystal set, Bakelite, vg	45
Phono turntables, (1) 45 rpm, (2)	18
Pioneer "Radio" parlor game, in box	40
Pittsburgh Radio Supply House SP2, w/(1) g BBT tube, less (1) AFT, e	675
Precision 200C signal generator, vg	20
Precision Apparatus 954 tube and set tester, w/updated adapter	15
R.E. Thompson horn speaker, vg	170
R.E. Thompson Neutrodyne, 3-dialer, vg	80
Rada Cron table clock/radio, TRF, e	200
Radio game, Bingo	40
Radio Shop (Sunnyvale, Ca.), Paramount/ Echophone A table, regenerative, w/AWA contest ribbon, grille cloth p, vg	950
Radio table, '20s, w/built-in 8" speaker, e	60
Radiola 25, w/loop, meter, refinished?, wk, vg	145
Ramstone Tri-Tube battery set, w/card	25
Raytheon 8TP-4 transistor radio, vg	70
RCA 6X5, 5-tube, shocking pink, vg	23
RCA 56X, AM, AC-DC, vg	20
RCA 100 drum speaker, (2), f, g	25, 30
RCA 100A cone speaker, driver g, e	30
RCA 100A cone speaker, nwk	25
RCA 100A speaker, repainted driver, g,	20
RCA 103 cone speaker, trim paint odd, vg	70
RCA 103A cone speaker, e	90
RCA BK-6 lavalier mike (MI-11017), e	23
RCA Radiola 16, vg	80
RCA Radiola 18, less hood, vg	30
RCA Radiola 18, on filigree cast stand, vg	80
RCA Radiola 18, w/hood, g	40
RCA Radiola 25 superhet, w/loop, meter, vg	180
RCA Radiola 60, g	80
RCA Radiola AR-812 portable superhet, vg	100
RCA Radiola III-A, w/199 tubes, vg	160
RCA small tube caddy, WT new & used	28
RCA TVM-5 signal generator	25
RCA UZ-1325 horn speaker, base p, driver g,	80
RCA UZ-1325 speaker, driver open, f	30
RCA Victor 2X61 table, vg	23
RCA Victor 8X542, vg	25
RCA Victor 9JY phono, 45 rpm, g	35
RCA Victor 45EY3, 45 rpm phono, (2), vg	35, 40
RCA Victor 56X, g	20
RCA Victor 75X12, g	25
RCA Victor 810T table, veneer loose,	70
Readrite 700 tube and set tester, in case	10
Readrite 720 tube and set tester, g	15
Realtone TR-861 transistor radio, g	35
Reception (Philadelphia), 3-dialer, g	35
Regal Electronics 205, Bakelite, brown, g	25
Regency AR136 VHF monitor set, vg	15
Regency TR-1 transistor radio, red, e	250
Regency tube amps, (1) large, (1) small	20
Reylux boy's radio, small crack	15
Rider's manuals, Vols. 1-20, w/indexes, g	300
Rider-RCA Chanalyst, f-g	35
Schneider-AES ARBE A-B-C supply, vg	70
Sencore "Hybrider" tube/transistor tester, vg	25
Sentinel 275T farm table, cabinet f	5
Shamrock 1-tube receiver, BBT, g	160
Shure 51 mike, floor stand f, e	40
Shure 55 Unidyne mike on stand, gold finish	70
Signal Corps BC-348N aircraft receiver, power supply added internally	170
Signal Corps EE-8 field phones, (2)	35
Signal Corps PG-102/CB portable pigeon cage, new, (no pigeon)	100
Silvertone 4500A table, AM, g	35
Silvertone 4500A table, f	28
Silvertone 4519	45
Silvertone 4586 console, AM-SW, g	175
Silvertone 4769 table, w/magic eye, cabinet g	40
Silvertone 6071 table, radio-phonograph, g	35
Silvertone 6424 table, g	40
Silvertone 7038 table, AM-SW, g	30
Silvertone 7166 lunchbox, portable, f	15
Silvertone 8003, steel case, vg	35
Silvertone 9005, Bakelite, brown, vg	15
Silvertone Neutrodyne, 1-dial, WT, e	70
Silvertone Neutrodyne, chassis-only, g	25
Sonora Deluxe cabinet horn speaker, driver g, vg	30
Spark coil, small, wood, HV winding, g	25
Sparton 400 table, TRF, vg	80
Sparton 867 console, g	60
Sparton AC62 table, TRF, McCullough AC tubes, w/book, vg	150
Spica ST-600 transistor radio, e	45
Standardyne, 3 dialer, WT, g	120
Stewart-Warner 300, 3-dialer, catalog, e	120
Stewart-Warner 801 table, TRF, g	25
Stewart-Warner R180A table, AM-SW, e	100
Stromberg-Carlson 325H table, AM-SW, vg	70
Stromberg-Carlson CCT-522210 (Navy ATA) transmitter, unconverted, vg	20
Stromberg-Carlson hi-fi sign, lighted, 1960s	110
Stromberg-Carlson portable, plastic/leather	40
Stromberg-Carlson AM tuner, tube-type, N.I.B.	25
Superior Electric 22A Powerstat, 0-140V, e	20
Superior TV 11 tube tester, wooden case	25
Supreme 89-D tube and set tester, g	40
Supreme 599A tube and set tester	10
"Talk Through Radio" mike, N.I.B.	30
Telegraph straight key, Bakelite base	110
Trancel 7TM-312F transistor radio, vg	55
Transcontinental ZR-4, partly disassembled	80
Trav-Ler table, TRF, f	45
Triplet 630 VOM, vg	20
Triplet 1612 tube tester, 8" meter, f	20
Tube cartons: Box lot for display	40
Tube(s): 01-A to 27, in cartons, (60±)	60
Tube(s): 01-A, (14)	110
Tube(s): 01-A, 47, 71, etc., in cartons, (35±)	60
Tube(s): 1L6, VT-25A, 5693, etc., fils g, (13)	55

(Continued on following page)

(Findlay Estate Auction, continued)

Tube(s): 2A3, used, g, (3)	55
Tube(s): 6B8 to 6Z7, octals, in cartons, (60±)	15
Tube(s): 10 (1 S-bulb, 1 ST), used, boxed, (2), g ..	50
Tube(s): 10 (4), VT25 (2), 874 (1), Tungar (1) ...	50
Tube(s): 27 to 78, in cartons, (60±)	60
Tube(s): 45, N.I.B., (5)	110
Tube(s): 45, used, g, (8)	70
Tube(s): 50 (1), 45 (3), 81, (2)	35
Tube(s): 50, used, boxed, emission tests g, (2) ..	130
Tube(s): 78 to 6B8, in cartons, (60±)	20
Tube(s): 201-A, (14)	110
Tube(s): 250TH on wood base, (2)	28
Tube(s): Big-pin (about half modern rectifiers), in cartons, (40±)	35
Tube(s): Metal-octal steel-stamped 1935, (28)	45
Tube(s): Metal-octal, steel-stamped, 1935, (6A8, 6C5, 6F5, 6F6, 6H6, 6J7, 6K7), (21)	50
Tube(s): Mullard EL37, 1 new, 1 used, (2)	15
Tube(s): Rectifiers and HV types, in cartons, (25), plus vibrators and lamps	20
Tube(s): Transmitting 203, 814, 866, TZ-40, etc., mostly new, (34)	100
Tube(s): WD11, (4)	65
Tube(s): WD12 (4), UV199 (4) (3 BB), 201A BB (1) ...	65
Tube(s): Western Electric 205Ds, fils g, (2) ..	190
Tube(s): Western Electric 215A in box and 217A, fils g	60
Tube(s): Western Electric 217A and VT-2, fils g. 130	
Tube(s): Western Electric 231D (3), (1) open, (2), fils g	25
Turner condenser mike, early 1930s, w/preamp box, nicked base, styled like RCA 4AA, w/home-built supply, finish e	1,600
Variable capacitor, huge, old	20
Variac, bench style	30
Vibroplex bug key w/carrying case, vg	130
Vibroplex bug key, less small parts, f	85
Victor Victrola VI table, crank phono, converted to horn speaker w/WE driver	70
Wega 1809 (?) table, AM-FM, case chipped ..	20
Wega 1809-1 table, AM-FM, vg	35
Wells-Gardner Navy RBL-3 VLF-LF, military, w/WWII nameplate, (USS New Jersey), vg ..	90
Western Electric 20AL candlestick telephone, made into lamp but recoverable	80
Western Electric 555W theatre horn-speaker, coils continuous, driver vg	1,050

Western Electric manual candlestick phone, bulldog transmitter, w/head receiver.	40
Western Electric manual candlestick phone, bulldog transmitter.	70
Western Electric TS-51/U radar frequency meter and wattmeter, vg	25
Western Union sounder	45
Westinghouse AC amplifier, w/199 tubes in adapters, new hinges and lid clasp	170
Westinghouse DA det/amp, NT, e	170
Westinghouse H-104 console	25
Westinghouse H-125 refrigerator, green, g	75
Westinghouse H-126 Little Jewel refrigerator, g ..	75
Westinghouse H-130 table, vg	15
Westinghouse H-621 transistor radio, vg	5
Westinghouse RA tuner, e	150
Westinghouse WR-184, 5-tube, g	80
Westinghouse WR12X4 table, g	25
Westinghouse WR15 grandfather clock, vg ..	300
Weston 519 tube and set tester, case f, vg	33
Weston 519 tube and set tester, g	18
Weston 547 tube and set tester, Bakelite, g ...	25
Weston Model 1 DC volt-ammeter, e, w/case, f ...	45
Zenith 2542 AM-FM table, vg	10
Zenith 5S127 tombstone, AM-SW, AC, g	120
Zenith 9S367 console, g	85
Zenith Deco console, g	35
Zenith H-500 Trans-Oceanic, vg	90
Zenith H500 Trans-Oceanic, original diagram and book, vg	110
Zenith H511 table, vg	30
Zenith H624 table clock-radio, g	18
Zenith J504 portable, g	20
Zenith M505 portable, e	10
Zenith Royal 500 transistor radio, vg	50
Zenith Royal 2000 transistor radio, vg	40
Zenith Royal 3000 Trans-Oceanic, g	35
Zenith Royal R705Y transistor radio, f	5
Zenith Trans-Oceanic	90
Zephyr ZR-620 transistor radio, vg	80

Photo credit: Robert Thomas, W3NE.

(Ray Chase, 1350 Marlborough Ave., Plainfield, NJ 07060; Ludwell Sibley, 44 E. Main St., Flemington, NJ 08822)

(Smith Auction Co., 1415 Horseshoe Pike, Glenmore, PA 19343)

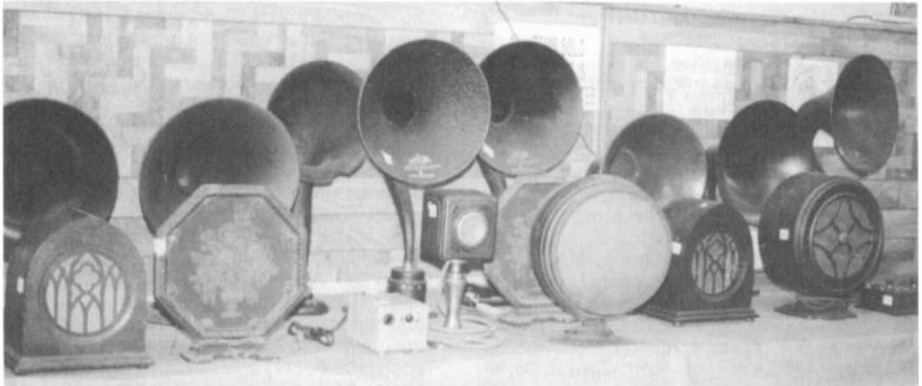

This early 1930s Turner microphone (front center) brought \$1,600, and is surrounded by a large assortment of radio speakers up for bids.



BOOK REVIEW

Evolution of the Audio Recorder

By Phil Van Praag

REVIEWED BY JOSEPH F. ESDALE

At long last there is a comprehensive book and guide about vintage tape recorders. Phil Van Praag's book *Evolution of the Audio Recorder* covers the whole story of magnetic recording from the history and theory to the restoration and collecting of vintage tape recorders, with particular emphasis between the decades spanning 1940 to 1970.

What is wonderful about this book is that it will appeal to all classes of collectors and audiophiles. Van Praag writes in a style that is not patronizing — it is fully understandable to those who don't know a capacitor from a resistor, yet can still hold the attention of the most accomplished electronics technician. His intent is not to write something that is dry and pedantic, but to create a reference work in the first person that makes readers feel they are having a genial discussion with the author about the tape recorder.

Van Praag succeeds in this endeavor, while sprinkling his book with a great number of genuinely humorous remarks and asides. One example is his comment that the Roberts Model 1000 audio recording/video recorder actually was a 3-function machine — that is, an audio recorder, a video recorder, and in the author's words, a "hernia inducer."

That the author loves tape recorders is an understatement that becomes clear as soon as one picks up this 540-page book, which begins with the theory of the tape recorder. It then proceeds with fascinating chapters on the history and evolution of recorders, special purpose recorders, service and restoration of tape recorders, as well as a guide to production models and a general price guide. There is also an appendix full of valuable resources for parts and materials and schematic diagrams for tape recorder restoration.

As good as Van Praag's easy flowing text is, the book is an absolute gold mine of tape recorder



photographs, pages from contemporaneous electronic catalogs, and reprints of manufacturers' literature. Even if one were illiterate, this book would be valuable and fun to look at just for the hundreds of great reproductions and photographs. In keeping with his easy-to-follow writing style, Van Praag also includes reproductions of several of the most imaginative and artistic electronic catalog covers of the 1940s-1950s, an art form which he correctly claims has long since disappeared.

There is so much to recommend this book that it is hard to speak to any one section. Nevertheless, Chapter 4, which deals with service and restoration, is a chapter that benefits not only tape recorder lovers, but any one of us who collects, repairs or services "vintage" mechanical and electronic equipment. If more of us would just follow Phil's advice to perform the basic check first and resist the temptation to plug our "finds" right in, we could save ourselves the costs of his book many times over.

Finally, if you are a tape recorder enthusiast, a collector, or just an audiophile, you should have this terrific reference guide.

Evolution of the Audio Recorder, is available from the publisher EC Designs, Inc., P.O. Box 33, Genesee Depot, WI 53127-0033, at a cover price of \$39.95. However, for a limited time, it is being offered at a discount. Be sure to check with the publisher for ordering information.

(Joseph F. Esdale, 1769 Eastwood, Highland Park, IL 60035)

Joe Esdale, president of Esdale Commercial Sound, Inc., has been an audio and tape recorder enthusiast for over 40 years. His company is a design/build contractor for professional sound reinforcement systems.



RADIO MISCELLANEA

"Radio Miscellanea" includes items of general interest selected from A.R.C.'s incoming correspondence. "In The Marketplace" items are based on information submitted by the businesses themselves. "From The Internet" items are obtained from internet newsgroups and other internet resources. Submitted items should be verified for accuracy; items may be edited by A.R.C. for publication, and publication is not guaranteed. See the masthead for more details.

Meet Seminars Better in Evening

Dear Editor:

On some evenings at the various club conventions, everything closes down. Attendees must then fill in the empty time, and there is absolutely nothing to do.

I make a point of being at Lansing, Elgin, and Rochester — the big meets. Conventions such as these are the place for presentations, discussion, tutorials, and the like. These sessions are always held during the day when the flea market is going on, and people don't want to be away from it. At the same time, the guy making the presentation must lose time outside.

Is there any reason why the presentations couldn't be after the dinner hour, say 7:30 to 9:00? This would offer the best evening entertainment possible. Little groups already have isolated bull sessions here and there. Why not have organized brainstorming sessions? A bit of skillful thinking would make the convention a more well-rounded affair. It would sure beat retreating to the motel room and doing little until time to hit the sack.

Doug Houston, Ortonville, MI

The Antique Radio Club of Illinois must have ESP. Note that this year, their presentations during Radiofest XVI are late in the day and in the evening. (Editor)

AK Advertising Frames

Dear Editor:

In the May 1997, *Photo Review*, Eileen Ancmen asks what kind of ads were used in Atwater Kent advertising frames. I found an October 1926 issue of *Radio Retailing* magazine, p. 105, containing "New Dealer Help Material, Aids to Greater Profits Provided by Radio Manufacturers." The following quote mentions the intended use of the picture frames: "The Atwater Kent Manufacturing Company, Philadelphia, is in a position to make shipment, direct to dealers, or to retailers via distributors, of the mahogany picture frames designed to display reprints of the company's magazine advertising which will be released shortly."

Wallace Geary, Mt. Pleasant, IA

Get Dated Bids on Paper

Dear Editor:

Don Bisbee's advice in the June issue of A.R.C., page 22, is good. Mail is preferable to phone, not so much with a large company, but with individuals. I would add that if you do get an offer by phone, you must also get it on paper, including name, address, phone number, amount of offer, and date. The date makes it legal, according to an old Army buddy of mine, and his advice has paid off for me a number of times. An example is my experience with someone who called and said he would pay \$25 over any other offer. I said OK, but I must have it on paper. I never got an answer from him.

(Color is good in A.R.C. Let's have more.)

Herb Eltz, Juniata, NE

Trans-Oceanic a TV Star

Dear Editor:

I was just wondering if anyone else does what I do. When I spot an old radio on a TV show or ad, I have to stop everything and identify it.

The best yet of any ad showing a well placed radio is the new Jurassic Park Watch/Burger King TV spot. After endless tries with the pause button on the VCR, I've concluded the radio is a Royal 1000 Trans-Oceanic.

Just why it is tuned to the 31 meter shortwave band for local news is a mistake the average TV viewer would not notice. Isn't stuff like this great?

Robert Goins, Lynchburg, VA

Australian Radio Wife Sends Kudos

Dear Editor:

My husband has really enjoyed your magazine for the past 12 months, and he has made several purchases. Sellers seem quite surprised by getting an inquiry from Australia! Thanks for a great magazine.

Jean I. Smith, North Bayswater, Australia

Overseas Mailing Inquiry

Dear Editor:

I have recently received several inquiries by fax or mail from collectors in Japan and Hong Kong concerning some relatively inexpensive items in one of my A.R.C. ads. The trouble is I have no idea how to ship packages to these countries economically, especially if the item may be worth only \$100 or less. UPS recently quoted a price of \$150-175 to Japan for a 20-pound package of parts valued at \$35, depending on actual weight and dimensions! I hate to ignore these inquiries — it doesn't seem the honorable thing to do. But neither do I want to ring up huge expenses. Are there any readers out there with experience in shipping overseas?

C.J. Poulos, Columbia, CT

Glowing Tube Substitutes Work

Dear Editor:

In the February 1996 A.R.C., page 20, Gary Strelow describes a substitute for 01-A tubes, using a FET and a photocell controlled by a pilot light.

I built one as a test, using a #47 lamp and a photocell and FET, all from the Radio Shack. I couldn't find a .004 capacitor, so I used a .0047, which is not critical. I tried it in my 1-tube reproduction Echophone Model J built from drawings supplied to me by Tom Millward, as described in his February 1995 A.R.C. article. The substitute works fine. It regenerates nicely on a simple short but outside antenna.

I'm going to make six more tube substitutes to use in my Radiola 20 or one of my Atwater Kents. This is as much fun as collecting!

Alton A. DuBois, Jr., Queensbury, NY

A.R.C. back issues are full of such fun! (Editor)



CLASSIFIED ADVERTISEMENTS

WANTED: Lists of radio stations pre-1980, including World Radio Handbook, Broadcasting Yearbook, Whites Radio Log (including photocopies). Ralph Marson, 8070 Busch, Centerline, MI 48015. (810) 754-3808

WANTED: Dumont Chatham TV, Stromberg-Carlson Manhattan porthole TC10H. Michael Storey, 412 10A St., NW, Calgary, Alberta, Canada T2N 1W8. (403) 283-3746

WANTED: No rust excellent working Radio Lamp of America, all metal with mushroom shade. Joseph DiCaro, 4155 Lastrada Hts., Mississauga, Ontario, Canada L5C 3V1. (905) 848-7759

WANTED: Juvenile books Radio Boys With the Air Patrol and Jack Heaton, Wireless Operator. Robert Stapleford, 1800 S.W. Randolph, Topeka, KS 66604-3158

WANTED: Hallicrafters S38EB, S38DB complete, clean, need not work. Buy or trade. List for SASE. Tom Mooningham, PO Box 487, Maugansville, MD 21767-0487

WANTED: Chrome chassis radios by EH Scott, McMurdo Silver, Zenith, Lincoln, others. Don Hauff, Box 16351, Minneapolis, MN 55416. 1-888-OLD-RADIO, or e-mail: DHauff@isd.net

WANTED: Pocket-size Japanese transistor radios. Roger Handy, Box 24527, Los Angeles, CA 90024. (310) 451-4040

WANTED: SSB receiving adapters such as Hammarlund HC-10 or military TMC. Byron Tatum, WA5THJ, Rt. 9, Box 163, Alvin, TX 77511. (713) 331-2956

WANTED: Japanese-made tube portable radios but no rust in battery compartment; Japanese-made early type transistor radios like Crown, NEC, Koyo, Sony, Mitsubishi and so on. Takashi Doi, 1-21-4, Minamidai, Seyaku, Yokohama, 246 Japan. Fax: 011-8145-301-8069. E-mail: taka-doi@kk.ij4u.or.jp

WANTED: Phonograph-related items: Best prices for Vogue picture records, Edison, Columbia, and any wax cylinder records, toy phonographs, needle tins and cutters, Nipper, record dusters, puzzles, fans, calendars, pocket advertising mirrors, dealer lapel pins, phonograph toys, posters, broadsides, original dealer advertising items from Edison, Victor, and Columbia. Thanks, Bernie Seimberg, 714 Moredon Rd., Meadowbrook, PA 19046-1907. (215) 886-6124. E-mail to: phonoman-bernie@worldnet.att.net

WANTED: Pair JBL 150-4C drivers. **FOR TRADE:** Martian Special, Perikon detector on mahogany base. Tim Phelan, 845 Lilybud Ct., Ballwin, MO 63011. (314) 227-9264

WANTED: Please don't sell your Zenith T-O 7G605 Clipper or R-520/URR until you call me first. Bob Davies, K7BHM, 1036 E. Carson Dr., Tempe, AZ 85282. (602) 839-3728

WANTED: Speaker for Zenith 5719 bookcase radio. Thanks! Mark Cowart, N4FBL, PO Box 550766, Jacksonville, FL 32255-0766. (904) 724-1364

WANTED: Crystal sets!!! Erwin Macho, Ambrosweg 17/A/8, A-1230 Vienna, Austria

WANTED: Hallicrafters S-28, S-80, SX-88, S-111, R-12, PM-23, 5R30, HTS, etc. Zenith consoles. Mike Talbot, 4695 MacArthur Ct., Ste. 1200, Newport Beach, CA 92660. (714) 222-2010

WANTED: Crosley crystal set, pay \$500 up. Ed Bell, 5311 Woodsdale Rd., Raleigh, NC 27606. Fax/ph.: (919) 851-1517

.....
 • A.R.C. Advertising Policy •
 • Sellers and Buyers, Please Note! •
 • Advertising is accepted only for early items •
 • related to radio, communication, etc. All •
 • items must be described fairly; reproduc- •
 • tions, reprints and not-original items must be •
 • so identified. Advertisers must agree to re- •
 • spond promptly to inquiries and orders, to •
 • resolve problems promptly if the buyer is not •
 • satisfied, and to comply with a buyer's •
 • refund request on unaltered returned items. •

WANTED: Anything Sony; pre-1960. Radios, signs, display cases, etc. Also TVs from 1970-1990, 1.5 to 5 inch only. Fax, send photo or list or bring to Elgin meet in August. Tom Christopher, 45 Boway Rd., South Salem, NY 10590. Fax: (914) 763-5936

WANTED: Nipper related items. Victor, RCA, advertising, etc. Please call. Frank Connors, 16 Windsong Cir., Bedford, NH 03110. (603) 472-9772

WANTED: Small transistor reel-to-reel tape recorders and TR mics for 50's/60's. Bob Davidson, 310 Main St., Concord, MA 01742. (508) 369-2007

WANTED: Old microphones. Astatic (JT-30, T-3, 10-D), Turner (BX/CX), Shure (707, 520, 9846B), and others, working or not. Also looking for old Hohner harmonicas for my collection. Please call. Dennis Gruenling, 26 Dupont Ave., Piscataway, NJ 08854. (908) 752-5737

WANTED: Magnabelt, Dictabelt, Memovox, wire, cylinder machines, any condition. Any information would be appreciated. Robert Norton, 527 Great Falls St., Falls Church, VA 22046. (703) 536-5329

WANTED: Mitchell, Mitchell, Mitchell appliances and radios. Need many models (but not bedlam or tall clock radios). Lee Mitchell, The Mitchell Collector, 175 E. Delaware, 8209, Chicago, IL 60611. (800) 869-7869

WANTED: Metal back for Admiral Bakelite 10" console TV. Interested in old TV's. Steve Cavell, 30144 Torry Ave., Flat Rock, MI 48134. (313) 379-3254. E-mail: cavell@wdl.net

FOR SALE: Edison memorabilia on 100th anniversary of phonograph 1978, "A Wonderful Invention" booklet published 1977 by the Library of Congress - \$50. Edison poster 29" x 19" showing Edison sitting by his first phonograph, listening to his new invention, issued 1977 by the Library of Congress - \$150. Etchings (8) from Edison's Fort Myers Museum, each - \$3. Prints from 1878 Harper's magazine and Scientific American showing Edison's phonograph, on heavy vellum, each - \$10. Plus shipping. For list of Edison, Victor, RCA memorabilia, send LSASE 55¢. J.J. Papovich, 53 Magnolia Ave., Pitman, NJ 08071. (609) 582-8279

FOR SALE: Zenith Trans-Oceanic 7G605 - \$275. Toshiba Cat's Eye w/speaker box - \$350. Realtone Comet 1088, ivory, N.I.B. - \$225. Toshiba Blue Lace w/ case - \$375. Also other high-end transistors. Allen Weiner, 80 Central Pk. West, New York, NY 10023. (212) 787-8357. Fax: (212) 496-6502. E-mail: amwcameras@msn.com

FOR SALE: (26) Vogue picture records, will trade for windup phonographs or parts. Larry Nelson, 1336 Howell, Cape Girardeau, MO 63701. (573) 334-8618

FOR SALE/TRADE: Transformers, 208/230v = 15v (v heavy), SOLA's, power, audio. **WANTED:** Arborphones, Cavacs, International Kadettes, St. Regis. Nevins Museum of Radio, Ken Nevins, 406 Jipson St., Blissfield, MI 49228. (517) 486-3019, evenings please

FOR SALE: Sams sets 116 thru 932 - \$2 ea. plus shipping. SASE for list. Leo Pedersen, 1881 Bradley Ln. LPR, Estes Park, CO 80517-6923. (970) 586-4576

FOR SALE: Excellent radio books, write for list: Paul Washa, 4916 Three Points Blvd., Mound, MN 55364-1245

FOR SALE: Older radio equipment, books, tubes, parts. List - \$1 and SASE. Joseph Bedlovics, PO Box 139, Stratford, CT 06497

FREE POSTER!

(... well, almost.)



This 24" X 30" sepia-tone poster is a great shot of vintage broadcast gear at a 1940s, small-town radio station. We give these away at trade shows, and you're welcome to pick one up at our factory, free! But if you can't make it by, just send us \$4 (stamps OK) and we will mail it to you, first-class, rolled in a protective tube.

Inovonics, Inc. 1305 Fair Ave.
Santa Cruz, CA 95060

FOR SALE: Best offers for the following: Omnigraphs, keys, sounders, pony relays, standard relays and other telegraph-related items. LSASE for photo list. Herman Fothe, 5292 Tiffany Ann, West Palm Beach, FL 33417. (561) 688-2794

FOR SALE: Have some back issues of A.R.C., Ant. Radio Gazette, ARCI, O.T.B. and Radio Age. Send 32¢ & 23¢ stamps for list. Les Rayner, 5512 N. 71st Pl., Scottsdale, AZ 85253

FOR SALE: Books, literature on radio/TV, telephone, telegraph, amateur radio. SASE for price list. James J. McGrath, W2IQJ, 2 Centerville Ln., West Seneca, NY 14224-2124. (716) 675-0160

FOR SALE: 16" transcription records of William Shirer. Any questions, call: Albert Marquis, 90 Yankee Green, Kittery, ME 03904. (207) 439-2054

**HAVE YOU MOVED? ARE YOU MOVING?
PLEASE NOTIFY US A.S.A.P.**

SEND US YOUR...

OLD ADDRESS

NEW ADDRESS and

SUB #

MANY THANKS!!!!!!

FOR SALE/TRADE: Scott 4312 FM tuner, nice original condition, in cabinet with original shipping box Akai R220S playback/record amplifier. Trade on Grundig RT40M tuner. Thomas Peters, PO Box 3925, McAllen, TX 78502

FOR SALE: N.O.S. tube specials - \$1 each: 6AC7, 6AU5, 6AX5, 6BE6, 6BK7, 6BN6, 6C4, 6CB6, 6J5, 6KA8, 6KT8, 6U8, 6X4, 50B5. Others: 6EU7 - \$8. 6CG7/6FQ7 - \$6. 6V6GT - \$7. 5U4GB - \$5.75. 5Y3GT - \$2. 7860 - \$10. Used specials: 6E5 - \$10. 5U4GB - \$1.25. 6SN7GB - 75¢. SASE for list of tubes, radios, parts & H.V. electrolytics. Just [?] organ parts and manuals. **WANTED:** AR SR-3A or SP-6 preamp. Tubes. Charles Blair, 815 N. 5th St., Cambridge, OH 43725. (614) 432-4453, 9-5

FOR SALE: Reproduction guarantee, instruction cards for Majestic Charlie McCarthy radios. Has: radio registry postcard, guarantee, service policy, instructions, parts lists, tube layout charts, schematics for Charlie McCarthy No. 1 and 2 models - \$4 postpaid. Paul Bourbin, 25 Greenview Ct., San Francisco, CA 94131. E-mail: paulbourbin@delphi.com

FOR SALE: 748 total Sams Photofacts #28-#1700, must sell all - Make Offer. For list of Sams, SASE to: John Lake, 2423 Tatham Ridge, Young Harris, GA 30582. (706) 896-4370

**Electricity Telegraphy
Telephony
Television Radio Wireless
Books and Literature**
Bought and Sold

Send for our catalog

Old Authors

PO Box 403 Morrisburg ON Canada K0C 1X0
Tel: (613) 543-3337 Fax: (613) 543-2380
e-mail: authors@mor-net.on.ca

WANTED: WWII Japanese military radio of any kind; anything WWII Japanese hardware, aircraft related. Takashi Doi, 1-21-4, Minamidai, Seyaku, Yokohama, 246 Japan. Fax: 011-8145-301-8069. E-mail: taka-doi@kk.ij4u.or.jp

WANTED: Hallicrafters S-28, S-80, SX-88, S-111, R-12, PM-23, 5R30, HTs, etc. Zenith consoles. Mike Talbot, 4695 MacArthur Ct., Ste. 1200, Newport Beach, CA 92660. (714) 222-2010

WANTED: Cutting and Washington Model 12, pay \$1,500. Also want Model 11. Ed Bell, 5311 Woodsdale Rd., Raleigh, NC 27606. Fax/ph.: (919) 851-1517

WANTED: For trade have AVR-20 rcvr. Want AVT-112 xmtr. Steve Bartkowski, 4923 W. 28 St., Cicero, IL 60804. (708) 863-3090

WANTED: Metal escutcheon for Philco 70. Metal cover for tube & coil on RCA #44 or 46. Also tube shield. Chassis for Philco 40-200 good condition. Tube shield & metal shield for tube & coil. Model 44 RCA Radiola chassis in restorable cond. Philco 40-200, also Philco tombstone Model 38-2670. Jerry Reed, 4438 S. Santa Fe Pl., Tulsa, OK 74107. (918) 446-4276

HAS YOUR SUBSCRIPTION

EXPIRED?

It has if your mailing label reads
"EXP=JUL97" or earlier.
Renew now!

**BONUS: Renew before
your "EXP" month and receive
13 issues per year instead of 12!**

Renewal rates are:
\$38.95 for Periodicals Mailing
\$55.95 for First-Class Mailing
(Two-year renewals are twice above rates.)

WANTED: Philco Model 52-942 in good/better condition. Need not work, (Bunis 2, p. 137). Tom Hunt, 3308 Grasmere, Lexington, KY 40503. (606) 223-7801

WANTED: U.S.-made Philips Type 660 VN, 4-tube fam radio of mid-40's. Will pay top dollars. Contact: N. Ahmad, 34 Saccheri Ct., Staten Island, NY 10308. (718) 966-9018

WANTED: Stromberg-Carlson 430-M console escutcheon and speaker. Denis Meany, 81 Madison St., Blue Point, NY 11715. (516) 363-0512

WANTED: 1941 Zenith black dial #26-258, pointer and 7" glass for 10S549. Ernie Mahler, 8260 S. Willow Ct., Oak Creek, WI 53154. (414) 768-8868

WANTED: Johnson Thunderbolt linear amp. Ed Fletcher, 180 Haddonfield-Berlin Rd., Gibbsboro, NJ 08026. (609) 435-7581. E-mail: vitaphone@juno.com

WANTED: Emerson Model 544, I don't care if radio plays but cabinet must be in top shape. **FOR SALE:** Radiola 18, very nice shape - \$90. Graybar 330, cabinet weathered, tubes, escutcheons OK - \$55. Jim Bumstead, 87 Sherman Ave., Williston Park, NY 11597. (516) 746-3811

**"Unquestionably the most
comprehensive
photo references on the
subject to date."**



Volume I references
1,400 tabletop radios,
individually pictured,
described and valued.
256 pgs. (1997 radio
value update included.)
Retail \$24.95

Volume II references
2,700 tabletop radios,
individually pictured,
described and valued.
360 pgs.
192 color photos.
No overlap w/ Vol. I
Retail \$28.95



Order your autographed copy of either or both books directly from the author and save:

Vol. I **\$20.95** plus **\$2.75** S&H (\$4.00 S&H Foreign)

Vol. II **\$24.95** plus **\$3.00** S&H (\$5.00 S&H Foreign)

Vol. I & II **44.95** plus **\$5.00** S&H (\$7.50 S&H Foreign)

1997 Radio value update Vol. I **\$5.95** -shipped free

SPECIAL LIMITED TIME OFFER:
1997 Radio Value Update for Vol. I will be included
with every Vol. I or II book order. (**\$5.95** Retail)

Maryland Residents add 5% Sales Tax.
Allow 3-6 Weeks for domestic orders.
Add \$3.00 per book for Priority Mail
Satisfaction guaranteed or money back!

Send Check or Money Order Payable to:
Radiomania®

2109 Carterdale Road, Baltimore, MD 21209

Or Charge Your Order:

Mail Card info to address above,
or Fax Info to: (410) 466-0815,
or E-Mail to: Radioman@crosslink.net



 **Radiomania®**

FOR SALE: 45 player parts, cartridges, needles, cycling cams, idler wheels, springs. LSASE 55c. J.J. Papovich, 53 Magnolia Ave., Pitman, NJ 08071. (609) 582-8279

FOR SALE: Majestic console radio cast iron bank - \$185. Kodak microphone lamp in the shape of an enclosed carbon mike - \$275. Reel antennae ca. 1920's antennae that looks like an oversized measuring tape - \$65. WE Suggestion Box from WE factory - \$125. Waves will be at the radio meets in Michigan in July, Ill. in Aug. and of course Rochester in Sept. Please call us if you are looking for something; we might have it and can bring it to any of the meets. Also don't forget that we are always looking to purchase. Contact: Waves, 110 W. 25 St., Suite 1005, New York, NY 10001. (212) 989-9284. Fax: (201) 461-7121. E-mail: c1wave@aol.com. Web site: <http://www.wavesradio.com>

FOR SALE: Radiola III - \$150. N.I.B. Jupiter boy's radio wristwatch - \$200. Radiola 103, mint - \$195. Radiola horn UZ-1325 - \$150. Regency TR1 red - \$450. TR1 leather case - \$25. Kent transistor radio - \$25. Crosley left-side bulls-eye 11-119U, blue, mint - \$295. Motorola Pixie, maroon - \$95. Arvin metal 341-T, sandalwood color - \$85. Zenith Trans-Oceanic G-500 with original inst. book - \$95. Mint Federal 61 with headphones - \$1,600. Crosley sub-mini tube book radios - \$175. Restored Philco 70 - \$250. Mint Grebe Synchrophase - \$250. Radiola bal. amp - \$250. Mint AK 82 - \$495. Martian Special crystal radio - \$595. Martian Big 4 - \$595. Northern Electric bullets, blue - \$185. Metallic, aqua - \$185. Majestic black celluloid horn speaker - \$150. Arvin 444, white - \$75. Arvin 444, white with handle - \$95. Federal 141 - \$195. Westinghouse Aeriola Sr. - \$195. AK 545 - \$150. AK 725 - \$150. Mini man rocket radio, N.I.B. MG-305 - \$150. Philmore rocket radio, N.I.B. VC-2000 - \$150. Commerce crystal radio - \$550. Emerson Momento - \$75. Vintage Radio, 87 Sandra Dr., Parsippany, NJ 07054. (201) 316-8424, voice or fax

FOR SALE: New on air lights - \$150. **WANTED:** (2) RCA 77 mics. Or any large mics. Mike Dupuis, 116 First Ave., Tuckerton, NJ 08087. (609) 296-4883

FOR SALE: Liquidating entire two boy's transistor collection, radio by radio. Send a LSASE for a picture list. Gary Willoughby, 5930 W. Jefferson Blvd., Los Angeles, CA 90016. (310) 559-0706. Fax: (310) 836-6518

FOR SALE: Delco car radio service manuals, 1965-1982 - \$4 ea. + shipping; 1-Superior Elect. power stat 0 to 132 Vac at .3 amps variac - \$15 + shipping. Jesse Armstrong, 220 Oakdale, Pasadena, TX 77506. (713) 473-8925



WANTED

Amrad 3670 as shown, any condition. Also a Type E crystal set, 3500-2 and other pre-1926 Amrad sets & parts.

Andrew Mooradian, 5 Priscilla Lane
Winchester, Massachusetts 01890
tel. 617-729-1873 after 7 pm

FOR SALE: 25 lbs. of books & lit. - \$25+. LSASE for detailed list. Robert Rossi, 10936 Melbourne St., Allen Park, MI 48101. (313) 386-8321

FOR SALE: Heathkit SB104-A SSB transceiver, SB604 speaker, SB614 monitor, SB634 console, SB644 remote VFO, manuals, cables, mic, excallent - Best Offer for all by July 11 + shipping. (3) vg military receivers (Federal Telephone) RBA-3, 15-600Kc, RBB-5, 5-4 Mc, RBC-2, 4-27 Mc, cables, power supplies, manuals - \$100/all 3. Pick up only! Original 1947 National Radio, 1946 Hallicrafters catalogs, exc - \$35 both. Doug Messimer, 10906 Newlands Ave., Richmond, VA 23233-1907. (804) 371-4952, weekdays 8 am-3 pm



FOR SALE: Emerson AU190 Catalin, case (cabinet) nice - \$650. Admiral Signal Corps U.S. Army radio, case CY-744/PRC, complete, original, nice - \$350. Motorola Airboy Model AR-96-23 Serial 8106, complete with RCA headphones, ant. cable, & box - \$100. Heathkit isolation transformer Model IT-1, Heath Co., Benton Harbor, Mi., nice - \$75. RCA Victor red TV Model 8-PT-70 10, all original, complete - \$350. Seeburg Wall-O-Matic 1949 3W1, chrome, nice, works, jukebox selector - \$450. Atwater Kent cathedral Model 84, all original, plays - \$500. Motorola 79XM21, 1950, green plastic - \$40. Tube CL2 12" long for 1 red four-prong Aug. 1945, Serial 1914 Westinghouse in box, seal not broken - \$350. Champion Spark Plug AM-FM radio, plays - \$75. Tandy 12-1921 Radio Corporation (Radio Shack) black candlestick phone, ex-nice, plays - \$55. Edison blue Amberola 4-minute cylinder records in boxes, (20) records, all nice, no chips nor cracks - \$200. Thomas A. Edison battery oil bottle free with records; Stromberg-Carlson amplifier Model AU R2 with tubes - \$75. RCA tubes, four 2A4 - \$100; four #1291 and adapters replacement for #45 - \$160. Three 27 MY227 Y227 - \$35. All new in boxes. Three: (12A), (PA112A), (35Z5) - \$35. Philco 40-155 1940 wood slant-front Deco cutout grille, 8 push buttons, 4 knobs, BC, SW, 8-tube, AC, (Bunis 4, p. 152) - \$75. **WANTED:** Radios that look like one book, any make. Edison Mabry, 715 W. Longview Ave., Mansfield, OH 44906. (419) 526-1175

FOR SALE: Atwater Kent radio, WT, power supply. Radio, no name, WT. Speaker Magnavox. Call: Ed Schmidt, 1865 Newark Dr., West Bend, WI 53095. (414) 334-7108

FOR SALE: Sharp PF-116, 1948, First Occupied Japan export tube radio, gold/bamboo design - \$150. Gerald Schneider, 3101 Blueford Rd., Kensington, MD 20895-2726. (301) 929-8593

FOR SALE: Hallicrafters S38 - \$85; A&B's - \$80; C - \$75; D&E - \$65; with manual shipped 48 U.S.A. Much more LSASE for list. Bob Schafer, WA7IHN, PO Box 442, Aumsville, OR 97325. (503) 749-1149

WANTED: Fada Catalin Model 652, 1000 and so on. Radio should be original, excellent condition and working. Takashi Doi, 1-21-4, Minamidai, Seyaku, Yokohama, 246 Japan. Fax: 011-8145-301-8069. E-mail: taka-doi@kk.ij4u.or.jp

WANTED: Aeriola Sr. in good original condition. Minoru Muraoka, 2-18-30-503 Kikuna, Kohoku-ku, Yokohama, Kanagawa 222, Japan. Fax: 81-45-401-1499. E-mail: muraoka@ja2.so-net.or.jp

WANTED: American Bosch radio Model 5A or 805. Please write to: Orlandini Iginio, Via Lessing 10, 00137 Rome, Italy

WANTED: VTM 9-16 "works": Radiola 18 Special, AP-736B amp, speaker, phonograph unit. Larry Boysen, 1469 16th Ave., San Francisco, CA 94122. (415) 681-8352

WANTED: Model 7-4135 GE FM/AM table radio, circa 1989. B.J. Cox, PO Box 272, Kiowa, KS 67070. (316) 825-4816

WANTED: Junker Zenith Royal 7000 for parts. Bruce Ralg, 10005 Bay Pines Blvd., #642, St. Petersburg, FL 33708. (813) 398-0966

WANTED: Radio Boys books by Chapman with dust jackets only. Henry O'Meara, 42 Aqua Ra Dr., Jensen Beach, FL 34957. (561) 229-2307

WANTED: RCA boom mic stands, RCA 10001 KU3 mic, Altec 612 cabinets. Vincent Gallo, 532 LaGuardia Pl., #600, New York, NY 10012. (212) 274-0432

WANTED: Type 930 photo tube. Thanks. J.O. Shaver, 241 Halfway Tree Rd., Baton Rouge, LA 70810-4002. (504) 765-7565

WANTED: Complete Philco Beam of Light turntable and external transformer. Jim Schwalbe, 1124 The Alameda, Berkeley, CA 94707. (510) 525-1325

WANTED: Winchester radio, table model or console. Ed Bell, 5311 Woodsdale Rd., Raleigh, NC 27606. Fax/ph.: (919) 851-1517

WANTED: Detrola console radios and phonographs. Detrola wood tabletops, cathedrals, tombstones. Scott Flaughner, 41100 Plymouth Rd., Plymouth, MI 48170. (313) 451-4221. E-mail: scottflaughner@unn.unisys.com

WANTED: Operating manual for International Projector Corp., Simplex movie projector with PS-20 sound attachment, RCA Photophone. Soterios Gardiakos, 63 S. Broadway Ave., Aurora, IL 60505-3325. (630) 844-0590. Fax: (630) 844-0591

WANTED: Fada 242, 246, 260, 254, 350, 354, 450 or 454. Merrill Mabbs, 709 Pluma Dr., Rapid City, SD 57702. (605) 342-4090. E-mail: boz@rushmore.com

WANTED: Coil (inductor) winding machine (of type common 30 years ago) in good condition. Bill Johnston, K52I, Box 370, White Sands, NM 88002. (505) 382-7804

WANTED: Deco radios; Catalin, Plaskon, Fada, Emerson, Detrola, Kadette, Garod, Motorola, Automatic, Air King, Cyart. Ross Litrenta, PO Box 41, Eastchester, NY 10709-0041. Tel/fax: (914) 337-7176

WANTED: Dial glass for RCA Model 61-5. Jim Berg, 4261 Wilcox Rd., Box A, Northport, WA 99157. (509) 732-4047

WANTED: Crosley radios from 50's like D25, E10BE, E15TN, 11-104 and so on. Radio should be original, excellent condition and working. Takashi Doi, 1-21-4, Minamidai, Seyaku, Yokohama, 246 Japan. Fax: 011-8145-301-8069. E-mail: taka-doi@kk.ij4u.or.jp

WANTED: Rek-O-Kut B6H, B12H, N34H turntables, Empire 208. Cage for Marantz 8B, Magnepan MG-1, SMG-A. Jack Smith, 288 Winter St., North Andover, MA 01845. (508) 686-7250

A. G. Tannenbaum

Electronic Service Data

PO Box 386, Ambler, PA 19002

Phone: (215) 540-8055

Fax: (215) 540-8327

THE



FOR

**Vintage Parts & Service Data
1920's - Present**

Free Catalog

Credit Cards Welcome

**Browse our web page at
www.agtannenbaum.com**

YARD SALE!

(GRILLE CLOTH)

\$20 per yard (51" x 36") for any quantity of yards of these patterns: #15, 16A, 17, 19A, 20, 21, 22, 23, 24, 25, 26, 27 until gone.

\$15 per yard for #11 - until sold out.

4 New Patterns!

#30 and 31 are not what I expected so I'm selling them cheap to recover my costs - \$12/yard! (36" x 44"). (If you can use a low cost generic look, this works.) #32 is a rust-colored Philco 90 type pattern for late 30's Zenith. #33 is for Buddy Boy, Kennedy tombstone and Temple speaker, and others.

**Send 55¢ LSASE (4"x10")
for full set of samples.**

MICHAEL KATZ

3987 DALEVIEW AVENUE

SEAFORD, NY 11783

(516) 781-6202 (EVENINGS/WK-ENDS)

FOR SALE: Facing surgery, must sell books. Following are \$17 each plus \$3 shipping, 5 or more - free shipping. Everybody's Radio Manual by Popular Science, Radio Experimenter-Pop. Science, Electrical Essentials of Radio, Servicing Record Changers, Pin-point Record Changer Troubles, Sams Record Changer Manual Vol. 3, Practical Radio Communicator, Electron Tubes in Industry, Encyclopedia of Electronic Circuits. Maurer Television, 29 South 4th St., Lebanon, PA 17042. (717) 272-2481

FOR SALE: Everything from 1960's TV station: RCA 2" VTR TR 22HB. Raytheon STL, KTR100, antennas & rack mount. Raytheon STL transmitter & receiver for live remotes. (3) RCA studio cameras TK-44. Many monitors. RCA TV transmitter TT2H ch 1. RCA TK29B film chain TP66 16mm complete. Projector, TK29, TR15. Multiplexer. 3" coax switch. Reject loads, modulation monitor, etc. Tubes, spare parts, etc. RCA TV projector. SC vacuum pump. Camera cables. Carbon arc spotlight. (2) Simplex E-7 35mm projectors w/light housing from drive in! James F. Phillips, The Great Wireless Talking Machine Inc., 414 Washington Ave., Defiance, OH 43512. (419) 782-8591. Fax: (419) 782-3299

FOR SALE: Going to Elgin?? Stop in Kansas City for some great radios!!! Zenith 9S244, 9S262, Royal 3000, transistors, 25-tube Capehart, RCA combo ca. 1960, Lone Ranger, shop til you drop!! Call ahead. Claude Chafin, NØFMO, 4223 E. 42nd Way, Independence, MO 64055. (816) 478-4518

FOR SALE: Collins R388 (51J-3), vg condition - \$400 + UPS. Bob Zimmer, NV1X, 205 Brigham Hill Rd., Milton, VT 05468. (802) 879-7235

FOR SALE: Selling: Dry transfer lettering, Philco cover for #47-900E# - \$15. Agreed? Renee May, 1242 N. El Centro Ave., Los Angeles, CA 90038. Ph/fax: (213) 464-9179

FOR SALE/TRADE: Radiola horn speaker UZ1325 in fine condition - \$95 plus UPS. Paul Fulton, 711 Jacquelyn Rd., Westwood, NJ 07675. (201) 664-5260

FOR SALE: Drum speaker, RCA Model 100, good condition, works - \$45 plus UPS. George Greenberg, KD4OBV, 1701 Andros Isle K2, Coconut Creek, FL 33066. (954) 971-9053

FOR SALE: Working Magictone whiskey bottle radio, some decal damage - \$250 plus shipping. L. Schimmel, 17411 Yakima So., Spanaway, WA 98387

FOR SALE: Sams, below 1000, as low as - \$1 ea. Must sell, overstocked. Send SASE for list. John E. Kendall, PO Box 436, Fallston, MD 21047

WANTED

WESTERN ELECTRIC

TUBES, SPEAKERS, HORNS & AMPS

TUBES: Telefunken, Genalex, RCA, Radiotron, etc. General Electric, AmpereX, JAN, Sylvania, GEC, National Union

McIntosh, Marantz, Dynaco, Jensen, Linn, Levinson, Fisher, Leak, Tannoy, Altec, EV, Thorens, EMT, JBL ... Amps, Spkrs., Turntables

MAURY CORB

12325 Ashcroft, Houston, TX 77035

Tel: (713) 728-4343

Fax: (713) 723-1301

FOR SALE/TRADE: Crosley #26 chassis, NT, excellent condition - \$75 plus UPS. David Buck, 3630 Wilcox St., San Diego, CA 92106. (619) 224-5821. E-mail: whnf46a@prodigy.com

FOR SALE: Megger, nice leather case - \$15. Triplett modulation monitor Model 1295, two meter style - \$15. Gordon Wilson, 11108 50 Ave., Edmonton, Alberta, Canada T6H 0H9. (403) 434-6257

FOR SALE: All speed turntables with 45 adapter, fabricated 16" transcription turntables, 78 players. Phono parts. West-Tech, PO Box 1415, Sebring, FL 33871. (941) 471-0922

FOR SALE: Fada 652 yellow/red trim - \$800. Emerson 400 Aristocrat brown/brown trim - \$600. Don Ausc, 82 Penn Rd., Jeannette, PA 15644. (412) 523-9204

PHONE NUMBER FOR ANTIQUÉ RADIO CLASSIFIED (508) 371-0512

Best time to call is weekdays:

8:30 am to 6 pm Eastern Time

(Please no classified ads by phone. Thanks!)

FOR SALE: My battery Philips Norelco blk. leather chrome dial, mint condition, 4 band, LW-SW-BC-FM, (5) push buttons, Type L SX287/01 - \$60 inc. ship. H. Weinborn, 12222 S.E. 41st Ct., Milwaukie, OR 97222. (503) 652-7224

FOR SALE: Old wire recorder, Dictascriber by Magnetic Corp. of America, appears complete, not tested approx. 12" square, heavy - \$100 including UPS. H. Andreoni, c/o 250-D So. Lyon Ave., Hemet, CA 92543

FOR SALE/TRADE: National NC-125 with matching speaker, good cosmetics - \$200 or trade for nice SX-117. Steve Pazar, 4950 Deerwood Dr., Santa Rosa, CA 95403. (707) 544-8142

FOR SALE: Heathkit SW717, working nice - \$35 plus postage. Reply: Elmer H. Jorgensen, 3535 E. Cook Lot 181, Springfield, IL 62702

FOR SALE: Tubes, tubes, radio, TV, ham industrial, odd ones, 9 pages free for SASE. Chuck Vaccaro, 708 Booth Ln., #J3, Ambler, PA 19002. (215) 646-3641

FOR SALE: Electro-Voice 950 oval chrome microphone with accessories, excellent original condition - \$230. John Poore, 1120 Driftwood Dr., Lincoln, NE 68510. (402) 489-8648

FOR SALE: Farfisa dual keyboard organ, professionally restored, complete - \$750 + shipping. **WANTED:** Marvel violet ray attachments. Charles Zafonte, N1FRX, RR3 Box 2075, Fort Kent, ME 04743. (207) 834-6273, eves.

FOR SALE: Colonial Globe, 1933, brown, fair condition, no cracks, not working - \$600. Paul Lisowski, 5603 E. 100 N, Knox, IN 46534. (219) 772-2021

FOR SALE: Detrola Jr. - \$125. Emerson 211 - \$115. RCA 45X1 - \$100. Transistors: Philco T4J124 - \$55; GE P850G - \$35; Sony TR730 - \$60; Brionvega TS502 (A.R.C. 1/97, p. 6) - \$425; Motorola X11B - \$25. McIntosh integrated amp MA230 - \$575; Scott receiver 340 - \$295; Knight multiplex KNMX3 - \$45; Calrad Crossover CN3 - \$30; Fisher Multiplex MPX200 - \$115; Rockola 1422 parts. All items electronically unrestored. **WANTED:** Deco radios and parts. Ross Litrenta, PO Box 41, Eastchester, NY 10709-0041. Tel/fax: (914) 337-7176

WANTED: Japanese Koyo made subminiature tube portable radios; Japanese-made early type transistor radios. Takashi Doi, 1-21-4, Minamidai, Seyaku, Yokohama, 246 Japan. Fax: 011-8145-301-8069. E-mail: taka-doi@kk.ij4u.or.jp

WANTED: Kits (prefer unbuilt), course & student materials from correspondence schools in radio. A.J. Sabin, 315 S. Plymouth Ct., Chicago, IL 60604. (312) 987-1441

WANTED: Zenith potted power transformer Part Number 95-705, for a Model 7S-530 radio. Tom Bates, 11322 Gaymoor, Houston, TX 77035. (713) 729-1982

WANTED: Broadcast and recording gear: mic preamps, RCA gear, line amps, quality mics, Daven pots, compressors and limiters. Jim Kollens, 29 W. Commercial, Addison, IL 60101. (630) 691-8890, evs., or (630) 628-0810, days

WANTED: Set of circuit boards for Heathkit GR-2001 color TV. John Phipps, 1412 Navaho Trl., Saint Charles, MO 63304-7325

WANTED: Philco 41-280 escutcheon. Sonora RCU-208 dial knobs. Philco 42-340 dial, pointer, knobs. Charles Phillips, 8607 Rembrandt Cir., Newark, DE 19702

WANTED: Printer and program card for Apple 2e computer to make a word processor. Alton A. DuBois, Jr., 67 Peggy Ann Rd., Queensbury, NY 12804. (518) 792-3130

WANTED: Realistic TRC-459, TRC-458, TRC-426, TRC-490 CB's. L. Stowers, 522 Center Way, Lake Jackson, TX 77566. (409) 299-1897

WANTED: Eveready radios, speakers. Old flashlights, related items. Flashlight Newsletter - \$12/year. Bill Utley, PO Box 4095, Tustin, CA 92781. (714) 730-1252. E-mail: flashlights@worldnet.att.net

WANTED: Stancor transformers PC-8412, PS-8415, UTC LS 20, HA137, and Peerless G-252-Q. I am also looking for Western Electric chokes and power transformers. Purchase or trade. Michael Payne, 803 S. Taylor, Alvin, TX 77511-3434. Voice: (281) 331-9217. Fax: (281) 585-2727

WANTED: Arvin Model 852P AC/DC portable, circa 1957, preferably red. Tony Herzog, 402 Walnut St., Ridgway, PA 15853. (814) 772-5256

WANTED: Electron tubes, ball bearings, radio & aircraft receivers & transmitters, connectors, lamps, relays, switches, breakers. Hy Ness Company, 709B Delair Rd., Cranbury, NJ 08512-4212. (609) 395-1116. Fax: (609) 395-1117

WANTED: Chassis or chassis parts or salvageable radio, Hammarlund-Roberts slant-front 2 dialer, ca. mid-20's. Any help appreciated. Dale Davenport, 622 S. 18th St., Ft. Smith, AR 72901. (501) 785-4929

WANTED: RCA KS-38 or MI-11056 boom mic stands, McIntosh MI-60 amps. Vincent Gallo, 532 Laguardia Pl., Suite 600, New York, NY 10012. (212) 274-0432

WANTED: RCA 813K console, Truetone D-911 table radio, antique radio lightning arrestors. Bob Eslinger, 20 Gary School, Pomfret, CT 06259. (860) 928-2628

WANTED: Fada 254, gold trim; Fada 260v; no cracks, with backs. Karen McCoy, 8104 N.W. 114, Oklahoma City, OK 73162. (405) 722-0595

WANTED: The following Tom Thumb radios for my collection: 1930 cathedral, 1933 Jr. in Bakelite cabinet, 1939 Model 933 in metal cabinet. George A. Fathauer, 116 N. Roosevelt, Ste. 121, Chandler, AZ 85226. (602) 961-5176. E-mail: snrnpub@aol.com

WANTED: Kenwood VC-10 converter, 118-174 MHz for the R-2000 receiver. Bob BAKINOWSKI, 1524 Saint Tropaz, Tucson, AZ 85713. (520) 624-8029

Announcing 

Our Annual Summer

ANTIQUE RADIO SWAP MEET

DeVry Institute - Parking Lot
1350 Alum Creek Drive
Columbus, OH 43209
(Exit 103B Off I-70 East)

Sponsored By

Central Ohio
Antique Radio Association

Saturday
July 19, 1997
7:00AM - NOON

For Details Or Reservations Call
Chuck Davis (614)792-6237

Admission FREE For Buyers
Sellers Setup Fee is \$10 For Members - \$15 For Non-Members



www.machineage.com

Machine Age provides antique radio dealers the Easiest and Most Professional way to buy and sell on the Internet.

Log in and enjoy:

- An All-New Interface
- World-Famous Radio Dealers
- Free Searchable Classified Ads
- Twentieth Century Design and Technology

Machine Age is free to buyers; low cost to dealers. Call for details:

(800) 818-0570

PUETT ELECTRONICS

PO BOX 28572 DALLAS TX 75228 U.S.A.
PHONES - 214-321-0927 - w/ANS. MACHINE
214-327-8721 - WITH FAX

CATALOG NO. 8

80-PAGES

CATALOG \$5.00 POSTPAID

\$5.00 DISCOUNT COUPON WITH CATALOG
APPLICABLE TO A \$20.00 OR LARGER ORDER

WE OFFER - MORE THAN 2,300

DIFFERENT ANTIQUE RADIO BOOKS AND
PUBLICATIONS FROM 1902 UP, HIGH-QUALITY
BOUND REPRINTS - HISTORICAL BOOKS,
INSTRUCTION & SERVICE MANUALS, ETC.

BY NEARLY ANY MANUFACTURER FOR
RADIOS, TEST EQUIPMENT, COMMUNICATIONS
RECEIVERS, HAM GEAR, ETC.

WE OFFER TUBES, OLD-TIME RADIO SHOWS
ON CASSETTES, SCHEMATIC DIAGRAMS, AND
MUCH MORE!

ORDER YOUR CATALOG TODAY! SUMMER SALE

JULY - AUGUST - SEPTEMBER 1997
SCHEDULED TO EXPIRE 30 SEPTEMBER 1997 - BUT
SUBJECT TO EXPIRATION WITHOUT NOTICE.

50% DISCOUNT

ON ALL MERCHANDISE IN CATALOG NO. 8
WITH EXCEPTION OF TUBES WHICH ARE OUT OF STOCK.

HOW IT WORKS

- (1) ADD TOTAL COST OF ORDERED MERCHANDISE.
 - (2) DIVIDE BY 2 TO RECEIVE 50% DISCOUNT.
 - (3) ADD ONLY ONE \$2.00 HANDLING FEE WITH ORDER.
 - (4) USE THE FULL NON-DISCOUNTED TOTAL OF YOUR MERCHANDISE TO DETERMINE YOUR SHIPPING COST FROM THE CHART ON BACK OF ORDER FORM OR FROM THE BACK OF THE CATALOG FRONT COVER.
 - (5) TEXAS RESIDENTS ADD 8.25% STATE SALES TAX BY STATE LAW APPLICABLE TO TOTAL OF MERCHANDISE PLUS HANDLING AND SHIPPING COST.
- YOU PAY NO STATE SALES TAX IF YOU DO NOT LIVE IN TX.

NO OTHER DISCOUNTS OR COUPONS
WILL BE ACCEPTED IN COMBINATION WITH THIS
SPECIAL 50% DISCOUNT SALE.

PAYMENT ACCEPTED BY

MASTER CARD/VISA, CHECK OR MONEY ORDER.
ORDER BY TELEPHONE. FAX, OR MAIL!

SHORT WAVE LISTENERS BROADCAST BAND LISTENERS

SUBSCRIBE TO

ANTIQUE RADIO TOPICS

THE RADIO DX ASSOCIATION BULLETIN

REGULARLY \$10. SUMMER SPECIAL \$7. FOR
ONE YEAR - SIX ISSUES

YOU RECEIVE REPORTS ON STATIONS WHICH HAVE
BEEN HEARD, LISTS OF SOURCES FOR SWL/BCL
RECEIVERS, EQUIPMENT AND BOOKS,
TESTS ON VARIOUS RECEIVERS. AND MUCH MORE!

SUBSCRIBE TODAY!

THE PUETT ELECTRONICS ANTIQUERADIO CLUB

WE OFFER 20 DIFFERENT SERVICES AND
DISCOUNTS, THE NEW ACQUISITIONS LIST TO
MEMBERS IN WHICH WE OFFER RADIOS, TEST
EQUIPMENT, BOOKS, RARE TUBES ETC.

REGULAR MEMBERSHIP - \$15. SUMMER SPECIAL \$7.

FOR SALE: A few scarcer books this month: Principles of Radio Communication 2nd Edition 1921, U.S. Army includes antique tube information - \$45. Essentials of Electricity, 1912, Textbook for Wiremen and Electricians - \$40. Practical Electricity by John C. Lincoln, 1924 - \$35. RCA Radiotron Designers Handbook, 3rd Edition - \$45. Radio For the Millions, Popular Science - \$25. All plus shipping. Maurer Television, 29 South 4th St., Lebanon, PA 17042. (717) 272-2481

FOR SALE: 1921 Westinghouse BC-98-A receiver with replacement clock, tube deck - \$600 or trade toward Baird Telesior, DeForest RJ4, or Stock Ticker. James Chisman, PO Box 1111, Clemson, SC 29633. (864) 639-2939

FOR SALE: Hammarlund speaker - \$75. Pilot T521 - \$35. Norelco AM, FM, SW - \$45. National NC60 - \$40. Test equipment - \$25 ea. Charles Voigt, 94 Cleveland St., Norfolk, MA 02056. (207) 338-6355, (508) 528-7928

FOR SALE/TRADE: My extra AR's, TR's and Photofacts. Send SASE for list or call: Lois Rasmussen, 1107 W. Jefferson St., Joliet, IL 60435. (815) 744-4565

FOR SALE: Three sets Rider's manuals. Also Sams from 11 thru 146. Extra low price if you pick up. Willie Carr, N4XE, 2739 Colonial Ave., Roanoke, VA 24015-3835. (540) 343-5606

FOR SALE: RCA WV-98C VTVM, good cosmetic and working condition, no probe - \$45. Steve Pazar, 4950 Deerwood Dr., Santa Rosa, CA 95403. (707) 544-8142. E-mail: steve.zarco@worldnet.att.net

FOR SALE: Western Electric WUIU.S. Army airplane radio receiving set Type SCR59 - \$865. Ken Smith, 55 Howard Ave., Staten Island, NY 10301. (718) 448-3738

FOR SALE: Spartan Cloisonne, have mint front panel and perfect chassis, no cabinet - Best Offer. Joseph Bettencourt, 75 Theresa St., So. Dartmouth, MA 02748. (508) 997-8076

FOR SALE: Oldradios 1930s, 1940s, Zenith tombstone, Philco cathedral, ornate Gothic, Federal, LaFrance, Gilfillan, Motorola, (50) more. Beta VCRs, high quality VHS VCRs. Fisher 500 TX stereo receiver, more. Tube amplifiers. Call: Charles Seidel, Box 1500, Merlin, OR 97532. (541) 474-2596

FOR SALE: Radios, mics, SASE list. NRI-33 signal-tracer, works, manual - \$25 + UPS. Tom Tetzlaff, 23 Nelson Dr., Silver Bay, MN 55614. No phone

FOR SALE: Large box of tubes. (3) old working TVs. (1) old not working TV. (1) Beta play, not working. Entire lot - \$200 advance payment. Delivery free 100 mile radius London, Ky. Details, leave number. Scott Thomas, PO Box 935, London, KY 40743-0935. (606) 528-7138, (606) 526-9910

FOR SALE: 125 radio collection. Send for list: Dave Pewowaruk, 931 23rd St., SE, Rochester, MN 55904. (507) 280-5975. E-mail: hp95@aol.com

FOR SALE: Philco 411-250 slant-front, plays - \$75. GE Model 67 clock radio, plays - \$40. Gary Nitkin, 102 Long Highway, Little Compton, RI 02837. (401) 635-2816

FOR SALE: Book: Crystal Set Projects, fifteen building projects - \$10 ppd. Ross Wollrab, 229 N. Oakcrest Ave., Decatur, IL 62522-1810. (217) 428-7385

RADIO CRAZE

John Sakas po box 4124 So. Hackensack NJ 07606-4124
 Phone (201)794-0437 ~ Fax 24 Hours (201)794-8359
 visit our web site at <http://www.radiocraze.com>

WANTED



AIR KING SKYSCRAPERS

paying \$12,500.00+ for near mint condition red or blue
 \$8,000.00+ for green, lavender or yellow
 \$3000.00+ for black and \$2000.00+ for white or brown

I also buy parts sets, they don't have to be MINT
ALSO WANTED ANY COLOR-ANY CONDITION
 COLLECTOR PAYING TOO MUCH, CALL ME LAST

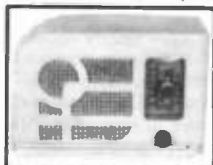

TOM THUMB RADIOS WANTED

paying \$2500.00+ for any mint one and
 \$6000.00+ for mint cond. red, green, orchid, blue or gray

ALSO WANTED ANY COLOR-ANY CONDITION

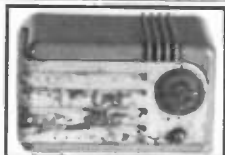

DETROLA PEE WEE & SUPER PEE WEE WANTED

paying \$600.+ for mint cond black, white
 \$1000.+ for beate, gray, salt & pepper
 \$2000.00+ for red, blue \$3000.+ for green or lavender

WANTED ANY CATALIN RADIO

FADA 115, 116, 200, 1000, all yellow \$575.00, maroon & yellow \$675.00
 yellow & red \$800.00, pea green \$900.00, blue & yellow \$2,000.00
 EMERSON AU 190 & BT 245, yellow \$1,200.00, green \$1,700.00
 dark red \$2,250.00, blue \$4,250.00, bright red \$11,000.00
 FADA L56, F55, S2, 5F50, 5F60, 136, 53X, yellow \$900.00
 light green \$1,350.00 maroon & yellow \$1,500.00, yellow & blue \$1,700.00
 yellow & red \$2,400.00, yellow & bright green \$2,500.00,
 blue & yellow \$5,500.00, emerald green & yellow \$5,750.00
 HALSON any color \$1,500.00 to \$5,000.00
 SPARTON CLOISONNE any color \$2,500.00 to \$5,000.00
 MOTOROLA 50XC green & yellow (UNRESTORED ONLY) \$4,250.00
 EMERSON BM 25H yellow \$750.00, green \$1,350.00
 red \$1,850.00, blue \$3,000.00
 DeWALD A501 (HARP) brown \$300.00, yellow \$400.00, red \$1,000.00
 ARVIN 532 any color combination \$1,350.00, EMERSON 520 \$60.00

always buying any catalin or pre-war colored bakelite radios
 we will buy one piece or entire collection
 watch out there's a new guy in town

FOR SALE



FADA 454

Brown Bakelite with Bakelite back, Mint, Hums \$325.00

F
O
R

S
A
L
E

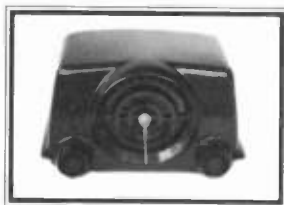

Crosley 11-101 U

Dark Blue Painted Bakelite, mint, not working \$395.00
 Orange Painted Bakelite, Near-mint, working \$325.00

F
O
R

S
A
L
E

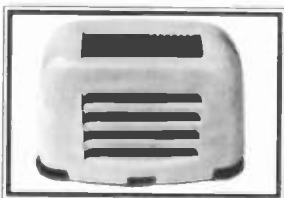

K.B. (Toaster) FB-10

White Bakelite, Mint, Not Working \$395.00

F
O
R

S
A
L
E

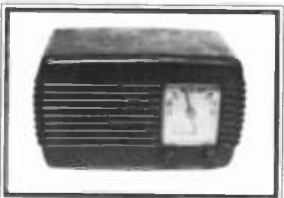

Federal 1040-TB

Brown Bakelite, Near-Mint, untested \$89.00

F
O
R

S
A
L
E

ALL PRICES ARE WITHOUT
 SHIPPING CHARGES

E V O L U T I O N

of the Audio Recorder

The "Vintage" Years: late '40s - early '70s



Theory · History · Restoration · Identification · Prices

by Phil Van Praag

- * the definitive wire & tape recorder guide
- * over 500 pages, with over 500 illustrations
- * over 125 brands, hundreds of models
- * over 250 color photos
- * simplified theory of magnetic recording
- * history & evolution traced: '40s - early '70s
- * service & restoration tips
- * coverage of special purpose recorders
- * identification & price guide
- * first 500 receive numbered, limited edition signed by author

For a limited time: **\$34.95** (\$39.95 cover price)

Please add \$3.00 pack / ship, except Canada \$7.00
WI residents add 5% sales tax.

**The only book
of its kind!**

Send check or money order to:
EC Designs, Inc., P.O. Box 33,
Genesee Depot, WI 53127

FOR SALE: Cool metal Biplane radio, Japanese - \$65. Big '50 Grundig 4088 multiband, exc - \$165. Philco Predictas (3), RCA TV #140P020 - \$55. Crosley Musical Chef, white - \$23. Bulova 103 clock radio - \$19. Pierre Cardin FM rcvr - \$9. Minolta 16 spy cam w/case - \$44. Phantom linear amp \$75. Zenith upside-down Bakelite radio - \$65. Koyo trans. AM/FM #RCA blonde phono w/ Nipper grille (comm'l) - \$89. Old Philco G-8000 VHF to UHF conv. - \$35. Early Delmonico (JVC) mini TV w/pwr - \$45. Zenith Trans-O 1000 - \$26. Royal 450V, pink - \$45. Kenwood comm/rcvr R-300 - \$45. Crosley/ Telechron JC-8WE, unique! - \$45. Valiant Deluxe transistor 10 - \$38. Admiral PR93 bicent. in box - \$13. Electreat Quacker in box - \$28. Slenderizer quack dev., exc - \$45. Dumont radio sign - \$75. 30's Lafayette HE-99 comm. rcvr - \$25. Eico 753 trans/rec - \$65. Echophone comm'l EC-1a - \$45. Heath HR-10 rcvr - \$19. Christy electronic tester (kit) - \$37. Short Wave Craft, 7 mags., 1936 - \$9 ea. Western Electric 15b Mainline Sounder - \$145. Jewel 10 tran. (USA), olive - \$35. Signal Corps freq. meter #BC-221-Q 125-20,000 Kc - \$55. Mil. rec/trans ST-70 built - \$65. Pack antenna, 8 lbs., extends to 32 feet! w/struts & balun. - \$95. Regency ACT-CAU early SS scanner - \$45. Hammarlund HQ-129X, exc - \$250. True breadboard old, old. Most Needed Radio 39, 40, 41, 42, 46-53, 55, 59; TV 48, 26-38 - \$125/all. Juliette - \$25. Sears Forward Observer walkies 1963 - \$28/pr. 2043 AM/FM Maytag - \$24. Sanyo TR-6 - \$19. Sears maple clock/hidden radio - \$35. Zenith R490 - \$18. Quack Bacti-Cinerator - \$22. Arvin 10 twin dial - \$29. Novelties: Charlie's Angels watch radio - \$28. Delco Voyager batt. radio - \$17. Japanese Stutz conv. #3288 - \$19. Pan. cig-box radio - \$14. Holly Hobby - \$23. Japanese canon - \$35. Bone-fone - \$12. Royal 97 nav. - \$28. 70's GE picture radio - \$12. Guild phone tube - \$49. Roll top - \$165. Hallicrafters S-120 - \$29. Philco mini rad-phonograph 713, red - \$15. Elgin 10 port. - \$16. JVC 3050 TV '76 w/pwr - \$55. Crown Melody Coins radio bank - \$65; world globe - \$85. Sharp BP-485 N.I.B. 9 trans. - \$35. In box BP-200 - \$22. Americana FC-60 - \$11. Emerson 911 Eldorado - \$39. Coke machine radio - \$11. Knight's head - \$9. Philco CR-4 car radio comp - \$19. Zenith Royal 12 - \$9. Longines Stereo Travler - \$18. Kowa BX-901A AM/FM - \$24. Sonys!: Mini camera & monitor, pro - \$55. GE Convertible, exc - \$38. TV-520 TV - \$18. TFM-3700w - \$13. TFM-121A AM/FM w/case - \$45. Digimatic 6RC-15 AM - \$9. '86 Trinitron 10" - \$95. ICF-150 - \$115. TFM-3700W AM/FM mini - \$18. TFM-116L multi - \$30. 8F-35W w/stereo adpt. - \$25. EN - \$48. 5F90w - \$12. Motorola Ranger - \$19. Turquoise! Mod 56L4 - \$45. Standard TR-8 - \$35. Toshiba IC-70 AM/FM - \$15. Sony 8F-35w w/stereo adp. - \$45. And Sphere clock radio inop - \$35. Jeff VanAssche, 103 W. Silvermeadow, Midwest City, OK 73110. (405) 732-5747. Fax: (405) 741-0458

FOR SALE/TRADE: Hallicrafters Model SX110 w/ speaker, near mint - \$300. Hallicrafters SX133 w/ speaker, nice condition - \$350. Hallicrafters S40A, nice condition - \$250. Plus UPS. Trade in your DAV mini keychain license plate tags for \$2 ea. off any radio or pay you cash. John Williams, Jr., PO Box 1545, Scarborough, ME 04070-1545. (207) 775-4212

FOR SALE: Five different Grundig sales brochures, showing eighty models from 1960's, 1970's - \$10 ppp. Ellsworth O. Johnson, 364 S. Coeur d'Alene St., Spokane, WA 99204-1063. Phone/fax: (509) 838-2161

WANTED: N.O.S. tubes OA2, 6CM6, 6CZ5, 6EM5, 2050, 502A. Paying \$1 ea. Bob Putnak, 1507 4th St., Monongahela, PA 15063. (412) 258-6236

WANTED: Coil (inductor) winding machine (of type common 30 years ago) in good condition. Rider's 18, 21, 22, 23 very good or better. Army TM's from 1950's and 1960's covering basic DC and AC electricity, circuits, vacuum tubes, transistors, passive components, motors, synchros, etc., to replace my set lost in a move. Bill Johnston, K5ZI, Box 370, White Sands, NM 88002. (505) 382-7804

WANTED: Wurlitzer AC/DC plastic radio designed by Russell Wright. Stephen Mauck, 428 S. Purdy, Lyons, KS 67554. (316) 257-5582

WANTED: Front cover for Sony CRF320A shortwave receiver. State price. Arnold Giron, PO Box 862533, Los Angeles, CA 90086. (213) 221-9211. (213) 622-8646

WANTED: For Star SR700A receiver: Manual and/or schematic, speaker, other Star receivers. Harry Blesy, N9CQX, 9S740 Clarendon Hills Rd., Hinsdale, IL 60521. (630) 789-1793

WANTED: For Airline 62-357 console: Whatever goes in center of "telephone" dial ring. Will pay your price. Chuck Regen, 2724 N. 27th St., Sheboygan, WI 53083

WANTED: Dial glass and front dial cover, or entire cabinet for Sonora Model RCU208. Herman Schnur, Rt. 3, Box 151, Greenville, NC 27858. (919) 752-2264

WANTED: Rotating disk Wimshurst static generator, or Holtz machine, Crooke's and Geissler tubes. New address! Louie Scribner, 510 Linden Rd., Pinehurst, NC 28374. (910) 295-8050

WANTED: 2 1/2" meter 1 amp RF. 7 to 7.15 MHz FT243 crystals. Still looking for pre-WWII comm-CW ham xmtr 10-50 watts. William G. Tumer, W2WV, 1243 Oakview Ave., Clearwater, FL 33758. (813) 447-7707

Call the CHRS Hotline: 415/821-9800

YOU DON'T HAVE TO LIVE IN CALIFORNIA ...TO BENEFIT FROM CHRS

- Four Journals per year. *"The finest radio club magazine in the nation."*
- Join now and receive *Hints & Kinks*, a valuable collection of restoration articles from 20 years of CHRS.
- 14 collector's events scheduled for 1997 all over Northern and Central California.
- Members receive access to the CHRS technical reprint service.
- All this and more for \$20 per year.



California Historical Radio Society
PO Box 31659
San Francisco, CA 94131
<http://www.wp.com/chrs>

WANTED: Radiocraft tuning dials. Gooseneck/bell for Magnavox R-2B hom. AK 80 cabinet. Bob Nicholson, 3423 S. Long, Topeka, KS 66605-2486. (913) 266-9473

WANTED: Faceplate for early Crosley 51, tapped contact switch at top of panel. Randy Belk, 918 West 58th St., Davenport, IA 52806. (319) 391-6255

WANTED: Chassis for Zenith cathedral Model 210-5. Also want cylinder phonograph or parts. Jim Allen, 420 S. 46th, Lincoln, NE 68510

WANTED: EV 605/905/638/641, Hi-Z. Shure 545/707A/520/440, Hi-Impedance; R7/R45/R5/R55 elements. Mic parts & connectors. Tom Ellis, Box 140093, Dallas, TX 75214. (214) 328-3225. Fax: 328-4217. E-mail: 74053.3164@Compuserve.com

WANTED: HRO-5 coil sets. Have coil sets A thru F, need all the rest. State price and condition. Can trade N.O.S. We 328A's for them if necessary. Also need large rolling inductor. F. Fuhrer, PO Box 3, Kent, AL 36045

WANTED: Turquoise Bulova 620, Arvin 61R13/16, German transistors, transistor components, related advertising. Rudi Herzog, PO Box 140 108, 30959 Hemmingen, Germany. Phone: 011-49-5045-7484. Fax: 011-49-5101-5100

WANTED: Philco PT-61. Ed Palazzo, 1739 Christian Hills Dr., Rochester Hills, MI 48309. (248) 375-1138. E-mail: epalazzo@helminc.com

WANTED: Motorola console, Model 6-Y-1, 10-Y-1, or 12-Y-1. Top price paid. Dick Waddingham, Blandford Hithe, Brompton, Berkshire RG7 4TD, United Kingdom. Tel.: +44 1734 713332. E-mail: dick@brimpton.demon.co.uk

WANTED: 16mm motion picture films, will buy or trade for radios. Hank Trabold, 2058 Nakiska Ct., Toms River, NJ 08755. (908) 244-2345. E-mail: trabold@exit109.com



Big, 10 inch wall clock with black "radio" dial face and brass colored bezel. Quartz controlled movement, sweep second hand, acrylic dial crystal and bezel. Battery included. \$19.95 includes shipping anywhere in the U.S. via Priority Mail. Massachusetts residents please add \$1 sales tax. Send check with order, please.

Antique Radio
835-A Pleasant Street
Frammingham, MA 01701
Tel: 508-879-2778

FOR SALE: One lot of new tubes: 11-12AX7A, 3-12AU7A, 9-6V6 GT and (5) used 6L6, (3) used 6V6 GT. All U.S. manufacture. All for \$150 plus shipping. Only one lot - hurry. Maurer Television, 29 South 4th St., Lebanon, PA 17042. (717) 272-2481

FOR SALE: Regency TR-7, black, vg - \$60. 1933 BOP auto radio, first factory radio for Buick, Olds and Pontiac, rare, good restorable cond., with documentation, missing original speaker - \$150. Prices plus shipping. Don Knotts, 3158 N.E. Azalea, Hillsboro, OR 97124. (503) 648-1738

FOR SALE: Western Electric 1923 "Instructions For Operating No. 10-A Loud Speaking Telephone Outfit," twelve-page booklet showing connections for the 7A amplifier & the 518W receiver with horn, booklet & horn only - \$200. Cliff Sullivan, 4902 W. Monte Cristo Ave., Glendale, AZ 85306. (602) 978-3551

FOR SALE/TRADE: Early French medicine diathermy spark apparatus - Offers. Tube radios: 1940's Tesla 402U - \$70. Grundig BE 97 - \$60. Early transistors: Philips table Bakelite (metal chassis) - \$70. Soviet VEF206 1960's, multiband - \$60. **WANTED:** 1920's and early 1930's radios, horn/cone speakers, restorable, OK. Argirios L. Adamidis, Kampoouridi 19, Panorama, Thessaloniki, Greece 55236. Tel.: (031) 342405

FOR SALE: RCA 9X-642 untested - \$55. Crosley 5M3 tombstone, untested - \$55. SASE for photos of above and/or list of twenty radios and twenty vintage radio ads. Gasper Gilardi, 181 Berkeley, Harahan, LA 70123. (504) 738-1415

FOR SALE: (6) 2A3 tubes - \$16 ea. (1) 2A3 thin plate - BO. Type BH tube - \$10. (3) Brass base 01-A tubes - \$10 ea. (1) UX200 - \$10. (6) 01-A tubes - \$8 ea. (13) Western Electric tubes - BO. All tubes checked good. Add shipping. Clark Trissell, 3530 Pawnee, Lincoln, NE 68506. (402) 488-5263

FOR SALE: Notice: After 50 years radio sales service buying selling, will sell off all unwanted and excess items N.O.S. and pull outs tubes, 75 plus box lots. All type test eqpt. Repair parts, meters, amps, AM-FM tuners, small radio sets, floor models, old service data, plus more. This is a cash and carry sale. Phone first. F. Krantz, 100 Osage Ave., Somerdale, NJ 08083-1136. (609) 783-0400

FOR SALE: Automatic Radio 50th Anniversary 1970 cuff-link tie-clasp set - \$25 includes shipping. Herb Parsons, 5 Surrey Ln., Peabody, MA 01960. (508) 535-1009

FOR SALE: Weston Model 341 AC/DC voltmeter, Standards type wood case - \$40. **WANTED:** HRO coils. R.F. Haworth, 112 Tilford Rd., Somerdale, NJ 08083. (609) 783-4175

FOR SALE: 80 pages - \$2 first class. Books, catalogs, manuals, radios, television, amateur, scientific, photographic, military. Francis H. Yonker, P.E., W2IBH, 1229 Inverary Pl., State College, PA 16801. (814) 867-1400

FOR SALE: Burgess brand batteries for antique and obsolete equipment. New batteries added monthly. Eveready brand special purpose batteries. Catalog - \$2. Prasse Power & Light, 1315 N. Bolton Rd., Freeport, IL 61032. (815) 235-8000

FOR SALE: Portables. Zenith 6-band, The Continental - \$35 + frt. Masterworks 2918 Navigator - \$25 + frt. Norman Landis, 1315 Marbendale Ct., Kirkwood, MO 63122-6932. (314) 821-7933

FOR SALE: Knight capacitor checker 83Y119, probes, manual, exc - \$30. Olson tube checker TE140 - \$10. Rich Yoch, 22410 Bartlett Dr., Rocky River, OH 44116. (216) 331-9206

FOR SALE: Hallicrafters TW2000, exceptional condition with spare tubes - \$125 ppd. Knight-kit Star Roamer, mint - \$65 ppd. Photos available SASE. Ralph Michelson, KG8FA, 4538 Golfview Dr., Brighton, MI 48116. (810) 225-9825

FOR SALE: Radiotron Designer's Handbook 3rd & 4th Edition - \$125/set. Tubes N.I.B.: (5) 811-A (RCA) - \$150. (4) C3J/A - \$150. BK 801 capacitor analyst w/ manual - \$80. GR Inductor Standards: 1482-H (10mH) & 1482-G (5mH) - \$125 ea. Todd Sharp, 1005 Malvern Rd., Franklin, TN 37069. (615) 591-7556

FOR SALE: Philco 20 cathedral cabinet, grille damaged - \$25 + UPS. Brad Winder, Box 160, Hay Lakes, Alberta, Canada T0B 1W0. (403) 878-3262. E-mail: g&m_winder@wildrose.net

•••••
• OLD TIME RADIO BROADCASTS •
• ON CASSETTES •
 • Many of your old time radio favorites are
 • available on quality cassettes at a reasonable
 • cost. You select the shows you want and pur-
 • chase them by the hour. Fast, friendly service
 • too. Send for our catalog listing over 5,400
 • shows arranged by show category & title,
 • many including original broadcast dates.
 • Only \$2.00 (P & H). Send request to:
 • **ERSTWHILE RADIO — P.O. BOX 2284**
 • **PEABODY, MA 01960**
 •••••

• WANTED •
**EARLY
 PLASTICS**



Top prices paid for prewar plastic radios by Air King, Kadette, Detrola, RCA, etc.

RADIOART

Jim Meehan
 P.O. Box 102 • Centerbrook, CT 06409
 (860) 526-1762

36TH ANNUAL AWA HISTORICAL RADIO CONFERENCE

Antique Wireless Association, Inc.
Wednesday-Saturday, September 3-6



Thruway Marriott Hotel,
Rochester (Henrietta), N. Y.
(716) 389-8300 for reservations



Easy access from the New York State Thruway
(I-90), I-390, or Rochester Airport

Four days of outstanding activities for the radio collector and historian

- Huge (3 acre) antique-radio flea market
- Four large auctions (communications equipment, tubes, literature, general, (including consoles!); IMPORTANT! Please bring an item to be donated for sale in the auction – proceeds to AWA Building Fund
- AWA Museum open with expanded hours
- Book fair extended to four days
- Top Notch Programming (Theme: Television):

Friday Banquet and Awards — Special Guest: Prof. Malcolm Baird, son of John Logie Baird, television pioneer; Television Lecture/Demonstration Series — Will feature several fine speakers, including Peter Yanczer, David Abramson, Dr. E.E. Taylor, Harry Poster, Robert Lozier, Dave Johnson, Richard Brewster, Floyd Jury, Jeff Lendaro, and Stephen Hofer; Prewar Television In The Studio and Home — A slide-illustrated presentation by Nat Pendleton; Key and Telegraph Seminar — A panel discussion moderated by Murray Willer; Collecting Tuska Receivers — Slides and a display of rare equipment presented by Dexter Deeley; Book and Magazine Seminar — Directed by John Terrey; Pre-1912 Wireless and Electrical Equipment Display — With Q&A led by Bruce Kelley; The War Emergency Radio Service: Civilian Radio During WWII — Presented by Robert Grinder; Amateur Radio Forum — The Story of the National SW-3 presented by Paul Bohlander, W3VVS; Vacuum Tubes, Chapter II — Additional history of early tubes presented by Jerry Vanicek

- Old-equipment contest/exhibit
- Ladies Luncheon & program; Annual Sightseeing Excursion

Details: AWA, Box E, Breesport, NY 14816. (607) 739-5443

Advance registration is advisable. Full program and registration materials in The Old Timer's Bulletin for August

FOR SALE: Hallicrafters SX101 – \$275. **WANTED:** Gonsel G-76 transceiver, Yaesu FT225RD. Ron Merrell, 10701 W. 54th St., Shawnee, KS 66203-1905. (913) 268-5973. E-mail: arongv@aol.com

FOR SALE: VT-2, won't light; weak WE205D; strong WE205D, tip-chipped. Cheap, please offer. Ming Yang, 1995 University Ave., #119, Berkeley, CA 94704. (510) 376-4220. Fax: (510) 376-8861

FOR SALE: Teachers Scotch whiskey bottle N.I.B. – \$75. **WANTED:** Red Sony TR63. Westrex sound tape cassettes. Any portable (60's vintage) to play them. Harald Herp, 6615 Michele Ct., Huntingtown, MD 20639. (301) 855-7071

FOR SALE: Fada 1000, marbled alabaster (Sidell, Fig. 103), small chip in handle – \$450 ppd. Randy Patterson, 9104 E. Farm Rd. 116, Strafford, MO 65757. (417) 736-2354

FOR SALE: Transistor/radio collection, pick up only. Zenith, German, novelty, etc. Floor models. Write: Paul Recupero, 265 Union St., Portsmouth, RI 02871-2209

FOR SALE: Books, 1965 ECI Electronic Components book, Call Book 1971-72 – \$5 ea. plus postage. David Buck, 3630 Wilcox St., San Diego, CA 92106. (619) 224-5821. E-mail: whnf46a@prodigy.com

FOR SALE: My collection of old radios, televisions, transistor, military, novelty radios, hearing aids, telephones, microphones, earphones, rare medical, science, aviation books, test equipment. Need room for other hobbies. Sell or trade for Catalans. For 10-page list, send two-stamp LSASE to: John Enigl, Sr., K9HJL, 5425 Cherry Ln., Egg Harbor, WI 54209. (414) 743-3672

FOR SALE: Fairbanks Morse Model 9A amp, only – \$35 + shipping. Norton Thompson, PO Box 422, Paonia, CA 81428. (970) 527-3017

FOR SALE: Fada 711, exc – \$550. Philco 34, rare – \$125. Crosley 51 with tubes – \$95. Geoff Shearer, 14101 Mesita Cliff Rd., NE, Albuquerque, NM 87112. (505) 293-8544. E-mail: GShea90278@aol.com

FOR SALE: Entire collection (due to birth of baby). Radiola IIIA with UV199's – \$175. Aeriola Sr. – \$150. Crosley 51, mint – \$150. GE A63 tombstone – \$150. Crosley 167 cathedral – \$150. Paul Roche, 9914 Indian Ln., Silver Spring, MD 20901. (310) 754-3608

FOR SALE: Tektronix 547, 575, 535 with plug-ins and scopemobile. Genrad 805B, 1021P2 generators. Mark W. Hilliard, N3NBL, 921 South Edward St., Allentown, PA 18103. (610) 432-8089

FOR SALE: My collection of (90) antique radios. SASE and \$1 for photo list. Don Michel, PO Box 667, Anna, IL 62906. (618) 833-7500. E-mail: import@midwest.net

FOR SALE: Two large Advent classic speakers. 1988 broadcast equipment catalog. Charles Harper, 2000 Jackstown Rd., Paris, KY 40361. (606) 484-9393

FOR SALE: Elvis type microphones; manuals; and a \$1 tube sale. Send LSASE with 55¢ for lists. Andy Bruck, RR1, Box 356, Cleveland, VA 24225. (540) 889-5591, after 6 pm

FOR SALE: Thermidyne TF5 – \$175. Bristol Super C speaker – \$55. Radio literature including juveniles, magazines, service manuals. 28-page Literature, 15-page Radio lists. Dave Sutherland, PO Box 201, Spofford, NH 03462. (603) 363-4459. E-mail: echocove@cheshire.net

FOR SALE: "A" supply, 4-7 volts, 3 amps with AC cord and enclosure – \$35 plus UPS. Jim Sinwell, 511 Newport Dr., Greensburg, PA 15601. (412) 834-0763

FOR SALE: (24) books, radio, electronics, math, older text books, SASE for list. Teimer Olson, WØYPT, 304 W. Iowa, Box 267, Monona, IA 52159. (319) 539-2315

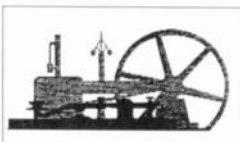

THE NEW ENGLAND MUSEUM OF WIRELESS AND STEAM, INC.

A Non-Profit, Public, Educational, Engineering Museum
1300 Frenchtown Road, East Greenwich, Rhode Island 02818
Fax (Preferred) 401-884-0683 — Tel. 401-885-0545
See Our Web Page At: <http://users.ids.net/~newsm>

YANKEE RADIO TUNE-UP

Saturday August 9, 1997 — 8:00 A.M. – 3:00 P.M.

Admission \$5.00 — Free Parking

*Antique Radio Flea Market & Tailgaters, Fidelity Amateur
Radio Club ~ K1NQG, Silent Auction Of Some Rare Items*

WANTED: Rebuilding old Utah 500-watt transmitter. Need following tubes: T-55, 203Z, ZB-120, 203B. National SW-3 Model 1, 2-volt version using 32-32-30 tubes. Browning Labs preselector, 1940's. Other pre-1950 ham gear. Dean Showalter, WA6PJR, 72 Buckboard Rd., Tijeras, NM 87059. (505) 286-1370

WANTED: Operation, repair manuals for Bang + Olufson 6000, 8000, 9000 hi-fi. V. Vogt, 330 S.W. 43rd St., #247, Renton, WA 98055. (206) 382-5571

WANTED: Motorola Model 55X15 as pictured in Collins 2 (Redux) page 69. Thank you. Bob Furtado, 23 Garden Rd., Alameda, CA 94502. (510) 521-3084

WANTED: Swan Mark 67B linear or other 3-500 6-meter amp. Joseph W. Pinner, KC5IJD, 201 Ruthwood Dr., Lafayette, LA 70503. (318) 981-7766. E-mail: kc5ijd@net-connect.net

WANTED: Bendix Model 853 and 953 radios. Radios need not work. Aaron Mall, 903 Dropleaf Ct., Baltimore, MD 21208. (410) 486-8813

WANTED: Old pay phones and pay phone parts. I pay top prices. Stanley Schreier, 350 Hendrickson Ave., Lynbrook, NY 11563. (516) 887-4966. Fax: (516) 887-4780

WANTED: 500K dual control with 250K taps and switch 1/4 round shaft 1 1/4 inch or longer. Rich Blanchard, 2621 Alta Vista, Newport Beach, CA 92660

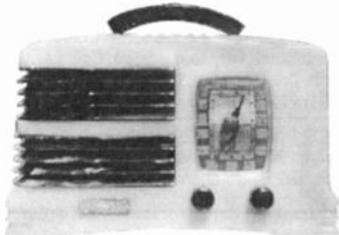

WANTED: Symphony and Detrola Catalin radios. I am not a human being: I am a radio collector. God forbid! Pity me the lost soul that I am and fulfill my humble needs. Please write or call collect: Rain Buttignol, 214 State St., #7, Portsmouth, NH 03801. (603) 427-1384

WANTED: 6D5 vacuum tube and tuning knob for Knight Ocean Hopper radio. Larry Daniel, 706 Pearson Rd., Wright-Patterson AFB, OH 45433. (937) 754-1567. E-mail: LDaniel102@aol.com

WANTED: Old telegraph keys & related equipment, catalogs, signs, etc. Gerry Maira, 31 Prospect St., Fredonia, NY 14063. (716) 672-5389

WANTED: Crosley Pup radio, good or better condition. Jim Bollman, 3323 Eaton Rd., Williamson, NY 14589. (315) 589-8815. E-mail: bollman@wrc.xerox.com

WANTED: One to four-tube ham/SWL receivers (regenerative). Factory kit or homemade. Bob Mattson, KC2LK, 10 Jane Wood Rd., Highland, NY 12528-2607. (914) 691-6247. E-mail: bobmattson@juno.com

WANTED: Phonograph for RCA V-225 console. David Collins, 21 Eagle St., Mt. Morris, NY 14510

WANTED: Federal D-40-60 radio chassis, AC version to fill a flawless cabinet. Jim McDermaid, 334 S. 900 E, Salt Lake City, UT 84102. (801) 975-4590

WANTED: Belknap radios (battery, cathedrals, tombstones and AC/DC). These radios were sold by a large hardware company in my hometown. Also, would like Belknap radio-related items. Wayne King, 103 North Main, Lawrenceburg, KY 40342. (502) 633-6564

WANTED: Small booklet titled Service Hints (Volume One) published by Hygrade Sylvania Corporation. Gregg Humanic, 540 Wicklow Ln., Monroe, OH 45050. (513) 539-8926

**E-MAIL ADDRESS FOR
ANTIQUE RADIO CLASSIFIED
ARC@antiqueradio.com**

**Ads - Subscriptions - Book Orders
See inside front cover for details**

WANTED: King Amplitone or Rhamstine Adapt-O-Phone horn speaker in good condition. Pat Stewart, W7GVC, 1404 Ruth Ave., Walla Walla, WA 99362-3558. (509) 525-1699

WANTED: Bendix 646A dial glass, Majestic 20 speaker, Rider's 19-23. **FOR SALE:** Majestic 15, Westinghouse WR-15 and Westinghouse WR-8 grandfather clocks. Philco 41-316/remote. Radiola 66. Greg Williams, 7602 Blue Boy Pl., Louisville, KY 40291. (502) 231-9430

WANTED: Old watt-hour meters, slide rules, RCA Photomultiplier manual PT-61. Bill Peterson, 3722 Swift Dr., Raleigh, NC 27606

WANTED: Looking for General Electric radio/phone console Model LFC 1118 made in 1940. Wanted for nostalgic reasons. Could pick up at Elgin or Midwest area. Bill Miedema, 101 Devonshire Rd., Tower Lakes, IL 60010. (847) 526-6131

WANTED: Philco 48-230 or 49-503 Transonchone Wedge in excellent original condition. Don Sechser, 117 Cottonwood Cir., Franklin, TN 37069. (615) 794-4681

WANTED: Power supply for a Model 40 Atwater Kent, must be good. Chuck Humphreys, Box 598, New Haven, WV 25265. (304) 882-2220

WANTED: (2) knobs for my Spartan 410 Junior; dial plate for Philco 57 compact. Brad Winder, Box 160, Hay Lakes, Alberta, Canada T0B 1W0. (403) 878-3262. E-mail: g&m_winder@wildrose.net

WANTED: Pocket small tube colorful plastic radios. Neat hearing aids. Mike Brooks, 7335 Skyline, Oakland, CA 94611. (510) 339-1751, evenings

WANTED: Early Collins Radio equipment, accessories, promotional items. Unbuilt transmitter kits. Vibroplex Zephyr key. Brian Roberts, K9VKY, 130 Tara Dr., Fombell, PA 16123. (412) 758-2688

10 BAND MINIATURE SHORTWAVE RADIOS!

Listen to the entire world! This unusual shortwave radio, 7 x 1 1/4 x 3/4 inches, is one of the smallest and most sensitive radios ever built. It has AM/FM/MV and 7 shortwave bands; you can listen to the entire world! It uses only two AA batteries or 3-volt adapter (not included). The cost including shipping and insurance is: Only \$35.00 per set N.I.B. 12, 9, 3 bands also available. If you purchase 2 or more, 10% discount will apply! E-mail: RGBENT@AOL.COM.

Call 908-607-0299, Fax 908-679-8524.

Mail your check or money order to:

R.G.B. Enterprises, Dept. 71

P.O. Box 5367, Old Bridge, N.J. 08857, U.S.A.

FOR SALE/TRADE: Pilot white Plaskon cabinet w/ black wraparound grille – \$650. Emerson yellow w/ black shutter Catalin – \$1,200. Emerson Mod 744B w/ red face and light grey body as in Collins Redux books – \$750. Utah double mushroom speaker – \$200. Rare limited edition Amplion horn speaker in black & brass cathedral metal cabinet, the most beautiful version I've ever seen – \$800. Midget cone pedestal speaker approx. 6" in diameter N.I.B. – \$250. Call: Larry Drago, 383 Lincoln Dr., Cheshire, CT 06410. (203) 272-6030, or fax (203) 272-2002

FOR SALE: (120) pamphlets from National Radio Institute, Wash., D.C.; includes Radio News, Home Study Radio Course and Course in Fixing Radios, years 1948 and 1949 – \$60 plus. Elwood Hunt, 308 Georgetown Rd., Cameys Point, NJ 08069-2512. (609) 299-5259

FOR SALE: Fisher X101C stereo amp – \$65. Garrard RC88/4 turntable with base – \$50. RCA 9JY phono – \$20. Fairbanks-Morse Model 91 console, Semaphore dial – \$60. Philco 46-1203 table, R/P has new phono changer, sounds great – \$70. Olympic LP213 AM/SW – \$55. Guy Forstrom, PO Box 159, Quinnesec, MI 49876. (906) 774-8116

FOR SALE: Zenith Model 9S244, 117 volts, 75 watts, cycles 50/60, long distance radio, licensed only for radio/amateur/experimental/broadcast, by Hazeltine Corporation for use in homes, Serial #R382036, needs restoration, 3 shutter dials – \$300 firm. Contact: Bill Dooley, 154 Pompeo Rd., North Grosvenordale, CT 06255. (860) 923-2569

FOR SALE: E.H. Scott 800-B, will separate or sell complete. Can bring to Elgin. Mark Hewitt, 6659 Tipperary Trl., Roscoe, IL 61073. (815) 623-8729

FOR SALE: National NC44A, hinged lid, isolated, new caps, works, looks great – \$99 + shpg. H. Mohr, 1005 Wyoming, Allentown, PA 18103

FOR SALE: Free! 40% off of 50-yr. collection retailer of television, radios, phonographs. Must go. Owner sold building. Must vacate B&W TVs inc. models of the 40's. Some sets working. Radios, parts, tubes, test equipment, schematics. Midway between Chicago and Detroit off I-94. G.R. & Ann Marcelletti, 31087 56th Ave., Paw Paw, MI 49079. (616) 657-4259

FOR SALE: Philco 42-390 – \$135. Delco R-1116 – \$90. **WANTED:** Zenith 12-S-266, 12-S-370 or 15-U-269. Thanks. Mike Gallo, 3955 Confederate Rd., Murfreesboro, TN 37128. (615) 895-9817

FOR SALE: Radio World magazine, 15 copies, 1935-1938, good condition – \$22 ppd for all. R. J. Eastwick, N2AWC, 224 Chestnut St., Haddonfield, NJ 08033. (609) 429-2477

FOR SALE: Zenith Royal 2000 AM-FM portable, vg – \$85 or trade. Pilot table wood Model T511, 1946, vg – \$65 or trade. Gilbert Simpson, 18 Beechwood Dr., Ansonia, CT 06401. (203) 374-4085

FOR SALE/TRADE: Heathkit SB221 & National NC240D. A. Bruno, 24 Butternut Dr., New City, NY 10956. (914) 354-8899

FOR SALE: Philco #70 as is – \$150. Elvis 78 rpm records – \$35 ea. Other 78s – Call. William Egan, 10332 S. Komensky, Oak Lawn, IL 60453. (708) 229-9676

FOR SALE/TRADE: Patterson Radio Co. first Allwave communications receiver Mod PR-10 (made in Los Angeles, Ca.), beautifully appointed w/two brass escutcheons, V.U. meter and excellent chrome chassis with black cabinet, very rare – \$650. Call: Larry Drago, 383 Lincoln Dr., Cheshire, CT 06410. (203) 272-6030, or fax (203) 272-2002

FOR SALE: Philco 86, 1929 highboy w/legs, wks, PU – \$100. Ozarka 90, 1928 console, wks, PU – \$90. Michael J. Doback, 592 E. Southlawn, Birmingham, MI 48009

New Wireless Pioneers

Books, Magazines, Literature Bought and Sold

New Wireless Pioneers buys and sells books, catalogs, magazines and other literature from the 1800's to 1950 that deal with early radio, wireless and electricity. A selection from our list of specialties:

Pre-1900 Electricity
Pre-1925 Radio or Wireless
Pre-1950 Computers

Pre-1900 Telegraphy
Pre-1940 Television
Early X-Ray

Magazines, Catalogs, Autographs or Ephemera related to the above topics. Also: Pre-1920 Wireless and Telegraph Apparatus – Radio-Related Novelties and Advertising – Early Vacuum Tubes and Electrical Devices.

Some items available in other technical subject areas also.

Several catalogs featuring items for sale are published each year.

New Wireless Pioneers – Jim & Felicia Kreuzer

P.O. Box 398, Elma, NY 14059

Phone: (716) 681-3186 Fax: (716) 681-4540

**IBM OR
Mac**

FREE

**SATISFACTION
GUARANTEED**

*That's right! We are that proud of
our Rider's on CD set. Try them in
the comfort of your own home
ABSOLUTELY FREE.*

If you like them - keep them. If you don't - return them.

It's that easy!

35,000 Pages At The Click of A Button!

Easy & Fun To Use.

Volumes One through Twenty-three - Complete

Check Out These Exciting Features:

- View any page on your screen.
- Print any page.
- Zoom-in, zoom-out.
- Flip through pages with lightning speed.
- Go directly to any page.
- Complete Rider indexes - included!
- Rider updates - included!
- Auto radios, records players & changers - included!



Great For The Non-Technical Collector Too!

Identify unknown radios by:

- Picture
- Cabinet design
- Tube layout
- Chassis numbers
- Production numbers

Don't Delay — Order Today — (210) 546-6913

**Visa, MasterCard, Discover, & American Express, or mail
check or money order in the amount of \$249.00 to:**

**BPS, INC., 164 Winter Haven
Brownsville, TX 78521**

FOR SALE: McIntosh 2505 – \$395. McIntosh C-20 – \$395. Hallicrafters S38B – \$75. Trans-Oceanic – \$140. Bernard Bank, 303 DeVoe Ave., Yonkers, NY 10705-2709. (914) 476-5933

FOR SALE: Bulova 100 – \$35. Philco PT25 – \$35. Philco 38-12 – \$50. Emerson 813 – \$20. Plus UPS. Dave Mock, 3 Larkspur Pl., Montpelier, OH 43543. (419) 485-3933

FOR SALE: Mercury tube tester Model 102 with manual, working. Phone or write: Thomas Burnside, 4838 S. Westhaven Dr., Jackson, MS 39209. (601) 922-2235

FOR SALE: Philco Predicta G4653W barber pole television, unrestored – \$450, pick up only. Qty. (4) new in box Taylor T-20 tubes – \$200. All prices plus shipping. Richard Sharisky, PO Box 521, Belmont, MA 02178. (617) 484-5784. Fax: (617) 489-6592

FOR SALE: Tubes. SASE for list. Volume discounts available on some types. Kirk Cline, 1818 Walker Ave., Greensboro, NC 27403-1760. Phone/fax: (910) 379-7197

FOR SALE: Vacuum tubes, all kinds, 15,000 on hand. Send SASE for prompt response. Tom Ivas, K9GTK, 2932 W. 99th St., Evergreen Park, IL 60805. Phone/fax: (708) 423-0528

FOR SALE: Philco 89 chassis parted out (no speaker). What do you need? Truetime D2210 Art Deco metal, aluminum trim – \$75. Westinghouse N-202 – \$50; RCA 28X – \$50; both have light-colored wood cabinets. Silvertone 7054 radio R/P – \$50. All good condition, need restoration. Maureen Martin, 1407 Memory Ln., Lutz, FL 33549. (813) 949-1835

FOR SALE: Oil-in-paper capacitors, (1,000's) of 'em. N.O.S. & old electronic magazines. Call or fax for list. Russell Hulme, 8504 Soneto Ln., Las Vegas, NV 89117. (702) 233-1379. Fax: (702) 242-3857

FOR SALE: Viking II – \$200. **WANTED:** Gonset G-76, Yaesu FT225RD transceivers. Ron Merrell, W0OIZ, 10701 W. 54th St., Shawnee, KS 66203-1905. (913) 268-5973. E-mail: arongv@aol.com

FOR SALE/TRADE: Made In Japan, by Handy, mint copies! – \$35 ea., quantity discounts. High-end transistor radios, see my website, <http://members.aol.com/Dmradios/index.html>. M.I.B. Champion spark plug novelty – \$89. Manwich novelty – \$35. **WANTED:** Linmark T80, Emerson 999 (junkers OK). High-end transistor radios, Emerson AX212. Donald M. Maurer, 29 South 4th St., Lebanon, PA 17042. (717) 272-2481. E-mail: Dmradios@aol.com

FOR SALE: Stromberg-Carlson 130-J Treasure Chest – \$85. Hallicrafters 5R10-A – \$45. Zenith T-O's: H-500, 8G005YT – \$75 ea. Test equipment, Hickock 600A – \$65. Precision 915 – \$40. Heathkit TC-2, Knight-kit 400-A – \$20 ea. Hickock 900-volt amp meter – \$35. Hickock marker calibrator 690, N.I.B. – \$80. **WANTED:** Cabinet Clarion 280 lowboy or will sell chassis and speakers. Buzz Miller, 715 Mt. Rock Rd., Carlisle, PA 17013. (717) 776-3279

FOR SALE: Kennedy 521 2-stage amp, San Francisco version, interstage transformers not original – \$475. Zenith Model 11, poor cond. – \$85. Arborphone 27, fair cond. – \$120. Crosley 52 SD, fair cond. – \$85. Montgomery Ward (Tri-City) W-2 one-tube regen. set – \$175. Freed-Eisemann NR-5, poor cond. – \$75. Mohawk 6-tube Cherokee, knobs missing, fair cond. – \$60. Fisher 500 AM/FM mono tube receiver, original, plays fine – \$75. Garrard Type A turntable, fair cond. – \$25. All plus UPS. Robert L. Bailey, 2451-3 Whispering Woods Blvd., Jacksonville, FL 32246. (904) 642-5837, ans. mach. after 4 rings

FOR SALE: Crosley book. Radio-Magic Mood (green), v exc – \$195 shipped prepaid. Glenn Piar, 4040 Allard Rd., Medina, OH 44256. (330) 239-1857

OLD RADIOS TALK AGAIN!

AM100 LINK TRANSMITTER

A Broadcast Quality Transmitter
For The Antique Radio Enthusiast

Entertain your friends with authentic,
"on the air" radio demonstrations!

Features:

- Selectable Flat/Phonograph Inputs
- High Fidelity, 100% Modulation
- Peak Modulation Limiter
- 800 KHz Ceramic Oscillator
- Antenna Matching Network
- Compact, Solid State Construction
- Rugged FET Linear Amplifier

Call or write today for technical
and delivery information.

Tusa Consulting Services Phone: (504) 892-7348
19 Augusta Dr. Fax: (504) 892-2075
Covington, LA 70435

ANNOUNCING ZENITH and Philco Grille Cloths

39 Patterns.....

and we're just getting started!
4 MORE NEW styles available NOW!

- ★ NEW generic console pattern for Philco, Zenith and others.
- ★ NEW Philco pattern for model 511.
- ★ 2 NEW silver/black deco patterns.
- ★ 12 Philco patterns.
- ★ 8 Zenith patterns.
- ★ Plus Stromberg, GE, RCA, Westinghouse, and Scott patterns.

SEE THEM ALL ON THE WEB @
<http://www.libertynet.org/~grcloth>

Send a 55¢ LSASE for samples and info to:
John Okolowicz, N3VSR
624 Cedar Hill Rd.
Ambler, PA 19002

E-mail: Grillecloth@compuserve.com

WANTED: Operators manual for Hallicrafters Model #HT-41 and #HT-37, and case enclosure for Model #HT-37. Thanks. Daniel Racovaz, 1237 Albion Rd., Rexdale, Ontario, Canada M9V 1A9. (416) 743-7052

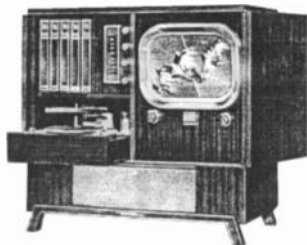

WANTED: 50's Motorola console TV, nice condition. Top price paid! Contact: Craig Stevens, 3902 Monroe, Dearborn Heights, MI 48125. (313) 274-5760. Fax: (313) 274-2752

WANTED: RCA R70 restorable chassis, dial and escutcheon. Millard Driscoll, 301 Driver Ave., Summerville, SC 29483. (803) 875-0847. E-mail: mdriscoll@worldnet.att.net

WANTED: All metal midget & lunch box radios. Kadette Jewels. Remler radios. Robert Norton, 4227 S.E. 15th, Portland, OR 97202. (503) 233-1956

WANTED: Owners and/or service manuals for Akai GX400DSS and Concord 776D reel-to-reel tape decks. Thomas Peters, PO Box 3925, McAllen, TX 78502

WANTED: Hammarlund SP600 cabinet or non-working SP600 for parts. Must include cabinet. J. Allen Call, 1876 E. 2990 S, Salt Lake City, UT 84106. (801) 484-4824

WANTED: RCA KS-38/MI11056 boom mic stands, RCA BA6A compressor/limiter, Altec/Peakless 4665 transformers. Vincent Gallo, 532 LaGuardia Pl., #600, New York, NY 10012. (212) 274-0432

WANTED: Antique and novelty tube and transistor radios. We buy complete collections or quality individual pieces. Also tubes, parts, literature, magazines, and advertising. Call or send list. Radio Daze, John & Kathy Slusser, PO Box 144, Mendon, NY 14506. (716) 624-9755. Fax: (716) 624-7857. E-mail: info@radiodaze.com

WANTED: Set three plastic knobs band selector/tuning/volume Zenith 7-S-3673 (Bunis 1, p. 168). Marv Glassman, 19300 Romar St., Northridge, CA 91324. (818) 993-4560

WANTED: One yellow Catalin DeWald pinwheel knob; Bakelite animal napkin rings. Peter Fee, 26 Small Ave., Caldwell, NJ 07006. (201) 403-8913

WANTED: One Westinghouse (RCA) crystal detector Model or Type DB. This detector is for use with an RCA Type RA tuner. Charles Lauter, 8280 S.W. 164 Ter., Miami, FL 33157. (305) 252-0163

WANTED: General Radio Type 1419-K capacitor decade box. Type 1409 Standard capacitors. Alan J. Kriss, 1872 Portsmouth Way, Union, NJ 07083. (908) 688-2092

WANTED: The Radio Amateur's Handbook, 1960 edition. Please state condition and price (incl. postage). Tom Tompkins, 106 Falls Rd., Apt. 1, Shelburne, VT 05482

WANTED: BC-342-N, and Philco 70 w/original finish. Michael Harrington, PO Box 250995, Little Rock, AR 72225

WANTED: Miniature cathedrals less than 10 inches tall. Jay Malkin, 1250 Galapago, #206, Denver, CO 80204. (303) 623-6451

WANTED: Zenith 807, 808, 811, 835, 5R317, 12S267. Emerson 645. John Pelham, W1JA, 1185 Bend Creek Trl., Suwanee, GA 30174. (770) 476-0473. E-mail: John_Pelham@msn.com

WANTED: Manual, Heathkit Q meter, QM-1. Instruction Booklet, Jewell, Radio Set Analyzer, Pattern 199. Copies welcome. Charles Rhodes, 10105 Howell Dr., Upper Marlboro, MD 20772. (301) 574-0214. Fax: (301) 574-1978



WANTED: Emerson Catalin radios. Nobody pays more than I. What an arrogant and inaccurate thing to say. I mean, like there isn't anyone wealthy enough, dumb enough, desperate enough - or any combination of the three - to pay even a dollar more than I would pay. I mean, c'mon, who am I trying to kid! Please write or call collect: Rain Buttignol, 214 State St., #7, Portsmouth, NH 03801. (603) 427-1384

WANTED: Zenith wooden table model 6S322 in excellent condition. Larry Boshor, PO Box 193, Palo Pinto, TX 76484. (940) 325-5333

WANTED: High-end, unusual, rare transistor radios. Also, colorful or marbled Kadettes, Detrolas, etc. David Mednick, 25 Jefferson St., Apt. #7-B, Hackensack, NJ 07601-5038. (201) 457-0802

WANTED: Wanted to buy U.S. brand 810 tubes, must be new in box. Tony Rinaldo, 308 Lenox Ave., Oneida, NY 13421. (315) 363-3644

WANTED: Schematic and additional information for Signal Corps box BX-4 power supply. Louis L. D'Antonio, 8802 Ridge Blvd., Brooklyn, NY 11209. (718) 748-9612, after 6 pm

REPLACEMENT DRIVERS FOR ATWATER KENT HORNS

Driver w/housing for Model M & Pooley horns (this assembly replaces all pot metal) \$65.75 + \$4.75 s&h

Driver w/repair ring for Models G, H, & L (repair ring replaces threads in base) \$59.85 + \$4.75 s&h

All drivers above include diaphragm, gaskets, spacer, and spring. All parts are also sold separately. Send SASE for price list.

**M. Harold Ezzone, 4861 Park Drive
West Des Moines, IA 50265 — (515) 221-9447**

FOR SALE: B&K adapters for 500 Series tube tester 615TC. Wagner fan brass blades, turns. Turner Road King dynamic microphone R.K. 50. Ann Bichanich (Jay's), 15 1/2 W. Lake St., Chisholm, MN 55719. (218) 254-4421

FOR SALE: Deluxe #1731 chrome front - \$160. Emerson #315 donut grille - \$150. Long SASE, list. Ripley, Box 9374, North St. Paul, MN 55109. (612) 777-6791

FOR SALE: Emerson Mickey black chrome. **WANTED:** Early electric brass fans and Deco fans. Rick Padron, 1005 E. Idlewild Ave., Tampa, FL 33604. (800) 320-3267

FOR SALE: Heath IP2717 0-400v B+/C-/12.6 VCT metered power supply - \$98. Tube testers: Hickoks: 800A - \$99; 6000, mint inside, original manuals, vg outside - \$195. Military TV2 - \$325. RCA WP-25 variable isolation transformer, 400w - \$68. B&K E200D solid-state metered sig. gen., 100kHz-216MHz, manual - \$95. Ballantine 5760A 600MHz frequency counter - \$98. (2) Simpson 260 VOMs, as is, both - \$15. EICO 955 in circuit capacitor tester - \$33. Sencore LC53 Z-meter, exc, manual - \$295. Much more, list LSASE. Kirk Ellis, KK4YP, 203 Edgebrook Dr., Pikeville, NC 27863. (919) 242-6000, evenings

FOR SALE: Frontier Capacitor, of Lehr, N.D. Buyers needs \$62,000. Available within next six months. \$37,000 up front. Business easily relocatable, and includes inventory, customer list, tool and equipment, 90 days training at your location. Buyer should appreciate that the eight years of constant growth in sales is more profitable than high profits feeding the IRS till. Call: Everett Hoard, Frontier Capacitor, PO Box 218, 403 S. McIntosh St., Lehr, ND 58460. (701) 378-2341, to 9 pm CDST

FOR SALE: Addison (Sideli Figure 9) - \$1,500; Figure 6 body repaired knobs and small band repro - \$300. N.E. 5000 rainbow original paint, age worn - \$60 ea. Shellbern #44 (Redux, p. 75) - \$40. Western Royal brown, (like Collins' Golden Age, p. 83) - \$75. GE (Machine Age C122) - \$90; C751 - \$50. H600 beetle - \$150. Mitchell 1250 - \$40. Silvertone 6319 - \$60. Peter Burnstad, 14508 Magdalen Cres., White Rock, British Columbia, Canada V4B 2X7. (604) 531-6882

FOR SALE: Fada 1001 wood, good cond., plays, (see Bunis 3) - \$45. Rod Galloway, 2220 Woodbury Rd., Melbourne, FL 32935. (407) 254-0280, after 5

FOR SALE: Vibroplex keys by mail auction. Details with July TVC. Non-subscribers send SASE. Tom French, W1IMQ, 151 Barton Rd., Stow, MA 01775

TUBES BOUGHT & SOLD

**Industrial • Power • Receiving
Special Purpose • CRT's**

— Vast Inventory —

**Contact: Donna - Sales Mgr.
(201) 751-2591 / (800) 526-1275
Fax → (201) 481-1524**

**United Electronics Co. Est. 1935
Tube Manufacturing Equipment For Sale
Assorted Tube Bases For Sale**

FOR SALE: Panasonic RF4900 shortwave communication receiver, excellent - \$300 plus shipping. Arnold Giron, PO Box 862533, Los Angeles, CA 90086. (213) 221-9211. (213) 622-8646

FOR SALE: Sams 1-2368 in cabinets, RCA-Zenith-GE service lit., TV parts, components, hundreds of tubes new & used, some test equipment. Richard Fain, 493 Flat Rd., Bethel, ME 04217. (207) 836-3200

FOR SALE: Hallicrafters Skyriders Jr. S41-W, plays OK, broadcast and SW - \$42 + UPS. Francis Turner, W7DOT, 500 Wheeler St., Lebanon, OR 97355-4351. (541) 258-5776

One Month Free!

BONUS FOR EARLY RENEWALS

If you renew before the month shown on your mailing label (your expiration month), you will receive an extra month on your subscription: 13 months instead of 12! 26 months for an early 2-year renewal!

FOR SALE: Gray autograph record cutting dictation machine Model BIC4; tubes, motor OK - \$50 plus. Jerome A. Weiland, 780 Charlestown Ln., Hoffman Estates, IL 60195. (847) 934-1790

FOR SALE: Alnor Pyrocon pyrometer, 0-400 F. ° meter, ext. arms, thermocouples, instructions and case - \$50. Carl Hackenson, 31 Hixson Farm Rd., Sharon, MA 02067. (617) 784-8834

FOR SALE: Hallicrafters SX-101A - \$125. HRO-7R/W/B, C, D coils - \$150. **WANTED:** Hallicrafters HT-32A or B. Robert Braza, N1PRS, 23 Harvard St., Pawtucket, RI 02860. (401) 723-1603

FOR SALE: Zeniths L507 Meridian - \$150; 6G601 Universal - \$65; 5G500 Universal - \$65. Hallicrafters TW500, green - \$125. Denis Burke, 308 Person St., Runnells, IA 50237. (515) 966-2871. E-mail: zeenith@msn.com

FOR SALE: RCA cathedral #121, vg - \$200. RCA tombstone T6-1 - \$100. GE S22, vg - \$150. Hickok Model 203 VOM, etc., nice - \$45. Weston Model 779 analyzer, exc - \$40. DeWald cathedral #740, 6 tube - \$75. Koehler Mfg. Co., Marlboro, Mass., a batt. charger, exc - \$40. DeForest loop antenna, real nice - \$150. Tower Meistersinger horn speaker - \$85. SASE for large list. All plus S&H. Please call before 9 pm. Wally Worth, 2 West Elm Ave., Wollaston, MA 02170. (617) 479-4512

FOR SALE: Zenith 1936 automobile radio 7M91 - \$35. Gillilan 5G - \$50. Portables: Zenith Trans-O's 3000-1 - \$85; H500 leather - \$165; MDL755 - \$20; Royal 500 black - \$40. Emerson 558 - \$25. Motorola 5A5 - \$40. **WANTED:** GM Ford Mopar 50/60's Wonderbar/signal seekers. John Linden, 575 Bridle Ct., Walnut Creek, CA 94596. (510) 939-1375

FOR SALE/TRADE: Kennedy 110/525. **WANTED:** Grebe CR6, RORK. Collins 30W, 32A, 32B, 4A, 30FX, 32G or 32RA transmitters. Stu Mount, W2AO, 35 Grand St., Highland, NY 12528. (914) 691-7957

FOR SALE: Air Champ and Little Wonder crystal sets also Grebe 7 parts set. Jay McAlister, PO Box 1889, Costa Mesa, CA 92628. (714) 963-1627



*Southeastern Antique
Radio Society Presents.*

The Annual Fall Mega Meet In Atlanta!

**New Indoor
Location!!!** Howard Johnson Midtown
(Formerly the Castlegate Hotel)
Located at, 1750 Commerce Drive NW
Atlanta, GA 30318

Just West of I-75, North Atlanta. Special rates available until August 25th
\$49 sgl. and \$59 dbl. for all attendees (limited availability so reserve early
and don't forget to mention S.A.R.S). Phone: (404) 351-6100

Friday, September 26

<u>Event</u>	<u>Time</u>
"No host" dinner (Ho Jo Midtown Hotel)	7:00 p.m.

followed by:

Atlanta Radio theater 8:30 p.m.
Players (an excellent
"Golden Age" radio
Production)

Saturday, September 27

<u>Event</u>	<u>Time</u>
Registration/Set up	7:00 a.m.
Flea Market	8:00 a.m. (all day)
Philco Display/contests	All day

*There will be no buying, selling or
trading of merchandise before 8:00 a.m.
on Saturday-Enforced!*

Fee Schedule

	<u>In Advance</u>	<u>At Door</u>
Vendor Space* (First space, table provided)	\$15.00	\$17.50
Additional Space (table provided)	8.00	10.00
Registration (per family)	5.00	7.50

**Vendor space includes registration fee*

Registration Form

(Save money and avoid early morning delays)

Name: _____

Address: _____

City/State/Zip: _____

Phone: _____

Enclosed

Registration (\$5 per family)

Vendor Space (1st space-\$15)

Additional Vendor Space(s) (\$8 per space).....

Total \$ _____

Mail form w/check to Larry Smith, S.A.R.S., P.O. Box 500025. Atlanta, GA 31150

FOR SALE: Marbleized blue bullet – \$2,350. Red trim for 200 bullet – \$325. Green trim for same – \$375. Red gumdrop knobs – \$125. Green handle for Sonora – \$60. Blue knobs for Fada – \$175. Blue knobs for Emerson night cabinet Catalin – \$175. Robert Norton, 4227 S.E. 15th, Portland, OR 97202. (503) 233-1956

FOR SALE: RCA novelties; Nipper salt and pepper shakers, porcelain w/Radio Corporation of America stamped on base and cork stopper – \$95/pr. Same but no name stamp on base – \$75. Nipper white dog, brown porcelain set – \$50. Dog & horn cast iron bank – \$75. Glass Sun Catcher 8"D w/Nipper & phonograph, Victor – \$75. Nipper (soft white fuzzy), 12" high – \$50. Limited quantities, plus shipping. For list send LSASE 55¢ postage. J.J. Papovich, 53 Magnolia Ave., Pitman, NJ 08071. E-mail: jipapo@juno.com

FOR SALE: Old metal electric phonograph Model 400, has keystone type characters painted around base, blue and yellow, works – \$95. RCA X551 radio with matching RCA 45J2 red top 45 rpm turntable, good condition – \$110. Jefferson Golden Hour clock, perfect, running – \$150. All plus ship. Doyle Roberts, HC63, Box 236-1, Clinton, AR 72031. (501) 745-6690. E-mail: drob@artelco.com

FOR SALE: RCA Victor Model 8X521, (Bunis 149 pict.) – \$40. Dave Pewowaruk, 931 23rd St. SE, Rochester, MN 55904. (507) 280-5975. E-mail: hp95@aol.com

FOR SALE: Kenwood R-5000 w/spkr, mint – \$650. **WANTED:** Hammarlund S-200 spkr. Joel Levy, 8 Waterloo Dr., Morris Plains, NJ 07950. (201) 285-0233

FOR SALE: Knight Space Spanner w/cabinet, missing 2 small knobs – \$50. Donald Sochurek, W191 S7500 Richdorf Dr., Muskego, WI 53150. (414) 679-0212

FOR SALE: Microphones: Shure Model 55-S – \$90. Electro-Voice Mercury Model 911 – \$100. Ed Davis, Box 203, West Baden, IN 47469. (812) 936-9611

FOR SALE: Telefunken hi-fi leather portable multiband original cartons – \$150. Zenith R7000 12-band fair – \$75. Altec 1567A mixer amp 1569A amp – \$350. Weltron 2001 8-track AM-FM – \$100. All plus shipping. Frank DeFilippi, 62 Second Ave., Massapequa Park, NY 11762. (516) 798-6577, 6 to 10 EST

FOR SALE: Zenith Trans-Oceanics 1000D, vg – \$150. A-600, vg – \$150. Have others. Ted Demski, 5806 225 Pl. SW, Mountlake Terrace, WA 98043. Phone/fax: (425) 778-7100

FOR SALE: DuKane 400-watt commercial mono rack amplifier, solid-state Model 1A833, new – \$350. Clyde Powell, 3822 Edwards Ter., Chattanooga, TN 37412. (423) 867-5022

FOR SALE: Transistor radios: Global GR-711, black, vvg, works well – \$150. Emerson hybrid Model 856, coral color, vvg, untested, clean – \$150. Hitachi TH-667, aqua color, vvg, original box in OK cond., instructions, case, untested – \$95. Toshiba 5TR-193, white, vvg, needs caps – \$350. Motorola 6X31C, untested, vvg – \$75. Postage extra. Kay Botzum, RD2, Box 419, Morgantown, PA 19543. (610) 286-0047. Fax: (610) 286-5315

FOR SALE: Send SASE for free list of parts, books, magazines, junk. P. Majewski, PO Box 92, Tamaqua, PA 18252

FOR SALE: Atwater Kent Model 44 radio with speaker Type E, original, unknown condition – \$75. Richard Lemay, 611 Charles St., Fall River, MA 02724

FOR SALE: Books and literature. Updated list. Specify paper list. LSASE with two stamps. Ray Schmidt, 607 1 Ave. SW, Austin, MN 55912. (507) 433-0069

FOR SALE: Are you in need of N.O.S. tubes? I've got 1000's. SASE for a complete list. Jeff Arndt, 1215 Division St., Manitowoc, WI 54220-5734

NEW AND USED TUBES WANTED

We urgently need the following tubes. All tubes must be well known brands such as GE, RCA, Sylvania, Tung-Sol, Phillips, etc. of U.S. or W. Europe manufacture. New tubes must be in their original boxes. All tubes are subject to inspection. Ship by UPS (ground); we'll mail a check to you upon receipt and testing at prices shown plus your shipping charges. Call or fax for buying procedures and complete bid list. Call before sending more than 10 pieces of one type of tube.

NEW TUBES

01A.....	\$9.00	6F6G.....	\$5.20	12BH7A.....	\$5.10	274B(WE).....	\$85.00	6146B/8298A.....	\$12.00
1L6.....	8.50	6GS/6U5.....	8.00	12DW7/7247.....	9.00	275A(WE).....	85.00	6267/EF86.....	6.00
2A3.....	24.00	6K5G.....	5.00	20LF6.....	16.00	300B(WE).....	250.00	6550/A.....	12.00
2B6.....	6.00	6KD6.....	15.00	26LX6.....	6.00	350B(WE).....	100.00	6550 (ST).....	34.00
5R4GY/A/B.....	3.40	6L6GC.....	8.40	35LR6.....	6.00	623.....	35.00	7189/A.....	5.30
5U4G.....	6.70	6LB6.....	7.50	45.....	30.00	808.....	16.00	7591A.....	20.00
5V4G.....	4.70	6LF6/GMH6.....	18.60	50.....	110.00	805/331A.....	32.00	8005.....	50.00
5Y3G.....	3.80	6V6.....	6.00	71A.....	8.20	845.....	80.00	8068.....	20.00
6BK4C/6EL4A.....	8.00	6V6G.....	6.50	80(ST).....	5.60	864.....	5.00	8908.....	27.50
6CA7/EL34.....	11.00	10.....	25.00	211(VT-4C).....	35.00	5691.....	15.00	8950.....	25.00
6F5G.....	5.80	12A.....	11.00	274A(WE).....	110.00	5692.....	18.00	M-2057.....	32.00

USED TUBES

01A.....	\$5.00	10.....	\$16.00	171A.....	\$7.00	245.....	\$23.00	845.....	\$31.00
2A3.....	12.00	12A.....	7.00	183/483.....	9.30	246.....	11.00	7591.....	8.60
5AR4/GZ34.....	6.00	20LF6.....	7.30	210.....	20.00	247.....	8.00	8417.....	8.50
6B4G.....	6.50	42(GLOBE).....	8.00	211(VT-4C).....	14.50	250.....	65.00	8950.....	12.30
6LF6/GMH6.....	9.20	45(VT-52).....	25.00	230.....	6.20	280.....	12.00	W201A.....	6.50
6V6G.....	2.10	45.....	11.00	237.....	8.50	282.....	8.00	WD-11.....	35.00
		50.....	60.00	240.....	8.50	401-CARDON.....	9.60	WD-12.....	24.00

ANTIQUE ELECTRONIC SUPPLY™

LIMITED PARTNERSHIP

8221 S. MAPLE AVE. • TEMPE, AZ 85283 • (802) 820-5411 • FAX (802) 820-4843 or (800) 708-6789

WANTED: Always looking for vintage mics, will buy outright or trade for following mics: RCA 77A, 77C, RCA shotgun. Western Electric 53A, Neumann/Telefunken CMV-3 bottle, U47, U49, U67 AKG C-12, early 414, Sony C-37A, C-37P. Have RCA 44BX, BK-S WE 1142, EV-V1 Amperite, Shure 55, 56 or trade or buy outright. Also looking for Shure 55, 250-ohm model. Always looking for RCA memorabilia. Chairs, curtains, clocks, signs, thermometers, posters. Have some for trade. What have you? W. Kremer, 5807 Papaya Dr., Ft. Pierce, FL 34982. Ph/fax: (561) 468-7732. E-mail: WKremer798@aol.com

WANTED: Electro-Voice, 18 wk[?] speaker, X2635 crossover, 6HD horn, T25A driver, (2) each 828HF drivers, (2) each A8419 horn sections. T.M. LeBlanc, 321 E. Spruce St., Sault Ste. Marie, MI 49783.

WANTED: Zenith transistorized Trans-Oceanic radio parts sets. Also want Westinghouse Little Jewel radio parts sets. Jim Montague, 1907 S. Stanley Ln., Spokane, WA 99212. (509) 535-9576

WANTED: Capehart record changer Model 10-12-C. John T. Meredith, 2462 Stantonsburg Rd., Ste. 152, Greenville, NC 27834. (919) 551-1882



WANTED: Philco Model 604 pictured. Must be complete, in good condition and restorable. Ted Rogers, 6938 East Waco Dr., Syracuse, IN 46567. (219) 457-8886, or fax: (219) 457-8776

WANTED: Old violet ray units, attachments, literature, etc. H. Andreoni, c/o 250-D S. Lyon Ave., Hemet, CA 92543

WANTED: Zenith 8S130 cabinet w/escutcheon, restorable condition. Jerry Reed, 4438 S. Santa Fe Pl., Tulsa, OK 74107. (918) 446-4276

WANTED: Grille for Emerson Patriot. Will buy broken set with good grille. Al Wirtenberg, 15 Wilson Rd., Weston, CT 06883. (203) 544-9270. E-mail: mswaw@mail.snet.net

WANTED: Mid 50's Allied Radio Catalog. **FOR SALE:** Emerson cardboard cabinet radio, plays but rough. Dean Gagnon, 20 Jackson Hts., Essex Junction, VT 05452. (802) 878-8293

WANTED: Any DeForest related material. Rob Loeser, 390 Beech St., South Hempstead, NY 11550. (516) 483-0463

WANTED: AK 208, 255, 273D, 312, 412, 608, 648, 710 or literature. Jeff Aulik, 1708 Parkview Ave., Rockford, IL 61107. (815) 399-1902

WANTED: Schematics and info on RCA Model 73-B professional disc recorder. Contact: Strozier Electronics, 365 Morphy Ave., Fairhope, AL 36532. (334) 928-6385. E-mail: Strozier@Fairhope.com

WANTED: Following Raytheon RK Series tubes: RK15, RK16, RK25A, RK25B, RK30, RK32, RK41, RK44, RK45, RK46, RK53, RK56, RK58, RK63A, RK100. John H. Walker, Jr., 16112 W. 125th St., Olathe, KS 66062. (913) 782-6455. E-mail: johnh.walker@alliedsignal.com



WANTED: Air King Skyscraper radios, except for that unbearably ugly model with the third (tuning) eye at the top that bears better resemblance to a frounder than to the face of a building. Please write or call collect: Rain Buttignol, 214 State St., #7, Portsmouth, NH 03801. (603) 427-1384

WANTED: RCA Victor "Red Seal" 78 rpm record albums from the 1930's and 1940's. Eric Beheim, 25114 Oak Ln., Descanso, CA 91916

WANTED: Volume knob for Stromberg-Carlson 345M console. Instructions for EMC 208 tube tester. Doug Fox, 603 S. 12th Ave., St. Charles, IL 60174. (630) 584-5915

WANTED: UTC CG-316 power xfmr. New London Instrument Model 901A tube analyzer, any condition. Westinghouse tubes RJ550, RJ553, RJ563, DRJ564. Westinghouse tube manuals. Pete Roody, 457 W. 57th St., #805, New York, NY 10019. (212) 944-1150, work; (212) 246-4719, eves./week. E-mail: therood@mindspring.com

WANTED: Panasonic RF-9000 large digital multiband portable. Daryl Jorud, R#1, Box 180, Battle Lake, MN 56515. (218) 864-5725

WANTED: Signal gen., old com. rec's. Trade R-390-A, N.I.B. PC66XL Uniden CB. N.I.B. Meade spotting telescope 20-60 zoom. A.R. Terry, RR#3, Box 19, Ellington, MO 63638. E-mail: terryE3@juno.com

WANTED: E.H. Scott! E.H. Scott! E.H. Scott! Interested in Scott battery and AC sets, military, accessories, advertising and literature. Radio Daze, John & Kathy Slusser, PO Box 144, Mendon, NY 14506. (716) 624-9755. Fax: (716) 624-7857. E-mail: info@radiodaze.com

WANTED: Dial glass and front dial cover, or entire cabinet for Sonora Model RCU208. Herman Schnur, Rt. 3, Box 151, Greenville, NC 27858. (919) 752-2264

WANTED: Pre-1930 crystal sets and detectors. I would consider an entire collection. Ed Bell, 5311 Woodsdale Rd., Raleigh, NC 27606. Fax/ph.: (919) 851-1517

WANTED: Plastic dial escutcheon for Philco Model 16B. James S. Fisher, 344 Harrison Ave., Manville, NJ 08835. (908) 725-7476. E-mail: Y_R_less@juno.com

WANTED: Unbuilt or partially assembled Heathkits and Knight-kits. Gene Peroni, Box 58003, Philadelphia, PA 19102. (215) 665-6182

FOR SALE/TRADE: Powerful Hammarlund SP-600 JX 26 rack mount - \$475. National HRO 50 w/4 coils - \$400. Conn. Tel. and Tel. rare Sodian DR-6 w/tube in beautiful mahogany chest, circa 1922 - \$1,600. Beautiful RCA (PB-90) mic (resembles 44BX) microphone all chrome & brass plated - \$1,200. Call: Larry Drago, 383 Lincoln Dr., Cheshire, CT 06410. (203) 272-6030, or fax (203) 272-2002

FOR SALE: Audio: Harmony guitar amp H400A. Keyboard and tube amp. Game caller and amp. Fisher receivers 500, 800C, 1800 Export. Bill Coolahan, 1450 Miami Dr. NE, Cedar Rapids, IA 52402-2933. (319) 393-8075

FOR SALE: Radio Shack 8 transistor radio kit (unassembled) - \$25. Lafayette Comstat 25B CB radio - \$35. Delco 1229 - \$35. Zenith J615W - \$35; T-402 - \$45. RCA B411 - \$50; 7-BX-8L - \$35. Comette tube intercom Bakelite - \$35. Bell amp 2418 - \$45. Heath kits GR-21 and GRA-21-1, both - \$35. National Panasonic RE784 - \$25. Benrus 10B01B15B - \$100. Michael Itzo, 515 77th Ave., Saint Pete Beach, FL 33706. (813) 360-1189. E-mail: transitzer@aol.com

FOR SALE: AK L horn only, no base - \$35. Airline 04BR-511A, excellent, hums - \$70. Silvertone 4500A, black, excellent but missing half the grille cloth - \$90. Bendix 526A, excellent, plays - \$55. Sentinel 118BT-216-S, brown plastic from 1938, excellent, works - \$45. AK L horn and base, no driver - \$45. Have two Zenith 6D15 one ivory and one brown - \$40 ea. Day-Fan 5, needs finish, NT untested - \$60. Radiola 118BT-2, wood battery set, excellent, untested - \$35. All plus UPS. Jerry DeWitt, 1937 Love Cir., Simi Valley, CA 93063. (805) 526-5093. E-mail: jdewitt@rain.org

FOR SALE: Large WWII military catalog #11, will be out this fall. Check future ads. Sam Hevener, W8KBF, The Signal Corps, 3583 Everett Rd., Richfield, OH 44286. (216) 659-3244

FOR SALE: Sentinel 284 - \$375 & \$800. Garod 6AU1 - \$600. Bendix 526C - \$475. Belmont 6D111 - \$175. Philco 39-30, restored - \$160. Philco 38-38 - \$100. Philco PT-65 - \$125. Arvin 444 - \$60. Arvin 842T - \$60. Delco 1107 - \$115. Fada 740 - \$85. DeWald small - \$65. Emersonette, mint - \$175. Crosley mini tombstone - \$100. Meridan small - \$90. Transistors: Raytheon 8TP - \$175. Crosley JM8BK - \$185. Emerson 888 Vanguard, red - \$100. Realtone Comet - \$125. Toshiba 6TP 394 - \$50. Toshiba 8TM 294B - \$30. Penney's 6TP 555 - \$25. Penney's 1130 - \$25. Candle PTR 85C - \$30. Nippco Jet - \$125. Realtone TR861 - \$25. Sony IR 81 - \$50. Micronic Rubys - \$65-\$95. **WANTED:** Kadette, Detrola, Fada, Catalins, beetle, Plaskon, transistors. New large photo catalog - \$1 + LSASE 2 stamps. Bob Masterson, Box 172, Valley Cottage, NY 10989. (914) 353-3151. E-mail: BMradio@aol.com

FOR SALE: Used tubes tested good, twelve 5U4GB - \$36 ppd. Twelve 2A4 straight tubes - \$50 ppd. Elwood Hunt, 308 Georgetown Rd., Carneys Point, NJ 08069-2512. (609) 299-5259

FOR SALE/TRADE: Clapp-Eastham loose coupler, 1912, licensed by Marconi Co. - \$750. Federal Jr. crystal set - \$400. Western Electric 10-D horn speaker, base w/driver - \$200. Treco combination crystal/tube battery receiver, made in Kansas City - \$300. Large crystal set kit radio - \$275. Factory radio kit built in a small Munchkins-style cardboard box, circa 1930's, really neat - \$200. Call: Larry Drago, 383 Lincoln Dr., Cheshire, CT 06410. (203) 272-6030, or fax (203) 272-2002

FOR SALE: Books, catalogs, magazines radio related - send SASE. ARC 5 rcvrs and transmitters & parts. H.N. Felder, 7517 Granada Dr., Bethesda, MD 20817

FOR SALE: Hallicrafters S-38, complete, not working - \$20 plus UPS. Ron Franzen, 4307 Wild Ivy Ct., Arlington, TX 76016. (817) 451-5282



NEW QUALITY CAPACITORS:



Volt 630 Axial Leads

Part Number	Value (UF)	*Price/25	Each
.001-630-AL	.001	\$ 6.00	24¢
.0047-630-AL	.0047	\$ 6.25	25¢
.01-630-AL	.01	\$ 6.50	26¢
.022-630-AL	.022	\$ 7.00	28¢
.033-630-AL	.033	\$ 7.25	29¢
.047-630-AL	.047	\$ 7.50	30¢
.1-630-AL	.1	\$ 8.00	32¢
.22-630-AL	.22	\$ 15.00	60¢

Volt 630 Radial Leads

.1-630-RL	.1	\$ 7.00	28¢
-----------	----	---------	-----

ELECTROLYTICS:

Volt 160 Axial Leads

22-160-AL	22	\$ 16.00	64¢
33-160-AL	33	\$ 21.00	64¢
47-160-AL	47	\$ 24.00	96¢

Volt 450 Axial Leads

10-450-AL	10	\$ 18.75	75¢
22-450-AL	22	\$ 28.00	\$1.12
47-450-AL	47	\$ 45.00	\$1.80
47-450-AL10	47	\$ 20.00 (per 10)	\$2.00

To order, Send Check or Money Order to:

BOB'S ANTIQUE RADIOS

111 East 29th Street La Grange Park, Illinois 60526

Telephone: (708) 352-0648 / Fax: (708) 352-0647

Ask About Super Bulk Rates/Sorry No Credit Cards or C.O.D.'s

Shipping & Handling included in price

*Sold in 25 piece lots - Wholesale Only - No Minimum Order

TUBES WANTED

New tubes must be well known brands made in U.S. or W. Europe with complete boxes. Used tubes need clear markings and silver color flashing. All must be undamaged and pass an electrical inspection. We will refund UPS shipping charges. Quantities wanted; write/fax for complete bid list.

NEW TUBES

USED TUBES

2A3.....	\$25.00	2A3(SP)	\$80.00
2A3(SP).....	125.00	45	12.50
6B4G	14.00	45A	17.50
6G5/6U5	10.00	46	4.00
10	30.00	50(ST-19)	90.00
45	30.00	171A(RCA)	15.00
46	8.50	210(globe)	35.00
50(RCA)	175.00	216B(globe)	20.00
274B(WE) ...	150.00	250(globe) ...	110.00
801A	30.00	274B(WE)	85.00

ANTIQUE TRIODE

653 Commercial St., Farnham, NY 14061
Phone 716-549-5379 Fax 716-549-3823

Radio Restoration Parts

Vacuum Tube Repair Wafers

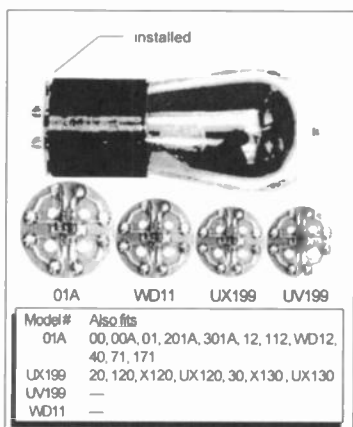

These tube repair wafers are solid-state devices for quick and easy repair of early vacuum tubes. The wafer is installed by simply sliding it over the tube pins and reinserting the tube into its socket. If the filament is intact, but there is little or no emission, the filament may be lit for best visual effect. However, the tube can be open filament.

No change in radio operating voltages is required. Any number of tubes may be repaired in a radio. If wafers are installed on all tubes, the B+ voltage may usually be reduced without sacrificing volume or sensitivity. Performance will vary between radio models.

\$10.00/each (\$7.50/ea. 3 or more)

New Atwater Kent Breadboard Switch

Exact replacement for Models:

9 • 9C • 10 • 10A • 10B • 10C • 12

and all additional models with board mounted switch.

Newly manufactured under high pressure heat from the same type brown thermoset resin used in the original. Beryllium copper spring contacts are used for long, trouble-free life. Custom built knurl is used to exactly reproduce the original.

\$50.00/each

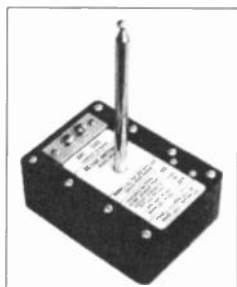
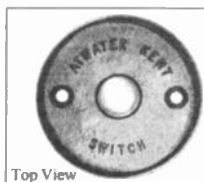
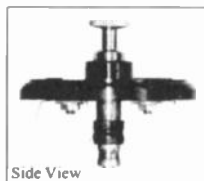

Active Antenna

Allows antique radios which were designed for a long wire outdoor antenna to operate on a 42" indoor whip antenna. Portable, operates from a 9 volt battery.

Only \$34.95

Order from: PTI, 7925 Mabelvale Cutoff, Mabelvale, AR 72103

Orders shipped UPS, prepaid in continental U.S. Please allow 3 weeks for delivery.

Arkansas residents add 5.5% sales tax.

To Order: Call (501) 568-1995



FOR SALE/TRADE: E.H. Scott's "first" chrome set, a 1931 Allwave 12 Deluxe with all ten plug-in coils, separate chrome power supply, excellent chrome, dual dials - \$1,000. Call: Larry Drago, 383 Lincoln Dr., Cheshire, CT 06410. (203) 272-6030, or fax (203) 272-2002

FOR SALE: Pioneer speaker 8" Model PE-8, 16Ω 5W; tweeter PT-3 20W, 16Ω crossover 2.8 kHz; woofer 15", PW-15A, 35W, 16Ω dividing network Model DN-3, constant resistance, attenuation 6db/octave, crossover 600 & 4,000Hz 16Ω all for - \$60 + UPS. Books: Modern Radio Servicing, Ghirardi 1935, 1st - \$23. Elements of Radio, Marcus and Horton - \$8. Every Pilot's Guide to Aviation Electronics, John Ferrara, 1974, 1st - \$12. All ppd. Send for SASE for list of books and things. Serge Casagrande, 1318 Norwick Dr., Lutz, FL 33549. (813) 949-6729. E-mail: SCasagra@ix.netcom.com

FOR SALE: Grunow 1151 console, exc cond - \$200. Will take Ekko stamps or albums in partial trade. Delivery to Extravaganza. Phil Brunais, 14185 Pleasanton Hwy., Bear Lake, MI 49614. (616) 864-3143

FOR SALE: Emerson Mod 547 - \$30. Southern States wood TM Mod 579 - \$35. Nava-Tech Mod 5BA - \$35. Sentinel Mod U171 - \$25. Zenith Mod X375, exc - \$25. Heathkit Mod BR-2TM - \$25. RCA Mod 9-BX-56 - \$20. Tele-King Mod RKP53, exc - \$25. Jensen stereo amp Mod A82, 80W - \$25. Philco Mod T160A, exc - \$20. Zenith Royal 75 - \$30. RCA Mod 3-X-533 - \$30. Sencore Mod RC167, The Substitutor - \$50. Silvertone 800 trans. - \$25. General Inst. hi-pot 0-5kV - \$50. Black light Spectronics Mod B-100, exc - \$25. All plus UPS. Gus Nianouris, 1316 Richard St., Miamisburg, OH 45342. (937) 866-1865

FOR SALE: White sale: Philco 49-501, H765-124, T1000-124, Predicta TV; Belmont A6D110, 6D121; Crosley 56TX; Emerson CY269, 581A; RCA 1X2; Sonora WAU-243; Silvertone 6002; Arvin RE200; GE YRB-60-12; Farnsworth GT-051; prefer to sell as one lot, makes a stunning display, but will consider alternatives - \$1,100. Can deliver to Elgin. Philco 49-1401 - \$70. Revox A700 - \$250. Rek-O-Kut M12 Challenger record cutter - \$125. Radiometer SMG1 professional stereo alignment generator - \$225. 10 1/2" plastic N.A.B. reels - \$3 ea. Phil Van Praag, W282 S3580 Ringneck Ct., Waukesha, WI 53188. (414) 524-9856, please call before 8 pm CST. Thanks

FOR SALE: EICO tube checker, Model 666 - \$75. Heathkit scope Model 10-21 - \$45. Heathkit signal generator SG-8 - \$35. Plus UPS. Stephen L. Bonino, 107 Georgetown Rd., Glassboro, NJ 08028. (609) 881-0244

FOR SALE: Lafayette Model HE 15B citizen's band transceiver - \$50 plus. Elwood Hunt, 308 Georgetown Rd., Carneys Point, NJ 08069-2512. (609) 299-5259

FOR SALE: Transistor radio video by Roger Handy and Eric Wrobbel, see review in May 1997 A.R.C., 1 3/4 hours - \$29.95 includes postage. Eric Wrobbel, Dept. A, 20802 Exhibit Ct., Woodland Hills, CA 91367. (818) 884-2282

FOR SALE: Northern Elect. Midge H-5508, dark blue - \$125. Addison Catalin Mod 2 marb. black, yellow trims - \$1,500. Addison Catalin Mod 5 marb. red yellow bars - \$1,000. Maurice Giroux, 559 Hudon, Laval, Quebec, Canada H7P 2L4. (514) 963-1601

FOR SALE: Radio News: (130) issues from 1929 to 1939 - \$10/issue. Issues 1925-1928 - \$11 ea. C. Kirsten, Radio Relics, 15556 Sandra Ln., Sylmar, CA 91342. (818) 364-0491. Fax: (818) 367-1442

FOR SALE: Deco-style Zenith Model 75 hearing aid, see-through plastic case, tubes - \$45. Gary Berg, 24 Pat Rd., Newburgh NY 12550. (914) 565-5077

FOR SALE: Thousands of N.O.S. tubes & sockets. Coastal Concepts, 407 Ridge Ct., Kohler, WI 53044-1601. (414) 458-8825. Fax: (414) 208-0353. <http://www.execcp.com/~tekman/tubes.html>. E-mail: tekman@execcp.com

FOR SALE: Airline 84BR1502, ivory painted Bakelite - \$60. Airline 74BR1502, ivory Plaskon - \$150. Admiral 14C5 - \$60. Fada 740 white Plaskon - \$80. Fada L96 white Plaskon - \$100. Globe 552? Streamline Bakelite - \$80. Westinghouse WR27 Deco wood - \$100. E.H. Scott 15-tube chrome chassis w/speaker & power supply - \$700. RCA Radiola 24 suitcase style w/loop ant., rough condition - \$100. Please add shipping, thank you. Dave Masterson, 145 Harbor Pond Dr., Apt. 7A, Meriden, CT 06450. (203) 634-4170

FOR SALE: Early TV books by Baker, Collins, d'Albe, Felix, etc. Send for free list. Old Authors, PO Box 403, Morrisburg, Ontario, Canada K0C 1X0. (613) 543-3337

FOR SALE: GE 6550A - \$25 ea. WANTED: 15GP22 picture tube. Don Jackson, 1394 Dansey Ave., Coquitlam, British Columbia, Canada V3K 3H8. (604) 931-7245

FOR SALE/TRADE: Heathkit W-6M (70 watt) mono block pure amplifiers with correct tubes - \$1,500 for pair. Grommes Mod 10-PG - \$200. Thordarson Mod T-31W-10 (triode amp) using 2A3's - \$300. Call: Larry Drago, 383 Lincoln Dr., Cheshire, CT 06410. (203) 272-6030, or fax (203) 272-2002

FOR SALE: Spittorf R-V-695 battery set - \$125. David Grimes Type V, Serial #1004, excellent condition with tubes - \$285. Original instruction manual RCA Model 121 or 122 - \$15. RCA World Wide Radio Booklet (orange & black) - \$10. Rider's 1-5 abridged and 6 thru 19, all for - \$450 or best offer. Rider's TV 2-3-4, 6 thru 11, 13-14, all - \$90. Victor Orthophonic Music wood coin box - \$50. Bill Skaggs, 36 Stanton Hall Dr., Destrohan, LA 70047. (504) 785-1054. (504) 764-9732

FOR SALE: (102) transistor radios. Including Regency XR-2A, Zenith Royal 755 solar radio, (3) Royal 500s, sell all for - \$2,500, will not sell separately. Batteries not included. LSASE for list. Jim Gianacos, Cosmos TV & Radio, 5919 15th Ave. NW, Seattle, WA 98107. (206) 784-9417

CATALIN	WANTED
WANTED	RADIOS



TOP PRICES PAID!

Michael Lawlor
P.O. Box 179
Santa Barbara, CA
93102
(805) 682-2336

EXTRAVAGANZA '97

Hosted by the Michigan Antique Radio Club
July 11-13, 1997



Holiday Inn South Convention Center
6820 S. Cedar Street, Lansing, MI 48911
(517) 694-8123



Come join us for our 12th annual convention

CONVENTION THEME: RADIOS OF THE WORLD
(emphasizing non-U.S. radios & related items)

• Robert Lozier to speak on "radio collecting activities in Italy"

• 2 Exhibits:
* German Radios
* Voice of Music Items

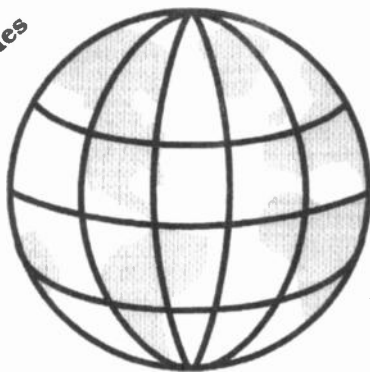

• 7 Equipment Contest categories related to non-U.S. items

• British Philco People's Radio to be raffled off

EXTRAVAGANZA '97 Registration

Note: Everyone attending EXTRAVAGANZA must register! Additionally, you must be a current MARC member or join MARC at this time in order to participate in the auction or equipment contest and/or to sell in the flea market.

REGISTRATION	TOTAL
Family registration _____ →	\$ 12
MARC membership (if not currently MARC member)	
Balance of 1997 (\$6) _____ →	\$
Flea Market sellers	
1st outside Flea Market space (\$20) _____ →	\$
Additional outside spaces <input type="text"/> # spaces x \$10 each _____ →	\$
8' table inside (under tent)* <input type="text"/> # tables x \$20 each _____ →	\$
<small>*Includes 8' table, and two chairs</small>	
Make check out to MARC for this amount	TOTAL \$

To mail check or to request a convention brochure, write: EXTRAVAGANZA '97, Suite 100, 3520 Okemos Rd. #6, Okemos, MI 48864. For additional information contact: Jim Clark @ (517) 349-7187 or E-mail: HGGW75A@PRODIGY.COM, or check out our MARC Homepage on the WWW at <http://sojourn.com/~micharc/web/index.html>

FOR SALE: Microphone Electro-Voice 644 and 638 – Best Offer. Hallicrafters 4-band SW 500 – \$40. Norman M. Landis, 1315 Marbendale Ct., Saint Louis, MO 63122. (314) 821-7933

FOR SALE/TRADE: Radiotron Designer's Handbook 3rd & 4th. **WANTED:** Rider's Volume 23. A.J. Bernard, PO Box 690098, Orlando, FL 32869-0098. (407) 351-5536

FOR SALE: National I thru IV and Rider's V thru XV and Index I thru XV. **WANTED:** Junk chassis or tuning dial shaft for Silvertone Model 1590-92. Will be at Michigan meet with DeForest F-5. Marion Van Hal, 1328 Orchard, Pella, IA 50219. (515) 628-2347

FOR SALE: Grundig 3059, fair condition – \$40. **WANTED:** Crosley 1137. Majestic 363 chassis, Regenoflex cabinet. Brian Kurtte, 2222 Nodleigh Ter., Jarrettsville, MD 21084. (410) 692-0450

FOR SALE/TRADE: Grommes (pure power) amps: (2) Mod 221 – \$500; McIntosh D-104 power amp (required for C-104) – \$150; McIntosh Mod 5100 amp, solid-state – \$500. Call: Larry Drago, 383 Lincoln Dr., Cheshire, CT 06410. (203) 272-6030, or fax (203) 272-2002

FOR SALE: Atwater Kent console 667, exc cond. – \$265. Philco 71 console, restored, exc cond. – \$125. Philco 630 console, restored, very good cond. – \$95. RCA 9K console, restored, exc cond. – \$125. RCA K80, unrestored, good cond. – \$90. RCA K60 console, restored, excellent – \$125. Zenith 10S567, plays well – \$145. Zenith 10S491, complete, partially restored – \$160. Zenith 10S155 – \$170. Majestic 20 grandfather clock radio, p-p 45 output, restored – \$375. Scott Phantom Deluxe, restored, exc cond. – \$2,500 OBO. Scott dual dial Allwave 12 w/good chrome, 12 plug-in coils, restored, exc in cabinet – \$1,500. **WANTED:** Philco 42-295 chassis, AK cathedrals. Ray Lamont, 70 Litchfield Rd., Unionville, CT 06085. (860) 675-6327

Visit the A.R.C. Web Site!

The URL to access the A.R.C. Web site is:
<http://www.antiqueradio.com/>

Our site includes highlights from current and recent issues:

- Editor's Comments
- Image of the Cover
- Feature Article
- Radio Miscellanea

- Plus:
- Photo Reviews
 - Book Reviews
 - Coming Radio Events
 - Complete Club Listing
 - List of Books For Sale
 - Subscription Information

While visiting our site, you may send e-mail and orders for books, videos and subscriptions.

Let us know what you think about A.R.C. on the Web!

FOR SALE/TRADE: Western Electric D-49, 1920's, (a k a 49-C) line amplifier, uses two 131A tubes – \$350. 1950 Western Electric military rcvr – \$300. Call: Larry Drago, 383 Lincoln Dr., Cheshire, CT 06410. (203) 272-6030, or fax (203) 272-2002

FOR SALE/TRADE: Belmont 6D111B white orig. back, bottom tag dated M-12-45 – \$175 OBO. Mastercrafters brown swirl Plaskon fireplace animated clock dated 5/10/55, cool! – \$225 OBO. Zenith Royal 500-H oval black, exc – \$125 OBO. Metrodyne 5-tube Neutrodyne, nice – \$125 OBO. WWII German-made aluminum 6K8 w/eagle – BO. Rek-O-Kut lathe & TT, swap for vacuum setup? Astatic 14" color wheel & electronics for CBS color system, swap for mics? RCA memorab.? Heath XO-1 crossover kit in box, incomplete, but has chassis, cage switches, manual xfmr – \$75 OBO. AR turntable, nice – \$75. Pentron 9-T-8, early 2-speed R-R, exc – \$85. Harman Kardon tube amp/preamp 6L6i, exc – \$100. Mics for trade; Electro-Voice V-1, nice Western Elec. 1142 film birdcage exc, RCA 44BX satin/umber vg, Shure 556, 55. Lots of stuff for sale. Trade SASE for list. W. Kremer, 5807 Papaya Dr., Ft. Pierce, FL 34982. Ph./fax: (561) 468-7732. E-mail: WKremer798@aol.com

FOR SALE: Twelve tested good 6D6 tubes and twelve good 6C6 tubes – \$40 ppd. Elwood Hunt, 308 Georgetown Rd., Carneys Point, NJ 08069-2512. (609) 299-5259

FOR SALE/TRADE: Pair of McIntosh MC-60's, works great – \$1,500. Pair of C-4's mono preamps – \$250. McIntosh MR71 and MR-78 – \$900 ea. Call: Larry Drago, 383 Lincoln Dr., Cheshire, CT 06410. (203) 272-6030, or fax (203) 272-2002

FOR SALE: New Johnson Viking II, Model 122, Hy-Gain multiband verticals, low pass RT filter 52 ohms, pick up only – \$950. John Nosbaum, 2743 Wilmette Ave., Wilmette, IL 60091. (847) 256-0547

FOR SALE: Catalogs. Allied 1972, Pioneer 1968, Lafayette 1971, Cameradio 1963 – \$15 ea. Plus S&H. Ed Povraznik, 9606 Biddulph Rd., Brooklyn, OH 44144. (216) 661-0032

FOR SALE: Instructions for lid of Windsor radio Magnadyne 3 dialer, good condition – \$25 + shipping. Darrell Combs, 6587 Pacheco Way, Citrus Heights, CA 95610. (916) 969-0635

FOR SALE: James Millen: monitor scope – \$135. KW Transmatch – \$250. Panel dial – \$35. RME 70 and matching speaker – \$245. RME 45 speaker – \$85. Lots more. New list – Free. Richard Prester, 131 Ridge Rd., West Milford, NJ 07480. (201) 728-2454

FOR SALE/TRADE: 23-Tube DuKane P.A. desk (4-6CD6's!) H-K tuner, mixer, Collaro changer, Astatic bullet included! Lansing, Elgin, Rochester. Nevins Museum of Radio, Ken Nevins, 406 Jipson St., Blissfield, MI 49228. (517) 486-3019, evenings please

FOR SALE: Zenith radio 5D01Z – \$40. RCA 5T-8 – \$110. Lang 406 – \$50. Airline 6Z-177 – \$115. Silvertone 87108 – \$85. Zenith 62-125 – \$125. Tube testers, thanks for all calls. A few left yet. Triumph #440 – \$45. (2) Dynajet #707 – \$65 ea. Hickok #540 – \$115. Hickok #560 – \$115. Triplett #3480 – \$45. Heathkit #TC-1 – \$30. Century in CKT capacitor checker #CT-1 – \$40. All items plus UPS. See also June issue, p. 66. Charles R. Boller, 3108 N.W. 91st, Seattle, WA 98117. (206) 782-8318

WANTED: Knobs and escutcheon for Grunow Mod 501 radio, (see Stein's M.A.J.A. 1, p. 112). Jeff Hoskins, 824 E. Madison Ave., Stuart, FL 34996. (561) 283-2291, after 7 pm

WANTED: Zenith Trans-Oceanics: all models, transistor and tube, any condition. Zenith military Trans-Oceanics R520/URR, R520A/URR. Zenith wood & plastic table models. Frank J. Manzano, 82 Monhegon Ave., Oakland, NJ 07436. (201) 337-5263

WANTED: Original speaker grille cloth for 1952 Telefunken 882WK or Opus 52, off-white weave with gold accenting threads. Will consider buying radio with good cloth. Igor Golio, 17 Addison Dr., Fairfield, NJ 07004. (201) 386-4284

WANTED: Sony television Model 8-301W, must be in near mint to mint cond., complete with antenna, visor and working. Barry Schlossberg, 322 Simon Bolivar Dr., Henderson, NV 89014. (702) 454-9669. Fax: (702) 456-0777

WANTED: Schematic and power transformer 54-14 for Heathkit PS-3 power supply. George Cortelyou, 1409 Portland NE, Albuquerque, NM 87110. (505) 255-3347

WANTED: Clarion AC60, AC61, AC70 chassis. Will pay your price for clean complete units. Need not be working. Mervyn Ellsworth, 2309 N. 25 St., Boise, ID 83702. (208) 345-6878

WANTED: For Tower speaker, I need drivers, type found in front of cone. Hand crank for Guild Country Belle. Crosley DB25 knobs. Majestic 20 speaker. Rider's 1-5, abridged. Greg Williams, 7602 Blue Boy Pl., Louisville, KY 40291. (502) 231-9430

WANTED: Atwater Kent variocoupler. AK variometer parts (need feet, knob and faceplate). Gold 01-A's. Gary and Laura Carter, WA4IAM, 1405 Sherwood Dr., Reidsville, NC 27320. (910) 349-1991. E-mail: gcarter01@sprynet.com

WANTED: Clean and complete late model Crosley 40S chassis. Martin Piepenburg, RR 1, Box 56B, Monterey, IN 46960. (219) 542-2591



Emerson 31A



Crosley (unknown)

WANTED: Pictured table sets in restorable condition. Also Models 30 with door, 33, and 559 chest. Bob Schafbuch, 2811 Highland Ave., Carrollton, KY 41008. (502) 732-9650

WANTED: Zenith Trans-Oceanic, original Model #7G605, working speaker w/good audio xformer or junker chassis w/speaker & good audio xformer. Jerry Mundel, 7738 N. 40th Dr., Phoenix, AZ 85051. (602) 381-6200. Fax: (602) 381-6222

WANTED: Tubes, N.O.S.: 6L6GC, 12AX7A, 5AR4/GZ34, 5881. Astatic JT-30 mics. John McGrath, 29 Ripley Rd., Belmont, MA 02178. (617) 484-0515. Fax: (617) 484-6180

WANTED: Lyric tabletop radios. Thank you. Robert Lutz, 9041 Gillette St., Lenexa, KS 66215. (913) 894-1327

WANTED: Chassis and speaker for Crosley 54G or 58, Buddy Boy or New Buddy. Dick Grogg, 206 Walnut St., Newton, IL 62448. (618) 783-3514



WANTED: Fada Catalin radios. Help! My entire collection spontaneously combusted during an interview with the "Enquirer." Replenish and repent ye sinners. Please write or call collect: Rain Buttignol, 214 State St, #7, Portsmouth, NH 03801. (603) 427-1384

WANTED: Set of (4) knobs and filmstrip for Airline movie dial. Thanks. Leon Bitters, 4209 Logtown Rd., Lena, WI 54139. (414) 834-3707

SEND ALL A.R.C. MAIL TO
Antique Radio Classified
P.O. Box 2, Carlisle, MA 01741

WANTED: Submarine telegraphy books by Western Union, Cameron, McNichol and others. Bob Voss, 3133 Charring Cross, Plano, TX 75025. (972) 618-5235

WANTED: Tubes wanted: New tubes must be in original boxes, must test good, with good silver color flashing, U.S. famous names or made in England, Holland or W. Europe, will refund shipping. New tubes: WE 205D/E (TB) shape - \$300. WE 205F (TB) shape - \$100. WE 2A3 (SP) or RCA - \$75. WE 252A - \$350. WE 274A/B - \$115. WE 300A/B - \$260. WE 275A - \$90. WE VT-52 - \$65. WE 284 - \$100. 50 to 350 Raytheon, RCA, DeForest - \$150. Siemens (ED) - \$300. England PP3/250, KT88 - \$100. England PP5/400 (D024) - \$100. England, PX25A, 4284 - \$100. England, D026, balloon - \$100. Philips, MCI/60 - \$100. Telefunken RE604, RS241 - \$100. Used tubes: WE 205D/E (TB) shape - \$100. WE 205F (TB) shape - \$60. WE 2A3 (SP) RCA, WE - \$60. WE 252A - \$250. WE 274A/B - \$50. WE 284 - \$50. WE 300 A/B - \$100. WE 275A - \$45. WE VT-52 - \$35. 50 to 350 Raytheon, RCA, DeForest - \$110. Siemens (ED) - \$150. England PPE/250, KT88 - \$50. England PP5/400, D024 - \$50. England PX25A 4284 - \$50. England D026, balloon - \$50. Philips MCI/60 - \$50. Telefunken RE604 RS241 - \$50. Call, write, fax to: George Stagakis, c/o Georges Antique TV & Radio Repair, 1714A 41st St., North Bergen, NJ 07047. (201) 867-9136. Fax: (201) 867-4044

WANTED: Chassis, speaker, bezel for Philco 20 Deluxe, or set with trashed cabinet. Larry Schiebel, 818 W. Lakeside St., Madison, WI 53715. (608) 277-7634

WANTED: Philco TP-10 parts set, with good grille, knobs and pointer. (1) 49-503 knob. Steven P. Berglund, 617 S.W. 146th St., Seattle, WA 98166

FOR SALE/TRADE: McIntosh Mod 240 w/cage near mint condition - \$1,800; (50) W-2 amp w/PS - \$500; MC-67 tuner - \$600; Lafayette Mod 255 stereo amp - \$325; vintage McIntosh A-116 (30-watt) power amp - \$500. Call: Larry Drago, 383 Lincoln Dr., Cheshire, CT 06410. (203) 272-6030, or fax (203) 272-2002

FOR SALE: New large summer photo catalog - \$1 + LSASE 2 stamps. Bob Masterson, Box 172, Valley Cottage, NY 10989. (914) 353-3151. E-mail: BMradio@aol.com

FOR SALE: Zenith: 15U269 shutter console - \$1,300. Oval 9-tube shutter console - \$700. Stars & Stripes console - \$475. 1934 American Bosch Art Deco radio bar - \$800. Philco cathedrals: #90 - \$550; #71 - \$350; #20 - \$350; #60 - \$275. RCA #128 - \$350. Trophy baseball radio - \$500. Microphone radio - \$225. Coca-Cola cooler radio - \$600. Catalins: Beautiful black/yellow Addison with repro grille - \$900. Excellent maroon and yellow Air King Duchess - \$950. Yellow and red Fada 652 with crack - \$350. Bakelites: Fada #254 Plaskon - \$250. Stewart-Warner Varsity - \$225. Phonos: 1902 Victor Model P - \$1,200. 1915 Edison Official Laboratory diamond disc - \$1,400. 1954 Seeburg 100R jukebox - \$2,900. Vendo 39 Coke machine - \$2,200. Neon clocks - \$800. Philco vertical Predicta TV - \$750. 1920 porcelain lollipop scales - \$1,700. Other radios and advertising pieces available. Sales tax 8.25% on all items. All merchandise must be picked up by 9/1/97. Buyers are responsible for insuring purchases prior to pickup. Robert Baughman, 6612 St. Anne, Dallas, TX 75248. (972) 250-4450, call after 6 pm

FOR SALE: 1930 National SW-5 Thrillbox, AC model, vg, working - \$425. Greg Gore, WA1KBQ, 11528 Watermoss Ln., Charlotte, NC 28262. (704) 549-4719

FOR SALE: Send a large SASE for my list of Atwater Kent breadboard parts for sale. Paul Thompson, 315 Larkspur Dr., Santa Maria, CA 93455. (805) 934-2778

Vintage Mics, Tube Gear & More!

Check Out The Recording Industry's Best Kept Secret!

Pro-Audio Marketplace is the only nationwide classifieds publication dedicated to recording gear sold by individuals, project & major studios, etc. Over 1500 pieces of gear per issue! **\$25 subscription includes 12 issues and 1 FREE ad per issue.**

Never seen one?

Call now for a FREE copy!

1-800-469-0023

www.proaudiomarketplace.com

Pro-Audio Marketplace



FOR SALE: Six N.I.B. tubes JAN 3B28 - \$20 ea. plus. One N.I.B. JAN 3C24 tube - \$25 plus. Two N.I.B. JAN 815 tubes - \$15 pair plus. Elwood Hunt, 308 Georgetown Rd., Cameys Point, NJ 08069-2512. (609) 299-5259

FOR SALE: Catalin. Bendix 526-C, has 2 small chips in black - \$550. Crown PR-535 tube portable, not perfect - \$75. Longwood pink transistor - \$50. Vernon Shatwell, 13721 West 86th St., Sapulpa, OK 74066. (918) 224-4551, after 7 pm

CLASSIFIED AD NOTICE

Please check your ads carefully before sending them in. Once ads are received, it is not always possible to refund the amount sent, pull the ad or make changes.

FOR SALE: Kennedy V - \$375; (2) 201A's brass base, tipped, good filaments - \$70. Floyd Paul, 1545 Raymond Ave., Glendale, CA 91201. (818) 242-8961

FOR SALE: Five 864 tubes with WD-11 type bases, all N.O.S. - \$20 ea. Eimac 750TL - \$100; 204A, 861 - \$60 ea. Ray Harland, 2602 Mary Ln., Escondido, CA 92025-7502. (760) 746-4584

FOR SALE: Consoles: Zenith chassis #N699583 C tube black dial 3-band, (5) Z knobs, 1936 - \$200. Philco slant-front 38-2, 11 tubes - \$175. Both work & good cabinets. No shipping. F. Vaillancourt, PO Box 726, Woodstock, VT 05091. (802) 457-3482

FOR SALE: Used 807 tubes, tested and guaranteed - \$5 ea. + \$3 priority mail. James T. Schlieslett, W4IMQ, PO Box 93, Cedartown, GA 30125. (770) 748-5968. E-mail: imq@bellsouth.net

FOR SALE: Arvin Radio Cruiser, sailing type chrome sails, 1941, similar to Majestic Radio Cruiser - \$150. R. Burick, 274 14th St., Ambridge, PA 15003. (412) 266-4516

FOR SALE/TRADE: Exquisite Fada bullet 1000 in butterscotch w/red trim - \$1,200. Fada bullet 1000 in red wine w/butterscotch trim - \$1,200. Emerson Little Miracle, yellow w/black shutter grille and knobs - \$1,200. All above cabinets are flawless and in museum condition. Call: Larry Drago, 383 Lincoln Dr., Cheshire, CT 06410. (203) 272-6030, or fax (203) 272-2002

FOR SALE: Airline 62-338 - \$30. Arvin 540T B-32 - \$50. Bulova A B-47 - \$30. Crosley 9-121 B-56 - \$25. Emerson 599A B-77 - \$35. Magnavox chairside radio-phonograph - \$35. Master's Art similar to Country Belle - \$15. Philcos: 38-93 B-150 - \$60; 84 B-190 - \$60; 47-206 B-155 - \$25; 48-200 B-155 - \$30; 48-461 B-156 - \$30. TV amplifier - \$25. RCAs: 6BX6C B173 (see 6BX6B) - \$20; 4-X-641 B-172 - \$25; 75X16 B-182 - \$50. Sentinel 332 B-195 - \$25. Westinghouse H338T5UB-227 - \$25. Zeniths: K66R B-247 - \$30; 2404L leather portable - \$20; H7232Z B-247 - \$25. Co-op by R.P.C. 30's wood - \$60. All plus shipping. H.B. McMahan, 313 W. Shaw, Tyler, TX 75701-3029. (903) 593-5433

FOR SALE: Nordmende Elektra, not working, cabinet in good condition - \$50 plus shipping. Jerry James, 1413 Gunnison, Wichita Falls, TX 76305. (940) 855-8335. E-mail: Owen@cyberstation.com

FOR SALE: Philcos recapped: excellent 47-205 - \$30; 54C - \$90. Audiola 6-tube cathedral, original except filters, works - \$250. AK 80 beautiful - \$500. Mike Schwartzman, 10 Susquehanna, Cooperstown, NY 13326. (607) 547-6264

ANTIQUE RADIO ON CD-ROM



RIDER'S PERPETUAL TROUBLESHOOTER'S MANUAL ON CD-ROM

THE FIRST AND ONLY INDEX ACCURATE RIDER'S CD-SERIES EVER PRODUCED • THE ONLY SERIES WITH A FULL DATABASE SEARCH ENGINE • THE ONLY SERIES THAT HAS OVER 50 RADIO MANUFACTURERS' SCHEMATICS THAT DO NOT EVEN APPEAR IN THE ORIGINAL RIDER'S INDEXES • USE THE FASTEST, EASIEST, MOST ACCURATE SYSTEM AVAILABLE • HIGH RESOLUTION IMAGES • ZOOM IN-OUT, ROTATE, BUILT IN GREY-SCALE SIMULATION TO ENHANCE PICTURE IMAGES • MAGNIFY DIFFICULT TO VIEW SCHEMATICS • PRINT ANY OR ALL PAGES • HAS RIDER UPDATES/CHANGES BUILT-IN • AUTO RADIOS, RECORD PLAYERS ALL INCLUDED • SEARCH ENGINE ALLOWS LOOKUP OF SCHEMATICS EVEN IF YOU CAN'T SPELL THE NAME OF THE RADIO OR ONLY HAVE PART OF A MODEL NUMBER • BUILT-IN HELP FILE FOR OPERATING THE PROGRAM • BUILT IN SETUP PROGRAM • *DON'T BE FOOLED BY "JOHNNY COME LATELY" LOW COST IMITATIONS - BUY REAL RIDER'S. YOU'LL BE GLAD YOU DID!* • THE PREMIER SERIES FOR THE SERIOUS COLLECTOR • SHIPPING SINCE 1996

Riders "Perpetual Troubleshooters Manual" - All 23 Volumes on 6 CD's, powerful database system, tired of trying to find schematics, this is the answer, over 35,000 schematics for over 100,000 radio models included in this famous series. The reference "Bible" of antique radio schematics - all "instantly" available on CD-Rom - 2 years in the making. 6 volumes covering V1-4, V5-8, V9-12, V13-16, V17-20, and V21-23. Can be purchased as individual volume sets. Try one before investing in the entire series! If you're serious about antique radio, this is a "MUST" for every antique radio lover. The first and only index accurate CD-series that has it all - speed, performance, high resolution and ALL of the radios!

\$ 85 each volume set or \$ 450 for the complete series postpaid USA

OTHER WORLD-FAMOUS CD-ROM PUBLICATIONS

The Radiophile Series - Articles, Books, Reference Data, Resource Books, Technical Info, Troubleshooting Courses, Theory, Schematics and more are available on this series. **Volume 1** - 29 books with theory, reference, history, and troubleshooting information; **Volume 2** - Gernsback Radio Serviceman's Books from 1931-1936, and Zenith service manuals Vols 1 & 2 from the beginning of Zenith through 1942; **Volume 3** - Tube substitution - foreign and USA, The Book of Radio, The fabulous Yaxley-Mullory Radio Encyclopedia, and the equally famous RCA Radiotron Design Handbook; **Antique Radio Repair Volume 1**, the first CD produced with just about everything that one would need to repair antique radios or to learn how to!

Only \$ 85 each postage paid USA, export plus shipping

SCHEMATIC DIAGRAM SERVICE - NOW WITH ELECTRONIC

DELIVERY BY EMAIL - CALL, WRITE, FAX, OR EMAIL AND VISIT US ON THE INTERNET @ <http://www.electrosys.com>

RADIO ERA ARCHIVES • div. ECS, Inc.

2043 Empire Central
Dallas, Texas 75235
Inquiries: 214-358-5195
Fax: 214-357-4693
Toll Free Orders: 888-EC-IMAGE
Hours: 9-5 M-F CST

Visit us on the Internet:
<http://www.electrosys.com>

We take all major credit cards

Order These Popular Books From Antique Radio Classified



Price Guide

The Collector's Guide to Antique Radios 4th Edition by Marty & Sue Bunis. 8,500+ Battery & AC sets from the '20s to the '60s. Updated prices. Many new photos. 1996. Shipping Now. — \$18.95



Price Guide

The Collector's Guide to Transistor Radios 2nd Edition by Marty & Sue Bunis. This book will help you identify the most sought-after vintage transistor radios. Over 2,900 models, all with current prices. Includes radio club listing. 375 all new color photos, 320 pages. 1996. — \$16.95

NEW BOOKS.....

The Magnetic Cone Speaker Notebook, Paul. 250+ cone speakers from 120+ companies. Photocopy. 1995. 58 pages. \$10.90

Shortwave Receivers Past & Present, Communications Receivers, 1945-1996, 2nd Ed., Osterman. For the radio collector, the informed receiver buyer or anyone interested in the history of shortwave radios. 500 radios listed. 350 pages. \$19.95

Hams! We now have 7 ham books - See our full page ad

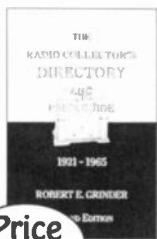

Price Guide

The Radio Collector's Directory and Price Guide, 1921-1965, 2nd Ed. by Robert Grinder. Over 20,000 radios by manufacturer, model number, year, etc. with prices. Radio history, cabinet style chapters. No photos, 264 pages. — \$26.95

Transistor Radios, A Collector's Encyclopedia and Price Guide by Robert Lane and David Lane. Identification guide to over 2,500 transistor and novelty radios. History and key to collecting chapters, 170 pages. — \$19.95

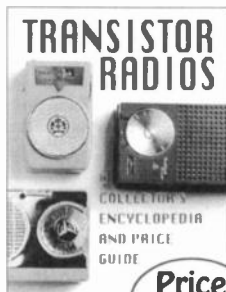

Price Guide

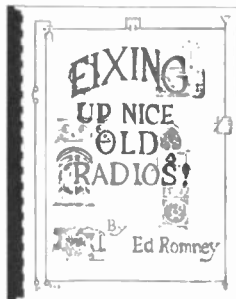

Fixing Up Nice Old Radios by Ed Romney. Written by a retired radio instructor. Plastic binding. 300+ figures, 185 pages. — \$29.00

Old Time Radios Restoration and Repair by Joseph J. Carr. A self-paced training guide. History, theory and practical operation of antique and classic radios. 200 illustrations, 256 pages. — \$19.95



U.S. Orders - Enclose \$3.00 per order for packing & book-rate shipping if total order is under \$35.00. If using VISA or MasterCard, include name on card, card number and expiration date. Send payment with order. Mass. residents add 5% sales tax. Money back return policy. Softcover unless stated otherwise. Most orders shipped the same day received, but allow 2-4 weeks to receive order. Foreign orders - write for shipping costs, or use credit card and specify air or surface (allow 2-3 months for surface shipping).



A.R.C., P.O. Box 2, Carlisle, MA 01741. Tel: (508) 371-0512

Fax: (508) 371-7129

Web: <http://www.antiqueradio.com/>



(Jul-97)

Order These Popular Books From Antique Radio Classified

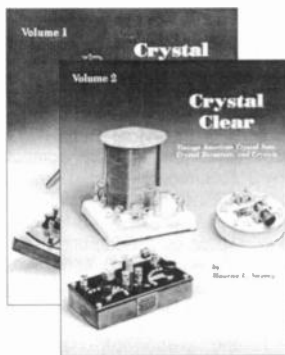

Crystal Clear Volume 1 and Crystal Clear Volume 2 by Sievers. *Comprehensive reference to crystal sets, crystal detectors, and crystals. Each volume contains different illustrations and information. Order by volume. — \$29.95*



Flick of the Switch by Morgan McMahon. *The classic photo reference guide for 1930s - 1950s radios. 1000+ photos of radios, 5" x 8", 263 pages. — \$11.95*

NEW BOOKS.....

Radio!Radio! 3rd Edition., Hill. *New transistor radio section, includes directory of 3,000 transistor radios. Brought up-to-date. 75 new pages, 50 new illustrations. 320 pgs \$64.95*
Classic Plastic Radios of the 1930s and 1940s - A Collector's Guide to Catalin Models, Sideli. *It's back! Over 200 models from 25 manufacturers listed in full color..... \$19.95*

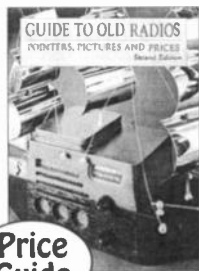

Guide to Old Radios, Pointers Pictures, and Prices, 2nd Ed. by Johnson. *Introduction to radio collecting. Includes hundreds of photos and a price guide. 272 pages. — \$19.95*



Antique Radio Restoration Guide, 2nd Ed. by Johnson. *Beginner's introduction to troubleshooting and repairing AC table model radios. 145 pages. — \$14.95*

Price Guide



The Zenith Trans-Oceanic: The Royalty of Radios by Bryant and Cones. *Presents the fascinating story of the development and use of the Trans-Oceanic. Several photos, documents, ads, etc. 160 pages. — \$24.95*

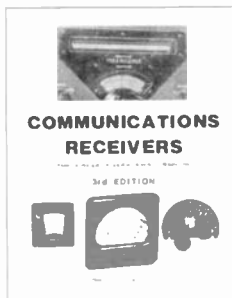

Communications Receivers, 3rd Ed. by Ray Moore. *Information on vacuum tube receivers by 66 manufacturers. 402 radios illustrated, 115 pages. — \$19.95*

U.S. Orders - Enclose \$3.00 per order for packing & book-rate shipping if total order is under \$35.00. If using VISA or MasterCard, include name on card, card number and expiration date. Send payment with order. Mass. residents add 5% sales tax. Money back return policy. Softcover unless stated otherwise. Most orders shipped the same day received, but allow 2-4 weeks to receive order. Foreign orders - write for shipping costs, or use credit card and specify air or surface (allow 2-3 months for surface shipping).



A.R.C., P.O. Box 2, Carlisle, MA 01741. Tel: (508) 371-0512

Fax: (508) 371-7129

Web: <http://www.antiqueradio.com/>



(May-97)

FOR SALE: McIntosh 240, with cage, new 7027A tubes, some rust - \$1,200. McIntosh C-20 preamp - \$500. Steve Harrell, 1179 Boylston St., #30, Boston, MA 02215. Phone/fax: (617) 247-0672

FOR SALE: Globe 6 & 2 meter VFO - \$75. Hallicrafters SX24 - \$150; & 5R10A - \$75. Philco #89 cathedral - \$275. Collins, mechanical filter - \$75. Peerless cathedral speaker - \$75. Ernest Odeneal, 2710 Lee St., Greenville, TX 75401. (903) 455-3112 or 5788. E-mail: odeneal@webwide.net

FOR SALE: Federal 59, near mint. Hallicrafters SX100, SX117, HT44, PS 150-120, PM 23 w/h logo. Marconi No. 52., CSR 5, Eddystone, Racal and 80 communications receivers. Tubes: RCA 811A N.I.B. PL 172; Myers BAC3 and many strange tubes. RCA AR88, CR88, CR91A, TMC, SBE 2 transmitter exciter. Bach. Simpson Model 77 wavemeter N.I.B. Christiane Gagnon, 235 Rte. Neigette, St. Anaclet, Quebec, Canada G0K 1H0. (418) 723-9689

FOR SALE: Many TV's and radios. No list, please call or write. Hicksville Radio and TV, 11 E. Marie St., Hicksville, NY 11801. (516) 822-4501

FOR SALE: Tube tester Hickok 600A - \$55. (1000+) tube list, one stamp to: Joe Knight, 3921 Windolyn Ct. S, Bartlett, TN 38133. (901) 372-5969

FOR SALE: 1930 Zenith 61 vertical dial highboy, original, complete less speaker, UPS shippable - \$85. Curt Brohard, 1417 Court St., Alameda, CA 94501. (510) 521-4299

FOR SALE: Radiola 20 w/loudspeaker 100, appears complete, not tested, very good condition - \$500. H. Andreoni, c/o 250-D So. Lyon Ave., Hemet, CA 92543

FOR SALE: Tektronics scope plug-ins, Type 1A1, 1A2, 1A6, 84, CA, G, Q, M. Frank A. Johnson, 530 Eiford Rd., Fairless Hills, PA 19030. (215) 943-8295

FOR SALE: Rare blonde 21" Philco Predicta "Holiday" model, 8+ cond., works well - \$950. Northern Electric Bullet, hammertone blue, exc - \$160. DeWald G-404, similar to Bantam, midget Bakelite, exc - \$125. Craftsman C500 amp and preamp/tuner, aftermarket power transformer, good chrome - \$225. Altec 602A duplex speaker, with dividing network, exc - \$225. Carlton ST-7, Wilco Deluxe, reverse-painted transistor, grey, exc - \$90. (3) 215B peanut tubes - \$25 each. **WANTED:** Chassis for Emerson AU-190, BT-245, or 213. Mike Herman, #2-1731 Rockland Ave., Victoria, British Columbia, Canada V8S 1W6. E-mail: edman@octonet.com

FOR SALE: Heathkit HW-101 SSB transceiver - \$120. Jefferson clock - \$60. NASA shuttle - \$30. Computer AM/FM - \$20. Sony 3" R/R, red/white - \$30. National AM/FM cass./phono - \$75. Sanyo Transcontinental, NW - \$20. Lafayette 324A amplifier - \$25. Philco cathedral 40th anniv. replica by Philco/Ford, 1971 - \$75. Check add previous issues (J/80, M/62, A/68). Thanks. Bret F. Johnson, 13495 102nd Ter. N, Largo, FL 33774. (813) 595-9287, leave message

FOR SALE: ART-13 in original wood box - Make Offer. Herb Ellmers, 775 Howard St., Ft. Pierce, FL 34982. (561) 466-0926

FOR SALE: Hallicrafters S-20R, totally original, very nice condition, with original manual, works great - \$125. Herb Ellmers, 775 Howard St., Ft. Pierce, FL 34982. (561) 466-0926

FOR SALE: Rider's I, II, III, IV & V, includes original 1-5 Index - \$195 plus shipping. Robert Vanderwarker, 607 Braecrest Cir., Steilacoom, WA 98388. (253) 588-0295

FOR SALE: Hundreds of books. All radio-related subjects, early to present, some rare. SASE. Richard Gray, 11869 High Ridge Rd., Lakeside, CA 92040

Attention Fellow Microphone Collectors and Enthusiasts:

We are pleased to announce that we are assembling a book on microphones. The object of this book will be to encompass, not only pictures and data on the microphones themselves, but the stories, experiences, applications and memories of those involved in all facts of using microphones; from the beginning to the present from normal applications to the most bizarre. We wish to include all types of microphones, from the simplest and cheapest, to the most sophisticated and expensive. Anything that has to do with the art and application of microphones.

If you have a spot in your heart for microphones and wish to submit pictures, stories, etc., anything that you think would be interesting to share with fellow enthusiasts, please don't hesitate to e-mail, fax, or mail your interests. Full credit will be given to everyone involved.

Kindest regards and thanks for your attention and support.

*Ward Lionel Kremer
Kremer Kraft and friends*

5807 Papaya Drive, Fort Pierce, Florida 34982

Ph/Fax: 561/468-7732

E-Mail: WKremer798@aol.com

John Sideli's Classic Plastic Radios of the 1930s and 1940s A COLLECTOR'S GUIDE TO CATALIN MODELS

IT'S BACK!



ADDISON
AIR KING
ARVIN
AUTOMATIC RADIO
BENDIX
CROSLEY
CYARTS
DEWALD
EMERSON
ESPEY
FADA
GAROD
GENERAL ELECTRIC
GENERAL TELEVISION
HALSON
KADETTE
LAFAYETTE
MOTOROLA
R.C.A.
SENTINEL
SONORA
SPARTON
STEWART-WARNER

127 Pages – Over 200 Illustrations of Radios in Full Color
55 different models from 25 manufacturers are extensively covered. Included for each is a description, the year of manufacture, dimensions, colors found and photos illustrating the various colors and variations. A 15-page introduction describes the growth of Catalin radio collecting, the Catalin material itself, the “Catalin” style, rarity and value, and colors and restoration. The introduction contains an additional eighteen photos, twelve in full color.

Softcover* – \$19.95

*Remainder Copies - Complete, slight mark on bottom edge indicating that they are remainders.

U.S. Orders - Enclose \$3.00 per order for packing & book-rate shipping if total order is under \$35.00. If using VISA or MasterCard, include name on card, card number and expiration date. Send payment with order. Mass. residents add 5% sales tax. Money back return policy. Softcover unless stated otherwise. Most orders shipped the same day received, but allow 2-4 weeks to receive order. Foreign orders - write for shipping costs, or use credit card and specify air or surface (allow 2-3 months for surface shipping).



A.R.C., P.O. Box 2, Carlisle, MA 01741. Tel: (508) 371-0512
Fax: (508) 371-7129

Web: <http://www.antiqueradio.com/>



(Jun-97)

FOR SALE: TeleMatic color TV jig, 35 adaptors for tube/transistor sets - \$90. Charles A. Days, PO Box 80205, S. Dartmouth, MA 02748-0205. (508) 979-3758. E-mail: radiodaz@ici.net

FOR SALE: Sky Master, lime green Plaskon portable radio in Collins book, excellent condition - \$125 BO. Mallory Radio Service Encyclopedia - \$20. Used RCA 6550 - \$15. Philco 70 cathedral, original, except grille cloth very nice, works but hums - \$325. Dynaco ST70 amp, original condition with tubes, good transformers - \$150. Grunow 11G console (11-tube set), chassis, no tubes - \$25; speaker - \$15; cabinet - \$20; all for - \$35. Cabinet, pickup only. Large chrome-plated early solid-state amp, jukebox? nice condition - \$12. Tektronix 360 indicator - \$10. Standard 18" rack mount for Tektronix units - \$10. Panasonic T100MD large multiband portable, works, good condition, dial string off - \$20. Toshiba RP 1900M multiband portable military look, good condition - \$20. Coronado 43-8190 as in Collins book, missing jewel and two cracks - \$125 OBO. Early Sony 8FC-55W clock radio, all chrome glass and wood, working - \$20. **WANTED:** Pilot radios and related items. Bill Moore, 3049 Box Canyon Rd., Huntsville, AL 35803. (205) 880-1207

FOR SALE: Tan Zenith Royal 500 - \$225. Zenith Suncharger in original box with accessories - \$275. Zenith Golden Triangle in original box - \$500. Many other Zenith and Emerson 888 transistors available. John Kern, 2320 Rosedale Rd., Quakertown, PA 18951. (215) 538-2128. E-mail: rqvh12a

FOR SALE: Zenith console Model 72X, nice, plays - \$225. GE TV 805, plays - \$125. Greg Bogel, Box 312, Peg Run Rd., Cherry Tree, PA 15724. (814) 743-9028

FOR SALE: Microphones from old estate: Shure 40D base with 70H head, no tubes or power supply, otherwise looks complete. Shure carbon mike with Western Electric 387 element, bud 6" stand. Brush Model BR2S with 8.5" stand. Astatic D104 Ser. #28346 on Astatic stand. Sales literature on Astatic radio receptor. Mikes, Tumer, Brush, American, RCA 74B, RCA 77A. Everything as found, uncleaned, unchecked, last used about 1939 or 1940. Best offer on entire lot, do not want to separate. Jim Shoemaker, RR#1, Box 118A, Prescott, KS 66767. (913) 471-4644

FOR SALE: Philco wood table Model 38-12, works good, 1938 - \$30 + shipping. Raymond Humphreys, 904 Jackson St., Macon, MO 63552. (816) 385-2821

FOR SALE: Rider's 1 through 21 - \$15 ea. and up. Bill Rolf, 30131 Center Ridge, Westlake, OH 44145. (216) 871-4547

**TUBES WANTED
HIGHEST PRICES PAID \$\$\$**

W.E. 101F, 205D, F, Tennis Ball, 274B, 300B, 211, 845, KT66, 77, 88. EL34, PX25, 280, 245, 250, Telefunken, Mullard, Bugle Boy ECC81, 82, 83, 801S, 802S, 803S.

—AUDIO EQUIPMENT WANTED—

McIntosh, Marantz, UTC, W.E. Trans, Black Beauty, A & B Resistor, etc.....

**FULL RANGE ELECTRON TUBE SHOP
Jonathan Woo**

Flat B, 37/F, Block 5, Greenfield Garden,
Tsing Yi, Hong Kong

Tel: (852) 24349466 Fax: (852) 24344963
<http://www.jeis.com/~fullrang/>

FOR SALE: Hallicrafters S108, works with original book - \$110 plus shipping. Hallicrafters S120, dial glass corner broken but works - \$35 P/S. Arvin Model 68, circa 1938, needs push buttons and knobs, cabinet broken in left rear, otherwise complete chassis w/back and works - \$60 P/S. Zenith H845 Prelude AM/FM radio, plays great - \$55 P/S. 1940 RCA BP10, complete, looks good, not working - \$65 P/S. Columbia Master Works, M2002W, AM/FM, wooden - \$45 P/S. RCA 2X-61, circa 1953 has small break in right side back, works, complete w/back - \$80 P/S. Sears Silvertone Model 20, circa 1951, S logo, creme, complete, not working - \$50 P/S. Sylvania tube manual - \$15 P/S. Crosley 66TC, circa 1946, wooden, not plastic cabinet, AM/SW, looks good, complete but doesn't play - \$70 P/S. Panasonic Model 45327 clock/radio, circa 1974, brushed aluminum sides, with talking time button on top - \$60 P/S. Zenith F452W small clock/radio - \$25 P/S. Westinghouse H30717, complete - \$50 P/S. Collins speaker, gray metal w/wire mesh grille, toggle switch on front of grille - Best Offer over \$65 by July 10. National Radio News magazines, Dec. 1944 to Jan. 1945, Feb. to March 1945, April to May 1945, and others, also 1914 to 1944 30th anniversary issue, call for price. Have other radios and tubes. Call with wants. Ron Crowe, PO Box 117, Handley, WV 25102. (304) 442-8179. E-mail: rgcrow@wvnet.edu

**NOTICE TO ALL
CLASSIFIED ADVERTISERS!
OUR CLASSIFIED AD DEADLINE IS
12:00 NOON
ON THE 10th OF EACH MONTH**

FOR SALE: Hallicrafters SX130/R50 speaker and manual - \$150. Heathkit LG1 sig. gen. and manual - \$75. SG103/URM25F sig. gen. - \$175. EICO 147A sig. tracer and manual - \$55. All plus shipping. Sam Luscomb, 510 Virgo St., Mission, TX 78572-6529. (956) 580-2474

FOR SALE: Sentinel Catalin wavy-grille Mod 284NI, cream - \$765. Fada 1000 bullet, b-scotch w/red trim, minor probs., case good - \$685. AK cathedral 92, early, w/hole in face - \$315. Majestic studio Mod 59, missing one knob - \$535. Silver-Marshall small cathedral, cute - \$245. Motorola 56H, turquoise - \$185. Jensen TF-3 speakers - \$180/pr. Antenna assy. for Zenith #59 - \$85. Bremer-Tully cathedral spkr, nice orig. - \$95. AK L horns. (2) - \$65 & \$85. AK E spkr - \$45. 10% discount after July 6. All are plus shipping. Lars Roose, 10100 Chapala Ct. NE, Albuquerque, NM 87111. (505) 296-4129

FOR SALE: Many Deco radios. **WANTED:** 1. Super Buddy Boy chassis. 2. Lyric J cathedral chassis. Randy Giles, 4020 San Ardo Cove, San Diego, CA 92130. (619) 792-7376. Fax: (619) 794-7682

FOR SALE: Tubes, early radio to "sweep" types. Send want list, SASE to: Dan Buchalter, 695 Dowling Blvd., San Leandro, CA 94577

FOR SALE: Nice original Zenith console 9S367 - \$400. Fada 652 cabinet only, hairlines - \$70. Fada 652 bezel - \$125. Small Addison, black and white marbled - \$420. Restored floor model Predicta - \$925. Stripped, basket-case floor model - cheap! Arvin 502 - \$65. Silvertone metal - \$55. Please call before 8 pm, thanks. Brad Jones, 4801 Crofton Springs Ct., Greensboro, NC 27407. (910) 547-1919

WANTED: Fixed condenser Type 260 for Tuska 224, porcelain rheostat for DeForest Audion detector. Don Sturzenbecher, 26990 Marion Rd., Sioux Falls, SD 57108. (605) 368-2135

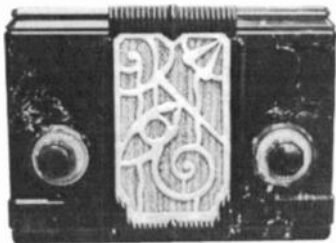

WANTED: Early (prewar II) plastic radios. I collect these objects of beauty to enhance my otherwise dull and uneventful life to which I am forever bound by my sad-but true unworthiness and shortcomings: physical, emotional, and intellectual. Please write or call collect: Rain Buttignol, 214 State St, #7, Portsmouth, NH 03801. (603) 427-1384

WANTED: Push-button escutcheon & (6) push buttons for Stewart-Warner 01-6B9. RCA vol. control & switch 111309 (974857-7). RCA idler 108602 or Walsco 1447-03. All Dial Stringing Guides. Noel S. Ilg, 228 Beck Rd., Avon Lake, OH 44012. (216) 933-5668. Fax: (216) 933-8864

WANTED: Victor Electrola/Radiolas, including parts sets. Especially need RCA power amplifiers AP-736 and AP-777, right-handed magnetic pickup and Radiola 64 drawer/chassis for VE 9-54. Jeff Lendaro, 1107 Logan St., Noblesville, IN 46060-2346. (317) 773-3969. E-mail: lendaroj@indy.tce.com

WANTED/TRADE: Microphones. Broadcasting, recording, theater, hi-fi audio. Tube mixing consoles, preamps, limiters, turntables, recorders. Robert Van Dyke, 2 Squires Ave., East Quogue, NY 11942. (516) 728-9835



WANTED: This Lewol radio with metal trim & radios with chrome grilles. Jay Malkin, 1250 Galapago, #206, Denver, CO 80204. (303) 623-6451

WANTED: Any manuals for Munston 1510 signal generator, Interstate F74 function generator. George Harris, 3212 36th St., Lubbock, TX 79413. (806) 799-2589. E-mail: gharris@juno.com

WANTED: FT-243 crystals. Frequency/channel: 8075/366, 8225/372, 8250/373. Ken Kinderman, 50 East 79th St., Apartment 3E, New York, NY 10021. (212) 512-1866, day; (212) 288-1310, eve.; (212) 288-3070, fax

WANTED: Power transformer for Philco 65. Knob for Crosley 148 or 167, good speaker for any of the following AK models: 80, 82, 84, 90, 92, 228, 558 or 627. Ralston Bailey, Rt. 1, Box 479, Benton, TN 37307. (423) 338-5923

WANTED: Philmore crystal sets, tuning knob for Parmak 5-tube battery radio, 2 AF transformers for AK 20. Gordon Emry, PO Box 99, Elk, WA 99009. (509) 292-2182

WANTED: For RCA SC-88, schematic, alignment instructions, manual. Copies okay. Henry Rogers, Virginia City Radio Museum, PO Box 511, Virginia City, NV 89440. (702) 847-9047

WANTED: Operating and service literature for Scott Type 830 FM stereo generator. Thank you. John Lomas, 253 Elm Ave., Glen Riddle, PA 19063-5739. (610) 459-0186



WANTED: Toy crystal radios, including Crown, Revell, Midget, Tinytone, Cathedral, Fuji, Disasteradio, Astralark, Miniman, Carron and zillions more. Mike Brooks, 7335 Skyline, Oakland, CA 94611. (510) 339-1751

WANTED: S meter for Hallicrafters SX-42 or complete junker for parts. Herb Ellmers, 775 Howard St., Ft. Pierce, FL 34982. (561) 466-0926

Join the AWA

ANTIQUÉ WIRELESS ASSOCIATION THE ORIGINAL AND LARGEST HISTORICAL RADIO-COLLECTOR GROUP

- Publishes *Old Timer's Bulletin* with:
 - Battery and AC receiver restoration
 - Vacuum-tube history and collecting
 - Old-time amateur-radio contests
 - Communications receivers
 - Free want-sell-swap ads
 - Early television
 - Horn loudspeakers
 - Reviews of current books
 - Keys and land-line telegraphy
 - News of U. S. and foreign clubs
 - Information on public radio museums.
- Maintains unique radio-TV museum.
- Produces the annual Rochester meet.
- Co-sponsors local meets.
- Publishes the annual AWA Review.



Membership is only \$15 per year (\$27 for two years, \$18 per year for overseas). Mail check to:

Antique Wireless Association, Inc.
Box E, Breesport, NY 14816

FOR SALE: Microphones. Astatic D103 - \$150. EV 638 - \$150. Shure 520 - \$100. With stands. Mark Schackow, 307 4th Ave. East, Lemmon, SD 57638. (605) 374-3424

FOR SALE: B&O Beomaster 3000 w/remote, beautiful - \$275. B&H & Heathkit scopes - \$25 & \$45. Precision 612 tube tester - \$40. B&K CRT rejuvenator - \$25. Akai X-200D x-field, 3-motor deck - \$75. Ampex 1100 deck - \$25. Ampex 622 speaker/amp - \$165. B&K 707 - \$75. Heath turntable & nice AA-141A preamp - \$90. Grundig radios, more! SASE for 4-pg. list. **WANTED:** Emerson 520 back; Zenith #5619 chassis; have RCA BB 201 & Cunningham C-300 w/tip, BB, trade for transistor radios. Thanks! Michael Hagan, 428 Sharron Dr., Waco, TX 76712. (254) 776-4760

FOR SALE: Oscilloscope Heath 10-14, looks good, nothing broken + lights up - Make Offer. Philco remote mystery type w/dial, beautiful wood, '30's. **WANTED:** The Palm Beach Community College "Big Band Hall of Fame" is opening in W. Palm Beach, Florida. We need donations. Your items will live on for history instead of die in a thrift shop. Name your price for the following items: Radio/phonograph console RCA + other RCA/Zenith/Philco w/ changers + good cabinets, working or not OK. Speakers JBL L100 and L200S, any cabinet. VM changer 45 rpm spindle, early type. Amp complete and knobs for RCA 45 table phono Model 45-EY-4. Tubes 50L6, 35W4 + 12SQ7 for RCA 45-EY-2. Zenith cobra changers, any year + 45 rpm spindle adapters. Radio transcriptions 16-inch records Big Band or Sammy Kaye "Sunday Serenade". Early Ampex 1-or-2-track recorders, working or not. Jukebox Rock-olla or Wurlitzer for display in world's only Big Band Hall of Fame in W. Palm Beach, Florida. Donate or on loan for display or ? Big Band memorabilia/ photos/transcriptions for Big Band Hall of Fame. **Contact:** Robert DeMars + Tim Pierce, 222 Lakeview Ave., Ste. 160/256, West Palm Beach, FL 33401. Phone: (561) 844-7434 or (561) 832-0171. Fax: (561) 844-1493. E-mail: BigBandHoff@aol.com

FOR SALE: Thorens portable gramophone Excelda with instructions, works, spring OK - \$450. Tom Murray, 3177 Latta Rd., #409, Rochester, NY 14612. Ph/fax: (716) 723-1672. E-mail: tomvidtek@aol.com

FOR SALE: Vibroplex presentation telegraph key - \$200. Fada 711 Catalin maroon with white knobs and handle, mint - \$600. Phillips Model 834 cathedral, exc - \$500. **WANTED:** Chassis for DeWald 440 table set. Thanks. Jon Steinhauer, 1205 E. Broadway, F-15, Hewlett, NY 11557. (516) 295-3147

FOR SALE: Tube sets: Philco 642, shouldered tombstone, 32V, nice shape - \$100. Philco 48-460 - \$50. Silvertone 6002, crack - \$45. Truetone D941, Deco Bakelite - \$125. GE 423, ivory - \$35. Transistor sets: GE 677, red, 3/8 inch crack in one corner - \$110. Universal PTR-62B, ivory N.I.B. - \$60. Angel boy's radio, red - \$60. Standard SR-G45, red, N.I.B. - \$195. Standard SR-H436, black, N.I.B. - \$175. Toshiba 5TP-90, maroon, underpainted - \$85. Russ Abrams, 2330 Villaret Dr. SW, Huntsville, AL 35803. (205) 883-7322

FOR SALE: Philco 41-235 parts set. **WANTED:** Stromberg-Carlson 61-U, Faribanks-Morse 91-T-4 tombstones. Curt Schreiber, 3923 East Latoka St., Springfield, MO 65809. (417) 887-5184 collect. E-mail: Curtradio@aol.com

FOR SALE: Philcos 90, 16b, grandfather, 96, (2) chairsides. AK BB 10c. Synchrophase. Silver-Marshall shielded 6 and home brew. (3) Zenith consoles. Majestic console. Stromberg-Carlson 635a with matching stand. Black Burns. Music Master 14 inch. Kolster 6d. Stromberg, Saal, (3) AK, (2) Western Electric, Rola, Thompson horns. (2) Kiel tables. All or none - \$4,500. Most prices figured with room for modest profit at Rochester. Scott Cavalari, 1258 Rt. 94, New Windsor, NY 12553. (914) 561-7913

FOR SALE: Pilot TV-37, very clean - \$200 + shipping. Used tubes: Arcturus 127 (2) blue tubes - \$18 + ship ea. DeForest Audion 503-A (BB & tipped, signature on base) and WE 211E, all tubes tested for good filaments only, sold as-is. Accepting offers on DeForest and WE tubes. Robert Carobene, PO Box 650206, Fresh Meadows, NY 11365. (718) 281-0504. E-mail: robertc894@aol.com

FOR SALE: Zenith Trans-Oceanic Royal D1000Y, N.I.B. - \$425. KLH FM 18 - \$50. Radiola IIIa - \$125. Dan Merz, 312 Sierra St., Richland, WA 99352. (509) 375-1334

FOR SALE/TRADE: Personal computer radio N.I.B. - \$18. Pool table (China) N.I.B. - \$30. Spice Chest (B482), vg - \$42. Champion Spark Plug (B314), vg - \$95. Plus shipping. Dan Sipola, 2840 Copeland Rd., Maple Plain, MN 55359. (612) 972-8214. E-mail: philco90@minn.net

FOR SALE: Transistor sale: Sony TR-63, Regency TR-4 working!, Hoffman Trans-Solar, many others. 55¢ LSASE for color catalog. Competitive offers. Act fast, best stuff goes first. Darryl Rehr, PO Box 641824, Los Angeles, CA 90064. (310) 477-5229. E-mail: dcrehr@earthlink.net

FOR SALE: Stewart-Warner Porto-Baradio, needs decanter stopper - \$130. Radiola III - \$105. Zenith A600 original box - \$35. Magic-Tone bottle radio, label 75% good - \$225. Stewart-Warner 206FA - \$100. Crosley 124F cathedral - \$225. National 110 - \$165. SW-3 w/PS - \$275. F.O.B. Coraopolis, Pa. Joseph A. Szabat, 1019 Hiland Ave., Coraopolis, PA 15108. (412) 264-7498

FOR SALE: Old radio magazines. 1924-25 Radio Digest, 10 copies - \$10 ea. 1928-29 Radio News, 15 copies - \$13 ea. Radio-Craft in binders, 1939, 11 issues - \$90. 1935, 36, 37, 12 issues ea. - \$100. 1930-34, 15 issues - \$125. Ralston Bailey, Rt. 1, Box 479, Benton, TN 37307. (423) 338-5923

FOR SALE: Marantz 7 stereo preamp - \$1,350. Electro-Voice Aristocrat 3-way - \$175. Sony 5420 stereo tuner - \$50. Can deliver to Lansing Extravaganza. Bo Brook, 4858 Willow Ln., Orchard Lake, MI 48324. (810) 681-7133

FOR SALE: Goodmans 15" triaxiom speaker - \$50. Pair ESS tweeters - \$100. Scott tube stereo integrated amp - \$50. Garrard RC91 - \$30. Plus shipping. Walter Bernd, 99 Parkwood Dr., Fairfield, CT 06430. (203) 254-8140

FOR SALE: N.O.S. 6JE6/6LQ6 sweep tubes, (75) - \$35 ea. RCA, used 6JE6/6LQ6, (78) - \$17 ea. RCA, all tested good. Call, fax or write to: George Stagakis, c/o George's TV & Radio Repair, 1714A 41st St., North Bergen, NJ 07047. (201) 867-9136. Fax: (201) 867-4044

The Collector's Guide To Antique Radios - 4th Edition

By Marty & Sue Bunis



**Order
Today!**

8,500+ Battery & AC sets from the '20s - '60s
400+ color photographs
Updated prices
\$18.95 - Softcover

There are no transistor radios listed in the fourth edition. You will find them in *The Collector's Guide to Transistor Radios* available from A.R.C. for \$16.95.

U.S. Orders - Enclose \$3.00 per order for packing & book-rate shipping if total order is under \$35.00. If using VISA or MasterCard, include name on card, card number and expiration date. Send payment with order. Mass. residents add 5% sales tax. Money back return policy. Softcover unless stated otherwise. Most orders shipped the same day received, but allow 2-4 weeks to receive order. Foreign orders - write for shipping costs, or use credit card and specify air or surface (allow 2-3 months for surface shipping).



A.R.C., P.O. Box 2, Carlisle, MA 01741. Tel: (508) 371-0512

Fax: (508) 371-7129

Web: <http://www.antiqueradio.com/>



(Ad-97)

FOR SALE/TRADE: A complete "Kenwood" ham station consisting of the following: TR-7400A, TS-430S, TS-440S, TS-820S, AT-250. Take all these near mint beautiful condition items, with all manuals and microphones for \$2,650. Call: Larry Drago, 383 Lincoln Dr., Cheshire, CT 06410. (203) 272-6030 or Fax: (203) 272-2002

FOR SALE: Transistors: Emerson #988, turquoise - \$65. Toshiba #7TH-45Y wall-hugger, (Bunis 1) - \$95. Universal #PTR-62B - \$20. Sony #2R-21, red - \$30, plus UPS. 1931 RCA Radiola Superette Service Notes, 22 pages - \$20 ppd. C. Hill, 6934 Orion Ave., Van Nuys, CA 91406. (818) 787-0376

FOR SALE: Magnavox AM-60, ivory with case, nice - \$25. Sharp TR-202 - \$20. Plus shipping. Carl Smith, 3203 Route 60, Vermilion, OH 44089

FOR SALE: Spirit of St. Louis replica AM/FM cassette field radio with brushed aluminum case, toggle switches, LED indicators and Bakelite knobs, rotating 180° loop antenna, also tunes in weather band and two TV bands, requires 4D batteries - \$65 ppd. Rich Stamer, 331 Virginia Ave., Collingswood, NJ 08108. (609) 869-0238

FOR SALE/TRADE: Philco, RCA, Tung-Sol, National Union, vintage tube signs and wall hangings and silk signs for your collection. Call: Larry Drago, 383 Lincoln Dr., Cheshire, CT 06410. (203) 272-6030 or Fax: (203) 272-2002

FOR SALE: Beginner's radio repair guides, charts, codes and repair information. Send SASE for list. Charles Ahr, 2291 Sylveld Ln., Cincinnati, OH 45238

FOR SALE: N.I.B. 807 tubes - \$10 ea. Tested used 807 tubes - \$5 ea. plus shpg., SW-3 Phenolic replacement plug-in coil forms, WD-11 tube bases, adapters and plug-in replacement tubes. Free literature on above. ARL-USA, 5355 So. 275 W, Cutler, IN 46920

FOR SALE: GE Tungar trickle charger 3049336, good - \$25, offers. Donald Bisbee, 685 S. Roys, Columbus, OH 43204. (614) 279-6163



WANTED: TELE-TONES radios model # 117, 117A wood with grill holes or slots, 1946-50 EMERSON wood radios with front speaker perforations, # 503, 507, 513, 517, 519, 535, etc. RCA VICTOR 78 record players in ALUMINUM CASE or parts. STEPHENS floor speakers 1956-64 wooden cabinet on metal legs with formica on front. Also WANT plastic ZENITH Radio Nurse and boxes or parts. Steven Cabella / mod. I. 500 Red Hill Ave. San Anselmo, CA 94960 415-461-6810

WANTED: WILL PAY PREMIUM PRICE FOR EXCELLENT CONDITION NEUTROWOUND RADIO. BLACK, BLUE, OR RED AND GOLD 01A TUBES. L.A. VORIS, 40 KUHLANI ST., HILO, HAWAII 96720 OR 808-959-2298

FOR SALE: Zenith 9S264 w/ or w/o cabinet - \$125. Philco 57 - \$80. Weston AC ammeter 155, vg - \$50. Buzz Miller, 725 Mt. Rock Rd., Carlisle, PA 17013. (717) 776-3279

FOR SALE: Hundreds of 50's and 60's plastic radios, good to poor condition - \$5 ea. in large quantities. Pick up only. Mike Gorski, 36501 Irish Ln., Custer Park, IL 60481. (815) 458-2909, please leave message

FOR SALE: Used tubes: (3) 801A; (3) 10Y; (2) 812A and (2) N.I.B. JAN 913 - \$15 ea. Floyd A. Paul, 1545 Raymond Ave., Glendale, CA 91201. (818) 242-8961

FOR SALE: Fada 755 white Plaskon, no cracks, works - \$100. Fairbanks-Morse 699, cabinet good, power transformer, not original - \$45. RCA 86T3 tombstone, very restorable - \$85. RCA 118 tombstone, complete, restorable - \$100. Windsor transistor cathedral, plays - \$15. Baby Sitters Club, bookshelf transistor, N.I.B. - \$45. Radio Shack battery transistor radio - \$25. All plus UPS. James M. Seal, 3309 Boatman's Mountain Rd., Morristown, TN 37814. (423) 581-8269, no calls after 9:30 pm, please!

FOR SALE: McIntosh 2100 amp, C-28 preamp, MQ-102 equalizer with Marantz 2215, for sale as unit - Offers. Hallicrafters SX-28 with matching speaker, manual - \$450. Hammarlunds, two 180's with manual - \$395 ea. Everything a 9+. Convenient to Wash./Balt. area. No shipping. Lots of battery sets and collectable Bakelites and plastics. Larry Stone, Rt. 3, Box 70-D, Martinsburg, WV 25401. (304) 267-6721

FOR SALE/TRADE: Silvertone 4500A - \$70. Airline 64BR-1514A - \$25. Philco 53-706 - \$70. B&K 606 tube tester - \$10. Novelties: Wrist radio - \$15. Knights head - \$15. Cannon w/brass trim - \$30. Phono w/morning glory horn - \$25. Telechron Bakelite clocks: Deco clock/timer, cathedral - \$15 ea. **WANTED:** Wilcox-Gay ASI, DeWald B401, Sentinel 314W, RCA 1X. Mike Anderson, 2040 Mittenwald Dr., #410, Colorado Springs, CO 80918. (719) 599-4208

FOR SALE/TRADE: Shortwave Radiocraft magazines and ARRL call signal books from 1920's and 30's and 40's to help you find the names of your father or grandfathers who were "hams" during those golden years. Call: Larry Drago, 383 Lincoln Dr., Cheshire, CT 06410. (203) 272-6030 or Fax: (203) 272-2002

WANTED: Collins Radio Company Catalogs, promotional literature, manuals 1933-1983. Jim Stitzinger, 23800 Via Irena, Valencia, CA 91355. 1-805-259-2011

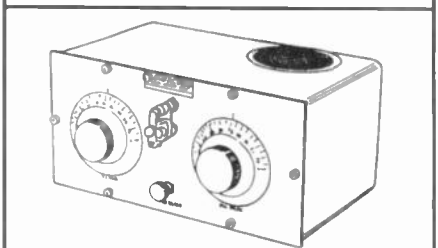

WANTED: Pre-1926 radios by AMRAD. Also, Amrad radio parts, accessories, and literature. Richard Sharisky, PO Box 521, Belmont, MA 02178. (617) 484-5784

WANTED: Electro-Voice 103C speaker package for Patricia IV. T.M. LeBlanc, 321 E. Spruce St., Sault Ste. Marie, MI 49783.

WANTED: Large Amperex tube manual from the 1950's/1960's. Also odd or unusual tube types. Will pay \$100 for Eimac 500T tube. John H. Walker, Jr., 16112 W. 125th St., Olathe, KS 66062. (913) 782-6455. E-mail: johnh.walker@alliedsignal.com

WANTED: Eucharistic minister looking for Catalins, beetle, Plaskon, Detrolas, Fadas, transistors. Bob Masterson, Box 172, Valley Cottage, NY 10989. (914) 353-3151. E-mail: BMradio@aol.com

WANTED: Coin-operated hotel radio, chairside style built by the Hotel Radio Corp. Call: Roger Reader, 526 13th Ave. N., Onalaska, WI 54650. (608) 783-0723

WANTED: Original factory sales and service catalogs for Altec, JBL, RCA, EV, Tannoy speakers. Alan Fong, 585 W28 Ave., Vancouver, British Columbia, Canada V5Z 2H2. (604) 879-1339

WANTED: Philco tombstone Mod #38-2670, restorable. Majestic Mod #90-B chassis restorable. Brass escutcheon for Philco 70. Tube shield and shield that covers tube and coil on center tube & coil of RCA Radiola Mod. #44 or 46. Jerry H. Reed, 4438 S. Santa Fe Pl., Tulsa, OK 74107. (918) 446-4276

WANTED: Hallicrafters S20R original, very nice, not working OK. George Guler, W00IR, 206 Alanhurst Way, Sun City Center, FL 33573. (813) 634-9489. E-mail: gguler@ij.net

WANTED: Browning-Drake 5R schematic diagram, spare parts, general information. A. David Wunsch, 111 Louise Rd., Belmont, MA 02178. (617) 489-0079. E-mail: wunsch@woods.uml.edu

WANTED: We buy tubes of all types. Please fax or send us a list, and we will promptly send our offer. Leeds Electronics, 68 North 7th St., Brooklyn, NY 11211. (718) 963-1764. Fax: (718) 963-1963

WANTED: Philco PT61 table radio, good condition, original equipment, knobs back, etc., restorable. Rod Kennedy, 2 Teodora Ct., Moraga, CA 94556. (510) 376-7885

WANTED: Cabinets for Crosley 1117, Sonora E-865/E-870. Power Unit 535 for a Stewart-Warner Model 503, 535. Dial and small knob, right side for Sparton 931. Al Webb, 8230 S. Linder Ave., Burbank, IL 60459. (708) 425-7153

WANTED: Photocopies: King-Hinners battery set manual, schematic, anything. Also need any info on: Ferris Industries, 32A Radio Noise Field Strength Meter, military test set I-56-J, RCA 151 oscillograph, Supreme 189 manual or any info. Don Merz, N3RHT, 47 Hazel Dr., Pittsburgh, PA 15228. E-mail: 71333.144@compuserve.com

ANTIQUÉ RADIO RESTORATION Satisfaction - Guaranteed. Ray Sanders, 342 South Third, Cottage Grove, OR 97424. 541-942-0866

PHONO NEEDLES & CARTRIDGES: (Ceramic & magnetic) What do you need? Send SASE. J.J. Papovich, 53 Magnolia Ave., Pitman, NJ 08071. (609) 582-8279

WANTED: Any Espy radio sets, especially table models, literature & advertising for same. Have some nice radios for trade, or buy outright. Belmont 6D111, Zenith 500-I + oval Metrodyne 5 (for trade). Also looking for Civil Defense, Cold War era stuff, helmets, posters, A-bomb press, air raid shelter stuff. What have you? W. Kremer, 5807 Papaya Dr., Ft. Pierce, FL 34982. Ph./fax: (561) 468-7732. E-mail: WKremer798@aol.com

WANTED: Small tube colorful coat-pocket size plastic radios. Damaged beauties that would display well also purchased. Got any tiny transistorized record players? Mike Brooks, 7335 Skyline, Oakland, CA 94611. (510) 339-1751, evenings

WANTED: EL-37 used, N.O.S.; Pilot AA-911 amp; book, manual oscilloscope basics; unbuild amp kits. Bill South, 13101 Foster Rd., Anchorage, AK 99516. (907) 345-9006

WANTED: Spruce bell for Music Master horn speaker for Philco 90; Guild spice chest novelty. Thanks. Ted Depto, Philco Collector, 9135th Ave., Patton, PA 16668. (814) 674-8834

WANTED: Fada 480 A, Brunswick 5K0 and a lid prop for a Magnavox TRF-50. Ken Martin, 12667 Eckard Way, Auburn, CA 95603. (916) 885-0243

WANTED: Zenith 805 case; Zenith 4R pot metal replacements; Clarion 420 chassis and escutcheons; Stewart-Warner Century of Progress chassis; Charley McCarthy, case only; Philco 70 case only. Richard B. Jehlik, 14441 North River Rd., Omaha, NE 68112. (402) 457-4604, after 7 pm Central

WANTED: Tuning dial for Westinghouse 1951 portable Model #H-343P5U. Bruce Ralig, 10005 Bay Pines Blvd., #642, St. Petersburg, FL 33708. (813) 398-0966

WANTED: Late model, small hearing aid. H. Eltz Repair, 4265 S. Bladen Ave., Juniata, NE 68955. (402) 756-6393

WANTED: National power supplies; speakers; coils, and parts. Sorry if I didn't get back to you yet or missed your call. I've had a won't quit cold. But, I still love National. Sylvia K. Thompson, N1WVJ, 33 Lawton-Foster Rd., Hopkinton, RI 02833. (401) 377-4912

WANTED: Philco's #39-19+, 57C, 41-231, 46-420L, 46-452, 37-604, PT-95. Donn Frederick, 8402 Hwy. 30 SE, Chatfield, MN 55923. (507) 867-4868

WANTED: Lightning arrestors, ceramic or others, with 2 terminals (radio/ground) or 3 terminals. Bob Puitre, 637 Stratford Rd., Baldwin, NY 11510. (516) 223-9667

Victrola Repair Service: Windup phonograph repairs, parts, springs, needles via U.P.S. Rod Lauman, 19 Cliff St., St. Johnsbury, VT 05819. (800) 239-4188, eves.

WANTED, ANY CONDITION: RBY, Hallicrafters S-35, PR-1, Collins 478R-1, Squires-Sanders SS-1V panadaptors; also schematics, manuals, ads, articles, technical data on them. John A. Benyo, 25 Schley Street, Garfield, NJ 07026

DONN'S ANTIQUÉ RADIOS — If you have nice quality Philco radios for sale, please call. Also buying some Crosleys and FADAs. Donn Frederick, 8402 Hwy. 30 SE, Chatfield, MN 55923. (507) 867-4868

FOR SALE: Zenith consoles: 10-S-559 - \$75; 10-S-669 - \$65. Pickup only. Rich Stamer, 331 Virginia Ave., Collingswood, NJ 08108. (609) 869-0238

FOR SALE/TRADE: A beautiful collection of twelve vintage Thomas Alva Edison books - \$450. Send for free title list. Larry Drago, 383 Lincoln Dr., Cheshire, CT 06410. (203) 272-6030 or Fax: (203) 272-2002

FOR SALE: ICA shortwave coils No. 1423, 6-prong, ICA, New York, U.S.A., box of 4 - \$55. Old Tungar bulb, 8" x 4" 189049 GE, 2" thread in socket with white porcelain base - \$25. Emerson radio, phonograph, 45's brown plastic, automatic record changer, 14" x 14" - \$55. 12-tubes 6B066TB 6AU4 1G3GT, (2) IP40 6S5F (3) 7A5, 6S5F, 3E8 1S4 in boxes - \$40. Philco Model 38 cathedral case & chassis, clean original finish battery type, one knob post broke - \$100. (3) RCA tubes: 5R4, 6BG6, 6BG6G - \$10. Edison Mabry, 715 W. Longview Ave., Mansfield, OH 44906. (419) 526-1175

FOR SALE: Used boxed, tested tubes 6D58 6E, Amperex BB - \$2 ea. 12BY7 U.S. brands - \$2 ea. Sherwood S-8000 receiver w/tubes, parts unit - \$50. Sherwood S-5500 amp, very good - \$75 firm. You pay shipping. **WANTED:** Faceplate, tube case for Harman Kardon Citation II amp. Finder's fee paid. Call: Lee M. McGough, 463 Lafayette Rd., Medina, OH 44256. (330) 772-3780

FOR SALE/TRADE: WE 7A amp, missing pull switch - BO. Radiola 28 w/loop top half only, NT - \$100. Zenith 5808 super nice original - \$275. Philco 40-200 - \$75. RCA projection TV from 40's - \$25. RAK-6 rcvr w/PS - \$100. Eddystone 770U - \$250. Hickok 533 & 534 N/W - \$25 ea. Lambda 29M high voltage PS - \$40. Delivery to Lansing. Fred Watson, 581 W. Summit St., McClure, OH 43534. (419) 748-8798

FOR SALE: Maroon RCA Catalin, 66X8, beautiful - \$60. Don Howland, 4621 W. Shawnee, Spokane, WA 99208. (509) 466-0939

FOR SALE: Sony FD-20A Watchman TV, plays, great shape - \$60 and UPS. Kenneth Miller, 10027 Calvin St., Pittsburgh, PA 15235. (412) 242-4701

FOR SALE: Hallicrafters SX-110, original & complete - \$195 + shipping. George Wright, 4181 Enders Way, Doylestown, PA 18901. (215) 997-4144

FOR SALE: Coronado 43-8245, bright red, absolutely mint and working, with original box. Mike Sullivan, 212 Beechwood Ln., Coppell, TX 75019. (972) 393-5084

WANTED: 1930 to 1942 Police Radio communications equipment. Any 6 VDC mobile communication equipment. Raymond Miller, 953 N. 1st St., Albemarle, NC 28001. (704) 982-0228

MILLEN ORIGINAL PARTS, manuals, equipment. New and used. Bought and sold. James Millen Electronic Equipment Mfg., PO Box 4215, Andover, MA 01810-0814. (508) 975-2711. Fax at (508) 474-8949

VINTAGE MANUALS AVAILABLE for amateur, audio, and radio-related equipment. Quality is number one customer priority. Satisfaction guaranteed. Send three \$32 stamps for catalog. Pete Markavage, THE MANUAL MAN, 27 Walling St., Sayreville, NJ 08872-1818. (908) 238-8964

FOR SALE: Scott 23-tube Allwave Imperial in Tasman cabinet - \$600. RCA 40X53 La Siesta - \$500. Arvin 341T - \$50. Radiola III - \$75. Belmont 5D128 - \$75. Zenith 8G005YT Trans-Oceanic, bad case, parts set - \$25. Gary Watkins, 8006 Greenwald, Belton, MO 64012. (816) 322-0773

FOR SALE: Philco 1920's socket power supply, #AB. Type AB425, complete with (4) glass Lytic bottles, restorable condition - \$90 includes UPS. Mike Tremper, 110 Lynncrest, Cheektowaga, NY 14225. (716) 834-9190, message only

FOR SALE: Military: WWII RAF bathtub key, brown Bakelite, nice - \$80. AN/SRR-12 Navy receiver (RCA), looks good, unworking, w/manual copy - \$135. National RAS receiver, 7 coils, missing nomenclature tag - \$170. Hallicrafters CY-1218 control box for BC-610, looks like JB-70, nice - \$130. SCR-284 mobile rig, BC-654 TRX, FM-41 mobile mount and many accessories, very nice - \$900. BC-654 with legs - \$260. BC-640 WWII VHF airport TX, 400 pounds in 5-foot rack, untested - \$100. WWII Navy RDZ VHF receiver by National, huge radio, as-is, w/manual - \$40. Don Merz, N3RHT, 47 Hazel Dr., Pittsburgh, PA 15228. E-mail: 71333.144@compuserve.com

FOR SALE/TRADE: Brand new RF audio transformers for Federal 58, 59, and 61 - \$150 ea. Also brand new "Remler" audio transformers - \$100 ea. Plus "Rasla", "Acme" and many other brand N.I.B. audio RF transformers from the late Frank Pagano's estate auction. Call: Larry Drago, 383 Lincoln Dr., Cheshire, CT 06410. (203) 272-6030 or Fax: (203) 272-2002

FOR SALE: We have been selling tubes and related components since 1923. July specials: (new) 12BY7A - \$8; 6SJ7GT - \$5; 5654, 6AH4GT, 12AV7, 6AQ7, 12BE6, 2AH2, 6T8A, 12AU6 - \$2 ea.; used tube specials: 7F19 - \$6; 2E26, 25L6GT, 6189 - \$2; 6K7, 6SQ7, 12SQ7, 1R5 - \$1 ea.; Altec 260 amplifier (push-pull 813's) pick up only - \$1,000. No catalog at this time. We stock over (3,000) different types. Leeds Electronics, 68 North 7th St., Brooklyn, NY 11211. (718) 963-1764. Fax: (718) 963-1963

FOR SALE: Wireless (infrared) Koss Stereophones (similar to Koss Pro-4A) operate from tape deck or receiver anywhere within 120 feet, brand new, original packing and warranty, request literature/photo, original price \$175, now - \$100. Charles Graham, 4 Fieldwood Dr., Bedford Hills, NY 10507. (914) 666-4523

FOR SALE: Philco Predicta blonde Model 4242 - \$425. (3) Northern Electric 5000 rainbow: brown, ivory, light brown - \$75 ea. Motorola Turbine NK 56-H, ivory - \$95. RCA Model BP-402 - \$75. All plus S&H. Catherine Hennessey, 1647 Jacques Bureau, Quebec, Canada G2G 2C5. (418) 877-0759

ELECTRON TUBES: Over 1 Million Tubes in Stock. Buy & Sell. Daily Electronics, 10914 NE 39th St. #B-6, Vancouver, WA 98682. 800-346-6667. 360-896-8856. 360-896-5476, fax

WANTED: Broadcast-type MICROPHONES. Early carbon, condenser, ribbons, etc. Cash or trade. James Steele, P.O. Box 620, Kingsland, GA 31548-0620. (912) 729-2242. E-mail: JSteele@k-bay106.com. Microphone collectors Internet site: <http://www.k-bay106.com/mics.htm>.

WANTED: Westinghouse WL-461, Taylor 833, DeForest 433 through 440 tubes, duds OK. John H. Walker, Jr., 16112 W. 125th St., Olathe, KS 66062. (913) 782-6455. E-mail: johnh.walker@alliedsignal.com

WANTED: Cabinet for Tuska 300 or 225. Merrill Bancroft, 169 S. Row Rd., Townsend, MA 01469. (508) 597-6623

WANTED: Rider's Volume XX; Radio Manufacturers of the 1920's, Volume 3. Wilcox-Gay information of any kind; factory service material, catalogs, misc. Book: The Boy Electrician. **FOR SALE:** Sams sets, most from 200s-500s - \$5 ea. set, includes postage. Doug Hershberger, 12 Lockport Ave., North Tonawanda, NY 14120. (716) 692-7836

WANTED: Radio Electronics magazine with Les Paul on cover, Popular Mechanics March 1953, manuals for Ampex PR-10 and Guild Echorec by Binson. Copies of manuals OK. Mike Samo, 236 Ridge Rd., Nutley, NJ 07110. (201) 667-7857

WANTED: Muzak U900 and U901 input transformers, also other Muzak items and paper. John Byms, 4390 N. Cottonwood Trl., Hoffman Estates, IL 60195. (847) 202-1394

WANTED: Philco PT-84 or 41-81, Minerva W117, Detra 219. Ichiro Yamada, 10-21 Chiyodadai-cho Kawachi Nagano-shi, Osaka, Japan 586. Phone/fax: 011-81-721-52-4695, mid/eve., local. E-mail: yamadnr1@osk.threewebnet.or.jp

WANTED: Speaker and escutcheon for Stromberg-Carlson 430-M console. Denis Meany, 81 Madison St., Blue Point, NY 11715

WANTED: Setchell-Carlson color or B&W TV's, any model or condition. Dwight Moody, 17839 Marquette, Roseville, MI 48066. (810) 778-6928

WANTED: EKKO: KQW, WJY, WDY, WCJ, WBL, WJX, KQL, and KYW. Dick Lowe, PO Box 296, Santa Clara, CA 95052-0296. (408) 984-1555

WANTED: Kadette Model 66, wood cabinet, rounded corners, horizontal grille cutouts, (Stein, Vol. 1, p. 116). Ralph Michelson, KG8FA, 4538 Golfview Dr., Brighton, MI 48116. (810) 225-9825

WANTED: Speaker for Silvertone 4500A (Bunis 2, p. 168). Will consider junker. Andrew Mitz, WA3LTJ, 4207 Ambler Dr., Kensington, MD 02895. (301) 897-5531. E-mail: arm@helix.nih.gov

WANTED: Hallicrafters Models S-2, S-33, S-35, EP-132, HT-2, HT-3, HT-8, HT-12, HT-14, and R-8 console speakers. For descriptions see my book "Radios By Hallicrafters." Chuck Dachis, "The Hallicrafter Collector," 4500 Russell Drive, Austin, Texas 78745, 512-443-5027

WANTED: Fairbanks Morse console Model 9C or 12B preferred. Charles E. Patterson, 2621 Sweetwater Rd. SP#33, National City, CA 91950. (619) 475-7141

WANTED HAMMARLUND: Comet, Comet Pro, HQ-66, HQ-88, HQ-225, S-200 and any other Hammarlund rarities. Charles P. Jedlicka, N9SOR, 1611 Clemens Rd., Darien, IL 60561-3510. (630) 515-1836. E-mail: sp600@aol.com. Hammarlund site <http://home.aol.com/sp600>

WANTED: Pair of Audiotechniques (Stamford, Conn. late 1970's - early 1980's) super red studio monitor speakers in excellent condition. Mike Ceklovsky, 8847 Olive Ranch Ln., Fair Oaks, CA 95628. (916) 962-2952

WANTED: Chassis with speaker and knobs for Apex 8A. Also cabinet for Crosley 6615 tombstone battery radio. Dick Folks, 115 Ln. 200F Lk. James, Angola, IN 46703

WANTED: Zenith 12-A-57, 15-U-269, S-7003, 7-S-529, 6-S-580, 990. Zenith displays and sales manuals. David Wilson, 5005 Moon Shadow, Las Cruces, NM 88011. (505) 522-1117. E-mail: dwilson@zianet.com

WANTED: Paying \$\$\$ for Art Deco style sets 1930-1940's, especially with chrome or metal grilles, trim. Adam Schoolsky, 15149 S.W. Cabernet Dr., Tigard, OR 97224. (505) 579-1080. E-mail: Adam@ArtDeco.com. <http://www.ArtDeco.com>

WANTED: Outside horn phonographs, horns, boxes, or parts. Also want Zenith 6S27 chassis & Crosley 54 chassis & bezel for Zenith 12S471. Thanks to all. J.L. Acciavatti, PO Box 806, Upton, MA 01568. (508) 476-3229

WANTED: Escutcheon for a Stewart-Warner Model 102A. It is flat on the bottom & circular on the top side with solid circle under dial. Gordon Phillips, 610 N.E. Royal Ct., Portland, OR 97232. (503) 234-3517

BOXED CLASSIFIED ADS WORK! This is a boxed classified ad. These ads can be run more than two months. See the inside back cover for details. Boxed ad deadline: the 1st of the month.



WANTED: Tube Hi-Fi components & commercial amplifiers by Marantz, McIntosh, Tannoy, Acrosound, Brook, Brociner, Fairchild, Hadley and others. Also want Western Electric theater amplifiers, speakers, tubes, & microphones. Richard Sharisky, PO Box 521, Belmont, MA 02178. Phone (617) 484-5784. Fax (617) 489-6592

WANTED: Vintage Electronic Music Synthesizers and modules by the following manufacturers, especially the listed models. Aires Modular, System III. ARP 2500. Buchia Modular, 100, 400. E-mu Modular. EML Electrocomp 100, 101, 200. EMS Synth A, Synthi AKS, VCS3. Korg Modular PS-3100, PS-3200, PS-3300. Moog Theramin, Modular, Series 15, 35, 55. Oberheim SEM modules, 2-, 4- & 8-Voice Systems. Paia Modular 2700, 4700. Roland Modular Systems 100, 700. Serge Modulars, System 79. Synton Modular System. Call and surprise me; make my day! John V. Terrey, 498 Cross St., Carlisle, MA 01741. (508) 369-9770. Fax: (508) 371-7129.

FOR SALE: Llay's(?) portable phonograph, plays 4 speeds, 3 sizes. Color bar gen. Hickok 246. Ann Bichanich (Jay's), 15 1/2 W. Lake St., Chisholm, MN 55719. (218) 254-4421

FOR SALE/TRADE: RCA Radiolas; 18 - \$90; 33 with matching speaker - \$125; 28 - \$200; 25, no loop - \$150; 106 speaker vgc - \$350. **WANTED:** 7-inch TVs, nice cathedrals, Seeburg 100H amp and read-out unit. Bryan Durbal, 1164 Ladd Rd., Walled Lake, MI 48390. (800) 654-8991

FOR SALE: Hammarlund HQ-170AC/VHF, matching S-200 speaker, original sales invoice, shipping cartons, owners manual, factory correspondence, near mint, belongs in museum - \$595, prefer driving distance, N.E. Tenn. Wayne Grills, 209 Eau Clair Dr., Kingsport, TN 37664. (423) 288-5804, until 9 pm EDT

FOR SALE: B100W Motorola with side speakers - \$30. Sentinel Model 286PR treasure chest - \$50. Silvertone 2004, ivory - \$25. Silvertone Model 214 black transistor - \$20. Zenith X334 - \$30. 1947 Silvertone 7080 phonoradio - \$40. RCA 103 loudspeaker, needs work - \$45. XL25 AC Dayton less tubes - \$125. Airline Enchanter battery set - \$100. GE Model 400 - \$30. Magnavox Prelude FMC48 - \$25. Rider's Volume 1 & 2 Television Manual - \$15 ea. Rider TV Volume 12 & 13 - \$10 ea. Rider Radio Volume 10 & 12 - \$10 ea. GE Model 408 - \$35. Zenith F-615 - \$15. Magnavox C006 clock radio - \$15. Zenith C845L - \$40. Guild 6407 Country Belle telephone radio - \$50. Jewel Model 5030 bed lamp, needs work - \$25. All plus shipping. Larry Chambers, 5026 Suter Dr., Nashville, TN 37211. (615) 833-2448

FOR SALE: Brandes, rectangular horn, non-working - \$35. Zenith 6G001 chassis, w/tubes, knobs, no speaker - \$25. Ralph Trotter, 103 Beach Rd., Bristol, RI 02809. (401) 254-0138

FOR SALE: R1051-H and C7715-U preselector, amplifier govn. reconditioned - \$1500 UPS. Edward L. Freeman, 631 Orchard Dr., Redlands, CA 92374. (909) 792-6779

FOR SALE: 1920's Shure Model 5B microphone - \$235. Send SASE for list wireless/radio parts. Arthur Harrison, 20 Suttlers Row, Hilton Head, SC 29928. (803) 689-3760

FOR SALE: Tubes, radio, TV, 40's thru 50's, SASE for list. Lee C. Dickinson, 401-3 Talcottville Rd., Vernon, CT 06066

FOR SALE: Atwater Kent Model 5, nice - \$6,600. Atwater Kent Model 9, working - \$1,295. Atwater Kent Model 9C, working with tags - \$1,295. Zenith nine-tube Walton - \$1,995. Stromberg-Carlson 140R mint original - \$375. Edison fireside phonograph, 1910, with original horn - \$1,500. Columbia phonograph, 1901, with beautiful nickel petal horn - \$3,500. Wurlitzer 412 jukebox, 1936, rare - \$1,600. RCA 121 cathedral - \$425. Call for free pictures: Harvey Daniel Rieff, PO Box M-372, Hoboken, NJ 07030. (201) 659-0401, work, or (201) 262-9466, ask for Harvey

FOR SALE: Lackner neon glow clock. Johnny Johnson, 7075 W. 32nd Ave., Wheat Ridge, CO 80033. (303) 274-5474

FOR SALE: Sixty FT-171-B crystals for BC-610 and rack. J. Allen Ross, W6JPS, 5468 E. Grant Ave., Fresno, CA 93727. (209) 255-7912

FOR SALE: Grundig Satellit 400 professional shortwave receiver, near mint - \$200 plus shipping. Arnold Giron, PO Box 862533, Los Angeles, CA 90086. (213) 221-9211. (213) 622-8646

FOR SALE: Dewald Lyre dial glass, flat - \$45 ppd. Addison dial glass green or brown - \$40 ppd. RCA 66X9, green, yellow, mint - \$750; 75X17 black oriental - \$200. **WANTED:** Large Addison yellow buttons, small Addison white trim, Crosley 1465 yellow buttons (tortoise for trade), Kadette Jewel, Topper. David Brenner, 71 Burdette Rd., Atlanta, GA 30327. (404) 257-1665

FOR SALE: Polygraph DC driver amplifier (12 tubes) by Grass Instruments Co., Quincy, Mass. - \$15. Joe Reisher, 2285 Ivan Rd., Chambersburg, PA 17201. (717) 263-5532

FOR SALE: All radios restored to perfection. Free photos. Philco cathedrals: 70 - \$335; 91 - \$450; 144 - \$435; 16 - \$450; 20 - \$225; 71 - \$350; 60 - \$225; 89 - \$225. Cathedral AK 84 - \$475. Philco tombstones: 625 - \$275; 116 - \$425; 16B - \$425. RCA tombstones: 9T - \$385; 143 - \$450; 140 - \$435 + UPS. Joe Milano, 57 Hillcrest Dr., Wayne, NJ 07470. (201) 694-3721

**FAX NUMBER FOR
ANTIQUE RADIO CLASSIFIED
(508) 371-7129 - 24 hours a day
Ads - Subscriptions - Book Orders
See inside front cover for details**

FOR SALE: Johnson Viking Ranger in vg working condition - \$275. Prefer local pickup. Jack Gelfand, 44 Harbourton-Woodsville Rd., Pennington, NJ 08534. (609) 737-7964. E-mail: jgg@princeton.edu

FOR SALE: Tubes, used, checked - \$5 ea. 6L6GA/GB/GC, 6CA7/EL34, 5881, 5U4GA/GB. Rosengarten, 1448 Lebanon Rd., Clarksville, OH 45113-9711. E-mail: brose@erinet.com

FOR SALE: N.O.S. Army Tech Manual for Zenith R-520/URR - \$80 shipped. Keith Wissman, 417 Hendrie Blvd., Royal Oak, MI 48067. (248) 542-9367. E-mail: kwissman@aol.com

FOR SALE: Heathkit AJ31 tuner, Zenith 5D011Z chassis - \$15 ea. **WANTED:** One good 7591. Jim Clifford, 108 Bayfield Dr., Brandon, FL 33511. (813) 654-7531. E-mail: j.c.clifford@juno.com

FOR SALE: Philco 89 lowboy console, very nice original condition, pickup only - \$130. Thanks. David S. Kendall, 401 Himes, Huntington, IN 46750. (219) 356-5096. E-mail: ke9wi@fwi.com

FOR SALE: Grebe CR-9, excellent - \$600. Myers tube receiver, spare N.I.B. tube - \$400. Harvey Laidman, 4923 Encino Ter., Encino, CA 91316. (818) 784-9501

FOR SALE: Going to Elgin?? Stop by K.C. for some great radios!! RCA 54B5 Catalin, Zenith 10-S-464, 10-S-567, 6-S-152, 12H670, Philco 82 Deluxe, Crosley Gem Chest. Call ahead. Claude Chafin, NØFMO, 4223 E. 42nd Way, Independence, MO 64055. (816) 478-4518

FOR SALE: Crystals and Tubes, a History of Radio Receiving in the 1906-1910 Period, 92 pages describing radio receiver development, following the initial success of wireless communications. Order Report No. 7, postpaid for - \$10 from: Crys Tech, c/o P.A. Kinzie, PO Box 6805, Kingman, AZ 86402

WANTED: Radio Boys book. Air Patrol by Breckenridge. Jeff Hoskins, 824 E. Madison Ave., Stuart, FL 34996. (561) 283-2291, after 7 pm

WANTED: 245/345 tubes: N.I.B. - \$50. Good/used - \$25. H. Kato, c/o Mr. T. Kato, 6868 Chelsea Rd., McLean, VA 22101

WANTED: Capehart Orchestrope, Victor 9-55, 10-50, early radio phonos with changers. Pre-1934 jukes. Alan Wohl, 247 Prospect Ave., Cedarhurst, NY 11516. (516) 295-5614

WANTED: Advertising or any literature for prewar Packard-Bell Phonocord home recorders. Ned Connors, 29 Allen Ave., Barrington, RI 02806. (401) 246-0164

WANTED: Stancor Williamson Amplifier Bulletins 479, 382R. **FOR TRADE:** Rider's VI, VII for II, X. John Bullock, 660 E. Robertson Rd., Castalian Springs, TN 37031. (615) 451-2268

WANTED: Ampex decks, limiters, microphones, McIntosh, Marantz, Precise 111M tube tester, Sencore test equipment, etc. Kim Gutzke, 7134 15th Ave. S, Minneapolis, MN 55423. (612) 869-4963

WANTED: Catalin parts: paying \$20-\$100 per knob, grilles \$50-\$100, handles \$25-\$50, chassis \$50-\$100, broken cabinets \$25-\$50. **FOR SALE:** Fada #1000, all yellow - \$600. Ray Carroll, 158 Oakwood Dr., Wayne, NJ 07470. (973) 696-1149

WANTED: Am looking for a Zenith 9-S-204 radio/phone & a Philco 41-620. 78 rpm copy "Jukebox Sat. Night" by Glenn Miller. Donald Cochrane, 858-I Antoinette Ln., S. San Francisco, CA 94080. (415) 875-1725

WANTED/FOR SALE: Mini mics, 1-3.5 in. wire or tape recorders. Jon Golden, 16 Roundwood Rd., Newton, MA 02164. (617) 332-5460. E-mail: 3dman@ziplink.net

WANTED: Knob for Philco 53-561, clear plastic with gold center. Patrick Franzis, 235 Millville Ave., Naugatuck, CT 06770-3848. (203) 723-8976



WANTED: E.H. Scott Laureate Grande. Eddie Burris, 2905 West 27th Ter., Lawrence, KS 66047. (913) 841-4174. E-mail: burris@cstp.umhc.edu

WANTED: McIntosh parts, cabinets, systems, tube amps, all tuners. Altec 604B, C, factory cabinets, factory Karlson 15" cabinets; Thorens, Garrard 301 turntables, Audiocyclopedia 1st & 2nd printings. Marantz 7 cabinet. Walt Fleming, 182 Plain Hill Rd., Norwich, CT 06360. (860) 889-1957

WANTED: Airline 62-101 chassis, door knob for Am. Bosch 48 console, Zenith 9-S-262 wood vol. knob. Keith Park, 795 Grooms Rd., Rexford, NY 12148. (518) 373-0417

WANTED: Manual for Sprague TO-6 capacitor checker, copy OK. Louis deGonzague, 15 Gail Ln., Latham, NY 12110. (518) 783-6327. E-mail: Zenithite@aol.com

WANTED: Speaker for Philco 38-7 console. Johnson Ranger II. AK 24 horn speakers, must work with good drivers. George Folse, KB5WWO, 630 Dolhonde St., Gretna, LA 70053. Ph/fax: (504) 362-1896. E-mail: kb5wwo@juno.com

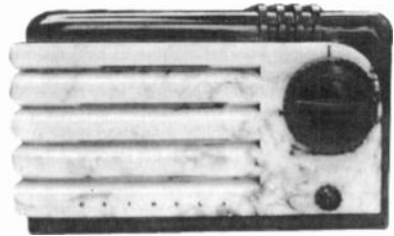

WANTED: More prewar plastics by Detrola, RCA, Kadette, Air King, et al. Take all my money before the relatives do. They are trying to hurry my already imminent demise. Please write or call collect: Rain Buttignol, 314 State St., #7, Portsmouth, NH 03801. (603) 427-1384

WANTED: Mackay Radio or Mackay Marine models 3007 or 3010 communication receivers in repairable condition. John Casale, W2NI, 3 Pickering Ln., Troy, NY 12180. (518) 272-3631

WANTED: Front panel for Pilot Super Wasp DC, or parts set. Kenny Mullis, KF4CQG, 1324 W. Shore Dr., Lancaster, SC 29720. (803) 283-4046

WANTED: Manual-copy HF receiver; R1451 (V); WLR6 (V). Weber, 4845 W. 107th St., Oak Lawn, IL 60453-5252

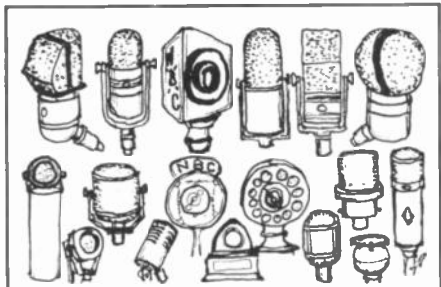

WANTED

FOR MY BROADCASTING MUSEUM

Microphones, stands, call letter plates. Tube amplifiers, mixers, compressors, Hi-Fi equipment. Speakers, on-air lights, equalizers. Disk, wire & tape recorders. Blank recording disks. Catalogs, magazines, manuals. 16" transcriptions, turntables, arms, pickups. Early TV cameras & receivers. Elaborate console, deco, plastic, mirror, novelty & wireless radios. Jukeboxes & parts. Acoustic phonographs.

We are looking for all makes of equipment, and especially *Western Electric*, *Telefunken*, *Neuhann* and *RCA*. The museum contains various duplicates and items surplus to our needs, and many of these articles are available for sale or trade. The collection is located in my Victorian seaside inn, The Caffrey House, situated on a bay next to the ocean, in the Southampton resort area of Long Island. A trade of equipment for a stay at the hotel is always encouraged.

Robert Van Dyke, 2 Squires Ave., East Quogue NY 11942
516-728-9835

FOR SALE/TRADE: "National Union" tube sign w/clock with multicolored reversed painted on glass logos, and slogans, illuminated by 8 small white bulbs, etc., works great - \$950. Larry Drago, 383 Lincoln Dr., Cheshire, CT 06410. (203) 272-6030 or Fax: (203) 272-2002

FOR SALE: Between 6-700 old radios from Sparton 506 bluebird to smalls, including domes, cathedrals, tombstones, Sirroco Crosleys, Catalins, Art Decos, etc. Some books, parts, condition good to very good. A steal at - \$21,000, less than half cost to me. Leonard L. Zeldow, 8 Leroy St., Binghamton, NY 13905. (607) 723-6869

FOR SALE: Cathedrals: Philco 70, very nice - \$275. Zenith 805, missing two knobs - \$175. General Motors Little General, professionally refinished - \$250. Plus UPS. Ernie Nagy, PO Box 822, Elk Rapids, MI 49629-0822. (616) 264-9412

FOR SALE: McIntosh MR-7082 tuner - \$650. McIntosh MC-300 power amp, with cabinet, mint - \$3,500. **WANTED:** Cabinet for McIntosh C-108 preamp. Robert Sprantz, 610 E. Juanita Ave., San Dimas, CA 91773. Phone/fax: (909) 394-1194

FOR SALE/TRADE: 1958 Hallicrafters SR34AC transmitter/receiver AC/DC/12 volt with all bells and whistles - \$450. Clean, electronically complete SX-28 w/cabinet needs work - \$300. Beautiful Viking 500 w/power supply - \$950. National 183D - \$300. Collin 32V3, needs work - \$300. Hammarlund H.O. 170 w/matching speaker - \$475. Call: Larry Drago, 383 Lincoln Dr., Cheshire, CT 06410. (203) 272-6030 or Fax: (203) 272-2002

FOR SALE: Many Crosley's D-25 - \$70 ea. Crosley E12WE - \$55 ea. Northern Electric rainbow - \$135. Some radios have small flaws. Ken Legare, 209 Military Rd., Box 273, Lancaster, Ontario, Canada K0C 1N0. (613) 933-8485

BUY • SELL • TRADE

CATALIN RADIOS

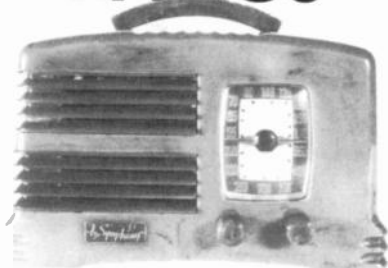

I'll buy single pieces or
whole collections. Top prices paid.

RADIOART

Jim Meehan

P.O. Box 102 • Centerbrook, CT 06409
(860) 526-1762

FOR SALE: Bluebird Jr. crystal set, newly manufactured, painted wood base w/original Philmore crystal holder, catwhisker and galena crystal, due to limited parts supply we only have (20), order this real crystal set for only - \$49.95, includes U.S. shipping. Vintage TV & Radio, 3498 West 105 St., Cleveland, OH 44111. (216) 671-6712, Wed. & Thurs. 1-4 pm

FOR SALE: Transistor: Emerson 888 Vanguard, black - \$85. Emerson 911 Eldorado white - \$75. Emerson Transtimer, no case - \$40. Emerson 838 hybrid-missing, 2 small chips on sides - \$75. Channel Master 6518 - \$30. Heathkit GR-151A - \$25. Hitachi TH-666 - \$85. Grundig 301 AM/FM, as is - \$20. Nordmende Mambo - \$40. Zenith Royal 2000 - \$50. Roberts R-200 forti-ish(?) MW/LW - \$90. Standard TR-8 forti-ish(?) MW/SW1/SW2 - \$45. Tube: RCA BX55 3-way portable - \$40. Truetone Tiny Four battery portable, luggage-type case - \$60. Joe Holdner, 443 2nd St., Brooklyn, NY 11215. (718) 768-6212. July & August: (914) 657-2399

**IF YOUR EXPIRATION DATE IS
JULY OR BEFORE, RENEW TODAY!
EARLY RENEWALS
RECEIVE AN EXTRA ISSUE!**

FOR SALE: Tektronix 575 transistor curve tracer - \$175. Heath sweep function generator - \$50. Sabtronics 2010 multimeter - \$35. Sprague TCA-L capacitor tester leakage to 0.6 micro-amp full scale. Charles Johnson, 21 Holly Hill Dr., Mercer Island, WA 98040. (206) 232-2040

FOR SALE: E.H. Scott 800BT w/escutcheon PS, spkr, very good chrome - \$500. Philco 38-4, recapped, nice - \$225. Hi-freq Labs Mastertone, recapped, refinished, beautiful - \$500. Midwest 18-36 - \$350. Hammarlund HQ120, black - \$250. RCA Mod C-13-2 recapped, refinished - \$325. Philco 116X - \$425. Philco 38-690-XX - \$2,350. Hallicrafters S-129, 1965 - \$150. Airline 04BR-730A recapped - \$225. Philco 70 cathedral - \$275. Zenith 6D520W - \$65. Zenette 4G800W, white - \$75. Wavemagnet ant. for Zenith 10S567 - \$35. Airline chassis' RCA 10K and 810K, no spkrs, both play well - \$85 ea. Crosley cathedral 124H - \$200. Philco 91 chassis, no spkrs - recapped, plays great - \$100. GE J805, plays good - \$250. Bogen amp Mod RP-2 - \$75. Multi-Elmac rcvr 26.995 Mc - \$40. 1929 Gulbransen rcvr, 9-tube, needs caps, spkr - \$65. Masco commercial 4-tube sound amp, MA-808 - \$75. Hallicrafters splatter guard Mod HA-8 - \$35. Airline 84WG-1804D wood, refinished, plays well - \$75. N.O.S. tubes: (4) 5691 red base, (1) 6LF6, (1) 6MJ6, (1) 6KM6, (3) 6LQ6, (4) 6012, (2) 8298, (3) 931-A, (4) 2050, (4) 923, (1) 1L6, (2) 7247, (1) 5751, (1) 7551, (4) used 6LQ6/6JE6, (1) 6146B used, (1) 572B-160L used, (8) 6SL7 N.O.S., (5) 65N7 N.O.S. Many Shortwave Craft, Popular Mechanics, others. All plus shipping. Richard Bruning, 2416 U.S. Hwy. 150 N, Rio, IL 61472-9681. Phone/fax: (309) 344-1968

FOR SALE/TRADE: Rare 1927 Freshman Masterpiece Model 6-F w/power supply and original sales and service manual - \$375. Aeriola Sr. w/WD11 tube - \$375. Aeriola Jr. crystal set - \$275. Call: Larry Drago, 383 Lincoln Dr., Cheshire, CT 06410. (203) 272-6030 or Fax: (203) 272-2002

FOR SALE: Stromberg-Carlson audio amplifier, Signet 33, 25 watts, 6L6G8's, mic, phono inputs, good - \$75 + UPS. Onerio L. Sabetto, 1717 Burgess Rd., Cleveland, OH 44112-1103. (216) 481-1036

FOR SALE: Grundig Satellit 500, M.I.B. - \$350 inc. shipping. **WANTED:** Near mint Telefunken Gavotte 8, 9 5253W. Ed Kalpa, 4622 Melbourne Ave., Los Angeles, CA 90027. (213) 661-1221

FOR SALE: Nordmende Model 250-9, 5-band, work - \$50 + UPS. Dave Metz, 1016 Ridgemont Dr., Staunton, VA 24401. (540) 885-7914, evenings till 10 pm EDT

FOR SALE: N.O.S. tubes, original boxes; #45 (3) - \$50 ea. #6L6G (2) - \$20 ea. ppd. Carl Hackenson, 31 Hixson Farm Rd., Sharon, MA 02067. (617) 784-8834

FOR SALE/TRADE: The following hi-fi speakers: Bozak stereo speaker system includes (2) Mod 207-A (two-way coaxials) and (1) Mod 209 mid-range - \$500; (1) Altec 605A - \$250; (1) James B. Lansing 15" Mod D-130 - \$200; Altec 511B sectoral horn w/802-C driver - \$225; 811B sectoral horn w/802D driver - \$200; Altec 603B multicell dia. cone - \$350; JBL Mod 075 - \$100. Call: Larry Drago, 383 Lincoln Dr., Cheshire, CT 06410. (203) 272-6030, or fax (203) 272-2002

FOR SALE: Books: Practical Radio Communication - Principles - Systems - Equipment - Operations by Arthur R. Nilson and J.L. Horning 2nd edition 1943; The Radio Amateur's Handbook fortieth edition 1963 - \$30 ea. plus. Elwood Hunt, 308 Georgetown Rd., Carneys Point, NJ 08069-2512. (609) 299-5259

FOR SALE: Mallory 6- & 12-volt filtered supply - \$20. Mitchell #1287 portable - \$50. Simpson VOM with Rotomatic - \$15. RCA 9Y510 radio phono - \$25. Hewlett Packard 652A osc. - \$20. Bogen 100-watt amp - \$40. Philco D655 portable - \$15. RCA WO-33A scope - \$35. Philco 46-1213 chassis - \$20. Gertsch RT5 ratio trans. - \$20. Johnson Messenger Two - \$20. Crosley #148 cathedral - \$140. Military #ME70A VOM - \$10. GE #AP brass fan - \$50. RCA 8X521 Bakelite - \$20. Gloritone 275 - \$140. Majestic #8B08D with spkr - \$20. Grundig Majestic #3192U - \$50. RCA 66XB portable - \$20. Midwest #18-36 console - \$240. Tubes: Sold in following groups. (1) group of 3C23, 1625, 966, 1616, 807 - \$10. (2) group of 311CT, 1625, 966, 6550, 2X2 - \$15. **WANTED:** AK two-tube TA amp & Crosley #48 chassis, doesn't have to work. Walt Wrabek, Rt. 4, Box 370, Menahga, MN 56464. (218) 564-4623

FOR SALE: (140) radios, parts, tubes JAN-5Y3WGTA, 6J5WGT, 5651WA, 5687WA, 5693, 5751, 5896, 6189. (15) pages - 2-stamp LSASE. W.F. Horn, 13110 Marsh Rd., Bealeton, VA 22712. (540) 439-9781

FOR SALE: Electronic textbooks from engineering program. SASE for list. Use to learn theory or impress your friends! Mike Korsower, 34 Cromwell Rd., Monroe, NY 10950

Virginia City RADIO MUSEUM 109 So. "F" St.

On display - Wireless and Radio Apparatus from 1915 through the 1950's. Plus hundreds of accessories, photos and Vintage Ham Radio Station.

**OPEN DAILY DURING SUMMER
CALL AHEAD FOR WINTER HOURS**

Henry (W7BUG) & Sharon (KK7EI) Rogers,
P.O. Box 511, Virginia City, Nevada 89440
Tel: 702-847-9047 or

Website: www.tek-majic.com/radio

FOR SALE: Zenith child's radio chassis. Zenith 8" speaker, 1250-ohm field. Zenith commemorative table model. Zenith radio nurse transmitter. Hammarlund Comet Pro. AK 30 console Mohawk console. Electrolytic Sprague capacitors 150 μ F-200 volt - 10¢ ea. Bill Coolahan, 1450 Miami Dr. NE, Cedar Rapids, IA 52402-2933. (319) 393-8075

FOR SALE: New 2,000-3,000 small tubes. Fred Hegel, 1901 Frank Pl., S. Daytona, FL 32119. (760) 760-7632

FOR SALE: Two N.O.S. 45 tubes, poor boxes - \$75. UPS prepaid. Cecil L. McLaggan, Jr., 2005 Pearl Ave., Albany, GA 31707. (912) 436-8396

FOR SALE/TRADE: The following hi-fi tube amplifiers, tuners and preamps: Scott 340 amp/tuner - \$375; Scott Mod 240 mono block amp - \$450. Scott 330-C tuner - \$175, and 121 preamp - \$50. (2) David Bogen DB-10 amps - \$200. Lafayette super powerful LA-235 stereo 70-watt amp - \$400. (2) Fisher Mod 70 mono blocks pure amps - \$425/pair. Fisher 500-C receiver - \$375. Scott 290 amp, 90-watt - \$600. Scott preamp Mod 130 - \$350. (2) Bogen DB20 amplifiers - \$350/pair. Sherwood 8000 receiver - \$300. McIntosh Mod 230 amp - \$400. (2) Heathkit W-5-M power amps w/pair of WA-P1 preamps - \$875. Heathkit W-M-1 power supply with Heathkit W3M amp - \$400. Dynaco ST-70 w/upgrade pad - \$380. Dynaco PAS-2 and FM 3 tuner - \$350/both. A pair of original Dynakit ST-70 power amps - \$650. Pair of HF-60 Eico power amps - \$1,250. Leak Varislope III preamp - \$100. Leak Point One Plus preamp - \$100. Citation Eleven preamp solid-state - \$325. Call: Larry Drago, 383 Lincoln Dr., Cheshire, CT 06410. (203) 272-6030, or fax (203) 272-2002

FOR SALE: Dual electrolytic capacitors. 50-300 mfd. at 160 Vdc - \$3.75 ea. for 4 or more. Includes P&H. Many other types of stock. Write, phone, or fax for free flyer. DH Distributors, PO Box 48623, Wichita, KS 67201. (316) 684-0050, v/f

A.R.C. BACK ISSUES

April '87 to current issue: Originals available
32 to 100 pages each.

Oct. '86 to Mar. '87: Reprints available
Reprinted from original artwork; 28 to 32 pgs. ea. Quality & appearance same as an original copy.

June '84 to Sept. '86: Photocopies available
Not original quality, useful for info.; 16 to 28 pages each.

Publication of *Antique Radio Classified* began in 1984 which had only five issues: June, Sept., Oct., Nov. & Dec. 1984. 1985 through current year have had 12 issues each.

**\$5.00 each - Postpaid to
U.S., Canada and Mexico.**

Orders of 6 issues or more may take a 10% discount. Orders for a full calendar year may take a 50% discount. Foreign orders other than Canada and Mexico: \$8.00 each by air. Mass. residents, please add 5% sales tax.

A.R.C. UNCUT, UNFOLDED COVERS

June 1991 to the present

9.25" x 12.5" - \$9.95 each

Postpaid to U.S., Canada, & Mexico
Mass. residents, please add 5% sales tax.

Send Order To:

**A.R.C., P.O. Box 2, Carlisle MA 01741
Or Call (508) 371-0512**



FOR SALE: Grommets, 185 vinyl grommets, (6) assorted sizes, new stock - \$7.85 plus freight. Sound Remedy, 331 Virginia Ave., Collingswood, NJ 08108. (609) 869-0238

FOR SALE: Freshman Masterpiece, 3 dial w/3 wave condensers, 2 flip switches - \$85. Home brew (maybe) 1 dial, (3) rheostats, 4-tube w/Conn. transformer 4-tube - \$80. Apex Super 5, @9, lift-top - \$75. Silvertone M-6050 table, 2 knobs @ - \$30. Radiola 25 w/antenna, @9 - \$175. Small Kert (AKP.Co) M-8822A, @9 - \$30. Plus S&H. Bernie Samek, 113 Old Palmer Rd., Brimfield, MA 01010. (413) 245-7174. Fax: 0441

FOR SALE: Stewart-Wamer Portafone handheld, tube CB walkie-talkies, pair, near-mint w/antennas, cases, paperwork - \$220. Lafayette HE-1050Kc-30Mc receiver, looks great, untested - \$90. Shure 55 microphone, looks good, tag corroded - \$90. Western Electric 522-W receiver with Victrola attachment, N.I.B. - \$60. Astatic N-30 chrome mic, looks like Astatic 10-D, excellent - \$45. Don Merz, N3RHT, 47 Hazel Dr., Pittsburgh, PA 15228. E-mail: 71333.144@compuserve.com

FOR SALE: Atwater Kent Mod. 90 cathedral - \$750. Never used or built AK 1922 (Model 3925 kit) their first breadboard, see page 71 of Douglas Vol. 1 (Radios of the 20's) - \$1,250. RCA Mod. 19 cathedral - \$250. Jax cathedral as seen in Evolution 2, page 16 - \$350. Call: Larry Drago, 383 Lincoln Dr., Cheshire, CT 06410. (203) 272-6030 or Fax: (203) 272-2002

FOR SALE: Chassis only. Philco M-GT-2/1/stone w/dial & bezel, clean - \$50. Zenith M-8S681 w/dial & 2 side panels w/tubes - \$45. Bernie Samek, 113 Old Palmer Rd., Brimfield, MA 01010. (413) 245-7174. Fax: 0441

FOR SALE: Fisher tube stereo receivers, with manuals: Model 400, w/wood case - \$300; Model 500B, no case - \$325, + UPS. C. Zafonte, RR3, Box 2075, Fort Kent, ME 04743. (207) 834-6273 EDT

FOR SALE: Rider's Vol. 1 Public Address Equipment - \$25. Weighs 12 lbs. can ship, or deliver to Lansing July 11. Fred Schultz, 1246 Lincolnway S, Ligonier, IN 46767. (219) 894-3779, fax after 5

FOR SALE: Vintage tube-type CB's: Knight, Hallicrafters, Lafayette, others. Browning 180 linear, excellent - \$300. Tom Bonomo, 81 Lakewood Cir., San Mateo, CA 94402. (415) 578-1897

FOR SALE: Nipco hi-fi 8 jet, red/white, works - \$100. Toshiba 6TP-309A, gray, works - \$50. Toshiba 6TP-385A, red/white, chip, works - \$30. Hitachi TH-627R, works - \$25. Gary Watkins, 8006 Greenwald, Belton, MO 64012. (816) 322-0773

VACUUM TUBES

1920's - 1950's

We stock more than 1,000 types of New Old Stock vacuum tubes including scarce G types. Also selected used tubes. Write for latest price list.

ANTIQUE TRIODE

653 Commercial St., Farnham, NY 14061
Fax 716-549-3823

FOR SALE: Weston DE6 (Navy) analyzer, good - \$60. X-mitter multi-Elmac AF67 5-bands 1.8-29.7 MHz - \$75. Luck Magneto-phone complete - \$100. James R. Lopaz, 5467 975 E. Ogden, UT 84405. (801) 476-1470

FOR SALE/TRADE: Just found a sizable collection of matched Tung-Sol (N.O.S.) 6550 tubes (Coke bottle shaped), made in the U.S.A. (same mfg. code) Sept/75 - \$70 ea. While supplies last! Larry Drago, 383 Lincoln Dr., Cheshire, CT 06410. (203) 272-6030 or Fax: (203) 272-2002

FOR SALE: In addition to those items listed in our June 1997 ad, these items have also been consigned to the Extravaganza '97 auction: Spanton 557 blue mirror radio, desirable Philco 38-690 console, Western Electric 3A with tubes, AK Kiel table and a rare chalk figure of the Crosley Bonzo Pup. For further information or a convention brochure write to: Michigan Antique Radio Club, Extravaganza, Suite 100, 3520 Okemos Rd., #6, Okemos, MI 48864

FOR SALE: Zenith Y825 maroon plastic 18" x 10" x 9" radio, 1 1/2" x 1/4" plastic handle volume indicator light, similar to K725 (Bunis 1, p. 173), rare, not listed, beautiful, plays - \$50. Setchell-Carlson 469, 1950 brown plastic FM AC/DC nice, plays (Bunis 3, p. 207) - \$50. Detrola 342 brown plastic square dial, red dial pointer, two knobs 12" x 14" x 7" AM/FM, not listed, beautiful, plays - \$85. Emerson 522, 1946, beige, portable, black knobs & handle, AM, looks and plays wonderful, (E.O.R. 2, p. 75) - \$50. Emerson 527 (same as 522), dial is different, plays, both have red Emerson logo - \$50. Howard 901A-1, 1946, white plastic square dial, 5-tube, 2-knobs, BC, AC/DC, 10" x 6" x 5", looks, & plays good, (Bunis 4, p. 115) - \$40. Benrus clock radio, 1954, heavy, looks like brass case, (E.O.R. 1, p. 117), plays - \$75. Pilot FM radio tuner 5-tube by Pilot Radio Corp., N.Y., finish nice - \$40. Cunningham 5-299 tubes, filament checks OK - \$100. (1) CX 380 - \$12. (3) German tubes RLM bal. 716, 5-prong Telefunken RS289 40v, nut on cap. - \$30. Macht 44 (G1404) 4-prong, eagle on tube wire from black cap. to nut on black base 7" x 3" - \$100. Telefunken RS383 (N106) (2106 42 VT), 5-short prongs, one is center, brass base, glass tipped, (2) chrome caps, 7" x 4" unusual - \$150. Edison Mabry, 715 W. Longview Ave., Mansfield, OH 44906. (419) 526-1175

FOR SALE: Arvin 442 metal midget black - \$65. Kent 422 metal midget with handle cream - \$65. John Koop, 48 Wheelbarrow Ln., Wantagh, NY 11793. (516) 731-6711

FOR SALE: 1937 E.H. Scott Philharmonic, (30) tubes, Warrington cabinet, good condition, completely restored - \$2,700 OBO. Call: Amie Sanchez, 9615 Rockhurst, Houston, TX 77080. (713) 939-9221

FOR SALE: 01-A, 20, 71A, 80, 120, 183, 199, 226, 381, 485, BH, others. Steve Marsh, 20 North Lake Dr., Hamden, CT 06517. (203) 288-5183. E-mail: smmarsh@ct2.nai.net

FOR SALE/TRADE: Radio-related toys, crystal detectors, key & sounder radio in orig. box, mint - \$175. Bob Fuschetto, WA2BCR, 1758 Michael Dr., Whitehall, PA 18052. (610) 435-8944, call bet. 7 pm & 9 pm

FOR SALE: GE 800 TV - \$100. WANTED: Want 21" TV flyback transformers, off-brand TVs. Glenn Bubenheimer, 27851 Terrence, Livonia, MI 48154. (313) 421-5574

FOR SALE: Summer slim-down. Radios: Radiola 64 - \$295. Philco 41-300 - \$345. Philco 39-116 & remote - \$275. Philco Predicta clock/radio - \$125. Spartan Visionola - \$850. Setchell-Carlson 427 frog-white - \$135. AK 9A, tags - \$1,150. Vintage hi-fi: Bogen monoblocks (2) 100w - \$350. Pilot stereo tuner FA 680, pre SP210, amp SP260 (EL 34's) - \$375. Heath W5M, mint - \$250. Miranda tape & cab. and remote - \$75. Pr. Bozak LS400 - \$75. EV Pro 12 - \$15. Stephens 101 Tru-Sonic - \$65. Tanberg 10 1/2 - \$175. Sony 500A deck & case - \$45. Concertone 505 - \$60. Revere deck - \$25. TV Dumont RA103, rough - \$75. Philco Princess Predicta, mint - \$225. Sentinel 7" port. - \$145. Can deliver to Lansing Extravaganza. Bo Brook, 4858 Willow Ln., Orchard Lake, MI 48324. (810) 681-7133

FOR SALE: Tubes, quality used. You name it, over 15,000 available. SASE with wants. Joe Pratt, Used Tube Central, 53 Liberty St., Clark, NJ 07066

RATE FOR ADDITIONAL WORDS:

27¢ per word

FIRST 20 WORDS FREE!

Cash or stamps OK for small amounts.

Your payment helps to keep A.R.C. healthy!

FOR SALE: And offer lists on following items. Old tubes: Western Electric, DeForest, Raytheon, Zenith, GE, RCA, Westinghouse brass base, tip, blue glass, rainbow. Collector type plus more. TV sets: Pilot 3" and lens, Motorola 7" port., Admiral 10" floor model, Philco 1001. Old radio catalogs. Radio News 1919 to 1928 will not break up. Plus other items. (2) LSASE for list(s). Please all via mail. F. Krantz, 100 Osage Ave., Somerdale, NJ 08083-1136

FOR SALE: Extra vaganza, in case you lost your first one. See you there! Jim Leckrone, 12174 Lynn St., Bear Lake, MI 49614. (616) 864-3365

FOR SALE/TRADE: The following hi-fi stereo tube equipment: Marantz 8-B power amplifier - \$1,600. McIntosh MR-71 tuner and MR-78 tuner - \$900 ea. Call: Larry Drago, 383 Lincoln Dr., Cheshire, CT 06410. (203) 272-6030, or fax (203) 272-2002

FOR SALE: Galena crystal radios. Deluxe, super selective and sensitive. Len Gardner, 458 Two Mile Creek Rd., Tonawanda, NY 14150. (716) 873-0447

FOR SALE: Rider's 6 and 8, clean intact - \$18 ea. Collins 180-V2 aircraft ant. tuner, box scuffed, inside mint - \$80. Mr. Marion J. Chelkowski, W5DBN, 1103 Kayton Ave., San Antonio, TX 78210-3624. (210) 533-1876

FOR SALE: Tubes N.I.B. IP40 (1) - \$9. 2A7 (1) - \$3. 5Y3 (12) - \$3. 5R4GY (1) - \$7. 5R4WGA (1) - \$4. 5T4 (1) - \$4. 5U4G (2) - \$10. 5V4G (5) - \$7. 5V4GA (3) - \$6. 5Y4G (1) - \$3. 5X4G (1) - \$2. 5Z3 (9) - \$4. 6A7 (6) - \$5. 6AC5GT (2) - \$5. 6AJ8 Mullard (1) - \$5. 6B8G (1) - \$6. 6BK4C (5) - \$10. 6BM8 (4) - \$3. 6CG7/6FQ7 (15) - \$6. 6DJ8 (5) - \$5. 6FG6 (2) - \$5. 6FG6 (1) - \$4. 6L6 (2) - \$10. 6JA5 (1) - \$10. 6K7G (5) - \$3. 6L6GA (2) - \$12. 6N6G (1) - \$15. 6N7G (2) - \$7. 6P5G7 (2) - \$8. 6V6 (8) - \$8. 6V6GT (7) - \$7. 12AU7 (15) - \$3. 12AX7 (15) - \$7. 12AX7A/7025 (10) - \$8. 813 (1) - \$25. 826 (1) - \$25. 843 (1) - \$35. CJ6 Cetron (1) - \$25. Many others. Prices per tube. Rider's manual 1931 - \$50. Ghirardi Radio Course #2 - \$20. Mallory 4th ed. - \$20. Call or write: Tony Rinaldo, 308 Lenox Ave., Oneida, NY 13421. (315) 363-3644

FOR SALE/TRADE: Amrad 5-tube Neutrodyne - \$475. DeForest 5-tube Model F-5-AW - \$675. Excellent working Grebe Mod CR-9 - \$850. Sodian DR-6 - \$1,600. Larry Drago, 383 Lincoln Dr., Cheshire, CT 06410. (203) 272-6030, or fax (203) 272-2002

FOR SALE: Tandberg 64 reel-to-reel deck, Dynaco PAT-4 preamp, and Dynaco stereo 120 amp. Thomas Peters, PO Box 3925, McAllen, TX 78502

FOR SALE: Six N.I.O.B. Sylvania X200A globe tubes, neat forest scene on boxes - \$20 ea. Bill Jewell, 3800 Ridgehaven Rd., Ft. Worth, TX 76116. (817) 377-4664. E-mail: oldradios@aol.com

FOR SALE: Rare 1939 Philco 39-6341 Art Deco table, SW, (6) push buttons, vg+ - \$18. Philco 60 Art Deco tombstone, vg+ - \$75. Both - \$85. Sony TV-720U 7" solid-state portable, near mint and working - \$50. All plus S/H F.O.B. Swarthmore, Pa. Sam Mannino, PO Box 233, Swarthmore, PA 19081. (610) 353-6747

FOR SALE: AK #10 breadboard, good condition, couple of parts missing, photo on request - \$325 plus shipping. Thomas A. Tamberelli, 106 Carpenter St., Muncy, PA 17756-1332. (717) 546-6515

FOR SALE: Pair Jensen Unax 8" speakers, tear in one cone - \$20. Pair Elco 8" speaker - \$25. Plus UPS. Mike Kitner, 735 Factory St., Carlisle, PA 17013. (717) 249-3851

FOR SALE: Books: Maintenance and Servicing Electrical Instruments, Ghirardi's Modern Radio Servicing, and RCA Designers Handbook No. 3. Phone calls only! Glen Richie, 643 Diamond Rd., Salem, VA 24153. (540) 389-3356

FOR SALE: (25) N.O.S. 2X2's - 50¢ ea. Heath IT3120 transistor tester - \$15. WANTED: RCA 2XF941 AM/FM. All items plus UPS. Jon Andreasen, PO Box 22, Newton, NJ 07860. (973) 579-6261, 6 to 9 pm Eastern. E-mail: 104456.2233@Compuserve.com

FOR SALE: RF linears: Heathkit SB-220 - \$500. Hammarlund HXL - \$300. Can't ship, local pickup. James J. McGrath, W2IOJ, 2 Centerview Ln., Buffalo, NY 14224-2124. (716) 675-0160

FOR SALE: E.H. Scott radios: Allwave 23 in Napier, Allwave 27 in Warrington, Allwave 23 in Lido, Allwave 15 in Wellington, Shield-Grid Nine N.I.B. Jack Sacra, 1720 Solomon Rd., Charlottesville, VA 22901. (804) 293-9985

FOR SALE: Replacement silk-screen tapestry for Radiola 103 speaker, excellent copy for - \$32 + S.H. Phil Guinan, 106 Page Rd., Litchfield, NH 03052. (603) 889-6213

FOR SALE: Grundig TR-307 3-band portable - \$45. Drake SW8 mint manual, boxed - \$495 + shipping. Gerald Silver, 10863 W. Clairmont Cir., Tamarac, FL 33321. (954) 720-1972

FOR SALE: Transmitting parts for high power: variable condensers, roller inductors, tubes and sockets. Plate transformer which provides 2000 volts at 500 mA. Send for listing. Roland Matson, K1OKO, PO Box 956, Lake Panasoffkee, FL 33538. (352) 956-1629

FOR SALE: Voltage regulators OA3, OB2, OB3, OC3, mix, match - 50¢. Minimum order six tubes - \$3 plus postage \$3. Jack Shaymow, Vintique Electronics, 52-C Tilford, Deerfield Beach, FL 33442. (954) 427-1222

FOR SALE: (16) E.H. Scott console for sale. Call for info. We accept Visa, MasterCard and Discover. Alan Jespersion, PO Box 17338, Minneapolis, MN 55417. (612) 727-2489, 8 am to 8 pm 7 days. Fax only: (612) 727-1908

FOR SALE: Motorola clock radio Mod 56C-2, green, nice - \$15. Sonora Bakelite 78 record player Mod RWF-78, needs work - \$15. Both plus post. Robert Parke, 504 Essex St., Gloucester City, NJ 08030-1015. (609) 742-8221

FOR SALE: Tube manuals: 30's to 60's, engineering size to pocket, GE, Tung-Sol, National Union, etc. - \$10 to \$50. Sept.-Oct. 1932 Television News - \$35. Robert Shuck, 10512 Winston Ln., Fishers, IN 46038. (317) 849-0381

FOR SALE: Perfect Catalins: Sentinel 284, DeWald Harp, Temples, superb red Garod Commander, marbled BT-245 yellow/maroon tombstone miniscule flaw. Also following Catalins with damage: Yellow/maroon Dewald 561, Arvin, maroon Temple, Stewart-Wamer, bottom 1/2 GE jewel box. Also ivory Truetone Petite, red prewar Emersonette crack, blue Philco 49-503 wedge/line, ivory Refrigeradio. 888's Explorers, Atlas, ivory Sony TR-84, Penney's 41-8TM-360. N.O.S. Reddy Kilowatt enamel pins/charms, Catalin clocks, S&P, poker chip racks/chips, red/butterscotch checkers 6 sets - \$100. Also green Plaskon Paul Frankl design Air-King style clock. Ted Chronister, 7073 Carlisle Pike, #26, Carlisle, PA 17013. (717) 766-6436

FOR SALE: Riders manuals: 1 thru 5 - \$45; 6 thru 16 - \$17; or all for - \$200. The following tube testers, all are nice & working: (1) Weston Navy Model OCL - \$150; (1) Signal Corps Model 1-177 - \$85; (1) Precision Model 10-60 - \$150; (1) KS 15560 LI made for Western Electric by Hickok - \$200. All prices & shipping. Jim McDowell, 8 Blanchel Ter., Jeffersonville, IN 47130. (812) 283-6387



BUY/SELL

TUBES

NEW & USED

SEND FOR OUR "WANT LIST"
OR
OUR FREE 1997 CATALOG

ELECTRON TUBE ENTERPRISES
P. O. BOX 8311
ESSEX, VT 05451-8311

TEL: 802-879-1844

FAX: 802-879-7764

EMAIL: etetubes@vbiemail.champlain.edu

FOR SALE: Speakers: Atwater Kent E - \$60. F-4 - \$75. Kolster K6 - \$60. Peerless cathedral - \$60. Brunswick Gothic style - \$65. RCA UZ-135 hom - \$150. RCA 103 tapestry, cloth w/m - \$80. J. Gary Cameron, 824 Andrews St., Southington, CT 06489. (860) 276-9200

FOR SALE: Rek-O-Kut K34H, with Pickering cartridge, works fine, but needs belt - \$75. Edward Krawczyk, 64 Old Chimney Rd., Up Saddle River, NJ 07458. (201) 825-3828

FOR SALE/TRADE: Restored Philco 70 - \$400. Gem Edison phonograph - \$350. All plus S&H. Mark Murphy, 1400 Chicago Ave., #802, Evanston, IL 60201. (847) 328-5036

FOR SALE: Airline movie screen table Model 62-318, excellent condition - \$299. Dale Johnston, 1305 Guadalupe Dr., Westminster, MD 21157. (410) 848-5279

FOR SALE: Browning Mark III, VFO, mic - \$500. WANTED: Paperwork for Lafayette tube tester #99-5063. Glenn Hendrix, PO Box 144, Ardmore, OK 73402. (405) 226-4644

FOR SALE: N.O.S. tubes: VT-225/307A (34) bulk Ken-Rad, Sylvania - BO. Used tubes: 6BK4 (22) - \$4 ea.; 19T8 - \$1.50 ea.; 12AU7, 5963 (150) - \$1 ea.; 6AT6, 6AV6, 12AV6, 6H6, 5T8/6T8 - 75¢ ea.; 3JC6, 4HT6 4JC6, 5X8, 6AU8, 6BA8, 6EB8, 6JC6, 6JD6, 6X8, 8AW8, 8JV8, 11KV8, (4) for - \$1. Clinton small phone, 3 speeds - BO. Blaupunkt radio, table, Sultan 2420, plays - BO. Grundig radio, stereo, BC, FM, SW (2) console/te mandello plays - \$75. Call, write, fax to: George Stagakis, c/o Georges Antique TV & Radio Repair, 1714A 41st St., North Bergen, NJ 07047. (201) 867-9136. Fax: (201) 867-4044

FOR SALE: Philco Model 37-116 high-fidelity console, restored to as-new condition - Best Offer. Pickup only. Sheldon Rubin, KT2L, 117 N. Ridge St., Ryebrook, NY 10573. (914) 937-6376

FOR SALE: Standard SR-G433 7-transistor micronic type, exc - \$85. Sony ICR120, complete, working, pristine w/chgr, manual, EP & display case, exc - \$500. Zenith Royal 500E, w/book, EP & leather case, vg - \$90. Sony 5-303W 5" micro-TV, w/owner's manual & cord, good picture, no sound, otherwise exc - \$95. Fisher K10 space expander reverb., complete w/manual copy - \$125. Pocketcom Model XB-100, pair mini-CB walkie-talkies, working in gc - \$85/pair. David Koesche, 61 S. Barrington Rd., South Barrington, IL 60010. (847) 382-7997

FOR SALE: Excellent Radiola III cabinet and panel, no chassis - \$35. Yaesumusen FRG-7 receiver - \$100. Emerson 888 Pioneer - \$75. GE 675 - \$95. Walter Kiefner, 6233 51st Ave. NE, Seattle WA 98115. (206) 526-1452

FOR SALE: GE 220, exc - \$35. Farnsworth GT-061, g - \$40. Triplett 2590 tester, exc - \$45. David Boardman, 10 Lemaistre, Sainte-Foy, Quebec, Canada G2G 1B4. (418) 877-1316

FOR SALE: Zenith Trans-Oceanics: all original and complete and 100% cosmetically restored to showpiece condition: 8G005YT - \$195; H-500 - \$190; B600 - \$190; T-600 - \$190; 7G605 bomber grille - \$295. Frank J. Manzano, 82 Monhegan Ave., Oakland, NJ 07436. (201) 337-5263

FOR SALE: Accepting bids for 25-199 dud tubes, (6) Bakelite base, (7) brass base, (12) brass and tipped. Maurer Television, 29 South 4th St., Lebanon, PA 17042. (717) 272-2481

FOR SALE: Reference Data for Radio Engineers 4th ed. - \$50+. Radio Amateur's Handbook 29th Ed. - \$15+. Higher Math For Electricians and Radioman - \$45+. Add 10% shipping. Vincent Zucco, 22 Aspinwall Rd., Red Hook, NY 12571. (914) 758-6712

FOR SALE: 78 rpm records, big band, approx. (900) records - \$400 plus shipping, or make offer. Robert J. Stone, 721 Fisk St., Piqua, OH 45356-3729. (937) 773-2217

FOR SALE: Collection of pre-World War II television sets by HMV, Marconiphone, Baird, Cossor, etc. John Gillies, 55 Hemmen Ln., Hayes, Middx, UB3 2JQ, England. Tel. 0181 573 7517

FOR SALE: This ad items from closed-up repair shops, lab. All may need some work, clean up or batts. Recal or probe. (17) assorted Simpsons 260 VOM from early to late models, all for - \$75 for parts use only. Other VOM-VTVM signal gens. Tube testers, Superior TV 11 tube tester - \$22 parts unit. Eico 625 tube tester parts unit - \$18. Micronta battery tester - \$8. Sencore FE 160 TVOM - \$22. Parts unit. Eico 239 TVM - \$15. Heath MMI-VOM - \$18. Heath IM-10Y VOM - \$12. Sears VOM - \$10. RCA WV 77-E VTVM - \$19.50. Eico 955 cap. tester - \$18. Simpson ohmmeter 372 - \$5.50. 362 - \$5.50. Triplett tube tester 1612 old counter type - \$32.50. Have some RCA 45 players. GR Type 358 wave meter 299 wood box, 4 coils - \$55. Junking Radiola 33. Precise 630 signal gen. - \$18. Precise 635 audio gen. - \$18. RCA VIZ isotap II transformer - \$20. Model CB 815 CB field meter - \$15. (3) assd. VOM - \$12. Tube caddys large - \$35; med. - \$25; small - \$22.50. RCA 10" electro dy. 106 speaker - \$25. Other sizes electro dy. speakers. 15" jukebox speaker - \$25. Bundles of service data RCA, GE, Motorola, Philco plus more by the bundle. Understanding Amateur Radio - \$6. ARRL Handbooks 1948, 63, 74, 78, 80, 88 - \$10 ea. Soldering guns irons plus other tools. (7) small AM transistor sets - \$27. Hallicrafters S-85, clean - \$68. AM-FM tuners, amps, tubes and transistor units - SASE list. German radios, some need little work. All AM-FM keyboard models Emud Record Junior 196, 6-tube blonde wood - \$35. Emud Record Junior 196 wood - \$32. Blaupunkt wood 5-tube Ballett 2003 - \$32.50. Blaupunkt Ballett 20003 Bakelite 5-tube \$32.50. Tubes ST style, used, tested 26 - \$3; 27 - \$2.50; 71-A \$4; 80 - \$4; 24A - \$3.50; 35/51 - \$4.75. Also have old tube sockets. Selling off 1000s of items. Write wants LSASE. Min. parts orders - \$8. All plus shipping. F. Krantz, 100 Osage Ave., Somerdale, NJ 08083-1136. (609) 783-0400

FOR SALE: Chassis for Philco, Zenith, RCA & others. SASE for list. EM & PM speakers available. Frank D. Atwood, Nostalgia Radio, 117 E. Main St., Merrimac, MA 01860. (508) 346-8100

FOR SALE: Grundig 101-U small three-tube wood table radio, very nice cond. - \$35. Arthur Kreitner, 2013 East Belle Ave., Belleville, IL 62221. (618) 233-5610

FOR SALE: (70) N.O.S., N.I.B. 12-volt plate/heater tubes (12DS7, etc.) - \$60 all ppd. Jim Farago, 4017 42nd Ave. S, Minneapolis, MN 55406-3528. (612) 722-0708

FOR SALE: Radiotron Designers Handbook 4th ed. - \$70. N.O.S. tubes: 8950 - Offers. Used CX350 - Offers. Pat Smith, 1207 E. 3rd St., Dayton, OH 45402. (937) 223-8823

FOR SALE: 1929 RCA Theremin with 106 speaker, complete working order, original manual - Best Offer over \$10,000. Sear Sound, 353 W. 48th St., New York, NY 10036. (212) 582-5404

FOR SALE: Catalin Patriot red mint - BO. Majestic #15 cathedral, mint - \$345. List LSASE. Richard Bednarck, 28 Steele Ave., Lincoln Park, NJ 07035. (201) 694-6374

FOR SALE: Make an offer. RCA W056A 7-inch oscilloscope, all good except power transformer which is RCA #96788, manual included. Alton A. DuBois, Jr., 67 Peggy Ann Rd., Queensbury, NY 12804. (518) 792-3130

FOR SALE: Rider's Volumes I thru 16 - \$12 apiece; Volume 20 for - \$50. Fair to good condition plus shipping. Lester Hobbs, 320 Herman, Ottumwa, IA 52501. (515) 684-6403

FOR SALE/TRADE: RCA 3-BX-671 Strato-World leather portable in excellent playing condition - \$90 + UPS. Paul Fulton, 711 Jacquelyn Rd., Westwood, NJ 07675. (201) 664-5260

FOR SALE: Project boxes, (100) assorted N.O.S. HQ - \$2-\$25. Agreed? Renee May, 1242 N. El Centro Ave., Los Angeles, CA 90038. Ph/fax: (213) 464-9179

FOR SALE: Tube amps and preamps by Bogen, Strom-Carlson, Dukane, Challenger, all operational, good tubes. Dukane S/S 100 watt w/5 mic mixer. 25-watt output xfmr 25/70V out. 25 vol. Rider TV manuals w/ index, small radios, UHF/VHF converter, AK 47 w/ tubes. New in box NIKKO S/S 50-watt stereo amp. Webster-Chicago wire recorder, V-M tape recorders, RCA 106 spkr cab. g. cond. AM/FM tube radio tuners, Wright-DeCoster speakers (1930). Rider Model 170 audio chanalyt, dual ch. Strom. power supply handle (8) 6L6's. Many other items, send LSASE for complete list. Ed Scribner, PO Box 279, Schoharie, NY 12157-0279. (518) 295-8819

FOR SALE/TRADE: Two original 16mm BW Laurel and Hardy, and Railroadin. 1945 Radio Amateurs Handbook. Gordon Wilson, 11108 50 Ave., Edmonton, Alberta, Canada T6H 0H9. (403) 434-6257

FOR SALE: Plastic dial covers for over two-hundred different radios; some of them are AK 145, Belmont 6D111, Addison #2, Crosley 61, Fada 1000, Hallicrafters S-38, S-39, Hammarlund HQ180 clock cover, National 240D, Zenith 8G005 - \$15 ea. includes postage. Doyle Roberts, HC63, Box 236-1, Clinton, AR 72031. (501) 745-6690. E-mail: drob@artelo.com

FOR SALE: Sprague N.O.S. can TwistLok electrolytics. Many combinations mmfds and WVDC - LSASE. Nick Terrence, 12 Eleanor Pl., Huntington, NY 11743. (516) 951-5477

FOR SALE/TRADE: Australian Mickey Mouse Mod EC Bakelite mantel - BO or trade for vintage tubes. Ray Pedri, VK6TI, 83 John St., Henley Brook, 6055, Western Australia. Phone: (61) (8) 92961702

FOR SALE: American Bosch Model 660T wood radio - \$60. N.O.S. tubes - call. Leonard Brenner, 1127 Towne Lake Dr., Longview, TX 75601. (903) 734-4174

FOR SALE/TRADE: Hallicrafters S-40B - \$150; S-77 - \$100. Stewart-Wamer 8-globe cakebox - \$150. 2-band wood Air King - \$60. SASE. Sam Timberlake, PO Box 161, Dadeville, AL 36853. (205) 825-7305. E-mail: stimber@worldnet.att.net

FOR SALE: Pair Wharfedale W-90 speakers - \$150 ea. Hammarlund HQ110 receiver, w/sprk - \$125. Garrard RC80M changer - \$75. Pilot T601A tuner - \$25. All neg. & plus shipping. Irv Sanders, RD #3, Box FA53, Harrisburg, PA 17112. (717) 469-2185. E-mail: irv3iuy@juno.com

FOR SALE: Magic-Tone 504, whiskey bottle, good label, works, clean - \$325 + UPS. Paul Hametty, 4805 Parkmoor Dr., Westerville, OH 43082. (614) 882-1979

FOR SALE: General Motors Lil General cathedral, restored - \$350. Columbia tabletop crank phono with lid - \$250. Fada #1000 parts: yellow handle - \$75; knobs - \$75; cracked cab. - \$30. (20) Edison Diamond Disc records - \$50. (100) subminiature tubes, 1/2 boxed - \$10. J.L. Acciavatti, PO Box 806, Upton, MA 01568. (508) 476-3229

FOR SALE/TRADE: Recently acquired one of the finest examples of a Federal 59 that I have ever seen. It is flawless inside and out and works like a new radio. This is the one you've been searching for to put into your museum or private collection, asking - \$1,850. Call: Larry Drago, 383 Lincoln Dr., Cheshire, CT 06410. (203) 272-6030, or fax (203) 272-2002

FOR SALE: HB book Electronics One-Seven, revised second edition by Harry Mileaf, used by U.S. Army, 2" thick - \$50 plus. Elwood Hunt, 308 Georgetown Rd., Cameys Point, NJ 08069-2512. (609) 299-5259

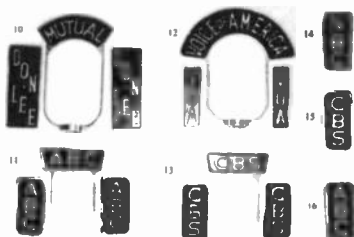

FOR SALE: Cast aluminum microphone flags, high polished, black background, over (30) different styles. Spring microphone stands, on air signs, yokes & shock mounts. Send or fax for list. Partial offerings from my list: #10, Mutual-Don Lee 3-piece set, fits WE-Altec 639 - \$185. #11, ABC 3-piece set, fits RCA 74 - \$145. #12, Voice of America 3-piece set, fits WE-Altec 639 - \$185. #13, CBS 3-piece set, fits RCA 74 - \$145. #14 NBC, #15 CBS, #16 ABC, clips on 5/8" shaft, fits any flag - \$35 ea. Add for priority mail & insurance. Ekkehart Willms, 137 W. 40th Ave., San Mateo, CA 94403. Ph/fax: (415) 571-9070, 6-10 pm only

FOR SALE: (3) Western Electric VT-1 tubes, good filament - \$50 ea. 35/51 N.O.S. - \$12/3. Philco 610, works - \$75. 521 with speaker, works - \$65. Hallicrafters S-38 - \$30. Stromberg-Carlson 231-F chairside, new mirror on top - \$225. Sterling Little Symphony parts set - \$30. Photos of these and other items available on the Internet at: <http://www.pcola.gulf.net/~oldradio/> in the Crosley Swap Shop. Don Reinsma, 610 Nix Rd., Pensacola, FL 32506. (904) 455-7721

FOR SALE/TRADE: Gorgeous original Radiola II, w/ built-in antenna - \$550; Radiola III - \$175; Radiola IV - \$325; \$750; Philco 70 (parts set) cathedral - \$250. Call: Larry Drago, 383 Lincoln Dr., Cheshire, CT 06410. (203) 272-6030, or fax (203) 272-2002



FOR SALE: Zenith brown plastic AC-DC, reddish swirl, ex-nice, plays, 3-Z knobs - \$150. Zenith H511 brown plastic. Zenith G516 1951 brown plastic, rounded ends, (2) knobs, BC, AC, DC, ex-nice, plays - \$60. Zenith 5-tube R-S 10 RZ1 red plastic portable, both ends round, checkered front like new, plays - \$60. Tower ship case, Adventurer, Boston, Ma., plays, has hard-to-see crack left at water line, looks excellent - \$90. Two small early cast iron battery motors, one 2-coil, fly wheel, 2 1/4" diameter, has nice action, one heavy 20-oz. 4" high coil inside, open, has 1 1/4" pulley, both run, both black, two - \$200. Sterling Deluxe 1940 radio (in Evolution Volume 2, p. 179), little rust on metal, celluloid nice, Model 1000 on tube location chart, 4-tube - \$175. Variac by General Radio Co., Mass., 0 to 260 large 5" x 5" right copper coil knob turns whole front, weight 15 lb. as shown - \$75. Eimac 1000T tube, 15" long x 4" 3" tube, metal cap, coming out 5" from bottom, tube has cap at top, 4-prong - \$150. Stabilovolt 5TV 280/15 ex. tube 12" x 3", 6-prong - \$150. AEG G1014D 5-volt 4-prong - \$40. Airline 04-BR-514B 5-tube 5 push button, cream Bakelite - \$40. Little Wonder mike - \$35. Three Vogue records, two R707, one R781, nice, three - \$160. Atwater Kent cathedral 84, all original, plays, wonderful - \$450. Seeburg Wall-O-Matic 1949 Model 3W1, chrome nice, works, jukebox selector - \$350. Vibroplex bug side winder No. 82875 key, iron base covered with black like tire - \$150. Two Western Electric Wutel Co. mainline sounders, brass on wood base, lever on end, clean, pair - \$125. Temple Superette G418 metal portable ivory radio, ex-clean, gold-colored Temple dial, plays, beautiful finish - \$150. Edison Mabry, 715 W. Longview Ave., Mansfield, OH 44906. (419) 526-1175

FOR SALE/TRADE: N.O.S. industrial tubes Phillips/P.E.I. 100 Amperex/6083 (Arizona list \$120 each) my price - \$50 ea. Also KT 88 - \$225, and KT 52 - \$58. (5U4) by Genelac Call: Larry Drago, 383 Lincoln Dr., Cheshire, CT 06410. (203) 272-6030 or Fax: (203) 272-2002

FOR SALE: IMA Classic table radio, MR-100-GR, M.I.B. Crosley reproduction (like 10-138, Bunis 3, p. 52) except this one is light green - \$60 includes UPS. Lloyd "Bud" Noel, W9BUD, 494 Clark St., Galesburg, IL 61401. (309) 342-2825

FOR SALE: Garage sale: Radios, laboratory test equipment, books, tubes, parts, ham gear. By appointment. Cash and carry. Stuart T. Carter, II, W4NHC, 680 Fernwood Dr., Melbourne, FL 32904. (407) 727-3015

FOR SALE: Baronet - \$95. Bendix 526A - \$50. 626A - \$55. Blaupunkt - \$55. Coronado 43-8201 - \$45. Crosley 56TV - \$50. 56TW - \$50. 66TC - \$60. Delco R-1235 - \$45. Emerson 507 - \$50. 517 - \$55. 522 - \$50. F182 - \$40. 7KW2282 - \$40. Firestone S-7403-6 - \$55. Majestic 5A410, nice - \$75. Nordmende 870 - \$40. Philco 84-B cathedral, fair - \$75. RCA 45X18 - \$60. 55X - \$60. 96T4 - \$50. 96-T5, nice - \$75. 5T tombstone, fair - \$75. T-60 - \$60. T-62 - \$60. Radiola 18, clean - \$90. Regal C527L - \$40. Silvertone 8010 - \$60. Stewart-Warner A61P1 - \$30. 1441 hairline - \$50. Sonora RBU-176 - \$45. Stromberg-Carlson 225H - \$50. Sylvania 540MA - \$35. Zenith J733 - \$35. J. Gary Cameron, 824 Andrews St., Southington, CT 06489. (860) 276-9200

FOR SALE: Tube radios: 1945 Fada Catalin maroon & yellow bullet, exc - \$950. 1946 Bendix 526C green/black Catalin, exc - \$850. 1936 Sparton blue mirror Model #517, vg+ - \$1,900. Admiral Blakon midget, exc - \$225. Weltron yellow 8-track ball, vg+ - \$250. Transistors: Toshiba 7TH-425 saucer, exc - \$225. Zephyr ZR930, exc+ in box - \$225. Emerson blue 888 Explorer blue, exc - \$125. Televisions: Red JVC Videosphere with base, exc - \$550. White JVC Pyramid, exc - \$750. 1948 Admiral 24A12 Bakelite console, exc - \$550. RCA 17PT gold metal portable with cart, exc - \$295. 1949 Teletone wood 7", exc - \$225. Microphones: Shure 51, vg+ - \$135. Shure 508B Stratoliner, vg - \$185. Altec 633A w/400 baffle, exc - \$165. Telefunken TD20, vg+ - \$95. Astatic JT30, exc - \$125. Electro-Voice studio stand with counterweight boom, quick lock and damper, vg - \$125. Tom Meers, 773 Carlisle Club Dr., Stone Mountain, GA 30083. (800) 777-1452

FOR SALE: Sony turntable #2251 w/cart. - \$50. Plus UPS. **WANTED:** Zenith chairside, 1938 (or '39), 7 or more tubes, working, cabinet etc. in fair to good condition. Dick Friedman, 1502 Elmwood, Wilmette, IL 60091. (847) 803-3050

FOR SALE: We offer speaker field coil rewinding and complete speaker repair. Call. New!! Replica copy of Zenith 25-tube Stratosphere owner's manual - \$15. New!! Replica faceplate for 1938 Zenith Robot dial, an exact copy of the original - \$45 with your restorable trade-in. Call for details. Reproduction 1936 or 1937 Zenith full-line poster - \$19 ppd. Zenith 7G605 Trans-Oceanic log chart reproduction - \$19.95 ppd. Excellent repro knobs, owner's manuals for most Zeniths and other brands, grille cloth and other radio parts, new and salvage. Universal dial belt kit, 6' of belt material, glue and instructions - \$8.95 ppd. Send for free catalog. Visa, Discover and MasterCard accepted. Alan Jerspersion, PO Box 17338, Minneapolis, MN 55417. (612) 727-2489. E-mail: mte612@aol.com

FOR SALE: Rider's manuals Volumes 10, 12, 13 - \$20 ea. plus S&H. Herb Ellmers, 775 Howard St., Ft. Pierce, FL 34982. (561) 466-0926

FOR SALE: Tube hi-fi: Dyna: PAM 1, vg - \$35; FM 1, vg - \$40; FM 3, vg - \$50. All working condition. R. Taylor, PO Box 161, Frankfort, MI 49635. (616) 352-7672

FOR SALE: (2) Webster-Chicago wire recorders, Mod 181-1 complete and untested and Mo. 858 (identical) for parts plus 8 spools of wire - \$45 for all plus S&H. Jeff Hoskins, 824 E. Madison Ave., Stuart, FL 34996. (561) 283-2291, after 7 pm

FOR SALE: Knight Model 145 amp - \$50. GE Models 411 and 226 - \$35 ea. RCA Model 9X571 - \$35. Silvertone Models 6130 - \$125; and 800 portable - \$40. Victor VV-IV - \$175. Charles E. Callahan, 2717 Glendale Rd., Apt. B, Baltimore, MD 21234-5605. (410) 663-0767

FOR SALE/TRADE: A collection of DeForest and other manufacturers plug-in honeycomb coils. Call: Larry Drago, 383 Lincoln Dr., Cheshire, CT 06410. (203) 272-6030 or Fax: (203) 272-2002

HIGHEST PRICES PAID FOR NEW and USED TUBES

WANTED!

**Western
Electric**

VT25/A VT52 101D/F
104D 205D/F 211D/E
252A 262A/B 274A/B
275A 300A/B 301A
310A/B 311A/B 347A
348A 349A 350B
417A 421A 422A

OTHER TUBES WANTED!

2A3 5AR4/GZ34 6CA7/EL34
6L6GC(RCA) 10(GLOBE)

12AX7/ECC83 (Amperex/Mullard/RCA/Telefunken)
45(GLOBE) 50(ST & GLOBE) KT66 KT77
KT88 211/VT-4C 845

5691 & 5692 (Red Base) 6550(ST) etc.

IF YOU HAVE ANY TUBES LISTED IN THIS AD,
PLEASE Call or Fax **DON SINGERHOUSE**

**SINGERHOUSE
OUND**

Tel/Fax: (715) 246-3899
P.O. Box 321, New Richmond, Wisconsin 54017

FOR SALE: Magazines (singles & whole years): QST: 1934-1970, CQ: 1948-1970. Ham Radio: V1#1 (1968) - 1975, 73: V1k#1(1960) - 1975, much more. Most \$1.50 ea. or less. ARRL Handbooks, 1930-1978 - \$6 and up. Send 2-stamp LSASE. Don Merz, N3RHT, 47 Hazel Dr., Pittsburgh, PA 15228. E-mail: 71333.144@compuserve.com

FOR SALE: (2) butterscotch knobs for Garod Catalin - \$80 for both. Atwater Kent 20 big box - \$125.30 - \$130. 32 - \$100. 33 - \$110. 40 - \$75. 42 - \$60. 46 - \$85. 55, clean - \$90. 61, fair - \$40. 67, fair - \$40. 165 cathedral, excellent - \$300. Tombstone 725 - \$160. American Bosch 5A - \$95. 28, fair - \$75. 38 - \$100. 205A - \$95. 610 - \$60. 828L - \$55. Brunswick 6KR - \$130. GE S22 Junior tombstone - \$245. Philco 18 lowboy - \$140. 66 tombstone, nice - \$120. Silvertone 3561 marbled ivory candy cane - \$80. Stromberg-Carlson 653A, very nice - \$150. Thompson S-70 - \$150. J. Gary Cameron, 824 Andrews St., Southington, CT 06489. (860) 276-9200

FOR SALE: Drake SW-8, 6 months old, most update model, N.I.B. - \$550. 1 ship. Doug McCarthy, 1010 E. Morrow Dr., Phoenix, AZ 85024. (602) 582-4291

FOR SALE/TRADE: Wood(s) AK 145 (Bunis 2), nice, plays - \$145. Grunow 660 (Bunis 1), nice, plays - \$120. Silver-Marshall, small, early thirties - \$165. Zenith 8S443, nice - \$350. Consoles: Crosley 1941 Model 34B4 Gramophone radio, record player, record cutter with microphone, excellent, plays - \$250. Zeniths: 7S53, good - \$300; 11S474, nice - \$365. Transistors: Bulova 290, black - \$50. Candle PTR-100, mint - \$35. Linmark T-80 damaged main body, excellent reverse paint - \$35. Microphone; Philmore Junior 500 N.I.B. - \$37. Cincinnati, Elgin, Rochester delivery. Trades considered. I pay packer, you pay shipper. Bill Timoszyk, 35283 Leon, Livonia, MI 48150. (313) 421-2076

FOR SALE: Collins KWM-2 owners: N.I.B. 6A28 tubes - \$3.50. 4D32 finials for 32V Series, factory-sealed - \$29. N.I.B. 302C-1 panel meters - \$35. Lowell Thomas, K6KC, PO Box 15026, Fresno, CA 93702. (209) 227-1605. E-mail: k6kc@lightspeed.net

FOR SALE: Little Wonder radio receiver, invented and manufactured by A.L. Clark, Los Angeles, California, crystal set, leatherette case, excellent - \$325. Vibroplex lightning bug, gray crackle, black paddle #255229 - \$50. Emerson Deco wood midget table set, walnut, resistance line cord, recapped, AX217 - \$75. RCA table shortwave #87T, green eye, recapped, very nice - \$60. Everplay rechargeable with case - \$35. Sony TFM121 AM/FM and Sony STA110 stereo adapter, both - \$25. N.O.S. midget Japanese 5-tube Stardust, 1 pink, 1 white - \$45 ea. Fresca pop can radio N.O.S. in box - \$30. Mork eggship radio - \$35. Communications: Hallicrafter Skydrier Defiant SX-24 - \$75. Sky Buddy - \$135. Swan 500C, 510X crystal switch, power supply, desk mike, manual, clean rig - \$250. National NC-303, speaker, manual - \$195. HRO-50T, all coils, mint - \$500. William McCuskey, PO Box 140, LaConner, WA 98257. (360) 466-4683

FOR SALE: Philco radios from my collection. Call, e-mail or send SASE for list. Prefer not to ship. Can deliver to MSARC meet in Louisville, Radiofest in Elgin, and RadiOctoberFest in Nashville. Ron Ramirez, 811 Maple St., Providence, KY 42450-1857. (502) 667-5440. E-mail: mrphilco@mail.wko.com

FOR SALE/TRADE: (6) N.O.S. Genelac KT-88 tubes in original boxes - \$225 ea. Also N.O.S. Philips/Mullard/Sylvania EL 34 - \$50 ea. Larry Drago, 383 Lincoln Dr., Cheshire, CT 06410. (203) 272-6030 or Fax: (203) 272-2002

FOR SALE: Tubes! 201A - \$8; 224 - \$5; 226 - \$6; 227 - \$6; 235 - \$5; 245 - \$35; 112 - \$20; 171 - \$22; 6F6G - \$5; 6V6G - \$6; 7591, matched pair - \$39. Many others - \$1 and up. Call, write wants, no list. Evan J. Chasse, 108 Cass St., Swanton, OH 43558. (419) 826-3776

FREE - 20 WORD AD EACH MONTH

To get your free 20 words,
include your SUB# with your Ad.
Additional words are 27¢ each.
Read inside back cover for details.
MANY THANKS!!!!

FOR SALE: E.H. Scott 800-B w/Garrard 80-C, plays. Seeking RCA 100B speaker for parts. Kelly Nichols, RD1, Box 103K, Greenwood, DE 19950. (302) 349-5059, voice/fax

FOR SALE: Majestic #463 - \$190. David Gamer, 1210 191/2 St. S, #6, Moorhead, MN 56560. (218) 236-5598

FOR SALE: To reference our Zenith models, order our 60-page 11x17 Zenith Brochure Book for - \$28.95 ppd. New this month: Philco 90 cathedral, original finish - \$550. Nice original Zenith 6S128 Deco tombstone; window sign "Zenith Radio-TV" red and pink neon; original Fada neon clock, face rescreened; Grunow 501 chrome front, excellent original finish - \$295. Beautiful small end table Stewart-Warner with claw and ball feet - \$250. Small Belmont cathedral - \$125. General Electric transistor display case, locks, 28"x28" - \$90. Call for current availability of Rider's manuals and most Trans-Oceanics. We have hundreds of radios for sale. We specialize in high-end and uncommon sets. Refer to last month's ad or call. We can and do ship consoles anywhere and we do it right. Free delivery to meets in Lansing or Elgin. All radios unrestored electrically unless noted. Shipping extra unless noted. Satisfaction guaranteed, highest quality possible assured. Electrical restoration service available. Visiting Minneapolis? Visit our store, Great Northern Antiques, 5159 Bloomington Ave., just five minutes from the airport. We accept Visa, Discover and MasterCard. Alan Jesperson/Mike Emery, PO Box 17338, Minneapolis, MN 55417. (612) 727-2489 or fax only (612) 727-1908, ans. mach. after 4 rings, 8 am to 8 pm 7 days. E-mail: mte612@aol.com

FOR SALE: H.P.: 200A, AB, B, CD audio oscillators; 400D AC VTVMs - \$26 + UPS ea. Joe Beady, Box 8 Star Rt., Huntingdon, PA 16652. (814) 643-0603

FOR SALE/TRADE: B&K #501 curve tracer - \$65. B&K #2810 DVM, 0.5% - \$18. RCA WV-97A Senior volt/hmyst - \$30. Dave Minchella, KE2GE, 80 Campfire Rd. N, Henrietta, NY 14467. (716) 359-3337

FOR SALE: Liquidating entire Two Boy's transistor collection radio by radio. Send a LSASE for a picture list. Gary Willoughby, 5930W. Jefferson Blvd., Los Angeles, CA 90016. (310) 559-0706. Fax: (310) 836-6518

FOR SALE: Trans-Oceanic 3000-1, excellent cond. with charts - \$150. Crosley book radio World of Music, nice - \$125. Ghirardi's Troubleshooting Guide, 3rd ed. - \$35 plus shipping. Dan Olson, E. 4913 Sumac Dr., Spokane, WA 99223. (509) 448-8828. E-mail: dolson4710@aol.com

FOR SALE: Air condensers with 4" knobs - \$10 ea. plus. Elwood Hunt, 308 Georgetown Rd., Carneys Point, NJ 08069-2512. (609) 299-5259

FOR SALE/TRADE: N.I.B. 1923 Myers Famous dry battery tube w/all fastening clips for Radiola rcvr - \$400. DeForest tubular Audion detector w/5 wires - \$450. DeForest Audion 410 and 510 globe tubes - \$95. DeForest 01-A, DL2, DV2, DV5, DV3 - \$85 ea. Also N.I.B. GE globe #50 - \$225 ea. Large selection of Arcturus blue tubes - \$40 ea. Ct. Tel. and Telegraph J-117 brass and glass tube made by Mr. Donie 1916 w/ good filament - \$475. Radiotron 203A, 201A B/B tipped. A large selection of Western Electric tubes, + WD 11, WD 12, WX 12, UX213, UX120, 199 BBT rainbowed. Call: Larry Drago, 383 Lincoln Dr., Cheshire, CT 06410. (203) 272-6030 or Fax: (203) 272-2002

FOR SALE: E.H. Scott SLRM. Hallicrafters: SX99, SX101A, SX42 & SP, S38B.C.D., SX71 & SP, SX110, SX130 & SP, WR4000, WR1000, URR 274 (SP600), NC 2-40D & SP, NC 183 & SP, HQ 129X, HQ 140XSP, NC 46 & SP, Collins R390A, R392, HQ 110 & SP, Lafayette 350, Allied SX190, Collins 51J & S, Knight RSS & Star Roamer BCT. Lots of Zenith Trans-Oceanics (no junkers or parts). Lots of German radios, Saba, Grundig, Telefunken, Philips. Call: Alan Carpenter, 524 Ponderosa Dr., Estes Park, CO 80517. (970) 577-0677

FOR SALE: Old metal electric phonograph, Model 400, has keystone type characters painted around base, blue & yellow, works - \$95. RCA X551 radio with matching RCA 45J2 red top 45 rpm turntable, excellent - \$110. Jefferson Golden Hour clock, perfect, running - \$150. All plus ship. Doyle B. Roberts, HC63, Box 236-1, Clinton, AR 72031. (501) 745-6690. E-mail: drob@artelco.com

FOR SALE: Western Electric KS6368 horn speaker with driver - Offer. Floyd A. Paul, 1545 Raymond Ave., Glendale, CA 91201. (818) 242-8961

FOR SALE/TRADE: Just purchased unique RCA collection of salesman samples and novelty advertising specialties, approx. 75 items such as RCA Zippo lighters, flashlights, key chains, belt buckles, knives, charms, key chains, Nipper dogs made of chalk, celluloid and porcelain, plus needle tins and other fascinating items. Videotape available - \$10 refundable. Call: Larry Drago, 383 Lincoln Dr., Cheshire, CT 06410. (203) 272-6030 or Fax: (203) 272-2002

FOR SALE: Tubes: These tubes are all new 6AQ5 Kerba - 75¢ ea. 6CM5 USSR - \$1 ea. 6CW7 USSR - \$1 ea. 6AV6 Japanese - 50¢ ea. 5Y3 USSR - \$1 ea. Shipping not included. Available from: Victor Bang, Video Tech Service, 7520 S. Rural Rd., A-3, Tempe, AZ 85283. (602) 491-1811

FOR SALE: Beautiful RCA illuminated clock sign, repair for your old-time radio display or replica radio repair shop, approximately 16 inches square, red and white with brown frame, only - \$125 plus shipping. Maurer TV, 29 S. 4th St., Lebanon, PA 17042. (717) 272-2481

FOR SALE: Tubes, about 20K radio, audio xmit & sweep tubes N.O.S. & used. No list. Best offer for lot only. Walt Murray, PO Box 2100, Lakeside, CA 92040. (619) 596-8402

FOR SALE/TRADE: Newly acquired crystal collection which includes crystal galena tin and wood boxes, mini detectors, galena rocks, phone condensers, tuning coil sliders, spark gaps, EICO and DeForest detectors, factory-made pocket crystal sets, approx. 60 unique items. Videotape available - \$10 refundable. Call: Larry Drago, 383 Lincoln Dr., Cheshire, CT 06410. (203) 272-6030 or Fax: (203) 272-2002

FOR SALE: Crystal, battery, cathedral radios. Crosleys, Radiolas, Zeniths. Much literature, tube manuals, books, catalogues. List - SASE. Bill Rolf, 30131 Center Ridge, Westlake, OH 44145

TUBES • PARTS • SUPPLIES YOUR COMPLETE SOURCE FOR...

TUBES:

Over 3500 receiving, transmitting, audio and industrial types in stock, including many foreign and early types.

TRANSFORMERS:

Hard to find power, filament and output transformers as well as filter chokes for tube equipment. We feature HAMMOND performance transformers as well as many new old stock transformers.

CAPACITORS:

High voltage electrolytic and mylar capacitors, multi-section capacitors and more for tube circuits.

PARTS:

Resistors, tube sockets, potentiometers, knobs, dial belt lamps, diodes, speakers, wire, phonograph needles and cartridges and much more.

LITERATURE:

Extensive selection of literature and books on antique radios, tubes, circuits diagrams, communication gear and hi-fi equipment. Some items not available elsewhere!

SUPPLIES:

Grill cloth, cabinet restoration supplies, batteries, chemicals, tools, test meters, gifts and kits.



CALL OR FAX FOR OUR NEW 40 PAGE CATALOG!

ANTIQUE ELECTRONIC SUPPLY™

LIMITED PARTNERSHIP

8221 S. MAPLE AVE. • TEMPE, AZ 85283 • (602) 820-5411 • FAX (602) 820-4843 or (800) 706-6789

FOR SALE/TRADE: Two beautiful Crosley Buddy Boy Repwood cathedrals - \$350-\$500. Also Crosley. Call: Larry Drago, 383 Lincoln Dr., Cheshire, CT 06410. (203) 272-6030, or fax (203) 272-2002

FOR SALE: CG1984 (Navy UV211) Westinghouse brass-base tipped - \$30. Brass base, no tip - \$20. John H. Walker, Jr., 16112 W. 125th St., Olathe, KS 66062. (913) 782-6455. E-mail: johnh.walker@alliedsignal.com

FOR SALE: Philco Model 20 chassis only, NT or knobs - \$65 plus. Elwood Hunt, 308 Georgetown Rd., Cameys Point, NJ 08069-2512. (609) 299-5259

FOR SALE: N.I.B. U.S. tubes: (2) 5Y1 7591A - \$75; (8) 6U5 - \$18 ea.; (8) 6E5 - \$9; (4) RCA 826 - \$20 ea.; (2) RCA 8000 - \$60 ea.; (2) Zenith 6AE7GT - \$15 ea.; (2) 5Y1 01-A - \$15 ea.; (10) Amperex 6CG7 - \$4 ea.; (1) RCA 801 - \$75; (10) 12BH7A - \$6 ea.; (2) 6E VT-25 - \$90; (4) Superior(?) SX200A \$15 ea.; (12) RCA 47 - \$12 ea.; (4) 6B4G - \$25 ea.; (10) 76 - \$8 ea.; (1) GE 8005 - \$75; (4) 8417 - \$35 ea.; (2) Amperex 5563 - \$50 ea. Used tested tubes: (4) RCA 7027A - \$50; (8) 45 (ST) - \$20 ea. Roland Barbeito, 19 Murray Ave., Westfield, MA 01085. Phone/fax: (413) 572-4745

FOR SALE: (300+) books on vacuum tube circuits and vacuum tubes. Send two-stamp SASE for list. Charles Brett, 5980 Old Ranch Rd., Colorado Springs, CO 80908. (719) 495-8660

FOR SALE/TRADE: Hallicrafters SX101A - \$475; SX43 - \$275; S-36 - \$400; SX14 - \$400; SX17 - \$300. Larry Drago, 383 Lincoln Dr., Cheshire, CT 06410. (203) 272-6030 or Fax: (203) 272-2002

FOR SALE: GE 511, white - \$20. RCA 75X11 - \$25. Teletone, tortoiseshell - \$20. Federal 1040TB, marble - \$45. Emerson 581A - \$27. Emerson CE-263 - \$20. Altec 342-A amp - \$100. Bogen CHA-100 - \$40. Bill Cherenky, 5 Kate Ln., Metuchen, NJ 08840. (908) 549-2165



*Craig L. Graybar
Furniture Works Ltd.*

(414) 258-2390

SPECIALISTS IN RESTORING,
REPAIRING AND REPRODUCING
CLASSIC STYLED ANTIQUE TV,
RADIO & PHONOGRAPH CABINETS

Send us your plans or your project
via UPS for immediate price quotes



1535 S. 84th St.
West Allis, WI 53214



"We Turn Ideas Into Heirlooms"

FOR SALE: Attention: Antique car radio repairers: Howard Sams Auto Radio, Volumes AR-1-3-5-7, cover years 1949-1958, all for - \$60 plus shipping. Maurer TV, 29 S. 4th St., Lebanon, PA 17042. (717) 272-2481

FOR SALE: Microphones RCA 77-A nice old mic, 11 lbs., no cord, dual ribbon, what a mic - \$1,350. Spring mic year 1926 Model #20 double carbon name: Universal. I only have the mic, no springs or stand as seen on page 281 of Vintage Microphone Book (Fig. 33) - \$95. RCA Mi 6226 year 1936 dynamic type, works & looks great, (V.M.B., p. 130) - \$95. Holland stereo mic EL3784/01 crystal, 1960s, works & looks great - \$65. California Telephone Company mic 702D year 1940s dynamic type. This is a very nice mic, it looks like the RCA 50A in (V.M.B., p. 133) and is all copper - \$195. Zephyr mic made in Berlin, all chrome, works & looks great, dynamic type - \$75. Shipping not included. Victor Bang, Video Tech Service, 7520 S. Rural Rd. A-3, Tempe, AZ 85283. (602) 491-1811. 831-2014, Sundays & evenings

FOR SALE: Tandberg TCD310 Mark III stereo cassette tape recorder, three motors, Dolby Illuminated VU's, the best there is: special - \$249.95 Tandberg 64 reel tape recorder - \$149.95 National HFS less/PS - \$84.99. Andrea G6B - \$98.99. Philco 37-62 - \$167.99. Hallicrafters S-107 - \$139.50. All plus shipping. Free superlist. Send your E-mail address for 8 pages of exotic vintage equipment. Steve Lipsky, W2VVN, PO Box 404, Barnegat Light, NJ 08006. (609) 361-8175. (215) 884-1817, alt. E-mail: slipsky@worldnet.att.net

FOR SALE: Philips BX925A gen. cov. comms. Rx., 16 tubes, 1952, little used since new, near mint, with manual, (see p. 348 Osterman's book) - \$400. Also Ameco CN144 2m Nuvisitor converter, mint with manual, one owner since new - \$50. + UPS both. Brian R. Cauley, VE3DFC, Caledon, Ontario, Canada L0N 1C0. (519) 927-5858

FOR SALE/TRADE: Heathkit Marauder TX, needs work - \$250. James Millen Transmatch Type 92200 - \$250. RCA Type SA-32A (30-watt) MI 12155, power amp - \$225. Call: Larry Drago, 383 Lincoln Dr., Cheshire, CT 06410. (203) 272-6030, or fax (203) 272-2002

FOR SALE: Ampex 351 console R/R tape recorder, w/ manual, excellent - \$600. Gates broadcast 8-ch. tube-type control board - \$400. Other control boards. Danny Brou, 212 Wainwright Rd., Pineville, LA 71360. (318) 484-4504, day; (318) 445-4843, night

FOR SALE: Original Zenith 8S661 dial pointer - \$25. Vogue picture record: Enric Madriguera/orchestra - \$50. Steve Beale, 4694 Chickasaw Rd., Memphis, TN 38117. (901) 685-0209

ARBE-III - Universal Battery Eliminator

\$149.95 Shipped USA

☞ Contact: ☜

Antique Radios Inc.

Box 6352, Jackson, MI 49204

(517) 787-2985 or

Fax (517) 782-7422



FOR SALE: RCA WT-100A tube checker manual - \$20. Meissner degaussing coil - \$40. Plus shipping. Tom Vilov, 603 Homewood Dr., Pocomoke City, MD 21851. (410) 957-1407

FOR SALE: Radiola 18, plays; AR turntable, plays. J. Finkelstein, 205 Alapocas Dr., Wilmington, DE 19803

FOR SALE: (2) EV-12TRXB - \$200. Drake SW-4A - \$150. Kenwood SP-23 - \$50. Hallicrafters S-119 - \$50. Mike Brillhart, 12551 Maiden Creek Rd., Abingdon, VA 24210. (540) 944-4387

FOR SALE: Sentinel television sign - \$50. Wurlitzer 841 wall box? amp and speaker - BO. John Lyle, 1161 S.W. Mulvane, Topeka, KS 66604-1456. (913) 232-0128

FOR SALE: Simpson 269 A.F. L/N - \$125; 313 vgc - \$125. 303-1 vgc - \$45. Auto Bty. Ldr., L/N - \$45. P.U. Dewey H. Shaffer, R.D. 2, Box 104-B, New Paris, PA 15554. (814) 839-4728

FOR SALE: Seco 1002 tube tester - \$95. John Kirby, 298 West Carmel Dr., Carmel, IN 46032. (317) 843-2212

FOR SALE: 1944 Zenith Radionic hearing aid A2A in box, \$40 new - \$40 now. Don Howland, 4621 W. Shawnee, Spokane, WA 99208. (509) 466-0939

FOR SALE/TRADE: AK 165. Zenith 10-S-155. 6-S-254. WANTED: Catalin radios. Tom Dell, 214 Pleasant St., Hanover, PA 17331. (717) 637-8875

FOR SALE: 274B Sylvania made for U.S. Navy, like new - \$35 ppd. 280 good test - \$23 ppd. 6F6G good test - \$5. (2) 45's used, both for - \$40 ppd. (2) 6L6GC used good - \$18 ppd. for both! Pete Putra, 1429 Lawndale Ave., Racine, WI 53403. (414) 632-2543

FOR SALE: Radio Age, July 92 thru Dec. 93 - \$20. Rider's Resonance and Alignment, AVC - \$10. Mark S. Rauber, PO Box 1077, Minden, NV 89423. (702) 782-3596

FOR SALE: 55¢ LSASE for list of new/used receiving/transmitting tubes. Many thousands added lately. Sell or trade for old or unusual tubes or related material for my collection. John H. Walker, Jr., 16112 W. 125th St., Olathe, KS 66062. (913) 782-6455. E-mail: johnh.walker@alliedsignal.com

FOR SALE/TRADE: Bell Systems version of famous (Western Electric 124A) amp, made by Western Electric and McIntosh (rack mount mono block), includes manual - \$850. Call: Larry Drago, 383 Lincoln Dr., Cheshire, CT 06410. (203) 272-6030, or fax (203) 272-2002

FOR SALE/TRADE: Seven Hi-Fi systems magazines, 1957, 1958, 1959 - \$70 plus UPS. WANTED: DAV/B.F Goodrich keychain license tags, paying \$2 ea. John Williams, Jr., PO Box 1545, Scarborough, ME 04070-1545. (207) 775-4212

FOR SALE: Crystal radio kits, complete with face panel and base board, 365 variable capacitor, large pre-wound coil, and many other parts for an old-style crystal radio. Remit - \$19.50. Carl & Grace Ent., 5636 Romeyn, Detroit, MI 48209

FOR SALE/TRADE: Edison motor exposed armature/governor, 110v AC/DC, good - BO. Stephen Sideroff, 46 Dutch Lane Rd., Marlboro, NJ 07746-2102. (908) 462-7987

FOR SALE: Electro-Voice SP-12 new in factory sealed carton - \$35. EL-38 Amperex N.I.B. - \$50/4. WE 2N-110 (1956) - \$15. Samson Quallpensator type W (1920's) - \$50. Wm. Harder, 911 W. Northrup St., Lansing, MI 48911-3640. (517) 882-2303

FOR SALE: HRO-50T-1 with 9 coil sets from 50 kHz to 30 MHz. Unit had been recapped recently, but underside chassis pan is missing. Original manual included and wooden storage for 8 coil sets. Prefer pickup but will ship - \$425. #5 Rider Television Manual - \$20 plus ship. Hallicrafters SX-62A, it's pretty ugly, and has bandswitch problems, AM-OK, FM-? - BO, no ship. Hammarlund HQ-110C with manual - \$95 plus ship. Jim Koehler, 242 Guy Lombardo Ave., Freeport, NY 11520-4454. (516) 623-0035

Classified Ad Deadline Noon

Jul. 10 for Aug. 1997 Issue

Aug. 10 for Sep. 1997 Issue

Boxed, Photo, & Display Ads - 1st

FOR SALE: N.I.B. 5U4GB tubes made in U.S.A. - \$10 ea. plus. Elwood Hunt, 308 Georgetown Rd., Cameys Point, NJ 08069-2512. (609) 299-5259

FOR SALE: Jackson Model 648A tube tester - \$70. Precision Model 912 tube tester - \$25. Sencore Model TC162 Mighty Mite tube tester - \$50. Heathkit Model EUW-27 sine-square generator - \$35. Sencore touch-tone cricket transistor tester - \$60. B&K color bar generator Model 1248 - \$35. Amprobe voltage-current tester - \$30. Crosley Model D-25MN radio - \$95. All plus shipping. Elbert Marshall, Rt. 2, Box 239, Hillsville, VA 24343. (540) 398-2283

FOR SALE: Vintage Microphone Book - History of Identification - How They Work. Table of Contents: AKG, American, Altec, Amperite, Astatic, Atlas Stands and Attachments, Beyer and Bruel (German), Brush, Bruno, Velotron, CAPPS, Crown, Duotone, Electro-Voice, Neumann (German) Tube Mics, also history of East and West with Diagrams, Novelty Radio Microphones, Primo, RCA 4AA Box Brownie and Control Panels 10-A, 11A, 11-B, 12-A Program Amp and Schematic, Robins, Ronette, Shure, Sennheiser (German), Sony, Sonotone, Tumer, Universal; Vintage Microphones - WE, GE, RCA, Westinghouse, Jenkins, Adair, American, Universal, Tumer, Bud, Johnson, Remler, also Water Mics; Early Microphone History, Baby Microphones - \$29.95, price includes shipping if necessary. Available from: Victor Bang, Video Tech Service, 7520 S. Rural Rd. A-3, Tempe, AZ 85283. (602) 491-1811

FOR SALE: Grebe CR-8 - \$600. SASE or e-mail for new list with (100) additional items. Jim Collings, 12005 Victoria Pl., Oklahoma City, OK 73120. (405) 755-4139. E-mail: jrcradio@swbell.net

FOR SALE: Motorola 68L11 - \$45. Silvertone 4500, black - \$75. RCA PX600, blue - \$35. Emerson 561, brown and gold - \$40. Zenith H-401, maroon - \$35. Zenith G-500 trans. - \$75. All in good condition and work, plus shipping. Bill Gebhardt, PO Box E, Liverpool, PA 17045. (717) 444-3403

FOR SALE: Zenith Model 12H696, pickup only. RCA Victor chassis Model 280. Telmer Olson, W0YPT, 304 W. Iowa, Box 267, Monona, IA 52159. (319) 539-2315

FOR SALE: Zenith 288 tombstone - \$250. Colonial 653 mini tombstone with metal inlay - \$185. RCA 120 cathedral, needs wood work - \$100. Clarion 32 cathedral, large with burl woods - \$225. GE E-81 tombstone - \$165. Crosley V - \$150. Timmons Talker speaker - \$85. Peerless speaker - \$35. Capehart Amperion, circa 1930, large, coin-op radio/phonograph - \$1,800. Victor 240, exceptional, original - \$200. Columbia early AH phonograph - \$1,800. Edison B80 - \$175. Cylinder records: 2 minute - \$6; 4 minute - \$4. RCA Victor 2-65 Orthophonic portable, gold-plated - \$195. Pathé acoustic phonograph with cone speaker, oak - \$850. Following items not in yet, call details: Zenith 230 cathedral, Philco 18 and 90 cathedrals, Victor 9-54 cabinet. Following items reduced from prior month's ad: Emerson BJ200 - \$75. Norelco B5X98A, works - \$100. Colonial Globe, brown - \$750. RCA AR812 and AG814 matching loop antenna, nice - \$225. Automatic Radio Tom Thumb portable with built-in camera - \$150. Zenith 420 10-tube console with automatic tuning - \$250. McMurdo Silver II, no cabinet, nice chrome - \$800. John Hayes, 27 Highland Dr., Henniker, NH 03242. (603) 428-3053, or fax only (603) 428-8315. E-mail: JHayesamfm@aol.com

FOR SALE: Edison Diamond Discs, I still have plenty of 'em - \$3 ea. and up, plus shipping. Please send a 7¢ stamp, or a dollar if it's easier for my 7-page double-sided list with prices. Thank you. You can snail mail me, or phone me, or e-mail me at: Steven Bohte, Box 287, Penngrove, CA 94951. (707) 585-6808. E-mail: SBotee@aol.com

FOR SALE: Zenith Royal 7000-1 - \$150 plus UPS. Tom Bump, 4127 142nd Ave. NE, Lake Stevens, WA 98258. (425) 334-4732

FOR SALE: McIntosh: MC-240 - \$1,450; MC-60 & C-104 preamp - \$950; MC-30 - \$550. All excellent original condition. Greg DePrez, 9941 S. Prairie Falcon Ln., Highlands Ranch, CO 80126. (303) 791-1522

FOR SALE: Old, old books: The Home Radio - How To Make and Use It, by Verrill, 1922 - \$20. Radio Simplified, by Kendall and Koehler, 1923 - \$10. The ABC of Vacuum Tubes in Radio Reception, by Lewis, 1922 - \$18. The Boy Inventor's Wireless Triumph, by Bonner, 1912 - \$18. Old magazines: Science & Mechanics, 1938; Popular Science, 1924-1938 - \$4 ea. 8-transistor radio by TransWorld, absolutely new in original box, with leather case and headphone - \$30. Boxed crystal sets by Spencer, one red, one green - \$85 ea. Telefunken unique Bakelite wave trap for radios of the mid-1920's, nice - \$135. Double crystal detector by Westinghouse, 1921, (Douglas, Radio Mfg. of the 1920's, Vol. 3, p. 10), very nice - \$395. Hewlett-Packard Model 241 oscillator, only - \$20! Early teens open armature motor on wood base, you fix it - \$20! Marvel crystal set, (see Crystal Clear, p. 73), almost all there, you fix it - \$70. Spiderweb coil, plug-in, for Supreme tester, got one? - \$10. Custom-made Crosley belt buckle, not old, unique design - \$10. Dayton Fan & Motor Co. adjustable IF coil, 200-1,000 meters Type 5011, brown Bakelite, unusual - \$10. Dave Crocker, 4B Beechwood Point Dr., Mashpee, MA 02649. (508) 477-1578, before 9 pm, thanks

FOR SALE/TRADE: Zephyr black & white unusual four-piece Plaskon case, circa 1937, repaired bottom crack, plays - \$385. Admiral midget Plaskon, 1939, black red knobs - \$295; burgundy with black knobs - \$475; both excellent shape. Emerson EP381 red Plaskon black handle, circa 1938, some hairlines - \$875; same in pistachio green - \$775. Kadette 1937 cameo set marbled rust, grey, tan, excellent condition - \$775. Mark Alzapiedi, 13 Fitch Farm Ln., Sterling, MA 01564. (508) 368-7223

FOR SALE: Amplifiers: Marantz 250 solid-state - BO. Marantz 7T preamp - BO. Dynaco stereo 70 tube - \$225. Dynaco 60-watt mono tube - BO. Teac R-R tape rec. - \$55. David Fearing, 1072 Sea St., Quincy, MA 02169. (617) 773-6436

Announcing The 7th Annual ARCO Antique & Collectible Radio Show

— Saturday August 16th —

Sponsored by the Antique Radio Collectors of Ohio

— FEATURING —

- A Display of Radios
- An Indoor/Outdoor Swap Meet
- An Auction of Radio Apparatus
- Your items for auction are welcome

— WHERE —

Holiday Inn - Dryden Rd., 2455 Dryden Rd., Dayton, OH
I-75 Exit 50A (Dryden Rd., just south of downtown), then 1 block north.

— COST —

Auction & general admission are FREE! Swap meet tables inside or spaces outside are \$10.

Program: Show/Swap Meet: 8:00 AM til 1:00 PM. Auction: 1:00 PM til 3:00 PM

Raffle: 1st Prize: Zenith console Model 5749.

2nd Prize: Philco R/P console Model 49-1601.

3rd Prize: Crosley table Model 56TN-L.

4th Prize: Philco table Model 47-204.

All radios work and have been restored. Buy tickets at the door. Tickets are \$1 ea. or 6 for \$5.

Door Prize: (Book: *Tube Lore*) Free sign up at the door. Must be present to win.

For Information Call: Karl Koogle (937) 294-8960 or Randy Frasure (937) 253-4330

Admission is Free!! The public is invited. Bring a friend!

FOR SALE: Fisher 800C, works but no 7591's, slight shipping damage but faceplate and glass look fine. I can ship without causing further damage - \$135. Western Electric M9B battery-powered volt/ohm/ammeter - BO. 10" field-coil speaker (RCA? Philco?) for push-pull 45's - BO. All plus shipping. C.J. Poulos, 29 Doubleday Rd., Columbia, CT 06237. (860) 228-7680, or fax 228-7681

FOR SALE: Nice working Eico 950 capacitor tester with instruction manual copy - \$40. Charles Combs, 508 E. Daniel, Albany, MO 64402. Ph/fax: (816) 726-3038

FOR SALE: Expanded list: Radios, parts, Blaupunkt, Geiger counters. SASE. Randy Seifert, Box 45, Middle, IA 52307. Fax: (319) 622-3461

FOR SALE: Thousands of tubes, new and used, TV, radio, audio, etc. Send your wants. Rick Weibezahl, 305 Belvidere Ave., Washington, NJ 07882

FOR SALE: Pilot TV Model TV-37, 3" screen, excellent condition, works - Best Offer over \$300. Bob Suslovich, Box 9053, McLean, VA 22102-0053. (703) 841-5889

FOR SALE: Ampran CT-50: Multiply your Amprobe 100-amp range by 50, in case with instructions - \$50. Carl Hackenson, 31 Hixson Farm Rd., Sharon, MA 02067. (617) 784-8834

FOR SALE: Transistors \$5 each: Sanyo RP1250, GPX A2845, GE P1791, GE 2550, Arrow. James S. Looney, Rt. 1, Box 54, Grundy, VA 24614. (540) 531-8677

FOR SALE/TRADE: Revox A-77 2-track, 7.5/15, vg - \$195. **WANTED:** Microphones: Sony ECM-77B, Sennheiser ME-40. Jay Myers, 1010 Spring Ln., Nashville, TN 37204-3213. (615) 297-5886

FOR SALE: Test equipment. Philco frequency meter BC-906-C (made for Army Signal Corps), good - \$100. Philco 7008 visual alignment generator with 3" CRT, good - \$100. Philco electronic circuit master 7001, good - \$50. Dumont oscilloscope 401A, good - \$50. EICO signal tracer 147A, good - \$50. Standard signal generator 560 FM, good - \$35. Hickok tube tester 600A, good - \$40. Adjust-a-Volt variable transformer, good - \$40. Electro D-612T filtered DC power supply, good - \$35. Radios: Hammarlund HQ-129-X, with speaker, good - \$175. Stewart-Warner Companion, fair - \$15. All above plus shipping. Gary Bernstein, 12 Spring Ave., Barrington, RI 02806. (401) 246-0146. E-mail: voyager1@webtv.net

FOR SALE: Grundig 4070U AM, FM, SW, stereo, excellent - \$135. Heath capacitor checker - \$50. Visual-aural signal tracer - \$55. Shipping extra. **WANTED:** Sonar tube CB equipment. Ron Johnson, 123 W. Mountain St., Worcester, MA 01606. (508) 852-0794

I am a serious collector and historian interested in all aspects of E. H. Scott.

Please contact me first if you are selling your E. H. Scott Radio, Select-World's Record Superhet, or Scott Transformer Co. items.

Always interested in any E. H. Scott stock certificates, literature, and military sets.

John T. Meredith
2462 Statonsburg Rd., Suite 152
Greenville, NC 27834 - (919) 551-1882

FOR SALE: Pair of JBL C40 Harkness loudspeaker systems (includes 130A 15" driver, 175DLH horn), and N1200 crossover), cabinets in light mahogany finish, great sounding and cosmetically nice, 29"H x 38"W x 20"D - \$700 plus crating and shipping expenses. Will consider trade for cosmetically perfect high-end transistors or Catalin. Bill Burkett, PO Box 2488, Sun City, AZ 85372. (602) 974-4535. Fax: (602) 974-4323

FOR SALE: Majestic N.I.B. tubes, IF xmrs and other misc. Majestic parts! Majestic bank. **WANTED:** Majestic & Grunow advertising items & chrome-front radios. Please note my new address and phone numbers as the eagle has finally landed (with most of its feathers intact)! Chip Taylor, 2223 53rd St., Sarasota, FL 34234. (888) 526-5566, toll free. Fax: (941) 359-6778

FOR SALE: Zenith Trans-Oceanic 1000-1 wavemagnet - \$120. Contents Telefunken console, 1967 rcvr, T-T, R-R rcdr, spkrs & mans. - \$150. Atwater Kent 45 - \$90. N.I.B. RCA promo items: (4) tape measures, (7) slide rules 6", (3) magnifying glasses - Best written offer for lot 8/20/97. All plus ship. Call or write for new list. Roger Ruddick, 33 Emily Ln., Ft. Myers Beach, FL 33931. (941) 463-8887

FOR SALE: 811A Sylvania's - \$18 ea. Bogen MC-225, McIntosh MC-30 schematics (copies) - \$5 ppd. Apex (U.S. Radio and TV) flyer for both models 36, 60, 89, 70 - \$10. 1932 Radiolek catalog - \$20. 1932 Wholesale Radio Service catalog, 146 pages - \$50. Will take N.I.B. 6E5 or 6U5 in trade. LSASE for my 5-page listing of tubes, parts, radios, literature, etc., or e-mail: splopes@aol.com. Stan Lopes, 1201-74 Monument Blvd., Concord, CA 94520. (510) 825-6865

FOR SALE: RCA 4X641 - \$25. Crosley E20GN - \$60. Sparton 5-06 - \$45. All work. Prices plus shipping. Request price list for used tubes. Dick Myhre, 8238 Birch Bay Dr., Blaine, WA 98230. (360) 371-5540. E-mail: rjmaz@juno.com



WANTED!

Microphones—all types:
Telefunken, Neumann, AKG, RCA, Sony, etc.
Also buying recording studio equipment,
tube compressors, EQ's: Pultec, Lang,
Teltronix, Urei, Fairchild, RCA, etc.

818.784.7611 • Fax 818.784.7564
Moving Hands Studios - Los Angeles, CA

FOR SALE/TRADE: Have (30) novelties (& others) for sale/trade for other novelties. SASE for list. Ray Weaver, 1047 Bunker Hill Rd., Columbus, GA 31907. (706) 687-1733

FOR SALE: Transistors: Westinghouse H179P6 - \$25; Toshiba 8TM294, chip - \$35; Silvertone 1205 - \$15. Dennis Schrank, 3129 S. Quincy Ave., Milwaukee, WI 53207. (414) 744-3374. Fax: (414) 744-8780

FOR SALE: Lafayette hybrid reel-reel 4-track, RK-650 stereo deck - \$15. RK-137A portable recorder - \$15. Both working. Arnold Hawk, Cobble Hill Rd., E. Thetford, VT 05043. E-mail: arnold.b.hawk@dartmouth.edu

FOR SALE/TRADE: Table radios, consoles, tunes, needles. Ray Seppeler, Sunshine Radio, 8 Main, Sodus, NY 14551. (315) 483-8451, days; (315) 926-5696, evenings. E-mail: sunrad@aiousa.com

FOR SALE: Zenith 6D312 classic - \$150. Ding Dong School 45 rpm player - \$125. Sam Samuelian, 2305 W. Deerfield Dr., Media, PA 19063. (610) 566-7248

FOR SALE: Belmont 6D111, ivory - \$100. Carol Scott, 1402 Cora #1, Ellensburg, WA 98926. (509) 925-1030. E-mail: scottc@televar.com. <http://www.adsnet.net/radio>



FOR SALE: MK-11 SOSL boombox field radio. During WWII the Field Commander of the U.S. forces led his troops with the help of a field radio very similar to this. This radio is a beautiful 1940's style field series with modern 1990's technology. It has a solid wood cabinet with a circular antenna, 18 controls for sound efficiency for its radio, CD and cassette players. You will be pleased with its quality, and proud to have this fine piece of equipment as part of your collection. Send check or money order for \$269 includes S&H, U.S., Eur. extra, to: Ben Martin, PO Box 118, 20885 Redwood Rd., Castro Valley, CA 94546. Information: (800) 595-0191 or fax (510) 583-1907

FOR SALE: Atwater Kent Model 12 - \$1,500. Clapp-Eastham Radak Type R4 - \$425. Both in excellent condition. Charles J. Stinger, W8GFA, 404 Ross Ave., Hamilton, OH 45013. (513) 867-0079

FOR SALE: Zenith 4R late version - \$675. Grebe CR9, WT, works - \$475. Grunow 500 chrome grille - \$200. Steve Wallace, 3707 Pricetown Rd., Fleetwood, PA 19522. (610) 944-7230. E-mail: kkks@epix.net

FOR SALE: Western Union Naval Observatory clock, set from Washington. **WANTED:** SSCP receiver or equipment. Henry Weiland, 8946 W. Grantosa Dr., Milwaukee, WI 53225. (414) 463-4681

FOR SALE: Motorola 77XM22 - \$35. Crosley 9-302 - \$30. Motorola 61L1 - \$30. Bogen K130 amp - \$55. All working. Jim Ligouri, 7 Sycamore Ct., Atkinson, NH 03811. (603) 362-5712. E-mail: Jiljigouri@aol.com

FOR TRADE: Butterscotch Emerson AU190 for another Catalin. What do you have? R. Gates, PO Box 187, Chesterfield, VA 23832. (804) 748-0382

FOR TRADE: Radios or cash for bipolar dynamos, motors, x-ray tubes, small early gas engines. Tom Burgess, 9 Belle Meadow Ln., Little Rock, AR 72210. (501) 455-0773

— WANTED —

**PICTURES FOR PHOTO REVIEW OR TELEGRAPH REVIEW
PHOTOS MUST BE SHARP IN DETAIL
A SHORT DESCRIPTION IS A MUST!
SEE PHOTO REVIEW PAGES FOR
ADDITIONAL INFORMATION**

HELP: Need source for reproduction paper labels for tubular (Cunningham) Audiotrons; red or black printing. Dale Davenport, 622 S. 18th St., Fort Smith, AR 72901. (501) 785-4929, eves.

HELP: Desperate! Old restoration! \$\$\$ for Paragon amplifying transformer, good external condition. Continuity? Rick Ammon, 1249 Solstice Ln., Fort Collins, CO 80525-1239. (970) 221-4001. E-mail: wireless@bamboo.verinet.com

HELP: Need schematic and service info for RCA AR67. Joe Beseda, 4730 S.E. 87th, Portland, OR 97266. (503) 775-7565

HELP: Need Centralab control parts: KR-1, KR-2 switches, shafts, pots. What do you have? Mark Oppat, 253 Blanche St., Plymouth, MI 48170

HELP: Need schematic showing disc capacitors values to Pyramid Phase Three PS-25 power supply. Greg Sheppard, KA3DBG, 4402 Jupiter St., Rockville, MD 20853-3255. (301) 946-6460

SERVICES: Electroplating of metal parts with gold, silver, nickel, copper. I can replace worn or corroded metal plating using submersible tank method. Reasonable rates. Mark Lang, 4601 Chelsea Ct., Titusville, FL 32796-1440. (407) 268-4697

SERVICES: Custom records cut. Want special music for your vintage phono? Records cut from your tape to 78, 45, or 33 1/3 rpm, stereo or mono. Call/write for price & info. The Audio Lathe, PO Box 5469, Eugene, OR 97405. (541) 345-3991

MESSAGE: Announcement: You can build a one-tube superhet radio using an easily available Compacktron. Speaker volume on local stations. Plug-in coils give you shortwave. For instructions and a complete schematic, send me a buck and a SASE. Want to build a TRF version? Send another buck. Dick Parks, 2620 Lake Ridge Ct., Oakton, VA 22124. (703) 242-8268

MESSAGE: For any last minute assistance you may need regarding anything associated with Extravaganza '97, call Jim or Brenda Clark at (517) 349-7187, fax us at (517) 349-7186, or e-mail us at hggw75a@prodigy.com. Michigan Antique Radio Club, Extravaganza, Suite 100, 3520 Okemos Rd., #6, Okemos, MI 48864

MESSAGE: Will the vendor who was set up on the "motel side" of the May 17th Golden Valley, Minn., radio meet & had the GE transistor portable (Model P780E), please write me. Mike Hanke, 1036 S. 15th Ave., Wausau, WI 54401. Don't phone

FOR TRADE: Radios/cash for old electric fans, brass blades/guards, ornate castings, pinstriping, little feet. Dave Friedlund, 36006 S.W. Bald Peak Rd., Hillsboro, OR 97123. (503) 628-1439. E-mail: davefr@mindspring.com

FOR TRADE: Does anyone out there have an old, good condition Heathkit, Eico or similar analog VTVM to trade for a Micronta LCD benchtop digital multimeter in vg condition with original box? Reason for trade? I just hate DVM's! Please make my bench-work happy again. Thanks. Harold LaRoche, 16426 Heiden Cir., Spring, TX 77379-7026. (281) 370-3451

FOR TRADE: RCA/Cunningham (issued 1933) RC-11 tube manual. Trade for RC-10, RC-12, or offers. Gary A. Micaneck, 226 Henry Ave., Manchester, MO 63011. (314) 227-7046

FOR TRADE: Atwater Kent, Model 1 breadboard. Want early Amrad, (3366, 3670 portable, Type E). J.C. Woychowski, 81 Penn. Ave., Niantic, CT 06357. (860) 739-6579

HELP: Need manual or Xerox for Heathkit VTVM Model V6. Metal lid for Atwater Kent Model 4S or other measuring 10 5/8" x 21" or will sell radio. **FOR SALE:** N.O.S. 15" Jensen dual unit speaker with control - \$75 plus S/H. Karl W. Doerflinger, 52 Interlocken Rd., East Providence, RI 02914. (401) 434-1116

HELP: I desperately need a speaker to fix my Royal 500 7XT40. Thank you. Chris Rogers, 38 Smethurst Ave., Pakenham, Victoria 3810, Australia. 61 (359) 401777

HELP: Need 1950's grille cloth for VM 557: Cream color with silver and gold threads criss-crossing. Gary Stork, 37530 E. Meadowhill, Northville, MI 48167. (248) 478-0990

HELP: Need any copies of advertisement on GE radios, etc. for theme of radio show in Louisville, Ky. in July. Please send or call: Allan Ferris, 2479 W. Bluelick Rd., Sheperdsville, KY 40165. (502) 543-8233

HELP: Need info for Boulevard Electronics shortwave receiver, Chicago 1953. Need copy manual. Jon Weiner, Box 4534, Greenville, SC 29608. (864) 294-7083

HELP: Offering \$50 for a Bakelite dial faceplate with veneer knob for Atwater Kent Type 11 tuner. John Koop, 48 Wheelbarrow Ln., Wantagh, NY 11793. (516) 731-6711

HELP: Need Centralab controls, KR-1, KR-2 switches, etc. IRC, Clarostat also. '41-'42 Philco faceplates. Mark Oppat, 253 Blanche St., Plymouth, MI 48170. (313) 455-4169

HELP: Need rebuildable motor for Edison Home Model D. Also rebuildable Edison and Victor reproducers - \$40 ea. Charles E. Callahan, 2717 Glendale Rd., Apt. B, Baltimore, MD 21234-5605. (410) 663-0767

HELP: I'm still looking for cabinet Zenith Model 6S222. If there's someone in the U.S.A. who can locate this cabinet for me, I will buy the radio working or not. Please call collect, evenings. Arnie Sanchez, 9615 Rockhurst, Houston, TX 77080. (713) 939-9221

HELP: Need manual and/or schematic for Fairchild oscilloscope Mod 766H (Dumont 102). Also drive belt for Edison Home Phonograph (cylinder). Joe Janovsky, 407 Phillips Rd., Saugerties, NY 12477. (914) 246-2452

SERVICES: Hickok, your authorized Hickok contact person offering affordable test equipment, sales, service & calibration. **FOR SALE:** Sig. gen. sig. tracers, tube testers, VTVM, laser copies of most major makes of test equipment. **WANTED:** Repairable radio test equipment, manuals, Hickok 288X, 209A, 156. Supreme Vedioizer, and other very old Hickok test equipment for my collection. Special needs, data for CA4 for use w/539B Hickok, also 539B for parts. Service that satisfies for 50+ years. Thanks. Wendell E. Hall, 3 Mockingbird Cir., Jeffersonville, IN 47130. Phone/fax: (812) 282-9709

One Month Free!

BONUS FOR EARLY RENEWALS

If you renew before the month shown on your mailing label (your expiration month), you will receive an extra month on your subscription: 13 months instead of 12! 26 months for an early 2-year renewal!

SERVICES: Rita's custom-made clear, plastic dial covers. **FOR SALE:** New/used tubes. Rita Hutchings, PO Box 382331, Germantown, TN 38183-2331. (901) 754-5565. E-mail: sally@netten.net

SERVICES: Radio schematics 1920-1960 - SASE + \$2.50. **FOR SALE/TRADE:** Duplicate service manuals - call or write with SASE. Steve Rosenfeld, PO Box 387, Ocean Gate, NJ 08740. (908) 269-2022

SERVICES: New dial scales. Grunow, Hoffman, RCA, many more. SASE for list. Rock-Sea Enterprises, 323 E. Matilija St., #110-241, Ojai, CA 93023. (805) 646-7362. E-mail: dials@Juno.com

SERVICES: Repair and restoration of antique radio and televisions. 2-week turnover, 40 yrs. experience, guaranteed work. Tom's Antique Radio & TV, 8 Howe Ln., Millbury, MA 01527. (508) 865-6293

SERVICES: Reproduction Philco cathedral cabinet parts. Clock finials. Reproduction 90 cabinets. **FOR SALE:** Schematics - \$2.75; books and manuals - SASE for list. Dick Oliver, 28604 Schwalm Dr., Elkhart, IN 46517. (219) 522-4516

SERVICES: Schematics 1920-1960, mailed or faxed: radios - \$3; TVs - \$4, ppd. Robert Schrantz, 610 E. Juanita Ave., San Dimas, CA 91773. Phone/fax: (909) 394-1194

SERVICES: Manuals and schematics. Some old, some new, some copies, some originals. Call: Walt Belsito, 149 Southmayd Rd., Waterbury, CT 06705. (203) 756-6376

MESSAGE: The flea market at Extravaganza '97 does start Friday morning July 11th, rather than Saturday July 12th as incorrectly mentioned in the June 1997 MARC Chronicle. Michigan Antique Radio Club, Extravaganza, Suite 100, 3520 Okemos Rd., #6, Okemos, MI 48864

MESSAGE: Will the Australian fellow who wanted to purchase Atwater Kent #20 contact me? I got your two phone messages but was out of town. I'll hold it for you. Also! Thanks for the great stories coming in my micbook - the art and application of microphones. It's gonna be some year! Keep it up guys!! W. Kremer, 5807 Papaya Dr., Ft. Pierce, FL 34982. Ph/fax: (561) 468-7732. E-mail: WKremer798@aol.com



OHIO - Jun. 27-28

**CINCINNATI ANTIQUE RADIO SOCIETY
ANTIQUERADIO COLLECTORS OF OHIO
RADIORAMA '97**

Florence, KY - Signature Inn, Turfway Rd.
Exit 182 off I-75 - (606) 371-0081

Jun. 26: 6-9 pm - Hospitality Session

Jun. 27: Dawn - Swap Meet starts
10 am - Open Exhibition: "Crosley - 75th
Anniversary"

2 pm - Caravan Tour - Gray History of
Wireless Museum

7 pm - Crosley seminar by Charles Singer

Jun. 28: Dawn - Swap Meet starts
10 am-till ? - Exhibition continues

Info: Bob Sands - (513) 858-1755

VIRGINIA - Jul. 2

**TIDEWATER ANTIQUE RADIO ASSN.
MEETING**

7 pm - Call for location & directions
Info: Phil Stroud, 2328 Springfield Ave.
Norfolk, VA 23523 - (757) 481-2561, eves.

ARKANSAS - Jul. 3

**ANTIQUERADIO COLLECTORS CLUB
OF FORT SMITH - CLUB MEETING**
Fort Smith, AR - St. Luke Lutheran Church
Waldron Road, at Free Ferry - 7:30 pm
Info: Paul Tucker, 4700 N. "N" Street
Fort Smith, AR 72904 - (501) 782-8178

WASHINGTON - Jun. 27-28

**RADIO ENTHUSIASTS OF PUGET SOUND
RADIO SHOWCASE V**

Theme: "180 Days 'Til Christmas"
Bellevue, WA - Overlake Hospital
Conference Center - (206) 455-9444

Jun. 27 pm: KIRO Mystery Playhouse
2 new radio dramas

Jun. 28: "Ethel & Albert meet Vic & Sade"
Other re-creations and two panels

Info: Mike Sprague, Showcase, PO Box 723
Bothell, WA 98041 - (206) 488-9518

CALIFORNIA - Jul. 5

**CALIF. HISTORICAL RADIO SOCIETY
MEET**

San Francisco, CA - St. Anne's of the Sunset
850 Judah St., off Funston (13th Ave.) - 8 am
Info: CHRIS Hotline - (415) 821-9800

WASHINGTON - Jul. 5

**RADIO ENTHUSIASTS OF PUGET SOUND
MEETING**

Seattle, WA - Queen Anne Library
400 W. Garfield - 2 pm

Info: REPS, 9936 NE 197th Street
Bothell, WA 98011 - (206) 488-9518

ONTARIO - Jun. 28

**LONDON VINTAGE RADIO CLUB
10th ANNIVERSARY MEETING**

London, Ontario - Jaycee Building
317 Adelaide St. South - 1 pm

Fred Hammond, Special Speaker

10th Birthday Cake - Special Contest

Info: Don Hatch, 14 Kingspark Cres., London
Ontario, Canada N6H 4C4 - (519) 472-6167

NEW YORK - Jul. 6

**GREATER NEW YORK VINTAGE
WIRELESS ASSN. - SWAP MEET**

Lake Ronkonkoma, NY - 367 Hawkins Ave.
N. of L.I. Expressway, lg. white house - 9-12 am

Info: Chris Lieppert - (516) 471-9526, or
Chris Bacon - (516) 821-7618

NEBRASKA - Jun. 29

**NEBRASKA ANTIQUE RADIO CLUB
MEETING**

Kearney, NE - Western Manufacturing Co.
2 blocks South of Hwy 30 on 12th Ave.

2 pm - Special guest Woody Bayshore

Info: Steve Morton - (308) 534-4778

MISSOURI - Jul. 8

**ANTIQUERADIO COLLECTORS & HISTORIANS
OF GREATER ST. LOUIS - MEETING**

St. Louis, MO - Kirkwood Community Center
111 S. Geyer Rd., Room 201-A - 7 pm

Info: Scott Teichmann, 103 Pleasant St.
Jerseyville, IL 62052 - (314) 256-6263

OHIO – Jul. 8

ANTIQUE RADIO COLLECTORS OF OHIO MEETING

Kettering, OH – National City Bank Basement
4100 Far Hills Ave., at Stroop Rd. – 7:30 pm
Wood & Plastic Table Model Radios

Info: Jim Cross – (513) 385-3855
ARCO, PO Box 292292, Kettering, OH 45429

PENNSYLVANIA – Jul. 8

DELAWARE VALLEY HISTORIC RADIO CLUB MEETING – SWAP MEET – AUCTION

Souderton, PA – 113 Main St.,
N. Penn Amusements Bldg.

7:30 pm

Info: DVHRC, PO Box 41031, Philadelphia,
PA 19127-0031 – Mike Koste – (215) 646-6488

TEXAS – Jul. 8

HOUSTON VINTAGE RADIO ASSN. MEETING

Houston, TX – Tides II Motel, Lai Lai
Restaurant, Holcombe at Main St.

7-10 pm – Auction & Program

Info: David Moore – (713) 485-1705

ARKANSAS – Jul. 10

ARKANSAS ANTIQUE RADIO CLUB MEETING

Little Rock, AR – Call for location – 7 pm

Info: Tom Burgess – (501) 455-0773

NEW JERSEY – Jul. 11

NEW JERSEY ANTIQUE RADIO CLUB MEETING

Freehold, NJ – Grace Lutheran Church
West Main St. & Park Ave. (old Rt. 33)

7:30-9:30 pm – Meeting & Swap

Info: Don Cruse – (908) 542-2848
Jim Whartenby – (908) 271-7701

W. VIRGINIA – Jul. 11

MUSEUM OF RADIO & TECHNOLOGY PRESENTATION

Huntington, WV – Museum of Radio & Tech.
1600 Florence Avenue

7 pm – Presentation on the Glass Tube
Discussion with Kenneth Jones and
Chuck Crawford on high-fidelity and audio

Info: Lloyd McIntyre – (304) 422-4690
Museum – (304) 525-8890

MICHIGAN – Jul. 11-13

MICHIGAN ANTIQUE RADIO CLUB EXTRAVAGANZA '97

Lansing, MI – Holiday Inn South Convention
Center, 6820 South Cedar Street
Off I-96 at Exit 104 – (517) 694-8123

Convention theme: "Radios of the World"

Jul. 11: All Day – Open-Air Flea Market
1-2 pm – The VM Story: Made to Last,
with Gary Stork

1-5 pm – Auction Preview

3-4 pm – Tape Recorder Repair,
with John Reinicke

6:30-10:30 pm – Auction w/Col. Rich Estes

Jul. 12: All Day – Open-Air Flea Market
9-10 am – The Pilot Radio Company, Its
History and Milestones, with Bill Moore

11 am-Noon – Transistor Transitions,
with Jim Weil

11 am-1 pm – Women's Luncheon

5-6 pm – Contest & Exhibit Viewing

7-10 pm – Speakers and Awards
Contest & Exhibit Viewing

Jul. 13: 9 am – Donation Auction

Info: Extravaganza '97, 3520 Okemos Rd.
#6, Okemos, MI 48864 – (517) 349-7187

CALIFORNIA – Jul. 12

PERHAM FOUNDATION ELECTRONIC FLEA MARKET

Los Altos, CA – Foothill College
Parking Lot A – 6 am-2 pm

Info: Perham Foundation – (408) 734-4453

OKLAHOMA – Jul. 12

OKLA. VINTAGE RADIO COLLECTORS MEETING

Oklahoma City, OK – Oklahoma Station BBQ
Springdale Shopping Center, 4331 NW 50th

6 pm – Dinner; 7 pm – Program

Info: Jim Collings – (405) 755-4139, after 6 pm
Mike Lapuzza – (405) 745-3394, after 7 pm

TEXAS – Jul. 12

HOUSTON VINTAGE RADIO ASSN. ELECTRONICS SEMINAR

Houston, TX – Tides II Motel, Lai Lai
Restaurant, Holcombe at Main St. – 9-12 am

Info: David Moore – (713) 485-1705

MISSISSIPPI – Jul. 13

MISSISSIPPI HISTORICAL RADIO & BROADCASTING SOCIETY – MEETING

Meridian, MS – 2412 C Street – 3 pm

Info: Randy Guttery – (601) 693-5958

MARK YOUR CALENDAR

Jun. 27-28 - OH, Cincinnati - RadioRama 97*
Jun. 27-28 - WA, Bellevue - REPS Showcase*
Jun. 28 - Ontario, London - LVRC Meeting*
Jun. 29 - NE, Kearney - NARCC Meeting*
Jun. 29 - OR, Forest Grove - NWVRS Display
Jul. 2 - VA, TBA - TARA Meeting §*
Jul. 3 - AR, Fort Smith - ARCCFS Meeting §*
Jul. 5 - CA, San Francisco - CHRS Meet*
Jul. 5 - WA, Seattle - REPS Meeting §*
Jul. 6 - NY, Lake Ronkonkoma - GNYVWA §*
Jul. 8 - MO, St. Louis - ARCH Meeting §*
Jul. 8 - OH, Kettering - ARCO Meeting §*
Jul. 8 - PA, Souderton - DVHRC Meeting §*
Jul. 8 - TX, Houston - HVRA Meeting §*
Jul. 10 - AR, Little Rock - AARC Meeting §*
Jul. 11-13 - MI, Lansing - MARC Extravaganza '97*
Jul. 11 - NJ, Freehold - NJARC Meeting §*
Jul. 11 - WV, Huntington - Museum Talk*
Jul. 12 - CA, Los Altos - Perham Flea Market*
Jul. 12 - OK, Okla. City - OKVRC Meeting §*
Jul. 12 - TX, Houston - HVRA Seminar*
Jul. 13 - MS, Meridian - MHR&BS Meeting §*
Jul. 14 - GA, Norcross - SARS Meeting §*
Jul. 14 - IL, Belleville - BAARC Meeting §*
Jul. 15 - CA, N. Highlands - CHRS Meeting §*
Jul. TBA - CO, Denver - CRC Picnic/Meet*
Jul. 16 - OH, Cincinnati - CARS Meeting §*
Jul. 16 - OH, Columbus - COARA Meeting §*
Jul. 19 - CA, Escondido - SCARS Meeting*
Jul. 19 - CA, Merced - CHRS Meet*
Jul. 19 - KY, Louisville - MSARC Swap Meet*
Jul. 19 - NH, Nashua - NEARC Swap Meet*
Jul. 19 - OH, Columbus - COARA Swap Meet*
Jul. 19 - TX, Irving - VRPS Meeting §*
Jul. 20 - KS, Leawood - MAARC Swap Meet*
Jul. 20 - MD, Burtonsville - MAARC Meeting §*
Jul. 20 - NM, Albuquerque - NMRCC Meeting §*
Jul. 20 - TN, Memphis - MARC Meeting*
Jul. 20 - TX, San Antonio - TARC Meeting §*
Jul. 22 - OH, Kettering - SPARK Meeting §*
Jul. 25-26 - WV, Huntington - Summer Heat*
† Jul. 26 - WA, Ellensburg - Radio Swap Meet*
Jul. 27 - BC, Richmond - CVRS/BC Meeting*
Jul. 27 - NC, TBA - AWA/Carolinas Meeting*
Jul. 27 - OH, Maineville - SPARK Open House*
Jul. 28 - AL, Birmingham - ALHRS Meeting §*
Jul. TBA - NY, Goshen - HARPS Meeting §*
Aug. 1-2 - TX, Houston - HVRA Mega Auction*
Aug. 2 - CA, Los Altos Hills - CHRS Meet*
Aug. 6-9 - IL, Elgin - ARCI Radiofest 1997*
Aug. 9 - NY, Amherst - NFWA/AWA Meet*
Aug. 9 - RI, E. Greenwich - Radio Tune-Up*
Aug. 16 - CA, Los Angeles - SCARS Meet*
Aug. 16 - OH, Dayton - ARCO 7th Show*
Aug. 16 - TX, Irving - VRPS Swap Meet*
Aug. 17 - WA, Seattle - PSARA Swap Meet*
Aug. 23 - IN, Elkhart - IHRS Summer Meet*
Aug. 23 - NH, Canterbury - NEARC BBQ Meeting*
Aug. 31 - IA, Dubuque - IARCS 4th Radiofest*
Sep. 3-6 - NY, Rochester - AWA Conference*
Sep. 6 - CA, Salinas - CHRS Meet*
Sep. 6 - MD, Baltimore - Radio Buffs Banquet*
Sep. 10 - Ontario, Ottawa - OVRC Meeting*
Sep. 13 - OR, Oregon City - NWVRS Meeting §*
Sep. 13 - RI, E. Greenwich - Yankee Steam-up*
Sep. 20 - NE, Lexington - NARCC Auction*
† Sep. 26-27 - GA, Atlanta - SARS Mega Meet*
Sep. 27 - CT, E. Hartford - Museum Swap Meet*
Oct. 4 - CA, Redding - CHRS Event*
Oct. 4 - KY, Lexington - MSARC Swap Meet*
Oct. 4 - MD, Upperco - MAARC Picnic/Meet*
Oct. 11 - CA, San Diego - SCARS Meeting*
Oct. 11 - IN, Greenfield - IHRS Fall Meet*
Oct. 17-19 - TX, Irving - VRPS/AWA '97

(Continued at top of next column)

MARK YOUR CALENDAR

(Continued from bottom left column)

Oct. 18 - CA, Fairfield - CHRS Picnic/Meet*
Oct. 18 - CA, San Diego - SCARS Swap Meet*
Oct. 18 - TN, Lebanon - MCVRPS Swap Meet*
Oct. 18 - WV, Huntington - Show/Auction*
Oct. 19 - IL, Elgin - ARCI Meeting*
Oct. 25 - NH, Nashua - NEARC Swap Meet*
Oct. 25-26 - OH, Cuyahoga Falls - BARPC Show*
Oct. 26 - UK, Exeter, Devon - NVCF Fair*
Nov. 1 - CA, Los Altos Hills - CHRS Meet*
Nov. 1 - OR, TBA - NWVRS Swap Meet §*
Nov. 1 - TX, Houston - HVRA Fall Swap Meet*
Nov. 8 - OH, Huber Heights - SPARK Meet*
† Nov. 14-15 - CA, Van Nuys - SCARS Meeting §*
Dec. 6 - TX, Houston - HVRA Party §*
Dec. 13 - OR, Oregon City - NWVRS Party §*
Dec. 14 - IL, Elgin - ARCI Auction/Meeting*

* See expanded listing this month. § Monthly Meeting
† Date changed from original announcement

GEORGIA - Jul. 14

SOUTHEASTERN ANTIQUE RADIO SOCIETY MEETING

Norcross, GA - Picadilly Cafeteria
3400 Holcomb Bridge Road

6 pm - Mini-Meet

6:30 pm - Meeting with Show & Tell

Info: Gordon Hunter - (770) 475-0713, or
SARS, PO Box 500025 - Atlanta, GA 31150

ILLINOIS - Jul. 14

BELLEVILLE AREA ANTIQUE RADIO CLUB MEETING

Belleville, IL - Belleville Area College - 7 pm

Info: Karl Stegman, 4 Cresthaven Drive
Belleville, IL 62221 - (618) 234-7992

CALIFORNIA - Jul. 15

CALIF. HISTORICAL RADIO SOCIETY SACRAMENTO CHAPTER - MEETING

N. Highlands, CA - SMUD Foothill Service
Center, Room D, corner of Elkhorn & Don Julio

7-9 pm

Info: CHRS, PO Box 162612, Sacramento,
CA 95816, or Don Steger - (916) 929-8274

COLORADO - mid-July

COLORADO RADIO COLLECTORS PICNIC AND SWAP MEET

Denver, CO - Call for date & location

11 am - Family Cookout

1 pm - Meeting, followed by Swap Meet

Info: Rick Ammon - (970) 221-4001

Submission Deadline - 5th of month.

OHIO - Jul. 16

CENTRAL OHIO ANTIQUE RADIO ASSN. MEETING

Columbus, OH - DeVry Institute of Tech.
1350 Alum Creek Rd., I-70 Exit 103B - 7:30 pm
Info: Chuck/Sue Davis - (614) 792-6237

OHIO - Jul. 19

CENTRAL OHIO ANTIQUE RADIO ASSN. SWAP MEET

Columbus, OH - DeVry Institute Parking Lot
1350 Alum Creek Rd., Exit 103B off I-70 East
7 am-Noon
Info: Chuck Davis - (614) 792-6237

OHIO - Jul. 16

CINCINNATI ANTIQUE RADIO SOCIETY MEETING

Cincinnati, OH - Provident Bank
8054 Reading Road - 7:30 pm
Info: Ted Lewis - (937) 446-3898

KANSAS - Jul. 20

MID-AMERICA ANTIQUE RADIO CLUB KANSAS CITY SWAP MEET

Leawood, KS - Leawood Park - 8 am-?
Info: Gary Watkins - (816) 322-0773

CALIFORNIA - Jul. 19

CALIF. HISTORICAL RADIO SOCIETY MEET

Merced, CA - Cliff's Radio Warehouse
Corner of 13th & X Streets - 9 am
Info: CHRS Hotline - (415) 821-9800

MARYLAND - Jul. 20

MID-ATLANTIC ANTIQUE RADIO CLUB MEETING

Burtonsville, MD - New Hope Seventh Day
Adventist Church gym - 2 pm
Info: Ed Lyon, 11301 Woodland Way
Myersville, MD 21773-9133 - (301) 293-1773

KENTUCKY - Jul. 19

MID-SOUTH ANTIQUE RADIO COLLECTORS - SUMMER MEET

Louisville, KY - Holiday Inn-Hurstbourne
I-64 & Hurstbourne Pky - (502) 426-2600
7:30 am-Noon EDT - Indoor Swap Meet
Old Equipment Contest - Lunch
12:30 pm - Auction
Info: Allan Ferris - (502) 543-8233, or
Lewis Owens - (606) 233-0376

NEW MEXICO - Jul. 20

NEW MEXICO ANTIQUE RADIO CLUB MEETING

Albuquerque, NM - Sierra Vista Bible
Church, 7509 Paseo Del Norte
1:30 pm - Tailgate Swap Meet
2 pm - Meeting: Zenith Products
Info: Bill Schultz, 7213 Donet Ct. NE
Rio Rancho, NM 87124 - (505) 867-8178

NEW HAMPSHIRE - Jul. 19

NEW ENGLAND ANTIQUE RADIO CLUB SWAP MEET

Nashua, NH - Resurrection Center
Rt. 3 (Everett Turnpike) Exit 6
1 1/2 miles West on Rt. 130, 449 Broad St.
7:30-8 am - Real Early Admission
8-9 am - Early Admission
9 am-1 pm - General Admission
Over 100 tables - 50/50 Raffle - Catered
Old Equipment Contest
Reservations required to sell
Info: Gregg Thompson, PO Box 298
Newtonville, MA 02160 - NEARC: (617) 923-2665

TENNESSEE - Jul. 20

MEMPHIS ANTIQUE RADIO CLUB/MEETING

Memphis, TN - St. Timothy United
Methodist Church, 4105 St. Elmo Ave. - 2 pm
Info: Mel Urban, 7190 Mimosa
Germantown, TN 38138 - (901) 754-6307

TEXAS - Jul. 20

TEXAS ANTIQUE RADIO CLUB NEW CLUB FORMING - MEETING

San Antonio area, TX - Shertz VFW Hall
2 pm
Info: Joe Koester, 7111 Misty Brook, San
Antonio, TX 78250-3498 - (210) 522-1662

TEXAS - Jul. 19

VINTAGE RADIO & PHONO. SOCIETY MEETING

Irving, TX - Senter East Building - 1 pm
Info: George Potter - (214) 315-2553
VRPS, PO Box 165345, Irving, TX 75016

*Attend a radio event near you,
learn, meet others in the hobby,
and perhaps find an item or
two for your collection!*

OHIO - Jul. 22

SOCIETY FOR PRESERVATION OF ANTIQUE RADIO KNOWLEDGE - MEETING

Kettering, OH - Cassano's Pizza
1680 E. Stroop Rd.

7:30 pm - Golden Age of Sound
Show & Tell: Small Radios

Info: Richard Arter - (513) 932-7721, eves.

OHIO - Jul. 27

SOCIETY FOR PRESERVATION OF ANTIQUE RADIO KNOWLEDGE OPEN HOUSE

Maineville, OH - South on Rt. 48, left at
4-way stop, left on Whalen, look for
antique antenna signs

Noon till ??

Info: Richard Arter - (513) 932-7721, eves.

W. VIRGINIA - Jul. 25-26

MUSEUM OF RADIO & TECHNOLOGY "SUMMER HEAT" RADIO CONVENTION

Huntington, WV - 1640 Florence Ave.

Jul. 25: Noon-Sundown - Trader's Market
1 pm - "How To Make the Best From
A Radio Contest" by F. Crews & G. Bourne
All Afternoon - Museum Tours

Jul. 26: All day - Trader's Market outside
10 am - Auction

6:30 pm - Museum Banquet & Awards
"Ghosts of Radio Past" play production
by James Duffield

Guest Speaker Garry Ritchie of WOWK-TV
Life of Collis P. Huntington by James Casto
The Back Yard Dixie Jazz Band

UpTowner Inns: (304) 525-7741,
mention Museum

Info: Jack Woodrum, 141 W. 9th Ave.
Huntington, WV 25701 - (304) 744-8082

ALABAMA - Jul. 28

ALABAMA HISTORICAL RADIO SOCIETY MEETING

Birmingham, AL - Homewood Public Library
1721 Oxmoor Road

7 pm

Info: Earl Ridolphi, 2413 Old Briar Trail
Birmingham, AL 35226 - (205) 823-3314

NEW YORK - Jul. TBA

HUDSON VALLEY ANTIQUE RADIO AND PHONO. SOCIETY/AWA - MEETING

For info on next meeting call:

Info: Peter DeAngelo - (914) 496-5130
HARPS, Box 207, Campbell Hall, NY 10916

WASHINGTON - Jul. 26

PUGET SOUND ANTIQUE RADIO ASSN. 2nd VINTAGE RADIO SWAP MEET

Ellensburg, WA - Washington Elementary
School, 5th and Sprague - 8 am-1 pm

Info: Gerry Scheffmaier or Carol Scott
(509) 925-1030

TEXAS - Aug. 1-2

HOUSTON VINTAGE RADIO ASSN. MEGA AUCTION

Houston, TX - Lai Lai Restaurant
Tides II Hotel, Holcombe at Main
(713) 522-2811

Info: Bill Werzner - (713) 721-2242

BRITISH COLUMBIA - Jul. 27

CANADIAN VINTAGE RADIO SOCIETY BRITISH COLUMBIA CHAPTER - MEETING

Richmond, BC - Steveston Hotel

12 Noon - Informal Swap Meet
2 pm - Meeting

Info: Fred Tutt - (604) 275-2033

CALIFORNIA - Aug. 2

CALIF. HISTORICAL RADIO SOCIETY MEET

Los Altos Hills, CA - Foothill College, Lot T
El Monte Rd. West off Hwy 280

8 am

Info: CHRIS Hotline - (415) 821-9800

CAROLINAS - Jul. 27

ANTIQUÉ WIRELESS ASSOCIATION CAROLINAS CHAPTER - MEETING

Location TBA

Info: Ron Lawrence - (704) 289-1166

A free* listing on these pages is available for each coming radio event. Sponsors should provide description of event, date, time, place, directions, & information/contact person. Since listings are on a "space available" basis, no guarantee of listing is made.

Submission Deadline - 5th of month.

*Club/museum/non-profit events are listed free; other events are obtained from advertisements placed elsewhere in A.R.C.

Enclose a SASE when requesting info.

ILLINOIS – Aug. 6-9

ANTIQUE RADIO CLUB OF ILLINOIS RADIOFEST XVI

Elgin, IL – Holiday Inn
Exit I-90 at 31 South – (847) 695-5000

Daily Events: Open-Air Flea Market all day
RCA Equipment Display – 50/50 Raffle
Refreshments & Snacks

Aug. 6: Evening Presentations –
History of Philco Radio with Ron Ramirez
History of Zenith Radio with Harold Cones

Aug. 7: Muchow Museum open
ABC's of Radio Repair with Ed Huether
Personal Collection Presentation
with Doug Houston

Awards Banquet with reenactment of
"Those Were the Days Radio Players West"
Old Radio Contest

Aug. 8: Auction with Harry Blesy

Aug. 9: Giant Donation Auction

Packing & shipping by Mail Boxes, Etc.

Info: ARCI, PO Box 1139, La Grange Park,
IL 60526 – Bob Piekarz: (708) 352-0648

OHIO – Aug. 16

ANTIQUE RADIO CLUB OF OHIO 7th ANNUAL ANTIQUE & COLLECTIBLE RADIO SHOW

Dayton, OH – Holiday Inn, Dryden Rd.
2455 Dryden Rd., I-75 Exit 50A, 1 block N

8 am-1 pm – Show/Swap Meet
1-3 pm – Auction

Raffle with 4 prizes – Door prize: *Tube Lore*

Info: Randy Frasure – (937) 253-4330, or
Karl Koogle – (937) 294-8960

NEW YORK – Sep. 3-6

ANTIQUE WIRELESS ASSOCIATION 36th HISTORICAL RADIO CONFERENCE

Rochester, NY – Thruway Marriott
Easy access from New York State Thruway
(I-90), I-390, or Rochester Airport
(716) 359-1800

Theme: Television

3-acre Flea Market – 4 Auctions
Sightseeing Excursion – Ladies' Lunch
Old Equipment Contest – Book Fair
Visits to AWA Museum

Programs:

Friday Banquet and Awards with
Special Guest Prof. Malcolm Baird

Television Lecture/Demonstration Series
Prewar Television in the Studio and Home

Key and Telegraph Seminar

Collecting Tuska Receivers

Book and Magazine Seminar

Pre-1912 Wireless and Electrical
Equipment Display

Shortwave Monitoring During World War II
Amateur Radio Fourm

Vacuum Tubes, Chapter II

Info: AWA, Box E, Breesport, NY 14816
Secretary's phone – (607) 739-5443

*[If you can go to only one meet,
make it to this one. Editor]*

NEW YORK – Aug. 9

NIAGARA FRONTIER WIRELESS ASSN. ANTIQUE WIRELESS ASSOCIATION JOINT SUMMER MEET

Amherst, NY – Amherst Museum, in Erie
County on South side of Tonawanda Creek,
Exit 49 from NY Thruway North 9 miles

8:30-11 am – Flea Market

11 am – Auction of items from
John Myers' Estate

12:30 pm+ – Museum open, w/NFWA
Display

12:30 pm – Speaker Ed Gable w/slides
on RME, his specialty

Contest with 5 Categories

Info: Larry Babcock – (716) 741-3082, or
Gary Parzy – (716) 668-2943

RHODE ISLAND – Aug. 9

NEW ENGLAND WIRELESS & STEAM MUSEUM – YANKEE RADIO TUNE-UP

E. Greenwich, RI – 1300 Frenchtown Rd.
8 am-3 pm

Flea Market Tailgating – Silent Auction
With Fidelity Amateur Radio Club, K1NQG

Info: Bob Merriam – (401) 885-0545
Fax: (401) 884-0683

GEORGIA – Sep. 26-27

SOUTHEASTERN ANTIQUE RADIO SOCIETY – FALL MEGA MEET

Atlanta, GA – Howard Johnson Midtown
(formerly Castlegate Hotel), new indoor
location, 1750 Commerce Dr. NW

SARS rates: (404) 351-6100

Sep. 26: 7 pm – Dinner

8:30 pm – Atlanta Radio Theater Players

Sep. 27: 7 am – Setup

8 am – Flea Market, all day

All day – Philco Display/Contests

Info: Larry Smith, SARS, PO Box 500025
Atlanta, GA 31150

Although non-members are welcome at all
events, joining may be required at some.
Admission is charged at some events.

N.Y. — N.J. — L.I. — CT.

**TRI-STATE ANTIQUE RADIO CLUB
NEW CLUB FORMING
Meeting 3rd Tuesdays**

Call for details: Bob Masterson, Box 172
Valley Cottage, NY 10989
(914) 353-3151

IOWA

**NEW CLUB FORMING
IOWA ANTIQUE RADIO CLUB AND
HISTORICAL SOCIETY**

Info: Gerald Lange, 2191 Graham Circle
Dubuque, IA 52002
(319) 556-3050

BUSINESS CARD ADS - \$49.00 FOR 3 MONTHS

(815) 235-8000

Specialty Batteries
& Portable Lighting



PPL
PRASSE POWER & LIGHT

1315 N. Bolton Rd.
Freeport, IL 61032

Since 1915

Play Things of Past

Sales • Service • Restoration of vintage
radios, tv's, jukeboxes and electronics.



Retail Sales Store

3552 W. 105th St
Cleveland, OH 44111
216-251-3714
Hours 8-9PM Wed, 12-6PM Sat
Other times by chance

Mail Address

Gary Schneider
Play Things of Past
9511 Sunrise Blvd., #J23
Cleveland, Ohio 44133
216-582-3094

Phone: (607) 865-7200
Fax: (607) 865-7222

E-Mail: info@audioclassics.com
www.audioclassics.com

AUDIO CLASSICS, LTD.,-

High-End & Vintage Stereo Components
Bought • Sold • Traded • Repaired • Modified

Steve Rowell
President



FREE Catalog

34 Gardner Pl.

US Post Office Bldg., POB 176
Walton, NY 13856-0176

Sam-5pm • Mon.-Fri. EST

412-837-5580

LOGANS TV-RADIO

SINCE 1952

BUY • SELL • TRADE

100's of N.O.S. PARTS AND TUBES. SCHEMATIC
SERVICE AVAILABLE. RESTORATION AVAILABLE.

REAR 526 Mt. PLEASANT ST., GREENSBURG, PA 15601

**Looking for early, portable
electronic calculators (1970-78)**
(Any that have LED or other "lighted" displays)

• Will Trade Transistor Radios (or buy outright) •
Especially: Basicorn, Berkeley/Keystone, Calfax, Columbia,
Commodore, Decimo, Educac, Garrett, Ian Jones, JCE,
Kingspoint, M.I.T.S., Monroe/Litton, Olympia, Royal,
Sanyo, Sinclair, Sperry Remington, Summit, Victor.

Buy "Mr. Calculator" Ball Fax-(714) 730-6140
14561 Livingston St., Tustin, CA 92780

**Memories on Main
Antiques**

Open everyday
Multi-dealer
Quality antiques
Early Radios



Visa/Mastercard
Main Street, Isanti, Minnesota

612-444-4488

Collector, Historian, Seeker of
Stromberg - Carlson Radio Apparatus



JOHN M. ENGLAND JR.
P.O. Box 59136
Schouburg, IL 60159
Ph (847) 883-5887

Entrepreneur: Art Moderne,
Streamline, Machine Age Design

Atlanta, GA area

ANTIQUE RADIO REPAIR

JOHN PELHAM, W1JA
1185 BEND CREEK TRAIL
SUWANEE, GA 30174
(770) 623-0533

E-MAIL: JOHN_PELHAM@MSN.COM

• Vacuum tube radios only

• Call, write or e-mail for information or to schedule a repair.

* GRUNDIG • SABA • TELEFUNKEN • NORDMENCHE • PHILIPS • SIEMENS •
- SPECIALIZING IN REPAIR OF EUROPEAN RADIO SETS -

**The Bavarian
Radio Works**



ROSS A. HOCHSTRASSER
(617) 417-4299

162 DEULAH ST.
WITMAN, MA 02382

Antique Tube Type Radios

Repairs - \$30.00 plus parts
Rebuilds - \$65.00 plus parts
Guaranteed to work well

CHUCKS

167 LYNN DR., NEW HAVEN, WV 25265
PHONE (304) 882-2220

ORDER NOW!

CHOICE OF TWO PLANS

FREE ISSUES

TV
GUIDE

SAVINGS VOUCHER

8 free issues

Order 40 issues and receive a
Total of 48 issues!

CHECK
HERE

Pay in 4 monthly installments
of just \$9.99 each.

**BEST
DEAL**

OR

4 free issues

Order 24 issues and receive a
Total of 28 issues!

CHECK
HERE

Pay in 4 monthly installments
of just \$5.89 each.

**SPECIAL
OFFER**

FREE ISSUES

TV
GUIDE

SAVINGS VOUCHER

Name _____
(please print)

Address _____

City _____ State _____ Zip _____

37578A7*B6

When term is not indicated shorter term will be served.
Your first issue will be mailed within 3-5 weeks.

RETURN THIS VOUCHER TODAY

SEND FOR YOUR SUBSCRIPTION
TODAY!

NO POSTAGE
NECESSARY
IF MAILED
IN THE
UNITED STATES



BUSINESS REPLY MAIL

FIRST CLASS MAIL PERMIT NO. 96 RADNOR, PA

POSTAGE WILL BE PAID BY ADDRESSEE



PO BOX 5550
RADNOR PA 19088-5551



BUSINESS CARD ADS - \$49.00 FOR 3 MONTHS

Antique Radios



David & Nancy Snow
P.O. Box 6352
Jackson, MI 49204
(517) 787-2985

We Buy, Sell, Repair
ARBE - III Battery Eliminators

ANTIQUE RADIO REPAIR
Repair - Restore - Buy & Sell
Schematic Service
Radios \$2.⁵⁰, TVs \$4.⁵⁰

DAMASKE ELECTRONICS
574-W16834 Janesville Road
Muskego, WI 53150
Phone: (414) 679-0838



K4GIT

1298 S.E. 5th Ave.
Melrose, FL 32666
E-mail: tubes@mindspring.com
http://www.mindspring.com/~tubes

RADIO ELECTRIC SUPPLY

We Specialize In Receiving and Special Purpose Tubes

Send For Price List

Dorothy and Don Gies Owners 352-475-1950
Phone or Fax

Are You Looking For Antique Radios, Parts, Tubes, Schematics and Restoration Services?

For Free Flyer, a 2-Stamp LSASE is required to insure a response to your request. Send to:

Olde Tyme Radio Company
2445 Lyttonsville Road, Suite 317
Silver Spring, MD 20910

Wish to contact us by phone or fax?
Our number is (301) 587-5280.
Please call 10 am to 10 pm (Local Time)

Wanted! (Top Paid)

Tube type amps by Western Electric, McIntosh, Marantz, Ampex, RCA, Langvin, etc.

Vintage speakers, units, by W.E., Tannoy, Altec, Jensen, JBL, EV, RCA, Goodman, etc.

Western Electric tubes & 6L6, 6550, 7591, KT66/77/88, etc.

David Yo, Tel: (818) 441-3942
PO Box 80371, San Marino, CA 91118-8371

1920-1970
SCHEMATICS + PAGES OF INFO
\$5.00 POSTPAID

MANUAL PRICES - SASE
RADIO/TV/HAM/MISC.

"IF I DON'T HAVE IT, YOU PROBABLY DON'T NEED IT."

ALTON H. BOWMAN - 4172 EAST AVENUE
CANANDAIGUA, NY 14424-9564

SPY EQUIPMENT WANTED!

- Code Machines
- Secret Radios
- Clandestine Weapons
- Secret Cameras
- OSS, SOE, CIA, KGB!
- I Buy or Trade!

Keith Melton

880 Jupiter Park Dr., Suite 5, Jupiter, FL 33458
(318) 747-9616 Days; Fax: (318) 747-9010



"The Home of Mr Happy Amp"

PR NOVELTY

VACUUM TUBE SPECIALISTS
Amplifier Rebuilding • Service
Surplus Parts Brokerage
(New! Old Stock and Used)

Paul Dorobalski Audio Technician
Robin Richards General Manager

PO Box 140 • Milwaukee • WI 53201
414 964 3392
414 940 8812

RADIOS & STRANGE MISCELLANEA IF YOU VISIT THE BRIMFIELD FLEA MARKET... STOP BY FIRST!



TEL: 413-245-7174

COUNTRY ROAD BARN - BERNIE SAMEK
OLD PALMER ROAD, BRIMFIELD, MASS.



ESTES AUCTIONS

Specializing in Vintage Radios

7404 Ryan Rd
Medina, Ohio 44256

Bus Phone 330-769-4992
Fax 330-769-4116
Res Phone 330-769-3987

WANTED
PRE 1900
ELECTRICITY
MEDICAL • X-RAY
TELEGRAPHY • TELEPHONE
PRE 1925
RADIO • WIRELESS
PRE 1940
TELEVISION



NEW WIRELESS PIONEERS
P.O. BOX 398
ELMA, NY 14059
716-681-3186
FAX 716-681-4540

BOOKS • TUBES • ARTIFACTS
MAGAZINES • AUTOCRAPHS
CATALOGS • EPHEMERA

REPAIRS • BUY • SELL • TRADE
PRE '65 AC SETS & CAR RADIOS

FRED'S OLD RADIO EMPORIUM
1612 WEST 7TH AVENUE
CORNICANA, TEXAS 75110

F.L. GORDON, PROPRIETOR
BUSINESS (903) 874-5185 HOME (903) 874-7147

BUSINESS CARD ADS - \$49.00 FOR 3 MONTHS



WAVES
ANTIQUES
EARLY RADIOS
&
PHONOGRAPHS
BOUGHT * SOLD
RENTALS * REPAIRS

MON-FRI 12-6
SAT-SUN 10-6

FAX 201 461-7121
e-mail: c1seve@aol.com
www.wavesradio.com

110 W 25th St., NY, NY 10001 Suite 1005 212 989-0264
PHOTOPIETS Bruce and Charlotte Mager

The Age of Broadcasting: RADIO

64-page book of letters, journals, famous broadcasts, essays, gov't. documents, etc., relating to early radio history. For ages 12 to adult.
\$5.95 plus \$2.55 S & H. MC/Visa/Check
800-729-1720. Discovery Enterprises, Ltd.
31 Laurelwood Drive, Carlisle, MA 01741



HAROLD C. BRAMSTEDT
C & N ELECTRONICS
6104 Egg Lake Road North
Hugo, MN 55038

- Buy
- Sell
- Transmitting & Industrial Tubes

612-429-9397
800-421-9397
Fax 612-429-0292



All Tube Equipment Repaired
"The Fisher Doctor"
Al Pugliese
718-948-7489
27 Daleham Street
Staten Island N.Y. 10308
VINTAGE FISHER PRODUCTS
Bought • Sold • Traded • Repaired

Two Day Antique Shop

(Fridays & Saturdays Only)
406 Calhoun Street
Johnston, SC 29832

Fred Favour
(803) 275-0202
or (803) 663-9878

**Always Over 150 Plastic & Bakelite,
30's & 40's Table Radios For Sale
In As-Found Condition.**

(No Lists)



CRYSTAL SETS

PARTS - PLANS - KITS - BOOKS
CATALOG \$2.00

Largest source of Vintage and New
Variable Air Condensers, Variometers,
Vario-Couplers, Tap Switches, Tap
Points, Galena and Germanium
Detectors, Detector Stands, Cat
Whiskers, Terminals, Sliders,
Headsets, Dial Knobs, Coil Forms,
Magnetic Wire, etc.

MIDCO
P O Box 2288
Hollywood, FL 33022
(954) 925-3670
BA Turke, Ph D E E



If you buy, sell or like jukeboxes you need
**ALWAYS JUKIN--THE MONTHLY JUKEBOX
MAGAZINE!!** Subscribers in 25 countries,
ALWAYS JUKIN LEADS THE WAY! Articles,
photos, show reports, ads, new products,
price guides, restoration tips, repairs--
everything you need to know about **JUKE-
BOXES--** the fastest appreciating collectible in
the world!!! Fun & a great investment.
Sample copy, \$3. \$33 per year.
**ALWAYS JUKIN, 221 YESLER WAY AR,
SEATTLE, WA. 98104. (206) 233-8460.**
Master/Visa ok.

PUT YOUR BUSINESS CARD HERE!

\$49 FOR 3 MONTHS - \$84 FOR 6 MONTHS
DON'T HAVE ONE? SEND AN EXTRA \$7 AND
WE WILL TYPESET ONE FOR YOU.

CAPACITORS - TUBES RADIO SERVICE ITEMS

Thousands in jam-packed illustrated
24-page catalog No. 49

**INFORMATIVE
INTERESTING
FUN-TO-READ**

Send \$3 U.S./Canada
\$5 overseas (U.S. funds)
for a Heavy-Paper limited
edition copy NOW!

DON DIERS 4276 North 50 St. Dept. ABB
Milwaukee, WI 53216-1313

Phono Needles/Style
1500 Types
Magnetic - Ceramic -
Crystal Cartridges



Rebuild Astatic
and All Types
of Crystal Cer-
amic Cartridges



West-Tech Services

648 N. Ridgewood Dr. #2
P.O. Box 1415
Sebring, FL 33871

Rebuild Obsolete Idlers
New Idlers and Belts
Fabricate 78 RPM Needles

STEVE KARPIAK C E T.
Phone (941) 471-0922

RADIO BOOKS FOR SALE

Large selection of books on Radio and Related Technology
Call or write for our List of Catalogs
Always buying, single items or collections.

RAINY DAY BOOKS

P.O. BOX 775, FITZWILLIAM NH 03447
(603)-585-3448

BUSINESS CARD ADS - \$49.00 FOR 3 MONTHS

BETA-TEK ANTIQUE RADIO SERVICE



- Repair of Radios, Communications Receivers & Test Equipment
- Power Supplies for Battery Sets

RAY BINTLIFF
2 Powder Horn Lane
Acton, MA 01720
508 263-7435

TEL: (214) 276-5458
FAX: (214) 272-1831



THE RADIO MAN

Buy-Sell-Trade
Antique Radios • Tubes • Parts

DICK MORGAN
RES: (214) 564-6464

P.O. BOX 461485
GARLAND, TX 75046-1485

784-9417

784-9417



COSMOS TV

- Low Prices
- TV Repair

Free Estimates
784-9417

- Quality Used TV's
- Antique Radio Repair
- Buy, Sell, Trade

5919 15th Ave. N.W.
Seattle, WA 98107

20 Years
Experience

Telephone/Fax
1-615-456-2529

Specializing in Antique Speaker Repair

- Very large stock of vintage parts
- Can repair most any cone-type speaker
- Field coils rewound • Fast turn-around
- Reasonable prices

Work
Guaranteed

Hank Brazel
103 N. Lake Point Ct
Crossville, TN 38555

ANTIQUE RADIO RESTORATION

Since 1936 Repair - Buy - Sell
Complete Restorations • Prompt Service

COOPER'S RADIO SERVICE

425 Court Street
Rockwell City, Iowa 50579



LARRY COOPER
712-297-7232

Old Time Replications

"TURN TO US WHEN YOU NEED KNOBS"
KNOBS • PUSHBUTTONS • ESCUTCHEONS
PLASTIC GRILLS • HANDLES

LARRY BORDONARO
5744 TOBIAS AVE VAN NUYS, CA 91411
PHONE (818) 786-2500 • FAX (818) 909-0241

VINTAGE RADIO SERVICES

Ken Hubbard
KA9WRN

Repair of
Vacuum Tube
Equipment

P.O. Box 792
Beloit, WI 53512-0792
(608) 362-1896
6 pm Evenings

Home-Auto

CANNAN & ASSOCIATES

Appraisers - Auctioneers - Liquidators

"SPECIALIZING IN ANTIQUE
ELECTRONICS"

PROTECT YOUR INVESTMENT • HAVE YOUR VALUED
COLLECTION HANDLED BY AN EXPERIENCED PROFESSIONAL

P.O. Box 28
Wise, NC 27594

PHONE/FAX
(919) 257-5688

E-MAIL AUCTIONSAM@AOL.COM



(708) 383-1640
BY APPOINTMENT

DO YOU HAVE
A PROBLEM RADIO ?

THE OLD RADIO SHOP

SERVICE OF VACUUM TUBE ELECTRONICS
SCHEMATIC DIAGRAM SERVICE
RESTORATION OR REPAIR • FREE ESTIMATES

ED HUETHER

1025 ERIE ST
OAK PARK, IL 60302

Free Estimates
Hrs - 10 AM - 7 PM EST
Tues - Sat

Tel/Fax(860) 928-2628
E-Mail radiodoc@neca.com
<http://www.neca.com/radiodoc/>



ANTIQUE RADIO RESTORATION & REPAIR

1920 - 1960's

Buy & Sell

Reasonable Rates, Tubes, Professional
Overhauls, Cabinet Refinishing Service
For All Antique Car, Table & Console
Radios, Communication Receivers &
Tube Amplifiers



BOB ESLINGER

20 Gary School Road
Pomfret Center, CT 06259

WANTED ! JAPANESE MILITARIA

any kind of WW-2 Japanese hardware - aircraft instruments
radios, optics, ammunitions etc .

Takashi Doi

Fax : 011-8145-301-8069
E-Mail : taka-doi@kk.ijfu.or.jp
1-21-4 Minamidai, Seyaku, Yokohama, 246 Japan.



WANTED: Tube Hi-Fi Components & Commercial Amplifiers of the 1950's & 1960's

Marantz, McIntosh, Scott, Fisher, Brook
Acrosound, Brociner, Western Electric
Fairchild, Altec, Tannoy, JBL

Richard Sharisky (617) 484-5784, phone
P.O. Box 521 (617) 489-6592, fax
Belmont, MA 02178

BUSINESS CARD ADS - \$49.00 FOR 3 MONTHS



TEST EQUIPMENT

BUY - SELL - TRADE
PARTS-ACCESSORIES-CABLES
MILITARY SURPLUS-ELECTRONICS
Illustrated Catalog Quarterly

Boca Electro Magnetic Lab
21218-10 St. Andrews Blvd.
Boca Raton, FL 33433
(561) 750-8911

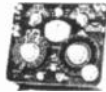

WANTED

Japanese Tubu Portable &
 Early Transistor Radio
 Unusual Shaped TV



Noriyoshi Tezuka
 1-11-2-403 Hiroo, Shibuyaku
 Tokyo 150 Japan
 Fax : 011-813-3440-8396

**78 RPM Cartridges
 Repaired**



Dead cartridges rebuilt
 right. New crystals etc., as needed. Allow 3-4 weeks. Most
 crystal and "horseshoe" magnet types \$34.50
 100 hr. sapphire setscrew needles (list \$2.50 ea.) ... 4/\$5.50



Joe Smolksi
 835-A Pleasant Street
 Framingham, MA 01701

Inquiries: (508) 879-2778,
 evenings and weekends.
 Prices include return
 postage. Please include
 payment with order.

**RADIO
 DIAL SCALES**

SEND SASE FOR LIST

ROCK-SEA ENTERPRISES **MIKE TOBIN**
 323 E. MATILIJA ST. #110-241 (805) 646-7362
 OJAI, CA 93023 RockSeaEnt@aol.com

COMMNAV BQUIP
 RADIO SETS
 NAVAL AIR FIELD
 U.S. FOREIGN

CHARLES DECCA KAI GON
 501 MYSTIC VALLEY PKWY
 MEDFORD, MASS 02155
 PHONE: 617-396-9334



MILITARY ELECTRONICS

BUY WANTED TRADE

PHILCO PREDICTAS WANTED:



BUY • SELL • TRADE • RENT • RESTORE

DAVID WEDDINGTON
 (615) 890-7498

2702 Albany Ct.
 Murfreesboro, TN 37129

"The Early Sound Man"

Mr. John P. Andolina, Jr.

Antique Phonographs



28 Glen Oaks Dr
 Rochester, NY 14624
 (716) 247-3056
 Reasonable prices

Collect - Repair - Restore
 Edison, Victor, Columbia
 Cylinder - Disc Records
 Phonograph Advertising
 Quality Repairs Since 1973



AWA
 Member

REPRODUCERS CLUB

INSTRUMENTS

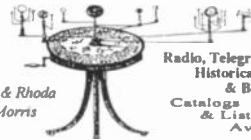

Radio, Telegraph,
 Historical Instruments,
 & Books For Sale
 Catalogs
 & Lists
 Available

Antiques of Science & Technology
 A of ST Box 1852 Wakefield Ma. 01880 U.S.A.
 Tel 617 243 2897 Fax 617 243 3572

Fender

Martin

Gibson



McIntosh

We Buy, Sell, and Trade

"PLAY IT AGAIN"

Vintage Guitars, Amps
 Stereo Equipment, Alnico Speakers,
 and Antique Radios
 Tube Equipment Our Specialty
 1-203-331-9155

PETER DeGREGORIO



Marantz

45 Moritz Pl., Fairfield, Ct. 06430-3527

Carbon Resistors • Capacitors • Vacuum Tubes

ALLTRONICS

Electronic Component Supply

2300 Zanker Road • San Jose, CA 95131
Voice (408) 943-9773 • Fax (408) 943-9776
BBS (408) 943-0622 • 24 Hrs. • N-8-1

Call or Fax for Catalog



Modern Radio Laboratories
 Since 1932

Crystal Set Instructions, Radio Parts, Supplies,
 Receiving Tubes. MRL Handbooks by Elmer G.
 Osterhoudt published by us.

Catalog \$2.00

MODERN RADIO LABS
 P.O. Box 14902
 Minneapolis, MN 55414-0902

SUNSHINE SOUNDS

WANTED:



Hi Fi TUBE & COMMERCIAL AMPS

McIntosh, Marantz, Dynaco, Heath,
 Altec, Scott, RCA, Fisher, Craftsman,
 Grommes, Fender, Ampex, W.E. Vox,
 Brook, Acro, Pultec, Fairchild

SPEAKERS & HORNS

Altec, Jensen, RCA,
 E.V., Western Electric,
 JBL, Tannoy

Phone: 405-737-3312 or Fax: 405-737-3355
 Sonny - 1413 Magnolia Ln., Midwest City, OK 73110

The Radio Collector's Directory and Price Guide, 1921-1965, 2nd Ed.

by Robert E. Grinder

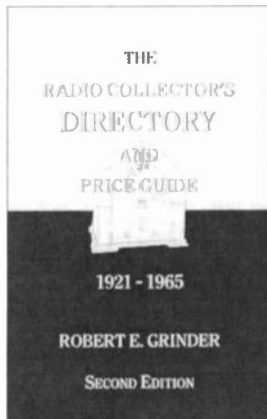

20,000+ Models Listed

U.S. models manufactured from 1921-1965.

Listing includes:

***Model Name,
Year of Production,
Type of Power,
Cabinet Style, and
Current Market Value Range.***

Rewritten Chapters On:

***Early Broadcasting,
Radio Broadcasting Regulation,
Advances Made in Receivers,
The Evolution of Radio Cabinet Styles.***

\$26.95 - Softcover

U.S. Orders - Enclose \$3.00 per order for packing & book-rate shipping if total order is under \$35.00. If using VISA or MasterCard, include name on card, card number and expiration date. Send payment with order. Mass. residents add 5% sales tax. Money back return policy. Softcover unless stated otherwise. Most orders shipped the same day received, but allow 2-4 weeks to receive order. Foreign orders - write for shipping costs, or use credit card and specify air or surface (allow 2-3 months for surface shipping).



A.R.C., P.O. Box 2, Carlisle, MA 01741. Tel: (508) 371-0512

Fax: (508) 371-7129

Web: <http://www.antiqueradio.com/>



(Oct-96)

REPRINT BOOKS ON EARLY RADIO - WIRELESS - TELEVISION TELEGRAPH - TELEPHONE

RADIO

- Harvard Radio Research Laboratory Series, *Ultra High Frequency Propagation*. Reed, Henry R. and Russell, Carl M. 1966. Boston Technical Publishing Inc. Illustrations with diagrams 5 1/2" x 8". 562 pgs.\$24.95
- Harvard Radio Research Laboratory Series, *Very High-Frequency Techniques*. 1965. Boston Technical Publishing Inc. Illustrations with diagrams 5 1/2" x 8". 1073 pgs. . \$34.95
- McNicol, D., *Radio's Conquest of Space*. 1946. A chronological treatment of the early days of radio, the scientists and their inventions. A few of the chapters: Spark Gaps & Oscillators, Wireless Spans the Atlantic, Regenerative Receivers, The Advent of Commercial Radio. 388 pgs \$31.95
- Report of the Chief Signal Officer: 1919*. A record of the telegraph, telephone and radio in WWI.\$51.95
- Schubert, Paul, *The Electric Word: The Rise of Radio*. 1928. Emphasis on economic and legal uses of radio from Marconi Maritime era and WWI to post-1920 popular use. 323 pgs. \$28.95
- Summers, H.B., ed., *Radio Censorship*. 1939. Collection of excerpts from articles & books + brief bibliography. ...\$25.95

THE FAMOUS M.I.T.

RADIATION LAB. SERIES

- #1 *Radar System Engineering*, 748 pgs \$15.95
- #2 *Radar Aids to Navigation*, 389 pgs \$15.95
- #5 *Pulse Generators*, 741 pgs \$15.95
- #7 *Klystrons and Microwave Triodes*, 533 pgs.... \$15.95
- #8 *Principles of Microwave Circuits*, 486 pgs..... \$15.95
- #9 *Microwave Transmission Circuits*, 725 pgs \$15.95
- #10 *Waveguide Handbook*, 428 pgs \$15.95
- #11 *Technique of Microwave Measurements*, 939 pgs \$15.95
- #13 *Propagation of Short Radio Waves*, 746 pgs .. \$19.95
- #15 *Crystal Rectifiers*, 457 pgs. \$15.95
- #16 *Microwave Mixers*, 381 pgs. \$15.95
- #17 *Components Handbook*, 640 pgs. \$19.95
- #18 *Vacuum Tube Amplifiers*, 761 pgs. \$19.95
- #19 *Waveforms*, 799 pgs. \$19.95
- #20 *Electronic Time Measurements*, 546 pgs. \$24.95
- #21 *Electronic Instruments*, 735 pgs. \$19.95
- #22 *Cathode Ray Tube Displays*, 764 pgs. \$19.95
- #23 *Microwave Receivers*, 618 pgs. \$15.95
- #24 *Threshold Signals*, 400 pgs. \$19.95
- #25 *Theory of Servomechanisms*, 383 pgs. \$19.95
- #27 *Computing Mechanisms & Linkages*, 371 pgs. \$19.95

TELEVISION

- Abramson, A., *Electronic Motion Pictures: A History of the Television Camera*. Mechanical TV to Zworykin to 1940's. 228 pgs. \$26.95
- Hess, G.N., *An Historical Study of the Du Mont Television Network*. 1960. Reviews the development of the Du Mont laboratories, network background, its development period, and its decline. A search for why the fourth television network failed. \$21.95

TELEGRAPH TELEPHONE

- Bennett, A.R., *The Telephone Systems of the Continent of Europe. 1895*; and Webb, Herbert Laws, *The Development of the Telephone in Europe. 1910*. In one volume - the development of European telephone networks near the turn-of-the-century plus a comparative study fifteen years later. Two vols. in one. \$40.95
- Electric Telegraph: An Historical Anthology*. The rise and progress of the electric telegraph from the late 19th century to recent times. A collection of early writings. 625 pgs. \$59.95
- Eyewitness to Early American Telegraphy*. Reprints of reports and letters of Alfred Vail from the 1830's and 40's. An invaluable primary resource. 288 pgs. \$34.84
- Kingsbury, J.E., *The Telephone and Telephone Exchanges: Their Invention and Development*. \$44.95
- Prescott, G.B., *Bells's Electric Speaking Telephone. It's Invention, Construction, Application, Modification and History*. \$42.95
- Signaling and Communicating at Sea*. A two-volume anthology of over 50 articles. Semaphores, pigeons, flashing lights, flags, radio, teletype. 2 vols., 480 & 524 pgs. \$121.90
- Smith, Willoughby, *The Rise and Extension of Submarine Telegraphy*. An engineer's and designer's autobiographical account of cable laying in the mid-1900s including the 1856-66 Great Eastern missions. 409 pgs. \$35.95

The above are quality reprints. Send for free list of over 70 reprints of books on early radio, television, broadcasting and telegraph available from A.R.C. Send payment with order. Mass. residents add 5% tax. Allow 2 to 4 weeks to receive books. Shipping and handling: add \$3.50 for first title and \$1.00 for additional titles. Foreign orders - write for shipping costs, or use credit card. Specify air or surface (allow 2-3 months for surface shipping).



A.R.C., P.O. Box 2, Carlisle, MA 01741. Tel: (508) 371-0512

Fax: (508) 371-7129

Web: <http://www.antiqueradio.com/>



(Jun-97)

CRYSTAL CLEAR

By Maurice L. Sievers

Volume 1

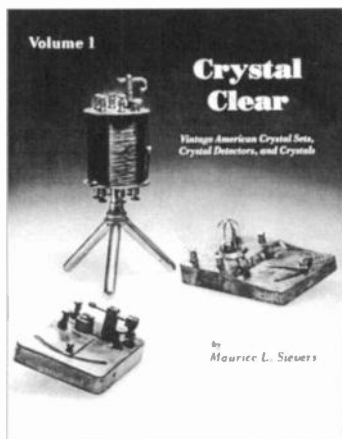

750 Illustrations – 570 Crystal Sets
341 Detectors – 207 Crystals
Perfect for the beginning collector!
Useful for the experienced too!

Crystal Clear is the most comprehensive reference for collectors, historians and anyone interested in early radio. In addition to the many excellent photos and reproductions of ads, *Crystal Clear* includes lists showing all sets by manufacturer, set name, selling price and date of manufacture. 8 1/2" x 11", 282 pages.

\$29.95 – Softcover

Volume 2

Crystal Clear, Vol. 2 supplements the first volume. It identifies an additional 172 crystal radio sets, 91 crystal detectors and 26 crystals by manufacturer, model, year produced, description and original selling price. Further research on many of the crystal sets covered in Volume 1. Detailed history on the Philmore Manufacturing Company and the Western Manufacturing Company. 8 1/2" x 11", 252 pages.

\$29.95 – Softcover

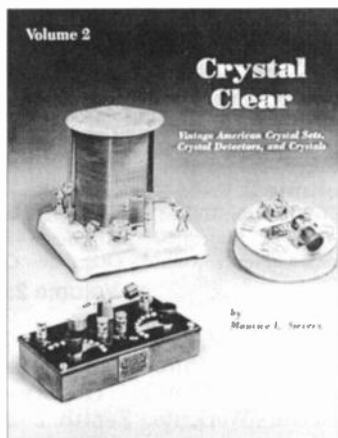

U.S. Orders - Enclose \$3.00 per order for packing & book-rate shipping if total order is under \$35.00. If using VISA or MasterCard, include name on card, card number and expiration date. Send payment with order. Mass. residents add 5% sales tax. Money back return policy. Softcover unless stated otherwise. Most orders shipped the same day received, but allow 2-4 weeks to receive order. Foreign orders - write for shipping costs, or use credit card and specify air or surface (allow 2-3 months for surface shipping).



A.R.C., P.O. Box 2, Carlisle, MA 01741. Tel: (508) 371-0512

Fax: (508) 371-7129

Web: <http://www.antiqueradio.com/>



(Oct-96)

Radio Manufacturers of the 1920's

BY ALAN DOUGLAS



"The definitive book on American broadcast receivers of the 1920s"

Volume 1: A-C Dayton - Adams Morgan - Air-Way - All-American Mohawk - American Bosch - Amrad - Amrad S-Tube - Apex - Atwater Kent - Bremer Tully - Browning-Drake - Clapp-Eastham - Crosley - Cutting & Washington - Day-Fan - DeForest - Eagle - ERLA - FADA - Federal - Ferguson. 225 Pages.

Volume 1: \$24.95 - Softcover Only

Volume 2: Freed-Eisemann - Eisemann - Freshman - Garod - Gilfillan - Grebe - Howard - Jones (Lester/Melco) - Jones (Jos.) - Kellogg - Kennedy - King - Kodel - Kolster - Leutz - Magnavox - Majestic - Marti - Metro - Klitzen/Michigan - Midwest - Mu-Rad - Murdock - Music Master - Neutrowound - Operadio - Ozarka - Pfanstiehl - Philco - Pilot - Priess. 266 Pages.

Volume 2: \$29.95 - Softcover Only

Volume 3: RCA - Scott - Silver-Marshall - Slagle - Sleeper - Sonora - Sparton - Splitdorf - Steinite - Stewart-Warner - Stromberg-Carlson - Thermodyne - R.E. Thompson - Thorola - Tri-City - C. D. Tuska - Ware - Western Coil - Western Electric - Workrite - Zenith. 292 Pages.

**Volume 3: \$29.95 - Softcover
\$39.95 - Hardcover**

U.S. Orders - Enclose \$3.00 per order for packing & book-rate shipping if total order is under \$35.00. If using VISA or MasterCard, include name on card, card number and expiration date. Send payment with order. Mass. residents add 5% sales tax. Money back return policy. Softcover unless stated otherwise. Most orders shipped the same day received, but allow 2-4 weeks to receive order. Foreign orders - write for shipping costs, or use credit card and specify air or surface (allow 2-3 months for surface shipping).



A.R.C., P.O. Box 2, Carlisle, MA 01741. Tel: (508) 371-0512

Fax: (508) 371-7129

Web: <http://www.antiqueradio.com/>



(Nov-96)

Amateur Radio Books



COMMUNICATIONS RECEIVERS



Communications Receivers 3rd Edition by Raymond S. Moore. A comprehensive guide to 732, 1932 to 1981, vacuum tube receivers by 66 manufacturers. New section on military receivers. 402 radios pictured! Sharper, clearer photographs. 8 1/2" x 11", 115 pages. Softcover. — \$19.95

Heathkit, A Guide to the Amateur Radio Products by Chuck Penson. Documentation of ALL Heathkit's amateur products. 200+ sharp photos. Most products are pictured with a full-page description. 8 1/4" x 11", 256 pgs. Softcover. — \$24.95

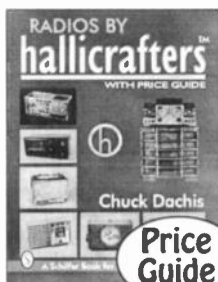

Radios by Hallicrafters by Chuck Dachis. This book includes over a thousand photographs (b/w & color) of radio receivers, transmitters, electronics accessories and advertising material. Technical descriptions are provided for every known Hallicrafters model, including dates of production, model numbers, accompanying pieces and original prices. A current price guide is included. 8 1/4" x 11", 225 pages. Softcover. — \$29.95

Ham Price Guide by Eugene Rippen. This book serves as a price guide and an identification guide. Handy index to help direct you from model numbers to the manufacturer. Small print. 8 1/2" x 11", 36 pages. Softcover. — \$9.95

Temporarily Out-of-Print

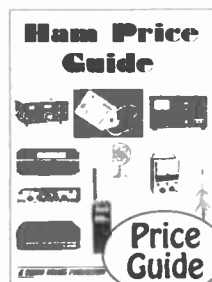

The Pocket Guide to Collins Amateur Radio Equipment 1946-1980 by Jay Miller. A pictorial guide to Collins equipment and accessories. 90+ sharp photographs. 3 1/4" x 7", 108 pages. Softcover. — \$19.95

Tube Type Transmitter Guide by Eugene Rippen. Provides a wealth of information on transmitters and transceivers. Includes ancillary items such as linear amplifiers, converters, modulators and VFOs. Over 500 illustrations. 8 1/4" x 11", 145 pages. Softcover. — \$17.95

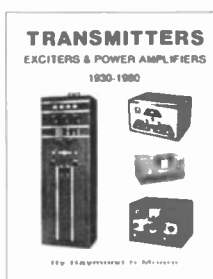

Transmitters, Exciters & Power Amplifiers 1930-1980 by Ray Moore. Pictorial and descriptive guide to amateur high frequency transmitters and amplifiers manufactured in the U.S.A. Over 500 photos. 8 1/4" x 11", 144 pages. Softcover. — \$21.95

Shortwave Receivers Past & Present Communications Receivers 1945-1998, 2nd Edition by Fred Osterman. This reference is designed for the radio collector, the informed receiver buyer or anyone interested in the history and development of shortwave radios. Over 500 receivers from 70 manufacturers. 8 1/4" x 11", 350 pages. Softcover. — \$19.95



U.S. Orders - Enclose \$3.00 per order for packing & book-rate shipping if total order is under \$35.00. If using VISA or MasterCard, include name on card, card number and expiration date. Send payment with order. Mass. residents add 5% sales tax. Money back return policy. Softcover unless stated otherwise. Most orders shipped the same day received, but allow 2-4 weeks to receive order. Foreign orders - write for shipping costs, or use credit card and specify air or surface (allow 2-3 months for surface shipping).



A.R.C., P.O. Box 2, Carlisle, MA 01741. Tel: (508) 371-0512

Fax: (508) 371-7129

Web: <http://www.antiqradio.com/>



(Jun-97)

Radios

of the Baby Boom Era

Six Volumes — 2000 pages — From Sams' Archives
 1946 to 1960 — 274 Brands — 3494 Illustrations (B&W)
 6769 Models — Catalin, Bakelite, Wood, Transistor Radios & More



All Volumes Available!

Vol.	Brands	Included
1	56	Admiral to Clearsonic
2	54	Co-op to Geloso
3	58	GE to Monitoradio
4	36	Motorola to RCA Victor
5	35	Realtone to Stratovox
6	35	Stromberg-Carlson to Zenith



1/2 Page for each illustrated radio including:

- Large illustration of the radio including knob functions
- Short description of the radio
- Number of tubes
- Power supply type (AC, Battery, etc.)
- Tuning range
- Manufacturer
- Sams Photofact Set number & year Photofact published.

ALSO

- Index by model number listing tubes in radio
- List of similar radio models indexed to pictured radio
- List of manufacturers and suppliers indicating their brand names
- Basic trouble-shooting hints

Each Volume: \$16.95 – Softcover
8 1/2" x 11" – Approx. 328 pages

U.S. Orders - Enclose \$3.00 per order for packing & book-rate shipping if total order is under \$35.00. If using VISA or MasterCard, include name on card, card number and expiration date. Send payment with order. Mass. residents add 5% sales tax. Money back return policy. Softcover unless stated otherwise. Most orders shipped the same day received, but allow 2-4 weeks to receive order. Foreign orders - write for shipping costs, or use credit card and specify air or surface (allow 2-3 months for surface shipping).



A.R.C., P.O. Box 2, Carlisle, MA 01741. Tel: (508) 371-0512

Fax: (508) 371-7129

Web: <http://www.antiquradio.com/>



(Oct-96)

Transistor Radio Books



Price
Guide

The Collector's Guide to Transistor Radios 2nd Edition by Marty & Sue Bunis. *This book will help you identify the most sought-after vintage transistor radios. Over 2,900 models listed, all with current prices. Includes radio club listing. 375 all new color photos. 5 1/2" x 8 1/4". 320 pgs. 1996.*

\$16.95 - Softcover

(1st edition still available for \$15.95)

The Portable Radio in American Life by Michael Schiffer. *Approximately 50 pages on transistor radios, beginning with the Regency TR-1 through to the later sets made overseas. 450 photographs, 193 transistor radios pictured. 8 1/2" x 11". 259 pgs.*

\$24.95 - Softcover
\$45.00 - Hardcover

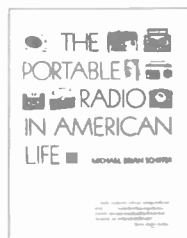

Price
Guide

Transistor Radios, A Collector's Encyclopedia and Price Guide by David Lane & Robert Lane. *Identification & price guide to over 2,500 transistor and novelty radios. History & key to collecting chapters. 8 1/2" x 11". 170 pgs.*

\$19.95 - Softcover

Collector's Guide to Novelty Radios by Marty Bunis & Robert Breed. *This book is the source for novelty transistor radios in all shapes and sizes. Radios are described in detail with current prices. Over 600 all new color photographs. 8 1/2" x 11". 224 pgs.*

\$18.95 - Softcover



Price
Guide

U.S. Orders - Enclose \$3.00 per order for packing & book-rate shipping if total order is under \$35.00. If using VISA or MasterCard, include name on card, card number and expiration date. Send payment with order. Mass. residents add 5% sales tax. Money back return policy. Softcover unless stated otherwise. Most orders shipped the same day received, but allow 2-4 weeks to receive order. Foreign orders - write for shipping costs, or use credit card and specify air or surface (allow 2-3 months for surface shipping).



A.R.C., P.O. Box 2, Carlisle, MA 01741. Tel: (508) 371-0512

Fax: (508) 371-7129

Web: <http://www.antiqueradio.com/>



(Feb-97)

COLLECTOR BOOKS AVAILABLE FROM A.R.C.

BOOKS MARKED WITH "CB" ARE THE MOST POPULAR AND ARE ESPECIALLY RECOMMENDED FOR NEW COLLECTORS!

- Antique Radio Restoration Guide, 2nd Ed., Johnson. *Beginner's introduction to troubleshooting and repairing AC table model radios.* 1992. 145 pgs. \$14.95
- The AWA Review. *Collections of articles.* Vol. 6: Hawaiian Wireless, U.K. TV, SCR-RC-BC Dir., NYC Wireless, etc. Vol. 7: Polidnu xmitters, Navy equipment, Arc xmitters, etc. Vol. 8: Keys, Federal Co., KFS-Federal-Mackay story, Nat'l Electrical Supply Co., Navy Electronics Dir., etc. Vol. 6-8, ea. \$10.00
Vol. 9: Marconi, The Int'l Contest for Radar, Magnetron Story, F. Lowenstein, Ham Licensing, Vol. 10: Atwater Kent, Race for Radiotelephone, Radio Central 75th Anniversary, The Heinz and Kaufman Story, Collins Radio Co. Vol. 9-10, ea. \$19.00
- The Antique Radio Boys and the Garrulous Grebe, Dryer. *Thrilling adventure story written in the traditions of the '20s and '30s.* 5 1/2" by 8 1/2". 51 pgs. \$4.95
- The Auto Radio, Matheson. *Info, photos & ads of the auto radio through the 1950s.* 316 pgs. (hardcover) \$34.95
- Audio! Audio!, Hill. *A comprehensive directory of classic audio amplifiers and control units. Details of over 850 models from nearly 150 British manufacturers from the 1940s to the 1970s.* Signed and numbered. 95 pgs. \$19.95
- Behind the Front Panel, Rutland. *Reviews radio circuits and radio history. Easy descriptions.* 25 pics. 158 pgs. \$18.95
- Blast from the Past, A Pictorial History of Radio's First 75 Years, Rhoades. *The performers, programs, & technology that made radio a part of everyday life. 100s of never-before-published photos* (hardcover) \$39.95
- Broadcasting's Forgotten Father: The Charles Herold Story, Adams. (Videotape, VHS). *One-hour documentary on this amazing inventor. Featuring his family, students, and photos to document his work.* \$29.95
- Classic Plastic Radios of the 1930s and 1940s - A Collector's Guide to Catalin Models, Sidell. *Info on all aspects of this popular collecting field. 200+ models from 25 companies are illustrated in full color.* 127 pgs. \$19.95
- Classic TVs, 2nd Ed., Wood. *Prevar to 1950s. Price guide. 140+ color photos, reproductions of catalogs & ads.* 86 pgs. NEW \$18.95
- CB The Collector's Guide to Antique Radios, 4th Ed., Bunis. *This guide covers radios from 1920s to 1960s. Over 8,500 prices and many all new color photos are included.* 1996. \$18.95
- The Collector's Guide to Novelty Radios, Bunis & Breed. *Descriptions with prices. 600+ color photos.* 1994. 224 pgs. \$18.95
- The Collector's Guide to Transistor Radios, 2nd Ed., Bunis. *Identifies the most sought-after vintage transistor radios. Includes club listing. Over 2,900 models, 375 all new color photos, with current prices.* 1996. 320 pgs. \$16.95
- Communication Receivers, 3rd Ed., Moore. *Information on 738, 1932 to 1981, vacuum tube receivers by 66 manufacturers. 402 radios illustrated. New section: 3 pages of military receivers.* 125 pgs. \$19.95
- The Compleat Talking Machine, 2nd Ed., Reiss. *A guide to antique phonographs. Revised and expanded. Covers construction, cleaning and repairing of parts and cabinets.* Over 700 pictures. 236 pages \$29.95
- Crystal Clear - Vintage American Crystal Sets, Crystal Detectors and Crystals, Sievers.
Vol. 1 - *Comprehensive reference with 750 illustrations, 570 crystal sets, 341 detectors, 207 crystals.* 282 pgs. \$29.95
Vol. 2 - *479 All new & different illustrations, more crystal sets, detectors and crystals identified.* 282 pgs. \$29.95
- Crystal Radio: History, Fundamentals, and Design, Kinzie. *Plus crystals for detectors.* 121 pgs. \$10.95
- Crystal Set Projects: 15 Radio Projects You Can Build, The Xtal Set Society. *Various designs and difficulty for everyone. Step-by-step instructions so you can build and design your own xtal sets no matter what your background.* 160 pgs. ... NEW \$14.95
- E.H. Scott Radio Collectors Guide, 1925-1946, Clark. *The reference for collectors of Scott radios, cabinets and accessories. Lists original prices of cabinets and accessories. Over 200 photos with descriptions.* 88 pgs. \$29.95
- Early Radio, In Marconi's Footsteps, Jensen. *Realistic description of Marconi's work and his surroundings. Early construction projects with diagrams. Color and B&W photographs.* 170 pgs. (hardcover only) \$39.95
- Evolution of the Radio, L-W Books. *Radios pictured and priced, plus reproductions of catalog pages and ads.*
Vol. 1 - *Eight-hundred + radios.* 1991. 227 pgs., 118 pgs. in color \$22.95
Vol. 2 - *Totally different from volume one with new photos, etc.* 1993. 654 color photos. 226 pgs. \$24.95
- Firco Radio Equipment, John Firth & Co., Inc. (reprint). *Twenty-six-page booklet of the Firco Co.* \$4.95
- CB Fixing Up Nice Old Radios, Romney. *Written by a retired radio instructor, this book covers Ohm's law, through battery sets, superhets and communications receivers.* 1990. 300+ figures, 185 pgs. \$29.00
- CB Flick of the Switch, McMahan. *The classic photo reference guide for '30s - '50s radios.* 1000+ photos. 263 pgs. \$11.95
- Great Radio Personalities (reprint). *B&W pics of the golden days of radio - Abbott & Costello, etc.* 128 pgs. \$12.95
- Guide to Old Radios - Pointers, Pictures & Prices, 2nd Ed., Johnson. *Introduction to radio collecting. Includes hundreds of photos and a price guide.* 1995. 272 pgs. \$19.95
- Hake's Guide to TV Collectibles. *Price guide and photos for 1600 TV shows, comic books, etc.* 1990. 185 pgs. \$14.95
- Heathkit, A Guide to the Amateur Radio Products, Penson. *Documentation of all Heathkit's amateur radio products, a complete history of the company, 200+ sharp photos.* 256 pgs. \$24.95
- International Directory of Antique Radio Collectors. *Lists collectors, clubs, museums, dealers.* 1996. 92 pgs. \$14.95
- Inventing American Broadcasting, Douglas. *A careful weaving of technology, social forces, and business decision making from the days of Marconi to broadcasting in the 1920s.* 1987. 363 pgs. \$14.95
- L. A. Radio Manufacturing, Paul. *Radio makers in L.A. from 1922-42. Echophone, Gilfillan & 10 others.* 88 pgs. \$10.50
- Supplement No. 1, Paul. *Coverage of additional manufacturers, people and sets.* 1993. 48 pgs. \$6.75
- The Magnetic Cone Speaker Notebook, Paul. *250+ cone speakers from 120+ companies. Photo copy.* 1995. 58 pgs. ... NEW \$10.90
- The Mechanics of TV, Yanczer. *Explanation of mechanical tv, details for a working system.* 5 1/2" by 7 1/2", 170 pgs. \$24.95
- Most Often Needed 1926-38 Radio Diagrams and Servicing Information (reprint). *600+ diagrams for mostly AC radios from '26-'38.* 240 pgs. \$18.50
- Old Gramophones, Bergonzi. *The development of phonographs and gramophones.* 64 photos. 32 pgs. \$4.95
- Old Radio Sets, Hill. *The development of the radio from the late Victorian era until the late 60s.* 60 photos 32 pgs. \$4.95
- Old-Time Radios! Restoration and Repair, Carr. *How to repair vacuum-tube and transistor radios. A self-paced training guide. 200 illustrations, 256 pgs.* \$19.95
- Philco Radio: 1928-1942, Ramirez. *A reference book on Philco. Shows receivers and company history year-by-year.* 464 color photos, 364 black & white photos and drawings. 1993. 160 pgs. \$29.95
- Phono-Graphics: The Visual Paraphernalia of the Talking Machine, Schwartzman. *Shows the collection of products associated with the phonograph. Beautiful photos from Art Nouveau to Art Deco era.* 1996. 119 pgs. \$16.95
- The Pocket Guide to Collins Amateur Radio Equipment 1946-1980, Miller. *A pictorial guide to Collins equipment and accessories. 90+ sharp photographs.* 3 1/2" x 7". 108 pages. \$19.95
- Portable Radio In American Life, Schuffer. *Traces the development of the portable radio and how it affected American culture and society.* 450 photos and drawings. 259 pgs. (hardcover) \$45.00 \$24.95
- Price Guide to Plastic Collectibles, McNulty. *Describes types of plastics, etc. (Radio is 8 of 207 pgs.)* \$17.95
- RCA Radiolas, Radiotrons, and Accessories (reprint). *Twenty-page booklet summarizing RCA's 1926 product line including the Radiola III, 20, 25, 26, 28, etc.* \$4.50
- Radio Art, Hawes. *A chronological, illustrated history of the technical and stylistic progress of the radio. Mostly British, but American sets are featured as well.* 250 photos, 150 in color, 128 pgs. (hardcover only) Low Price \$9.95

COLLECTOR BOOKS AVAILABLE FROM A.R.C.

BOOKS MARKED WITH "E" ARE THE MOST POPULAR AND ARE ESPECIALLY RECOMMENDED FOR NEW COLLECTORS!

- Radio Art Postcard Deck.** 30 full-color photographs from *Haves*' book. \$7.50
- Radio Collector.** (Videotape, VHS). The five-part Emmy-nominated PBS series combined on one 130-minute videotape. Meet collectors, see collections, attend swap meets, learn about radio restoration. \$29.95
- The Radio Collector's Directory and Price Guide, 1921-1965, 2nd Ed.,** Grinder. Directory of over 20,000 radios by manufacturer, model number, year, etc., with prices. Radio history, cabinet styles, vacuum tube development chapters. Over 1,200 trade names listed. Thoroughly revised and expanded. 500 pgs. \$26.95
- Radio Collector's Guide,** McMahon. Listing of 9,000+ radios made by some 1200 companies from 1921 to 1932. Gives manufacturer, year, model name and other info. No photos, 264 pgs. \$11.95
- The Radio Collector's Guide to Philco Bakelite Block Condensers, 2nd Ed.,** Bintliff. A detailed description of Philco Bakelite block condensers with illustrations and parts lists. 1995. 57 pgs. \$9.95
- Radio Craft - 50 Years of Radio** (reprint). March 1938 issue of *Radio Craft* magazine. Numerous articles on the development of radio, then 50-years old, and on early radio pioneers. 144 pgs. \$15.95
- Radio Diagram Sourcebook,** Gray. Valuable tool for identifying radios. Tubes used, replacement dial lamps, and I.F. frequency. Reprint of *Sylvania's tube complement guide* is included listing almost 10,000 radios. 290 pgs. NEW \$18.95
- Radio Horn Speaker Encyclopedia,** Paul. Listing of horn speakers for 320+ manufacturers for the 1920s. Expanded info. on 10 companies. 145+ photos, 80 pgs. \$14.90
- Radio Horn Speaker Notebook, Rev. H. Paul.** The companion to the Encyclopedia. Over 450 horn picture ads are shown, over 325 manufacturers are identified. Photocopy. New Index. 1995. 72 pgs. \$15.90
- Radio Manufacturers of the 1920's,** Douglas. Three comprehensive volumes.
- Vol. 1 covers A-C Dayton thru Ferguson (softcover only) \$24.95
- Vol. 2 covers Freed-Eisemann thru Pries 266 pgs. (softcover only) \$29.95
- Vol. 3 covers RCA thru Zenith. 292 pgs. (hardcover: \$39.95) \$29.95
- Radio Redux,** Collins. Subtitled "Listening in Style." This book showcases the sleek lines and luscious colors of over 80 gleaming sets from the collection of Philip Collins. 120 pgs. (hardcover: \$29.95) \$17.95
- Radio!** Radio!, 3rd Ed., Hill. Comprehensive coverage of British radios from the 1920s-70s. This expanded edition includes the previous versions plus 75 new pages and 50 new illustrations. New transistor radio section. (hardcover only) NEW \$64.95
- Radio/TV Finder,** Okolowicz. Reference to nearly 7,000 radio and TV pics found in 24 books. No photos, 110 pgs. \$13.95
- Radio & T.V. Collector's Guide Book, Biraud.** The "Vintage Radio" illustrated guide to European sets from early wireless to the 1930s (a few later). Text is in both French and English. Vol. 1: History & Manufacturers A to P. 256 pgs. Vol. 2: P to Z & T.V. Speakers, Tubes, Loops, Parts & Novelties. 256 pgs. (Per Volume) \$49.95
- Radios by Hallicrafters,** Dachis. The most definitive book on the company. Over 600 photos (some color) on everything they made. An invaluable tool for anyone interested in Hallicrafters. 220 pgs. \$29.95
- Radios of the Baby Boom Era.** Pictures and info from Sams Photofacts. 3,494 radios illustrated plus 3,275 additional radios listed. 274 brands. 1946 thru 1960. Six volumes, 300+ pages per volume. Order by volume: Vol. 1: Admiral - Clearsonic. Vol. 2: Co-op - Gelsco. Vol. 3: GE - Monitorradio. Vol. 4: Motorola - RCA. Vol. 5: Realtone - Stratovox. Vol. 6: Stromberg-Carlson - Zenith. (Per Volume) \$16.95
- Refinishing Old Furniture, Wagoner.** Written by a furniture restoration instructor. A step-by-step guide to furniture (or radio) restoration, from removal of finishes right up to the final polish. 178 pgs. \$14.95
- Saga of the Vacuum Tube,** Tyne. The development of vacuum tubes - 1880 to 1930. From Edison, Thomson and Fleming to de Forest, Phillips, Siemens and many more. 100+ tube photos, 495 pgs. \$18.95
- Shortwave Receivers Past & Present, Communications Receivers 1945-1996, 2nd Ed.,** Osterman. For the radio collector, the informed receiver buyer or anyone interested in the history of shortwave radios. 500+ receivers listed. 350 pgs. NEW \$19.95
- Sound & Vision Yearbook 1995/96.** An annual directory of radio & TV collectors, primarily European. \$6.95
- S. Gernsback Radio Encyclopedia** (reprint). 1927 classic encyclopedia on radio. From "A" B'2yery to Zirconium, with 1000s of entries in between. 100s of illustrations, 175 pgs. \$9.95
- 70 Years of Radio Tubes and Valves,** Stokes. The story of the radio tube from the lab to the public. 247 pgs. \$25.95
- 75 Years of WE Tube Manufacturing,** Magers. A log book history 750+ WE tubes. Illustrated. 133 pgs. \$16.95
- Tomart's Price Guide to Radio Premium and Cereal Box Collectibles,** Tumbusch. Includes comic character, pulp hero, TV and other premiums. 1991, 3,000+ illustrations, 176 pgs. \$22.95
- Transistor Radios, A Collector's Encyclopedia and Price Guide,** Lane. Identification guide to over 2,500 transistor and novelty radios. History and key to collecting chapters. 1994. 170 pgs. \$19.95
- Transmitters, Exciters and Power Amplifiers 1930 - 1980,** Moore. Pictorial and descriptive guide to amateur high frequency transmitters and amplifiers manufactured in the U.S.A. Over 500 photos. 144 pgs. \$21.95
- Tube Lore,** Sibley. Trends in tube design, receiving and audio tubes, special-purpose and transmitting tubes, military types, tips on testing, repairing, adapting various tubes, auction prices from six major sales. 186 pgs. NEW \$19.95
- Tube Type Transmitters,** Rippen. Provides a wealth of information on transmitters and transceivers. Includes ancillary items such as linear amplifiers, converters, modulators and VFOs. Over 500 illustrations. 145 pgs. \$17.95
- The Weekend Refinisher,** Johnson. A complete guide to stains and finishes and tips for setting up your own workshop. A handy furniture "first aid" kit for quick repairs. Illustrated. 296 pgs. \$12.00
- Westinghouse Catalog** (reprint). 1920s catalog of the RA-DA and other early Westinghouse equipment. 8 pgs. \$4.00
- Wireless Communication in the U.S.,** Mayes. Early development of American radio operating companies. Alternators, coherers, stock promotions, unpublished letters, etc. 160 illustrations, 240 pgs. \$29.95
- The Xtal Set Society Newsletter,** Anderson. Complete set of the Society's newsletter. Order by volume. Vol. 1: 7/91 to 5/92 - Field Strength Meter, FM Xtal Set, Xtal Sets & Wireless, & more. Vol. 2: 7/92 to 5/93 - The Lead Pencil Detector, The Universal Xtal Set, etc. Vol. 4: 1/94 to 11/94 - Measuring Coil Capacitance, home-brew headphones and curvo tracers, etc. Vol. 5: AM Receiver Design, Marconi Type 107, Radio Outfit in a Headset, & more. (Per Vol.) \$9.95
- The Xtal Set Handbook,** Anderson. Formulas for coil inductance, a procedure for measuring coil capacitance, circuit matching theory, & more. Also included is Vol. 3 of the Xtal Set Society Newsletter. \$10.95
- Zenith Radio Corporation** (reprint). The instructions for installation and operation for Models 39-39A Models 392-392A, and Electric Zenith Receivers. 3 schematics, 3 photos, 7 1/2" by 5", 16 pgs. \$4.50
- The Zenith Trans-Oceanic: The Royalty of Radios,** Bryant and Cones. Presents the fascinating story of the development and use of the Trans-Oceanic. Several photos, documents, ads, etc. 160 pgs. \$24.95

U.S. Orders - Enclose \$3.00 per order for packing & book-rate shipping if total order is under \$35.00. If using VISA or MasterCard, include name on card, card number and expiration date. Send payment with order. Mass. residents add 5% sales tax. Money back return policy. Softcover unless stated otherwise. Most orders shipped the same day received, but allow 2-4 weeks to receive order. Foreign orders - write for shipping costs, or use credit card and specify air or surface (allow 2-3 months for surface shipping).



A.R.C., P.O. Box 2, Carlisle, MA 01741. Tel: (508) 371-0512
Fax: (508) 371-7129

Web: <http://www.antiqueradio.com/>



(Jul-97)

Vintage TVs and radios

HARRY POSTER

Stereo 3D & quality cameras

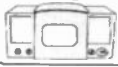

PO Box 1883 S.Hackensack, NJ 07606

hposter@worldnet.att.net

24 Hr FAX:(201)794-9553

24 Hr Phone:(201)794-9606

PLEASE SEE OUR TEMPORARY HOMEPAGE AT:

WWW.HARRYPOSTER.COM

Cowboy Radiol

Anna says
SELL IT!



This is the Silvertone Model #4, a black plastic set with a cowboy on horse, his lasso spelling the Silvertone logo, and a 6-shooter on the tuning knob! Really nice except some minor warping on top and the logo has worn a bit. **A great find..\$465**

FOR SALE: RCA 28T. This 1940 3-band, 6 pushbutton set is a huge wooden table top about 12" high and 18" wide, from the time of the pre-war TVs. It is marked to be used with the TT5 and FM adapters. An 8-tube radio with a pair of 6K6-GT's in the output, it lights up but there's no sound..\$57

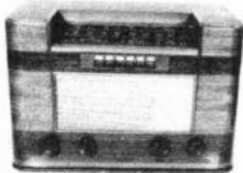

FOR SALE: Radio Dial Belt Display Box.

A black painted metal box-some wear but not too bad-with over 100 packaged belts, plus a second worn box with another dozen belts, a 60 page guide, and belt measurer. We've seen the belts sell for \$2 each at the meets. The lot of..100+ belts...\$71



FOR SALE: "RCA TUBES" topper. This is the red and yellow screened metal counter sign which would top a display of RCA tubes, probably from the 1930s or 1940s. Good condition and only \$69

FOR SALE: Philco Mystery Box! What is it? It's no mystery-it's a 1930s wooden remote control. The top holds an early plastic telephone dial which turns a magnetic vane inside the box. In nice condition it's priced at..\$68



WANTED: Zenith Radio Nurse

This is just a brown bakelite intercom but it has an unusual look! We buy these in any condition, and if it's mint, uncracked, we pay \$450

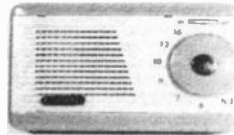

FOR SALE: Global 4 tube Japanese pocket radio in translucent green-blue, with bright blue knobs and a reverse painted off-white face..\$94



FOR SALE: Zenith Royal 675 & Royal 755.

The Royal 675 is a leather covered portable with chrome front. Has 6 plug-in oval transistors. It's missing a snap, and the handle is split...\$33

The Royal 755 is slightly larger. Has 8 plug-in tubular transistors. (Both have CD marks) ..\$46

FOR SALE: Nova Tech Pilot II Model RDF-404.

Has 12 transistors and 4 bands (Beacon, broadcast, Marine and VHF), direction finding antenna, and DF-level meter on front. Exc...\$49



FOR SALE: Philco Model 51-932.

This is an unusual brown bakelite 6-tube radio which has a large plexi-glass dial on the top with brass trim. The tubes light up but there is no sound. Price-\$78

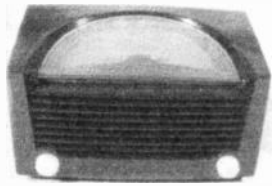

WANTED: Panasonic Flying Saucer.

Model TR-001, this is a small 1970's oval TV in grey plastic, on a chrome tripod. It's only about 10" tall and we will buy these in any condition (we need parts)! If yours is mint, and unchipped, we're paying \$350 each!

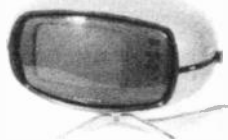

CLASSIFIED ADVERTISING POLICY

ONE FREE 20-WORD AD for subscribers in each issue; additional words are 27¢ each. See details below. Classified ads sent by mail, fax or by any other method must be received (not just postmarked!) by Noon Eastern Time on the classified ad deadline date to guarantee inclusion in the current issue. Late ads are held for the following issue. Please enclose correct payment with all ads. Stamps or cash are OK for small amounts. (Canadian and other foreign advertisers, please see "Payment" on page 2 for methods.) "Free words" cannot be accumulated from month to month; free words must be requested when ad is submitted.

Faxed & e-mailed ads: Please see additional information on the inside front cover.

When including ads with other A.R.C. correspondence, write the ads on a separate piece of paper. Include SUB# with ad. Ads may be sent in advance; but, write each ad on a separate piece of paper and indicate the month (or successive two months) you want the ad to run

To minimize our typing errors: Please write legibly. Use both capital and small letters. Do not use a dash between words. Carefully write the following numbers and letters (especially in model numbers) since some can look alike; for example 1, l and I (the number one, the capital i and the small L.) Also: 0, O, o, Q and D; r and n; 6, b and G; V, U, u, v and Y; A and R; 5, S and s; 2, Z and z. We try to correct spelling errors, so when using an uncommon word or manufacturer which we might mistake as a more common word or manufacturer, note it so that we do not "correct" it. Editor's annotations are in [brackets].

Advertising is accepted only for early items related to radio, communication, etc. All items must be described briefly; reproductions, reprints and not-original items must be so identified. Advertisers must agree to respond promptly to inquiries and orders, to resolve problems promptly if the buyer is not satisfied, and to comply with a buyer's refund request on unaltered returned items.

The publisher reserves the right to edit ads without notification to the advertiser and to reject ads for any reason. Names other than the advertiser will be edited out of ads. Ads with non-radio-related items will be returned or edited unless the non-radio-related items are for trade of radio-related items, or they are incidental to and appear at the end of an otherwise acceptable ad. The publisher is not responsible for errors due to illegibly written ads or for any other reason.

Clubs: Since club activities receive free coverage on the *Coming Radio Events* pages, the free 20 words may not be used for club activity ads. See inside front cover for additional information.

CLASSIFIED AD DETAILS

Deadline: NOON ET- 10th of the month!

Classified ads must have a standard heading such as **WANTED, FOR SALE, FOR TRADE, FOR SALE/TRADE, SERVICES, MESSAGE, HELP, AUCTION, MEET**, etc. This heading is the only bold or all-capitalized words allowed in the ad. Capitalize only manufacturer names, model names, etc. This standard ad format makes scanning the ads easier.

Before writing your ad, please look over the ads in a recent issue of A.R.C., and try to write your ad in the same style. Full name (or company name) and address is required in all classified ads; we will add it if you forget.

To encourage varied content of the ads, the same classified ad may be run only once per issue and for only two consecutive months. (To run an ad longer, use a boxed classified or display ad.)

Classified Ad Rates per Month

Subscribers:

- First 20 words: **FREE***
- 27¢ per word for extra words over 20 plus
- 10¢ per word for a shaded ad (count all words including free words).
- * Subscribers may take 20 free words on only one ad each month.

Non-Subscribers:

- 45¢ per word plus
- 10¢ per word for shaded ad.

Please do not forget to send in the extra 27¢ per word when your classified ad runs over the free 20 words; your payment will be appreciated, and it will help to keep A.R.C. healthy.

BOXED CLASSIFIED AD DETAILS

Deadline: 1st of the month!

Boxed classified ads can run unchanged for three months or more. No words are free. Ads may be shaded and may include bold and all-capitalized words freely. The ad need not begin with "For Sale," etc. Minimum run is 3 months, prepaid. Discount: 10% for 6 months; 20% for 12 months.

Boxed Classified Ad Rates per Month

Nonshaded ads:

- 38¢ per word for all words,* none free, plus
 - 10¢ per word for each bold word plus
 - 10¢ per word for each all-caps word.
- Shaded Ads (All words are bold at no charge):
- 48¢ per word for all words* plus
 - 10¢ per word for each all-caps word.

Non-Subscribers:

- Add 20¢ per word to above costs.
- *Three words can be bold-all-caps at no extra charge.

PHOTO & DRAWING DETAILS

**Deadline: 1st of the month
for all ads with drawings or photos!**

Drawings and photos are encouraged as the response to your ad is much larger and the reader knows better what you want or are selling. Send in your drawing or photograph, and A.R.C. will reduce it or enlarge it as needed.

Photo and Drawing Rates per Month

\$22.00 per month for each photo or drawing (If ad is canceled, this amount cannot always be refunded.)

CHANGES & CANCELLATIONS

Please check your ads carefully before sending them in. Once ads are received, it is not always possible to refund the amount sent, pull the ad or make changes.

IMPORTANT — COUNTING WORDS — IMPORTANT

The standard headings: **WANTED, FOR SALE**, etc., count as one word each time used in an ad. Name, address and (one) telephone number, count as 6 words, regardless of length. Ham call letters and business name can be included in the 6 words and do not count extra. Full name (or company name) and address is required in all classified ads. Each additional word, abbreviation, model number or number group, extra telephone numbers, fax, e-mail, etc. count as one word each. Hyphenated words count as two words.

PERIODICALS



A.R.C., P.O. Box 2, CARLISLE, MA 01741

RETURN POSTAGE GUARANTEED

**CLASSIFIED AD
DEADLINE JULY 10th
Noon Eastern Time**