



VOLUME 13

FEBRUARY 1996

NUMBER 2

THE NEW WAVE COMMUNICATIONS RECEIVERS



HEATHKIT'S "MOHAWK"

A.R.C. — THE NATIONAL PUBLICATION FOR BUYERS AND SELLERS
OF OLD RADIOS AND RELATED ITEMS — PUBLISHED MONTHLY

ANTIQUE RADIO CLASSIFIED

Antique Radio Classified (ISSN:8750-7471) is published monthly, 12 times per year, by John V. Terrey, One River Road, P.O. Box 2, Carlisle, MA 01741. Second-class postage paid at Carlisle, MA, and additional mailing offices. Telephone: (508) 371-0512, 8:30 AM to 6:00 PM ET weekdays; machine answers phone at other times.

Annual subscription rates within the U.S. are \$36.95 by Second Class mail and \$53.95 by First Class mail.

Annual foreign rates. By air: Canada - \$58.00; Mexico - \$64.00; Other foreign countries - \$100.00. Surface mail: Canada - \$47.00; Other foreign countries - \$52.00. (Surface delivery to countries other than Canada may take two or more months and cannot be guaranteed.)

Two-year subscriptions are twice these rates and receive an extra month. Sample issues are available free on request.

© Copyright 1996 by John V. Terrey.

POSTMASTER: Send address changes to Antique Radio Classified, P.O. Box 2, Carlisle, MA 01741.

Printed in U.S.A.

STAFF:

Publisher and Editor: John V. Terrey
Production Manager: Scott J. Young
Office Manager: Lisa A. Friedrichs
Advertising Manager: Cindie P. Bryan
Managing Editor: Dorothy Scheer
Radio Events Editor: Chris Frederickson
Publishing & Editorial Staff: Ray Bintliff, Dave Crocker, Dick Desjarlais, Bobby Lyman, Jean Meldonian
Founding Publisher/Editor: Gary B. Schneider
Contributing Writers: Mike Adams, Richard L. Arnold, Ray Bintliff, Ron Boucher, Paul J. Bourbin, Norman S. Braithwaite, Dave Crocker, Alan S. Douglas, Richard C. Foster, Fred Geer, Jim Kreuzer, Ron Ramirez, Henry Rogers, Ian L. Sanders, Gary B. Schneider, Daniel Schoo, Dwane Stevens, Frank R. White, Ralph Williams

PURPOSE. Antique Radio Classified is published for people involved in the radio collecting hobby. Its purpose is to stimulate growth of the hobby through the buying, selling and trading of radios and related items, and to provide a monthly forum for the interchange of ideas and information.

CONTACTING ANTIQUE RADIO CLASSIFIED. All correspondence should be sent to:

A.R.C., P.O. Box 2, Carlisle, MA 01741.

Only UPS, Federal, etc. items to street address: One River Road.

Telephone: (508) 371-0512; Fax: (508) 371-7129

E-mail: ARCMagazine@aol.com — Web: www.antiqueradio.com
 Please, no classified ads by telephone; thanks.

Your ads, renewals, letters, etc. can be handled faster and more efficiently if your name, address and SUB# are written on each.

Unfortunately, A.R.C. is not staffed to answer letters with questions about antique radios or requests for advice. However, A.R.C. does solicit letters of interest to its readers and publishes them as space permits. A.R.C. assumes that permission is given to edit and to publish all correspondence and articles received unless otherwise indicated.

GUARANTEE. You may cancel your subscription at any time and receive a pro rata refund for issues not yet mailed. If errors to ads are made by A.R.C., upon request a free correction will be run in the next available issue.

PAYMENT. Please send in full payment with your order or ad. A.R.C. does not carry accounts; all subscriptions, ads, etc. must be prepaid (except for the 6 and 12 month display ads indicated below). Pay in U.S. funds. Checks drawn on a U.S. bank, money orders, VISA or MasterCard (\$10.00 min.) are preferred. Make check out to "A.R.C." U.S. stamps or cash are OK for small amounts. Canadian payers may send a Canadian check but specify U.S. funds. Subscriptions will be prorated to amount sent if amount is incorrect.

FAX & E-MAIL PROCEDURES/PAYMENT. Subscriptions, book orders, classified ads, display ads, etc. are welcome by fax or e-mail. Deadlines are the same as for ads received by mail. Please calculate the amount due. Payment by VISA or MasterCard is preferred if your order is over \$10. If under \$10, or if you prefer to send a check or money order, state the amount being sent and that the payment is in the mail. Do not send another copy of your ad with your payment; simply indicate that it is a fax or e-mail payment. If you want confirmation of our receipt of your fax, call immediately after sending your fax.

CHANGE OF ADDRESS. Please notify us 4 weeks in advance of a change of address. Send both your new and old addresses, and include your SUB# and effective date of your new address. Temporary address changes can be made also.

SUBMISSION OF MATERIAL. Antique Radio Classified welcomes and solicits information that pertains or relates to radio history or collecting. This may include articles, book reviews, photos, information on upcoming radio events, meetings, antique radio organizations, radio auctions, sources of old radio and restoration supplies, and other related and interesting material. All material submitted should be carefully researched, typed and accompanied by good photos, if appropriate. Computer disks are appreciated. Writing guidelines are available upon request. Unless prior arrangements are made, all submitted materials may be edited, become the property of Antique Radio Classified and will not be returned. Publication is subject to approval by A.R.C. and to time and space constraints.

MAILING OF ISSUES. U.S. subscribers can receive A.R.C. by First or Second Class mail (Second Class is the way most magazines are mailed). The mailing of First Class copies is staggered over one to four days with faraway copies mailed before local copies. Non-U.S. copies are mailed on the first day. Second Class copies are mailed on the last day. Mailing dates change each month, but mailing is usually completed by the 27th of the month. First Class copies usually are received by the 5th of the month; copies by Second Class mail, by the 10th.

ETHICS. No person involved in the production of A.R.C. is to act on any information in the magazine until the first delivery day after information is mailed.

DISCLAIMER. The publisher is not responsible for any buying and selling transactions incurred, or for any other use of the contents of this publication.

Antique Radio Classified subscription rates, frequency of publication, content, policies, size and ad details, and rates are subject to change at any time by A.R.C.

DISPLAY AND BUSINESS CARD ADS - DETAILS AND RATES

The deadline is the first of the month for display and business card ad artwork, payment and repeat requests.

Advertising is accepted only for early items related to radio, communication, etc. All items must be described fairly; reproductions, reprints and not-original items must be so identified. Advertisers must agree to respond promptly to inquiries and orders, to resolve problems promptly if the buyer is not satisfied, and to comply with a buyer's refund request on unaltered returned items.

Advertising must be prepaid, except as noted below; see "Payment" paragraph above for details. Late ads will be run only if space and time permit. Since artwork is reduced to 63% in the printing process, originals must be the artwork size listed below. Do not send in artwork on art board or send negatives. Ads should be typeset or typed neatly with a carbon ribbon, black ink (not pencil) on white. If used, reverse type must be limited to 25% of the ad. If you want us to prepare your ad, include the one-time cost below for A.R.C. to make up the ad.

Photos should be at an 85-line screen; otherwise, add \$14.00 per photo for screening. Do not cut or trim photos or glue photos to artwork; submit separately.

If you are confused by these requirements and terms, please

contact A.R.C. before beginning to prepare your ad. We will be happy to advise you on your ad ideas, estimate how much the ad will cost, recommend an ad size, etc.

We assume that advertisers want all ads which are submitted to run without delay; therefore, we will run the ad and bill for any additional work required for the ad to meet these specifications. A late ad will run beginning with the next month. "Tear sheets" will be sent only for 1/8th-page or larger ads and only if requested when the ad is submitted.

First business card per advertiser is at lower rate.

The 3-month rates represent about an 11% discount, the 6-month rates 23%, the 12-month rates 30%. Placement requests: add 15% but call first. Clubs: write for discount policy.

Page	ARTWORK SIZE (SEND IN THIS SIZE)		As Printed (size in magazine)		Cost for 1-month	Cost for 3-months	Cost for 6-months	Cost for 12-months	One Time to make up Ad
	H x W (inches)	H x W (inches)	H x W (inches)	H x W (inches)					
Full	12 7/16 x 7 1/2	7 3/4 x 4 3/4	\$249.00	\$664.00	\$1149.00*	\$1999.00**	\$69.00†		
1/2 H	5 1/4 x 7 1/2	3 5/16 x 4 3/4	\$126.00	\$336.00	\$582.00	\$1013.00**	\$35.00†		
1/2 V	12 7/16 x 3 9/16	7 3/4 x 2 1/4	64.00	170.00	295.00	514.00	18.00†		
1/4	5 1/4 x 3 9/16	3 5/16 x 2 1/4	33.00	88.00	152.00	265.00	8.50†		
1/8	2 5/8 x 3 9/16	1 5/8 x 2 1/4	not avail.	45.00	78.00	136.00	6.50†		
Business Card (1st)	2 x 3 3/4	1 1/4 x 2 3/8	not avail.	59.00	102.00	177.00	6.50†		
Business Card (2nd...)	2 x 3 3/4	1 1/4 x 2 3/8							

* Full page, 6-mos.; 1/2 due with order; 1/2 due in 3 mos. ** Full & 1/2 page, 12-mos.; 1/4 due with order; 1/4 due at 3, 6 & 9 mos.

† For 6 and 12 month ads, no ad make-up charge if no change is made to ad for entire run.



ANTIQUE RADIO CLASSIFIED

EDITOR'S COMMENTS

We're often asked which comes first — the article or the cover photo? Answer: sometimes one, sometimes the other. Whether the choice is by accident, inspiration, deliberate plan, bolt of lightning — the result makes the editorial process more interesting.

This month's lead article by Wayne Childress on communications receivers came first; however, it didn't take long to connect it to A.R.C. staff member Ray Bintliff's review of Chuck Penson's book on Heathkit with its excellent photos — thus, a cover!

This combination of two articles and the cover accents three aspects of collecting under-represented in the pages of A.R.C. — amateur radio, communications receivers, and the collecting and building of kit equipment. Heathkit perpetuated all three of these until the company decided to drop out of the kit business only a few years ago. (See A.R.C., Dec. 1993.) That decision brought an end to an era — a time when America's dining room tables were often littered with Dad's latest kit-building project.

Communications receivers are championed in the Childress article, in which he describes the attraction of these metal boxes. He also offers tips to buyers on identifying the hidden problems that this equipment often acquires after modifications by previous owners.

Dave Crocker, another A.R.C. staff member, describes an unusual cone speaker made in the late 1920s by the Symphonic Sales Corporation. The details of how a cone speaker is incorporated into a world globe are fascinating.

We include a report on the Vintage Radio and Phonograph Society/Antique Wireless Association October convention near Dallas, Texas. More than 800 lots brought over \$48,000 at the auction. Hats are off to George and Michael Potter for their tabulation of the results. I attended the auction and observed that the Potters examined each item as it came off the auction block and meticulously recorded the model numbers and conditions.

The Smith Auction Company in Pennsylvania, now holding regular radio auctions, reports on its November auction where over 300 radio items were sold. The high bid at the auction, which included high-fidelity and test equipment as well as radios, was a Bunnell galvanometer selling for \$4,100.

Chester Gehman sent in a description of his efforts to determine the function of a Philco circuit, which includes a third winding on an IF transformer. Chester was unable to resolve the mystery and

invites A.R.C. readers to help out.

We continue to receive numerous approaches to solid-state tube replacement, but the one presented this month is unique — a substitute that glows. Gary Strelow's replacement device uses a lamp in place of the tube filament, and the light from the lamp controls the gain of the transistor. In fact, the filament rheostat functions nearly the same as when real tubes are used in the radio.

A very useful update to a classic — *Grinder's The Radio Collector's Directory and Price Guide* — is reviewed in this issue by Ed Taylor. The first edition of this book, published nine years ago, was one of the first price guides for collectors.

Several unusual sets are featured in this month's *Photo Review* — a Scyrad crystal set from 1922, another early 1920s set by F.M. Doolittle of New Haven, Conn., and an Emerson 5-tube radio in a black lacquered case painted with an oriental scene. *Radio Miscellanea* includes feedback from readers on our recent advertising price increases.

A.R.C. on the Web. We continue to receive kudos on our World Wide Web site. Although we do not make ads available there, we do post highlights from each issue including the full radio event calendar. Visit our site at <http://www.antiqueradio.com/>.

Coming Radio Events. Forty radio events across the U.S. entice the collector during the month of February. A 4-day event of note is the Spring Extravaganza held by the Music City Vintage Radio and Phonograph Society, at Opryland Hotel in Nashville, Tenn., from February 28 to March 2. On the previous Sunday, February 25, Radio XXVII will be held by the Greater Boston Antique Radio Collectors (GBARC) at the Westford Regency hotel, just off I-495. Last year's event drew over 600 attendees and 90 seller tables. A visit to the A.R.C. editor's collection is a feature of this event. A.R.C. manages Radio XXVII for GBARC, so we issue a special invitation to all of our readers to attend the show.

Happy Collecting

John V. Terrey, Editor

ON THE COVER

Our cover photo, provided by Chuck Penson, is from his excellent book *Heathkit, A Guide to the Amateur Radio Products*, which is reviewed in this issue. On page 167, Chuck tells us that the RX-1 "Mohawk", one of the earliest kit-form communications receivers on the market, was Heath's first "ham band only" receiver. It was also one of the first sets produced in the green color that became a Heathkit trademark. Designed with 15 tubes, this 52-pound unit will receive upper and lower sideband as well as AM and CW. It covers 160 to 10 meters and has a separate band position and dial markings for 6- and 2-meter coverage (with optional converters).

OOPS!

In the November 1995 report on the AWA conference, the upper right photo on page 17 showed another view of the Federal amplifier, not the crystal set as the caption stated.

COMMUNICATIONS RECEIVERS

Communications Collecting – The New Wave

BY WAYNE CHILDRESS

In this article Wayne Childress brings to light an aspect of collecting not often addressed — communications equipment and the “communication gap” between collectors of such and collectors of home radios. He explains what the communications equipment collector is looking for and why he views these sets as valuable additions to his collection. Wayne’s objective is also an A.R.C. priority — to develop an appreciation of the interests of others among collectors. (Editor)

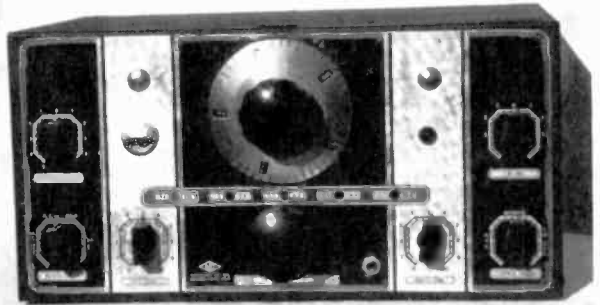

Figure 1. The National NC-100, ca.1936, with a tuning eye.

A few months ago, a fellow radio collector stopped by for a look at my radio collection. As we stepped into the “radio room,” he immediately began to gawk at some of my 1920s battery sets. After perusing the wooden sets, he started to walk out of the room.

My “Hey” seemed to startle him. I asked, “Why didn’t you look at these communications receivers?” I could tell by the look on his face, he was thinking, “Why should I?” So, I asked him if he was wondering why I was collecting all this “junk,” to which he replied, “Well, yeah.” I bit my lip.

The above exchange exemplifies a common misconception about vintage communications receivers. There’s no doubt that collecting these big, heavy metal “rigs” is an acquired taste, but the collector of vintage communications equipment is no different from any other radio collector. His reasons for collecting are for nostalgia, beauty, interest in technology, performance, rarity, preservation of history, etc., but mainly for the love of what he’s collecting. He’s also interested in using his equipment on a daily basis.

BETTER LISTENING AND CRAFTSMANSHIP

I had collected wooden sets of the 1920s-1940s for a couple of years before I acquired my first communications receivers. For me, the initial hook was performance. Being used to mediocre AM DX’ing with broadcast radios, I was suddenly thrown into another realm with communications receivers.

I was not only getting more distant AM stations, but now the world of shortwave listening was truly at hand. Larger band coverage, bandspread tuning, beat frequency oscillators, and other features allowed me easy and more enjoyable shortwave listening.

As I added new communications receivers to my collection, I began to realize that these receivers were not out of place in my collection. Although the wood cabinets had been replaced by painted metal cabinets for the most part, I still had a good representation of styling. For instance, one of my favorite sets is a National NC-100, circa 1936, shown in Figure 1. This set exemplifies the classic styling of the 1930s. Another National receiver, the SW-3, shown in Figure 2,

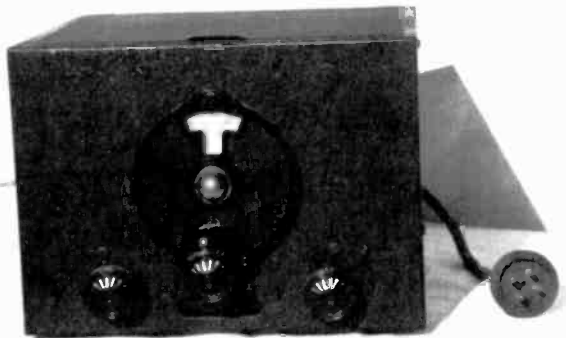

Figure 2. The National SW-3, a 3-tube regenerative receiver, has a dial straight out of the 1920s.

has a dial straight out of the 1920s. This popular 3-tube regenerative receiver was produced during the late 1920s and early 1930s.

Particular communications receivers represent other styles as well. So, I not only found myself with better performing radios, but I truly began to appreciate the craftsmanship of the cabinets and their overall eye appeal. Unfortunately, not every piece of communications gear will be in as good condition as the National NC-100 and SW-3 pictured. As we'll see, even these two receivers with their nice exteriors have their problems.

Sadly, thanks to modification articles in the ham magazines, not much of the vintage communications equipment has gone untouched by experimenters and tinkerers over the years. Compound this meddling with the fact that some of this equipment was hauled out into the field for portable operation or for Field Day use under emergency conditions where it took abuse. No wonder pristine communications gear does not exist in abundance. Still, good clean, unmodified communications gear *does* exist.

CONDITION CONCERNS

The communications equipment collector's concerns about condition are the same as those of any other radio collector, if not more intense. Some collectors will tolerate various degrees of condition, while others want only museum quality, but all are concerned about the state of their prospective purchases.

It is rare to find a collector whose interest spans the entire spectrum of the radio collecting hobby. On the other hand, most of us do have some idea of interests outside our own, and we sometimes acquire unfamiliar items to trade and sell. Here is where the trouble begins.

What may appear to the average radio collector as a nice piece of communications gear, may, in fact, have been modified to the extent of being junk. The result is that it is especially hard for the communications collector to buy things by phone. To close the information gap between the communications equipment buyer and the radio collector as the seller, the following are things to check when you come across vintage communications gear that has ended up in someone else's garage.

Starting with the outside of the equipment, look for cabinets in reasonable condition. Things



Figure 3. The badly worn finish on this National NC-173 cabinet can be compared to a bad finish on a wooden set.

like discoloration, peeling paint, or rust on metal cabinets present a collector with problems similar to those encountered in wooden cabinets, such as missing veneer, surface scratches, bad finishes and hairline cracks. The National NC-173, shown in Figure 3, is an example of a metal cabinet with a badly worn finish.

As seen in the upper left-hand corner of the SW-3 chassis in Figure 4, communications gear will often have added holes, which sometimes suggest a modification, or de-modification. Also, the metal cabinets may have had a new paint job in a nonoriginal color. Some of these things don't present much of a problem, but depending on how bad it is, the cabinet condition can make the piece a parts set.

(Continued on following page)

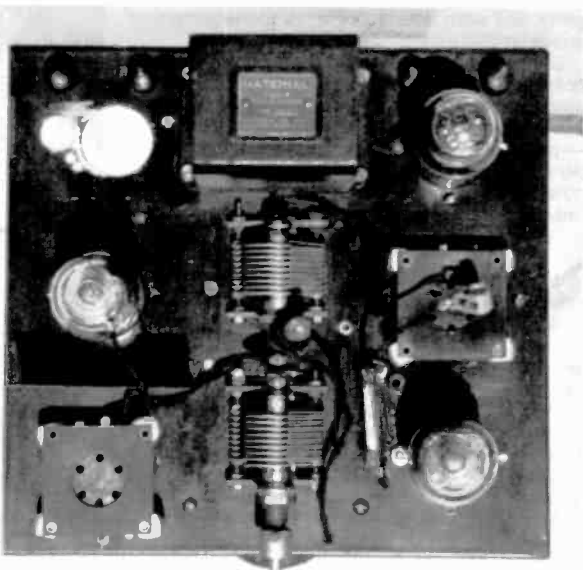

Figure 4. The originality of this National SW-3 chassis has been destroyed by the addition of several holes in the upper left corner.



Figure 5. The original variable tone control on this National NC-173 has been replaced by a slide switch, shown at left, second from the bottom.

(Communications Collecting, continued)

Extras on a cabinet may seem at first glance to be good. For instance, handles on the side or top may make hauling a heavy brute more convenient, but they detract from the originality of the gear. Of course, some equipment may have come from the factory with handles, but, if not, eliminating the extra holes represents more work. Just as a GE S-22 tombstone looks great with its original handle on top, adding handles to a wooden cabinet would offend most radio collectors.

With respect to physical condition, other things to look for are the same as for any radio. Torn grille cloth, missing tube shields, cracked dial glass, and worn lettering all testify to the general condition of the piece of equipment.

Missing knobs are a problem for any radio collector. Communications gear will be found with extra knobs more often than home radios. These knobs may not match the other knobs on the gear — perhaps an indication that the equipment simply lost a knob somewhere along the way. On the other hand, and more likely, the rogue knob can indicate a modification.

MODIFICATIONS

Modifications bring us to the chassis of the equipment. It is not uncommon to find a piece of vintage communications gear that has been modified in some way. These "mods" may be relatively simple, like the addition of an SO-239 coax antenna connector. Another example is the replacement of a variable tone control with a slide switch, as shown in Figure 5. On the other hand, "mods" may be completely destructive, like replacing octal sockets and tubes with 7- and 9-pin miniatures, as shown in the NC-173 chassis in Figure 6.

Some gear has been so heavily modified that the set is not anywhere near what it was when it left the factory. These modifications may have saved the original owner money, or "improved"

the piece in his eyes, but to the collector, it can mean nightmarish work or monetary losses.

If you're unfamiliar with communications equipment, there are several things to check, which can indicate modifications. Since a lot of communications equipment allows access with lift-up lids, rogue parts are easily exposed.

The chief indicator of a modification is the tube complement. The first step is to compare the tubes in the set against those marked on the chassis or in the manual to determine if tube substitutions have been made.

For example, something as simple as a substitute rectifier tube can be indicative of a replacement power transformer. This may seem like a minor thing, especially if the gear works. On the other hand, if the original transformer is unique, as in the National NC-100 and NC-200 series receivers which have the

company's logo stamped on the top and are painted to match the chassis, then a replacement transformer takes away from the integrity of the set. Figure 7 shows a replacement power transformer installed in an NC-100 on the left and the correct transformer on the right.

Another kind of modification to beware of requires that a tube be added to the chassis. Increasing the tube complement, even by just one tube, can cause the power transformer to over-

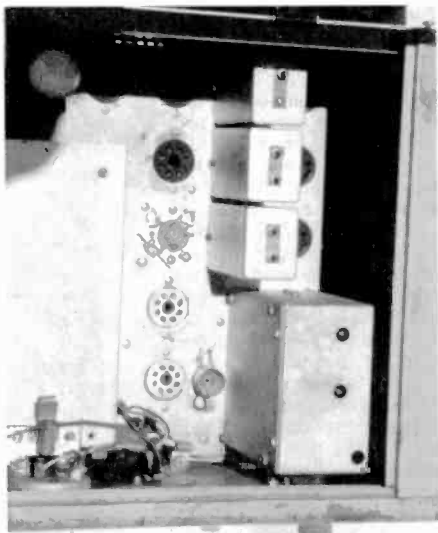

Figure 6. The two miniature tube sockets on this NC-173 chassis were "improvements" which smoked the power transformer.

heat during normal operation, thus decreasing the life expectancy of the transformer. Of course, these added tubes will not be marked on the chassis or in the manual.

Other modifications can usually be spotted by their home-made look. Although some people are master craftsmen, few can create a modification that can't be detected. If it doesn't look factory made, it probably isn't.

Good indicators of a modification are the mounting holes associated with it. Factories generally make clean holes. Also, these holes are usually drilled or stamped before painting, so the inside of the holes will be painted. In addition, look for things that seem to be in odd places. For example, since much of this gear used separate speakers and original speakers were sometimes not purchased with the set, rogue audio transformers sometimes ended up under the chassis.

EXCEPTIONS

As with any rules, there are always exceptions to modifications. Some tube changes may be either an exact substitution or changed at the factory. For example, some chassis of the National NC-57 are stamped to indicate a Type 6SN7 tube but use a Type 6SL7 instead. In these cases, the 6SN7 stamping was inked out by the factory. Factory accessories were often made for communications equipment, and some units were plug-ins and marked with the set maker's name.

Also, since the communications field was an always advancing technology, you may run across a weird variant or "factory modification." Although a factory replaced tube may be hard to ascertain, factory accessories and mods can usually be determined by their "manufactured" look.

Modifications aren't the end of the world. Recently, I purchased a National NC-46 receiver through the mail. The seller had described the receiver in detail, and I debated whether to buy it. There were many modifications to it, according to the description, but the price reflected this, and I could always use the parts.

When the NC-46 arrived, I wasn't the least bit disappointed, since it had been described accurately. A few days after its arrival, I gave the set a closer look. There was no physical damage to the cabinet, and the chassis hadn't been hacked on. It happened that I had all the missing parts for the NC-46, which I had collected from other National junkers. Although the work is still in progress, I should be able to put Humpty Dumpty back together again.

So, those junkers and parts sets serve a valuable purpose in preserving other more restorable sets. In fact, sometimes two junkers can be made into a nice collectible piece.

BUYER AND SELLER RESPONSIBILITY

The responsibility for a successful buy or trade

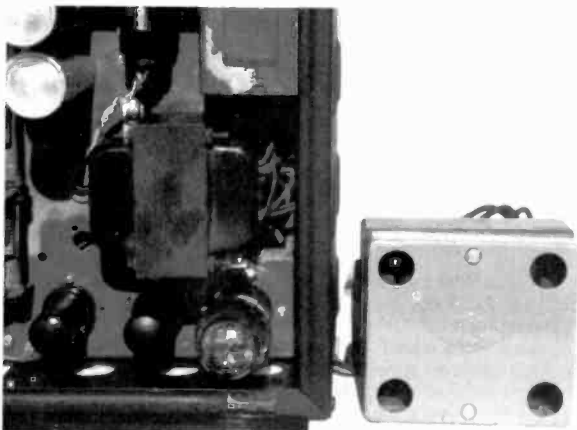

Figure 7. A National NC-100 with a replacement transformer (left) and an original power transformer (right).

does not lie entirely in the hands of the seller. The vintage communications collector must understand it's not a given that the person on the other end of the phone line has seen every piece of gear, or knows how, why, or if a piece of gear has been modified.

After all, the communications collector may not know the difference between Catalin and walnut Bakelite, so there's no reason to assume that a radio collector knows what type of antenna connector should be on a Hallicrafters SX-73. Thus, it is imperative that the buyer ask the right questions and base his/her decision to buy, or not to buy, on the answers.

The emphasis for the seller is on getting to know what and to whom he is selling. Vintage communications collectors prize their finds, just as any other radio collector does. To them, these sets are works of art, just as the Scotts, Philco 90s, and transistor radios are to their prospective collectors. Communications collectors get the same warm feeling inside when they are shortwave listening or transmitting that the radio collector does when listening to Glenn Miller over his "Walton" Zenith tombstone.

Although it is impossible for collectors to be experts in every area of radio collecting, being able to give a better description of that "hunk of metal" you just picked up from the flea market will give the communications collector a better understanding of its condition. If buyer and seller work together, a more positive transaction can take place for both parties.

(Wayne Childress, 1903 Jerome Pl., #3, Helena, MT 59601)

Wayne has collected radios since 1992. After he had spent a year concentrating on 1920s vintage battery sets, a battered National NC-57 made its way into his collection. Since then, he has specialized in collecting products manufactured by the National Company. He is also a ham (KC7KUE) and an avid shortwave listener.

WITH THE COLLECTORS

The Symphonic Globe Speaker

BY DAVE CROCKER

"When you *have* the world, you can *hear* the world!" (No, that's not it.) "New speaker makes earth-shattering news!" (No, not quite right.) "The best speaker *in* the world!" Ah, yes, that's it! That would have been an excellent advertising statement for the radio speaker described in this article. However, as it was, the Symphonic came and went with all the other cone speaker innovations of the late 1920s.

The Symphonic was introduced in mid-1927, along with many, many other cone speakers, whose manufacturers were eager to cash in on the radio owners' rush to replace their obsolete horn speakers. The horn just couldn't match the superior tone qualities offered by the cone speaker. It was also an awkward blend with household furniture styles.

On the other hand, the cone's pleasing, round

shape was a designer's dream, and the 120-or-so cone manufacturers installed them in everything and anything! The cone's one drawback was its delicate paper construction, which was prone to punctures and tears; therefore, the advantage of packaging it behind a grille or in some kind of enclosure became evident. Thus, it was that the Symphonic Sales Corporation of New York City designed its cone speaker totally hidden inside a 13-inch world globe, as shown in Figure 1.

Of the 250-odd cone speaker designs offered in the late 1920s, this was one of the most unusual. Looking like an ordinary library globe, it fits well with any decor. Imagine how striking it would have been if it had lit up!

THE SPHERE

The globe sphere is a full-color and accurate representation of the world of 1927 (now quite outdated) and rotates on its axis. Each of the globe's upper and lower halves is constructed of a heavy fiberboard material. Each half has twelve



Figure 1. The Symphonic Globe speaker on its tripod base stands a full 20½ inches tall.



Figure 2. The Symphonic Globe speaker opened at its equator to show the cone. Also note one of the covered speaker openings on the lower section.

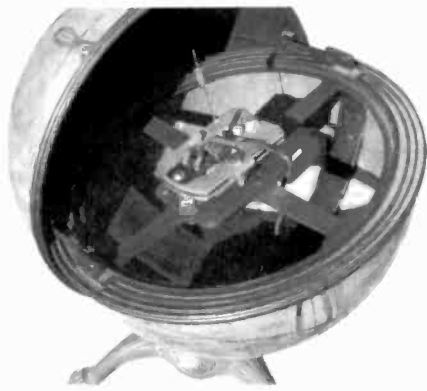

Figure 3. The Symphonic's paper cone is removed to show how the permanent magnet driver is mounted. By looking into the bottom, you can see how the grille cloth covers each of the lower openings.



Figure 4. The cast-iron base shows the name tag stating that the device was made by the Symphonic Sales Corp. of New York, N. Y.

(longitude) segments, bent and glued together to form a bowl or half sphere. On these halves are glued a colored paper map of the world. It is interesting to note that on the Symphonic Globe the entire Soviet Union is labeled "Russia," Iran is "Persia," and Thailand is "Siam." Such was the world in the 1920s.

Eight wedge-shaped openings in the globe's lower section have a fine woven, gold grille cloth covering. Although these openings are enough for proper sound emanation, the globe's truly unique feature is the sliding top. When slid back, it reveals the 9½-inch, horizontally mounted fabric and paper cone top. The tone qualities can be changed by adjusting the opening of the top cover, which pivots on two brackets. Figure 2 shows the Symphonic globe speaker in its fully-opened position.

THE CONE

The cone is supported at its peak by a thin shaft leading down to a horizontally mounted permanent magnet, quite common to most of the cone speakers of the period. An adjustable rubber plug at the end of this shaft allows the cone

Symphonic GLOBE SPEAKER



A new and unique design of a speaker. It is a beautiful accurate library globe that should be a part of your home furnishings—and of your education. By simply raising upper half of globe (as shown in smaller illustration) it becomes a speaker of unusual merit. Globe turns freely on its axis, is clearly marked, beautifully colored and can be easily cleaned with a damp cloth. The purity of tone, the perfect reproduction of the full range of sound will amaze you. The tone may be modulated by opening or closing the upper half of globe—a feature found in no other speaker. Comes complete with 20 feet of cord. Order a sample speaker—it will help you sell many more. Shipping wt., 25 lbs.
2K5177—Retail price, \$35.00.
 Your cost **\$21.00**

Figure 5. The announcement of the Symphonic Globe speaker, which appeared in the August 1927 issue of "Talking Machine World," a dealer-related magazine.

either to vibrate free of any edge support, or to have its perimeter rest slightly on the metal equator. See Figure 3. A 20-foot speaker cord leads out from the bottom of the globe, allowing the globe to be positioned far enough away from the radio to appear unassociated.

THE BASE

The globe is supported by a decorative, cast-iron base with an oval "Symphonic Sales" name tag, which can be seen in Figure 4. The base's weight alone is more than adequate to stabilize the globe above. The complete unit's weight is 25 pounds.

The Symphonic advertisement, shown in Figure 5, says that the Symphonic Globe speaker was offered to the radio public for \$35. This price allowed the radio dealer to clear a \$14 profit from each sale. In many cases, such a profit was equal to a week's salary in 1927.

It's apparent that this unique radio speaker didn't "set the world on fire"—rather, the world swallowed it up!

(Dave Crocker, 6 Raymond St., Sandwich, MA 02563)

Dave Crocker is on the A.R.C. staff and has been actively collecting radios for more than 24 years. Many of these years have been spent researching and collecting radios manufactured by the Crosley Radio Company.



PHOTO REVIEW



This column presents in pictorial form many of the more unusual radios, speakers, tubes, advertising, and other old radio-related items from our readers' collections. The photos are meant to help increase awareness of what's available in the radio collecting hobby. Send in any size photos from your collection. Photos must be sharp in detail, contain a single item, and preferably have a light-colored background. A short, descriptive paragraph **MUST** be included with each photo. Please note that receipt of photos is not acknowledged, publishing is not guaranteed, and photos are not returned.

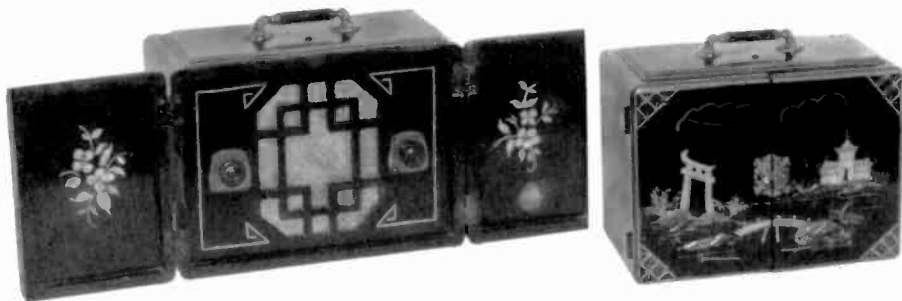

EMERSON CHINA CHEST – This wooden cabinet, tabletop set features a black-lacquered case, solid brass hardware and a beautifully hand-painted Oriental scene. The front doors open to reveal the speaker and controls. The tuning dial is in the early 0-100 scale. The small 10 x 8 x 6-inch case is packed with 5 tubes. (*David Sacco – Rochester, NY*)

RCA VICTOR MODEL UNKNOWN – This 1936-1937 Art Deco, 6-tube "mystery set" by RCA has been restored to its original condition except for the grille cloth. It has broadcast, shortwave, amateur, and police bands. (*Rod Kennedy – Moraga, CA*)

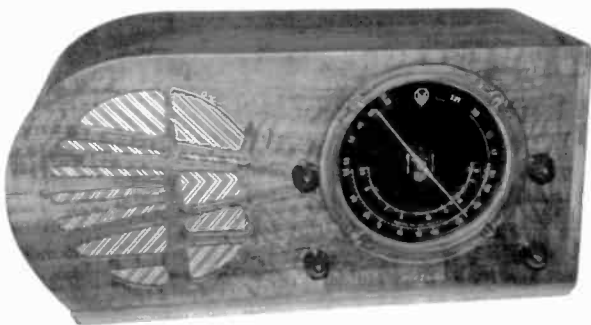

F.M. DOOLITTLE MODEL UNKNOWN – F.M. Doolittle Co. of New Haven, Conn., was the real pioneer of stereo broadcasting in the early 1920s. The company later established the radio station WDRC. This set has AMRAD audios and Federal RF transformers. I know of one other identical set. (*Merrill Bancroft – Townsend, MA*)



PHOTO REVIEW

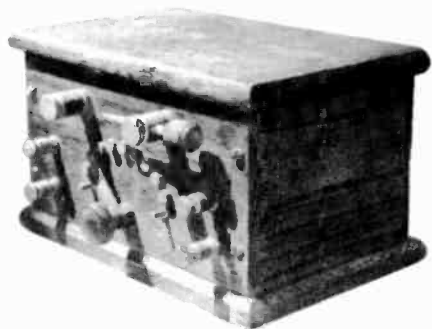

SCYRAD SR-12 CRYSTAL SET – Made by the Schenectady Radio Corporation, Schenectady, New York, this set has a tag on the bottom identifying it as a "Scyrad SR-12." The serial number is #1687, with a test date of 1922. To the best of my knowledge this model, sold in 1922 and 1923, was the only one made by the company. (Sam Fotundo – Utica, NY)

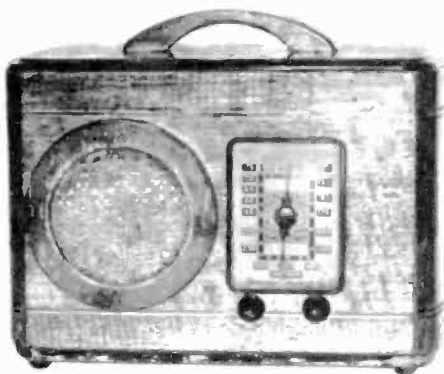

DETROLA MODEL 330 – Is this set a "kissing cousin" to the Motorola Catalin radio in the July 1935 A.R.C. "Wanted" photo ad? Curiously this set isn't listed in Rider's. It has an unusual X-shaped back cover over the Detroscope antenna. An AC/DC set, it uses Types 12A8, 12K7, 12Q7, 50L6 and 35Z5 tubes. (George Hausske – Wheaton, IL)



ECHOPHONE MODEL 14 – This 6-tube superheterodyne, ca. 1932, has shadowgraph tuning and tone control. Phone jacks are mounted on the rear apron. (Ed Paski – Berwyn, PA)

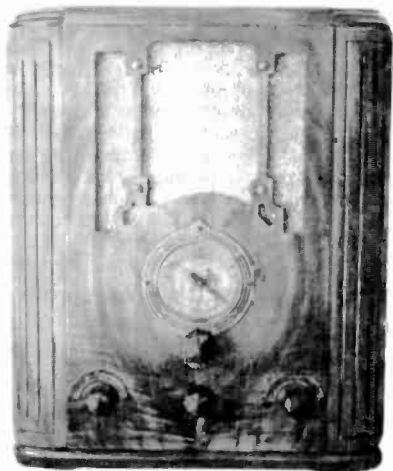

CROSLY MODEL 855 – This 8-tube superheterodyne set, ca. 1935, has two shortwave bands and performs very well. (Bill Harris – Roanoke, TX)



AUCTION REPORT

VRPS/AWA 1995 Convention and Auctions Irving, Texas — October 27-29, 1995

COMPILED BY GEORGE AND MICHAEL POTTER

The 20th annual convention of the Vintage Radio & Phonograph Society (VRPS) and the Antique Wireless Association (AWA) was held October 27-29, 1995, at the DFW Airport Holiday Inn South in Irving, Texas. Over 490 attended the event.

Friday's events included a silent auction and a main auction. The well attended technical sessions included presentations by Tom Burgess of Mabelvale, Arkansas, on transistorized tubes; his "vacuum tube repair wafers" appear in full-page ads in A.R.C. Another presentation by John Bryant, of Oklahoma City, included rare slides of industrial designs by Robert Davol Budlong. The Old Equipment Contest also occurred on Friday.

Saturday's events featured a silent auction, a main auction, and the Awards Banquet. Guest speaker John Bryant gave a slide presentation of the flamboyant Commander Eugene F. McDonald, Jr., founder of Zenith Radio Corporation.

In the skilled hands of auctioneer Michael Sherman, auction proceeds came to \$48,550 for 838 items sold, with 54 passes. The Friday night auction was extended because of the overabundance of equipment. When this auction ended at 11 P.M., there were over 150 unsold items left over. This situation has prompted VRPS directors to review ideas for a more equitable auction

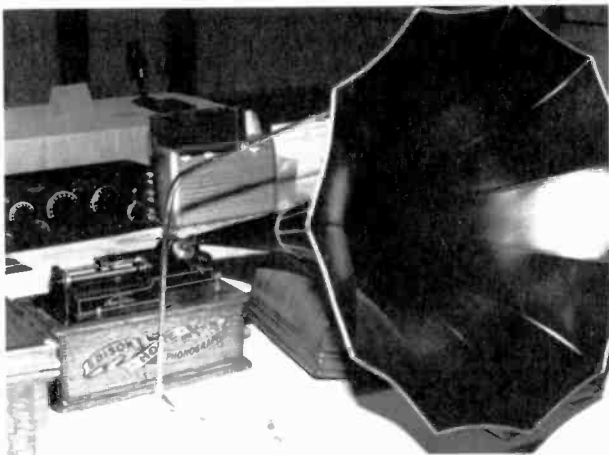

This Edison Model B with horn, a winning entry in the contest, reminds us that VRPS members collect phonographs as well as radios.

plan for future auctions.

Among the high priced items sold at the auctions were the following: an RCA 77DX mike selling at \$750; a DeForest DT-700 Everyman crystal set at \$550; a Pilot 3-inch TV, ca. 1947, at \$425; a Lone Star beer bottle radio, ca. 1930, at \$300; a BC-115 1920s aircraft radio at \$250; a Crosley grandfather clock radio at \$325; a Pathé cone speaker at \$350; a Zenith 7-J252 Walton tombstone at \$435; a Fada 652 Catalin at \$280; a Crosley neon sign at \$325; a spark key with a marble base at \$160; an Edison Diamond Disc machine and 150 records at \$190; and an interesting novelty set, the Crayola radio, at \$110.

Also sold were a Wimhurst static machine at \$290, a King AM-PLI-TONE headphone horn at



The BC-115 aircraft receiver, on left, went for \$250, and the DeForest DT-700 Everyman crystal set sold for \$550.

A warning: Auction prices are not current values. A listing such as this cannot adequately include the condition of cabinets, chassis, transformers, tubes, the operating status of the set, and the inclusion of incorrect, restored or replica components, etc. Auction prices are the result of the excitement of the auction process, the skill of the auctioneer and the specific interests of the participants. Nevertheless, auction prices serve as useful references and as another element in the value determining process. The possibility of error always exists, and if we are notified, corrections will be reported.



This Crosley grandfather clock radio, Model 124, sold for \$325.

\$200, a Scott Super 12 at \$240, a Detrola clock radio at \$325, and a Truetone M-278-5D beetle plastic set at \$325. For 1995, console prices were very high, 1920s battery sets prices were a little over last year's, Bakelite and plastic sets were down, and 1930s wood set radios brought excellent prices. Rider's volumes averaged \$25 each.

The following list of equipment combines all four auctions. Every effort was made to observe and identify the equipment, but accuracy is not guaranteed. Some sets do not have model numbers, since none were found either on the set or on the auction form.

e=excellent, vg=very good, g=good, f=fair, p=poor, unk=unknown, BB=brass based, WT=with tubes, NT=no tubes, N.I.B.=new in box

AC Dayton LX-10, WT, g	\$50
Admiral 20KB6, N.I.B., e	130
Aero shortwave converter, f	18
Air Chief 4-A-70, f	15
Air King shortwave converter, e	140
Airline 6Z-177, vg	75
Airline 6Z-351, unk	70

Airline 6Z-455, g	70
Airline 6Z-98, ca. 1934, g	70
Airline 64BR-1503B, g	15
Airline 74BRI502B, g	30
Airline 84BR-1053A, f	10
Airline 84KRP, unk	20
Airline 94GSE chairside, g	70
Airline BR 526A, g	36
Airline M-93WG-800E, e	55
Algene AR5U overnight radio	65
Allocation maps, U.S.A./RCA	55
American Bosch speaker, f	25
American Electric wall telephone, g	110
Amrad Royal DC-6, WT, vg	40
Artone 12-1046U, g	45
Arvin 442, metal, f	30
Arvin 617B, g	120
Arvin 850T, p	12
Arvin 6640, g	35
Atlas battery novelty set, g	18
Atomic 572, g	20
Atwater Kent 7 console, refinished	45
Atwater Kent 20 big box, f	40; g, 55
Atwater Kent 20 big box, NT, (2), f	20, 40
Atwater Kent 20C, NT, g	90
Atwater Kent 30, WT, g	70
Atwater Kent 33, WT, unk	50
Atwater Kent 35, NT, f	24
Atwater Kent 36, f	35
Atwater Kent 40, E-speaker, f	55
Atwater Kent 40, E speaker, g	60
Atwater Kent 40, NT, p-f	46
Atwater Kent 43 and F4 speaker, f	43
Atwater Kent 43, NT, f	55
Atwater Kent 44, NT, g	55
Atwater Kent 60 chassis, g	75
Atwater Kent 70 console, f	45
Atwater Kent 74 console, hums	50
Atwater Kent 74 consolette, e	80
Atwater Kent 145, g	100
Atwater Kent E speaker, (2), g	26, 55
Atwater Kent E2 speaker, (2), g	45, 65
Atwater Kent F-4A speaker, (2), f	30, 50
Atwater Kent F-7A speaker, g	40
Atwater Kent H horn, g	90
Atwater Kent L horn, modified, g	75
Atwater Kent L horn, vg	140
Atwater Kent M horn, f	75
Automatic Radio 613X, (2), g	20, 70
AWA <i>Old Timer's Bulletins</i> , 1974-1995	55
Belmont 6D121, g	60
Bendix 753M, g	20
Big Bird novelty radio, vg	26
Blabbermouth novelty radio, (2)	16, 22
Brandes B15 console, vg	10
Brandes cathedral, unk	60
Brandes headsets, (2)	20
Buccaneer Treasure Chest, vg	160
Camcorder novelty set, vg	34
Camera novelty set, g	36
Camus bottle radio, N.I.B.	28
Catalin clock, (2)	ea., 80
Celestrion speaker, g	70
Clarion shortwave, g	10
Coca Cola radio, N.I.B.	16
Continental M-1600, vg	170
Coronado 526, (2), f	26, 65
Country Bell telephone radio	30



This Patné heavy frame cone speaker sold for \$350, even with a tear in the cone.

(Continued on following page)

Crayola novelty, box, e	110
Crosley 5-50, WT, g	65
Crosley 6H2, f	75
Crosley 9-105, g	30
Crosley 10-1-1B8, vg	45
Crosley 10-135, g	50
Crosley 10-137, g	35
Crosley 11-103, g	55
Crosley 11-103, vg	100
Crosley 11-1074, f-g	18



John Bryant, author of "The Zenith Trans-Oceanic, Royalty of Radios," was guest speaker at the annual banquet.

Crosley 11-107U, (2), f	12, 50
Crosley 11-109U, vg	55
Crosley 52SD, NT, g	85
Crosley 56TC, g	50
Crosley 56TD Duette, vg	120
Crosley 58TK, g	15
Crosley 66TA, (2), g	50, 55
Crosley 66TC, g	55
Crosley 124 grandfather clock, vg	325
Crosley 167 cathedral, f	70
Crosley 515, g	80
Crosley 517, g	77
Crosley 577, g	45
Crosley 6669-A, g	55
Crosley Ace 2B, WT	75
Crosley Bandbox, NT, f	45
Crosley clock radio, vg	140
Crosley E-155L, g	34
Crosley E20GY, f	10
Crosley neon sign, e	325
Crosley VI, WT, g	150
Dahlberg pillow radio, g	100
Davis 1221 FM tube type, g	25
DeForest DT-700 Everyman crystal set, g	550
Delco R-1126, f	20
Delco R-1231A, e	50
Delmonic NT-5	15
Detrola 5-tube, g	24
Detrola 302 clock radio	325
DeWald Bakelite, red, g	22
DeWald rooftop set, g	130

Dictograph horn, vg	120
Dictograph speaker	140
Edison Diamond Disc and 150 records, g	190
Emerson 510, e	40
Emerson 520 Catalin, f	170
Emerson 520, no cracks, e	210
Emerson 541, g	10
Emerson 645, vg	12
Emerson 646A, g	17
Emerson 833B, g	20
Emerson 988, g	20
Emerson BM206, f	25
Emerson EP405, g	170
Emerson HX312, f	35
Emerson St. Regis, g	45
Emerson tombstone, unk	80
Eveready console, refinished	250
Eveready speaker, f	20
Exide battery jar	15
Fada 652 Catalin, vg	280
Fada kit set, NT, g	50
Fada M-192A, vg	75
Fada M-652 Catalin, f	100
Firestone 4A155, f	10
Firestone S7426-62	24
Fisher 800B receiver	55
Freed-Eisemann FE-15, NT, g	55
Freed-Eisemann NR-5, WT, e	130
Freed-Eisemann NR-12, NT	unk, 65; g, 100
Freshman Masterpiece, NT, g	65
Garod 5A2, g	35
Garod RAF, NT, g	30
GE J85 console, vg	85
GE K53, g	65
GE LCP609, f	20
GE M630, g	50
GE ME61, g	65
GE S-22, g	55
GE TV 12TI, unk	40
GE TV 810, vg	100
GE TV M10TS, f	75
General Radio wavemeter, g	130
General TV & Radio 5A5, g	55
German Peoples set, WWII, unk	80
German WWII K42N radio, unk	225
Ghost Busters novelty radio, N.I.B.	18
Gilfillan GN-1, WT, g	55
Globe Fleetwood, g	20
Glortone cathedral, g	100
Gonset M-3233 ham transmitter, g	75
Graybar 100 speaker, refinished	87
Grebe Synchrophase, NT, g	160
Grundig 85, f	32
Hallicrafters AT-CL-7, unk	28
Hallicrafters M-51-C1, e	45
Hallicrafters S-38, f	34
Hallicrafters S-81, g	20
Hallicrafters salesman's radio	60
Hallicrafters Sky Buddy	55
Hallicrafters Sky Champion, e	60
Hammarlund, w/clock, g	120
Home brew crystal set, f	60
Home brew superhet, p	50
Home brew, 1-tube, e	45
Howard 118 console, vg	150
Howard 435A, shortwave, g	38
Howard 901A, g	30
Hoyt tube tester, vg	65
Instructograph, box, vg	15

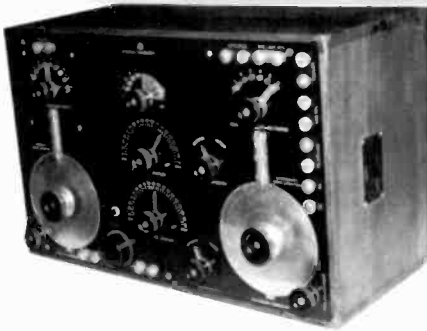

A beautiful 1918 IP-500 receiver displayed at the Old Equipment Contest.

Jukebox novelty, w/cassette player	30
Key, spark, marble base, nice	160
King AM-PLI-TONE speaker, g	200
Kit battery set, f	15
Kit, regenerative set, vg	65
Kleer-tone antenna tuner, g	14
Kolster 6J, NT, g	30
Lafayette semi-auto bug, box, vg	44
Lone Star beer bottle, g	300
Loop antenna, collapsible	44
Magnavox chairside, f	40
Magnavox M-4 horn, g	55
Magnavox R-3 speaker, g	75
Majestic 20, g	60
Majestic 59, f	80
Majestic 310B, p	35
Majestic 371, g	70
Majestic 440, chrome front, vg	170
Majestic M-50, vg	170
Majestic neon sign, g	120
Michigan kit set, NT, g	70
Micronic Ruby, NT, vg	34
Midwest, NT, vg	95
Minerva Tropic Master, f	34
Motorola 5X120, g	14
Motorola 6T, vg	120
Motorola 53H, f	30
Motorola 55LT-40F	32
Motorola 57X	16
Motorola 60, f	24
Motorola 68T 110, f	12
Motorola 77 FM 21, phono	40
Motorola car grille radio, f	170
Motorola Goldenview 71 MA TV, f	40
Motorola M1096, f	45
Motorola Pixie transistor radio, g	24
Murdock 200, NT, w/horn, g	60
Music Master 175, vg	60
National 173, e	g, 30; e, 90
National power supply	36
National RCP, f-g	100
National SW-54, vg	60
Naval Observatory clock, g	36
Ohmite resistors in cabinet	30
Olympic 1056 transistor radio	15
Owl radio, f	38
Packard Bell 5DA, 1947, g	14
Panasonic RC-1091, clock radio	10
Paramount, Neutrodyne kit, f	20
Pathé speaker, clean	350
Peerless speaker, g	60
Philco 16B tombstone, f	180
Philco 18H console, f	40

Philco 16 RX, 2-piece console, e	240
Philco 37-610, (2), g	50, 60
Philco 37-611, g	65
Philco 37-620, g	50
Philco 37-650, g	30
Philco 37-84 cathedral, p	f, 45; p, 75
Philco 38-2, g	50
Philco 38-4D battery set, g	50
Philco 38-15CS, (2)	f, 60; restored, 130
Philco 38-62, f	45
Philco 38-93 cathedral, f	60
Philco 40-130, vg	58
Philco 40-140, g	50
Philco 41-226, f	40
Philco 41-280 console, vg	150
Philco 42-365 console, g	70
Philco 42-1010, f	30
Philco 42-1013 console, vg	70
Philco 48-230, f	18
Philco 48-460, g	22
Philco 49-505 Transitone, g	32
Philco 50 cathedral, (2), g	ea. 150
Philco 50-522, f	20

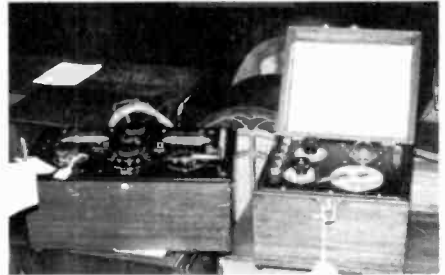

This Radiola III-A, left, went for \$70, but the nice Aeriola Senior with dud WD-11 sold at \$150.

Philco 53-1750 phono console, g	100
Philco 60, f	60
Philco 70, g	280
Philco 80, f	85
Philco 90 cathedral, p, (2)	70, 170
Philco 111 console, vg	160
Philco 545-386, unk	12
Philco battery set, 1938, f-g	50
Philco E-675-124, p	10
Philco M-20, vg	220
Philco M-37-62, g	55
Philco M-45, vg	45
Philco Safari TV, H-2610, g	160
Philco Transitone, g	45
Philco Transitone, PT-3, f	20
Philmore Blackbird crystal w/headphones, f	130
Philmore crystal set, red	80
Phono Jr., German, f	16
Pilot Jr. T-704, f-g	50
Pilot TV, 1947, works, vg	425
Popular Electronics magazines, 1957-1961	10
Popular Radio magazines, (10-15)	55
Porto Bar radio, f-g	80
Radio keg, g	75
Radio Shack football novelty	40
Radio Tel coin-op, g	95
Radiola III-A, NT, clean	70
Radiola 33 w/speaker, f	35

(Continued on following page)

Radiola 61-5, g	30
Radiola UZ1325 horn, no driver	20
Radiola UZ1325, vg	120
RCA 4T cathedral, f	60
RCA 6-T-2 tombstone, g	75
RCA 6RF9, vg	20
RCA 6XF9 AM-FM	10
RCA 7T1, 1936, tuning eye, g	75
RCA 8-BT-7J	24
RCA 8-X-6F, vg	20
RCA 9-TX-50, 1939, g	45
RCA 45-EY-3, phono, f	20
RCA 56X5, g	20
RCA 77DX mike, less base, e	750
RCA 86T, g	35
RCA 100A speaker, unk	30
RCA 101 tombstone, g	65
RCA 103 speaker, rear shroud gone	95
RCA 103 speaker, f-g	25
RCA 103 speaker, tapestry OK	80
RCA 103 speaker, tapestry torn	55
RCA 121 cathedral, e	210
RCA 143, g	220
RCA 551, g	28
RCA 810T, e	160
RCA AM-FM, 8-X-71, vg	14
RCA B274, g	30
RCA M-75X11, g	42
RCA R28P, e	160
RCA R93A record player	22
RCA sign, 18" diameter, g	85
RCA sign, wooden, e	100
RCA T7-5 tombstone, g	10
RCA tube caddy, (300) tubes	40
Realistic DX-160, vg	60
Records, 16" transcription, (12)	20
Records, 16" transcription, (4)	20
Records, 78 rpm, (12), g	15
Regency TR7, f	27



This beautiful Philco 16RX chairside, left, and remote speaker sold for \$240.

Rider's Vol. 6, 9 and Index 1-10	45
Rider's Vol. 8	20
Rider's Vol. 9	26
Rider's Vol. 10	26
Rider's Vol. 11	26
Rider's Vol. 12	25
Scott Super 12, g	240
Seiberling 576, g	45
Sentinel 338	30
Sentinel 41405, works	50
Sentinel AM-FM shortwave, f	25
Setchell-Carlson, f	45
Signal Corps BC-115, aircraft, f	250
Signal Corps BC-6548, f	35
Signal Corps BX100 crystals	22
Silvertone 101-823, g	30
Silvertone 2015, g	20
Silvertone 4500A, g	34
Silvertone 6050, f	35
Silvertone candy cane, g	28
Silvertone R1161, g	45
Silvertone shortwave, 1930, g	65
Silvertone World's Fair radio, f	140
Sonora battery set, WT, g	55
Sony 5-303W	45
Spark coil, f	25
Sparton Equasonne, works, g	50
Spiltdorf R-100, NT, e	120
Steinite cathedral, hums, g	140
Sterling tube rejuvenator	26
Stewart-Warner 525/power supply, g	50
Stewart-Warner A2T4, g	35
Stewart-Warner A61P21, g	50
Stewart-Warner book end radio, vg	85
Stewart-Warner D751A, g	35
Stewart-Warner lighted ad mirror, p	80
Stromberg-Carlson, 1A, NT, (2), g	70, 90
Stromberg-Carlson, 225H, vg	210
Stromberg-Carlson, 561, f	14
Stromberg-Carlson, 600H, f	12
Stromberg-Carlson, 1204, p	10
Telefunken 5083, works, vg	50
Telegraph register, early, vg	180
Temple horn, speaker, g	160
Thorola Equadyne, NT	50
Thorola horn, g	55
Thorola horn, good driver, f	45



RCA 77DX microphone sold, without the base shown, for \$750.



With this \$300 long-neck novelty radio, Royce can pour out some Sweet Lone Star country sounds.

Thorola horn, works, f.....	150
Tom Thumb radio, unk.....	110
Transformers, box of (20).....	48
Trav-Ler 5008, f.....	30
Trav-Ler 5180, clock radio, f.....	20
Trav-Ler tombstone, f.....	75
Treasure Chest, g.....	80
Truetone D-711, g.....	90
Truetone D-726, g.....	45
Truetone D-1012, e.....	65
Truetone D-1012, g.....	45
Truetone D-2624, SW.....	50
Truetone D-10001, 1942, g.....	75
Truetone M-278-5D, beetle plastic.....	325
Universal transistor radio, N.I.B.....	15
Utah headphones, vg.....	10
Vibroplex, in box.....	75
Victor phono portable, p.....	20
Victor VV-IV phono, g.....	18
Walltone radio, f.....	65
Watterson 4581, f.....	20
Wax cylinders, 2 min., (5).....	50
Wax cylinders, 4 min., (7).....	20
Wax cylinders, box, (24).....	60
Western Bell sounder.....	75
Western Electric 10D horn, g.....	40
Western Electric horn mike, f.....	25
Western Electric straight key.....	30
Western Mfg. crystal set, g.....	65
Westinghouse Aeriola Senior, dud WD-11, g150.....	150
Westinghouse H165, f.....	30
Westinghouse H182.....	14
Westinghouse H435TS, g.....	10
Westinghouse WR-12 grandfather clock, f.....	130
Westinghouse WR120.....	46

Wimhurst static machine, e.....	290
Workrite, Neutrodyne, NT, f.....	30
Xonex, replica, AM-FM, vg.....	24
Zenith 4B321, f.....	45
Zenith 4T26, g.....	50
Zenith 5A10, vg.....	80
Zenith 5A135, g.....	70
Zenith 5D610, g.....	40
Zenith 5L42, f.....	55
Zenith 5R135, (2).....refinished, g, 65; vg, 70.....	70
Zenith 5R216, g.....	90
Zenith 5R236 chairside, refinished.....	130
Zenith 5R236, vg.....	170
Zenith 5S120, f.....	110
Zenith 5S127, vg.....	170
Zenith 5S213, g.....	65
Zenith 5S228, vg.....	100
Zenith 5S317, e.....	55
Zenith 5S319, g.....	12
Zenith 6S527, e.....	50
Zenith 6B321, g.....	8
Zenith 6D015, AM, vg.....	36
Zenith 6D029, table, g.....	25
Zenith 6D030.....	20
Zenith 6D219, g.....	85
Zenith 6D315, g.....	120
Zenith 6D510, vg.....	35
Zenith 6D510W, f-g.....	15
Zenith 6D525, (2).....g, 80; e, 85.....	85
Zenith 6D615, g.....	85
Zenith 6D629.....	75
Zenith 6D2620, AM.....	35
Zenith 6G001 Y21 TV, f.....	25
Zenith 6G801, w/box, mint.....	325
Zenith 6P2615, e.....	55
Zenith 6R684, phono/radio, g.....	60
Zenith 6S229 tombstone, (2).....p, 35; vg, 140.....	140
Zenith 6S511, f.....	36
Zenith 7M918, FM, g.....	18
Zenith 7S28, e.....	160
Zenith 12S568, f.....	220
Zenith 288, tombstone, g.....	230
Zenith 500, early hand-wired.....	75
Zenith 500-2, f.....	26
Zenith 808, e.....	200
Zenith 1000, vg.....	40
Zenith 3000-1 AM-FM.....	100
Zenith 4600, f.....	80
Zenith 7000, vg.....	200
Zenith 7002, f.....	12
Zenith 8605Y.....	80
Zenith A-600, f.....	90
Zenith A-600L, leather, vg.....	90
Zenith A835, f.....	25
Zenith advertising clock.....	30
Zenith B-510Y, vg.....	24
Zenith B-519Y, clock radio, f.....	16
Zenith console, black dial, vg.....	260
Zenith consolette, f.....	20
Zenith G500, g.....	70
Zenith H-500, (3).....f, 45; f, 45; g, 70.....	70
Zenith H-723, f.....	24
Zenith L-600 Trans-Oceanic, w/guidebook, f.....	90
Zenith M-8A02, e.....	350
Zenith neon sign, g.....	150
Zenith place mats, early.....	50
Zenith R600, g, (2).....	55, 95
Zenith radio sign, neon, g.....	150

(Continued on following page)

(VRPS/AWA 1995, continued)

Zenith Royal 3000-1, f	85
Zenith sign, plastic	45
Zenith Super Seven, w/BB, dud tubes, vg	120
Zenith T600, p	30
Zenith Walton, 7-J232, f-g	435
Zenith X-600, vg	90
Zenith Y724, AM/FM	20

Tube(s):

01-A's, (10), g	84
01-A, 27, 41, 76, 78, g	18
6E5, (2) tuning eye	55
6E5, (9), unk	30
24A, (4), g	12
26 (4), 71A (2), g	25
45, (5), g	(3), 38; (2), 30
71A, 56, 22, 27, globe	22
80, 71A, 27, w/boxes	38
201A, UX (5), g	50
201A, 199, 71, 300, w/boxes	75
215A, (10), g	80

301A, (5), g	42
301A, Cunningham w/box	14
304TL, (2), g	45
327, 56, 71A, 80, w/boxes	55
811A, (2), g	22
DeForest 430, Sylvania 99	20
Duds, 99, (4)	10
Miniatures, (150) in boxes	14
Octals, (80) in boxes	14
Transmitting tubes, misc. box, (20)	34
Tube adapters, (20)	28

(George Potter, 2069 Sienna Trail, Lewisville, TX 75067)

For information on the Vintage Radio & Phonograph Society, write: VRPS, PO Box 165345, Irving, TX 75016. Club dues are \$13.50 per year. In addition to the annual convention, VRPS holds monthly meetings and a spring auction. The club puts out a quarterly publication — "The Reproducer" — and the monthly "Soundwaves."

Smith Auction Highlights Downington, Pennsylvania — November 18, 1995

CONTRIBUTED BY ANNETTE SMITH

The Smith Auction Company of Downington, Pennsylvania, conducted a very specialized radio and electronics sale on November 18, 1995, at the Downington Marketplace. The 6-hour sale was very active with over 100 registered bidders from Pennsylvania and from up and down the East Coast. A ten percent buyer's premium was charged.

The highlight of the sale was a 1887 Bunnell and Co. galvanometer and resistance box in a leather case, which drew strong bidding from both a phone bidder and a registered floor bidder. Starting at \$1,000, bidding quickly escalated in \$100 increments to the final knockdown price of \$4,100.

Over 300 radios were sold, as well as a great selection of telegraph equipment, hi-fi equipment, transistor and novelty radios, commercial receivers, and speakers. A cream-colored Bakelite Fada tabletop radio in excellent condition brought an astounding \$748. A Lansing N-1200 large speaker sold for \$550, a large pair of University cabinet speakers for \$110, an Altec 601A Duplex speaker for \$105, a Radiola Victrola VE915X and Superheterodyne for \$550, and a Philco mantel clock radio for \$330.

Other equipment of interest included an Atwater Kent floor model in excellent condition selling at \$264, a Story and Clark grandfather clock radio for \$165, a Garrard Model 301 transcription motor at \$231, a National NC-183 receiver at \$247, a Northern Electric pay phone at \$187, a nice solid oak wall phone at \$154, a brown 1-dial Zenith radio at \$165, and a National SW3 receiver at \$209.

Action throughout the sale in every category was high with hundreds of lots selling in the range of \$50 to \$100. This was the second successful Smith catalogued radio and electronics sale. A



This Atwater Kent lowboy, in excellent condition, sold for \$264.

third sale will be held in March 1996. Interested consignors or buyers may contact the Smith Auction Company at (610) 269-1036.

(Auctioneers Harold and Annette Smith and Dennis Childress, R.R. 322, Box 302, Glenmoore, PA 19343)

RESTORATION TOPICS

A Philco Circuit Oddity

BY CHESTER A. GEHMAN

Occasionally one encounters an unusual circuit variation when least expected. Such was the case when I was restoring a very tired and badly abused Philco Model 37-670. Once it had been coaxed out of intensive care by the usual capacitor replacement operation and had given signs of imminent recovery by responding to several BC band stations, the set overloaded horrendously, even on moderately-powered stations. In addition, it became very obvious that some dimwitted technician had vented his wrath on the AVC system — including clipping off the lugs on some of the "black-box caps" that Ray Bintliff has so thoroughly researched in his useful book, *The Radio Collector's Guide to Philco Bakelite Block Condensers*.

About this time, I was totally convinced I had paid too much for the carcass, but decided to continue the restoration effort by removing all the dangling resistors and capacitors the butcher had left me and starting over. As the work progressed, I traced my way back to the first IF transformer and suddenly discovered it had not four but six leads — one top-side to the grid and five on the bottom. And there it was on the schematic, clear as day — a third winding. Usually additional leads are related to a bandwidth or fidelity switch, but not so in this case. As shown in the partial schematic in Figure 1, a third winding is connected to the suppressor-grid of the 6K7.

After completing repairs, including alignment, I had this 37-670 working just fine, and turned my attention to the purpose of that third winding. Over a cup of Maxwell House, I considered the possibilities: (a) injecting more signal into the IF amplifier, (b) positive feedback, (c) negative feedback. Any of these should change the IF gain: (a) and (b) should decrease the gain if disabled, while (c) should increase gain if disabled.

An easy first approach was to short-circuit the suppressor to ground. This caused a very slight reduction in gain, due to the shorted tertiary winding, which was corrected with a slight readjustment of the IF tuning.

Next, that third winding was disconnected, and grid #3 of the 6K7 was grounded. No change. Now totally frustrated, I reversed the leads of the third winding — and still no change. These steps had been taken while I monitored the AVC voltage on a strong local station. Unhappy with the results, I went to an unmodulated signal from my signal generator, but I still found that the third winding produced no measurable effect.

Although my good friend Ray Bintliff could add nothing further on this circuit, he did agree that it might have some connection to the bandwidth. He suggested that a visual test using a sweep generator and an oscilloscope might shed some light. Several days later, I resurrected my RCA Model 150 sweep generator, hooked up an oscilloscope, and

went to work. The result — I could see no difference in the bandpass with or without that tertiary winding.

The next day, just seeing that set on the bench brought out the stubborn Dutchman in me. Philco had avoided the use of metal tubes, clinging to the full-sized glass types, along with the rust-prone square shields — but a metal 6K7 was in the IF socket. Could that be part of the story? Out came the metal tube, and in went the 6K7G — and a shield. All previous tests were repeated, but the results were the same — I could find no practical reason for that third winding.

At first, I assumed this circuit-oddity was a one-shot feature, but a search of Rider's Volumes VI, VII and VIII identified the following 1937 sets: Models 37-650 and -660 (Vol. VII); Models 37-62, -665, -2650 and -2670 (Vol. VIII); and the following 1938 models: 38-4, -5, -7, -10, -60, and -89 (Vol. VIII), with four different part numbers for the 6-lead transformers.

I hope someone with more sophisticated equipment will take the time to investigate this circuit, and equally important, to report the results.

(Chester A. Gehman, 150 Burwell Rd., Winsted, CT 06098)

Chester A. Gehman is Associate Professor Emeritus of Electronics at Ward College of Technology, of the University of Hartford, in Conn. His interest in radio goes back to the 1930s, and his primary concentration is on the restoration of 1930s-1940s equipment, especially multiband, multitube receivers. He also collects and repairs Simpson Type 260 and related VOMs.

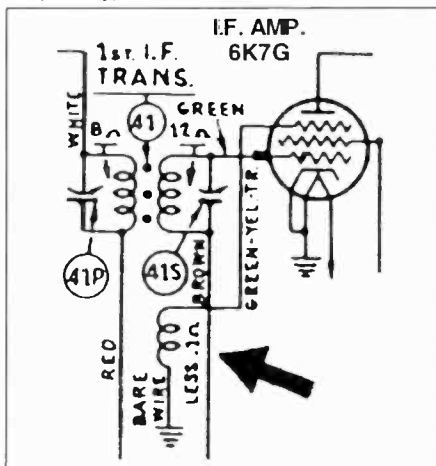

Figure 1. The mysterious third winding on the secondary of the first IF transformer. This schematic is from Rider's Volume VII, page 7-73.

RESTORATION TOPICS

A Tube Substitute That Glows

BY GARY STRELOW

Because of the dwindling supply of tubes used in early battery sets, some resourceful collectors have developed a variety of solid-state tube substitutes. However, these solid-state devices usually have one or two shortcomings. This article, that could be subtitled "They said it could not be done, but I found a way to do it," describes a novel approach to a tube substitute that has tube-like characteristics.

I have experimented with Field Effect Transistors (FETs) in various tube replacement circuits, but I was not satisfied with them because of their inability to control gain (volume), particularly in regenerative circuits. In addition, some tube substitutes require the addition of a diode to function in a detector stage. The addition of a diode limits the use of the device to a detector stage only.

Most tube substitutes draw very low current. As a result, a battery-operated radio's low resistance filament rheostat cannot provide adequate control of volume. Using my design, a battery set's rheostats will function as if vacuum tubes were installed in the radio. Further, my circuit does not require the addition of a diode to function as a detector.

As the schematic diagram shown in Figure 1 indicates, my design uses a photocell (R2) in the source lead of an FET (Q1). The photo cell is illuminated by a miniature incandescent lamp (I1). The lamp's voltage and current rating is the same as the filament rating of the tube it is replacing. A list of lamp types and associated tube types is provided in Table I. The lamp's brightness is controlled by

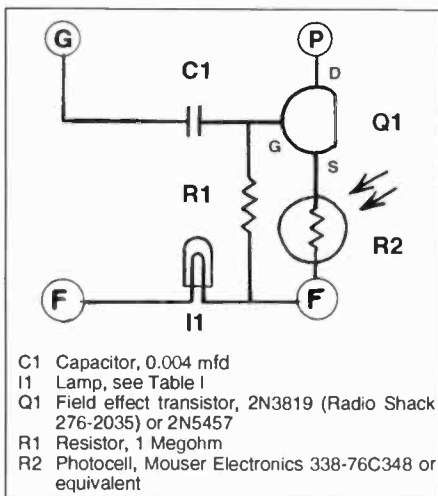

Figure 1. The schematic and parts list for the solid-state tube substitute.



Figure 2. Tube substitution components, mounted on a circular piece of perforated board.

the radio's filament rheostat. When you turn up the rheostat, the brightness of the lamp increases. As the brightness increases, the resistance of the photocell decreases, which, in turn, controls the gain of the FET. The gain of the FET can be controlled over a range from zero to about 15.

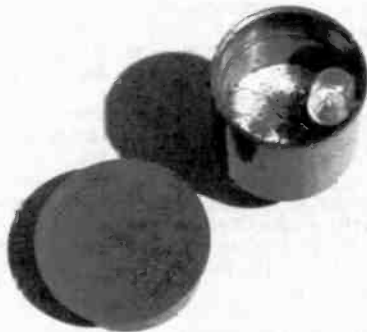

Figure 3. The completed tube substitute mounted in a Type 01-A tube base.



Figure 4. The tube substitute with the black plastic cap in place.

The tube substitute's components are mounted on a circular piece of perforated board, as shown in Figure 2. The assembled unit is mounted in a tube base, as shown in Figure 3. The tube base was taken from a dud tube. As Figure 4 shows, each tube base is fitted with a black plastic cap which keeps ambient light from affecting the performance of the photocell. But if you want your radio to glow, just omit the plastic cap.

Figure 5 shows two schematic diagrams of a Crosley Model 51 battery radio. The schematic on the left depicts the radio circuitry with Type 01-A vacuum tubes. The modified schematic on the right shows the tube substitutes in place. Note that when the tube substitutes are used, the B-supply consists of two 9-volt batteries wired in series. The A-supply requirement is identical to that of the vacuum tubes that are being replaced.

I worked with lamps and photocells, as well as with the spacing between them. My goal was to

Table I. List of lamp types		
Lamp Type	Lamp Base	Associated Tube Types
41	Screw	99
43	Bayonet	99
44	Bayonet	01-A
46	Screw	01-A
48	Screw	30
49	Bayonet	30
222	Screw	WD-11 and WD-12

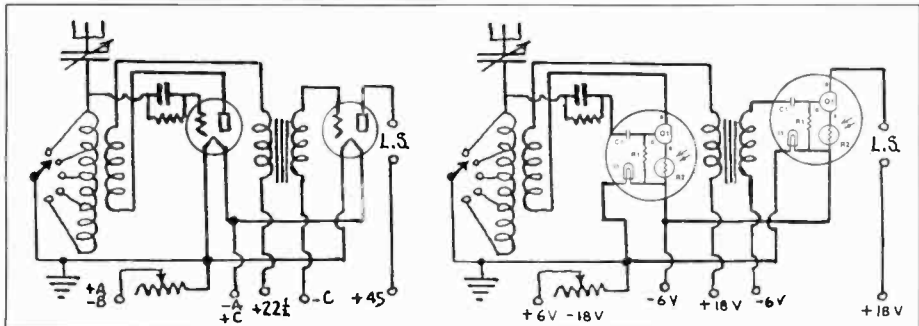

Figure 5. On the left, the schematic diagram for a Crosley Model 51 using Type 01-A vacuum tubes. The schematic diagram on the right shows the radio with tube substitutes in use.

A.R.C. Test Results

By RAY BINTLIFF

A.R.C. had the opportunity to try out two of the Type 01-A substitutes in a Crosley Model 51. First, to calibrate our ears, the radio was fired up using two good Type 01-A tubes and a battery eliminator. Next, the solid-state substitutes were installed, and the conventional B-supply was replaced with two 9-volt batteries. The radio's rheostat did control the volume as if vacuum tubes were in use.

On the plus side, the tube substitutes seemed to have more gain than the 01-As. Their higher gain could be an advantage when used in a radio with poor sensitivity. Another advantage of the solid-state devices is that the need for a C-supply is eliminated. In the Crosley, we simply strapped the C-connection to the A- and C+.

The tube substitute looks easy to build, and all components are readily available from electronics supply houses. And it does glow in the dark.

get the FET to respond to various filament voltages as closely as possible to that of a vacuum tube. As it turned out, the plate current versus grid voltage curves for the Type 01-A and the response of the FET are the same. I put five of the solid-state replacements in an Atwater Kent Model 20 and the radio performed exactly as it did with vacuum tubes. When the rheostats were turned off, the B-battery current went to zero.

So, here is a tube substitute that not only performs like a vacuum tube, but it will light up and create the impression that there are real tubes inside the radio.

Photographs by Dave Crocker.

(Gary Strelow, 3580 Everett Rd., Richfield, OH 44286)

Gary Strelow does electronic calibration for an international commercial airline company. He holds a First Class commercial FCC license. Living on a former chicken farm with lots of outbuildings allows him to store about 3,000 radios, along with his antique cars. He is primarily interested in battery radios, anything before 1926.



BOOK REVIEW

Heathkit — A Guide to the Amateur Radio Products, By Chuck Penson, WA7ZZE

REVIEWED BY RAY BINTLIFF, K1YDG

If you have ever owned a piece of Heathkit ham equipment, *Heathkit — A Guide to the Amateur Radio Products* by Chuck Penson is sure to bring back pleasant memories of Amateur Radio in simpler times when much of the equipment on the operating desk could be built from kits. You can almost smell the hot soldering iron as you read. On the other hand, if you are a potential purchaser of some used Heathkit gear, this book will be equally valuable as a buyer's guide.

SCOPE

Heathkit covers ham radio equipment produced by Heathkit from 1952 through 1992. As

you might expect, receivers, transmitters, transceivers and linear amplifiers are covered. But, ancillary items such as keyers, phone patches, antenna tuners, monitor scopes and ham-related test equipment are included as well. Many old favorites, including the "Cantenna" dummy load, appear in the book. As Penson states, "It's hard to go to a flea market and not see one Cantenna."

The author provides a brief description of Heathkit's origins but does not dwell too long on this subject that has been well documented by others. However, he does describe in impressive detail Heathkit's entry into the ham radio field and its long string of successful products. Alas, he also describes the demise of Heathkit's kit business. Photographs of some of the individuals responsible for Heathkit's success, along with short descriptions of their contributions, make this book more than straight technical stuff.

A GUIDE TO AMATEUR RADIO PRODUCTS

It is obvious that Penson has done a superb job of researching material for this book. The text is loaded with facts about Heathkit and its amateur radio products, but his writing style keeps the reading easy and interesting. The bulk of the book, a section titled *A Guide to Amateur Radio Products*, is devoted to photographs and descriptions



of various Heathkit ham gear. One of the outstanding features of the book is the high quality of its photographs. The photographs are larger than those found in most equipment guides. As a result, the photos show useful detail of front panels and other equipment features.

This section of the book is easy to use since it is arranged in alphanumeric order by model number. Most models are described on one page, while some descriptions run two pages. There is never more than one model covered on the same page. Consequently, a given model is easy to locate, and there is never any confusion regarding which

photograph goes with which text.

The descriptions follow a standard format in that they include the manufacturing dates, original price, and the product's weight and size. Another useful bit of information is a listing of related products — a list of earlier or later models that perform the same function. For example, the Model CO-1 code practice oscillator (1959 to 1967) lists the HD-16 (1967 to 1974) and the HD-1416 series (1975 to 1991) of code practice oscillators as related products. Using this related products information, it is easy to trace the restyling and design improvements introduced over the years. It is also interesting to track the price increases that occurred.

Equipment descriptions and specifications are supplemented by useful information such as the technical problems and shortcomings of a particular model, problems to look for when buying a used item — including undesirable modifications, Heath's engineering changes and variations that may be found in a certain model, and recommended modifications. The author also rates the rarity of the various models from common to rare.

BUYING AND COLLECTING

One section of the book, "Buying and Collecting Heathkits," is devoted to practical information in-

cluding a buyer's checklist. Guaranteed to make you chuckle is a paragraph about flea markets with a translation of "flea-speak" responses to the question "Does it work?"

SUPPLEMENTAL DATA

The book also contains two useful indices: (1) an index arranged by model which lists equipment type, notes/specs, first year made, last year made, and last price; (2) an index arranged by equipment type (e.g. amplifier, antenna, etc.) that provides the same information contained in the model index.

The "Product Reference" section of the book, arranged in model number order, contains references to articles in *CQ* and *QST* magazines that deal with such things as product reviews, modifications and product announcements.

The "Product Timelines" section contains a chart that depicts the production periods for each Heathkit model.

SUMMARY

The book is so crammed with practical information that it is not possible to include all of its features in this book review. The production quality is equally good. However, one glitch did occur — page 144 was omitted from the bound book and has been inserted as a loose-leaf page.

Do I like the book? You bet! It is both entertaining and instructive.

Heathkit - A Guide to the Amateur Radio Products is published in paperback by Electric Radio Press, Durango, Colorado. Priced at \$24.95, this book is softbound in an 8" x 11" format and contains 248 pages. Copies may be ordered from the publisher, A.R.C., and other A.R.C. advertisers. Be sure to check with the suppliers for ordering and shipping information.

Ray Bintliff, 2 Powder Horn Lane, Acton, MA 01720

The Radio Collector's Directory and Price Guide, 1921-1965, Second Edition - By Robert E. Grinder

REVIEWED BY ED TAYLOR

The second edition of *The Radio Collector's Directory and Price Guide* by Robert E. Grinder has been greatly expanded to 500 pages, 200 more than in the first edition.

Part I — "Radio in America, 1921-1965" — consists of six chapters of easy-to-read history of the radio industry. It covers the many technological advances of tube-type radio receivers from 1921 to 1965. The chapter on design innovations gives the reader tips on how to determine when a particular receiver was manufactured. Trends in the style of plastic radio cabinets, including Catalin, are discussed from Art Deco to kitsch. At the end of each chapter are especially useful references to other published works.

Part II — "The Radio Directory and Price Guide" — is the heart of the book. 20,000 vintage broadcast sets are listed by manufacturer/model, year, power, style and price. Grinder presents his comprehensive pricing guide as a system of from one to six stars as follows:

\$0-\$50	* \$301-\$600
\$51-\$150	** \$601-\$1,200
\$151-\$300	*** \$1,200-\$2,400

This section also has comments on receiver

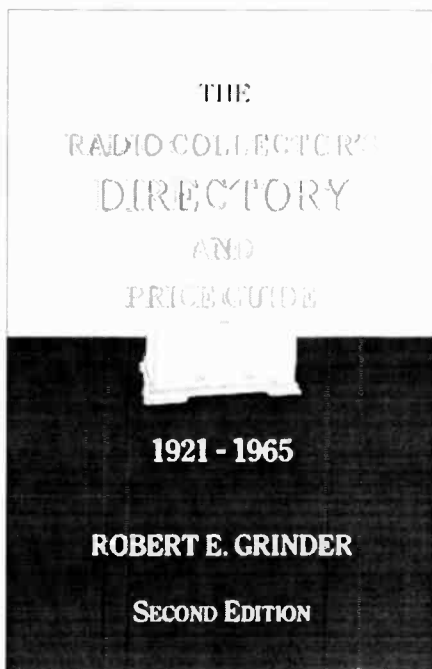

integrity, including cosmetic and operating condition. The range from mint to junker is of great consideration in any evaluation. For anyone contemplating selling or buying an old radio, this section is a must-read.

Caveat on using this or any other price guide: Any radio is only worth what someone is willing to pay for it.

Part III — "The Trade Directory" — is comprised of two very helpful cross-references. Section 1 lists trade names alphabetically opposite their manufacturers. Section 2 reverses the procedure and lists the manufacturers alphabetically opposite their trade names. This information is of great assistance in set identification and in locating radio schematic diagrams in Gernsback, Supreme, Rider or Sams publications.

The Radio Collector's Directory and Price Guide, Second Edition is published in paperback by Sonoran Publishing, Inc., in an 8½ x 5½ format. It is available at \$26.95 from A.R.C. and other A.R.C. advertisers. Please check these sources for ordering and shipping information.

(Ed Taylor, 245 N. Oakland Ave., Indianapolis, IN 46201)



RADIO MISCELLANEA

"Antique Radio Classified" invites its readers to contribute letters and information for inclusion in "Radio Miscellanea" and elsewhere in the magazine. The topic should be of general interest and sent to A.R.C., P.O. Box 2, Carlisle, MA 01741. All material submitted should be verified for accuracy and may be edited for publication, which is not guaranteed. See the masthead for more details.

Major Meet Dates Conflict

Dear Editor:

We were very disappointed to see that the Elgin and Rochester shows are less than one week apart (August 28-31 and September 4-7). We don't know if other readers feel the same way, but it might be an interesting topic for A.R.C. For us, it simply means that, unfortunately, we won't be attending the Elgin Radiofest. We would guess that attendance at both of these will suffer from what they might be if they were more separated in time.

John and Kathy Slusser, Honeoye, NY

Telicon Info Sought

Dear Editor:

I received a Telicon AM/SW table radio in 1941 as a Christmas gift, so I assume it was made in 1940 or 1941. The name tag shows it to be a Model 12-R, manufactured by the Telicon Corp., New York City, N. Y. None of the collectors I have met have ever heard of Telicon, so I was hoping that someone out there might share a schematic, sales literature, or any other info on the Telicon Corp.

J. Toensing, Nevada City, CA

The A.R.C. Web Site

Dear Editor:

The A.R.C. Web site looks great. Even though we are all interested in old radios and related items, I feel it necessary to support new technology. I'm glad you do too. Thanks again for the Web site.

A.D. Tipword, Half Moon Bay, CA

Dear Editor,

It is great to have an international channel to A.R.C. — <http://www.antiqueradio.com/>.

Bruno Pinto, Tel-Aviv, Israel

Dear Editor,

I enjoy my A.R.C. subscription every month and having A.R.C. on the Web lets me point others to resources to help them as well.

Chuck Schwark, Chicago, IL

Wife Relief via A.R.C.

Dear Editor:

My wife feels that the shelves in my part of the basement which hold my "junkie" are finally looking better due to having advertised in A.R.C. The very best to one and all at A.R.C. in 1996!

R. Whetstone, Arthur, WV

High Praise for Ford Coverage

Dear Editor:

Each issue is better and more organized than the last. Your 3-part coverage of the Ford Museum Auction was very well done and of great interest to me. Keep up the fine work!

Dennis Branch, Lancaster, CA

Ad Rate Increases & Comments

Dear Editor:

I note that additional words over the 20 free ones are now 25¢ each. But, I also notice in one place on the classified ad policy page that you didn't change the 22¢ from prior printings. So now I'm a proofreader!

Let's keep A.R.C. flying, but please attempt to keep the increases for subscriptions and ads at a reasonable level. I know — the cost is well worth it, but this subscriber is a penny pincher and hasn't gotten used to inflation.

Thanks for listening and keep up the good work. Love the color.

Stan Lopes, Concord, CA

Dear Editor:

Your ads are so reasonable I'm not going to take my 20 free words. Enclosed is full payment.

I am a new subscriber and have tremendously enjoyed my first issue. Thank you for a wonderful publication.

Jim Kollens, Addison, IL

Dear Editor:

As a longtime subscriber and monthly photo ad contributor, I am very upset about the tremendous increase in photo ad costs (from \$14 to \$20). There is absolutely no justification for such a large increase. An increase of \$2 or \$3 would have been reasonable and understandable. Photo ads provide you with benefits — increased revenues and added reader interest — which translate into more subscribers. I cannot understand why you would impose an increase that will discourage photo advertisers.

Also, please spare us from any more photos of virtually valueless, plain-Jane Philco cathedrals in the *Photo Review*. We have seen these radios in your magazine and in other magazines hundreds of times. There is no interest in them (just try to sell one).

Jay K. Malkin, Denver, CO

First, thanks to the many who, although they would naturally prefer no rate increases, understand the need to increase rates, as the costs of copy preparation, printing, postage and staff go up, and we try to maintain a growing and improving magazine.

Regarding the classified ad extra word increase from 22¢ to 25¢ — remember, the 20-word free ad remains. The increase is an alternative to charging a percentage of the selling price or higher rates for commercial advertisers, as do some publications.

Photo ad rates are increased to bring them closer to display ad rates; a 1/8 page display ad costs at least \$33.

We find it hard to agree with Mr. Malkin's opinion of Philco, since response to our Philco articles and surveys has been positive. Also, the preponderance of Philco ads, as well as interest in the Ramirez/Prosize book — "Philco Radio 1928-1942" — belie Mr. Malkin's premise.

The bottom line is that we must distribute our costs of publishing a quality, monthly, 100-plus page magazine between our readers and advertisers, while balancing a wide range of interests and opinions. (Editor)



CLASSIFIED ADVERTISEMENTS



WANTED: Lists of radio stations pre-1980, including World Radio Handbook, Broadcasting Yearbook, Whites Radio Log (including photocopies). Ralph Marson, 8070 Busch, Centerline, MI 48015. (810) 754-3808

WANTED: Philco 640 chassis in good condition. **FOR SALE:** Copies of manuals for Eico, Heathkit, PACO, Precision and other test equipment. Send two-stamp large envelope for list. Also have (3) Genalex KT66 new and (3) National Union 350B new. Clayton Mundine, 6112 S. Flores St., San Antonio, TX 78214

WANTED: Instruction manual for Superior Instrument Co. Model TV-11 tube tester. Mark Anderson, Rd. #1, Box 58A, Greenwich, NY 12834. (518) 692-2593

WANTED: I'm looking for a copy of an old 78 record called Breakfast in Bed on Sunday Morning. It was on the Victor label and only one side was recorded on. I'm not sure who the singer was, but it might be John Loudermilk. I can't have had the only copy ever made. Please help!! John Theisen, 917 Broadway Ave., Valley Springs, SD 57068. (605) 336-3650, days, or (605) 757-6775, evenings

WANTED: Theremin. Mint tube CB's. **FOR SALE:** Fisher K10 Spacexpander. Collins R390, R390A, R391 manuals. Vintage CB's: LSASE - list. C. Zafonte, RFD 1, Box 75, Ft. Kent, ME 04743. (207) 834-6273

WANTED: Clean late Collins S-Line. Frank Czaja, A19T, 8968 W. Forest Home Ave., #4, Greenfield, WI 53228. (414) 529-9395

WANTED: Parts for old telephones. John Phipps, 1412 Navaho Trl., St. Charles, MO 63304

WANTED: Hallicrafters SX-96, SX-99 or SX-100 with speakers/manuals/price. Tony Wentkiewicz, 4107 County Rd., 138, Barnum, MN 55707. (218) 389-6907

WANTED: Book: Radio & Television Receiver Troubleshooting and Repair, by Ghirardi & Johnson. Top dollar. Paul Kawerau, 35 Cloke Ct., Hamilton, Ontario, Canada L8T 1N4. (905) 389-2781, evenings. Or fax: (905) 389-0340, anytime

WANTED: Old microphones. General PA types, like EV 605, Astatic JT-30, T-3, Shure 707A, 520, etc. Bullet shapes and others. Thanks!! Dennis Gruening, 26 Dupont Ave., Piscataway, NJ 08854. (908) 752-5737

WANTED: Manual & schematic for Hickok 810 transistor radio tester. Reproduction OK. Michael Burke, PO Box 439, Westminster, MA 01473. (508) 874-0908

WANTED: Octal tube bases, N.O.S. Fred Cranshaw, 1624 Bitter Ck., Garland, TX 75040. (214) 494-4917

WANTED: Colorful Japanese pocket radios. Tube-type or transistor. Will trade older wooden and plastic American radios, American transistors, or novelty radios. Send description, Xerox, and tell me what you like. Will pay cash if you're not interested in a trade. Bruce Phillips, 127 Bunker Hill, Stratham, NH 03885. (603) 772-3796, after 5 pm

WANTED: Tube hi-fi amplifiers, preamplifiers, tuners, etc. McIntosh, Altec, Dynaco, Marantz, Fisher, Scott, Craftsman, Heath, Leak, Quad, Pilot, etc. Also tubes: KT-66, KT-77, KT-88, Western Electric 300A&B, 350B, 274, 275, 6550, 5AR4, EL-34, EL-37, 211, 845, etc. Happy New Year. Sonny Goldson, 1413 Magnolia Ln., Midwest City, OK 73110. (405) 737-3312. Fax: (405) 737-3355

WANTED: Philco 46-1209 chassis. Will consider purchasing entire set if needed. Will pay top dollar and shipping. Scott Starr, 2845 Page Pl., Montgomery, AL 36116. (334) 281-0960

.....
• **A.R.C. Advertising Policy**
• **Sellers and Buyers, Please Note!**
• **Advertising is accepted only for early items**
• **related to radio, communication, etc. All**
• **items must be described fairly; reproduc-**
• **tions, reprints and not-original items must**
• **be so identified. Advertisers must agree to**
• **respond promptly to inquiries and orders, to**
• **resolve problems promptly if the buyer is not**
• **satisfied, and to comply with a buyer's**
• **refund request on unaltered returned items.**
•
•

WANTED: Eveready radios, speakers, old flashlights, flashlight catalogs, related items. Subscribe Flashlight Newsletter - \$12 year. Bill Utley, PO Box 4095, Tustin, CA 92681. (714) 730-1252.

WANTED: Will pay top prices for scarce pre-1926 items. I like horn speakers, crystal sets and detectors, wireless equipment, one-tube sets, regenerative sets, tubes, amplifiers, or what have you? Ed Bell, 5311 Wooddale Rd., Raleigh, NC 27606. Phone/fax: (919) 851-1517

WANTED: Broadcast microphones, tube limiters, equalizers, mixers; guitars, guitar amps. Mike States, Box 81485, Fairbanks, AK 99078. (907) 456-3419, phone/fax

WANTED: Metal back for 10" Admiral console television. Stamped with No. 16D14. Steve Cavelli, 30144 Torry Ave., Flat Rock, MI 48134. (313) 379-3254

WANTED: Speakers for AK 410; Zenith 7S260 or 7S261. Chassis and speaker for AK 317 console. Jack Mattox, 1443 Platte Ave., Alliance, NE 69301. (308) 762-8831

WANTED: Crystal sets, crystal radio kits, toy crystal sets and pocket crystal radios. Erwin Macho, Am-brosweg 17/A/8, A-1230 Vienna, Austria

WANTED: Cathedrals & t-stones, parts, fair to basket cases. Pat Wilson, 101 Mooney, Oglesby, TX 76561. (817) 470-2101, evenings

WANTED: Stellar baseball radio, baseball trophy radio or any sports radio. Alex Kertesz, 605 Pelican Way, Delray Beach, FL 33483. (407) 276-5021

FOR SALE: Random Sams Photofacts. Write or call for list. Bill Olson, Route 1, Filer, ID 83328. (208) 326-4962

FOR SALE/TRADE: Books: Radio Amateurs Handbook 1933 by F. Collins - \$15; DeForest Radio/TV Courses 1937, 38, 100, 20+ pages - \$50/all; Radio Physics Course by Ghirardi - \$15. Many radio books and magazines in my 18-page list. Send \$1. **FOR SALE/TRADE:** Radios: Penguin Akkord batt. port., nice - \$65; Zenith Mod RF88Y port., 5-band, clean, bad switch - \$35; Hallicrafters TW1000 World Wide, needs handle, good - \$100; Philco Mod 960 big table, 8-tube, 9-band, exc. All above plus UPS. **WANTED:** Chassis, Philco 60B, 40-180; cabinets for Jackson Bell Mod 62 Sunburst, Majestic cath. Mod 194. Ben Martin, 18334 Pepper S, Castro Valley, CA 94546. (510) 582-6804

FOR SALE: Cleaning house, Sams Photofacts - 50c ea. in lots of (10). SASE for list, 1 thru 1500. You ship. John Snow, 4539 N. Bartlett Ave., Shorewood, WI 53211. (414) 964-0194

FOR SALE: Truetone 585 tombstone - \$100. Music Master 100, fair - \$60. Silver-Marshall 1930's table model - \$60. Emerson 659, white - \$30. 1932 Crescent car/home radio - \$125. Federal B-20 Ortho-Sonic - \$75. 1950's Technical & Circuit Digest magazines, 1950's Radio Television Electronics Service, Radio Electronics 1950's, 1950's Radio & Television News, all mag. - \$1 ea. Rough Bosch 1920's Cruiser - \$55. German UM002 transistor radio - \$55. Monarch Style 1920's battery set - \$75. Philmore 1-dial 1920's battery set - \$75. Radiola 20, rough - \$45. Crosley 855 tombstone - \$55. Philco 37-89 tombstone, nice - \$100. Nathaniel Baldwin wooden case speaker - \$65. Rider XII, VIII, XI - \$12 ea. Stewart-Warner B61T1 - \$35. Grebe Synchrophase chassis - \$80. Pfanstiehl Overtone - \$65. Apex Super 5 - \$65. The American Six, rough - \$60. Silver-Marshall Model 726SW chassis only w/speaker - \$125. All the above plus UPS. **FOR TRADE:** C7 Leutz. Larry Chambers, 5026 Suter Dr., Nashville, TN 37211. (615) 833-2448

FOR SALE: Zenith 3000-1 T.O., near mint - \$125. Scott 299C, good 7591s - \$100. **WANTED:** DeForest D10 coils. Will pay cash or trade for good parts, e.g., early Radiola (GE) rheostat, Federal #65 or Radiola X/Regenoflex audio transformers. Dave Gonshor, 7121 S. Jellison St., Littleton, CO 80123. (303) 979-9511

FOR SALE: Jensen 15" field coil speaker A15 with power supply, 5x10 horn, University N2B crossover, N1 filter - Best Offer. E.V. Royal 400, 18" woofer, plus pair of stereo 300's, very nice - Best Offer. Gray Research tone arm. Fisher 400, mint, with original carton - \$200. Grundig Majestic 1055W - \$95. Hallicrafters S53-A - \$30. Dale Raduege, 411 N. Greenfield Ave., Waukesha, WI 53186. (414) 547-0742

FOR SALE: Heath Cheyenne transmitter - \$150. Vicking Mobile with manuals - \$150. LM-14 frequency meter, complete w/cables, manual - \$40. Lafayette LC-4 capacitor checker - \$20. EICO 950-A - \$25. AVR-20 receiver - \$45. Heath speaker HS-24 - \$20. Vibroplex vibro keyer standard - \$45. GRC-9 set, GRC-9 accessories. Henry Engstrom, KD6KWH, PO Box 5846, Santa Rosa, CA 95402. (707) 544-5179

FOR SALE: RCA SelectaVision video disc player Model SKT 090 with one disc and manual, works - \$175 plus shipping. Norman Jordan, Box 213, Hills, MN 56138. (507) 962-3458

FOR SALE: Detrola Pee Wee, white with red knobs and feet - \$600. GE H-500, brown with white knobs, (Collins, p. 47) - \$150. Crosley Bullseyes, orange - \$195; white - \$135; blue - \$185; black - \$135; green - \$155. Fada 454 ivory Plaskon - \$150. Arvin 444, metal, white - \$75. CBS, green, (same as Trav-Ler Collins, p. 96) - \$80. Airline 93 (Radios, p. 38) - \$135. ATTP Tom Thumb (Bunis 1, p. 33) - \$75. Crosley Duettes, red - \$125; white - \$180. Kadette Jr., light brown marbled - \$575. Grantline 606-A, white, (Collins, p. 83) - \$165. Belmont 5D-128, ivory, (Collins, p. 48) - \$155. Two Emerson 520 Catalins, brown marbled - \$185 ea. Two Motorolas 53H (Radios, p. 95), bright red or green - \$130 ea. Sterling Deluxe, black and chrome, rare - \$385. Stewart-Warner Air Pal, black with white knobs, (Collins, p. 78) - \$135. Stewart-Warner B51T1, ivory, (E.O.R., p. 185) - \$135. Airline 84KR-1520A, orange, (Bunis 3, p. 21) - \$60. Airline 93BR-423B, red with gold knobs, (F.O.S., p. 52) - \$235. Philco 49-901, green and gold, (Bunis 3, p. 167) - \$175. Crosley leftside Bullseye 11-115U, red, (Radios, p. 89) - \$220. Emerson 713 Sunburst, wood, (Bunis 3, p. 76) - \$95. (3) Westinghouse Little Jewels: H124, white - \$130; brown - \$125; green - \$135. GE 114, white, (Bunis 1, p. 75) - \$55. All radios are in very good to excellent condition. Call evenings before 9:30pm Eastern Time. Mark Chamberlain, 9735 Oxford St., Naples, FL 33942. (941) 591-4835

**E-MAIL ADDRESS FOR
ANTIQUE RADIO CLASSIFIED
ARCMagazine@aol.com
Ads - Subscriptions - Book Orders
See inside front cover for details**

FOR SALE: Western Electric KS-15560-L1 tube tester by Hickok, working, outer leatherette, poor condition - \$250, plus shipping. Art Zimmerla, 501 Thorngate Pl., Millersville, PA 17551. (717) 871-3293

FOR SALE: Radios. Crosley XJ, with tubes and book, caps look great - \$180. Thorola Islodynne, great cosmetically, has one missing coil - \$100. 1955 Ford car radio, excellent and complete with knobs - \$40. Bill Manny, 1103 N.W. Despain Ave., Pendleton, OR 97801. (541) 276-3152, days. (541) 276-7439, evenings and weekends

FOR SALE: Simpson 270 VOM, taut band movement, mirror scale, high accuracy, 25 KV probe, L.N. Glen Richie, W4JGO, 643 Diamond Rd., Salem, VA 24153. (703) 389-3356

FOR SALE/TRADE: M.I.B. Beane Weenee novelty radios - \$36 ppd or trade for Delco radios. Herman Gross, W9ITT, 1705 Gordon Dr., Kokomo, IN 46902-5977. (317) 459-8308

FOR SALE: Antique telephones 202 & candlesticks. SASE \$1 for photos. M.S. Small, 407 West Walnut St., Leitchfield, KY 42654

FOR SALE: Crosley 54G "new buddy" - \$275. 50A amp, NT - \$150. 62TD refinished - \$50. Zenith 6S527 refinished - \$65. 6D030 refinished - \$50. 5C01 wood Consoltone, not restored - \$25. DeWald 650 wood table model refinished - \$75. Victor Model 40 Animato-phone projector w/book & sprk & instructions, rusty but restorable - \$50 or ? Joe Svihel, 17227 Co. Rd. 54, Avon, MN 56310. (612) 356-7601

FOR SALE: Globe 454 portable, beautiful carmel marbling, cover slightly warped - \$75. Steve Lange, 1351 N. 58 St., Milwaukee, WI 53208. (414) 259-1031

MARCH 22 & 23 1996, Fri. & Sat.

Charlotte, NC

20th Annual

Spring Meet in the Carolinas

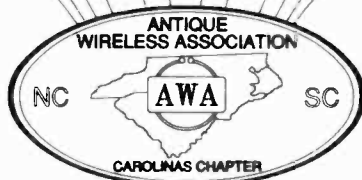

THURSDAY EVENING: 7:30pm, Get-together for early arrivals in Hotel atrium.

FRIDAY: 8:00am, Flea Market all day; 4:30pm BBQ dinner, 7:30pm, Equipment Auction

SATURDAY: Flea Market ALL day, 10:00am Contest Check-in 1:00pm, Contest wrap-up, Guest Speakers

There will be **NO BUYING, SELLING, TRADING, or DISPLAYING** of Merchandise before 8 AM on Friday! **ENFORCED!!**

The Sheraton Airport Plaza Hotel

Located on I-85 at exit 33, Billy Graham Parkway

***** VERY IMPORTANT *****

Rooms are limited, make your reservations before MARCH 1st. Special AWA room rates are only good thru February 28th.

Call 1-800-325-3535 for reservations.

REGISTRATION

	In Advance	At the door
Meet Registration*.....	\$ 5.00	\$10.00
Vendor Pass**.....	\$10.00	\$20.00
Ladies Activity***.....	\$15.00 per person	N/A
BBQ Dinner***.....	\$ 9.00 per person	N/A

* EACH PERSON MUST REGISTER, INCLUDING VENDORS (SPOUSES FREE)

** EACH VENDOR VEHICLE MUST HAVE A VENDOR PASS TO ENTER FLEA MARKET

*** REGISTRATION MUST BE RECEIVED NO LATER THAN MARCH 15

To send Registration or to request a flyer write to:

CC-AWA

POBox 11358

Charlotte, NC 28220-1358

Ron Lawrence, 704/289-1166 or Stephen Brown, 704/847-1301

FOR SALE: \$7 each, all play, Truetone DC2415, Motorola C2P6, Motorola C16W25, Lafayette no model #. James S. Looney, Rt. 1, Box 54, Grundy, VA 24614-9705. (540) 531-8677, after 7 pm

FOR SALE: Novelties: Raid Bug, w/original styrofoam - \$210. Pepsi dispenser, w/box - \$475. 15" Champion Spark Plug, 110v, M.I.B. - \$165. Pillsbury Doughboy - \$75. Superman, M.I.B. - \$65. Snoopy 2d, Skoal snuff, Tropicana, Beenie Weenie - \$25 ea. Pan Am airplane, M.I.B. - \$150. '65 Black T-bird, '67 white T-bird - \$65 ea. Shell old-time gas pump, M.I.B. - \$35. Mobil 1, Havoline Oil - \$30 ea. Atlas battery - \$35. Ballantine whiskey - \$125. Pepsi can - \$20. Budweiser AM/FM, Coors AM/FM, M.I.B. - \$30. Frank Rose, 1600 Olympic Blvd., Santa Monica, CA 90404. (310) 450-1736, days. (818) 789-1106, evenings

FOR SALE: Zenith Trans-Oceanics: 7G605 - \$195; G500, vg - \$150; H500, vg - \$150; 1000, early production, vg - \$125; 1000 - \$75; 3000, vg, with book, original adaptor - \$160. Ted Demski, 5806-225 Pl. SW, Mountlake Terrace, WA 98043. Phone/fax: (206) 778-7100

FOR SALE: Ampex Model A tape deck - \$50. **WANTED:** Acrosound II amp, any condition. Charles Johnson, 21 Holly Hill Dr., Mercer Island, WA 98040. (206) 232-2040

FOR SALE: (5) tabletop tube radios, (2) transistor. SASE for list. Peter Hittle, 5415 Bushnell Ave., Sioux City, IA 51106-3834. (712) 276-2316

FOR SALE: Philco 40-185 console, restored, pickup only - \$125. Greg Allen, 5802 Tattersall Dr., #11, Durham, NC 27713. (919) 572-2554. E-mail: heels1st@aol.com

FOR SALE: Cromwell portable record cutter, player with built-in AM radio - \$75 plus shipping. Guy Forstrom, PO Box 159, Quinnesec, MI 49876. (906) 774-8116

Visit the A.R.C. Web Site!

The URL to access the A.R.C. Web site is:
<http://www.antiqueradio.com/>

Our site includes highlights from current and recent issues:

- Editor's Comments
- Image of the Cover
- Feature Article
- Radio Miscellanea

- Plus:
- Photo Reviews
 - Book Reviews
 - Coming Radio Events
 - Complete Club Listing
 - List of Books For Sale
 - Subscription Information

While visiting our site, you may send e-mail and orders for books, videos and subscriptions.

Let us know what you think about A.R.C. on the Web!

FOR SALE: Emerson 636-A, 1950 - \$60 plus shipping. Robert J. Stone, 721 Fisk St., Piqua, OH 45356-3729. (513) 773-2217

FOR SALE: Early Bell & Howell 6V6 hi-fi amp - \$25. RCA AVR 101A aircraft radio - \$20 Misc. single unit rack-mount cabinets - \$20 ea. N.I.B. National Velvet dial - \$12. Single drawer Sams Photofact filing cabinet - \$20. Tube-type phase meter Technology Instrument Corp. - \$25. Early Regency tube-type base station N.O.S. CB - \$85. KLH FM tuner - \$25. Philco 48-472 - \$15. Philco PT-26 - \$25. Pilot Little Maestro - \$95. Pilot T-132 - \$95. RCA Duo Reotron AP-937 - \$75. Slaughter ARC-Detector #103/105 - \$25. Early Aircraft receiver by Electronic Specialty Co. - \$25. Lear Catalin Aircraft radio - \$75. Meissner 17-tube AM-FM tuner - \$30. N.O.S. University outdoor horns - \$15 ea. Early Wilcox-Gay Recordio - \$45. N.O.S. automobile SW converter - \$15. **WANTED:** Pilot radios, any model, any condition. Bill Moore, 3049 Box Canyon Rd., Huntsville, AL 35803. (205) 880-1207

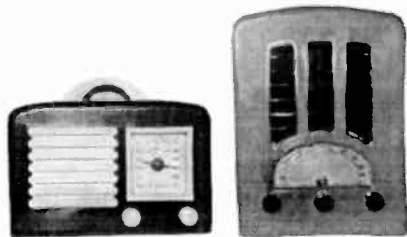

FOR SALE: General Television, black w/white trim (mint) - \$225; and Emerson, shows nice - \$550. Don Hauff, PO Box 16351, Minneapolis, MN 55416. (612) 933-9070. E-mail: McMurdoDon@aol.com

FOR SALE: Book entitled Jim Clark's E.H. Scott Radio Collectors Guide (1925-1946) - \$32.95 shipped. Jim Clark, 3520 Okemos Rd., #6, Okemos, MI 48864. (517) 349-2249

FOR SALE: Amrad Model 2596/2634 detector/amplifier, vgc, by mail auction. SASE for picture and rules. Gene Greneker, 184 Lake Somerset Dr., Marietta, GA 30064. (770) 422-2979

FOR SALE: Grebe RORN with all four coils - \$975. Federal 110, NT - \$750. Federal 57, NT - \$795. Radak R-4, NT - \$285. GE AR1300 xtal rec. - \$350. AA1400 det. amp, NT - \$350. Joe Suihel, 17227 Co. Rd., #4, Avon, MN 56310. (612) 356-7601

FOR SALE: Early spark stuff. Audion control box, unknown make, with single-wing DeForest spherical Audion, 1 good filament - \$3,200. Electro-Import Bulldog spark coil, exc cond. - \$450. Electro-Import 15 1/2" loose-coupler, exc cond. except coil windings are loose - \$350. Rotary spark gap, unknown make, about 1915, on white marble 6" by 11" base - \$350. Large spark key on gray slate base - \$120. Two Wm. J. Murdock 8" ribbon-wound oscillation transformers - \$175 ea. Board-mounted small spark coil, looks like pre-1910 - \$125. Small spark coil on 3" by 6" mahogany box-type base, about 1914-1916 - \$75. (16) keys, various kinds and makes - \$400 all. (13) old sounders/relays - \$300 all. 1896 Ruhm-korff inductor, made in Paris, rebuilt glass condenser and condenser box - \$3,500. Buyer pays shipping. Dennis Branch, 1238 W. Ivyton St., Lancaster, CA 93534. (805) 723-1569

WANTED: Dud WE 216A tubes, and Atwater Kent breadboard variable capacitor housing (only). Steve Pazar, 4950 Deerwood Dr., Santa Rosa, CA 95403. (707) 544-8142. E-mail: pazar@sr.hp.com

WANTED: Collins 51S1 receiver. James Okubo, W6OU, 529 Kevin Way, Placentia, CA 92670. (714) 528-5652

WANTED: Crystal radios pre-1960, catwhiskers, detectors, parts, incompletes, crystal boxes and tins, germanium diode radios, variometers, loose couplers, DeForest DT600 box, Boonton 260A ohmmeter. Collection at (105) pieces, trade my duplicates for yours. The Crystal Radio Guy, Galen Feight, 3104 S.E. 20th, Portland, OR 97202. (503) 231-9708

WANTED: Kennedy Model 281 chassis (early battery set) and an I.P.-501 cabinet, a large wood case. Gary B. Schneider, 9511 Sunrise Blvd., #J-23, North Royalton, OH 44133. (216) 251-3714

WANTED: Catalin radios, cabinets, knobs, parts; large Addison Model 5 yellow knobs, Fada 652 yellow or red knobs, DeWald knobs, others; call me before you run your ad; items made of Catalin; DeForest D-10 coils; Burns black horn bell, can be broken; Music Master wood bell; UZ1325 base; miscellaneous horn speakers and parts; early battery and xtal sets. Call before 2 pm EST or call later and leave message. John Pisarki, 114 Evans Rd., Norristown, PA 19403. (610) 539-0756

WANTED: Pocket-size tape or wire recorders with 2" or smaller reels. Thank you. Guy Doss, 736 Los Padres Blvd., Santa Clara, CA 95050. (408) 241-2437

HAS YOUR SUBSCRIPTION

EXPIRED?

It has if your mailing label reads
"EXP=FEB96" or earlier.
Renew now!

BONUS: Renew before
your "EXP" month and receive
13 issues per year instead of 12!

Renewal rates are:

\$36.95 for Second-Class Mailing
\$53.95 for First-Class Mailing

(Two-year renewals are twice above rates.)

WANTED: Eveready radios, speakers, old flashlights, flashlight catalogs, related items. Subscribe Flashlight Newsletter - \$12 year. Bill Utley, PO Box 4095, Tustin, CA 92681. (714) 730-1252

WANTED: Hitachi TH-666, ivory. Looking for excellent example, complete with leather case and any accessories. Scott Starr, 2845 Page Pl., Montgomery, AL 36116-3142. (334) 281-0960

WANTED: Plastic escutcheon & knob for off & on switch for Philco 90 cathedral. Dale Whitis, 608 South 9th St., Cambridge, OH 43725. (614) 432-4414

WANTED: McIntosh MC 30, 40, 60, 75, pre pan-lac cabinets. Mint tuners. C8-stereo, literature, and accessories. Scott: 310 tuners, MPX adaptors. Thorens 124 w/base or will buy bases. S.M.E. 2000 plinth for Thorens 124. Walt Fleming, 182 Plain Hill Rd., Norwich, CT 06360. (860) 889-1957

ORDER TODAY!

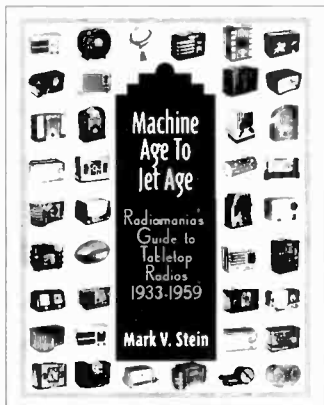

OVER 250 PAGES 1,400 RADIOS

Most not in any other reference
EACH RADIO INDIVIDUALLY PICTURED,
IDENTIFIED AND VALUED

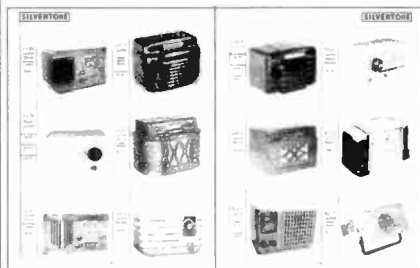

Special For
ARC Readers!

\$24.95 List Price

Now \$21.95!

Only When Purchased From Radiomania Directly
All ARC Orders Autographed by Author

Add \$1.75 Shipping U.S.A., \$3.50 Canada, \$5.00 All Other Countries

Send Check or Money Order Payable to:

Radiomania
2109 Carterdale Road, Baltimore, MD 21209

Maryland Residents add 5% Sales Tax. Allow 2-4 Weeks for domestic orders.



Radiomania™

FOR SALE: Thousands of tested tubes w/warranty! Send for new list with improved discounts and monthly specials. Both xmit and rec. tubes. I have acquired many common tubes recently. Buy those spare tubes for your tube radio, audio, ham and electronics. Most tubes are used at about 33% of new, many are about \$1. I have bunches of octal, older, 7- and 9-pin tubes. All tubes are tested on TV-7D/U tester and then boxed. I give a 30-day warranty. Send wants or SASE with two stamps for list. Daniel Nelson, 1025 E. Desert Ln., Phoenix, AZ 85040. (602) 243-7421, evenings. E-mail: djn@indirect.com

FOR SALE: Profitable electronic surplus business for sale, operating for 30 years, one story sq. ft. building plus 5,500 sq. ft. parking. N.E. Philadelphia. Owner retiring. Call, fax, write: Leon Fertik, 5400 Ella St., Philadelphia, PA 19120. Ph./fax: (215) 455-2121

FOR SALE: Mic ID plates, CBS, NBC, clip-on type. **WANTED:** Broadcast microphones, any shape, will trade. Taking offers on wooden Garod 3-band radio, works. Mike Dupuis, 116 First Ave., Tuckerton, NJ 08087

FOR SALE: Axial lead electrolytics. Fresh new Nichicon miniature 22 mFd. at 450 Vdc - \$1.25 ea. for 8 or more. Includes P&H. Many other types in stock. Write, phone, or fax for free flyer. DH Distributors, PO Box 48623, Wichita, KS 67201. (316) 684-0050 w/f

FOR SALE: Goniometer CFT 473-72 - \$15. Pulse and transmission measuring set, #TT3-25B - \$15. Dual channel amplifiers: CA-1785 (Dept. of Commerce), FA-5342 (FAA) - \$20 ea. (2) EE8 military phones - \$20 ea. Western Electric BC-459A transmitter - \$35. Emerson Disco 80 phonograph - \$25. **WANTED:** Flat dial glass for Sentinel 284 Series radios. Thanks. Del Tysdal, 812 Broadway, Fargo, ND 58102. (218) 287-2562

FOR SALE: Sony 2R-26 with case, manual and accessories. Offers or trade. Al Manieri, 384 Bates St., Phillipsburg, NJ 08865. (908) 454-3699

FOR SALE: Capehart-Farnsworth Model 112 M-2 FM, phono flips records - \$500. Mike Reber, 14507 Madris Ave., Norwalk, CA 90650. (714) 974-4054

FOR SALE: RCA Service Data Redbooks: Volumes I 1923-1927, IV 1947-48, V 1949, VII 1959 - \$150 plus shipping. Henry Galbraith, 1214 So. Alvord, Evansville, IN 47714. (812) 476-7601

FOR SALE: Radiola AC 2-stage audio amplifier Type AC Style 326032 Serial #112969 in very clean condition, no tubes. Harry Hatcher, 1 Hatcher Ln., Friendswood, TX 77546. (713) 482-7642. E-mail: skunky5@phoenix.net

FOR SALE: Selling out dual garage, attic, house, basement, full of radios, speakers, parts, tubes, N.O.S. and pullouts. Test, eqpt., amps, tuners, service data, books, magazines. Cash and carry. No lists. Phone first. F. Krantz, 100 Osage Ave., Somerdale, NJ 08083-1136. (609) 783-0400, 10 am-8 pm EST

FOR SALE: 1964 Gertsch Model FM3AM freq. meter, good cond. - \$50. Clough Brengle old battery-operated signal generator, good cond. - \$30. Military freq. meter BC906D in original wood case, exc cond. - \$40. Taffet Radio & Television Co. audio osc. Model T5382 D/U, fair - \$40. John Be Lille, 302 Herndon St., Park Forest, IL 60466. (708) 747-1850, before 6 pm Central

FOR SALE: The Vail Correspondent, telegraph collector's illustrated quarterly, free ads - \$20 /yr. U.S.A. Sample - \$2. TVC, Box 88-A, Maynard, MA 01754

FOR SALE: Crystal radio kits, complete with face panel and baseboard, 365 variable capacitor, large prewound coil, and many other parts for an old style crystal radio, remit - \$19.50 plus \$3 shipping. Carl & Grace Ent., 5636 Romeyn, Detroit, MI 48209

FOR SALE: Radiola 18 with Model 100 drum speaker, works - \$130. Other radios and TVs. Rod Rowland, 4211 Woodland Ave., Drexel Hill, PA 19026. (610) 623-6141

FOR SALE: Dynakit Mark 2 missing power transformer - \$35. Tube tester GE YTW-1 - \$20. Hallicrafters S40, needs alignment - \$55. Viking record/playback preamp Model B - \$15. Multi Elmac AF68, untested, no power supply - \$25. Hickok 755 noise generator - \$20. Vibroplex bug S/N 162312 with original cord and wedge - Best Offer. Collect ARRL and Radio Engineers Handbooks and odd tubes and tube-related manuals. Maybe work a swap? Joe Monego, 6419 Nashua Dr., Port Richey, FL 34668. (813) 847-0279. E-mail: Radiow2ofb@aol.com

FOR SALE: Tubes, new: 6JS6 - \$17; 6JB6, 6LB6 - \$12; 6KD6, 5692 - \$20; 6JE6 - \$24; 6LF6 - \$22; 6550, Chinese - \$15. Used: 80 - \$4. Frank Johnson, 530 Elford Rd., Fairless Hills, PA 19030. (215) 943-8295

FOR SALE: SR38B - \$45. Military RT285 A/URC-11 - BO. Lists old items - 1 stamp ea.: Radio related; microphone/headsets; electrical miscellaneous; fire; police; meters, flashlights; quack; lighters; slide rules. 16-page illustrated telegraph - \$2 (refundable) plus 2 stamps. A.R. Jacobs, 60 Seaview Ter., Northport, NY 11768. (516) 261-1576

FOR SALE: Emerson Catalin butterscotch radios, (2) - \$625 ea. or make offer. Steve Blank, 407 Hamilton Ave., Linwood, NJ 08221. (609) 926-9277

WANTED

Catalogs from 1950 - 1970
Allied Radio, Lafayette Radio,
Radio Shack

— Top Prices Paid —

Arnold L. Chase — 9 Rushleigh Rd.
W. Hartford, CT 06117
(860) 521-5280

VISIONETTE
MECHANICAL
TELEVISION
24 LINES
AUTHENTIC OPERATION
SCANNING DISK CAMERAS AND RECEIVERS
EASY TO BUILD KITS OR READY TO GO
AVAILABLE NOW!
A collection is incomplete
without the VISIONETTE
FOR INFORMATION, CALL OR WRITE
PETER YANCZER, 836 BRICKEN
St. Louis, MO 63122
Ph. 1-314-822-1748 or a SASE

WANTED: Old guitars & guitar amps, speakers, & effects boxes (reverb, echo, fuzz, wah wah, etc.) Fender, Vox, Gibson, Rickenbacker, Gretsch, Martin, Supro, Univibe, Maestro, Premier. Some old microphones. Altec, Western Electric, Neumann, etc. Happy New Year. Sonny Goldson, 1413 Magnolia Ln., Midwest City, OK 73110. (405) 737-3312. Fax: (405) 737-3355

WANTED: German table radios. Saba, Telefunken, Nordemende, Grundig, etc. Please send pictures and prices. Mike Simos, 100 Commonwealth Ave., Merrick, NY 11566. (516) 223-1470

WANTED: Complete or partial NRI Communications Course (home study) from the 50s to the 70s, including instructional material and built or unbuilt kits. W.J. Klewchuk, PO Box 927, Wadena, Saskatchewan, Canada S0A 4J0. (306) 338-3119

WANTED: Dial glass for Westinghouse Model 697. Bryan Olson, Box 6, Site 17, RR#5, Calgary, Alberta, Canada T2P 2G6. (403) 936-5885

WANTED: Belmont Boulevard portable. Japanese tube portables. Bowmar, Busicom, Melcor, MITS, Summit pocket calculators. Larry Gilbert, 2602 Amapola Dr., Davis, CA 95616. (916) 758-5025

WANTED: Speaker 550 ohms any condition for RCA 110K; antenna for RCA K80, K82, K62. Leon Gann, 1134 E. 50 Pl. N, Tulsa, OK 74126. (918) 425-3590

WANTED: Dials, 3- or 4-inch, BC tuning condenser. Len Gardner, 458 Two Mile Creek Rd., Tonawanda, NY 14150. (716) 873-0447

WANTED: H. H. Scott power amps and preamps. Model 335 multiplex adapter. Fisher 80-C preamp and SA1000 pwr. amp. RCA SP-20 pwr amp. Pye HF-25, Bell 2145/ A and Scott 220A pwr amps. Knight KN370 and Crosby R80 rcvrs. Realistic 212 preamp and 214 tuner Charles D. Maples, 1623 Saddle Dr., Murfreesboro, TN 37130-3410. (615) 893-0255

WANTED: Vertical mount power transformer, approximately H4.5"xW3.5", 360v. David Rush, WB4FRE, 45 High Ponc Ln., Bedminster, NJ 07921. (908) 234-0321

WANTED: Headsets for 1920's battery sets. Martin Lamonde, 265 DuPont, Apt. 101, Quebec, Quebec, Canada G1K 6L8

CLASSIFIED AD NOTICE

Please check your ads carefully before sending them in. Once ads are received, it is not always possible to refund the amount sent, pull the ad or make changes.

WANTED: Left side push buttons w/mechiniziam(?) and top row of buttons for Zenith 70A2. Bill Newell, 31H Rt. 1, Epsom, NH 03234. (603) 736-8319

WANTED: Radiola 17, including junker sets for parts. Jim Wilson, 888 Pearse Rd., Schenectady, NY 12309. (518) 372-9625

WANTED: Speakers. Hi-fi, theatre & commercial, coaxial, triaxial, corner speakers, horn speakers, drivers & crossovers. 888c. Altec, Jensen, Tannoy, Electro-Voice, Stephens, JBL (Lansing), Western Electric, IPC, Heath, RCA, etc. (Blown OK). Happy New Year. Sonny Goldson, 1413 Magnolia Ln., Midwest City, OK 73110. (405) 737-3312. Fax: (405) 737-3355

WANTED: WWII Japanese military radio of any kind; Japanese-made tube portable radios like Crown, Koyo, Excel, Global and so on, anything German airships related. Takashi Doi, 1-21-4, Minamidai, Seyaku, Yokohama, Japan. Fax: 011-8145-301-8069

WANTED: Steering wheel selector knob for Zenith Model 10S669. Jim Walker, 404 Hillcrest, Waterloo, IL 62298. (618) 939-3214

WANTED: General Radio Company test equipment catalogs. Ross Wollrab, 229 N. Oakcrest Ave., Decatur, IL 62522. (217) 428-7385

A. G. Tannenbaum

Electronic Service Data

PO Box 386, Ambler, PA 19002

Phone: (215) 540-8055

Fax: (215) 540-8327

THE



FOR

**Vintage Parts &
Service Data
1920's - Present**

Free Catalog

Credit Cards Welcome

RADIO ★ GRILLE ★ CLOTH

Now **34** patterns & color combinations are available to suit most radio needs! 55c LSASE for samples

**More Good News!
Even More Variety!**

- 1) **Three** new patterns: one for Repwoods, one for 100A speaker, and a great new console pattern.
- 2) Selling off my remaining stock of green Philco V cloth, Now only \$15 for a full 1 1/2 square yard piece. Enough for up to 10 sets.
- 3) Still offering sampler packages of 5 or 10 pieces of cloth for \$20 and \$38, postpaid. See prior issues of A.R.C. for details, or call.

**MICHAEL KATZ
3987 DALEVIEW AVENUE
SEAFORD, NY 11783
(516) 781-6202 (EVENINGS)**

AUCTION AUCTION AUCTION

Southern California
Antique Radio Society (SCARS)
announces its

ANNUAL AUCTION

with a professional auctioneer

FEBRUARY 17
1996

St. Andrews Lutheran Church,
15520 Sherman Way, Van Nuys,
California 91406



INCLUDING

A GREAT SELECTION OF
BATTERY RADIOS,
CATALINS, CATHEDRALS,
TOMBSTONES,
NOVELTY SETS,
TRANSISTORS,
CONSOLES, SPEAKERS,
HAM GEAR, TUBES, HI-FI,
LITERATURE,
MANUALS, ETC., ETC.

INFO & PLEDGES,
call Kosh (213) 465 9919
Fax 213 465 2956
or Richard Gray (619) 390 9128

MEMBERS ONLY AT
THE AUCTION

(Join SCARS at the door)

FOR SALE: Crosley 11-109-U, 1952 - \$55 plus shipping. Robert J. Stone, 721 Fisk St., Piqua, OH 45356-3729. (513) 773-2217

FOR SALE: (12) Radio News, July '25-June '26, bound Vol. 7, good condition - \$145 ppd. Radio Relics, 15556 Sandra Ln., Sylmar, CA 91342. (818) 364-0491. Fax: (818) 367-1442

FOR SALE: Zenith 4T26 tombstone, Deco cutouts.
FOR TRADE: Zenith N731 for Zenith 660 multiband receiver. Rich Yoch, 22410 Bartlett Dr., Rocky River, OH 44116. (216) 331-9206

FOR SALE: N.O.S. tubes, #30 (12) - \$4 ea. Used tubes: #281 (2) - \$16 ea.; #112A (3) - \$12 ea.; #226 (7) - \$7 ea.; #42 (4) - \$5.50 ea.; #5U4 G.B. (20) - \$2 ea. Brass-base tipped UV200 (6) - \$30 ea.; (1) - \$15. Brass-base no tip UV 200 (1) - \$15. Brass-base tipped UV201A (3) - \$35 ea.; (1) - \$20 ea. Brass-base no tip UV 201A (9) - \$20 ea. Bakelite base UV201A (2) - \$10 ea.; UX201A (45) - \$9 ea.; (15) - \$5 ea. Brass base UV199 (2) - \$25 ea. Brass base tipped UV199 (2) - \$35 ea. Bakelite base UV199 (15) - \$20 ea.; (3) - \$12 ea. UX199 (7) - \$15 ea.; (4) - \$9 ea. UX120 (1) - \$15. X99 (3) - \$14 ea. UX371 (1) - \$12. WD-11 tipped w/Bakelite base (2) - \$60 ea.; (1) - \$40. WD-12 brass-base tipped (1) - \$60. WD-12 brass-base duds w/tips (2) - \$15 ea. (1) Bakelite w/tip in original box - \$15. WE (VT-1), (4) - \$100 ea. or BO. For the collector: Daven MU-20, Marathon AC-608R, Marconi VT (golden), Volutron brass-base 201A w/box, RCA neon light bulb - Best Offer on above. WWII Japanese shunt - \$50. All items plus UPS. George Jones, 1943 Palm Dr., Fernandina Beach, FL 32034. (904) 261-6533

FOR SALE: Stock certificates, scarce Emerson Radio Corp. (not common phonograph co.), excellent - \$47 ppd. Gerald Schneider, 3101 Blueford Rd., Kensington, MD 20895-2726. (301) 929-8593

FOR SALE: Heathkit regenerative SW receiver GR-81, mint - \$28. (104) CQ magazines 1959-68 - 50c ea. Arthur Kreitner, 2013 East Belle Ave., Belleville, IL 62221. (618) 233-5610

FOR SALE: Emerson 838 tube & transistor set - \$110. Micronic Ruby SRH-437 - \$100. Sony 610, red, cracks, displays well - \$45. Two Boy's radios N.I.B. - \$50 ea. Penney's RP-1-124, (Bunis, p. 150) - \$75. Suzanne Wyatt, 4403 Boyd Rd., Dearborn, MO 64439. (816) 992-8811

FOR SALE: Aeriola Sr. and Radiola AC 2-stage audio, with tubes - \$450. Atwater Kent breadboard Model TC, with tubes, plays - \$675. A-C Dayton Model X1-20-6, beautiful front - \$145. American Bosch Model 28 - \$125. Steinite 261 Series - \$165. Federal A-10 - \$140. RCA R-28, poor cabinet - \$90. Gloritone Model 27 - \$125. Shell stereo tube amp, (2) channels, (11) tubes, and others - Best Offer. Kolster K-60 - \$125. Acratone wood front and metal arched sides cathedral, nice - \$225. Contact: R. Whetstone, HC 84, Box 44, Arthur, WV 26816. (304) 749-7295, between 5-9 pm

FOR SALE/TRADE: Radios, transmitters, books, parts, tubes, 1930 up. List - \$1 and SASE. Joseph Bedlovics, PO Box 139, Stratford, CT 06497

FOR SALE: 5" scope, EICO Model 460, wide band, instruction book, with spare CRT - \$55 plus UPS (40 lbs.). George Greenberg, 1701 Andros Isle K-2, Coconut Creek, FL 33066. (305) 971-9053

WANTED: Western Electric 713C driver, Lansing 801 driver, Fairchild SMI cartridge, Barber & Howard radio. Vincent Gallo, 532 LaGuardia Pl., #600, New York, NY 10012. (212) 274-0432. Fax only: (212) 274-9416

WANTED: Demco satellite M-10A SWR meter. David Berkey, 226 Greenwood Hts., Bellevue, OH 44811. (419) 483-4688

WANTED: Copy of owner's manual for a Clough-Brenge Model #712 capacitor checker. Kurt Hirsch, 640 N. Galen Dr., La Habra, CA 90631. (310) 697-4989

WANTED: Manual or copies schematics on an RCA Victor Model 9BT9E transistor radio. Florian A. Rogowski, 25103 Cunningham, Warren, MI 48091

WANTED: Chairside radio, blonde/limed oak, Deco; describe design, dimensions, condition; price, photo helpful. Paul Campbell, 107 Edgewood Dr., Conneaut, OH 44030. (216) 593-3273

**HAVE YOU MOVED? ARE YOU MOVING?
PLEASE NOTIFY US A.S.A.P.
SEND US YOUR...
OLD ADDRESS
NEW ADDRESS and
SUB #
MANY THANKS!!!!**

WANTED: Any of the following detector crystals: IN76, IN26 suffix A, B, C; Sylvania D4112, HP420A-95B, IN23, E, F. Jim Krajovic, 546 Sheridan, Pittsburgh, PA 15206

WANTED: Movie projector and films that were used in the radio electronics course in the 50s and 60s, which were supplied by DeForest Training and later by DeVry Technical Institute of Chicago. W. J. Klewchuk, PO Box 927, Wadena, Saskatchewan, Canada S0A 4J0. (306) 338-3119

WANTED: Catalin Emerson Aristocrat/Patriot cabinet, must be excellent shape without hairlines/cracks. Prefer bright red or blue. Bob Zuch, PO Box 4242, Chatsworth, CA 91313. (818) 719-2608

WANTED: Any Collins equipment parts or manuals. Also need manual for Sprague Tel-Ohmike TO-5, TO-6, TO-3, Rider Chanalyst. Phillips scopes 3262, 3265E. Hank Kolesnik, WD5JFR, 4161 Oak Rd., Tulsa, OK 74105. (800) 364-4265

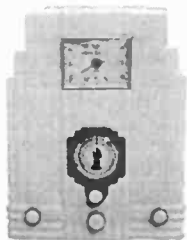

WANTED: Air King Skyscrapers, wealthy extraterrestrial seeks examples of this architectural marvel for new intergalactic communications museum. Please write or call collect: Rain Buttignol, 214 State St., #7, Portsmouth, NH 03801. (603) 427-1384

WANTED: Working Stromberg-Carlson radios. J. Finkelshtein, 205 Alpacas Dr., Wilmington, DE 19803

WANTED: Japanese transistor radios, pocket or coat-pocket size, need not work. Call or write: Bob Davidson, 310 Main St., Concord, MA 01742. (508) 359-2007

WANTED: Spark transmitters and loose coupler crystal receivers; anything prewar Japanese steamships related like N.Y.K. Takashi Doi, 1-21-4, Minamidai, Seyaku, Yokohama, Japan. Fax: 011-8145-301-8069

WANTED: Four prong plug-in speaker for Atwater Kent 67. **FOR SALE:** Six Ediphone cylinders in boxes. Leo Kimmelt, 612 So. 4th, Canon City, CO 81212. (719) 275-4901

WANTED: Sams or Rider's Photofact schematic for Stewart-Warner tabletop Model R116A. Lance Walker, 7116 Reedy Creek Rd., Charlotte, NC 28215. (704) 568-5379

WANTED: Shure 545S, 707A, 54PE. Astatic JT-30, T-3. EV 619, 605, 638. Turner BX/D, CX/D, VT-73. Ready to buy. Tom Ellis, Box 140093, Dallas, TX 75214. (214) 328-3225. Fax: (214) 328-4217

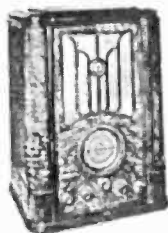

WANTED: Pilot set pictured and similar, also Pilots with drum-type dials. Pay to \$1,200 or have trades. Pay finders fee for information leading to purchase. Shipping from anywhere no problem. Thanking everyone in advance. Bill Moore, 3049 Box Canyon Rd., Huntsville, AL 35803. (205) 880-1207

WANTED: Philco table models, good working condition: 40-95, 40-124C, 41-231T, 41-22CL, 42-322T, 42-PT7. Donn Frederick, 8402 Hwy. 30 SE, Chatfield, MN 55923. (507) 867-4868

www.sscsi.com/machine_age

MACHINE AGESM
browse
for antique
radios and other
design objects on-line.

WWW

Consider This Profitable New
Sales Tool For Your Business.

For Free Information
Call (800) 818-0570

e-mail: sandler@sscsi.com

THE TWENTIETH CENTURY DESIGN SUPER-SITE

FOR SALE: Popular Electronics, 1st issue thru 1973 complete years, plus others. SASE - info. Michael J. Doback, 592 E. Southlawn, Birmingham, MI 48009-4715

FOR SALE: Western Electric 101-F tennis ball, new in the original box, rare, special green tip tube - \$250. J. Arndt, 1215 Division St., Manitowoc, WI 54220. (414) 684-8830, machine on 24 hrs. a day

FOR SALE: Modern Electrics magazines 1910, 1911. QST 1917. Lots of other old literature. Steve Lange, 1351 N. 58 St., Milwaukee, WI 53208. (414) 259-1031

FOR SALE: Beautiful 1930's Emerson table radio in hand-painted case with oriental designs - \$450/BO. Martin S. Doctor, 49 Indian Rock Rd., Nashua, NH 03063. (603) 881-4895

FOR SALE: 10-tube Zenith console, cabinet has been professionally restored, over \$350 in refinishing, chassis needs re-capped and a speaker - \$250. Frank Nocera, 2305 S. Lila Ln., Tampa, FL 33629. (813) 254-8830. E-mail: fnocera@ix.netcom.com

FOR SALE: Taking cash offers on AK 10C breadboard, good physical condition. Leon Bitters, 4209 Logtown Rd., Lena, WI 54139. (414) 834-3707

FOR SALE: Rider's TV Manuals 1 thru 10 & 14; Radio Manuals 4, 6, 8 thru 17 - \$15 ea. Call between 6 pm and 9 pm Monday thru Friday: Frank Waskiewicz, 143 Carl's Path, Deer Park, Long Island, NY 11729. (516) 667-3269

FOR SALE: Antique radios and related items. Send SASE for list. David Petrozello, 80 Lincoln Ave., Johnson City, NY 13790. (607) 770-4026

FOR SALE: TV7/U military tube tester, works - \$85. Bob Rolffness, PO Box 881, Royal City, WA 99357. (509) 765-4721. E-mail: rsrolfne@atnet.net

FOR SALE: Sony Superscope 464D stereo tape deck w/original Sony walnut case, aux. input panel, manual, exc cond. - \$85 + shipping. George Flanagan, W2KRM, 42 Cygnet Dr., Smithtown, NY 11787. (516) 360-9011

FOR SALE: Mics, Volu-tone 1930's ribbon, very unusual - \$250. Shure 55C w/switch - \$175. Others. Tubes: about 25K N.O.S. & used popular audio, sweep & radio. Send wants. Crystal radio 1923 Pandora - \$225. Walt Murray, PO Box 231340, San Diego, CA 92123. (619) 271-1858. Fax: (619) 271-1859

FOR SALE: Regency TR-1, ivory w/case - \$350. Vanguard 888, red - \$90. Bulova 660 - \$60. Danny Brou, 212 Wainwright Rd., Pineville, LA 71360. (318) 445-4843

FOR SALE: B&K 1077B, mint - Offers. HP heart monitor 7830A, Sansui 9000, Magnavox console tube TV - Trades. Jim Addison, 171 Hartford Rd., A-7, New Britain, CT 06053. (860) 223-5141

FOR SALE: Stromberg 240R - \$650. GE white Plaskon C-122, mint - \$175. Hallicrafters S-38-B - \$50, S-40-B - \$75, Best Offers. B. Bank, 303 Devoe Ave., Yonkers, NY 10705. (914) 476-5933

FOR SALE: Plans for 1-2-3-tube radios, crystal sets, copies of old radio ads. SASE. Ernie Nagy, 207 S. Collier, Seawatch Apartments, 4-105, Marco Island, FL 33937. (941) 389-9101

FOR SALE: Admiral Catalin, works, white, like Gloritone (Machine Age Jet Age, p. 234) - \$185. Joe Quinn, 30511 Manhasset Dr., Bay Village, OH 44140. (216) 835-8420

FOR SALE: Philco Model 16 in Continental Custom cabinet, looks like bow-front dresser, record player is not original, good condition - \$150. Spencer Doggett, 61333 North Ridge Trl., Washington, MI 48094. (810) 651-3811

FOR SALE: Junking 1940's Silvertone tabletop radio Model R1171 and 1950 RCA TV KCS47. Richard Korb, 43 River St., Holden, MA 01520. (508) 829-2063

FOR SALE: Radio tubes reasonably priced. Send one stamp for 1,000+ item list to: Joe Knight, 3921 Windolyn Cl. S, Bartlett, TN 38133

FOR SALE: Beautiful 1930's Emerson table radio in hand-painted case with oriental designs - \$450/BO. Martin S. Doctor, 49 Indian Rock Rd., Nashua, NH 03063. (603) 881-4895

FOR SALE: Taking cash offers on AK 10C breadboard, good physical condition. Leon Bitters, 4209 Logtown Rd., Lena, WI 54139. (414) 834-3707

FOR SALE: Rider's TV Manuals 1 thru 10 & 14; Radio Manuals 4, 6, 8 thru 17 - \$15 ea. Call between 6 pm and 9 pm Monday thru Friday: Frank Waskiewicz, 143 Carl's Path, Deer Park, Long Island, NY 11729. (516) 667-3269

FOR SALE: Antique radios and related items. Send SASE for list. David Petrozello, 80 Lincoln Ave., Johnson City, NY 13790. (607) 770-4026

FOR SALE: TV7/U military tube tester, works - \$85. Bob Rolffness, PO Box 881, Royal City, WA 99357. (509) 765-4721. E-mail: rsrolfne@atnet.net

FOR SALE: Remler 21-3 cathedral (Bunis 2, p. 160) - \$175. DeWald B-401 with original box, excellent condition. (Bunis 3, p. 66) - \$95. Emerson Catalin, hairline. Reasonable offers considered. Bob Furtado, 23 Garden Rd., Alameda, CA 94502. (510) 521-3084

FOR SALE: Sony Superscope 464D stereo tape deck w/original Sony walnut case, aux. input panel, manual, exc cond. - \$85 + shipping. George Flanagan, W2KRM, 42 Cygnet Dr., Smithtown, NY 11787. (516) 360-9011

FOR SALE: Mics, Volu-tone 1930's ribbon, very unusual - \$250. Shure 55C w/switch - \$175. Others. Tubes: about 25K N.O.S. & used popular audio, sweep & radio. Send wants. Crystal radio 1923 Pandora - \$225. Walt Murray, PO Box 231340, San Diego, CA 92123. (619) 271-1858. Fax: (619) 271-1859

FOR SALE: Regency TR-1, ivory w/case - \$350. Vanguard 888, red - \$90. Bulova 660 - \$60. Danny Brou, 212 Wainwright Rd., Pineville, LA 71360. (318) 445-4843

FOR SALE: B&K 1077B, mint - Offers. HP heart monitor 7830A, Sansui 9000, Magnavox console tube TV - Trades. Jim Addison, 171 Hartford Rd., A-7, New Britain, CT 06053. (860) 223-5141

FOR SALE: Remler 21-3 cathedral (Bunis 2, p. 160) - \$175. DeWald B-401 with original box, excellent condition. (Bunis 3, p. 66) - \$95. Emerson Catalin, hairline. Reasonable offers considered. Bob Furtado, 23 Garden Rd., Alameda, CA 94502. (510) 521-3084

RADIO XXVII

★ SAME-GIANT ★ ★ OUR 27th ★
LOCATION GET-TOGETHER

An Indoor Old Radio Flea Market

6500 square feet — 90+ Tables Available

Last year attendance was over 600!

Sunday, February 25, 1996 — 8:00 A.M. till 1:00 P.M.

Registration begins for all at 7:30 A.M. in inside heated foyer.

\$4.00 admission (spouse & children free) — Sellers see below.

Westford Regency Inn — Regency Room — Westford, Mass.

(I-495 at Exit 32 — directions below)

Coffee, Donuts, Sandwiches, Soup, etc., will be available.

The Westford Regency Inn and Conference Center is a 193-room hotel with 3 restaurants and over 500 parking spaces. With over 20,000 square feet of conference space, we have room to expand our future radio meets!

Also, visit John Terrey's Collection of Early Radio & Wireless

5 mi. from meet. 1:00 P.M. - 3:00 P.M. Sign up at meet.

Pre-registration & Information: Lisa Friedrichs at: A.R.C., P.O. Box 2, Carlisle, MA 01741 — (508) 371-0512.

Sellers: \$4.00 per person for admission plus \$15 per 8' table (for either 30" or 36" wide). Table sizes and location assigned on a first come-first serve basis. Early registration is recommended in order to obtain space in the main hall. Adjacent rooms will be used for overflow. Four table limit per seller. Sellers may register at the door or may pre-register by mailing payment to: Radio XXVII, c/o A.R.C., P.O. Box 2, Carlisle, MA 01741. (Make check/MO to A.R.C.; Visa or MasterCard OK, too.) If paying by credit card, sellers may pre-register by calling (508) 371-0512 or faxing (508) 371-7129. **New Policy:** After reporting to the registration desk, sellers may enter the hall to deposit goods at their table and then must return to the foyer until the doors open for everyone at 8 A.M. Last year's sellers may reserve the same location as last year if we receive their paid registration by 2/1/96. **Cancellation Policy:** Table fee will be refunded only if requested and the table is resold. If a table is not occupied by 9 A.M., a table may be cancelled and resold.

Overnight stay: Westford Regency Inn at 1-800-543-7801 (In Mass.: 1-800-543-7802.) Mention Radio XXVII for special rates. Bring your family to enjoy indoor pool, health club, racquetball courts, three restaurants, bar, etc. Night skiing at Nashoba Valley Ski Area, only 2 miles away!

Directions: From I-495, take Exit 32. Follow sign to Rt. 110. At stop light, turn right onto Rt. 110-West for .4 miles. The Westford Regency is on the right. Use doors on right (north) side of Inn. Ramps at both show entrances!

Sponsored by:

The Greater Boston Antique Radio Collectors

Not a club, no dues, no newsletter... just a great group of collectors!

Thanks to Antique Radio Classified for organizing this meet.

FOR SALE: Radio books: Cathode Ray Tube At Work - \$15. Automatic Frequency Control Systems - \$15. Mathematics for Electricians & Radiomen - \$15. Vacuum Tube Voltmeters - \$15. Transistor Manual - \$5. FM Modulation - \$15. Radio Operators Licence Guide - \$5. The Oscillator At Work - \$15. Plus shipping. Robert J. Stone, 721 Fisk St., Piqua, OH 45356-3729. (513) 773-2217

FOR SALE: Used test equipment. **FOR SALE/TRADE:** Assorted tubes. Some with good filaments, some duds. LSASE for lists. Please specify which list. Sam W. Wrenn, 2314 Seminole Dr., #1207, Arlington, TX 76010

FOR SALE: Thinning out National stuff, including SW3 and FB7. SASE for list. Hank Bredehorst, KD6TJQ, 2440 Adrian St., Newbury Park, CA 91320. E-mail: QuailHill@aol.com

FOR SALE: Over (300) radio/TV/telegraph books from \$1 to \$200, from Harmsworth to Fleming to Radio Boys; many items of radio ephemera; (30) catalogs; (200+) early radio magazines. 58¢ U.S. stamps for new 22-page list. Roger Hart, 4533 Harvard Ave., Montreal, Quebec, Canada H4A 2X3. (514) 483-3857. Fax: (514) 483-6114

FOR SALE: Axial electrolytics 30 mFd. 450v - \$1.25 ea.; 33 mFd. 450v, 1/2" leads - 75¢ ea.; 100 mFd. 450v - \$3 ea. Plus shipping. Apex Jr., 3045 Orange, La Crescenta, CA 91214. (818) 248-0416. Fax: (818) 248-0490

FOR SALE: Universal black & white test picture tubes (8YP4 & 8XP4) and various troubleshooting equipment, excellent condition. Also classical 78 rpm records. For price list: Nick Conzo, 64 Eagle Ln., Hauppauge, NY 11788. (516) 724-4041. E-mail: nconz@aol.com

FOR SALE: (10) RCA Tube Manuals 1954 to 1975. SASE for list. Michael J. Doback, 592 E. Southlawn, Birmingham, MI 48009

FOR SALE: More manuals, professionally reproduced; RCA AR-88D/F; Hallicrafters SX-28; Scott RCH. Bob Bakinowski, 1524 Saint Tropaz, Tucson, AZ 85713. (520) 624-8029

FOR SALE: Newly acquired! (45) early transistor & novelty radios - \$5-\$25 ea. Guild phone radio - \$65. Emerson 888, Motorola Tandem, Hallicrafters clock radio & AM/FM, 2-tr. boy's radio. Jeff VanAssche, 103 West Silvermeadow, Midwest City, OK 73110. (405) 732-5747

FOR SALE/TRADE: Revox A-77 recorders - \$300 ea. or trade for microphones: Sony ECM-77B, Sennheiser 416, ME-40. Jay Myers, 1010 Graybar Ln., Nashville, TN 37204. (615) 297-5886

FOR SALE: Radios, tubes, test equipment and supplies. Mid-America Antique Radio Store, 233 S. Tulane, Liberal, KS 67901

FOR SALE: Vintage tube equipment. Eico HFT 90 - \$55 ea., (2). Realistic 40A - \$125. Realistic TM/8C - \$85. Scott 99D - \$175. Eico HF81 - \$95. Pilot 602 - \$225. HK TA3000 - \$75. Scott 222B - \$225. Craftsmen RC10 - \$165. Knight 734 - \$165. PASII's - \$125, \$150. Dynatuners - \$115, \$125. Heathkit A9B&A9C - \$95 ea. ST70's - \$225, \$250, \$275. Knight S750 - \$175. Pacemaker 2221B - \$75. McIntosh MA5100 - \$235. Marantz 2238 - \$95. Pioneer CTF1250 - \$85. Akai X1800SD - \$55. Garrard Sychrolab 72B - \$55. Bogen DB130 & R660 - \$225/both. Heathkit AA151 & AJ12 - \$275/both. Sherwood 5500 - \$195. Sherwood 3000 II - \$145. Sansui 1000's - \$175 ea. (2). Pilot AF825 - \$155. Eico ST40 - \$175. Heathkit W5M's, KT66's - \$725/pair. Eico 2715 - \$125. Scott LT10 - \$125. Fisher 90T, blond wood case - \$175. Heathkit SP2 - \$125. Heathkit WAP2 - \$50. Scott LC110 - \$145. Scott LC21 - \$175. Pilot 610 - \$175. All + shipping. Vince Rhea, 2407 Lore Rd., Anchorage, AK 99507. (907) 349-5519. E-mail: 71722.3065@compuserve.com

QUALITY VINTAGE

RADIOS WANTED

for our upcoming
**6th Annual Vintage Radios
Consignment Auction**

to be held on
Saturday, April 13th, 10:00 am

We need an unlimited amount of quality vintage radios for this great auction. Radios needed by March 1st for proper advertising. Call toll-free,

1-800-862-6674

for details. Special commissions & transportation available on larger collections

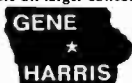

ANTIQUE AUCTION CENTER, INC.

203 S. 18th Ave., PO Box 476, Marshalltown, Iowa 50158
Auctioneers: Gene Harris & Julie Harris Stern, CAI
45 Years Serving America in Iowa, 1950-1995

NEW HI QUALITY

CAPACITORS

Volt 630 Axial Leads	
Value (UF)	*Price/25
.001	\$ 6.00
.0047	\$ 6.25
.01	\$ 6.50
.022	\$ 7.00
.033	\$ 7.25
.047	\$ 7.50
.1	\$ 8.00
.22	\$ 15.00

ELECTROLYTICS

Volt 160 Axial Leads		Volt 450 Axial Leads	
Value (UF)	*Price/25	Value (UF)	*Price/25
22	\$16.00	22	\$28.00
33	\$21.00		
47	\$24.00		

To order, call or write:

BOB'S ANTIQUE RADIOS

111 East 29th St., LaGrange Park, IL 60526
Telephone: (708) 352-0648
Fax: (708) 352-0647

*** Satisfaction Guaranteed ***

*Sold in 25 piece lots only. Shipping & Handling included in price.
Ask about super bulk rates.

- Whole Sale -

WANTED: Any strange or unusual tubes out there? Let me know what you have. Duds, too! Sam W. Wrenn, 2314 Seminole Dr., #1207, Arlington, TX 76010

WANTED: Recording mike for Philco 41 608. Swap Radiola 67 for RAE 79. Harris Schnare, 166 Lowell St., Arlington, MA 02174-3910. (617) 648-7447

WANTED: Supplement (or copy) for Heathkit Model TC-1 tube tester. John Lovering, 70 Park Ave., Hampton, NH 03842. (603) 926-2790. E-mail: JohnRa239@aol.com

WANTED: General Motors Little General cathedral. Richard Arnold, Box 275, Lone Grove, OK 73443. (405) 226-5626

WANTED: Service data for Seeburg Type SCC7 solid-state control center and TSA7 amp. Dwight Baker, 4137 E. 24th St., Des Moines, IA 50317. (515) 263-0278

WANTED: Wooden sets with metal grilles or trim. Jay Malkin, 1250 Galapago, #206, Denver, CO 80204. (303) 623-6451

WANTED: RCA Model 6T10 with chrome stand & trim. Johnny Johnson, 7075 W. 32nd Ave., Wheat Ridge, CO 80033. (303) 274-5474

One Month Free!

BONUS FOR EARLY RENEWALS

If you renew **before** the month shown on your mailing label (your expiration month), you will receive an extra month on your subscription: 13 months instead of 12! 26 months for an early 2-year renewal!

WANTED: Historical information on Presto Recording Corp. Any literature, books, articles, catalogs, correspondence - from any former employees, even anecdotes from users of Presto record cutting equipment. Alan Graves, PO Box 5469, Eugene, OR 97405. (541) 345-3991

WANTED: To restore National NC-240-D, need dial scale and power trans. Will consider junker. Wes Chatterlier, 1950 Chevelle Dr., Baton Rouge, LA 70806

WANTED: SABA 200/10T or Freudenstadt 100 table radios. Phil Holahan, PO Box 392, Grafton, MA 01519. (508) 839-3765. E-mail: holahan@mtpc.org

WANTED: Regency TR-1, Sony TR-63; Japanese-made tube portable radios; anything Hughes Spruce Goose related. Takashi Doi, 1-21-4, Minamidai, Seyaku, Yokohama, Japan. Fax: 011-8145-301-8069

WANTED: Hickok VTVM Model 209B. W.J. Klewchuk, PO Box 927, Wadena, Saskatchewan, Canada S0A 4J0. (306) 338-3119

WANTED: Zenith Trans-Oceanics 7000 American or Taiwanese or 3000-1, working or not. Jim Montague, 1907 South Stanley Ln., Spokane, WA 99212. (509) 535-9576

WANTED: Allen-Bradley one and two watts resistors. Tubes: WE 310A, EYE-6AD6/6AF6. Raul Gil, 180 Union Ave., Belleville, NJ 07109. (201) 751-5959

WANTED: David Grimes radios models: M3XP and 4DL. Mike Grimes, 3805 Appomattox Cir., Plano, TX 75023. (214) 867-6373

4th ANNUAL Rx FOR (Radio) Spring Fever

March 30th, 1996
Washington, PA Fairgrounds

- At the crossroads of the nation - I79 & I70
- Unlimited parking
- Hook-up for 60 RV's
- Indoor drive-in flea market for all collectors - antique, transistor & novelty
- Large auction
- All motels and hotels
- Fabulous Trolley Museum
- Check in at 7:00 a.m.
- Lunch on the grounds
- Auction at 1:00 p.m.

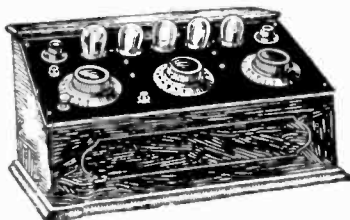

Sponsored By:
Pittsburgh Antique Radio Society

West Virginia Chapter -
Antique Wireless Association

Mid-Atlantic Antique Radio Club

Museum of Radio
& Technology, Inc.

Niagara Frontier Wireless
Association

Buckeye Antique Radio &
Phonograph Club

FOR DETAILED INFORMATION
WRITE TO:

SPRING FEVER 4
4204 Thorn Apple Ln.
Charleston, WV 25313

FOR SALE: Toggle switches at wholesale prices, electronic supermarket, 1001 items, call or write, free list. Fertik's, 5400 Ella St., Philadelphia, PA 19120. Ph./fax: (215) 455-2121

FOR SALE: Books: Practical Antenna Handbook - \$18; 1959 and 1962 GE Transistor Manuals - \$8 ea. Plus shipping. Ross Wollrab, 229N. Oakcrest Ave., Decatur, IL 62522. (217) 428-7385

FOR SALE: Western Electric amplified speaker M101A - \$45; Tektronix dual-trace o'scope M585 - \$285; rare RCA antenna kit MRK40-A, N.I.B. - \$45. RCA 56X5 - \$85; 16T4 - \$70; 3"7/8" scopes - \$35 ea.; 1946 tube tester - \$30; Silvertone M1868 - \$55, M7104 - \$35; 1947 Silvertone or Bendix - \$50 ea.; Farnsworth AT-50 - \$100; nice Zenith 5D627 - \$90; Westinghouse refrigerator H126 - \$75; Radiola 17 - \$40. All plus UPS.

WANTED: Zenith 12H650, 12H696, 6D644, or Philco 37-610 table or 37-604. Dick Sprouse, 6371 Meadow Dr., Gloucester, VA 23061. (804) 693-9608

FOR SALE: Tuska 225, nice - \$450. **WANTED:** Philco 1713 cathedral, Philco 35 cathedral. Ted Depto, The Philco Collector, 913 5th Ave., Patton, PA 16668. (814) 674-8834

FOR SALE: Books for sale: Audels Radiomans Guide, 1955, shows use - \$15. Practical Radio, Moyer/Wostrel, 1926 - \$18. Elements of Electronics, Hickey/Vellines, 1955, shows use - \$6. Reference Data for Radio Engineers, ITT, 4th - \$22; 5th - \$25. Modern Radio Servicing, Ghirardi, 1935 with dj - \$30. Complete Encyclopedia of Television Program, #1 and #2 - \$15 ea. Radio Manual, Sterling, 3rd, with dj - \$30. (2) slide rules for radio: Allied Coil Winding; Parallel Resistance and Series Capacitances - \$7 ea. **WANTED:** For Philips 830A: 2 knobs, grid cap (bronzish) schematic, or will sell for \$85 plus UPS. LSASE (78c) for long list of books and paper. Del Tysdal, 812 Broadway, Fargo, ND 58102. (218) 287-2562

FOR SALE: Collins Station Control SC-101 Ser. 59, vg, less IB - \$700. WE Micro 639-B (Altec) yoke cable, IB, ribbon and sealer OK - \$700. Marcel Vallee, 703 Boul. St. Germain, Rimouski, Quebec, Canada G5L 3S6

FOR SALE: FM tuners: Howard 482, Pilot T601, vg condition - \$25 ea. plus \$6 UPS. Kenneth Miller, 10027 Calvin St., Pittsburgh, PA 15235. (412) 242-4701

FOR SALE: Cutting & Washington 11A with extras, good condition - \$675 or Best Offer. Jim Ellis, Box 822, Rochester, MN 55903. (507) 288-1201

FOR SALE: Walkie-Recordall, uses peanut tubes, SASE for description. John Uscinowski, RR#1 Box 379, Greenwich, NY 12834-9519

Virginia City Radio Museum

109 So. "F" St.

*Wireless and Radio Apparatus from 1915
through the 1950's — Antique Radios,
Speakers, Vacuum Tubes, Microphones,
Telegraph Keys, Photographs, Ham
Equipment & Vintage Ham Radio Station*

We also repair and restore antique radios

*Henry & Sharon Rogers — P.O. Box 511
Virginia City, NV 89440 Tel: 702-847-9047*

FOR SALE: Philco 20, exc - \$200. Philco 37-89, vg original like 38-89, (Bunis 3, p. 158) - \$115. Machine age designs: Bendix 526A, vg - \$60; Majestic 5LA7, cream, good original - \$60; Crosley 56XTW, vg - \$50; Motorola 67X, good - \$40; RCA X351, vg - \$35; Fada 740, white, good - \$60; Kadette 77, exc - \$100; Airline 5D81, vg - \$40. Will sell individually or will trade all or part for a Catalin of equal value. Frank Nocera, 2305 S. Lila Ln., Tampa, FL 33629. (813) 254-8830. E-mail: fnocera@ix.netcom.com



FOR SALE: Reduced prices! Airline as shown: Regency TR5C (mint N.O.S.). Bulova: 270; Hoffman Solar: 706 tan, 706 aqua, 709 white; Magnavox AM-2; Regency leather cases, TR1 instructions (reprint); Sony: TR510, 610, 620, ICR-100, 2R-26, TR-86; Standard Micronic Ruby SR-G430 w/case, box, etc.; Toshiba 7TP-352S, 352M w/box; Emersons 888's; Zenith Royal 500 maroon handwired, 500H. Don Hauff, PO Box 16351, Minneapolis, MN 55416. (612) 933-9070. E-mail: McMurdoDon@aol.com

FOR SALE: Zenith 12H092, 1946 radio/phonograph, repaired and playing - \$200. Sony 7" reel-to-reel tape recorders, all need work. Tanburg Model 64 reel-to-reel. Roberts Model 450. Realistic 999B. Sony Model 230. Fisher Model 70R1 and Series 80 AM/FM tuners - \$50 ea. Zenith Model 6G001Y radio, plays - \$35. RCA Model 811K electric tuning console - \$70. GE Model G-75 console - \$60. Quasar Model VR-1000PW VCR, uses a special shape cassette with 4 tapes - \$50. I also have other early VCR's for sale. John P. Den Hartigh, 5346 East Main St., Kalamazoo, MI 49004. Call: (616) 343-7072 after 5:30 pm, or (616) 342-1512, days

FOR SALE: AK Model 60 chassis, vg, plays - \$60. Rider's 6 & 8 - \$18 ea. Experimental Wireless Stations by Edelman, 1922 - \$35. All in good shape. Marion J. Chelkowski, W5DBN, 1103 Kayton, San Antonio, TX 78210. (210) 533-7876

FOR SALE: New U.S.A. tubes: 6LF6 - \$29; 6LX6 - \$23; 6LR6 - \$21; 6JG6 - \$22; 6JE6 - \$34; 20LF6 - \$25; 8950 - \$60. All are GE, EI, Procom, Raytheon, new Sure 526T Series II - \$85; 444D - \$60; Astatic TUG8-D104 - \$65; TUP9-D104 - \$85; Ranger RC1 9000 - \$125; Knight K810 meter - \$50. Bill Dunham, 305 West Williams St., Waterloo, NY 13165. (315) 539-9727

FOR SALE: Magic Tone whiskey bottle radio, good condition, works - \$295. Phone radio, excellent - \$40. Alan Piorek, WB9RAD, 1050 N. Paulina St., Chicago IL 60622. (312) 235-1523

FOR SALE: N.O.S. 12AX7 - \$9 ea.; 5881 - \$20 ea.; 6V6 - \$9 ea.; 6BG6GA - \$5 ea.; 5U4GB - \$10 ea. Bill Adams, 608 N. G, Imperial, CA 92251. (619) 355-4221

FOR SALE/TRADE: Zenith 5R317 glass rod parts/ parts set. Also nice 6S52 console - \$250. Bill Timoszyk, 35283 Leon, Livonia, MI 48150. (313) 421-2076



ESTES AUCTIONS

Will conduct a Vintage and Collectible Radio Auction.

DATE: Saturday, February 17, 1996
TIME: 10:00 a.m. E.S.T. - Preview at 9:00 a.m.
LOCATION: The Seville Antique Auction Barn
8240 Wooster Pike Road
Medina, Ohio 44256

This will be a large sale with items from two (2) private collections, consisting of many nice radios and related items for all areas of collecting.

- Consoles
- Battery Sets
- Military Pieces
- Horn Speakers
- Wood Table Radios
- Tubes
- Books
- Magazines
- Phonographs
- Test Equipment
- Service Manuals
- Transistor Radios
- Crystal Sets
- Bakelite and Plastic Sets
- Parts
- Advertising Items
- Small Collectibles

In addition we have a huge record collection to sell thousands of 78-45 and L.P. albums to be sold at this auction. Flyers first of February, call or write S.A.S.E. please:

Richard Estes Auctioneer
Estes Auctions
7404 Ryan Road
Medina, Ohio 44256

Phone 216-769-4992
216-769-3987
FAX 216-769-4116
Sale day # 216-769-4910

FOR SALE: Philco 46200, 1946 - \$45 plus shipping. Robert J. Stone, 721 Fisk St., Piqua, OH 45356-3729. (513) 773-2217

FOR SALE: Echophone Commercial receiver, in good condition - \$75. Buyer pays shipping and handling. Jim Barrows, 15121 41st Ave. SE, Bothell, WA 98012-6113. (206) 337-4880

FOR SALE: Basement sale: 3/16/96 9 am-5 pm, 3/17/96 1-4 pm. Radios, some parts. Call for information/directions. Ripley, Box 9374, N. St. Paul, MN 55109. (612) 777-6791

FOR SALE: Tubes, test equipment 1920's parts, silk-covered wire, magazines, books SASE for list. Harry Cap, 190 Beech St., Bridgewater, MA 02324. (508) 697-8648



FOR SALE: Speakers: Dictograph copper - \$395; and Little Spitfire - \$150. Don Hauff, PO Box 16351, Minneapolis, MN 55416. (612) 933-9070. E-mail: McMurdoDon@aol.com

FOR SALE: Browning Laboratories RJ20A AM-FM 15-tube tuner - \$60. Emerson 555 All American, yellow/gold - \$55. H.H. Scott 99D mono tube amplifier - \$45. Hallicrafters SX-100 - \$45. Lafayette KT-320 receiver - \$55. Call: Sheldon Kane, 360 Rhinecliff Dr., Rochester, NY 14618. (716) 442-6338

FOR SALE: Tubes, radios, TV, 40's thru 50's, SASE for list. Lee C. Dickinson, 401-3 Talcottville Rd., Vernon, CT 06066

FOR SALE: Harman Kardon T300X tuner, A500 amp. Fisher 6BQ5 stereo amp SA-16. Offers. J. Stueber, 8920 Lexington Ave. NE, Albuquerque, NM 87112. (505) 299-2414

FOR SALE/TRADE: Collins 32S1 transmitter w/manual, extra finals, excellent - \$200. Trade for: AK or Zenith tombstone or cathedral, early transistor radios, or really cool stuff - what have you? Go ahead, make my day! Call 8 pm-10 CDT: Claude Chafin, NØFMO, 4223 E. 42nd Way, Independence, MO 64055. (816) 478-4518

ARBE-III - Universal Battery Eliminator

\$149.95 Shipped USA

Contact:

Antique Radios Inc.

Box 6352, Jackson, MI 49204

(517) 787-2985 or

Fax (517) 782-7422



FOR SALE: Fada 252, wood - \$250. GE-GD60, (2) - \$100 ea. 10 bands shortwave miniature radio, brings in the entire world!, AM/FM/MV/+7 SW - \$35. Richard Brill, PO Box 5367, Old Bridge, NJ 08857. (908) 679-8026. Fax: (908) 679-8524

FOR SALE: Grunow 1291 console, 1936, 12 tubes, good condition - \$300. Philco Model 37-675 deluxe console, (Ramirez, p. 93) - \$225 pick up only. **WANTED:** Restorable cabinet for Zenith 5-S-218 or 5-S-220 or 5-S-228. Jim Martin, 5826 E. Lakeside Dr., Hanahan, SC 29406

FOR SALE: Sonata TR162A, M.I.B. shirt-pocket transistor, perfect!, made in American Ruky. Atwater Kent 40 w/spkr - \$89. N.I.B. 960 transistor radio analyst - \$125. Tube, transistor radios, tape recorders, TVs, books. For sale, 5 lists - \$3. **WANTED:** Zenith Royal 500, Regency TR1, Atwater Kent tombstones. D.M. Maurer, 29 South 4th St., Lebanon, PA 17042. (717) 272-2481

FOR SALE: Paper stuff: Midwest catalog reprints 1934, 1936, 1938, 1940, 24-tube Royale brochure. E.H. Scott/McMurdo Silver catalog reprints. Inquire, many other items, call. Don Hauff, PO Box 16351, Minneapolis, MN 55416. (612) 933-9070. E-mail: McMurdoDon@aol.com

FOR SALE: Automobile radio vibrators. Free catalog. See our boxed classified ad. Dan Schulz, Antique Automobile Radio, Inc., 700 Tampa Rd., Palm Harbor, FL 34683. (800) 933-4926. Fax: (813) 789-0283

FOR SALE: Consoles for pick up: Philco 38-116, (15) tubes - \$165. Philco 16X - \$125. Stromberg-Carlson 535M, (15) tubes - \$175. Zenith 8S563 - \$150. All excellent. Zenith 7S342 chairside, needs help - \$120. Dennis Schrank, 3129 S. Quincy Ave., Milwaukee, WI 53207. (414) 744-3374



FOR SALE: As shown Radio USA mike style 16-inch tall, all metal, AM/FM - \$35. Red racing car, AM/FM with clock built into sunroof - \$25. Great buy. 1912 Simplex car AM - \$25. 1828 locomotive AM - \$25. Ferrari AM car - \$25. All N.I.B., all transistor. Also (22) Philips/Grunig/Telefunken radios, please ask for prices. Postage UPS and insurance included in all prices. Richard Brill, PO Box 5367, Old Bridge, NJ 08857. (908) 679-8026. Fax: (908) 679-8524

FOR SALE: Radios, tube hi-fi, loudspeakers, parts. Fada P80, maroon - \$95. General Television case - \$60. Air King brown Bakelite - \$75. Zenith 500, maroon - \$90. Knobs for Coronado 43-8190 (Collins, p. 77) - \$45. Tannoy 15" speaker with crossover and case - \$925. Jensen filter unit F-5A - \$195. Scott integrated amplifier 299D - \$175. Dynakit 70 - \$325. Pilot amplifier 264 - Best Offer. **WANTED:** Detrolas, Kadettes, Fada, tube hi-fi amplifiers and mono blocks, Western Electric, loudspeakers, tubes. Ross Litrenta, 1 Wilton Rd., Eastchester, NY 10709. (914) 337-7176

WANTED: BC-222(SCR-195), TBY-7; WWII Japanese military radio of any kind; anything Pan American China Clipper related. Takashi Doi, 1-21-4, Minamidai, Seyaku, Yokohama, Japan. Fax: 011-8145-301-8069

WANTED: Junker or restorable Viking Ranger. VG Valiant. Globe Scout Deluxe, 755VFO, UM-1 modulator, PTTD104. Ron Merrell, 10701 W. 54th St., Shawnee, KS 66203

WANTED: Zenith Deluxe clock radio models L518, J514, J616, with case in good condition. Geo. Boettcher, Jr., PO Box 100, Dingman's Ferry, PA 18328. (717) 686-1200

WANTED: Chapman's Radio Boys To The Rescue. McElroy or Speed-X bug. Collins Signal magazines. Brian Roberts, 3068 Evergreen Rd., Pittsburgh, PA 15237. (412) 931-4646

**PHONE NUMBER FOR
ANTIQUÉ RADIO CLASSIFIED
(508) 371-0512**

**Best time to call is weekdays:
8:30 am to 6 pm Eastern Time**

(Please no classified ads by phone. Thanks!)

WANTED: Nice working transistor radios, pocket or portable, with removable leather cases. Lee M. Metcalf, 9319 Nash Ln., Lake Charles, LA 70605. (318) 598-2913

WANTED: Wave trap filter for use with crystal set and long wire antenna. Knox Lee, 630 Shadowbrook Dr., Columbia, SC 29210. (803) 772-6593

WANTED: Atwater Kent radio Models 82Q, 84Q, 415Q, 515Q, 625Q and 657Q. Dennis Craft, 10513 E. Clinton, Scottsdale, AZ 85259. (602) 860-8951, after 5 pm MST

WANTED: Static electricity! Crooke's and Geissler tubes, Wimshurst electric machine, Leyden jars. Louie Scribner, 1415 West Leigh Dr., Charlottesville, VA 22901. (804) 977-5521. E-mail: lls@virginia.edu

WANTED: Working Grunow chassis 1191 (Model 11G) or sell you my cabinet. A. Bruno, 24 Butternut Dr., New City, NY 10956. (914) 354-8899

WANTED: Technical information on Leeds-Northrup KS 3011. Probably is antique telephone test equipment - bridge? Hugo Kann, 2320 King's Ct., Marion, IA 52302

WANTED: Atwater Kent Model 4600, breadboard and a cabinet for a Radiola IV. Dick Bury, PO Box 25, Gurnee, IL 60031. (708) 623-7746

WANTED: Zenith 3R parts, pot metal parts or whole chassis. Don Smith, 10 Village Hill Rd., Belmont, MA 02178. (617) 484-1572

WANTED: 1000, 3000, 3000-1 Zenith Trans-Oceanics, not working or almost junkers. Jim Montague, 1907 South Stanley Ln., Spokane, WA 99212. (509) 535-9576

WANTED: I buy receivers not working but worth saving. Ham radios only. Ron Merrell, 10701 W. 54th St., Shawnee, KS 66203

WANTED: Zenith Trans-Oceanic Clipper, Model 7G605. Reasonable price, or will trade. Nils Hardin, Box 1094, Summerland, CA 93067. (805) 969-0358

WANTED: Back for my Sentinel Model 284N table radio. There's got to be one out there, somewhere. Harry Hatcher, 1 Hatcher Ln., Friendswood, TX 77546. (713) 482-7642

WANTED: Echophone Model EC-2 dial plate. A junker is OK if dial plate is good. Please, state price including shipment. Rustan R. Crespo, 440 59th St., West New York, NJ 07093-2108

WANTED: 1950's transistors: the component, not radios! I buy or trade. Write for details. Early transistor data sheets and books also wanted. Dr. Andrew Wylie, 21 Brancaster Ln., Purley, Surrey CR8 1HJ, England

WANTED: Midwest 24-tube Royale, and 16 or more tube Midwest models. Steve Chapman, 1602 Alexander, Waxahachie, TX 75165. (214) 938-2726

WANTED: 7027A, 211 & 264C (WE) tubes; RCA LC-1 or SP-515 loudspeakers; open reel tapes. R. Brown, PO Box 686, Farmington, CT 06034. (860) 677-4828

WANTED: Radio-related handbooks. Sprague TO-5, EICO 666 schematic, 1600v capacitors .1 mFd., power resistors. Ed Strickland, AB64W, 155 Perkins Ave., Vallejo, CA 94590-5711

WANTED: Rider's Radio #22, offering \$55 ppd. Dave Metz, 1016 Ridgmont Dr., Staunton, VA 24401. (540) 885-7914, evenings til 10 pm EDT

New Jersey Antique Radio Club

Presents its Spring
Hightstown Meet

Saturday, March 16
7 AM - 1 PM



Location: All indoors (outdoor overflow, weather permitting), at the Hightstown Country Club near Exit 8 of the NJ Turnpike and just off Route 33. From the Turnpike, go east on Rt. 33 about 200 yards (past "Mom's Peppermill" restaurant); continue 1/4 mile to the first jughandle, and come back west. At the first traffic light, bear right onto Monmouth St., then 300 yards to the Hightstown Country Club on the left.

Rates to sellers: \$20 per table indoors (\$5 discount to NJARC members); \$15 outdoors (\$3 discount to NJARC members, no refund); parking, \$2 per car. Food and beverages nearby. There is a Ramada Inn across Monmouth St. [(609) 448-7000]. On Rt. 33 nearby there is also a Day's Inn [800-DAYS-INN, or (609) 448-3200], and the Town House Motel [800-922-0622, or (609) 448-2400].

Contact: Marv Beeferman (609) 693-9430, or Richard Brill (908) 679-8026. Reservations are advised for tables; please send checks to 2265 Emeralda Park Dr., Forked River, NJ 08731.

WANTED

**Unbuilt Heathkits,
Knight-kits, Eico Kits**

— Top Prices Paid —

**Arnold L. Chase
9 Rushleigh Road
W. Hartford, CT 06117
(860) 521-5280**

FOR SALE: The rent man wants higher rent so it's clean-out time. All have got to go. Sold as I bought them; some play, some need work or part(s). Metal case with 9" Jensen PM speaker - \$18. Crosley wood cab. Model 56TNL - \$27.50. VM Model 1404 stereo amp - \$45. RCA mic sound amp Model MI-13296-A - \$65. Hallcrafters TW1000 7-band port. - \$50. Sears 6-band Model 8227 - \$35. Zenith G503Y/5641 - \$27.50. RCA port. PX 600 - \$25. Zenith port. L505 - \$30. Zenette port. 4-tube - \$20. Crosley 10-30-7-M - \$25. Emerson port. 833-B - \$20. Radioette, metal case - \$30. National SW54 - \$32.50. Hallicrafters S38-C - \$35. Hallicrafters SW500 - \$32.50. Hallicrafters 5-R-10 - \$35. Sears Model 8227 6-band port. - \$40. Grundig-Majestic 960 - \$32.50. Nordemende Transita 4-band. port., plays - \$32.50. Emud Rekord Junior 196, plays - \$32.50. (2) Channel Master BC marine small sets Model TR Deluxe, bot - \$25. Have (150) other small sets for sale. Glass or porc. ant. insulators, small - 40c, med. - 50c, large - 75c ea. Carrier-operated loudspeaker 3A control units - \$27.50. Vol. #10 Rider Radio, binder not orig. - \$10. Junking following: Chassis Philco 77, 86, 95, 112, parts. Edison 1/4" flat records - \$3 ea. Howard Sams Dial Cable Restranging Guides #1, 2, 3, 4, all - \$35. Keys, (5) import. - \$24. SCJ38 - \$15. (2) keys Bakelite base - \$15. Sorting out tubes. Will have asssd. tube caddies. Phono-recorder arms, (5), all - \$15. Lot arms, parts only, about 10+ pounds, all - \$12.50. Old parts, all may need some sort of repairs, (5) old variometers, all - \$30. (6) inside coils from junked variometers, all - \$18. 4+ 3 circuit tune coils, all - \$20. Lot 7+ coils - \$15. Lot (5) asssd. coils - \$15. (1,000) asssd. variable cond's., no list - write wants. 1,000's of unlisted items of all types - SASE wants. Atwater Kent radio brass logo plate, 4 1/2" x 2 3/4" - \$8. Have old elect. parts fittings. Test eqpt. old orig. radio and TV service manuals. For sale: Test eqpt. Heath tube testers TC-1 port. case, papers, crack on plastic meter - \$32.50. TC2 port. case - \$32.50. TC-3 metal case - \$30. Model IT-17, will test to 12 pin tubes, metal case - \$35. Superior TV tube tester, port. case - \$30. Following test eqpt. sold as removed. Heath VTVM 1-MII - \$15. PACO V70 VTVM - \$15. Precise 909 VTVM - \$20. RCA Voltohmyst WV77E - \$18. Philco panel VTVM PTE2991 - \$15. Precise 630 and 635 RF-AF-TV signal gens., both for - \$35. Eico 360 FM sweep gen. - \$35. Eico 320 sig. gen. - \$22. (3) asssd. VOM, all - \$10. (4) pieces test gear amp power supply fuse tester, all - \$15. Have some phono record players. 1- to 4-speed automatic units. Emerson Model R tombstone radio, untested, cab. needs some reglue - \$30. Crosley 515 radio, cab. needs work, untested - \$30. Paper. Thordarson Radio Servicing Guides, (2), one no cover, both - \$10. Radio Electronics 101 Circuits - \$7; fair - \$5. Shortwave Radio, (5) 1934 copies, all - \$22.50. Making Things With Tools, 1928 - \$6. Radio News Tube Saga Series, March 1943 to April 1946, per mag. - \$3. QST 50th anniv. issues, ran all 1964, per month - \$2.50. Radio for Everybody, 1922, Lescarboua - \$6.50. Radio Physics Course, Ghirardi, fair copy - \$8. (4) copies Telephony magazine, 1920, all - \$15. (5) copies, 1930's Science and Mechanics, all - \$15. How To Make Commercial Type Radio Apparatus, 1922, 156 pages - \$22.50. Hammarlund SW Manual How To Make Parts - Call Letters - \$9.50. Radio News, 1929 to 1935 - \$2.75 ea. Radio News, 1949 to 1958, copy - \$1.50. Radio Craft, 1946 to 1948, copy - \$1.25. Radio Electronics, 1949 to 1967, 12 for - \$10. Old tubes N.O.S. and used in stock; Type 37, 56, 76 N.O.S. - \$2.50 Ballast tubes

CONTINUED AT TOP OF NEXT COLUMN

CONTINUED FROM BOTTOM LEFT

in stock. 1,000's of unlisted parts. Write wants - SASE. 1 pound asssd. resistors and 1 pound asssd. cond's, both - \$10. Min. parts orders - \$8. All items shipping extra. These items pick up only. 7" Motorola port. TV - \$100. Philco TV 1001 10" - \$115. Motorola 10" - \$75. (3) asssd. tables to hold radio - \$20 ea. Philco Model 65 - \$50. 512 - \$50. Kellogg 507 batt. radio - \$175. Assorted radio phono table combos - \$25 to \$35 ea. Krantz, 100 Osage Ave., Somerdale, NJ 08083. (609) 783-0400

FOR SALE: Many novelty, transistor radios made in Japan from the 1960's. Most radios new in box. Free list - SASE. Bill Hyde, 34 Cerrado Loop, Santa Fe, NM 87505. (505) 466-6613

FOR SALE: Radio books, manuals, catalogues, tube manuals. Early television literature. Many old radios. Large list - SASE. Bill Rolf, 30131 Center Ridge, Westlake, OH 44145

FOR SALE: \$10 specials: Tables, GET155, Panasonic RE-710, portables, Tele-Tone 185, Airline GEN 1329A, Philco 51-631, GE portable. Plus \$5 shipping. Guy Forstrom, PO Box 159, Quinnesec, MI 49876. (906) 774-8116

FOR SALE: Used globe (balloon) tubes, boxed: UX01-A's - \$12 ea.; UX200 - \$12 ea.; UX280 and UX281 - \$15 ea.; Type 50 - \$90 ea.; 56 - \$15 ea.; and 24's - \$10 ea. UV199's - \$20 ea. Also have (1) WE 274-A for - \$100; and (1) WE 262-A for - \$20. All test good, WE tubes: good filaments. Arcturus Blue globe (balloon) tubes: Types 24, 26, 27, 57, 58, and 59 - \$25 ea. Type 45 - \$40 ea.; 51 and 27-tipped - \$30 ea.; 71-A's - \$35 ea. All test good. Type PZ - \$40 ea.; and Wunderlich - \$75 ea., good filaments. Buyer pays shipping. Dennis Branch, 1238 W. Ivyton St., Lancaster, CA 93534. (805) 723-1569

FOR SALE: Bountiful, expanded number of antique and collectible radios, televisions, transistors, military, amateur, novelty radios. Mikes, earphones, telephones, high fidelity equipment. Military uniforms, equipment. Antique radio, medical, scientific, aircraft books. Test equipment. Past buyers: Many recent additions. For list, send two-stamp LSASE to: John Enigi, Sr., K9HJL, 5425 Cherry Ln., Egg Harbor, WI 54209. (414) 743-3672

FOR SALE: Philco 60, (Ramirez, p. 68) - \$100. Silver-tone 6012, top push buttons - \$40. Maguire 561DW, left dial - \$40. All good condition and playing. Send for free picture. Rod Galloway, 2220 Woodbury Rd., Melbourne, FL 32935. (407) 254-0280

FOR SALE/TRADE: Mahogany Regency TR-1, excellent in original box - \$1,000. **WANTED:** RCA 9SX Little Nipper. David Mednick, 1450 Palisade Ave., #5H, Fort Lee, NJ 07024. (201) 461-3082

FOR SALE: Copies of manuals for Eico, Precision, PACO, Triplett, Heathkit and other test equipment. Send large two-stamp envelope for list. Also some test equipment and radios - write your needs. Clayton Mundine, 6112 S. Flores St., San Antonio, TX 78214

FOR SALE: Triplett M-666K VOM and RCA WV-77E Volt ohmyst. Make offer. G.E. Godsoe, 4327 Brookhaven Dr., Greensboro, NC 27406. Fax: (910) 674-2391

FOR SALE: 2.5-volt, 10-amp filament transformers, N.O.S. - \$10 ea. Jim Ussaiis, 24 O'Donnell Dr., Florence, MA 01060. (413) 585-8645

The Antique Radio Club of Illinois'

RADIOFEST '96

August 28th, 29th, 30th and 31st

Holiday Inn Holidome and Convention Center
345 River Road, Elgin, IL 60123

Phone (708) 695-5000, (847) 695-5000 After 1/20/1996

Room reservations are now being accepted in blocks of three or four consecutive days only. One or two day reservations will be accepted after June 25th, as permitted by remaining hotel space.

ARCI is also pleased to offer an "Early Reservation Discount Package" to those persons reserving the first 160 rooms for Wed., Thurs. and Fri. nights, August 28th, 29th and 30th, at the special 1-4 person rate of \$72 + 9½% tax per room per night. In order to be eligible for the Discount Package, room reservations must be made directly with the Holiday Inn, must include the above three nights, and the person making the reservations must identify him/herself as being with the Antique Radio Group. All parking lot assignments will be made by ARCI on a first registered, first served basis. Pre-registration is necessary to help insure a seller's space. Pre-registrations will not be accepted after July 29.

NO OPEN SELLING IN PARKING LOT BEFORE WEDNESDAY MORNING

SINGLE ROOM EARLY DISCOUNT PACKAGE

Registration \$8. One paved seller's space \$15. Auction bid card \$2. Trip to Muchow Museum \$5. Banquet \$20. This \$55 value \$ 35 _____
One extra selling space \$ 30 _____
Second extra selling space \$ 40 _____

DOUBLE ROOM EARLY DISCOUNT PACKAGE

Registration \$8 or \$16 non-family. One paved seller's space \$15. Auction bid card \$2 or \$4 non-family. Trip to Muchow Museum \$10. Two banquet tickets \$40.
This up to \$85 value \$ 60 _____
One extra selling space \$ 30 _____
Second extra selling space \$ 40 _____

NON-DISCOUNT PACKAGE RATES

Registration (\$10 at door) \$ 8 _____
Awards banquet \$ 20 _____
Holiday Inn Guests:
Seller's fee (one blacktop space) \$ 15 _____
One extra selling space \$ 30 _____
Second extra selling space \$ 40 _____
Selling space on grass-car or pickup \$ 30 _____
Selling space on grass-van or lg. truck \$ 40 _____
Vendors Not Staying At Holiday Inn:
Seller's fee (one blacktop space) \$ 30 _____
One extra selling space \$ 40 _____
Second extra selling space \$ 50 _____
Selling space on grass-car or pickup \$ 40 _____
Selling space on grass-van or lg. truck \$ 50 _____

NAME _____ PHONE _____
ADDRESS _____
CITY _____ STATE _____ ZIP _____

Make check payable to ARCI and send to:
Carolyn Knipfel, Rt. 3, 200 Langham, Morton, IL 61550.

Your reservation packet will be held at the door.

For further information contact:

Jeff Aulik, 1708 Parkview Ave., Rockford, IL 61107.
(815) 399-1902 evenings or weekends.

FOR SALE: Tube sets. Microphone radio, black plastic, KSDA on flag, plays, exc cond. - \$150. 1947 Wilmak Den Chum, small handsome wood set, N.I.O.B. - \$90 Hoffman Nugget Model RP402, subminiature tube portable, red and gold, exc cond., no tubes - \$450. Champagne Music champagne-bottle radio, very good cond. and plays, some scratches on label - \$550. Aeriola Sr., early wood panel style, good cond. - \$200. Crosley hybrid book radio, Magic Mood, very good cond. except missing brass retaining screw - \$200. Buyer pays shipping. Dennis Branch, 1238 W. Ivyton St., Lancaster, CA 93534. (805) 723-1569

FOR SALE: Antique Vacuum Tube Book for the years 1918-1944, 960 types, 56 pages; includes transmitting, receiving, klystrons, magnetrons, thyrotrons, VT cross-reference, deluxe bound - \$10 U.S.A. ppd 1st class, - \$12 foreign. R.J. Buchan, WOTJF, 28490 Portsmouth Dr., Sun City, CA 92586

FOR SALE: Excellent reproduction of DeForest loop antenna, fully assembled, correct wire - \$135 plus \$15 shipping. Ed Bell, 5311 Woodsale Rd., Raleigh, NC 27606. Fax/phone: (919) 851-1517

FOR SALE: After New Year sale. 3/8th off Bunis 3rd Edition prices for following console radios: 1941 Airline 62-2504, 1940 Silvertone 6439A, 1937 RCA-Victor 813K, K60, 1941 Philco 41-608, 1938 Philco 38-3. Pickup only. Loren H. Dudley, 14 Valley Rd., Bath, ME 04530. (207) 442-8419, after 6 pm EST only

FOR SALE: Crosley 52TE, ivory, like 56TW (Bunis 3) - \$25. Emerson 509 w/plastic back no cracks - \$30. RCA 97X, 1938, wood, 6 PB's - \$30. Classic Radio & Television, 541 Riverside Dr., Box 61, Augusta, ME 04330. (207) 623-2059

FOR SALE/TRADE: Remco transistor radio and broadcast system kit with box and instructions - \$95. Will trade for working Zenith Royal 500. Dan Schlie, 60 Maple Ave., Port Byron, NY 13140. (315) 776-4596

FOR SALE: All radios excellent & working. Free photos + UPS. Philco cathedrals: 144 (Ramirez, p. 64) - \$475; 91 (Bunis 1) - \$450; 71 (Bunis 2, p. 125) - \$365; 71 (Bunis 2, p. 138) - \$295; 70 (Ramirez, p. 28) - \$325; 89B (Ramirez, p. 49) - \$190; 50 (Ramirez, p. 27) - \$225; 60 (F.O.S., p. 118) - \$185; 20 (Bunis 3) - \$225; 19 (Bunis 1) - \$325. Gloritone 99 (Bunis 3) - \$230. Philco 37-610 bullet - \$125. Philco tombstones: 118 (Bunis 2) - \$160; 620 (Bunis 1) - \$185. RCA 9T (E.O.R. 2, p. 161) - \$360. Echophone S3, S4, (Bunis 3) - \$295. Sparton 410 Junior (Bunis 1) - \$395. AK 90 (Bunis 1) - \$465. Crosley 124 grandfather clock - \$425. Gloritone 27, pointed top, (G.O.R., p. 62) - \$255. Joe Milano, 61 Furman Dr., Wayne, NJ 07470. (201) 694-3721

FOR SALE: Plastic dial covers for AK 145, Emerson 400, Fada 1000, Zenith 7G605 and many others, or your with old cover and/or drawing. Doyle Roberts, HC 63, Box 236-1, Clinton, AR 72031. (501) 745-6690

FOR SALE: LSASE for list of new/used receiving tubes; octal, loctal, miniature, some older. Sell or trade for old or unusual tubes or related material for my collection. John H. Walker, Jr., 16112 W. 125th St., Olathe, KS 66062. (913) 782-6455

FOR SALE: 1940's Genco pinball machine, not operating but very good condition - \$150. Emerson 439 Ingraham cabinet - \$75. Admiral Tilt Top console - \$200. Stromberg-Carlson 69 - \$100. Vance Rayburn, 2718 Homestead Rd., Madison, WI 53711. (608) 274-3002

FOR SALE: Icom R-71A - \$500. Sony Pro-80 - \$225. Mint. Manuals, shipping incl. Joel Levy, 8 Waterloo, Morris Plains, NJ 07950. (201) 285-0233

FOR SALE: Zephyr ZR-930 - \$25. Universal YT-161 N.I.B. with charger - \$25. DBX-II Model 124 - \$20. **WANTED:** 3-transistor radios, any transistor junker sets. Paul Steingel, 2153 10th West, Seattle, WA 98119-2844. (206) 284-8412

NEW AND USED TUBES WANTED

We urgently need the following tubes. All tubes must be well known brands such as GE, RCA, Sylvania, Tung-Sol, Phillips, etc. of US or W. Europe manufacture. New tubes must be in their original boxes. All tubes are subject to inspection. Ship by UPS (ground), we'll mail a check to you upon receipt and testing at prices shown plus your shipping charges. Call or fax for buying procedures and complete bid list. Call before sending more than 10 pieces of one type of tube.

NEW TUBES

01A	\$9.00	6F6G	\$5.20	12BH7A	\$5.10	274B(WE)	\$85.00	6146B/8298A	\$12.00
1L6	8.50	6G5/6U5	8.00	12DW7/7247	9.00	275A(WE)	85.00	6267/EF86	6.00
2A3	24.00	6K5G	5.00	20L6F	16.00	300B(WE)	250.00	6550/A	12.00
2B6	6.00	6KD6	15.00	26LX6	6.00	350B(WE)	100.00	6550 (ST)	34.00
5R4GY/A/B	3.40	6L6GC	8.40	35LR6	6.00	623	35.00	7189/A	5.30
5U4G	6.70	6LB6	7.50	45	30.00	808	16.00	7591 A	20.00
5V4G	4.70	6LF6/6MH6	18.60	50	110.00	805/331A	32.00	8005	50.00
5Y3G	3.80	6V6	6.00	71A	8.20	845	80.00	8068	20.00
6BK4C/6EL4A	8.00	6V6G	6.50	80(ST)	5.60	864	5.00	8908	27.50
6CA7/EL34	11.00	10	25.00	211(VT-4C)	35.00	5691	15.00	8950	25.00
6F5G	5.80	12A	11.00	274A(WE)	110.00	5692	18.00	M-2057	32.00

USED TUBES

01A	\$5.00	10	\$16.00	171/A	\$7.00	245	\$23.00	845	\$31.00
2A3	12.00	12A	7.00	183/483	9.30	246	11.00	7591	8.60
5AR4/GZ34	6.00	20L6F	7.30	210	20.00	247	8.00	8417	8.50
6B4G	6.50	42(GLOBE)	8.00	211(VT-4C)	14.50	250	65.00	8950	12.30
6LF6/6MH6	9.20	45(VT-52)	25.00	230	6.20	280	12.00	V201A	6.50
6V6G	2.10	45	11.00	237	8.50	282	8.00	WD-11	35.00
		50	60.00	240	8.50	401-CARDON	9.60	WD-12	24.00

ANTIQUE ELECTRONIC SUPPLY™

LIMITED PARTNERSHIP

6221 S. MAPLE AVE. • TEMPE, AZ 85283 • (602) 820-5411 • FAX (602) 820-4643 or (800) 706-6789

WANTED: Emerson L style chassis for Regal model, chest, and cathedral; these are L559, L459, L556, L456. Thanks. P. Burton, Box 912, Belchertown, MA 01007. (413) 323-5019

WANTED: Push-pull input transformer, p/n A-4104, for Spartan 931/931AC. Will take complete power converter assembly if necessary. Gary J. Alley, 7100 Constantine Ave., Springfield, VA 22150. (703) 569-8964

WANTED: Two caps for tube shields, 1 11/16" diameter by 1 1/4" high, to complete All Star Junior. H.K. Fredrickson, RR 2, Kemble, Ontario, Canada N0H 1S0

WANTED: Tube sockets Grebe CR9. Also knobs and dial pointer Kadette Clockette K25. Charlie Poulton, 25626 Oaks Blvd., Land O'Lakes, FL 34639. (813) 973-7030

WANTED: Volume control for RCA Victor RE-75 and knobs for McMillan 975. Jerry James, 1413 Gunnison Dr., Wichita Falls, TX 76305. (817) 855-8335

WANTED: Realistic Astronaut-8 multiband, need not work. Phil Vaccaro, 2309 Helena Ave., N, Oakdale, MN 55128. (612) 779-8339

WANTED: Escutcheon for Philco 118 with shadow-graph, any two opening type accepted. R.F. Haworth, 112 Tilford Rd., Somerdale, NJ 08083. (609) 783-4175

**FAX NUMBER FOR
ANTIQUA RADIO CLASSIFIED
(508) 371-7129 – 24 hours a day
Ads – Subscriptions – Book Orders
See inside front cover for details**

WANTED: AK 465Q, 735, 24, 74, 20 big box. TV-2 tube tester. George Folse, KB5WVO, 630 Dolhonde St., Gretna, LA 70053. (504) 362-1896, T/F

WANTED: Electronic Engineering magazine, British, Vol. 24, 1952. Meissner IF transformer replacement manual, 1945-1950. 1946 Hallicrafters catalog. John A. Benyo, 25 Schley St., Garfield, NJ 07026

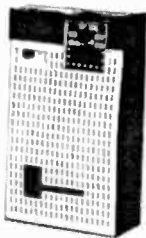

WANTED: Offer stands at \$1,500 (U.S.) for Sony, Tokyo Tsugin Kogyo Ltd. TR-52. Tom Christopher, 5350 Alum Rock Ave., San Jose, CA 95127. (408) 926-2808

WANTED: Front cover for Zenith Trans-Oceanic 3000-1, or junker with good front cover. Ken Armstrong, Box 216, Storm Lake, IA 50588. (712) 732-3012

WANTED: Does anybody, anywhere have an extra RCA WG-301 RF detector probe tip for the WV-98C VTVM? Dan Langston, 820 Harrington Dr., Milledgeville, GA 31061. (912) 453-9066

WANTED: X-ray tubes and machines, Geissler and Crookes tubes, quack medical devices and other large odd-shaped tubes (transmitting). David Rickert, 2107 S. 5th St., Apt. 1, Arlington, VA 22204. (703) 486-2782

WANTED: Original audio transformer for DeForest interpanel MR-6, open OK. Ed Bell, 5311 Wooddale Rd., Raleigh, NC 27606. Fax/phone: (919) 851-1517

WANTED: Following 800 Series tubes: 825 (RCA), 827R, 839, 848, 853, 854, 855, 856, 859, 870, 875, 881, 887, 888, 891, 895, 896, 897, 898, 899. John H. Walker, Jr., 16112 W. 125th St., Olathe, KS 66062. (913) 782-6455



WANTED: Emerson Catalin radios. Would you believe that my mother's last request is that I gather every known example of this radio ever made. I guess she wanted me to suffer a long time. Please write or call collect: Rain Buttignol, 214 State St., #7, Portsmouth, NH 03801. (603) 427-1384

WANTED: Acrosound Ultralinear II power amp, Quad II power amp, Eico ST84 preamp. New tubes: EL37, EL34/6CA7, 6550, RCA 2A3. Mitchell Colby, 2730 Schurz Ave., Bronx, NY 10465. (718) 829-3063

WANTED: Echophone cathedral Model 80 cabinet, absolutely any condition. Atwater Kent cathedral 206 escutcheon. Robert Alexander, 7314 E. Berridge Ln., Scottsdale, AZ 85250-5506. (602) 948-9332

WANTED: Knight Span-Master and Ocean-Hopper. Larry Daniel, 706 Pearson Rd., Wright-Patterson AFB, OH 45433. (513) 754-1567

WANTED: Need all except cabinet for early 40's floor model (half round) Zenith all band. Bill Price, 232 Cherry St., Blountville, TN 37617

WANTED: Chassis and speaker for Majestic Model 44B, dial pointer and face for Arvin 422, knobs and handle for RCA 22S. AK Model 2 breadboard within reason. Vance Rayburn, 2718 Homestead Rd., Madison, WI 53711. (608) 274-3002

WANTED: (Buick) Delco auto radios: 980899, 1950; 980980, 1951/52; 981323, 1953; 981551, 1954; 981652, 1955; 981313, 1957; 981903, 1958; 981966, 1959; 980052, 1960. Alan J. Kriss, 1872 Portsmouth Way, Union, NJ 07083. (908) 688-2092

• • • • •
• **OLD TIME RADIO BROADCASTS** •
• **ON CASSETTES** •
• Many of your old time radio favorites are •
• available on quality cassettes at a reasonable •
• cost. You select the shows you want and •
• purchase them by the hour. Fast, friendly service •
• too. Send for our catalog listing over 5,400 •
• shows arranged by show category & title, •
• many including original broadcast dates. •
• Only \$2.00 (P & H). Send request to: •
• **ERSTWHILE RADIO — P.O. BOX 2284** •
• **PEABODY, MA 01960** •
• • • • •

FOR SALE: Early headphone sets. Brandes, Cannonball, Scientific Electric Works, Dymac, Stromberg-Carlson and N&K double-headsets – \$20 ea. One pair Dictograph marbled brown Bakelite phones, very rare – \$125. One pair John Firth Co., adjustable, made in Germany, very rare – \$80. (6) single-phone headsets from 1915 to 1950 – \$50 to \$5 ea. All in good working cond. Buyer pays shipping. Dennis Branch, 1238 W. Ivyton St., Lancaster, CA 93534. (805) 723-1569

FOR SALE: GE E52 – \$65. Zenith G730 – \$50. Grunow 660 – \$175. Airline 93BR715A – \$40. Sylvania BT3-1W – \$30. All plus S/H. SASE for more. Bud Santoro, 3715 Bower Rd., Roanoke, VA 24018. (540) 774-9153

FOR SALE: Allied (Japan) A-2509 5-band comm. rcvr, works – \$25 + UPS. Donald Sochurek, W191 S7500 Richdorf Dr., Muskego, WI 53150. (414) 679-0212

FOR SALE: Radio receiver CN-208 Serial #1, 250-3100 meters, made for Bureau of Steam Engineering by National Electric Supply Co., date 1-27-1917, side handles missing, one knob is a Marconi, some flaking on main dials; this is actually the very first U.S. receiver built for the Navy, own a piece of history – \$6,000 firm. Pat Stewart, W7GVC, 1404 Ruth Ave., Walla Walla, WA 99362-3558

FOR SALE: Brunswick phonograph, plays Edison and other 78s, cabinet needs refinishing, works good – \$300, you ship. John W. Weyer, 16979 119 Ave., Sperry, IA 52650. (319) 985-2405

FOR SALE: HQ-160 – \$300. NC-88 – \$200. SX-42 – \$300. NC-33 – \$150. S-72 – \$300. T-O 3000 – \$200. Wayne White, 5267 Arcadia Ct., Las Vegas, NV 89118. (702) 871-0754

FOR SALE: Black Sony TR-86 with problems – \$195. Enrico Tedeschi, 54 Easthill Dr., Brighton, BN41 2FD, United Kingdom. Tel./fax: +441273 410749, anytime

FOR SALE: Jefferson Golden Hour Deco clock, running, very good – \$155. Displays great with old radios. Doyle Roberts, HC 63, Box 236-1, Clinton, AR 72031. (501) 745-6690

FOR SALE: Quality reproduction of tube covers for Neutrowound sets – \$20 ea. plus postage. Limited supply. Ed Bell, 5311 Woodsdale Rd., Raleigh, NC 27606. Fax/phone: (919) 851-1517

FOR SALE: Hickok signal gen. 615. Hickok shop bar gen. 246. B&K Precision sub master 2902. Color manuals: Ford, Bendix, Motorola, Phillips, Chrysler. New radio & TV tubes. Ann Bichanich (Jay's), 15 1/2 W. Lake St., Chisholm, MN 55719. (218) 254-4421

FOR SALE: Tubes, schematics, service notes, Riders, Sams Photofact Folders and transistor books, etc. for early radios. LSASE for price list. Sam Faust, PO Box 94, Changewater, NJ 07831

FOR SALE: Satchell-Carlson 416, small, all white – \$75. Coin-op meters, 25c 2 hours, external mount, all metal, 3x5x6" – \$25. Transistors: Penney's 6TP-555 – \$25; Realtone, N.I.B. 2864, black – \$35; Londale (like Zephyr), sky blue, top plastic front has crack, works – \$25; Magnavox AM-84, black – \$25; GE Super Star, red-white-blue, N.I.B. – \$30; Viscount 616A, white/black – \$25; Emerson 977, white/black – \$30; Bulova 626, red, cracked case, plays – \$30; Hi-Delity, TS-650, white/maroon, cracked case and front, works – \$40. Zenith 6J-230, C-8 – \$150. Zenith 7S-633 – \$65. Silver-tone similar to 4763 – \$55. Crosley Trirdyn Super Deluxe with speaker, near mint – \$200. Victor record books: 9-1-24 – \$10; black and blue labels only – \$15; red seal only – \$15. Plymouth auto radio, Mopar 803, chrome front, untested – \$85. Offers? Sure! Del Tysdal, 812 Broadway, Fargo, ND 58102. (218) 287-2562

FOR SALE: (9) ST shape 26 tubes A1 test – \$2.50 ea. (2) 304TL Eimac unused. Frank A. Sanatore, 312 W. Wooster St., Navarre, OH 44662. (216) 879-5950

Catalins Wanted

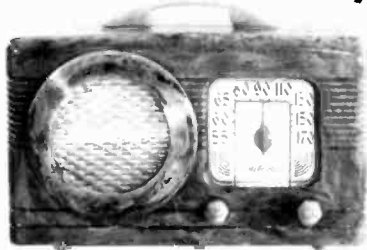

Fada • Emerson • Motorola
Addison • Air King • Arvin • Detrola
Crosley • Symphony • Tom Thumb
I buy all makes and models.

Michael Lawlor
P.O. Box 179 • Santa Barbara, CA 93102
(805) 682-2336

JOIN THE AWA

ANTIQUÉ WIRELESS ASSOCIATION THE ORIGINAL AND LARGEST HISTORICAL RADIO-COLLECTOR GROUP

- Publishes *Old Timer's Bulletin* with:
 - Battery and AC receiver restoration
 - Vacuum-tube history and collecting
 - Old-time amateur-radio contests
 - Communications receivers
 - Free want-sell-swap ads
 - Early television
 - Horn loudspeakers
 - Reviews of current books
 - Keys and land-line telegraphy
 - News of U. S. and foreign clubs
 - Information on public radio museums.
- Maintains unique radio-TV museum.
- Produces the annual Rochester meet.
- Co-sponsors local meets.
- Publishes the annual AWA Review.



Membership is only \$12.00 per year (\$22.00 for two years). Mail check to:

Antique Wireless Association, Inc.
Box E, Breesport, NY 14816

The Radio Collector's Directory and Price Guide, 1921-1965, 2nd Ed.

by Robert E. Grinder

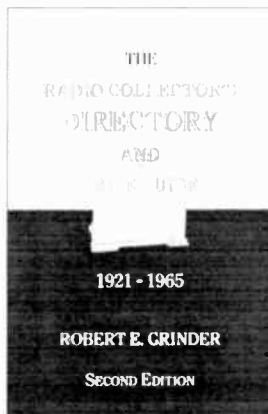

20,000+ Models Listed

U.S. models manufactured from 1921-1965.

Listing includes:

***Model Name,
Year of Production,
Type of Power,
Cabinet Style, and
Current Market Value Range.***

Rewritten Chapters On:

***Early Broadcasting,
Radio Broadcasting Regulation,
Advances Made in Receivers,
The Evolution of Radio Cabinet Styles.***

\$26.95 - Softcover

U.S. Orders - Enclose \$3.00 per order for packing & book-rate shipping if total order is under \$35.00. If using VISA or MasterCard, include name on card, card number and expiration date. Send payment with order. Mass. residents please add 5% sales tax. Money back return policy. Most orders shipped the same day received, but allow 2-4 weeks to receive order. Foreign orders - write for shipping costs, or use credit card and specify air or surface (allow 2-3 months for surface shipping).



**Send Order To: A.R.C., P.O. Box 2, Carlisle, MA 01741
or Call: (508) 371-0512 Fax: (508) 371-7129**



FOR SALE: Crosley Pup base plates, exact reproduction, painted black wrinkle-finish - \$50 ea. Label not supplied Federal Jr. crystal set - \$450. Heathkit missile type diode radio kit, N.I.B. - \$75. Coca-Cola soda machine transistor radio - \$125. Buyer ships. Dennis Branch, 1238 W. Ivyton St., Lancaster, CA 93534. (805) 723-1569

FOR SALE: Hallicrafters S22R - \$95. Continental 5R41 - \$45; 5R10A - \$45. Grundig 2540 - \$65. Sentinel 312P - \$50. Charles Voigt, 94 Cleveland St., Norfolk, MA 02056. (508) 528-7928

FOR SALE: Very old Radio Institute of America lessons, 1 thru 52 bound, 53 thru 68 looseleaf. Wimshurst, Holtz, quack(?) static electric generator. William L. Clark, 15476 Wellington Pl. Dr., Basehor, KS 66007. (913) 724-1203

FOR SALE: Over (55) issues of A.R.C. from 1985 to 1993 - \$30 plus shipping. Dennis Doonan, KG9DO, 3138 94th St., Sturtevant, WI 53177

FOR SALE: 15-tube RCA console radio Model C15-3, works, needs some cabinet work - \$225. Steve Finelli, 37 Stonecroft Dr., Easton, PA 18045. (610) 252-8211

FOR SALE: Teletone 7" TV149, vg - \$75. Arvin 4444 metal midget, white - \$70. W.S. Co. Series 9200 large Deco green marble clock w/horsehead on front, exc, works - \$65. Weston's #1 milli-voltmeter w/case, mint - \$25. All plus S/H. Sam Mannino, PO Box 233, Swarthmore, PA 19081. (610) 353-6747

FOR SALE: Airline 14BR 525A - \$50. Crosley 56TD, damaged - \$50. Crosley 56TD, ivory - \$125. Emerson 520, damaged - \$45. Emerson 132 - \$60; 543 - \$45; 729 - \$70. Motorola 5X3-1U, mint - \$85; 53H, grey - \$75; 68L11 - \$60. Philco 49-901 Secretary - \$125; 46-420 - \$50; 39-25 - \$50. New photo catalog \$1 + LSASE, 2 stamps. Bob Masterson, Box 172, Valley Cottage, NY 10989. (914) 353-3151

WANTED

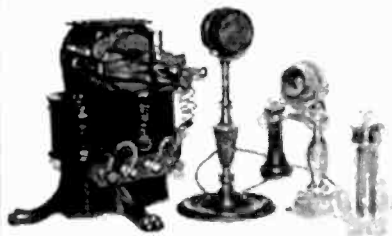

**Batteries, Broadcasting
Microphones, Telephones,
Bi-Polar Motors, Related
Parts, Catalogs, and Early
or Unusual Fans.**

Alan Willms
1823 El Camino Real
Redwood City, CA 94061
(415) 571-9070

FOR SALE: Estate sale. SB220 - \$700. SB200 - \$350. SB614 - \$125. SB610 - \$125. H013 - \$175. RX1 - \$275. AC1 - \$75. HT45 with PS - \$350. S108# - \$175. SR150 with PS - \$225. SR400 with PS - \$325. S20 - \$175. S85 - \$150. TR4C AC4 - \$275. PNB34 - \$75. GLA1000 - \$275. HQ180 S200 - \$450. Ranger - \$250. RF4900 - \$375. RF2600 - \$275. ICF SW1 - \$225. CRF150 - \$175. CRF1 - \$1,000. TS8205 - \$450. VFO 820 - \$150. SP820 - \$75. TS830S # - \$550. DS1A DCDC - \$50. Y0100 - \$225. FC901 - \$125. HTX100# - \$125. V180 2M linear - \$275. 2010 - \$225. TR7400A# - \$150. # with box. All items excellent or like new, offers? Some pick-up only! Jim Weil, KG8SZ, 824 Heather Lake Dr., Clarkston, MI 48348-3648. (810) 391-7687



FOR SALE: Majestic Grundig Starlet transistor radio w/ speaker attachment - \$395. Don Hauff, PO Box 16351, Minneapolis, MN 55416. (612) 933-9070. E-mail: McMurdoDon@aol.com

FOR SALE: Consoles: E.H. Scott Philharmonic, Warrington cabinet, Scot Phantom Deluxe, Braemar cabinet, Mod 262 RCA 10-tube 1934, very good; Philco Mod 90 (Riders 2-22). Books: Zenith Service Manual Vol. 2, Rider's Perpetual Troubleshooter 1931, Rider's Complete Perpetual Troubleshooter, 1933. Troubleshooting and Repairing VCRs. Vintage Radio 1887-1929 pictorial. Radio Set Socket Layout 1921-1935 (RCA book). GE Essential Characteristics Tube Manual. Dozens of Sams TV Photofacts for almost every TV set. Bunis 1st Edition - \$25. Bunis 2nd Edition, (2) copies - \$25 ea. GE Radio Service Guide, Vols. 3, 5, 6. Most Often Needed Radio Diagrams, 1959. The ARRL Antenna Book, 1955. GE Lamp Catalog. Sams Handbook of Electronic Tables & Formulas, 6th edition, a must! Radio Theory and Operating, hardbound, good, 1927. **WANTED:** Rider's 19, 21, 22, 23. Thanks to all, Richard R. Bruning, 1901 U.S. Hwy. 150 N, Apt. B, Galesburg, IL 61401. (309) 344-1968

FOR SALE: Hickck 209A VTVM, IB exc - \$100 ppd. Lucien Goulet, 120 Northfield St., Montpelier, VT 05602. (802) 223-7802

FOR SALE: Used radio books: magazines, handbooks, databooks, etc. List \$1, stamps OK; tube list SASE. Softwave, 1515 Sashabaw, Ortonville, MI 48462

FOR SALE: A few select horns. Send for list, SASE. UX250 - \$100. Floyd A. Paul, 1545 Raymond, Glendale, CA 91201

FOR SALE: Factory service bulletins, lot of (415) covering 1930's to 50's radios, Motorola, Westinghouse, Emerson, RCA, GM, Sears, Stromberg-Carlson, Kaiser Frazer, Grunow, GE, Arvin, Fada, Crosley, Airline, Fairbanks Morse, and Firestone - \$200 for lot + shipping. Phil Guinan, 106 Page Rd., Litchfield, NH 03052. (603) 889-6213

WANTED: Rider's manual Volume 17, also Viking reel-to-reel tape deck Model 86RQH. John S. Jones, 4453 S. 200 E, Anderson, IN 46017. (317) 644-0244

WANTED: Complete chassis for Majestic Model 55. Edna Black, 1400 FM 509, #L-632, San Benito, TX 78586. (210) 399-2382

WANTED: Airline 74BR-1501B, 1507A metal back plate with antenna and dial face, or will buy junker with good cabinet. Chassis not important. Milt Faivre, K4EBT, 1445 2nd Rd. SW, Vero Beach, FL 32962. (407) 778-0648

WANTED: Professional Model TC101 tube chart date book. Roy Cameron, 114 E. 2nd St., Pana, IL 62557-1420

WANTED: Bandleader wants two junk RCA ribbon mikes. Needs housings to hold modern mikes. Dick Parks, 2620 Lake Ridge Ct., Oakton, VA 22124. (703) 242-8161

WANTED: Green Motorola radio Model 55A1. Stromberg-Carlson Model 1121 table model radio. Thanks. Charles Harper, 2000 Jackstown Rd., Paris, KY 40361. (502) 769-0404

WANTED: Radio Troubleshooting Guide by Ghirardi. Dan Olson, E. 4913 Sumac Dr., Spokane, WA 99223. (509) 448-8828

WANTED: Motor Musicradios for motorcycles. Stephan Samourkas, Lustigkullagatan 3A, S-72464 Vasteras, Sweden. Tel.: +46-21-181049

WANTED: Chassis for Philco Model 655. Basket case OK. David Sundblom, 1286 E. Cordova, Casa Grande, AZ 85222. (602) 836-4821. E-mail: dsundblom@aol.com

WANTED: RCA broadcast microphones. RCA 44DX and RCA 77's and mic stands. Call: Andrew Cartoun, PO Box 459, Sandy Hook, CT 06482. (203) 270-0806. Fax: (203) 261-4790

WANTED: Speaker for Belmont 70 Series cathedral radio. Will buy junker if speaker OK. Thanks. P. Burton, Box 912, Belchertown, MA 01007. (413) 323-5019

WANTED: Industrial/special purpose tube manuals or pamphlets. Also any odd or unusual tube types. Will pay \$100 for Eimac 500T tube. John H. Walker, Jr., 16112 W. 125th St., Olathe, KS 66062. (913) 782-6455

WANTED: Top cover for blue Neutrowound. Must have good paint and no rust. Gary J. Alley, 7100 Constantine Ave., Springfield, VA 22150. (703) 569-8964

WANTED: British wood-case radios from the 1930's. Paul Kawerau, 35 Cloke Ct., Hamilton, Ontario, Canada L8T 1N4. Tel: (905) 389-2781, evenings. Fax: (905) 389-0340

WANTED: Squires-Sanders SS1BS-SS1RS receivers & manuals. Harry Weber, 4845 W. 107th St., Oak Lawn, IL 60453-5252

WANTED: Complete chassis for RCA color TV CT100. Neil Dorfman, 7028 Clemens, West Bloomfield, MI 48322. (810) 661-8770

WANTED: ARC R-11, R-23, R-148, BC-453 receivers, any condition; will buy or trade R-19s for them. Also: want unused 5AP1 and 5BP1 CRTs, and 11-pin sockets for them. Also: want CRT tester for above. Bruno R. Ruchalski, PO Box 2153, Clifton, NJ 07015

WANTED: Philco 70, and Crosley 1127 console. Michael Harrington, PO Box 7619, Little Rock, AR 72217

WANTED: Will pay generously for wiring diagram or schematic for Clapp-Eastham HR one tuber so I can restore mine to original. If you have, please contact me. Jim Church, 1035 Suwannee Dr., Evansville, IN 47711. (812) 867-0721

WANTED: An RCA Accucolor TV Model EQ335W 13- or 14-inch screen. Raymond C. Busch, 1911 Quincy St. NE, Minneapolis, MN 55418

Heathkit, A Guide to the Amateur Radio Products

by Chuck Penson

**Documentation of
ALL Heathkit's
amateur products**

**Complete history
of the company**

**200+ sharp
photos**

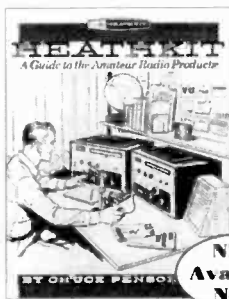

**Most products are
pictured with a
full-page
description**

256 pages

\$24.95

**NEW!
Available
Now!**

U.S. Orders - Enclose \$3.00 per order for packing & book-rate shipping if total order is under \$35.00. If using VISA or MasterCard, include name on card, card number and expiration date. Send payment with order. Mass. residents please add 5% sales tax. Money back return policy. Most orders shipped the same day received, but allow 2-4 weeks to receive order. Foreign orders - write for shipping costs, or use credit card and specify air or surface (allow 2-3 months for surface shipping).



**Send Order To: A.R.C., P.O. Box 2, Carlisle, MA 01741
or Call: (508) 371-0512**

Fax: (508) 371-7129



(Dec-95)

FOR SALE: Arvin 662 – \$50. Bendix 526C green – \$550; 526A – \$55. Firestone 4A2 – \$30. General Electric H600 – \$35. Knight 5A152 – \$35. Mitchell 1250, night light – \$50. Radiola 61-10 – \$40. RCA 56X – \$45. Traveler 5356 – \$35. Zenith L515 – \$35. Tombstones: Crosley 6H2 – \$125. Majestic 20 – \$175. Philco 37-38 – \$80. **WANTED:** Fada radios, Bakelite, Plaskon, wood or Catalin. Steve T. Davis, 6600 Stonehedge Way, Stone Mountain, GA 30087. (770) 413-2265, after 6 pm

FOR SALE: Collection of metal box, gem and band box radios. Zenith long box, good. Paul Recupero, 265 Union St., Portsmouth, RI 02871-2209

Classified Ad Deadline Noon

Feb. 10 for Mar. 1996 Issue

Mar. 10 for Apr. 1996 Issue

Boxed, Photo, & Display Ads - 1st

FOR SALE: Hi-fi speakers: University Model N1 high pass filter N.I.B., Model 4401 tweeter N.I.B. – \$15 ea. (2) 12" Diffusicone coaxial N.I.B. – \$25 ea. 8" Diffusicone, good – \$15. Stromberg 12" RC-58 & 8" red cone, good – \$15. GE Dynapower 850, 8", N.I.B. – \$5. Oaktron 8" FE-8KW, good, pair – \$15 ea. Herald 12" 3-way N.I.B. – \$30. EV-Wolverine LT-12 N.I.B. – \$45. EV-Wolverine LS-12, new – \$35. EV LS-12A cone repaired – \$20. Utah 12" CP12C, new – \$40. Pioneer SE-2P headphones, N.I.B. – \$15. Weathers P-650 power supply & 12" tonearm, wood, repaired – \$25. Grey 16" arm with GE cartridge – \$35. 1958 Hi-fi Buyer's Guide Directory – \$15. Bob Gidney, 411 W. Spruce St., West, TX 76691. (817) 826-5105

FOR SALE: Eico tube and transistor tester 666 and 667 – \$50 ea. BW grid dip meter – \$30. Heath HW 22, PS and mike – \$75. Ameco 6 meter converter – \$25. Eico capacitor tester – \$30. HP 400D VTVM – \$30. Linear systems mobile power supply – \$25. Starlite plastic radio – BO. Heath HA-201A 2-meter amp – \$30. (40) assorted meters – \$75. Plus UPS. **WANTED:** Telonic SM2000 plug-ins. Scanner. HV door knob capacitors. Manual for Millen GDM. Atwater Kent 337 for parts. Bud Machado, AA6HL, 4110 Crestview Dr., Pittsburg, CA 94565. (510) 439-7143

FOR SALE: See tube ad for December. LSASE brings 5-page of radio stuff. Stan Lopes, KB6LGV, 1201-74 Monument Blvd., Concord, CA 94520. (510) 825-6865. E-mail: splopes@aol.com

FOR SALE: Airline 62-177 tombstone, black grille – \$65. RCA 3-BX-671 Strato-World (Trans-Oceanic.), leather – \$75. John Lyle, 1161 S.W. Mulvane, Topeka, KS 66604-1456. (913) 232-0128

VACUUM TUBES

20's – 50's N.O.S. & USED

Reasonable Prices — Free List

**ANTIQUÉ TRIODE
BOX A2, FARNHAM, N.Y. 14061**

Fax/Phone (716) 549-5379

FOR SALE: Capacitors, 3 of each – \$10 plus \$2 shipping. .01 uF. @630.V. dip metal poly. .022uF. @630.V. dip metal poly. .05 uF. @630.V. dip metal poly. .1 uF. @630.V. dip metal poly. .22 uF. @160.V. electrolytic axial. 33 uF. @160.V. electrolytic axial. 47 uF. @160.V. electrolytic axial. 10 uF. @450.V. electrolytic radial. Offer good February only. Frontier Capacitor, Box 218, Lehr, ND 58460. Phone or fax: (701) 378-2341

FOR SALE: Catalins: Sentinel 284, sand colored – \$1,100. AMC peaktop, yellow & red, (3) stress lines – \$1,300. Fada 652, pea green, open grille, has hairlines, some red marbling, nice – \$500. Fada 845, white marbled hairlines on bottom & repro knobs, nice – \$225. RCA Model 8B-43 marbled – \$50. Zenith 3000-1 Trans-Oceanic – \$100. Early 60's bowling pin radio with box, nice – \$125. Prices plus UPS. Vernon Shatwell, Rt. 5, Box 195, Sapulpa, OK 74066. (918) 224-4551, after 7 pm CT

FOR SALE: 50's AR-3t speaker, n/w – \$25. AR-3a pair, need help – \$100, p/u only. Ohmite plate chokes, N.I.B. – \$5. Seco grid circuit tester – \$15. Nobility port. – \$20. Beaut. Miracord t/table – \$45. Oak wall phone repro, WE, late 70's – \$45. RCA EY's – \$35. **WANTED:** Heath PT-1 tuner w/mpx adapter. Chassis for Zenith 6S27. Heathkit manuals. Schematics for SP-2 preamp. UA-2 amp. Allied, Radio Shack, Lafayette catalogs 50's-60's. Thanks! Michael Hagan, 428 Sharron Dr., Waco, TX 76712. (817) 776-4760

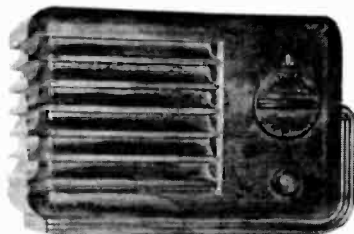

FOR SALE: Swirled maroon Plaskon Mighty Mite, very attractive – \$495. Don Hauff, PO Box 16351, Minneapolis, MN 55416. (612) 933-9070. E-mail: McMurdoDon@aol.com

FOR SALE: Winter clearance, going fast! \$20 ea., \$50/3: Motorola 5C, Regency MR33, Philco 50-522, RCA X551, Silvertone 2038 pink, Telechom 8H59, Grundig 80U, Emerson 691, RCA PX1, Zenith J733, Bulova 100, Mitchell bedlamp. Bob Masterson, Box 172, Valley Cottage, NY 10989. (914) 353-3151

FOR SALE: McKay Dymek DA3 ferrite loop broadcast band antenna – \$100. Rick Krzemien, 5398 Concerto Cir., Concord, CA 94521. (510) 687-2719

FOR SALE: Grundig Majestic 6063XD, AM, FM, SW, PH, good condition, plays – \$100 plus UPS. Art Kingsley, 3 Glen Rd., Highland Falls, NY 10928

FOR SALE: Harman Kardon T300X stereo – \$75. Scott kit Stereo Master stereo – \$50. Motorola 40's auto-radio Mod AS-191 – \$50. All plus UPS. **WANTED:** Super Flex or other radios by Radio Products Manufacturing of Birmingham, Al. Terry Browning, 312 11th St. SW, Alabaster, AL 35007. (205) 620-4345

FOR SALE: Fada 845. Trade for cathedral by Atwater Kent, Lyric, Philco 90, or Regency TR1. Don M. Maurer, 29 South 4th St., Lebanon, PA 17042. (717) 272-2481

Radio Restoration Parts

Vacuum Tube Repair Wafers

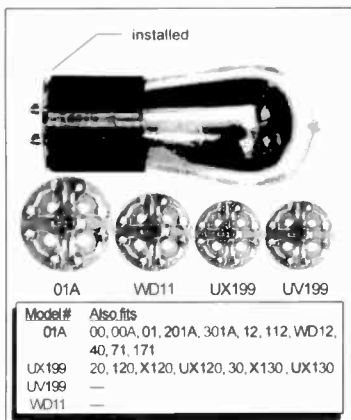

These tube repair wafers are solid-state devices for quick and easy repair of early vacuum tubes. The wafer is installed by simply sliding it over the tube pins and reinserting the tube into its socket. If the filament is intact, but there is little or no emission, the filament may be lit for best visual effect. However, the tube can be open filament.

No change in radio operating voltages is required. Any number of tubes may be repaired in a radio. If wafers are installed on all tubes, the B+ voltage may usually be reduced without sacrificing volume or sensitivity. Performance will vary between radio models.

\$10.00/each (\$7.50/ea. 3 or more)

New Atwater Kent Breadboard Switch

Exact replacement for Models:

9 • 9C • 10 • 10A • 10B • 10C • 12

and all additional models with board mounted switch.

Newly manufactured under high pressure heat from the same type brown thermoset resin used in the original. Beryllium copper spring contacts are used for long, trouble-free life. Custom built knurl is used to exactly reproduce the original.

\$50.00/each

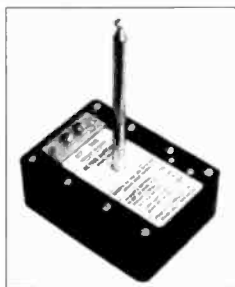
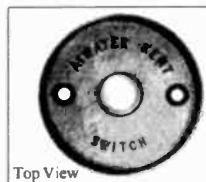
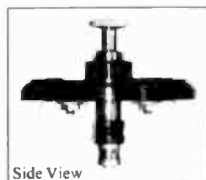

Active Antenna

Allows antique radios which were designed for a long wire outdoor antenna to operate on a 42" indoor whip antenna. Portable, operates from a 9 volt battery.

Only \$34.95

Order from: PTI, 7925 Mabelvale Cutoff, Mabelvale, AR 72103

Orders shipped UPS, prepaid in continental U.S. Please allow 3 weeks for delivery.

Arkansas residents add 5.5% sales tax.

To Order: Call (501) 568-1995



CRYSTAL CLEAR, Vol. 1

By Maurice L. Sievers

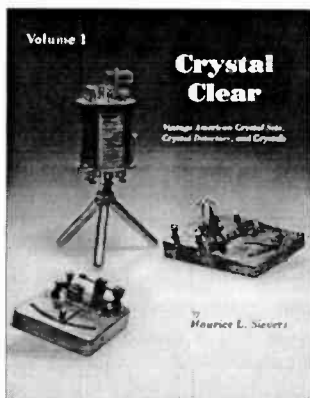

750 Illustrations – 570 Crystal Sets
341 Detectors – 207 Crystals
Perfect for the beginning collector!
Useful for the experienced too!

Crystal Clear is the most comprehensive reference for collectors, historians and anyone interested in early radio. In addition to the many excellent photos and reproductions of ads, *Crystal Clear* includes lists showing all sets by manufacturer, set name, selling price and date of manufacture. 8 1/2" x 11", 282 pages.

\$29.95 – Softcover

* **Crystal Clear, Vol. 2 – \$29.95 ***

COMMUNICATIONS RECEIVERS

3rd Edition – Revised & Expanded

By Raymond S. Moore

402 radios pictured!

Sharper, clearer photographs

A comprehensive guide to 700 vacuum tube communications receivers from 1932 to 1981. In addition to Collins, Hallicrafters, Hammarlund and National, 66 other manufacturers from Allied to Tobe are included. New section on military receivers.

The description of each set includes years, band coverage, type, filters, tubes, a photo in many cases and other info. 8 1/2" x 11", 115 pages.

\$19.95 – Softcover

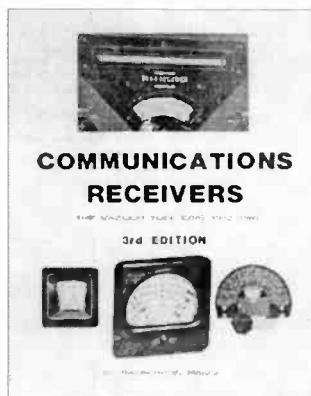

U.S. Orders - Enclose \$3.00 per order for packing & book-rate shipping if total order is under \$35.00. If using VISA or MasterCard, include name on card, card number and expiration date. Send payment with order. Mass. residents please add 5% sales tax. Money back return policy. Most orders shipped the same day received, but allow 2-4 weeks to receive order. Foreign orders - write for shipping costs, or use credit card and specify air or surface (allow 2-3 months for surface shipping).



Send Order To: A.R.C., P.O. Box 2, Carlisle, MA 01741
or Call: (508) 371-0512 Fax (508) 371-7129



CRYSTAL CLEAR, Vol. 2

By Maurice L. Sievers



479 All New Photographs and Illustrations Cumulative Index of Both Volumes

Crystal Clear, Vol. 2 supplements the first volume. It identifies an additional 172 crystal radio sets, 91 crystal detectors and 26 crystals by manufacturer, model, year produced, description and original selling price. Further research on many of the crystal sets covered in Volume 1. Detailed history on the Philmore Manufacturing Company and the Western Manufacturing Company. 8 1/2" x 11", 252 pages, softcover.

\$29.95

* **Crystal Clear, Vol. 1 is also available for \$29.95 ***

U.S. Orders - Enclose \$3.00 per order for packing & book-rate shipping if total order is under \$35.00. If using VISA or MasterCard, include name on card, card number and expiration date. Send payment with order. Mass. residents please add 5% sales tax. Money back return policy. Most orders shipped the same day received, but allow 2-4 weeks to receive order. Foreign orders - write for shipping costs, or use credit card and specify air or surface (allow 2-3 months for surface shipping).



Send Order To: A.R.C., P.O. Box 2, Carlisle, MA 01741
or Call: (508) 371-0512 Fax: (508) 371-7129



Order These Popular Books From Antique Radio Classified



Price
Guide

The Collector's Guide to Antique Radios 3rd Edition by Marty & Sue Bunis. 8,500+ Battery & AC sets from the '20s to the '60s. Updated prices. Over 650 all new photos, 278 pages. — \$18.95



Price
Guide

The Collector's Guide to Transistor Radios by Marty & Sue Bunis. This book will help you identify the most sought-after vintage transistor radios. Over 2,200 models, all with current prices. Over 400 color photos, 256 pages. — \$15.95



Price
Guide

The Radio Collector's Directory and Price Guide, 1921-1965, 2nd Ed. by Robert Grinder. Over 20,000 radios by manufacturer, model number, year, etc. with prices. Radio history, cabinet style chapters. No photos, 264 pages. — \$26.95

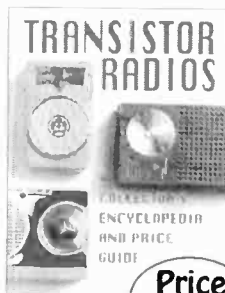

Price
Guide

Transistor Radios, A Collector's Encyclopedia and Price Guide by Robert Lane and David Lane. Identification guide to over 2,500 transistor and novelty radios. History and key to collecting chapters, 170 pages. — \$19.95

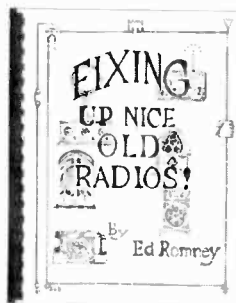

Fixing Up Nice Old Radios by Ed Romney. Written by a retired radio instructor. Plastic binding. 300+ figures, 185 pages. — \$25.00

Old Time Radios Restoration and Repair by Joseph J. Carr. A self-paced training guide. History, theory and practical operation of antique and classic radios. 200 illustrations, 256 pages. — \$18.95



U.S. Orders - Enclose \$3.00 per order for packing & book-rate shipping if total order is under \$35.00. If using VISA or MasterCard, include name on card, card number and expiration date. Send payment with order. Mass. residents please add 5% sales tax. Money back return policy. Most orders shipped the same day received, but allow 2-4 weeks to receive order. Foreign orders - write for shipping costs, or use credit card and specify air or surface (allow 2-3 months for surface shipping).



Send Order To: A.R.C., P.O. Box 2, Carlisle, MA 01741
or Call: (508) 371-0512

Fax: (508) 371-7129



(Feb-96)

Order These Popular Books From Antique Radio Classified



Crystal Clear Volume 1 and Crystal Clear Volume 2 by Sievers. *Comprehensive reference to crystal sets, crystal detectors, and crystals. Each volume contains different illustrations and information. Order by volume. — \$29.95*



Flick of the Switch by Morgan McMahon. *The classic photo reference guide for 1930s - 1950s radios. 1000+ photos of radios, 5" x 8", 263 pages. — \$11.95*



Guide to Old Radios, Pointers, Pictures, and Prices, 2nd Ed. by Johnson. *Introduction to radio collecting. Includes hundreds of photos and a price guide. 272 pages. Available late October. — \$19.95*



Antique Radios Restoration and Repair, by Johnson. *Beginner's introduction to troubleshooting and repairing AC table model radios. 145 pages. — \$14.95*

Price
Guide

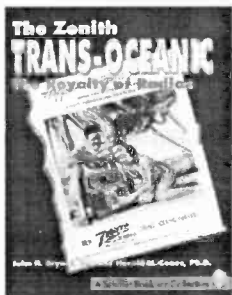

The Zenith Trans-Oceanic: The Royalty of Radios by Bryant and Cones. *Presents the fascinating story of the development and use of the Trans-Oceanic. Several photos, documents, ads, etc. 160 pages. — \$24.95*

Communications Receivers, 3rd Ed. by Ray Moore. *Information on vacuum tube receivers by 66 manufacturers. 402 radios illustrated, 115 pages. — \$19.95*

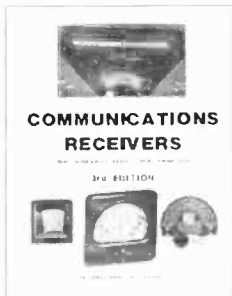

U.S. Orders - Enclose \$3.00 per order for packing & book-rate shipping if total order is under \$35.00. If using VISA or MasterCard, include name on card, card number and expiration date. Send payment with order. Mass. residents please add 5% sales tax. Money back return policy. Most orders shipped the same day received, but allow 2-4 weeks to receive order. Foreign orders - write for shipping costs, or use credit card and specify air or surface (allow 2-3 months for surface shipping).



Send Order To: A.R.C., P.O. Box 2, Carlisle, MA 01741
or Call: (508) 371-0512

Fax: (508) 371-7129



(Jan-96)

FOR SALE: Walter Ashe catalogs: 1952, 1953, 1954 – \$15 ea. Allied: 1941, 1956, 1958, 1959, 1960, 1963, 1968 – \$20 ea. Other catalogs and literature for sale. No lists. Ray Schmidt, 607 1 Ave. SW, Austin, MN 55912. (507) 433-0069. (507) 433-3250

FOR SALE: Bridge-tested oil-filled capacitors. The good ones that don't deteriorate, example: 20@330VAC – \$5 ppd U.S.A. List SASE. Robert Larson, 1325 Ridgeway, Medford, OR 97504

FOR SALE: Emerson 849 brick/orange – \$185. Zenith 500 owl eyes – \$100. Zenith 500H black – \$95. Novelties: Big Hulk – \$60. Batman – \$60. **WANTED:** Raytheon T150 or T100. Harald Herp, 6615 Michele Ct., Huntingtown, MD 20639. (301) 855-7071

FOR SALE: Grundig SO-290, Hallicrafters S47, Radio Masters, 230v. Variac, transistors, record changers, catalogs, books. F.H. Yonker, P.E., W21BH, 1229 Inverary Pl., State College, PA 16801. (814) 867-1400

— WANTED —

PICTURES FOR PHOTO REVIEW OR TELEGRAPH REVIEW PHOTOS MUST BE SHARP IN DETAIL A SHORT DESCRIPTION IS A MUST! SEE PHOTO REVIEW PAGES FOR ADDITIONAL INFORMATION

FOR SALE: Climax Ruby (Stein, p. 51) – \$1,250. Climax Ruby Supreme, (E.V. 1, p. 120) – \$1,250. Climax Emerald (E.V., p. 119) – \$750. Stromberg-Carlson Model SC-340Y – \$300. Stromberg-Carlson Model #10 – \$175. Philco Model #37-610, mint – \$250. George Breckenridge, 17790 W. Pond Ridge Cir., Gurnee, IL 60031. (708) 356-5787

FOR SALE: New photo catalog, 150+ radios – \$1 + LSASE 2 stamps. Bob Masterson, Box 172, Valley Cottage, NY 10989. (914) 353-3151

FOR SALE: Rider Radio Vols. 5, 6, 7, 9, 10, 11, 13 – \$20 ea. Beitman 1941, 1942 – \$7 ea. TV Schematic books, early 50's – \$6 ea. Eico 625 tube tester – \$25. + shipping all items. Steve Rosenfeld, PO Box 387, Ocean Gate, NJ 08740. (908) 269-2022, days

FOR SALE/TRADE: SX 99 MKI, spkr. Heath HX-11, SB-301, SB-220. Ray Williams, 4521 Whitfield Ln., Saint Louis, MO 63134-3821. (314) 428-1963

FOR SALE: 24-tube E.H. Scott Model 800-B – \$425. Mark Hewitt, 6659 Tipperary Trl., Roscoe, IL 61073. (815) 623-8729

FOR SALE: Victor R-35 1929 console, excellent working condition, interesting dial, pickup only – \$150. Matthew Hinson, 1663 Bridge St., Merrick, NY 11566. (516) 379-3601

FOR SALE: Black Zenith 500H – \$100. Black Zenith 500E – \$50. **WANTED:** Simpson 55 tube tester Blackhawk Radio Rider 18-21-22. Leon Gann, 1134 E. 50 Pl. No., Tulsa, OK 74126. (918) 425-3590

FOR SALE: Drake T4XC + pwr – \$199 + shpg. **WANTED:** Guthman U17, U50. Henry Mohr, W3NCX, 1005 W. Wyoming, Allentown, PA 18103

FOR SALE: Hickock 605A tube tester, no manual – \$50. EV mikes, 644 – \$100 ea. GE Tube Essential Characteristics Book – \$15. Heathkit stereo FM tuner AJ-JZ – \$50. Bill Cherenksy, 6 Kate Ln., Metuchen, NJ 08840. (908) 549-2165

FOR SALE: Tombstones. Crosley 5V1, @8 – \$140. Emerson Mod 36 or 45, 5 to 2 gang(?) tuner, @8 – \$65. Silvertone Mod 1905 B/C SW 4KN 6 to 3 gang, @8 – \$80. Plus P&S. Bernie Samek, 113 Old Palmer Rd., Palmer, MA 01069. (413) 245-7174

FOR SALE: Rider service available – \$3 + SASE. Stephen Schaub, PO Box 1258, Peoria, IL 61654

FOR SALE: Western Electric 7A amp with 216A W tubes, looks superb! – \$300 plus UPS. Jerry Katz, Aborn True Value, 43B Harvard St., Brookline, MA 02146. (617) 277-4533

FOR SALE: Crosley 25AY chassis, escutcheons, knobs, working, (Bunis 2) – \$50. Dan Merz, 312 Sierra St., Richland, WA 99352. (509) 375-1334

FOR SALE: Mallory 3-gang inductor 54-216MHz – \$12 ppd. R.J. Eastwick, N2AWC, 224 Chestnut St., Hadonfield, NJ 08033. (609) 429-2477

FOR SALE: Philcos: 49-905, P.T. 30, 48460, 51-530. Hallicrafters S103 SW, Motorola 56R-65T21. Heath TC 2-T.T. Eico 950 C.R.C.B. Ted Gasiorek, 201 Golden Ave., Briggsville, WI 53920. (608) 981-2051

FOR SALE/TRADE: Offers or swap: Four Motiograph theater amps, Schober tape reverb, pair of RCA Telephone hi fidelity theater amps, Western Electric 707A amplifier supply voltage cabinet, RCA World's Fair horn 1939, and Western Electric station monitor. Michael Payne, 803 S. Taylor, Alvin, TX 77511. (713) 331-9217. Fax: (713) 585-2727. E-mail: we300b@aol.com

FOR SALE: Ivory Bulova 250 with two small defects and repro label – \$350. Jerald Hueber, 1368 King Richard Pkwy., W. Carrollton, OH 45449. (513) 866-6958

FOR SALE: Grunow 1291 Teledial, mint – \$400. Day-Fan 7 5050, WT – \$85. Sky Buddy – \$65. Crosley 51-S, WT – \$120. Radiola III, NT – \$80. Dave Fitzenberger, 7638 2nd Ave. So., Richfield, MN 55423. (612) 866-9211

FOR SALE/TRADE: 1955 Heathkit Catalog. 1955 Heathkit Specifications and Schematics book, 96 pgs. **WANTED:** Catalogs: Radio Shack 1954, WRL 1952-1956; Walter Ashe 1955, 1956; BA 1954, 1955. Alvin J. Bernard, PO Box 690098, Orlando, FL 32869-0098. (407) 351-5536

FOR SALE: Upright Edison Diamond Disc phonograph – \$450 pickup only. Emerson 530-A, needs new dial sting – \$40 + UPS. Jeffrey Williams, 201 E. 62nd St., Apt. 8C, New York, NY 10021. (212) 754-5865

FOR SALE: For U.P.S. (35) 7-pin sockets, extra cans; (25) 9-pin sockets, some cases; (5) IF trans. 455 Kc; (7) 85 Kc; (4) Meissner components in cans. Old TV trans. Thomas F. Pollock, WB6ZYE, 243 West Lime Ave., Monrovia, CA 91016-2714. (818) 359-8013

FOR SALE: All channel UHF converter Model 99, new in box – \$10. L. Gardner, 458 Two Mile Creek Rd., Tonawanda, NY 14150

FOR SALE: 16 pic. tubes, old types, 7" to 21" – \$150 or BO. Radios, TVs. Malcolm D. Burdick, W1NOO, 156 Station Rd., Hampton, CT 06247. (860) 455-9640

FOR SALE: Bunnell & Co. telegraph sounder and key, nice original board and finish – \$80. Don Robinson, W3ES, 515 Chester Dr., Lower Burrell, PA 15068. (412) 335-4775

The Collector's Guide To Antique Radios - 3rd Edition

By Marty & Sue Bunis

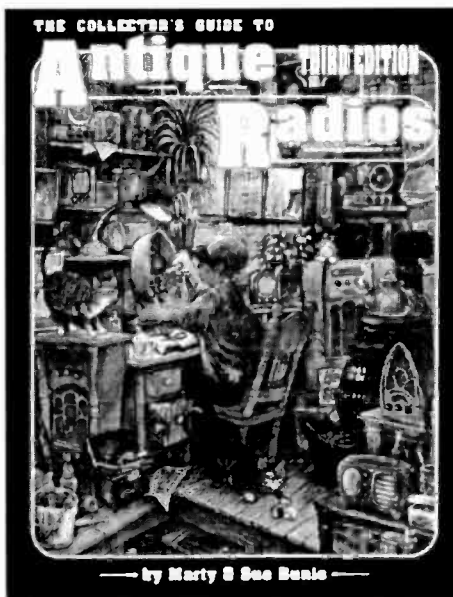

8,500+ Battery & AC sets from the '20s - '60s
Expanded listing of radios from the '60s
Over 650 all new color photographs
Updated prices
\$18.95 - Softcover

There are no transistor radios listed in the third edition. You will find them in *The Collector's Guide to Transistor Radios* available from A.R.C. for \$15.95.

U.S. Orders - Enclose \$3.00 per order for packing & book-rate shipping if total order is under \$35.00. If using VISA or MasterCard, include name on card, card number and expiration date. Send payment with order. Mass. residents please add 5% sales tax. Money back return policy. Most orders shipped the same day received, but allow 2-4 weeks to receive order. Foreign orders - write for shipping costs, or use credit card and specify air or surface (allow 2-3 months for surface shipping).



Send Order To: A.R.C., P.O. Box 2, Carlisle, MA 01741
or Call: (508) 371-0512 Fax: (508) 371-7129



FOR SALE: Linda red-headed doll radio - \$200. Bill Coolahan, 1450 Miami Dr., NE, Cedar Rapids, IA 52402-2933. (319) 393-8075

FOR SALE: N.R.I., one - \$60. RCA Service, one - \$50. Simpson 340 - \$40. Pick up only. Dewey Shaffer, RD2, Box 104-B, New Paris, PA 15554. (814) 839-4728

FOR SALE: Linda radio dolls, red nightie, original box - \$100; dolls, no box - \$50. Lloyd Nesbitt, 2840 Alabama St., La Crescenta, CA 91214. (818) 248-5855

FOR SALE: Rider's manuals: Radio 1, abridged 1-5; TV 1 - \$60 each delivered. Rich Jendrucko, 458 Hillvale Turn East, Knoxville, TN 37919. (423) 523-7323

FOR SALE: Kennedy 281 receiver, WT - \$675. Western Electric 4-D receiver, was station monitor at WFLA Tampa 1920's, WT - \$375. Crosley Ace Model VI, WT - \$250. Freed-Eisemann Model NR-6, No. 840-A 5-tube Neutrodyne, WT - \$250. Golden Leutz Pliodyne 6, 1925, 35-3500 meters including original construction blueprints (two sheets), schematic, instruction book, color advertising flyer, original invoice, less cabinet and tubes - \$165. RCA AR 8510 15-650 Kc VLF regenerative receiver with copy of manual, WT, less cabinet - \$250. Howard 5-tube Neutrodyne Serial No. 91, NT - \$135. Parker Heinemann, 87 Cove Rd., Lyme, CT 06371. (813) 262-2568

FOR SALE: Electro-Voice microphone Model V2 - BO. Bing Crosby Jr. jukebox - \$275. Victor VVXI oak console crank phono, exc - \$325. Victor VVXI mahogany console crank phono, exc - \$250. American Bosch 808P, butterfly grille - \$85. RCA 100A & 101 spkrs - \$35 ea. Ericsson crank cradle phone, European plug - \$125. Orig. Edison 10-pedal phono horn - \$150. Columbia cyl. phono - \$425. Grebe Synchrophase, chassis only, no cab. - \$110. Philco #60 cathedral - \$175. **WANTED:** AK 206 chassis, Crosley Buddy Boy chassis, AK 82 sprk - cash or many trades. J.L. Acciavatti, PO Box 231, Southborough, MA 01772. (508) 476-3229

FOR SALE: Radiola III diagram, professionally enlarged with itemized parts list giving all values - \$3 plus LSASE. David P. Smith, Box 81, Olney, IL 62450

FOR SALE: Transistors: Sony TR-730 - \$60; Philco T45-124 - \$25; Realtone TR-8611, cracked, displays well - \$30; Westinghouse H61-7PT - \$40; Motorola X11G, green - \$30; Portable RCA B-411, brown marbled - \$50. Novelities: Sanyo ball radio, no stand, red - \$10; Switchet ball radio that lights up - \$25; Garfield - \$25; red dice - \$10; cannon - \$30; Ti-Nee crystal diode toy-type, black - \$60. Table radios: Fada 845, brown marbled - \$200; RCA 66X11 - \$40; Truetone D-2616 - \$30; Stewart-Warner swoop-side, like football, 0755 - \$40; Arvin metal radio, the one with louvers - \$45; Silvertone metal, like Arvin - \$45; Arvin 542-T, mint - \$60. Some radios are untested. Shipping is extra. Call for details. Jim Martes, 15400 E. 2nd St. S, Independence, MO 64050. (816) 836-0668

FOR SALE: Panasonic RF-B600 digital multiband - \$185. DEC professional portable microfiche reader - \$80. **WANTED:** Zenith 9S324. Zenith 8-inch speaker/transformer assemblies: P/N 49-203 for 7S232 and P/N 49-183 for 12S232. Armand Cote, 11 Berge Ln., Derry, NH 03038. (603) 437-4431, before 10 pm EST

FOR SALE: Test equipment manuals (copies): Hickok, Precision, Eico, Superior, Heathkit and many others - SASE for list. John Snow, 4539 N. Bartlett Ave., Shore wood, WI 53211. (414) 964-0194

FOR SALE: Beautiful Nordemende Isabella top-of-the-line German console, same chassis for Tannhauser-Arabella, looks and sounds great, excellent cond., 11 tubes - \$200. Vern Oehlke, Box 112, Ghent, NY 12075. (518) 392-4945

FOR SALE: (1) 12A; (1) 99X; (1) 01-A Kenrad - \$50. N.O.S. sealed boxes. (2) good used 203A RCA - \$30. Pete Putra, 1429 Lawndale Ave., Racine, WI 53403 (414) 632-2543

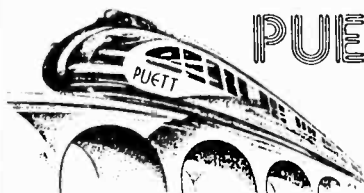

PUETT ELECTRONICS

P.O. BOX 28572 DALLAS TX 75228

NEW CATALOG 77

**GET THIS
WORLD'S
GREATEST
RADIO
CATALOG**

CATALOG 77/PLL-2 (56-PAGES) ----- \$5.00 POSTPAID

YOU RECEIVE A \$6.00 DISCOUNT COUPON WITH THIS CATALOG!

MORE THAN 1,500 DIFFERENT ANTIQUE RADIO PUBLICATIONS FROM 1902 TO THE 1960'S OFFERED, REPRINTED BOTH SIDES OF THE PAGE AND BOUND!

WE OFFER BOOKS, INSTRUMENT MANUALS, SERVICE DATA, SALES BROCHURES, ATWATER KENT, RCA, CROSLY, ZENITH, ETC. FACTORY SERVICE MANUALS, SCOTT, MC MURDO SILVER, STROMBERG CARLSON, CAPEHART, FISHER CLASSIC RADIO LITERATURE, DIRECTORY OF ANTIQUE RADIO SERVICES, SCHEMATIC DIAGRAMS, OLD TIME RADIO PROGRAMS ON CASSETTES, TUBES, TUNING DIALS, KNOBS, 30-SERVICES & DISCOUNTS WITH **THE PUETT ELECTRONICS ANTIQUE RADIO CLUB** AND MUCH MORE - ORDER YOUR CATALOG TODAY!

OUR NEW BOOK "THE WORLDS LARGEST RADIOS" IS NOW AVAILABLE, PHOTOS, SCHEMATICS, BY J.W.F. PUETT - \$14.95 PLUS \$2.00 HANDLING. INCLUDES SCOTT, MC MURDO SILVER, PHILCO, RCA, ZENITH, LINCOLN, FRED EISEMANN, FISHER, MEISSNER, MAGNAVOX, CROSLY + MANY MORE!

WANTED: AK 165 chassis in working condition. (Bunis 2, p. 30). Thanks. Steven L. VanderLinden, KC6YRB, 2123 Elizabeth Ave., Winston-Salem, NC 27103. (910) 727-1247

WANTED: Electron tubes, ball bearings, Collins Avionics parts & equipment, aircraft instruments, Bell helicopter parts, Grimes lights and synchros. Hy Ness Company, 709B Delair Rd., Cranbury, NJ 08512-4212. (609) 395-1116. Fax: (609) 295-1117

WANTED: Copy of instruction manual for RCA WR-49A or Eico 324 signal generator. Thanks. Henry Boersma, 6253 Dolores Dr., Oak Forest, IL 60452. (708) 687-9444

WANTED: DeForest D-10 loop, picture, physical dimensions, mechanical description, electrical specifications to assist duplication. William P. Turner, WAOABI, 1117 Pike, St. Charles, MO 63301

WANTED: Antique medical devices especially violet rays, scientific, small table fans and radios. Richard Cane, 1333 N.W. 127th Dr., Sunrise, FL 33323. (305) 846-7116

WANTED: Meters for RT-834/GRC-106, AM-3349/GRC-106 & MD-522A/GRC, part of AN/GRC-142-C Hut. Edward J. White, WA3BZT, 809 Seymour Rd., Bear, DE 19701-1121. (302) 322-1313

WANTED: Tube amps, limiters, record cutting lathes, tube tester (Hickok, Western Electric), capacitor checker (Sencore, Elco), Tektronix 570 curve tracer Dyna 70 cages. Kim Gutzke, 7134 15th Ave. S, Minneapolis, MN 55423. (612) 869-4963

WANTED: Dow key 115-volt with SO239 connectors. Robert Braza, N1PRS, 23 Harvard St., Pawtucket, RI 02860. (401) 723-1603

WANTED: BC-342-N and FT-154 shock mount for BC-348-Q. Michael Harrington, PO Box 7619, Little Rock, AR 72217. (501) 223-9056

WANTED: Atwater Kent radio Models 273D, 312, 412, 255. Jeff Aulik, 1708 Parkview Ave., Rockford, IL 61107. (815) 399-1902

WANTED: (4) knobs for Atwater Kent tombstone radio 145. F.E. Oswald, 711 Carl Ave., Altoona, PA 16602

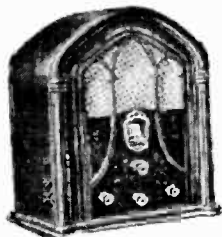

WANTED: Large multiband Lafayette cathedrals & tombstones such as the one pictured. Have cash or trades and can pay finders fee. Thanking everyone in advance. Bill Moore, 3049 Box Canyon Rd., Huntsville, AL 35803. (205) 880-1207

WANTED: 1938 Zenith Stratosphere console, good to restorable condition. 1939 Zenith console Model #8S463, good to restorable condition. 1940 Zenith Model # OS567 chassis less tubes. Jerry H. Reed, 4438 S. Santa Fe Pl., Tulsa, OK 74107. (918) 446-4276

WANTED: RCA Radiola I, 1923 xtal set. Will trade AK 10 breadboard for nice one. Byron Bernor, 2479 W. Sierra Hwy., Acton, CA 93510. (805) 269-5459

WANTED: Driver assembly for Atwater Kent Model E speaker, coil open OK. Manual for Triplett Model 850 VTVM. James F. Crews, HCR 63, Box 4, Arbovale, WV 24915. (304) 456-4798. E-mail: fcrews@nrao.edu

WANTED: Restored Hammarlund SP-600 VLF, SP-300 or Collins R-389 VLF. Lloyd Burton, 11657 Roseglenn St., El Monte, CA 91732. (818) 443-4438

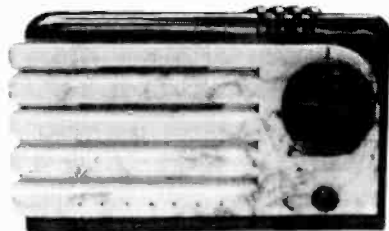

WANTED: Prewar plastics by Detrola, Kadette, RCA, Philco, etc. My cousin Vinny and I we was thinking, "Hey, we got the cash," (a cool mil, to be exact), "so let's spend some before dem girls gets hold of it." You know what I'm saying? Please write or call collect: Rain Buttignol, 214 State St., #7, Portsmouth, NH 03801. (603) 427-1384

WANTED: Big Navy motor-generators, starters, control units, antenna switches. I can pick up. William Donzelli, 304 South Chester, Park Ridge, IL 60068. (708) 825-2630. E-mail: integrat@usr.com

WANTED: Knobs & push buttons for 1941 Crosley 02CA console. Thanks! Mark Cowart, N4FBL, PO Box 550766, Jacksonville, FL 32255-0766. (904) 724-1364

WANTED: Tom Thumb Jr. 1933 (Bunis 1, p. 33). Victor Zummo, 20344 Mobile St., Canoga Park, CA 91306. (818) 883-8468

WANTED: RCA AVR5A, AR60 Western Electric, or equipment marked Civil Aeronautics or any airline. James Treherne, 11909 Chapel Rd., Clifton, VA 22024. (703) 830-6272

WANTED: Bakelite table radios, Crosley, Emerson, Zenith, and so on. Radios should be in excellent condition. Need pictures. Takashi Doi, 1-21-4, Minamidai, Seyaku, Yokohama, Japan. Fax: 011-8145-301-8069

WANTED: Any information on Churchill radio with Ozarka chassis. Also need more info on Clago radio. Can anyone help? Peter Burton, PO Box 912, Belchertown, MA 01007. (413) 323-5019

WANTED: Odd brand 01-A tubes. There are over (500) different ones. Ask for list of ones I have. Ed Bell, 5311 Woodsdale Rd., Raleigh, NC 27606. Fax/phone: (919) 851-1517

WANTED: Push-pull input transformer, p/n MS-200, for Zenith 770-B/775-B, chassis no. 2059. Will take junker chassis if necessary. Also need (9) gold-colored tube shields for this chassis. Gary J. Alley, 7100 Constantine Ave., Springfield, VA 22150. (703) 569-8964

WANTED: Westinghouse WL-461, Taylor 833, DeForest 430 through 440 tubes, duds OK. John H. Walker, Jr., 16112 W. 125th St., Olathe, KS 66062. (913) 782-6455

FOR SALE: Rare Fada 1000, blue, marbled, mint – \$2,500. Bob Masterson, Box 172, Valley Cottage, NY 10989. (914) 353-3151

FOR SALE: Transcription disks, 16 inch, 200 disks, various artists, good condition. Rek-O-Kut turntable (Rondine) with 16-inch arm and new Shure M55E on mahogany base, sold as complete package only – \$1,000. George Breckenridge, 17790 W. Pond Ridge Cir., Gurnee, IL 60031. (708) 356-5787

FOR SALE/TRADE: Best offer by February 10th. Brach, U.S. Army Signal Corps World War I, field induction telegraph. Just like the one shown in the November 1995 issue of A.R.C. in the photograph on page 20. (I like crystal sets and tube-type communications and ham gear.) Harry Blesy, N9CQX, 9S740 Clarendon Hills Rd., Hinsdale, IL 60521. (708) 789-1793

FOR SALE/TRADE: Grebe CR9 – \$650. Collins 516E1. **WANTED:** Jan. 1930 Radio News, UX213 tubes, Clapp-Eastham HZ, Paragon detector or DA2 early Collins transmitters. Stuart Mount, K2OA, 35 Grand, Highland, NY 12528. (914) 691-7957

FOR SALE: Pepsi 1930's bottle radio. GE H-500, cocoa, mint. Teletone. Ivory Emerson 706-B. Stromberg-Carlson 1500-H, mint. Catalins: Emerson AU-190, BT-245, (3) Fada bullets, red Commander, Bendix, white Patriot – \$475. Butterscotch Garod – \$350. Parts sets Temple and Patriot. Transistors: Crosley book-radio, tiny Channel Master micrettes N.I.B., turquoise 888 Vanguard, (2) Boy's radios, Universal PTR-62B N.I.B., Realtone white TR-8611. Also have unused old circus posters and seven-piece Tiffany desk set. Ted Chronister, 7073 Carlisle Pike, #26, Carlisle, PA 17013. (717) 766-6436

FOR SALE: ARRL handbooks, over (200), 1926 to 1990's – SASE for list. Parker Heinemann, W1YG, 87 Cove Rd., Lyme, CT 06371

FOR SALE: Crystal sets. Howe radio receiver – \$100. Spencer pocket radio – \$100. Loose coupler set – \$500. Plus UPS. Chuck Bray, 1322 Ivy Rd., Bremerton, WA 98310. (360) 373-1013

FOR SALE: National NC101X, matching speaker – \$275. HRO coils G&H – \$100 ea. Military handset H-350/U – \$10. RME DB 22A, HF 10-20, VHF 152A – \$125. Many others – call. Write – free list. Richard Prester, 131 Ridge Rd., West Milford, NJ 07480. (201) 728-2454

FOR SALE: Magnavox drawer, no rust – \$50. Green Eveready Model 2 with speaker – \$160. Michigan one-tube – \$125. Plus shipping. Ross Mason, 715 S. Pennsylvania Ave., Mason City, IA 50401. (515) 423-4687

FOR SALE/TRADE: Offers or swap: McIntosh 50W2 no PS, McIntosh AE2 with PS N.I.B., McIntosh MC30 power xfms and chassis logos, Martin KT 66 audio amps Model 352A very unique, Fisher 70 and 80 amps, KPRC station monitor amp PP 2A3, and (3) General Radio audio xfms. Michael Payne, 803 S. Taylor, Alvin, TX 77511. (713) 331-9217. Fax: (713) 585-2727. E-mail: we300b@aol.com

FOR SALE: Heathkit CR-1 crystal receiver – \$150. RCA 5T, with manual – \$50. New-in-box Lafayette HE-10, plus matching speaker – \$200. Misc. crystal sets – \$10 to \$25. Regency ACTC4HLU scanner – \$10. N.O.S. TP32A Aiwa recorder – \$20. Philco 41-221 – \$25. Details – SASE. David P. Smith, Box 81, Olney, IL 62450. (618) 392-6601, supertime

FOR SALE: Zenith: 5S-127 cabinet, 5F-134, 5F-166 chassis, power pack; 7S-488 chassis; 12" speaker 49-249; gold and silver tube covers; colored advertising tag. Bill Coolahan, 1450 Miami Dr., NE, Cedar Rapids, IA 52402-2933. (319) 393-8075

FOR SALE: Antique radio parts, 1920's, early 30's: Eria, Acme, General Radio, etc. Most new-in-box – SASE for list. John Snow, 4539 N. Bartlett Ave., Shorewood, WI 53211. (414) 964-0194

FOR SALE: United Motors Model 4048 and Monarch, both thirties wood Deco toaster radios – \$85 and \$95. Philco 41-226 Deco-styled wood table – \$70. R. Burick, 274 14th St., Ambridge, PA 15003. (412) 266-4516

FOR SALE: Moving to apt., attic & garage full of old radios, TVs, quack medical machines. Lots of test equipment, some work, some don't. RCA 103 speaker & others. Power, output & interstage xfms several various restorable chassis. Lots of radio & TV parts. (1) Philco console, some big dial Zenith. About (600) or more early Sams sets. Lots of literature. About (2,000) N.I.B. tubes & lots of used. No list, bring truck & cash. Phone first. Donald Smith, 1323 North B St., Hamilton, OH 45013. (513) 863-2060

FOR SALE: RecordRadio radio-player recorder, books, catalogs, manuals. H.N. Felder, 7517 Granada Dr., Bethesda, MD 20817

FOR SALE: Chinese heavy chrome keys, N.O.S. – \$65 ea. ppd. Int'l. MO please. **WANTED:** 6D5, not 6D5G/6D5MG, RCA 65BR9. Sony TR8. Japanese Mt & Sub Mt tube portables. Japanese tr. radios using oval-shaped tr. solar radios. Hallicrafters 505 (doghouse TV). European-made tube & tr. hybrid radios. Japanese WW2 sets. WW2 German peoples radios. Noriyoshi Tezuka, 1-11-2-403 Hiroo, Shibuyaku, Tokyo 150, Japan. Fax: 011-813-3440-8396

WANTED

WESTERN ELECTRIC

TUBES, SPEAKERS, HORNS & AMPS

TUBES: Telefunken, Genalex, RCA, Radiotron, etc. General Electric, Amperex, JAN, Sylvania, GEC, National Union

McIntosh, Marantz, Dynaco, Jensen, Linn, Levinson, Fisher, Leak, Tannoy, Altec, EV, Thorens, EMT, JBL ... Amps, Spkrs., Turntables

MAURY CORB

12325 Ashcroft, Houston, TX 77035

Tel: (713) 728-4343 Fax: (713) 723-1301

WILL PAY \$1,500 FOR:



WANTED: Used Western Electric tubes. Paying: Globe 274A - \$175; 262A - \$45; tennis ball, used, 101D - \$120; 101F - \$100; 104D - \$120; 205D - \$160. All others wanted. Tim Metz, 221 Wheatland, Fairview, OK 73737. (405) 227-2456

WANTED: Coke bottle radio 1930's, chassis for Peter Pan cathedral, Giffilan Model 84. All small cathedrals. Any bottle tube-type radios. I need a red back for Regency TR-1 transistor. Sam Bates, 6144 Fair Ave., North Hollywood, CA 91606. (818) 985-9912

WANTED: Fada 140A, Moon, Firth, other pre-1924. Any condition is okay. I enjoy a challenging restoration project! Write: Craig Ball, 10101 Oak Hollow Cir., Austin, TX 78758. (512) 837-8129, after 7 pm

WANTED: AM/FM stereo tube set working or not, complete with green tuning eye. Rick Blanchard, 2621 Alta Vista, Newport Beach, CA 92660

WANTED: Volume knob for Stromberg-Carlson 345M. 1960's Heathkit catalogs. 250K potentiometer/SPST switch. Doug Fox, 603 S. 12th Ave., St. Charles, IL 60174. (708) 584-5915

WANTED: To buy a van load of good stuff located between Elgin and Rochester the end of August. Will have time to kill and money to burn! Ed Bell, 5311 Woodsdale Rd., Raleigh, NC 27606. Fax/phone: (919) 851-1517

WANTED: Western Electric tubes. Paying the following for new ST in original box: VT52 - \$80; 101D - \$30; 104D - \$50; 205F - \$90; 231D, 239A, 262B - \$40; 274B - \$150; 301A - \$100; 310A/B - \$12; 311A/B - \$10; 348A - \$40; 349A - \$40; 404A - \$8; 422A - \$40. Most all others wanted, new or used. Tim Metz, 221 Wheatland, Fairview, OK 73737. (405) 227-2456

WANTED: Power transformer for Grundig Model SO-191 PX. Ray Sander, 342 South Third, Cottage Grove, OR 97424

WANTED: To buy a van load of good stuff located between Elgin and Rochester the end of August. Will have time to kill and money to burn! Ed Bell, 5311 Woodsdale Rd., Raleigh, NC 27606. Fax/phone: (919) 851-1517

WANTED: 1952 Allied Radio catalog. Stanley Caesar, 512 Country Club Cir., Midwest City, OK 73110. (405) 737-3257

RATE FOR ADDITIONAL WORDS:

25¢ per word

FIRST 20 WORDS FREE!

Cash or stamps OK for small amounts.

Your payment helps to keep A.R.C. healthy!

WANTED: Working or clean chassis for AK Model 82. Will pay dearly. R.B. McEntire, 307 Muirwood, Sugar Land, TX 77478. (713) 242-5878, before 9 pm CST

WANTED: Coke bottle radio 1930's, chassis for Peter Pan cathedral, Giffilan Model 84. All small cathedrals. Any bottle tube-type radios. I need a red back for Regency TR-1 transistor. Sam Bates, 6144 Fair Ave., North Hollywood, CA 91606. (818) 985-9912

WANTED: 1952 Allied Radio catalog. Stanley Caesar, 512 Country Club Cir., Midwest City, OK 73110. (405) 737-3257

WANTED: Working or clean chassis for AK Model 82. Will pay dearly. R.B. McEntire, 307 Muirwood, Sugar Land, TX 77478. (713) 242-5878, before 9 pm CST

WANTED: Restorable Zenith 6-S-27 or 6-V-27 tombstone radio, any condition. Hopeless basket cases OK. James S. Fisher, 344 Harrison Ave., Manville, NJ 08835. (908) 725-7476

WANTED: Hammarlund or Bruno 4-pin plug-in coils; Meissner 6L6 oscillator/exciter; APR-5 maintenance manual. Dick Lowe, Box 296, Santa Clara, CA 95052-0296. (408) 984-1555

TUBES • PARTS • SUPPLIES YOUR COMPLETE SOURCE FOR...

TUBES:

Over 3500 receiving, transmitting, audio and industrial types in stock, including many foreign and early types.

TRANSFORMERS:

Hard to find power, filament and output transformers as well as filter chokes for tube equipment. We feature HAMMOND performance transformers as well as many new old stock transformers.

CAPACITORS:

High voltage electrolytic and mylar capacitors, multi-section capacitors and more for tube circuits.

PARTS:

Resistors, tube sockets, potentiometers, knobs, dial belt lamps, diodes, speakers, wire, phonograph needles and cartridges and much more.

LITERATURE:

Extensive selection of literature and books on antique radios, tubes, circuits diagrams, communication gear and hi-fi equipment. Some items not available elsewhere!

SUPPLIES:

Grill cloth, cabinet restoration supplies, batteries, chemicals, tools, test meters, gifts and kits.



CALL OR FAX FOR OUR NEW 40 PAGE CATALOG!

ANTIQUE ELECTRONIC SUPPLY™

LIMITED PARTNERSHIP

6221 S. MAPLE AVE. • TEMPE, AZ 85283 • (602) 820-5411 • FAX (602) 830-4643 or (800) 706-6789

FOR SALE: Dial belt frustration? 36-page book (copy) of correct belt to radio model - \$10 ppd. John Snow, 4539 N. Bartlett Ave., Shorewood, WI 53211. (414) 964-0194

FOR SALE: Crosley 10-135, paint chips - \$65. Crosley 725 - \$90. Delco 1106, painted - \$100. GE A-53 - \$100. Hallicrafters SX-43 - \$75. Michigan MRC-12 - \$225. Radiola Sr. & AC amp, dud WD-11 tubes - \$350. Zenith 809 - \$250. Zenith 6D015Z - \$65. All plus shipping.

WANTED: Echophone/meteor cabinet; Magnavox AC-3 cabinet; Philco 20 speaker baffle; Radiola V crystal detector with Bakelite knob and audio transformer. Don Sturzenbecher, 26990 S. Marion Rd., Sioux Falls, SD 57116. (605) 368-2135

FOR SALE: Rider's 6 & 8, good condition - \$20 ea. 1975 ARRL handbook - \$4. Jim Gauldin, 134 Hawthorne Dr., Danville, VA 24541. (804) 791-2286

FOR SALE/TRADE: Drake 2B w/2AQ multiplier - \$100. Hallicrafters Skybuddy - \$75. Gonset G66B w/speaker - \$75. Emerson 569 w/o cord - \$45 plus UPS. Trade for mini keychain license plates, made by Disabled American Veterans. Also motorcycle plates wanted. John Williams, Jr., PO Box 1545, Scarborough, ME 04070-1545. (207) 883-8249

FOR SALE/TRADE: 1919 Donle Type C vacuum tube, Connecticut Telephone, (see Saga, p. 337) - \$875. Ed Bell, 5311 Woodsdale Rd., Raleigh, NC 27606. Fax/phone: (919) 851-1517

FOR SALE: Stromberg-Carlson console 430-PLW - \$40, pick up. Melchior record album - \$15. David Randall, 40-04 150th St., Flushing, NY 11354. (718) 463-1720, 6:30-7:30 pm EST or Sun. am

FOR SALE: Outstanding Victor V with spear-point wood horn, serious callers only. Spartan 410 Junior - \$275. Geoff Shearer, 14101 Mesita Cliff Rd., NE, Albuquerque, NM 87112. (505) 293-8544

A.R.C. BACK ISSUES

April '87 to current issue: Originals available
32 to 100 pages each.

Oct. '86 to Mar. '87: Reprints available
*Reprinted from original artwork; 28 to 32 pgs. ea.
Quality & appearance same as an original copy.*

June '84 to Sept. '86: Photocopies available
Not original quality, useful for info.; 16 to 28 pages each.
Publication of *Antique Radio Classified* began in
1984 which had only five issues: June, Sept.,
Oct., Nov. & Dec. 1984. 1985 through current
year have had 12 issues each.

**\$4.00 each - Postpaid to
U.S., Canada and Mexico.**

*Orders of 6 issues or more may take a 10%
discount. Orders for a full calendar year may
take a 50% discount. Foreign orders other
than Canada and Mexico: \$6.00 each by air.
Mass. residents, please add 5% sales tax.*

A.R.C. UNCUT, UNFOLDED COVERS

June 1991 to the present
9.25" x 12.5" - \$9.95 each

Postpaid to U.S., Canada, & Mexico
Mass. residents, please add 5% sales tax.

Send Order To:

**A.R.C., P.O. Box 2, Carlisle MA 01741
Or Call (508) 371-0512**



FOR SALE/TRADE: Earphones, DeForest, Brush in orig. box, Trimm featherweight, Trimm reg., Federal, Murdock, Victor, cannon ball Dixie - \$185/all. Edison spark plugs in orig. box - \$35 ea. Edison medal, 1929, 50 yr. of light - \$25. Music box outside horn phono bell is 8 in. long - \$100. Gernsback Official Radio Service Manual, Vol. 1 & IV - \$80 BT. Radiotron Designers Handbook, 3rd & 4th Ed. - \$65 BT. Radio App. Cat. 1924 - \$25. Radio Record Book - \$25. Jan. 1937 Radio Index - \$20. Radio Construction for the Amateur, Duston, 2nd. Ed. 1923 - \$30. Andrews Radio Log 1926 - \$25. N.O.S. The Telephone, J. Brooks - \$20. The Radio Reading Course, (5) Vols., 1924, Morecroft - \$50. General Radio Construction Manual for the Universal 4-tube Receiver - \$25. Radar & Your Telephone, Bell System - \$35. Rip Discovers Radio, RCA - \$20. Victor Record Cat. 1916 - \$25. WOR Radio News Map - \$20. Bremer-Tully Cat. 1927 - \$20. Cunningham Tube Data Booklet - \$25. Call between 7 pm & 9 pm. Bob Fuschetto, WA2BCR, 1758 Michael Dr., Whitehall, PA 18052. (610) 435-8944



FOR SALE: Invest in a Zenith! 1936-12A57 (exc), 1938-9S262 (exc/mint, mis-stamped 12S266), 1939-9S367 (mint). Call for pricing. Don Huff, PO Box 16351, Minneapolis, MN 55416. (612) 933-9070. E-mail: McMurdoDon@aol.com

FOR SALE: Retiring, sell magazines as follows, most good condition: Radio TV News, 1950-1958, (50) issues - \$140; Photofact Reporter by Sams, 1956-1962, (140) issues - \$125; Electronic Servicing, 1969-1971, (76) issues - \$75; Radio Electronics, 1950-1954, (51) issues - \$85. All plus \$20 shipping each lot. Maurer TV, 29 S. 4th St., Lebanon, PA 17042. (717) 272-2481

**NOTICE TO ALL
CLASSIFIED ADVERTISERS!
OUR CLASSIFIED AD DEADLINE IS
12:00 NOON
ON THE 10th OF EACH MONTH**

FOR SALE: GE H-530, nice, works - \$110. Crosley 11-117U, repainted met. blue, works - \$95. Belmont 6D111, brown, looks nice, comes in weak - \$110. **WANTED:** Conar tube tester 224, operating instructions. Thank you. Durrell Derstine, Rt. 5, Box 287, Detroit Lakes, MN 56501. (218) 847-7415

FOR SALE: Zenith Television Service Manual Vol. I, 1948-1952 - \$45. Zenith Royal 94 interoceanic multi-band - \$40. Astatic Model A mike head - \$35. Plus shipping. Wm. Ernst, 16300 Campbell Rd., Comins, MI 48619. (517) 848-5002

FOR SALE: Westinghouse RC - \$250. Crosleys, all work: 51 - \$95; 52 - \$120; VI - \$175; Ace 3B - \$160; Trirdyn - \$90. Aeriola Sr. - \$140. Western Electric 10D speaker - \$140. BBT UV200 - \$25. Tower Ship speaker - \$180. Bob Barnes, Box 275, Monroe City, MO 63456. Ph./Fax: (573) 735-2945

WANTED: Philco 70 chassis, Philco 90 cabinet, Crosley Model 817 Super 8 cabinet, tube chart and book for Weston TV-4U tube checker, book for Sprague TO-6A Tel-ohmike, someone to resurface rubber phono parts.
FOR SALE: Remote for Philco 39-116 - \$60. Lous Hiltz, 551 Sunrise Ave., Harrisonburg, VA 22801. (540) 433-3202

WANTED: For Victrola phonograph, green felt turntable pad & windup handle. Howard Schwartz, 22 Inwood St., Yonkers, NY 10704. Fax: (718) 842-6001

WANTED: Manual for Heathkit Model HD-15 hybrid phone patch, orig. preferred but good copy OK. Jim Robinson, 46 Branch St., Scituate, MA 02066

WANTED: Early Farnsworth TVs and equipment, pre-war or scanning disk TVs and related items. Fred Ringwald, MSC #293, PO Box 196940, Anchorage, AK 99519-6940. (907) 392-3217

WANTED: Knight kit Space-Spanner receiver. Please call after 5 pm EST or write. Daniel Baum, WB8YUG, Arnoldsburg Rt. Box 48AA, Spencer, WV 25276. (304) 655-7244

WANTED: Schematic, information about Pentatron metal cathedral with ornate Repwood front, (5) tubes, ca. 1931. Dennis Smith, KN8H, Box 113, Trenton, NJ 48183. (313) 675-5847

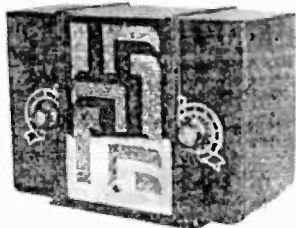

WANTED: This Colonial chrome grille set & other sets with metal grilles or trim. Jay Malkin, 1250 Galapago, #206, Denver, CO 80204. (303) 623-6451

WANTED: Command set receiver BC453 and BC455. Call or write with price. Michael Durand, 21 Le Grande Ave., Tarrytown, NY 10591. (914) 631-0493

WANTED: Detrola consoles, with or without phonograph, can travel within 49 states. Scott Flaughner, 913 Findlay St., Perrysburg, OH 43551. (313) 451-4221. E-mail: FlaughSM@po5.pl.unisys.com

WANTED: Swap Marconi 2 KW spark key with tag, for Bunnell single paddle gold bug. Robert Enemark, Box 1607, Duxbury, MA 02331. (617) 934-5043

WANTED: Top front lid from Zenith Trans-Oceanics: 1000, 3000, or 3000-1 or junker with top front lid. Also need 3000, or 3000-1 or 7000 Zenith Trans-Oceanic working or not. Jim Montague, 1907 South Stanley Ln., Spokane, WA 99212. (509) 535-9576

WANTED: Phonograph related items: Top dollar paid immediately for Vogue picture records, Edison, Columbia, and any wax cylinder records, toy phonographs, needle tins and cutters, Nipper, record dusters, puzzles, fans, calendars, pocket advertising mirrors, dealer lapel pins, phonograph toys, posters, broadsides, original dealer advertising items from Edison, Victor, and Columbia. Thanks. Bernie Seiberger, 714 Moredon Rd., Meadowbrook, PA 19046-1907. (215) 886-6124

WANTED: Manual for WLR-67 receiver HF. R-1451. Harry Weber, 4845 W. 107th St., Oak Lawn, IL 60453-5252

WANTED: Ugly 50's Philco 49-501, 49-506, 48-230, Motorola 56LD, 57CC, 56H, 57R. 40's Crosley 56TD, Belmont 6D111, Fada 740, 790. Bob Masterson, Box 172, Valley Cottage, NY 10989. (914) 353-3151



WANTED: Will pay \$700 for the pictured horn speaker (\$700?). Yes! It's manufactured by the Florentine Art Products Co. and is of a rather heavy cast material, almost 24" tall. This horn speaker is called "Voice From the Sky." If you have one, put me to the test, call or write: Dave Crocker, 6 Raymond St., Sandwich, MA 02563. (508) 888-6236

WANTED: Complete detector assembly for Radiola I. Gary J. Alley, 7100 Constantine Ave., Springfield, VA 22150. (703) 569-8964

WANTED: Repro or clean original plastic clock cover for 60's Hammarlund receivers. Please, no cracked or yellowed ones. Thank you. Paul Rosen, 30 Cherrystone Dr., Willowdale, Ontario, Canada M2H 1S1. (416) 493-6962, eves. EST

WANTED: Beckley-Ralston info for research project; Rauland Amplicall (1945); Sound Inc. Intersound. Dennis Osborne, 711 E. Whitaker Mill Rd., Raleigh, NC 27608. (919) 834-9112

WANTED: Altec speakers, Klipsch LaScala; tube broadcast limiters, compressors, EQ; ribbon and Neumann microphones. Mike States, Box 81485, Fairbanks, AK 99708. Ph./fax: (907) 456-3419

WANTED: Original tube shields and dial in good condition for a Zenith 5S218, back cover for Zenith 5S312, interstage for Sparton 410. Willard Smith, 1802 13th St., Bedford, IN 47421. (812) 275-5760, eves.

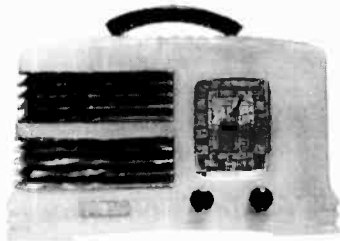

WANTED: Symphony and Detrola Catalins. If only you knew how necessary these radios are to my very existence. Gee, if you knew that you'd probably never call and hope I'd wither away ending once and for all these stupid ads. Please write or call collect: Rain Butignol, 214 State St., #7, Portsmouth, NH 03801. (603) 427-1384

WANTED: Military tube tester 7V-7B/U or equivalent in very good conditions. Giovanni Labbiento, 2335 Deschambault, Laval, Quebec, Canada H7E 1E2. (514) 871-6536

WANTED: 60W multitap modulation transformer. Spencer Cromwell, 7607 Stevenson Way, San Diego, CA 92120. (619) 582-8280

FOR SALE/TRADE: Marantz Mod 2 40-watt amp - \$1,650. Marantz Mod 10-B tuner, absolutely pristine condition - \$1,975. Circa 1955 McIntosh A-116 mono block w/MAC C-104 preamp - \$725 both. McIntosh amplifiers, over 23 to choose, from MC-30 to Mod 240 - call me for your needs and reasonable prices. Knight 60-watt stereo amp Mod 83-YU-777 chrome-plated w/ 4-EL 37 tubes - \$625. Eico ST 70 stereo amp w/HFT 90 FM tuner - \$495. Dyna Pas 3 preamp - \$150. Eico MX99 Multiplex Autodaptor - \$100. Fisher 500C stereo receiver w/Space Expander and reverb kit - \$475. Pair of Bogen D-B-10 hi-fi amplifiers - \$250. Pair of E.I.C.O. HF-14 amps w/HTF 90 tuner, preamplifiers and Multiplex Autodaptor - \$425 for entire system. Larry Drago, 383 Lincoln Dr., Cheshire, CT 06410. (203) 272-6030

FOR SALE: RCA 45 phonographs: Model 45EY3, brown Bakelite - \$59; 7HF4S, cherrywood cabinet - \$90; 6EY1 in carrying case - \$69. All plus \$20 shipping. Also (18) used 6AS7G tubes - Make Offer. Maurer TV, 29 S. 4th St., Lebanon, PA 17042. (717) 272-2481

FOR SALE: General Radio variac, 5 amps, 0-130 VAC - \$50. Rider's #8 - \$75. Hickok 6000 mutual conductance tube tester - \$125. Agreed? Renee May, 1242 N. El Centro, Los Angeles, CA 90038. (213) 464-9179

FOR SALE: GE H-530, nice, works - \$110. Crosley 11-117U, repainted met. blue, works - \$95. Belmont 6D111, brown, looks nice, comes in weak - \$110. **WANTED:** Conar tube tester 224, operating instructions. Thank you. Durrell Derstine, Rt. 5, Box 287, Detroit Lakes, MN 56501. (218) 847-7415

FOR SALE/TRADE: Western Electric Mod 555-W speaker receiver w/36"x36" horn - \$1,500. Wonder Phone electrodynamic speaker w/5" horn and #80 tube - \$650. Four Western Electric tubes #275A - \$120 ea. Send SASE for other Western Electric tube list to: Larry Drago, 383 Lincoln Dr., Cheshire, CT 06410. (203) 272-6030

FOR SALE: New-in-box Philmore antenna loop with instructions - \$25 you ship. John Snow, 4539 N. Bartlett Ave., Shorewood, WI 53211. (414) 964-0194

FOR SALE/TRADE: Crosley paper-maché Bonzo dog by King Cole, believe it or not; a superb, original piece - \$1,275. Ed Bell, 5311 Woodsdale Rd., Raleigh, NC 27606. Fax/phone: (919) 851-1517

FOR SALE: Radio schematics - \$2.75. Books: Working With the Oscilloscope, Saunders - \$10. The Oscillator At Work, Rider - \$12. Fundamentals of Radio, Evevitt - \$10. Applied Practical Radio, Coyne, 5 volumes - \$70. Radio For Beginners, Marcus - \$10. Service manuals, Xerox copies: Zenith 31/42, 900+ pages - \$60; Crosley Vols. I & II Philco - \$25 ea.; Rider's Radio Index 1 thru 23 - \$25. All plus S&H. SASE for list. Dick Oliver, 28604 Schwalm Dr., Elkhart, IN 46517. (219) 522-4516, evenings

FOR SALE/TRADE: The following National communications receivers: National NC 100A - \$425; HRO M - \$400; Mod 183 - \$465; Mod 190 - \$125; HRO 500 - \$925; NC-173 - \$275; HRO SR (Prototype) built by National Engineer Samuel Samouin in 1938 w/Prototype PS, speaker and manual - \$750. F-B-7 w/3 sets coils - \$675. National 1-10 w/all coils and PS - \$465; SW-3 w/8 sets of coils - \$475. Larry Drago, 383 Lincoln Dr., Cheshire, CT 06410. (203) 272-6030

FOR SALE: Federal 59, near mint, with tubes & original Type 53-W phones - \$1,200 plus ship. H.K. Fredrickson, RR2, Kemble, Ontario, Canada N0H 1S0

FOR SALE: New germanium diodes, work great in old crystal sets - \$3/10 plus a SASE. Steve Pazar, 4950 Deerwood Dr., Santa Rosa, CA 95403. (707) 544-8142. E-mail: pazar@sr.hp.com

FOR SALE: RME VHF shortwave converter 152-A - \$150 or make offer. Gary Berg, 24 Pat Rd., Newburgh, NY 12550. (914) 565-5077

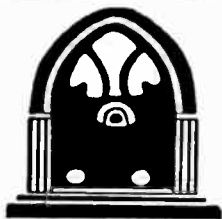

*Craig L. Graybar
Furniture Works Ltd.*

(414) 258-2390
SPECIALISTS IN RESTORING,
REPAIRING AND REPRODUCING
CLASSIC STYLED ANTIQUE TV,
RADIO & PHONOGRAPH CABINETS

Send us your plans or your project
via UPS for immediate price quotes



1535 S. 84th St.
West Allis, WI 53214



"We Turn Ideas Into Heirlooms"

GLASS AUDIO

Vacuum tubes for Audio
are back...
and they sound better
than ever!

Glass Audio

brings together yesterday's tubes
and today's improved components,
making smooth sound possible
from your audio again.

**Ask for your first FREE
issue, without obligation!**

Glass Audio

PO Box 176, Dept. ARC6
Peterborough, NH 03458-0176 USA
FAX (603) 924-9467

WANTED: Philco 89 oscillator coil. Will buy junker chassis if necessary. Also: Crosley 1117 speaker, 7" Firestone TV knobs, RC 621 glass retainers, Dokorder 1140 manual. John Lee, 1658 E. 5th St., Ontario, CA 91764. (909) 984-4592. E-mail: edsel@stbbs.com

WANTED: Tubes: I'll buy your N.O.S. & used vacuum tubes. Fax or send a list. Roland Barbeito, 19 Murray Ave., Westfield, MA 01085. Fax/phone: (413) 572-4745

WANTED: Belmont Boulevard, other small tube portables. Early Motorola transistor radios (e.g. 56T1, 6X28, 7X23). Pocket calculators by Bowmar, Busicom, MITS, Summit. Larry Gilbert, 2602 Amapola Dr., Davis, CA 95616. (916) 758-5025

WANTED: Philco 49-501, 49-503, 49-506, 50-526, 51-930, 51-532, 52-548, 53-566, TP-7, T-1000. KLH 8 and accessories. AR-1 speakers. Mint Philco Predictas, plus instructions, service information, sales literature. Marantz, Acrosound, Fairchild, Fisher, Hadley, Karg, REL, etc., tube hi-fi equipment, accessories, sales literature. 1950's-1960's hi-fi books, plus Allied, Lafayette, Heathkit, etc., catalogs. Promotional items, such as signs, banners, clocks, tube caddies, etc., by hi-fi manufacturers and tube companies. Paul Creasy, 6216 Worlington Rd., Bloomfield Township, MI 48301. (810) 737-0429. E-mail: 74664.1153@compuserve.com

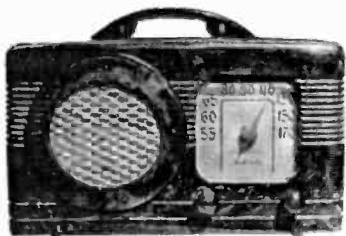

WANTED: Motorola Catalins. I have been commissioned by the Almighty Himself to gather as many of these wonderful jewels for preservation before judgment day is upon us. Forsake these worldly objects before it's too late! I pay cash. Please write or call collect: Rain Buttignol, 214 State St., #7, Portsmouth, NH 03801. (603) 427-1384

WANTED: 2nd AF input transformer for AK Type H chassis. Don Trimarchi, 38 Prospect St., Williamstown, MA 01267. (413) 664-7729

WANTED: Zenith 9S30 or 10S130 tombstone, Simplex NT tombstone, Philco 91 cathedral speaker. James Romauld, 7732 Vincent Ave. N, Brooklyn Park, MN 55444. (612) 561-6957

WANTED: Paperwork, copies okay, for 1967 Allied Model A-2515 receiver. Paperwork for Heathkit capacitor Model CT-1. Leslie M. Orsetti, 315 Ravine Ave., Round Lake, IL 60073. (708) 546-5003

WANTED: National FB-7. Also 1/4" knobs for SW-3. Marvin Faupel, 4004th St. SE, Altoona, IA 50009. (515) 967-4627

WANTED: Field telephone Kellogg Mod 1914. Please write to: Orlandini Iginio, Via Lessing, 10 00137-Roma, Italy

WANTED: Pre-WWII Superhet ham receiver w/bandspread i.e. Hallcrafters S-20, SX24, SX25. Rodney Schrock, 402 Lincoln St., Somerset, PA 15501

WANTED: Brass-based, tipped WB-800 ballast tube. Looks like a brass-based, tipped WD-11. Need for radio restoration project. Also wanted early RCA UV-204 transmitting tube with spherical midsection. Not the UV-204A. Stephen C. Brown, KD4YFY, 3808 Champaign St., Charlotte, NC 28210. (704) 847-1301

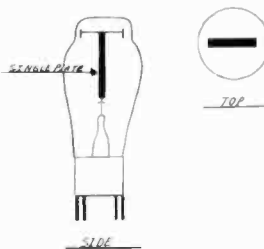

WANTED: 2A3 single plate tubes, used, paying \$60, looks same as regular 2A3 except plate is flat as pictured. Also used C585, used paying \$120. KT88 new in original box, paying \$120. Tim Metz, 221 Wheatland, Fairview, OK 73737. (405) 227-2456

WANTED: Radio Boy's book, Aiding the Snowbound by Chapman. Pay cash or trade. Jeff Hoskins, 824 E. Madison Ave., Stuart, FL 34996. (407) 283-2291, after 7 pm

WANTED: Western Electric 394-47A microphones, RCA 4-AP-1 (4A type) microphones, and prewar recording equipment, primarily Presto (especially recording amps). Trent Ruane, 111 N. Grant #1, San Mateo, CA 94401-1953. (415) 340-8371

WANTED: Colonial radio for grandfather clock circa 1931. Chassis may be same as tombstone and cathedral models, central dial window, four knobs arranged in trapezoid. Allen Miller, 167 Carriage Dr., Glastonbury, CT 06033. (860) 633-5710. Fax: (860) 633-7230. E-mail: a.miller2@GEInie.com



WANTED: Any E.H. Scott radio with wireless remote. Anyone who would pay more for a clean example would qualify for psychoanalysis under any HMO. Eddie Burris, 2837 Winterbrook Dr., Lawrence, KS 66047. (913) 841-4174. E-mail: burris@cstp.umkc.edu

WANTED: Speaker table that matches the Arborphone 27, also Arborphone, Cavac, International Kadette paper items for: Nevin Museum of Radio. Ken Nevins, 406 Jipson St., Blissfield, MI 49228. (517) 486-3019, evenings please

WANTED: Any Allied Radio catalog from 1946 to 1952. Marion L. Clemens, 10129 Lapeer Rd., Davison, MI 48423. (810) 653-2439

WANTED: Rider's Radio Manuals, any Volumes 17 to 23. Jeff Hoskins, 824 E. Madison Ave., Stuart, FL 34996. (407) 283-2291, after 7 pm

FOR SALE/TRADE: Hallicrafters SR-20, S-40, S-38B, S-38C, S-41W, SX-100, S-94, SX-130, S-120, HW 12-A 75 meter 55B transceiver w/speaker and HP 13A PS. Larry Drago, 383 Lincoln Dr., Cheshire, CT 06410. (203) 272-6030

FOR SALE: General purpose and two-way radio test gear for - Best Offer, any or all. Measurements Corp. (Boonton) Model 80. A Boonton Model 800, excellent w/ book. Motorola Model T1130A, deviation and carrier freq. meter, beautiful cosmetically. Bird Model 43, thru-line watt meter with several extra coils. General Radio Company Type 1213D and Type 1203B in one cabinet, power supply and freq. calibrator. All were from working shop. Bill Manny, 1103 N.W. Despain Ave., Pendleton, OR 97801. (541) 276-3152, days. (541) 276-7439, evenings and weekends

FOR SALE: (12) E.H. Scott consoles for sale, including a beautiful Warrington Philharmonic. Call for info. We accept Visa and MasterCard. Alan Jerspersion, PO Box 17338, Minneapolis, MN 55417. (612) 727-2489, 8 am to 8 pm, 7 days. Fax only: (612) 727-1908

FOR SALE: Conn. Telephone and Telegraph, circa 1922, J-117 vacuum tube designed by Harold Donle for the JR-3-2 radio receiving set, resembles large hypodermic needle, rare and unique collectors piece - \$325. (2) A3 tubes - \$45 ea.; 6550's - \$40 ea.; KT-88, used - \$75 ea., KT-66, new and used - \$60 to \$85; 45's - \$25 ea.; 83's - \$30 ea. Send SASE for Western Electric tube list to: Larry Drago, 383 Lincoln Dr., Cheshire, CT 06410. (203) 272-6030

FOR SALE/TRADE: Sunbeam 5-tube battery set - \$200. 7-tube Premier radio made in Defiance, Ohio - \$225. Acme Regenoflex kit, 5-tube battery set - \$325. Western Electric Mod 100F loudspeaker amplifier - \$275. Zenith Mod 3000 Trans-Oceanic - \$150. Larry Drago, 383 Lincoln Dr., Cheshire, CT 06410. (203) 272-6030

Wanted

(Top Prices Paid)

1. Western Electric Tubes, Amps, Drivers, Horns, Speakers, Parts, etc.
2. Tube-type amps from Marantz, McIntosh, ARC, Quad, Leak, Dynaco, Fisher, etc.
3. Telefunken audio tubes & KT-66/77/88, etc.

Also Wanted... Vintage watches from Patek Philippe, Vacheron Constantin & Audemars Piguet

David Yo — Audio City USA
PO Box 80371
San Marino, CA 91118-8371
Telephone: (818) 441-3942

FOR SALE/TRADE: Fada 100, bullet with insert grille in burgundy and butterscotch, flawless museum quality condition - \$3,000 or will trade for any McIntosh, Marantz or Western Electric tube amplifiers of equal or even lesser value. Larry Drago, 383 Lincoln Dr., Cheshire, CT 06410. (203) 272-6030

FOR SALE: HP 200CD signal generator, excellent - \$50. Superb home-brew SW3 with coils - \$75. WE 10D speaker - \$100. Low loss nameless kit - \$60. Scott 800B, excellent, works, has spare set each chassis, Chippendale cabinet - \$300. WR 12 Columnaire, ratty - \$30. (2) speakers for RCA R-35, etc. - \$45/pair. AK Model E speaker for console - \$25. Grimes RGS inverse duplex - \$125. Homemade rack device - \$10. Homemade 20's xmtr, ratty - \$15. Quicker's Most Often Needed TV, 1950-1958 - \$3 ea. Dennis Osborne, 711 East Whitaker Mill Rd., Raleigh, NC 27608. (919) 834-9112

FOR SALE/TRADE: Scott, Capehart, Midwest, other elaborate consoles. Broadcasting, recording, theater & hi-fi audio. Jukeboxes. SASE. Robert Van Dyke, 2 Squires Ave., East Quogue, NY 11942. (516) 728-9835

FOR SALE: RCA AR88, can deliver to Charlotte meet. **WANTED:** M49HG ballast tube N.O.S. Clegg 22'er or Gonset Communicator 4. Advertisements and owners manual for Air King Model 770 skyscraper. Gary Carter, WA4IAM, 1405 Sherwood Dr., Reidsville, NC 27320. (910) 349-1991

FOR SALE: Misc. for BO. Two Jensen SS 100, 3-way speaker systems. Buy complete or I'll take speakers out. Cabinets fair. Speakers excellent. Also have gorgeous ESL, Gyro-Balance stereo arm, new in never-opened box with all papers and warranty card. Have miniature Tung-Sol tube/tool box, green and gray with Tung-Sol logo - \$25. Same in GE, orange and gray - \$20. Bill Manny, 1103 N.W. Despain Ave., Pendleton, OR 97801. (541) 276-3152, days. (541) 276-7439, evenings and weekends

FOR SALE: Tubes for sale: Ediswan P-61, N.I.B. - \$12. Diktator 12A, N.I.B., (4) - \$12 ea. Diktator 01-A, N.I.B., (3) - \$12 ea. Sylvania 01A-ST, N.I.B. - \$10. Cunningham C-300 - \$12. Gold Seal 01-A - \$12. Sylvania SX-230 - \$12. Cunningham CX-301A, (4) - \$12. Radiotron UX201A, (4) - \$10 ea. Silvertone 201A - \$10. Klystron X-26D (1), K-4014 (2) - \$12 ea. Duds at \$1.50 ea. Thanks. Offers? Sure! RCA 19K console, excellent - \$145. Del Tysdal, Rte. 1, Box 157, Glyndon, MN 56547. (218) 287-2562

FOR SALE: If you like Philcos, you need these excellent copies of the 1935, 1937, and 1939 Philco parts catalog - \$6 for 1, \$10 for 2, \$13 for all 3. Carl Blomstran, 2107 Heather Green, Houston, TX 77062. (713) 486-5262

FOR SALE: Zenith Trans-Oceanics, all are original, complete, cosmetically restored. 7G605 bomber grille - \$325. 8G005YT - \$175. G-500 - \$185. H-500 - \$180. Y600 - \$180. A600 - \$180. 3000-1 transistor. Zenith full color repro ads, circa 1940's - \$7 ea. Frank J. Manzano, 82 Monhegon Ave., Oakland, NJ 07436. (201) 337-5263

FOR SALE/TRADE: The following Radiola speakers: Mod 103 w/nice tapestry - \$200; Mod 101 - \$50; 100B - \$50; 100A - \$75. Also Radiola Mod III, 2-tube battery set - \$150; and Radiola Mod 5 with crystal detector on front panel - \$700. Larry Drago, 383 Lincoln Dr., Cheshire, CT 06410. (203) 272-6030

WANTED: Morris, or similar, coil winder. Bill Olson, Route 1, Filer, ID 83328. (208) 326-4962

WANTED: LS-3 speaker, and Crosley 1127 console. Michael Harrington, PO Box 7619, Little Rock, AR 72217. (501) 223-9056

WANTED: Back including antenna or complete chassis, if necessary, for Silvertone 7039. Perhaps there is an equivalent I don't know about. Also can anyone give me a reasonable price; I can purchase any of the following for: Coronado 1070A, Crosley 556, Howard 268, Lafayette C117, Truetone D-723, RCA T80. Thank you. Jack Calhoun, 2415 Elizabeth, Des Moines, IA 50317. (515) 265-1430

WANTED: Will pay top price for: Western Electric 16A horn, 15A horn, 550 drive, 46C amp, 48 amp, 4181 woofer. Also any Edison movie projector, Edison stock ticker, Marantz 9, Marantz 7, MC MI 200, MC 275. Sam Huh, 1017 6th Ave., 3rd Fl., New York, NY 10018. (212) 921-2862. Fax: (212) 997-5404

WANTED: 4 1/2" dial glass and 5 1/4" dial face for Zenith 5S237 or good Zenith 5521 chassis with glass. Hal Kravitz, 2615 Juneway Dr., Memphis, TN 38134. (901) 388-2857. Fax: (901) 388-5102 fax

WANTED: JVC Pyramid TV and radio Model #3100R, must work. Brandon Angel, 3575 Lake Dr., Cocoa, FL 32926. (407) 632-7659

WANTED: Old tube-type CB radios and CB operating/owners manuals, CB call books. Warren Belles, 1421 E. Royal Palm Rd., Phoenix, AZ 85020. (602) 943-4135

WANTED: Zenith Trans-Oceanics, all models, tube and transistor, any condition. Zenith military Trans-Oceanics R520/URR, R520A/URR. All Zenith wood table models between 1935 and 1942. Zenith portable 6GB01L. Frank J. Manzano, 82 Monhegon Ave., Oakland, NJ 07436. (201) 337-5263

WANTED: Morris coil winder with gears, cams & instructions. Clive Beckwith, 465 Lighthouse Ave., Sebastian, FL 32958. (407) 388-0414

WANTED: One of the following picture tubes: 21ACP4, 21AMP4, 21BSP4, or 21CUP4. I also need a Zenith Space Command 400 remote control unit. Thanks. Dave Bertinot, 680 Havenwood Dr., Baton Rouge, LA 70815-6605. (504) 275-9462. E-mail: 102600.1673@CompuServe.com

WANTED: Schematic for Patterson All-Wave receiver. J. Capron, W6SKM, 6544 Picardy Pl., Newark, CA 94560-1737. CIS 74663,272

WANTED: RCA chairs, curtains, clocks, thermometers, signs, also other cool promo stuff, RCA & Western Electric, Collins, what have you? Always looking for tube EQ's compressors, vintage mics, amps, etc. Have tube audio, Rek-O-Kut lathe vintage recorders Brush 403, 401, for sale or trade. Ward Kremer, 301 S.W. 16 St., Ft. Lauderdale, FL 33315. Phone/fax: (305) 524-5652

WANTED: Early broadcast/recording equipment product literature, catalogs, technical manuals, schematics, photos. Technical trade show - stuff? For RCA, Gates, Collins, GE, Altec, JBL, Raytheon, Pultec, mixers, compressors, eq's, reverbs, limiters, etc. **FOR SALE:** NEVE #5432 broadcast console 8 ch. M. Meehan, PO Box #2, Harborcreek, PA 16421-0002. (814) 868-0866, anytime!

WANTED: Arvin metal sets: Model 302A radio phonograph - \$175; 444AH with handle - \$125; Model 40 - \$100. Model 502A, 522, 524A, 740T - \$75 ea. P&P not included. Rudi Sillen, 31 Limberg B-2230 Herselt, Belgium Phone/fax: 32.14.54.68.89

WANTED: On/off switch for a GE-J-71, (2) glass rods for a Zenith glass rod radio. Joe Kelly, 537 Stafford Ave., Erie, PA 16508. (814) 459-3910

WANTED: Marconi identified equipment or components for U.S. National Marconi Museum. Write: Ray Minichiello, 45 Shaw Dr., Bedford, NH 03110. (603) 472-9746. Fax: (603) 472-3622

WANTED: Philco 84B chassis and knobs, junker OK. **FOR SALE:** Majestic 72 cabinet - \$15. Andrew Mitz, WA3LTJ, 4207 Ambler Dr., Kensington, MD 20895. (301) 897-5531. E-mail: arm@helix.nih.gov

WANTED: Manual, copy OK, Sylvania 216 sig. gen., RCA WR-50B sig. gen., H.P. 400H VTVM, Hickok 1605M VTVM. Art Zimmerla, 501 Thorngate Pl., Millersville, PA 17551. (717) 871-3293

WANTED: CEI 357/R1401A LW receiver. Tweeter for KLH6 speaker. Cabinet for MR71 tuner. Dale Raduege, 411 N. Greenfield Ave., Waukesha, WI 53186. (414) 547-0742

WANTED: 1st IF coil for RCA 6K3, #11617; operation manual for Philco 7300 generator; output transformer for a Philco 40-150 #32-8053N, 336856, and King, Highwave and Jade transistors. David Hamm, 7220 Zuni St., #B1, Denver, CO 80221

WANTED: Military entertainment receivers such as REO, REH, REP, R-520/URR - R-100/URR, Minerva Tropic Master & manuals for these sets. Henry Engstrom, PO Box 5846, Santa Rosa, CA 95402. (707) 544-5179

WANTED: Capehart consoles w/h phono Zenith 9-S365 case, excellent condition only. John, Antique Edison, 1141 Galaxy Cir., Pittsburgh, PA 15241. (412) 221-6763

WANTED: Detrola Super PeeWee, red or blue knobs, repro OK. Zenith K412R brown handle. Steve Veney, Box 41, Bremen, IN 46506. (219) 546-2734

WANTED: ARC T-17 1.3-2.1 Mc transmitter, old BC-430 or BC-230 transmitters, dual 100 mmf double speed variable transmitting capacitor. **FOR SALE:** Heath SB-101 SSB transceiver, power supply, speaker & all manuals - \$150 + UPS. (4) 35TG new tubes - \$20 ea. (4) new JAN 2A3 tubes - \$20 ea. + UPS. Wayne LeTourneau, Box 62, Wannaska, MN 56761. (218) 425-7826

WANTED: Both dial pointers for Zenith 6S254. Scott Beard, 2600 Garfield Ave., Terre Haute, IN 47804. (812) 466-9367

WANTED: A Morris coil winder with gears and complete, for \$35. Kenneth W. Hunt, WL7MV, 1200 Lincoln St., #294, Bellingham, WA 98226. (360) 734-9572

WANTED: Minerva W-117, old Jensen 12" speaker w/ 80 recti. Belmont Boulevard 5P113. Ichiro Yamada, 10-21 Chiyodadai-cho, Kawachi, Nagano-shi, Osaka, Japan 586. Phone/fax: 011-81-721-4695, mid/eve. local

WANTED: Escutcheon plate for AK 185, will consider a junker set. Call after 5. Griffon Barry, 1406 Buena Vista, Springdale, AR 72762. (501) 750-2577

FOR SALE/TRADE: Magnavox AC-2C, 2 stage/2 with 201-A tubes, speaker amplifier, a must for horn collectors (see Douglas V2, p. 135) in beautiful/working condition - \$400. Music Master horn speaker Mod VI w/ 14" walnut horn and ornate driver base - \$275. Larry Drago, 383 Lincoln Dr., Cheshire, CT 06410. (203) 272-6030

FOR SALE: H.H. Scott 480A integrated amplifier, 85 watts per channel, near mint condition - \$125. Clyde Powell, 3822 Edwards Ter., Chattanooga, TN 37412. (423) 867-5022

FOR SALE: 1950's Raytheon tubes motion lamp - \$165. 1950's RCA electron tubes long lighted sign - \$135. Sam Samuelian, 2305 W. Deerfield Dr., Media, PA 19063. (610) 566-7248

FOR SALE: Admiral Catalin, works, white, like Gloritone, (Machine Age Jet Age, p. 234) - \$125. Joe Quinn, 30511 Manhasset Dr., Bay Village, OH 44140. (216) 835-8420

FOR SALE: Zenith Trans-Oceanic RD7000Y, excellent - \$225. SASE for test equipment list. Chase Hearn, 104 Glenwood Dr., Williamsburg, VA 23185. (804) 229-7263

**IF YOUR EXPIRATION DATE IS
FEBRUARY OR BEFORE, RENEW TODAY!
EARLY RENEWALS
REQUIRE AN EXTRA ISSUE!**

FOR SALE/TRADE: Atwater Kent Mod 165 cathedral - \$275. Philco Mod 38 cathedral, two-tone finish - \$200. Trav-Ler M-1 cathedral, two-tone maple and walnut finish - \$200. Zenith tombstone Mod 136 - \$175. Zenith Mod 319 brass escutcheon w/ivory knobs - \$200. Graybar GT8 tombstone, eight tube - \$200. American Bosch Mod 28 w/cathedral-style speaker - \$200. Philco 89 cathedral - \$300. Larry Drago, 383 Lincoln Dr., Cheshire, CT 06410. (203) 272-6030

FOR SALE: Sherwood S-3000IV tuner - \$25. S-5000II amp - \$40. Knight stereo preamp - \$20. KP-70 preamp - \$40. Eico HFT-90 - \$20. Hickok #533 - \$35. **WANTED:** Dial glass P/N 112987 for Airline 14BR-911A. Joe Sloss, 4732 119th SE, Bellevue, WA 98006. (206) 747-5349

FOR SALE: Knob and handle for Motorola S-grille, original manuals/warranty cards for Radiola 33 and 102 speaker. Wood Fada temple. Microphones: RCA BK-6B, (2) Shure bullet mikes, JT-30 N.I.B. Need a Philco 20 cabinet and dial for a Sparton 557. Please call before 8 pm. Brad Jones, 4801 Crofton Springs Ct., Greensboro, NC 27407. (910) 547-1919

FOR SALE: AC Dayton Model A-C 63, good, complete - \$125. Operadio metal speaker, excellent - \$50. Carleton Rand, W1PZI, RR1, Box 209, Epsom, NH 03234. (603) 736-9695

FOR SALE: Philco 37C - \$45. **WANTED:** Blackhawk (Audiola 31) TRF coils, chassis, or parts set. Curt Schreiber, 3923 E. Latoka St., Springfield, MO 65809. (417) 887-5184

FOR SALE/TRADE: Two 1950's Rek-O-Kut Mod # Rondine L-34 12" turntables w/bases in fair condition - \$225 for both. Thorens Mod T.D. 124 turntable - \$295. Altec 418B 15" speaker - \$325. (4) 15" Stromberg-Carlson chrome-plated woofers - \$300. Larry Drago, 383 Lincoln Dr., Cheshire, CT 06410. (203) 272-6030

FOR SALE: Replacement parts for tube piano radios: plastic music stand, the mold is finished! - \$25; wood music stand - \$15; brass foot pedals - \$15; back leg, lid support with spring - call for a price. Geoff Shearer, 14101 Mesita Cliff Rd., NE, Albuquerque, NM 87112. (505) 293-8544

FOR SALE: German Bakelite radio Siemens 11-6W, 4 weird tubes, good cabinet, broken dial glass - \$10. Mervyn Ellsworth, 2309 N. 25 St., Boise, ID 83702. (208) 345-6878

FOR SALE: McIntosh MR-71 tuner, near mint - \$650. MR-67 - \$750. Dynaco ST-70 - \$350. Dynaco PAS-2 - \$150. Scott 340B receiver - \$250. McIntosh C-24-C-26 tuners - \$400 ea. Pair Eico HF-14 amplifiers w/FM tuner, preamp and Mx 99 multiplex system - \$500. Chrome Craftsman 550-C w/350-C preamp, all chrome - \$595. Larry Drago, 383 Lincoln Dr., Cheshire, CT 06410. (203) 272-6030

FOR SALE: Mechanical filters: F455J-15 - \$185; F455FA-21 - \$55; LSB for PRC-47 - \$50. Joseph Pinner, KC5JJD, 201 Ruthwood Dr., Lafayette, LA 70503. (318) 981-7766. E-mail: kc5jjd@aol.com

FOR SALE: N.O.S. U.S. tubes: 7199 (2) - \$27. 6LQ6 - \$30, 6JB6 - \$14, 812A (3) - \$75, 807 - \$8, 6LF6 - \$30. Much more, fax or send want list. Thanks. Roland Barbeito, 19 Murray Ave., Westfield, MA 01085. Fax/phone: (413) 572-4745

FOR SALE: Radiola Grand empty cabinet - \$25. John Lee, 1658 E. 5th St., Ontario, CA 91764. (909) 984-4592. E-mail: edsel@stbbs.com

FOR SALE: Audio: Dyna MKIII/manual - \$250. Dyna tube mono preamp, (2), 1/manual - \$50 ea. Dynakit stereo control - \$50. Marantz 240 power amp/wood case U.S.A. - \$450. Marantz 3250 preamp - \$250. Marantz 1180DC integrated amp - \$325. Pioneer SX-2500/remote/SCA - \$100. Pioneer TX9100 tuner, scratched - \$75. Military: Collins built R392 - \$150. Dubrow built R392/new sealed audio amp, rough - \$40. Motorola built R390A w/meters & covers 363-PH-54 - \$250. BC221 AL/TS 164/AR, mint - \$40. LS166/U speaker - \$20. Television: Sony CVC/2100A TV camera/view finder - \$20. Hallicrafters T-54: complete - \$125, one rough - \$75. Motorola 7VT5RA portable w/ antenna - \$200. RMS SP-4 video preamp - \$10. Regency DB-410 & DB520 signal booster - \$10 ea. Tape: Brush BK-401 sound mirror - \$110. Radio: Philco 42-350 - \$55. Zenith Royal 7000-1 chassis 18ZT40Z - \$225. 1000 chassis 9AT40 - \$95. Zenith Model 587, missing knob - \$20. Maguire 561DW inductive tuning - \$55. Test equipment: EICO 460 DC wideband scope kit, unassembled - \$100. B&K 960 transistor radio analyst - \$45. Trionyx TR1000 counter - \$75. Novelty radios: 1931 FS207 car - \$20; SD8451 antique car - \$45. Teachers highland, cream - \$110. (2) owls - \$65 ea. 1963 Cadillac/box - \$35. Polaroid 600 - \$20. Coca-Cola bottle, not working - \$12. Dispenser machine AM/FM2001 - \$65. Transistor radios: Sony TR-86, cracked - \$135; TR1814 - \$20; 2F-23W - \$10; 2F-21 earphone/case mint - \$45. Everplay - \$35. Arvin 62R16 - \$20. Minivox clock radio RR-34B, fair - \$95. Motorola X11E - \$35. Bulova 290P - \$65. 640 - \$85. Carahet Blue Boys radio - \$40. GE P-808H - \$15. P-745A - \$15. Golden Shield 2-band, no rod ant. - \$10. Channel Master 6506, rough - \$10. Sanyo RP5060 AM/FM - \$12. Plus shipping. Tom Murray, 3177 Latta Rd., #409, Rochester, NY 14612. Voice/fax: (716) 723-1672

WANTED: Rheostat, p/n WD-11A, for Kennedy 281. Gary J. Alley, 7100 Constantine Ave., Springfield, VA 22150. (703) 569-8964

WANTED: Table radios, transistors, all makes wood, Bakelite, Catalin, etc. Bob Masterson, Box 172 Valley Cottage, NY 10989. (914) 353-3151

WANTED: Horizontal output transformer for Philco Predicta Mod G4654L, 21 in., Part #32-8853-1. Dale McLellan, 19 Pineview Ct., Pleasant Hill, CA 94523. (510) 682-9970

WANTED: Zenith consoles 12S266 and 12A58, (E.O.R., p. 200); also Walton's 12S232. Trades or cash. Dave Stamper, 45 High St., Stewartstown, PA 17363. (717) 993-3571

WANTED: McMurdo Silver Masterpiece III chassis. Mike Greene, 19113 Alpenglow Ln., Brookeville, MD 20833. (301) 774-3203



WANTED: Fada Catalins. I like 'em perfect or in pieces - whatever you have to offer. Don't humiliate yourself by letting some other "big shot" collector take advantage of you. Go ahead and use me. Uh oh! Please write or call collect: Rain Buttignol, 214 State St., #7, Portsmouth, NH 03801. (603) 427-1384

WANTED: Good split-second dial, shutters and grille cloth for Zenith robot dial 12S265. Mark W. Hilliard, N3NBL, 921 South Edward St., Allentown, PA 18103-4657. (610) 432-8089

WANTED: For AK 55C, F-4 speaker (has odd 4-pin plug), power transformer, (2) tube shields. Charles A. Days, PO Box 80205, S. Dartmouth, MA 02748-0205

WANTED: Fisher K-10 Space Expander Unit; 800-C receiver/amplifier. Tod Prowell, W3URG, 413 N. York Rd., Mechanicsburg, PA 17055-6016. (717) 697-5227

WANTED: Speaker and chassis for All American Hawk Lyric Model S-62. Thanks! Rick Schwalbe, 9434 Old Man Ct., Columbia, MD 21045. (410) 328-5569

WANTED: Box for Radiola amp. Escutcheon for Jackson Bell mini-cathedral. Ancman, 6218 Winnepeg Dr., Burke, VA 22015. (703) 764-9561

WANTED: Drake R8A receiver. Tektronix 503 manual & probes. Reasonable grid-dip & frequency meter. Edward D. Davis, 411 Franklin St., Apt. #505, Cambridge, MA 02139. (617) 547-4181

WANTED: Any Zenith Trans-Oceanic portable, must be working and in excellent physical condition. Steve Guss, 1536 S. Hillcrest Ave., Clearwater, FL 34616. (813) 443-2587, evenings

WANTED: Detrola 139, Fada 711, Zenith K-510W, RCA 1X56, Teletone 195, Airline 94HA-1562. Dan Pyle, 2579 Yarmouth Ln., Tallahassee, FL 32308. (904) 893-5477

WANTED: AK chassis Model 80, 82, 84, 90, 92 or 627. Gary Formica, 823 91st St., Niagara Falls, NY 14304. (716) 283-2274. E-mail: radio@ns.moran.com

WANTED: National HRO 50 or 60. Will consider any condition. Call or e-mail: Larry Ware, 7436 Fieldcrest Ave., Winter Park, FL 32792. (407) 679-6975. E-mail: lrware@aol.com

WANTED: Novelty radio, Love Is, (Breed book, Plate #205), N.I.B. or exc. Include price. Thanks. Bill Cramer, PO Box 1075, Bella Vista, CA 96008

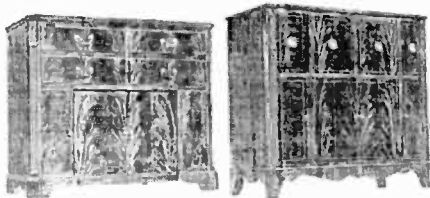

WANTED: Zenith 22H698 or 22H699 radio/phono consoles. I'm willing to pay top price for either set and will also arrange for pickup. Martin Blankinship, PO Box 157, Lecompton, KS 66050. (913) 887-6560

WANTED: Nipper decals for Victor Type E external horn phonograph. Howard T. Douglas, 701 N. Camino Del Codorniz, Tucson, AZ 85748. (520) 298-6450

WANTED: Zenith power supply for Trans-Oceanic Royal 3000-1. George Demeroukas, 1417 N. 36th, Melrose Park, IL 60160

WANTED: F24/ARC5, R25/ARC5 receivers, T17/ARC5 transmitter. Pete Hamersma, WB2JWU, 87 Philip Ave., Elmwood Park, NJ 07407

WANTED: Any radio or parts from Pennsylvania Wireless Co. This gear is from my hometown. Joseph Nocera, 1222 Finch St., New Castle, PA 16101-4840. (412) 658-7305

WANTED: Early communication receivers and transmitters. Wayne Steiner, 1212 17th Rd. NW, New Strawn, KS 66839. (316) 364-5353

WANTED: I'm paying \$300 each for these transistors. **FOR SALE/TRADE:** RCA Radiotron advertising figure. Bob Wood, 3612 N. 12th Ave., Pensacola, FL 32503. (904) 432-3782



WANTED: Philco radio chassis & speaker Model #551 or 51 or 52 or 24. John Shafer, 2275 S. Canal St., Newton Falls, OH 44444. (216) 872-7777

WANTED: Oscillator coil for early chassis AK 84. Still looking for Zenith 6S27 or 6V27. Tony Rizzini, 6 Chiswick Rd., Greenville, RI 02828

WANTED: Crosley 52, Crosley 50 amplifier; Crosley VI, Crosley X, (1) lg. tuning knob for Crosley 51, Crosley Audion detector, Crosley radio frequency tuned amplifier. Bill Moss Settle, 120 Clarksdale Cir., Glasgow, KY 42141. (502) 651-6525

FOR SALE: Silver Model 903 grid dip meter with (2) coils, 7 to 50 Mc, as new - \$151 ship. John Snow, 4539 N. Bartlett Ave., Shorewood, WI 53211. (414) 964-0194

FOR SALE/TRADE: Fleming valve, stamped "Marconi" on side of glass - \$1,250. Ed Bell, 5311 Woodsdale Rd., Raleigh, NC 27606. Fax/phone: (919) 851-1517

FOR SALE: Cabinets, Stewart-Warner R-1401A. Cathedrals: Kennedy, Philco 19. Reproduction Philco cathedral cabinet parts: Front panels 70 - \$40; bottom moulding 70 - \$15; rear arch 70, 19, 38/38A, 20 - \$14; bottom board 70, 19, 20 - \$15. Plus S&H. Dick Oliver, 28604 Schwalm Dr., Elkhart, IN 46517. (219) 522-4516, evenings

FOR SALE: Radios: Wood, metal, Bakelite. Tubes: Vintage, specials, transmit, receiving. For lists send LSASE. Call or write: Gil Jungert, 3061 Wellington Ave., Grand Junction, CO 81504. (970) 434-5000

FOR SALE: Jackson Bell Model 59 - \$250. Majestic Model 461 Master Six - \$150. Amberola VI with matching table - \$1,200. AK cathedral Model 84 - \$450. GE E61 - \$160. All radios in good condition, photo avail. Please call after 6 pm or leave a message; I will call back. Luis Amory, PO Box 522, Richlandtown, PA 18955. (215) 529-9644

FOR SALE: All xint. RCA 1X, Bakelite - \$60. Sony TR-84 - \$80. National T-55, blue - \$65. Ed Kalpa, 4622 Melbourne Ave., Los Angeles, CA 90027

BOXED CLASSIFIED ADS WORK! This is a boxed classified ad. These ads can be run more than two months. See the inside back cover for details. Boxed ad deadline: the 1st of the month.



WANTED: Tube Hi-Fi components & commercial amplifiers by Marantz, McIntosh, Tannoy, Acrosound, Brook, Brociner, Fairchild, Hadley and others. Also want Western Electric theater amplifiers, speakers, tubes, & microphones. Richard Sharisky, PO Box 521, Belmont, MA 02178. Phone (617) 484-5784. Fax (617) 489-6592

WANTED: Vintage Electronic Music Synthesizers and modules by the following manufacturers, especially the listed models. **Aires** Modular, System III. **ARP** 2500. **Buchia** Modular, 100, 400. **E-mu** Modular. **EML Electrocomp** 100, 101, 200. **EMS** Synthi A, Synthi AKS, VCS3. **Korg** Modular PS-3100, PS-3200, PS-3300. **Moog** Theramin, Modular, Series 15, 35, 55. **Oberheim** SEM modules, 2-, 4- & 8-Voice Systems. **Paia** Modular 2700, 4700. **Roland** Modular Systems 100, 700. **Serge** Modulators, System 79. **Synton** Modular System. Call and surprise me; make my day! John V. Terrey, 498 Cross St., Carlisle, MA 01741. (508) 369-9770. Fax: (508) 371-7129.

FOR SALE: Retiring, sell magazines as follows, most good condition: Radio TV News, 1950-1958, (50) issues - \$140; Photofact Reporter by Sams, 1956-1962, (140) issues - \$125; Electronic Servicing, 1969-1971, (76) issues - \$75; Radio Electronics, 1950-1954, (51) issues - \$85. All plus \$20 shipping each lot. Maurer TV, 29 S. 4th St., Lebanon, PA 17042. (717) 272-2481

FOR SALE: HP 332A distortion analyzer, appears to work - \$125. B&K scope #1461, missing bezel & has vert problems - \$25. Harry Pewowaruk, 1535 No. 8th Ave., St. Cloud, MN 56303. (612) 252-9910. E-mail: PewowarukH@aol.com

FOR SALE: Good used tubes, tested and boxed: OC4, OD3, OZ4, IR5, IS5, IU4, IU5, 5Y3GT, 6AQ5, 6AU5, 6AU6, 6AX5, 6C4, 6C5, 6K7, 6L7, 6S4, 6X4, 6X5GT, 6SF5, 6SF7, 6SH7, 6SJ7, 6SK7, 6SQ7, 12A6, 12AT6 12AU6, 12AV6, 12BA6 12BE6, 12SJ7, 25EH5, 35C5, 35W4, 50C5 - \$1; 5Y4G, 5Z3, 6AN8, 6CG7, 6CB5, 6CD6, 6J5, 6SC7, 6SL7, 12AU7, 12SA7, 12SK7, 12SG7, 25L6, 35Z5, 50EH5, 50L6, 117L7, 117Z3, 117Z6 - \$1.50; 5U4GB, 5V4G/GA, 6BG6G/GA, 6BQ5, 6V6GT, 12AX7, 12BH7, 12BY7 - \$2. Stock up now while supplies last! Herb Ratner, 3542 Westminister Ct., Holiday, FL 34691

FOR SALE: Scott 310-C tuner and Scott 121-C preamp - \$115 plus shipping. Thomas Peters, PO Box 3925, McAllen, TX 78502

FOR SALE: AK BB - \$750. Emerson butterscotch, Catalin - \$425. 8,000 tubes - \$500. Liquidating large collection. Call or send want list. Steve Blank, 407 Hamilton Ave., Linwood, NJ 08221. (609) 926-9277

ELECTRON TUBES: Over 1 Million Tubes in Stock. Buy & Sell. Daily Electronics, 10914 NE 39th St. #B-6, Vancouver, WA 98682. 800-346-6667. 360-896-8856. 360-896-5476, fax

WANTED: Hallicrafters Models S-2, S-33, S-35, SX-112, EP-132, HT-2, HT-3, HT-8, HT-12, HT-14, console speaker R-8, RCA Model AVR-1, AR-88, Philco 38-690, Midwest 20-38 chassis & speaker. Chuck Dachis, The Hallicrafter Collector, 4500 Russell Dr., Austin, TX 78745. (512) 443-5027

CAPACITOR REBUILDING - We rebuild any can type capacitor. Typical turn-around time now 2-4 weeks maximum. Twist-Locs, old wet type & tubulars rebuilt. Call for prices. **FRONTIER CAPACITOR**, Box 218, Lehr, N.D. 58460. Phone or fax: 701-378-2341. Via UPS, to 403 S. McIntosh St. Everett Hoard - owner

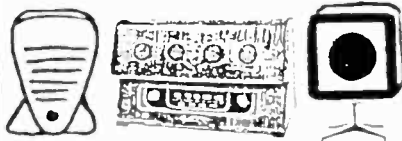

Wanted. The following radios and speakers, your price based on condition. **TELE-TONES** #117 and #117A. Wood with round speaker holes. late 40's. **STEPHANS** Tru-Sonic, cube floor speakers. 1957-61. **SILENT-NURSE** plastic table speaker. 1950's. Steven Cabella, 500 Red Hill Ave., San Anselmo, CA 94904. Phone 415-461-6810

WANTED: Crystal detectors: Amrad, Tuska and Grebe, consider others. Ed Bell, 5311 Woodsdale Rd., Raleigh, NC 27606. Fax/phone: (919) 851-1517

WANTED: Philco cathedral cabinets, any condition. Dick Oliver, 28604 Schwalm Dr., Elkhart, IN 46517. (219) 522-4516, evenings

WANTED: Early X-ray, Geissler tubes, Scientific American magazine supplements, bipolar motors & dynamos. Tom Burgess, #9 Belle Meadow Ln., Little Rock, AR 72210. (501) 455-0773

WANTED: Sams TSM23; AA10 & 11. Mallory Service Encyclopedia Volume 6. Cash or many books to trade. Richard Gray, 11869 High Ridge Rd., Lakeside, CA 92040. (619) 390-9128

WANTED: TV's odd-brands, Andrea, Garod, etc. Can pick up in some areas. Thanks! Glenn Bubenheimer, 27851 Terrence, Livonia, MI 48154. (313) 421-5574

WANTED: Old broadcast an recording equipment, literature on above. Jim Kollens, 29 W. Commercial, Addison, IL 60101. (708) 628-0810 days; (708) 691-8890 evenings

WANTED: Philco cabinets 80B, 84, 89B. Chassis for Gloritone 26, Stewart-Warner 1231. Richard B. Jehlich, 14441 North River Rd., Omaha, NE 68112. (402) 457-4604, after 7 pm CST

WANTED: Chassis, escutcheon for Philco 39/39A cathedral battery set. Cabinet similar to Philco 89B (Bunis 3, p. 171). Chuck Regen, 2724 N. 27th St., Sheboygan, WI 53083

WANTED: Radio Boys books by Chapman. Ted Scott Flying Stories by Dixon. Thank you. Bob Barr, 3130 Bellanca St., Columbus, GA 31909. (706) 322-2180

WANTED: Emerson 580 plastic radio, dial pointer for an Emerson 256 Strad. Geoff Shearer, 14101 Mesita Cliff Rd., NE, Albuquerque, NM 87112. (505) 293-8544

WANTED: R388 & R390A receivers, AC power adaptor for R3000-1 Trans-Oceanic. Christopher P. Demeroukas, 133 Basswood Rd., Springfield, IL 62707. E-mail: christopher.demeroukas@accessil.com

WANTED: Zenith 1940: 15S479, 12S475, 12S445, 12S471; 1939-9 tube dial or dial w/chassis. Curt Brohard, 1417 Court St., Alameda, CA 94501. (510) 521-4299

VINTAGE MANUALS AVAILABLE for amateur, audio, and radio-related equipment. Quality is always our number one customer priority. Satisfaction guaranteed. Send two 32¢ stamps for catalog. Pete Markavage, **THE MANUAL MAN**, 27 Walling St., Sayreville, NJ 08872-1818. (908) 238-8964

WANTED: 1930 to 1942 Police Radio communications equipment. Any 6 VDC mobile communication equipment. Raymond Miller, 953 N. 1st St., Albemarle, NC 28001. (704) 982-0228

ANNOUNCING "Radios by Hallicrafters," the definitive book on the Hallicrafters Company and its products by Chuck Dachis 'The Hallicrafter Collector.' More than 200 pages, over 600 photographs and 10 years in the making. Available late March 1996 at \$29.95 from Schiffer Publishing Ltd., 77 Lower Valley Rd., Atglen, PA 19310

WANTED: Western Electric tubes. Paying the following for new S⁻ in original box: VT52 - \$80; 101D - \$30; 104D - \$50; 205F - \$90; 231D, 239A, 262B - \$40; 274B - \$150; 301A - \$100; 310A/B - \$12; 311A/B - \$10; 348A - \$40; 349A - \$40; 404A - \$8; 422A - \$40. Most all others wanted, new or used. Tim Metz, 221 Wheatland, Fairview, OK 73737. (405) 227-2456

WANTED: High-quality audio frequency input, interstage, output transformers. Old loudspeakers with carrying handles. Vernon Vogt, 330 S.W. 43rd St., #247, Renton, WA 98055. (206) 382-5571

WANTED: Reasonably priced Atwater Kent Type II tuner for breadboard - \$30. Finder fee. John Koop, 48 Wheelbarrow Ln., Wantagh, NY 11793. (516) 731-6711 pm

WANTED: N.O.S. tubes 45, 145, 245; balloon - \$35; used - \$12; 45 (ST) N.O.S. - \$15 ea.; used (ST) 45 - \$12 ea.; N.O.S. 50, 150, 250, balloon - \$115. Used - \$65. N.O.S. larger 50 (ST) 5 15/16 inches tall - \$90. Used - \$50. Smaller N.O.S. (ST) 5 1/4 inches tall - \$50. Used - \$27. N.O.S., WE, 205D, E, F, tennis ball shape - \$110. Used - \$60. 274 A, B, WE N.O.S. - \$90. Used - \$35. 300, A, B, WE, N.O.S. - \$260. Used - \$130. 104D, WE tennis ball shape - \$50. Used - \$12. N.O.S. tubes must be in original boxes, used in bubble wrap. Pack in strong box, crushed newspaper or popcorn for strong foundation on bottom, on top the same. Tubes in middle. Check mailed within three days. All tubes must test good. Ship to: George Stagakis, George's Radio and TV Repair, 1714A 41st St., North Bergen, NJ 07047. (201) 867-9136

WANTED: Broadcast-type **MICROPHONES**. Early carbon, condenser, ribbon, dynamic, etc. Cash or trade. James Steele, PO Box 620, Kingsland, GA 31548-0620. (912) 729-2242

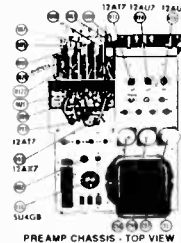

WANTED: Parts for a 1961 Columbia Masterworks, Model 1066. The parts needed: pot transformer number #507-1 and a push-button slide type made by Oak Inc. switch number #69589-130. Call or write. Kurt A. Wieseman, 25735 Lorain Rd., #117, North Olmsted, OH 44070. (216) 777-6038, call after 7:30 pm

WANTED: BRUNSWICK UPRIGHT PHONOGRAPH w/curved sides in oak or walnut, v. good or better cond. I'll pay your price for the right one! Call or write: Bo Broock, 4858 Willow Ln., Orchard Lake, MI 48324. (810) 681-7133, eves.

WANTED: KLH-8, KLH-13, related accessories and any KLH-8 manuals or literature. Also any Tandberg radios. Gary Klawans, 825 Thorndale Ct., Lake Zurich, IL 60047. (708) 654-9100, ext. 2940, 9 am-4 pm weekdays, or (708) 438-7339, after 7 pm, or e-mail: binkyboo@aol.com

FOR SALE: Hi-voltage probe Heathkit Model 336, new in orig. box - \$15 I ship. John Snow, 4539 N. Bartlett Ave., Shorewood, WI 53211. (414) 964-0194

FOR SALE/TRADE: 1919 Donle Type C vacuum tube, Connecticut Telephone, (see Saga, p. 337) - \$875. Ed Bell, 5311 Woodsdale Rd., Raleigh, NC 27606. Fax/phone: (919) 851-1517

FOR SALE: My garage is overflowing with radios; my loss your gain: Plastic tube radios from 50's in various makes & colors, not tested, but most complete with tubes & knobs - \$25/5, \$45/10. Emerson 610, ivory, small hairline, works good - \$15. Zenith X334 AM-FM, wood, very nice - \$15. Emerson 805B, blk., exc cond. - \$15. Silvertone 2 metal, nice orig., ivory - \$55. GE C2418A Mickey Mouse clock radio - \$60. Ampro 757 reel-to-reel - \$20. 1/4" 1,800-foot. tapes - Offer. Old Earl Webber tube tester - \$20. 1938 Rider chanalyt with books - \$75. Joe Svihel, 17227 Co. Rd. 54, Avon, MN 56310. (612) 356-7601

FOR SALE: Single plate 2A3's, test OK but on lower end of good scale, as is - \$70 ea. ppd. Darrell Combs, 6587 Pacheco Way, Citrus Heights, CA 95610. (916) 969-0635

FOR SALE: Bell Sound Systems audio amplifier Model 3725, 7 tubes, with carrying case - \$55. Jim Ligouri, 7 Sycamore Ct., Atkinson, NH 03811. (603) 362-5712

SOLID-STATE VIBRATORS for automobile radios 1932-58. Exact duplicates of originals in metal cans. Synchronous, Non-sync, European. Dealer inquiry invited. Free catalog. Visa, MasterCard, Discover. Antique Automobile Radio Inc., 700 Tampa Road, Palm Harbor, FL 34683. (800) WE FIX AM 933-4926, or Fax (813) 789-0283

RADIO SCHEMATICS PLUS DATA STILL \$3.00 EACH. TV \$4.00, POSTPAID USA. STAMP FOR TUBE AND TEST EQUIPMENT LIST. JOSEPH R. FORTH, 321 LONG VUE ACRES, WHEELING, WV. 26003. (304) 277-3154

PHONO NEEDLES & CARTRIDGES: (Ceramic & magnetic) What do you need? Send SASE. J.J. Papovich, 53 Magnolia Ave., Pitman, NJ 08093. (609) 582-8279

ANTIQUE RADIO RESTORATION Satisfaction - Guaranteed. Ray Sanders, 342 South Third, Cottage Grove, OR 97424. 541-942-0866

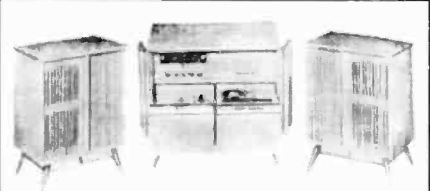

WANTED: RCA hi-fi/stereo console Model SHF-1 (pictured) or similar RCA consoles/home entertainment centers, late 50's-early 60's (especially blond Danish moderne look). RCA Product Catalogs, RCA Engineer, RCA Electronics Age, from 1956-1962. Any help appreciated. John McLawhorn, 112 Walnut St., Cary, NC 27511. (919) 467-8018

FOR SALE: Scarce solid-state tube tester by B&K, Model 747, last model manufactured at end of tube era, mutual conductance, all accessories & charts - \$135 plus \$25 shipping. Don Maurer, Maurer Television, 29 S. 4th St., Lebanon, PA 17042. (717) 272-2481

FOR SALE: Capehart Deluxe Model 410M, 1942, 31 tubes, 4 bands, with flip-over record changer, very nice cabinet - \$1,800. Pick up only. Photo available - \$1. Antique Radio Store, 8376 LaMesa Blvd., LaMesa, CA 91941. (619) 668-5653

FOR SALE: B&W video camera, single lens, 16mm, all tubes, including video con., commercial quality with manual, vg - \$150 + 30 lbs. shipping. John Nosbaum, 2743 Wilmette Ave., Wilmette, IL 60091-2278. (847) 256-0547

FOR SALE: Piano radios: Brown Bakelite Continental - \$50. Brass Fada - \$400. Wood General Television - \$200. Full size 1939 spinet-style, electric Ansley piano with built-in Ansley Dynaphone radio and phonograph - \$650. Kenneth Zander, PO Box 2652, Sunnyvale, CA 94087. (408) 286-1104

FOR SALE: RCA display rack, free standing 4'x4', reads across top, "Table Radios RCA Victor Portable Radios," has wire brackets to hold as many as (12) radios, pictures available - \$200 OBO, pickup only. Bob Turner, 11632 Co. Rd. 48, Fairhope, AL 36532. (334) 928-0051, or e-mail: Radio coll@aol.com

FOR SALE: Rider's Vols. 3, 4, 5, 17, 18 - \$30 ea.; Vols. 6-16 - \$15 ea. + UPS. Greg Mitchell, 8017 Dema Dr., Des Moines, IA 50320. (515) 287-2005

FOR SALE: Presto A-920 play-back record amplifier, working condition - \$150 + UPS. Harry C. Nuss, 47 Gravel Hill Rd., Huntingdon Valley, PA 19006. (215) 357-5061

FOR SALE: Hickok 532 tube tester with supplement tube charts and operating instructions - \$60. Don Rathbun, 27851 Bruno St., Hayward, CA 94544. (510) 783-1841, mornings

Victrola Repair Service: Windup phonograph repairs, parts, springs, needles via U.P.S. Rod Lauman, 19 Cliff St., St. Johnsbury, VT 05819. (800) 239-4188, eves.

WANTED, ANY CONDITION: RBY, Hallicrafters S-35, PR-1, Collins 478R-1, Squires-Sanders SS-1V panadaptors, also schematics, manuals, ads, articles, technical data on them. John A. Benyo, 25 Schley Street, Garfield, NJ 07026

MESSAGE: The Michigan Antique Radio Club announces that **EXTRAVAGANZA '96** will be held July 12-14, 1996, in Lansing, Michigan. Please **MARC** your calendars now! To be put on the **EXTRAVAGANZA '96** mailing list, send postcard to: **EXTRAVAGANZA '96, PO Box 585, Okemos, MI 48805-0585**

SPEAKER PARTS: Adhesives, Cone, Dust Caps, Gaskets, Voice Coils (Round and Edgewound) Spiders and Terminals. Refoam Kits - \$14-\$18 for speakers. Cat. avail. \$10.00 (Refund.) 800 order line Visa/MC/Am.Ex. Speaker Parts Co., PO Box 14731, Fremont, CA 94539. 510-490-5842/510-490-1961
FAX

WANTED: Crystal detectors: Amrad, Tuska and Grebe, consider others. Ed Bell, 5311 Woodsdale Rd., Raleigh, NC 27606. Fax/phone: (919) 851-1517

WANTED: Bearcat 8 repair info/parts (little xfmr broken. Hank Seesselberg, 22 Christy Dr., Warren, NJ 07059. Phone/fax: (908) 469-5539

WANTED: Meissner high-tube kits, like Traffic Master #7502, Communication Scout, any condition. Call collect: Bruce C. E. Russell, VE7HII, 4411 Hastings, E, Willingdon at Hastings, Burnaby, British Columbia, Canada, V5C 2K1. (604) 298-1038

WANTED: BFO add-on kit, Zenith #S-53472 allows CW-SSB reception for Royal 1000/3000 Trans-Oceanic. Marty Dzik, 412 Gregory St., Schererville, IN 46375-2290. (219) 322-4104

WANTED: Crypto equipment and accessories; books on telegraphic codes and ciphers. Richard Brisson, 159 Grandpre Ct., Navan, Ontario, Canada K4B 1K3. (613) 830-0379. E-mail: hagelin@magi.com

WANTED: Fisher AM tuner #AM-80. Will consider #80-R also. Thanks. John Sampson, 75 Glenwood Dr., Leominster, MA 01453. (508) 537-0092

WANTED: Reward! \$40 for Telefunken tube manual. \$25 for Altec 4722 mic trans. Tom Miller, PO Box 20138, London Terrace Station, New York, NY 10011. (212) 675-7704

WANTED: Band selection shaft, pot metal, for Zenith 12H689 chassis. A.J. Long, 11830 Heath Rd., Chesterland, OH 44026. (216) 729-8451

WANTED: Car radio for a 1939 Ford. Chip King, 808 South Ridge Rd., Burlington, NC 27217. (910) 228-6368

WANTED: Fada Neutrodyne 6 chassis, would consider parts set. **FOR SALE:** A, B & C battery eliminators, original - \$30 ea. + shipping. Denis Meany, 81 Madison St., Blue Point, NY 11715

The Olde Tyme Radio Services Directory is now available. Find the services and parts needed to restore that old radio or t.v., also included are clubs and publications all categorized and sorted by state for easy look-up. Over 225 suppliers listed, and always adding more each year. Send \$4.00 ppd. Andrew Mooradian, 5 Priscilla Lane, Winchester, MA 01890

WANTED: Tubes: 300A/B, 274A/B, 262A/B, 275A, 252A, 101D, 104D/F, 211A/D/E, 271A, VT2, 205D/E/F, VT52, 272A, 244A, 284D, 348A, 349A, 293A, 290A, 285A, 301A, 216A, 345A, 351A, 339A, 306A, 422A, 303A, 292A, 347A, 398A, 440A, 442A, 310A (S. H/M. H). Other: 50/250/350/450, 183/4E3, 45A, 845/W, VT52, VT62, 5C24, AB150, HF120, HF140, 211B/D, C182, C183, 2A3H, 1276, 2A3 (M. F). European tubes, old power tube only. Transformers: WE, Peerless, Langevin, UTC, Triad, other. Parts: Capacitor, resistors, cloth-covered wire, other. Jazz LPs: 1950's, 1960's. Speakers unit: 8"-15", old only. Kouji Matsuo, 6-2, Tsurumi-Cho, Beppu-Shi, Oita 374, Japan. Tel/fax: 81-977-23-9579

WANTED: Collins Radio Company Catalogs. promotional literature, manuals 1933-1983. Jim Stitzinger, 23800 Via Irana, Valencia, CA 91355. 1-805-259-2011

WANTED: Used Western Electric tubes. Paying: Globe 274A - \$175; 262A - \$45; tennis ball, used, 101D - \$120; 101F - \$100; 104D - \$120; 205D - \$160. All others wanted. Tim Metz, 221 Wheatland, Fairview, OK 73737. (405) 227-2456

WANTED: Working Orpheus radio chassis. Also, metal dial with good lettering for Glorionta 26. Smokehouse Antiques, R. T. Bailey, R#1, Box 479, Benton, TN 37307. (423) 338-5923

SEND ALL A.R.C. MAIL TO
Antique Radio Classified
P.O. Box 2, Carlisle, MA 01741

WANTED: Mitchells. Mitchell radios, Mitchell TVs and other Mitchell brand appliances. Thanks. Now call free: Lee Mitchell, The Mitchell Collector, 175 E. Delaware, 8210, Chicago, IL 60611. (800) 869-7869

WANTED: Manuals/info for: Racal RA6217-D19 receiver; Singer MF5/VR4 spectrum analyzer. Copies OK. Hal Layer, KK6HY, PO Box 27676, San Francisco, CA 94127

WANTED: Feet for Radiola 60. Chassis for RCA R-73 tombstone. Carol Scott, 1402 Cora, #1, Ellensburg, WA 98926. (509) 925-1030. E-mail: scottc@adsnet.net

WANTED: Wilcox-Gay #A-17 (Machine Age, p. 210). Robert Lutz, 9041 Gillette St., Lenexa, KS 66215. (913) 894-1327

WANTED: Selling your collection? Contact me last. Fair prices. Also looking for Radio Glo. Phil Harris, The Radio Nuts, 45 Windsor on the Marsh, Savannah, GA 31419. (912) 925-1512

WANTED: Unassembled Heathkits, Knight-kits, others. Gene Peroni, Box 58003, Philadelphia, PA 19102. (215) 665-5182, days

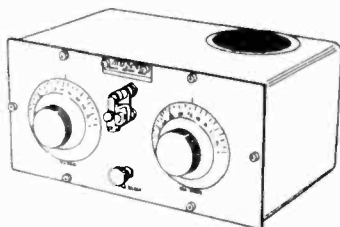

WANTED: Pre-1926 radios by AMRAD. Also, Amrad radio parts, accessories, and literature. Richard Sharisky, PO Box 521, Belmont, MA 02178. (617) 484-5784

WANTED: Radio Callbooks 1900 thru 1927. Bob Arrowsmith, W4JNN, PO Box 166, Annandale, VA 22003. Collect (703) 560-7161

WANTED: Fairbanks Morse console Model 9C or 12B preferred. Charles E. Patterson, 2621 Sweetwater Rd. SP#33, National City, CA 91950. (619) 475-7141

WANTED: Front panel for Pilot A.C. Super-Wasp. Bob Grega, P.O.B. 391086, Solon, Ohio 44139. 216-475-6643 after 6:00 P.M. EST

FOR SALE: Motorola X14E, black, works, needs dial scale - \$30. Radiola 111, NT - \$85. Crosley 51S, NT - \$90. (3) WECO crystal sets - \$45 ea. No-name xtal set, 3" vertical with slide tuner - \$55. Fada 711, maroon with white trim, has re-glued handle, original back - BO. Zenith 6S-128, jumbo tombstone - BO. Thanks. Del Tysdal, Rte. 1, Box 157, Glyndon, MN 56547. (218) 287-2562

FOR SALE: Two very good SW radios: Knight Star Roamer - \$65; Hallicrafters S-38 - \$95 with original manual. Plus shipping. Carl Blomstran, 2107 Heather Green, Houston, TX 77062. (713) 486-5262

FOR SALE: Atwater Kent #55 - \$150. National #One-Ten super regenerative, circa 1936, with dog-house power supply and separate speaker and original ear-phones, black krinkle finish, super clean condition - \$375 or trade for other communication receivers. Fada 1000 bullet repro, M.I.B. - \$75. Frank J. Manzano, 82 Monhegan Ave., Oakland, NJ 07436. (201) 337-5263

FOR SALE: Parts-used, original for vintage radio, audio & test equipment. Electrical parts, case parts (wood or plastic) and cosmetic parts available. Send brand name & model number of the piece of equipment along with name/description of the needed part(s) addressed to: V.E. Parts, PO Box 436, Fallston, MD 21047. Fax: (410) 877-1697. E-mail: vintel@aol.com

FOR SALE: RCA Redbooks. Vol. I 1923-1928, cover has some water damage, not too bad, insides excellent - \$50. Vol. III 1931-1932, same condition as above - \$25. Also Vol. III with excellent cover - \$30; and Vol. IV 1933 with excellent cover - \$30. Jim Traynor, 3198 Boudinot Ave., Cincinnati, OH 45211. (513) 662-4344

FOR SALE: Sparton Bluebird replica - \$200. Akai 4000-DS tape recorder - \$65. GE #P4960A 8-band radio - \$12; P-795-D - \$18. Sabtronic 8610-A freq. counter - \$35. General 1142-A freq. meter/discriminator - \$40. Video special effects generator - \$80. Realistic DX-360 - \$75. Bret F. Johnson, 13495 102nd Ter. North, Largo, FL 34644. (813) 595-9287

FOR SALE: All items good condition. H.H. Scott Type 250 amps, no cages - \$400/pr.; 130 preamp - \$175; LT-10 - \$30; LT-110 brown face - \$90, LT-110 silver face - \$60, 330D AM/FM wood case - \$90, LM-35 adaptor brown face - \$80, 299 int. amp - \$75. Knight PA amps: 3050 HD - \$40; 3235 - \$30. Heath W4 two outputs & 2 chokes - \$60. Stancor N.O.S. PC-8405 - \$15; P-4078 - \$15; A-3301 - \$15; UTC-CG-41 - \$10. RCA 98680 S.P. - \$20. Hammond 1650K outputs - \$60 pr. Tubes N.O.S. RCA 866A, (4) - \$25; #80, (10) - \$25; (2) 872A - \$20. Parts for R-390A receiver. Call for your needs, have several sets for parts, 3TF7 (RT510). Ballast tube new - \$25. 26Z5W tubes - \$10. **WANTED:** Heath kit DX-100 transmitter. Paul Busnuk, 2110 E. Lombard St., Baltimore, MD 21231. (410) 522-0431, 6-10 pm EST

FOR SALE: (8) Zenith Royal 500 D&E radios - \$225/all. (2) RCA B&W cameras, Model TC2511012 - \$100 ea. (1) 9 in. B&W Vicon monitor - \$75. **WANTED:** Volume control for Zenith 500E radio. Vincent Scopacasa, 8900 S. 85th Ave., Hickory Hills, IL 60457. (708) 598-3472

FOR SALE: Emerson 461 - \$35. Zenith 6D-030 - \$50. Automatic 237 - \$40. Philco 54 - \$75. Philco plastic flashlight, N.I.B. - \$25. (2) #45 tubes, N.I.B. - \$85. Knobs and speaker from a Philco 96 - \$40. Thank you. Joe Kelly, 537 Stafford Ave., Erie, PA 16508. (814) 459-3910

FOR SALE: Test equipment. Old Aerovox LC checker, Model #97, N.I.B. with booklet, adapters, etc. - \$30. Sierra Model 219A-B, transistor beta checker, in excellent condition with book and leads - \$30. Bill Manny, 1103 N.W. Despain Ave., Pendleton, OR 97801. (541) 276-3152, days. (541) 276-7439, evenings and weekends

FOR SALE: Tired of high tube prices? Large SASE for list of over 1,000 types of N.O.S. tubes. Prices start at just 25c. Charles D. Blair, 815 N. 5th St., Cambridge, OH 43725. (614) 432-4453, 9-5

FOR SALE/TRADE: For wanted items: RCA BK5B, exc - \$475. 74 Jr. vg - \$350. EV664 chrome, exc - \$135. Gold, good - \$75. (2) EV 644 shotguns, fair/good - \$75 & \$100 ea. Altec M-30 Lipstick tube mics w/pwr supplies - Offers. Dynakit SS40W stereo - \$85. Altec 351-C mono 50W - \$50. 1599 A/B aux. mixers - \$60 ea. Ampex AG-350 SS FT mono - \$150. Heath WAP2's, exc - \$40 ea. Zenith 755, vg - \$40; 705, vg - \$30. **WANTED:** WE 640/RA1095 mic/amp combo. WE 630 Eightball. Altec M21B Coke bottle. Yokes for M-30 Lipsticks. (3) RCA chairs. RCA & other curtains, banners, clocks, signs, thermometers, etc. SASE for new list. Ward Kremer, 301 S.W. 16 St., Ft. Lauderdale, FL 33315. Phone/fax: (305) 524-5652

FOR SALE: (4) Altec 1592-B solid-state mixer - \$100 ea./Offer. (3) Pritec/Mcghohan 100 watt amps w/preamp PP 7027's - \$200 for all. **WANTED:** 1957 Allied Catalog. Joe Esdale, 1769 Eastwood Ave., Highland Park, IL 60035. (708) 831-2544

FOR SALE: Fisher 500 - \$200. Scott stereo tuner, tubes - \$125. Hallicrafters SX25 with speaker - \$175. Several integrated mono amps - Call. Zenith Model 92 console - \$200. RCA Model 90 console - \$150. Hallicrafters S-108 in box - \$150. Several TV sets for sale - call for wants. Chassis also for sale, some CRTs. Garrard Model A turntable - \$75. 1948 Buick Roadmaster - \$5,000. **WANTED:** Airline or Sentinel 7-inch porthole TV. Raytheon 7-inch porthole. Rider's 1 to 14, will trade for 19-23. Vaughn Rudisill, 11 E. Marie St., Hicksville, NY 11801. (516) 822-4501

FOR SALE: Collection of (30) interesting transistor radios. Sell as a single lot, SASE for list. Paul Ernst, 238 Meadow Ln., Webster, NY 14580

FOR SALE: Collection, valves, semi's protected, fresh tested, need quantity desired, a fair bid, N.O.S. or like new shipping instruction, plus your 100% satisfaction. Do visit, I Feel Good!, Jim Brown, 7708 Main St., West Rushville, OH 43163. (614) 536-7322

FOR SALE: Red Army pack set, HF transceiver. German HRO, copy 1950's and one WWII. British WWII Suitcase set/SOE :B2. **WANTED:** WWII German receivers. Rag Otterstad, OZ8RO, Hosterkbovej 10, DK-3460 Birkerød, Denmark. Phone: -45-4281 5205. E-mail: danmec@inet.uni-c.dk

FOR SALE: Collins R388 general coverage receiver - \$100 OBO. Bob Rolffness, 2327 Malaga Rd. NE, Moses Lake, WA 98837. E-mail: rsrolfne@atnet.net

FOR SALE: (175) Blue tubes, misc. types-tested - \$1,750. 201A's, tested - \$10 ea. James Kroegel, 856 Old Farm Rd., Columbus, OH 43213. (614) 864-8327

FOR SALE: Over 10 years A.R.C. issues, only one issue missing - \$60 plus shipping. Tom Margaretic, 2040 T St., Merced, CA 95340. (209) 722-1824

WANTED: Book on Scott radios titled Silver Ghosts by Puett, and manual for hi-fidelity All Wave. Chuck Ulrick, 8282 Afolkey Rd., Dakota, IL 61018. (815) 563-4905, after 6 pm

WANTED: A radio part from the Henry Ford Museum auction. A black molded variometer that is broken off at the mounting. I believe this to be the one I've been searching for. Stephen C. Brown, KD4YFY, 3808 Champion St., Charlotte, NC 28210. (704) 847-1301

WANTED: RCA, Andrea, and other U.S. prewar televisions. Will purchase in most any condition. Lee Rhoden, 8906 Clayco Dr., Dallas, TX 75243. (214) 430-0060, office; (214) 343-5721, h

WANTED: 7027A tubes. Manual and repair data for Hickok 123A Cardmatic tube tester, copy OK. Lafayette KT-600 preamp, any condition. Info and calibration data on Jackson tube testers. Thank you. Charles D. Blair, 815 N. 5th St., Cambridge, OH 43725. (614) 432-4453, 9-5

WANTED: Columbia Grafonola with record ejector and other crank phonographs. Have one? Try me! Also need Garrard 301 or other electronic turntable that can play 78s. Thank you. Richard Rubin, 227 Riverside Dr., Apt. 5-A, New York, NY 10025. (212) 864-8416

WANTED: A main power transformer for a Siltronix Model 1103D amateur transmitter. Or buy your junker unit. Bill Manny, 1103 N.W. Despain Ave., Pendleton, OR 97801. (541) 276-3152, days. (541) 276-7439, evenings and weekends

WANTED: For Heathkits: T3 pwr transformer and schematic. FMO-1 schematic. AD-1013 manual. Chuck Ulrick, 8282 Afolkey Rd., Dakota, IL 61018. (315) 563-4905, after 6 pm

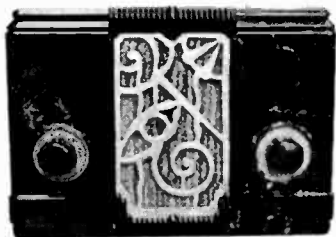

WANTED: Kadette pictured, Detrola, RCA, Air King, etc. prewar plastics. I am new to the field of collecting but have plenty of money to live with big mistakes. Please write or call collect: Rain Buttignol, 214 State St., #7, Portsmouth, NH 03801. (603) 427-1384

WANTED: Western Electric 640A/RA1095 mic amp combo, WE 630 Eightball, Altec M-21 Ccke bottle, yokes for Altec M-30 Lipstick mics, RCA 77A. RCA PB-17 ribbon mic & preamp, RCA UZ-4083/MI 4020 Box Camera Mike. Have some RCA ribbons. Altec tube cond. etc. for trade or buy outright. Ward Kremer, 301 S.W. 16 St., Ft. Lauderdale, FL 33315. Phone/fax: (305) 524-5652

WANTED: Volume control knob shaft and pointer for Zenith Model 7. Steve Metzgenber, 2818 So. 284th, Federal Way, WA 98003. (206) 941-0699

WANTED: TV tubes: 6KG6/EL-509, 6LW6, 6LF6. A&B carbon resistors one & two watts. Raul Gil, 80 Union Ave., Belleville, NJ 07109-2067. (201) 751-5959

WANTED: Fada C34, portable. Lid for Radiola 33. Cabinet for Philco 118. Chassis and speakers for RCA 110 cathedral and Majestic 331 cathedral. Tony Parjus, 816 Richard Ln., Gretna, LA 70056. (504) 393-0099

WANTED: Zenith Stratosphere and other high-tube count radios. Also Zenith and other pre-1950 advertising. We will buy or trade. Alan Jespersen, PO Box 17338, Minneapolis, MN 55417. (612) 727-2489

WANTED: Kellogg 401 tubes. Sleeper Model 66 front panel, Trimm and Baldwin horn tops. Ken Martin, 12667 Eckard Way, Auburn, CA 95603. (916) 885-0243

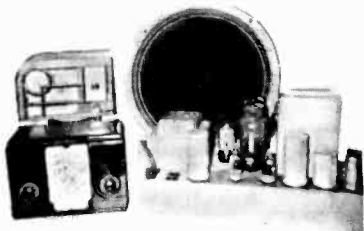

WANTED: Deco radios; Detrolas, Kadettes, Fadas, others. Tube hi-fi amplifiers and mono blocks, speaker (Altec, Jensen), Western Electric, tubes. Call or send list. Ross Litrenta, 1 Wilton Rd., Eastchester, NY 10709. (914) 337-7176

WANTED: Working Philco 60 chassis. Volume and vertical hold knobs for a Predicta Model G-4654. Stewart-Warner 102-A knobs and cabinet. Pioneer SX-1280 receiver. Wing speakers for a Seeburg DS160 jukebox. Dan Cutler, PO Box 1203, Douglas, WY 82633. (307) 358-6219

WANTED: Atwater Kent Model 80 chassis or AK 82 cathedral with good original finish. Ralph Kemper, 297 27 3/8 Rd., Grand Junction, CO 81503. (970) 243-2576

WANTED: Detrola Pee Wee cream plastic dial. Cabinets for Airlines 14BR-521A & 74BR-1501B and all items listed on p. 71 of A.R.C., November '95. Larry Porter, 4115 Beam Rd., Crestline, OH 44827. (419) 683-2540

WANTED: Ozarka radios and literature. Don Patterson, 636 Cambridge Rd., Augusta, GA 30909. (706) 738-7227

WANTED: Original color ad/photostat of late 30's Scotts and Zenith Stratosphere. Will pay! Rick Ammon, 1249 Solstice Ln., Fort Collins, CO 80525-1239. (970) 221-4001

WANTED: Zenith Model 970 console. Have only the cabinet. Need radio chassis and speakers. Chuck Menard, WB9IFE, 232 N. Brashares Dr., Addison, IL 60101. (708) 543-4699

WANTED: McIntosh tube amps: MC 30, 40, 60, 75, all others; mint tuners, all models; complete McIntosh systems, tube or solid-state, cabinets, literature, accessories. Walt Fleming, 182 Plain Hill Rd., Norwich, CT 06760. (860) 889-1957

WANTED: Old Jensen speakers 8", 10", 12", & 15" Alnico Concert Series. N.C.S. audio tubes, 5881/6L6GC, 12AX7/7025, 5AR4/GZ34, 7027, 6550, 7591, 6BQ5, 6CA7. Old harmonicas, all makes & models. John McGrath, 29 Ripley Rd., Belmont, MA 02178. (617) 484-0515. Fax: (617) 492-7921

FOR SALE/TRADE: DeForest spherical Audion, single wing, excellent in every respect, 1908 paper sticker - \$1,500. Ed Bell, 5311 Woodsdale Rd., Raleigh, NC 27606. Fax/phone: (919) 851-1517

FOR SALE: Sencore Model FE-149 senior field effect meter, as new, with manual and probes, batteries not included - \$50 you ship. John Snow, 4539 N. Bartlett Ave., Shorewood, WI 53211. (414) 964-0194

FOR SALE: General Radio variac, 5 amps, 0-130 VAC - \$50. Rider's #8 - \$75. Hickok 6000 mutual conductance tube tester - \$125. Agreed? Renee May, 1242 N. El Centro, Los Angeles, CA 90038. (213) 464-9179

FOR SALE/TRADE: (25) plastic/Bakelite radios. Trade for deer antlers or plastic/Bakelite Zeniths. List, SASE. Phil Brunais, 14185 Pleasanton Hwy., Bear Lake, MI 49614. (616) 864-3143

FOR SALE: Crosley #10-135, white, paint blemish on side - \$65. Gloritone #26 cathedral, nice - \$120. Ron Timperley, 1725 Mission Ct., Huron, SD 57350. (605) 352-4723

HAS YOUR SUBSCRIPTION

EXPIRED?

It has if your mailing label reads
"EXP=FEB96" or earlier.
Renew now!

*BONUS: Renew before
your "EXP" month and receive
13 issues per year instead of 12!*

Renewal rates are:

\$36.95 for Second-Class Mailing

\$53.95 for First-Class Mailing

(Two-year renewals are twice above rates.)

FOR SALE: 1LE3/WD-11 - \$15. 1G4GT/WD-11 - \$17.50. 864-WD-11 - \$20 ea. plus \$3 shipping. Restore your Radiola III, IIIA, or bal. amp book - \$2 ppd. Robyn scanner, works, Model 100B - \$35 + \$5 shpg. New SW-3 coil forms - \$7.50 ea. Knight R/C tester, untested - \$25 + \$5 shpg. RCA Volt-Ohmyst WV-77E, unchecked - \$25 + \$5 shpg. James Fred, RR1, Cutler, IN 46920. (317) 268-2214

FOR SALE/TRADE: Peerless cathedral speaker - \$45. American Bosch 28 - \$65. Zenith 8-H-034 - \$25. GE #6D60 - \$55. Mark Thornquist, 45 Second St., Glens Falls, NY 12801. (518) 761-4143

FOR SALE: Sony TR84 pink (+case), very good, works - \$55. WWII pilot radio (T-20/ARC-5); includes transmitter tubes, eye tube and crystal - \$50. Fisher eleven-tube receiver (chassis #61), works - \$50. N.I.B. tubes: 6550 - \$28, 6JE6A - \$22, 5881 - \$16, 5U4GB's - \$10. New (reboxed) Eimac 4PR60A - \$20. Used 5U4GB - \$5. Bill Jewell, 6828 Trinity Landing N, Fort Worth, TX 76132. (817) 294-9061

FOR SALE: Westinghouse RC - \$250. Crosleys, all work: 51 - \$95; 52 - \$120; V1 - \$175; Ace 3B - \$160; Trirdyn - \$90. Aeriola Sr. - \$140. Western Electric 10D speaker - \$140. BBT UV200 - \$25. Tower Ship speaker - \$180. Bob Barnes, Box 275, Monroe City, MO 63456. Ph/Fax: (573) 735-2945

FOR SALE: Radio Masters catalogs: big, big books, cover everything electronic at time of issue, lots of history. Editions available: 1957, 1960, 1962, 1963, 1964 - \$25 ea. or \$100/all plus \$25 shipping. Maurer TV, 29 S. 4th St., Lebanon, PA 17042. (717) 272-2481

FOR SALE/TRADE: (25) plastic/Bakelite radios. Trade for deer antlers or plastic/Bakelite Zeniths. List, SASE. Phil Brunais, 14185 Pleasanton Hwy., Bear Lake, MI 49614. (616) 864-3143

FOR SALE: Crosley #10-135, white, paint blemish on side - \$65. Gloritone #26 cathedral, nice - \$120. Ron Timperley, 1725 Mission Ct., Huron, SD 57350. (605) 352-4723

FOR SALE: Zenith Television Service Manual Vol. I, 1948-1952 - \$45. Zenith Royal 94 interoceanic multi-band - \$40. Astatic Model A mike head - \$35. Plus shipping. Wm. Ernst, 16300 Campbell Rd., Comins, MI 48619. (517) 848-5002

FOR SALE: 1LE3/WD-11 - \$15. 1G4GT/WD-11 - \$17.50. 864-WD-11 - \$20 ea. plus \$3 shipping. Restore your Radiola III, IIIA, or bal. amp book - \$2 ppd. Robyn scanner, works, Model 100B - \$35 + \$5 shpg. New SW-3 coil forms - \$7.50 ea. Knight R/C tester, untested - \$25 + \$5 shpg. RCA Volt-Ohmyst WV-77E, unchecked - \$25 + \$5 shpg. James Fred, RR1, Cutler, IN 46920. (317) 268-2214

FOR SALE/TRADE: Peerless cathedral speaker - \$45. American Bosch 28 - \$65. Zenith 8-H-034 - \$25. GE #6D60 - \$55. Mark Thornquist, 45 Second St., Glens Falls, NY 12801. (518) 761-4143

FOR SALE: Sony TR84 pink (+case), very good, works - \$55. WWII pilot radio (T-20/ARC-5); includes transmitter tubes, eye tube and crystal - \$50. Fisher eleven-tube receiver (chassis #61), works - \$50. N.I.B. tubes: 6550 - \$28, 6JE6A - \$22, 5881 - \$16, 5U4GB's - \$10. New (reboxed) Eimac 4PR60A - \$20. Used 5U4GB - \$5. Bill Jewell, 6828 Trinity Landing N, Fort Worth, TX 76132. (817) 294-9061

FOR SALE: Stromberg-Carlson console 430-PLW - \$40, pick up. Melchior record album - \$15. David Randall, 40-04 150th St., Flushing, NY 11354. (718) 463-1720. 6:30-7:30 pm EST or Sun. am

FOR SALE: Outstanding Victor V with spear-point wood horn, serious callers only. Spartan 410 Junior - \$275. Geoff Shearer, 14101 Mesita Cliff Rd., NE, Albuquerque, NM 87112. (505) 293-8544

FOR SALE/TRADE: 1921 Paragon 2-5-U transmitter, excellent, rare and expensive. Ed Bell, 5311 Woodsdale Rd., Raleigh, NC 27606. Fax/phone: (919) 851-1517

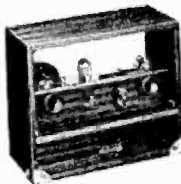

WANTED

Amrad 3670 as shown, any condition. Also a Type E crystal set, 3500-2 and other pre-1926 Amrad sets & parts.

Andrew Mooradian, 5 Priscilla Lane
Winchester, Massachusetts 01890
tel. 617-729-1873 after 7 pm

FOR SALE/TRADE: Connecticut Telephone & Telegraph Co. rare large handheld microphone - \$275. Connecticut Radio microphone, w/springs, 1922, very rare - \$400. Larry Drago, 383 Lincoln Dr., Cheshire, CT 06410. (203) 272-6030

FOR SALE: Old book list, electric old test instruments for experimenters. Western Union time service for radio stations. Henry Weiland, 8946 West Grantesa Dr., Milwaukee, WI 53225. (414) 463-4681

FOR SALE: McIntosh C4 preamps, PAS 3x. **WANTED:** MC60's, Bigg G30 (Gott), 1 MC30. Dave Barth, 8320 Bevan St., San Gabriel, CA 91775. (818) 286-6503

FOR SALE: Beautiful original, complete Colonial Cavalier highboy, (Douglas, p. 153) - \$225. Bob Eslinger, 20 Gary School, Pomfret, CT 06259. (860) 928-2628

FOR SALE: Hammarlund HQ-110. Stromberg-Carlson AU-64 PA amp. Popular Electronics magazines, 1956-1976. Dave Minchella, 80 Campfire Rd. North, Henrietta, NY 14467. (716) 359-3337

FOR SALE: Philco 49-501 white boomerang, no back - \$275. HC Citation III-X tuner - \$100. Hallicrafters SX-96 - \$120. John Malley, 19 Claremont Ave., Enfield, CT 06082. (860) 745-0733

FOR SALE: Bitterscotch Burns 205D horn speaker, nice, no cracks, plays - \$650. Fred Schultz, 1246 Lincolnway S, Ligonier IN 46767. (219) 894-3779, 9-5, fax after 5

FOR SALE: Zenith R-1000 and R-1000 parts set - \$100/both. **WANTED:** Sony 6800W. Mike Brillhart, 12551 Maiden Creek Rd., Abingdon, VA 24210. (540) 944-4387

FOR SALE: Sony transistors, pocket & portables. Zenith Royal 500 blk. w/case, book & earphone, nice, plays well - \$95. SASE for list. David Koesche, 61 S. Barrington Rd., South Barrington, IL 60010. (708) 382-7997

FOR SALE/TRADE: 1921 Paragon 2-5-U transmitter, excellent, rare and expensive. Ed Bell, 5311 Woodsdale Rd., Raleigh, NC 27606. Fax/phone: (919) 851-1517

FOR SALE: Zenith Trans-Oceanic 8G005YT - \$95. Nordmende Tannhauser 57 - \$180. Wristwatch (Breed 493) - \$55. Plus shipping. Dan Sipola, 2840 Copeland Rd., Maple Plain, MN 55359. (612) 972-8214

FOR SALE: Zenith chassis and two speakers, fits Models 770, 775, 780, 476, #2032 chassis - \$150. Jim Berg, 4261 Wilcox Rd., Box A, Northport, WA 99157. (509) 732-4047

FOR SALE/TRADE: 1924 telegraph set made by Conn. Radio, in original box with literature, contains a pair of professionally designed mahogany container bases with brass keys and sander on top w/original batteries inside - \$275. Larry Drago, 383 Lincoln Dr., Cheshire, CT 06410. (203) 272-6030

FOR SALE: Mylar capacitors: .0022uFd 600v AX \$5/50; .0047 uFd 600v AX - \$5/50; .0082 uFd 400v AX - \$5/50; .022 uFd 400v AX - \$5/45; .047 uFd 400v AX, voltage unmarked - \$5/50; 22 uFd 600v AX - \$5/20; .33 uFd 400v AX - \$5/25. Electrolytic capacitors: 10uFd 450v radial - \$4.50/10; 22 uFd 450v AX - \$5/4; 33 uFd 450v axial \$6/4; 47 uFd 450v axial - \$7/4; 47 uFd 160v AX - \$5/10; 33 uFd 160v axial - \$5/15. Please add UPS if prepaying. Santech Electronics, PO Box 187, Tappan, NY 10983. (914) 359-1130

FOR SALE: WWII military equipment, BC-603, BC-312, BC-348M, BC-454B, BC-457A, BC-221J, BC-221Q, TS-92/AP, TS-382AV. Larry Cooper, 425 Court St., Rockwell City, IA 50579. (712) 297-7232, daytime

FOR SALE/TRADE: 1935 Patterson PR-16 receiver in black wrinkle finish, Art Deco cabinet w/brass escutcheons on face, all chrome chassis, absolutely beautiful, works, w/speaker and manual - \$600. Larry Drago, 383 Lincoln Dr., Cheshire, CT 06410. (203) 272-6030

"Do you know me?"

I started the world's first broadcasting station. I'm Charles Herrold, and between 1912 and 1917 I was sending music and news to an audience in San Jose, California, on a regular schedule. But while I may have been first, most people forgot all about me. Now there's hope; my story is told in this exciting new videotape from the creator of the award-winning PBS series 'Radio Collector.' It's available from the Perham Foundation. Don't leave home without it!"



"Broadcasting's Forgotten Father: The Charles Herrold Story"

VHS-Hi-Fi, close-captioned, \$29.95 plus \$3.50 S&H.

Order directly from the Perham Foundation,
101 First St., Suite 394, Los Altos, CA 94022.

Or call 1-800-771-KTEH and use your credit card.

All profits go to support the preservation of electronics history.

FOR SALE: Send \$4 to receive a copy of the world's premier catalog of rare 78 rpm records, cylinders and related items. Nauck's Vintage Records, 6323 Inway Dr., Srping, TX 77389-3643

FOR SALE: Radiola Special missing cover. Gloritone cathedral #99A - \$345. RCA #630TS - \$235. All mint. List - LSASE, Richard Bednarcik, 28 Steele Ave., Lincoln Park, NJ 07035. (201) 694-6374



FOR SALE: Privatear pocket radio (exc), circa 1948, white w/original box, instructions - \$350 + UPS. Don Hauff, PO Box 16351, Minneapolis, MN 55416. (612) 933-9070. E-mail: McMurdoDon@aol.com

FOR SALE: 9" GE 810 TV - \$70. Zenith 13" metal Z151ZJUJZ TV, unusual, 1950's; styling: large handle folds down, twin metal tubes (jet ports) along sides - \$80. Photos - \$2. Larry Kellough, PO Box 849, Canton, CT 06019-0849. (203) 693-8269

One Month Free!

BONUS FOR EARLY RENEWALS

If you renew **before** the month shown on your mailing label (your expiration month), you will receive an extra month on your subscription: 13 months instead of 12! 26 months for an early 2-year renewal!

FOR SALE: Empire of the Air by Lewis, brand new hardcover copy - \$12.50 ppd. Rainy Day Books, PO Box 775, Fitzwilliam, NH 03447. (603) 585-3448

FOR SALE: Trans-Oceanic owners need Receiver Saver 200 to extend tube life. SASE brings brochure. Jeff Kincaid, WA6BIL, 5529 W. 140th St., Hawthorne, CA 90250

FOR SALE: (2) pr. Langevin AM-50 amps - \$150/pr. Pr. JBL 404 amps - \$175/pr. Hickock TN-118 Cardmatic tube testers - \$200. RCA 3BX-671 shortwave, mint - \$135. Zenith tombstone 4B - \$100. Emerson 811 - \$35. Happy New Year. Sonny Goldson, 1413 Magnolia Ln., Midwest City, OK 73110. (405) 737-3312. Fax: (405) 737-3355

FOR SALE: Needles Genuine Shure for Shure V15 Type III cartridge, hyperelliptical, reg. \$61.95, special - \$50 + \$2 shipping. Deluxe needles in stock. J.J. Papovich, 53 Magnolia Ave., Pitman, NJ 08071. (609) 582-8279

FOR SALE/TRADE: MiKern Rotary Quench spark gap - \$400. Will trade for crystal stands or sets. Wallace McPeak, Rt. 4, Box 293A, Canton, TX 75103. (903) 567-6653

FOR SALE: Sams MHF/TR/TSM - \$10. CB - \$7. AR - \$5. All new plus S/H. Ed Crockett, 128 Buccaneer, Hattiesburg, MS 39402. (601) 264-4755. Fax: (601) 264-0226

FOR SALE: Crosley 124 cathedral, restored - Best Offer. Tube plastic tabletop radios - LSASE list. Charles Zalante, RFD 1, Box 75, Fort Kent, ME 04743. (207) 834-6273, eve.

FOR SALE: Toggle switches at wholesale prices, full size, miniature, subminiature. Fertik's Electronics, 5400 Ella St., Philadelphia, PA 19120. Ph./fax: (215) 455-2121

FOR SALE: Compactron adapters, set of (2) adapters which allow 9-pin and 12-pin compactron sweep tubes to be tested on TV-7 type tube testers. This lets popular tubes such as 6JB6, 6JE6, 6JF6, 6JM6, 6JS6, 6JU6, 6JZ6, 6KD6, 6KM6, 6KN6, 6LB6, 6LF6, 6LQ6, 6LR6, 6LX6, 6ME6, 6MJ6, 12BJ6, 20LF6, 21JS6, 23JS6, 24JE6, 27LF6, 30KD6, 40KD6, 8950, 7868 be tested on TV-7 testers which do not have compactron sockets. Tube test setup and test data are supplied for the TV-7 tester series only. This includes switch settings and bias values as well as minimum and "as new" test values. (2) adapters as well as tube test information and pin-out conversion data are supplied. Please send \$25 to Daniel Nelson, 1025 E. Desert Ln., Phoenix, AZ 85040. (602) 243-7421, evenings. E-mail: djn@indirect.com

FOR SALE: Philips 940A2-tube mini dome-top Bakelite, early 1930s, works fine - \$450. Late 1920's Regentone 2-tube small Bakelite radio, working, speaker separate, rare - \$475. Sparta crystal set, brown Bakelite, nice - \$450. Rare WE ebonite horn, excellent - \$650. Philco 444 peoples radio, 4 tubes, 1936 black Bakelite cathedral, original condition, works well - \$950. Ekco AD36 round Bakelite, 4-tube, 1936, excellent, original - \$950. All plus UPS. Jim Taylor, G4ERU, No. 5 Luther Rd., Winton, Bournemouth, England BH9 1LH. Phone/fax: U.K 01202-510400



FOR SALE: International sales! Shown: Early 50's EKCO Type U159 portable, British - \$35. American Bosch Model 5, solid, original, working - \$40. Planatair crystal radio, in box with original instructions, Japanese - \$55. GEICO late 40's portable, British - \$35. Bush Type DAC90A Bakelite, 1940's, British - \$65. Eldon kit crystal radio with instructions, U.S.A. - \$45. Marconi Model 289 table set, 1950's, Canadian - \$30. Murphy Type U198, early 50's, British - \$55. Not shown: DeForest honeycomb coils, (3), with original adjustable mount - \$40. Hearover plastic rocket radio, Japanese - \$45. Atwater Kent Model 94, 7-tube chassis, with all tubes - \$35. AK Model 42 receiver with Type E speaker, original and working - \$120. Newtowne 14" cone speaker, rebuilt, works - \$75. O'Neil cone speaker, rebuilt, works - \$75. Send SASE for periodic updates on sets for sale. Dave Crocker, 6 Raymond St., Sandwich, MA 02563. (508) 888-6236, before 9 pm please

FOR SALE: Scott LK-110 lab FM tuner, LT-72 lab amp - \$100/pair plus shipping. Michael Franzen, 405 East Sinto, Spokane, WA 99202. (509) 325-7354

FOR SALE: Used and new ST tubes of a great many types including 2A3's, 50's, 45's, 6L6's and so on. Fair prices. Your best bet is to call. SASE for list, but lists out-date fast. Also many N.I.B. GT tubes. Dennis Branch, 1238 W. Ivyton St., Lancaster, CA 93534. (805) 723-1569

FOR SALE: Catalin Sentinel 284NI butterscotch case, badly cracked - Offers. Call: Bob Zuch, PO Box 4242, Chatsworth, CA 91313. (818) 719-2608

FOR SALE: Zenith 7G605 Trans-Oceanic missing front cover - \$100. Emerson 888 black Pioneer - \$30. Sony TR-650 - \$30. Heathkit A9-C tube amp - \$125. Dukane tube PA amp 5881 output - \$60. Craftsman C-400 tube hi-fi amp, chrome - \$100. Hallicrafters S20R - \$75. Ampex 6-15 guitar amp 6L6 output conversion - \$250. Fisher R-200 tube FM-AM stereo tuner - \$125. Marantz 115 stereo tuner - \$50. Janszen Z500 electrostatic speakers - \$100/pr. E.H. Scott SLR 12B naval SW receiver - \$200. Electro-Voice SP12B - \$30. Electro-Voice 664 mike - \$40. Jensen P125 Alnico 12-inch - \$50. All plus shipping. Frank DeFilippi, 62 Second Ave., Massapequa Park, NY 11762. (516) 798-6577, 6 to 10 EST

**E-MAIL ADDRESS FOR
ANTIQUE RADIO CLASSIFIED**

ARCMagazine@aol.com

Ads - Subscriptions - Book Orders

See inside front cover for details

FOR SALE: Sansui 1000A, mint, new 7591A's w/ manual - \$300. Pioneer SX34, exc - \$120. Telefunken Opus 6 - \$100. George Stringe, 3075 Moorhead Ave., Boulder, CO 80303. (303) 494-9261. Fax: (303) 494-6211

FOR SALE: G.R./L.N. resistance decades and galvanometers - \$5 to \$10. Joe Brady, Box 8 Star Rt., Huntingdon, PA 16652. (814) 643-0603

FOR SALE: Marantz Superscope sign 22 3/4 x 10 1/2. Listen to Us, good condition - \$45. Buddy Cartee, 205 Mason Rd., Chesnee, SC 29323. (864) 578-3532

FOR SALE: Spica ST 711 transistor, black, in box with papers, good - \$125. Doyle Roberts, HC 63, Box 236-1, Clinton, AR 72031. (501) 745-6690

FOR SALE: 20-year collection of radios and parts in various conditions - \$1,500 takes all. Jim Powell, 5101 Labradore Dr., Roanoke, VA 24012. (540) 977-0768

FOR SALE: Thinning out my collection of antique, transistor and novelty radios. LSASE gets my list. Hank Trabold, 2058 Nakiska Ct., Toms River, NJ 08755. (908) 244-2345

TUBES WANTED

HIGHEST PRICES PAID \$\$\$

101D, F, 205D, F, Tennis Ball, 300B, 274B, 211, 845, KT66, KT77, KT88, EL34, PX25, 280, 250, 102F, Telefunken, Bugle Boy, Mullard, ECC81, 82, 83, 801S, 802S, 803S.

AUDIO EQUIPMENT WANTED

Fisher, Scott, Dynaco, McIntosh, Marantz, JBL, Altec 604, B, C, D, E, 515, B, C, 288, B, C. UTC trans.; Black Beauty, A&B Resistor, etc...

FULL RANGE ELECTRON TUBE SHOP

Jonathan Woo Yik Fan

Flat B, 37/F, Block 5, Greenfield Garden

Tsing Yi, NT, Hong Kong

Tel: (852) 24349466 - Fax: (852) 24344963

FOR SALE: Stewart-Warner 07-5B3Q Dionne Quint, no decal, maroon color but not original finish, no cracks, plays, what's it worth? Harvey W. Hunt, 455 Gladstone St., Sheridan, WY 82801. (307) 672-9253

FOR SALE: RCA Service Data books 1966-1978. Sams Photofacts 1-1709. Make me an offer. Ann Bichanich (Jay's), 15 1/2 W. Lake St., Chisholm, MN 55719. (218) 254-4421

FOR SALE: Emerson AU-190, perfect condition with back - \$2,500. Zenith 12S267 shutter dial, rough but restorable - \$325. Two Zenith 9S262, both restorable - \$275 and \$200. Silvertone Mod 1965, perfect - \$125. Fairbanks Morse Model 72, good condition - \$130. All firm prices or possible trade. Pickup only. Karl Johnson, 3517 Morton, Brookfield, IL 60513. (708) 485-2349, after 6 pm

FOR SALE: DeForest 2 1/2" white dial - \$20. Wilcox Lab. 2" white with black inter knob, (2) - \$10 ea. Red Faradon RCA Wireless Spec. UC-1831 dial, (2) - \$7.50 ea. G.R. 722N Precision var. cap. in wood box - \$35. Kodak panels with most parts, (2) - \$60 ea. Radioette crystal set - \$90. Carron Tee-Nee wood radio crystal set with earphone - \$150. Sodian 1-tube lever tuning with tube and specs, very good panel with original parts (cab. not) - \$225. Federal #22 rheostat, (2) - \$10 ea. Wm. Harder, 911 W. Northrup St., Lansing, MI 48911-3640. (517) 882-2303

FOR SALE: Test equipment in walnut boxes: Wheatstone bridge by Rubicon, 10"x10" - \$45. Beautiful multimeter, 9x12 by Rawson - \$40. D.C. ammeter/MA, 10x12 by Norton - \$30. Radiola 103 spkr, vg with repro tapestry - \$85. Lafayette tiny 4-tube portable - \$20. M.I.T. thermistor bridge, impressive! - \$20. DeForest loop antenna repro, excellent - \$150. Another Heath HR10B, mint & plays - \$45. All plus S&H. Please call before 9pm. LSASE for list. Wally Worth, 2 W. Elm Ave., Wollaston, MA 02170. (617) 479-4512

Introducing

Exciting New

ZENITH Grille Cloths



Authentic reproductions
based on original patterns
using original materials



- The very Deco 'block' pattern for 1937 shutterdial sets is available NOW!
- The 'swirl' pattern for Walton's sets is nearing completion.
- Plus 20 other patterns for most manufacturers also available.
- Satisfaction or money back guarantee.
- Free installation instructions with every order.

Now on the World-Wide Web at
<http://www.libertynet.org/~gricloth/>

Send a 55¢ LSASE for samples to:

John Okolowicz, N3VSR
624 Cedar Hill Rd.
Ambler, PA 19002

E-mail: Grillecloth@aol.com

FOR SALE: DeForest training kits, VOM & sig. gen., vg to exc - \$10 ea. you ship. John Snow, 4539 N. Bartlett Ave., Shorewood, WI 53211. (414) 964-0194

FOR SALE/TRADE: 1927 red Neutrowound, red ones were made for display only, very scarce, with good tubes - \$2,000 plus shipping. Ed Bell, 5311 Woodsdale Rd., Raleigh, NC 27606. Fax/phone: (919) 851-1517

FOR SALE: Sams A.R. 3 to 250, TR1 to 75, N.O.S. - \$2.50 ea. + shipping. Louis L. Veltre, 643A Sherwood Ct., Lakehurst, NJ 08733-4207. (908) 657-7592

FOR SALE: Patrick Henry Jr. crystal set - \$395. Radio Boys books - \$100/10. 1938 Scott escutcheons - \$55. Bakelite radios: Zenith pop-up - \$65. Westinghouse refrigerator, green - \$100. RCA Nipper logo dial - \$59. Regal - \$25. Fancy Emerson - \$30. RCA 2X61 - \$25. Admiral 69B4 - \$18. Philco PT-30 - \$20. Maroon Zenith - \$15. Wooden radios: GE LCP 609 - \$25. Zenith 50027Z - \$30. Bill Rolf, 30131 Center Ridge, Westlake, OH 44145. (216) 871-4547

FOR SALE: Kennedy Model 220 good cond. - \$750. Bill Jungwirth, 2819 W. Evergreen Dr., Visalia, CA 93277. (209) 732-7163

FOR SALE: Hammond HR1C amplifier, uses (4) 6V6; I couldn't get it to work - \$25. Jack Campellone, KD4HAK, PO Box 232, Genoa, OH 43430. (419) 855-4420

FOR SALE: Crys Tech Report No. 3 on crystals and crystal detectors. Includes historical background, compares early day and modern materials, plus applications. Discusses crystal properties, with details on how to make your own and how to use them. Also describes detector stands then and now, and how to build them. Order Report No. 3 for - \$4.75 ppd, from: Crys Tech, c/o P.A. Kinzie, PO Box 6805, Kingman, AZ 86402

FOR SALE: Box of mics, microphones, approximately 10-15 pieces. RCA, EV, etc. Dwain Stevens, 151 Dog Fork, Pikeville, KY 41501. (606) 478-8248 EST

FOR SALE: Radio Masters catalogs: big, big books, cover everything electronic at time of issue, lots of history. Editions available: 1957, 1960, 1962, 1963, 1964 - \$25 ea. or \$100/all plus \$25 shipping. Maurer TV, 29 S. 4th St., Lebanon, PA 17042. (717) 272-2481

FOR SALE: Ten good, used 5U4 tubes for - \$65 including UPS. Hank Andreoni, c/o 250-D So. Lyon Ave., Hemet, CA 92543

FOR SALE: AWA Fisk Radiolette, excellent; Brush pottery bug xtal set - \$10 ea. firm. Robert Shuck, 10512 Winston Ln., Fishers, IN 46038. (317) 849-0381

FOR SALE: Scanners, BC III - \$50/10; BC 210 - \$30/5. Have others. Shipping extra. Steve Whited, 3637 West 71st St., Indianapolis, IN 46268. (317) 298-9967

FOR SALE: Grundig Satellit 700, like new - \$350. Icom R1 communication receiver, with extras - \$350. Sanyo RP-8880, mint - \$200. Emerson wood table radio CV295 - \$75. All + shipping. **WANTED:** Nordemende multiband radios. Gerald Silver, 10863 W. Clairmont Cir., Tamarac, FL 33321. (305) 720-1972

FOR SALE/TRADE: 1921 military field radio. trade for a Radiola III or 1920's crystal radio. Doug Wright, 1343 Hoffman Ln., New Braunfels, TX 78132. (210) 625-5577, after 5 pm

FOR SALE: Perpetual Trouble Shooters Manual XIII - \$12. Image Orthicon tube - \$15. Plus UPS. Ed Povraznik, 9606 Biddulph Rd., Brooklyn, OH 44144. (216) 661-0032

FOR SALE/TRADE: Saba automatik Frieberg/125 Super - \$550. Nordemende Othello MPX Super DeLuxe - \$290. Grundig multiband MPX - \$175. Blaupunkt Salerno Super - \$150. Nordemende Transita DeLuxe - \$125. Nordemende Globe Traveler - \$125. **WANTED:** European table models/portables. GR signal generator. John Sarkies, 75 Breakwater Shores, Hyannis, MA 02601. (508) 771-5955



The California Historical Radio Society

- ✓ *Eight meets per year all over Northern California*
- ✓ *Two or more Journals per year featuring original historical and technical articles*
- ✓ *Join now and get our 75-page collection of restoration articles from 20 years of CHRS!*
- ✓ *A mere \$15 per year!*

For more information, or to join...
write to: PO Box 31659
San Francisco CA 94131
or Call 415-978-9100

Are You Into Tubes?



Then You Need

VACUUM TUBE VALLEY

Now Available

A New High Quality Publication devoted to the Best in
Modern and Vintage Vacuum Tube Electronics.

Hi-Fi Amps, Guitar Amps, Tubes, Tuners,
Speakers, and More!

4 Issues - 1 Yr.
\$25 US or \$35 Foreign
No Credit Cards

Vacuum Tube Valley
1095 E. Duane Ave. #106
Sunnyvale, CA 94086

FOR SALE/TRADE: Squires-Sanders Model SS-1BS communication receiver w/matching video band scanner and amplified matching speaker, extremely rare and highly collectible, all units are in like-new condition. Call: Larry Drago, 383 Lincoln Dr., Cheshire, CT 06410. (203) 272-6030

FOR SALE: DC power supply, LKB Model 3371E, 0-1200 Vdc output, 50 mA max, voltage and current meters - \$50. Sweep/marker generator, B&K Model 415 with manual - \$60. Realistic Model 40T, FM/AM stereo tuner - \$60. Chassis for Crosley Model 48-BF without tubes - \$25. All plus shipping. **WANTED:** Cabinet for Fisher Model 90-T or 90-R tuner, four knobs for Fisher Model 400 receiver. Kevin Buranen, PO Box 23, Brooke, VA 22430. (540) 659-9859

FOR SALE: Collins KWM-2 meters - \$30. CC-2, (round emblem) carrying cases for KWM-2/30L-1 - \$73. All N.I.B. Lowell Thomas, AA62D, PO Box 15026, Fresno, CA 93702. (209) 227-1605

FOR SALE: Cathedrals: Erla cathedral, exc cond., plays - \$290. Zenith Model 805, exc - \$290. Sterling Model 7-C-709 - \$150. Majestic Mod 370 - \$225. Philco Mod 84B, exc, plays - \$140. Sid Stivland, 17725 6th Ave. N, Plymouth, MN 55447. (612) 475-1332

FOR SALE: B&K 1405 scopes, 3" solid-state, working - \$55 ea. S-38E parts set, no knobs, rusty cab., good dial - \$15. Philco Type G spkr w/plug - \$25. Many tubes, new and used for sale. **WANTED:** Unusual horn spkrs, Zen. radio 1936-40, tubes. Thanks! Bob Dobush, 3554 W. 105, Cleveland, OH 44111. Ph./Fax: (216) 647-3908

FOR SALE: Consoles, Apex 10B - \$60. Truetone D700 - \$55. **WANTED:** Hallicrafters PM-23 speaker. Bill Regan, 4566 O'Dell Pl., Jamesville, NY 13078. (315) 492-2817

FOR SALE: Mallory Vibrator Data Book, fundamental principles of vibrator power supplies, 1947 first edition, 135 pages - \$15 ppd. Howard Sams dial cord stringing guide, first edition, Volume 1, 1938-1947 - \$12 ppd. Ellsworth O. Johnson, 364 S. Coeur d'Alene St., Spokane, WA 99204. (512) 259-5762

FOR SALE: 1920's Paragon RA-10 w/2-tube Paragon kit audio detector that perfectly matches and combines w/RA-10 unit - \$1,425. Larry Drago, 383 Lincoln Dr., Cheshire, CT 06410. (203) 272-6030

FOR SALE: Big literature sale! ARRL handbooks: \$12 ea. '44, '46, '48, '50, '52, '55, '56 - \$10 ea. '60, '63, '65, '69, '77, '51 (no cover) - \$6. Many other ARRL books, inquire. RCA '38-'42 - \$35. Zenith TV #1 - \$16. '48 Philco TV - \$10. Beitman's TV '48, '49 - \$8 ea. '50 n.c. - \$5. Supreme record changers, etc. - \$12. Sams TV Tube Locators Vols. 1-5, 7 - \$5 ea. CB#3 - \$9. Rider's 1-9 index - \$9. Ham callbooks #33, #38 - \$11 ea. Magazines: Popular Electronics, Electronics Illustrated, Electronics World 1960-1965 - \$2 ea., \$15/10 or offer for all or part. We are still the best source for discount electrolytic and mylar capacitors, wood knobs. SASE for flyer. Mark Oppat, Antique Audio, 253 Blanche, Plymouth, MI 48170. (313) 455-4169, 10 am-9 pm EST

FOR SALE: 1. Rare prewar TV GE Model HM 171 restored and working - \$6,400. 2. Emerson Mae West radio - \$1,050. 3. Stewart-Warner blue and yellow Varsity radio - \$325. Contact: Waves, 32 E. 13 St., New York, NY 10003. (212) 989-9284. Fax: (201) 461-7121. E-mail: c1wave@aol.com

FOR SALE: Atwater Kent 46 - \$75. AK F-2 speaker - \$70. Airline 04BR-511A - \$60; 14BR-736A - \$75; 74BR-1502B - \$75; 93BR-421B - \$80. Air Chief 4-A-10 - \$40; 4-A-24, nice - \$55. Crosley 11AB - \$50. DeWald D508 - \$40. Philco 37-62 - \$70; 46-420 - \$50. Radiola 18 - \$85. Emerson 636A - \$55; DP332 - \$55. GE A-64 tombstone - \$75. RCA 66X13 - \$50; 46X24 - \$55. Radiola 61-3 - \$50. Nordemede Sterling, nice - \$125. Stromberg-Carlson 14 speaker, no cloth - \$50. U.S. Army receiver by Philco - \$60. Zenith 7S634 - \$90. J. Gary Cameron, 824 Andrews St., Southington, CT 06489. (860) 276-9200

FOR SALE: Silvertone tombstones: Model 6425, works - \$70; 1863 32v - \$50. GE F80 left-hand dial, works - \$95. Don Reinsma, 610 Nix Rd., Pensacola, FL 32506. (904) 455-7721

FOR SALE: Plans for one/two-tube radios, crystal sets; copies of old ads, operating guides. LSASE. Ernie Nagy, 207 S. Collier Blvd., Unit 105, Building 4, Marco Island, FL 33937. (941) 389-9101

FOR SALE: Ten issues SOWP Sparks Journal from years 1980 thru 1986 - \$25. Millen gid-dip meter No. 90651, circa 1947, with coils and manual - \$30. All plus shipping. Neil Spencer, W4PC, 4665 75th Ave. N, Pinellas Park, FL 34665. (813) 546-8711

FOR SALE/TRADE: Over (80) headsets in all brands, sizes & shapes, as is - \$10 ea. Other brands such as Murdock, Eisemann, Western Electric, Baldwin, O-Brunet of Paris, C-M French, are - \$25 ea. Call: Larry Drago, 383 Lincoln Dr., Cheshire, CT 06410. (203) 272-6030

FOR SALE: Western Electric cradle telephone with oak crank-type ring box - \$150 plus shipping. Don Mier, 4009 N. Foxdale Ave., Covina, CA 91772. (818) 338-9225

FOR SALE: Toshiba 7TF30 in original metal case - \$75; Trav-Ler TR-287-B, white/red - \$65. Bulova 792 - \$40. Automatic 613X, beautifully refinished, works - \$75. Zenith A600 Trans-Oceanic, works, broken dial cord - \$60. Radiola III - \$70. **WANTED:** Dial escutcheon for Philco 16 console. Gary Watkins, 8006 Greenwald, Belton, MA 64012. (816) 322-0773

FOR SALE: Early portable Gibson amplifier, large dynamic speaker, working, canvas cover, excellent condition - \$425. Stuart T. Carter, II, WANHC, PO Box 033177, Indialantic, FL 32903-0177. (407) 727-3015

FOR SALE/TRADE: Ozarka V16 cabinet, good condition. Would like to trade for E.H. Scott material. You pick up! John T. Meredith, 2462 Stantonsburg Rd., Ste. 152, Greenville, NC 27834. (919) 551-1882

FOR SALE: AVR-20-A1 RCA 12-volt aircraft receiver. SASE for info. No phone calls. Maurice Pope, 39 Highland Ave., Gorham, ME 04038

FOR SALE: (2) Hopalong Cassidy radios, 1 black, 1 red, 2 different poses, nice. Magic Tone bottle radio - \$275. Arvin Rhythm Maid tombstone - \$300. Bristol 1-tube amp - \$165. Fircro Vocaloud speaker - \$175. Zenith 6S254 - \$195. Zenith 9S365 - \$300. Zenith 9S365 chassis/speaker - \$100. Zenith 1937 8-tube chassis, needs one shaft - \$85. Radiobar, some glass missing - \$1,200. Need speaker for 9-tube Walton set. Trans. extra. Joseph A. Szabat, 1019 Hiland Ave., Coraopolis, PA 15108. (412) 264-7498

FOR SALE: New list of radio & TV books, magazines and radio-related printed matter is ready, over (3) pages - send \$1 to: Maurer Television, 29 S. 4th St., Lebanon, PA 17042. (717) 272-2481

FOR SALE: Tubes: 807, EL 34, 6A3, T-40, 6L6, etc. would like to sell all approx. 50-60 pcs. Dwain Stevens, 151 Dog Fork, Pikeville, KY 41501. (606) 478-8248 EST

FOR SALE: Adirmal 4215-C7, plays - \$145. Crosley E 20GN, plays - \$60. Crosley, wood, 56T-VO, plays - \$50. GE 103, wood, plays - \$75. Kolster K-48, N/W, lowboy, double front doors - \$65. RCA 117, wood, plays - \$145. Zenith Royal 7000-1, N/W - \$75. Tubes, N.I.B. 12AX7, U.S.A. - \$7 ea. 7025/12AX7 U.S.A. - \$10 ea. Penta brand, minimum 20, mixed or same, 866A, N.O.S. - \$13 ea. Used tubes: 3CB6, 3BZ6, 4CB6, 6CB6, 6BZ6, 6AU6, three for - \$1; 5Y3GT - \$2 ea.; 12AX7 - \$3. U99, short pins - \$25; used pyrex socket for 201A - BO. Modified tubes equal to 1L6 - \$5 ea., must buy 5; 5814/5963, equal to 12AU7, \$1 ea., (100) minimum order - \$25 plus shipping. All tubes tested good, cleaned and boxed. MO or check to: George Stagakis, George's Radio and TV Repair, 1714 A 41st St., North Bergen, NJ 07047. (201) 867-9136

FREE - 20 WORD AD EACH MONTH
To get your free 20 words,
include your SUB# with your Ad.
Additional words are 25c each.
Read inside back cover for details.
MANY THANKS!!!!

FOR SALE: Spare parts RCA: ET-4331 (MI-8199) transmitter, oscillator unit K-878634-501 & K878633-501 pwr supply. Merit choke C-2991 (N.I.B.), Emerson R-156 mini tombstone - \$125. Zenith 6D2615 (no back) - \$225. Grundig Majestic 4095 - \$300. Regency DB-400 Deluxe TV signal booster - \$25. Zenith Royal 275 - \$50. Jackson tube tester 648S (needs fixed) - \$30. Hammond amp, (2) 6BQ5's w/12" spkr - \$50. More - send SASE. Call for details, prices negotiable. Send want list & SASE. Thanks, Wilbur Gilroy, 129 Belmont Ave., Clarks Green, PA 18411. (717) 586-7356

FOR SALE: H.H. Scott 331B receiver, clean, works - \$150. Lafayette record cutter, U.T., intact - \$85. Edward Krajczyk, 64 Old Chimney Rd., Upper Saddle River, NJ 07458. (201) 825-3828

FOR SALE: Remco Caravelle trans./rcvr, box - \$120. Amplifiers: RCA MI 12222 - \$65. Altec 1568A - \$225. **WANTED:** Langevin 128-N amp. Altec 755 speaker. Frank Hagenbuch, 1440 Lafayette Pkwy., Williamsport, PA 17701. (717) 326-0932

FOR SALE: Philco 38 cathedral - \$95. Delco 3203 tombstone, 32v - \$65. Victor cathedral, battery set - \$55. Zenith Cobramatic turntable - \$15. Shell tube checker - \$10. Richard Haneline, 3600 Cuba Blvd, Monroe, LA 71201. (318) 387-6764

FOR SALE: CRT's: BG75A, 3" - \$40; and SSF120G, 5" - \$50. Both for WWII Japanese radar, test good with spec., postage extra. Chinese pump key (Keys II p. 9), N.O.S. - \$65 ppd. Int'l Postal MO please. Noriyoshi Tezuka, 1-11-2-403 Hiroo, Shibuyaku, Tokyo 150 Japan. Fax: 011-813-3440-8396

FOR SALE/TRADE: Stewart-Warner Porto Baradio - \$65. Sears 8086B AM/wire recorder - \$60. Zenith 921Z AM/FM - \$35. Bob Fuerderer, Holly Farm, 813 Rt. 12A, Surry, NH 03431. (603) 352-3005

FOR SALE: Speak-check Model SC-1 by Snowy, exc cond with manual - \$20 I ship. John Sney, 4539 N. Bartlett Ave., Shorewood, WI 53211. (414) 964-0194

FOR SALE/TRADE: DeForest spherical Audion, single wing, excellent in every respect, 1908 paper sticker - \$1,500. Ed Bell, 5311 Woodsdale Rd., Raleigh, NC 27606. Fax/phone: (919) 851-1517

FOR SALE: Used tubes 6550A, 5U4GB, 6CA7, 6CG7, 6EU7, 12AU7A, 12BH7A, etc. Offers plus shipping. Gregory Sheppard, KA3DBG, 4402 Jupiter St., Rockville, MD 20853-3255. (301) 946-6460

FOR SALE: RCA wire recorder, cartridge type, Model MI2875, 5 tube - \$60. RCA WV98C VTVM w/book - \$50. + shipping. J. J. Papovich, 53 Magnolia Ave., Pitman, NJ 08071. (609) 582-8279

FOR SALE: Radiola 30 cabinet (only), excellent; RCA Chassis RK-121/123 from 1947 Model 612V1. Cheap! Gary A. Micanek, 226 Henry Ave., Manchester, MO 63011. (314) 227-7046

FOR SALE: C.T.I. tube checker, Model TC-20 w/charts - \$30. Heathkit resistance decade box model DR1 - \$20. Wheatstone bridge, Industrial Instruments. Model RN-1 - \$45. All plus UPS. Stephen L. Bonino, 107 Georgetown Rd., Glassboro, NJ 08028. (609) 881-0244

FOR SALE: 1970 transistor 2M crystal mobile transceiver, Simpson - \$50. Ham stuff, books literature, SASE lists. Bill Tucker, W4FXE, 1965 S. Ocean Dr., Apt. 15-G, Hallandale, FL 33009. (954) 456-1349

FOR SALE: Signal Corps radio transmitters T14H/TRC-1 & T19C/TRC-1 - \$60 ea. RCA 75X16 - \$40. Jewel 910 - \$30. Zenith 6D015, white & brown - \$40 ea. Philco dial escutcheon for Models 14, 15, 17, 18, 91, etc. & for Models 111, 112 - \$10 ea. Dial: AK 185 - \$10. RCA amp SA352LC [(2) 7027A] - \$75. Zenith TV 1955 A1820WU, Thordarson/Meissner TV Replacement Guide 1960-62 & 1954 cuts. TV components: Ram, Merit, CBS Hytron, Miller, etc. - \$30 all N.O.S. vibrators, tubes, etc., send want list! Thanks. Wilbur Gilroy, 129 Belmont Ave., Clarks Green, PA 18411. (717) 586-7356

FOR SALE: Mickey Mouse phonograph - \$20. Emerson #640 small portable - \$40. Zenith ZH615 - \$25. Realistic 15" speaker - \$15. Knight 18 wall amp - \$15. Knight KG65 tuner - \$15. (11) Mixed panel meters - \$15. Bell & Howell Opticonics amp - \$20. Grundig mini-tape recorder - \$25. Tobc condenser analyzer - \$10. Sony CF-550A portable radio - \$30. Hickok 450 VOM - \$8. CTI #TC-20 tube tester - \$20. Clackson 715 tube tester - \$30. Magnavox 11-tube chassis - \$35. Edison cylinder phonograph - \$275. General Cement dial belt drawer - \$10. RCA 45 player (45d2) - \$25. **WANTED:** Information on 3Y4 tube (not 3V4) & Victor 4P-20017 radio. Walt Wrabek, Rt. 4, Box 370, Menahga, MN 56464. (218) 564-4623

FOR SALE: Gibson guitar amp, 1948?, Model 6A50T, fair condition, works - \$300 plus shipping. Kevin Kuehn, 1615 13 1/2 Ave., Barron, WI 54812. (715) 537-3225, 9-4:30 or (715) 537-9395, after 5 pm

FOR SALE: N.O.S. bubble magnifier for 12-inch TV - \$25. MacIntosh MQ-102 Environmental Equalizer - \$25. Heathkit RF signal generator, small, working - \$15. **WANTED:** Manual copies for GR-1650A bridge, RCA WR50B RF generator. Norman S. Braithwaite, PO Box 992443, Redding, CA 96099. (916) 246-4209, eves.

FOR SALE: Over (5,000) tubes, many N.I.B. Tony Jones, 3727 Baxter Ave., Nashville, TN 37216. (615) 227-8136

FOR SALE: Radio literature: Riders, Sams, magazines, juvenile books, pamphlets, service magazines and manuals. Free list. Radio list. **WANTED:** Dial for Philco 49-501. Dave Sutherland, PO Box 201, Spofford, NH 03462. (603) 363-4459

FOR SALE/TRADE: Midwest Miraco Mod MA-4 (see Douglas, p. 176 bottom left corner) - \$525. Radiola Mod 5 with crystal detector on panel in working condition - \$700. Universal 4-tube rcvr, circa 1920's, rare - \$1,200. Crosley Ace Mod #3-B w/3 WD-12 tubes - \$400. Workrite George Walker multi-unit set, 1 tube, with coil and coil adapter plug (see Douglas 3, p. 245) - \$275. Larry Drago, 383 Lincoln Dr., Cheshire, CT 06410. (203) 272-6030

FOR SALE: Rider's complete index (copy) for Vols. 16 thru 22, no 23 - \$10 ppd. John Snow, 4539 N. Bartlett Ave., Shorewood, WI 53211. (414) 964-0194

FOR SALE: Zenith console TV, mahogany cabinet, very nice, early 50's. Dwain Stevens, 151 Dog Fork, Pikeville, KY 41501. (606) 478-8248 EST

FOR SALE/TRADE: Fleming valve, stamped "Marconi" on side of glass - \$1,250. Ed Bell, 5311 Woodsdale Rd., Raleigh, NC 27606. Fax/phone: (919) 851-1517

FOR SALE: Heathkit 5" oscilloscope 0-6, mint - \$50. Techmaster FM tuner, metal - \$10. Sony TV-770, 5" portable TV, AC & batt., needs work - \$10. All + UPS. Onerio L. Sabetto, 1717 Burgess Rd., Cleveland, OH 44112. (216) 481-1036

FOR SALE: Colonial 32AC chassis, restored, works - \$65. Day-Fan Model A500-5 console with doors, works - \$175. Freed-Eisemann NR5 - \$300. Military BC-221AH frequency meter - \$30. Many others, send SASE for list: Charles Chapman, 1357 N. Broad Creek Ln., Strafford, MO 65757. (417) 736-2772

FOR SALE: Tan Zenith Royal 500, w/case, exc - \$300. Royal 500H two-tone grey - \$150. Zenith 7000 Trans-Oceanic (American) - \$175. Raytheon T-100-4, red and ivory, Electrohome version with the three v's - Offers. Have other transistors for sale, will trade for transistors or Deco plastics, Catalin parts, etc. **WANTED:** Empire Troubadour turntable complete w/cartridge, gold finish. Mike Herman, #2-1731 Rockland Ave., Victoria, British Columbia, Canada V8S 1W6

FOR SALE: Sams CB 1-53 - \$135. AR: 54 vols. between 17-322 - \$100. Allen Jochem, 2205 Broadway, Quincy, IL 62301. (217) 223-6751

REPLACEMENT DRIVERS FOR ATWATER KENT HORNS

Driver w/housing for Model M & Pooley horns (this assembly replaces all pot metal) \$65.75 + \$4.75 s&h

Driver w/repair ring for Models G, H, & L (repair ring replaces threads in base) \$59.85 + \$4.75 s&h

All drivers above include diaphragm, gaskets, spacer, and spring. All parts are also sold separately. Send SASE for price list.

**M. Harold Ezzone, 4861 Park Drive
West Des Moines, IA 50265 — (515) 221-9447**

FOR SALE/TRADE: Amos N Andy standing cardboard figures Pepsodent Toothpaste premiums, dated 1930, in color, 8" tall, beautiful collectibles - \$400. Jim Beam decanters of Charlie McCarthy and Mortimer Snerd - \$200/pair. Amos N Andy hard-cover book w/newspaper articles from 1930's - \$75. Larry Drago, 383 Lincoln Dr., Cheshire, CT 06410. (203) 272-6030

FOR SALE: Garod pk. tp. yellow with red trim - \$1,500 or BO. Crystal set Willemin Prov., R.I. - \$250. Ed Kendall, 679 Westhampton Rd., Northampton, MA 01060. (413) 586-3390

FOR SALE: Astatic 12" pickup arm with 78-33/45 turnover cartridge N.I.B. - \$700 OBO. Bernard Bank, 303 Devoe Ave., Yonkers, NY 10705. (914) 476-5933

FOR SALE: Heath sig. gen. - \$35. VTVM, transistor tester, code practice osc. - \$15 ea. Grundig AM, FM, SW - \$125. Hewlett Packard VHF receiver 10MHz-500MHz - \$125. Silvertone 4500A (Bunis), 1936, plastic - \$75. Ernest Odeneal, 2710 Lee St., Greenville, TX 75401. (903) 455-2113 or 5788

FOR SALE: Scarce solid-state tube tester by B&K, Model 747, last model manufactured at end of tube era, mutual conductance, all accessories & charts - \$135 plus \$25 shipping. Don Maurer, Maurer Television, 29 S. 4th St., Lebanon, PA 17042. (717) 272-2481

FOR SALE/TRADE: Dynaco (all chrome) Mark II amp - \$375. Scott Mod 355 AM & FM tuner preamp - \$375. Scott Mod 208 amp, 80 watt amp - \$400. Triad amp mono HF-10 - \$200. Larry Drago, 383 Lincoln Dr., Cheshire, CT 06410. (203) 272-6030

FOR SALE: Fifty antiques including: Hallicrafters TW500, AK 70 with owners manual, Benrus Brass clock radio, RCA Model 66X3, Aircastle with magic eye, Stromberg-Carlson 61H, Motorola 77X, etc. Send envelope for complete list. Alfred Welch, 2248 S. 33rd St., Milwaukee, WI 53215. (414) 383-9908

Frankenstein's Radio Laboratory

4010 Fairmont Parkway, Suite 285

Pasadena, Texas 77504

(713)998-0130

ELECTROLYTICS, AXIAL LEADS			EACH	20+	
2.2uf	450v	Rubycon	5.65	\$6.60	
4uf	150v	(N.O.S.) Sprague	.30	.25	
4.7uf	450v	ICC	.70	.65	
10uf	450v	Xicon	1.00	.95	
22uf	160v	Rubycon	.75	.70	
22uf	450v	Xicon	1.30	1.25	
33uf	160v	Rubycon	1.08	1.03	
47uf	160v	Xicon	1.30	1.20	
47uf	450v	Xicon	2.25	2.00	
50uf	150	CDE	1.30	1.15	
VALUE	VOLTS	MANUF	LEADS	EACH	20+
.001	600	Sprague 715P	radial	5.42	5.37
.0022	600	Sprague 715P	radial	.42	.37
.0047	600	Sprague 715P	radial	.42	.37
.01	600	Sprague 715P	radial	.54	.49
.022	600	Sprague 715P	radial	.65	.60
.047	400	CMC	axial	.40	.35
.047	600	Sprague 715P	radial	.73	.68
.1	600	Sprague 715P	radial	1.00	.90
.1	630	Xicon	radial	.65	.60
.22	600	Sprague 715P	radial	1.50	1.35
.22	630	Xicon	radial	.75	.70
.33	630	Xicon	radial	.85	.80
.47	630	Xicon	radial	1.95	

Shipping to anywhere in the U.S.A. is a flat rate of \$ 4.00

Buying your surplus components, transformers & tubes.

FOR SALE: Tabletop radios: RCA RHC17N, RLC20, RLC28W, all AM/FM, 115v - \$15 ea. Radiola 76ZX12, 6-tube, AM, 115v - \$20. Sentinel 315 AM/FM, 6-tube 115v - \$15. Sears 8002 AM transistor, 115v - \$10. All + UPS. Onerio L. Sabetto, 1717 Burgess Rd., Cleveland, OH 44112. (216) 481-1036

FOR SALE: Estate: Ten pickup loads of vintage radios, amplifiers, test equipment, ham equipment, telegraph apparatus, handbooks, catalogs, Riders, Sams, etc. List. LSASE appreciated. Dennis Hoffman, KW9G, 3519 Hoffman Rd., Chippewa Falls, WI 54729. (715) 831-1855, evenings/weekends. E-mail: hoffman@edp.net

FOR SALE: QST, CQ, 73 magazines 1940 to 1989. Send LSASE for free list. Gerald Scott, N7WVY, PO Box 2731, Elko, NV 89803

FOR SALE/TRADE: RCA 77DX microphone - \$850. RCA BK-1A, N.I.B. - \$350. Shure Mod? is larger than 55-B - \$225. RCA Victor 45 rpm w/radio (The Skipper) in beige and coral, Mod 6-BY-4, battery operated, with original manual - \$200. Larry Drago, 383 Lincoln Dr., Cheshire, CT 06410. (203) 272-6030

FOR SALE: Microphones: Monarch TM-16, N.I.B. - \$35. Shure 404B, N.I.B. - \$25. Turner 350C - \$15. Shure 450, N.I.B. - \$40. Radios: Arvin metal, blue - \$80. Bendix 526B - \$40. Emerson 502 Catalin, cracked - \$100. Emerson 540 - \$125. Mirrortone - \$50. Motorola 600 tube portable, mint - \$40. Motorola 53X - \$35. Philco 46-420 - \$40. Philco C-660, tube portable, black with underpainted silver grille, original box - \$60. Philco 42-121 - \$35. RCA 8X541 - \$30. RCA 66BX - \$30. Truetone D2018 - \$125. Truetone D2102A - \$20. Westinghouse H-147 - \$30. Tube tester Jackson 648A - \$45. Russ Abrams, 2330 Villaret Dr., Huntsville, AL 35803. (205) 883-7322

FOR SALE: Original Emerson 1937 Mickey Mouse radio chassis - \$150. Larry Drago, 383 Lincoln Dr., Cheshire, CT 06410. (203) 272-6030

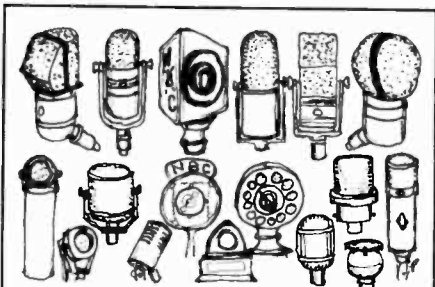

WANTED

FOR MY BROADCASTING MUSEUM

Microphones, stands, call letter plates. Tube amplifiers, mixers, compressors, Hi-Fi equipment. Speakers, on-air lights, equalizers. Disk, wire & tape recorders. Blank recording disks. Catalogs, magazines, manuals. 16" transcriptions, turntables, arms, pickups. Early TV cameras & receivers. Elaborate console, deco, plastic, mirror, novelty & wireless radios. Jukeboxes & parts. Acoustic phonographs.

We are looking for all makes of equipment, and especially Western Electric, Telefunken, Neumann and RCA. The museum contains various duplicates and items surplus to our needs, and many of these articles are available for sale or trade. The collection is located in my Victorian seaside inn, The Caffrey House, situated on a bay next to the ocean, in the Southampton resort area of Long Island. A trade of equipment for a stay at the hotel is always encouraged.

Robert Van Dyke, 2 Squires Ave., East Quogue NY 11942
516-728-9835

FOR SALE/TRADE: Philco Radio neon & etched plate glass sign (see Philco Radio backcover of book by Ramirez) - \$695. Admiral neon sign, emerald green tube, 26"x6", works beautiful - \$275. RCA 3'x4' metal 3-color Radiotron tube sign - \$200. Larry Drago, 383 Lincoln Dr., Cheshire, CT 06410. (203) 272-6030

FOR SALE/TRADE: Crosley paper-maché Bonzo dog by King Cole, believe it or not; a superb, original piece - \$1,275. Ed Bell, 5311 Woodsdale Rd., Raleigh, NC 27606. Fax/phone: (919) 851-1517

FOR SALE: Marconi marine Nebula Type EC 958-5, 10kHz to 30MHz manual, excellent condition - \$1,500. Edward Freeman, 631 Orchard Dr., Redlands, CA 92374. (909) 792-6779

FOR SALE: Thorens TD134 turntable - \$40. Bell carillon #6070 AM/FM tuner w/CD marks - \$299. Zenith L600 leather Trans-Oceanic - \$150. Hallicrafters TW1000 - \$99. Electro Tech TO-60 dual trace, 15MHz o'scope - \$99. (110) issues of Pop. Electronics 1972-1984. (204) issues of QST 1935-1975. (32) various meters. (100) plus electronics books. (31) pieces test equipment. (67) pieces audio equipment. (20) SW + old radios. (100) plus Sams Audio Photofacts. (64) original owners-operators manuals. (100) plus transformers & chokes. (51) various crystals. Send for list SASE. Clayton Vedder, PO Box 2823, Durango, CO 81302. (970) 247-2969, after 6 pm

FOR SALE: New list of radio & TV books, magazines and radio-related printed matter is ready, over (3) pages - send \$1 to: Maurer Television, 29 S. 4th St., Lebanon, PA 17042. (717) 272-2481

FOR SALE: Zenith 10S669 chassis, speaker, Wave-magnet - \$60 GE F-85 chassis, speaker - \$40. Fada 170CK chassis, speaker - \$40. Philco 48-460 parts sets - \$40/3. Grundun 1171 chassis, clean - \$75. Philco 37-610 table model, refinished, works - \$90. RCA 6T, nice, works - \$100. RCA 16X4, nice, works - \$30. Westinghouse WR-175, nice, works - \$50. Arvin 664A, cabinet damaged - \$20. Philco PT-30, nice, works - \$30. Emerson 652, nice - \$30. Crosley 52TD - \$25. Crosley 9-104W - \$25. Zenith 7H822, works - \$40. Grundig 2035, nice, works - \$125. Silvertone 1, nice, works - \$50. RCA 45X1 - \$35. BRC-636, Truetone, ivory, (Stein, p. 203) - \$100. Neutrowound, 1926, black, needs cosmetics, 1 tube cap missing - \$375. Hallicrafters S19R, needs cosmetics, works - \$75. Hallicrafters SW-500, nice, works - \$65. Hallicrafters S-120, nice, works - \$65. Hallicrafters SX-110 with speaker, nice, works - \$160. Hallicrafters SX-16 Super Sky rider, knobs not original - \$150. Hallicrafters S-40-B, nice, S-meter added - \$100. Pilot Super Wasp, nice, with coils - Make Offer. National 1-10, nice, with book, no PS - \$300. National 1-10A, nice, with book, no PS - \$300. Hallicrafters SX-100, works - \$150. National SRR, nice, with PS - \$350. Heathkit IT-5230 color picture tube tester & rejuvenator, nice, with book & adapters - \$75. QST magazines, 20s to 90s - will deal on quantities. RCA BP-10, nice - \$75. Hammarlund HQ-129-X with original speaker & book - \$225. Sams TSMs: 27, 36, 37, 42, 57, 75, 76, 139, 144, 152, 155, 156, 157, 158, 159, all mint - Make Offer on all. Sams MHF: 51, 67, 134, 139, 140, 200, all mint - Make Offer. Sams TR: 12, 52, 204 - Make Offer. Sams Automatic Record Changer Service Manual, First Edition, 1947 - Make Offer. All plus shipping. Open to offers. Ed Wilmart, 593 W. 15th Pl., Chicago Heights, IL 60411. (708) 747-6423

FOR SALE: (Copies) schematics for radios, also kit radios 1922-1950. Manuals: Test equip., ham gear, etc. Contact me for prices, availability. Duane Ballew, KB7QZK, 6813 152nd St. Ct. NW, Gig Harbor, WA 98332. (206) 851-4505

FOR SALE/TRADE: McMurdo Silver Masterpiece II chrome-plated chassis w/poor chrome but has excellent parts and original manual - \$275. Larry Drago, 383 Lincoln Dr., Cheshire, CT 06410. (203) 272-6030

FOR SALE: Hammarlund Roberts Hi-Q 6. Westinghouse fan with brass blades. Spice rack transistor radio with spice bottles. Browning-Drake kit. Hallicrafters S-40A. Heathkit Seneca VHF-1 transmitter (see front cover of Heathkit, A Guide to the Amateur Radio Products). Keuffel and Esser 1915 catalog. Rider's 9, 13. Emerson 10" TV made about 1949. Bob Warren, Church Street, PO Box 279, Waverly, PA 18471. (717) 587-2405

FOR SALE/TRADE: Heathkit Two-Er transceiver - \$85. Heathkit multiplier Mod QF-1 - \$75. Abbott transmitter/receiver Mod TR-4 - \$150. Swan Mod 260 w/manual 55B transceiver - \$325. Hammarlund HQ 180, near mint condition - \$475. Larry Drago, 383 Lincoln Dr., Cheshire, CT 06410. (203) 272-6030

FOR SALE: Restored working Philco 70 - \$350. Philco 37-610 - \$95. Grebe Synchronphase - \$250. Crosley radios & home, maroon Zenith Royal 500 - \$95. Radiola 103 speaker - \$145. RCA 128 - \$295; 143 - \$395. Emerson Momento wood - \$125. Zenith Royal 7000 - \$295; 7G605 - \$325. Bristol 1-stage power amp - \$175. Cutting & Washington 11B - \$450. Radiola 60 - \$175. Freed-Eisemann NR7 - \$175. Radiola 16 - \$145. Brown Sparton Polo radio - \$375. Radiola IIIA - \$150. RCA UZ1325 horn speaker - \$150. Yellow DeWald Catalin small crack, has handle on top - \$295. Arvin metals: brown 444 - \$85; white - \$85; black 422 - \$85; green 540 - \$55; white Kent with handle - \$65. Sears loose couple Meteor - \$275. Philco 45 butterfly radio GE J-72 cathedral - \$295. Sony Micro TV 4-203 walkie-talkie - \$150. Mercury Midget cathedral - \$195. Yellow body, black grille Emerson Big Miracle, no cracks - \$800. Radiola 100 speaker - \$65. 3PK4 CRT for Pilot TV - \$65. Sylvania radio tubes small sign - \$65. Motorola suitcase port. 68L11 - \$65; 69L11 - \$65. Zenith Trans-O, average condition, R600 - \$65; 8G605 - \$65. Royal 3000 - \$75; 7G605, no lid - \$150; brown USA neon(?) pointer - \$150. RCA oriental radio, mint+ - \$175. Federal Jr. - \$275. Crosley Super Triridin Regular - \$95. Grundig, green plastic table radio, SW, FM, AM - \$125. Siemens German WWII Nazi radio, with tubes - \$350. Guild telephone radio - \$75. Raytheon cardboard signs Channel Master Banner Transistor & Tube Radios - \$95. Nordemende Globe Traveler III - \$150. On-off switch n/g. General Television black Plaskon piano radio, crack on top - \$295. Rare Fada Catalin 652 with yellow insert grille, small hairlines, red trim - \$550. Zenith sub-mini hearing aids - \$45. Panasonic TV TR-001 - \$150. Singer TV with N.I.B. UHF antenna - \$150. RCA Jr. velocity mike - \$450. Stewart-Warner Companion - \$85. Vintage Radio Company, 87 Sandra Dr., Parsippany, NJ 07054. (201) 316-8424, voice or fax

FOR SALE: Needles, Pfanstiehl & other brands, over (1,500) N.O.S. Call or write your requirements with model or cartridge numbers. Bob Lynn, 26 E. Orchard St., Somerville, NJ 08876. (908) 685-9070

FOR SALE/TRADE: RCA 77D w/20-ft. cable and shock mount - \$750. RCA BK-1 A, N.I.B. - \$250. RCA 74B chrome and black microphone w/original (NBC) top and side call letter flags - \$975. Larry Drago, 383 Lincoln Dr., Cheshire, CT 06410. (203) 272-6030

FOR SALE: Universal dial belt kit, 5 belts, glue and instructions - \$8.50 ppd. To reference most Zenith models from 1920-1946, we offer our 60-page 11x17 Zenith Brochure Book with pictures and specs on most models - \$28.95 ppd. Laser reprint 1937 total line catalog - \$21 ppd. Our 1936 Zenith poster reproduction shows the complete 1936 lineup plus all three Stratospheres - \$20 ppd. Zenith T-shirts and sweats, call for info. Visa and MasterCard accepted. Alan Jespersen, PO Box 17338, Minneapolis, MN 55417. (612) 727-2489

CLASSIFIED AD NOTICE

Please check your ads carefully before sending them in. Once ads are received, it is not always possible to refund the amount sent, pull the ad or make changes.

FOR SALE: Fisher 49T tuner & 49A amp - \$100/pr. RCA 8-BT-10K portable transistor AM radio (1956) - \$35. RCA 6-B-5-B portable tube-type AM radio (1955) - \$35. Zenith H724 AM-FM table radio (1951) - \$35. University 8" trumpet speaker #1B-8 N.I.B. - \$20. Radiola 42 - \$75. H.H. Scott 296 dual laboratory amp - \$500. Remington Model 5 portable typewriter - \$35. Garrard RC88/4 record changer - \$75. Scott LT-112 stereo transistor FM tuner - \$45. Stromberg-Carlson 17CM2, 17-inch B&W console TV - \$75. EICO 625 tube tester - \$50. B&K transistor/FET tester, Model #162 - \$35. Picture tube brighteners for 1950's vintage B&W TV's - \$5 ea. Hickok #546 tube tester with manual - \$375. Tektronix 502A dual beam oscilloscope - \$200. All prices plus UPS. Bob Lynn, 26 E. Orchard St., Somerville, NJ 08876. (908) 685-9070

FOR SALE/TRADE: Edison Standard cylinder phonograph - \$425. Edison home cylinder phonograph - \$475. Crosley Dynacone Type C cone metal speaker, nice - \$175. AmpereX X-01023-R, TV camera tube - \$250. Larry Drago, 383 Lincoln Dr., Cheshire, CT 06410. (203) 272-6030

FOR SALE: Hallicrafters Civic Patrol with antenna matching preamplifier by Millen - \$85. Zenith Trans-Oceanic 7G605 bomber - \$225. Zenith Trans-Oceanic D7000Y - \$185. Radio Amateur's Handbooks: 1942 - \$45; 1943 - \$40; and 1963 - \$25. Ad shipping. Tony Parjus, 816 Richard Ln., Gretna, LA 70056. (504) 393-0099

FOR SALE: For Heath collectors. Have several models to sell as a group or will split. Best Offer. Heathkit Model #1's AD 1304, AD 1305, AA 15, AA1506 and AN 2016. All excellent condition. Also have an extra AN 2016 in kit form, N.I.B., with assembly manuals and operations book. Bill Manny, 1103 N.W. Despain Ave., Pendleton, OR 97801. (541) 276-3152, days. (541) 276-7439, evenings and weekends

FOR SALE/TRADE: Addison Catalin Mod 5 in ebony black w/butterscotch marbling vertical bars and knobs, beautiful flawless condition - \$1,875. Beaver Baby Grand crystal set fits in palm of hand - \$375. Stewart-Warner ivory Mod A-5IT3 binocular style radio w/vertical bars - \$275. Larry Drago, 383 Lincoln Dr., Cheshire, CT 06410. (203) 272-6030

FOR SALE: JFD Sockettes radio tube adapters—\$1 ea. SASE for list. John Snow, 4539 N. Bartlett Ave., Shorewood, WI 53211. (414) 964-0194

FOR SALE: RCA 45 phonographs: Model 45EY3, brown Bakelite — \$59; 7HF4S, cherrywood cabinet — \$90; 6EY1 in carrying case — \$69. All plus \$20 shipping. Also (18) used 6AS7G tubes — Make Offer. Maurer TV, 29 S. 4th St., Lebanon, PA 17042. (717) 272-2481

FOR SALE: Radios for sale. Battery sets: Federal E10. Airline 6, (2). Metrodyne, 7 tubes. Gilfillan Neutrodyne 5N. Gadio Graff II. Radiola 18, (2). American Bosch 28. AK 46 (2). AK 33. AK 49. AK 30. AK 35. Cathedrals: Majestic 50 on stand. GEK 64. Philco 38A. Clarion 80. Philco 80 Jr. Majestic 56 Ardmore. RCA R87. Crosley 187. Falk. Steinite 700. U.S. Radio Gloritone 99A. Shortwave sets: Hallicrafters 77. Hallicrafters Sky Buddy. Hallicrafters 20R. Echophone Commercial, (2). Eico DX718. Hallicrafters S38E. Tombstones: Delco 1105. RCAT5-2. Silvertone 1994. Philco 610, (2). Delco 1102. GE S22. RCA 6T2. Philco 37624 battery. Philco 66. Zenith 4T26. GE L6B battery. Stromberg-Carlson 58. Other radios: RCA 73X10. Stewart-Warner 301A shortwave converter. Howe crystal set. Steinite crystal set. Philmore crystal set. Miller HRAM crystal receiver. Real Rite tube tester analyzer. Jefferson tube rejuvenator. Radiola III case. (3) Sams Photofacts books. Grunow 5B. Clarion 1933 lathe, Art Deco. Clarion, 1934, Art Deco. Call after 5 pm weekdays, anytime weekends: Arthur J. Stratton, N6902 Post, Spokane, WA 99208. (509) 328-8471

FOR SALE: Approx. 1,500+ glass tubes, R & Tel. in two cardboard drums as found from radio shop — \$450 ppd. Info: Charles Filer, Rt. 2, Box 56S, Summerland Key, FL 33042. (305) 745-1801 EST

FOR SALE: 1921 silver Elgin National pocket watch — Best Offer. Dwain Stevens, 151 Dog Fork, Pikeville, KY 41501. (606) 478-8248 EST

FOR SALE/TRADE: 1927 red Neutrowound, red ones were made for display only, very scarce, with good tubes — \$2,000 plus shipping. Ed Bell, 5311 Woodsdale Rd., Raleigh, NC 27606. Fax/phone: (919) 851-1517

FOR SALE: (20) analog meters, various sizes, most removed from instruments — \$20 + UPS. Dave Betz, 449 Chandlee Rd., Rising Run, MD 21911. (410) 658-6130

FOR SALE: Both 1930 Silver-Marshall, Around the World Six, Model SM-735AC and Silver-Marshall shortwave converter Model SM-738AC with all coils, mint. Lester P. Rayner, 5512 N. 71st Pl., Scottsdale, AZ 85253-5902

FOR SALE: Tube radios. Minerva W710A — \$25. Tru-tone D2634 — \$30. DeWald C-800 AM-FM — \$30. Guild Spice Chest w/papers — \$75. Olympic LP3244 — \$20. Telechron 8H59 — \$25. Firestone 4A26 — \$20. Emerson 535 — \$20. Zenith Y723 — \$25. Zenith H725, nice — \$35. RCA 4X644 — \$10. Airline 62-225 tombstone — \$75. Dave Mock, 3 Larkspur Pl., Montpelier, OH 43543. (419) 485-3933

FOR SALE: Zenith transistor radios, excellent condition, no cracks or chips: Royal 200, coral — \$110; turquoise — \$100; Royal 275, green — \$45; grey — \$45; Royal 300, white — \$125; green — \$70; Royal 400, white — \$75; green — \$70; Royal 500 handwired, maroon — \$125; black — \$110; Royal 500H, grey — \$125; black — \$100. John Kern, 2320 Rosedale Rd., Quakertown, PA 18951. (215) 538-2128

FOR SALE/TRADE: National 173 communications receiver in like-new condition — \$200. National FB-7 w/3 coil sets — \$675. National 1-10 rcvr w/10 coils — \$425 (Circa 1934). Rare complete National Hallicrafters Mod SX-24 Super Defiant — \$250. National 183 — \$350. 1938 HRO Prototype one-of-a-kind in new condition, w/ five coils & manual — \$750. Larry Drago, 383 Lincoln Dr., Cheshire, CT 06410. (203) 272-6030

The “Radio Collector” Video

Writer-producer Mike Adams and the Perham Foundation Electronics Museum are pleased to present the original, best-selling PBS series, “Radio Collector”. Nominated for an Emmy, Best Information Series, “Radio Collector” is now available complete and uncut. All five half hour shows have been newly duplicated from the original broadcast masters.

Order the Popular VHS
Videotape “Radio Collector”
Directly From
the Perham Foundation!



Writer-producer Mike Adams

You'll meet dozens of collectors and experts, see hundreds of radios made between 1900 and 1960, plus you'll learn about radio restoration!

Send \$29.95 plus \$3.00 S&H to:

Perham Foundation,
101 First Street, Suite 394,
Los Altos, CA 94022

For more information,
call us at 408-734-4453
Proceeds support construction
of our new museum!

FOR SALE/TRADE: 1960's Ampeg all chrome guitar amp Mod #B-15N w/15" chrome-plated speaker - \$675. Mills jukebox amp Mod #MCP 2802-A - \$225. Larry Drago, 383 Lincoln Dr., Cheshire, CT 06410. (203) 272-6030

FOR SALE: Fada 652 Temple Catalin, butterscotch - \$500. Fada 711 Catalin, butterscotch, hairline - \$450. Philco 95 highboy, real nice - \$300. Freed-Eisemann NR9 console - \$175. American Bosch 28 - \$140. Fada 192A Neurolette - \$150. Radiola 20 - \$150. J. Gary Cameron, 824 Andrews St., Southington, CT 06489. (860) 276-9200

FOR SALE: General Radio Telexsa, round searchlight style, (E.O.R. 1, p. 140) - \$475. Emerson 511, red Plaskon with gold swirls, hairlines - \$250. Very nice original Coca Cola cooler radio - \$650. Radiola III and amplifier - \$235. Philco 91 cathedral. General Motors 291 Queen Anne console radio/phone, exquisite - \$595. Airline Lone Ranger, minor hairlines. Charlie McCarthy. Butterscotch Emerson Aristocrat, chip under handle - \$495. RCA 140 or GE K80 - \$395. Original Zenith brochures: 1939 showing some table models - \$15 ppd; 1937 Auto Radios - \$10 ppd; 1936 Philco 651 8-tube tombstone - \$225. Philco 39-116 remote console - \$325. Nipper stuffed animal, new, 6" - \$15. 9" stuffed Nipper - \$25. Atwater Kent 92 cathedral - \$475. Refinished Stromberg-Carlson 225H, rosewood - \$325. Riders Manuals, 8-14 - \$15 ea. Call for current availability on other numbers. We have available all type Trans-Oceanics except 7G605 and military, electrically restored, if requested, and guaranteed. Excellent color laser reprint of the original Trans-Oceanic 7G605 brochure - \$10 ppd. We have for sale many console radios not advertised: Stromberg, Philco, RCA, Airline and many others, call. Zenith consoles: 15S373A, 15S372, 15U270, 15U269, 12S569, 12S471, 12U159, 12U158, 12S370, 12S371, 12S265, 12S266, 12S267, 11S474, 10S153, 10S155, 10S156, 10S157, 9S54, 9S262, 9S367, 8S154, 8S463 (5808), 8S359, 7S366, 7S363, 7S260, 7S258, 410 and many others. Zenith chairsides: 9S344, 6S147, 8S451, 7S343, 6S241 bar radio, 6S239. If you are looking for a set not listed, please call for more info. We can and do ship consoles anywhere and we do it right. Zenith table models: 5S228, 5S127, 5S226, 6D219, 6S330, 9S30A export, 7S28, 7S323, 6V27, 6S27, 6S128, 6S222, 7S432, 807, 808 and many others, call. All radios unrestored electrically unless noted. Shipping extra unless noted. Satisfaction guaranteed, highest quality possible assured. Send for our free catalog showing restoration and shop supplies, owner's manual reprints etc. When in Minneapolis, be sure to visit our retail location Great Northern Antiques, 5159 Bloomington Ave., just five minutes from the airport. We accept Visa and MasterCard. Alan Jespersen/Mike Emery, PO Box 17338, Minneapolis, MN 55417. (612) 727-2489 or fax only (612) 727-1908, ans. mach. after 4 rings, 8 am to 8 pm, 7 days

FOR SALE: Univox guitar amps, 4-tubes with 12" Jensen spkr #U-45B - \$100. Arkay audio amp #FL-10, 2-6V6's - \$40. Pierson radio chassis, Rockford, Ill., chassis only - \$40; with (2) 45's tubes - \$65. Philco chassis w/tubes Type 19 - \$25. RCA #94BP4 wood portable - \$27. RCA #6C8B 1950's green clock radio - \$16. RCA R28P wood tombstone - \$100. **WANTED:** Phono oscillators and mini transmitters on broadcast band. Kevin and Kathy Moe, 616 Lockrem St., Ottawa, IL 61350. (815) 433-4598

FOR SALE: Crosley 51 portable, very good condition - \$170. Belmont Lever Tune Model 536, wood cabinet - \$65. Emerson Model 503, very good - \$30. Bob Barnes, Box 275, Monroe City, MO 63456. Ph./Fax: (573) 735-2945

FOR SALE: Crosley center bullseye in red, wrong knobs - \$165. RCA Radiola 3 - \$95. Emerson 418 Ingraham - \$135. Mirror Tone Deluxe 804 midget - \$60. Temple G-418 metal - \$50. Airline 74BR-1504B - \$40. Jefferson Golden Hour clock - \$50. Silvertone 7 transistor in box - \$25. Lee Gentry, 834 Paxton Dr., Knox, TN 37918. (423) 281-7554

FOR SALE/TRADE: Two movie theater 100-watt Dukane Mod 1-A-803 solid-state amplifiers w/manuals, new in box, that were to be used as replacements for tube amps until the neighborhood theatre closed. If you know of a theatre still in business or under renovation that could use them, call: Larry Drago, 383 Lincoln Dr., Cheshire, CT 06410. (203) 272-6030

FOR SALE: Transistors: Zephyr, Capri, Regency TR-5C. Electro-Voice broadcast mikes. Call before 8 pm. Brad Jones, 4801 Crofton Springs Ct., Greensboro, NC 27407. (910) 547-1919

FOR SALE: Vintage tubes, SASE for list. Radios: Airline (1929 mystery) 15 - \$110. Andrea G6B 6 Vdc AM/SW - \$99. Philco cathedral Model 89 (1933) - \$199. All plus UPS. **WANTED:** National SW-3 with coils and power supply for my ham receiver collection. Trades and offers encouraged. Steve Lipsky, W2VVN, 1254 Cox Rd., Rydal, PA 19046-1207. (215) 884-1817. E-mail: 74144.2634@compuserve.com

FOR SALE: Hallicrafters speaker PM100 - \$45. National SW54, nice - \$65. Hallicrafters SR10, like new - \$75. Lafayette 1940 139/247 wraparound grille - \$100. G. Stevens, PO Box 704, Longmont, CO 80502-0704. (303) 776-9036

FOR SALE/TRADE: Catalin clock collection. (7) clocks, (2) barometers - \$1,000 or nice Catalin. Jim Leckrone, 12174 Lynn St., Bear Lake, MI 49614. (616) 864-3365

FOR SALE: Rider's Radio VI - \$100; V3 - \$50; V10 - \$15; V14 - \$15. Also radio mag. of the 1920's - \$5 to \$16. Plus shipping. Ricky Parrish, 1260 Marilyn Dr., Cape Girardeau, MO 63701. (314) 334-1726

FOR SALE: New speaker and case MS4 for Drake TR4 in original carton - \$35. Francis Turner, 500 Wheeler St., Lebanon, OR 97355. (541) 258-5776

FOR SALE: Vacuum tubes, N.O.S. and used. Send two-stamp LSASE for List #3. Neal Simpson, 27-1 Queen Rd., Lambertville, NJ 08530. (609) 397-3346

I am not a dealer, but a serious collector and historian interested in all aspects of E. H. Scott.

Please contact me first if you are selling your E. H. Scott Radio. Select E. H. Scott Radio tone Coils, World's Record Superhet, or Scott Transforms mer Co. items.

Always interested in any E. H. Scott stock certificates, literature, and military sets.

**John T. Meredith
2462 Statonsburg Rd., Suite 152
Greenville, NC 27834 - (919) 551-1882**

FOR SALE: Belmont 6D111, 1946 - \$225 plus shipping. Robert J. Stone, 721 Fisk St., Piqua, OH 45356-3729. (513) 773-2217

FOR SALE: RCA UZ1320 horn speaker, good driver, in excellent condition - \$225. Radio Shop Model 3, mint - \$350. Radiola RC, mint - \$350. Roger Hart, 4533 Harvard Ave., Montreal, Quebec, Canada H4A 2X3. (514) 483-3857. Fax: (514) 483-6114

FOR SALE: Philco Predicta, 19-inch table model, used every day as 2nd TV - \$500, U-ship. Tom Muller, KE6FDL, PO Box 6128, March AFB, CA 92518. (909) 655-7689, 7:30-5 days PST

FOR SALE/TRADE: 1955 Chevrolet car radio in nice shape for novelty/pocket transistor or \$35. Paul Fulton, 711 Jacquelyn Rd., Westwood, NJ 07675. (201) 664-5260

FOR SALE: Working farm radios in wood or plastic cabinets. Choice at \$55 includes UPS shipping. Call or write: Ron Marley, 172 Brandi Way, Winchester, TN 37398. (615) 967-7219

FOR SALE: HP200CD 5Hz-600kHz audio oscillator, manual - \$50. Weston 433 lab AC voltmeter, ideal for Variacs - \$25. Oscilloscopes: Hitachi V-209, very compact 20 MHz dual trace, battery/120VAC - \$159; Mil USM-32 - \$17; HP1741A 100MHz dual trace, storage - \$375. Eico 955 in-circuit capacitor tester - \$32. Genrad: 1650A RL/DQG bridge - \$185; 1551C sound level meter, 1559 microphone calibrator, both - \$62. Heath IM-4100 45MHz counter - \$50. Much more, list LSASE. Kirk Ellis, KK4YP, 203 Edgebrook Dr., Pikeville, NC 27863. (919) 242-6000, evenings

FOR SALE: Radios, 30's thru 50's, SASE for list. Sam Giansante, 4255 West Avenue Rd., Elba, NY 14058



FOR SALE: Sony ICR-100. First Sony integrated circuit radio complete, w/box, case, manual, earphones, etc. Taking offers. Don Hauff, PO Box 16351, Minneapolis, MN 55416. (612) 933-9070. E-mail: McMurdoDon@aol.com

FOR SALE: Motorola 6X32E-1, dk. gray - \$90. Motorola 6X32E-1, dark gray - \$90. Bulova Comet 620, ivory - \$120. Emerson 555, turq. - \$50. Penney's RPI-124, turq. - \$75. Hitachi TH-848, red - \$35. Lefco, hi-fi-8, red and white - \$90. **WANTED:** 2 transistor and boy's radios. Gary Willoughby, 5930 W. Jefferson Blvd., Los Angeles, CA 90016. (310) 559-0706

FOR SALE: Photoflash capacitors, small size, low leakage, 160 µfd, 330 volt, - \$8/50, \$15/100. Plus postage. Gordon Wilson, 11108 50 Ave., Edmonton, Alberta, Canada T6H 0H9. (403) 434-6257

FOR SALE: Octal sockets with metal mounting ears, N.O.S. U.S.A. - \$10 for 10 ppd. Bob Putnak, 1507 4th St., Monongahela, PA 15063. (412) 258-6236

FOR SALE: Manuals (copies) all ppp; SP-6700-JX-17 factory - \$25. TV-7 operation - \$20. TS-323 maintenance - \$20. Bob Bakinowski, 1524 Saint Tropaz, Tucson, AZ 85713. (520) 624-8029

FOR SALE: Nice, rare S-meter unit for S-40, S-40A - \$45. HP-23 - \$40. **WANTED:** Nice Valiant, junker or restorable Viking Ranger, Globe Scout Deluxe, 755VFO, UM-1 modulator. No calls after 5 pm. Ron Merrell, 10701 W. 54th St., Shawnee, KS 66203. (913) 268-5973

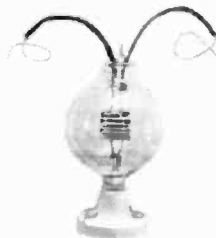

FOR SALE: Spherical Audion working replicas, single wing type, ca. 1907, 3 1/2-volt filament - \$350 ea. Price includes candelabra base and shipping. Ca. residents add 7% sales tax. Science Resources, 1260 Liberty Way, Suite B, Vista, CA 92083. (619) 727-6933

FOR SALE: Radios: Portable, pocket, table, hi-fi, etc. 12 new and updated pages. SASE please. Chuck Vaccaro, 708 Booth Ln., #F, Ambler, PA 19002. (215) 646-3641

FOR SALE: Jackson Bell 88 parts: front of cathedral case - \$30; (3) knobs - \$30; speaker - \$35. Sutchell-Carlson frog-eye, small, all white - \$75. Del Tysdal, 812 Broadway, #4, Fargo, ND 58102. (218) 287-2562

FOR SALE: Transformers, new auto radio, 6 volts, 65mA universal half-shell - \$9 plus postage. Jack Shaymow, Vintique Electronics, 52C Tilford, Deerfield Beach, FL 33442. (954) 427-1222

FOR SALE: Radios, misc., SASE list. Zenith 6G601ML missing front cover, works, alligator-covering with (2) white Z knobs - \$45 + UPS. Philco cathedral model unknown, not working, cabinet solid/complete radio, fancy, 4-tuber/not 84B - \$110 + UPS. Tom Tetzlaff, 23 Nelson Dr., Silver Bay, MN 55614. No phone

FOR SALE: Mono tube tuners: Browning Labs RV10B, exc, working, no escutcheon - \$40. Brooks ST10, unusual inductive tuning, near mint, not working - \$50. H.H. Scott 311D, w/case, vg+, sounds gorgeous - \$80. Heath W4M, grey, + WAP2 mono power amp and preamp, vg+, working - \$100/both. Zenith G500 Trans-Oceanics, vg+, clean, working - \$135. DeWald A500, broken case, no dial glass, mint working chassis - \$20. Markel Playmaster, ca. 1950 3-speed turntable, mint, no headshell - \$25. Al Wirtenberg, 15 Wilson Rd., Weston, CT 06883. (203) 544-9270

FOR SALE: Zenith 715, rough - \$75 including UPS shipping. Harvey Leners, 5426 So. 185, Omaha, NE 68135. No calls!

FOR SALE/TRADE: Crystal sets: Miller tuner (wood cabinet) - \$120. Rocket radio w/box, Heathkit CR1 - \$80 ea. Harry Blesy, 9S740 Clarendon Hills Rd., Hinsdale, IL 60521-7049. (708) 789-1793

FOR SALE: Victorean lowboy Model 345, on cover A.R.C. Dec. 1989, pristine. John R. DeLoria, 101 Doverbrook Rd., Chicopee, MA 01022. (413) 593-1180

FOR SALE: Setchell-Carlson small frog-eyes (#416): one white with brown tuner knobs, one brown with white tuner knobs, excellent - \$75 ea. RCA phonograph: P-903 - \$45. Crescent C-651 - \$45. RCA 9-Y-510 R/P - \$55. Thanks. Del Tysdal, Rte. 1, Box 157, Glyndon, MN 56547. (218) 287-2562

FOR SALE: Vintage tube CB's & accessories; N.I.B. tubes. LSASE - list (Specify). **WANTED:** Theremin. Charles Zafonte, RFD 1, Box 75, Fort Kent, ME 04743. (207) 834-6273, eves./weekends

FOR SALE: Galaxy FM 210 2-mtr transceiver w/xtals \$25/52, 25/85, 675/075, 28/88, 34/94, mic, PS, manual - \$75. Echophone EC-1 - \$50. Jim Ford, NM1F, 194 Rocky Hill Rd., Plymouth, MA 02360. (508) 747-2224

FOR SALE: Copy of Sams DC-1, DC-2 and DC-4 dial cord stringing guides, spiral bound - \$12.50 ea. shipping included. Ron Crowe, PO Box 117, Handley, WV 25102. (304) 442-8179

FOR SALE: Valves: Telefunken EL152 (1) N.I.B. - \$100; EL156 (2), tested good - \$50 ea.; RCA 1624 (4) N.I.B. - \$25 ea. Transistor radios: Japan: Standard 6, small hairline the back, Spica both in leather etui - \$50 ea. Hilton, small crack/back - \$15 China Friendship, N.I.B. manual - \$35. Hong Kong Welt Funk, shipped, in box - \$15. Federal, N.I.B. - \$30. Browni, N.I.B. manual - \$35. Esvepe, shirt - \$20. Viba Vision, novelty - \$15. P&P not included - \$10 ea. Rudi Sillen, 31 Limberg, B-2230 Herselt, Belgium. Phone/fax: 32.14.54.68.89

FOR SALE: Federal 59, all Bakelite good, inside and instruction card good, some cabinet wear, NT - \$795. Steven Roth, 217 W. Broadway, F-24, Columbia, MO 65203. (314) 449-4216

FOR SALE: Rare Steinite Seville highboy - \$395. Mahogany Brunswick Ultona phonograph - \$350. TV-2/U tester - \$150. All OBO. Richard Rubin, 227 Riverside Dr., Apt. 5-A, New York, NY 10025. (212) 864-8416

FOR TRADE: Wanted to trade: King Comics Book One 1936 for old radio items. Dale Kinstler, W1361 Aasen Rd., Banagr, WI 54614. (608) 486-2589

FOR TRADE: Nice Truetone Boomerang+ for Philco Boomerang, nice AK-82Q for AK-206. Merrill Mabbs, 709 Pluma Dr., Rapid City, SD 57702. (605) 342-4090. E-mail: radio@aol.com

FOR TRADE: Lincoln Radio Mfg., Milwaukee, one tube, slant panel, early 1920's, rare set. Ed Bell, 5311 Woodsdale Rd., Raleigh, NC 27606. Fax/phone: (919) 851-1517

SEND ALL A.R.C. MAIL TO
Antique Radio Classified
P.O. Box 2, Carlisle, MA 01741

FOR TRADE: Hammarlund Comet Pro with coil set, Heath CR1 crystal set. Amrac spark xmtr. DeForest tube xmtr. WWII German transceiver. Microphone stand for 77 RCA. AK breadboard. **WANTED:** Western Electric tubes, transformers, speakers, and some test equipment. Michael Payne, 803 S. Taylor, Alvin, TX 77511. (713) 331-9217. Fax: (713) 585-2727. E-mail: we300b@aol.com

FOR TRADE: Radiola AR, RF amp, e. for Amrad 3366 or 3670 port. reflex sets. J.C. Woychowski, 17 Hope St., Niantic, CT 06357. (860) 739-6579

FOR TRADE: Have TV-3 B/U tube tester, trade for WWII radio gear. Steve Bartkowski, 4923 W. 28 St., Cicero, IL 60650. (708) 863-3090

FOR TRADE: 45, 2A3, etc. for Amperex Bugle Boy and Telefunken 6DJ8, 12AX7, 6922, etc. John Birck, 458 E. 600 N, Orem, UT 84057. (801) 224-4809

FOR TRADE: Pepsi bottle radio for early spark transmitter. **WANTED:** Early radio books and magazines for my reference library. John H. Dilks, K2TQN, 125 Warf Rd., English Creek, Egg Harbor Twp., NJ 08234-8501. (609) 927-3873. E-mail: john.dilks@academia.com

NEW BOOKS FOR COLLECTORS OF AMPLIFIERS, SYNTHESIZERS & JUKEBOXES

The History of Marshall, Michael Doyle. Forward by Billy "F" Gibbons. *Essential reading for musicians, technicians and collectors alike. Follows the rise of the company. Complete list of all Marshall products ever made. 62 color pages. 254 pages. Softcover. \$32.95*

Amps! The Other Half of Rock 'n Roll, Ritchie Flegler. *How the amplifier evolved & how it works. Fender, Vox, Ampeg, Marshall histories, etc. 20-page full color photo gallery. Troubleshooting chapter. 120 pages. Softcover. \$24.95*

Vintage Synthesizers, Mark Vail. *Looks at the history (1962-1992) of the electronic music synthesizer. Over 200 photos. Dealer tips on finding and buying synthesizers. Price guide. 300 pages. Softcover. \$19.95*

Jukeboxes - Obscure, Mysterious and Innovative American Jukeboxes, Adams. *First volume of a history of the lesser known manufacturers of phonographs, music boxes and jukeboxes. 182 pgs. \$29.95*

Jukebox Art, Pearce. *The evolution of the jukebox from the coin-operated record changer to the flashing lights of the rock-and-roll generation. 250 photos. 128 pgs. Hardcover. \$29.95*

Jukebox Art Postcard Deck. *30 colorful photos from Pearce's book. \$9.95*

U.S. Orders - Enclose \$3.00 per order for packing & book-rate shipping if total order is under \$35.00. If using VISA or MasterCard, include name on card, card number and expiration date. Send payment with order. Mass. residents please add 5% sales tax. Money back return policy. Most orders shipped the same day received, but allow 2-4 weeks to receive order. Foreign orders - write for shipping costs, or use credit card and specify air or surface (allow 2-3 months for surface shipping).

Send Order To: A.R.C., P.O. Box 2, Carlisle, MA 01741

Phone: (508) 371-0512 — Fax: (508) 371-7129



(Jan-95)

SERVICES: Shortwave specialist. Professional radio overhauls. 3-year guarantee. Free estimates, brochure. Always buying new tubes. Captain Larry Rau, Occidental Radio Workshop, Box 1139, Occidental, CA 95465. (707) 874-1000

SERVICES: Repair of TV-7 tube testers w/calibration: I will fix and then verify calibration of your TV-7 tube tester for \$45 plus all shipping or return it no charge. Daniel Nelson, 1025 E. Desert Ln., Phoenix, AZ 85040. (602) 243-7421, evenings. E-mail: djn@indirect.com

SERVICES: Rider Radio Schematics, 1930 through 1950's. Includes alignment data. Send \$3 with make, model and SASE to: George M. Bonanno, WA2KPE, 34 Charles St., Clifton, NJ 07013. (201) 746-5953

SERVICES: Phonograph crystal cartridges rebuilt, obsolete idlers resurfaced, True 78 needles, all types. Best prices, new parts warranty. Contact: West-Tech Services, 648 N. Ridgewood Dr., Ste. 11, PO Box 1415, Sebring, FL 33871. (941) 471-0922

SERVICES: Schematic and Service Data Rider Radio Vol. 1-22, Record Changers and Audio Amps 1930-1950's, Car Radios to 1940's. Send SASE \$2.50, make, model to: Steve Rosenfeld, PO Box 387, Ocean Gate, NJ 08740. (908) 269-2022, days

SERVICES: Antique radio & television repair. 40 years experience. Two week turnover excluding major mechanical parts. Tom's Antique Radio, 8 Howe Ln., Millbury, MA 01527. (508) 865-6293

SERVICES: Schematics 1920's thru 1950's, mailed or faxed - \$3 radios; \$4 TVs ppd. Robert Schrantz, 610 E. Juanita Ave., San Dimas, CA 91773. Phone/fax: (909) 394-1194

SERVICES: Your Hickok man. Also servicing most major makes such as B&K, Precision, Triplett, Sencore, Heath, Eico, & military test equipment. Technical & operators data at reasonable cost. Obsolete & foreign tube data, service that satisfies for over 50 years.

FOR SALE: Set of 4 new after-market 4-5-6-7-pin obsolete plug-in test adapters w/test data especially for Hickok 6000 Series tube testers - \$65 including shipping. New octal, 7 & 9 pin socket [?] - \$18 ea. including shipping. See \$95 test equipment specials below. And there's lots more: Hickok, Solar, Sprague, Amphenol, Heathkit, Eico, RCA, Sencore, Triplett, HP, Daven, Jackson, etc. All priced to sell. **FOR SALE/TRADE:** Upgrade your test equipment now with quality, reconditioned & calibrated units from stock. Also provide active [?] need list for special requirements. Hickok 690 VHF/UHF marker calibrator; Hickok 695 TV/FM sweep gen.; Hickok 610 TV/FM working sweep gen.; Hickok 691 marker/adder w/leads; Hickok 600A, 800A, 6000A tube testers. B&K 1801 freq. counter; B&K 1076 TV analyst; B&K 667 TV/FM tube tester, RCA color bar gen. Amphenol 857 color CRT tester. Amphenol 860 color bar gen. Amphenol batt-operated VTVM. All above Amphenol inst. are solid-state, compact high quality. Most have operator manuals. Your choice while they last for - \$95 ea. + S&H. Wendell E. Hall, 3 Mockingbird Cir., Jeffersonville, IN 47130. (812) 282-9709

SERVICES: Repair/replacement of meters before 1945.

WANTED: Old meters/galvos before 1910 as is okay. Ye Olde Meter Cellar, Leonard W. Cartwright, 879 Russet Dr., Sunnyvale, CA 94087. (408) 739-6025

MESSAGE: Announcement: John Okolowicz has just established a grille cloth headquarters on the World Wide Web. Point your browser to: <http://www.libertynet.org/~grcloth> to see the complete portfolio of antique radio grille cloth on-line plus much, much, more. Discover the latest developments. You can now provide feedback directly and influence future products. So, what are you waiting for, the surf's up. John Okolowicz, 624 Cedar Hill Rd., Ambler, PA 19002

MESSAGE: Voice of Music (VM) "Collector's Voice" newsletter covers VM audio products, restoration and company history! Issue #1 is free for a SASE. Written by collectors, with access to and consent of VM Corporation! Gary Stork, 37530 E. Meadowhill, Northville, MI 48167. (810) 478-0990

HELP: Seeking information about Lettine Radio Mfg. Co., Valley Stream, Long Island, New York and/or Lettine 240 transmitter. Paul Eisenbarth, W72CA, 1365 McDonald Dr., Reno, NV 89503

HELP: N.O.S. receiving tubes needed: 7B7 7C6, 7G7, 7H7 - Offering \$2.50 ea. 1L6 & 1U6 - Offering \$8.50 ea. Scott Phillips, 368 Clinton St., Binghamton, NY 13905. (800) 314-3957. Fax: (607) 797-0013

One Month Free!

BONUS FOR EARLY RENEWALS

If you renew **before** the month shown on your mailing label (your expiration month), you will receive an extra month on your subscription: 13 months instead of 12! 26 months for an early 2-year renewal!

HELP: How does the AVC operate in my Scott hi-fidelity All Wave and how do I set it up? What should the sensitivity control do? I have Rider's info only. Thanks. Chuck Ulrick, 8282 Afolkey Rd., Dakota, IL 61018. (815) 563-4905, after 6 pm

HELP: Need photocopy of schematic for Precision 920 tube tester. Bill Walls, 605 Ashland Dr., Mebane, NC 27302. (919) 563-5543. E-mail: slate@netpath.net

HELP: Need operators service manual for a Hickok synthesized CB RF signal generator Model No. 266, copy OK. Ross Bongiovanni, 237 Washington St., Albion, NY 14411

HELP: Thanks to all who helped with schematic for Heathkit tube tester. Jeff Hoskins, 824 E. Madison Ave., Stuart, FL 34996. (407) 283-2291, after 7 pm

HELP: I need a Sams for RCA Victor of Japan, Model No. 4P-20017. Also does anyone have 3Y4 tube, DL97 or is the sub. for it. Edmund DeCann, 307 3rd Ave. W, Box 543, Osakis, MN 56360. (612) 859-4282

HELP: Want to learn more about my British Decca 121 projection TV. Knowledgeable? Eric Stumpf, PO Box 60245, Santa Barbara, CA 93160. (805) 964-9417

HELP: Need dial lens for Rodgers Model #832 to complete restoration. Robert Nicholson, General Delivery, Manila, Ontario, Canada K0M 2J0. (705) 357-1466

HELP: Need Kolster 6J power transformer or complete supply. Simplex 6D metal top. Cris Van Houten, 728 Keup Rd., Cedarburg, WI 53012. (414) 377-5873



COMING RADIO EVENTS

N.J. - Jan. 29-Mar. 23

**EXHIBIT OF 1914-1950's RADIOS
"RADIOS OUR GRANDPARENTS
LISTENED TO"**

Mays Landing, NJ - Atlantic County Library
Route 40 and Farragut Avenue

Info: John H. Dilks, K2TQN, 125 Warf Rd.
Egg Harbor Twp., NJ 08234 - (609) 927-3873

NEW YORK - Feb. 3

**GREATER N.Y. VINTAGE WIRELESS
ASSN. - INDOOR SWAP MEET**

Lake Ronkonkoma, NY - Holy Cross
Lutheran Church, 307 Hawkins Ave.

8 am-12 Noon

Info: Chris Lieppert - (516) 471-9526 eves.
Chris Bacon - (516) 821-7618, eves. to 11:30

ARKANSAS - Feb. 1

**ANTIQUE RADIO COLLECTORS CLUB
OF FORT SMITH - CLUB MEETING**

Fort Smith, AR - St. Luke Lutheran Church
Waldron Road, at Free Ferry

7:30 pm

Info: Paul Tucker, 4700 N. "N" Street
Fort Smith, AR 72904 - (501) 782-8178

WASHINGTON - Feb. 3

**RADIO ENTHUSIASTS OF PUGET SOUND
MEETING**

Seattle, WA - Queen Anne Library
400 W. Garfield - 2 pm

Info: REPS, 9936 NE 197th Street
Bothell, WA 98011 - (206) 488-9518

CALIFORNIA - Feb. 3

**CALIF. HISTORICAL RADIO SOCIETY
SWAP MEET**

Redwood, CA - Ampex Corp. Parking Lot
8 am

Info: CHRS 24-hr. Hotline - (415) 978-9100

OHIO - Feb. 4

**BUCKEYE ANTIQUE RADIO AND
PHONOGRAPH CLUB - MEETING**

Brunswick, OH - Brunswick Library
3649 Center Rd., Rt. 303 - 1-4:30 pm

Info: Rich Bradley - (216) 842-5937

FLORIDA - Feb. 3

**FLORIDA ANTIQUE WIRELESS GROUP
WINTER MEET**

Orlando, FL - VFW Hall
4444 Edgewater Dr.

9 am-1 pm

Info: Dennis - (407) 895-0146, days, or
Paul - (407) 365-9305, eves.

WASHINGTON - Feb. 4

**VINTAGE AUDIO LISTENERS AND
VALVE ENTHUSIASTS - MEETING**

Poulsbo, WA - Classic Radio
1127 N.W. Bright Star Ln.

10 am-2 pm

Info: Dan Schmalte - (360) 697-1936

MICHIGAN - Feb. 3

**MICHIGAN ANTIQUE RADIO CLUB
WINTER SWAP MEET**

Grand Rapids, MI - Airport Hilton
4748 28th St. SE - (616) 957-1000

8 am-1 pm

Equipment Contest - Silent Auction
50/50 Raffle

Advance seller table reservations required
Info: Larry Anderson - (313) 274-1948, or
E-mail: 76020,2251

VIRGINIA - Feb. 7

**TIDEWATER ANTIQUE RADIO ASSN.
MEETING**

7 pm - Call for location & directions

Info: Phil Stroud, 2328 Springfield Ave.
Norfolk, VA 23523 - (804) 481-2561, after 6 pm

ARKANSAS - Feb. 8

**ARKANSAS ANTIQUE RADIO CLUB
MEETING**

Little Rock, AR - Call for location - 7 pm

Info: Tom Burgess - (501) 455-0773

NEW JERSEY – Feb. 9

NEW JERSEY ANTIQUE RADIO CLUB MEETING

Freehold, NJ – Grace Lutheran Church
West Main St. & Park Ave. (old Rt. 33)

7:30-9:30 pm – Meeting & Swap

Info: Don Cruse – (908) 542-2848

Tony or Kathleen Flanagan – (908) 462-6638

MISSISSIPPI – Feb. 11

MISSISSIPPI HISTORICAL RADIO & BROADCASTING SOCIETY – MEETING

Meridian, MS – 2412 C Street

3 pm

Info: Randy Guttery, 2412 C. Street
Meridian, MS 39301 – (601) 693-5958

ALABAMA – Feb. 10

SOUTHERN VINTAGE WIRELESS ASSN. SWAP MEET

Decatur, AL – 9th St. Methodist Church

7 am-1 pm – Rain or Shine

Info: Jim Makar – (205) 233-8357

GEORGIA – Feb. 12

SOUTHEASTERN ANTIQUE RADIO SOCIETY MEETING

Norcross, GA – Picadilly Cafeteria
3400 Holcomb Bridge Road

6 pm – Mini-Meet

6:30 pm – Meeting

Info: Charles Milton – (770) 922-6507, or
SARS, PO Box 500025 – Atlanta, GA 31150

OKLAHOMA – Feb. 10

OKLA. VINTAGE RADIO COLLECTORS MEETING

Oklahoma City, OK – Spencer's Barbeque
63rd and North May Avenue

6 pm – Dinner

7 pm – Program

Info: Mike Lapuzza – (405) 745-3394, after 6 pm
OKVRC, PO Box 332, Wheatland, OK 73097

ILLINOIS – Feb. 12

BELLEVILLE AREA ANTIQUE RADIO CLUB MEETING

Belleville, IL – Belleville Area College

7 pm

Info: Karl Stegman, 4 Cresthaven Drive
Belleville, IL 62221 – (618) 234-7992

OREGON – Feb. 10

NORTHWEST VINTAGE RADIO SOCIETY MEETING

Portland, OR – NW Vintage Radio Museum
7675 SW Capitol Highway

10 am – Meeting

Info: Ed Charman, PO Box 82379

Portland, OR 97282-0379 – (503) 654-7387

CALIFORNIA – Feb. 13

CALIF. HISTORICAL RADIO SOCIETY NORTH VALLEY CHAPTER MEETING

Redding, CA – 7 pm

Info: Chris Galantine, 15853 Ontario Place
Redding, CA 96001-9785 – (916) 244-2337

TENNESSEE – Feb. 10

MUSIC CITY VINTAGE RADIO & PHONO. SOCIETY – SOCIETY WORK DAY

Nashville, TN – Ryman Auditorium
116 5th Avenue, North

7 am – Changing out the radios & related
items

Info: Larry Chambers – (615) 833-2448, or
Marty Evans – (615) 459-0158

MISSOURI – Feb. 13

ANTIQUÉ RADIO COLLECTORS & HISTORIANS OF GREATER ST. LOUIS – MEETING

St. Louis, MO – Kirkwood Community Center
111 S. Geyer Rd., Room 201-A

7 pm

Info: Scott Teichmann – (314) 256-6263

MINNESOTA – Feb. 11

NORTHLAND ANTIQUE RADIO CLUB RADIO WORKSHOP

St. Louis Park, MN – Pavek Museum
1 pm

Info: Steve Raymer – (612) 571-2084

OHIO – Feb. 13

ANTIQUÉ RADIO COLLECTORS OF OHIO MEETING

Kettering, OH – National City Bank Basement
4100 Far Hills Ave., at Stroop Rd.

7:30 pm – Left-handed Radios and
Radios with Unusual Tuners

Info: Steve Geary – (513) 492-0972
ARCO, PO Box 292292
Kettering, OH 45429

MARK YOUR CALENDAR

Jan. 29-Mar. 23 - NJ, Mays Landing - Display*
Feb. 1 - AR, Fort Smith - ARCCFS Meeting §*
Feb. 3 - CA, Redwood - CHRS Swap Meet*
Feb. 3 - FL, Orlando - FAWG Winter Meet*
Feb. 3 - MI, Grand Rapids - MARC Meet*
Feb. 3 - NY, Ronkonkoma - GNYVVA Meet §*
Feb. 3 - WA, Seattle - REPS Meeting §*
Feb. 4 - OH, Brunswick - BARPC Meeting §*
Feb. 4 - WA, Poulsbo - VALVE Meeting §*
Feb. 7 - VA, TBA - TARA Meeting §*
Feb. 8 - AR, Little Rock - AARC Meeting §*
Feb. 9 - NJ, Freehold - NJARC Meeting §*
Feb. 10 - AL, Decatur - SVWA Swap Meet*
Feb. 10 - OK, Okla. City - OKVRC Meeting §*
Feb. 10 - OR, Portland - NWRRS Meeting §*
Feb. 10 - TN, Nashville - MCVRPS Work Day*
Feb. 11 - MN, St. Louis Park - NARC Workshop*
Feb. 11 - MS, Meridian - MHR&BS Meeting §*
Feb. 12 - GA, Norcross - SARS Meeting §*
Feb. 12 - IL, Belleville - BAARC Meeting §*
Feb. 13 - CA, Redding - CHRS-NVC Meeting*
Feb. 13 - MO, St. Louis - ARCH Meeting §*
Feb. 13 - OH, Kettering - ARCO Meeting §*
Feb. 13 - PA, Souderton - DVHRC Meeting §*
Feb. 14 - Ontario, Ottawa - OVRC Meeting*
Feb. 15 - NY, Goshen - HARPS Meeting §*
Feb. 17 - AZ, Phoenix - AARC Radio Roundup
Feb. 17 - CA, Van Nuys - SCARS Auction*
Feb. 17 - IN, Indianapolis - IHRS Meeting*
Feb. 17 - OH, Medina - Estes Radio Auction*
Feb. 17 - TX, Irving - VRPS Meeting*
Feb. 18 - NM, Albuquerque - NMRCC Meeting §*
Feb. 18 - WA, Seattle - PSARA Meeting §*
Feb. 20 - CA, N. Highlands - SHRS Meeting §*
Feb. 21 - OH, Cincinnati - SPARK Meeting §*
Feb. 21 - OH, Columbus - SPARK Meeting §*
Feb. 24 - MD, Burtonsville - MAARC Meeting §*
Feb. 25 - MA, Westford - GBARC Radio XXVII*
Feb. 26 - AL, Birmingham - ALHRS Meeting §*
Feb. 27 - OH, Kettering - SPARK Meeting §*
Feb. 28-Mar. 2 - TN, Nashville - MCVRPS*
Mar. 3 - NY, Lake Ronkonkoma - GNYVVA §*
Mar. 9 - AZ, Scottsdale - AARC Swap Meet
Mar. 10 - CO, Denver - CRC Meeting*
Mar. 16 - FL, Bradenton - Fla. AWA Meet*
Mar. 16 - NJ, Hightstown - NJARC Spring Meet*
Mar. 17 - CT, Plainville - CVRC Show & Sale*
Mar. 22-23 - NC, Charlotte - AWA Meet*
Mar. 23 - TX, Irving - VRPS Spring Auction
Mar. 30 - CA, Benecia - CHRS Meet
Mar. 30 - Ontario, London - LVRC Meeting
Mar. 30 - PA, Washington - Spring Fever 4*
Apr. 13 - IA, Marshalltown - Radio Auction*
Apr. 13 - KY, Henderson - MSARC Swap Meet
Apr. 20 - NH, Nashua - NEARC Swap Meet
Apr. 28 - MI, Clare - MARC Spring Meet
May 3-5 - TX, Houston - HVRA Convention
May 17-18 - MN, Bloomington - Radio Daze '96
May 17-19 - OH, Dayton - 1996 Hamvention
May 18 - TX, Irving - VRPS Swap Meet
May 25 - Ontario, London - LVRC Meeting
Jun. 27-29 - WA, Seattle - REPS Showcase IV
Jun. 29 - Ontario, London - LVRC Meeting
Jul. 12-14 - MI, Lansing - Extravaganza '96
Jul. 20 - NH, Nashua - NEARC Swap Meet
Aug. 10 - NY, Amherst - NFWA Summer Meet
Aug. 17 - TX, Irving - VRPS Swap Meet
Aug. 28-31 - IL, Elgin - ARCI Radiofest 1996
Sep. 4-7 - NY, Rochester - AWA Conference
Oct. 5 - KY, Lexington - MSARC Swap Meet
Oct. 26 - NH, Nashua - NEARC Swap Meet
Nov. 18-19 - CA, Los Angeles - SCARS Meet

* See expanded listing this month. § Monthly Meeting
† Date changed from original announcement

PENNSYLVANIA - Feb. 13

DELAWARE VALLEY HISTORIC RADIO CLUB MEETING - SWAP MEET - AUCTION

Souderton, PA - 113 Main St.,
N. Penn Amusements Bldg.

7:30 pm

Info: DVHRC, PO Box 41031, Philadelphia,
PA 19127-0031 - Mike Koste - (215) 646-6488

ONTARIO - Feb. 14

OTTAWA VINTAGE RADIO CLUB MEETING

Ottawa, Ontario - Ottawa Citizen
Conference Room, 1101 Baxter Road

7 pm

Info: Tom Devey, 810 Edgeworth Avenue
Ottawa, Ontario K2B 5L5 - (613) 828-5152

NEW YORK - Feb. 15

HUDSON VALLEY ANTIQUE RADIO AND PHONO. SOCIETY/AWA - MEETING

Goshen, NY - Cataract Firehouse, Main St.

7-9 pm

Info: John & Linda Gramm, Box 1, Campbell
Hall, NY 10916 - (914) 427-2602, 6-9 pm

CALIFORNIA - Feb. 17

SOUTHERN CALIF. ANTIQUE RADIO SOCIETY - ANNUAL AUCTION

Van Nuys, CA - St. Andrews Lutheran
Church, 15520 Sherman Way

7 am - Check-in; 9 am - Auction starts

Info: Kosh - (213) 465-9919

Richard Gray - (619) 390-9128

INDIANA - Feb. 17

INDIANA HISTORICAL RADIO SOCIETY WINTER MEETING

Indianapolis, IN - Holiday Inn Southeast
5120 Victory Lane - (317) 783-7751

7 am-2 pm

Info: Dr. Mike Clark - (317) 738-4649

Alex Whitaker - (317) 535-4174

OHIO - Feb. 17

ESTES RADIO AUCTION

Medina, OH - Seville Antique Auction Barn
8240 Wooster Pike Road

9 am - Preview

10 am EST - Auction

Info: Estes Auctions, 7404 Ryan Road
Medina, OH 44256 - (216) 769-4992

TEXAS - Feb. 17

VINTAGE RADIO & PHONO. SOCIETY MEETING

Irving, TX - Senter East Building
1-5 pm

Info: George Potter - (214) 315-2553

NEW MEXICO - Feb. 18

NEW MEXICO RADIO COLLECTORS CLUB MEETING

Albuquerque, NM - Sierra Vista Bible Church, 7509 Paseo Del Norte
1:30 pm - Philco Radios

Info: Bill Schultz, 11605 Versailles Ave. NE Albuquerque, NM 87111 - (505) 294-5302

WASHINGTON - Feb. 18

PUGET SOUND ANTIQUE RADIO ASSN. MEETING

N. Seattle, WA - Shoreline Museum
749 No. 175th St. & Linden Ave.

9 am - Swap Meet
12 noon - Meeting

Info: Al Atworth, PO Box 125 Snohomish, WA 98291-0125 - (360) 568-2698

CALIFORNIA - Feb. 20

SACRAMENTO HISTORICAL RADIO SOCIETY - MEETING

N. Highlands, CA - SMUD Foothill Service Center, Room D, 5026 Don Julio, 1 mi. W. of I-80
7-9 pm

Info: SHRS, PO Box 162612, Sacramento CA 95816, or Don Steger - (916) 929-8274

OHIO - Feb. 21

SOCIETY FOR PRES. OF ANTIQUE RADIO KNOWLEDGE/CINCINNATI CPT. - MEETING

Cincinnati, OH - Richards Radio & TV
4041 Edwards Rd., I-71, Exit 6
7:30 pm

Info: Tim Kaiser, PO Box 81 Newport, KY 41071 - (606) 441-2548

OHIO - Feb. 21

SOCIETY FOR PRES. OF ANTIQUE RADIO KNOWLEDGE/COLUMBUS CPT. - MEETING

Columbus, OH - DeVry Institute of Tech.
1350 Alum Creek Road, I-70 Exit 103B
7:30 pm

Info: Sharon/Ken Fullerton - (614) 237-2621

MARYLAND - Feb. 24

MID-ATLANTIC ANTIQUE RADIO CLUB MEETING

Burtonsville, MD - New Hope Seventh Day Adventist Church gym
6:30 pm

Info: Sam Cannan, 1010 Siske Road Stony Creek, MD 21226 - (410) 255-7728

MASSACHUSETTS - Feb. 25

GREATER BOSTON ANTIQUE RADIO COLLECTORS - RADIO XXVII

Westford, MA - Westford Regency Inn I-495, Exit 32; West on Rt. 110 for .4 mi Same giant (6500 sq. ft.) and warm location!
8 am-1 pm

Coffee, Donuts, Sandwiches, etc. available
For hotel reservations: (800) 543-7801; (in Mass. 800-543-7802) - Mention Radio XXVII

Seller Preregistration & Info:

Lisa Friedrichs, c/o A.R.C., PO Box 2, Carlisle, MA 01741 - (508) 371-0512

ALABAMA - Feb. 26

ALABAMA HISTORICAL RADIO SOCIETY MEETING

Birmingham, AL - Homewood Public Library
1721 Oxmoor Road - 7 pm

Info: Earl Ridolphi, 2413 Old Briar Trail Birmingham, AL 35226 - (205) 823-3314

OHIO - Feb. 27

SOCIETY FOR PRESERVATION OF ANTIQUE RADIO KNOWLEDGE - MEETING

Kettering, OH - Cassano's Pizza
1680 E. Stroop Rd.

7:30 pm

Info: Harold Parshall - (513) 865-5900, days (513) 268-2909, eves. until 9 pm

TENN. - Feb. 28-Mar. 2

MUSIC CITY VINTAGE RADIO & PHONO. SOCIETY - SPRING EXTRAVAGANZA

Nashville, TN - Opryland Hotel
Feb. 28-Mar. 1: Antique Radio & Phonograph Display

Mar. 1: 2 pm - Judging of Old Equipment Display

7 pm - Awards Ceremony

Mar. 2: 7 am - Flea Market & Swap Meet at McGavock High School, Two Rivers Parkway near Opryland

Info: Larry Chambers - (615) 833-2448, or Marty Evans - (615) 459-0158

NEW YORK – Mar. 3

GREATER NEW YORK VINTAGE WIRELESS ASSN. — SWAP MEET

Lake Ronkonkoma, NY – 367 Hawkins Ave.
N. of L.I. Expressway, lg. white house
9-12 am

Info: Chris Lieppert – (516) 471-9526, or
Chris Bacon – (516) 821-7618

COLORADO – Mar. 10

COLORADO RADIO COLLECTORS MEETING

Denver, CO – SouthWest Bank Bldg.
1380 So. Federal Ave., Community Room
1 pm – Meeting,

followed by Swap Meet in parking area
Info: Rick Ammon – (970) 221-4001

FLORIDA – Mar. 16

ANTIQUE WIRELESS ASSOCIATION FLORIDA SPRING RADIO MEET

Bradenton, FL – Stewart Elementary School
7095 15th Ave. NW
8 am

Info: Norm Smith, 7203 17th Ave. NW
Bradenton, FL 34209 – (941) 792-0003, after 6 pm

NEW JERSEY – Mar. 16

NEW JERSEY ANTIQUE RADIO CLUB SPRING MEET

Hightstown, NJ – Hightstown Country Club
Exit 8 from NJ Turnpike, just off Route 33
7 am-1 pm

Info: Marv Beeferman, 2265 Emerald Park
Dr., Forked River, NJ 08731 – (609) 693-9430

CONNECTICUT – Mar. 17

CONNECTICUT VINTAGE RADIO CLUB RADIO SHOW AND SALE

Plainville, CT – VFW Hall
Northwest Drive and Route 10
8 am-1 pm

Info: Ray Lamont, 70 Litchfield Road
Unionville, CT 06085 – (203) 675-6327

Although non-members are welcome at all
events, joining may be required at some.
Admission is charged at some events.

Attend a club event near you, learn,
meet others in the hobby, and perhaps
find an item or two for your collection!

N. CAROLINA – Mar. 22-23

ANTIQUE WIRELESS ASSN./CAROLINA SPRING MEET IN THE CAROLINAS

Charlotte, NC – Sheraton Airport Plaza Hotel
I-85 at Exit 33, Billy Graham Parkway
Reserve by Feb. 28th – (800) 325-3535

Fri.: 8 am – Flea Market, all day

2 pm – Auction Check-in

4-6:30 pm – Barbeque Dinner

7:30 pm – Equipment Auction

Sat.: 8 am – Flea Market, all am

9-12 am – Ladies Trolley Line Tour

10 am – Contest Check-in

1 pm – Contest Viewing

1:30 – Contest Wrap-up w/Robert Lozier

2 pm – Collecting Transistor Radios,
by Marty Bunis

2:45 pm – The Trans-Oceanics Story,
by Harold Cones

3:30 pm – Hints and Kinks

See our full-page ad in this issue.

Info: CC-AWA, PO Box 11358, Charlotte,
NC 28220-1358 – (704) 289-1166

PENNSYLVANIA – Mar. 30

PITTSBURGH ANTIQUE RADIO SOCIETY 4th ANNUAL SPRING FEVER

Washington, PA – County Fairgrounds
I-79 at I-70

7 am – Check-in

1 pm – Auction

Sponsored by: W. Virginia Chapter-AWA,
Mid-Atlantic Antique Radio Club,
Museum of Radio & Technology, Inc.,
Niagara Frontier Wireless Assn., Buckeye
Antique Radio & Phonograph Club

Info: Spring Fever 4, 4204 Thorn Apple Ln.
Charleston, WV 25313

IOWA – Apr. 13

GENE HARRIS ANTIQUE AUCTION CENTER 6th VINTAGE RADIO CONSIGNMENT AUCTION

Marshalltown, IA – Gene Harris Antique
Auction Center, 203 S. 18th Ave.

10 am

Info: Gene Harris – (800) 862-6674

A free* listing on these pages is available for
each coming radio event. Sponsors should
provide description of event, date, time,
place, directions, & information/contact
person. Since listings are on a "space avail-
able" basis, no guarantee of listing is made.

Submission Deadline – 5th of month.

*Club/museum/non-profit events are listed
free; other events are obtained from adver-
tisements placed elsewhere in A.R.C.

BUSINESS CARD ADS - \$45.00 FOR 3 MONTHS



K4GIT

RADIO ELECTRIC SUPPLY

We Specialize In Receiving and Special Purpose Tubes
Send For Price List

Dorothy and Don Gies
Owners

Box 2790 RR#2
Melrose, FL 32666

904-475-1950
Phone or Fax

PUT YOUR BUSINESS CARD HERE!

\$45 FOR 3 MONTHS - \$78 FOR 6 MONTHS
DON'T HAVE ONE? SEND AN EXTRA \$6.50 AND
WE WILL TYPESET ONE FOR YOU.

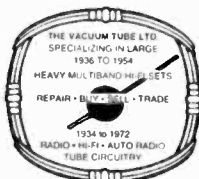

MAGNAVOX STROMBERG-CARLSON MIDWEST HOWARD

Play Things of Past

Sales - Service - Restoration of vintage radios, tv's, jukeboxes and electronics.



Retail Sales Store

3552 W. 105th St.
Cleveland, OH 44111
216-251-3714
Hours: 6-9PM Wed, 12-6PM Sat.
Other times by chance

Mail Address

Gary Schneider
Play Things of Past
9511 Sunrise Blvd., #123
Cleveland, Ohio 44133
216-582-3094

5,000,000 Vacuum Tubes In Stock Industrial & Receiving Types

Electronics Emporium Inc.
107 Trumbull Street
Elizabeth, NJ 07206

Buying & Selling, Call For Prices & Delivery

800 - OLD TUBE
(653 - 8823)

Ph: 908-351-0100

Fax: 908-351-8600

Allan H. Weiner Radio Engineer Antiques of Technology

Electrical, Electronic, Scientific, and
Mechanical Artifacts.
Early WWII Radar a Speciality.

97 High St.
Kennebunk, ME 04043 (207) 985-7547

Buy • Sell • Trade

• GRUNDIG • SABA • TELEFUNKEN • NORDMENDE • PHILIPS • SIEMENS •
- SPECIALIZING IN REPAIR OF EUROPEAN RADIO SETS -

The Bavarian Radio Works

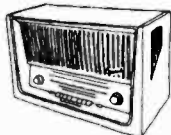

Ross A. Hochstrasser
16171 417-4299

162 Beacon St.
WITMAN, MA 02382

LOGANS TV-RADIO

SINCE 1952

BUY • SELL • TRADE

100's OF N.O.S. PARTS, TUBES IN STOCK.
PARTIAL OR TOTAL RESTORATION AVAILABLE.

412-837-5580

REAR 526 MT. PLEASANT ST., GREENSBURG, PA 15601

WANTED
PRE 1900
ELECTRICITY
MEDICAL • X-RAY
TELEGRAPHY • TELEPHONE
PRE 1925
RADIO • WIRELESS
PRE 1940
TELEVISION



BOOKS • TUBES • ARTIFACTS
MAGAZINES • AUTOGRAPHS
CATALOGS • EPHEMERA

**NEW WIRELESS
PIONEERS**
P.O. BOX 398
ELMA, NY 14059
716-681-3186

WHAT... You have CATALINS?

I'll Pay Top \$'s — Any Models

Please Send a Photo and Price To:
Kunihiko Suzuki
2173 Takao, Fukuroi-Shizuoka, Japan 437
(Fax) 81 538 43 3188

RADIO BOOKS FOR SALE

Large selection of books on Radio and Related Technology
Call or write for our List of Catalogs
Always buying, single items or collections.

RAINY DAY BOOKS

P.O. BOX 775, FITZWILLIAM NH 03447
(603)-585-3448

* * WANTED * *

**Masco, Newcomb PA Systems
Turner, Shure, Astatic Mics
Jensen 8", 10" speakers,
any condition.**

* Gary (203) 777-7426 *

BUSINESS CARD ADS - \$45.00 FOR 3 MONTHS

VINTAGE RADIO SERVICES

Ken Hubbard
KA9WRN

Repair of
Vacuum Tube
Equipment

P.O. Box 792
Beloit, WI 53512-0792
(608) 362-1896
6 pm Evenings

Home-Auto

REPAIRS • BUY • SELL • TRADE

PRE '65 AC SETS & CAR RADIOS

FRED'S OLD RADIO EMPORIUM
1612 WEST 7TH AVENUE
CORNICANA, TEXAS 75110

F.L. GORDON, PROPRIETOR
BUSINESS (903) 874-5185 HOME (903) 874-7147



ESTES AUCTIONS

Specializing in Vintage Radios

7414 Ryan Rd
Medina, Ohio 44256

Bus. Phone 216-769-4992
Fax 216-769-4116
Res. Phone 216-769-3987

RADIOS & STRANGE MISCELLANEA
IF YOU VISIT THE BRIMFIELD FLEA MARKET... STOP BY FIRST!

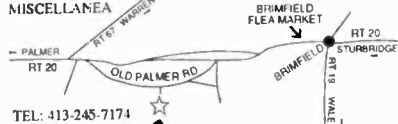

TEL: 413-245-7174

COUNTRY ROAD BARN - BERNIE SAMEK
OLD PALMER ROAD, BRIMFIELD, MASS.

WANTED

SELECTONE

Transformers • Coils • Condensers
Radios

John T. Meredith
2462 Stantonsburg Road,
Suite 152
Greenville, N.C. 27834

(919) 551-1882



The Sights and Sounds of Early 20th Century Broadcasting

Presented at Lakewood's Historical Belmar Village - Denver Area
Sept./95 to March/'96 - Mon-Sat - Info: (303) 987-7860

RADIOS □ TV'S □ VINTAGE STUDIO EQUIPMENT
LISTENING POSTS □ SPECIAL PROGRAMS

Can't make it? Order the museum gallery guide by mail.
Pictures/Descriptions - Historical articles - Newcomer's radio dating

Only \$5 post/hnd included - Send cash, check or money order To:
The Colorado Radio Collection Antiquo Radio Club (CRC)
5270 E. Nassau Circle, Englewood CO 80110

Are You Looking For Antique Radios, Parts, Tubes,
Schematics and Restoration Services?

For Free Flyer, a 2-Stamp LSASE is required to
insure a response to your request. Send to:

Olde Tyme Radio Company
2445 Lyttonsville Road, Suite 317
Silver Spring, MD 20910

Wish to contact us by phone or fax?
Our number is (301) 587-5280.
Please call 10 am to 10 pm (Local Time)

Antique Radios



David & Nancy Snow

P.O. Box 6352
Jackson, MI 49204
(517) 787-2985

We Buy, Sell, Repair
ARBE - III Battery Eliminators

1920-1970
SCHEMATICS + PAGES OF INFO
\$5.00 POSTPAID

MANUAL PRICES - SASE
RADIO/TV/HAM/MISC.

"IF I DON'T HAVE IT, YOU
PROBABLY DON'T NEED IT."

ALTON H. BOWMAN - 4172 EAST AVENUE
CANANDAIGUA, NY 14424-9564

ANTIQUO RADIO REPAIR

Repair - Restore - Buy & Sell

Schematic Service
Radios \$2.⁰⁰, TVs \$4.⁰⁰

DAMASKE ELECTRONICS

S74-W16834 Janesville Road
Muskego, WI 53150
Phone: (414) 679-0838



New/Old Stock Parts
Reproduction Items
Books & Refinishing Supplies

\$2.00 for 20 page catalog.
Refundable with first order.

Vintage Tv & Radio

3498 West 105 St. Cleveland, OH 44111
216-671-6712

Radio & TV Tubes

— New Old Stock —

Call/write for price list & availability

db ELECTRONICS - 105 Rt. 47 South
Cape May Court House, NJ 08210
609-465-5005

BUSINESS CARD ADS - \$45.00 FOR 3 MONTHS

784-9417



COSMOS

TV

- Low Prices
- TV Repair

• Buy, Sell, Trade

Free Estimates
784-9417

784-9417



- Quality Used TVs
- Antique Radio Repair

5919 15th Ave. N.W.
Seattle, WA 98107

WANTED: Tube Hi-Fi Components & Commercial Amplifiers of the 1950's & 1960's

**Marantz, McIntosh, Scott, Fisher, Brook
Acrosound, Brociner, Western Electric
Fairchild, Altec, Tannoy, JBL**

Richard Sharisky (617) 484-5784, phone
P.O. Box 521 (617) 489-6592, fax
Belmont, MA 02178

Free Estimates
Hrs. - 10 AM - 7 PM EST.
Tues. - Sat.

Tel./Fax (860) 928-2628
E-Mail: oradiodoc@aol.com

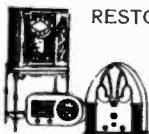

BOB ESLINGER

ANTIQUE RADIO RESTORATION & REPAIR

1920 - 1960's

Reasonable Rates, Tubes, Professional
Overhauls, Cabinet Refinishing Service
For All Antique Car, Table & Console
Radios, Communication Receivers &
Tube Amplifiers.

Buy & Sell

20 Gary School Road
Pomfret Center, CT 06259



VINTAGE HI-FI EQUIPMENT & NEW OLD STOCK TUBES WANTED

We also buy Used, New, & Vintage
Speakers, amps, parts, guitars, and pedals
Any condition - working or not
Top prices and shipping paid

GUITAR OASIS

7451 Warner Avenue, Suite 1 - Huntington Beach, CA 92647
Phone (714) 842-7402 - Fax: (714) 842-7462
MON-FRI 9:30-7:00 PST • SAT 12:00-6:00 PST

ANTIQUE RADIO RESTORATION

Since 1936 Repair - Buy - Sell
Complete Restorations • Prompt Service

COOPER'S RADIO SERVICE

425 Court Street
Rockwell City, Iowa 50579



LARRY COOPER
712-297-7232



"The Honor of Mr. Happy Amp"

PR NOVELTY

Glass Audio Specialists
Amplifier Rebuilding • Service
Sartorius Parts Brokerage
(New Old Stock and Used)

Paul Innebrinkski Audio Technician 190 Box 140 • Milwaukee • WI 53201
Robin Richards General Manager 414-964-3392

Old Time Replications

"TURN TO US WHEN YOU NEED KNOBS"
KNOBS • PUSHBUTTONS • ESCUTCHEONS
PLASTIC GRILLS • HANDLES

LARRY BORDONARO

5744 TOBIAS AVE. VAN NUYS, CA 91411
PHONE (818) 786-2500 • FAX (818) 909-0241

WANTED ! JAPANESE MILITARY RADIOS

any kind of WW-2 radios & aircraft instruments

Takashi Doi



FAX : 011-8145-301-8069
1-21-4, Minamidai, Seyaku, Yokohama, Japan



HARD TO FIND BATTERIES

that really run your antique radios!!
1 1/2 to 135 volts of various sizes &
shapes! Also available: new & used panel
meters; VTVM & multimeters; JAN
16mm projectors, UHER reel-to-reel
recorders and more! Wanted: Meters &
reel-to-reel recorders.

S&G ELECTRONICS 618 S 62nd St, Phila, PA 19143
Phone 215-474-7663 - Fax# 215-726-9761

BETA-TEK ANTIQUE RADIO SERVICE

- Repair of Radios, Communications
Receivers & Test Equipment
- Power Supplies for Battery Sets



RAY BINTLIFF
2 Powder Horn Lane
Acton, MA 01720
508 263-7435



THE RADIO MAN

Buy-Sell-Trade
Antique Radios • Tubes • Parts

DICK MORGAN
RES: (214) 564-6464

TEL: (214) 276-5458
FAX: (214) 272-1831
P.O. BOX 461485
GARLAND, TX 75046-1485

20 Years Experience Telephone/Fax
1-615-456-2529

Specializing in Antique Speaker Repair

- Very large stock of
- Can repair
- Fast turn-around
- Reasonable prices

SHOP CLOSED JAN → FEB

Work
Guaranteed

Hank Brazzel
103 N. Lake Point Ct.
Crossville, TN 38555

BUSINESS CARD ADS - \$45.00 FOR 3 MONTHS

Carbon Resistors • Capacitors • Vacuum Tubes

ALLTRONICS

Electronic Component Supply

2300 Zanker Road • San Jose, CA 95131
Voice (408) 943-9773 • Fax (408) 943-9776
BBS (408) 943-0622 • 24 Hrs. • N-8-1

Call or Fax for Catalog

50 years

CHUCKS

of service!

Any Tube Radio Repaired and
Guaranteed to work good.
\$25 plus parts & UPS

CHUCKS

167 LYNN DRIVE - PO Box 598
NEW HAVEN, WV 25265 - Ph (304) 882-2220

78 RPM Cartridges Repaired



Dead cartridges rebuilt right. New crystals etc., as needed. Allow 3-4 weeks. Most crystal and "horseshoe" magnet types \$34.50
100 hr. sapphire setscrew needles (list \$2.50 ea.) ... 4/\$5.50



Joe Smolksi
835-A Pleasant Street
Framingham, MA 01701

Inquiries: (508) 879-2778,
evenings and weekends.
Prices include return
postage. Please include
payment with order.

PHILCO PREDICTAS WANTED:



BUY • SELL • TRADE • RENT • RESTORE

DAVID WEDDINGTON
(615) 890-7498

2702 Albany Ct.
Murfreesboro, TN 37129

ELECTRON TUBE ENTERPRISES

BOX 8311 11 LINDEN LN
ESSEX, VT. 05451

BUY

TEL: 802-879-1844

SELL

FAX: 802-879-7764

INTERNET: ETETUBES@AOL.COM

WRITE FOR FREE 1996 CATALOG

(Lowest prices for new & used tubes)

INSTRUMENTS

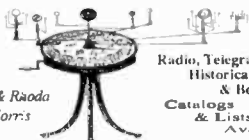

Jim & Raoda
Morris

Radio, Telegraph,
Historical Instruments,
& Books For Sale
Catalogs
& Lists
Available

Antiques of Science & Technology
A of ST Box 1852 Wakefield MA 01880 U.S.A.
Tel 617 245 2897 Fax 617 245 3572

COMMNAV EQUIP
RADIO SETS
NAVAL AIR FIELD
U.S FOREIGN

CHARLES DICICCA KATIGON
301 MYSTIC VALLEY PKWY
MEDFORD, MASS 02155
PHONE: 617-396-9354



MILITARY ELECTRONICS

BUY

WANTED

TRADE

"The Early Sound Man"

Mr. John P. Andolina, Jr.

Antique Phonographs



26 Glen Oaks Dr.
Rochester, NY 14624
(716) 247-3056
Reasonable prices

Collect • Repair • Restore
Edison, Victor, Columbia
Cylinder • Disc Records
Phonograph Advertising
Quality Repairs Since 1973



AWA
Member

REPRODUCERS result



THE FINISHING TOUCH



Todd E. Hinzman Restorations
SHOW WINNING FINISHES

— AUTO INTERIOR WOOD —
• RADIOS • MECHANICAL
• 78 RPM JUKEBOXES • ELECTRONICS



203-274-0705

203-268-6060



182 JUDD FARM ROAD
WATERTOWN, CONN. 06795



All Tube Equipment Repaired



"The Fisher Doctor"

Al Pugliese
718-948-7489

27 Daleham Street
Staten Island N.Y. 10308

VINTAGE FISHER PRODUCTS
Bought • Sold • Traded • Repaired

SUNSHINE SOUNDS

WANTED:



Hi Fi TUBE & COMMERCIAL AMPS

SPEAKERS & HORNS

McIntosh, Marantz, Dynaco, Heath,
Altec, Scott, RCA, Fisher, Craftsman,
Grommes, Fender, Ampex, W.E. Vox,
Brook, Acro, Pultec, Fairchild

Altec, Jensen, RCA,
E.V., Western Electric,
JBL Tannoy

Phone: 405-737-3312 or Fax: 405-737-3355
Sonny - 1413 Magnolia Ln., Midwest City, OK 73110

Looking for early, portable electronic calculators (1970-78)

(Any that have LED or other "lighted" displays)

• Will Trade Transistor Radios (or buy outright) •
Especially: Basicom, Berkeley/Keystone, Calfax, Columbia,
Commodore, Decimo, Educalc, Garrett, Ian Jones, JCE,
Kingspoint, M.I.T.S., Monroe/Litton, Olympia, Royal,
Sanyo, Sinclair, Sperry Remington, Summit, Victor.

Guy "Mr. Calculator" Ball Fax-(714) 730-6140
14551 Livingston St., Tustin, CA 92680

BUSINESS CARD ADS - \$45.00 FOR 3 MONTHS

SPY EQUIPMENT WANTED!

- Code Machines
- Secret Radios
- Clandestine Weapons
- Secret Cameras
- OSS, SOE, CIA, KGB!
- Buy or Trade!

Keith Mellon
P.O. Box 5755 Bossier City, LA 71171
(318) 747-9616 Days. FAX (318) 747-9010



If you buy, sell or like jukeboxes you need ALWAYS JUKIN...THE MONTHLY JUKEBOX MAGAZINE! Subscribers in 25 countries, ALWAYS JUKIN! LEADS THE WAY. Articles, photos, show reports, ads, new products, price guides, restoration tips, repairs--everything you need to know about JUKEBOXES--the fastest appreciating collectible in the world!!! Fun & a great investment. Sample copy, \$3. \$33 per year. ALWAYS JUKIN, 221 YESLER WAY AR, SEATTLE, WA. 98104. (206) 233-9460. Master/Visa ok.



HAROLD C. BRAMSTEDT
C & N ELECTRONICS
6104 Egg Lake Road North
Hugo, MN 55038

- Buy
- Sell
- Transmitting & Industrial Tubes

612-429-9397
800-421-9397
Fax 612-429-0292



SPEAKER PLACE NEW-FOAM

3047 West Henrietta Road • Rochester, New York 14623

Phone Toll Free	Fax Toll Free	Voice Mail Toll Free
1-800-NEW-FOAM	1-800-2FX-FOAM	1-800-FOAM-MAIL
1-800-639-3626	1-800-239-3626	1-800-362-6692

Mon. Tues. & Thur. 10:30-6:00 Wooders, Mid Ranges, Tweeters
Wed. & Fri. 10:30-8:30 Crossovers, Grille Cloth, Horns
Sat. 10:30-5:00 Voice Coils, Books & Accessories

VISA MC Speaker Repair & Replacement Parts
Nationwide Service Since 1979 AMEX DISC

WE RE-FOAM AND RE-CONE SPEAKERS



30 years experience
Jackson Speaker Service
Expert Antique Loudspeaker Repairs
(Cone Types) And Rebuilding A Speciality.
Speaker Parts And Repair Service On
Virtually Any Speaker Made Including
Stereo, P.A., And Antique Auto Speakers.
217 Crestbrook Dr. Owner
Jackson Mich 49203 Ron McGee
Ph. - (517) 789-6400, Ans. 4th ring
Wk - days 10: am - 7pm Wk - Ends 9-5pm



Get your ZENITH Transoceanics working again... on batteries! It only takes 6, maybe 7 "D" cells. You need the PORTA-POWER, CVA-9 converter. It works on others sets too.

You can get everything you need directly from me at the new low price of \$84.50 plus \$4 shipping. Over 200 sold! Peter Yanczer
TESLA ELECTRONICS (314) 822-1748
836 BRICKEN, ST. LOUIS, MO 63122

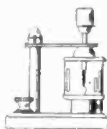

CRYSTAL SETS

PARTS - PLANS - KITS - BOOKS
CATALOG \$1.00

Largest source of Vintage and New Variable Air Condensers, Variometers, Vario-Couplers, Tap Switches, Tap Points, Galena and Germanium Detectors, Detector Stands, Cat Whiskers, Terminals, Sliders, Headsets, Dial Knobs, Coil Forms, Magnetic Wire, etc.

MIDCO
P.O. Box 2288
Hollywood, FL 33022
(305) 925-3670
B.A. Turke, Ph.D.E.F.



Fender Martin Gibson
We Buy, Sell, and Trade
"PLAY IT AGAIN"
Vintage Guitars, Amps,
Stereo Equip, Amico Speakers, & Antique Radios
Tube Equipment Our Specialty
1-203-331-9155
Mointosh *PETER DeGREGORIO* Marantz
85 Burroughs Rd, Fairfield, Conn.
06430-3504

(510) 490-5842

Fax (510) 490-1961

Speakerworld®

Expert Speaker Reframing and Reconing

2000 Warm Springs Ct. #6 Visal *Free Return
Fremont, CA 94539 MC Freight By UPS

*For Antique Speakers Only

Vintage Radio

- ◆ Repairs
 - ◆ Restorations
 - ◆ Specializing in all tube type car and home radios
 - ◆ FM additions
- Bob's Radio & TV**
2300 Broad St
San Luis Obispo
California 93401
(805) 543-2946

Full warranty on work performed, walk-ins welcome, stop by and see our antique radio museum

CAPACITORS - TUBES RADIO SERVICE ITEMS

Thousands in jam-packed illustrated 24-page catalog No. 49

Send \$3 U.S./Canada \$5 overseas (U.S. funds) for a Heavy-Paper limited edition copy NOW!

DON DIERS 4276 North 50 St. Dept. AB8
Milwaukee, WI 53216-1313

INFORMATIVE
INTERESTING
FUN-TO-READ

Phono Needles/Style
1500 Types
Magnetic - Ceramic -
Crystal Cartridges



Rebuild Astatic
and All Types
of Crystal Car-
amic Cartridges



Rebuild Obsolete Idlers
New Idlers and Belts
Fabricate 78 RPM Needles

West-Tech Services

648 N. Ridgewood Dr. #11
P.O. Box 1415
Sebring, FL 33871

STEVE KARPIAK C.E.T.
Phone (941) 471-0922

Radio Manufacturers of the 1920's

BY ALAN DOUGLAS



"The definitive book on American broadcast receivers of the 1920s"

Volume 1: A-C Dayton - Adams Morgan - Air-Way - All-American Mohawk - American Bosch - Amrad - Amrad S-Tube - Apex - Atwater Kent - Bremer Tully - Browning-Drake - Clapp-Eastham - Crosley - Cutting & Washington - Day-Fan - DeForest - Eagle - ERLA - FADA - Federal - Ferguson. 225 Pages.

Volume 1: \$24.95 (softcover only)

Volume 2: Freed-Eisemann - Eisemann - Freshman - Garod - Gilfillan - Grebe - Howard - Jones (Lester/Melco) - Jones (Jos.) - Kellogg - Kennedy - King - Kodel - Kolster - Leutz - Magnavox - Majestic - Marti - Metro - Klitzen/Michigan - Midwest - Mu-Rad - Murdock - Music Master - Neutrowound - Operadio - Ozarka - Pfanstiehl - Philco - Pilot - Priess. 266 Pages.

Volume 2: \$29.95 (softcover only)

Volume 3: RCA - Scott - Silver-Marshall - Slagle - Sleeper - Sonora - Sparton - Splittorf - Steinite - Stewart-Warner - Stromberg-Carlson - Thermiodyne - R.E. Thompson - Thorola - Tri-City - C. D. Tuska - Ware - Western Coil - Western Electric - Workrite - Zenith. 292 Pages.

Volume 3: \$29.95 (hardcover: \$39.95)

U.S. Orders - Enclose \$3.00 per order for packing & book-rate shipping if total order is under \$35.00. If using VISA or MasterCard, include name on card, card number and expiration date. Send payment with order. Mass. residents please add 5% sales tax. Money back return policy. Most orders shipped the same day received, but allow 2-4 weeks to receive order. Foreign orders - write for shipping costs, or use credit card and specify air or surface (allow 2-3 months for surface shipping).



Send Order To: A.R.C., P.O. Box 2, Carlisle, MA 01741
or Call: (508) 371-0512

Fax: (508) 371-7129



Radios

of the Baby Boom Era

Six Volumes — 2000 pages — From Sams' Archives
 1946 to 1960 — 274 Brands — 3494 Illustrations (B&W)
 6769 Models — Catalin, Bakelite, Wood, Transistor Radios & More

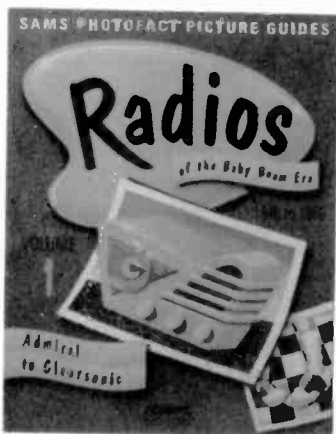

All Volumes Available!

Vol.	Brands	Included
1	56	Admiral to Clearsonic
2	54	Co-op to Geloso
3	58	GE to Monitoradio
4	36	Motorola to RCA Victor
5	35	Realtone to Stratovox
6	35	Stromberg-Carlson to Zenith

1/2 Page for each illustrated radio including:

- Large illustration of the radio including knob functions
- Short description of the radio
- Number of tubes
- Power supply type (AC, Battery, etc.)
- Tuning range
- Manufacturer
- Sams Photofact Set number & year Photofact published.

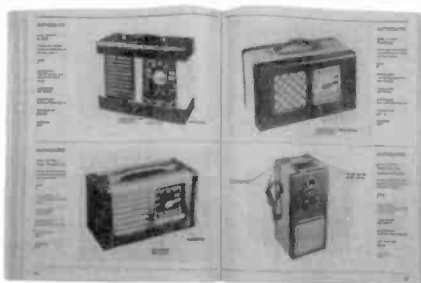

ALSO

- Index by model number listing tubes in radio
- List of similar radio models indexed to pictured radio
- List of manufacturers and suppliers indicating their brand names
- Basic trouble-shooting hints

Each Volume: \$16.95 – Softcover
 8 1/2" x 11" – Approx. 328 pages

U.S. Orders - Enclose \$3.00 per order for packing & book-rate shipping if total order is under \$35.00. If using VISA or MasterCard, include name on card, card number and expiration date. Send payment with order. Mass. residents please add 5% sales tax. Money back return policy. Most orders shipped the same day received, but allow 2-4 weeks to receive order. Foreign orders - write for shipping costs, or use credit card and specify air or surface (allow 2-3 months for surface shipping).



Send Order To: A.R.C., P.O. Box 2, Carlisle, MA 01741
 or Call: (508) 371-0512 Fax: (508) 371-7129



(Jan-96)

Transistor Radio Books



The Collector's Guide to Transistor Radios by Marty & Sue Bunis. *This book will help you identify the most sought-after vintage transistor radios. Over 2,200 models, all with current prices. Over 400 color photos. 5 1/2" x 8 1/2". 256 pgs.*

\$15.95 - Softcover

Made In Japan by Roger Handy. *A stunning book on the development and growth of the transistor radio featuring over 175 transistor radios in full color. 10" x 9 3/4". 108 pgs.*

\$16.95 - Softcover

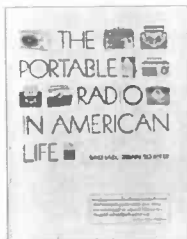

The Portable Radio in American Life by Michael Schiffer. *Approximately 50 pages on transistor radios, beginning with the Regency TR-1 through to the later sets made overseas. 450 photographs, 193 transistor radios pictured. 8 1/2" x 11". 259 pgs.*

\$24.95 - Softcover
\$45.00 - Hardcover

Collector's Guide to Novelty Radios by Marty Bunis & Robert Breed. *This book is the source for novelty transistor radios in all shapes and sizes. Radios are described in detail with current prices. Over 600 all new color photographs. 8 1/2" x 11". 224 pgs.*

\$18.95 - Softcover



Transistor Radios, A Collector's Encyclopedia and Price Guide by David Lane & Robert Lane. *Identification & price guide to over 2,500 transistor and novelty radios. History & key to collecting chapters. 8 1/2" x 11". 170 pgs.*

\$19.95 - Softcover

U.S. Orders - Enclose \$3.00 per order for packing & book-rate shipping if total order is under \$35.00. If using VISA or MasterCard, include name on card, card number and expiration date. Send payment with order. Mass. residents please add 5% sales tax. Money back return policy. Most orders shipped the same day received, but allow 2-4 weeks to receive order. Foreign orders - write for shipping costs, or use credit card and specify air or surface (allow 2-3 months for surface shipping).



Send Order To: A.R.C., P.O. Box 2, Carlisle, MA 01741
or Call: (508) 371-0512 Fax: (508) 371-7129



(Jan-96)

COLLECTOR BOOKS AVAILABLE FROM A.R.C.

- BOOKS MARKED WITH "NEW" ARE THE MOST POPULAR AND ARE ESPECIALLY RECOMMENDED FOR NEW COLLECTORS!**
- Antique Radio Restoration Guide, 2nd Ed.**, Johnson. *Beginner's introduction to troubleshooting and repairing AC table model radios.* 1992. 145 pgs. \$14.95
- The AWA Review.** Collections of articles. Vol. 6: Hawaiian Wireless, U.K. TV, SCR-RC-BC Dir., NYC Wireless, etc. Vol. 7: Poldin xmitters, Navy Equipment, Arc xmitters, etc. Vol. 8: Keys, Federal Co., KFS-Federal-Mackay Story, Nat'l Electrical Supply Co., Navy Electronics Dir., etc. Vol. 6-8, ea. \$10.00
- The Antique Radio Boys and the Garrulous Grebe, Dryer.** *Thrilling adventure story written in the traditions of the '20s and '30s.* 5 1/2" by 8 1/2". 51 pgs. \$4.95
- The Auto Radio: A Romantic Genealogy, Matteson.** *Info. photos & ads from the early days of the auto radio through the 1950s.* 316 pgs. (hardcover) \$34.95
- Behind the Front Panel, Rutland.** *Reviews radio circuits and radio history.* Easy descriptions. 25 pics. 158 pgs. \$18.95
- Blast from the Past, A Pictorial History of Radio's First 75 Years, Rhoades.** *The performers, programs, & technology that made radio a part of everyday life.* 100s of never-before-published photos. (hardcover) NEW \$39.95
- Broadcasting's Forgotten Father: The Charles Herrold Story, Adams.** (Videotape, VHS). *One-hour documentary on this amazing inventor. Featuring his family, students, and photos to document his work.* \$29.95
- Classic TVs, Wood.** *Prewar to 1950s, with price guide.* 140+ color photos, plus repros of catalogs & ads. 86 pgs. \$16.95
- The Collector's Guide to Antique Radios, 3rd Ed., Bunis.** *This guide covers radios from 1920s to 1960s. Over 8,500 prices and over 650 all new color photos are included.* 1994. 278 pgs. \$18.95
- The Collector's Guide to Novelty Radios, Bunis & Breed.** *The source for novelty transistor radios. Full descriptions with current prices. Over 600 color photos.* 1994. 224 pgs. \$18.95
- The Collector's Guide to Transistor Radios, Bunis.** *Identifies the most sought-after vintage transistor radios. Over 2,000 models, 400+ color photos, with current prices.* 1993. 256 pgs. \$15.95
- Communication Receivers, 3rd Ed., Moore.** *Information on 738, 1932 to 1981, vacuum tube receivers by 66 manufacturers. 402 radios illustrated. New section: 3 pages of military receivers.* 125 pgs. \$19.95
- The Compleat Talking Machine, Reiss.** *A guide to restoration of antique phonographs.* 183 pgs. \$19.95
- Crystal Clear - Vintage American Crystal Sets, Crystal Detectors and Crystals, Sievers.**
 Vol. 1 - *Comprehensive reference with 750 illustrations, 570 crystal sets, 341 detectors, 207 crystals.* 282 pgs. \$29.95
 Vol. 2 - *479 All new & different illustrations, more crystal sets, detectors and crystals identified.* 252 pgs. \$29.95
- E.H. Scott Radio Collectors Guide, 1925-1946, Clark.** *The reference for collectors of Scott radios, cabinets and accessories. Lists original prices of cabinets and accessories. Over 200 photos with descriptions.* 88 pgs. NEW \$29.95
- Early Radio, In Marconi's Footsteps, Jensen.** *Realistic description of Marconi's work and his surroundings. Early construction projects with diagrams. Color and B&W photographs.* 170 pgs. (hardcover only) NEW \$39.95
- Empire of the Air, Burns.** (Videotape, VHS). *2-hour video based on Lewis' book.* \$24.95
- Empire of the Air, Lewis.** *Biographical radio history on De Forest, Armstrong and Sarnoff.* 1991. 421 pgs. \$13.00
- Evolution of the Radio, L-W Books.** *Radio pictured and priced, plus reproductions of catalog pages and ads.*
 Vol. 1 - *Eight-hundred + radios.* 1991. 227 pgs., 118 pgs. in color. \$22.95
 Vol. 2 - *Totally different from volume one with new photos, etc.* 1993. 654 color photos. 226 pgs. \$24.95
- Firco Radio Equipment, John Firth & Co., Inc. (reprint).** *Twenty-six-page booklet of the Firco Co.* \$4.95
- Fixing Up Nice Old Radios, Romney.** *Written by a retired radio instructor, this book covers Ohm's law, through battery sets, superhets and communications receivers.* 1990. 300+ figures, 185 pgs. \$25.00
- Flick of the Switch, McMahon.** *The classic photo reference guide for '30s - '50s radios.* 1000+ photos. 263 pgs. \$11.95
- Great Radio Personalities (reprint).** B&W pics of the golden days of radio - Abbott & Costello, etc. 128 pgs. \$11.95
- Guide to Old Radios - Pointers, Pictures & Prices, 2nd Ed., Johnson.** *Introduction to radio collecting. Includes hundreds of photos and a price guide.* 1995. 272 pgs. \$19.95
- Hake's Guide to TV Collectibles.** *Price guide and photos for 1600 TV shows, comic books, etc.* 1990. 185 pgs. \$14.95
- Heathkit, A Guide to the Amateur Radio Products, Penson.** *Documentation of all Heathkit's amateur radio products, a complete history of the company, 200+ sharp photos.* 256 pgs. NEW \$24.95
- Hertz: The Beginning of Microwaves, Bryant.** *Photos and descriptions of Hertz's apparatus and experiments. A book prepared for the IEEE Hertz Centennial exhibit.* 50 pgs. \$15.00
- Inventing American Broadcasting, Douglas.** *A careful weaving of technology, social forces, and business decision making from the days of Marconi to broadcasting in the 1920s.* 1987. 363 pgs. \$14.95
- Los Angeles Radio Manufacturing, Paul.** *History of radio manufacturers in the L.A. area from 1922 to 1942. Features Echophone, Gilfillan, Jackson Bell & 9 others.* 88 pgs. \$10.50
- Supplement No. 1, Paul.** *Coverage of additional manufacturers, people and sets.* 1993. 48 pgs. \$6.75
- Made in Japan, Handy.** *A stunning book on the rise of the transistor radio. 175+ radios in color.* 1993. 108 pgs. \$16.95
- The Mechanics of Television, Yanczer.** *History and explanation of mechanical television, plus construction details for a working system.* 1987. 5 1/2" by 7 1/2". 170 pgs. \$24.95
- Most Often Needed 1926-38 Radio Diagrams and Servicing Information (reprint).** 600+ diagrams for mostly AC radios from '26-'38. 240 pgs. \$11.95
- Novelty Radios, Breed.** 500+ transistor novelty radios in full color with current prices. 1990. 217 pgs. \$24.95
- 1994 Price Update - Novelty Radios, Breed and Bunis.** 14 pgs. \$4.95
- Official Radio Service Manual (reprint).** 100s of pre-1930 circuits & notes. 356 pgs. \$24.95
- Old Gramophones, Bergonzi.** *The development of phonographs and gramophones.* 64 photos. 32 pgs. NEW \$4.95
- Old Radio Sets, Hill.** *The development of the radio from the late Victorian era until the late 60s.* 60 photos. 32 pgs. NEW \$4.95
- Old-Time Radios! Restoration and Repair, Carr.** *How to repair vacuum-tube and transistor radios. A self-paced training guide.* 200 illustrations, 256 pgs. \$18.95
- Philco Radio: 1928-1942, Ramirez.** *A reference book on Philco. Shows receivers and company history year-by-year.* 464 color photos, 364 black & white photos and drawings. 1993. 160 pgs. \$29.95
- Portable Radio In American Life, Schiffer.** *Traces the development of the portable radio and how it affected American culture and society.* 450 photos and drawings, 259 pgs. (hardcover) \$45.00 \$24.95
- Poster's Radio & Television Price Guide, 1920 - 1990, 2nd Ed.** 875+ TV's, 650 transistor radios and 2,200 other radios listed. 600 sets illustrated, 75 in color. 1993. 7" x 10". 264 pgs. \$17.95
- Price Guide to Plastic Collectibles, McNulty.** *Describes types of plastics, etc. (Radio is 8 of 207 pgs.)* \$17.95
- RCA Radiolas, Radiotrons, and Accessories (reprint).** *Twenty-page booklet summarizing RCA's 1926 product line including the Radiola III, 20, 25, 26, 28, etc.* \$4.50
- Radio Art, Hawes.** *A chronological, illustrated history of the technical and stylistic progress of the radio. Mostly British, but American sets are featured as well.* 250 photos, 150 in color. 128 pgs. (hardcover only) Low Price \$9.95
- Radio Art Postcard Deck.** 30 full-color photographs from Hawes' book. \$7.50

COLLECTOR BOOKS AVAILABLE FROM A.R.C.

BOOKS MARKED WITH "€" ARE THE MOST POPULAR AND ARE ESPECIALLY RECOMMENDED FOR NEW COLLECTORS!

- Radio Collector.** (Videotape, VHS). The five-part Emmy-nominated PBS series combined on one 130-minute videotape. Meet collectors, see collections, attend swap meets, learn about radio restoration. \$29.95
- The Radio Collector's Directory and Price Guide, 1921-1965, 2nd Ed.,** Grindler. Directory of over 20,000 radios by manufacturer, model number, year, etc., with prices. Radio history, cabinet styles, vacuum tube development chapters. Over 1,200 trade names listed. Thoroughly revised and expanded. 500 pgs. \$26.95
- Radio Collector's Guide,** McMahon. Listing of 9,000+ radios made by some 1200 companies from 1921 to 1932. Gives manufacturer, year, model name and other info. No photos, 264 pgs. \$11.95
- The Radio Collector's Guide to Philco Bakelite Block Condensers, 2nd Ed.,** Bintliff. A detailed description of Philco Bakelite block condensers with illustrations and parts lists. 1995. 57 pgs. \$9.95
- Radio Craft - 50 Years of Radio** (reprint). March 1938 issue of *Radio Craft* magazine. Numerous articles on the development of radio, then 50-years old, and on early radio pioneers. 144 pgs. \$15.95
- Radio Equip. & Supplies,** (reprint). 1922 radio catalog, accessories, etc. RCA, Clapp-Eastham, etc. 168 pgs. \$19.95
- € **Radios-The Golden Age,** Collins. Full-color book on the colorful Catalin and Bakelite radios from the late 1930s to the early 1940s. 128 pgs. (hardcover \$29.95) \$17.95
- Radio Horn Speaker Encyclopedia,** Paul. Listing of horn speakers for over 320 manufacturers for the 1920s. Expanded information on ten manufacturers. Over 145 photos, 80 pgs. \$14.90
- Radio Horn Speaker Notebook, Rev. H, Paul.** The companion to the Encyclopedia. Over 450 horn picture ads are shown, over 325 manufacturers are identified. Photocopy. New hulex. 1995. 72 pgs. \$15.90
- € **Radio Manufacturers of the 1920's,** Douglas. Three comprehensive volumes. (softcover only) \$24.95
 Vol. 1 covers A-C Dayton thru Ferguson. 225 pgs. (softcover only) \$29.95
 Vol. 2 covers Freed-Eisemann thru Priess. 266 pgs. (hardcover \$39.95) \$29.95
 Vol. 3 covers RCA thru Zenith. 292 pgs.
- Radio Poster,** Sonoran Publishing. Color 20" x 26". A radio timeline. 20 radios from the Pup to transistors. NEW \$10.95
- Radio! Radio!, 2nd Ed.,** Hill. Revised easy-to-read subject index, separate A-Z directory listing of 1,000+ British radio models with clearer photographs than first edition. 978 photos, 244 pgs. (hardcover only) \$44.95
- Radio Redux,** Collins. Subtitled "Listening in Style." This book showcases the sleek lines and luscious colors of over 80 gleaming sets from the collection of Philip Collins. 120 pgs. (hardcover \$29.95) \$17.95
- Radio/TV Finder,** Okolowicz. Reference to nearly 7,000 radio and TV pics found in 24 books. No photos, 110 pgs. \$13.95
- Radio & T.V. Collector's Guide Book,** Biraud. The "Vintage Radio" illustrated guide to European sets from early wireless to the 1930s (a few later). Text is in both French and English. Vol. 1: History & Manufacturers A to P. 256 pgs. (Per Volume) \$49.95
 Vol. 2: P to Z & T.V., Speakers, Tubes, Loops, Parts & Novelties. 256 pgs.
- Radios by Hallicrafters,** Dachis. The most definitive book on the company. Over 600 photos (some color) on everything they made. An invaluable tool for anyone interested in Hallicrafters. 220 pgs. (Available in March) NEW \$29.95
- Radios of the Baby Boom Era.** Pictures and info from Sam's Photofacts. 3,494 radios illustrated plus 3,275 additional radios listed. 274 brands. 1946 thru 1960. Six volumes. 300+ pages per volume. Order by volume.
 Vol. 1: Admiral - Clearsonic. Vol 2: Co-op - Geloso. Vol 3: GE - Monitoradio. Vol 4: Motorola - RCA. (Per Volume) \$16.95
 Vol 5: Realtone - Stratoox. Vol 6: Stromberg-Carlson - Zenith.
- Refinishing Old Furniture, Wagoner.** Written by a furniture restoration instructor. A step-by-step guide to furniture (or radio) restoration, from removal of finishes right up to the final polish. 178 pgs. \$14.95
- Saga of the Vacuum Tube,** Tyne. The development of vacuum tubes - 1880 to 1930. From Edison, Thomson and Fleming to de Forest, Philips, Siemens and many more. 100+ tube photos. 495 pgs. \$18.95
- Sound & Vision Yearbook 1995/96.** An annual directory of radio & TV collectors, primarily European. \$6.95
- Syntony and Spark,** Aiken (reprint). Subtitled "The Origins of Radio." Describes the development of radio from Maxwell's work in the 1860s through the contributions of Hertz, Lodge and Marconi. 1976. 347 pgs. \$16.95
- S. Grensbach Radio Encyclopedia** (reprint). 1927 classic encyclopedia on radio. From "A" Battery to Zirconium, with 1000s of entries in between. 100s of illustrations, 175 pgs. \$9.95
- 70 Years of Radio Tubes and Valves,** Stokes. The story of the radio tube from the laboratory to the commercial market. 247 pgs. \$25.95
- 75 Years of WE Tube Manufacturing,** Magers. A log book history 750+ WE tubes. Illustrated. 133 pgs. \$16.95
- Tomart's Price Guide to Radio Premium and Cereal Box Collectibles,** Tumbusch. Includes comic character, pulp hero, TV and other premiums. 1991, 3,000+ illustrations, 176 pgs. \$22.95
- Transistor Radios, A Collector's Encyclopedia and Price Guide,** Lane. Identification guide to over 2,500 transistor and novelty radios. History and key to collecting chapters. 1994. 170 pgs. \$19.95
- € **Vintage Radio,** McMahon. The classic photo reference guide for collectors of radios prior to 1930. Crystal sets, battery sets, tubes, horns, parts, etc. Over 1000 pictures. 263 pgs. (Temporarily Out-Of-Print) \$44.95
- The Weekend Finisher,** Johnson. A complete guide to stains and finishes and tips for setting up your own workshop. A handy furniture "first aid" kit for quick repairs. Illustrated. 296 pgs. \$10.00
- Westinghouse Catalog** (reprint). 1920s catalog of the RA-DA and other early Westinghouse equip. 8 pgs. \$4.00
- Wireless Communication in the U.S.,** Mayes. Early development of American radio operating companies. Alternators, coherers, stock promotions, unpublished letters, etc. 160 illustrations, 240 pgs. \$29.95
- The Xtal Set Society Newsletter,** Anderson. Complete set of the Society's newsletter. Order by volume.
 Vol. 1: 7/91 to 5/92 - Field Strength Meter, HF Broadcasting, FM Xtal Set, Xtal Sets & Wireless, & more.
 Vol. 2: 7/92 to 5/93 - The Lead Pencil Detector, Detector Binsing, The Universal Xtal Set, etc.
 Vol. 4: 1/94 to 11/94 - Measuring Coil Capacitance, home-brew headphones and curve tracers, etc. (Per Vol.) \$9.95
- The Xtal Set Handbook,** Anderson. Formulas for coil inductance, a procedure for measuring coil capacitance, circuit matching theory, & more. Also included is Vol. 3 of the Xtal Set Society Newsletter. \$10.95
- Zenith Radio Corporation** (reprint). The instructions for installation and operation for Models 39-39A Models 392-392A, and Electric Zenith Receivers. 3 schematics, 3 photos, 7 1/2" by 5", 16 pgs. \$4.50
- The Zenith Trans-Oceanic: The Royalty of Radios,** Bryant and Cones. Presents the fascinating story of the development and use of the Trans-Oceanic. Several photos, documents, ads, etc. 160 pgs. \$24.95

U.S. Orders - Enclose \$3.00 per order for packing & book-rate shipping if total order is under \$35.00. If using VISA or MasterCard, include name on card, card number and expiration date. Send payment with order. Mass. residents please add 5% sales tax. Money back return policy. Most orders shipped the same day received, but allow 2-4 weeks to receive order. Foreign orders - write for shipping costs, or use credit card and specify air or surface (allow 2-3 months for surface shipping).



Send Order To: A.R.C., P.O. Box 2, Carlisle, MA 01741
 or Call: (508) 371-0512 Fax: (508) 371-7129



(Feb-96)



A NEW YEAR...WITH GREAT NEW ITEMS!

**FOR SALE:
 Delmonico JVC**



This is the Delmonico 4T-20U, a mid-1960s portable, and possibly the first TV with "JVC" (Japan Victor Company). This grey, black and chrome 25 transistor/25 diode TV is only about 5" square by 9" long, with an AC adapter half the size of the TV! **Price....\$49**

**FOR SALE:
 Singer TV6**



Another cute mid-1960s transistor portable TV, this one in grey metal with chrome trim with the antenna built into the handle. Size about 6" square by 7" long including the attached AC adapter. This one gets a raster. **With instructions and schematic....\$42**



FOR SALE: Sub-miniature tubes! We got a few more in....these are pencil thin vacuum tubes which were to replace the regular miniature tubes, but were quickly disposed of by transistors, and were only used in a very few radios! New old stock from Ratheon. **15 assorted tubes...\$34**
»Nuvistors! These metal vacuum tubes are half the size of sub-minis! 3 tubes for display (including a "power" type 7587). **3 Nuvistors....\$16**

FOR SALE: Picture Tubes--CRTs. These are all used, but they have been tested, and are good.

Type	Used in	Picked-up	Box&Ship
3KP1	3" Green tube	\$ 40	\$ 55
3KP4	Pilot TV-37	see chassis above, right!	
7DP4	RCA 621TS	Call	
7EP4	Viewtone, etc.	\$ 70	\$ 90
7JP4	1940s 7" sets	\$ 60	\$ 75
8BP4	1940s 8" sets	\$ 75	\$ 95
10BP4	Typical 1940s 10"	\$ 65	\$ 90
12LP4	Late 1940s 12"	\$ 75	\$100
14EP4	1950s 14" sets	\$ 55	\$ 80
17EP4 (NEW!)	Predicta 17"	\$120	\$145
21EAP4	Rebuilt Pred. 21"	\$125	\$155

»We ship to Europe, Asia, and around the world«



**FOR SALE:
 Regency TR1
 and Copies**

This is a very early and very important group of radios which was America's entry into the then new "all-transistor"

radio race. These are in excellent condition--no cracks and no repairs. It includes the first radio--the Regency TR-1, in grey, plus copies: The Bulova model 250 series in ivory, the Mantola (super rare!) model M-4D in black, and the Mitchell 1101 in brown leather with chrome front. They're pricey---but it's a rare opportunity! **Your instant collection....all 4 only....\$2,270**

**FOR SALE: Hickok 810
 Transistor Radio Tester.**

So you have all those radios, but don't know how to fix 'em? Well, here is your answer! This Hickok is an oscillator,



receiver and audio amp. It tests everything from the loop antenna to the speaker. It even has a TRF receiver built-in to test the signal anywhere in the set. **And, it looks unused, boxed, with instructions...\$66**

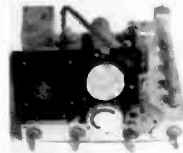

FOR SALE: Pilot TV-37 chassis. This 3" chassis has the original white CRT, and has been restored. It is in good working condition and the chassis is complete. **Restored and working Pilot TV-37 chassis...\$170**

»Another TV-37 chassis. This one clean and complete, but no CRT, and it has **not** been restored...\$68

FOR SALE: Zenith Royal 760 Navigator. This 1959 portable has 8 push-in transistors, and covers broadcast and long wave. In blonde cowhide. It's very nice, except 1 knob is cracked Direction finding wheel on top. **Royal 760...\$43**
»Zenith Royal 750. Again a 1959 portable, it has 7 push-in transistors. Nice brown cowhide radio with some cracking on the back flap...\$27

FOR SALE: 1948 Experimental Transistor. This is a very unusual peek into the beginnings of transistor development. Bell Laboratories took a small metal tube with a hole drilled in the side, then carefully positioned a developmental transistor inside. When everything looked okay, they epoxied the unit and numbered the tube. These are marked in pen "A1729X" **Each....\$42 or all 3 for \$105**



CLASSIFIED ADVERTISING POLICY

ONE FREE 20-WORD AD for subscribers in each issue; additional words are 25¢ each. See details below. Classified ads sent by mail, fax or by any other method must be received (not just postmarked!) by **Noon Eastern Time** on the classified ad deadline date to guarantee inclusion in the current issue. Late ads are held for the following issue. Please enclose correct payment with all ads. Stamps or cash are OK for small amounts. (Canadian and other foreign advertisers, please see "Payment" on page 2 for methods.) *Free words" cannot be accumulated from month to month; free words must be requested when ad is submitted.

Faxed & e-mailed ads: Please see additional information on the inside front cover.

When including ads with other A.R.C. correspondence, write the ads on a separate piece of paper. Include SUB# with ad. Ads may be sent in advance; but, write each ad on a separate piece of paper and indicate the month (or successive two months) you want the ad to run.

To minimize our typing errors: Please write legibly. Use both capital and small letters. Do not use a dash between words. Carefully write the following numbers and letters (especially in model numbers) since some can look alike; for example 1, l and I (the number one, the capital i and the small L.) Also: 0, O, o, Q and D; r and n; 6, b and G; V, U, u, v and Y; A and R; 5, S and s; 2, Z and z. We try to correct spelling errors, so when using an uncommon word or manufacturer which we might mistake as a more common word or manufacturer, note it so that we do not "correct" it. Editor's annotations are in [brackets].

Advertising is accepted only for early items related to radio, communication, etc. All items must be described fairly; reproductions, reprints and not-original items must be so identified. Advertisers must agree to respond promptly to inquiries and orders, to resolve problems promptly if the buyer is not satisfied, and to comply with a buyer's refund request on unaltered returned items.

The publisher reserves the right to edit ads without notification to the advertiser and to reject ads for any reason. Names other than the advertiser will be edited out of ads. Ads with non-radio-related items will be returned or edited unless the non-radio-related items are for trade of radio-related items, or they are incidental to and appear at the end of an otherwise acceptable ad. The publisher is not responsible for errors due to illegibly written ads or for any other reason.

Clubs: Since club activities receive free coverage on the *Coming Radio Events* pages, the free 20 words may not be used for club activity ads. See inside front cover for additional information.

CLASSIFIED AD DETAILS

Deadline: NOON ET— 10th of the month!

Classified ads must have a standard heading such as **WANTED, FOR SALE, FOR TRADE, FOR SALE/TRADE, SERVICES, MESSAGE, HELP, AUCTION, MEET, etc.** This heading is the only bold or all-capitalized words allowed in the ad. Capitalize only manufacturer names, model names, etc. This standard ad format makes scanning the ads easier.

Before writing your ad, please look over the ads in a recent issue of A.R.C., and try to write your ad in the same style. Full name (or company name) and address is required in all classified ads; we will add it if you forget.

To encourage varied content of the ads, the same classified ad may be run only once per issue and for only two consecutive months. (To run an ad longer, use a boxed classified or display ad.)

Classified Ad Rates per Month

Subscribers:

First 20 words: **FREE***

25¢ per word for extra words over 20 **plus**

10¢ per word for a shaded ad (count all words including free words).

* Subscribers may take 20 free words on only **one** ad each month.

Non-Subscribers:

41¢ per word **plus**

10¢ per word for shaded ad.

Please do not forget to send in the extra 25¢ per word when your classified ad runs over the free 20 words; your payment will be appreciated, and it will help to keep A.R.C. healthy.

BOXED CLASSIFIED AD DETAILS

Deadline: 1st of the month!

Boxed classified ads can run unchanged for three months or more. No words are free. Ads may be shaded and may include bold and all-capitalized words freely. The ad need not begin with "For Sale," etc. Minimum run is 3 months, prepaid. Discount: 10% for 6 months; 20% for 12 months.

Boxed Classified Ad Rates per Month

Nonshaded ads:

36¢ per word for all words,* none free, **plus**

10¢ per word for each bold word **plus**

10¢ per word for each all-caps word.

Shaded Ads (All words are bold at no charge):

45¢ per word for all words* **plus**

10¢ per word for each all-caps word.

Non-Subscribers:

Add 20¢ per word to above costs.

*Three words can be bold-all-caps at no extra charge.

PHOTO & DRAWING DETAILS

Deadline: 1st of the month

for all ads with drawings or photos!

Drawings and photos are encouraged as the response to your ad is much larger and the reader knows better what you want or are selling. Send in your drawing or photograph, and A.R.C. will reduce it or enlarge it as needed.

Photo and Drawing Rates per Month

\$20.00 per month for each photo or drawing

(If ad is canceled, this amount cannot always be refunded.)

CHANGES & CANCELLATIONS

Please check your ads carefully before sending them in. Once ads are received, it is not always possible to refund the amount sent, pull the ad or make changes.

IMPORTANT — COUNTING WORDS — IMPORTANT

The **standard headings:** WANTED, FOR SALE, etc., count as **one** word each time used in an ad. **Name, address** and (one) **telephone number**, count as **6 words**, regardless of length. Ham call letters and business name can be included in the 6 words and do not count extra. Full name (or company name) and address is required in all classified ads. Each additional word, abbreviation, model number or number group, extra telephone numbers, fax, e-mail, etc. count as **one** word each. Hyphenated words count as **two** words.

SECOND CLASS

ANTIQUE RADIO CLASSIFIED

A.R.C., P.O. Box 2, CARLISLE, MA 01741

RETURN POSTAGE GUARANTEED

EXP=NOV96

G-26 SUB# 28-2477
RICK MURILLO

700 SUNDANCE BOX 608 CA 95703
TULARE

**CLASSIFIED AD
DEADLINE FEB. 10th
Noon Eastern Time**