

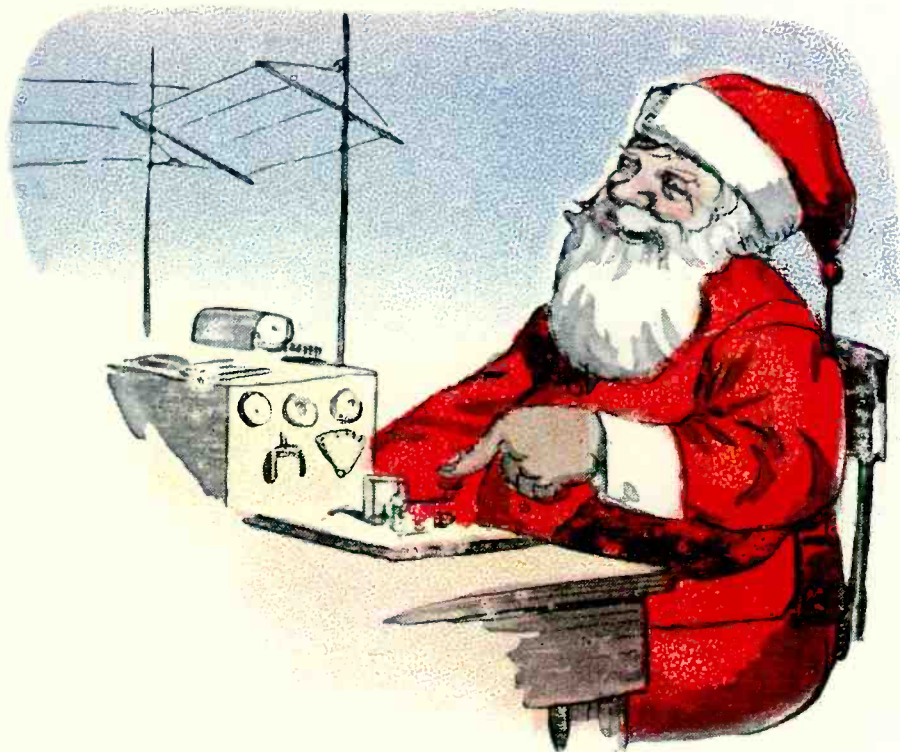

VOLUME 10

DECEMBER 1993

NUMBER 12



## *Season's Greetings by Radio*

A.R.C. — THE NATIONAL PUBLICATION FOR BUYERS AND SELLERS  
OF OLD RADIOS AND RELATED ITEMS — PUBLISHED MONTHLY

## ANTIQUE RADIO CLASSIFIED

Antique Radio Classified (ISSN:8750-7471) is published monthly, 12 times per year, by John V. Terrey, One River Road, P.O. Box 2, Carlisle, MA 01741. Second-class postage paid at Carlisle, MA, and additional mailing offices. Telephone: (508) 371-0512, 9:00 AM to 5:00 PM ET weekdays; machine answers phone at other times.

Annual subscription rates within the U.S. are \$29.95 by Second Class mail and \$44.95 by First Class mail.

Annual foreign rates. By air: Canada - \$48.00; Mexico - \$47.00; Other foreign countries - \$85.00. Surface mail: Canada - \$39.00; Other foreign countries - \$43.00. (Surface delivery to countries other than Canada may take two or more months and cannot be guaranteed.)

Two-year subscriptions are twice these rates and receive an extra month. Sample issues are available free on request.

© Copyright 1993 by John V. Terrey.

POSTMASTER: Send address changes to Antique Radio Classified, P.O. Box 2, Carlisle, MA 01741.

### STAFF

**Publisher and Editor:** John V. Terrey  
**Production Manager:** Scott J. Young  
**Office Manager:** Lisa A. Friedrichs  
**Publishing Staff:** Dave Crocker  
 Chris Frederickson  
 Shirley Sauer  
 Dick Desjarlais  
 Bobby Lyman  
 Dorothy Schechter  
**Founding Publisher/Editor:** Gary B. Schneider  
**Contributing Writers:** Mike Adams  
 Richard L. Arnold Ray Bintliff  
 Ron Boucher Paul J. Bourbin  
 Norman S. Braithwaite Dave Crocker  
 Alan S. Douglas Richard C. Foster  
 Fred Geer Jim Kreuzer  
 Ron Ramirez Henry Rogers  
 Ian L. Sanders Gary B. Schneider  
 Daniel Schoo Dwane Stevens  
 Frank R. White Ralph Williams

**PURPOSE.** Antique Radio Classified is published for people involved in the radio collecting hobby. Its purpose is to stimulate growth of the hobby through the buying, selling and trading of radios and related items, and to provide a monthly forum for the interchange of ideas and information.

### CONTACTING ANTIQUE RADIO CLASSIFIED.

All correspondence should be sent to:

A.R.C., P.O. Box 2, Carlisle, MA 01741.

Send only UPS, Federal, etc. items to One River Road.

Telephone: (508) 371-0512; Fax: (508) 371-7129

Please, no classified ads by telephone; thanks.

Your ads, renewals, letters, etc. can be handled faster and more efficiently if (1) each is on a separate piece of paper, and (2) your name, address and SUB# are written on each.

Unfortunately, A.R.C. is not staffed to answer letters

with questions about antique radios or requests for advice. However, A.R.C. does solicit letters of interest to its readers and publishes them as space permits. A.R.C. assumes that permission is given to edit and to publish all correspondence and articles received unless otherwise indicated.

**GUARANTEE.** You may cancel your subscription at any time and receive a pro rata refund for issues not yet mailed. If errors to ads are made by A.R.C., upon request a free correction will be run in the next available issue.

**PAYMENT.** Please send in full payment with your order or ad. A.R.C. does not carry accounts; all subscriptions, ads, etc. must be prepaid (except for the 6 and 12 month display ads indicated below.) Pay in U.S. funds. Checks drawn on a U.S. bank, money orders, VISA or MasterCard (\$10.00 min.) are preferred. Make check out to "A.R.C." U.S. stamps or cash are OK for small amounts. Canadian payers may send a Canadian check but specify U.S. funds. Subscriptions will be prorated to amount sent if amount is incorrect.

**CHANGE OF ADDRESS.** Please notify us 4 weeks in advance of a change of address. Send both your new and old address, and include your SUB# and effective date of your new address. Temporary address changes can be made also.

**SUBMISSION OF MATERIAL.** Antique Radio Classified welcomes and solicits information that pertains or relates to radio history or collecting. This may include articles, book reviews, photos, information on upcoming radio events, meetings, antique radio organizations, radio auctions and price reports, sources of old radio and restoration supplies, and other related and interesting material. All material submitted should be neat and verified for accuracy. Unless prior arrangements are made, all submitted materials may be edited, become the property of Antique Radio Classified and will not be returned.

**MAILING OF ISSUES.** U.S. subscribers can receive A.R.C. by First or Second Class mail (Second Class is the way most magazines are mailed). The mailing of First Class copies is staggered over one to four days with faraway copies mailed before local copies. Non-U.S. copies are mailed on the first day. Second Class copies are mailed on the last day. Mailing dates change each month, but mailing is usually completed by the 26th of the month. First Class copies usually are received by the fifth of the month; copies by Second Class mail, by the tenth.

**ETHICS.** No person involved in the production of A.R.C. is to act on any information in the magazine until the day after local copies are mailed.

**DISCLAIMER.** The publisher is not responsible for any buying and selling transactions incurred, or for any other use of the contents of this publication.

Antique Radio Classified subscription rates, frequency of publication, content, policies, size and ad details, and rates are subject to change at any time by A.R.C.

### DISPLAY AND BUSINESS CARD ADS - DETAILS AND RATES

The deadline is the first of the month for display and business card ad artwork, payment and repeat requests.

Advertising is accepted only for early items related to radio, communication, etc. All items must be described fairly; reproductions, reprints and not-original items must be so identified. Advertisers agree to respond promptly to inquiries and orders, to resolve problems promptly if the buyer is not satisfied, and to comply with a buyer refund request on unaltered returned items.

Advertising must be prepaid, except as noted below; see "Payment" paragraph above for details. Late ads will be run only if space and time permit. Since artwork is reduced to 63% in the printing process, originals must be the artwork size listed below. Do not send in artwork on art board or send negatives. Ads should be typeset or typed neatly with a carbon ribbon, black printing on white. No reverse type if A.R.C. is to make up the ad. If you want us to prepare your ad, include the one-time cost below for A.R.C. to make up the ad.

Photos should be at an 85-line screen; otherwise, add \$10.00 per photo for screening. Do not cut or trim photos or glue photos to artwork; submit separately.

If you are confused by these requirements and terms,

Page	ARTWORK SIZE		As Printed		One Time				
	(SEND IN THIS SIZE)		(size in magazine)		Cost for 1-month	Cost for 3-months	Cost for 6-months	Cost for 12-months	up Ad to make
	H x W (inches)		H x W (inches)						
Full	12 3/16 (or 10 1/2)	x 7 1/2	7 3/4 (or 6 5/8)	x 4 3/4	\$188.00	\$499.00	\$869.00*	\$1580.00**	\$60.00†
1/2 H		5 1/4 x 7 1/2		3 5/16 x 4 3/4	94.50	252.00	435.00	790.00**	30.00†
1/2 V	12 3/16 (or 11 13/16)	x 3 9/16		7 7/16 x 2 1/4	94.50	252.00	435.00	790.00**	30.00†
1/4		5 1/4 x 3 9/16		3 5/16 x 2 1/4	47.75	127.00	220.00	399.00	15.00†
1/8		2 5/8 x 3 9/16		1 5/8 x 2 1/4	24.50	65.00	112.00	199.00	7.50†
Business Card		2 x 3 3/4		1 1/4 x 2 3/8	not avail.	34.00	59.00	107.00	5.50†

\* Full page, 6-mos.: 1/2 due with order; 1/2 due in 3 mos. \*\* Full & 1/2 page, 12-mos.: 1/4 due with order; 1/4 due at 3, 6 & 9 mos.

† For 6 and 12 month ads, no ad make-up charge if no change is made to ad for entire run.



## EDITOR'S COMMENTS

From A.R.C. to our readers — a holiday bonus that includes Santa on the cover in full color, a new record of 860 classified, photo and boxed ads, a record number of article pages, and numerous radio-related gifts unlike any others. In this, A.R.C.'s tenth holiday season, our special gift to you is a pledge to continue publishing the best monthly magazine in the antique radio community.

Our lead article this month is by Norman Braithwaite, and features the E.H. Scott 1931 Allwave Superheterodyne. This set was E.H. Scott's first truly classic receiver, characterized by chrome plated chassis, a large number of tubes, ornate cabinets, and outstanding performance. Norm also compares the Scott product with the competition of the day — offerings by Silver-Marshall and Lincoln.

A very rare set is described by Dave Crocker — the Harko Crystal set, Powel Crosley's second complete radio product. Dave was surprised by the rather crude construction of this early set, especially the use of nails as switch stops on the coil tap switch. This set preceded many of the standard components and cabinets that characterize other early Crosley sets.

Robert Lozier presents an interesting bit of research on cleaning methods. He reports the results of subjecting sixteen metal panels to different cleaning compounds in a very hot and humid environmental chamber for 72 hours. The bottom line is that we owe it to our radios to take care when using potentially damaging cleaning compounds.

Robert Perlstein describes the construction of a device useful for speaker collectors — a speaker switching box. Robert's "hom box" contains an impedance matching transformer which allows old, as well as modern radios/amplifiers to be used with old, as well as modern speakers.

Although you cannot buy a Heathkit today, many of us remember the first Heathkit we built. Fred Geer writes about his first — the Model A-7C audio amplifier. Sadly, Heathkits are no longer made, but the company still sells to the electronics education market. Recently, Dick Desjarlais of the A.R.C. staff contacted the Heath Company, and he reports further on its history.

The last big annual show of the year — the Vintage Radio and Phonograph Society's annual convention and auction — in the Dallas, Texas, area is reported this month by George and Michael Potter. Three auctions of nearly 600 items totalled about \$36,000, and the outstanding old equipment contest attracted 99 entries.

Sequels on the silver screen are common, and it seems that sequels of radio books are becoming popular too. Scott Wood, of L-W Books, gathered up another collection of photos from radio collectors and combined them in *Evolution of the Radio, Volume 2*. David Pope reports to A.R.C.

readers on this new book.

Several shorter items from our readers are included this month. David Fuls shares an interesting find; this story is mindful of the discovery of the Ken-Rad crystal sets reported in our March 1993 issue. No place is too strange to find an old radio! Even more strange are the CeCo tube-type designations unraveled by Richard Mackiewicz. On the other hand, the story of a 1930 Philadelphia radio bonfire provided by Dennis Schrank goes beyond "strange" to the "stranger (or more horrible) than fiction" category.

We also have another Gridley's Radio shop cartoon from Ron Boucher and further reader contributions on our *Photo Review* and *Radio Miscellanea* pages.

Summarizing the many articles in this issue prompts me to thank all of our readers who have sent in contributions, small and large, during this past year. Remember, nearly all of our articles are contributed by you, our readers, so if you have a particular radio-related interest, please do not hesitate to write about it. Be sure to look over the "Submission of Materials" paragraph on the A.R.C. masthead, and send for our guidelines.

**Renew Now and Save!** A final reminder that our subscription rates will be increased about 6% on January 1, 1994. Rate increases are always announced in advance so that subscribers will not be surprised when they renew their subscriptions. Call or write now to renew/extend your subscription for up to 5 years at the current rates to avoid the increase; remember that all early renewals receive 13 months for each annual extension. Also, all advertising rates will be increased in order to distribute A.R.C. production costs fairly between readers and advertisers.

**Club Events.** Two dozen club activities are sandwiched into the busy month of December; scan our *Coming Radio Events* pages for one near you. A new year is around the corner, and for those of you who plan ahead, the dates for the "big ones" are included through October 1994. Clubs, be sure to send us your free listings well in advance of your event. A.R.C. makes it to nearly a dozen meets a year, so look us up.

Happy holidays and happy collecting from all of the Antique Radio Classified team — John, Scott, Lisa, Dave, Dick, Chris, Bobby, Shirley and Dorothy!  
John V. Terrey

---

## ON THE COVER

Santa and "Junior" communicate using the latest invention — wireless. The illustrations are taken from a 1925 postcard from the editor's collection. A cover wrap, or an envelope, protects our full-color holiday cover this month.

# WITH THE COLLECTORS

## E.H. Scott Receivers

### 1931 Allwave Superheterodyne and the Competition

BY NORMAN S. BRAITHWAITE

*Longtime A.R.C. readers will remember Norm Braithwaite's excellent series of articles on E.H. Scott products in the late 1980s and 1990. Some examples are the Scott 48 Tube Custom receiver (July 1987), the Scott Quaranta (February 1987), The Scott Allwave 15 (September 1987), and the Scott Telematic (February 1990). We are delighted that Norm has once again found the time to share his extensive knowledge of the Scott line. (Editor)*

The year was 1931. Radio manufacturers who had survived the first year of the Great Depression were struggling to identify and respond to the consumer demands for radios. While most radio manufacturers found economy in construction to be a formula for survival, one company found prosperity in responding to the small demand for high performance custom-built receivers. That company was E.H. Scott Radio Laboratories, a small manufacturer of high quality radio receivers, established in 1924 as the Scott Transformer Company.

#### FIRST SCOTT MODELS

E.H. Scott Radio Laboratories had initially responded to the Depression in 1929 by offering two compromised models — the Shield Grid AC-10 and the Shield Grid Symphony. These were also the first Scott offerings which were completely assembled at the Scott factory.

The Shield Grid AC-10 was a 12-tube (counting rectifier and ballast tubes) superheterodyne receiver, while the Shield Grid Symphony was a 4-tube (battery operation) or 5-tube (AC operation) tuned radio frequency receiver. The Symphony was the only receiver in the history of the



*Figure 1. The E.H. Scott Allwave Superheterodyne in an early Warrington console, the top of which lifts up to expose the tuner chassis.*

company to be offered with a circuit other than a superheterodyne.

Although both of these receivers were well built, they still employed a Bakelite chassis, had non-metallic faceplates and did not have fully shielded radio frequency (RF) or intermediate frequency (IF) stages. They also failed to lead the industry in performance as had previous Scott models. Consequently, sales must have been slow. E.H. Scott himself must not have been too proud of these offerings because in the April 1932 issue of *Scott News*, he failed to identify the sets in a brief history of Scott receiver performance.

Many factors had to be considered before offering another model. Probably due to the poor consumer response to the last models and to demands from his loyal customers, E.H. Scott chose not to compromise the

new model. Demands for high performance radios during the early 1930s were changing rapidly. In 1931, the greatest concerns were sensitivity, selectivity, and tone quality. Image rejection had become less of a concern, since the newer sets employed higher intermediate frequencies. Ease of use was an issue but was probably less important to Scott's demanding customers than the ability to receive shortwave broadcasts.

Thus in 1931, taking some risk and balancing these factors with little regard to cost, E.H. Scott proceeded to produce the first of the true classic Scott receivers — the Allwave Superheterodyne, shown in Figure 1 in an early Warrington console. The decision to pursue this no-compromise receiver proved to be a good one. The E.H. Scott Radio Laboratories entered a market where the big manufacturers could not afford to compete — the pro-

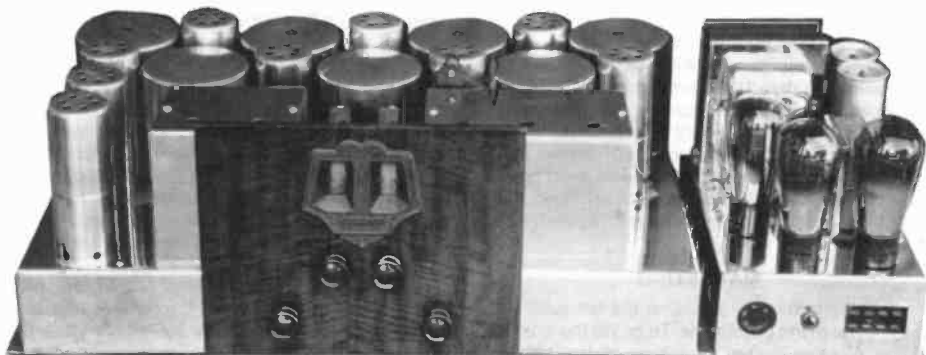

Figure 2. The Scott Allwave Superheterodyne.

duction of high quality, high performance custom receivers for a limited but wealthy audience.

### THE ALLWAVE SUPERHETERODYNE

As seen in Figure 2, the Allwave Superheterodyne was well built and again led the industry in performance. The set consisted of a 9-tube tuner and a 3-tube amplifier feeding a good quality 11-inch Rola speaker, which is shown in Figure 3 along with a complete set of coils for the shortwave bands. Features included 15- to 550-meter reception, 1-microvolt or better sensitivity on the broadcast band, very good selectivity and an audio response of 50 to 1,000 CPS (cycles per second)  $\pm$  3 dB (decibels). No specifications are available for levels of distortion. The circuit contained an RF amplifier, 4 stages of single tuned IF amplification at 470 Kc (kilocycles), a power detector, a push-pull audio amplifier stage and a push-pull audio output stage.

The chassis, made of heavy gauge steel, was polished and chrome-plated. Aluminum shields were used to cover all tubes and coils above the tuner chassis. The power transformer and a choke on the power amplifier were also chrome-plated. The complete chassis set plus speaker was offered for \$130.

A choice of high quality cabinets was available at extra cost. Additional options included an optional power amplifier using push-pull Type 50 tubes, a control box for phonograph, radio or mi-

crophone operation, an auditorium speaker, a 470 Kc test oscillator (for home alignment!) and a continuity tester. Included with every purchase was a set of literature — an instruction and technical service manual (with schematic and alignment instructions), a tuning guide and a station finder to relate dial settings to shortwave frequencies.

### DRAWBACKS

Although the set was packed with features and was of superior construction, there were some drawbacks. The most significant of these was the difficulty of operation. Allwave reception was accomplished by the use of plug-in coils. Since there was a stage of RF amplification, 2 coils were required for each band. Six bands were used to cover the receiver frequency range; therefore, a total of 12 coils was required (and supplied with every receiver).

In addition to swapping coils when changing bands, the owner had to remember to switch the grid cap wire of the first detector when tuning across 38 meters and to change the grid cap wire of the RF amplifier when tuning across 184 meters. Also, the aluminum shields covering the plug-in coils had to be removed and left off when tuning the shortwave bands.

Due to the lack of practical automatic volume control (which had not yet been developed), a sensitivity control had to be set to the correct position to prevent distortion in the power detector (second detector). Separate controls were provided for tuning the oscillator and for tuning the ganged RF amplifier and the first detector. The separate controls added to the difficulty of using the set but allowed the receiver to have greater selectivity and sensitivity. Although this set appears particularly difficult to operate, the other allwave sets available at the time were also difficult to operate.

The other drawback of the set was its poor upper audio frequency response. A response of 50 to 1,000 CPS is unbalanced and will produce excessive bass. To make things

(Continued on following page)

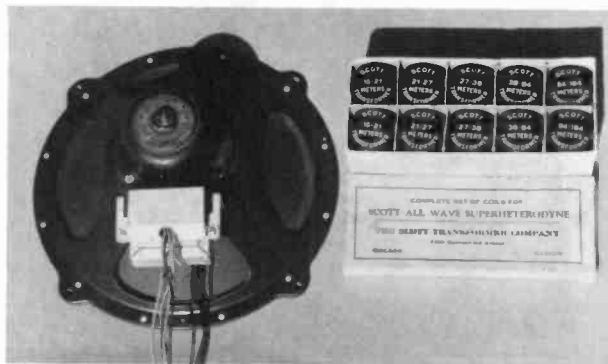

Figure 3. The 11-inch Rola speaker used in the Scott Allwave and a complete set of coils for the shortwave bands.

*(Scott Receivers, continued)*

worse, there was no tone control. Regardless of these shortcomings, the Allwave Superheterodyne was considered to be among the best sounding receivers of the time. Numerous testimonials regarding the good tone of this receiver were probably due to the low distortion of the set, the lack of bass response in the speaker (tending to balance the overall audio response), and the poor tone quality of many other sets available at the time.

### MARKETING

Even with these drawbacks, the set excelled in the eyes of the purchaser. To prove the quality of the Allwave Superheterodyne to the public, E.H. Scott used the set to receive every program broadcast from VK3ME in Melbourne, Australia, for a period of 10 weeks. Logs of the transmissions and recordings on aluminum disks were verified by VK3ME. This feat set a world record for consistent distance reception. The distance between Melbourne and Chicago is 9,560 miles. The world record and letters of verification were used repeatedly for promoting the set.

Additionally, in January of 1932, Scott offered \$3,000 in prizes in a distance reception (DX) contest for owners of the Scott Allwave Superheterodyne. The result of this contest (verified by certified public accountants!) was more publicity using the unique claim "Scott Allwave owners logged 9,535 programs from 186 foreign stations in 40 foreign countries." The Allwave Superheterodyne sold well, and E.H. Scott developed a unique market for his premium quality sets.

### COMPETITORS

Few other manufacturers of allwave receivers had sets which competed directly with Scott's Allwave Superheterodyne on a technical and marketing basis. Scott's most prominent competitors at this time were Silver-Marshall and Lincoln. Although neither of these companies produced chassis of such high quality construction, both were offering allwave receivers with similar features to the public.

### SILVER-MARSHALL MODEL 726SW

Silver-Marshall's initial competition to Scott's Allwave Superheterodyne was the Model 726SW, shown in Figure 4. The Model 726SW was promoted as an allwave superheterodyne without plug-in coils, covering a frequency range of 10 to 550 meters. Silver-Marshall also boasted of the Model 726SW's double conversion (two intermediate frequencies were used). As shown in the top view of the chassis in Figure 5, the 726SW

employed 11 tubes performing the following functions: SW oscillator, SW converter, broadcast RF, oscillator, 1st detector, IF (2 tubes), power detector, push-pull output (2 tubes), and rectifier.

The chassis, along with a 10.5-inch Silver-Marshall Model 855 dynamic speaker was offered for \$139.50. The chassis and faceplate were made of a thin gauge steel. The chassis was painted, while the faceplate was finished with an artificial woodgrain finish. In addition to controls for tuning, switching bands and volume, a tone control was provided.

Although the bandswitching and IF features of the Model 726SW seem impressive, the circuit and construction show the true nature of these features. The 726SW was a broadcast band superheterodyne receiver with a Silver-Marshall Model 738 shortwave converter built on a common chassis. The broadcast band IF (and second IF for shortwave) was 175 kilocycles. The first IF for shortwave reception was set by the user between 600 and 750 kilocycles at the lower end of the broadcast band.

The bandswitch was a useful feature but was only used for switching between shortwave bands. Switching between the broadcast band and shortwave required turning the broadcast-shortwave switch, tuning the broadcast receiver to the desired first IF, and tuning the first IF oscillator to the same frequency before selecting the band and desired frequency on the shortwave section.



Figure 4. The Silver-Marshall Model 726SW.

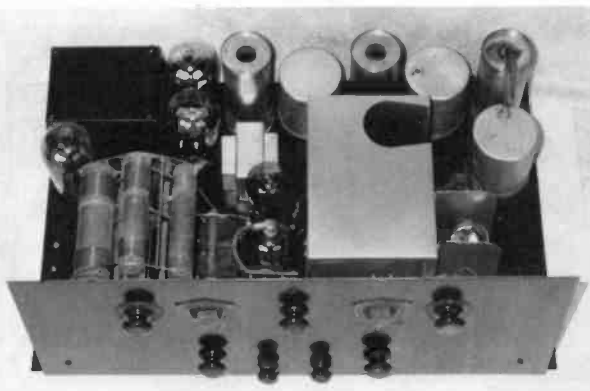

Figure 5. Top view of the Silver-Marshall Model 726SW chassis.

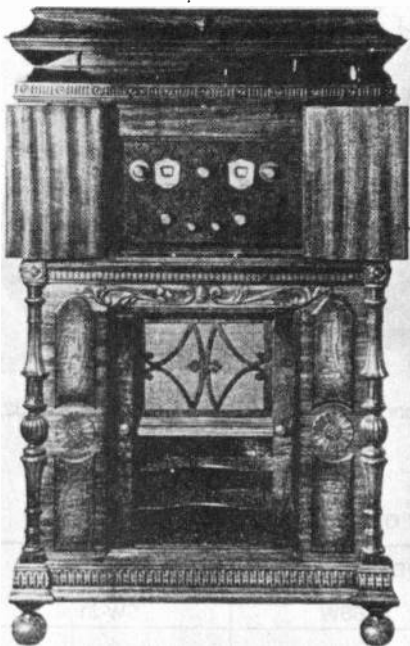

Figure 6. The Silver-Marshall Model 726SW, custom-built for silent film star Norma Talmadge. Photo from "The Radiobuilder," No. 24, October 15, 1931.

The construction of the Model 726SW was substantially inferior to the Scott. The placement of components and wiring, although electrically adequate, was aesthetically poor. The set literally looked as if it were built by an amateur set builder. However, the Silver-Marshall Model 726SW took on an impressive look when housed in the console, pictured in Figure 6, which was custom-built for silent film star Norma Talmadge, who did radio work with George Jessel.

During February 1932, near the end of Scott's run of Allwave Deluxe receivers, Silver-Marshall introduced the Model 727SW receiver because of "drawbacks" in the 726SW. These drawbacks are described in Silver-Marshall's "Radiobuilder" as a complicated coil selecting and tuning arrangement and "unavoidable reactions between harmonics of the broadcast and shortwave oscillators" causing "burps" which occurred as the shortwave dial was tuned. Nevertheless, Silver-Marshall proceeded to claim that the 726SW "was so far superior to that obtained from previous shortwave sets, it was believed that nothing better could be hoped for."

The 727SW, shown in Figure 7, differed from the 726SW primarily in the radio frequency, oscillator and intermediate frequency circuits. The RF amplifier present in the 726SW was eliminated. The broadcast band oscillator remained. To accomplish shortwave reception, a harmonic generator was added. The purpose of the harmonic generator was to produce harmonics of the broadcast band oscillator necessary for shortwave reception. This arrangement resulted in a single

bandswitch and, with the exception of an antenna trimmer, single dial tuning. The disadvantage of deriving shortwave oscillations using this method is that there is considerable overlap in the upper shortwave bands. The intermediate frequency of the 727SW was increased to 465 kilocycles to improve image rejection. Also of significance, the 727SW incorporated automatic volume control making it the first of the popular allwave receivers to offer this feature.

#### THE LINCOLN MODEL SW-31

Lincoln's competitive offering was the Model SW-31. Figure 8 shows the Model 31 chassis which is similar in appearance to the SW-31. This was Lincoln's first model offering shortwave reception. Like the Scott, the SW-31 used plug-in coils for changing bands. Unlike the Scott, the Lincoln did not have a stage of RF amplification; therefore, only one set of coils was required. The SW-31 circuit consisted of an oscillator, a first detector, four stages of single tuned IF amplification, a second detector, an audio amplifier and push-pull audio output. The SW-31 chassis was stamped out of a thin gauge of steel and then cadmium plated.

As with all Lincoln receivers manufactured between 1929 and 1933, the SW-31 had knobs on top of each IF can for adjustment of the IF frequency. This feature allowed the user to change the intermediate frequency if an image fell on a station of interest. Additionally, the user could adjust the IF bandwidth to a limited extent for the best signal.

Once the IF was adjusted, the SW-31 was almost certainly easier to operate than the Scott or the Silver-Marshall, since it had only one plug-in coil set, a volume control and an antenna trimmer. The ease of operation of the SW-31 was not without sacrifice. The absence of an RF amplification stage most likely meant that the SW-31 lacked the sensitivity and selectivity of the Scott and Silver-Marshall sets.

From the standpoint of workmanship and construction, the Scott Allwave Superheterodyne was distinctly superior to the Silver-Marshall and the Lincoln radios. Comparing features, the Silver-Marshall, having tone controls and AVC, and being the first to eliminate the use of plug-in coils, had to be considered better. The performance of the Silver-Marshall 726SW, having burps in the shortwave bands, could not be considered equal to the performance of the Scott Allwave Superheterodyne. The performance of the Lincoln and the Silver-Marshall 727SW probably lagged behind the Scott due to the lack of an RF amplifier stage. A summary of features of all three sets appears in Table I.

If the number of early allwave receivers surviving today is any indication of their success in capturing the custom-built receiver market, the Scott would have to be considered the most successful. The Silver-Marshalls and Lincolns are much less common today. The Scott Allwave Superheterodyne became the first of a series of classic Scott receivers which dominated the custom-built and high performance markets until production of Scott receivers

(Continued on following page)

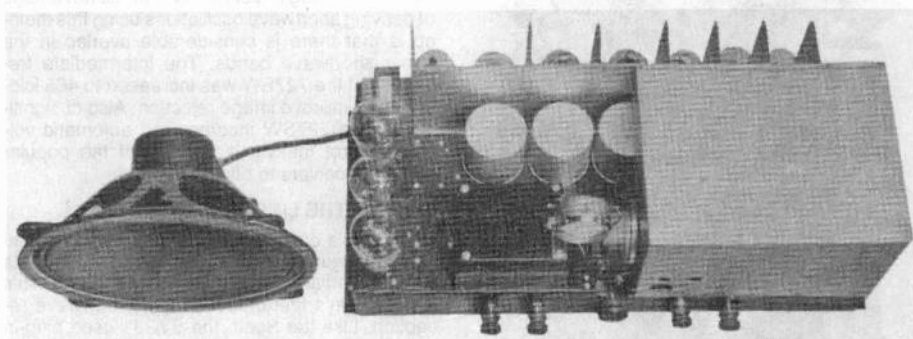

Figure 7. The Silver-Marshall Model 727SW. Photo from "The Radiobuilder," No. 25, Feb. 10, 1932.

Table 1. Summary of Features

	EH SCOTT ALLWAVE	SILVER-MARSHALL 726SW	LINCOLN SW-31
<b>CIRCUIT</b>			
SW Osc.	-	27	-
SW Det.	-	24A	-
RF	24A	51	-
Osc.	27	27	27
1 Det.	24A	24A	24A
IF	3x24A	2x51	4x24A
2 Det.	27	27	24A
1 AF	2x27 (PP)	-	27
Output	2x45 (PP)	2x47 (PP)	2x45 (PP)
Rect.	80	80	80
<b>CONTROLS</b>	Power Volume Tuning Sensitivity	On-Off/Volume BCST Tuning SW Tuning SW Ant. Trim SW Bandswitch BCST/SW Switch Tone	Power Volume Tuning Ant. Trim Sensitivity Radio/Phono
<b>RANGE</b>	15-550M	10-550M	15-550M
Bands	6	5	5
Band Change	2-Sets Plug-In Coils	Switches	1-Set Plug-In Coils
<b>IF</b>	470 Kc Single Tuned	600-750 Kc Single Tuned Set By User, 175 Kc Double Tune	300-500 Kc Set By User
<b>DIMENSIONS</b>			
Tuner	21.5 x 11 x 8.5	19.5 x 12 x 8.5	21 x 10.8 x 7.5
Power	10.8 x 6.5 x 8	(Integral w/Tuner)	9 x 8 x 7
<b>WEIGHT</b>			
Tuner	30 Lbs.	30 Lbs.	-
Power	18 Lbs.	(Total)	
<b>PRICE</b>	\$130.00	\$139.59	\$190.00
<b>INTRODUCED</b>	June 1931	July 1931	May 1931
Superseded	May 1932	February 1932	January 1932
(By)	(Allwave Deluxe)	(727SW)	(SW-32)



ceased for production of military sets during World War II.

#### Credits:

Special thanks to John Peterson of Seattle for loaning me his collection of Silver-Marshall's "The Radiobuilder" and data sheets.

#### References:

Advertisements: *Citizens Radio Call Book Magazine and Technical Review*, and *Radio News*, 1931 and 1932.

Gernsback, Hugo. *Official Radio Service Manual*, (Lincoln SW-31 schematic), ca. 1931.

Hobbs, Marvin. *E.H. Scott, The Dean of DX*, North Frontier Press, 1985.

*Radio News*. "An All-Wave Super Without Plug-in Coils," McMurdo-Silver, August 1931.

*Scott News*: Vol. 4, No. 2, October 1931; Vol. 5, No. 3, January 1932; Vol. 5, No. 7, April 1932.

Silver-Marshall Data Sheet No. 28, July 15, 1931

Silver-Marshall "The Radiobuilder": No. 23, July 15, 1931; No. 24, October 15, 1931; No. 25, February 1932.

*The Scott Allwave Superheterodyne, Instruction Booklet and Service Manual*, 1931.

(Norman S. Braithwaite, P.O. Box 992443, Redding, CA 96099)

Norman S. Braithwaite, an independent civil engineer, began collecting radios in 1975. His speciality is radios manufactured by E.H. Scott and its competitors. His collection includes representative sets from 1917 to 1960, the prize being the rare Scott 48-tube custom receiver, which he has been restoring for the past 7 years. Founder of the North Valley Chapter of the California Historical Radio Society (CHRS), he served as director from 1989 through 1992.

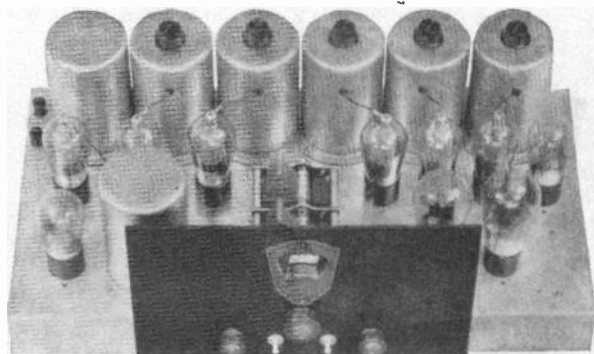

Figure 8. The Lincoln Model 31 from a photo in "Radio News," October 1930.

## The Case of the Missing Mitchells

BY DAVID FULS

"Hey, Ethel, have you seen my radio?"

"No, Fred. In fact, I haven't been able to find mine either. Do you suppose that the carpenters made off with them?"

This is a conversation that could have taken place in the late 1950s, when a small house built in the 1940s in Vina, California, was remodeled and a new room added.

In July of 1993, a friend of mine, Bill Himes, was doing another remodeling job on this same house. In the process of removing a wall, out tumbled two identical Model 1251 Mitchell Lullaby radio/bed lamps.

Bill purchased both radios from the home's new owner for \$15, brought them to me and told me that he wanted one of them back in working

order and that I could keep the other one.

They both needed new electrolytics and a good cleaning. The radio pictured on the right below also needed repair of a small crack (probably from the fall), refinishing, and replacement of the light lens. For the new lens, I used a clear piece of plastic and sandblasted it on one side. It cannot be distinguished from the original.

Both Mitchells have turned out to be good players.

One never knows where a nifty radio might turn up. Just be careful which walls you tear out! Case solved!

(David Fuls, 17347 Deacon Ln., Cottonwood, CA 96022)

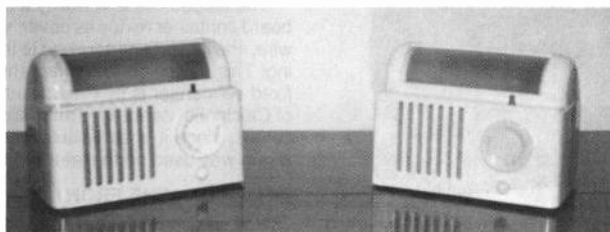

The two Model 1251 Mitchell Lullaby radios that were recovered from behind a wall.

# WITH THE COLLECTORS

## The Crosley Harko Crystal Receiver

BY DAVE CROCKER

Yes, Virginia, there *are* Crosley crystal sets. Rare as they are, they do exist. Let me tell you a little about their history.

Early in 1921, Powel Crosley had been producing various radio components and cabinets. Later that year, he decided to market a complete radio receiver and introduced the tiny Harko crystal set, shown in Figure 1. It sold for a mere \$9 and was virtually one-third the size of the Harko Senior radio receiver. No examples of this first crystal set seem to exist; therefore, the details of its detector remain vague due to the poor quality of the existing advertisements of this receiver.

Crosley's second radio, the Harko crystal receiver, shown in Figure 2, can be described in detail. I obtained the set from a Canadian collector who purchased it in Cincinnati — a good omen, indeed, since Cincinnati was the home of the Crosley enterprise.

The last crystal set Crosley made was the 1922 Crosley Model 1, shown in Figure 3. This set is more familiar, yet is almost as elusive as any of the Crosley crystal sets.

### CONSTRUCTION OF THE HARKO CRYSTAL SET

The Harko crystal receiver measures 6" high by 8¼" wide by 4⅞" deep. Its cabinet is mostly ¼"

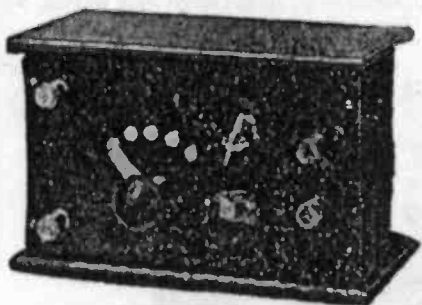

Figure 1. The very first Harko crystal set that preceded the receiver shown in Figure 2. From an advertisement in "Radio News," March 1922.



Figure 2. The Crosley Harko crystal receiver.

plywood with solid wood sides. The stain is a red-brown mahogany. Later sets would have the Adam brown mahogany stain. The panel is also of ¼" plywood, painted black. It's quite obvious that Powel opted for the cheapest nail-and-glue construction possible. Having been in the phonograph and radio cabinet building business himself, he knew how to keep the cost down.

Inside the set, shown in Figure 4, we see the patented Crosley book condenser, designed by Dorman Israel, Powel's associate. This first version was constructed entirely of wood and was the only one to use the all-wood book condenser in its circuit.

The tapped coil is in reality a 3-inch long paper-board container minus its cover, wound with cotton wire, shellacked and screwed to the panel — amazing! This device certainly kept the cost down. The fixed condenser is by the Edward J. Goetz Co. — of Cincinnati, naturally. The wiring is as crude as it comes, since it is all flexible wire. Rigid buss-bar wiring was used on the later Model 1.

### THE FRONT PANEL

Powel Crosley used a binding post bought from a supplier. He designed his own binding post, familiar to many, but it did not appear until



Figure 3. The more familiar Crosley Model 1 crystal set.

tap switch is the same as the one used on many early Crosley sets, again purchased from someone else. Common nails are used for the tap switch stops. The panel's lettering is stamped into the plywood, a true indication of cost-cutting procedures.

### THE DETECTOR

We know little of the first Har-ko detector and only a little more about the Wireless Specialty detector used on the Model 1. However, the detector shown in Figure 5 is truly unique. I've never seen anything like this one, and it seems odd that Powel would choose this unit for detecting on such an inexpensive set. Knowing there were simpler and cheaper units on the market at the time, I wonder why he made this choice.

The cat whisker arm can pivot because of the spring and cotter-pin device holding it to its bracket. The same spring and cotter-pin style is used on the back of the tap switch. The arm can be pulled up or down through a hole in the horizontal shaft to which it is attached. The crystal is odd indeed. It is simply a crystal cup, cut in half and held in place by one screw, allowing it to pivot for better contact with the cat whisker.

*(Continued on following page)*

later on the 2-tube Model VI.

I added a section of hacksaw blade for use as an interrupter for testing the crystal contact. This was often done on early crystal sets of the time. The tuning dial, also procured from a supplier, has a metal skirt and wooden center knob. The

crystal is odd indeed. It is simply a crystal cup, cut in half and held in place by one screw, allowing it to pivot for better contact with the cat whisker.

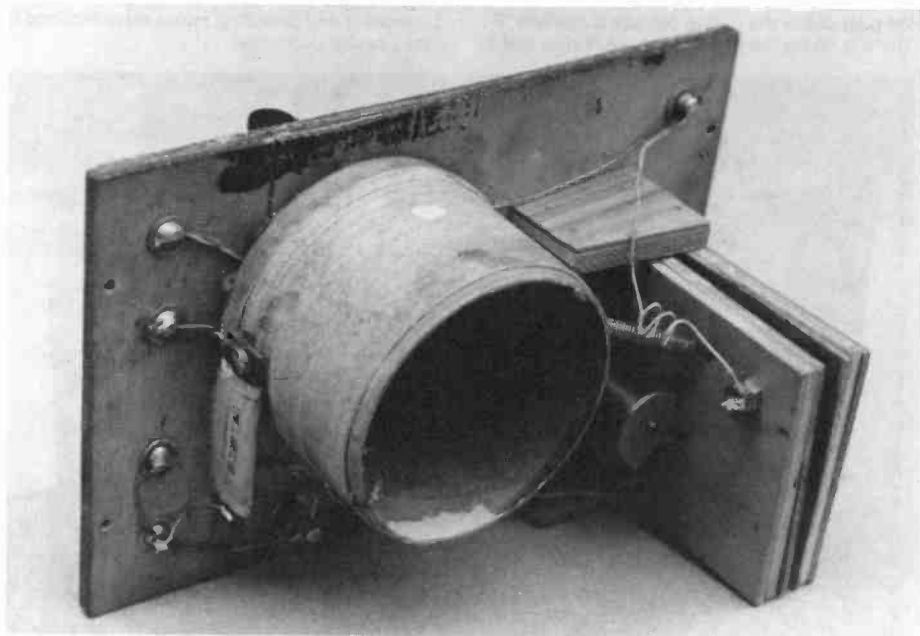

Figure 4. Interior of the Crosley Har-ko crystal set showing its simple, crude construction.

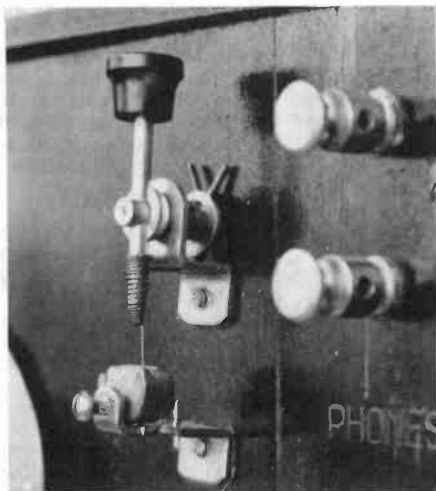

Figure 5. Close-up of the crystal detector used on the Crosley Harko crystal set.

*(Crosley Harko, continued)*

It would be interesting to know whether such a detector was manufactured in the Cincinnati area, as no identification appears on it.

#### OPTIONS

Why are there four binding posts to the right of this simple crystal set? Well, usually there are only the two phone outputs, but here the post above the two phone outputs is marked "G" and the post below the phone outputs is marked "F". There is no mystery here when we realize that in

1922 Crosley advertised a 1-tube Audion detector unit whose 4 binding posts matched only this Harko set and could be added to bypass the crystal unit already on the Harko. How this hook-up was done is shown in Figure 6. Notice that the crystal detector is shown in the no-contact position to allow the detector tube to take over. With the Audion doing the detecting, the Harko reverts to a tuner only.

This capacity to add on components was used to its fullest in 1923 with the famous Crosley modular units. This was how the Crosley Model 1 was connected to an Audion detector, a radio frequency tuner amplifier (RFTA), and a 2-stage audio amplifier. These could all be switched around in many combinations for a system to please its operator.

For a picture of the Harko crystal set, refer to page 29 of the "Crosley Better Costs Less Radio Apparatus" booklet of 1923. If you don't have the original, a popular reprint is available from A.R.C. (\$4.95 plus \$2.50 postage). Pages 29 and 30 deal mostly in words describing how to hook up the Harko, while the picture of the receiver is quite small indeed. It seems that production of this set was just as small. If any of our readers have any of the Harko crystal sets in their collections, it would be interesting to know just how many are still in existence. Drop me a line and let's compare.

*(Dave Crocker, 6 Raymond St., Sandwich, MA 02563)*

*Dave Crocker is on the A.R.C. staff and has been actively collecting radios for over 23 years. A good part of these years has been spent researching and collecting radios manufactured by the Crosley Company.*

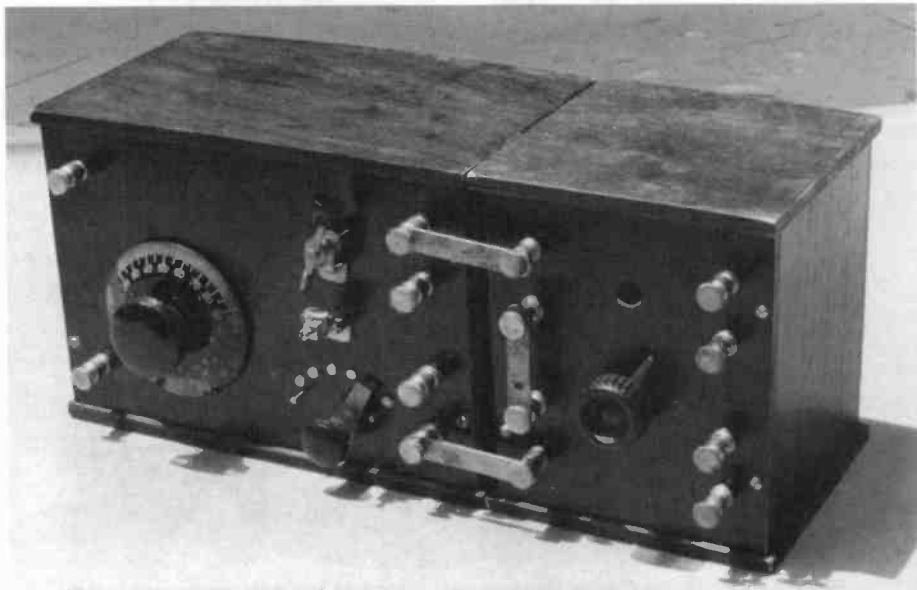

Figure 6. The Harko set connected to the Crosley Audion detector for tube detection.



# RADIO MISCELLANEA

"Antique Radio Classified" invites its readers to contribute letters and information for inclusion in "Radio Miscellanea" and elsewhere in the magazine. The topic should be of general interest and sent to A.R.C., P.O. Box 2, Carlisle, MA 01741. All material submitted should be verified for accuracy and may be edited for publication, which is not guaranteed. See the masthead for more details.

## Skateboard Collector?

Dear Editor:

My grandson saw the November 1993 issue of A.R.C. on my desk and said, "Grandpa, who's this old man in the parking lot with his skateboard?"

James Madison Stanfield, Auburn, AL

## Cleartone Radio Company

Dear Editor:

I would like information on the Cleartone Radio Company of Cincinnati. I recently acquired one of their radios. It is a 4-tube TRF with a solid brass front panel. I also have a small S-shaped horn speaker with the name "Clear-Tone" on the driver. I'm not sure if this is the same company or not. The speaker has been painted black but was originally a gold color, and the bell is brass, possibly to match the brass front of this radio? There is no model number on the radio, and another interesting feature is that the audio transformers are encased in nickel shells, making this a really beautiful radio. I would appreciate any help I could get on this company and possibly the year or name of this model.

David Smith, Granville, OH

*Note: Send information to A.R.C. for inclusion in a future issue. (Editor)*

## Nevr Dull as a Contact Cleaner

Dear Editor:

I have been using Nevrr Dull metal cleaner as a contact cleaner for several years with good results. Nevrr Dull is available as a can of cotton wadding. I initially used the product on the Tormat memory units of Seeburg jukeboxes, which have two rows of nail head contacts that are tracked by contacts as the mechanism scans. The Nevrr Dull leaves a much smoother surface after cleaning than using abrasives like a point file.

To clean other contacts, I have cut small strips (1/4" x 3") of paper drywall tape and soaked them in the cotton wadding for several days. Then I insert the soaked paper between the problem contacts, close the contacts, and pull the paper out, usually covered with black streaks of corrosion from the contacts. Nevrr Dull can also be used on a potentiometer, depending on its style. You may be able to insert the soaked paper under the "wiper" as it sweeps by an opening in the case. I have also soaked Q-tips and round toothpicks in Nevrr Dull by inserting them within the cotton wadding, and used the toothpicks to carefully clean tube sockets. I usually follow up the Nevrr Dull treatment with a good spray of Blue Shower.

Does anyone know of a problem using Nevrr Dull on contacts? Are the chemicals in Nevrr Dull available any other way besides the cotton wadding in a can? A liquid that could be applied directly would be easier to use.

Don Pehlke, Bloomington, IL

## Fan Mail

Dear Editor:

It was a pleasure to met you at AWA — and all this time I thought you folks were old fuddy duddies!

Bernie Samek, Palmer, MA

## Cortlandt Street Memory

A.R.C. learned recently of the passing of Harry L. Schneck at age 94 in September of this year. Readers will remember the July 1990 article on H.L. Schneck, who opened the first radio retail store in lower Manhattan on Cortlandt Street in 1922. The article, written by his son Ed Schneck, tells of the glory days of "Radio Row" in the 1920s and 1930s. Our condolences to Ed and his family and our gratitude for the radio memories now stored in an issue of A.R.C. (Editor)

## Philco Survey Update

Dear Editor:

The Philco Survey is coming along. We now have data from about 230 radios, and that will probably grow to 240 or 250 before we're done. It looks like the report will be in three installments, and the first will be on Models 20 and 21, so there's still time to get questionnaires in for the Models 79 and 90. We'd even welcome more info on the Models 20 and 21, as I will continue to expand the database even after the articles have been written.

The survey form appeared in the August 1993 issue of A.R.C., with corrections noted in the September issue.

Ron Boucher, Goffstown, N. H.

## On A.R.C. & '50s-'60s Hi-Fi Makers

Dear Editor:

Just a few comments on your well balanced and professionally presented publication. I am one of those who would supremely dislike going through A.R.C. in five minutes. That's what would happen if merchandise and services were over-classified. Keep it as is. I still find things at the second reading and others again at the third. It's fun. A hobby has to be fun!

And a suggestion: Why not run a series of articles on the present whereabouts of the leading hi-fi manufacturers of the 1950s and 1960s? It would be most interesting to learn who has recycled himself into what, who has merged with whom, who has just closed his doors while selling his name and logo to the Japanese, and who is still alive and well though maybe lacking exposure. These questions arise when one comes across relatively recent pieces of equipment bearing well known names...from manufacturers that supposedly disappeared long ago.

Léon Brassard, Laval, QC, Canada

*Are there any takers out there on this research project? (Editor)*

# RESTORATION TOPICS

## Testing Your Cleaning Methods

BY ROBERT E. LOZIER

I am 46 years old and expect that it will be necessary for me to sell off some or all of my radio collection to finance my retirement. To protect the market value of my equipment, I keep most of my collection in a temperature and humidity controlled area, but still wonder how much deterioration will take place over the next few decades. There are a few items in my collection that I have owned for more than 20 years, and on recent inspection, they seemed not to be in as good condition as I remember they once were.

The most noticeable change in condition seems to be on the zinc-plated or painted steel chassis of radios and TVs. This made me wonder whether I had used the proper cleaning agents or procedure on this equipment years ago.

I have access to a Tenney Engineering environmental test chamber so I decided to set up an experiment. I cut two aluminum panels, each large enough to hold eight zinc-plated steel electrical junction box covers. These panels are shown in Figures 1 and 2. After cleaning all the box covers with a degreaser (1-1-1 trichloroethylene), I used a marking pen to divide each box cover into three sections.

The left section of each cover was left free of any cleaning agents to serve as a reference. The remaining surfaces (center and right sections) were washed with one of 16 cleaners, listed in Table I, and allowed to stand for about one minute. Then the cleaner in the right section was wiped off with a few light strokes of a cotton ball moistened in distilled water. In addition, the top half of each of the three sections was coated with acrylic lacquer.

The test panels were then placed in the environmental chamber. Since I don't have 20 years to spare, I made an arbitrary decision to subject the test panels to a 72-hour exposure with the temperature set at 85° C and a relative humidity of 90%.

The test results show that the residues of all 16 cleaners will, to some degree, react with and thus accelerate the deterioration of good metal plating. The results also show that the deterioration will be much, much less if whatever cleaner you use is wiped off with a clean rag soaked with distilled water.

I have now posted a sign right over my workshop bench that says "Rinse in H<sub>2</sub>O, Stupid!" I pay 70 cents for a gallon of distilled water at the supermarket. When used only to wipe down parts after cleaning, a gallon lasts a long time.

Since any damaged plating or paint on equipment parts will continue to deteriorate with the

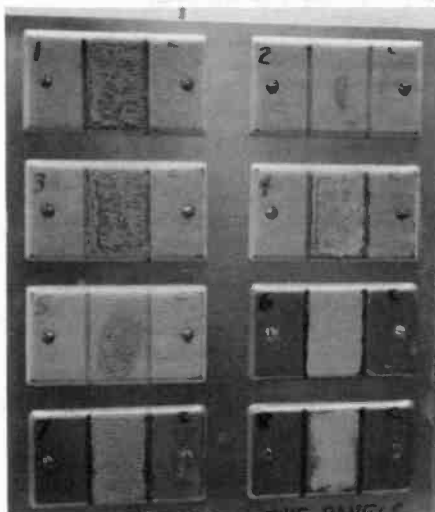

Figure 1. This test panel contains the zinc-plated junction box covers on which cleaning agents 1-8 in Table I were applied.

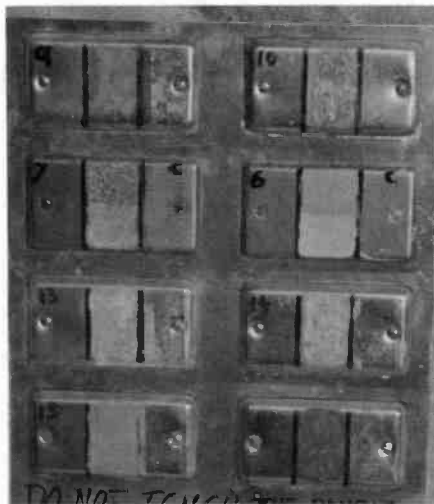

Figure 2. This test panel contains the box covers on which cleaning agents 9-16 in Table I were applied.

**Table I**

Sample	Cleaning Agents
1	Sodium Bisulfite (Ph Minus, Sparex #2)
2	Formula 409
3	Multi-Purpose Cleaner by Armor All
4	Super Clean by Castrol
5	Trisodium Phosphate such as used in TSP by Savogran and Spic and Span
6	Dishwashing liquid
7	Combination of Castrol cleaner and Ph Minus
8	Pine cleaner
9	Household ammonia
10	Chlorine bleach (sodium hypochlorite 5%)
11	Non-Chlorine bleach (hydrogen peroxide)
12	Pledge furniture cleaner/polish
13	Protectant by Armor All
14	Formula 2001 Super Protectant
15	Go Jo hand cleaner
16	Naval Jelly rust remover

passage of time, it is desirable to take measures to slow this deterioration. The easiest way to do this is to apply a clear coating to the old surface that will seal out moisture.

After rinsing the part off, I use a heat gun to warm the part enough to insure that no free water is left in the part. I then immediately give the part a protective coat of satin or gloss acrylic lacquer.

To prove the value of this process, I then sprayed a high quality acrylic lacquer on the top half of the eight test panels. I expected that the acrylic coating would perform a greater service in providing a barrier to airborne contaminants that would collect on the surfaces as time goes by. I then placed the panel in the environmental cham-

ber for another round of heat and humidity.

The test shows that the deterioration of the plating is slowed by the acrylic coating but not to the degree that I had hoped would be the case.

**SUMMARY**

To insure the long-term preservation of your collectibles, you must do three things:

1. Clean the part thoroughly to remove the unknown mix of contaminants that have collected on surfaces over the years.

2. Make sure that you remove all traces of the cleaners used from the past.

3. Cover the part with a protective coating to slow down the additional deterioration that will occur as time goes by.

In the collecting of artifacts, whether they be radios, clocks, works of art or anything else, you should consider yourself to be the "owner at present," not "the owner." You owe it to yourself and the next owner to take active steps to minimize deterioration.

*(Robert E. Lozier, Jr., KD4HSH, 600 E. Green St., Monroe, NC 28112.)*

*Robert E. Lozier, a collector of broadcast receivers for over 25 years, has recently become interested in the development of foreign radio technology. He has presented lectures on radio collecting in Italy, as well as on restoration and preservation techniques, early television, and the Magnavox Company. His free time is spent in developing restoration techniques and in preparing radio artifacts for exhibition.*

**Gridley's Radio Shop — December 1937**

**By Ron Boucher**

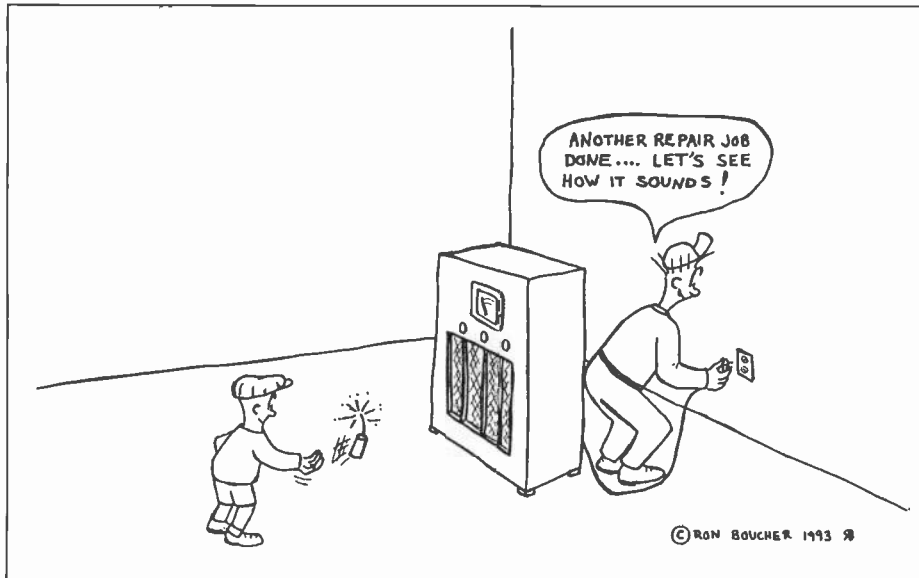



# PHOTO REVIEW



This column presents in pictorial form many of the more unusual radios, speakers, tubes, advertising, and other old radio-related items from our readers' collections. The photos are meant to help increase awareness of what's available in the radio collecting hobby. Send in any size photos from your collection. Photos must be sharp in detail, contain a single item, and preferably have a light-colored background. A short, descriptive paragraph **MUST** be included with each photo. Please note that receipt of photos is not acknowledged, publishing is not guaranteed, and photos are not returned.



**PHILCO MODEL PT-87** – These two AC/DC battery portables are identical except for the leatherette covering over the wooden cabinets and their vintage; the one on the left is 1941, while the other is 1942. The original P-87 battery pack cost \$7.50, occupied the bottom third of the cabinet, and weighed almost as much as the radio itself. (*Barry Cheslock – Arlington, VA*)



**WOOLAROC MODEL 3-1A** – This Art Deco Bakelite 5-tube set, circa 1955, was manufactured by Phillips Petroleum. It is 15 inches wide, 8 inches high, and 7 inches deep. (*Randy King – Lincoln, NE*)



**TELETONE MODEL TV149** – This 1948 TV uses 21 tubes and a 7-inch picture tube. (*Tony DeMara – Mt. Clemens, MI*)



**PHILCO MODEL 18** – This remote control radio consists of two units. The larger cabinet is a slant-front speaker enclosure. The chassis and radio controls are housed in the smaller Queen Anne cabinet. (*Cort and Eileen Ancman – San Antonio, TX*)



---

## PHOTO REVIEW

---



### THE HARTMAN PEDESTAL REPRODUCER

— Patented on November 25, 1924, this brown mahogany unit stands 4 feet tall, weighs 13 pounds, and has four 4" x 9" grilles. It is powered by a Utah driver. (Harry Kundrat — New Providence, NJ)

---



**E.H. SCOTT PHILHARMONIC** — A common problem for the E.H. Scott collector is owning a Scott chassis with no cabinet. To display and operate a set in this state is often difficult. Such was the case for my Philharmonic. The problem was solved this year when Art Hobson of Oakville, Ontario, built this Napier console from scratch. Art receives an A+ for a job well done. (Scott Guthrie — Guelph, Ontario, Canada)

---

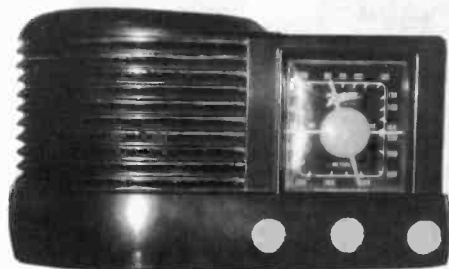

**ZENITH MODEL 6D516** — This 6-tube set, ca. late 1930s-early 1940s, has a popular cabinet style, which is similar to the push-button Model 5R312. (Richard Arnold — Lone Grove, OK)

---



**CROSLLEY MODEL 148** — This 1934 Deco tombstone uses the "fiver" chassis. (Alexandria Nelson — Albuquerque, NM)

---

# WITH THE COLLECTORS

## The Hornbox Horn Switcher Box

BY ROBERT PERLSTEIN

I enjoy collecting horn speakers. Part of the fun is showing them off to my friends. My horn speaker demonstration consists of comparing and contrasting the design and the sound quality of my various types of horns. I got tired of plugging and unplugging my speakers from the radio set during a demonstration. It's much more dramatic to switch quickly between speakers. I also found it handy to have a "better" audio source than an antique radio especially when I'm servicing or restoring an antique horn or cone speaker.

To fill the need I built a simple switcher box — a "hornbox." Actually it's more than just a switch box. It also contains a matching transformer so that devices with low impedance outputs, such as audio amplifiers meant to drive 8-ohm speakers, can be used to drive high impedance horn speakers. I also included switching so that antique radios can be used to drive low impedance speakers such as modern permanent magnet (PM) loudspeakers as well. It took me one evening to put this switch box together.

In a nut shell, this switch box contains two 4-pole, 3-position rotary switches, an Input Select Switch, a Speaker Selector Switch, and an audio transformer. The Speaker Selector Switch routes the audio signal to one of three speaker connectors, and the Input Switch selects input and output impedance matching.

The Input Switch selects three possible input connection schemes. In the "Direct" position this switch connects the input terminals directly to the speaker selector switch. In the "Hi-Lo" position, the input terminals are connected to the high impedance primary of the matching transformer, and the low impedance secondary is routed to the speaker selector switch.

In the "Lo-Hi" position, the input terminals are connected to the low impedance secondary of the matching transformer and the high impedance primary is connected to the Speaker Selector Switch.

The Speaker Selector switch- es both the positive and nega-

tive speaker terminals. This prevents any potential leakage or cross-coupling conditions, insuring that only the activated speaker is energized, especially when the speaker is connected as part of the DC plate circuit of a radio's output tube.

I housed the "hornbox" circuitry in a small plastic box. Obviously the circuitry could be contained in any convenient enclosure. It could even be constructed breadboard or haywire style.

I used binding posts to make convenient connections to the switch box approximately 5 3/4" wide by 3" high. Since many horn speakers use phone tips as connectors, you could use tip jacks instead of binding posts. Binding posts are more versatile for connecting to and from the switcher box since they accommodate phone tips as well as many other types of leads.

For the selector switches I used standard 3-position, 4-pole rotary switches. When switching between speakers, the rotary switch I've specified ("break-before-make" type, also called "nonshorting") momentarily disconnects the speaker from

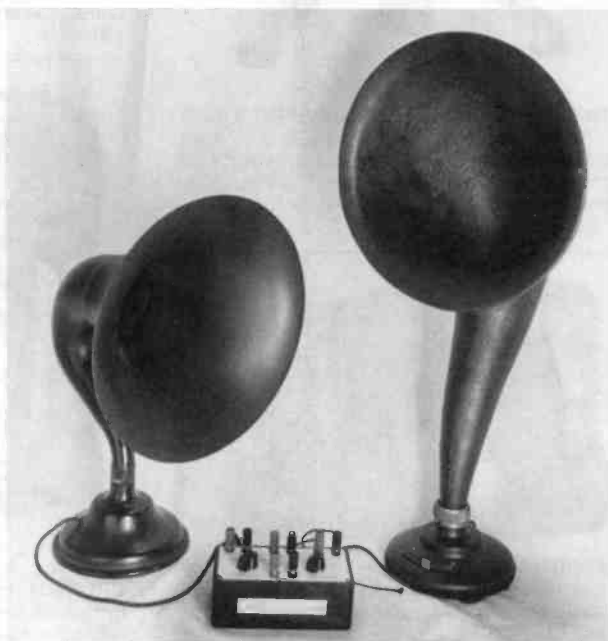

Figure 1. Two horns and the hornbox.

the radio. The result is a voltage transient which can cause loud, clicking noises in the selected horn speaker as it is connected to the radio. This sound is probably most bothersome if you use headphones instead of a loudspeaker with the switcher box.

### THE TRANSFORMER

I determined the matching transformer's characteristics by experiment. I chose a transformer for the best compromise between primary and secondary impedances — first, by matching a typical horn speaker to a low impedance amplifier; second, by matching the plate circuit of a 201 tube to a modern 8-ohm PM loudspeaker. If you want to make the input selector switching circuit more complex, you could use two matching transformers to produce the best coupling between high and low impedance devices and vice versa. For most applications, my single transformer hookup works fine.

One winding of a typical matching transformer should mimic a horn speaker driver while the other winding provides matching to a low impedance PM speaker. Therefore the transformer should have a 1,000 to 2,000-ohm impedance primary winding and an 8-ohm secondary impedance winding. Keep in mind the DC resistance (as measured by a VOM) of either a horn speaker driver or the transformer windings may vary substantially from the actual AC signal impedance.

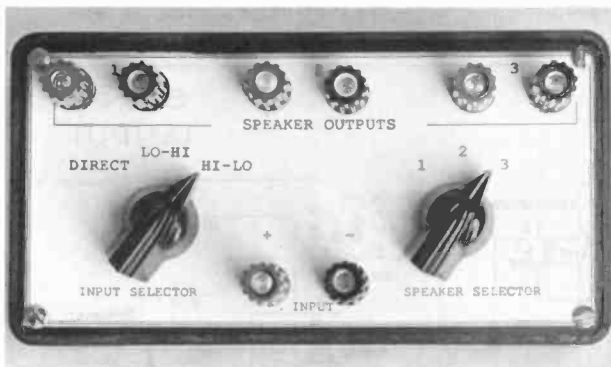

Figure 2. Front panel of the hornbox.

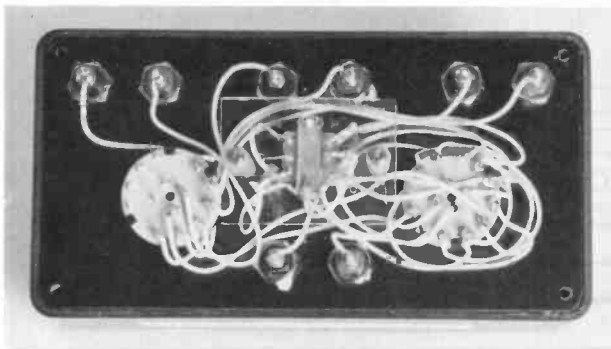

Figure 3. Rear view showing internal wiring.

The use of a "make-before-break" or "shorting" type of rotary switch for the Speaker Selector Switch will minimize switching noise. However, all speakers in use at a given time must be of the same type (high impedance or low impedance). Of course, high impedance headphones and speakers may be mixed.

Use of a shorting type switch for the "Input Select Switch" is not recommended. If the switcher box is connected to a radio without an audio output transformer, switching from the "Direct" to the "Hi-Lo" position will cause the radio's B+ voltage to appear at the speaker output terminals. (Editor)

I used the 8-ohm output of an Echophone Model EC-1 radio connected to the low impedance winding of my impedance matching transformer. The high impedance winding I connected to a variety of horn speakers, such as the Atwater Kent Model H, the RCA UZ1325, and others. I tested numerous transformers this way and selected those which seemed to allow the EC-1 radio to drive the horns loudest.

Next, I used an Atwater Kent Model 32 radio to drive an 8-ohm PM loudspeaker via the same transformers. This time the high impedance winding was connected to the radio and the low impedance winding to the PM speaker. The transformer I decided to use provided the best compromise between allowing the Echophone EC-1 to drive the horns the loudest and allowing the AK 32 to drive the PM speaker the loudest.

You could experiment with transformers in the same way. If you have a well stocked junk box, I'm sure you'll come across an old output transformer that will work. The miniature transformer I specify works fine. Although the manufacturer does not provide voltage insulation specifications, I have had no trouble from arcing or voltage leakage using the typical 90-135 volt B+ potential most antique radio output tube circuits specify (Type 201s, 210s, 199s, etc.).

You should keep the insulating capability of your matching transformer in mind if you plan to use the impedance matching feature of this switcher box with radios that use power tubes such as the Type 171A in the output stage. Also make sure that the transformer has an adequate audio power rating.

It should take you one evening to construct the hornbox. All of

(Continued on following page)

(Hornbox, continued)

the parts are readily obtainable. I have provided a source for the parts I used on the following page. If you have a well stocked junk box, or go to a hamfest armed with the parts list, it should cost very little to construct this unit.

### PANEL LAYOUT AND WIRING

Figure 1 shows two horns and the hornbox. Figure 2 is a direct view of the hornbox front panel. Component layout is not critical. Figure 3 shows the internal wiring for which I used point-to-point wiring technique. A schematic diagram is provided in Figure 4. I mounted the transformer on a small piece of acrylic plastic. The plastic is, in turn, screwed to standoffs which are dowels that have been epoxied to the hornbox front panel.

Once you've wired the unit, I suggest you check for proper continuity and short circuits with an ohmmeter. Set the Input Selector Switch to the "Direct" position, and be sure that the positive input terminal connects to each positive speaker terminal with every corresponding position of the Speaker Selector Switch. Do the same for the negative input terminal. Then check to be sure none of the speaker terminals are connected together.

Next, select the "Lo-Hi" position with the Input Selector Switch. There should be no continuity between the input and output terminals. If there is, either you have a wiring error or the matching transformer windings are shorted together. Set the input switch to the "Hi-Lo" position and perform the same test.

Now check to be sure the DC resistances of the transformer windings correspond to the input switch settings. For example, if you use the transformer I've specified, when the input switch is in the "Lo-Hi" impedance setting, the DC resistance across the input terminals of the switcher box should be approximately 1 ohm. The resistance across the speaker connection terminals should be about 80 ohms.

When the input selector is set to the "Hi-Lo" input impedance position, the resistance measurements should reverse — that is, you should measure 80 ohms across the input terminals and 1 ohm across the speaker connection terminals.

If all the above measurements are correct, you're in business! I made an accessory for the hornbox which is simply a 6-foot piece of head-phone cord with pin jacks on each wire. This cord connects the radio to the hornbox.

**Caution:** When used with radios without an audio output transformer, high voltage will be present at the input and possibly at the output terminals of the switch box. Personal injury or speaker damage may result.

(Robert Perlestein, 17 Vine St., Medford, MA 02155)

*Robert Perlestein, who holds an Amateur Extra Class license, collects "anything and everything." Battery radios are a special interest, as is hi-fi gear. He is an electronic product design consultant — "To afford all the goodies," he says.*

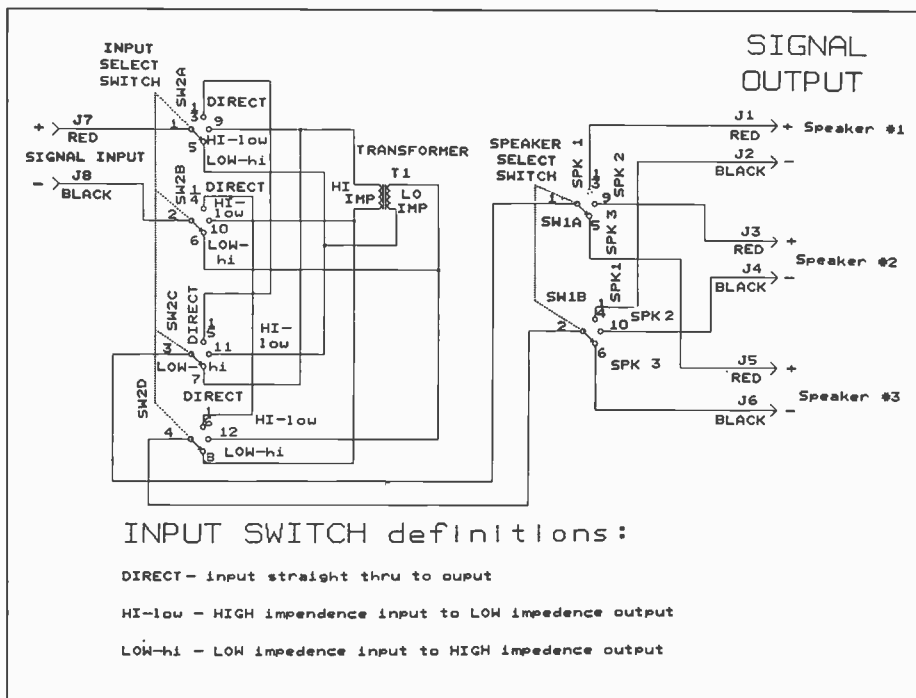

Figure 4. Schematic diagram.

## TABLE 1. PARTS LIST

### Source:

**DIGI-KEY Corporation**, 701 Brook Ave. South, Thief River Falls, MN 56701-0677  
Catalog No. 924, July-August 1992

- 1 ea. Phenolic box, Part #700K-ND - \$4.39
- 1 ea. Phenolic box panel, Part #2037K-ND - \$1.38
- 2 ea. 3-position, 4-pole "non-shorting" rotary switch, Part #EG1957-ND or EG1958-ND (pins or lugs) - \$4.31 ea.
- 4 ea. Red binding posts, Part# J164 - \$1.65 ea.
- 4 ea. Black binding posts, Part# J165 - \$1.65 ea.

### Source:

**Mouser Electronics**, 12 Emery Ave., Randolph NJ 07869-1362.  
Catalog 3570, June 30, 1992.

- 1 ea. Transformer, Part # 42TM003 - \$1.65
- 2 ea. Pointer knobs, Part #45KN012 - 69¢ or 512-2300 - 55¢

### Source:

**Antique Electronic Supply**, 6221 S. Maple Ave., Tempe, AZ 85283  
1993 Catalog

- 6 feet "Old Style Speaker Wire," Part #PW-413 - 40¢/ft
- 4 ea Phone tips, Part #SH-33-156 - \$2.20 pkg/10

### Miscellaneous parts:

- Piece of plastic or perf board (to mount transformer)
- Hook up wire
- Five-minute Epoxy glue (to glue dowel standoffs to panel)
- 4-inch piece of 3/8" dowel (to make standoffs for transformer mount)
- 2 ea. #2 x 1/4" round head wood screws (to retain perf board to standoffs)
- Self-sticking label material (to label binding posts and switch positions)

# CeCo Early Vacuum Tube Designations

COMPILED BY RAY BINTLIFF FROM INFORMATION PROVIDED BY DICK MACKIEWICZ

During the early days of the vacuum tube, U.S. manufacturers managed to achieve some degree of standardization for tube type designations. But it was not uncommon for some tube manufacturers to go their own way and use distinctive designators. For example, Cunningham chose to add the "C" prefix to what were otherwise commonly used tube types. Others, such as CeCo, used some rather unique approaches to tube identification.

Table I provides a cross-reference list of CeCo tubes and the more common tube types. This cross-reference was printed on the reverse side of CeCo tube specifications wrapped around the tube inside the tube carton. It is interesting to note that no equivalents were shown for four of the CeCo tubes. Since CeCo tubes are still to be found, this cross-reference should be useful to many collectors.

(Dick Mackiewicz, 1549 North River Rd, Coventry, CT 06738)

Photo at right: CeCo tubes — part of a Len Arzoomanian display of Rhode Island manufacturers at the 1993 Yankee Tune-Up at the New England Museum of Wireless and Steam, East Greenwich, Rhode Island, on July 31, 1993. (Photo by John V. Terrey)

Table 1 — Cross-Reference List

CECO TYPE	COMMON TYPE	APPLICATION	BASE TYPE	FILAMENT SOURCE
A	201-A	General Purpose	UX Large	Storage Bat.
B	199	General Purpose	Small	Dry Cell
BX	199	General Purpose	UX Small	Dry Cell
C	199	General Purpose	UV Large	Dry Cell
E	120	Power Amplifier	UX Small	Dry Cell
F-12	112	Power Amplifier	UX Large	Storage Bat.
F-12A	112A	Power Amplifier	UX Large	Storage Bat.
G	240	High Mu Amplifier	UX Large	Storage Bat.
H	—	Detector	UX Large	Storage Bat.
J-71	171	Output Amplifier	UX Large	Storage Bat.
J-71A	171-A	Output Amplifier	UX Large	Storage Bat.
K	—	RF Amplifier	UX Large	Storage Bat.
L-10	210	Power Amplifier	UX Large	AC
L-15	—	Output Amplifier	UX Large	AC
L-45	245	Power Amplifier	UX Large	AC
L-50	250	Power Amplifier	UX Large	AC
M-26	226	Amplifier	UX Large	AC
N-27	227	Detector/Amplifier	5-prong	AC
R-80	280	Full-wave Rectifier	UX Large	AC
R-81	281	Half-wave Rectifier	UX Large	AC
RF-22	222	Four Element	UX Large	Storage/Dry
A.C.-22	—	Four Element	5-prong	AC



# MEET AND AUCTION REPORT

## VRPS/AWA Convention & Auctions Irving, Texas — October 15-17

COMPILED BY GEORGE AND MICHAEL POTTER

The Vintage Radio and Phonograph Society (VRPS) and the Antique Wireless Association (AWA) held their 18th annual convention and four auctions October 15-17, 1993, at the Holiday Inn, Dallas/Fort Worth Airport South, Irving, Texas. Over 380 attended this event.

This year there were two main auctions and two silent auctions. The total auction proceeds came to \$35,927 for 577 items, excluding 105 passes.

Some items of note in the auctions were an Atwater Kent 10C breadboard selling for \$500 (a 10B and 10C had too high minimums); a Burns black horn for \$190; a beautiful Federal 141 with cabinet for \$475; a Silvertone grandfather clock radio for \$280; and two Zenith Walton sets for \$525 and \$725, respectively. In fact, anything with Zenith on it sold very well! Cathedrals and Catalins drew much lower prices compared to previous years. Phonographs did very well this year.

The Friday equipment contest had 99 entries, and 62 awards were presented. The Saturday night banquet, attended by 199 people, featured Wes Wire, who once was associated with KLIF Dallas, a Gordon McLendon station.

The Sunday morning indoor flea market, with many early bargains, was a success as always.

The following itemized list is a selection of items from the four auctions. Incomplete listings and boxes of miscellaneous gear have been deleted. Due to the number of items in the auctions and a rushed time element, no guarantee is made of the accuracy of this list. Every effort was made to describe the equipment sold.

Note: Some sets listed do not have model numbers, because none were found on set.

**A warning:** Auction prices are not current values. A listing such as this cannot adequately include the condition of cabinets, chassis, transformers, tubes, the operating status of the set, and the inclusion of incorrect, restored or replica components, etc. Auction prices are the result of the excitement of the auction process, the skill of the auctioneer and the specific interests of the participants. Nevertheless, auction prices serve as useful references and as another element in the value determining process. The possibility of error always exists, and if we are notified, corrections will be reported.

e=excellent, vg=very good, g=good, f=fair, p=poor, unk=unknown, WT=tubes, NT=no tubes, N.I.B.=new in box

At Friday's auction and silent auction 271 items were sold (54 passes) for a total of \$11,148. The silent auction let sellers set their own minimums, while the Friday night auction had a \$10 minimum bid. Auction items included Bakelite/plastics, transistors, tubes, literature, ham equipment, microphones, headsets, test gear and wood/metal sets.

Air King, g .....	\$50
Air King, orig. box, new .....	80
Airline 54BR, g .....	20
Airline 84BR, g .....	44
Airline 1525A, red, g .....	30
Airline Bakelite, f .....	32
Airline portable, g .....	75
Airline TeleDial 6v set .....	34
Arvin 71, g .....	39
Arvin 410T, f .....	50
Arvin 450TL, Bakelite, f .....	20
Arvin 664A, f .....	20
Arvin metal, blue, f .....	25
Arvin metal, g .....	40
Atlas horn driver, g .....	20
Atwater Kent 30, parts box .....	18
Atwater Kent 40, unrestored .....	10
AWA Old Timer's Bulletins, 1975-85 .....	60
Aztec microphones, g .....	20
Baldwin Type C headphones, g .....	10
Belmont 4B115, battery, vg .....	90
Belmont 6D121, g .....	65
Belmont 356, g .....	85
Belmont ED128, white, vg .....	95
Belmont, metal, g .....	60
Bendix 678-A portable, f .....	10
Blabber Mouse, transistors, (2), g, f .....	30, 22
Brush and Brandes headphones, f .....	12
Budweiser bottle transistor, vg .....	42
Burns horn driver and neck, g .....	48
Carron phono model 1000, f .....	22
Cathedral, repro., transistor, g .....	28
Coronado 43-8354, f .....	10
Cow transistor set, g .....	30
CQ magazines, (41) .....	10
Crosley 9S12, f .....	10
Crosley 10-135, g .....	65
Crosley 11-1024, e .....	130
Crosley 11-117U, g .....	85

Crosley 5628-B, SW, g	50	Popular Science magazines, (10), e	10
Crosley battery/SW, f	10	Port-O-Radio, g	20
Crosley Dashboard style, set, g	85	Radio News magazines, (30)	70
Crosley Duette, g	65	Radio News, magazines, 1940-45	20
Crosley, Bakelite, push button, f	28	Radio Rex novelty	34
Crosley, repro, FM/tape	14	RCA Radiola III, f	20
Dalhberg pillow radio, w/speaker, cracked, g	50	RCA 8X681 SW, g	42
DeForest coils, bag	34	RCA 15, Bakelite	27
Dictograph test speaker, g	70	RCA 45 rpm record changer, g	38
Edison Diamond Disc records, (15)	60	RCA 45-EY2 phono	50
Eico signal generator, new	28	RCA 66X1 radio, g	25
Emerson 309, f	14	RCA AR-88, tubes	80
Emerson 756B, f	10	RCA lighted clock	35
Fada 740, cracked, f	22	RCA lighted sign, modern	10
Federal, Bakelite, g	15	RCA Nipper stuffed dog	24
Firestone 4A-68, f	12	RCA TV Lucite lighted sign	60
Firestone 116-11, f	16	Rider's Vols. 6, 7, 8	28
Firestone Air Chief, metal, g	40	Rider's Vols. 12, 13, 14	20
GE 201, unk	26	RME-84, g	42
GE L-631, g	26	Sentinel 335P, f	25
GE, Bakelite, g	26	Shure 3R, single button mike, no ring	40
Ghost Breakers, transistor, g	16	Silvertone 6-178A, e	190
Gonset 211, works, f	50	Silvertone 9001, f	18
Hallicrafters S-22K, g	44	Silvertone No. 1, metal, g	32
Hallicrafters S-36A, e	44	Silvertone, Bakelite	14
Hallicrafters S-38, hums, f	14	Sonora RQU-222 AC/DC, vg	42
Hallicrafters S-53-A, g	35	Sonora, white Bakelite, unk	46
Hallicrafters S-72, f	35	Steamboat paddle wheeler, transistor, g	50
Hallicrafters S-120, f	24	Steinway transistor, g	40
Hallicrafters SR-20, g	25	Sterling tube tester	18
Hallicrafters SX-43, g	55	Stromberg-Carlson, Bakelite, works	85
Hammarlund HQ-129, g	55	Toilet paper roll novelty transistor, g	14
Hammarlund HQ-180, vg	190	Tony the Tiger novelty transistor, g	28
Helping Hand transistor, g	27	Truetone D115, g	50
Hickok 536 tube tester, unk	24	Truetone D2018, vg	110
Hickok 543 tube tester, unk	18	Tube, WD-11, Bakelite, tipped, g	50
Howard 435, g	70	Tubes, 24A, bag of duds	10
Kadette 4-tube, Bakelite, works	80	Tubes, 45, (3), g	24
Kodel 8 battery eliminator, g	15	Tubes, 201A brass tipped, (4), 200A, (1), g	130
Lewol leatherette, vg	75	Tubes, 201A, (27), g	5.50 ea.
Madison-Moore coils, (5), g	22	Tubes, 866A, (28), N.I.B., g	18
Majestic 5A4-10, g	42	Tubes, misc., (7 boxes)	10/box
Majestic portable, f	24	Tubes, ST 80, (6), g	35
Mantola R-654, f	26	Tubes, tuning eye, unk	34
Meters, watch case, (4), g	15	Tubes, UV-199, (3), g	30
Michigan kit set, Bakelite, g	60	Tubes, UX-199, (5), g	50
Mike radio, novelty, p-f	36	Tubes, WD-11, (1) brass tipped, (1) Bakelite, g	80
Mitchell bed lamp radio, f	35	Valley Electric battery charger	32
Motor, electric, old	85	WE 509 headphones, g	14
Motorola portable, f	10	Westinghouse clock radio, 1953, g	40
Olympic, Bakelite, g	55	Westinghouse H-38 portable, f	10
Philco 46-35 portable, wood, g	20	Westinghouse refrigerator radios, f, g, vg	48, 70, 110
Philco 46-420, g	32	Weston meters, (2)	10
Philco 48-123, g	60	Weston meters, (3)	15
Philco 48-200, g	19	Wireless Telephony, Bucher, 1922	14
Philco 49-601 portable, f	10	Zenith 5DQ15, g	40
Philco 50-621	15	Zenith 6D614, g	65
Philco 51-930, works	28	Zenith 7E01 AM-FM, g	35
Philco 53-566	20	Zenith 1939 console shipping box, e	36
Philco 53-658 portable, leather	12	Zenith 86005YT Trans-Oceanic, f	34
Philco Bakelite, f	20	Zenith A500 Trans-Oceanic, g	28
Philco Bakelite, g	24	Zenith Deluxe Royal 500	32
Philco portable, f	20	Zenith J615, f	32
Philco store banner, g	40	Zenith K510, f	17
Philco Transitone, f	40	Zenith L-403 portable, f	42
Philmore AC/DC kit radio, N.I.B.	20		
Pilot battery charger	15		

(Continued on following page)

*(VRPS/AWA Convention and Auction, continued)*

Zenith L-600 Trans-Oceanic, g .....	44
Zenith lighted sign .....	28
Zenith owl set, g .....	50
Zenith Royal 26, new .....	22
Zenith Royal 2000, g .....	25

Saturday's main auction results include Saturday's silent auction items. There were 306 items sold with 51 passes, for a total of \$24,779. This main auction had a minimum bid of \$20 and included horns and speakers, phonographs, records, wood/metal sets, consoles, Catalin radios, TVs, crystal sets, wireless and early broadcast equipment.

Air King 720, AM, g .....	\$40
Airline 675A, g .....	40
Airline chairside console, f .....	75
Arborphone, 1923, NT, unk .....	32
Atwater Kent 5B driver, g .....	25
Atwater Kent 10C breadboard, WT, f .....	500
Atwater Kent 20, incorrect audio .....	55
Atwater Kent 32, NT, unk .....	44
Atwater Kent 33, NT, unk .....	55
Atwater Kent 35, NT, unk .....	36
Atwater Kent 36, NT, unk .....	48



*This Atwater Kent Model 10C breadboard brought just \$500!*

Atwater Kent 36, WT, g .....	75
Atwater Kent 40, NT, g .....	75
Atwater Kent 46, Pooley cabinet, f-g .....	30
Atwater Kent 47, with F speaker restored, vg ..	147
Atwater Kent 49, NT, unk .....	46
Atwater Kent 57A speaker, f .....	26
Atwater Kent 84, cathedral, vg .....	260
Atwater Kent 545 tombstone, vg .....	85
Atwater Kent 558, cathedral, vg .....	270
Atwater Kent 856, vg .....	110
Atwater Kent dealer sign, electric, works .....	280
Atwater Kent E, speaker, g .....	60
Atwater Kent F, speaker, (2), g .....	55, 38
Atwater Kent H horn, g .....	75
Atwater Kent H ignition coil, g .....	40
Atwater Kent L horn, no driver .....	32
Atwater Kent M-46 console, F2 speaker, g .....	65
Belmont 6D11, g .....	25
Boston key, vg .....	85
Brunswick/Radiola AR-813 console, e .....	600

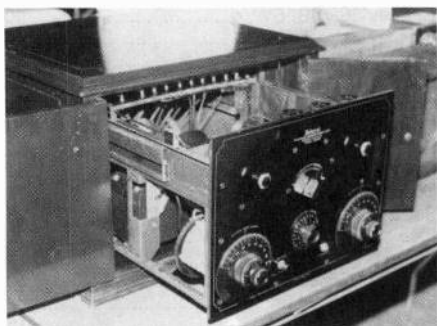

*This beautiful Federal 141 sold for \$475 at Saturday's auction.*

Burns horn, black celluloid, slight crack, g .....	190
Cecilian phonograph, oak, vg .....	110
Clarion Jr., cathedral, g .....	70
Crosley 25W, f .....	70
Crosley 51, wood panel, g .....	35
Crosley 148 cathedral, vg .....	120
Crosley 167 cathedral, vg .....	160
Crosley 1930 Art Deco, mantle, g .....	70
Crosley Deco set w/tuning eye .....	55
Crosley Type F speaker, g .....	42
Crystal set, home brew, (2) .....	24, 47
Crystal set, home brew, metal .....	42
Crystal set, wood, carved man, novelty .....	55
Detrola, g .....	50
DeWald Catalin, g .....	350
Edison 2/4 min. Home cylinder machine w/ original wood packing crate, e .....	850
Edison A-100 phonograph, missing parts .....	70
Edison Amberola 4 min. cylinder phono, vg ..	300
Edison Blue Amberola cylinders, (14), f .....	46
Edison horn (for Home cyl. machine), vg .....	80
Emerson library book radio, g .....	85
Emerson R-262, wood, vg .....	70
Emerson TV, 1950, f .....	20
Emerson, table radio, sliding doors, vg .....	210
Federal 141 Deluxe cabinet, WT, e .....	475
Frede-Eisemann NR5, tubes, g .....	110
GE cathedral, g .....	85
Gilfillan 556, g .....	38
Grebe Synchronphase, WT, vg .....	175
Grunow 116 console, vg .....	110
Guild clock radio, Old Timer, vg .....	80
Guild Country Belle telephone radio .....	35
Halsol 64F, wood, vg .....	120
Hammarlund-Roberts, 5-tube, WT, g .....	90
Hoffman 1951, TV, g .....	20
Home brew crystal set, g .....	28
Home brew crystal set, ornate .....	50
Kellogg candlestick telephone, g .....	60
Kolster K-20, g .....	80
Kolster K-80, console, g .....	65
Little Wonder phono records, (12) .....	120
Loose coupler, g .....	90
Magnavox AC-3 amp, 3 tipped tubes, e .....	300
Magnavox M1 horn, vg .....	120
Majestic 50 tombstone, vg .....	100
Majestic 90-B console, 1929, f .....	32



Majestic console, p	20
Majestic small tombstone, chrome grille, g	130
Metro cone speaker, g	65
Monarch radio table, g	36
Monarch, wood, table, g	35
Music Master 100, NT, f	48
Music Master wood horn, g	100
Peerless speaker, p, g	34, 55
Philco 20, f	55
Philco 37-116 console, vg	250
Philco 37-61 cathedral, g	85
Philco 38 console, battery, g	34
Philco 38, cathedral, f	65
Philco 39-610, g	75
Philco 40-180 console, g	100
Philco 40-216 remote control	110
Philco 41-24, f	20
Philco 52, unk	150
Philco 60, unk	65
Philco 70, hums, unk	160
Philco 81, hums, f	100
Philco 89, e	120
Philco 90, vg	375
Philco chairside, f-g	48
Philco console, g	35
Philco M-610, console, hums, f	20
Philco Predicta TV, f	75
Philco tombstone, g	60
Phonograph horn, brass, 30", dented	65
Phonograph records, 1900-1940, (50)	20
Quack medical device	32
RCA 91-B battery radio, g	160
RCA 100A speaker, f	32

Silvertone 1771, f	32
Silvertone grandfather clock, replaced clock	280
Silvertone metal, AC/DC	40
Silvertone No. 1, f	30
Sky Rover 625, g	38
Sonora RCU-208, 1946, f	34
Sony TV, first transistor model, 1956, unk	110
Spark gap, early	32
Spark gap, home brew	110
Stewart-Warner, cathedral, unk	160
Stromberg-Carlson M-14, speaker	75
Telephone radio, novelty	22
Temple metal radio	55
Victor VV-VI, g	170
Watterson 46-transistor, wood set	25

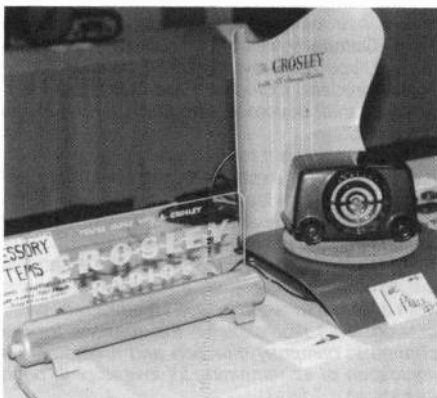

A Crosley advertising display by Barry McDaniel of Little Rock, Ark., received Best of Show.



This Magnavox AC-3 amplifier was a good buy at \$300.

RCA phono/console	30
RCA Radiola 18, w/UZ1325 speaker, g	100
RCA Radiola 20, NT, g	65
RCA Radiola 25, w/loop, g	85
RCA Radiola 80, upright, g	85
RCA Radiola III, NT, f	36
RCA Radiola III, NT, manual	75
RCA Victor M-128 console	170
Roberts 3-dial, NT, f	40
Setchell-Carlson, g	55

Watterson coin-op motel radio	28
Westinghouse Aeriola Sr., NT, g	100
Westinghouse Aeriola Sr., restored dials, WT, g	150
Westinghouse Aeriola Sr., WT, (2), g	95,85
Zenith 5-S-33, 1936, hums	80
Zenith 7-J-368 console, restored	145
Zenith 7S console, f	60
Zenith 8-S-661 console, g	140
Zenith 10-S-669 console, vg	170
Zenith 12-S-568 console, 1942	90
Zenith 34P drum dial radio	90
Zenith chairside 8-S-647, 1942, g	270
Zenith chairside, black dial, f	110
Zenith D-630, vg	60
Zenith S-808 console, tuning eye restored	170
Zenith Stars & Stripes, table, g	100
Zenith Walton 7-J-232, AC/DC	725
Zentih Walton 7-S-232, missing parts	525

(George Potter, 2069 Sienna Trl., Lewisville, TX 75067)

For information on the Vintage Radio & Phonograph Society (VRPS), write Larry Lamia, P.O. Box 165345, Irving TX 75016. Club dues are \$13.50 per year.

# VINTAGE HI-FI

## The Heathkit Amplifier Model A-7C A Lifetime Occupation In A Box

BY FRED GEER

*After completing a consumer survey on Heathkits, a marketing consultant once said to the Heath Company president, "You don't have customers, you have evangelical loyalists!" Many of our readers, including Fred Geer, are long-time Heathkit devotees who probably qualify as "loyalists."*

*As a supplement to Fred's nostalgic article on his first Heathkit experience, we offer some excerpts from "The Heath Story," a company history of the development of the Heathkit concept from its beginnings in 1926 to 1976.*

*For those who might wonder why Heathkits are no longer available, we also provide excerpts from a flier attached to a 1992 Heathkit mail order catalog. This flier explains the reasons for the change in company direction and promotes the liquidation of its remaining kit inventory through its catalog. (Editor)*

A big lump formed in my throat as the letter disappeared into the mailbox. The letter contained a check and an order for a Heathkit audio amplifier Model A-7C, shown in Figure 1. Seventeen dollars and fifty cents represented nearly 6 months' allowance. My mind flashed from excitement and happi-

---

**"Hi-fi was the latest electronic development, and Heathkit's price was attractive. Still, deep in the back of my mind, was a nagging question — could I build it and make it work? Life would be unbearable if I failed, and all my beautiful dreams would turn into nightmares."**

---

ness into total depression. Enormous questions tore my emotions in all directions. Could a 15 year old build it? What if it did not work?! That one tugged at me, but the letter was on the way.

You can't imagine the anticipation a boy suffers when a Heathkit is on order. All these doubts haunt you each day. Week one isn't too bad, but in the second week a new fear enters the picture.



Figure 1. Heathkit Model A-7C audio amplifier.

Was the letter lost? Had the post office smashed the package?

Having built a 3-tube radio from a "Progressive Edu-Kit" Mom had given me for Christmas, I did have a small amount of credibility and confidence. However, that was just beginner's stuff, and poor directions had not enticed me into building the other 14 projects. A Heathkit was the real thing!

Hi-fi was the latest electronic development, and Heathkit's price was attractive. Still, deep in the back of my mind, was a nagging question — could I build it and make it work? Life would be unbearable if I failed, and all my beautiful dreams would turn into nightmares.

Finally, a small box with Heathkit's name emblazoned on its side arrived. My nervous hands carefully tore open that delightful box. Inside, all neatly packed, were the parts needed to build my dream.

A bright yellow and black booklet held the key. It explained everything one would ever need to know about 6-watt amplifiers. Excitement blurred my eyes, making reading the booklet even more difficult. As my heart pounded, I sorted through all the packets, checking with the booklet to make sure nothing was missing.

Following the directions, I performed each task. First, nut and bolt construction slowly made the amp take form, and it began to look like the magazine picture. A big pictorial showed where all wires and parts should be located. With the booklet's directions and the large drawings, a mistake would be hard to make. There were even descriptions of how to make professional-looking pigtails on each end of the shielded wire.

After frantic hours checking and double-checking my work, I sat back and admired the little amplifier. Would all that back-breaking work be in vain?

Temporarily hooking up the speaker and phono-graph, I faced the big moment! My shaking

hand powered up the amp. What seemed like forever passed as my watchful eye, ear, and nose strained for any sign of improper operation. As the tubes began to glow, a slight hiss came from the speaker. A press of the reject button, and the phono dropped the first record. My heart was thumping and my mouth was dry as the phono went through its cycle. I could hear its amplified movement through the speaker. It was working!

All my anxiety was over when the needle touched the record and very loud, beautiful music filled the room. Adjusting the bass and treble made the music sound better. My heart had slowed, and my cold sweat subsided. I was very proud of what I had built.

That little Heathkit gave me a lifelong occupation/hobby and the confidence that I could do anything! No doubt many of us got a start because Heathkit had done such a good job teaching electronics. These thoughts about my first Heathkit were brought into focus by Heath's announcement in June of 1992 — the company has shifted from kits to the burgeoning electronics education market.

The 40-year kit craze is officially over!

#### References:

*Popular Electronics*, October 1954, pp. 84-86, 91, 117.

*Radio Electronics*, Feb. 1951, p. 83.

(Fred Geer, 6042 Brookridge Rd., Jacksonville, FL 32210)

*Fred Geer's radio collecting began in 1953 with a Shure microphone and an RCA R-32. In addition to his collection, Fred owns around two thousand old-time radio programs which he can broadcast to any radio in his house. Through his articles, Fred likes to help others explore various aspects of collecting and radio history.*



## The Heath Story

COMPILED BY DICK DESJARLAIS

*In 1976, the Heath Company published a brief history of its origins and the development of the "kit idea." The philosophy of the company and a few excerpts from the history are presented here.*

### THE HEATHKIT HISTORY

Ed Heath, who had a colorful flying career already behind him by 1926, founded the Heath Airplane Company in Chicago. Within a short time, he had designed and tested a series of light single-wing sport and racing planes known as Parasols. Ed Heath took the even more signifi-

cant step of producing and marketing the Parasol in both assembled and kit forms.

A test flight crash in 1931 resulted in Ed Heath's untimely death.

During 1935 and 1936, a new investor, Howard Anthony, reorganized the company and moved it to Benton Harbor, Michigan. In 1941, the forerunner of the *Heath Catalog* appeared with the title "The Heath Beacon."

Heath's business increased over 300 percent in the war-production years of 1941-1942. By the

*(Continued on following page)*

(Heath Story, continued)

end of World War II, surplus electronic parts and accessories became available in large quantities and varieties. The Heath Company began to procure and assemble groups of these parts (or kits) and offer them for sale.

The electronic kit business started in 1947 with a simple oscilloscope put together from World War II surplus parts. From the first kit, Heath steadily expanded its line of products until, in 1976, its product line included nearly 400 items.

#### WHAT HAPPENED TO HEATHKIT?

In 1992, the Heath Company made the decision to discontinue its Heathkit product line. The company published a flier explaining the reasons for its decision and attached this flier to copies of the 1992 *Heathkit Catalog*. Excerpts from this flier follow:

"BENTON HARBOR, Mich. — Recent articles in *The New York Times* and *Forbes* magazine notwithstanding, Heath Company is alive and well, and thriving here in Benton Harbor, Michigan, its home for over half a century.

Bill Johnson, president of Heath Company and longtime Heathkit builder, puts it this way: 'To paraphrase Mark Twain, the rumors of our demise are greatly exaggerated. Contrary to what you may have heard, we are not,' he emphasizes, 'not going out of business. We are, however, changing our focus from the rapidly shrinking electronic kit business to the burgeoning electronics education market.' "

Johnson goes on to explain that the current nature of electronics no longer lends itself to kits. The diodes, resistors, capacitors and other components that used to make kit building so fascinating and challenging have been replaced by integrated circuits on printed circuit boards. On the other hand, Johnson adds that "demand for electronics education has been growing at an increasing rate for years, and is projected to continue growing well into the future. More and more schools, businesses and individuals are discovering that understanding the basics of electronics and computers — and how to apply them

— is absolutely essential in this day and age. And that — in a nutshell — is why we're exiting the kit business and concentrating all our energies on electronics education."

Reaching the decision to exit the electronic kit business wasn't easy for the folks at Heath. "Our name is synonymous with electronic kit building," says Johnson. "For nearly a half century, people all over the world have been buying and assembling Heathkit shortwave radios, hi-fi systems, TV sets, computers — even robots — and experiencing the great sense of accomplishment and self-satisfaction that comes with the completion of any real challenge.

"I think our kits are going to be missed out there," Johnson adds, "and I know we're going to miss making and selling them."

#### WHAT HAPPENED TO HEATHKIT'S CLOSING KIT INVENTORY?

This is a question that undoubtedly has occurred to those Heathkit loyalists who might have hoped to obtain just one more kit from Heath. The good news is that a limited inventory of the latest kits existed at the time the product lines were discontinued.

The not-so-good news is that a "Last Call" closeout for Heathkits was featured in a 1992 Heathkit mail order catalog. Charles Gilmore, Heath vice president, noted that "In keeping with a long standing tradition at Heath, we want to give our regular customers the first chance to purchase the last build-it-yourself Heathkits we'll probably ever make."

The flier accompanying the catalog proclaimed "Think of this LAST CALL closeout as a retirement party for our famous kits. Join in the festivities, and stock up on the last Heathkits ever made. Don't forget — Quantities are limited and disappearing fast. Order now!"

Chances are that by now the Heathkit inventory is completely gone. But cheer up, Heathkit loyalists! Now you can focus your attention on yard sales and flea markets, searching for assembled Heathkits and Heathkit instruction manuals. Who knows, the day might come when you unearth a Heathkit project, *new in box*, and just waiting to be assembled!

### The Heathkit Philosophy

**A kit is more than just a product...**

**It's a "partnership" between Heath and the customer. He is an integral part of the finished product. He sees, from the inside out, the care that has gone into his Heathkit product. And then, he adds a little bit of himself.**

**His pride and satisfaction make him an exceptionally loyal customer. He knows every wire and resistor. He appreciates the quality, value and sense of personal accomplishment that he just can't get from an off-the-shelf assembled product. He takes pride in saying, "I built it myself."**

*From The Heath Story.*

#### References:

The Heath Company flier, Benton Harbor, Michigan, 1992.

*The Heath Story*, The Heath Company, Benton Harbor, Michigan, 1976.

(Dick Desjartais, c/o A.R.C., P.O. Box 2, Carlisle, MA 01741)

"Heath Nostalgia," a new book by Terry Perdue, a former Heath employee, tells the Heath Company kit story from the first catalog issued in 1925 to Heath's departure from the kit business. The book's 124 pages contain many pictures and illustrations. It is available at \$9.95 from Antique Electronic Supply, P.O. Box 27468, Tempe, AZ 85285-7468. (602) 820-5411. Be sure to check Antique Electronic Supply for ordering information.



## BOOK REVIEW

### Evolution of the Radio, Volume 2

Edited by Scott Wood

REVIEWED BY DAVID POPE

The availability of *Evolution of the Radio, Volume 2*, edited by Scott Wood, should please those collectors who enjoyed the first volume in the series.

The structure of both volumes is simple and straightforward. The author asked collectors to send him photos of individual radios in their collections. These pictures were then compiled alphabetically by manufacturer into an album format, listing the manufacturer, model number and model year as supporting documentation. A current value for each radio is included at the back of both books.

The over 200 color photographs of radios and related equipment in the second volume are larger and clearer than those pictured in Volume 1. Catalog and magazine advertising for American radios of the 1920s through the 1950s is limited to 21 pages of the 226-page book — far less than the 100-plus pages of similar material offered in Volume 1. Contributor listings and present-day dealer advertising fill only five pages of Volume 2.

Examples of radios of all types and styles, as well as amplifiers, horns and speakers, range from the early 1920s to the late 1960s in this edition. Sets from the United States dominate the book, but examples from Australia, Belgium, Britain, Canada, Finland, France, Germany and Italy appear throughout.

The various errors and omissions of the first

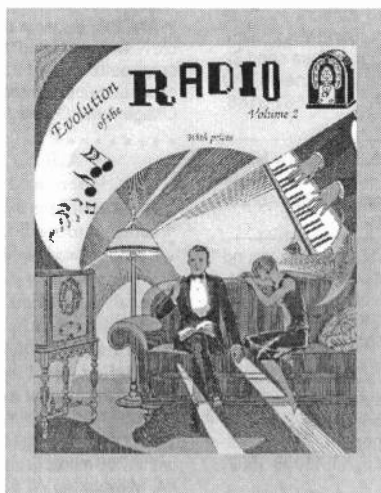

volume have been corrected in this well edited second volume. The price guide seems reasonably accurate considering the drastic value fluctuations currently happening in the hobby.

Potential buyers of the book should not be confused by its title. They will acquire knowledge about radio only through visual observation, since no data explains or supports the "evolution" of the radio. Reasons for changes in styling, materials used and marketing strategies are not given. Concepts such as TRF, superhet and transistor are also not included. Readers must be prepared for nothing more than a nonchronological picture history.

The strength of *Evolution of the Radio, Volume 2*, is essentially this — you will see some radio sets you have not seen before and you will like some of the sets you see.

*Evolution of the Radio, Volume 2*, is published by L-W Book Sales, P.O. Box 69, Gas City, IN 46933. It has 226 pages in a softbound, 8½" x 11" format. The suggested list price is \$24.95, and it is available from the publisher, A.R.C., and other A.R.C. advertisers. Be sure to check these suppliers for ordering information.

(David A. Pope, P.O. Box 89, Plympton, MA 02367)

## Radio Bonfire

CONTRIBUTED BY DENNIS SCHRANK

The following is a brief account of a "tragic" event reported in "Radio News," March 1930. Today's collectors of early equipment will read it and weep. [Editor]

City officials, a squadron of police, and members of the fire department of Philadelphia, Pennsylvania, witnessed the biggest burning of obsolete radios in the history of the industry on a day in 1930 that should be etched in the memories of collectors. Thousands of spectators were attracted to the event, which was held near City Hall under the auspices of Philco's local dealers.

Although scores of other sets were saved as contri-

butions to hospitals and the poor, 1,000 radio receivers, judged obsolete, went up in flames. Actually, the bonfire, presided over by a representative of the mayor's office, was a sales gimmick. It was arranged by J.C. Marden with the idea of boosting the sales of new sets, in keeping, he said, with the Hoover prosperity pleas.

Since ninety percent of a radio receiving set is metal, many parts remained after the fire. These were sold as junk, and the money realized was turned over to the Philadelphia Christmas Seal Relief Fund.

(Dennis Schrank, 3129 S. Quincy Ave., Milwaukee, WI 53207)



# CLASSIFIED ADVERTISEMENTS

**FOR SALE:** Audio Catalog #1 - the personal library of the late Donald Aldous, previous editor of Hi-fi News magazine, comprising hundreds of rare and out-of-print books pertaining to early audio and vacuum tube technology. Many are written by noted authors such as Olson, Crowhurst, Briggs, Moir, Babani and McLachlan. For catalog to be mailed in December, please send \$2 (U.S.), or \$4 (foreign) to: New Wireless Pioneers, PO Box 398, Elma, NY 14059 U.S.A. (716) 681-3186, phone/fax

**FOR SALE:** Axial lead electrolytics. Fresh new Nichicon miniature 22 mFd at 450 VDC - \$1.25 ea. for 8 or more. Includes P&H. DH Distributors, PO Box 48623, Wichita, KS 67201. (316) 684-0050

**WANTED:** Eico ST-40 schematic; 16 rpm background music records; Kostelanetz Columbia LP's: CL-704, 792, 806 and specially 789 Carnival Tropicana. Ferrograph, Leak, Quad tube equipment. Kalamazoo Duplex motor or box. Léon Brassard, 2272 Aladin, Laval, Quebec, Canada H7K 1M2

**WANTED:** Emerson R chassis in reasonable condition, from any model: R-152, R-153, R-156, R-158, R-167, or R-189. Tubes and cabinet not important. Bob Schafbuch, 2811 Highland Ave., Carrollton, KY 41008. (502) 732-6718

**FOR SALE:** Transistorized 201A tubes - \$5 ea. You furnish ducts. Send LSASE for information. Jacob Anthes, Box 52, Lutz Rd., Glidden, WI 54527. (715) 264-5004

**FOR SALE:** Zenith 1SU269, 10S153, 5S319, AK 82, AK 84, Philco 90, Fada Bullet 1000. Kent Martin, 7803 Butterfield Dr., Elkridge, MD 21227. (410) 796-1953

**WANTED:** Any make of American or Japanese transistor radios, working or not. Doug Ferrero, WB8YXZ, 33673 Chatsworth, Sterling Heights, MI 48312. (313) 268-3677

**WANTED:** McMurdo Silver radios, brochures, parts (no test equipment). Have cash and excellent trades. Don Hauff, Box 16351, Minneapolis, MN 55416. (612) 374-9739

**FOR SALE:** Radio Schematics 1920-1960 - \$2.50 ea. TV Schematics 1950-1965 - \$4 ea. ppd. Joseph R. Forth, 321 Long Vue Acres, Wheeling, WV 26003. (304) 277-3154

**WANTED:** BC614 speech amplifier, JB-70 junction box, CX1599 cable - T195 to R392. Kevin Stromgren, 529 South Ln., Granville, MA 01034. (413) 357-6153

**FOR SALE:** Electronic supermarket, transformers. OP=12.2VCT-6A, 8.5V-5A, or 20.7V-5A - \$10/3; OP=40VCT-1.5A - \$10/4; OP-48VCT-3A, 15VCT-1A, 25VCT-.25A - \$10/3; wall type 9.2V-20mA - \$2/6. Sockets miniature 7- or 9-pin - \$3/9. DC fans, grab bags, relays, hardware, silver mica caps - \$5/100. High voltage capacitors - LSASE. 5001 great buys! Fertik's, 5400 Ella St., Philadelphia, PA 19120. (215) 455-2121

**WANTED:** FM tuners from the 1940's and 1950's, small size tube units, with chassis using 1, 2, 3, 4 tube circuits. Any model except Granco. Richard Matiassek, #3, 2212 S. 139th Ct., Omaha, NE 68144

**WANTED:** Buyer in this area to buy a large quantity of old N.O.S. and used radio parts, TV parts, tubes, books, small sets, service manuals, service data. Pick up and cash. Located 12 miles from Camden, N.J. Krantz, 100 Osage Ave., Somerdale, NJ 08083. (609) 783-0400

A.R.C. Advertising Policy  
Sellers and Buyers, Please Note!

Advertising is accepted only for early items related to radio, communication, etc. All items must be described fairly; reproductions, reprints and not-original items must be so identified. Advertisers agree to respond promptly to inquiries and orders, to resolve problems promptly if the buyer is not satisfied, and to comply with a buyer's refund request on unaltered returned items.

**WANTED:** Vox AC-30 guitar amplifier. Will pick-up within 200 miles. Frank Czaja, 8968 West Forest Home, #4, Milwaukee, WI 53228

**WANTED:** Antique brass microscopes. Scientific and medical apparatus. Optical and electrical. Allan Wissner, Box 102, Ardsley, NY 10502. (914) 693-4628

**FOR SALE:** Stewart-Warner, AM/FM tabletop, wood case, 1948 - \$35. Victrola portable, crank, 1930's. WWI combination telephone/telegraph. Electrolysis set, portable (battery), 1940's. Pen Register. Western Electric magneto ground test, 1930's. Meters, microphones, quacks. Code Instructors, tapes. Relays, code keys, parts, telegraph items, Western Union Secret Sounder. 8-page list - \$1 plus 2-stamp SASE. Dr. Joe Jacobs, 60 Seaview Ter., Northport, NY 11768. (516) 261-1576

**FOR SALE:** Stromberg-Carlson work safely patches, 2" x 4", red and blue type, white field - \$5. Jay Volke, PO Box 337, Lyons, IL 60534. (708) 442-0817

**WANTED:** Juvenile fiction books: Wireless Patrol at Camp Brady and Radio Pals Marooned. Robert Stapleford, 1800 S.W. Randolph Ave., Topeka, KS 66604

**WANTED:** Early model transistor radios from Japan. Please send details and price to: Roger Handy, Box 24527, Los Angeles, CA 90024. (310) 451-4040

**FOR SALE:** Cathedrals, all mint. Stromberg - \$395. Pathé - \$450. Philco 70 - \$375. Majestic 15 - \$335. American Bosch 440T - \$365. Gloritone 99 - \$345. List LSASE. Richard Bednarcik, 28 Steele Ave., Lincoln Park, NJ 07035. (201) 694-6374, eves.

**FOR SALE:** Original instruction manual for Scott Model 510, AM-FM-phonograph - \$10 ppd. Harry Blesy, NSCQX, 2409 Northgate, No. Riverside, IL 60546. (708) 442-8855

**WANTED:** Gelo tape recorder, Gelo radio, tube models. Grommes Little Jewel 10-watt amplifier, any condition. Richard Matiassek, #3, 2212 S. 139th Ct., Omaha, NE 68144

**WANTED:** Push button assembly for Zenith 10S464 console, contains 6 channel select buttons. Also interested in 10S464 parts radios. Write or call: Larry Bell, 4314 Silas Hutchinson Dr., Chantilly, VA 22021. (703) 263-9483, before 9 pm EST

**FOR SALE:** Give a stock certificate for Christmas: Columbia Graphophone, 1922 - \$150; Emerson Phonograph, 1915 - \$50; Marconi Wireless, 1912 - \$60; Baird, 1933, TV Limited - \$75; Orpheum Circuits, 1920 - \$30; Collins, 1969 - \$20; Admiral, Sentinel, ATT, Western Union, IRC, TungSol, Philips NV, Jefferson, Travis - \$10 each. J. J. Papovich, 53 Magnolia Ave., Pitman, NJ 08071. (609) 582-8279

**FOR SALE:** RCA V301 console 1940, AM/3SW, tuning eye, w/orig. owners manual, nice shape - \$50. Colin Spence, 107 Pittsburgh Ave., Massapequa, NY 11758. (516) 541-9597



**WANTED:** Bulova 250 series. Any color, any condition. Marty Bunis, RR1, Box 36, Bradford, NH 03221. (603) 938-5051

**FOR SALE:** Sharman-Hozier coherer wireless receiver C1899 by Harry W. Cox, London, with ticker tape printer and key; WWI British Army 2-tube trench set; WWII Polish B.P.5 spy transceiver with Dynamotor; WWII British Type A MKII spy set; German miniature clandestine SSB receiver, C1970. Jim Taylor, G4ERU, 5 Luther Rd., Winton, Bournemouth, United Kingdom BH9 1LH. 0202-510400

**RATE FOR ADDITIONAL WORDS:**

17¢ per word

**FIRST 20 WORDS FREE!**

Cash or stamps OK for small amounts.

Your payment helps to keep A.R.C. healthy!

**MESSAGE:** In our effort to obtain as many schematics of electronic equipment as possible, we have needed to buy all sorts of electronic paperwork. If you collect memorabilia, special paperwork or books, drop us a line with SASE and we will try to help. Lists are impossible. We will also keep you on file. We also want to say thank you to our customer of the past year and wish you Happy Holidays. Joseph R. Forth and East Coast Electronics, 321 Long Vue Acres, Wheeling, WV 26003. (304) 277-3154

**WANTED:** Zenith Trans-OR-7000 1 or 2 for parts. Also running. Phil Marie, 197 Main St., Niantic, CT 06357. (203) 739-9686

**WANTED:** Speaker for RCA 811K or 812K, must include output transformer. Todd Hinman, 182 Judd Farm Rd., Watertown, CT 06795. (203) 274-0705

**FOR TRADE:** 100+ European radios and rare tubes, photolist - \$2. Need 1920's radios, cathedrals, horns. Argirios L. Adamidis, 19 Kampouridi St., Panorama, Thessaloniki, Greece 552 36

**FOR SALE:** N.O.S., and used radio and TV tubes, no picture tubes, send LSASE for lists. C. Elmer Nelson, 11 S. Church St., Princeton, IL 61356

**WANTED:** Info: Heath GR-21, GR-36, 0-11; Fisher 80-R; Echophone EC-2; RCA Q109, WR30B. Thanks. Michael Harla, N2MHO, 1337 Norris Dr., Vineland, NJ 08360. (215) 843-8628

**FOR SALE:** We have a large selection of HV capacitors and electrolytics for tube circuits. Many vintage items. Check out our Tri-Mark dial marker/calibrator. Goodies at prices you'll like. Visa/MC. \$1 brings catalog and coupon. U.S.A./Canada only. Two Fox Electric, PO Box 235, Tivoli, NY 12583. (914) 757-5800

**WANTED:** Temple Tone radio and phonograph assembly Model Number 8-61 or 8-81 or 8-91. Need chassis, power supply, speaker, turntable mechanism and pick-up assembly; workable or restorable. Contact: Billy Calhoun, 2210 Locklaine, Pasadena, TX 77502. (713) 473-4686

**WANTED:** Parts for Capehart 406M. Also, GE Monitor-Top refrigerator, double door model with twin porcelain evaporators in good working condition. Also any service, promotional, accessory items relating to Monitor-Top units. Need to speak with someone with service experience on Emerson brass-bladed fans. Randy Sorenson, 8904 Bancroft View Dr., Spring Valley, CA 91977. (619) 463-5459

**FOR SALE:** Truetone/Detrola Deco wood table set, AM-2SW, multicolor Network airplane dial, Rola speaker, nice - \$80. Jay Myers, 1010 Graybar Ln., Nashville, TN 37204. (615) 297-5886

## RADIO GRILLE CLOTH

YEAR-END SPECIALS  
THROUGH DECEMBER 31 !!

- 1) Discontinued patterns #1B, 1C and 6. Call for new lower prices. Please refer to my display ad on pg. 31 in A.R.C's Oct. '93 issue for my complete grille cloth list.
- 2) Special sale prices on all current patterns  
10 x 12 ..... \$ 4.<sup>50</sup>      20 x 24 ..... \$ 15.<sup>00</sup>  
12 x 12 ..... 5.<sup>00</sup>      24 x 24 ..... 18.<sup>00</sup>  
15 x 18 ..... 9.<sup>00</sup>      51 x 36 ..... 35.<sup>00</sup>  
Patterns #7 and #11 ..... Please call !
- 3) New sampler package available - Buy any 5 patterns available in 10 x 12 or 12 x 12 size for only \$20.00.
- 4) Now available! 5 new console patterns: 29¢ LSASE for these 5 new samples, or 52¢ LSASE for all available patterns.

**MENTION AD TO RECEIVE DISCOUNTS!**

**MICHAEL KATZ**  
3987 DALEVIEW AVENUE  
SEAFORD, NY 11783

**(516) 781-6202 (EVENINGS ONLY)**

**FOR SALE:** 1938 Zenith Distributors Catalog, 170 pages with illustrations of all the 1938 models. This is a quality reprint of an exceedingly rare catalog printed for district representatives, demonstrating the complete 1938 Zenith line of radios. The Stratosphere is pictured along with many unusual models, service data, sales tips and advertising plans. This printing is limited to only 100 copies. A must for all Zenith collectors!!! Please send \$27.50 plus \$2 postage to: New Wireless Pioneers, PO Box 398, Elma, NY 14059. (716) 681-3186, phone/fax

**WANTED:** Emerson, GE, Firestone, and Stromberg-Carlson sales literature, brochures, handouts, etc., showing wood table sets and model numbers, from 1935 thru 1942. Copies only. Bob Schafbuch, 2811 Highland Ave., Carrollton, KY 41008. (502) 732-6718

**FOR SALE:** Receiving, transmitting, and industrial tubes. Large inventory. DH Distributors, PO Box 48623, Wichita, KS 67201. (316) 684-0050

**HELP:** Someone around who could fix tube amps? Léon Brassard, 2272 Aladin, Laval, Quebec, Canada H7K 1M2

**WANTED:** Centralab Compentrol Senior or Junior, or similar tone compensated, tapped, loudness volume controls made by IRC, Mallory, etc. Richard Matiassek, #3, 2212 S. 139th Ct., Omaha, NE 68144

**WANTED:** Catalogues, advertising and texts for pre-1940 electricity, science and vacuum. Ed Graper, 5960 Mandarin Ave., Goleta, CA 93117. (805) 964-7117

**FOR SALE:** Vintage parts. Send stamp and request Vintage Flyer. U.S.A. only. B-E since 1954. Bigelow Electronics, PO Box 125, Bluffton, OH 45817

**FOR SALE/TRADE:** Marconi V2 & ampl., 100% original, working order. German war radio with swastika sign. G. W. H. Faassen, Heideweg 1, 5953 T.L. Reuver, Holland

**FOR SALE:** A large quantity of N.O.S., and used old radio, TV parts, sets, books, tubes, wire, 1000's of items. Located 12 miles outside side Camden, N.J. Pick up and cash. Krantz, 100 Osage Ave., Somerdale, NJ 08083. (609) 783-0400

**FOR SALE:** Transistorized 201A tubes that work like brand new for \$5. Send LSASE. Jacob Anthes, Box 52 Lutz Rd., Glidden, WI 54527. (715) 264-5004

**WANTED:** Original power transformer for Zenith 15U269 console. Kent Martin, 7803 Butterfield Dr., Elkridge, MD 21227. (410) 796-1953

**WANTED:** Sams Sets 45, 47. Auto Radio Books 2-17. Rider's Auto Radio Books. Gary A. Micanek, 226 Henry Ave., Manchester, MO 63011. (314) 227-7046

**FOR SALE:** Reproduction DeForest loop antennas, very well made, wire exactly like original, fully assembled, satisfaction assured - \$125, \$8 shipping U.S. Ed Bell, 5311 Woodsdale Rd., Raleigh, NC 27606. Fax/phone (919) 851-1517

**CLASSIFIED AD NOTICE**

**Please check your ads carefully before sending them in. Once ads are received, it is not always possible to refund the amount sent, pull the ad or make changes.**

**WANTED:** Jackson Bell Model 25 Peter Pan (as in F.O.S., p. 102, lower left). Jack Gray, 1162 Broadmoor Dr., Napa, CA 94558. (707) 226-2550

**FOR SALE:** Replacement meter glass - \$1.50+. Books, tubes, testers, 160+ utility insulators. **WANTED:** Panel meters. Chris Cross, PO Box 94, McConnell, IL 61050

**FOR TRADE:** Atwater Kent Model 337, complete, working original. Will trade for Deco, Streamline Moderne or Machine Age radios. Will consider cash offer. Jim Murray, 7522 E. McDonald, Scottsdale, AZ 85250. (602) 265-7227



**Ralph's Radios**

**c/o Ralph Bonamo  
229 Ramona Ave.  
Staten Island  
NY 10312**

**(718) 356-3410  
Please call  
for details !**

**FOR SALE:  
Repro Radios**

- Phonograph .....\$75
- Multi-color, light-up Jukebox .....\$55
- Cathedral .....45
- Patriot/Bullet/Jewel Box .....30

- AM/FM, most with cassette player
- Ask about discounts for ten or more  
(For five or more with the multi-color, light-up Jukebox)
- Excellent for shows, stores, flea markets, etc. !!
- Send LSASE for color flyer
- Prices do not include UPS
- All checks made out to Ralph Bonamo



**WANTED:** USL catalogs, pamphlets, advertisements - originals or color copies. Also #AC-7 and #AC-6 radios, USL accessories, and USL consoles. Joe Pawell, 6 Augustine Ave., Ardsley, NY 10502. (914) 693-9374

**WANTED:** Information on Worthington Cathedral Model 5, Philco 17B cathedral. Ted Depto, 818 5th Ave., Patton, PA 16668. (814) 674-8834

**FOR SALE:** Power amps: McIntosh MC50 - \$250 or BO; Sherwood S-360 pair - \$150. Tubes testers: Hickok 600A complete, needs work - \$25, F177 military - \$35; new Japanese KT-66's - \$15 ea.; Pilot FM Multiplex unit - \$15; Model T ignition coil - \$20, (original); blue/brass Deco Firestone clock radio, nice & working - \$15; Pilot FM tuner chassis T601 - \$5; lots of early Pilot parts, inquire. **WANTED:** Pilot radios, any model, any condition, any model. Bill Moore, 3049 Box Canyon Rd., Huntsville, AL 35803. (205) 880-1207

## One Month Free!

### BONUS FOR EARLY RENEWALS

If you renew **before** the month shown on your mailing label (your expiration month), you will receive an extra month on your subscription: 13 months instead of 12! 26 months for an early 2-year renewal

**FOR SALE:** Westinghouse H204 - \$50. Philco PT44 - \$75. Truetone D2919 - \$25. Bulova 350 - \$30. Bulova CR 190 - \$20. NRI kit - \$40. RCA 2X62 - \$40. Zenith 6D030E - \$40. Silvertone 2421 - \$50. Lafayette HE51 - \$50. Marshall 638 - \$125. Polaroids one dollar plus SASE. Bud Santoro, 3715 Bower Rd., Roanoke, VA 24018. (703) 774-9153

**FOR SALE:** AD-YU phase meter, needs work - \$35 ppd. Viking 85 tape deck, stereo 7 1/2 - 3 3/4 - \$35 ppd. J. Honl, 717 Green Ave., Stevens Point, WI 54481

## A.R.C. BACK ISSUES

Feb. '87 to current issue: Originals available 32 to 100 pages each.

Oct. '86 to Jan. '87: Reprints available Reprinted from original artwork; 28 to 32 pgs. ea. Quality & appearance same as an original copy.

June '84 to Sept. '86: Photocopies available Not original quality, useful for info.; 16 to 28 pages each.

Publication of *Antique Radio Classified* began in 1984 which had only five issues: June, Sept., Oct., Nov. & Dec. 1984. 1985 through current year have had 12 issues each.

**\$4.00 each - Postpaid to U.S., Canada and Mexico.**

Orders of 6 issues or more may take a 10% discount. Foreign orders other than Canada and Mexico: \$6.00 each by air. Mass. residents, please add 5% sales tax.

### A.R.C. UNCUT, UNFOLDED COVERS

June 1991 to the present  
9.25" x 12.5" - \$9.95 each

Postpaid to U.S., Canada, & Mexico  
Mass. residents, please add 5% sales tax.

Send Order To:

A.R.C., P.O. Box 2, Carlisle MA 01741



Or Call (508) 371-0512



**FOR SALE:** Victor Orthophonic Victrola, Model 8-4 - \$425. Cabinet for Auto Orthophonic Victrola 10-35. 1947 Sparton 10-76-PA AM/FM/phone - \$60. Richard Trahan, 551 Wrentham Rd., Bellingham, MA 02019. (508) 883-8340

**WANTED:** Philco Model 37-33B cathedral battery operated. Aircastle Model 1070B-157 tombstone battery operated or Cabinette and speaker for same. Regulator tubes 5E1 and 1A1. Grid-Dip meter covering broadcast band. Instruction manual for Zenith 12S265 has 1204 chassis. Gale Roberts, 912 Church St., Clyman, WI 53016. (414) 696-3491

**FOR SALE:** Sams Photofacts Set 224-1549 complete - BO. Jim Hensen, 4196 Pheasant Dr., Carson City, NV 89701. (702) 885-0347

**WANTED:** Crosley chassis for grandfather clock Playtime, could be #124. Also novelty transistor whiskey bottles, and parts for Westinghouse Little Jewel ref. radio. Maurice Labrie, 38 Shank St., Lewiston, ME 04240. (207) 782-7864. Fax (207) 783-4220

**WANTED:** Westinghouse: RA, DA, RC, RT, AR, DR, CB load coil. Clapp-Eastham: HR, HZ & other apparatus. Tubes: UV200, UV201, UV202, UV203. Stu Mount, K2OA, 35 Grand, Highland, NY 12528. (914) 433-7714

**FOR SALE:** "Mirror in the Lid" TV Emerson #609. Also over 11,000 N.O.S. tubes, coils, Sams, knobs - make offers. Jim Brown TV, 7708 Main St., West Rushville, OH 43163. (614) 536-7322

**FOR SALE:** AK 856 tombstone, vg - \$100. Freshman Concert table radio with built-in good speaker - \$150. Zenith radio/phonograph, 1953, excellent cond. in original box - \$60. B-D 4R in excellent cabinet with B/P & Browning manual - \$120. Clapp-Eastham Model DD, 1923, wrong coil - \$125. All plus UPS. LSASE for list of 82 others. Wally Worth, 2 W. Elm Ave., Wollaston, MA 02170-2938. (617) 479-4512

## Bellingham Antique Radio Museum

The museum wishes to obtain more examples of pre-1927 radios.

We will pay top dollar for single pieces or entire collections.

We have some duplicate material for trade.

Please call Jonathan Winter:  
(206) 734-4168

or write to us at:

1421 Saint Paul Street  
Bellingham, WA 98226

**WANTED:** Airline Rudolph radio. Bob Brooks, 418 No. Main St., Suffield, CT 06078. (203) 668-8950

**WANTED:** General Radio Company catalogs, instruction books, old Experimenter magazines and apparatus. John Tiedeck, 212 Grandview Rd., Media, PA 19063. (215) 566-8049

**FOR SALE:** McIntosh MX-110 tuner-preamp w/factory cabinet, service and owners manuals. New and used tested tubes. No list. State wants. Ex: KT 88 used tested reads over 90 In scale - \$30. **WANTED:** Knobs for Zenith H-725. Will buy junker set. Zenith 5-G-2617, and 7-S-634. Still looking for dial and shields (3) 6K7 (2) and 6O7 (1) for Philco 37-620. Carlos Martinez, #21 Colonel Irizarry St., Cayey, PR 00736. (809) 263-2741

**WANTED:** Any crystal set. Collection now at 276 pieces; seeking more. Erwin Macho, Ambrosweg 17A/8, A-1230 Vienna, Austria. (01143)-1-8814203

**WANTED:** Eveready #2 speaker. Eveready radios. Flashlights & catalogs. Subscribe to Flashlight Newsletter - \$12 year. Bill Utley, PO Box 1425, Tustin, CA 92680. (714) 730-1252

**FOR SALE:** Televisions, radios, hi-fi & stereo consoles from the 40's, 50's and 60's. Call or write for free catalog. Al Anderson, 510 Park Ave., Mechanicville, NY 12118. (518) 664-6846

**WANTED:** Dial glass and speaker for Scott 510. Write: Giovanni Verrienti, Via Magenta n. 12, 10097 Collegno (TO), Italy

**WANTED:** Philco table model 41-231 (Bunis, p. 130), good condition please. Tom Vaughn, 2016 Village Rd., La Porte, IN 46350. (219) 324-3494

**WANTED:** Harman Kardon Citation III X stereo tuner or owners manual. Jack Philpot, 632 E. 160th Ct., South Holland, IL 60473

**WANTED:** Incomplete, damaged telegraph, and Vibroplex type keys, parts and pieces, also new items. James J. McGrath, W2IOJ, 2 Centerview Ln., West Seneca, NY 14224-2124. (716) 675-0160

**WANTED:** Zenith Bakelites of 40's & 50's. Cash or trades considered. Send details: Harvey Leners, 5426 So. 185, Omaha, NE 68135

**FOR SALE:** Thirty Bakelite/plastic radios, all work and are in nice condition. Also four working wood radios.

**WANTED:** Emerson Midget 504A for Xmas gift. Also buying other type Midgets working or not OK. John Piotrowski, 807 Severn Ave., Metairie, LA 70001-5152. (504) 831-4353

**WANTED:** Good power transformer for Sparton Model 410 Jr. or 420 Jewell. Forrest Baker, 1558 W. Garfield, Davenport, IA 52804. (319) 391-7870

**FOR SALE:** Transistors: Zenith RC20L & Royal 2000. Bulova 10. Lloyds TR6KA. Sonic TR99. Browni 3-band. Coronet 2 trans. new in box w/antenna, case, & earphone. GE P826A, small w/wire handle. Airline GEN1253. Hitachi TH-100. Swank desk lamp radio. Tip Top balancer. Switch It. Tropicana. Yogi Bear. Pocket Rocker. Barbie figural 2D. Body Phone. Musicooler picnic cooler. Novelty plates; 12, 15, 45, 109, 131, 139, 149, 179, 195, 199, 220, 222, 250, 268, 308, 309, 317, 328, 338, 402, 408, 438, 463, 478, 486, 496, 497, many more. Picture tube for old projector TV #5TP4, affordable. Bally pinball manuals. Will buy or trade for old slot cars. Thanks. Robert Rogers, 1407 Riverside Rd., Old Hickory, TN 37138. (615) 847-2475, 4 pm CST

**WANTED:** Mallory Vibra-Packs, WWII radar equip. and info on WE Type TJ transmitters. Jim Krajovic, 546 Sheridan, Pittsburgh, PA 15206

**WANTED:** Ham FM six meter transceiver. **FOR SALE:** Radios, TV's, books, parts. Send want list with SASE. Don Weiler, 4641 Kawanee Ave., Metairie, LA 70006

~Buying~  
**Catalin  
Radios**



Motorola

Fada

Sentinel



Emerson



Garod/AMC



Air King

Also Arvin, Detrola, Crosley,  
Sparton, Tom Thumb, & Epsy.

All models. Any condition.

What's a top price? Call me.

**Rod Smith**

P.O. Box 1061, Boston, MA. 02117

**(617) 423-3796**



**Collins 32-V-1 AM transmitter  
Serial No. 1, approx. 1946 mfg.  
Cash offers solicited**

If you would like to view in detail a set of 6 color photos, send \$6.00, refundable to:

Bob Travis Keagle — KB4NGZ  
5925 Antilla Dr., Orlando, FL 32809



**FOR SALE:** Majestic 196 cathedral, very nice Gothic style, good original finish, nice new grille cloth - \$230. Philco 37-60 cathedral, nice refinish - \$150. Philco 42KR5, early refrigerator wood clock radio, Deco, good original ivory finish, very few chips - \$60. Coronado 43-8180, nice refinish, semi-Deco - \$35. Truetone D2615 Stratoscope, beautiful Deco radio, made by Belmont for Truetone, very nice ivory finish - \$130. Philco 625, very nice tombstone, very good original finish and knobs - \$100. AK 60 metal table radio, and matching external speaker, top cover refinished, good condition - \$70. GE 60, very nice 1947 clock radio - \$30. Airline 84B6-1518A, semi-Deco, push buttons, appears to be made by Belmont, ivory refinish - \$40. RCA 9-X-641, good brown Bakelite - \$20. All radios play, most are re-capped, have good or new line cords. UPS extra. Thanks! Lloyd (Bud) Noel, 494 Clark St., Galesburg, IL 61401. (309) 342-2825

**FOR SALE:** The following cathedrals: RCA Mod 125 - \$100. Majestic 20 - \$185. Majestic 50 w/stand - \$250. Airline Model ? - \$275. AK 84 - \$275. Philco Mod 38 - \$175. Philco 84 - \$120. Silvertone plain front with ornate grille - \$70. Philco 60 - \$125. L. Drago, 383 Lincoln Dr., Cheshire, CT 06410. (203) 272-6030

**WANTED:** 16" transcription turntable. James Pappajohn, P.O. Box 1440, Morgantown, WV 26507. (304) 599-7000

**FOR SALE:** 1926 Neutrowound with all original tube covers, shipping crate, and copy of manual - \$425. Hickok 750 tube tester - \$50. Both plus shipping. Will also consider trade. David S. Smith, 2159 River Rd. SE, Granville, OH 43023-9521. (614) 587-0679

**FOR SALE:** Plastic reproduction dial covers for Fada 1000, Belmont 6D111, Emerson 375, 400, 520, AU190. Fourteen dollars and fifty cents - \$14.50 ppd. Others with old cover or drawing. Doyle Roberts, HC63, Box 236-1, Clinton, AR 72031. (501) 745-6690

## One Month Free!

### BONUS FOR EARLY RENEWALS

If you renew **before** the month shown on your mailing label (your expiration month), you will receive an extra month on your subscription: 13 months instead of 12! 26 months for an early 2-year renewal!

**WANTED:** Premium offers for your crystal sets: Amrad 2575/Type E - \$400. Wireless Specialty AR1375 - \$900; AR1382 - \$1,100; Lemco - \$250; Metropolitan Little Giant - \$300; BTH (British) - \$550; Aeriola X - \$250; Signal Corps BC14A - \$500, and other identifiable cased sets. Don't hesitate to offer because I always want them. Keep this ad in your file. Finding fee available. Help me, please. **FOR SALE/TRADE:** AK 10 breadboard - \$900. Edison cylinder phonograph - \$495. Cathedrals. All excellent. SASE want/sale list. Jimmy K. Chan, 5280 Little Mountain Dr., #E8, San Bernardino, CA 92407. (909) 880-1628

**WANTED:** General Electric tombstone Model E71. Will pay generously. Harold Grissom, 5013 - 4 Ave., Meridian, MS 39305. (601) 485-4427

**WANTED:** Unassembled Knight-kits, top prices paid. Also need Knight R-195. Jack McCreary, 7783 Wildcreek Trl., Huntsville, AL 38502. (205) 882-0037

**WANTED:** Wanted for Emerson 33 (similar to E.O.R. Vol. 1, p. 134 top left), brass escutcheon for volume, approx. 1 1/4 dia. with 1/2-inch center hole. Also wooden acorn knob approx. 3/4 in. H, 7/8 in. wide. Also 3 brown push buttons approx. 1 in. long, 3/8 in. dia. (similar to Bunis 2, p. 13). Many thanks! Robert Tappan, 2143 N. Rolf St., Arlington, VA 22209. (703) 522-2943

**WANTED:** Antique light bulbs, fans, Edison bi-polar dynamos or motors, glass jar batteries. Have radios, cyclinder phonographs or cash to trade. Gene Baudouin, 247 Lowe St., Hahnville, LA 70057. (504) 783-2610



**FOR SALE:** TR1 signal telegraph set, pictured, green Japanese toy, real nice - \$75. Manhattan telegraph sounder and sender on nice finished board 8" x 5", as in picture - \$300. Telegraph sounder and sender on board 9" x 5", black paper label with train says American Railway Communications Schools Inc., in picture 2nd right - \$225. Lyric cathedral superheterodyne by All American Mohawk Corp., N. Y., cabinet brass plaque Wurlitzer 5-tube, 16" x 18", plays, it's nice - \$350. Edison Mabry, I Collect Best in Radios, 715 W. Longview Ave., Mansfield, OH 44906. (419) 526-1175

**WANTED:** Outside horn Victor, Edison, Columbia tabletop windup phonographs, need not be working. Also want phonograph-related items: picture records, needle tins, record dusters, Nipper, Edison and RCA Victor advertising. Top prices paid. Bernie Seiberger, 801 Sand Wedge Ct., Warrington, PA 18976. (215) 343-7743

**WANTED:** RCA 9INT1 (BOM, p. 307); detachable cassette deck for JVC PC-M100; inductive tuner for Detrola 426; 7591A tube. Chuck Ulrick, 8282 Afolkey, Dakota, IL 61018. (815) 563-4905, evenings.

**FOR SALE:** Chrome Avin transistor 61R48 with leather cover and straps, nice - \$50, plus UPS. Alva May, R1, Box 313, Shenandoah, VA 22849. (703) 652-8638

**FOR SALE:** Eleven Beitman TV books, - \$20. Zenith radio, record changer service notes - \$7.50. John Schehrer, 508 Gray, Joplin, MO 64801. (417) 781-4028

**FOR SALE:** Complete TV shop including 5,000 TV tubes. Lots of good equipment. 2519 Sams in 2 sets. (5) 4-drawer steel cabinets and 600 Sams in volumes. Hundreds of new parts. Everything to repair tube type sets. All tubes on shelf so you can inspect and inventory. Total weight about 3 tons. If you will come and look we can deal. Will consider selling tubes separately or Sams. Buy entire lot of 5,000 tubes at - \$1 ea. Most of these tubes wholesale at \$5 to \$30 each. Buy the 2519 Sams at - \$2 ea. with the (5) 4-drawer steel cabinets free. Clarence B. Shippey, PO Box 741, Midvale, UT 84047. (801) 566-8593, day; (801) 568-1989, evenings or Sunday until 10 pm Mountain time

**WANTED:** "Inside the Vacuum Tube" book by John Rider, will pay \$25. Steve Melkisetian, c/o Angela Instruments, 10830 Guilford Rd., Suite 309, Annapolis Junction, MD 20701. (301) 725-0451. Fax (301) 725-UTBE/725-8823

**WANTED:** Tape recordings and memorabilia relating to WLAC radio, Nashville, Tenn., night R&B programs from '47 to '74. Particularly Moss Allen, John R, Gene Nobles, Randy or Ernie's Record Shop, or Baby Chicks. Mason Mitchell, 205 Sonata Dr., Lewisville, NC 27023. (919) 945-3481

**FOR TRADE:** My transistor radios for your early portable calculators. Send "have" list. Guy Ball, "Mr. Calculator," 14561 Livingston St., Tustin, CA 92680

**WANTED:** Zenith dial Part #26-258, 7 1/8" round convex dial glass, Model 10A1. Lew Dunning, 3343 Savage Rd., Sarasota, FL 34231. (813) 922-3101

**WANTED:** Zenith 8H061 console, and Zenith 7S240 chairside. Rowland Harris, 100 Commerce St., Greenville, NC 27858. (919) 321-0630

**FOR SALE/TRADE:** Aerola dial plates restored from originals. Also, variocouplers and variometers by Hillco, Eisemann, Sheppo, Radisco, and Grebe. Variable condensers by Grebe, and Remler. Also, selling out my dial plate restoration business consisting of: professionally made Aeriola and DeForest dial plate silk screens, ample supply of newly silver-plated original Aeriola plates, ink and instructions. Send SASE for details and list. Sonny Campbell, W5VFG, 2729 Winterstone Dr., Plano, TX 75023-7948. (214) 596-9037

**WANTED:** Old style tall Sylvania 8417 tubes; these tubes are about 4 1/4" long, need at least one. RCA 6XY-5A/B any cond. JVC HR-D566 VCR working or not. HH Scott 310E FM tuner. Al Manieri, 384 Bates St., Phillipsburg, NJ 08865. (908) 454-3699

**WANTED:** Promotional plastic car/AM radios from the mid-60's, not reproductions. Jerry Becker, 3331 Larry Dr., Plover, WI 54467. (715) 341-7610

**WANTED:** For Hallicrafters Model S20R: power transformer and cabinet bottom cover or entire cabinet. Spencer Cromwell, K6VRS, 7607 Stevenson Way, San Diego, CA 92120. (619) 582-8280

**FOR SALE:** Large quantity test equipment, mostly tracked, some prewar, some 50s-60s era, all pristine, sold in lots; WWII transmitters, lots of parts, military surplus, etc. Sams mags, located central Calif. Norm Brady, 975 Cobblestone Dr., Orange Park, FL 32065. (904) 276-5427

**MESSAGE:** I wish to correspond with those experienced in early broadcasting. Clint Springer, 10369 CR 1141, Tyler, TX 75709

**WANTED:** Manual for Harris 504 digital video signal corrector circa 1972. Buy/copy yours. Dave Sica, 1459 St. Georges Ave., Rahway, NJ 07065. (908) 882-0618

**IF YOUR EXPIRATION DATE IS  
DECEMBER OR BEFORE, RENEW TODAY!  
EARLY RENEWALS  
RECEIVE AN EXTRA ISSUE!**

**FOR SALE:** Sonora RDAU-209, nice curved cabinet wood radio, no play - \$35. Arvin 2 tube, nice but could be repainted, has back, original knobs - \$75. Toshiba 6TP-309, white, transistor, plays, nice - \$65. Paper maché horn, no base - \$25. Tubes: 18" GE Coolidge, 81321 - \$17; Fischer #3593, good fil. - \$25; Fischer #4670, bad fil. - \$15; Underwood 4 pin, cloudy, good fil. - \$7; another no name, good filament, 4 pin "JE", brass base, 14434-amp, good filament - \$25. Crosley 51 for parts, transformer is out, has tag - \$55. Signal Corps U.S. Army #EE-8 phones - \$45. Call Del in N.D. Thanks. Del Tysdal, 812 Broadway, No. 4, Fargo, ND 58102. (701) 293-9328

## A Message From Play Things Of Past - Cleveland, Ohio...

### CATALOG

Our new catalog is still not available yet! It is currently being worked on and tentatively should be ready sometime in April/May 1994. Please do not send money until it is advertised as being ready. In the meantime catalog #0692 may be used, although there may be some price increases on tubes. We have thousands of unlisted items in the way of tubes, parts and literature. If certain tubes or parts are required that are not listed in our catalog, a written request by letter with a SASE will guarantee a reply. An inquiry to our phone or answering machine will guarantee nothing. This policy is required because we are just too overwhelmed with request for items.

### RESISTANCE LINE CORD

Sometime ago we advertised the possibility of resistance line cord being manufactured for us. We finally have received a quote from the manufacturer this late October. The good news is that it is feasible to have made, the bad news is that it is expensive. Without some kind of feedback from the collectors as to what they are willing to pay for this custom-made resistance line cord and the demand for it, then we will be forced to abandon this project. The cost to us to take this risk is just too high. May we hear from you soon on a postcard? (Note: if the wire is made, then there is still a 60-90 day manufacturing delivery time.)

**MAIL ADDRESS:**  
Play Things Of Past  
Gary B. Schneider  
9511 Sunrise Blvd., #J-23  
Cleveland, Ohio 44133  
216-582-3094



**RETAIL STORE:**  
Play Things Of Past  
3552 West 105th St.  
Cleveland, Ohio 44111  
Wed.: 5 to 9 PM  
Sat.: 12 to 6 PM

— RADIO SALES - SERVICE/REPAIR - RESTORATION - PARTS - TUBES —

**WANTED:** Indoor antenna for geh'l coverage receiver. Levy, 8 Waterloo, Morris Plains, NJ 07950. (201) 285-0233

**WANTED:** Radio News 1946 April, June, August; 1945 May, June, July, September, January, February. Alvin J. Bernard, PO Box 690098, Orlando, FL 32869-0098. (407) 351-5536

**WANTED:** A few old 6-32 x 3/4" wood screws, for restoration project (Kennedy). Happy to pay \$5 or \$10. Heads should be slotted, generally slightly convex, and nickel-plated. Please help! Thanks! Gary Gordon, 21112 Bank Mill Rd., Saratoga, CA 95070. (415) 857-4958, days

## HAS YOUR SUBSCRIPTION

### EXPIRED?

It has if your mailing label reads  
"EXP=DEC93" or earlier.  
Renew now!

*BONUS: Renew before  
your "EXP" month and receive  
13 issues per year instead of 12!*

Renewal rates are:

\$29.95 for Second-Class Mailing

\$44.95 for First-Class Mailing

(Two-year renewals are twice above rates.)

**WANTED:** Transistor radios: shirt pocket and vest pocket size with CD marks and nice looks. Will pay cash. Please send Xerox copy of radio if possible. Also need band selector knob for 3000-1 Royal Zenith. Warren Thompson, 8500 Redwing Dr., Pensacola, FL 32534. (904) 478-0413

**WANTED:** Radio owl turns set off. AK 55 driver transformers, and top to cover RF and detector tube. John & Barbara Smith, 1924 Dolphin Blvd., St. Petersburg, FL 33707

**FOR SALE:** (2) Operating guides and (1) service manual with schematics for Zenith Royal 3000-1 Trans-Oceanic - \$10 each. Alex Sandoval, 33 Brook Cir., Pella, IA 50219. (515) 628-2510

**WANTED:** AK 30 No. 3 R.F.T. and grid leak. Ron Both, 1964 Cheshire Ln., Wheaton, IL 60187. (708) 682-4265

**WANTED:** Knobs for Fairbanks Morse, 1936 console, set of 4 (5 counting double tuning knob). David Buck, 3630 Wilcox St., San Diego, CA 92106. (619) 224-5821

## Radio Grille Cloth

E. H. SCOTT  
Philco, Emerson, RCA  
& Zenith

radios & speakers  
Send LSASE for FREE  
samples to:

John Okolowicz  
624 Cedar Hill Rd.  
Ambler, PA 19002

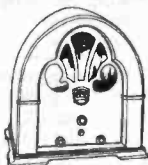

Select from  
12 patterns

**FOR SALE:** Hickock tube tester 6000-A - \$70. Stancor degaussing TV coil - \$20. Superior Genometer TV-50-A - \$30. RCA WR-99A marker generator - \$30. Old Superior channel analyzer 100Kc - 18 MHz - \$20. Heathkit SG-8 generator - \$10. Heathkit T-2 signal tracer - \$10. B&K 700 tube tester - \$50. Sencore CG-12 color generator - \$20. Plus UPS. Kevin L. Moe, 616 Lockrem St., Ottawa, IL 61350. (815) 433-4598, evenings

**FOR SALE:** RCA red 66X8 Catalin, Arvin 532 yellow tortoise Catalin, Bendix 114, Emerson red Explorer perfect w/case. Ted Chronister, 7073 Carlisle Pike, #26, Carlisle, PA 17013. (717) 766-6436

**WANTED:** Any book about vacuum tube construction by Walter Kohl. Will pay up to \$30 each. Steve Melkisetian, c/o Angela Instruments, 10830 Guilford Rd., Suite 309, Annapolis Junction, MD 20701. (301) 725-0451. Fax (301) 725-TUBE/725-8823

**FOR SALE:** Tower Adventurer cone speaker - \$200 or BO. Garod AM radio, Model 5A-2, Drake's Cyclopedia of Radio & Electronics, Manly/Gorder - \$8 or BO. Blue Arcturus tube, No. 127 - \$15 or BO. **WANTED:** Crank phonographs, parts, junk machines any style or condition. Dave Faehrich, 8215 Stone Rd., Independence, OH 44131. (216) 447-0837

**FOR SALE:** AK 37 chassis - \$10. Radiola 60 escutchions - \$15. Majestic cathedral, Gothic - \$195. Jeff Gentry, 708 Locust Ave., Charlottesville, VA 22902-4913. (804) 979-0699

**WANTED:** Original 1949 Majestic Coke Cooler radio, restorable-mint condition. George Wong, 19 Oxford St., Toronto, Ontario, Canada M5T 1N8

**WANTED:** Atwater Kent Model 20 big box radios, any condition. I have cabinets and need chassis & parts only. Please state price. Paul Thompson, 315 Larkspur Dr., Santa Maria, CA 93455. (805) 934-2778



This year, give a VISIONETTE television kit to someone or yourself.

Easy to build, for the beginner or engineer.

A good investment of your time and money.

Available only from PETER YANCZER  
TESLA ELECTRONICS CO.

835 BRICKEN, ST. LOUIS, MO  
zip 63122 PH. 314-822-1748

Everything you need to build a working 24 line NIPKOW scanning disk camera and receiver, including cabinets. Only \$830 plus UPS

Finished units are also available.



**FOR SALE:** In time-capsule since 1958! Seven TVs & sales literature: 16" Motorola 1771 blonde wood table set; 17" Crosley, Chassis 356-1, in small red mahogany console; 17" RCA, 1951 vintage, blonde wood table set; 19" Hoffman Easy-Vision 891 red mahog., double door console; 21" DuMont RA356/7A blonde console; 21" DuMont RA164/5 blonde console; 21" RCA 21-T-6082 black metal table set; sets are in excellent unrestored condition, your choice - \$100 each, you arrange shipping. Small fold-out brochures: price includes postage, several of each available. Regency TR-1 - \$55. '48 Brunswick radios & Panatropes - \$25. '56 Emerson radios, incl. 838 transistor - \$35. '56 Columbia phonos - \$15. '55 Stromberg-Carlson radio-phonos - \$5. '57 Olympic-OPTR German radios, phonos - \$10. '56 Emerson TVs - \$20. '58 Zenith radio-pho's., including Royal 500 - \$35. '56 Hallicrafters b&w, color TV - \$25. '56 Philco TV's - \$35. '55 Sentinel b&w, color TV - \$25. '56 GE TVs - \$10. '55 Hallicrafters TV - \$20. '56 Olympic radio, pho., hi-fi - \$10. '59 Steelman phonos - \$5. '54 Webcor Quintet cl. radio - \$5. '54 Hallicrafters TV & radio - \$25. '54 Hallicrafters radio-phono-hi-fi - \$20. John Eckland, 969A Addison Ave., Palo Alto, CA 94301. (415) 323-0101

**WANTED:** E.H. Scott, McMurdo Silver radios. Also Hallicrafters DD-1 Sky rider Diversity. Mike Greene, 19113 Alpenglow Ln., Brookeville, MD 20833. (301) 774-3203

**FREE - 20 WORD AD EACH MONTH**  
**To get your free 20 words,**  
**include your SUB# with your Ad.**  
**Additional words are 17¢ each.**  
**Read inside back cover for details.**  
**MANY THANKS!!!!!!**

**FOR SALE:** Philco Model 70 grandfather clock. **WANTED:** Dial or dial decal for RCA T7-5. Darryl Grable, 116 Holly Dr., Mechanicsburg, PA 17055. (717) 766-4343

**FOR SALE:** Synchronous detector for 455 kHz IF receivers. Dramatically improves AM: reduces fading distortion, selectable sideband cuts interference. Kit - \$139. Built/tested - \$199. info - \$3. Steve Johnston, PO Box 3420, York, PA 17402-0420

**WANTED:** Manual and schematic for Hickok Model 580A tube tester and same for Hickok military TV-3A/U tube tester. Prefer originals but will accept photocopy. H. E. Whitted, Jr., 3710 Kirklees Rd., Winston-Salem, NC 27104. (919) 765-5977

**FOR SALE:** Rider's Radio Manuals 1 thru 23, 1 thru 5 abridged - \$350 complete. Sams 1 thru 600 in folders - \$350 complete. Ronald Naasko, 1360 S.W. Timian, Corvallis, OR 97333. (503) 753-5242

**Attention Technicians and Experimenters**

- Tubes
- Test Equipment
- Cellular Telephone Surplus
- Old Radio Books and Magazines
- Master Card & Visa accepted
- Send \$2 (cash, stamps, or check) for our catalog. Price of catalog refunded with first order. Send for your copy today!

*Classic Radio*

*P.O. Box 800742*

*Houston, Texas 77280-0742*



**FOR SALE:** Philco-Ford small white plastic, tubes, 1950's, mint - \$25. Philco beige, 1950's, tubes, Model 53-562, 25 louvers on left, airplane dial on right - \$45. RCA Model 66 X 11 brown heavy plastic, beautiful set - \$45. No cracks on cabinets. All sets work. Plus shipping. John Kara, 1700 Baltimore Ave., Whiting, NJ 08759. (908) 849-4318

**FOR SALE:** Parted out National 300, Hallicrafters 40, RME 45, all parts for sale. Send SASE and wants. Chuck Humphreys, Chuck's, PO Box 598, New Haven, WV 25265

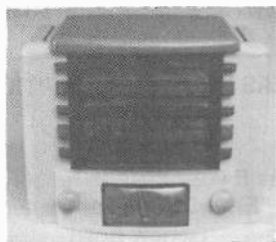

**WANTED:** Kadette radios in any color, form, and condition. I be the Jethro of radio, lean on smarts and fat in the pocket. Y'all write or call back collect real soon now. Rain Buttignol, 214 State St., #7, Portsmouth, NH 03801. (603) 427-1384

**FOR SALE:** Rider's Nos. 7, 8, 9, 11, 12 - \$12 each. Rider's TV Nos. 1 through 12 - \$150 for set (prefer pick-up on TV manuals). Fada bullet #115, blue/white swirls pumpkin trim - \$2,250. Jim Downes, 607 East 12th Ave., Covington, LA 70433. (504) 893-7057

**FOR SALE:** Arvin metal, nice - \$50. Small brass blade desk fan, works - \$40. 1946 RCA Galambrottron complete, UT - \$65. Arvin 955t, black & white - \$35. Trade all or part of above for/toward Belmont 6D111 in good original shape. Royal Shaw, 954 Greenwood Ct., Clarksville, TN 37040. (615) 647-7220

**WANTED:** Service data for Brunswick console Model AR-1038. Terry A. Rohler, 18 Joyce St., Stafford, VA 22554. (703) 659-0263

**FOR SALE:** Military walkie-talkie RT-196/(B)PRC-6, telegraph key J-45 (KY-116/U) - \$40 each & UPS. P. Wipperman, PO Box 81, Elmwood, MA 02337

**FOR SALE:** Hallicrafters SX-24 Sky rider Defiant, matching speaker, extra tuner - \$250. N.O.S. Japanese big wristwatch radio - \$60. Prices include UPS. Robert Burleson, 1731 Naudain St., Philadelphia, PA 19146. (215) 545-5726

**WANTED:** Tiny table model radios, in metal or plastic, must be complete. Ernest D.M. Yeaw, RR #3, Tatamagouche, Nova Scotia, Canada B0K 1V0. (902) 657-2554

**FOR SALE:** Reducing my collection of ham radios. Send SASE for list of 25+ radios. Fenton Wood, KB5VQ, 109 Shoreline Dr. S. H., Malakoff, TX 75148

**FOR SALE:** Audio tubes, four RCA #7591A N.I.B. - \$35 ea. N.O.S. bulk packed 12AX7 - \$3 ea. 12AU7/6189 - \$1.75 ea. #6080 - \$2 ea. Eico tube stereo amp #ST-40 - BO. Eico tube FM tuner #ST-97 - BO. Bogen tube mono amp #DB10-1 - \$30. RCA #100A speaker - \$20. Crosley #11-114U chassis - \$18. Shipping extra. Rick Yerke, PO Box 392, Moscow, PA 18444. (717) 842-4857

**WANTED:** Copy of Audio Cyclopeda. Marantz, REL, Karg, Fairchild, Hadley, Acrosound, etc., tube hi-fi equipment. Western Electric sound equipment. 1950's-1960's hi-fi brochures, catalogs, and books. Audiocraft, Audio Engineering, and Audio, etc. magazines, 1950-1965. Paul Creasy, 6216 Worrlington Rd., Bloomfield, MI 48301. (313) 737-0429

**WANTED:** For Hickock 752 tube checker schematic diagram & ?. Will pay for copy or manual. Thanks. Pete Anderson, 1209 West Cochiti, Hobbs, NM 88240. (505) 392-8866, after 6 pm MDT

**FOR TRADE:** Collins 51S1, excellent cond. for early Fender guitar. Also trade or sell RCA Borgia II and Philco 20. Larry Inks, PO Box 1338, Columbia, CA 95310. (209) 532-1200, bus.; (209) 533-1594, home

**FOR SALE:** Crosley, Art Deco, airplane dial, brown plastic in working cond., Model 56TA-L - \$35 plus UPS. Call or write: Tomas Burnside, 4838 S. Westhaven Dr., Jackson, MS 39209-4711. (601) 922-2235

**WANTED:** Magnetic tuning switch for Philco 38-690.  
**FOR SALE:** Philco dial glass 41-250, chassis for Philco 41-295, Philco 296 console - \$100. Crosley 21 - \$30. Ray Lamont, 70 Litchfield Rd., Unionville, CT 06085-1318. (203) 675-6327

**WANTED:** Dial escutcheon for a Silvertone 6359 farm set. Dwight Baker, 4137 E. 24th St., Des Moines, IA 50317. (515) 263-0278

**FOR SALE:** Lee de Forest explains his audion in illuminating technical detail and describes its development and applications of the time. The 40-page 1920 Franklin Institute printing (xeroxed) is available for \$15 ppd. It's a rarely seen and key piece of radio history! Gil Arroyo, 2766 S.W. 167 St., Seattle, WA 98166

**WANTED:** AK WD-11 tube island and detector unit. Jim Peters, 983 Chapel Ct. South, Glen Ellyn, IL 60137. (708) 790-9699

**FOR SALE:** (2) kits: Premier 11 meter citizen band receiver kits - \$55 each or 2 for \$100. Plus shipping. John Kara, 1700 Baltimore Ave., Whiting, NJ 08759. (908) 849-4318

**FOR SALE:** Stewart-Warner 9100-C projection, mirror in lid w/magnifier and instruction, real cute and very good condition - \$400. RCA 9PC41 and 8PCS41 large projection, these are monsters, repair manuals included, all for - \$300. Philco 49-1240, near mint condition, very unusual design - \$300. Hallicrafters 1949 T506 7" tabletop, porthole with 13 push buttons - \$200. Want all? Let's talk!!! Jon Prabel, 2733 Wood Eagles, St. Charles, MO 63303. (314) 947-1543

**WANTED:** Hallicrafters Model SM40 tuning meter. This is a factory add-on S meter for the Model S-40A receiver. Jerry L. Parker, 10 White Oak St., Etowah, NC 28729. (704) 891-4279

**WANTED:** Jensen speakers 10 or 12 inch, blown or ripped OK, permanent magnets only. A. Michailoff, 3147 Old Post Rd., Slatington, PA 18080. (215) 767-9097

**FOR SALE:** Philco Model 20 cathedral, very good condition - \$175. Will not ship! Will not ship! Suzanne Wyatt, Box 83, Dearborn, MO 64439. (816) 992-8811

**FOR SALE:** Electronic books: Reading Schematics, How to Repair TVs, Radios - Supreme Manuals, Sams TSM, etc. For list send SASE. John Wiorek, 908 W. Greenfield, Milwaukee, WI 53204

**WANTED:** Tombstones: Atwater Kent 465Q and 735, GE Model K-80, RCA Model 128. Bob Alexander, 20 Haycamp Rd., St. Paul, MN 55127-6507. (612) 483-6177

**FOR SALE:** Setchell-Carlson late 1940's "jet" model, AM/FM, very unique wooden design, very good condition and works - \$500. Brian Berry, PO Box 75, Germantown, MD 20875. (301) 540-6349

## Racal and the RA.17 Communications Receiver

Mention the RA.17 (or its US-made counterpart, the RA.71) and watch the eyes of many old-timers (and some not-so-old) light up!

The story of one of the UK's best-known radio manufacturers, and of its first and probably most famous product, is currently featured in

*The vintage wireless magazine*  
**Radio  
Bygones**

*Amateur radio • aviation • broadcasting • marine • military • mobile • domestic radio and TV • recording*

*Reminiscences • personalities • equipment • techniques  
Plus a full-colour photo-feature in every issue*



Radio Bygones is published by G C Arnold Partners (AC),  
9 Wetherby Close, Broadstone, Dorset BH18 8JB, England.  
Phone/FAX: 0202 658474 - International +44 202 658474



**FOR SALE:** 1939 wood Truetone chairside, AM, tubes, set pulls out, beautiful, set works - \$110 plus shipping. John Kara, 1700 Baltimore Ave., Whiting, NJ 08759. (908) 849-4318

**FOR SALE:** Crosley S52, 3 tube, regen., 2 amps, tunes SW/BC, some LW - 800 meters, beautiful cond., orig. tubes, works fine - Bids. R. Monterosso, 4156 Harriet Rd., Bethpage, NY 11714. (516) 796-3804

**NOTICE TO ALL  
CLASSIFIED ADVERTISERS!  
OUR CLASSIFIED AD DEADLINE IS  
12:00 NOON  
ON THE 10th OF EACH MONTH**

**WANTED:** Old mics, especially RCA 44XB or 77DX. Also need port. tube tester. Contact: S. Rivchun, 4437 Alton Pl. NW, Washington, DC 20016-2021

**FOR SALE:** Zenith 15U269, 10S153, 5S319, AK 82, Philco 90. Contact: Kent Martin, 7803 Butterfield Dr., Elkridge, MD 21227. (410) 796-1953

**FOR SALE:** Jewel Wakemaster, 1/2" hairline crack - \$50. Rider's 10 thru 15 - \$10 each. **WANTED:** N.O.S. globe shape tubes. N.O.S. brass base WD-11's & WD-12's. Aerolia Sr., good or junk. Fada 263w & 60w. DeForest tubes DU1, DU2, DU3, DU4, DU5, DL4, new or used. Tony & Lynn DeMara, 40231 Day, Clinton Township, MI 48038-4739. (313) 263-0325

**MESSAGE:** Free: Reproduction dial for Philco 89. Send SASE. **WANTED:** External horn phonograph. Info for Precision 612 tube tester. Dave Gonshor, 7121 S. Jellison St., Littleton, CO 80123. (303) 979-9511

**FOR SALE/TRADE:** AN/PRC-9A/RT-175 transceiver. **WANTED:** Any piece, or part, of SCR-274N, or AN/ARC-5. Crystals for: TBS; TCS; SCR-522, in CR-1A, or DC-11 holders; in FT-243 holders for, AN/GRC-9A; marked for, "in 620"; "in 611". Wm. Stokesbury, #305 W. 142nd St., Ocean City, MD 21842-4428

**WANTED:** I'm paying top \$\$\$ or trade hi-fi gear for N.O.S. tubes; 10, 50, 801, 2A3, 211/VT4, 812, 845, 8005. Western Electric Types VT-25, VT-52, 211, 300A/B. Amperex or Telefunken 12AX7, EL-34. Genalex KT-66, 77, 88. The tubes are for building and restoration of equipment, not export. Charley Kittleston, PO Box 691, Belmont, CA 94002. (415) 595-4164, 8-10 pm PST

**FOR SALE:** Philco 48-1000 parts set - knobs, back, mask, etc. or all for - \$100 + UPS. Jon Prabel, 2733 Wood Eagles, St. Charles, MO 63303. (314) 947-1543

**FOR SALE:** VT4C, 6080WA, 6L6W, 6550, 6922, 6C33, 6844 Nixie. Send \$2 for list. Andrea Moretti, Via Colle Bisenzio 31, 50040 Usella FI, Italy

**WANTED:** Philco 51 cathedral cabinet. Larry Dunlap, 1115 Ichabod St., North Pole, AK 99705. (907) 488-6938, collect

**WANTED:** I already have a black Regency TR-1, 1954, but would also like the following items for display in my museum in England: Regency 22.5 volt battery type 215, Regency earphone, leather carrying case and any original display cards/brochures/leaflets, etc. all relating to the TR-1. Bampton Museum, 2-4 Brook St., Bampton, Devon EX16 9LY, England. **MESSAGE:** If you plan to be over in England next May, why not come along to the third National Vintage Communications Fair at the National Exhibition Centre in Birmingham? To be held on Sunday 15th May 1994, you'll be sure to find something of interest among the 200+ stalls crammed with vintage radios, telephones, TV, gramophones, jukeboxes and records, etc! Details from: Jonathan Hill, Bampton Museum, 2-4 Brook St., Bampton, Devon EX16 9LY, England.

**FOR SALE:** Matched set of RF coils, ant, RF & det, air wound doughnut shaped, 4" x 1.5", circa 1922 - \$30 ppd. Polaroid - \$1. George Greenberg, KD4OBV, 1701 Andros Isle K-2, Coconut Creek, FL 33066. (305) 971-9053

## TUBES WANTED

We need the following tubes to replenish our stock (first digit on 3 digit types is optional). You may ship your tubes to us by UPS or Parcel Post. We'll mail our check upon receipt and testing of tubes. We pay prices shown plus shipping charges. We buy all types of receiving and transmitting tubes. Send us your list for our bid.

### USED GLOBE OR BALLOON SHAPE TUBES - ALL MUST TEST GOOD

WD-11*.....\$ 35.00	UV-199*.....\$ 14.00	231.....\$ 5.00	247.....\$ 7.50
WD-12*.....20.00	UX-199*.....12.00	233.....4.00	250.....40.00
WX-12*.....20.00	UV-201A.....6.50	237.....7.50	256.....6.50
112A.....8.50	UX-201A.....6.50	240.....8.00	280.....8.50
120*.....11.00	210.....12.00	245.....16.00	281.....7.50
171A.....8.00	227.....2.00	246.....9.00	282.....7.50
183/483.....8.00	230.....6.00	*Tubular	

### USED ST SHAPE TUBES NEEDED

01A.....\$ 5.00	6B4G.....\$ 5.50	6L6G.....\$4.00	40(ST).....\$ 3.50
2A3.....9.00	6F5G.....2.50	10.....4.50	45.....9.00
6A5G.....7.50	6K5G.....2.00	12A.....5.50	50.....30.00

### NEW TUBES URGENTLY NEEDED

01A(ST).....\$ 8.00	6A5/G.....\$ 10.00	6K5G.....\$ 4.00	42.....\$ 7.00
2A3.....16.00	6B4G.....10.00	6L6G.....8.00	45.....20.00
2A5.....5.00	6F5G.....3.50	6N6G.....7.00	47.....8.00
2B6.....6.00	6F6G.....4.50	6V6G.....4.00	48.....5.00
5U4G.....5.50	6GM5.....4.50	10.....10.00	50.....40.00
5Y3G.....3.50	6J5G.....3.50	12A.....10.00	71A.....7.50
5V4G/GA.....3.00	6J7G.....2.00	40.....6.00	75.....4.00

## ANTIQUE ELECTRONIC SUPPLY

6221 S. MAPLE AVE., TEMPE, ARIZONA 85283    PHONE (602)820-5411    FAX (602)820-4643



# This Holiday Season, Give A Gift To A Friend... Or Treat Yourself !!



- Subscriptions ..... Center Coupon
- Books & Videos ..Pgs. 52-53, 57 & 95-101
- Gift Subscriptions .....48
- Back Issues (*Great for new subscribers*) .....33
- New Item: *Radio! Radio!* .....95
- New Item: Transistor Radio Books.....57



**Antique  
Radio  
Classified**  
**Is Your  
Gift Source !!**

— Call Us At (508) 371-0512



**WANTED:** Novelty 1966 Ford pickup truck, dealer give away with camper on back with Philco radio on top of camper. Also cigarette packs, any brand. Maurice Labrie, 38 Shank St., Lewiston, ME 04240. (207) 782-7864. Fax (207) 783-4220

**FOR SALE:** Mahogany GE Longfellow grandfathers clock, fine condition, clock works, radio untried - \$400. Simon L. Sharp, 309 State St., Seaford, DE 19973. (302) 628-3009



**WANTED:** Help identifying this Sentinel's model number. Will buy chassis or junker. Call collect: Curt Schreiber, 3923 East Latoka St., Springfield, MO 65809. (417) 887-5184

**FOR SALE:** Heath W5M and WAP2 - \$150. Other misc. tube audio. B&K 606 tube tester - \$50. John H. Apps, 323 Orchard Ln., Green Bay, WI 54301. (414) 339-8793, days or weekends

**SEND ALL A.R.C. MAIL TO**  
**Antique Radio Classified**  
**P.O. Box 2, Carlisle, MA 01741**

**FOR SALE:** Following vg to exc and play plus S&H: SX-62A with R46 speaker - \$155, 60#; Panasonic RF4800 digital comm. rec. w/manual - \$130, 25#. Following PU: Motorola 12K2 console, BW, exc, plays well; Radiola 80, exc, console, cabinet, plays. Following untested - \$60 ea.: Zenith 11E, missing lid/back, 60#; RCA AR812, NT, loose veneer, 50#; Glortione 26, missing electrolytics, 45#; Airline chassis 62-194, missing tuning knob speaker, 30#. **WANTED:** Crosley 59 power transformer #W22413, case Fada 740, gc 1432 idler. Verne Folk, 115 Randy Dr., Butler, PA 16001. (412) 287-6987

**WANTED:** Step by Step Wiring Book or copy for kit Form 240-104-1 Johnson Viking Valiant, and instruction manual for 275 Watt Johnson Matchbox. Roger Quickel, 5511 S. Ridge W, Geneva, OH 44041. (216) 466-6808

**FOR SALE:** Your choice - \$20 ea. Arvin RE206, GE P820A transistor, Motorola 55L1 portable RCA 95T5 (Bunis 2, p. 154), RCA BX6 (Bunis 2, p. 156), Zenith 5G003 portable, Zenith H723Z, Zenith Royal 670 transistor. Dennis Schrank, 3129 S. Quincy Ave, Milwaukee, WI 53207. (414) 744-3374

**WANTED:** Old Fender tube guitar amps with tweed linen covering, will pay up to \$2,500 each. Steve Melkisetian, c/o Angela Instruments, 10830 Gullford Rd., Suite 309, Annapolis Junction, MD 20701. (301) 725-0451. Fax (301) 725-TUBE/725-8823

**WANTED:** A white or gray Zenith Royal 500H in excellent working condition. Mark Hewitt, 4396 Straw Ln., Roscoe, IL 61073. (815) 623-8729

**FOR SALE:** Satisfaction guaranteed on all items or full refund including return UPS fees for items less than 35 lbs. within the continental U.S.A. Philco tombstone 38-60 Deco set - \$80. Philco 42-PT94, beautiful finish - \$40. Mitchell Lullaby 1261 - \$25. Crosley 10-135 Deco plastic set - \$100. 15-inch Altec Lansing Model 803-A speaker - \$65. Continental M-500 tiny plastic portable - \$40. B&K Dyna-Jet 707 tube tester - \$45. Devry oscilloscope - \$35. GE CRO-5A oscilloscope - \$30. Heathkit AG-8 five band audio generator - \$30. HP 400D VTVM - \$20. Hickok 288X signal generator - \$35. Sencore TC142 tube tester - \$30. Early Jensen hi-fi horns - \$25 & \$30. Schematic (copy) for McMurdo Silver Masterpiece Five - \$5. Plus early parts, many more radios, test equipment and lots of literature. Please send a SASE or call after 7:30 pm Montana Time. Neil O'Donnell, 1809 Sampson St., Butte, MT 59701. (406) 494-8162

**FOR SALE:** Philco 41-300 console cabinet, original finish - \$35. Jim Cook, 1446 Reymond Rd., Columbus, OH 43220-3833. (614) 459-3892

**WANTED:** Zenith 5S319 or Zenith 5S220, must be in excellent condition. Larry Bosh, PO Box 193, Palo Pinto, TX 76484-0193. (817) 325-5333

**FOR SALE:** Microphone, 1920's/30's. WE 600 double button carbon, used at Radio KSTP. Complete with repro mounting ring, springs, instructions - \$10 plus UPS. Ralph Michelson, KG6HW, 4538 Golfview Dr., Brighton, MI 48116. (313) 229-8339

**WANTED:** DeForest unit panels blank or otherwise, Western Electric or other ring for microphone, Nortronics tape head information, old small guitar amps. Michael Payne, 803 S. Taylor, Alvin, TX 77511. (713) 331-9217

**WANTED:** Cabinets for Emerson BA199 and Zenith 5R312 Record Stacker. Mike Keller, 5861 Riverton Rd., Columbus, OH 43232. (614) 866-7725

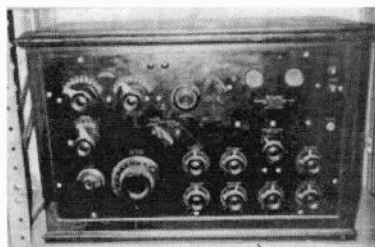

**FOR SALE:** As in picture: Federal 61, all complete and original, nice - \$1,200. Edison Mabry, I Collect Best in Radios, 715 W. Longview Ave., Mansfield, OH 44906. (419) 526-1175

**WANTED:** Zenith Chassis 11S474, 10S443, 452, 464, 470, 491 or 492. A. Bruno, 24 Butternut Dr., New City, NY 10956. (914) 354-8899

**WANTED:** Info on Radiola Super VIII rear door. Another owner please write. Gordon Wilson, 11108-50 Ave., Edmonton, Alberta, Canada T6H 0H9. (403) 434-6257

**FOR SALE:** Tubes, mostly dual triode types, 6350, 6463, 5965, 5844 and a few 6AQ5's, mounted on a vector socket with numerous good looking quality salvageable resistors, one watt and one-half watt, (55) units, total for - \$25 plus UPS. Ellsworth O. Johnson, 364 S. Coeur D'Alene St., Spokane, WA 99204. Phone/fax (509) 838-2161

**FOR SALE:** The famous Kleertone improved - \$6. (5) assd. radio quack items, all - \$15. (10) assd. plug-in coils: Pilot, National, others, all - \$30. (5) assd. ham type air plug-in coils - \$22.50. Have some converter sockets to use WD-11 or 199 type tubes. SASE list WD-11/199. (3) small transistor sets made in Japan + total 4, all - \$30. Emerson Model 868 port. 4 plug-in transt's, made in U.S.A. - \$35. RCA Victor R-22-S-5-tube super, 1930's, Repwood cab., untested - \$45. Emerson wood cab. radio, 1930's, 4-tube TRF, cab. needs some repairs - \$30. RCA Catacomb 8 socket model - \$15. Wood case vib. type spark coil 3/4" Dayton Dickco, works - \$27.50. The following test eqpt. sold as removed from repair shops. Most do not have papers or all test leads. Cornell-Dublier capacitor analyzer Model BF - \$22.50. Wintronix 828 intermittent condition analyzer - \$15. Wintronix Dynamic AGC circuit analyzer 825 - \$15. Lavoie Labs microwave freq. meter 375 to 725 Mc - \$25. RCA vibration pickup calibrator Type TMV 163-A - \$10. GE SG-3-A signal gen. - \$18. Heath AV-2 AC voltmeter - \$10. Electronics Mfg. Co. VTVM - \$15. Heath capi. tester CT1 - \$9. Philco PTE VOM analyzer panels - \$15. PACO V7D VTVM - \$10. RCA WV77-E VTVM - \$10. Boonton Model 59 grid dip meter, head, 7 coils - \$18. HP Model 410-B VTVM with leads - \$20. Coletronics Model B-16 late tubes socket adapter - \$10. Philco 050 tube tester - \$15. Lafayette 99-5063 tube tester, late type tubes, papers - \$15. Eico Model 667 port. metal case tube tester for late tubes, roll chart papers - \$40. (End). Zenith 5H40 parts set - \$40. (2) small, (2) sizes transistor cathodal sets, both - \$12. Philco 1937 N.O.S. outdoor ant. kit - \$35. RCA Radiola AR813 panel and set, no cab. - \$45. Pop. Mechanics Golden Anniv. issue - \$5. Pop. Mechanics 1936 to 1948, (5) copies, all - \$15. New in orig. box RCA Victor Nipper plate 8 1/2" from 1980 - \$30. Assd. RCA small pocket guides, 1945 to 1964, each - \$3. Small loop fold up needs some repairs, will supply new Litz wire - \$25. Loop 35" arms, no base, will supply new Litz wire, fold to ship - \$35. Lot (15) headphone units, all - \$15. Lot (12) assd earphone units - Sig. Corps, Kellogg, Trimm, Brush, all - \$12. Lot headphone parts, 3 pounds, all - \$10. Kellogg 177-C, 178C, mics only, no plate or mouthpiece - \$2 each. Assd. horn magnetic drive units - Utah, Baldwin, others - \$12 each. WE 522-W driver unit - \$15. (2) driver units with leads, both - \$15. (2) Brandes driver units with leads, both - \$12. WE 527-W driver unit - \$18. (3) speaker tools for large Temple voice coils, jigs, all - \$15. 7-9-pin tube straightener tool, polish stick, brass wire brush, all - \$5. Philco Beam-O-Light, (4) parts (display), all - \$12.50. (3) assd. dosimeters, all - \$5. Shadow meters, used, from Philco, AK, Zenith - write SASE. (3) BPI scope tube - \$9. Have other scope

## VINTAGE SAMS

OWN THE FINEST SERVICE DATA  
FOR YOUR VINTAGE  
RADIO AND TV

A.G. TANNENBAUM

P.O. BOX 110  
EAST ROCK AWAY N.Y. 11518

516 887 0057

### — CONTINUED FROM LOWER LEFT —

tubes. Heath CR1, crystal rec. - \$85. Tuner coil 1-slider - \$15. Coil tuner 2 sliders - \$20. Small horn speaker used on test bench, Baldwin driver - \$35. Radio Electronics 50th Anniversary issue - \$10. Radio Craft jumbo copy 50 Years of Radio - \$10. Metro Jr. crystal rec. det. not orig. - \$65. Airphone Model G crystal set w/2 coils det. not orig., some chips - \$75. Gen. Radio (2) coils - 277-C, 277-B, and plug in base w/box, all - \$16. Have 1000s of unlisted items, write wants - SASE. Min. orders \$8. All items plus shipping. Type CAN 24167 aux. keying unit, U.S.N. - \$12. GE tube caddys - \$20. Philco Serv. Manual, 1 1/2" thick, 1928 to 1936, Xerox - \$30. Signal Corps Fluxmeter TS 15-CC/AP w/case, ins. book, some probes missing - \$22. These items on pick up only. Table model radio phono combo's - \$35 to \$50 each. Fisher 31-R AM-FM amp - \$40. Fisher Sears AM-FM-amp 143 - 9254050 - \$50. Philco Model 60 chairside radio - \$100. Bendix 646-A teatable radio, needs dial scale - \$50. Philco 1001 TV - \$125. Fada (TS630), wood cab., Model 799, 10" - \$100. RCA 10" 9T252 - \$75. Motorola 7" parts set - \$50. Have (4) mil. type radios, assd. tube testers, VTVM, signal gen's., tubes, parts, write wants. SASE for reply. Updated hard-to-find tube list CTL4 - \$4. List N.O.S. boxed parts. List old tune coils. List horn speakers. SASE for each list. Books, magazines. Krantz, 100 Osage Ave., Somerdale, NJ 08083. (609) 783-0400, 9 am to 9 pm EST

**FOR SALE:** Spartan Bluebird Model 506, mint condition, excellent working order - \$3,000 OBO. Doris Fitch, 1985 Blossom Hill Rd., Easton, PA 18042. (215) 559-7382

**MESSAGE:** McElroy is here. W1IMQ's biography of T. R. McElroy, World's Champion Radio Telegrapher. Includes every Mac Key. Limited hardcover edition (if available) - \$39.95. Softcover - \$19.95. Add \$2 shipping to order. Artifax Books, Box 88-A, Maynard, MA 01754

## America's Radio Club

Fulfill Your  
Collecting Dreams:



- Local chapters
- The GAZETTE quarterly
- See many of your favorite radios in "Living Color"
- The only magazine for the hobby printed in color
- Large membership certificate
- Members in all 50 states and many foreign countries
- National convention each June
- Local meets during the year and special events
- Dues \$12.00 - will be \$15.00 January 1

— Sample GAZETTE \$3.50 —

Antique Radio Club of America, Inc.  
300 Washington Trails, Dept. C  
Washington, PA 15301-8210

**FOR SALE:** Lafayette 6 meter transceiver Model HA-750, no manual or accessories, untested - \$25 plus 5 lbs. UPS. John Uscinowski, RR#1, Box 379, Greenwich, NY 12834-9519. (518) 692-7538

**FOR SALE:** Zenith Royal 500 w/case - \$45. **WANTED:** Brass blade fans (cash/radio trades). Dave Friedlund, 36006 S.W. Bald Peak Rd., Hillsboro, OR 97123. (503) 628-1439

### Classified Ad Deadline Noon

Dec. 10 for Jan. 1994 Issue

Jan. 10 for Feb. 1994 Issue

Boxed, Photo, & Display Ads - 1st

**WANTED:** Wurlitzer jukebox table models (#41, #61, and 71). Wolfgang Hornik, Hedwigstr. 11, D 8000 München 19, West Germany. Phone 011-49-89-1292750

**FOR SALE:** (100) radio/TV tubes, mixture, some in wrong cartons, used/new/etc. metal types/glass types, including (100) new tube cartons - \$15 plus UPS. Ellsworth O. Johnson, 364 S. Coeur D'Alene St., Spokane, WA 99204. Phone/fax (509) 838-2161

**FOR SALE:** Military R-1051B/U rcvr., excond. - \$275. Eico 1171A decade res. box, new - \$10. Gary Gleicher, Box 427, Little Neck, NY 11363. (718) 423-1911

**WANTED:** Sams TSM-4 and TSM-13, needed to complete my set of TSMs. Wayne Tesch, 2085 N.W. 26 Ave., Rochester, MN 55901. (507) 282-3045

**FOR SALE:** Radios, SASE list. Large round, AM/FM solid-state Japanese radio, works - \$45. Tom Tetzlaff, 23 Nelson Dr., Silver Bay, MN 55614

**FOR SALE:** U.T.C. transformers, used condition, 2-LS 10 @ - \$30. 1 LS 30 @ - \$25. Plus UPS. Harry C. Nuss, 47 Gravel Hill Rd., Huntingdon Valley, PA 19006

**FOR SALE:** I have a new Hickock 800 tube and transistor portable tester for sale. Have two of them, and will sell one. Are you interested? Price - \$80 ppd. George Friedrich, 7162 Lake Jacqueline, Custer, WI 54423

**FOR SALE:** Original instruction books, xmtrs TV3, TV4, TV6, TV9, TV15, TV20 - \$12.50 ea. ppd.. Fred Fish, PO Box 73, Edgewood, NM 87015. (505) 281-5537

**WANTED:** AK detector unit - \$125, and coupled circuit tuner - \$250. Thanks. Jim Peters, 983 Chapel Ct. South, Glen Ellyn, IL 60137

**FOR SALE:** Tubes, radio, TV, 40's thru 50's. SASE for list. Lee C. Dickinson, 401-3 Talcottville Rd., Vernon, CT 06066

**FOR SALE:** Martin Copeland Co. of Providence, R. I. reproducer with nice wooden speaker (not horn) - \$45. Majestic-Garfield Model 311, nice case (only) with dial escutcheon - \$15. RCA Model 96T6, complete set - \$20. Table model cabinet for Bosch Cruiser with all escutcheons and brass tags - \$20. All prices plus UPS shipping. C-2-C, 77 County Rd., E. Freetown, MA 02717-1629. (508) 763-5028

**WANTED:** Western Electric 274A, 348A and 349A tubes. Rodney Schrock, 402 Lincoln St., Somerset, PA 15501

**WANTED:** Heathkit hi-fi amplifier W5M, any condition. Call or write: Michael Durand, 21 Le Grande Ave., Tarrytown, NY 10591. (914) 631-0493

**FOR SALE:** Philco 37-650 console, electrically restored, good original finish, plays well, pick up only - \$175. Paul Brouillette, KA8LMC, 611 Illinois St., Geneva, IL 60134. (708) 208-6406

**FOR SALE:** Audel's Hawkins Electrical Guide, 1914, 1917, 1922, fair condition - \$16 + postage for 3. SASE for list of others. Larry Kellough, Box 849, Canton, CT 06019-0849. (203) 693-8269

## WANTED — AIRWAY SETS

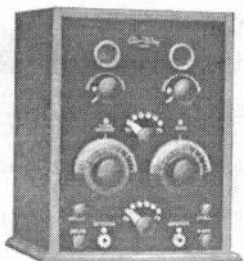

Airway Model "B"

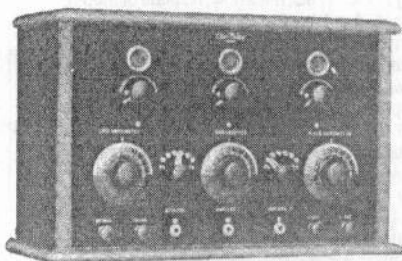

Airway Model "C"

Other Airway Sets Wanted: Models "G" & 51

**ALSO WANTED:** Cutting & Washington 8A, 9A, 11, 12, 14 & Teledyne; Federal 8, 56, 60 & 142; Grebe CR-10, CR-11, CR-17, CR-18, CR-19, RORC, RORD (early), RORG, RORL & RORJ; Kennedy 100, 311 (with amp), X, XI & VI; Tuska 221, 222, 223 & 227; Western Electric 2-A Ant. Tuner, 4-A & 20A Filter; Zenith 2R & 1M Amp.

*As it may be a long time before I find any of these sets, remember to call me if and when you can part with yours. I am putting together a broad collection of early broadcast and wireless equipment from many manufacturers, and adding to it each month. I buy single sets or collections - also, books, catalogs, manuals and other related documentation. Now that I have moved my business (A.R.C.) out of my home, I have lots of room!*  
*Call and surprise me; make my day! — Please leave a message if my answering machine answers. Thanks.*

**John V. Terrey, 498 Cross Street, Carlisle, MA 01741 — (508) 369-9770**

**FOR SALE:** Stromberg-Carlson 30-watt monaural amplifier, push-pull 6L6's, currently has 6V6's installed, clean, not tested; microphone input, various output impedances, has nice cover with handle, Model AU58B, price - \$30 plus UPS. Ellsworth O. Johnson, 364 S. Coeur D'Alene St., Spokane, WA 99204. Phone/fax (509) 838-2161

**FOR SALE:** (2000) 1950's-70's radio and TV tubes, most N.I.B., 1/2 price, send wantlist. Don Sturzenbecher, Rt. 3, Box 28, Sioux Falls, SD 57106. (605) 368-2135

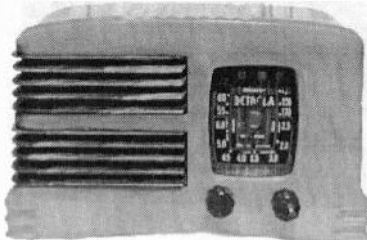

**WANTED:** Symphony and Detrola Catalins. Carpe Catalin; ne plus ultra! Please write or call collect: Rain Buttignol, 214 State St., #7, Portsmouth, NH 03801. (603) 427-1384

**FOR TRADE:** Sams for Sams under 600. SASE for list of duplicates (180) & needs (66). Dave Metz, 1016 Ridgmont Dr., Staunton, VA 24401

**WANTED:** Anything made by an Edison Company. Bill Androlia, 1880 Century Park East, #519, Los Angeles, CA 90067. (310) 277-1391

**FOR SALE:** Zenith Cobra-matic early stereo phono, excellent working portable with manual & newspaper ad - \$60. Phil Brunais, 14185 Pleasanton Hwy., Bear Lake, MI 49614

**WANTED:** Magnavox Model AM-62 Weekender transistor radio, must be in excellent condition. Richard Bosch, PO Box 172, Lacenter, WA 98629. (206) 687-4414

**FOR SALE:** Crosley 11-1240 (blue) - \$95, Philco 37-98 - \$145, Admiral 5A33 - \$15, Zenith 6S-152 - \$225, Silvertone 1968A (4.45s) - \$200. Cranston Ford Gyron in box - \$175. Will trade above for tube hi-fi, speakers, & guitars & guitar amplifiers. Sonny Goldson, 1413 Magnolia Ln., Midwest City, OK 73110. (405) 737-3312

**WANTED:** Audio output transformer and band knob for Zenith 7H820. Need turntable with good drive wheel (rubber tire) and needle cup for an RCA Victor U-9. **FOR SALE:** Green metal Arvin - \$65. RCA Victor 9K2. RCA Victor T-120 television. Atwater Kent 20 in Pooley cabinet. Univox guitar amplifier. 16mm movie on Westinghouse appliances. Joseph Loubriel, 524 James St., New Milford, NJ 07646. (201) 385-1677

**FOR SALE:** Vibrators for most automobile radios, vibrator transformers. Dealer discounts, free cataog. Dan Schulz, Antique Automobile Radio, Box 892, Crystal Beach FL 34681. 1-800-933-4926, or fax (813) 789-0283

**FOR SALE/TRADE:** Sylvania Thunderbird - \$300; maroon/yellowbullet - \$550. **WANTED:** Regency, Toshiba, Hoffman, Sony (transistors). David Mednick, 1450 Palisade Ave., #5-H, Fort Lee, NJ 07024. (201) 461-3082

**WANTED:** Jackson Bellcathedral Model 68. **FOR SALE:** Jetco chairside, coin-op, Model P1-12-C. Doug Bennet, 2297 Richland Ave., San Jose, CA 95125

**WANTED:** Heath semiconductor curve tracer IT1121. Tim Galli, 34 Eastview Ter., Pittsford, NY 14534. (716) 381-3768

**FOR SALE:** Used test equipment (as found in old Radio/Television Repair Shop). 58 cent LSASE for list. Sam W. Wrenn, 2314 Seminole Dr., #1207, Arlington, TX 76010

**FOR SALE:** Zenith H723Z - \$25. GE-402 - \$35. Emerson mid-30's Bakelite - \$25. Truetone mid-30's table model - \$25. Admiral 6T02-5B1, no chassis - \$10. Plus UPS. Michael Lapuzza, 2015 E. Willow Crk., Mustang, OK 73064. (405) 745-3394

#### CLASSIFIED AD NOTICE

Please check your ads carefully before sending them in. Once ads are received, it is not always possible to refund the amount sent, pull the ad or make changes.

**WANTED:** Speaker for Atwater Kent Model 206. Louis E. Siciliano, 20180 Governors Hwy., Olympia Fields, IL 60461. (708) 747-7840

**FOR SALE:** Heathkit TX1 Apache from good storage, tubes lite, excellent condition, no accessories - Best Offer plus shipping (approx. 50 lbs.). B&K Dynaquik Model 700 tube tester from same storage - Best Offer plus 15\$ shipping. M.F. Hewitt, KG6ZD, 1602 Brycedale Ave., Duarte, CA 91010. (818) 357-3989

**FOR SALE:** Custom-molded plastic knobs. Send knob to be duplicated with make and model plus \$8 each for solid color; \$12 each for imitation wood or Catalin. Also, custom-formed plastic dial lenses. Send old lens if possible, tracing of lens opening, and bezel (if radio has one) with make and model plus \$15 each to: L. W. Terrell, 7109 E. Arbor Ave., Mesa, AZ 85208. (602) 830-7849

**WANTED:** Will pay \$20 for an original Hickok 539-C tube tester manual in good condition. Alan Kriss, 1872 Portsmouth Way, Union, NJ 07083. (908) 688-2092

**WANTED:** Odd brand 01-A tubes. There were 500 different brands. I'm short 350. Ask for my want list. Your help appreciated. Ed Bell, 5311 Woodsdale Rd., Raleigh, NC 27606. Fax/phone (919) 851-1517

**FOR SALE:** LSASE for list of new/used receiving tubes; octal, locat, miniature, some older. Sell or trade for old or unusual tubes or related material for my collection. John H. Walker, Jr., 16112 W. 125th St., Olathe, KS 66062. (913) 782-6455

RADIO RESTORER'S SPECIALS			Each	20+
32 mFd	150 v	tubular	\$0.60	.50
47 mFd	160 v	radial	85	.75
10 mFd	450 v	radial	90	80
22 mFd	450 v	tubular	1.20	1.05

The following are 500v rated "greenie" Mylars:  
 .001, .0047 ..... \$0.25 20  
 .02, .01 ..... 30 25  
 .03, .047 ..... 35 30

Send a SASE for our New Flyer!

We believe these are the lowest priced fresh stock capacitors ever advertised in this publication. Add \$3 shipping to any order. Michigan residents add 4% tax. Check or M.O. only.

Antique Audio (of Michigan)

41560 Schoolcraft, Plymouth, MI 48170

# ARBE\* — III

## \* Antique Radio Battery Eliminator



➤ FEATURING:

- Adjustable high current "A" supply
  - 8 different "B" and "C" voltages
    - All outputs electrically isolated
    - 5-year limited warranty
    - Short circuit protection

---

*Terrific Christmas Gift Idea !!*



\$149.95 Shipped  
within continental U.S.A.  
*(Michigan Residents add 4% sales tax)*

Call or write for complete data sheet:

Antique Radios Inc.  
P.O. Box 6352  
Jackson, Michigan 49204  
Phone 517-787-2985  
Fax 517-782-7422



# **ARBE — III IS NOT A KIT**

*Please consider the following when purchasing your power supply:*

## **CAREFULLY DESIGNED**

### **SAFETY FEATURES NOT FOUND IN KITS**

Completely enclosed electronics means that potentially lethal voltages are not exposed. Front panel is electrically grounded via the 3 terminal power cord. Internal fuse will open and protect components before damage occurs. Front panel On/Off switch so that unit is not accidentally left on.

## **ARBE-III WILL WORK PROPERLY**

### **AS SOON AS YOU PLUG IT IN**

Each unit is professionally manufactured and electrically "burned in" before shipment. If you have ANY problem, simply return it and it will be repaired or replaced free. WE GUARANTEE IT FOR FIVE FULL YEARS.

## **ARBE-III USES**

### **QUALITY COMPONENTS THROUGHOUT**

This unit uses computer grade electronic components and a custom wound power transformer designed specifically for this application. We do not use surplus or factory seconds.

## **ARBE-III'S ELECTRICAL SPECIFICATIONS**

### **ARE CONSERVATIVE, NOT OVERSTATED**

We have over 25 years experience in the design and manufacture of power supplies. We guarantee our specifications and have proven them under laboratory conditions. *Antique Radio Classified* has done a field test report on ARBE-III which will confirm our quality and specifications (September 1991 issue).

**Don't Be Fooled – You Usually Get What You Pay For**

**FOR SALE:** Vintage microphones: Turner bullet, original box, instructions - \$125. EV 630, 664 - \$50 each. John Casper, 2605 S. Peninsula Dr., Daytona Beach, FL 32118. (904) 767-2075

**FOR SALE:** B&K 1076 TV analyst, excellent working condition, includes manual - \$35 + UPS. James S. Fisher, 344 Harrison Ave., Manville, NJ 08835. (908) 725-7476

**FOR SALE:** N.I.B. Eico 710 grip dip meters - \$85. Like new HP200CD oscillator, original manual - \$73. B&K E200D 100 kHz-216 MHz solid-state RF generator, metered output with manual - \$95. Heathkit: IT-17 tube tester - \$40; IG-5280 RF generator, 310 kHz-220 MHz solid-state with manual - \$65. Marconi TF1066B/6 RF generator, 10 MHz-470 MHz, AM, FM, CW, meters, calibrated attenuator, manual - \$195. HP651B oscillator, as-is, manual - \$35. Eico 955 capacitor tester - \$20. HP1703A 35 MHz dual trace scope, manual, exc - \$225. List - LSASE. Kirk Ellis, KK4YP, 03 Edgebrook Dr., Pikeville, NC 27863. (919) 242-6000, evenings

**HELP:** Need 4 square push buttons for Philco #40-185 console, and faceplate (plastic style, not warped), also AK 206 chassis, speaker and knobs, AK 376 chassis OK. Dig it up and call: Terry McGee, 101 Castle Dr., Madison, AL 35758. (205) 830-8040, 9:30-7, M-F

**FOR SALE:** Philmore Super Radio Crystal Set, Cat. No. 336, excellent condition in original box. National Panasonic transistor radio, Mod R-8, hot pink color, looks like miniature table model; top raises for jewelry/ring storage, rare and very unusual in original box - Offers. Harold LaRoche, 16426 Heiden Cir., Spring, TX 77379. (713) 370-3451

**FOR SALE:** Crosley 124 cathedral - \$125; Crosley Coloradio, hairline - \$40. Spectacular Truetone D1124 - \$250. John Lyle, 1161 S.W. Mulvane, Topeka, KS 66604-1456. (913) 232-0128

This Holiday Season...

Give A Gift Subscription to  
Antique Radio Classified

**BONUS:** December 1993 Free!  
All gift subscriptions received before  
December 31 will be sent the December  
1993 issue free!\*

To Order:

1. Fill out the card in this issue with the recipient's name and address.
2. Enclose a gift card which we will send along with the bonus issue. (We will enclose our card with your name if you wish.)
3. Include payment or charge to VISA or MasterCard, and send to:  
A.R.C., PO Box 2, Carlisle, MA 01741

Or Call (508) 371-0512.

P.S. There are more gift ideas from  
A.R.C. on page 41.

\* If already a subscriber, a 13-month extension  
will be made to the recipient's subscription.

**FOR SALE/TRADE:** Philco 38-38 wooden Art Deco - \$35. RCA 106 speaker. 1940's pinball machine. Mike Heffner, 724 Elmira St., Williamsport, PA 17701. (717) 323-3647

**FOR SALE:** Emerson, eight-transistor, Model 31P56 - \$35. Mint Philmore transistor, Model TR12, N.I.B. - \$30. Ed Povraznik, 9606 Biddulph Rd., Brooklyn, OH 44144

**WANTED:** Zenith portable G-503. Also info on Hickok oscilloscope MX-2330/G or AN/USM-81. Don Baldwin, 26 Schoolhouse Dr., Medford, NJ 08055-9209. (609) 654-0344

**FOR SALE:** (250) antique, collectible and novelty radios, Garod 6AU1 Catalin, early crystal set. Also early transistor radios and televisions. Test instruments. Past customers: have added many radios to list. For list send two-stamp LSASE to: John Enigl, Sr., K9HJL, 5425 Cherry Ln., Egg Harbor, WI 54209. (414) 743-3672

**WANTED:** Philco Bing Crosby 46-1201, wood-grain decal, must be in good condition. Thanks. Harold LaRoche, 16426 Heiden Cir., Spring, TX 77379. (713) 370-3451

**FOR SALE:** Radio ephemera. SASE for list. **WANTED:** Cabinet for Silvertone 4505. R. C. Moore, 452 West Park Ave., Aurora, IL 60506. (708) 264-0488

**FOR SALE:** Zenith 5D-027, exc - \$45. Philco 48-61 - \$20. Philco 46-250, exc - \$27. GE 415, exc - \$20. Arthur Kreitner, 2013 East Belle Ave., Belleville, IL 62221. (618) 233-5610

**WANTED:** Colonial grandfather clock radio in good original condition. Sam Zuckerberg, 578 Fifth Ave., New York, NY 10036. (212) 354-7407, noon-5 pm, Mon.-Fri.

**FOR SALE:** Hallicrafters TW-2000, Allied catalogs, 1955, etc. Clock radios. H. N. Felder, 7517 Granada Dr., Bethesda, MD 20817

## TUBES WANTED

— TOP PRICES PAID ! —

**WESTERN ELECTRIC TUBES  
NEW AND ORIGINAL BOXES:**

300 A/B, 104D, 274 A/B, 205 D/F,  
252 A, 242 C, 284 D, 339 A

\*\*\*\*\* INVITATION \*\*\*\*\*

I am looking for people all over the world to find tubes for me, and I will pay a bonus to the people who supply me with the best tubes!

**FOR SALE:** Record player, EMT 950 for studio use. Nice condition & looking. \$15,000 (U.S.) with shipping.

**TRIODE SUPPLY JAPAN  
1-101 227 Kasimada Saiwaiku  
Kawasakiki Kanagawaken Japan  
Fax 81-44-511-3492  
Tel 81-44-511-6343**



**FOR SALE:** Nice Trans-Oceanic D7000Y - \$175. Red Channel Master 6515 - \$35. Shipping extra. **FOR TRADE:** Vogue records R722 & R780 for one I don't have. Don Howland, 4621 W. Shawnee, Spokane, WA 99208. (509) 466-0939

**FOR SALE:** Philco Model #50 cathedral, needs speaker cone - \$100. Paul or Roy Swiatek, 1261 Commercial St., Pittsburgh, PA 15218. (412) 343-3032

**IF YOUR EXPIRATION DATE IS  
DECEMBER OR BEFORE, RENEW TODAY!  
EARLY RENEWALS  
RECEIVE AN EXTRA ISSUE!**

**WANTED:** Chassis and speaker for Philco Model 89. Hank Brazeal, 103 N. Lakepoint Ct., Crossville, TN 38555. (615) 456-2529

**FOR SALE:** Air King Model 66 globes, black crystalized - \$3,400. Bill M. Jolliffe, 2733 Benvenue Ave., Berkeley, CA 94705. (510) 549-1248, ask for Don

**FOR TRADE:** Transistor radios - Zenith Royal 500, Motorola 56T1, Realtone, etc. **WANTED:** Hoffman Nugget, Motorola Pixie, Belmont Boulevard, Automatic TT528/600. Steven Martin, 8625 E. Bellevue Pl., #1023, Scottsdale, AZ 85257. (602) 947-2853

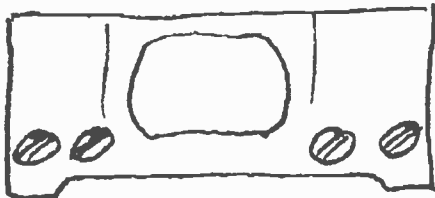

**WANTED:** 10" GE TV approx. 1950, has 10FP4 pix, four concentric shaft controls, 6G136G, a burned out flyback and poor sync cabinet must be reasonable. John Grady, PO Box 1154, Littleton, MA 01460

**FOR SALE:** Brewster Deco Bakelite - \$80. Howard Model 920, small Deco set factory white, painted - \$30. GE tiny wooden tombstone (July 92 Photo Review) - \$45. GE wooden Teledial (G.O.R., p. 80) - \$40. Zenith Sailboat Model 6G-601, factory fresh - \$130. Zenith 6G-501, missing top handle - \$45. Zenith cabinet only, Model 6S-439, nice - \$15. Zenith 5D-2611, restorable - \$20. Mitchell bed lamp - \$20. RCA 6TB6, fresh - \$95. Sentinel 6-volt child's console, needs refinishing - \$50. Teeco stereo tube amp, nice - \$20. Astatic D-104 microphone, nice - \$40. Grundig remote extension speaker for your Grundig; suspended by Deco table stand, (2) Grundig speakers inside, only 11 inches tall, very nice item - \$45. 1953 Packard auto radio - \$30. 1949 GE Model 807 television, nice, works, pick up only - \$100. Restored reliable telephones for workbench and home. All telephones are postpaid. Candlestick with dial - \$275. 1939 WE 300 - \$125. Danish cradle phone, circa 1939, very ornate - \$220. Holland cradle phone similar to WE 300 - \$100. Call for honest descriptions and to reserve items. Photos are available on most items. Phone restoration service also available. Frank Franowsky, 440-A Jemez Rd., Santa Fe, NM 87505. (505) 473-4150

**FOR SALE:** Motorola Airboy AR9623 w/headphones - \$35. Fisher 50M Fader - \$20. Clinton 254 - \$55. Steve Lange, 1351 N. 58 St., Milwaukee, WI 53208. (414) 259-1031

**FOR SALE:** Emerson 157 - \$75. Trans-Oceanic - \$65. Crosley Musical Chef - \$80. Zenith 5G-003, red. Dictaphones. Paul Recupero, 265 Union St., Portsmouth, RI 02871. 847-8589

**FOR SALE/TRADE:** Hallicrafters V-118 - \$65. National HRO-7 AA coil - \$30. Philmore VC-1000 crystal set - \$65. **WANTED:** Volume escutcheon and knobs for Emerson 250 (or parts set). Emerson 110/W. National SM-57 (signal meter for NC-57) and NC-77X receiver. National manuals and catalogs. Wayne Childress, 1903 Jerome Pl., #3, Helena, MT 59601. (406) 443-7255

**WANTED:** (3) plastic handles for Zenith Trans-Oceanics Models 3000-1. Complete front covers for 3000-1 and 1000 Trans-Oceanics. Will consider junkers with above parts. Complete Trans-Oceanics Models 3000, 1000-1, 7000R Taiwan. Zenith wood table models 7S633, 6D2615, 7S529, 7S635. Zenith plastic table models Y723, Y724, 6D315, 6D311, 6D312, 8D015, 6D615. Zenith plastic clock radios L515, J616. Zenith Model 4G903 Flip Top portable. Admiral tube portable #6P32, Palm Tree grille cloth. Admiral solar power transistor 7L16. Majestic portable with Eagle on grille cloth #7-P-420. Stromberg-Carlson shortwave portable #AWP-8. Tesla or Tailsman plastic table radio Model #308. Clinton Deco wood table radio #139. Frank Manziano, 82 Monhegon Ave., Oakland, NJ 07436. (201) 337-5263

**FOR SALE:** Amateur radio 5 cent stamps. Full sheet. Best offers considered. Walt Joyce, 20145 Morgan Ln., Gulfport, MS 39503

**FOR SALE:** Unique homemade paddle key. Heavy base 2 x 4 inches. Offers. Walt Joyce, 20145 Morgan Ln., Gulfport, MS 39503

**SERVICES:** Antique radio & TV repair, 40 yrs. ex., 2 wk. turnover, excluding major parts. T. Romano, 8 Howe Ln., Millbury, MA 01527. (508) 865-6293

**WANTED:** Sams AR manuals 267, 301, 321. W. D. Huneycutt, 2125 Rancho Rd., Hartsville, SC 29550. (803) 332-5928

**FOR SALE:** Superior Electric S945 Powerstat, 420 Hz, no knob - \$5 plus 5 lbs. UPS. Signal Corps chest set SC9248J, new condition - \$5 plus UPS. GE multi RC-Box, ca. 1947 - \$10 plus 20 lbs. UPS. John Uscinowski, RR#1, Box 379, Greenwich, NY 12834-9519

**WANTED:** Cabinet for AK 30 table model. **FOR SALE:** Test equipment manuals for Eico, PACO, Precision, Triplett and Simpson. Copies only. Write your needs, include large two-stamp envelope. Holiday blessing to all. Clayton Mundine, 6112 S. Flores St., San Antonio, TX 78214

## TRANSISTOR NETWORK

More and more radio people are discovering the excitement of novelty and regular transistor collecting. Why not join the fun? Now is the time to subscribe to the Transistor Network - a monthly transistor newsletter featuring transistor related articles and classified ads. Only \$12.00 for a one year subscription (12 issues).

Not sure? Send a SASE for a sample copy and find out what you've been missing! Call or write: Transistor Network, RR 1, Box 36, Bradford, NH 03221. (603) 938-5051

**FOR SALE:** Philco 42-340 (Bunis II, p. 132) - \$50. Emerson 708, small plastic - \$30. Philco D661 - \$25. RCA 7BX8J (Bunis II, p. 126) - \$25. Zenith H615-W (Bunis II, p. 210) - \$45. Silvertone 8003, white metal midget - \$65. Westinghouse H716T5 - \$15. Crosley 930Z, portable - \$15. **WANTED:** Restorable/complete Philco 90, need not work. Robert Schrantz, 610 E. Juanita Ave., San Dimas, CA 91773. (909) 394-1194

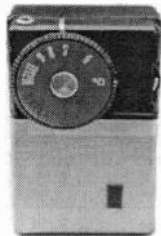

**WANTED:** Sony TR-63, any color, any condition. Marty Bunis, RR 1, Box 36, Bradford, NH 03221. (603) 938-5051

**FOR SALE:** Rare 1928 Workrite Model 48 AC console w/doors, works, excellent original condition - \$200 Canadian. Don Hatch, 14 Kingspar Cr., London, Ontario, Canada N6H 4C4. (519) 472-6167

### Classified Ad Deadline Noon

Dec. 10 for Jan. 1994 Issue

Jan. 10 for Feb. 1994 Issue

Boxed, Photo, & Display Ads - 1st

**FOR SALE:** National SW-54 - \$40. Hallicrafters S-38-B - \$37.50; S-38-C - \$40; S-76 w/matching speaker - \$85. All look good, working condition. Beautiful preserved showpiece. AK 45, metal, blk. w/green cover w/pear-shape tubes. All plus shipping. New 3-page list ready Nov. 15 - 50¢, SASE. Chet Wisner, 1014 Main, Dalton, MA 01226

**WANTED:** Interesting, old, junk vibrating code keys, used or new, parts or pieces, etc. James H. McGrath, W2IQJ, 2 Center View Ln., West Seneca, NY 14224-2124. (716) 675-0160

**WANTED:** Cylinder records in nice original containers with tops. Also pre-1930 empty tube boxes in excellent condition. Pay top \$. John Sudduth, 1842 Hwy. 92 North, Fairburn, GA 30213

**FOR SALE:** Transistor radios, perfect. Toshiba 7TP352S, 2-band blue, M.I.B., papers, handy book photo - \$150. Bendix Navigator 420, 3-band, gray - \$125. Emerson 888 Titan, turquoise - \$100. Philco T-7, white, case - \$85. Emerson Gemini, 31P58, N.I.B., Japanese, black - \$60. Presentation box Zenith Royal 500H, black leather case, mint, hang tag - \$60. Magnavox Micro AM 803, black, minor grille dents - \$30. Motorola Pixie 45P2, brown, case, plastic sleeve - \$175. Richard S. Lambert, 166 East 34th St., Apt. 13-H, New York, NY 10016. (212) 684-6564, eves.

**FOR SALE:** Hallicrafters SX-42 power transformer. Robbins and Myers brass blade fan. R. D. Chenez, RFD 2, Box 437-J, Plymouth, NH 03264

**WANTED:** Remler Model 5300B1 Scottie r/p. Mike Delahanty, 4833 N. Keeler, Chicago, IL 60630. (312) 283-4683

**HELP:** Need AK 206 or 376 chassis, knobs, spkr, dial lens. Dig it out and call: Terry McGee, 101 Castle Dr., Madison, AL 35758. (205) 830-8040, 9:30-7, M-F

**FOR SALE:** J.D.'s Radiowear breadboard and cathedral greeting cards - \$4.50/pkg. 12; radio collector caps - \$7.50; cathedral mugs - \$7.50; Deco, breadboard, and cathedral T-shirts - \$13.95, and sweatshirts - \$19.95. All prices ppd., all XXL add \$1. J.D.'s Radiowear, 1161 S.W. Mulvane, Topeka, KS 66604-1456. (913) 232-0128

**WANTED:** Harman Kardon Citation III tuner. Reasonable. Aaron Krueger, 3719 Woodland Ridge Rd., Wausau, WI 54403. (715) 675-6674

**WANTED:** Transistors, radios, parts, radio sales brochures, flyers. Call or send list, pictures. Ross Litrenta, 1 Wilton Rd., Eastchester, NY 10709. (914) 337-7176

**FOR SALE:** (40+) novelty radios. Send for list. SASE. Wesley M. Matous, 1824 Glengarry Dr., Carrollton, TX 75006. (214) 242-4168

**FOR SALE:** RCA serviceman's drop cloth, 53" x 35", red with white figures - \$85 postpaid. Charles Randall, 8711 Greens La., Randallstown, MD 21133. (410) 922-1623

**WANTED:** E.H. Scott receivers RBO, RCH, SLR-B, SLR-H and all manuals. Also want Nems-Clarke 1301, 1501, 1907 receivers and manuals especially for the 1301. Thanks! Tom Smith, N5AMA, 13034 Elmington Dr., Cypress, TX 77429-2062. (713) 376-3436

**WANTED:** Paying \$20-\$45 for McMurdo Silver newsletters, booklets that I don't have. Don Hauff, Box 16351, Minneapolis, MN 55416. (800) 769-9980

**FOR SALE:** Silvertone 2225, portable, AC-batt. - \$20. RCA Victor, 3RC76 - \$20. Lafayette, no model number. Thanks. James S. Looney, Rt. 1, Box 54, Grundy, VA 24614. (703) 531-8677, after 7 pm

**FOR SALE:** Thinning out my collection. Table models and three consoles. Send LSASE for list. Dave Mock, 3 Larkspur Pl., Montpelier, OH 43543. (419) 485-3933

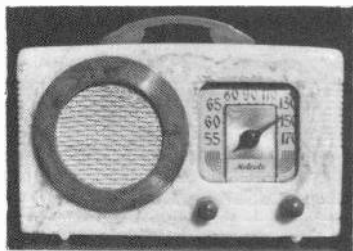

**WANTED:** Motorola Catalins, Motorola Catalins, Motorola Catalins, Motorola Catalins, ad-hoc, ad-infinitum, ad-lib, ad-cetera. Please write or call collect: Rain Buttignol, 214 State St., #7, Portsmouth, NH 03801. (603) 427-1384

**FOR SALE:** From closed TV store illuminated sign "Motorola - Works in a Drawer Solid-State TV," advertising first solid-state color TV made; has clock, works - \$150 plus \$20 shipping. Also other "Quasar Works in a Drawer" sign - \$100 plus shipping. D. Maurer, 24 S. 4th St., Lebanon, PA 17042

**WANTED:** Hallicrafters SX-73 in good condition. German WW2 ex-service equipment. **FOR SALE/TRADE:** German WW2 HRO copy. Ragnar Otterstad, Hosterkøvej, 10. DK-3460 Birkerød, Denmark. Tel. 011-45-42 81 52 05

**WANTED:** Eimac 300T and 500T. Industrial/Special purpose tube manuals or pamphlets. Also any odd or out-of-the-ordinary tube types. John H. Walker, Jr., 16112 W. 125th St., Olathe, KS 66062. (913) 782-6455

**WANTED:** Tube guitar amplifiers & guitars from Fender, Gibson, Vox, Silverstone, Gretsch, Marshall, Supro, Valco, Ampeg, Danelectro, etc. Sonny Goldson, 1413 Magnolia Ln., Midwest City, OK 73110. (405) 737-3312

**FOR SALE:** Levermatic clock from RCA Model C-4E - \$12 includes shipping. Hank Boersma, 6253 Dolores Dr., Oak Forest, IL 60452

**FOR SALE:** Used test equipment, new and used components, tubes, books. Eight-page list free to residents of Continental U.S.A. **WANTED:** Schematic/manual for Jackson Model 106 signal generator. Sue Coulter, 4200 Prince St., Bakersfield, CA 93301

**WANTED:** Pre-1940 telephones, paying top \$. John Sudduth, 1842 Hwy. 92 North, Fairburn, GA 30213

**FOR SALE:** Experience the Golden Age of HiFi in the 1950's with the new video: Vintage HiFi-The Golden Era 1947-65. Features dozens of collectible hi-fi amps, tuners, speakers from Altec, Dyna, McIntosh, Fisher, Scott, and many more. This quality 35 minute video is available December 6, 1993 for \$32.50 ppd. U.S. and \$45 foreign. Only a few copies of the Vintage HiFi Spotter's Guides 1 and 2 are still available for \$32 ppd. both or \$17.95 ea. (\$40 and \$25 foreign). Charles Kittleson, PO Box 691, Belmont, CA 94002. (415) 595-4164

**FOR SALE:** Fada 845 cream, perfect - \$300. Philco 65, maple - \$165. AK Kiel table model 55 - \$250. Grebe Synchrophase MU1 - \$225. Crosley/Sears 51 - \$125. Emerson Model 545 table TV, 1947, wood knobs, Channel 1, plus Magnaview - \$300. AK breadboard 4340, excellent - \$1,150. Mark DeFrancisco, 108 Mystic Rd., Marlton, NJ 08053. (609) 985-2974, after 1 pm

**WANTED:** Televisions to add to my collection: Philco 48-700, DuMont, Garod, National, GE 803, Crosley, Sparton, any 50's color TV. What do you have? Can pick up in Midwest. Thanks. Glenn Bubenheimer, 27851 Terrence, Livonia, MI 48154. (313) 421-5574

**WANTED:** Jewell tube testers Models 538, 214, and 533. Also, Supreme Instruments catalogs & papers. Randolph Warren, 5026 Portsmouth Rd., Fairfax, VA 22032. (703) 978-6144

**FOR SALE/TRADE:** Telefonken Recorder/Player Magnetophone 75, reel-to-reel, like new, includes mike, 12" x 11" x 5" high - \$60. Paul Fulton, 711 Jacquelyn Rd., Westwood, NJ 07675. (201) 664-5260

**PHONE NUMBER FOR ANTIQUE RADIO CLASSIFIED (508) 371-0512**

**Best time to call is weekdays: 9 am to 5 pm Eastern Time**

(Please no classified ads by phone. Thanks!)

**FOR SALE/TRADE:** Bendix 65P40. Channel Master transistor. Emerson portable Model 847. All work. Richard Arnold, Box 275, Lone Grove, OK 73443. (405) 657-3319

**WANTED:** Regency brand audio amplifiers, will pay up to \$600 per pair! Steve Melkisetian, c/o Angela Instruments, 10830 Guilford Rd., Suite 309, Annapolis Junction, MD 20701. (301) 725-0451. Fax (301) 725-TUBE/725-8823

**WANTED:** Clock assy. with glass/wood trim for Westinghouse WR-8 grandfather (Empire State Building) clock radio. Larry Krasnow, KM6IA, 140 Grand St., Redwood City, CA 94062

**FOR SALE:** (1300) new TV tubes in original boxes. Any reasonable offer accepted. Harry Cap, 190 Beech St., Bridgewater, MA 02324-3508. (508) 697-8648

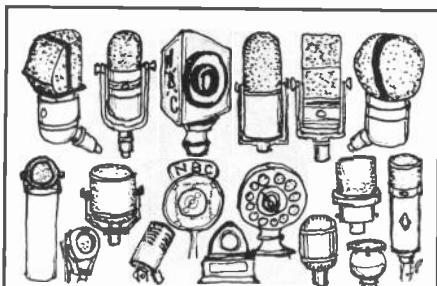

**WANTED FOR MY BROADCASTING MUSEUM**

Microphones, stands, call letter plates. Tube amplifiers, mixers, compressors, Hi-Fi equipment. Speakers, air-raft lights, equalizers. Disk, wire & tape recorders. Blank recording disks. Catalogs, magazines, manuals, 15" transcriptions, turntables, arms, pickups. Early TV cameras & receivers. Elaborate console, deco, plastic, mirror, novelty & wireless radios. Jukeboxes & parts. Acoustic phonographs.

We are looking for all makes of equipment, and especially *Western Electric*, *Telefunken*, *Neumann* and *RCA*. The museum contains various duplicates and items surplus to our needs, and many of these articles are available for sale or trade. The collection is located in my Victorian seaside inn, The Caffrey House, situated on a bay next to the ocean, in the Southampton resort area of Long Island. A trade of equipment for a stay at the hotel is always encouraged.

Robert Van Dyke, 2 Squires Ave., East Quogue NY 11942  
516-728-9835

**OLD TIME RADIO BROADCASTS ON CASSETTES**

Many of your old time radio favorites are available on quality cassettes at a reasonable cost. You select the shows you want and purchase them by the hour. Fast, friendly service too.

**The Great Gildersleeve**

- The Whistler
- Suspense
- Jack Benny
- Sherlock Holmes
- Fibber McGee & Molly
- Lux Radio Theater
- Amos 'N' Andy
- Sgt. Preston
- The Lone Ranger



Send for our catalog listing nearly 5,000 shows arranged by show category and title, many including original broadcast dates.

Only \$2.00 (P & H). Send request to:

**ERSTWHILE RADIO  
P.O. BOX 2284  
PEABODY, MA 01960**

# Do Your Holiday Shopping This Season From These Selected Books From Antique Radio Classified!

(IT'S O.K. TO SHOP FOR YOURSELF, TOO!)

*Every radio collector from the novice to the experienced should have a copy of this book:*



## GUIDE TO OLD RADIOS

A primer to collecting. 128 pages, 350 photos and 3300 current prices. 7" x 10". Johnson.

Softcover.....\$16.95

*A guide to repairing vacuum tube and transistor sets:*



## OLD-TIME RADIOS! RESTORATION AND REPAIR

A self-paced training guide. History, theory and practical operation of antique and classic radios.

256 pages, 200 illustrations. 7" x 10". Carr. Softcover.....\$16.95

*Price guide for over 7,400 battery & AC sets from 1920-1959:*

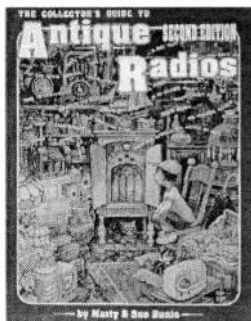

## A COLLECTOR'S GUIDE TO ANTIQUE RADIOS - 2<sup>ND</sup> EDITION

Collectors Marty & Sue Bunis have consolidated data from auctions, ads, flea markets, etc. in this beautifully illustrated price guide. Over 540 new color photos. 8 1/2" x 11". Bunis. Softcover.....\$17.95

*A book to help every collector get those old battery and AC sets playing again:*

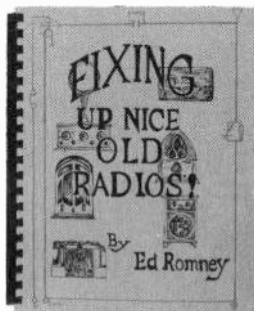

## FIXING UP NICE OLD RADIOS

Written by an old radio instructor. 185 pages, 300+ figures. 8 1/2" x 11", plastic binding. Romney.

Softcover.....\$19.00

*U.S. Orders - Enclose \$2.50 per order for packing & book-rate shipping if total order is under \$35.00. If using VISA or MasterCard, include name on card, card number and expiration date. Send payment with order. Mass. residents please add 5% sales tax. Money back return policy. Most orders shipped the same day received, but allow 2-4 weeks to receive order. Foreign orders - write for shipping costs, or use credit card and specify air or surface (allow 2-3 months for surface shipping).*



Send Order To: A.R.C., P.O. Box 2, Carlisle, MA 01741  
or Call: (508) 371-0512 Fax: (508) 371-7129



(Dec-93)

# Do Your Holiday Shopping This Season From These Selected Books From Antique Radio Classified!

(IT'S O.K. TO SHOP FOR YOURSELF, TOO!)

*This book is a must for anyone collecting radios and crystal sets from the 1920s:*

*This book is a must for anyone collecting radios from the 1930s to the 1950s:*



## VINTAGE RADIO

Standard photo reference guide for radios before 1930. 1000+ pictures. 5" x 8". McMahan.  
Softcover.....\$11.95

*A must for collectors of 1920s battery sets:*



## RADIO MANUFACTURERS OF THE 1920s.

Douglas. 1920s battery sets. 8 1/2" x 11".  
Vol 1. A-C Dayton - Ferguson ..(softcover only) \$24.95  
Vol 2. Freed-Eisemann - Priess .....(\$39.95\*) \$29.95  
Vol 3. RCA - Zenith .....(\$39.95\*) \$29.95

(\* Hardcover Prices)

**Close Out Special!**  
*Communications Receivers 2nd Ed.*  
by Ray Moore  
Only a few in stock  
Was \$17.95  
Now \$13.95  
(3rd edition will be available soon)



## FLICK OF THE SWITCH

Standard photo reference guide for 1930s to 1950s radios. 1000+ pictures. 5" x 8". McMahan.  
Softcover.....\$11.95

*For collectors of '30s & '40s plastic and other collectible radios:*



## RADIOS - THE GOLDEN AGE.

Collins. Full-color book on the stunning Catalin and Bakelite radios from the late 1930s to the early 1940s. 10" x 8 1/2".....(\$25.00\*) \$14.95

(\* Hardcover Price)

*U.S. Orders - Enclose \$2.50 per order for packing & book-rate shipping if total order is under \$35.00. If using VISA or MasterCard, include name on card, card number and expiration date. Send payment with order. Mass. residents please add 5% sales tax. Money back return policy. Most orders shipped the same day received, but allow 2-4 weeks to receive order. Foreign orders - write for shipping costs, or use credit card and specify air or surface (allow 2-3 months for surface shipping).*



**Send Order To: A.R.C., P.O. Box 2, Carlisle, MA 01741**  
or Call: (508) 371-0512 Fax: (508) 371-7129



(Dec-93)

**FOR SALE:** Excellent reproduction cast aluminum microphone flag for RCA 44 mic. Frank Nocera, 1572 Argyle Dr., Fort Myers, FL 33919. (813) 936-7197, after 6 pm

**FOR SALE:** Grundig table radio, plastic cabinet, no cracks, Model 88U FM/AM, clever 3-tube chassis, one tube missing, two knobs missing, as found, clean, not tested - \$20 plus UPS. Ellsworth O. Johnson, 364 S. Coeur D'Alene St., Spokane, WA 99204. Phone/fax (509) 838-2161

**WANTED:** Type 245/345 tubes, N.I.B. @ \$35, used @ \$20. H. Kato, c/o Mr. Omura, 3852 Mohr Oak Ct., Fairfax, VA 22033

**FOR SALE:** Rider's radio manuals Vol. 1 & Vol. 2 produced exclusively for National Radio Institute. Vol. 1 (receivers before 1946), Vol. 2 (receivers 1946 thru 1949) with cumulative index. Excellent to like new - \$5 each l ship. John Snow, 4539 Bartlett, Shorewood, WI 53211. (414) 964-0194

**FOR SALE:** Old radios, Catalin, wood, plastic, table models, lots of Sams facts, house antennas. List - \$2. N. Guertin, 281 Grafton St., Worcester, MA 01604

**WANTED:** Maas Carillon organ amplifier Model 500. Victor Gregowski, 3635 Orvall Dr., Fort Gratiot, MI 48059. (313) 385-9479

**FOR SALE:** 200+ radios, TVs, audio, misc. Send \$1 for 28 page catalog with photographs. John Kendall, PO Box 436, Fallston, MD 21047. (410) 483-3884

**FOR TRADE:** Zenith Spinnet and Sentinel 284 Catalin for Federals, breadboards and Amplion horns. Scott Cavalari, 1258 Rt. 94, New Windsor, NY 12553. (914) 561-7913

**WANTED:** Record/playback head, Bell Howell 300M. pt. 188-37, Brush 109U-4. Contact: Harold Lejuez, 46-16 160 St., Flushing, NY 11358. (718) 463-4110



*Craig L. Graybar  
Furniture Works Ltd.*

(414) 258-2390

SPECIALISTS IN RESTORING,  
REPAIRING AND REPRODUCING  
CLASSIC STYLED ANTIQUE TV,  
RADIO & PHONOGRAPH CABINETS

Send us your plans or your project  
via UPS for immediate price quotes



1535 S. 84th St.  
West Allis, WI 53214



*"We Turn Ideas Into Heirlooms"*

**FOR TRADE:** Ecco trees, circular Ecco AD65 (black/chrome, hairline), AD65 brown (vgc), Ecco ACT 96 black & chrome, Australian brown Radiolette (larger model, ivory fret and feet), blue Champion Venus globe (very rare! small repair!), early Marconi amplifier (voice/valve, Model NB2, ca. 1920), Philips 830, Silvertone ceramic whiskey keg, very rare French green Radio-capte by Celard ("piano" base with triple loop rotating antenna - futuristic in the extreme), black Radiolette tombstone (Australian improved version of Air King, ca. 1935). Crystal sets, horn speakers, some 1920s. For quality Catalin and exciting trades. Simon Wade, Finchcroft, Broadwater Down, Tunbridge Wells, Kent TN2 5PE, United Kingdom. (44) 892 543505, evenings

**FOR SALE:** Bakelite TV's, 10" GE Streamline, 7" Motorola Porthole - \$150 ea., pickup only. Wayne Abare, 335 Meadowood Ln., W. Melbourne, FL 32904. (407) 727-8559

## One Month Free!

### BONUS FOR EARLY RENEWALS

If you renew **before** the month shown on your mailing label (your expiration month), you will receive an extra month on your subscription: 13 months instead of 12! 26 months for an early 2-year renewal!

**WANTED:** Astatic JT-30 and other bullet mics like Shure Green Bullet, pay up to \$125. Steve Melkisetian, c/o Angela Instruments, 10830 Guilford Rd., Ste. 309, Annapolis Junction, MD 20701. (301) 725-0451. Fax (301) 725-TUBE/725-8823

**WANTED:** Aeriola Junior or early Aeriola Senior (3 horizontal ribs) cabinets or parts sets. Dick Kowalski, KB8MR, 32823 Gloede Dr., Warren, MI 48093

**FOR SALE:** Tube checkers, Heath #IT-3117 & copy of manual - \$22. Sencore TC-136 & book - \$22. Sencore TC-162 & book - \$40. All plus UPS. **WANTED:** Collins 55G-1 preselector and CCI TK-1 digital readout, also Hammarlund SPC-10 SSB converter & SP-300 speaker, HRO-50 coils AB, AC, F. Dan Mason, R. Rt. 1, Box 204F, Santa Fe, NM 87501. (505) 455-3416

**FOR SALE:** Philco Model 44 multiband cathedral, restored - \$200. David S. Kendall, 401 Himes St., Huntington, IN 46750. (219) 356-5096

**WANTED:** Crosley Musicone speaker in new condition. Also, other nice decorative or unusual speakers. Ed Bell, 5311 Wooddale Rd., Raleigh, NC 27606. Fax/phone (919) 851-1517

## TUBES - CAPACITORS - ETC.

**ALL-NEW GREATLY ENLARGED  
1992-93 ILLUSTRATED 16 PAGE  
CATALOG #48**

Jam-packed with thousands of  
tubes, etc. with current prices

Send \$2 (cash, stamps or check)  
(Canada \$3 - Overseas \$4)  
**FOR YOUR COPY NOW!**

DON DIERS 4276 North 50 St. #AD11  
Milwaukee, WI 53216-1313

**FOR SALE:** Radiola III, w/o tubes - \$75. Radiola 18 Canadian version - \$125. Radiola AR 812 - \$150. L. Drago, 383 Lincoln Dr., Cheshire, CT 06410. (203) 272-6030

**WANTED:** Zenith dial, Part #26-258 for Model 10A1. Lew Dunning, 3343 Savage Rd., Sarasota, FL 34231. (813) 922-3101

**FOR SALE:** Wurlitzer 5-6 Lyric cathedral table radio, circa 1931, 40 years unused, good condition, needs electrical work. Ms. Alice Wilkinson, 915 E. Walled Lake Dr., Walled Lake, MI 48390

**FOR SALE:** Good Radiola III - \$100 plus postage  
**WANTED:** The tuning knob for Radiola RC! Bill Moss Settle, 120 Clarksdale Cir., Glasgow, KY 42141. (502) 651-6525

**WANTED:** Tuning gang for Philco Model 620. Jeff Gault, 2571 Seminole, Ann Arbor, MI 48108. (313) 973-6445

**FOR SALE:** N.I.B.: 6HB5, 6JB6A, 6JG6A, 6KD6, 36KD6 - \$10 each; 6JE6C, 6LF6 - \$20 each. Ron Pfeffer, 653 Commercial St., Farnham, NY 14061

**FOR SALE:** Zenith, portable, The Navigator, AM-SW-LW, nice - \$90. Will trade for cute transistor. Jim Martes, 15400 E. 2nd St. S, Independence, MO 64050. (816) 836-0668

**WANTED:** Clarostat RPC-5A, dual ganged 500k ohms potentiometers, Jun Mizuno, 933 Portswood Cir., San Jose, CA 95120. (408) 268-4016

**FOR SALE:** Majestic 5AK-711 unusual black Bakelite - \$125. Firestone 57402-1 marbled beetle plastic, repaired crack - \$90. Westinghouse WR-165 white Plaskon w/red knobs - \$165. Flush wall 5P white front - \$110. Bulova, 120 pink & gold - \$45. Some Kadettes available, call. Several other nice sets, call. Thanks. Jon Steinhauer, 636 Westminster Rd., Baldwin, NY 11510. (516) 223-9878

**FOR SALE:** National Electric Supply SE-899 mfg. 11-6-18, 300m to 12,000m and SE 1071 audio amp by Western Electric - \$2,000 OBO. Simplified Reinartz set with good tubes - \$95. Crosley Super Trirdyn Special, exc w/tubes - \$105. Tuska 228 - \$250. Atwater Kent Model 37 with pwr supply - \$135. Atwater Kent Model 30 in original box - \$200. Zenith 7G605 - \$150. Radiola 60 - \$90. Eagle Neutrodyne, works - \$150. RCA UZ-1325 - \$75. Atwater Kent Model 20 DeLuxe - \$125. Zenith Super VII - \$250. Philco 21 tandem w/good pic tube - \$350. Shipping extra. D. Patterson, 636 Cambridge Rd., Augusta, GA 30909. (706) 738-7227

**FOR SALE:** (Battery radios): Paragon Type Two, good - \$495. Radio Electrical Co., Pittsburgh, Pa., early 2-tube amp, nice - \$450. Remler 8-tube (99s) superhet, extra nice - \$425. Western Air Patrol Model 100 - \$95. Crosley 51P portable w/tubes, extra nice - \$215. Hayes, Grand Haven, Mich., w/tubes - \$135. Jim Clark, 1292 Starboard, Okemos, MI 48864. (517) 349-2249. Fax (517) 349-4059

**WANTED:** Horn only for Magnavox R-3 driver. Ron Franzen, 4307 Wild Ivy Ct., Arlington, TX 76016. (817) 451-5282

**WANTED:** Knobs for ivory Philmore radio Model 205, would consider junker. Still looking for any info, photos, brochures, photocopies, etc. on L. Tatros or any other Iowa radio. Thanks. Dennis Hilberg, 804 Ravine St., Decorah, IA 52101

**FOR SALE:** GE remote control, Model GM-8 for Models G-95, G-105, G-106. Buyer assumes all responsibility. Darrell Combs, 6587 Pacheco Way, Citrus Heights, CA 95610. (916) 969-0635

**FOR SALE:** From the '50's #6 Zenith table radios, AM-FM, repaired, working well - \$39 ea. #40 science fiction paperbacks from the '50's. - \$3 ea., \$100 for all plus postage. Harry J. Blair, 3401 S Lituania Ave., Chicago, IL 60608. (312) 247-7949

# Active Antenna

## Model AA10

Allows antique radios which were designed for a long wire outdoor antenna to operate on a 42" indoor whip antenna. Operates from 9 volt battery.

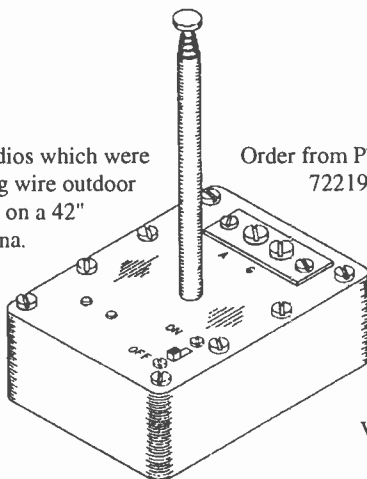

Only \$34.95

Order from PTI, Box 191117, Little Rock, AR 72219, (501)568-1995. Orders shipped UPS, prepaid in continental U.S. Please allow 3 weeks for delivery. Arkansas residents add 5% sales tax.

Visa and MasterCard accepted

**WANTED:** Hi-fi theater audio equipment, mono/stereo, broken or not, tubes, drivers. Khanh Do, 1161 Copper Verde Ln., Modesto, CA 95355. (H) (209) 525-8359; (W) (209) 835-9759

**WANTED:** Output transformer for Stromberg-Carlson SAU70 amplifier, uses 6550 tubes, with 4/8/16 ohm & 70 volt output. Jon Andreasen, PO Box 22, Newton, NJ 07860. (201) 579-6261, 5:30-9:30 pm ET

**RATE FOR ADDITIONAL WORDS:**

17¢ per word

**FIRST 20 WORDS FREE!**

*Cash or stamps OK for small amounts.*

*Your payment helps to keep A.R.C. healthy!*

**FOR SALE:** Michigan one-tube (looks identical to illustration V.R., p. 128) w/o tube - \$95. Collection of (15) antique capacitors for battery set - \$10. Dozen good grid-leaks - \$15. Wireless parts: woodblock variometer (V.R., p. 158) - \$15. Parts for constructing slide tuners - \$12. Rare Manhattan var. cond. (similar to V.R., p. 161, but vertical plates!) - \$55. Plus shipping. Arthur Harrison, 2707 Lynnwood Dr., Columbia, MO 65203. (314) 449-3134

**FOR SALE:** RCA Senior Voltohmyst, as-is, Model WV-98C - \$25 + \$5 shpg. Precision E-200C signal generator, with manual - \$40 + \$7.50 shpg. Johnson Messenger, 223, no mic, as-is - \$20 + \$7.50 shpg. Patrolman Pro 2, Realistic VHF monitor rcvr, as-is - \$20 + \$7.50 shpg. Lafayette Comstat 19, no mic or xtals, as-is - \$15 + \$7.50 shpg. Johnson Viking Messenger, with mic, one knob gone, unchecked - \$20 + \$7.50 shpg. Regency MR-33 Monitoradio, 30-50 Mc, unchecked - \$25 + \$7.50 shpg. Delco Electronics CBD-10 solid-state CB radio, with mic, unchecked - \$25 + \$7.50 shpg. James Fred, R 1, Box 41, Cutler, IN 46920. (317) 268-2214

**WANTED:** Microphones - RCA 77's & 44's, etc. James F. Phillips, 414 Washington Ave., Defiance, OH 43512. (419) 782-8591

**FOR SALE:** International 9-transistor A9101 Deluxe, like new in store box and with papers - \$75. Channel Master 6509, small shirt pocket - \$50. Arvin 61R48, 7-transistor - \$40. All plus shipping. Tim Yeany, PO Box 23, Rimerburg, PA 16248. (814) 473-8345

**FOR SALE:** Fisher Series 80-C Master Audio Control and Equalizer - \$39. New 2A3sylvania tubes - \$22.50. Glen Richie, W4JGO, 643 Diamond Rd., Salem, VA 24153. (703) 389-3356

**WANTED:** Copy of instructions for Precision CRT tester/rejuvenator Model #CR-60. Robert Lozier, 600 E. Green St., Monroe, NC 28112. (704) 283-2638

**WANTED:** Standard Micronic Rubies, Sony Micro 1R81, as well as other Micros, preferably, M.I.B. Victor Visalli, 48 Cedar Ave., Maywood, NJ 07607. (201) 845-0463

**FOR SALE:** Rainbow 203 tube (open fil.) in original base - \$35. 212D tube in original base - BO. Green Bendix, nice - \$625. Zenith all Bakelite radio (most were recalled) - \$125. Early Pilot parts, such as Superwasp, etc. vintage - Inquire. **WANTED:** Pilot radios, any model, any condition, any vintage. Bill Moore, 3049 Box Canyon Rd., Huntsville, AL 35803. (205) 880-1207

**WANTED:** Nordmende Globe Traveler shortwave portable radio. This radio could be placed on its side, handle tilted the face of the radio upward. Must be in new & mint condition. Stephen H. Friedman, KA2GRR, 333 East 46th St., #11C, New York, NY 10017-7417. (212) 490-3919

**FOR SALE:** National NC-100A with manual, good condition - \$80. Buyer pays packing and shipping. Jim Barrows, W7BC, 15121 41st Ave. SW, Bothell, WA 98012. (206) 337-4880

**FOR SALE:** Original September 1927 Atwater Kent radio instruction book, 4th edition, exc condition - \$20 plus \$1.75 postage. Ron Burtzos, 2325 Chestnut Ln., Sycamore, IL 60178

# WANTED!

## ★ 1920-1924 Battery Sets ★

Amrad, Clapp-Eastham, Cutting & Washington, De Forest, Federal, Grebe, Kennedy, Marconi, Paragon, Radiola, Tuska, AK, Leutz, Crosley, Crystal Sets, and Horn Speakers.

Serious collector. Will consider others and entire collections. Can travel.

**Ed Bell — 5311 Woodsdale Rd.  
Raleigh, NC 27606  
FAX/PH: 919-851-1517**

mf/ volts	manuf	each	20 & up
.001/600	Sprague 715P	\$ .40	\$ .35
.002/600	Sprague 715P	.41	.36
.0047/600	Sprague 715P	.42	.37
.01/400	Xicon (radial)	.26	.21
.01/600	Sprague 715P	.54	.49
.015/600	Sprague 6PS-	.50	.45
.02/400	Xicon (radial)	.27	.22
.022/600	Sprague 715P	.65	.60
.047/400	CMC (axial)	.35	.30
.047/600	Sprague 715P	.68	.63
.05/400	Xicon (radial)	.35	.30
.1/400	Xicon (radial)	.50	.45
.1/600	Sprague 715P	1.00	.90
.22/600	Sprague 715P	1.50	1.35
2.2/450	Rubycon (axial)	.65	.60
4.7/450	ICC (axial)	.66	.61
10/450	Xicon (axial)	.98	.91
22/160	Rubycon (axial)	.75	.70
22/450	Xicon (axial)	1.30	1.25
33/160	Xicon (radial)	.88	.83
33/160	Rubycon(axial)	1.08	1.03
47/160	Xicon (radial)	1.30	1.15
47/160	Xicon (axial)	1.30	1.15
47/450	Rubycon(axial)	1.95	1.80
80/450	CWI (axial)	2.60	2.20
shipping charge, U.S.A. flat \$ 4.00			
FRANKENSTEIN'S RADIO LABORATORY			
4010 Fairmont Pkwy, Suite 285			
Pasadena, Texas 77504			
(713) 998-0130			



# New Books for the Transistor Radio Collector

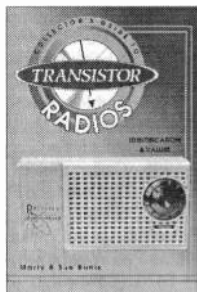

**The Collector's Guide to Transistor Radios**  
by Marty & Sue Bunis. *This book will help you identify the most sought-after vintage transistor radios. Over 2,200 models, all with current prices. Over 400 color photos. 5 1/2" x 8 1/2". 256 pages.*

**\$15.95 - Softcover**

**Made In Japan** by Roger Handy. *A stunning book on the development and growth of the transistor radio featuring over 175 transistor radios in full color. 10" x 9 9/16". 108 pgs.*

**\$16.95 - Softcover**

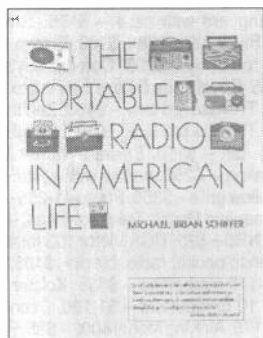

**The Portable Radio in American Life** by Michael Schiffer. *Approximately 50 pages on transistor radios, beginning with the Regency TR-1 through to the later sets made overseas. 450 photographs, 193 transistor radios pictured. 8 1/2" x 11". 259 pages.*

**\$24.95 - Softcover**

**\$45.00 - Hardcover**

U.S. Orders - Enclose \$2.50 per order for packing & book-rate shipping if total order is under \$35.00. If using VISA or MasterCard, include name on card, card number and expiration date. Send payment with order. Mass. residents please add 5% sales tax. Money back return policy. Most orders shipped the same day received, but allow 2-4 weeks to receive order. Foreign orders - write for shipping costs, or use credit card and specify air or surface (allow 2-3 months for surface shipping).



**Send Order To: A.R.C., P.O. Box 2, Carlisle, MA 01741**  
**or Call: (508) 371-0512**

**Fax: (508) 371-7129**



(Nov-93)

**FOR SALE:** Toshiba Rice Bowl 6TR-92, very nice with one small chip - \$395. Belmont 6D111, white with some paint chips - \$150. Coronado Bakelite with blue trim, (Collins #1), repainted - \$250. Toshiba 6P-10, white and olive green - \$45. Stewart-Warner 1272 Art Deco 5 tube tombstone, notchrome, very good original - \$210. Bendix 526C Catalin - \$625. Zenith 5R312 - \$145. Raven Bakelite 3 tube superhet with 01-A's, approx. 12" x 3" - \$85. Home brew xtal set, nice small routed cabinet - \$80. Play Pal bar Deco radio, missing one glass, with cards, clay poker chips and dice, cabinet needs some work - \$275. Atwater Kent 558 cathedral, cabinet needs work, guts nearly perfect - \$575. Philco 70 - \$295. General Television black Bakelite, white trim - \$90. Excellent original Philco 89 - \$185. Beautiful mahogany Stromberg-Carlson 240W, 11 tube console Governor Winthrop desk (F.O.S., p. 180) - \$850. 14" Philco etched glass neon dealer window sign, 1931 - \$550. Stromberg-Carlson shortwave converter, 1934 - \$150. RCA 111 - \$110. Pilot FM tuner - \$35. Howard FM tuner - \$110. Stewart-Warner Varsity 97-562, brown - \$225. RCA T-10-1 tombstone, refinished; Zenith chrome front tombstone 809. Zenith consoles: 15U270; 15U269; 15S373A; 12S371; 12S370; 12U158; 12A58; 12S265; 12S266; 9S365; 9S262; 9S367; 8S154; 8S463; 7S366; 7S363; 7S, 410, 880 and many others. Zenith chairside: 12S245; 9S344; 9S244; 9S242; 7S240; 7S343 and many others. If you are looking for a set not listed, please call for more info. We can and do ship consoles anywhere and we do it right. Zenith table models: 7S28; 7S527; 7S529; 7S432; 6S527; 6D525; 7S633; 7S634 and many others. To reference most Zenith radios, we offer a 60-page 11" x 17" Zenith Brochure Book depicting models from 1920 to 1946 - \$28.95 ppd. Zenith Trans-Oceanics: 1000 - \$175; 3000 - \$175; American 7000 - \$295; Pristine American 7000, with box and paperwork - \$365. We accept Visa and MasterCard. All radios unrestored electrically unless noted. Shipping extra unless noted. Satisfaction guaranteed, highest quality possible assured. When in Minneapolis, be sure to visit our retail location in our own Radio Row, just a few minutes from the airport. Alan Jesperson/Mike Emery, PO Box 17338, Minneapolis, MN 55417. (612) 727-2489, 8 am to 8 pm Central time, 7 days. Fax only: (612) 727-1908, 8 am to 8 pm

**FOR SALE:** Uher 4400 IC stereo professional reel-to-reel recorder, 4 speeds, 4 track, 2 channel, operated on 5 D cells of AC adapter - \$75 as is. S&G Electronic, 618 S. 62nd St., Philadelphia, PA 19143. (215) 474-7663

**WANTED:** Come on folks, I've been looking forever! Surely one of you has a Stromberg-Carlson 225H that you'd part with. Wooden table set, black octagonal dial on right, wooden flowers on speaker grille, left, (pictured in F.O.S., p. 180 and E.O.R., p. 187). Leads also appreciated. Adam Schoolsky, 38007 Stenhammer Dr., Fremont, CA 94536. (510) 791-0330, after 7 pm or leave message

**WANTED:** Hytron/National Union: 274A/B, 300A/B, 350A/B, VT-25A, VT-45, VT-50, VT-52. Leif Blackmon, 4 Larson Rd., North Reading, MA 01864. (508) 664-0174

**FOR SALE:** Belmont 6D111 vq repainted - \$145. RCA 9X641 vq/exc - \$45. Emerson DQ 334 exc - \$50. Emerson EC301 exc - \$60. Emerson 343 repaired vq/exc - \$30. Crosley 56TN exc - \$55. Zenith Y723 exc - \$30. Zenith 6D614 v exc repainted - \$50. Westinghouse 226 refrigerator g - \$85. RCA 12X exc - \$50. Assorted clock radios and junk - \$7 ea. Plus shipping. Bob Masterson, Box 172, Valley Cottage, NY 10989. (914) 353-3151

**FOR SALE:** Stay home this winter; there are no meets to go to. But I have done the leg work and stocked up, so here we go with another exciting list. Sparton 7-sided mirror radio blue glass, all original - \$2,700. Sparton 3 knob, all original - \$2,500. Emerson Patriot white body, red grille, blue handle & knobs - \$1,200. Yellow Fada bullet - \$700. Pilot 3" TV, excellent - \$295. Emerson AU-190, green with original back, perfect - \$2,600. Emerson BT-245, green with white louvers, perfect - \$2,600. Emerson BT-245, red with white louvers, crack on bottom - \$3,300. RCA Little Nipper Catalin, yellowbody, red knobs, unnoticeable hairline one side - \$1,000. Fada Model 252 prewar blue Catalin, unnoticeable hairline under dial - \$2,000. Emerson brown Bakelite Model BA 199 (Collins I, p. 31) - \$295. Detrola Pee Wee in marbled brown (Collins I, p. 33) - \$475. Westinghouse Little Jewel Model H124 (Collins I, p. 63) - \$125. Majestic Melody Cruiser prewar version (Collins I, p. 73) - \$395. (Collins I, p. 75) Airline 64BR 1501A - \$95. (Collins I, p. 77) Coronado Plaskon, small hairline on top - \$295. (Collins I, p. 98) perfect hairline Rudolph - \$1,300. (Collins I, p. 102) mike radio - \$195. (Collins II, p. 31) Detrola Pee Wee brown - \$350. Kadette (Collins II, p. 36) - \$475. (Collins II, p. 45) RCA World's Fair - \$1,250. (Collins II, p. 47) GE H500 beetle plastic, unnoticeable repair on side where a hairline was - \$250. (Collins II, p. 51) RCA LaSiesta - \$900. Detrola on the cover of Collins III - \$250. Chrome front, (Collins II, p. 62) in white Belmont version - \$195. (Collins II, p. 63) Silvertone Candy Cane, some hairlines - \$150. (Collins II, p. 69) Motorola Mother's Day radio - \$95. Farnsworth bullet similar to Northern Electric on p. 75 - \$165. (Collins II, p. 81) radio premium Jack Armstrong pedometer with original mailer & instructions - \$95. (Collins II, p. 85) frog eyes in maroon & white - \$195. (Collins II, p. 85) Motorola 5X12U - \$75. (Collins II, p. 87) Crosley Model 10-139 - \$175. (Collins II, p. 91) Pepsi Cooler - \$600. (Collins II, p. 94) Motorola green body, green grille - \$145. (Collins II, p. 97) Emerson 744 black body, green grille, one foot broken - \$275. Arvin metal 540T, green with back - \$95. Arvin 444, white, perfect - \$125. Arvin 840T, white - \$85. Silvertone Model 2 - \$94. Transistors: Made in Japan book p. 73 Dick Tracy boy's radio, new in box - \$195. Perfect white Vanguard with case - \$175. Grey 888 Explorer - \$100. Black Atlas 888 - \$100. Bulova Comet 620, black grille, red body - \$295. Coronet boy's radio with antenna - \$55. Royal Tone Deluxe new in box 2 tran. boys radio - \$75. Toshiba red lace - \$450. Zenith Royal 500, white - \$75. Toshiba red lace - \$450. Zenith Royal 500, white - \$75, tan - \$150. Stewart-Warner Varsity radios, white Plaskon - \$250, yellow with white grille - \$400, blue with yellow grille - \$350. Philco 41-255 - \$135. Perfect ornate American Bosch Treasure Chest - \$250. Freed-Eisemann NR5 - \$95. RCA Victor 103 tombstone - \$95. Perfect Zenith pocket radio, black - \$135. Montgomery Ward 62-177 tombstone - \$135. Kolster Model K-20, perfect AK 10 breadboard - \$1,100. Deco tombstone GE M63 - \$175. AirKing Model 4002 - \$85. Radiola III with balanced amp - \$395. Westinghouse Aeriola Sr. Receiver & Aeriola amp - \$500. Motorola Pixie, light grey - \$250. RCA red oriental radio - \$275, black - \$195. Arvin metal 243T sand bronze color - \$125. RCA BP10 - \$65. Philco 20 - \$250. Philco 21 - \$650. Philco 90 - \$600. AK 84 - \$500. AK 82 - \$600. Now was this list unbelievable, so call fast or stop by and reserve any radio. Many more available. Remember we buy radios also, so call us after them. Less than 28 miles west of George Washington Bridge, easy-on easy-off Route 80. Call first. Eric & Sirelle Fogel, 87 Sandra Dr., Parsippany, NJ 07054. (201) 316-8424, call 10 am-10 pm, fax 10 pm-10 am

**FOR SALE:** Sparton radio Model 5-26 battery set. This walnut finish table model is 28 inches in length with lid that lifts to expose tubes and drop front door to expose dials and controls. Also sets on table which holds storage battery. Set has 5 tubes: 1-71A, 4-01-A; 01-A tubes are bad. This 1926 model set belongs to a customer of mine and he will take \$200 plus freight. Clarence B. Shippey, PO Box 741, Midvale, UT 84047. (801) 566-8593, day; (801) 568-1989, evenings and Sundays until 10 pm Mountain time

**FOR SALE:** Electronic, electrical books and magazines, 1930's to 1960's. Two stamps for list to: H.P. Horton, 3828 W. Spurgeon St., Ft. Worth, TX 76133. (817) 926-2178

**SEND ALL A.R.C. MAIL TO**  
**Antique Radio Classified**  
**P.O. Box 2, Carlisle, MA 01741**

**WANTED:** Tube amplifiers, microphones, record cutting machines, audio tubes, 16" turntables, records, jukeboxes, 40s/50s memorabilia. Kim Gutzke, 7134 15th Ave. South, Minneapolis, MN 55423. (612) 866-6183

**WANTED:** Chassis for Radiola III; Regenoflex balanced amplifier; Westinghouse WR-14; General Motors 250; Crosley 125, 1137; Majestic 195, 363; Philco 60, 37-38, 42-340. Junkers considered. Also empty binder for Rider's Vol. I. Brian Kurrle, 208 Crofton Rd., Bel Air, MD 21014. (410) 838-6534

**FOR SALE:** Following "Little Radios": Zenith cube, AM only - \$75. Arvin Model (422) - \$75. Mirror Tone, Mod 630 or S-30 - \$50. Westinghouse Mod H-379TA - \$50. Crosley Mod 9-120W - \$65. Ribbon Grille Delco F1231A, - \$95. Emerson 706B - \$75. L. Drago, 383 Lincoln Dr., Cheshire, CT 06410. (203) 272-6030

**FOR SALE:** Old 1923 crystal set board, signed by H. Wilcox, coils, terminal post, dials and crystals in original container, take all for \$50. L. Drago, 383 Lincoln Dr., Cheshire, CT 06410. (203) 272-6030

**FOR SALE:** Zenith Trans-Oceanics: 7000 - \$195. 5H40, very nice - \$65. 8G005YT, loctal, average - \$35. Stewart-Warner 300, nice cabinet - \$85. Delco 3201, 32 volts, nice - \$55. Philco Super Hetrodyne Seven console with short wave converter, as is - \$75. Philco 90 console, beautiful cabinet - \$300. RME DB23 - \$25. SX25 speaker in cabinet - \$40. Pilot T511 - \$35. Radio III, good audios - \$85. Riley-Klotz chrome speaker, no driver - \$125. G. Stevens, PO Box 704, Longmont, CO 80502-0704. (303) 776-8036

**WANTED:** Silk screen dial glass, round knob, and pinched knob for Scott Phantom. Dial escutcheon for Zenith 5S-29. Junker Sets OK. Eddie Burris, 4224 Stoneham Ln. NW, Rochester, MN 55901. (507) 282-1879

**WANTED:** Tubes made by Addison, N.O.S. or good used: 12SQ7, 12SK7, 12SA7, 50L6, 35Z5. Robert Sukosky, 62 Strong St., Manchester, CT 06040. (203) 646-8857, call between 5 pm to 9 pm EST

**MESSAGE:** Correspondence with someone who knows FM broadcast quality equipment, equalization, AGC, etc. **WANTED:** Lafayette KT 600 or LA 600 preamp. Manuals Heathkit impedance bridge IB 28 & Heathkit Q meter. John Sampson, 75 Glenwood Dr., Leominster, MA 01453. (508) 537-0092

**FOR SALE:** Sams Photofacts RCA Service Data Consumer Electronics Products books. 1967 thru 1978. Write (Jay's) Ann Bichanick, 15 1/2 W. Lake St., Chisholm, MN 55719. (218) 254-4421, evenings

**FOR TRADE:** Remco toy crystal radio kit, new in box. Looking for early transistor radios. John Hoffnagle, 10 Sunset Ave., New Oxford, PA 17350. (717) 624-8894

## **TUBES • PARTS • SUPPLIES** **YOUR COMPLETE SOURCE**

### **TUBES:**

3000 audio, receiving and industrial types in stock, including early and foreign types. Discount prices!

### **CAPACITORS:**

High voltage electrolytic and mylar capacitors for tube circuits.

### **TRANSFORMERS:**

Hard-to-find power transformers, audio transformers, and filter chokes for tube equipment.

### **SUPPLIES:**

Chemicals, test equipment, wire, batteries, tools, etc.

### **LITERATURE:**

Extensive offering of literature and books on antique radios, hi-fi, communications equipment, tube data, and circuit diagrams.

### **PARTS:**

Resistors, lamps, tube sockets, potentiometers, grill cloth, knobs, vibrators and more.



**"Write or call for our 32 page wholesale catalog"**

**ANTIQUE ELECTRONIC SUPPLY**

6221 S. Maple Avenue, Tempe, AZ 85283, Phone (602) 820-5411, FAX (602) 820-4643

**WANTED:** Zenith Trans-Oceanics, tube and transistor models, any condition. Frank Manziano, 82 Monhegon Ave., Oakland, NJ 07436. (201) 337-5263

**FOR SALE/TRADE:** Philips radio made in the twenties, Model 2511. **WANTED:** Catalin radio. Luis Sabater, TVV, Ademuz S/N, 46100 Burjasot, Valencia, Spain. Fax (6) 3645863

**FOR SALE:** Philco 37-690 console, 20 tubes, 7 speakers, 2 chassis, 15+ watts audio, PP6B4's, pick-up - Bids. Francis H. Yonker, P.E., W2IBH, 1229 Inverary Pl., State College, PA 16801. (814) 867-1400

**NOTICE TO ALL  
CLASSIFIED ADVERTISERS!  
OUR CLASSIFIED AD DEADLINE IS  
12:00 NOON  
ON THE 10th OF EACH MONTH**

**WANTED:** Early crystal sets and 1-tube receivers. Also 1950's crystal sets. Matt Erdahl, 6506 S. Dorsey Ln., Tempe, AZ 85283. (602) 730-0570

**WANTED:** Always want AK breadboard parts, any condition. AK 228, 447, 567. Bob Nicholson, 3423 S. Long, Topeka, KS 66605-2486. (913) 266-9473, after 4:30 pm

**FOR SALE:** Firestone Air Chief battery set - \$55. National loudspeaker - \$40. Grundig Majestic 2035 - \$85. Airline Model 62315, wood Deco - \$55. Zenith Model 8H034 (Bunis, p. 206) - \$50. Zenith Universal (G.O.R., p. 87) - \$35. Philco Model 50-900 - \$30. Knight RF generator Model KG686 - \$45. Pilot Model T521 - \$45. Silvertone console, Model 1845 - \$60. Silvertone console, 9-tube - \$45. Hallicrafters S-95 - \$35. Gonset Citizens Communicator G-12 - \$25. IBM Aperature Card Micro Fische reader - \$20. Techmaster FM tuner - \$20. SWL Microlog - \$40. John F. Dubino, KA1SBN, 73 Devens St., Greenfield, MA 01301. (413) 774-5826

**WANTED:** Tube type CB radios, Elenco power cord plugs, with two glass fuses inside. Warren Belles, 1421 E. Royal Palm Rd., Phoenix, AZ 85020. (602) 943-4135

**WANTED:** Schematic or blueprint for Norden-Hauk C-10 Navy Superheterodyne (10 tubes, machined brass chassis, V.R., p. 144). Mel Goldberg, 1472 Gunpowder Rd., Rydal, PA 19046. (215) 572-0231

**FOR SALE:** Admiral transistor radio new in box with earphone, case and original battery, Model Y2231, works well. Mayfair Model PH-77, tiny phonograph measures 8 inches by 3 1/2 inches by 1 3/4 inches tall, new in box, but needs work. Both items are new old stock, will sell as pair only - \$80. Frank Franowsky, 440-A Jemez Rd., Santa Fe, NM 87505. (505) 473-4150

**FOR SALE:** General Electric transistor Model 672 w/ case, ivory, 1958, 1st transistor by GE - \$125. Tony Flanagan, 92 Joysan Ter., Freehold, NJ 07728. (908) 462-6638, after 6 pm or weekends

**WANTED:** 6" dynamic speaker for 1936 Crosley, Model 167. Will trade or sell Rider manuals. Contact: Bill Wieczorek, 1116 Cummings Dr., Boulder City, NV 89005. (702) 293-2548

**WANTED:** Philco 20 knobs. RCA RF tuning dial. Sencore VA62A. Sencore LC53. Sencore YF33. Simpson 330 tube tester data. Dan Cutler, PO Box 1203, Douglas, WY 82633. (307) 358-6219

**FOR SALE:** Western Electric 111-C repeat coils, (10) available. Henry Galbraith, 1214 South Alvord, Evansville, IN 47714. (812) 476-7601

**WANTED:** RF module for radio receiver 1051B. Jack Meyers, 2656 N. Halleck, Portland, OR 97217. (503) 283-0821

**WANTED:** Zenith Trans-Oceanic Royal 3000-1, prefer excellent/mint condition. Gene Peroni, Box 58003, Philadelphia, PA 19102. (215) 665-6182, daytime

Run <sup>®</sup> Atwater Kent/Zenith/RCA/Federal/Croceley/Grebel/Magnavox/Marconi/Freshman



# Battery Eliminator Kits

Westinghouse/Freed Eismann/Western Coil/Howard/Stromberg-Carlson/GE/etc.



- ✔ Best Specifications
- ✔ All outputs fully protected
- ✔ High quality components and design
- ✔ Safe and simple to operate
- ✔ Printed Circuit means **no wiring**
- ✔ 1 Hour or less to assemble

### A-B Farm Set Specifications:

- ✔ A - Output 1.25 to 8 volts adjustable (1.8 Amps max.)
- ✔ B - Output 90 Volts Fixed (emulates two 45 volt batteries) at 25 mA.
- ✔ Total of 5 different terminals.

### A-B-C Bench Top Specifications:

- ✔ Will run nearly any battery set ever produced
- ✔ A - Output 1.25 to 8 Volt adjustable (3 Amps max.)
- ✔ B - Output 22, 45, 67, 90, 115 at 70 ma (135 V optional)
- ✔ C - Output 5 terminal 0 to -16 Volts in increments
- ✔ C - Variable Output 0 to -22 adjustable
- ✔ Panel mounted A and C adjustable dials
- ✔ Total of 15 different terminals



The compact A-B Farmset Supply is stand alone or can be installed.

Measures 3 X 5 X 2.5 inches.

An Atwater Kent Model 33 being powered by the A-B-C Benchtop Supply (Right)  
Measures 5.5 X 7 X 3.5 inches.

Our battery eliminators out perform all others. Check and compare our prices, features and specifications. No one comes close. These easy to assemble kits include all parts and easy to read instructions. Assembly takes 1 hour or less. All you need is a soldering iron, wire snips and a small flat head screwdriver. All kits are guaranteed. A-B-C Supply is \$79.95, A-B Supply is \$39.95. Add \$6.00 S/H. Allow 2-3 weeks for delivery. To order call Peptronics toll free at 1-800-299-3005 or write Peptronics, 103 Rio Villa Drv. Punta Gorda, Florida 33950. Visa and Mastercard accepted.

**WANTED:** IF transformer between oscillator and 2nd detector for Philco Jr. Model 81. Philco #06100. A. J. Long, 11830 Heath Rd., Chesterland, OH 44026. (216) 729-8451

**WANTED:** Aragain, Aragain, Aragain. I'm looking for any items from this Niagara Falls, N.Y., manufacturer! Radios, parts, pieces, paper. Joseph Pawell, 6 Augustine Ave., Ardsley, NY 10502. (914) 693-9374

**FOR SALE:** Six, original, Western Electric ads, 1941-1947, full page - \$70 (includes postage). Gene Katz, KC6BLD, 212 Burnamwood Dr., Mt. Laurel, NJ 08054. (609) 866-1189

**WANTED:** Hallicrafters SX11, SX12, S14, SX15. Robert Braza, N1PRS, 49 Fifth St., East Providence, RI 02914. (401) 438-8927

**FREE - 20 WORD AD EACH MONTH**

To get your free 20 words,  
include your **SUB#** with your Ad.  
Additional words are 17¢ each.  
Read inside back cover for details.  
**MANY THANKS!!!!**

**WANTED:** For Philco Model 41-250 large plastic es-cutechon plate that surrounds the dial, set of 4 knobs, and 8 push buttons. For Atwater Kent 10C RF interstage coil (not the switched one) with or without windings intact. James F. Crews, HCR 63, Box 4, Arbovale, WV 24915. (304) 456-4798

**FOR SALE:** Rider's XVII - \$30. MYE 1st ed. - \$15. MYE 5th ed., 3rd ed. - \$12.50 each. Mallory tech manual - \$12.50. Sams Red Book 1st edition, 1938 to 1948 - \$15. Robert Shuck, 10512 Winston Ln., Fishers, IN 46038. (317) 849-0381

**FOR SALE:** Silvertone Model 6157 console, excellent original condition, working, PU only - \$150 or BO. Thank you. Harry Kundrat, 29 Walton Ave., New Providence, NJ 07974. (908) 665-1873

**WANTED:** Top prices. Paid for N.O.S. and used RCA 845, 811A, 50, 250, WE 300B, 350B. Jason Chou, 108-42 63rd Rd., Forest Hills, NY 11375. (718) 275-9184

**FOR SALE:** The remainder of my collection: 110 radios (wood, metal and Bakelite), five filled tube caddies plus over 100 used tubes, numerous parts and test equipment, meters, earphones and speakers - \$3,000 firm. Cash only, no shipping. Walter Keith, 269 White St., So. Burlington, VT 05403. (802) 862-4394

**FOR SALE:** Superior tube tester - \$45. Guild Country Belle - \$85. RCA 65X1 - \$45, 8R71 - \$45. Zenith Royal 675 - \$30. Charles Voigt, 94 Cleveland St., Norfolk, MA 02056. (508) 528-7928

**FULL RANGE ELECTRON  
TUBE SHOP - HONG KONG**

**- HIGH PRICES PAID -**

McIntosh MC225, 240, 275, M1200MR67, MR71. Marantz Model 1, 2, 3, 4, 5, 6, 7, 8B, 9, 10, 10B. Fisher 70AZ, 80AZ, 100AZ, 50AZ, or any other tubes pre-amp & power amp.

**- TUBES WANTED -**

EL34, EL37, KT66, KT77, KT88 (British made). 12AX7, 12AT7, 12AU7 Telefunken & Bugle Boy. 7728, 7729, 7730, 7591, 2A3, 6B4G, 12AX7, 12BH7 (black plate). 6FQ7 (side flash).

**Jonathan Woo Yik Fan**

**14/F, Flat B, 10-14 Reclamation Street  
Sun Lee Building, KLN Hong Kong  
Tel: (852)-771-5957 - Fax: (852)-771-5850**

**FOR SALE:** Viking tube recorder electronics - \$120/pr. Harvey 106PA power supply - \$100. Richard P. Robinson, 868 South Main St., Plantsville, CT 06479. (203) 621-7445

**WANTED:** Western Electric Millibox test set used for adjusting relays. Robert Wallace, 8007 Red Lion Rd., Springboro, OH 45066. (513) 748-0657

**WANTED:** Zenith 1 or 2, 3, 4 Series, cash or trade. Steve Melvin, 34 Deep Brook Harbor, Suffield, CT 06078. (203) 668-6821

**FOR SALE:** RCA 5T tombstone, nice, working - \$85. Early medical quack instrument, complete with shockers, very clean - \$35. Original large wood knobs for Eveready 54 console - \$30. Original wood Z knobs - \$10 ea. **WANTED:** Empty (or full) 1920's headphone boxes, especially Crosley, etc. Also, small old style B batteries approx. 3"-4" square(?). Still looking for a Kodol crystal set, any condition, including a parts set. Go ahead - make my day! Dave Crocker, 6 Raymond St., Sandwich, MA 02563. (508) 888-6636, before 9 pm

**WANTED:** Westinghouse RA/DA/RC; tube hi-fi. **FOR SALE:** Bozak B300 speaker (one), excellent - \$95. Radiocraftsmen 10 tuner, lettering on glass mostly gone, excellent chrome & performance - \$15. Al Wirtenberg, 15 Wilson Rd., Weston, CT 06883. (203) 544-9270

**FOR SALE:** 845 Fada, white, repro knobs, hairline on bottom, exc - \$350. Fada bullet, yellow, damaged case & handle - \$350. Fada 659 repro knobs, small hairline, exc cond. - \$475. Emerson AX235 restored white, tube burn on side otherwise exc cond. - \$600. Crosley Fiver tombstone, nice - \$85. All prices plus UPS. Vernon Shatwell, Rt. 5, Box 195, Sapulpa, OK 74066. (918) 224-4551, call after 7 pm CT

**FOR SALE:** Sams Radio Photofacts, many random sets from 306-2000 - \$2 plus postage. Bill Olson, Route 1, 4023N-2000E, Filer, ID 83328. (208) 326-4962

**NEW!**



**FADA BULLET WALL CLOCK**

Actual size reproduction of a FADA 1000 radio face, houses a clock in place of the radio dial. Hand-cast in realistic imitation catalin plastic, featuring yellow body with red knobs, handle, and trim-ring. Uses one AA battery (not included). Size: 10 1/2" x 5 1/2" x 1 1/8". 1 1/2 lbs.

TO ORDER: Send \$49.95 to L.W. TERRELL, 7109 E. ARBOR AVE., MESA, AZ 85208. (602) 830-7849.

# VINTAGE RADIO RESTORATION VIDEO TAPE

## THE RADIO DOCTOR

### Volume 1: VINTAGE RADIO REPAIR and RESTORATIONS

- COVERS THE COMPLETE RESTORATION of a 1930s SET
- INCLUDES COSMETIC RESTORATION of a WOOD CABINET
- COVERS ELECTRONIC REPAIR and ALIGNMENT
- DESIGNED FOR THE BEGINNER and INTERMEDIATE LEVEL RESTORER, PRESERVATION IS STRESSED
- "HEARTILY RECOMMENDED... FOR THOSE WITH A YEARN TO LEARN" 5-92 Radio Age review
- 4 HOURS ON 2 VHS VIDEO TAPES

### → NEW VIDEO TAPE ←

### Volume 2: CONSOLE RESTORATIONS

- PICKS UP WHERE VOLUME 1 LEAVES OFF
- COVERS MORE ADVANCED RESTORATION TOPICS
- THE FORMAT DIFFERS FROM VOL. 1 WHICH FOLLOWED ONE SET FROM START TO FINISH, VOL. 2 USES SEVERAL DIFFERENT SETS TO SPOTLIGHT MANY DIFFERENT RESTORATION PROBLEMS.
- CONSOLES ARE THE FOCUS BUT THE PRINCIPLES APPLY TO ALL TYPES OF SETS.
- 4 HOURS ON 2 VHS VIDEO TAPES

**TAPE PRICES \$23.95 EACH VOLUME PLUS SHIPPING TAPE SHIPPING \$4.00 for one or both volumes.**

**SPECIAL OFFER:** Those who have bought both volumes in the past or by DEC 31 may order one transistor mini-replica Crosley 56TDR or Emerson BA199 style radio from us for \$20 ppd. (See photo NOV ARC pg 77). Quantities limited, expires Dec 31, limit one radio per customer.

## NEW Bargain Books

- R) **EVOLUTION OF THE RADIO WITH PRICES, VOL 2, 1993**  
NEW LIST PRICE \$24.95 OUR PRICE \$21.25
- S) **PHILCO RADIO: 1928-1942**, by Ron Ramirez, 1993  
NEW LIST PRICE \$29.95 OUR PRICE \$25.50
- T) **MADE IN JAPAN: Transistor Radios of the 50s & 60s, 1993**  
NEW LIST PRICE \$16.95 OUR PRICE \$14.50
- A) **COLLECTOR'S GUIDE TO ANTIQUE RADIOS, 2nd Ed. 1992, Bunis. List \$17.95 OUR PRICE \$15.25**
- B) **EVOLUTION OF THE RADIO WITH PRICES, 1992**  
List Price \$22.95 OUR PRICE \$19.50
- C) **RADIO MANUFACTURERS OF the 1920's**, by Douglas  
1) **VOLUME 1: A.C. DAYTON to J.B. FERGUSON**  
a) SOFTCOVER List \$24.95 OUR PRICE \$21.25  
b) HARDCOVER List \$39.95 OUR PRICE \$34.00  
2) **VOLUME 2: FREED-EISEMANN to PREISS**  
a) SOFTCOVER List \$29.95 OUR PRICE \$25.50  
b) HARDCOVER List \$39.95 OUR PRICE \$34.00  
3) **VOLUME 3: RCA to ZENITH**  
a) SOFTCOVER List \$29.95 OUR PRICE \$25.50  
b) HARDCOVER List \$39.95 OUR PRICE \$34.00
- NEW) **COLLECTOR'S GUIDE TO TRANSISTOR RADIOS, 1993**  
by Bunis LIST \$15.95 OUR PRICE \$13.25
- E) **COLLECTING TRANSISTOR NOVELTY RADIOS, 1990**  
by breed. List \$24.95 OUR PRICE \$21.25
- F) **70 YEARS OF RADIO TUBES and VALVES** by Stokes  
List Price \$25.95 OUR PRICE \$22.00
- G) **RADIOS: the GOLDEN AGE, 1987**, by Collins.  
a) SOFTCOVER List \$17.95 OUR PRICE \$15.25  
b) HARDCOVER List \$25.00 OUR PRICE \$21.25
- H) **ANTIQUE RADIO RESTORATION GUIDE, 2nd Ed., 1992**  
by Johnson LIST \$14.95 OUR PRICE \$12.75
- I) **RADIOS REDUX: Listening in Style, 1992, Collins**  
a) SOFTCOVER List \$17.95 OUR PRICE \$15.25  
b) HARDCOVER List \$29.95 OUR PRICE \$25.50
- O) **CLASSIC TVs: PREWAR thru 1950s with prices**  
List Price \$16.95 OUR PRICE \$14.25
- NEW) **POSTER'S RADIO & TV PRICE GUIDE 2nd Ed 1993**  
LIST PRICE \$17.95 OUR PRICE \$15.25

**BOOK SHIPPING:** \$2.50 for one, \$1 each additional

SEND SASE FOR OUR COMPLETE LIST.

## OZARK VINTAGE RADIO

DEPT. A  
3923 East Latoka Street  
Springfield, MO 65809

**WANTED:** Hallicrafters S29 or S39, any condition. Bill Gustavson, 1819 Green Tree, Duncanville, TX 75137. (214) 296-7275, leave message on recorder

**WANTED:** Guild radios Grafonola and Tea Kettle and the other less common models. Ruth & Jim Whartenby, 120 W. Franklin St., Bound Brook, NJ 08805. (908) 271-7701

**SERVICES:** Repair/replacement of old meters, instruments before 1930 - no trades required! Cash is fine. Leonard W. Cartwright, Ye Olde Meter Cellar, 879 Russet Dr., Sunnyvale, CA 94087. (408) 739-6025

**HELP:** Need photocopy of operation instructions for NRI Professional Model 71 tube checker. Dwane Stevens, KC5MT, Rt. 3, Box 25A, Ardmore, OK 73401. (405) 223-4303

**FOR SALE:** Kennedy V - \$375. Kennedy 22 - \$250. Kodel 1-tube - \$300. Others. Anthony Caserta, 47 Vista Ln., Levittown, NY 11756. (516) 731-7175

**WANTED:** 1941 GE Model J-62 and Truetone Model D1117 Treasure Chest table radios. D. Hershberger, 101 Columbia Dr., Williamsville, NY 14221. (716) 839-5597, 632-2662

**FAX NUMBER FOR  
ANTIQUE RADIO CLASSIFIED  
(508) 371-7129 - 24 hours a day  
Ads - Subscriptions - Book Orders  
Charge to VISA/MasterCard  
Minimum Charge: \$10.00**

**WANTED:** Knob for Philco Transitone #53-561. **FOR SALE:** Firestone FC #7270 table radio with phonograph - Best Offer over \$15. Emerson Bakelite, Firestone 4-A-110, Westinghouse 11-204A and others - \$10 each or Best Offer. Cleo McAlexander, Box 4, Stanleytown, VA 24168

**FOR SALE:** Motorola 59X11, 1950 - \$24. Meck 5D7W18, 1947 - \$26. Zenith 5G636, 1942, Deco grille - \$52. Ralph Ripke, 9580 Caribbean Blvd., Cutleridge, FL 33189-1555. (305) 233-2621

**FOR SALE:** Arvin, Model 61, large top of the line tombstone, 3 bands, very nice - \$225. RCA Radiola 33 in accessory console cabinet with RCA 106 speaker, unusual and pretty - \$175. Fifty or more clean original sets always available, thinning my collection. Sorry, no shipping; come see my inventory! Dickering done here. All inquiries to include SASE. Francis W. Pond, 98 High Rd., Leed, NJ 03824. (603) 659-3831, no calls after 9 pm EST

**WANTED:** Alto, bass, lo bass switch assy. from any Zenith. Also 5 section push buttons from Zenith 6S330. Robert Haworth, 112 Tilford Rd., Somerdale, NJ 08083. (609) 783-4175

**FOR SALE:** Sams A.R.T.R. CB, N.O.S. Phonograph needles and cartridges. RCA Geiger counter WF-10A. Louis L. Veltre, 643A Sherwood Ct., Lakehurst, NJ 08733-4207. (908) 657-7592

**WANTED:** Chassis for Crosley Buddy Boy cathedral. Super Buddy Boy cathedral. Will pay \$10,000 for Spar-ton Nocturne. I will pick it up in the States. **FOR TRADE:** (2) Standard transistor radios, wkg. condition. The first transistor, reel-to-reel tape, portable, new in box. Looking for interesting cathedrals. Make offers. Bruno Pinto, 24 Remez St. #7, Tel-Aviv, 62192, Israel. Fax: (03) 517-3016. Phone: (03) 6734729

**FOR SALE:** Tested tubes w/warranty! Buy those spare tubes for your tube radio, audio, and electronic gear. Prices are about 35% of new. I have a bunch of octal, older and several thousand 7 and 9 pin tubes. All tested on TV7 tester and boxed. I give a 30-day warranty. Send wants or SASE with two stamps for list. Repair of TV-7 tube testers and calibration: I will fix and then verify calibration of your TV-7 tube tester for - \$45 plus shipping or return it no charge. Please no units with bad meter movements or missing components. Unit must be repairable and not a basket case. Daniel Nelson, 1025 E. Desert Ln., Phoenix, AZ 85040. (602) 243-7421

**FOR SALE:** Novelty radio that looks like a liquor/cognac bottle, N.I.B., price reduced to - \$20. Wireless aeroplane antenna reels made by Brach and dated 1918, reduced to - \$25. Commodore 64 computer with 1541 disk drive - \$100. Panasonic 1180 printer with Xetec Super Graphics interface for Commodore - \$100. Sakata SC-100 color monitor - \$50. Misc. software. Add UPS. Will accept trades of crystal sets for all above items. **WANTED:** Panel for Radiola I. Norm Hertz, 4904 Amboy Rd., Staten Island, NY 10312. (718) 967-1025

**WANTED:** 279 Detrola. Dan Claus, 2305 W. Rice, Sioux Falls, SD 57104. (605) 332-3747

**FOR SALE:** Transistor type novelty radios. Send SASE for list. Don Tomlinson, 2311 15th Ave. SW, Austin, MN 55912, or call (507) 437-3582

**FOR SALE:** Zenith transistor, Royal 500 Deluxe w/ case, owl eyes, chassis 8AT40Z2, black mint - \$95. Atwater Kent Model 20 - \$95. Bob Turner, PO Box 2313, Fair Oaks, CA 95628. (916) 721-9063

**SERVICES:** Transistor radios restored like new. Eric Wrobbel, 20802 Exhibit Ct., Woodland Hills, CA 91367. Phone or fax (818) 884-2282

**FOR SALE:** Home brew 500-watt linear with two 811-A's in grounded grid; amplifier is complete with power supply and control circuitry in 36" bud rack cabinet with 3" casters (39" overall), very heavy - \$125. Converted ARC-5 receiver in 12" x 19" cabinet, complete with VHF converters - \$60. ARC-5 transmitter set up as VFO (no finals or tank circuit) - \$20. Aerotron 600 VHF/FM transceiver with mic - \$50. LM-21 crystal calibrator - \$20. Equipment is as bought, prices plus shipping. **WANTED:** Data on Sansui stereo amplifier AU2200. Very old RCA test equipment. Cable operated car radios. Dr. B. A. Hodgson, 14 Evergreen Dr., Voorhees, NJ 08043

**FOR SALE:** AK Model 30 wood metal front, has 7' cable, real nice, all original - \$225. Philco old chrome 5" diameter round base, has Philco on basket green screen on off switch, like new - \$55. DK Model 1067 TV analyzer, sold new \$300, sell - \$125. Signal Ect Minn. relay on wood base, nice - \$135. Master phone amplifier with Mastermic No. VR0505, old mike as mint - \$125. Henleys 222 radio circuits designs, original 1923 by W. Whentley Co., nice - \$20. See my photo ads in this issue. Thank you. Edison Mabry, I Collect Best in Radios, 715 W. Longview Ave., Mansfield, OH 44906. (419) 526-1175

**WANTED:** Chassis for Garod 6AU1 Commander. Danny Thornton, 1175 Springdale Cir., Spartanburg, SC 29303. (803) 578-8518

**WANTED:** Help! One radio! That's all I ask! Wood Traveler #315 (Bunis #1, p. 152). Please call: Randall Giles, 12552 Camarero Ct., San Diego, CA 92130. (619) 792-9391. Fax (619) 792-7376

**FOR SALE:** Zenith Trans-Oceanics: L500 - \$40; L600 - \$40; 1000D, exc - \$100; 3000-1 - \$125; 1000 parts set - \$25. Solid brass speaker horn - \$45. Coronado Cub - \$35. RCA R-28 tombstone - \$140. RCA video disc player - \$12. Weston 772 VOM - \$15. Precision E-200 sig. gen. - \$25. Hallcrafters S-38EM - \$40 and S-40A parts set - \$15. Violet ray machines. National RCQ rcvr - \$100. Steve Leffel, 1790 Edison St., Green Bay, WI 54302. (414) 465-1855

**FOR SALE:** Horns to transistors, horn speaker Selector, Seattle - \$100. Belmont 6D111 w/end crack - \$150. Clake box 15" dynamic speaker w/baffle & rubber shock mounts - \$75. Electro-Voice Sono-Caster portable speaker in molded case - \$50. Silvertone wire recorder-phonograph - \$200. Ever-Ready (English) Sky Leader 5 transistor portable - \$200. Tonex folding style travel radio alarm, green genuine leather case - \$150. Toshiba 6P15, red, ivory & gold - \$75. All plus UPS. Chuck Bray, 1322 Ivy Rd., Bremerton, WA 98310. (206) 373-1013

**WANTED:** Bench power supply 200-300v up to 100 mA plus 6.3 VAC 4A, or similar power supply, amplifier speaker combination to power R1155. Graham Stubbs, 34 Babcock St. #204, Brookline, MA 02146. (617) 734-6209

**FOR SALE:** Emerson BT247 Snow White - BO. Bing Crosby Junior Juke - \$325. Columbia Graphophone crank phono w/louvers - \$160. Philco 89 cathodal restored, working - \$160. Satisfaction guaranteed. Jahan L. Acciavatti, PO Box 231, Southborough, MA 01772

**FOR SALE:** Console case Spartan on legs Deco @ 10 - \$50. Stewart-Warner Mod 106A Consolette A/O N/O \$140. Crystal rcvr Mod CR-1 Heathkit - \$55. GE c/rad Mickey Mouse, 2 sm chips @ 9, plays, 1967 - \$65. Crosley Model F5-TWE Musical Chef, white w/red kn. 2 timer @ 9 - \$45. GE c/rad M-516F, white A/O/N/D @ 10/p - \$45. Philco portable (beach) Mod 666 A/DC @ 10/p, maroon w/light - \$65. AKAI hi-fi spkrs stereophonics w/cords (twin pack) @ 9 - \$60. Silvertone Mod 7020 metal @ 8, no scratches - \$40. Graybar Vstone no # 8 tubes @ 10 - \$150. AK bread boxes (1) M-40 case @ 4 chass. @ 7 w/5t - \$45. (2) AK 40 w/t @ 8 - \$55. (3) AK 42 case @ 8 chass. @ 4 (NEST) - \$30. Zen. trans. Mod 16 no spkr @ 8 - \$40. Sony A/FM M-TFM-6160W @ 9 3v - \$20. Sony AM/rcvr TR-3230 9v @ 9 - \$25. QST 4/59 1-4-5-7-1963 1-2-4-5-11-1964 lot - \$15. Testers: Triplet M2413 w/papers - \$35. Superior M612 w/papers wd. case - \$40. Plus pkg. & shpg. Bernie Samek, 53 Old Palmer Rd., Palmer, MA 01069. (413) 245-7174

**WANTED:** Pocket-size radios (transistor, tube, or crystal) made in Japan or America. Eric Wrobbel, 20802 Exhibit Ct., Woodland Hills, CA 91367. Phone or fax (818) 884-2282

**WANTED:** VT-2, PPN-2 bag & antenna WWII and PPN-1 radio. Steve Bartkowski, 4923 W. 28 S.T., Cicero, IL 60650. (708) 863-3090

**FOR SALE:** Blue Arcturus tubes: 127 - \$10 ea., 145 - \$25 ea., 122 - \$20; 180 - \$20; 51 - \$15 ea.; 01-A 7 ea.; UX-199 - \$15 ea.; 120 - \$20 ea. Geoff Shearer, 13115 Rounding Run Cir., Herndon, VA 22071. (703) 860-1617

**FOR SALE:** Philco 49-905 & 51-530. RCA 6XF9 & 3X521. Setchell-Carlson Super 8 chassis with speaker. Peerless Speaker A-37889 Ted Gasiorek, 201 Golden Ave., Briggsville, WI 53920. (608) 981-2051

**WANTED:** Parts for restoration. Hallicrafters SX-11 main dial disc and bottom cover. Will buy complete radio if dial is good. Millen 42000 Series coils, jack bar with swinging link, 500 watt. Millen 90711 V.F.O. I expect to pay too much for these items! Dean Showalter, WA6PJR, 36308 Panorama Dr., Yucaipa, CA 92399. (909) 797-1782

**FOR SALE:** Sams TV Photofacts #1-800-\$150. **WANTED:** Philco console 78 turntable, circa 1946-48. Phil Boydston, 102 Concorde Pl., Mandeville, LA 70448. (504) 845-0867

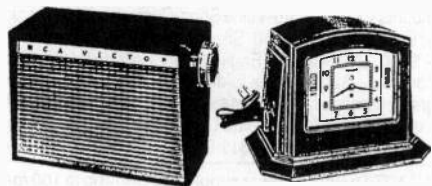

**WANTED:** RCA 2-R-51 or 2-R-52 portable radio and Philco clock per picture. John Okolowicz, 624 Cedar Hill Rd., Ambler, PA 19002. (215) 542-1597

**FOR SALE:** FBX. HRO-5AT1. RAS-5 chassis. RAS-5 coils. Collins 51J-4 receiver. General coverage Super Pro. Collins 651S-1 manual. RME-69 with DB-20. SX-18. Super Pro parts. HRO-50. Central Electronics 200v transmitter. HRO-5. Bill Coolahan, 1450 Miami Dr. NE, Cedar Rapids, IA 52402. 319-393-8075

**FOR SALE/TRADE:** TV CRT collection, mostly from the 30's & 40's including a rare 1939 Baird Cathovisor, American Television Institute 7" CRT & Phasmajector (also from 1939), 22 items, sell as a lot only. Many are pictured in Keller's book The Cathode Ray Tube - \$1,700 including packing & shipping. Sonny Clutter, 14407 N.E. Fremont St., Portland, OR 97230. (503) 254-9296

**WANTED:** Crosley. Pre-1925 parts accumulations, parts sets, original literature or what have you? Ed Bell, 5311 Wooddale Rd., Raleigh, NC 27606. Fax/phone (919) 851-1517

**FOR SALE:** 9QP4 pix tube, used TV knobs, 30 lbs. - \$20 plus shipping. Pete Putra, 1429 Lawndale Ave., Racine, WI 53403. (414) 632-2543

**FOR SALE:** Used Sams #73, 83, 112, 113, 114, 118, 119, 136 - \$3 each ppd. Hugo M. Kann, 2320 Kings Ct., Marion, IA 52302-1445

**FOR SALE:** Zenith: R-1000, good, works - \$65; R-3000-1, better, works - \$85. Charts, battery cases included. Robert Taylor, PO Box 10503, Bradenton, FL 34282. (813) 751-1072

**FOR SALE:** Transistor and novelties: Popeye - \$75, Heritage Castle - \$100, Jewel jukebox - \$50, Caesar's AC - \$45, Endura suitcase - \$85, Stantex 3-tube - \$125, Pollak's crystal - \$70. Ed Heiser, 5554 Colony Dr., Bethlehem, PA 18017. (215) 261-1355

**WANTED:** Gillfilan Model 56, must be two tone wood with tan cloth grille. Larry Hescok, 549 Silver Leaf Dr., Oroville, CA 95966. (916) 589-5612

**WANTED:** Victrola, Edison machines, any parts, any condition wanted. **FOR TRADE:** Pilot 3" TV. Have Catalin items for trade. Bob Laboda, 1641 Mattingly Rd., Hinckley, OH 44233. (216) 278-2944

**FOR SALE:** Brand new lined radio collector jackets, yellow with a small Philco cathedral on the upper left side and a snap down front - \$29.95 ppd + \$1 XXL: J.D.'s Radiower, 1161 S.W. Mulvane, Topeka, KS 66604-1456. (913) 232-0128

**FOR SALE:** Radio brochures: ABC Radio Apparatus (Jewett), 1920's, radios & parts, 20 pages - \$13 ppd. Sparton Jubilee 591, 593 Instruction book - \$12 ppd. Sparton 1953, full line 18 different table radios (oblong oval, oblique, unique) - \$12 ppd. Bill Timoszyk, 35283 Leon, Livonia, MI 48150. (313) 421-2076

**WANTED:** 6B4-G or 2A3 triodes with single-plate construction. #50 triodes. Western Electric 101L; sockets to fit 101L. RCA escutcheons to fit 816K, 813K, 9T, 10T, 9K, 9K2, 9K3, 10K, 10K1, 13K, 15K. Thank you. Carlton Carver, 303 Magnolia Dr., Washington, NC 27889. (919) 946-2358, evs.

**FOR SALE:** Coils A & B for HRO 50T-1 - \$40 plus UPS. Phil Jaque, 1908 Ruhland Ave., Redondo Beach, CA 90278. (310) 374-1746, evs.

**FOR SALE:** Rare collection quack medical. SASE list. **WANTED:** Pre-1920 galvanometers and book on galvanometers. M. Rosenthal, 5 The Strand, New Castle, DE 19720. (302) 322-8944

**WANTED:** Rheostat and wiring diagram or information for a Westinghouse DA amplifier. Dial glass for a Silver-tone 4785 console. **FOR SALE:** WE tubes 348A, 313C, 354A and 374A. Admiral radio, white plastic with brown specks, missing one push button - \$100. Charles Juedemann, 262 Churchill Ln., Ballwin, MO 63011. (314) 256-3727

**FOR SALE:** Sentinel Model 284-NR, white/yellow - \$695. Fada Model 115, yellow/red - \$900. A/K Jolly Jumper repros, nice - \$15 ea. **WANTED:** Philco 90 cabinet, good condition. Mark Delauter, 6253 S. H. 120, Metamora, OH 43540. (419) 923-7737

**PHONE NUMBER FOR  
ANTIQUÉ RADIO CLASSIFIED**  
(508) 371-0512

**Best time to call is weekdays:  
9 am to 5 pm Eastern Time**

(Please no classified ads by phone. Thanks!)

**FOR SALE:** Crystal Chest CH-219 with 89 of 106 DC-35 crystals for radio set SCR-543-D (BC-669-D) and later, chest needs repainting, felt liner is good - \$75 plus UPS. Also some DC-34 and extra DC-35 crystals @ \$3 or offer for lot. Have most connectors for set. Parting out PE-110-D, BC-669-B. LSASE or call. Robert W. Downs, WA5CAB, 2027 Mapleton, Houston, TX 77043. (713) 467-5614

**WANTED:** Crosley 515 or 51SD cabinet, Junker. Clarion 61 or 70 chassis or a good one. Thumb wheels for a Grebe CR9, large tuning knobs for a Grebe CR9. Several Jefferson #41 audios. 6.3v filament trans. CT, 1 to 2 amp Freshman Masterpiece tuning condenser & knob. Ship speaker frame any kind. Crosley 122, 123 or 124 chassis or just the last IF coil. Philco 70 and Philco 20 cabinets. Bob Barnes, 511 N. Chestnut, Monroe City, MO 63456. (314) 735-2945

**WANTED:** 8" speaker part 29-117 for Zenith 8S129. Dial and knobs for Sentinel 293-1. Dial for Majestic Treasure Chest. AK E-3 speaker, working prefer poor case. Antique Radio Store, 8376 LaMesa Blvd., LaMesa, CA 91941. (619) 668-5653



**FOR SALE/TRADE:** Cathedral types, Clarion Jr. AC-60 - \$190. Small unusual Graybarette 4 - \$225. Small Remler 21 - \$225. Gloritone 27 - \$200. Atwater-Kent 165 - \$275 & General Motors Little General - \$300. All + packing & shipping. Sonny Clutter, 14407 N.E. Fremont St., Portland, OR 97230. (503) 254-9296

**WANTED:** Tuska 225 cabinet. Also, Tuska 220, 221 and 227 sets. Ed Bell, 5311 Woodlake Rd., Raleigh, NC 27606. Fax/phone (919) 851-1517

**WANTED:** Mitchell, Mitchell, Mitchell brand radios and all other Mitchell appliances. Thanks. Lee Mitchell, The Mitchell Collector, 875 North Michigan Ave., 3412, Chicago, IL 60611. (312) 337-3123, 266-7100

**FOR SALE:** Tubes: Arcturus blue 55, tests new - \$20. Raytheon BH, Bakelite base - \$15. Transistor radios: Omegas 1962, cream color w/orig. box and case - \$20. Silvertone Medalist, turquoise/chrome, heavy, leather case - \$30. Orms Suburban 12 trans. w/case and box, chip - \$10. GE P-807A, black with gold grille, excellent case - \$15. Arvin 61R58, early needs knob, works - \$10. Philco NT-802WHG, white w/chrome grille, small - \$10. Microphones: Shure 737A crystal; Electro-Voice 635; American M-2/U - all BO. Hi-fi: Shure M75CS, Empire 888 TE; ADC QLM32 MKIII - cartridges only - \$10 ea. Calrad P.R.E. mono preamp, chrome plated - \$15. Challenger HF8A small mono tube amp - \$15. Misc.: Unimetrics 25 watt marine band radio - \$40. Johnson Messenger 323A CB radio - BO. Bearcat IV scanner - \$10. Superior TV-12 tube tester - \$15. Jeffrey Viola, 784 Eltone Rd. Jackson, NJ 08527. (908) 928-0666

**WANTED:** Top dollars for Motorola X14 and X-15 shirt pocket transistors in very good or better condition. Larry Mitchell, 7963 Depew, Arvada, CO 80003

**WANTED:** National NC-400, NC-183D, Gonset G-77, GSB-201; also receivers by E.H. Scott. Jeff Kyle, 4933 Midway Rd., #40, Vacaville, CA 95688. (916) 678-6154

**FOR SALE:** Amps and microphones: RCA with push pull 45 and Rola speaker. Howard FM converter model. Fisher preamp. Realistic stereo amp. Shure mike 55E. Turner mike 34X. Turner U9S. Turner ceramic. Small Eicor. Collins base C3. Two P.A. amps. Bill Coolahan, 1450 Miami Dr. NE, Cedar Rapids, IA 52402. 319-393-8075

**FOR SALE:** Oscilloscopes, RCA Type 160B or DuMont Type 275A, working - \$60. DuMont Type 208, needs power transformer - \$30. Shipping extra. Louis J. Philipp, 502 Greenwich Ave., Paulsboro, NJ 08066. (609) 423-4306

**FOR SALE:** Detrola Model #3281, good shape, plays - \$175 + UPS. Lamar Cooper, 660 Webb Dr., Spartanburg, SC 29303. (803) 583-3490

**WANTED:** Case for Mantola R-651. Ivory table radio. Diagrams for Zenith GD-311, Silvertone 109. Station knob for Arvin 540-T. R. Bartlett, 3834 N.E. 178 St., Seattle, WA 98155. (206) 365-3056

**FOR SALE:** Radiola 18 with matching 100A speaker - \$45/set. Philco 89 cathedral, nice original condition, works - \$145 OBO. Philco 38-35 tombstone, beautiful working condition (Bunis II, p. 128) - \$125. Stromberg-Carlson 1101 (Bunis II, p. 181), perfect, works - \$45. Zenith Royal 275 transistor - \$20. Magnavox 2AM-70, perfect - \$12. **WANTED:** Crosley Model 59 Oracle, Repwood radio/clock combination in very good to excellent condition (A.R.C., Sept. 93, p. 19). Keyhole type knob and legs for Radiola 33. All items F.O.B. Swarthmore. Sam Mannino, PO Box 233, Swarthmore, PA 19081-0233, 2-9 pm

**FOR SALE:** Plastic radios: Packard Bell 100A, Silvertone 3025, Zenith G516, RCA Globetrotter 7BX8J, Westinghouse H383T5, GE Musaphonic T171A, Audiotronics 250. Most work, some need minor repair. All for \$90. Mike Kennedy, 3417 W. Magill, Fresno, CA 93711. (209) 435-3159

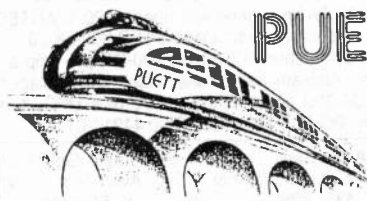

# PUETT ELECTRONICS

P.O. BOX 28572 DALLAS TX 75228

**NEW CATALOG 77**

GET THIS  
**WORLDS  
GREATEST  
RADIO  
CATALOG**

CATALOG 77/PLL-2 (56-PAGES) ----- \$5.00 POSTPAID

YOU RECEIVE A \$6.00 DISCOUNT COUPON WITH THIS CATALOG!

MORE THAN 1,500 DIFFERENT ANTIQUE RADIO PUBLICATIONS FROM 1902 TO THE 1960'S OFFERED, REPRINTED BOTH SIDES OF THE PAGE AND BOUND!

WE OFFER BOOKS, INSTRUMENT MANUALS, SERVICE DATA, SALES BROCHURES, ATWATER KENT, RCA, CROSLEY, ZENITH, ETC. FACTORY SERVICE MANUALS, SCOTT, MC MURDO SILVER, STROMBERG CARLSON, CAPEHART, FISHER CLASSIC RADIO LITERATURE, DIRECTORY OF ANTIQUE RADIO SERVICES, SCHEMATIC DIAGRAMS, OLD TIME RADIO PROGRAMS ON CASSETTES, TUBES, TUNING DIALS, KNOBS, 30-SERVICES & DISCOUNTS WITH THE **PUETT ELECTRONICS ANTIQUE RADIO CLUB** AND MUCH MORE - ORDER YOUR CATALOG TODAY!

OUR NEW BOOK "THE WORLDS LARGEST RADIOS" IS NOW AVAILABLE, PHOTOS, SCHEMATICS, BY J.W.F. PUETT - \$14.95 PLUS \$2.00 HANDLING. INCLUDES SCOTT, MC MURDO SILVER, PHILCO, RCA, ZENITH, LINCOLN, FREED EISEMANN, FISHER, MEISSNER, MAGNAVOX, CROSLEY + MANY MORE!

**FOR SALE:** Hewlett Packard Mod #3440A with 3442A plug-in, digital DC voltmeter, good working unit—\$79.95. Northwest Electronics, 2509 West 11, Eugene, OR 97402. (503) 485-3016

**FOR SALE:** Zenith Royal 675, leather wear on hinges/handle crack, works temperamentally — \$20 ppd. A.T. Shost, 1307 Maple Ln., Sedalia, MO 65301. (816) 827-2655

**WANTED:** Schematic Ampeg music amp R-12. Sams AR Man. 1 to 5, 7, 8, 10. Joe Grace, 15 Copperleaf Ter., Staten Island, NY 10305. (718) 987-7014

**WANTED:** Pilot Model T-500U, Brown back for Emerson U5A. **FOR SALE:** Radio bank by Marx — \$225. Dave Masterson, 792 Marion Rd., Cheshire, CT 06410. (203) 271-9852

**FOR SALE:** Riders IX & X — \$28 includes shipping. Larry A. Dowell, Rt. 2, Box 17-A, Hurdle Mills, NC 27541. (919) 364-2756

**FOR SALE:** Egg crate partitions, any length, any width, any spacing. Send for free information. Matty's Radio Shop, 295 Grove St., Providence, RI 02909. (401) 274-4836

**WANTED:** Early transistor radios. OK if not working. Please write or call: John Hoffnagle, 10 Sunset Ave., New Oxford, PA 17350. (717) 624-8894

**WANTED:** AC power transformer for Atwater Kent 84. Good or bad but prefer good. Knox Lee, 630 Shadowbrook Dr., Columbia, SC 29210. (803) 772-6593

**FOR SALE:** Philco 116 items: cabinet, needs refinishing — \$40; speaker, works, cone alright — \$25. Ed Martin, 485 Benwood Hill Rd., Benwood, WV 26031-1301

**FOR SALE:** Philco Transitone 53-563, red — \$30. Clock radios: Firestone 4-A-110, wood — \$20; Crosley JC-6TNN, tan leatherette — \$25. John Koop, 48 Wheelbarrow Ln., Wantagh, NY 11793. (516) 731-6711

JOIN THE  
**AWA**

**ANTIQUE WIRELESS ASSOCIATION**  
THE ORIGINAL AND LARGEST HISTORICAL RADIO-COLLECTOR GROUP

- Publishes *Old Timer's Bulletin* with:
  - Battery and AC receiver restoration
  - Vacuum-tube history and collecting
  - Old-time amateur-radio contests
  - Communications receivers
  - Free want-sell-swap ads
  - Early television
  - Horn loudspeakers
  - Reviews of current books
  - Keys and land-line telegraphy
  - News of U. S. and foreign clubs
  - Information on public radio museums.
- Maintains unique radio-TV museums.
- Produces the annual Rochester meet.
- Co-sponsors local meets.
- Publishes the annual *AWA Review*.

Membership is only \$12.00 per year (\$22.00 for two years). Mail check to:

Antique Wireless Association, Inc.  
Box E, Breesport, NY 14816



**FOR SALE:** Floor consoles: G.E. H-51 — \$200. Beautifully carved and very ornate, Spartan Mod 89-A, complete with tubes & original paperwork — \$150. Radiola 62 in perfect condition — \$200. Larry Drago, 383 Lincoln Dr., Cheshire, CT 06410. (203) 272-6030

**FOR SALE:** Philco 16X chairside combo — \$350. Zenith 9S367 — \$375. RCA 813K — \$200. Philco Predicta G4242 — \$400. Spartan Model 39 — \$150. Many other radios, TV's and test equipment. Send long SASE for pic list. All prices U.S. Don Jackson, 1394 Dansey Ave., Coquitlam, B.C., Canada, V3K 3H8. (604) 931-7245

**WANTED:** Zenith Walton sets and Zenith black dial farm set tombstones. Johnny Johnson, 2201 Newton St., Denver, CO 80211. (303) 455-3421

**FOR SALE:** Emerson 888 Pioneer transistor, red exc — \$45. **WANTED:** Fada 845, green plastic. Mike Sullivan, 2182 Beechwood Ln., Coppell, TX 75019. (214) 393-5084

**HAVE YOU MOVED? ARE YOU MOVING?**  
**PLEASE NOTIFY US A.S.A.P.**  
**SEND US YOUR...**  
**OLD ADDRESS**  
**NEW ADDRESS and**  
**SUB #**  
**MANY THANKS!!!!**

**FOR SALE:** Addison 5 red with yellow trim, excellent original condition — \$1,400 firm. Cliff Schwartz, 3212 Corral Ct., Westbank, British Columbia, Canada V0G 2A0. (604) 768-9504

**WANTED:** Chrome grille wooden sets, Arvin metal sets, and Canadian Fleetwood metal sets. Jay Malkin, 1250 Galapago, #206, Denver, CO 80204. (303) 623-6451

**FOR SALE:** SP-600-JX-1 rcvr, w/o cabinet, poor/fair condition — \$60. RCA Victor TV Model 8-T-241, fair/good — \$60. Fisher Series Ninety tuner, fair — \$30. Two Eico HF-81 control amps, good w/o tubes — \$20 ea. Altec 342B PA amp, good w/o tubes — \$20. **WANTED:** SWL'er seeks very clean unaltered SP-600-JX-26 rcvr, will pick-up. Fisher four button 400-CX pre-amp any condition. Also any new or used Fisher tubes. Cage to Fisher SA-300 amp. All the above plus UPS. Keith Matheny, PO Box 119, Bath, Ohio 44210-0119

**FOR SALE:** Early Japanese owl — \$70. Gold-Silver Globe — \$80. Cadillac car — \$50. Avon Skin-So-Soft N.I.B. — \$35. White Spica (Handy, p. 64) — \$50. GE P790B, turquoise (Bunis, p. 75) — \$35. **WANTED:** Toshiba 9TM-40, 6TP-309Y and 6TP-304 any color, excellent only pay generously. Harold Herp, 6615 Michele Ct., Huntingtown, MD 20639. (301) 855-7071

**WANTED:** Tr. radios: Sony ICR-100, Standard Micronic Ruby, any models made in '50s. Tr. TVs: Sony 8-301W, Philco Safari, any models made before '65. Gifillan GN-1. Any Japanese WWII set, i.e., 1-tube TRX Type 94-6, also TX Type 94-5, 3-tube RX Type 94-5. Old telegraph keys and bugs. Noriyoshi Tezuka, 1-11-2-403 Hiroo, Shibuyaku, Tokyo 150 Japan. Fax. 011-813-3440-8396

**FOR SALE:** Zenith 10H571 — \$200. Westinghouse WR-8 grandfather clock — \$300. Kennedy Model 20 AC console — \$150. RCA Model 110K — \$200. Radio Lite-Tenna — \$40. Blank console cabinet — \$30. Vance Rayburn, 2718 Homestead Rd., Madison, WI 53711. (608) 274-3002

**WANTED:** 1920's Indiana manufactured radios such as Aladyne, Amaco, American, Apodyne, Cardinola, Case, Diamond T, Elmco, Everhome Future, Grahm Built, Handcock, Hatfield, Imperial, King Cole, Le Pilote, Lyradion, Melody, Midland, Nicholson, Okay, Queen Quality, Showers, Sinclair, Skylark, Slagle, Star Raider, Starr, Tilman, Vizo, Washburn Burner and any literature, factory brochures and other information regarding any of these radios. Also looking for E.H. Scott, McMurdo Silver, Lincoln, Leutz, Norden Hauck, and mid-1930s Canadian-made radios. Michael Feldt, 12035 Somerset Way E, Carmel, IN 46033. (317) 844-0635

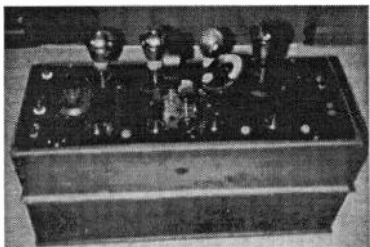
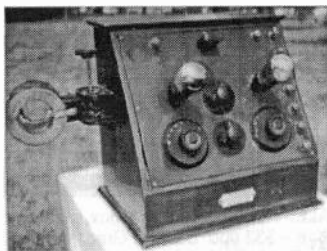

**FOR SALE:** 2 radios as pictured. Slant front says on plaque licensed by Marconi. It is British. Breadboard top 4-tube has British seal BBC, so it is factory made in Britain. Both are real nice. The two - \$1,200. Edison Mabry, I Collect Best in Radios, 715 W. Longview Ave., Mansfield, OH 44906. (419) 526-1175

**WANTED:** Transistors: Sony, Realtone, Regency, Toshiba, Global, Zephyr, Standard, Marvel, Fleetwood, or similar types. Rod Abernethy, 1101A Capital Blvd., Raleigh, NC 27603. (919) 821-3600

**WANTED:** RCA 9TX Little Nippers, Emerson 540, Bang & Olufsen early European radios. Dave Working, 2816 E. Coast Hwy., Corona Del Mar, CA 92625. (714) 640-5093

**FOR SALE:** Reasonable radio & TV tubes. Used 100%. Tested: 0A3(G), 1E7G, 1H4G, 1L4, 3A5, 3Q4, 6J7G, 6L56, 6SN7GT, 7F7, 27, 41 - \$1.50 ea. N.O.S. (boxes): 0B2, 0D3, 0-Z4, 5X8, 6AU6, 6AX4GT, 6BZ6, 6D7, 6W6GT, 12SA7, 12SK7, 12SQ7, 35W4, 35Z5GT, 50C5, 50L6GT, 117Z3 - \$2 ea. 5U46B (N.O.S.) - \$4 ea. Prices plus \$4 flat shipping. Call or send LSASE for complete list. Ted Babcock, 163 Long Island Dr., Moneta, VA 24121. (703) 721-1222

**WANTED:** Philco 37-116-122 in working condition. Dick Friedman, 1502 Elmwood, Wilmette, IL 60091. O: (708) 803-3050; H: (708) 256-1432

**FOR SALE:** Zenith chassis and speaker only. Model 12S475 Ch 1207. Also fits 12S445; 12S453; 12S471 and 12S494. Complete with push buttons, works very well - \$200 or trade plus shipping. John Snow, 4539 Bartlett, Shorewood, WI 53211. (414) 964-0194

**WANTED:** "Thermionci Vacuum Tube" book by Van Der Bijl, will pay \$25. Steve Melkisetian, c/o Angela Instruments, 10830 Guilford Rd., Suite 309, Annapolis Junction, MD 20701. (301) 725-0451. Fax (301) 725-TUBE/725-8823

**WANTED:** Crosley Buddy Boy. Please write or fax price including shipping to: Magic Jukebox Museum, Olieu Geert, Buurtweg 107, 8930 Memen, Belgium, Europe. Fax 011 32 56518562

**HELP:** Need a set of three adapters possibly marked Alden No. 944 web, No. 978 web, No. 972 web to enable testing of Western Electric tubes in a Hickok tube tester. J. Arndt, 1215 Division St., Manitowoc, WI 54220. (414) 684-8830

**WANTED:** 1920's British & European crystal and battery sets. Amplion horn speakers. Ian L. Sanders, 16725 Wild Oak Way, Morgan Hill, CA 95037. (408) 778-7547

**FOR SALE:** Jukebox Collector Magazine; sample - \$3, subscription - \$30. Jukebox Collector, 2545 S.E. 60th Ct., Suite 105, Des Moines, IA 50317

**WANTED:** Knight T400 transmitter, Lafayette KT390 transmitter, EICO receiver, any unassembled kits. Nick England, KD4CPL, 811 Kenmore Rd., Chapel Hill, NC 27514. (919) 929-4342

SEND ALL A.R.C. MAIL TO  
Antique Radio Classified  
P.O. Box 2, Carlisle, MA 01741

**WANTED:** Zenith push-button assembly for a 10S464. Will consider entire radio if price is reasonable. Also need a speaker for AK 55. Larry Bell, 4314 Silas Hutchinson Dr., Chantilly, VA 22021. (703) 263-9483

**MESSAGE:** Don't throw your old calculators away! Collect them! And join the only organization for collecting early portable electronic calculators. Membership includes informative quarterly newsletter - \$8/yr., sample - two 29¢ stamps. International Association of Calculator Collectors, 14561 Livingston, Tustin, CA 92680



**WANTED:** Catalin radios by Emerson in all shapes and forms. Allow me to satisfy your appetite for wealth. Please write or call collect. Rain Buttignol, 214 State St., #7, Portsmouth, NH 03801. (603) 427-1384

**FOR SALE:** Battery BA-38 for BC-611, BC-1136, others, new Sept. '93 - \$42.50, 12 @ \$39.50. Choke, 2.5 Hy, 280 mA, 43 ohm, upright open frame, 3C317-22, NOSB - \$2.50, \$10/5. DY-17A/ART-13, NOSB - \$45. Plus UPS. **WANTED:** Aluminum CS-48's, buy or trade steel ones. Rectifier RA-34, generators GN-45, PE-49, PE-162-A. Robert W. Downs, WASCAB, 2027 Mapleton, Houston, TX 77043. (713) 467-5614

**FOR SALE:** Zenith 15U269, 10S153, 7S232, AK 82, Philco 90, Trans-Oceanic, Fada bullet 1000. Contact: Kent Martin, 7803 Butterfield Dr., Elkridge, MD 21227. (410) 796-1953

**FOR SALE:** AA 1300 & AA 1400 - \$650. Zenith 500H, black - \$85. Music Master spruce horn - \$175. Floyd A. Paul, 1545 Raymond Ave., Glendale, CA 91201. (818) 242-8961

**WANTED:** Original catalogues from early 1920's: Amrad, Clapp-Eastham, DeForest, Kennedy, Paragon, Tuska, etc. Ed Bell, 5311 Woodsdale Rd., Raleigh, NC 27606. Fax/phone (919) 851-1517

**WANTED:** Hallicrafters portable TW-55 (Baby Boom III, p. 123). Zenith radio nurse. Wolfgang Hornik, Hedwigstr. 11, D 8000 München 19, West Germany. Phone 011-49-89-1292750

**FOR SALE/TRADE:** For swap or BO: 1929 Heath Parasol airplane engine, Motorola red transistor XIIR, Motorola 52B6, pair Eico HF60 amps, (2) Western Electric peanut tube sockets N.I.B, exact porcelain rheostat for DeForest RJ4, RJ5, AK F4 speaker, 2-track tape player with tapes, old hearing aid with exploded promotional display in frame, U.S.S.B. 2-step audio amp Serial #45 has peepholes and uses 1-A's. Michael Payne, 803 S. Taylor, Alvin, TX 77511. (713) 331-9217

**FOR SALE:** NBC Radio boxed game, Paul Wing's Spelling Bee, 1938, fine original condition! - \$30. Gerald Schneider, 3101 Blueford Rd., Kensington, MD 20895-2726. (301) 929-8593

**WANTED:** Single gang 365pF or larger variable capacitors. Radio construction project books or magazines. David Dameron, KG6BP, 819 Boundary Pl., Manhattan Beach, CA 90266-6621

**FOR SALE:** RK Radiokeg, 1933, excellent original - \$300. Coke Cooler radio, nice original - \$575. Walt Curry, 10035 Country View Rd., La Mesa, CA 91941. (619) 461-9327



**WANTED:** Fada Catalin radios from rags to riches. Who said money can't buy happiness? Please write or call collect: Rain Butignol, 214 State St., #7, Portsmouth, NH 03801. (603) 427-1384

**FOR SALE/TRADE:** Emerson 911 Eldorado, butterscotch, small chip - \$40. Buying: Zenith Royal 500s, TV Guides. Don M. Maurer, 29 South 4th St., Lebanon, PA 17042. (717) 272-2481

**FOR SALE/TRADE/WANTED:** Vintage tube CB's - all makes, models. List - LSASE. **FOR SALE:** Zenith F615. Charles Zafonte, N1FRX, RFD 1, Box 75, Fort Kent, ME 04743. (207) 834-6273, eves.

**FOR SALE:** Original Zenith Radio Service Manual, Volume 2, 1941, shop-worn binder otherwise good condition - \$25 plus UPS. Ellsworth O. Johnson, 364 S. Coeur D'Alene St., Spokane, WA 99204. Phone/fax (509) 838-2161

**WANTED:** Restorable chassis for 3 knob Sparton Bluebird. Please write or call: Frank Nocera, 1572 Argyle Dr., Fort Myers, FL 33919. (813) 936-7197, after 6 pm

**WANTED:** Power transformer for the National NC-100A or 101XA rcvr. James T. Schlietstett, W4IMQ, PO Box 93, Cedartown, GA 30125. Fax/phone (404) 748-5968



**FOR SALE:** "Radio" radio, new in box, works, excellent, see picture - \$33 ppd. David J. Grace, 20 Oneida St., Johnston, RI 02919. (401) 331-6641

**WANTED:** European receiving tube data manuals, 50s and 60s vintage in good condition. Daniel Schoo, 526 Colonial Dr., DeKalb, IL 60115. E-Mail "SCHOO@FNAL.GOV"

**WANTED:** Plastic radios must be clean and working. Colors preferred. Microphones wanted. Dennis Duffy, 625 Lost Pine Way, Absecon, NJ 08201. (609) 748-1050

#### CLASSIFIED AD NOTICE

**Please check your ads carefully before sending them in. Once ads are received, it is not always possible to refund the amount sent, pull the ad or make changes.**

**FOR SALE:** Stromberg-Carlson clock radio, Model C-1, (Bunis II, pix) - \$75. Zenith Model M510R (Bunis II, pix) - \$75. Both excellent condition. Stephen L. Bonino, 107 Georgetown Rd., Glassboro, NJ 08028. (609) 881-0244

**FOR SALE:** 1. Zenith glass rod 6D317 - \$250. 2. Zenith chairside - \$150. 3. Zenith tombstone 55127 - \$250. 4. Pepsi bottle radio, 1940's - \$650. 5. Fada butterscotch Temple, chipped - \$250. 6. Fada butterscotch Temple, cracked dial - \$500. 7. Fada blue Plaskon 1005 - \$400. 8. Fada bullet, yellow & red - \$600. 9. Fada butterscotch 711, replaced knobs - \$500. 10. Philco Predicta blonde barber pole - \$1,000. 11. Emerson lime green Catalin 652, one knob - \$500. 12. Emerson gold & white marbled, 511 - \$200. 13. Crosley Buddy Boy - \$250. 14. Crosley green dashboard D25CE - \$125. 15. GE tombstone E-61 - \$150. 16. GE beetle brown & white KL51 - \$250. 17. Airline brown marbled GSE1622A - \$200. 18. Airline green marbled 15GSE-1068 - \$125. 19. Martian crystal radio - \$800. 20. Philmore crystal radio, M.I.B. - \$150. 21. Sony tabletop transistor TR7170 - \$75. 22. Marlboro transistor, M.I.B. - \$35. 23. Sherwood tube receiver 58000 - \$125. 24. Temple blue metallic G418 - \$100. 25. RCA Geiger counter - \$65. 26. Atwater Kent tombstone 854 - \$200. 27. Farnsworth Deco white, maroon grille ET667BRX - \$125. 28. Silvertone beetle, brown, green & white - \$250. Gus Constantine, 32 Poplar St., Hudson Falls, NY 12839. (518) 747-3053

**WANTED:** Lid for Aeriola/Radiola Senior, any condition. Tim Healy, 18 Abby Ln., Syosset, NY 11791. (516) 496-7206

**WANTED:** Power transformer for Majestic Model #50. This is about 1931 model with the following tubes: 3-#24A, 2-#27, 2-#45, 1-#80. Will buy good Majestic transformer or new right size transformer or chassis with good transformer and power supply. If chassis available prefer one with working dial cable. Tubes not necessary. Clarence B. Shippey, PO Box 741, Midvale, UT 84047. (801) 566-8593, day; (801) 568-1989, evening or Sunday until 10 pm Mountain time

**FOR TRADE:** My transistor radios for your early electronic portable calculators. Send "have" list. Guy Ball, Mr. Calculator, 14561 Livingston, Tustin, CA 92680

**WANTED:** RCA MX-7 Music Control Center, AM-FM stereo amplifier. Clean original unit. Gilbert Smith, 248 South 36th St., San Diego, CA 92113. (619) 236-7990

**FOR TRADE:** IC-735 SN 34949 as new, both manuals, non-smoker, never mobile. **WANTED:** Antique radio & parts of equal value. John Snow, 4539 Bartlett, Shorewood, WI 53211. (414) 964-0194

**FOR SALE:** AK 10 breadboard, no tubes, marginal but complete - \$300. Emerson 520 Catalin - \$95. Lou Hiltz, 95 Perry St., Harrisonburg, VA 22801. (703) 433-3202

**WANTED:** Help me make someone's Christmas, sell me your undamaged Radiola IIIA cover plate. Thanks. Steven VanderLinden, KC6YRB, 2123 Elizabeth Ave., Winston-Salem, NC 27103. (919) 727-1247

**FOR SALE:** In not perfect cond. Fada L56 yellow w/pea-green grille - \$1,100. Air King Skyscraper, crystalized black - \$2,000 OBO. Anthony Scarfoglio, 13 Fourth St., Brooklyn, NY 11231. (718) 858-1231

**FOR SALE:** Arcturus #27 blue, used tubes - \$10 ea. L. Drago, 383 Lincoln Dr., Cheshire, CT 06410. (203) 272-6030

**FOR SALE:** Transmitter mfg. by H. G. Fischer Co. of Chicago, wooden case with Bakelite front, labeled SWD 12 meter on front, has 2 #822 tubes & (2) 866 rectifiers, good condition - Offer. Old X-ray machine by General Electric X-ray Co. of Chicago, rough - Offer. Projects but complete: RCA 813K console - \$135. Philco 37-116 console - \$135. Crosley 124 cathedral - \$135. Red Lion desk cabinet - \$50. Mohawk one dial cabinet - \$35. Philco 39-45 console cabinet, nice - \$45. Junker Crosley 11-105U - \$35. Fred Watson, KB8NRF, PO Box 58, 581 W. Summit St., McClure, OH 43534. (419) 748-8798



## WANTED

Will pay up to \$250 for the pictured Amrad 2575 crystal set. I also want pre-1926 Amrad sets & parts.

Andrew Mooradian  
5 Priscilla Lane  
Winchester, MA 01890  
Tel. (617) 729-1873 after 7 pm

**FOR SALE:** The following Emersons: Model 511 black w/maroon grille moderne - \$75. 706B - \$75. Mod 587-A - \$60. Mod 507 w/handle - \$50. Mod 540 cracked case - \$70. L. Drago, 383 Lincoln Dr., Cheshire, CT 06410. (203) 272-6030

**FOR SALE:** Radiola Loudspeaker Model 100. Hallcrafters SX62A with manual (copy). Harwitron Variometer (quack medical unit). Hickock 639C tube tester. Altec A33A amplifier. Herb Ellmers, 603 Howard St., Ft. Pierce, FL 34982. (407) 466-0926

**HELP:** Need copy of operating instructions for RCA WV87A voltohmmyst, RCA WR89A generator, Heathkit IG18 generator and Heathkit IM16 voltmeter. Sidney Oliphant, Rt. 1, Box 107, Colmesneil, TX 75938. (409) 283-3528, evenings

**FOR SALE/TRADE:** IP-501, restorable, discolored front panel, no cabinet, minus some small fittings, a project for sure but not a lifetime project, offer? **WANTED:** WW2 radio items of German, Italian, Japanese forces, any condition. Gray RCA aircraft receiver, Type AVR?, to match my trans. AVT23. Also interested in: U.S. military mobile and Forest Service equip. Old civilian boat and aircraft radios, especially with tunable receiver on shortwave band. Anything radio built in Wa., Or., B.C. Shortwave regenerative radios, factory, kit, or homemade. Manuals, catalogs on any of above. (Person who sent partial payment for Russian transistor, please write again.) Hugh Miller, 6400 Maltby Rd., Woodinville, WA 98072-8375

**FOR SALE:** Used tubes Arcturus blue: good 2-124, 5-127, 1-126, 1-58; duds 2-127, 1-124, 1-147. Majestic sprayed tubes: good 2-G-57, 1-658, 1-624, 1-62A7; dud G6Y5. Ameco 2 and 6 meter xmtr. Gonset Communicator GC105 2MTR AC and 12YDC. Pete Putra, 1429 Lawndale Ave., Racine, WI 53403. (414) 632-2543

**WANTED:** Radiola 25 info and top loop antenna, any condition. Richard Gentry, Box 9274, Phoenix, AZ 85068

## OLD TECH BOOKS & THINGS

Early  
Technical  
Books &  
Apparatus

Announcing - Catalog No. 1  
Available Soon\*  
Write For Free Copy.

### We Specialize In:

Wireless - Radio - Television - Telegraph  
Telephone - Electricity - Computers - Slide Rules  
Electro-Medical - Calculators - Typewriters  
Atomic Energy - Astronomy - Skiing

### We Buy & Sell:

Books - Juveniles - Catalogs - Magazines  
Manuals - Ephemera - Novelties - Apparatus  
Anything Related!

Send us a list of your general & specific wants.

### OLD TECH - BOOKS & THINGS

John V. Terrey, Proprietor  
P.O. Box 803, Carlisle, MA 01741 U.S.A.

\*Still delayed, but eventually I will get it finished!

**FOR SALE:** French crystal set. Trecla crystal set. Fola cone speaker. Splitdorf cone speaker. Trimm horn speaker. Rogers-Myers horn speaker. (5) headphones. Timmons power supply. Kolster speaker table. Home brew 6' A-K transmitter. 1914, The Boy Electrician book. REL wave meter. Signal loose coupler. Kit loose coupler. Bill Coolahan, 1450 Miami Dr. NE, Cedar Rapids, IA 52402

**WANTED:** Grebe 421 transformer. Also: CR Series sets, parts, parts sets, and original literature. Ed Bell, 5311 Woodsdale Rd., Raleigh, NC 27606. Fax/phone (919) 851-1517

**WANTED:** Urgently need metal tube shield for Philco Model 70. Dennis Craft, PO Box 4522, Scottsdale, AZ 85261. (602) 860-8951

**FOR SALE:** 10-watt Newcomb audio amp Model E-10 - \$35 plus UPS. J. M. Stueber, 8920 Lexington Ave. NE, Albuquerque, NM 87112. (505) 299-2414

**FOR SALE:** 12AU7/5963, new boxed, all made U.S.A. brands - \$1 plus shipping. Jack Shaymow, Vintique Electronics, 52-C Tilford, Deerfield Beach, FL 33442. (305) 427-1222

**WANTED:** Quack medical, scientific, and optical devices, especially violet rays in excellent condition. Richard Cane, 1333 N.W. 127th Dr., Sunrise, FL 33323. (305) 846-7116

**WANTED:** Service information for Tele-Tone Model TV 149A, 7 inch table model TV. This set looks identical to Model TV149 in Sams Number 56 but chassis is not the same. Gregg Humanic, 540 Wicklow Ln., Monroe, OH 45050. (513) 539-8926

**FOR SALE:** Amperex 5894 tube - \$20. Jewel 910 - \$35. **WANTED:** Nice UZ1325 speaker for Radiola IIIA. Paul Roche, 7368 Eden Brook Dr., #634, Columbia, MD 21046. (410) 381-0471

**WANTED:** Hallicrafters Sky Riders with entire front panel silver color; also S-30, S-33 S-35 pan adaptor, SX-112, HT-2, HT-3, HT-8, HT-12, HT-14, EP-132; wood console speakers R-8, R-12; parts, advertising & memorabilia. Chuck Dachs, The Hallicrafter Collector, 4500 Russell Drive, Austin, Texas 78745

**WANTED:** AN/TRC-10 radios; AN/PRC-1; AN/PRC-5; M-209 Cipher machines; any radios beginning with letters "SS" (example "SSR-5"). Keith Melton, Box 5755, Bossier City, LA 71171. (318) 747-9616

**SOLID STATE VIBRATORS** for most automobile radios 1932-57. Exact duplicates of originals in metal cans. Synchronous, Non-sync, European. One-year guarantee. Dealer prices. Free catalog. Order toll free: 1-800-WE FIX AM. Visa, Mastercard. Antique Automobile Radio, Box 892, Crystal Beach, FL 34681. (813) 785-8733

**ELECTRON TUBES:** Over 1 Million Tubes in Stock. Buy & Sell. Daily Electronics, 10914 NE 39th St. #B-6, Vancouver, WA 98682. 800-346-6667. 206-896-8856. 206-896-5476, fax

**WANTED:** Collins Radio Company Catalogs, promotional literature, manuals 1933-1983. Jim Stitzinger, 23800 Via Iranov, Valencia, CA 91355. 1-805-259-2011

**FOR SALE:** Radio schematics - \$2.50. Radio related books/publications. SASE for list. Dick Oliver, 28604 Schwalm Dr., Elkhart, IN 46517. (219) 522-4516, evenings

**FOR SALE:** Grebe Synchrophase Seven, good - \$150 or BO. Saal Symphony Grand horn, good - \$195 or BO. Sparton table radio, wood grain metal and chrome trim, needs speaker recone and grille cloth - \$195 or BO. Emerson butterscotch Patriot, hairline - \$275 or BO. Rick Yerke, PO Box 392, Moscow, PA 18444. (717) 842-4857

**WANTED:** Table porthole TV, such as Hallicrafters 505, Stromberg-Carlson TC10H; Zenith 28T925E or similar models. John Proden, 110 - 9th St., SW, Portage la Prairie, Manitoba, Canada R1N 2N4. (204) 857-3556

**WANTED:** Sylvania 3102 Thunderbird transistor radio. Any condition considered. State condition and price. Thanks! Marty Dzik, 412 Gregory St., Schererville, IN 46375-2290

**FOR SALE:** National HRO 50T1, calibrator, ABCD coils, manual - \$225. Drake 2B, calibrator, Q-multiplier, excellent - \$195. Richard Prester, 131 Ridge Rd., West Milford, NJ 07480. (201) 728-2454

**FOR SALE:** Broadcaster kit. Why settle for current fare on your antique radio when you can tune in vintage music and programs, instead? Our 3-transistor broadcaster connects to the output of a record, tape or disc player, allowing you to transmit your choice of recorded material to any nearby AM radio. The affordable Model PO-3T operates from a single 9-volt battery and features adjustments for transmitting frequency and modulation level. This easily-built kit includes printed circuit board, all components, wire, solder, etc. Assembly requires a small soldering iron, wire cutters and pliers. To order, send a check for \$19.95 each plus \$3 P&H (Vt. residents please add tax) to: Metco Electronics, PO Box 549, Shelburne, VT 05482

**BOXED CLASSIFIED ADS WORK!** This is a boxed classified ad. These ads can be run more than two months. See the inside back cover for details. Boxed ad deadline: the 5th of the month.



**WANTED:** Early tube Hi-Fi components and studio equipment by Marantz, McIntosh, Tannoy, Acrosound, Brook, Brociner, Fairchild, Hadley and others. Also want Western Electric theater amplifiers, speakers, tubes, & microphones. Richard Sharisky, PO Box 521, Belmont, MA 02178. (617) 484-5784

**WANTED/FOR TRADE:** Will trade namebrand high quality radios for old fountain pens by Parker, Sheaffer, Waterman, Mont Blanc, Conklin, etc., or pay cash for the pens. Contact: Frank Weissman, 4 Shadbush Ln., Westport, CT 06880. (203) 454-1267, after 9 pm EST

**FOR SALE:** AK 246 cathedral (F.O.S., p. 67) - \$350. Jewel white plastic 956, (Boomers 3, p. 155) a 9 - \$65. Zenith 825, needs work - \$75. Craftsman 500 - \$75. MacIntosh MC-30 - \$90. Dynkit pre-amp - \$40. Books, test equipment, tubes, parts, miscellaneous. Send LSASE for list. **MESSAGE:** Collecting information on Crosley Fiver. So far have 3 different cabinets and friend has another one. Chassis 517 on label lists eleven. Would appreciate collectors sending description or pictures for future article. Stan Lopes, KB6LGV, 1201-74 Monument Blvd., Concord, CA 94520. (510) 825-6865

**FOR SALE:** Hallicrafters S-25, mint - \$175. Hallicrafters S-20R - \$90. Panasonic RF-2200 8-band - \$75. Philco 37-610 - \$90. 10FP4 N.O.S. - \$75. 5BP4 N.O.S. - \$50. FLY1 N.O.S. - \$35. RCA TV 630 - \$175. Motorola 7" TV - \$75. William B. French, 7104H Kensington, Indianapolis, IN 46226. (317) 545-5784

**WANTED:** Zenith 12UP4 metal picture tube. Also television backs for Zenith 12" porthole console Model No. G2346R and Admiral 10" dual chassis console Model No. 24A12. Steve Cavelli, 300144 Torry Ave., Flat Rock, MI 48134. (313) 379-3254

**FOR SALE:** Tube/transistor portables: Motorola 56B1 - \$35. Motorola 5P31 - \$30. Westinghouse H598P4 - \$25. RCA 6-BX-6 - \$30. GE 637 - \$35. GE 140 - \$40. Toshiba 10TL-429F - \$30. Emerson 869 - \$40. GE P1870A - \$10. GE P840A - \$25. Zenith Royal 710 - \$25. Zenith Royal 755 - \$25. GE P807H - \$20. Panasonic R-159 - \$15. Channel Master 6252A - \$40. Emerson 888 Pioneer - \$80. GE Sportmate - \$45. Silvertone 174.22480400 - \$25. Richard A. Botzum, R.D. 2, Box 419, Morgantown, PA 19543. (215) 286-0047

**FOR SALE:** General Radio precision wavemeter, Type 724-A, covers 1Kc to 50 MHz, very clean unit, only - \$199.95. Northwest Electronics, 2509 West 11, Eugene, OR 97402. (503) 485-3016

**WANTED:** Cabinets for Kennedy 110 and 525 or close-up pictures and measurements or set to visit in Washington or Oregon. Also need driver for Rola Re\*Creator horn speaker. Ralph Day, 30211 137th Ave., SE, Auburn, WA 98002.

**FOR SALE:** Transistors: Toshiba 6P-15 - \$25. Silvertone 2207, ice blue - \$20. Magnavox 2-AM-70, in box, nice - \$40. Airline 62-1237A - \$15. Viscount 6TP-102, 1/4" crack - \$20. Magnavox AM-60, crack - \$15. RCA T-2K and 1-T-2D - \$20/pr. UPS extra. Thanks! Scott Olson, 1405 25th Ave. S, Apt. #104, Fargo, ND 58103. (701) 293-9238.

**FOR SALE: FOAM SURROUND REPLACEMENT KITS.** Kit includes two foam surrounds, cement, centering shims & instructions. 10" Kit = \$24.95, 12" Kit = \$29.95. (N.J. residents add 6% sales tax) + \$3.00 S/H. Sound Remedy, 331 Virginia Avenue, Collingswood, NJ 08108. (609) 869-0238

**FOR SALE:** Receiving Tubes, Used, Guaranteed: Under \$2.85. Sams 183-450: Under \$3.50. CQ, QST, Ham Gear, Antiques, Test Gear, Parts. LSASE to DMI, 47 Hazel Drive, Pittsburgh PA 15228.

**WE'RE STILL HERE!** Tubes: "Oldest," "Latest" Schematics. SASE for lists to Steinmetz Electronics, 7519 Maplewood Ave., Hammond, IN 46324

**MESSAGE:** Just wanted to thank you guys who helped me identify my Clarion AC-60. **WANTED:** Now I need a speaker grille, front escutcheon, and chassis for the AC-60. I'll also consider a chassis for AC-61, AC-70. **FOR SALE:** Rider index for Vol. 1-10. Thank you. Jose Reyes, 3198 Roosevelt St., Hollywood, FL 33021. (305) 985-8103

**FOR SALE:** Tubes: 5U4GB - \$1 used, \$6 new. 12BE6, 12BA6, 12AV6, 35W4, 50C5 - 75¢ used, \$2.50 new. Most TV tubes - 50¢ used. Herb Ratner, 3542 Westminister Ct., Holiday, FL 34691. (813) 937-7452

**FOR SALE:** Pair of Heathkit W4-AM Williamson mono amplifiers, exc condition - BO. Dan Wroblewski, 415 41st Ave. NW, Rochester, MN 55901. (507) 282-9601

**WANTED:** Crosley phono with brass HF on grille, 8" x 12" spkr gold frame, green cone. John May, 205 Wren, Scotia, NY 12302. (518) 377-9522

**FOR SALE:** Tubes IB3 6SN7 5U4GB used tested - 25¢. TV tubes N.I.B. - 50¢. Send want list. Sencore Mighty Mite tube tester - \$15. Hickok Model 660 color bar dot generator - \$25. Superior Model 88 transistor radio tester - \$15. All plus UPS shipping. John Martin, 111 Bancroft, Rochester, NY 14616. (716) 663-4182

**FOR SALE:** (4) matching hardcover ca. 1897 books, depicts dynamos, motors, electric railways, lighting, & 2 other hard covers Electrical catechism etc. - \$45 takes all. Joe Nocera, 1222 Finch St., New Castle, PA 16101-4840

**WANTED:** Connecticut collector will pay up to \$500 for receivers and amplifier combinations made by Conn. Tel & Tel such as Sodian or similar style, or for anything made by them! I also collect any sets made in Connecticut by any company except General Electric. Reward for information leading to purchases. Larry Drago, 383 Lincoln Dr., Cheshire, CT 06410. (203) 272-6030

**WANTED:** Broadcast-type MICROPHONES. Early carbon, condenser, ribbon, dynamic, etc. Cash or trade. James Steele, PO Box 620, Kingsland, GA 31548-0620. (912) 729-2242

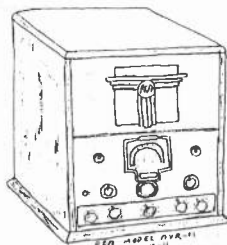

**WANTED:** RCA Model AVR-11 (AV-11) airport receiver as shown, any condition, housed in a steel tabletop cabinet approximately 20"W x 24"H x 16"D, 1937 vintage. Similar to the ACR-111 but is not the same radio. Chuck Dachis, The Hallicrafter Collector, 4500 Russell Dr., Austin, TX 78745. (512) 443-5027

**WANTED:** Thordarson amplifiers: 2A3 Pono Amp T-30W10, T-31W10 e.c. Heathkit WA-1. Schematics and other related items. Paul Gil, 180 Union Ave., Belleville, NJ 07109. (201) 751-5959

**FOR SALE:** Nice Aeriola Sr. — \$175. Radiola III and IIIA. Silvertone Neutrodyne — \$60. Radiola 100A — \$30 and \$35. Radiola V — \$125. Midwest Miraco — \$95. Radiola 20 — \$165. AK-E speaker — \$50. AK-35 — \$60. Richard A. Botzum, R.D. 2, Box 419, Morgantown, PA 19543. (215) 286-0047

**FOR SALE:** Allen B. DuMont cathode-ray oscillograph in very good condition, Mod #164 E., only — \$125. Northwest Electronics, 2509 West 11, Eugene, OR 97402. (503) 485-3016

**WANTED:** Martian Beauty 1-tube receiver, any condition. Also sales and repair literature or owners manual, RCA UC-1820 Faradon tuning condenser, RCA AG-1380 loop antenna. Stephen C. Brown, 3808 Champaign St., Charlotte, NC 28210. (704) 552-1102

**FOR SALE:** Crystal radio kits, come complete with face panel and baseboard, (2) 365 variable capacitors, and many other parts for old style crystal radio, remit — \$29.50. Carl & Grace Ent., 5636 Romeyn, Detroit, MI 48209

**FOR SALE:** Test instruments: Heath IGB-102 signal generator — \$17. Superior Model 76 Ris-cap bridge-1 signal tracer — \$15. RCA WR-99A crystal-calibrated RF generator 19 to 260 Hz and 3 crystals with data — \$23. B&K Model 466 CRT tester — \$6. Hickok 533 mutual conductance tube tester — \$20. Silver Voxam Model 600 VTVM by McMurdo Silver — \$8. RTTA signal generator 150 Kc - 84 MHz — \$13. Superior TV-11 tube tester — \$20. RCA WR-64B color bar/dot generator, great cabinet or power supply for 1926 battery radios — \$8. Small DeForest scope with 2AP1 — \$10. Variac 2.4 amp, 120 volts — \$8. HP-410-B VTVM with manual — \$15. All tested and working + UPS. Mervyn Ellsworth, 2309 N. 25 St., Boise, ID 83702. (208) 345-6878

**WANTED:** Schematic for Precision Radiation Instruments Inc. Model 117. **FOR SALE:** H-P 5254L, 5253B, 5262A, AC-DC supply 5v .25A & 12 & 15v, 0S8C/U scope & case, L&N XL630 chart recorder, L&N 4385, 4399 & 4399C, Apple II computer, tech books. For list, SASE to: Buddy Herring, 1310 Andover Rd., Charlotte, NC 28211

**FOR SALE:** Zenith Deluxe 10-tube chassis, 1927-28, untested, very heavy — \$150. AK 35, rusty but complete — \$35. RCA radio/marine ET8059, works — \$50. Airline 305 AM/SW — \$30. Dennis Atkinson, Upper Park St., Phillips, ME 04966. (207) 639-3111

**FOR SALE:** Speaker, electric voice, SP-12-B — \$15 + UPS. Jim Cook, 1446 Reymond Rd., Columbus, OH 43220. (614) 459-3892

**Victrola Repair Service:** Windup phonograph repairs, parts, springs, needles via U.P.S. Rod Lauman, 8 Sunset Circle, St. Johnsbury, VT 05819. (802) 748-4893, eves.

**WANTED: CALLBOOKS, Amateur, Broadcast, Government, Commercial and Military. 1900-1930.** Bob Arrowsmith, W4JNN, PO Box 166, Annandale, VA 22003. (703) 560-7161 Collect

**PARTS** for collectors. Hard to find Electrolytics, High Voltage Capacitors, High Power Resistors, Plugs, Switches and more. Free Catalogue. A.G. Tannenbaum, P.O. Box 110, East Rockaway, NY 11518. 516-887-0057. FAX 516-599-6523

**FOR SALE:** The following Art Deco radios: Bendix Mod 112 — \$65. Philco 41-226 — \$125. RCA 9x571 bull horn — \$75. Philco 39-30 — \$80. Zenith wood with "V" dial 6-D 029 — \$65. Setchell-Carlson "Frog Style" radio — \$60. Larry Drago, 383 Lincoln Dr., Cheshire, CT 06410. (203) 272-6030

**WANTED:** Books on radio personalities, radio advertising, stock certificates and memorabilia. Dennis Duffy, 625 Lost Pine Way, Absecon, NJ 08201. (609) 652-0105

**FOR SALE:** Motorola Ranger transistor — \$20. Panasonic midget transistor radio, 1960's stereo console look — \$40. Home brew battery set kit — \$50. Case for Mohawk Cherokee — \$10. WD-12 brass base tipped tube — \$40. A few old QST magazines 1921/22, great photos of early equipment — \$9 ea. Ocean Wireless Boys books, similar to Radio Boys series — \$8 ea. Atwater Kent 145 tombstone, nice — \$130. 1928 article with photos of early television — \$8. Philco 38-90, very nice — \$70. A Colonial and King battery set — \$100 ea. RCA BP-10 portable — \$35., and more. R. Burick, 21-B North Earl St., Shippensburg, PA 17257. (717) 530-5040

**FOR SALE:** Rider's 18, 19, 20, 21, 22; all in good condition — \$40 ea., plus postage. Sam Zuckerberg, 578 Fifth Ave., New York City, NY 10036. (212) 354-7407, noon-5 pm

**WANTED:** Owner's manual for Philco 20. 1 megohm / 2 watt lead end resistor. Doug Fox, 603 S. 12th Ave., St. Charles, IL 60174. (708) 584-5915

**FOR SALE:** 1928 Zenith Model 40A console radio, very large and ornate — \$1,200. Brian Morelli, 1932 Las Gallinas Ave., San Rafael, CA 94903. (415) 472-2866

**FOR SALE:** Books — \$8 ea. ppd: Elements of Radio, Marcus and Horton; Basic TV, Grob; Principles of Radio, Henney; Fundamentals of Vacuum Tubes, Eastman; Practical Radio Communication, Nilson and Horning; HF Measurements, Hund; Fundamentals of Radio and Electronics, Guy; Fundamentals of Engineering Electronics, Dow; Electronics, Millman; Electrical Communication, Albert; Understanding Servicing Test Equipment, Gilmore; Electronics, Wright and Scott; Understanding Microwaves, Young; Fundamentals of Radio, Jordan; TV Servicing, Buchsbaum; TV Simplified, Kiver; Mandl's TV Servicing, Mandl. Heath DC Power Supply HWA-17-1, 12v to 340v DC — \$10 + \$2 UPS. Happy Holidays to all. R. J. Eastwick, N2AWC, 224 Chestnut St., Haddonfield, NJ 08033. (609) 429-2477

**WANTED:** 12" speaker and chassis with good dial for 12S266 Zenith. Thanks. James Young, Rt. 14, Box 593, Florence, AL 35633. (205) 764-5969

**FOR SALE:** Sams 177 to 1801. Also Sams AR's, TSM's, MHF's. \$2.50 each plus postage. Maria P. Troutman, PO Box 760, Brewer, Maine 04412-0760

**WANTED:** Fairbanks Morris console Model 9C or 12B preferred. Charles E. Patterson, 2621 Sweetwater Rd. SP#33, National City, CA 91950. (619) 475-7141

**WANTED:** Pay well for pre-1898 phonograph parts, basket cases, Edison motors. Léon Brassard, 2272 Aladin, Laval, Quebec, Canada H7K 1M2



**FOR SALE:** Novelty radios: Wine cask Pl. 377 - \$80; Gulden's Mustard Pl. 363, M.I.B. - \$60; Mr. D.J. Pl. 356, M.I.B. - \$125; Raggedy Ann and Andy Pl. 131, M.I.B. - \$40; Camcorder, M.I.B. - \$75; Blue Max Pl. 519, mint - \$45; Ford Badge Radio, M.I.B. - \$50; Arco Supreme Motor Oil Can, exc - \$45; Getty Tire Pl. 318, M.I.B. - \$50; Starrod IM1 Pl. 243, M.I.B. - \$100; Starrod IR1-2, exc - \$60; Railroad Crossing Signal, M.I.B. - \$60. Kay Botzum, R.D. 2, Box 419, Morgantown, PA 19543. (215) 286-0047

**FOR SALE:** Military frequency meter, #AN/URM-32A, 125 Kc to 1000 MHz, with manual and charts, very clean - \$99.95. Northwest Electronics, 2509 West 11, Eugene, OR 97402. (503) 485-3016

**WANTED:** Copy of manual for Hickok tube tester 539A, will pay. Dennis Rauscher, 4209 Sternberg Ave., Schofield, WI 54476. (715) 359-8276

**FOR SALE:** Empire of the Air, new hardcover - \$19.95 ppd, limited number. Merrill Bancroft, 169 S. Row Rd., Townsend, MA 01469

**FOR SALE:** QST 40 year run, 1937-1976 - \$75. **WANTED:** Dialescutcheon for Masterpiece IV (junkier?). Wayne Steiner, 1212 17th Rd., NW, Burlington, KS 66839. (316) 364-5353

**WANTED:** B&K Model 960 Transistor Radio Analyst and pre-July '92 A.R.C. issues. Richard Bligh, 318 Las Palmas St., Royal Palm Beach, FL 33411. (407) 793-5483

**FOR SALE:** Grundig Satellit 400 portable receiver, includes SW, FM, MW, LW; like new with box, manual, warranty cards, etc. - \$200 + shipping. Gerald Silver, 10863 W. Clairmont Cir., Tamarac, FL 33321. (305) 720-1972

**FOR SALE:** Two transistor active antenna - \$32. Hewlett-Packard microvolt-ammeter, Model 425A - \$25. Rev. H.W. Johnson, 36 Sunset Dr., Bristol, VA 24201. (703) 669-2239

**WANTED:** Rocketship and satellite type crystal set. Harry MacMullan, 2662 Bancroft Dr., Aston, PA 19014

**FOR SALE:** Junk chassis, Grunow Model 1191, Westinghouse Model H162 - \$10 ea. plus shipping. Raymond Humphreys, 1044 N. Jackson St., Macon, MO 63552. (816) 385-2821

**FOR SALE:** Meter glass - \$1.50 + shipping. Free list books, tubes, testers, radios, meters, WWII aviation. Computer programming, typing. Chris Cross, PO Box 94, McConnell, IL 61050

Join Crystal Set Society. \$9.95 brings six bi-monthly newsletters on designing, building, understanding sets. Phil Anderson, 789 N. 1500 Rd., Lawrence, KS 66049-9194

**MOVED MOVED MOVED.** Leonard W. Cartwright, Ye Olde Meter Cellar, 879 Russet Dr., Sunnyvale, Calif. 94087. (408) 739-6025

**CAPACITOR REBUILDING** - We rebuild single Twist-Loc or other round capacitors for \$12. prepaid return. Simply add \$1. for additional sections. Maximum 450. volts at this price. **FRONTIER ELECTRONICS**, p.o. box 38 OR 403 S. McIntosh St., Lehr, N.D. 58460. Ph. 701-378-2341 Everett Hoard

**FOR SALE:** Old glass tubes for display. Miniature and transmitting mounted on redwood base, most with sockets, filaments OK. Stamp for list and info. \$5 plus shipping. Neil Spencer, W4PC, 4665 75th Ave., No. Pinellas Park, FL 34665

**FOR SALE:** A.C. Dayton XL10 (Bunis II, p. 7) - \$155. Westinghouse 1922 Model R.C., believed to be first commercially made battery set in U.S.A. - \$200. Zenith 1927 11-E, the first electric radio in U.S. - \$200. Stromberg-Carlson "rare" 1928 "Treasure Chest" Model 635 - \$200. Freed-Eisemann Mod N.R. 60 w/ brass tuners and all tubes - \$175. Bremer-Tully counter phase Model 6-35 - \$75. Larry Drago, 383 Lincoln Dr., Cheshire, CT 06410. (203) 272-6030

**FAX NUMBER FOR  
ANTIQUE RADIO CLASSIFIED  
(508) 371-7129 - 24 hours a day  
Ads - Subscriptions - Book Orders  
Charge to VISA/MasterCard  
Minimum Charge: \$10.00**

**WANTED:** Extra cards for Hickok Cardmatic tube tester. Older-tube adapter for Hickok 6000A. **FOR SALE:** Zenith Royal 755 - \$35. Y600 Trans-Oceanic - \$80. GE P-808H - \$20. Coronet Boys - \$25. Rider's Index: 5, 6, 7, 9 - \$6 ea. Rider's Automobile Vol. 1 pages - \$15. AT&T 1953 green book - \$20. Armand Cote, 11 Berge Ln., Derry, NH 03038. (503) 437-4431

**FOR SALE:** Radio Retailing magazines, miscellaneous issues 1928 through 1939. Telephone or write for details: Frank Bequaert, Rainy Day Books, PO Box 775, Fitzwilliam, NH 03447. (603) 585-3448

**FOR SALE/TRADE:** Call or write for list of (33) novelty radios. No SASE necessary. Dave Chase, 5749 Birch Rd., White Bear Lake, MN 55110. (612) 429-1527

**WANTED:** These radios in excellent original condition (or better): GE K-60, Philco Models 17, 18, 21, 43, 45, 51, RCA 5T, 6T, 7T, 10T, Atwater Kent 93, 155, 275, 217, 447, Crosley Treasure Chest, Emerson Black U5A. Transistors: White Zenith Royal 500H, Silver-tone 9204, 9205, 9206, 211, 212, 213, 8204, 8206, 8208, Zenith Royal 300 and Royal 500 hand-wired sets, 500 C, D & E models, John Kern 888's, unusual grandfather clock radios. John Kern, 2320 Rosedale Rd., Quakertown, PA 18951. (215) 538-2128

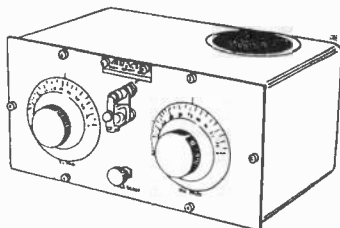

**WANTED:** Pre-1926 radios by AMRAD. Also, Amrad radio parts, accessories, and literature. Richard Sharisky, PO Box 521, Belmont, MA 02178. (617) 484-5784

**RADIO SCHEMATICS**, Sams, Riders, Beitman Gernsback. \$2.50 each. Postpaid USA. Joseph R. Forth, 321 Long Vue Acres, Wheeling, WV 26003. (304) 277-3154

**FOR SALE:** Wood Majestic radio, resembles famous Silver-Marshall Mod 47A - \$85. L. Drago, 383 Lincoln Dr., Cheshire, CT 06410. (203) 272-6030

**WANTED:** Remote control unit for Philco 39-116. Herb Ellmers, 603 Howard St., Ft. Pierce, FL 34982. (407) 466-0926

**WANTED:** Model 257 tube tester by Accurate Instrument Co., reasonable. Larry Cook, 362 East South, Richland Center, WI 53581

**FOR SALE:** Admiral, Bulova, GE, Grundig, Motorola, Silvertone, Westinghouse, Zenith. Send for my list. Art Collatz, N7818 Barker Lake Rd., Winter, WI 54896

**FOR SALE:** Large, old switchboard meters, dynamometers, rotary inverters, UV therapy lamps, etc. SASE for lists. H. Andreoni, 250-D So. Lyon Ave., Hemet, CA 92543

**WANTED:** Looking for old Hallicrafters hand microphones Model RA-45. Loren H. Dudley, KA1PRV, 14 Valley Rd., Bath, ME 04530. (207) 442-8419

**FOR SALE:** Zenith R1000 - \$65. Guild Country Belle, mint - \$85. **WANTED:** McIntosh MA6 outboard MPX. Walt Fleming, 182 Plain Hill Rd., Norwich, CT 06360. (203) 889-5018

**WANTED:** Brook and RCA 2A3 amps, triode amps working or not. E.V. Patricia 4, T350-16 coil for T25A, Ionovac and parts. Altec 515, 3000A Read's book, 2A3, 45, 50, 274, 275 tubes. Tom Morgan, 1021 Claremont St., Lincoln, NE 68508. (402) 475-2510

**FOR SALE:** Ca. 1970 Philco 90 cathedral, the original Philco-Ford reproduction - \$50. Majestic 60 Deco - \$50. Emud Junior 196 - \$35. Howard 474(?) , ivory Plaskon - \$35. Sony 5-303W micro TV - \$45. Sony BMC-500 CCD Super Beta camcorder - \$100 or trade. Most work. Add UPS. Walt Kiefner, 6233 51st Ave. NE, Seattle, WA 98115. (206) 524-1388

Satisfaction Guaranteed

# J.D.'s Radiowear



**\* RADIO DECO \***

Expertly silkscreened on black in red, yellow, blue and white.

- \* T-shirts - 50/50 cotton blend \$13.95
- \* Sweatshirts - \$19.95

(available in M, L, XL, & XXL \$1.00 extra)

All prices include shipping. Indicate size and quantity. Send check or money order to: J.D.'s Radiowear, 1161 SW Mulvane, Topeka, KS 66604 (913) 232-0128

**MESSAGE:** Join the only organization for collecting early portable electronic calculators. Membership includes quarterly newsletter - \$8/yr., sample - two 29¢ stamps. International Association of Calculator Collectors, 14561 Livingston, Tustin, CA 92680

**FOR SALE:** Supreme Publications 1966 Master Index, copy, 48 pages - \$25 ppd. John Snow, 4539 Bartlett, Shorewood, WI 53211

**FOR SALE:** Spartan Bluebird - \$2,200. Emerson Patriot, red - \$1,100. Large Addison red/yellow - \$1,300. All exc cond. Anthony Scarfogliero, 13 Fourth St., Brooklyn, NY 11231. (718) 858-1231

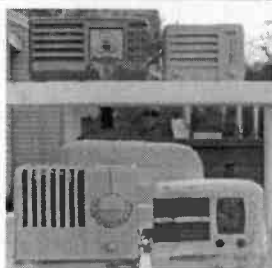

**WANTED:** Unusual prewar colored plastics, such as sets in photograph: From top left, red Emerson, pistachio green Emersonette, lavender Silvertone, Beetle plastic with orange trim Detrola. If you have one of these type radios or other prewar colored sets, please call me collect or write. I will pay top dollar in cash or have great sets to trade. Thank you. Mark Alzapiedi, 21 Peach Tree Ln., Leominster, MA 01453. (508) 840-0466

**FOR SALE:** Detrola 327 brown Bakelite with white marbled knobs and white marbled split grille, has handle brass & orange Catalin trim airplane dial, BC & SW, no cracks and plays, looks nice but missing back - Best offer over \$350. Fred Watson, KB8NRF, PO Box 58, 581 W. Summit St., McClure, OH 43534. (419) 748-8798

**FOR SALE:** LOKI - The Life of Charles Proteus Steinmetz, good condition - \$21 ppd. Frank R. White, PO Box 3283, Olathe, KS 66063

**WANTED:** Paying more for over a decade for Vintage eqpt. Now offering \$300 for WE 300 A/B, \$125 ea. for 50ST, \$100 KT88, \$50 Tungsol 6550, \$15 ea. 7591, \$65 8005, \$1,500 for Hadley amp, \$1,000 Fisher - Lincoln, \$700 Fisher FMR-1, Leak TL12, \$600 Ionovacs. Also: Brook, Regency, RCA transcistmen, McIntosh MI200 or parts, Fairchild, RCA 9289, Amperex Bugle Boys, Altec, Fisher, Scott, REL, E.V., Partridge, Tannoy, Acrosound. Ed Schneck, 1401 Ocean Ave., Brooklyn, NY 11230. (718) 377-7282, M-F, 3-6 pm

**FOR SALE:** Information on vintage radio parts, service, codes and etc. Send SASE for list. Charles Ahr, 2291 Sylveld Ln., Cincinnati, OH 45238

**FOR SALE:** Rider's 1 through 17 - \$15 ea. and up. Large collection old radios, books magazines, catalogues - SASE for list. Bill Rolf, 30131 Center Ridge, Westlake, OH 44145. (216) 871-4547

**WANTED:** Whip antenna for Zenith Trans-Oceanic 8G005Y. Ivory RCA 66X and Zenith 12S266. Mark W. Hilliard, N3NBL, 523 N. Law St., Allentown, PA 18102. (215) 432-8089

**FOR SALE:** Coke Cooler radio, vg, no cracks - \$725. RCA La Siesta radio, vg - \$695. Miray mirrored radio, vg - \$1,100. Tri City 1 tube battery set - \$165. DuMont RA 346 Oriental radio, exc - \$165. Radiola IIIA, no tubes - \$150. Radiola III, no tubes - \$110. Kardon strip battery radio, exc with tubes - \$165. Universal carbon microphone with flag - \$275. Zenith Trans-Oceanic 1000D, vg - \$150. Tom Thumb 4 tube battery set by Automatic Radio - \$225. RCA 77DX microphone - \$675. Waves has many other items in stock; please let us know what you are looking for. We buy collections and individual pieces, call us. Waves, 32 E. 13 St, New York City, NY 10003. (212) 989-9284. Fax (201) 461-7121. Shop hrs. 12-6 Tues.-Fri., 12-5 Sat. Sun. & Mon. by appointment

**FOR SALE:** RCA MI-34654 Negative Peak Limiter. Needs power switch. SASE. Maurice Pope, 39 Highland Ave., Gorham, ME 04038

**WANTED:** Uher reel-to-reel repair man. S&G Electronics, 618 S. 62nd St., Philadelphia, PA 19143

**WANTED:** Dial cover, knobs and nameplate for Charlie McCarthy, or cabinet without figurine. **HELP:** Info on Tourist 8 from Kustombilt Radio Mfgs., S.F., Cal. Info 501 Beaver and Onado. Eugene Rippen, 105 Donnington, Auburn, CA 95603. (916) 885-6147

**FOR SALE:** Restored, brilliant white Emerson Patriot, one-inch hairline on back side, completely original - \$775. Deco Truetone beetle plastic push button - \$300, non push button - \$250. Crosley left bullseye, ivory - \$175. Grantline Deco by Belmont, white - \$275 Art Deco neon sign, circa 1935, red, red neon - \$250. **WANTED:** Unusual prewar beetle and colored plastics. Mark Alzapiedi, 21 Peach Tree Ln., Leominster, MA 01453. (508) 840-0466

**FOR SALE:** Large transistor radio collection for sale. Approx. 500 radios, many different brands, styles, colors, etc. A video of the collection will be ready approx. Dec. 1, '93. For further info, call: Mike Schaffer, PO Box 11062, Englewood, CO 80151-1062. (303) 777-4191

**WANTED:** For future article: Any information on the Lincoln Ultra Deluxe receiver, ca. 1934. Also interested in purchasing this and other Lincoln chassis built prior to 1937. N.S. Braithwaite, PO Box 992443, Redding, CA 96099

**MESSAGE:** Although our main catalog is not available, we do have the portion listing the transformer section ready. If you are in need of power, choke or audio transformers, then a \$1.25 will get you this 12-page listing of over (800) transformers. Play Things Of Past, Gary B. Schneider, 9511 Sunrise Blvd, #J-23, Cleveland, OH 44133. (216) 582-3094

**FOR SALE:** EH Scott consoles for sale: Philharmonic in Warrington; Waverly Allwave 23; Milton Grande Allwave 23; Warrington Allwaves 23, one original, one refinished; Tasman Allwave 23; Wilshire 16; Westminster Allwave 15; Regent Allwave 15; Lido Allwave 15; Acoustacraft late Super 12; Oxford Phantom. McMurdo Silver 15-17 in Oxford cabinet, chrome 80%, 15-17, no cabinet, chrome 90%. Photocopy of (2) EH Scott catalogs showing cabinets, 1934 or 1935 - \$16 ea. ppd. We ship consoles anywhere and can probably arrange delivery if desired. Unless noted all radios are un-restored electrically, but integrity is guaranteed. Satisfaction guaranteed, shipping extra. Alan Jespersen/Mike Emery, PO Box 17338, Minneapolis, MN 55417. (612) 727-2489, 8 am to 8 pm, 7 days. Fax only: (612) 727-1908, 8 am to 8 pm

**FOR SALE:** Box of old TV knobs, 11 1/2 lbs. - \$25 plus UPS. Kenneth Miller, 10027 Calvin St., Pittsburgh, PA 15235. (412) 242-4701

**FOR SALE:** Violet light Suncraft dual tube w/infrared - \$89. Unmodified BC-348-R w/LS-1 speaker - \$135. +UPS. 10-page superlist. SASE plus \$1. Thanks! Steve Lipsky, 1254 Cox Rd., Jenkintown, PA 19046-1207. (215) 884-1817

**MESSAGE:** Sellers or collectors of transistor radios please note my relocation: Bill Burkett, PO Box 2488, Sun City, AZ 85372. (602) 974-4535. Fax (602) 974-4323

**FOR SALE:** Alba British midget, green Bakelite, white honeycomb grille, immaculate, works fine, ca. 1948 - \$650. Jim Taylor, G4ERU, No. 5 Luther Rd., Winton, Bournemouth, BH9 1LH United Kingdom. Tele. 0202-510400

**WANTED:** Stancor and Heath two-chassis hi-fi maps w/ 807s, 807 5691 & 5692 tubes. Allied catalogs 1950 to 1958. Rick Graves, 4500 Ninth Ave. NE, #300, Seattle, WA 98105-4762. (206) 632-9929. Fax (206) 633-6038

**FOR SALE:** Crosley Mod 124 Playboy cathedral, nice looking, good working - \$225. Airline 1 tube set by Tricities, very good, w/tube - \$165. **WANTED:** Crosley Mod 54 chassis right-hand thumbwheel tuning. Thanks. Bob Barnes, 511 N. Chestnut, Monroe City, MO 63456. (314) 735-2945

**WANTED:** Realtone TR-870 Satellite, as shown in Bunis Transistor Price Guide p. 170, buy or trade. Robert Davidson, 310 Main St., Concord, MA 01742. (508) 369-2007

**FOR TRADE:** Nice butterscotch EP-375 for: AK 4066, 3975, or possibly other green can model. Beautiful folding Priess loop for DeForest loop, or trade D-17 for Preiss set. Three Geissler tubes for good Emission rainbow 01-A's, or ? **FOR SALE/TRADE:** Nice Jack Armstrong flashlight; Crosleys, 11-107U, 11-108U, 56TD, Superhet Vanity; GE 200, 201; Admiral 451TL; Telechron 8H59 Musicalcam; Arvin 358T; misc. metal Arvins; Emerson 541; Zenith Royal 450, Royal 59-1, S829 chrome front; Philco 41-226. Dale Davenport, 622 S. 18th St., Ft. Smith, AR 72901. (501) 785-4929, eves.

**FOR SALE:** Crosley 50 - \$150. Crosley 51 - \$125. Crosley 52 - \$135. Crosley V - \$135. Crosley VI - \$175. Crosley 3R3 - \$110. Crosley 51-SD - \$135. Ace V - \$200. Ace 3B - \$160. Atwater Kent 145 tombstone - \$125. AK E and E-3 speakers - \$30 ea. Radiola III, excellent - \$110. Atwater Kent Kiel table - \$225. RCA RE-75 - \$250. Tubes: WD-11's - \$45. WD-12's - \$35. 199's - \$15 to \$35. Cylinder records 2 and 4 minute - \$4 ea. Victor wind-up Credenza - \$800. John Hayes, 27 Highland Dr., Henniker, NH 03242. (603) 428-3053

**WANTED:** Battery pack for Zenith Trans. 3000-1. Also looking for tuning knob for Silvertone Model 1 (Bunis, p. 164). Luis Amory, 43 Monroe Pl., Bloomfield, NJ 07003. (201) 748-9373

**FOR SALE:** Old radio parts, test equipment, ham equipment. List, send SASE. Robert Larson, W7LNG, 1325 Ridgeway, Medford, OR 97504

**FOR SALE:** Radiola AR-812 with AG-814 loop antenna - \$225. Fada bullet 1000, yellow - \$525. GEC short-wave, made in England by General Electric - \$250. Gary Cameron, 824 Andrews St., Southington, CT 06489. (203) 276-9200

**FOR SALE:** The following Philcos: Art Deco Model 41-226 - \$125. Model 39-30 slant front - \$75. Mod 42-PT 94 w/handle - \$90. Cathedral Mod 38 - \$175. L. Drago, 383 Lincoln Dr., Cheshire, CT 06410. (203) 272-6030

**FOR SALE:** The following radios are working with nice cabinets: Philco 46-200, ivory - \$35. RCA 2X62, ivory - \$40. Philips P143, brown/ivory, Canadian - \$45. Silvertone 8013, brown - \$35. Zenith H72421 AM-FM - \$35. RCA 66X1, Canadian model, ivory - \$45. Firestone 4-A-187, coral - \$20. The following transistors are in almost new condition: Motorola table XT6CL, seafoam green/white - \$15. Zenith Royal 80, black, w/case, perfect - \$40. Hy-Lite E164 w/case - \$10. Panasonic R-1013, red - \$10. Channel Master 6469 AM/marine, leatherette case - \$15. GE P780A, nice case, needs chassis work - \$10. Classic Radio and Television, R1, Box 393, Solon, ME 04979. (207) 643-2799

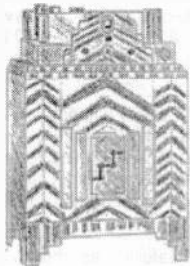

**WANTED:** Radio pictured, with or without chassis. Mike Greene, 19113 Alpenglow Ln., Brookeville, MD 20833. (301) 774-3203

**FOR SALE:** Consoles. Splitdorf Lorenzo, very unusual, 4 doors, 1928, (Douglas V. 3), AC - \$450. Majestic 92, NT, needs refinish, worked good - \$75. Philco 77, nice cabinet, works - \$95. Brunswick 14, stripped, NT, needs work - \$40. Silvertone 6437, 13 tubes, 7 bands, (F.O.S., p. 172), works, cabinet nmr - \$75. Cannot ship consoles. Over 150 radios, TVs, test equipment. SASE for list. **WANTED:** Dial scale 26-268, pointer, 18 push buttons for Zenith 10H571, 10H573. Chassis for Zenith 12U158. National 7" metal TV, unrestored. Dennis Smith, KN8H, Box 113, Trenton, MI 48183. (313) 675-5847

**FOR SALE:** Bosch 58. Philco 38-4. Heathkit EK-2. Simpson 372 M.I.B. Detrola 282. All working. Robert Rossi, 10936 Melbourne St., Allen Park, MI 48101. (313) 386-8321

**WANTED:** National SW-4 and Harvey Radio Labs FT-30 xmtr for exceptional cash or trade. Robert Enemark, W1EC, Box 1607, Duxbury, MA 02331. (617) 934-5043

**FOR SALE:** Marlboro novelty, boxed N.O.S. - \$50. Guild transistor Town Crier - \$125. Pilot TV-37, many tubes missing - \$150. Travler snakeskin 5028-A - \$110. (2) JAN 5BP1 pic tubes - Offer. Philco radio polish - \$20. Sam Samuelian, 2305 W. Deerfield Dr., Media, PA 19063. (215) 566-7248

**FOR SALE:** Tubes, GE #VT-4C, new - \$15. Cetron #572B/T160L, new - \$40. #815, used - \$5. #809, used - \$5. Rick Yerke, PO Box 392, Moscow, PA 18444. (717) 842-4857

**WANTED:** Cabinet for Fisher 400 FM stereo. Send price to: Gary Ledbetter, 7321 Granalta Cir., Frederick, MD 21702. (301) 473-4563

**FOR SALE:** Fisher 800-B - \$125. QST 1930-1993 - \$500. CQ 1946-1993 - \$200. Textbooks, ARRL. Bill Tucker, W4FXE, 1965 S. Ocean Dr., Apt. 15-G, Hallandale, FL 33009. (305) 456-1349

**FOR SALE:** (Deco/novelty): Lone Ranger radio, excellent and working - \$1,250. Silvertone black 6110 vacuum cleaner radio, v. nice - \$1,600. Radio Lamp Co. of America lamp/radio, excellent and working - \$350. Fridron football tube radio, black/gold, Notre Dame?, excellent and working - \$725. Guild Pirate Treasure Chest radio w/pistol, inop - \$150. WFUZ microphone radio, inop - \$125. Philco Transitone lamp/radio - \$100. Chassis for Kadette Classic - \$110. Fada red Plaskon (Collins, p. 27), very nice but not perfect - \$350. Philco 41-230 (European look), brown Bakelite, working - \$100. Jim Clark, 1292 Starboard, Okemos, MI 48864. (517) 349-2249. Fax (517) 349-4059

**FOR SALE:** Wizard wire winder, ex-nice, complete - \$450. Philco Model 70, all original, nice, plays - \$450. Lyric cathedral, all original, nice, works. Silvertone tombstone Art Deco, shortwave, wood, nice, plays - \$130. Radiola tombstone #118, all original, real nice, works - \$175. Crosley tombstone #515 small wood, fine, plays - \$95. Hallicrafters S-38-E - \$75. Hallicrafters S-38, fine, works - \$80. Renew life quack violet ray - \$50. Hallicrafters S-118, nice, plays - \$75. Temple midget, metal, white #G418, all original paint, real nice, plays, a beautiful radio, has strap handle - \$150. Temple midget, metal, brown paint, nice, no chips, plays - \$100. Zenith H-500 Royal, oval speaker black, nice - \$125. Beaver baby grand crystal, real nice - \$375. Philmore slant-front crystal set, nice - \$125. Silver brand crystal set, nice - \$175. Four War I calvary patches with horse head, nice - \$75. Signal etc. really with internal code, nice - \$95. E.F. Jonson Co., Waseca, Minn., sounder, brass on wood, ex-nice - \$75. Westinghouse style - \$925. Black 10" fan has red cardinal on cage, nice, runs - \$45. Western Elect. 12" brass blades, a beautiful fan, oscillates - \$165. R and M 16" brass blade, runs, fine, oscillates - \$125. Peerless 16" brass blade, nice, runs - \$85. Lg. horn speaker with name, real nice, works, a beautiful horn - \$175. GE 12" brass blade #117913 8"lg. motor switch center, motor, in back Art Deco cast base 1900 to 1902 model, runs, no guard, runs, fine condition - \$275. Howart #901A white plastic, nice, plays - \$75. Detrola #342 brown, plays nice - \$75. Edison Mabry, I Collect Best in Radios, 715 W. Longview Ave., Mansfield, OH 44906. (419) 526-1175

**WANTED:** Will pay top dollar for a working Philco stepper unit, Part #38-9689 or suitable substitute. Robert Prillwitz, Box 212, Rt. 1, Black River Falls, WI 54615. (715) 284-9847, call collect

**WANTED:** RCA tabletop phonographs from the 50's. Must have nice original blond finishes. Jerry Traub, 806 McDonald Ave., Santa Rosa, CA 95404. (707) 545-9425

**FOR SALE:** Four novelty transistors. Rolls Royce, Hong Kong, fair to good condition. All - \$25 plus UPS. David L. Borino, 1480 Glenaire Dr., Casper, WY 82609. (307) 237-2368

**FOR SALE:** Sonora RDAW-209, nice curved cabinet wood radio, no play - \$35. Paper maché horn, no base - \$25. Tubes: 18" GE Coolidge, 81321 - \$17. Fischer #3593, good fil. - \$25. Fischer #4670, bad fil. - \$15. Underwood 4-pin, cloudy, good fil. - \$7. Another no name, good filament, 4-pin JE, brass base, 14434-amp, good filament - \$25. Crosley 51 for parts, transformer is out, has tag - \$55. Signal Corps U.S. Army #EE-8-B phones - \$4. Call: Del Tysdal, 812 Broadway #4, Fargo, ND 58102. (701) 293-9328

**FOR SALE:** (Consoles): Zenith 12-tube chairside, 12S550 - \$195. Rare Zenith 7S261 bookshelf set - \$1,750. Blonde Moderne cabinet only for Scott 800B - \$200. Zenith Aviatric console, restored and working - \$1,350. Unusual Sparton grandfather clock/radio - \$600. Atwater Kent Kiel, rare possible one-of-a-kind variation, excellent and working - \$900. Jim Clark, 1292 Starboard, Okemos, MI 48864. (517) 349-2249. Fax (517) 349-4059

**FOR SALE:** Trans-Oceanic T-600, mint - \$100. Truetone Stratoscope, excellent - \$100. Philco 630 tombstone, mint - \$120. Chris or John Watts, 133 Prospect St., Plantsville, CT 06479. (203) 621-3523

**WANTED:** Will pay \$15 for 2uF/2000v round, one screw terminal; pay up to \$1,000 for Western, Marantz, Brook, Jensen. **FOR SALE:** Daven tubes - \$90/3. (3) 01-A/ brass/tip - \$35. Kellogg 401 - \$30. Will trade for 6B4G, 845. Mike Somers, 852 W. Aldine, #1, Chicago, IL 60657. (312) 868-1696

**FOR SALE:** Edison C4 radio phono - \$275. GE H51 highboy - \$150. Pick up only. **WANTED:** Two speed tuning mechanism used in AK 735, 456, etc. Steven Thompson, 798 Joseph Club Dr., Mableton, GA 30059. (404) 941-0429

**FOR SALE:** Zenith 12-S-268 and 12-U-158, cabinets been refinished, both work - \$650 ea. Lester Hobbs, 320 Herman, Ottumwa, IA 52501. (515) 684-6403

**WANTED:** Circa 1938 Detrola (Truetone) 155 console. Top \$ paid. Al Bernard, PO Box 690098, Orlando, FL 32869-0098. (407) 351-5536

**FOR SALE:** Original magazine ads for tube and transistor radios - \$2 each plus postage. SASE for list. Evan Powell, 4717 Conquista Ave., Lakewood, CA 90713. (310) 429-3793

**FOR SALE:** Transistor Coke machine radio - \$40. Pair 4CX250B tubes - \$40. Federal signal generator #804 CSI - \$25. Sears #7208 transistor - \$12. Rough Zenith 5R216 - \$35. 120 volt 6 amp Variac - \$15. Radiola UZ1325 speaker - \$50. Horn speaker - \$25. Old GE battery charger #155529 - \$25. Rex, blue leather, portable windup record player - \$95. Plus UPS. Jim O'Neill, 170 Devon Rd., Delaware, OH 43015. (614) 363-3682

**FOR SALE:** RCA microphone Model S36 made by Shure Brothers - \$55. Transistor radios: Arvin 61R35 - \$50. Emerson 838 Hybrid, small hairline - \$100. Philco Ford T-bird car, 1967, vg - \$75. 1965 T-bird, missing rear lights - \$50. Mellow-tone boy's radio - \$55. Admiral Y2229 - \$35. Emerson 911 Eldorado, coral, vg - \$60. Top-line boy's radio, blue & white - \$20. RCA 4-R6-34 - \$20. Zenith 500E, vg outside, some battery damage inside, plays - \$50. Realtone TR-970 SW, chip - \$30. Viscount 616 - \$10. Zenith 275, hairline - \$12. Delmonico 7YR707, damage back - \$20. Claricon Micro JT-602, damage back - \$8. Star-Lite, missing handle - \$10. Raleigh 16 trans. - \$8. Ross RE-101 - \$10. Novelty 650P in box - \$6. Elgin R-1000 - \$8. (2) Japanese hi-fi 6 trans., 1 good, 1 parts - \$15. Falcon-Crown, damage, TR-690 - \$6. Cleartone hearing aid, small & chrome - \$10. Truetone 5 trans. walkie-talkie, round metal grille - \$10. Novelty radios: Michael Jackson - \$15. G.B. Marshmellow man, N.I.B. - \$18. G.B. Slimmer, N.I.B. - \$18. Winston Cooler radio, N.I.B. - \$20. Mickey Mouse tuning ears - \$10. Snoopy dog - \$20. Radio Log Book mother of pearl and Catalin front. Index with cities and call letters - \$55. All plus shipping. Thanks! Danny Thornton, 1175 Springdale Cir., Spartanburg, SC 29303. (803) 578-8518

**FOR SALE:** Stromberg-Carlson Mod 350M console - \$150. Stromberg-Carlson Mod 635 Treasure Chest, stunning - \$250. L. Drago, 383 Lincoln Dr., Cheshire, CT 06410. (203) 272-6030

**FOR SALE/TRADE:** BC-191, BC-375 meters 0-500 mA, 0-8 RF - \$10 each, or \$4 with exchange. Mercury tube tester - \$8. W.C. Fields battery checker - \$5. TS-297/U multimeter - \$35. Victor RGS19A AM/FM/clock tube radio - \$4. GE P-808J early xstr radio - \$4. Telegraph glass insulators - \$5. Collector's Guide to Antique Radios, 1991 - \$13.95. Elements of Radio, 1945 - \$10. 70s-80s QST - \$1.50 ea. JAN-CWL 860, VT-17 tube - \$12. 12AT7, 12BA6 - 95¢. Much more, free list. **FREE:** Dud tubes, misc. books. Services: Meter glass - \$2.50 ppd. Computer programming, typing, stained glass. **WANTED:** Panel meters, old scopes, WWII aviation. Chris Cross, Box 94, McConnell, IL 61050

**WANTED:** Cabinets for Truetone Model D2615 and Philco Model 80. **FOR SALE:** Books: Practical Radio Communication, Introductory Radio, Essentials of Radio-Electronics, Reference Data Radio Engineers. \$6 ea. QST's 1925-1950. Kenneth Gregory, 5180 Ada, Beaumont, TX 77708. (409) 898-7270

**WANTED:** Audio tubes. Tubes head-amp, tubes preamp, tubes power amp, turntable with tone arm, tube receiver manuals, Hickok tube tester w/cardmate. Lawrence Yip, 13K Jardine House, 1 Connaught Pl., Central, Hong Kong. Fax: 852-844-9318

**HELP:** Santa, my wife wants for Christmas the book, The Edison Cylinder Phonographs, 1877-1929, by George Frow, sold by Antique Electronic Supply. Also owners manuals, advertising, etc. for a Sparton 301 Equasonne, Philco S11 and a Zenith 10S669 console. Santa remember, if Mama ain't happy, ain't nobody happy this holiday. James W. Walcher, 1311 Janet Dr., Wilmington, IL 60481. (815) 476-9184

TOGGLE SWITCHES AT WHOLESALE PRICES					
NEW SWITCHES-125V or 1/2 RATING AT 250V					
— FULL SIZE TOGGLE SW. 1/2" Dia. —					
Type	Mod #	Cont. Rat.	Lead	Price/100	/1000
SPST	S125	6A/125V	6" WIRE	.75	.65
SPST	S128	4A/125V	Solder	.55	.45
DPDT	S126	5A/125V	Solder	.75	.65
DPDT/ ON-OFF-ON	S127	10A/125V	Solder/ Screw	1.15	1.05
— MINIATURE TOGGLE SW. 1/4" Dia. —					
SPST	S131	6A/125V	Solder	.55	.45
SPDT	S132	6A/125V	Solder	.59	.49
SPDT	S141PC	6A/125V	PC	.59	.49
SPDT	S145PC	6A/125V	PC/Rt-Ang	.59	.49
SPDT/ MOM-OFF-MOM	S129	6A/125V	Solder	.75	.65
SPDT/ ON-OFF-ON	S134	6A/125V	Solder	.75	.65
DPDT	S133	6A/125V	Solder	.65	.75
DPDT	S143PC	6A/125V	PC	.65	.55
DPDT	S146PC	6A/125V	PC/Rt-Ang	.65	.55
DPDT/ ON-OFF-ON	S135	6A/125V	Solder	.90	.80
DPDT/ ON-OFF-ON	S144PC	6A/125V	PC	.90	.80
DPDT/ MOM-OFF-MOM	S130	6A/125V	Solder	.90	.80
— SUB-MINIATURE TOGGLE SWITCHES 1/8" Dia. —					
SPDT	S136	3A/125V	Solder	.80	.70
DPDT	S137	3A/125V	Solder	.90	.80
— MOMENTARY PUSHBUTTON SWITCHES 1/4" Dia. —					
SP-NOR OPEN MS-1	3A/125V	Solder	.25	.22	
SP-NOR CLOSED MS-2	3A/125V	Solder	.25	.22	

**FERTIK'S ELECTRONICS**  
5400 Ella Street, Philadelphia, PA 19120 — (215) 455-2121

**FOR SALE:** Antique table and floor model radios, test equipment, books, tubes, and many related items. Most items can be shipped by UPS. Send \$1 for 25-page catalog listing over 150 radios, 26 items of test equipment, and much more. Catalog price will be refunded if an order is placed. Catalog is ready for first-class mailing. Rod's Vintage Electronics, PO Box 211, Earlsville, VA 22936

**WANTED:** Toshiba transistor radios with lace fronts. Any color, any condition. Marty Bunis, RR1, Box 36, Bradford, NH 03221. (603) 938-5051



**FOR SALE:** Repairable Crosley 50 with Brandes ear-phones. For details: Dale Tittler, Box 7361, Gulfport, MS 39506. (601) 864-3785

**WANTED:** Paragon RA-10, DA-2. McElroy bug. **FOR TRADE:** AK-10C. Amperite RBM mic. Brian Roberts, K9VKY, 3068 Evergreen, Pittsburgh, PA 15237. (412) 931-4646

**HAVE YOU MOVED? ARE YOU MOVING?  
PLEASE NOTIFY US A.S.A.P.  
SEND US YOUR...  
OLD ADDRESS  
NEW ADDRESS and  
SUB #  
MANY THANKS!!!!**

**WANTED:** 175 Kc IF coil, 140 ohms primary, dual 70 ohms secondary. David Altobelli, 921 Denton Blvd., #1001, Fort Walton Beach, FL 32547. (904) 862-9790

**FOR SALE/TRADE:** Thordarson amp, no p.s., 2A3 outputs - \$55. Stromberg-Carlson Authorized Dealer certificate, 1920's - \$45. Pair KLH 38 speakers, near mint - \$60. Microphones; E-V 664 - \$60. Shure 430 Commando and 710A - \$15 ea. Silver-Marshall absorption freq. meter with coils - \$18. Edison miner's lamp with storage battery - \$45. **WANTED:** Grebe CR-8, RORK or RORD. Original, or source of reproduction bell for Amplion AR-19 horn. Frank Hagenbuch, 1440 Lafayette Pkwy., Williamsport, PA 17701. (717) 326-0932

**WANTED:** Farnsworth radios. Herman Zeps, WD9JKQ, 319 S. Williams St., PO Box 282, Bluffton, IN 46714

**FOR SALE:** Philco Quick Selector: parts directory, illustrated, first edition, 1947, spiral loose leaf binder, near mint condition, 110 pages - \$15 plus \$3 shipping. Ellsworth O. Johnson, 364 S. Coeur D'Alene St., Spokane, WA 99204. Phone/fax (509) 838-2161

**FOR SALE:** Pink plastic fifties radios: GE 913D, Zenith A402, Motorola A16P3 - \$75 for all. Bill Cherenky, 6 Kate La., Metuchen, NJ 08840. (908) 549-2165

**WANTED:** RCA 44BX and 77DX microphones with desk stands. Tom O'Brien, 301 G St. SW, #731, Washington, DC 22024. (202) 554-8448

**WANTED:** General Electric radio World Monitor II. Bill Johnson, 573 West Park Ave., Oakhurst, NJ 07755. (908) 229-3743

**WANTED:** Westinghouse WL-530 Pearl Harbor radar tube, Western Electric 219D, DeForest 430 through 440 tubes. John H. Walker, Jr., 16112 W. 125th St., Olathe, KS 66062. (913) 782-6455

**WANTED:** Tube hi-fi, commercial amplifiers, speakers, & horns & tubes. Marantz, Altec, McIntosh, Dynaco, Heath, Eico, Scott, Fisher, Craftsman, J.B. Lansing, Brook, Jensen, RCA, Leak, UTC Electro-Voice. Audio power tubes KT-66, KT-77, KT-88, 6550, 2A3, 45, 50, EL-34, 7591A, etc. Sonny Goldson, 1413 Magnolia Ln., Midwest City, OK 73110. (405) 737-3312

**FOR SALE:** Bulova transistors, 830(?) Watchface, and smaller #840; Toshiba 6TP-375 in box; Zenith Royal 800; others. Rare novelties including Yogi N.I.B., Pinocchio, brass golf cart among others. Most sets on list reduced. Need to move some radios. Reasonable offers will be considered. Call or write: Don May, 16 Gulley Dr., South Windsor, CT 06074. (203) 644-0258, before 9 pm EST please

**FOR SALE:** Webster-Chicago record changer - \$12.50. Port. wire recorder - \$50. Motorola radio - \$12.50. Jerry Schaefer, 932 North 4th St., Grand Forks, ND 58203

**WANTED:** Help with repairing TEAC 3300 tape recorder. I have service; would appreciate corresponding with knowledgeable repairman. Ray Barnes, 38 Woodmere Rd., Framingham, MA 01701. (800) 877-6040

**FOR SALE:** Airline 64WG-1511A2 exc, gold grille cloth looks mint - \$45. Silvertone 2015, good, recapped - \$25. GE 400, good, plays - \$25. GE 203, fair, missing knob - \$15. GE T104A, antique white - \$10. Philco 53-559, small crack on side - \$10. IAK K-67, 6 trans. pocket radio kit unassembled, made in Japan, N.I.B. - \$18. Heathkit Mod G-2 audio generator, sine and square wave output, works - \$15. Philco Mod 421 tube tester, wood case - \$15. Plus pack. and shipping. Jim Collins, 16727 N.E. 88th St., Redmond, WA 98052-3758

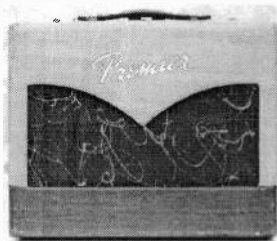

**WANTED:** Vintage guitar amps like those featured in my article in A.R.C. 8/93. All years, all sizes. Send pix and price. I also want old guitar effects pedals and amp catalogs. Amps are for my collection only, not for resale. Contact: Thomas Crocker, PO Box 11582, Glendale, CA 91226. (818) 246-4757

**FOR SALE:** Victor Talking Machine Model VE-9-55. Victor's largest and fanciest set from 1927, sold for \$1,550 new. World's first set to combine record changer, electric pickup and radio (Radiola 28). Impressive carved walnut cabinet. Complete, unrestored. R. Baumbach, 101 East Santa Anita Ave., Burbank, CA 91502. (818) 845-7807, days

**WANTED:** Gold 01-A's. Grebe MU1 audio transformers must test good. Belmont Model 519 parts. Gary Carter, WA4IAM, 1119 Van Wert St., Greensboro, NC 27403. (910) 292-5861

**FOR SALE:** Radiola AR 812 w/tubes, beautiful condition - \$150. Amer. Bosch 28 w/tubes - \$125. Zenith w/tubes Model 11E - \$175. L. Drago, 383 Lincoln Dr., Cheshire, CT 06410. (203) 272-6030

**FOR SALE:** (Transistor radios): Green Hoffman (U.S.) solar radio - \$500/BO. Black Hoffman (U.S.) solar radio - \$400/BO. Zenith Royal 56 solar transistor radio in display box - \$350. Rare Quaker Oats novelty transistor radio - \$325. Many novelty transistors, please inquire. Jim Clark, 1292 Starboard, Okemos, MI 48864. (517) 349-2249. Fax (517) 349-4059

**WANTED:** Radio power button for '86 Lincoln Town Car. Chauffeur phone for 30's formal sedan. David Edyvean, 2508 Campbell Ave., Schenectady, NY 12306

**FOR SALE:** Philco lamp-radio 53-706, no shade - \$90. Westinghouse H126, white - \$85. Shipping extra. Victor Marett, 3201 N.W. 18 St., Miami, FL 33125. (305) 634-9569

**FOR SALE:** Westinghouse RC RA tuner DA detector in simple cabinet 3-tube WD-12 brass base, fil. OK, made in Canada, Can. Wes. Co., Hamilton, (see A.R.C. June '91) - \$450 U.S. Marcel Vallee, 703 Boul. St. Germain, Rimouski, Quebec, Canada G5L 3S6

**WANTED:** Knob and dial pointer for green Crosley, Model 11-102U. Henry Trabold, 2058 Nakiska Ct., Toms River, NJ 08755. (908) 244-2345

**FOR SALE:** Etalage Magi-Clock - \$45. Majestic 5C3, white - \$50. Emerson 724, black - \$45. **WANTED:** Crosley 10 Series Coloradios. Lee Gentry, 2121 Windbrook Rd., Knox, TN 37923. (615) 694-8903

**FOR SALE:** Zenith black dial 6-B-128, and more send SASE. Glenn A. Heimroth, 268 Hudson Ave., Hopatcong, NJ 07843. (201) 398-0566

**WANTED:** J. W. Miller crystal hi-fi tuner. Your price. Preston DeShan, 4915 19th St., Lubbock, TX 79407. (806) 799-8744

**FOR SALE:** CRT's, 3BP1, 3WP1, 5NP1, 5FP1, 5BP1 - \$15 each. Many tubes both new & used, 12 volt vibrators, ballast tubes; let us know your wants. Power Bros. Electronics, PO Box 70, Gladys, VA 24554-0070

**FOR SALE:** (2) Vibroplex keys & 1 key, 3 for - \$125. 1916 10" Westinghouse brass fan - \$100. 1888 pat. ohmmeter in wooden case - \$130. Majestic 90 power supplies - \$30 ea. (1) Zenith power supply, V201A & X201A ck & guaranteed - \$9. All plus UPS. Dan Claus, 2305 W. Rice, Sioux Falls, SD 57104. (605) 332-3747

**WANTED:** Fada 185-90 (battery). Earl radios. American Super 5 (battery). McMurdo Silver. Scotts. Earl Lucas, 480 Border Hill Dr., Los Altos, CA 94024. (415) 941-3675

**FOR SALE:** Tube type wood table model radios. Send SASE for list to: Don Tomlinson, 2311 15th Ave. SW, Austin, MN 55912, or call (507) 437-3582

**WANTED:** Realtone 6 transistor, pocket radio with ivory case dating 1964. E. H. Scott, Breting and Patterson receivers wanted in any condition. John T. Meredith, 1644 Parkside Cir., Niceville, FL 32578. (904) 897-7734

**FOR SALE:** Zenith Trans-Oceanic A600 - \$69. Mint T-O A600 - \$75. Zenith transistor 500E, white - \$50. Westinghouse Little Jewell, green - \$100. Temple metal with handle - \$55. Jim Montague, 921 S. Cuba, Spokane, WA 99202. (509) 535-9576

**FOR SALE:** Spirit of St. Louis field radio,, repro, brand new in box, AM/FM, TV1, TV2, weather bands and cassette player (on side), 8 1/2" x 14" x 15 1/2" H, only 4 left - \$35 ea. + \$4 UPS. Joseph Gambaccini, 192 Division Ave., Shelton, CT 06484. (203) 924-0271

**FOR SALE:** Crosley 5M3, with green WLW dial, Crosleys 1924 station. Recapped works, cabinet needs work. This radio is a sleeper. Final sale - \$90 + S&H. Edward Krawczyk, 64 Old Chimney Rd., Upper Saddle River, NJ 07458. (201) 825-3828

**WANTED:** Western Electric tubes, parts and Data-sheet. 101, 102, 104, 205, 211, 212, 216, 242, 252, 262, 271, 274, 275, 276, 284, 300, 310, 339, 347, 348, 349, 350, 418A, 421, 422, VT1, VT2, VT25A, VT52. Also Western Electric - amp, spkr, socket, xfmr, wire, Data-sheet. Others: RCA50/250/350, VT62/801A, 845, European tubes. Will pay top \$\$\$\$. Jun Mizuno, 933 Portwood Cir., San Jose, CA 95120. (408) 268-4016

**FOR SALE:** Truetone #D2210 (E.O.R. 1, p. 191) - \$110. Grunow #566 wooden Deco - \$125. Sonaor RBU-176 (Bunis II, p. 172) - \$65. Arvin 544R (G.O.R., p. 99) - \$45. Motorola #57X12 (Bunis I, p. 102) - \$45. Delcor ribbon grille R1233 (E.O.R. 2, p. 70) - \$40. Robert Lutz, 9041 Gillette St., Lenexa, KS 66215. (913) 894-1327

**FOR SALE:** Set of three data-sheets (text and diagrams) detailing use of Radiola-III as a crystal set - \$3 plus long SASE. David P. Smith, Box 81, Olney, IL 62450. (618) 392-6601

**WANTED:** Heathkit #2 chassis mono audio amplifiers. Models W-1A (807s) and/or W-2A (5881s). Michael D. Illfelder, 5726 S. Blackstone Ave., #3E, Chicago, IL 60637-1845. (312) 955-1423

**FOR SALE:** Hallicrafters SX-101 - \$125. Also Super Zenith Trans-Oceanic - \$75. Both exc cond. Fred Hegel, 1901 Frank Pl., Daytona, FL 32119. (904) 760-7632

**FOR SALE:** Zenith 12-S-370 - \$600. Philco 37-610 table - \$80. **WANTED:** Majestic #906 Riviera. David Gamer, 1210 19 1/2 St. S #6, Moorhead, MN 56560. (218) 236-5598

**WANTED:** Cabinets for Stromberg-Carlson Model 1A, Crosley Trirdyn, Radiola II, Philco Model 50-527, Silver-tone Model 4500. Complete record changer & power supply for RCA Victor Electrola Model VE9-16X (mounting board 16 1/2" x 13"). Handbook & tube charts for Western tube checker Model 672, Type 2. Dial for Airline Model 62-274, will buy junker. Larry Porter, 4115 Beam Rd., Crestline, OH 44827. (419) 683-2540

**FOR SALE:** Transistors: Philco Model T-67; Realtone Model 2208. Tabletop white plastic Sylvania 519; GE 518-F white plastic; GE 10A brown plastic; tape recorder Wollensak T-1515; Army multichannel receiver R-278; Jeep radio PP12-GR; Navy navigation device, many odd test units, teletype boxes. For list and photos send large SASE and a buck to help offset Xerox costs to: John Strattan, 701 Waterson Tr., Middletown, KY 40243-1852

**FOR SALE:** Send LSASE for new list of radios. Transistors, including an Emerson 888 Explorer. Many wood table models and tombstones. Guild Town Crier, Westinghouse RA/DA cabinet, Music Master wood horn bell and neck, etc. Gary Watkins, 8006 Greenwald, Belton, MO 64012. (816) 322-0773

**FOR SALE:** Antique tubes – SASE for list. **WANTED:** Globe-shaped tubes – Send for buy list. Ron Pfeffer, 653 Commercial St., Farnham, NY 14061. (716) 549-5379

**FOR TRADE:** Marilyn radio made by Cecinea, clear plastic, dome top, neon lights, AM-FM, N.I.B. Trade for cute transistor. Jim Martes, 15400 E. 2nd St. S, Independence, MO 64050. (816) 836-0668

**WANTED:** Western Electric amps. Models 43, 46, 86, 91, 92, 124 and parts. WE 555, 594, 597, TA4181. Jun Mizuno, 933 Portwood Cir., San Jose, CA 95120. (408) 268-4016

**FOR SALE:** Philco 7 chassis w/spkr, & tubes – \$50. AK 145 chassis w/tubes, no spkr – \$35. Thorola 2 dial chassis w/engraved panel – \$25. Univex 8mm projector, old – \$35. AK 84, all original, mint – \$395. Motorola 61T21 AC, BC & SW, wood – \$30. Sentinel 82H175S, wood, AC, BC & SW – \$35; both unchecked as is. The following all restored in exc cond.: Bendix 526B ivory – \$50; Electronic Labs 2701 wood table model – \$25; GE 102 brn. Bakelite – \$30; Philco 48-460 brn. Bakelite – \$45; RCA X551 brn. Bakelite – \$30; RCA 66X12 ivory – \$40; RCA 45EY3 brn. Bakelite 45 player portable – \$25; Singer 910BD transistor wood case portable w/handle nice – \$20; Silvertone golden arch dial in brn. Bakelite or ivory – \$30 ea.; Truetone Boomerang – \$150; Zenith J615 brn. Bakelite – \$35; Zenith H725 AM-FM brn. Bakelite – \$35. Can supply pictures of all sets. All plus UPS. Open to offers on some sets. **WANTED:** Detrola Pee Wee, Kadette K150, General Television sets in various colors & other compact sets for the 30's. Joe Svihel, 17227 Co. Rd. 54, Avon, MN 56310. (612) 356-7601

**FOR SALE:** Phono needles, cartridges; coils, tubes, much misc. 6V6 GT, used exc – \$1.50 ea. 80ST, used exc – \$3.24, 27 ST, used exc – \$1.50 ea. Dial belts – \$4 & up. Military VOM's as is – \$12 ea. Sams – \$1.50/set. Arcturus adaptor #1 (use 1629 for 6U5) – \$11.50 ea. Call 4-6 pm EST or send card for reply: Arcturus Radio Supply, 3554 W. 105, Cleveland, OH 44111. (216) 647-3908

**FOR SALE:** Copies of pamphlets: Warped Records Straightened and Record Care – \$10. 101 ways to Use VOM & VTVM – \$10. 1963 Tube Substitution Guide – \$5. 100 (1923) Radio Hookups – \$10. 1931 How To Use Radio Set Analyzers – \$10. 1933 Radio Stations & Stars – \$10. Sams Dial Restraining Guides: DC1 – \$15; DC2, DC3, DC4, DC6 and DC8 – \$10 ea. Sams TP1 Radio Tube Replacement Guide, 1938 to 1948, 1880 sets – \$20. Profitable Transistor Radio Service by Motorola – \$10. All Electronic Alternator Systems for Cars by Motorola, 1961 – \$10. 1924-27 course, Practice and Theory of Modern Radio, 20 lessons – \$30. Book list available, send LSASE 58¢ postage. Also have Rider's (TV) manuals #4 through 25, only – \$200 + shpg. J. J. Papovich, 53 Magnolia Ave., Pitman, NJ 08071. (609) 582-8279

**WANTED:** Dynaco PAS-2 preamp. **FOR SALE:** Coke can transistor, M.I.B. – \$45. 1930's Philco console speaker – \$25. Wesley Carroll, 735 Blanchard St., Baton Rouge, LA 70806. (504) 387-9807

**FOR SALE:** Silvertone 1 – \$75. Arvin 747P, green – \$75. Arvin 450T – \$50. Several clock radios, list – 52¢. Dave Sutherland, PO Box 201, Spofford, NH 03462

**FOR SALE:** Emersonette, ivory Plaskon, vg, repro knobs – \$175. Emerson 520, exc – \$185. Arvin 444, vg, plays needs paint – \$45. Stromberg-Carlson 1101, ivory, vg, new filters – \$55. Wayne Eaton, 184 Sawyer Dr., Owego, NY 13827. (607) 687-1102

**FOR SALE:** Garod "Commander" Catalin, butterscotch w/yellow wrap-around grille, gorgeous condition – \$725. L. Drago, 383 Lincoln Dr., Cheshire, CT 06410. (203) 272-6030

**FOR SALE:** (Table radios): Zenith 8S129 tombstone, nicely restored and working – \$395. Zenith 6D116 and 6D117 – \$85 ea. Zenith 5S127, needs minor cabinet work – \$90. Stewart-Warner (wood) display vertical or horizontal – \$135. Zenith Waltons 7-tube chassis – \$125. Jim Clark, 1292 Starboard, Okemos, MI 48864. (517) 349-2249. Fax (517) 349-4059

**WANTED:** Hallicrafters S-40, SX-42, SX-43, S-40B. Radios must be in excellent condition and working. Will pay premium price. Gerald Silver, 10863 W. Clairmont Cir., Tamarac, FL 33321. (305) 720-1972

**FOR SALE:** Cathedral: Philco 84 – \$145. Wood tables: Zenith 4B437 – \$35; Firestone – \$30. Joe Quinn, 30511 Manhasset Dr., Bay Village, OH 44140. (216) 835-8420

**FOR SALE:** SWAN transceiver, early electronic organ service manuals, parts, misc. items. List – SASE. C. F. Hooper, 1629 Keystone Ct., Clearwater, FL 34616. (813) 442-3926

**WANTED:** Ivory handle for General Television 1A5 radio, Casio shirt pocket television. Frank Williams, 6723 C.R. 11, Rising Sun, OH 43457. (419) 457-7594

**FOR SALE:** Plastic dial covers for Belmont 6D29, 6D111, Detrola 147, Emerson AM169, 375, 400, 520, AU190, Fada 20W, 254, 5F60, L-56, 1000. Zenith Boomerang 5-G-2617 – \$14.50 ppd. Many others in stock or yours with old cover or drawing. Doyle Roberts, HC63, Box 236-1, Clinton, AR 72031. (501) 745-6690

**FOR SALE:** German galvanometer Baumuster PSL-2 #Ant. 2.F1 26763 – \$20. Transistors: Panasonic T-50AA case, 2 small inside chips CD markings – \$20. Ross Supreme AM/FM dual slide rule dials, AM works, FM hiss – \$18 w/case. Magnavox #AM-81 8-transistor – \$10. Panasonic R-70 panapet ball and chain – \$20. Realistic FM transmitter – \$40. Realistic dogs – \$15. AM/FM. **WANTED:** Front panel for Philcos #70/90, must be nice and intact. Speaker for Philco Model 60 cathedral with screws. Bret F. Johnson, 13495 102nd Ter. N, Largo, FL 34644. (813) 595-9287

**WANTED:** Detrola Pee Wee and Super Pee Wee, Emerson Mae West, Emerson AX212, Detrola #274 split grille. Robert Lutz, 9041 Gillette St., Lenexa, KS 66215. (913) 894-1327

**FOR SALE:** Professionally enlarged Radiola-III diagram with fully itemized parts list giving all values – \$3 plus long SASE. David P. Smith, Box 81, Olney, IL 62450

**FOR SALE:** Zenith Trans-Oceanic 9A540 in good condition – \$45. HQ-170 with clock, manual in very good condition – \$175. Collins 75S-3, 32S-1, 516F-2 Winged Emblem Station with manuals, cables, microphone, spare set of tubes in very good condition – \$750. Motorola BC receiver maroon plastic portable MN 52-M-U in good condition – \$35. Johnson Matchbox MN 250-23 in very good condition with original complete manual – \$125. Let's talk. Clyde Sakir, N410K, 4243 E. First St., Tucson, AZ 85711. (602) 323-1120

**FOR SALE:** Radios, hi-fi, etc., added 4-page list; panel, bench meters, 3 pages. SASE please. Chuck Vaccaro, 708 Booth Ln. #D, Ambler, PA 19002. (215) 646-3641



**FOR SALE:** Speakers: (2) RCA 100-A - \$50 ea. Utah cathedral style electro magnetic speaker - \$125. Sonachorde octagon shaped speaker - \$100. Cathedral style Amer. Bosch speaker - \$75. L. Drago, 383 Lincoln Dr., Cheshire, CT 06410. (203) 272-6030

**FOR SALE:** (Cathedral): 1st cathedral radio, 1926 Beaver Electric using 5/01-A's (predates Thompson Minuet), set is nicely refinished - \$550. (Communication receivers): RME HF10, 1939 - \$160. Jim Clark, 1292 Starboard, Okemos, MI 48864. (517) 349-2249. Fax (517) 349-4059

**MESSAGE:** Thanks for all the calls on the Motorola 50XC3, it sold to the second caller. I need one knob, any color, for a Crosley Bulls-Eye radio and have stuff to trade. For sale is a Radio News newsstand paperweight from the 1930's for \$190. Ira Grossman, 3100 Birchtree La., Silver Springs, MD 20906. (301) 460-3981

**FOR SALE:** N.O.S. tubes: 01-A(ST) - \$11; 12A(ST) - \$15. Used: 2A3(ST) - \$15, 71A(ST) - \$5. All guaranteed good. Box of several hundred tubes 1930's to 1960's - \$25 pick up only. Fisher 500 receiver and Philco 46-480 receiver complete less cabinet - Make Offer. **WANTED:** Philco 38-9 or similar radio. Mark Gutekunst, 2600 Martin Rd., Willow Grove, PA 19090. (215) 657-8552

**FOR SALE/TRADE:** Fisher 80-C amp; 4X150A and 4X150G tubes; wall telephone tube radio; please check previous ads in A.R.C., July p. 63, August p. 58, September p. 64, November p. 43. Wish to trade for crystal sets, 1 or 2 tube battery sets, Kolster Decrometer detector, collector tubes. Michael Crain, RR 1, Box 472, Harveys Lake, PA 18618-9782. (717) 639-2794

**WANTED:** Rider's Receiving Tube Substitution Guide Book; Sams DC-4; Supreme's Radio '49 & '66-'69; AK 4340 breadboard board and wire; Gernsback Vol. 8; dial for Day-Fan 5069. Steve Russell, 121 Horseshoe Dr., Kalispell, MT 59901. (406) 755-3321

**FOR SALE:** The Book of Radio, 1922 - \$20. New tubes 6A5's-6A3's-82 N.O.S. - \$10-20. Transistor novelties - Trade for space novelties or space crystal sets - Statue of Liberty in box, Helping Hand in unopened shipping carton, Polaroid AM-FM in box. **WANTED:** Pilot radios, any model, any condition. Bill Moore, 3049 Box Canyon Rd., Huntsville, AL 35803. (205) 880-1207

**FOR SALE:** 1946 Sparton Model 5AW16, white plastic - \$50. Mirror-tone Model 4B7, midget Bakelite, white with red knobs and red pointer - \$75. 1946 Fada Model 605, white plastic, small hairline at bottom front - \$55. 1931 Atwater Kent Model #84, cathedral, excellent - \$400. 1931 Philco Model 90, cathedral, nice - \$400. 1957 Zenith Trans-Oceanic Model A-600L, brown leatherette, super nice - \$170. 1947 Setchell-Carlson Model 427, white plastic - \$75. 1950 Crosley Model 10-135, white with circular dial, chrome trim - \$90. 1948 Fada Model 790, brown Bakelite, criss-cross grille with T, 4 knobs - \$75. 1946 Fada Model 740, white plastic, nice - \$75. All items plus UPS. George Jones, 1943 Palm Dr., Fernandina Beach, FL 32034. (904) 261-6533

**HELP:** Looking for information on my pair of Western Electric 109A (KS21880L2) special purpose speakers. Appear to be from 1980, have smallish cane-front cabinets with circuit board inside, 2 knobs on top, and telephone-style modular data jack in rear. What are they? Al Wirtenberg, 15 Wilson Rd., Weston, CT 06883. (203) 544-9270

**WANTED:** Emerson 1939 Model BA-199. Jim M 15400 E. 2nd St. S, Independence, MO 64050. 836-0668

**WANTED:** Early plastic, beetle plastic or colored Plaskon radios by Kadette, Detrola, Sparton, GE, Majestic, Silvertone, RCA, Admiral Firestone, or others. Please call or write and let me know what you have for sale or trade. Thanks: Jon Steinhauser, 636 Westminster Rd., Baldwin, NY 11510. (516) 223-9878

**FOR SALE:** Telegraph, communication and telephone stamps. SASE for list. Ron Pfeffer, 653 Commercial St., Farnham, NY 14061. (716) 549-5379

**FOR SALE:** Air King, white tombstone with clock and large AK knob, excellent condition, few very minor flaws - \$4,600. Reasonable offers discussed. Barry Vanhar, 1505 Middleton Dr., Greenville, MI 48838. (616) 754-9949

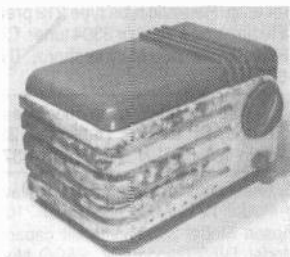

**WANTED:** Detrola, Kadette, RCA, Silvertone and many other prewar (That's World War II and soon to be III). I'll pay your sellers premium when it comes to auction times. Please write or call collect: Rain Buttignol, 214 State St., #7, Portsmouth, NH 03801. (603) 427-1384

**FOR SALE:** Old stuff: Supreme Radio analyzer 339 Deluxe - \$75. Readrite 711 tester - \$65. Field supply for Operadio - \$35. (2) fixed Federal crystal detectors - \$45. Ott-Williams rotatable loop, not all there - \$65. 20's Mont. Ward Radio Catalog - \$35. Annual of Scientific Discovery, 1865 - \$65. Cunningham Globe 45, N.I.B. - \$45. DeForest 401-A, N.I.B. - \$45. Matched pair of 5881, RCA or Tung-Sol - \$10. Communication stuff: National SW54 - \$65. Vocaline CB with mike, crisp & mint - \$45. Knight Space Spanner, a little rough - \$35. Transistors, portables, and silly stuff: White & chrome Zenith 500L, absolutely mint in beat-up box - \$125. Stantex tube portable - \$45. Black Vanguard 888, nice enough but not mint - \$35. Coronet Boys - \$35. Chicago Bulls basketball radio - \$35. (1) knob for Japanese owl - \$20. Both knobs for red Crosley bullet - \$45. Nice white Setchell-Carlson frog-eye - \$85. Philmore Model 1000 crystal set, N.I.B. - \$85. Altec Lansing 1591-A compressors, as is untested - \$125/pair. All the following items are no shipping, hook-up with me anywhere in the midwest, I travel regularly. Beautiful Sonora Coronet Catalin, like Collins but plum trim - \$1,250. A big heavy pile of four Altec Lansing 1570B amplifiers, some parts missing but you should be able to get a working pair out of this - \$450. And finally, a rack mount amateur-built transmitter from the forties, looks like it would still fire up with a little help, (6) big heavy chassis, take it all - \$75. I welcome sales from anyone anywhere, but I ship U.S. only. If you are overseas, arrange shipping to U.S.A. Please call weekdays 6 pm to 8 pm Central only. Bill Jenkins, 4335 N. Damen, Chicago, IL 60618. (312) 528-1341

**FOR SALE:** Lots of table sets (1930's-1950's) and misc. ham gear. Radiola-III & III-A technical literature Service folders (Sams, misc. factory, books, catalogs, ham manuals. 4-page list free for long SASE. David P. Smith, Box 81, Olney, IL 62450

**FOR SALE:** RCA Catalin 66X9 beautiful red marbled electronically restored - \$500. RCA 110 cathedral electronically restored - \$175. All plus UPS. Dan Claus, 2305 W. Rice, Sioux Falls, SD 57104. (605) 332-3747

**MESSAGE:** Operadio-2 repairs needed. Would someone owning one of these, please call me collect nights. Herb Fredrickson, 218 Skeena Cres., Saskatoon, Saskatchewan, Canada S7K 4G8. (306) 242-9275

**FOR SALE:** Jukebox Collector Magazine. Sample - \$3. Subscription - \$30. Jukebox Collector, 2545 S.E. 60th Ct., Suite 105, Des Moines, IA 50317

**WANTED:** Fisher 80AZ and Heath W4-AM (gold) power amps. One Knight KN-812 coax 12" speaker. Eico HF-60 power amp. Realistic tube type 212 preamp and 214 tuner. Electro-Voice 3303 or 3304 tuner. Charles D. Maples, 1623 Saddle Dr., Murfreesboro, TN 37130. (615) 893-0255

**FOR SALE:** 1920's battery table model sets, horn speakers. Send SASE to: Don Tomlinson, 2311 15th Ave. SW, Austin, MN 55912, or call (507) 437-3582

**FOR SALE:** Great buys on test equipment. Navy Hickok tube tester Model TV10/AU, Elco Model 710 grid dip meter, Simpson Model 383A in-circuit capacitometer, Superior Model TV50 Genometer, PACO Model C-20 resistance/capacity/ratio bridge, Sencore Model S5105 sweep circuit trouble shooter, Eico Model 147 signal tracer, Sprague Model KT-1 capacitor checker, Heathkit Model C-3 condenser checker, Century Model CT-1 condenser tester, IFS capacity checker, Eico Model 1050 battery eliminator & charger, Lafayette Model LC-4 cap/res checker, Micronta Cat. #22-024 transistor checker, Anchor Model T-471 Reacto Tester CRT checker, Mercury Model 900 color TV pix tube analyzer, Sencor CG153 Color King 2 Deluxe color generator, Superior Model PB200 multimeter, Signal Corps Model I-177 tube tester. Most with manuals. Frank D. Atwood, Nostalgia Radio, 117 E. Main St., Merrimac, MA 01860. (508) 346-8100

**WANTED:** General Electric E-71 chassis. Obsolete tube listing for Heath TC-2. Thanks. Henry Tessier, 935 Commercial St., E. Weymouth, MA 02189. (617) 337-7279

**FOR TRADE:** Kennedy SSIK (Italian) 1940's; Philco 20, restored case, wrong knobs; Howard FM tuner, very small; Philco S2-548, maroon, modern, others. Want small Addison, Belmont 6D-111, other Deco Belmonts, Crosley Bullseye Coloradio, other Deco plastic. Greg Carlson, 821 Hillcrest Manor, Bemidji, MN 56601. (218) 751-6479

**FOR SALE:** Ford 6v tube car radio - \$45. Hallicrafters S38, S38B - \$30 ea. RCA 16X13, case broken - \$20. Stewart-Warner B61T2 case broken - \$20. Motorola Ranger 700 - \$20. (20) misc. pocket radios - \$35. (50) misc. plastic tube table models, mostly '60's - \$10-\$15, call. Thousands new/used tubes, many 2-digit, 1/4-1/2 catalog price, list, call. All plus shipping. Andrew R. Lewis, 3929 South Sherman, Englewood, CO 80110. (303) 781-5573

**FOR SALE:** Philco Model 90, super excellent, w/tubes - \$500 or partial cash and trade for pocket transistors. Call: Mark Malin, 135 Ocean Pines, Berlin, MD 21811. (410) 641-5877

**FOR SALE:** "RCA Victor Radio & Television" red neon sign 4' long x 12" high. Still in original wood crate dated 5/13/48, never used, a real killer. Accepting best offer. L. Drago, 383 Lincoln Dr., Cheshire, CT 06410. (203) 272-6030

**FOR SALE:** (TVs): Admiral 7" in less common wood table cabinet, excellent cosmetically - \$250. Emerson 10" Bakelite table model - \$95. 1946 Rembrandt 12" w/ DuMont tuner; DuMont television clock, working - \$125. Jim Clark, 1292 Starboard, Okemos, MI 48864. (517) 349-2249. Fax (517) 349-4059

**FOR SALE:** Zenith plastic 7H820W - \$28. Transistors: Zenith Royal 12, Airline GEN1127A - \$25 both. **WANTED:** SME tone arm. Mark van Rooijen, 11 Braman St., Providence, RI 02906. (401) 272-7754

**FOR SALE:** Transistors: Motorola X14R, red - \$85; Motorola X34B, aqua - \$40; Motorola X19E, black - \$80; Bell Products, Hit Parade, N.I.B., (Handy p. 224) - BO; Bell Products 2TR Futura - BO; Admiral y.829, 1961, U.S., N.I.B. - \$75; Toshiba 7TP-303 - \$85; Toshiba 6TP-309A - \$65; Hitachi TH-627R - \$65; Hitachi TH-862R - \$45; GE 830A - \$45; GE 675 - \$65; GE P806A - \$30; Starlite FT601 - \$35; Audition 1069 - \$30; Magnavox AM60 - \$30; Magnavox AM80 - \$30; Ch. Master 6512, BC/SW - \$95; Ch. Master 6515 - \$35; Philco T76-124, leather - \$40. Scott Hagerman, 3 Deer Trail Rd., Decatur, IL 62521. (217) 692-2373

**WANTED:** Schematic/manual for Navy receiver RAK-7 or RAL-7, 1936 vintage, six tubes, 500KHz to 23MHz. Graham Stubbs, 34 Babcock St. #204, Brookline, MA 02146. (617) 734-6209

**FOR SALE:** RCA AR 77R - \$250. Drake R4 all filters - \$800. R7A - \$875. Navy RDZ belt radio complete, all original - \$100. WWII sound powered set - \$25. Hickok 536 - \$125. I-177 - \$55. All above vg to excellent. Silvertone 110 complete - \$50. (955) tubes - 95¢ ea., 10 or more - 75¢ ea. **WANTED:** Information on paint color and texture and service information, other than Rider's, for Breting 14. Black HRO's and/or coils and National table racks for HRO's. John Oroahood, N5SPQ, 5819 Miller Valley, Houston, TX 77066. (713) 440-5598

**HELP:** I am compiling a list of radios that were designed by recognized designers. I would like readers to drop a postcard to me if they know of particular radios designed by industrial designers, especially interested in 1930's-60's individuals such as Walter Dorwin Teague, Donald Peskey, Raymond Loewy, Norman Bel Geddes, Walter Von Nessen, Alexander Girard, George Nelson, Charles Eames, Paul McCobb, etc. (Sparton, Nocturne-Teague, Emerson Patriot Bel Geddes, already listed). I would also like any information on radios using molded plywood cabinets supplied by Evans Molded Plywood of Santa Monica, California/or Michigan. Bob Turner, PO Box 2313 Fair Oaks, CA 95628. (916) 721-9063

**FOR SALE:** Radiola 20, excellent original condition - \$160. **WANTED:** Atwater Kent cathedrals, unusual horns & speakers, Radiola 6-7-7B. Also any other early Radiola owners manuals and advertisements. Robert Kramer, 7185 Oakwood Dr., W. Bloomfield, MI 48322. (313) 669-7005. Fax (313) 669-5214

**FOR SALE:** Receiver Saver 200 protects your vintage radio receiver against the stresses of modern life. Can you afford not to have one? Only \$25 each postpaid in U.S.A. SASE brings brochure. Jeff Kincaid, WA6BIL, 5529 West 140 St., Hawthorne, CA 90250

**FOR SALE:** New 50-page illustrated catalog of WWII military communications collectibles - \$2 U.S., \$5 foreign, refundable. Sam Hevener, W8KBF, The Signal Corps, 3583 Everett Rd., Richfield, OH 44286-9723. (216) 659-3244

**FOR SALE:** If you have a Stokes book 70 Years of Radio Tubes and Valves, have you wished for an index by tube number to look up a certain tube? I have now compiled one. Copies available for \$3.50 each ppd. in U.S.A. only. Anthony Jacobi, 8053 Maywood, Ralston, NE 68127

**WANTED:** Plasma globe, Telsa coil (early), Ring of Fire spark gap, galvanometers. M. Rosenthal, 5 The Strand, New Castle, DE 19720

**FOR SALE:** Radio - Atwater Kent 1924 model 4910 6-tube on 10 x 34-inch breadboard. W. Wakefield, 2703 Cub Hill Rd., Baltimore, MD 21234. (410) 668-2451

**FOR SALE:** 13 yr. antique radio collection, (126) radios sold as a unit only, 5-page list; enclose dollar bill. (18) Radio-Electronics, 63-68-25¢ ea. (15) Radio-TV News, 56-59 - 25¢ ea. John Martin, 817 Cook Ave., Billings, MT 59101. (406) 252-4287

**WANTED:** Speaker for AK Model 84. Gary Riola, 10845 Hastings St., Westchester, IL 60154. (708) 409-1430

**WANTED:** Schematic for Tryon power supply HR 40 3B & Heath calibrator IG4505. Parts for TRS 80 III. S. Goldhor, 2147 Trombas, San Leandro, CA 94577. (510) 357-3788

**FOR SALE:** Sentinel, mini portable, tube lineup 1R5, 1T4, 1S5, 3Q4, EC - \$30 plus UPS. Rich Yoch, 22410 Bartlett Dr., Rocky River, OH 44116. (216) 331-9206

**FOR SALE:** Surplus Radio Conversion Manuals 1 & 2 - \$30 I ship both. **WANTED:** Crosley 5526 chassis. Wilbert K. Kimple, 3015 Kelsey Creek Rd., Spartanburg, SC 29302. (803) 585-6465

**WANTED:** American D9T microphone in good or excellent condition. Frank Nocera, 1572 Argyle Dr., Fort Myers, FL 33919. (813) 936-7197, after 6 pm

**WANTED:** English valves: #S215, H210, P2, LP2, MS4, MH4, MLS. Also BC coils for NCSW3, also Ekco AD 65 radio. Wiesner Radio & Electronics, 149 Hunter Ave., Albany, NY 12206. Call business hours Eastern Time: (518) 438-2801. (518) 371-9902, evenings

— **WANTED** —  
**PICTURES FOR TELEGRAPH REVIEW  
PHOTOS MUST BE SHARP IN DETAIL  
A SHORT DESCRIPTION IS A MUST!  
REQUIREMENTS FOR TELEGRAPH REVIEW  
ARE THE SAME AS FOR PHOTO REVIEW**

**FOR SALE:** Parting out Radiola 80 - Inquire. Zenith J402Y, black, good cond., works - \$40. HH Scott tube type FM tuner, works - \$25. H-K tube type stereo amp, weak output - \$20. DuKane 5-chan. tube type PA sys., works - \$75. Telefactor Biomed receiver, 2-chan., looks new - \$25. All plus shipping. Harold Wright, Rt. 1, Box 259, Chancellor, AL 36316. (205) 347-0393

**FOR SALE:** N.O.S. Cornell-Dublier molded mica capacitors, mica filled Bakelite cases, high quality for audio coupling, etc. .01 mFd/600 working volts, 1000 volt test, (450) pcs. available - 25 cents each, plus UPS. Ellsworth O. Johnson, 364 S. Coeur D'Alene St., Spokane, WA 99204. Phone/fax (509) 838-2161

**WANTED:** Two Zenith plug-in transistors #121-47, matched pair, N.O.S. Robert Jenkinson, 10156 12 1/2 Ave., Hanford, CA 93230

**FOR SALE:** Rider's manuals: Volumes 1-17. Prices range from \$12.50 to \$85 per volume. LSASE for price list. Sam Faust, PO Box 94, Changewater, NJ 07831

**WANTED:** Stromberg-Carlson #61-H Allwave radio receiver owner's manual photocopy. Mark Phillips, 171 Buckley Hill, Wellsburg, WV 26070-2203

## WANTED

### Top Prices Paid

**Radio & Audio Tubes:** 2A3, 45's, 50's, 845, 8005, KT66/88, etc.

**Western Electric Tubes:** 101, 102, 104, 203, 305, 211, 212, 242, 244, 252, 262, 264, 271, 274, 275, 276, 284, 285, 300, 301, 310, 339, 345, 347, 348, 349, 350, 421, 422, VT25A, VT52, etc.

**W.E. Speakers & Tweeters:** 555, 594, 595, 596, 597, 713, 728, 754, 755, 756, 757, TA4151, 4153, 4181, 4191, 4194, etc.

**W.E. Consoles & Amps:** 25B, 41, 42, 46, 86, 91, 92, 94, 95, 105, 106, 117, 118, 120, 121, 124, 129, 130, 131, 142, 143, etc.

**W.E. Horns:** 22, 24, 25, 26, KS-6368, 12024, 12025, 12027, etc.

**W.E. Microphones & Parts, etc.**

*Also looking for:*

*Tube-type equipment by McIntosh, Marantz, Westrex, ARC, Leak, Quad, Langevin, Altec, Telefunken, Siemens, Neuman, etc.*

*Vintage speakers, units, by Tannoy, Jensen, Altec, JBL, EV, Telefunken, Siemens, etc.*

**Audio City USA, PO Box 802, Northridge, CA 91328-0802  
(818) 701-5633**

**FOR SALE:** GE Mickey Mouse radio - \$75. Military radio R-48-TRC-8 230 to 250 mgz[?] - \$75. Radiometer IM-74C/PDR-27C - \$50. RF signal gen. AN/URM-26 4 to 408 mgz - \$45. Audio amp AM-215 A/U - \$45. Heterodyne freq. meter CKB-74028 125 kc to 20 mgz - \$40. Signal Corps 3 stage amp BC-1141C - \$50. BC-645A - \$45. Loudspeaker LS-3 - \$35. Phantom antenna made for Bureau of Aeronautics by Freed radio in 1943 - \$40. Early fax machine with mod and fax paper QWIP-1200 Series - \$30. Diablo power supply with manual Model 1329 - \$35. Ameco 2&6 meters converters - \$20 ea. Riders TV - \$6 ea. Transistor radio kit N.O.S. - \$25. All plus UPS. Peter Dieguez, 36-48-34th St., Long Island City, NY 11106. (516) 625-0429

**FOR SALE:** Unusual 1937 Art-Deco Truetone D731, four push buttons, nifty over-the-top red translucent dial, shiny Bakelite case, no cracks - \$139. Crosley Super Trirdyn Regular w/tubes - \$99. Radiola, 16 no/tubes - \$99. All +UPS. **WANTED:** Hallicrafters aluminum bandselect knob, (SX-43), SX-42 parts set, pre-WWII Breting, Howard, Patterson RME, and other communications receivers. Still want BC-14(A). Will pay cash or trade generously from new 10-page superlist. SASE for list to traders, or plus \$1 to vintage radio buyers. Thanks! Steve Lipsky, 1254 Cox Rd., Jenkintown, PA 19046-1207. (215) 884-1817

**WANTED:** Battery 1920's Superheterodyne, kit or home brew. Must be electrically complete. Graham Stubbs, 34 Babcock St. #204, Brookline, MA 02146. (617) 734-6209

**WANTED:** Top playing for field-coil hi-frequency units. Sumner McDanel, 3104 So. 147th E. Ave., Apt. O, Tulsa, OK 74134

**FOR SALE:** Philco 41-226 (Bunis 2nd, p. 130) with black louvers and knobs! - \$130. Philco 37-602 (Bunis 2nd, p. 126) - \$50. Emerson BJ-210 (Bunis 2nd, p. 70) beautiful condition - \$80. Zenith 705 (similar to Bunis 2nd, p. 208), beautiful marquetry work! - \$125. General Motors nice cathedral - \$250. Rare Ellsworth cathedral, very nice - \$190. Westinghouse WR-10 tombstone, nice - \$85. Majestic 20, exc cathedral - \$155. General Radio & Television 17A5, nice - \$45. Hallicrafters S-53A - \$65. Rare Emerson, beautiful inlaid and roll front, cabinet by Ingraham - \$155. Hallicrafters S-120, near mint - \$45. Please add shipping. **WANTED:** Philco 89 chassis, working. Tony Parjus, 816 Richard Ln., Gretna, LA 70056. (504) 393-0099

**WANTED:** Copy or service manual for Telex economy cassette copier. Also inoperative machine for parts. Tom Earnest, PO Box 603, San Angelo, TX 76902. (915) 651-9506

**WANTED:** Crosley 516 in vg to excellent condition. Joe Bentravato, 1802 Sagebrush Rd., Plant City, FL 33567. (813) 754-3856

**FOR SALE:** TR-1s, JVC Videosphere 1950's crystal sets, Philco 70/90, etc. Radioactivity prevails! Henry B. Cohen, Mister Transistor, 2459 Eighth St., Fort Lee, NJ 07024. (201) 585-0030. Fax (201) 585-1659

**FOR SALE:** RA-DA, Radiola 26, Radiola 24 Western Electric horn speakers 10D-521 CW, 7 amp, 14A amp, 4B receiver. **WANTED:** Radiola 1, Radiola Special, Sony CRF 1 - 330, 320, Nordemede Globe Traveller Pro. Glass dial for Nordemede Tanhauser U.S.A. E.N. 338 & side speaker grille. Phillip S. Gilliana, 5733 Warren Ave., Morton Grove, IL 60053. (708) 965-7327

**FOR SALE:** Crosley 10-137 light green Coloradio; Lorus N.I.B. wrist radio/watch; Hafler DH-10 preamp; two large Advent speakers; Zenith 500D maroon; Spica transistor 6, white; Sony AM stereo/FM stereo SRFA100; Ladybug transistor; Koss preset digital radio, most were recalled, rare; RCA B411 tube portable; Silvertone 210, marbled green portable; RCA 45EY 245 record player; rare Crosley Bakelite B548A, battery table model, with "stationized" dial, very Deco. **WANTED:** Detrola 106 radio. Charles Harper, 150 Duncan Ave., Paris, KY 40361. (502) 769-0404, 6:30 pm-10:30 pm Eastern

**FOR SALE:** Emerson AU-190, yellow, damaged, some reproduction parts - \$350. Bendix 114, brown marbled - \$200. General Television 5B5, black with marbled trim - \$90. Stewart-Warner 07-51H - \$65. Crosley D25CE - \$65. Coronet 2 transistor boy's radio in the box - \$60. Several Astatic JT-30 bullet mikes - \$45 ea. Looking for RCA 44 microphone and unrestored jukeboxes. Please call before 9 pm. Thanks. Brad Jones, 4107 Crabapple Ln., Greensboro, NC 27405. (919) 375-6340

**WANTED:** Old Weston, Simpson & other analogue meters & old meter technician/repairman. S&G Electronic, 618 S. 62nd St., Philadelphia, PA 19143. (215) 474-7663

**FOR SALE:** Guild Spice Chest, vg, maple - \$85, pine - \$65. Stewart-Warner Porto Baradio, g, with non-original glassware - \$225. Silvertone Model 1 small metal brown - \$60. Rolls Royce transistor with box, paper, vg - \$28. Zenith 6-S-229 tombstone, vg - \$265. Zenith 6-G-128, g - \$215. Clarion C104, g. All above work. Lots more. SASE for radios, test equipment, earphones and windup phonographs. Eugene Rippen, 105 Donnington, Auburn, CA 95603. (916) 885-6147

**FOR SALE:** Plastic tube type table radios. Send SASE for list of Crosley Coloradios, Belmont made radios and others. To: Don Tomlinson, 2311 15th Ave. SW, Austin, MN 55912, or call (507) 437-3582

**WANTED:** Western Electric telephones Models AA1, 102, with or without dials. Thanks. Stanley Schreier, 350 Hendrickson Ave., Lynbrook, NY 11563. (516) 887-4966

**WANTED:** Kennedy receivers Models 100/LWR200, 110, 200, 281, 521, 200, SWR-6. D. Reginald Tibbetts, 2151 Camino Pablo, Moraga, CA 94556. (510) 376-5082. Fax (510) 376-8015

**FOR SALE:** (100+) radios including Deco Bakelites, Plaskons, wood, chrome grilles, early transistors, 50's kitsch. We now have bargain basement selections also, where prices reduce each month. Send \$1 and LSASE for November/December photo catalog to: Radiomania, 2109 Carterdale Rd., Baltimore, MD 21209. (410) 466-2814

**FOR SALE:** Sams, Riders, QSTs, other literature. LSASE for list. Also set Sams #1-3399. Radio Daze, John & Kathy Slusser, PO Box 144, Mendon, NY 14506. (716) 624-9755

**WANTED:** Owners manual for Scott 348B and 299 stereos. Also want Hi-fi/Stereo magazines from '60's. Michael Stern, 1285 Alum Creek Dr., Columbus, OH 43209. (614) 252-4422

**FOR SALE:** Sprague, Mallory top grade fresh 16 uF/450v - \$3.49, 20 uF/500v - \$4.49, 70 uF/350v - \$3.95. \$15 minimum. Jeffrey Korneff, 111 Thornberry Dr., Pittsburgh, PA 15237. (412) 486-9135

**FOR SALE:** Untested farm radios: Philco 38 cathedral - \$80. 1937 Coronado 850B console - \$40. 1937 Coronado 650 - \$30. 1942 RCA 25BT-2 - \$40. Philco 46-132 - \$30. (Wood table models). Pictures - \$1 ea. LSASE for list of over (120) misc. radios. Ray Schmidt, 607 1 Ave. SW, Austin, MN 55912. (507) 433-0069 or (507) 433-3250, nights

**FOR SALE:** Westinghouse WR-8 Columnaire grandfather clock radio in good shape, missing back and two knobs, clock and radio work - \$250. John Ellsworth, 563 West Avon Rd., Avon, CT 06001. (203) 675-9916

**MESSAGE:** Merry Christmas & Happy Holidays to all my friends & customers. **FOR SALE:** '47 GE AM-FM Model 218 - \$55. '53 Philco Transitone Model 53-701 - \$25. '38 Porto-Bar radio and glassware R-3863 - \$175. (great for X-mas). '37 Zenith tombstone 4B231 - \$65. '47 GE 201 - \$40. Campbells soup transistor - \$35. '47 Sentinel Treasure Chest 286 PR - \$55. Zenith '38 mini-console, 6v-110v, 5J255 - \$125. **WANTED:** Curved glass dial Sonora Model RZU-222 (top price). Bulova transistors. Don Nordboe, 3220 W. Broadway, Council Bluffs, IA 51501. (712) 322-2255

**FOR SALE:** Hallicrafters R46B speaker - \$50. Hammarlund HQ110 speaker - \$55. McMurdo Silver 903 wavemeter with 9 coils - \$30. Atwater Kent RF transformer Type LR, boxed - \$45. William Ernst, 1619 Campbell Rd., Comins, MI 48619. (517) 848-5002

**FOR SALE:** Zenith Trans-Oceanic Model 600 (leather), good case, not working - \$75 plus UPS. Dave Bishop, 702 Clearview, Decorah, IA 52101. (319) 382-4122

**FOR SALE:** Radiola balanced amplifier - \$190. Aeriola Jr. - \$275. Aeriola Sr. - \$125. Aeriola Sr. (parts) - \$50. Rider's Vol. I (early) - \$70. Rider's Vols. 6, 7, 16 - \$10-\$12 ea. Heathkit SW-717 communications receiver - \$25. Radio Physics Course by Ghirardi - \$10. All plus shipping. Best offers considered. William Reigle Jr., 4 Fayette St., Waterloo, NY 13165. (315) 539-3180

**FOR SALE:** AK 84 - \$275. AK 20 "Big Box" - \$100. AK 46 metal bread box style - \$75. AK 246 - \$250. L. Drago, 383 Lincoln Dr., Cheshire, CT 06410. (203) 272-6030

**FOR SALE:** HP-419A DC voltmeter - \$35. Heath 16W47 osc. - \$25. Autotformer 1.3A - \$5. Add shipping. Harry Pewowaruk, 1535 No. 8th Ave., St. Cloud, MN 56303. (612) 252-9910

**WANTED:** Erla Model 22P clock cathedral. Must be restorable. Stephen Short, 1590 Union St., Schenectady, NY 12309. (518) 346-2245

**WANTED:** Old brass toggle switch suitable for Radiola 18. Knob for Philco Transitone #53-561. Cleo McAlexander, Box 4, Stanleytown, VA 24168. (703) 629-2972

**FOR SALE:** Early 1920's crystal set, small wood box has tapped switch and glass enclosed detector - \$90. RCA 6T5 tombstone, with tuning eye, veneer chipped, plays fine - \$100. Small red Lafayette AC/DC portable, same as GE jewel, small crack, plays fine - \$55. Cylinder records - \$5 ea., two or four min. available. Escort radar detector, works excellent - \$100. Composite and wood horn for cylinder phonograph original paint and decal - \$125. Frank Eder, RRI, Box 36, Garrison, NY 10524. (914) 424-3470

**FOR SALE:** Transistors: Emerson #888 transtimer - \$100. Red Channel Master #6506 - \$35. & many others. Norman Landis, 1315 Marbendale Ct., Kirkwood, MO 63122-6932. (314) 821-7933

**WANTED:** Midget table model radios. In metal, Bakelite or plastic. Ernest D.M. Yeaw, RR#3, Tatamagouche, Nova Scotia, Canada B0K 1V0. (902) 657-2554

**FOR SALE:** (Speakers): Atwater Kent Model L, nice and working; rare RCA 102 drum speaker - \$225; Saal (?) floor speaker - \$250. (Headphones, all working): Crosley, Federal, Frost, Kellogg, Brandes, Dymac (Providence, R.I.). Jim Clark, 1292 Starboard, Okemos, MI 48864. (517) 349-2249. Fax (517) 349-4059

## — WANTED —

### WESTERN ELECTRIC TUBES, SPEAKERS, HORNS & AMPS

**TUBES:** 300A, B, 274A, B, 262A, B, 275A, 350B, 284D, 252A, 271A, 242A, 348A, 349A, 301A, 339A, 205D, E, F, VT52, VT1, VT2, 211, 212, 104D, 216A.

**SPEAKERS:** 555, 594, 596, 597, 713, 754, 755, 728, 4151, 4153, 4181, 4194, 753, 757.

**HORNS:** 22, 24, 26, 25, 12, 6368, 15A, 13A.

**AMPLIFIERS:** 86, 1086, 91, 22, 94, 95, 105, 106, 120, 121, 130, 131, 124, 129, 142, 143.

### VICTOR VICTROLAS, EDISON, ETC.

**TUBES:** TELEFUNKEN, GENALEX, RCA, RADIOTRON, ETC.

GENERAL ELECTRIC, AMPEREX, JAN, SYLVANIA, GEC, NATIONAL UNION

### MCINTOSH, MARANTZ, DYNACO

CITATION, LANGEVIN, ROGERS, LEAK, TANNOY, ALTEC, EV,  
THORENS, EMT, JBL,...AMPS, SPEAKERS, TURNTABLES

TEL: (713) 728-4343  
FAX: (713) 723-1301

MAURY CORB  
12325 ASHCROFT  
HOUSTON, TX 77035

**FOR SALE:** Batteries for antique radios: specials include 1 1/2v dry cells with binding post, @ 6 for—\$10. 45v B batteries with binding posts, 4 for—\$10. Large 6v dry cell batteries, @ 4 for—\$5. Meter batteries include: 22.5v, 30v & 15v, @ 2 for—\$5. Pocket size battery test set with adapters to put appropriate load on antique radio batteries. Comes in O.D. green belt-pouch—\$30. SASE for listing. (New listing coming out Jan. 1, 1994). S&G Electronic, 618 S. 62nd St., Philadelphia, PA 19143

**FOR SALE:** Flawless Fada 1000 insert bullet. Emerson tombstone. Kadette Classic in lavender. Early Kadettes. Emerson Deco D-dial in translucent lime green. Rare Fada 845 in maroon with white trim. Fada 845 in cream with red trim. Silverstone vacuum cleaner. Philco Boomerang in white, mint. Atwater Kent #447 tombstone. Spartan Jr. cathedral, excellent. Gorgeous Colonial cathedral with metal strips on face. Zenith #809 chrome front. Colonial cathedral in white. GE K52. Gloritone cathedral. Zenith 12 tube table model #12S445, very rare. Western States battery set from Kansas City, 20's. AK breadboard parts, some original in boxes. Splendid Grand by W.F. Main Radios. Ozarka table set 4 dial with battery box. Magnavox Eton Model battery set. Temple portable uses 10C tubes. Lone Ranger radio. Melody Cruiser by Majestic. Zenith chairside #7S240, great condition, 12S-371, no grille cloth, refinished—\$350. Amrad console uses #50 tubes, very good condition. Emerson All-American jewel box radio, red, white & blue stripes. N.C. 46 receiver & speaker. Raytheon 2500 transistor. Sony TR-8 Camera (?) radio. Toshiba 6TP-385A. Melody Coins transistor jewel box by Crown. Fisher R3, 30C audio control, 202-R AM-FM tuner. The 100 power amp. McIntosh MR-55 tuner, MC-30 amp, C-4 preamp, MR-55 face plate Sylvania Halo-Vision TV with glass shelf, blonde-Ultra 50's. L.E. Knott speaker base, rare ship's speaker with chain boarder. Bring the family, bring the relatives, bring a bulldozer, bring in the sheaves, bring whatever. Please write or call: Rain Buttignol, 214 State St., #7, Portsmouth, NH 03801. (603) 427-1384

**WANTED:** SABA 4000 console in excellent condition in Boston area. Thanks. Phil Holahan, 12 Pigeon Hill Dr., PO Box 392, Grafton, MA 01519. (508) 839-3765

**FOR SALE:** Meters: Triplet 630 Type III & Type IV with batteries—\$35. Navy multimeters: TS352/B with beautiful black Bakelite face in ruggedized waterproof case; comes with high-voltage probe, batteries & manual—\$25. VTVM TS505 w/probes in ruggedized waterproof case—\$25. S&G Electronic, 618 S. 62nd St., Philadelphia, PA 19143. (215) 474-7663

**WANTED:** Table models Zenith 12S445 and RCA Q44. Robert Schoenbeck, 9301 Texhoma Ave., Northridge, CA 91325. (818) 993-7174

**FOR SALE:** Clough-Brengle CLB-60007 RC bridge—\$25. Most-Often-Needed 1946—\$7. **WANTED:** Klipschorn, 1950's-1960's. Dave Minchella, KE2GE, 80 Campfire Rd. North, Henrietta, NY 14467. (716) 359-3337

**FOR SALE:** Transistors - GE Model P-800A—\$25. Another GE like P-800A but, metal case with handle strap—\$30. Channel Master, 6506, chipped on all corners, front is nice looking in leather case—\$16. Koyo 6 trans. metal front, black plastic vertical dial, leather case—\$30. All untested. Add \$4 UPS. Jim Martes, 15400 E. 2nd St. S, Independence, MO 64050. (816) 836-0668, evenings

**FOR SALE:** National Electric Supply SE-899 mfg 11-6-18, 300m to 12,000 m and SE 1071 audio amp by Western Electric—\$2,000 OBO. Simplified Reinartz set with good tubes—\$95. Crosley Super Trirdyn Special exc w/tubes—\$105. Tuska 228—\$250. Atwater Kent Model 37 with pwr supply—\$135. Atwater Kent Model 30 in original box—\$200. Zenith 7G605—\$150. Radiola 60—\$90. Eagle Neutrodyne, works—\$150. RCA UZ-1325—\$75. Atwater Kent Model 20 DeLuxe—\$125. Zenith Super VII—\$250. Philco 21 tandem w/good pic tube—\$350. Shipping extra. D. Patterson, 636 Cambridge Rd., Augusta, GA 30909. (706) 738-7227

**FOR SALE:** Tubes N.O.S., 5066, 35W4, etc.—\$3; 12AX7, 12BH7, 6V6—\$5; 6L6W6B—\$9. Many more. Send SASE for list to: Walt Murray, PO Box 231340, San Diego, CA 92194. (619) 271-1858

**CLASSIFIED AD NOTICE**  
**Please check your ads carefully before sending them in. Once ads are received, it is not always possible to refund the amount sent, pull the ad or make changes.**

**WANTED:** Tapes of old pop radio shows, Philco 45, 38-12, Westinghouse 226, Bulova 100. Bob Masterson, Box 172, Valley Cottage, NY 10989. (914) 353-3151

**FOR SALE:** Motorola 52 Catalin, yellow/amber (Sideli, p. 107). 40's Raytheon advertising sign, excellent—\$75. Craftsman hi-fi amp, tuner/preamp, nice chrome—\$120. Shipping extra. Adam Schoolsky, 38007 Stenhammer Dr., Fremont, CA 94536. (510) 791-0330, after 7 pm

**SERVICES:** Certified appraisals and evaluations of radios, phonographs and ham gear. (Appraisals, are when actually inspected). Sworn affidavits with credentials. Evaluations are \$3 per unit plus \$5 total handling. Our data base contains over 5,000 items and growing fast. May be used for probate, sales, insurance, etc. SASE for free details and forms. Sound Values, 105 Donnington, Auburn, CA 95603

**WANTED:** Hallicrafters SX-42, Motorola 5A7, Arvin 40, Philco 40-81, Minerva W-117. Ichiro Yamada, 10-21, Chiyodadai-cho, Kawachi Nagano-shi, Osaka, Japan 586. 0721-52-4695, eve., local

**FOR SALE:** Eight Victrola tone arms, some with brackets—\$10 each, or will sell lot. **WANTED:** Crank phonographs and parts, any kind/any condition. Dave Faehrich, 8215 Stone Rd., Independence, OH 44131. (216) 447-0837

**WANTED:** Dial glass and manual for Hallicrafters SX-110, also dual volume control for General Motors 120, 130 or 140. Dan Budd, 4214 2nd Ave. NW, Olympia, WA 98502. (206) 866-2310

**FOR SALE:** Tube and solid-state audio equipment. List changes constantly. SASE. Doug Weiss, 7305 Reynard Ln., Charlotte, NC 28215

**FOR SALE:** Bosch Model 46—\$145. Federal B-20—\$135. Stromberg-Carlson chassis 1A—\$100. H. Hayden, 4617 Highway, Jacksonville, FL 32254. (904) 778-2509

**FOR SALE:** R-11, 190-550 kHz/AC—\$45. Kenwood R2000 N.I.B.—\$99. RCA Stratoworld RJM 68E—\$55. Heath lunch box 2M—\$35. Hallicrafters S120—\$55. Regency HR2A 6M transceiver—\$55. Morrow 10-80 converter—\$37.50. Ernest Odeneal, 2710 Lee, Greenville, TX 75401



### **ARKANSAS - Dec. 2**

**ANTIQUÉ RADIO COLLECTORS CLUB  
OF FT. SMITH  
CLUB MEETING**

Ft. Smith, AR - St. Luke's Church,  
Waldron Road, at Free Ferry

7:30 pm

Info: Illa Davenport - (501) 785-4929

### **ONTARIO - Dec. 8**

**OTTAWA VINTAGE RADIO CLUB  
NEW CLUB FORMING/MEETING**

Ottawa, Ontario - Ottawa Citizen conference  
room, 1101 Baxter Rd. (Pinecrest Exit)

7 pm

Info: Tom Devey, 601 - 810 Edgeworth Ave.  
Ottawa, Ontario, Canada K2B 5L5  
(613) 828-5152

### **TEXAS - Dec. 4**

**HOUSTON VINTAGE RADIO ASSOC.  
CHRISTMAS PARTY**

Houston, TX - Henry's Hunan Chinese  
Restaurant, 11403 Chimney Rock

6 pm

Buffet Dinner and Donation Auction

Info: Bill Werzner - (713) 721-2242

### **CALIFORNIA - Dec. 8**

**SACRAMENTO HISTORICAL RADIO  
SOCIETY  
MEETING**

N. Highlands, CA - SMUD Foothill Service  
Center, Room D, 5026 Don Julio

7-9 pm

Info: Secretary SHRS, PO Box 162612  
Sacramento, CA 95816

### **TEXAS - Dec. 4**

**VINTAGE RADIO & PHONOGRAPH  
SOCIETY  
CHRISTMAS CHEER/SILENT AUCTION**

Irving, TX - Senter East Bldg.

Info: George Potter - (214) 315-2553

### **ARKANSAS - Dec. 9**

**ARKANSAS ANTIQUE RADIO CLUB  
ARKANSAS CHAPTER/ARCA  
MEETING**

Little Rock, AR - The Auditorium  
S.W. Bell Bldg., 120 W. 8th Street

7 pm

Info: Tom Burgess - (501) 565-1750

### **NEW YORK - Dec. 5**

**GREATER NEW YORK VINTAGE  
WIRELESS ASSOCIATION  
SWAP MEET**

Lake Ronkonkoma, NY - 367 Hawkins Ave.  
North of Long Island Expressway

lg. white house across fr. Dairy Barn store

9-12 am

Info: Steve Conklin - (516) 324-3012, or  
Chris Bacon - (516) 821-7618, or  
Chris Leippert - (516) 471-9526

### **NEW JERSEY - Dec. 10**

**NEW JERSEY ANTIQUE RADIO CLUB  
MEETING**

Freehold, NJ - Grace Lutheran Church  
West Main St. & Park Ave. (old Rt. 33)

7:30-9:30 pm - Meeting & Swap

Info: Don Cruse - (908) 542-2848

Tony or Kathleen Flanagan - (908) 462-6638

### **IOWA**

**NEW CLUB FORMING  
IOWA ANTIQUE RADIO CLUB AND  
HISTORICAL SOCIETY**

Info: Dennis Hilberg, 804 Ravine St.  
Decorah, IA 52101, or

Gerald Lange, 2191 Graham Cir.  
Dubuque, IA 52002

### **FLORIDA - Dec. 11**

**FLORIDA ANTIQUE WIRELESS GROUP  
MONTHLY TAILGATE MEET**

Orlando, FL - Radio Relics, 321 Evans St.  
8 am

Info: Paul Currie - (407) 365-9305, or  
FAWG - (407) 895-0146

## **FLORIDA - Dec. 11**

### **ANTIQUE WIRELESS ASSOCIATION FLORIDA FALL MEET**

Bradenton, FL - Stewart Elementary  
School, 7905 15th Ave. NW

8 am - Swap Meet

Info: Norman Smith - (813) 792-0003

## **GEORGIA - Dec. 14**

### **SOUTHEASTERN ANTIQUE RADIO SOCIETY MEETING**

Chamblee, GA - Shoneys Restaurant  
Peachtree Industrial, 1 mi. North of I-285

6:30 pm - Meeting: Catalin or Deco Sets  
6 pm - Mini Meet before monthly meeting

Info: Charles Pierce - (404) 233-1340, or  
David Martin - (404) 578-1270

## **OKLAHOMA - Dec. 11**

### **OKLA. VINTAGE RADIO COLLECTORS MEETING**

Oklahoma City, OK - Spencer's Barbeque  
NW 63rd and May Avenue

6 pm - Dinner; 7 pm - Speaker Night

Info SASE to: OKVRC, PO Box 72-1197  
Oklahoma City, OK 73172-1197

Karen McCoy - (405) 722-0595, or  
Jim Collings - (405) 755-4139, evenings

## **MISSISSIPPI - Dec. 14**

### **MISSISSIPPI HISTORICAL RADIO AND BROADCASTING SOCIETY MEETING**

Meridian, MS - 2412 C Street

7 pm

Info: Randy Guttery, 2412 C. St.  
Meridian, MS 39301 - (601) 693-5958

## **WASHINGTON - Dec. 12**

### **PUGET SOUND ANTIQUE RADIO ASSN. MEETING/SWAP MEET**

Seattle, WA - Shoreline Museum  
749 North 175th St. & Linden Ave.

1 mile West of I-5, Exit #176

12 noon - Meeting

Info: Al Atworth, PO Box 125  
Snohomish, WA 98291-0125 - (206) 568-2698

## **OHIO - Dec. 14**

### **ANTIQUE RADIO COLLECTORS OF OHIO MEETING**

Kettering, OH - First Natl. Bank Basement  
4100 Far Hills Avenue

SE corner of Far Hills Ave. and Stroop Rd.

7:30 pm

Info: Stan Kleen, 200 Castle Drive  
Dayton, OH 45429 - (513) 293-3194

## **ILLINOIS - Dec. 12**

### **ANTIQUE RADIO CLUB OF ILLINOIS WINTER MEET**

Elgin, IL - Holiday Inn, 345 River Rd.  
I-90 & Rt. 31 - (708) 695-5000

7 am - 1 pm - limited table space

Info: Jeff Aulik, 1708 Parkview Ave.  
Rockford, IL 61107 - (815) 399-1902

## **PENNSYLVANIA - Dec. 14**

### **DELAWARE VALLEY HISTORIC RADIO CLUB MEETING - SWAP MEET - AUCTION**

Souderton, PA - 117 Main St.  
N. Penn Amusements Building

7:30 pm

Info: Radio Attic, PO Box 624  
Lansdale, PA 19446 - (215) 368-2520

## **ILLINOIS - Dec. 13**

### **BELLEVILLE AREA ANTIQUE RADIO CLUB MEETING**

Belleville, IL - Belleville Area College

7 pm - Meeting: White Elephant Radios

Info: Karl Stegman, 4 Cresthaven Dr.  
Belleville, IL 62221 - (618) 234-7992

## **MISSOURI - Dec. 17**

### **ANTIQUE RADIO COLLECTORS & HISTORIANS OF GREATER ST. LOUIS CHRISTMAS PARTY**

St. Louis, MO - Kirkwood Community Center  
6-10 pm

Info: Charles Juedemann, 262 Churchill Ln.  
Ballwin, MO 63011 - (314) 256-3727

## **CALIFORNIA - Dec. 14**

### **CALIF. HISTORICAL RADIO SOCIETY NORTH VALLEY CHAPTER MEETING**

Redding, CA - 7 pm

Info: Norm Braithwaite - (916) 246-4209,  
or Chris Galantine - (916) 244-2337

Listings on these pages are free to  
antique radio clubs, as space permits.  
Please include date, time, where, direc-  
tions, & information/contact person.  
Submission Deadline - 5th of month.



## MARYLAND - Dec. 18

### MID-ATLANTIC ANTIQUE RADIO CLUB MEETING

Burtonsville, MD - New Hope Seventh Day Adventist Church

6:30 pm

Info: Lloyd Kendall, 1312 Deep Run Ln.  
Reston, VA 22090 - (703) 471-6143

## OREGON - Dec. 18

### NORTHWEST VINTAGE RADIO SOCIETY MEETING

Portland, OR - NW Vintage Radio Museum  
7675 SW Capitol Highway, at 32nd St.

2:30 pm - Christmas Meeting

4:30 pm - Dinner

Info: Ed Charman, PO Box 82379  
Portland, OR 97282-0379 - (503) 654-7387

## ALBERTA - Dec. 19

### ALBERTA VINTAGE RADIO SOCIETY MEETING

Edmonton, Alberta - 12845 102 Avenue  
Alberta Provincial Archives Lecture Room  
2 pm

Info: Nap Pepin - (403) 424-2214  
AVRS, PO Box 43012 Metropolitan Pl. P.O.  
Edmonton, Alberta, Canada T5J 4M8

## OHIO - Dec. 28

### SOCIETY FOR PRESERVATION OF ANTIQUE RADIO KNOWLEDGE MEETING

Dayton, OH - ITT Technical Institute  
3325 Stop Eight Road

7:30 pm

Info: Harold Parshall - (513) 298-4044, days  
(513) 268-2909, evenings

## COLORADO - Jan. 9

### COLORADO RADIO COLLECTORS MEETING - SWAP MEET

Denver, CO - South West Bank Bldg.  
Community Room, 1380 S. Federal Blvd.

1 pm - Meeting  
3 pm - Swap Meet

Info: Barney Wooters - (303) 770-5314

*Attend a club event near you,  
learn, meet others in the hobby,  
and perhaps find an item or  
two for your collection!*

## MARK YOUR CALENDAR

Dec. 2 - AR, Ft. Smith - ARCCFS Meeting §  
Dec. 4 - TX, Houston - HVRA Christmas Party\*  
Dec. 4 - TX, Irving - VRPS Christmas Cheer\*  
Dec. 5 - NY, Lake Ronkonkoma - GNYVWA §  
Dec. 8 - CA, N. Highlands - SHRS Meeting §  
Dec. 8 - Ontario, Ottawa - OVRC Meeting §  
Dec. 9 - AR, Little Rock - AARC Meeting §  
Dec. 10 - NJ, Freehold - NJARC Meeting §  
Dec. 11 - FL, Bradenton - AWA/Fia. Meet\*  
Dec. 11 - FL, Orlando - FAWG Meet §  
Dec. 11 - OK, Oklahoma City - OKVRC Meeting §  
Dec. 12 - IL, Elgin - ARCI Winter Meet\*  
Dec. 12 - WA, Seattle - PSARA Show §  
Dec. 13 - IL, Belleville - BAARC Meeting §  
Dec. 14 - CA, Redding - CHRS-NVC Meeting\*  
Dec. 14 - GA, Chamblee - SARS Meeting §  
Dec. 14 - MS, Meridian - MHR&BS Meeting §  
Dec. 14 - OH, Kettering - ARCO Meeting §  
Dec. 14 - PA, Souderton - DVHRC Meeting §  
Dec. 17 - MO, St. Louis - ARCH Party\*  
Dec. 18 - MD, Burtonsville - MAARC Meeting §  
Dec. 18 - OR, Portland - NWVRS Meeting §  
Dec. 19 - Alberta, Edmonton - AVRS Meeting\*  
Dec. 28 - OH, Dayton - SPARKS Meeting §  
1994

Jan. 9 - CO, Denver - CRC Meeting\*  
Jan. 12 - MO, St. Louis - ARCH Meeting §  
Jan. 15 - TX, Irving - VRPS Meeting §  
Jan. 20 - NY, Goshen - HARPS Meeting §  
Jan. 22 - MI, Grand Rapids - MARC Winter Meet  
Jan. 22 - NH, Nashua - NEARC Meet  
Jan. 24 - AL, Birmingham - ALHRS Meeting §  
Jan. 29 - OH, Columbus - SPARK Swap Meet  
Jan. 29 - TX, TBA - HVRA Mega Auction  
Feb. 19 - IN, Indianapolis - IHRS Meeting  
Mar. 1 - TX, Houston - HVRA Meeting §  
Mar. 12 - MS, Meridian - MHR&BS Meet/Show  
Mar. 26 - TX, Irving - VRPS Spring Auction  
Apr. 16 - NH, Nashua - NEARC Meet  
Apr. 23-24 - CO, Denver - CRC Show & Swap  
May 7 - NY, Bloomfield - AWA Spring Meet  
May 13-14 - IN, Kokomo - IHRS Meeting  
Jun. 9-11 - AR, Little Rock - ARCA '94  
Jun. 25-26 - OH, Cincinnati - Midwest Radio Rama  
Jul. 8-10 - MI, Lansing - MARC Extravaganza '94  
Aug. 21 - OH, Kettering - ARCO Show  
Sep. 21-24 - NY, Rochester - AWA Conference  
Oct. 14-16 - TX, Irving - VRPS/AWA Convention

\* See expanded listing this month. § Monthly Meeting

## MISSOURI - Jan. 12

### ANTIQUARIAN RADIO COLLECTORS & HISTORIANS OF GREATER ST. LOUIS MEETING

St. Louis, MO - Kirkwood Community Center  
7 pm - Bring item for show & tell

Info: Charles Juedemann, 262 Churchill Ln.  
Ballwin, MO 63011 - (314) 256-3727

## TEXAS - Jan. 15

### VINTAGE RADIO & PHONOGRAPH SOCIETY MEETING

Irving, TX - Garden Arts Bldg., 906 Senter St.  
4 pm - Swap Meet

5:30 pm - Meeting

Info: George Potter - (214) 315-2553

## FLORIDA

**NEW CLUB FORMING  
SOUTH FLORIDA  
ANTIQUE RADIO COLLECTORS**  
Info: Victor Maret, 3201 N.W. 18 Street  
Miami, FL 33125

## HAWAII - NEW CLUB

**HAWAII CHAPTER  
ANTIQUÉ RADIO CLUB OF AMERICA**  
Workshops on Antique Radio Collecting-  
History-Restoration  
Children's classes to build crystal radio sets.  
"Window on the World" program provides  
SW sets to handicapped persons.  
Info: ARCA-Hawaii, 95-2044 Waikalani Pl. C-401  
Miiilani, HI 96789 - (808) 847-3313

## KY. - NEW CLUB FORMING

**KENTUCKY CHAPTER  
ANTIQUÉ RADIO CLUB OF AMERICA**  
Meetings - Meets - Future Museum  
Info: Ky. Chapter - ARCA, Jim McDowell,  
#8 Blanchel Ter., Jeffersonville, IN 47130  
(812) 283-6387

## RHODE ISLAND

**NEW CLUB FORMING  
RHODE ISLAND ANTIQUE  
RADIO ENTHUSIASTS**  
New club - RARE - for trading antique  
radio *information* rather than hardware.  
Informal monthly meetings.  
Info: Len Arzoomanian - (401) 232-0869

## SOUTH CAROLINA

**NEW CLUB FORMING  
CAROLINA ANTIQUE RADIO SOCIETY**  
Info: Carl R. Shirley, 824 Fairwood Rd.  
Columbia, SC 29209 - (803) 776-6850

## SPAIN

**NEW CLUB FORMING  
FRIENDS OF RADIO CULTURAL  
ASSOCIATION**  
Info: Associacio Cultural Amics de la Radio  
c/o Rei Jaume, 55, 08840 Cardedeu  
Spain

Enclose a SASE when requesting info.

## BUSINESS CARD ADS - \$34.00 FOR 3 MONTHS

### WRIGHT'S ELECTRONIC SERVICE THE RADIO DOCTOR

"You Don't Have To Worry When It's Done Wright"

1920-1960'S RADIOS-PHONOS-CAR RADIOS- TUBE AMPS

CHASSIS REPAIRS FROM SIMPLE TO COMPLETE REFURBISHMENT  
MOST REPAIRS FROM \$25 MOST REFURBS \$50 TO \$100

WRIGHTS ELECTRONIC SERVICE  
(206) 859-3592

P.O. BOX 8252  
FEDERAL WAY, WA. 98003

### Play Things of Past

Sales - Service - Restoration of Vintage  
Radios and Electronics.

Gary Schneider



#### Retail Sales Store

3552 W 105th  
Cleveland Oh 44111  
Hours 6-9pm Wed.  
12-6pm Sat.

#### Mail Address

9511-23 Sunrise Blvd  
Cleveland Oh 44133  
216-582-3094

Buy - Sell - Trade Radios, TV's, Tubes, Parts

## PUT YOUR BUSINESS CARD HERE!

\$34 FOR 3 MONTHS - \$59 FOR 6 MONTHS  
DON'T HAVE ONE? SEND AN EXTRA \$5.50 AND  
WE WILL TYPESET ONE FOR YOU.

Collector, Historian, Seeker of  
Stromberg - Carlson Radio Apparatus



JOHN M. ENGLAND JR.  
P.O. Box 59136  
Schaumburg, IL 60159  
Ph. (708) 823-5287

**Stromberg-Carlson**

Entrepreneur: Art Moderne,  
Streamline, Machine Age Design

## FENDER and VOX WANTED!

- Cash for guitar amps from 1950-1960's
  - Any condition
  - Pickup within 200 miles
- Frank Czaja  
8968 W. Forest Home  
Apartment #4  
Milwaukee, WI 53228  
(414) 529-9395

## ★ ★ WANTED ★ ★



- McMurdo Silver, Lincoln, Zenith chrome chassis radios
- Advertising brochures, literature, etc. for these sets
- Prewar televisions



Don Hauff (612) 374-9739  
P.O. Box 16351  
Minneapolis, MN 55416

**BUSINESS CARD ADS - \$34.00 FOR 3 MONTHS**

**SPY EQUIPMENT WANTED!**

- Code Machines
- Secret Radios
- Secret Cameras
- OSS, SOE, CIA, KGBI
- Clandestine Weapons
- I Buy or Trade!

Keith Mellon  
P.O. Box 5755 Bossier City, LA 71171  
(318) 747-9616 Days: FAX (318) 747-9010



If you buy, sell or like Jukeboxes you need **ALWAYS JUKIN'-THE MONTHLY JUKEBOX MAGAZINE!!** Subscribers in 25 countries, **ALWAYS JUKIN' LEADS THE WAY:** Articles, photos, show reports, ads, new products, price guides, restoration tips, repairs—everything you need to know about **JUKE-BOXES—the fastest appreciating collectible in the world!!!** Fun & a great investment.  
Sample copy, \$5. \$30 per year.  
**ALWAYS JUKIN', 221 YESLER WAY AR, SEATTLE, WA. 98104. (206) 233-9460.**  
Master/Visa ok.

*"Dead Radios Brought Back to Life"*

**FRANKENSTEIN'S RADIO LABORATORY**

*Specializing in Antique Radios.  
Old Radio Cadavers and Parts Bought and Sold.  
Mail Order Sales of New, N. O. S. and Used Parts.*

MAIL ORDER SALES—  
4010 Fairmount Pkwy., Suite 285  
Pasadena, Texas 77504

Gordon R. Rolston  
*Repairs by Appointment*  
(713) 998-0130

**TUBES  
TUBES  
TUBES**



**QUEST ELECTRONICS, INC.**

5715 West 11th Ave, Denver, CO 80214  
PHONE (303) 274-7545 • FAX 274-2317



30 years experience

**Jackson Speaker Service**

*Expert Antique Loudspeaker Repairs  
(Cone Types) And Rebuilding A Speciality.  
Speaker Parts And Repair Service On  
Virtually Any Speaker Made Including  
Stereo, P.A., And Antique Auto Speakers.  
217 Crestbrook Dr. Owner  
Jackson Mich 49203 Ron McGee  
Ph. - (517) 789-6400, Ans. 4th ring  
Wk - days 10: am - 7pm Wk - Ends 9 - 5pm*



RELIABLE - PROMPT - GUARANTEED

**SOUND REMEDY  
LOUDSPEAKER REPAIR SERVICE**

331 Virginia Avenue  
Collingswood, New Jersey 08108

Richard G. Stamer

Telephone  
(609) 869-0238

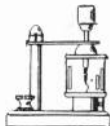

**CRYSTAL SETS**

PARTS - PLANS - KITS - BOOKS  
CATALOG \$1.00

Largest source of Vintage and New  
Variable Air Condensers, Variometers,  
Vario-Couplers, Tap Switches, Tap  
Points, Galena and Germanium  
Detectors, Detector Stands, Cat  
Whiskers, Terminals, Sliders,  
Headsets, Dial Knobs, Coil Forms,  
Magnetic Wire, etc.

**MIDCO**  
P.O. Box 2288  
Hollywood, FL 33022  
(305) 925-3670  
B.A. Turko, Ph.D.E.E.

**Oldies Only Radio Service**

**Antique radio repair & restoration  
for the collector of fine  
automobile & home radios**

Joe Grace  
15 Copperleaf Terrace  
Staten Island, NY 10304  
(718) 987-7014

(510) 490-5842

Fax (510) 490-1961

**Speakerworld®**

*Expert Speaker Refoaming and Reconing*

2000 Warm Springs Ct. #6  
Fremont, CA 94539

Visa/ Free Return  
MC Freight By UPS

784-9417

784-9417

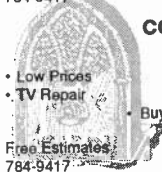

**COSMOS  
TV**

- Low Prices
- TV Repair

- Quality Used TVs
- Antique Radio Repair

• Buy, Sell, Trade

Free Estimates  
784-9417

5919 15th Ave. N.W.  
Seattle, WA 98107

**WE PAY MORE FOR VINTAGE HI-FI !**

**ANGELA  
INSTRUMENTS**



10830 Guilford Rd., Suite 309  
Annapolis Junction, MD 20701

Phone (301) 725-0451  
Fax (301) 776-2892

Cash for tube gear by  
Marantz, McIntosh, Dyna,  
Western Electric and most  
other makers. Also buying  
all audio tubes, tube testers,  
old mics, output transformers,  
books about tube electronics  
and hi-fi, related clocks  
and signs, etc.

**HAVE CASH  
WILL TRAVEL ANYWHERE!**

**RADIO BOOKS FOR SALE**

Large selection of books on Radio and Related Technology  
Call or write for our List of Catalogs.  
Always buying, single items or collections.

**RAINY DAY BOOKS**

P.O. BOX 775, FITZWILLIAM NH 03447  
(603)-585-3448

## BUSINESS CARD ADS - \$34.00 FOR 3 MONTHS

**WANTED**  
PRE 1900  
**ELECTRICITY**  
MEDICAL • X-RAY  
TELEGRAPHY • TELEPHONE  
PRE 1925  
RADIO • WIRELESS  
PRE 1940  
TELEVISION

BOOKS • TUBES • ARTIFACTS  
MAGAZINES • AUTOGRAPHS  
CATALOGS • EPHEMERA



**NEW WIRELESS  
PIONEERS**  
P.O. BOX 398  
ELMA, NY 14059  
716-681-3186

COMM/NAV EQUIP  
RADIO SETS  
NAVAL AIR FIELD  
U S FOREIGN

CHARLES DICCOCA KAI OON  
591 MYSTIC VALLEY PKWY  
MEDFORD, MASS 02155  
PHONE: 617-394-9334



**MILITARY ELECTRONICS**

BUY                      WANTED                      TRADE

**ANTIQUE RADIO REPAIR**  
*Repair - Restore - Buy & Sell*

Schematic Service  
Radios \$2.<sup>50</sup>, TVs \$4.<sup>50</sup>

**DAMASKE ELECTRONICS**  
S74-W16834 Janesville Road  
Muskego, WI 53150  
Phone: (414) 679-0838

IF YOU VISIT THE BRIMFIELD FLEA MARKET...  
STOP BY FIRST!

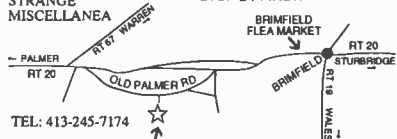

TEL: 413-245-7174

COUNTRY ROAD BARN - BERNIE SAMEK  
OLD PALMER ROAD, BRIMFIELD, MASS.

50 years                      **CHUCKS**                      of service!

Any Tube Radio Repaired and  
Guaranteed to work good.  
\$25 plus parts & UPS

**CHUCKS**  
167 LYNN DRIVE - PO Box 598  
NEW HAVEN, WV 25265 - Ph (304) 882-2220

**VACUUM TUBES**  
*Electronic Components*

Write or call for list

Network Sales                      (708) 773-4733  
5N105 Rt. 53  
Itasca, IL 60143

Are You Looking For Antique Radios, Parts,  
Tubes, Schematics and Restoration Services?

For Free Flyer, a 2-Stamp LSASE is required to insure a  
response to your request. Send to:

*Olde Tyme Radio Company*  
2445 Lyttonsville Road, Suite 317, Silver Spring, MD 20910

Wish to contact us by phone?  
Our number is (301) 585-8776.  
Please call 10 am to 10 pm (Local Time)

**Antique Radios**



David & Nancy Snow  
P.O. Box 6352  
Jackson, MI 49204  
(517) 787-2985

We Buy, Sell, Repair  
**ARBE - III Battery Eliminators**

WANTED: Tube Hi-Fi Components & Studio  
Equipment of the 1950's and 60's

Marantz, McIntosh, Scott, Fisher, Brook  
Acrosound, Brocner, Western Electric  
Fairchild, Altec, Tannoy, JBL

Richard Sharisky  
P.O. Box 521                      (617) 484-5784  
Belmont, MA 02178

**E.H. Scott Radio**

Collector Historian Admirer



JIM CLARK  
1292 STARBOARD  
OKEMOS, MI 48864  
(517) 349-2249

1920-1970  
**SCHEMATICS + PAGES OF INFO**  
\$5.00 POSTPAID

MANUAL PRICES - SASE  
RADIO/TV/HAM/MISC.

"IF I DON'T HAVE IT, YOU  
PROBABLY DON'T NEED IT."

**ALTON H. BOWMAN - 4172 EAST AVENUE**  
CANANDAIGUA, NY 14424-9564

RADIO - TELEVISION - Hi Fi  
Tubes 1940 & Later  
Send S.A.S.E. for Catalog and Prices

**KIRBY**

Up To 90% Off List Price

John Kirby  
298 West Carmel Dr.  
Carmel, IN 46032

317-843-2212



**BUSINESS CARD ADS - \$34.00 FOR 3 MONTHS**

**RADIO ROADMAP**

**PRE-1945 RADIO SCHEMATICS**

**\$4.00 EACH POSTPAID**

**LANCE WILSON 602-483-8993**

**8429 VIA LINDA**

**SCOTTSDALE, ARIZONA 85258**

**WANTED**

**SONY CRF320  
CRF330**

Chris Clark, 117 Hudson Street, NYC, 10013  
TEL. (212) 219-1783

Free Estimates  
Hrs - 10 AM - 7 PM  
Mon.-Sat

Tel./Fax (203) 928-2628



**ANTIQUE RADIO  
RESTORATION & REPAIR**

1920 - 1960's

*Buy & Sell*

Reasonable Rates Tubes,  
Parts & Service on all  
Antique Car, Console &  
Table Radios, Tube Amps  
& Phonos

20 Gary School Road  
BOB ESLINGER Pomfret Center, CT 06259



**john d. eckland**

*vintage american & european radio repair*

969A ADDISON AVENUE PALO ALTO, CALIFORNIA 94301  
415/323-0101

**ANTIQUA RADIO RESTORATION**

Since 1936 Repair - Buy - Sell  
Complete Restorations • Prompt Service

**COOPER'S RADIO SERVICE**

425 Court Street  
Rockwell City, Iowa 50579



**LARRY COOPER**  
712-297-7232

PAUL

ROBIN

**DR NOVELTY**  
JUKEBOX AMPLIFIER REBUILDING

414 964 3392

**Old Time Replications**

"TURN TO US WHEN YOU NEED KNOBS"  
KNOBS • PUSHBUTTONS • ESCUTCHEONS  
PLASTIC GRILLS • HANDLES

**LARRY BORDONARO**

5744 TOBIAS AVE. VAN NUYS, CA 91411  
PHONE (818) 786-2500 • FAX (818) 909-0241

Sight

Sound

**RAY'S  
ANTIQUA ELECTRONICS**

Repair or Full Restoration  
1920 to 1960

Contact us for Shipping  
*Satisfaction Guaranteed*

342 South Third St.  
Cottage Grove, OR 97424

(503) 942-0866

Schematics Repair Notes History

**Radio Schematic Service  
And Research Information**

Don Davis K4ZDB  
8833 Brucewood Drive  
Richmond, VA 23235  
(804) 272-4452

\$4 + SASE Per Schematic  
Provide Mfr., Model,  
and/or Tube Layout.  
Quotes on other info.

**BETA-TEK**

**ANTIQUA RADIO SERVICE**



- Repair of Radios, Communications Receivers & Test Equipment
- Power Supplies for Battery Sets

**RAY BINTLIFF**  
2 Powder Horn Lane  
Acton, MA 01720  
**508 283-7435**



**THE RADIO MAN**

*Buy-Sell-Trade*  
Antique Radios • Tubes • Parts

**DICK MORGAN**  
RES: (214) 231-3099

TEL: (214) 276-5458  
FAX: (214) 272-1831  
P.O. BOX 461485  
GARLAND, TX 75046-1485

Conc and Voice  
Coil Replacement

Field Coils  
Rebound

Specializing in

**Antique Speaker Repair**

18 Years  
Experience

Conventional  
PM Speaker Repair

Hank Brasen  
103 N. Lake Point Ct.  
Crossville, Tn. 38555  
1-615-456-2529

**BUSINESS CARD ADS - \$34.00 FOR 3 MONTHS**

**WANTED**

*Pre-1940 Aircraft and Airport Radios, Equipment, Memorabilia.*

James Treherne  
11909 Chapel Rd., Clifton, VA 22024  
703-830-6272

• GRUNDIG • SABA ALL WORK GUARANTEED  
• TELEFUNKEN • NORDMENDE

**The Bavarian Radio Works**  
SPECIALIZING IN REPAIR OF EUROPEAN RADIO SETS

ROSS A. HOCHSTRASSER  
(617) 447-9104

162 BEULAH ST.  
WHITMAN, MA 02382



**ANTIQUE RADIO RESTORATIONS**

635 S. Lincoln Ave., O'Fallon, IL 62269  
618-632-7423

*Collectors of Old Radios  
Electronic Consultant, Dial Reproductions  
Catacombs - Restored*

Clinton Blais, P.E.  
Life Member I.E.E.E.  
AWA, ARCA, ARCI, MAARC

Ron Blais

**ELECTRON TUBE ENTERPRISES**

(DEALERS IN SURPLUS ELECTRON TUBES)

BOX 8311  
ESSEX, VT. 05451  
TEL:802-879-0611  
FAX:802-879-7764

**FREE 1993 CATALOG AVAILABLE**

"Dedicated to the Preservation of Radio Antiquity"



**MARCONI ELECTRONICS**

*Late 20's to Late 50's Vintage  
Radio Repair and Restoration*

Pat Ryan  
2122 Marconi Avenue, St. Louis, MO. 63110 • 314-664-7080

Andrew Mooradian

Wanted Pre-1926 Radios by

**AMRAD**

Also, Radio Parts, Accessories  
and Literature

5 Priscilla Lane, Winchester, MA 01890

**CLASSIC RADIO SERVICE®**

55 - 60 - 70 - 80 - 90 - 100 - 110 - 120 - 130 - 140 - 150 - 160



P.O. BOX 764, 25 MAPLE ROAD  
WOODACRE, CA 94973



DAN HEALY

Telephone: 415-488-4596



THE FINISHING TOUCH



*Todd E. Hinman Restorations*  
SHOW WINNING FINISHES

— AUTO INTERIOR WOOD —

- RADIOS
- MECHANICAL
- 78 RPM JUKEBOXES
- ELECTRONICS



203-274-0705

203-268-6060



182 JUDD FARM ROAD  
WATERTOWN, CONN. 06795



**GOLDEN AGE RADIO**

Antique Radio  
Sales & Repairs

**WE BUY ANTIQUE  
RADIOS, TUBES, PARTS  
& ADVERTISING**

1609 Ceddor St.  
Curtis Bay, MD 21226

410-354-OLDE  
354-6533

Wed - Fri 1-8  
Sat & Sun 10-6

SAM, WILL, KAREN, FRANK & DON

**SUNSHINE SOUNDS**

WANTED:



**Hi Fi TUBE & COMMERCIAL AMPS**

McIntosh, Marantz, Dynaco, Heath,  
Altec, Scott, RCA, Fisher, Craftsman,  
Grommes, Fender, Ampex, W.E. Vox,  
Brook, Acro, Pultec, Fairchild

**SPEAKERS & HORNS**

Altec, Jensen, RCA,  
E.V., Western Electric,  
JBL, Tannoy

405-737-3312

Sonny - 1413 Magnolia Ln., Midwest City, OK 73110



**ANTIQUE RADIO SERVICE**

RADIOS REBUILT  
BOUGHT SOLD TRADED

*Auto and Home*

WE BUY AUTO RADIOS

RICHARD FOSTER  
12 Shawmut Ave.  
Cochituate, MA. 01778

(508) 653-2418

**NEW**  
**2nd Edition**

— Jonathan Hill's

# **Radio! Radio!**

**Second Edition**



---

*“Radio! Radio! is a fine work... one that no serious collector or historian can afford to overlook”*

*(Richard Foster,  
A.R.C. Sept. 1993)*

---

## **244 Pages - 978 Photographs of British Sets**

Comprehensive overview of the development of wireless covering the 1920s to the 1960s. Illustrated chapter on the history of wireless. Descriptive information on each radio pictured. Revised, easy-to-read subject index, making it easier to find the particular radio you are interested in. A-Z directory listing of 1,000+ radio models.

**Hardcover Only: \$44.95**

**Individually signed and numbered!!**

**Dealer Inquiries Invited**

*U.S. Orders - Enclose \$2.50 per order for packing & book-rate shipping if total order is under \$35.00. If using VISA or MasterCard, include name on card, card number and expiration date. Send payment with order. Mass. residents please add 5% sales tax. Money back return policy. Most orders shipped the same day received, but allow 2-4 weeks to receive order. Foreign orders - write for shipping costs, or use credit card and specify air or surface (allow 2-3 months for surface shipping).*



**Send Order To: A.R.C., P.O. Box 2, Carlisle, MA 01741**  
**or Call: (508) 371-0512**

**Fax: (508) 371-7129**



(Oct-93)

# Radios

of the Baby Boom Era

Six Volumes — 2000 pages — From Sams' Archives  
 1946 to 1960 — 274 Brands — 3494 Illustrations (B&W)  
 6769 Models — Catalin, Bakelite, Wood, Transistor Radios & More

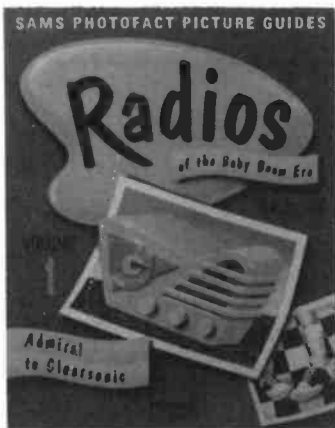

## All Volumes Available!

Vol.	Brands	Included
1	56	Admiral to Clearsonic
2	54	Co-op to Geloso
3	58	GE to Monitoradio
4	36	Motorola to RCA Victor
5	35	Realtone to Stratovox
6	35	Stromberg-Carlson to Zenith



### 1/2 Page for each illustrated radio including:

- Large illustration of the radio including knob functions
- Short description of the radio
- Number of tubes
- Power supply type (AC, Battery, etc.)
- Tuning range
- Manufacturer
- Sams Photofact Set number & year Photofact published.

### ALSO

- Index by model number listing tubes in radio
- List of similar radio models indexed to pictured radio
- List of manufacturers and suppliers indicating their brand names
- Basic trouble-shooting hints

Each Volume: \$16.95 — Softcover  
 8 1/2" x 11" — Approx. 328 pages

*U.S. Orders - Enclose \$2.50 per order for packing & book-rate shipping if total order is under \$35.00. If using VISA or MasterCard, include name on card, card number and expiration date. Send payment with order. Mass. residents please add 5% sales tax. Money back return policy. Most orders shipped the same day received, but allow 2-4 weeks to receive order. Foreign orders - write for shipping costs, or use credit card and specify air or surface (allow 2-3 months for surface shipping).*



Send Order To: A.R.C., P.O. Box 2, Carlisle, MA 01741  
 or Call: (508) 371-0512 Fax: (508) 371-7129



(May-93)



# New Books for the Collector

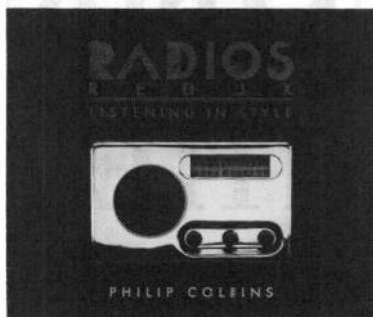

**RADIOS REDUX BY PHILIP COLLINS.** Subtitled "Listening in Style," this book showcases the sleek lines and luscious colors of over 80 gleaming sets from the collection of Philip Collins. 120 pages, 10" by 8 3/4" ..... **HARDCOVER: \$29.95. SOFTCOVER: \$17.95**

**AND STILL AVAILABLE...**

**RADIOS: THE GOLDEN AGE BY PHILIP COLLINS.** Collins' first book of the colorful Catalin and Bakelite radios from the late 1930s to the early 1940s. 128 pages, 10" by 8 3/4".

..... **HARDCOVER: \$25.00. SOFTCOVER: \$14.95**



**SPECIAL PURCHASE!**

**NEW LOW PRICE!**

**RADIO ART BY ROBERT HAWES.** This outstanding book is a chronological illustrated history of radio that celebrates the technical and stylistic progress of the radio. Although the coverage of the book is mostly British, many American sets are featured as well. 9 1/4" by 12", 128 pages. 250 photos, 150 in color. .... **HARDCOVER: ~~\$29.95~~ \$19.95**

**RADIO ART POSTCARD DECK.** 30 full color photographs from Hawes' book ..... **~~\$9.95~~ \$7.50**

**ALSO...**

**JUKEBOX ART BY CHRIS PEARCE.** The evolution of the jukebox from coin-operated record changer to the rock and roll generation. 9 1/4" by 12", 128 pages. 120 color photos. .... **HARDCOVER: \$29.95**

**JUKEBOX ART POSTCARD DECK.** 30 full color photos from Pearce's book ..... **\$9.95**

*U.S. Orders - Enclose \$2.50 per order for packing & book-rate shipping if total order is under \$35.00. If using VISA or MasterCard, include name on card, card number and expiration date. Send payment with order. Mass. residents please add 5% sales tax. Money back return policy. Most orders shipped the same day received, but allow 2-4 weeks to receive order. Foreign orders - write for shipping costs, or use credit card and specify air or surface (allow 2-3 months for surface shipping).*



**Send Order To: A.R.C., P.O. Box 2, Carlisle, MA 01741**  
**or Call: (508) 371-0512** Fax: (508) 371-7129



(Aug-93)

# EMPIRE OF THE AIR

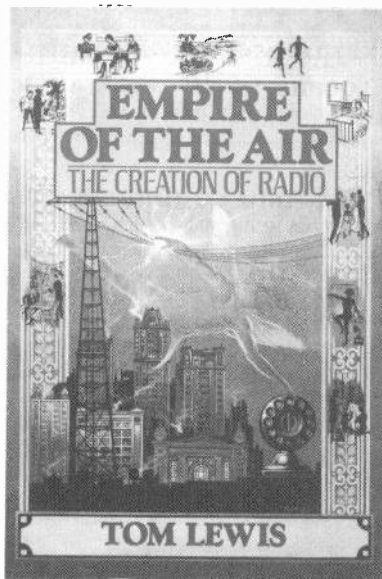

## The Video...

by Ken Burns

PBS series "The Civil War" Producer

Narrated by Jason Robards

120 minutes - VHS

Based on the book by Tom Lewis

A documentary spanning from 1906 to 1955 weaving together the lives of David Sarnoff, Lee de Forest and Edwin H. Armstrong.

**\$24.95**

## The Book...

by Tom Lewis

416 pages - Hardcover - Illustrated

A biographical history of radio focusing on David Sarnoff, Lee de Forest and Edwin H. Armstrong.

"...the best book on radio history ever written," Douglas. "We can't imagine anyone interested in radio history not being interested in this book," *The Pittsburgh Oscillator*.

Softcover - \$13.00

Hardcover - \$25.00

*U.S. Orders - Enclose \$2.50 per order for packing & book-rate shipping if total order is under \$35.00. If using VISA or MasterCard, include name on card, card number and expiration date. Send payment with order. Mass. residents please add 5% sales tax. Money back return policy. Most orders shipped the same day received, but allow 2-4 weeks to receive order. Foreign orders - write for shipping costs, or use credit card and specify air or surface (allow 2-3 months for surface shipping).*



Send Order To: A.R.C., P.O. Box 2, Carlisle, MA 01741  
or Call: (508) 371-0512

Fax: (508) 371-7129



# Radio Manufacturers of the 1920's

BY ALAN DOUGLAS



*"The definitive book on American broadcast receivers of the 1920s"*

**Volume 1:** A-C Dayton - Adams Morgan - Air-Way - All-American Mohawk - American Bosch - Amrad - Amrad S-Tube - Apex - Atwater Kent - Bremer Tully - Browning-Drake - Clapp-Eastham - Crosley - Cutting & Washington - Day-Fan - DeForest - Eagle - ERLA - FADA - Federal - Ferguson. 225 Pages.

**Volume 1: \$24.95 (only softcover in print)**

**Volume 2:** Freed-Eisemann - Eisemann - Freshman - Garod - Gilfillan - Grebe - Howard - Jones (Lester/Melco) - Jones (Jos.) - Kellogg - Kennedy - King - Kodel - Kolster - Leutz - Magnavox - Majestic - Marti - Metro - Klitzen/Michigan - Midwest - Mu-Rad - Murdock - Music Master - Neutrowound - Operadio - Ozarka - Pfanstiehl - Philco - Pilot - Priess. 266 Pages.

**Volume 2: \$29.95 (hardcover: \$39.95)**

**Volume 3:** RCA - Scott - Silver-Marshall - Slagle - Sleeper - Sonora - Sparton - Splitdorf - Steinite - Stewart-Warner - Stromberg-Carlson - Thermodyne - R.E. Thompson - Thorola - Tri-City - C. D. Tuska - Ware - Western Coil - Western Electric - Workrite - Zenith. 292 Pages.

**Volume 3: \$29.95 (hardcover: \$39.95)**

*U.S. Orders - Enclose \$2.50 per order for packing & book-rate shipping if total order is under \$35.00. If using VISA or MasterCard, include name on card, card number and expiration date. Send payment with order. Mass. residents please add 5% sales tax. Money back return policy. Most orders shipped the same day received, but allow 2-4 weeks to receive order. Foreign orders - write for shipping costs, or use credit card and specify air or surface (allow 2-3 months for surface shipping).*



**Send Order To: A.R.C., P.O. Box 2, Carlisle, MA 01741**  
**or Call: (508) 371-0512** Fax: (508) 371-7129



# COLLECTOR BOOKS AVAILABLE FROM ANTIQUE RADIO CLASSIFIED

BOOKS MARKED WITH \* ARE THE MOST POPULAR AND ARE ESPECIALLY RECOMMENDED FOR NEW COLLECTORS

- Antique Radio Restoration Guide, 2nd Ed., Johnson. *Beginner's introduction to troubleshooting and repairing AC table model radios.* 1992, 145 pgs. ....\$14.95
- The AWA Review. *Collections of extended articles.* Vol. 1: Tesla, Farnsworth TV, WWI Ham Radio, National Co., Atwater Kent, etc. Vol. 2: DeForest, Spark Transmitters, Atwater Kent, Hammarlund, Telegraph Keys, etc. Vol. 6: Tubes, Hawaiian Wireless, U.K. TV, SCR-RC-BC Directory, NYC Wireless, etc. Vol. 7: Tubes, Poldhu Transmitters, Navy Equipment, Arc Transmitters, etc. Vol. 8: Morse Keys, Tubes, Federal Telephone Co., KFS-Federal-Mackay Story, National Electrical Supply Co., Navy Electronics Directory, etc. .... (Per Volume) \$10.00
- The Antique Radio Boys and the Garrulous Grebe, Dryer. *Thrilling adventure story written in the traditions of the '20s and '30s.* 5 1/2" by 8 1/2", 51 pgs. ....\$4.95
- The Auto Radio: A Romantic Genealogy, Matteson. *Information, photos & ads from the early days of the automobile radio through the 1950s.* 316 pgs. .... (hardcover) \$34.95
- Classic TVs, Wood. *Prewar to 1950s, with price guide.* 140+ color photos of television sets plus reproductions of old catalog pages and magazine ads. 86 pgs. ....\$16.95
- \* The Collector's Guide to Antique Radios, 2nd Ed., Bunis. *This guide covers radios from 1920 to 1959. Over 7400 prices and over 540 new color photos are included.* 1992, 208 pgs. ....\$17.95
- The Collector's Guide to Transistor Radios, Bunis. *Identifies the most sought-after vintage transistor radios. Over 2,000 models, 400+ color photos, with current prices.* 1993, 256 pgs. ....NEW \$15.95
- Communication Receivers, 3rd Ed., Moore. *Information on 738, 1932 to 1981, vacuum tube receivers by 66 manufacturers. 402 radios illustrated. New section: 3 pages dedicated to military receivers.* 125 pgs. (Sharper, clearer photographs than 2nd ed.) .... (Available Dec.) NEW \$19.95
- The Compleat Talking Machine, Reiss. *A guide to restoration of antique phonographs.* 183 pgs. ....\$19.95
- Crosley Catalog (reprint). *1923 catalog covering the early Harko through the XX models.* 32 pgs. ....\$4.95
- Empire of the Air, Burns. (Videotape, VHS). *2-hour video based on Lewis' book.* ....\$24.95
- Empire of the Air, Lewis. *A biographical history of radio focusing on Lee de Forest, Edwin H. Armstrong and David Sarnoff.* 1991, illustrated, 421 pgs. .... (hardcover \$25.00) \$13.00
- Evolution of the Radio, L-W Books. *Radios pictured and priced, plus reproductions of catalog pages and ads.*  
Vol. 1 - Eight-hundred + radios. 1991, 227 pgs., 118 pgs. in color. ....\$22.95  
Vol. 2 - Totally different from volume one with new photos, etc. 1993, 654 color photos, 226 pgs. ....NEW \$24.95
- Firco Radio Equipment, John Firth & Co., Inc. (reprint). *Twenty-six-page booklet of the Firth Company with bulletins, descriptions of accessories and original prices.* ....\$4.95
- Fixing Up Nice Old Radios, Romney. *Written by an old radio instructor, this book covers Ohm's law, through battery sets, superhets and communications receivers.* 1990, 300+ figures, 185 pgs. ....\$19.00
- \* Flick of the Switch, McMahon. *The classic photo reference guide for collectors of radios from the '30s to the '50s.* 1000+ photos of radios. 263 pgs. ....\$11.95
- Great Radio Personalities (reprint). *Black & white portraits and info on all the favorites from the golden days of radio - Abbott & Costello, Baby Snooks, and more.* 128 pgs. ....\$11.95
- \* Guide to Old Radios - Pointers, Pictures & Prices, Johnson. *The latest book by the Johnsons describes the history of radio and includes 350+ photos and a price guide to 3300 sets.* 1989, 128 pgs. ....\$16.95
- Hake's Guide to TV Collectibles. *Price guide and illustrations for 1600 TV program premiums, games, puzzles, comic books, action figures, lunch boxes, toys and other collectibles.* 1990, 185 pgs. ....\$14.95
- Hallcrafters Co. 1932-1982; A Partial Product Listing Covering 50 Years of Production, 5th Ed., Dachis. *Listing of over 500 receivers, transmitters, televisions, speakers and accessories. No photos, 44 pgs.* ....\$12.50
- Hertz: The Beginning of Microwaves, Bryant. *Photos and descriptions of Hertz's apparatus and experiments. A book prepared for the IEEE Hertz Centennial exhibit.* 50 pgs. ....\$15.00
- Inventing American Broadcasting, Douglas. *A careful weaving of technology, social forces, and business decision making from the days of Marconi to broadcasting in the 1920s.* 1987, 363 pgs. ....\$14.95
- Jukeboxes - Obscure, Mysterious and Innovative American Jukeboxes, Adams. *First volume of a history of the lesser known manufacturers of phonographs, music boxes and jukeboxes.* 182 pgs. ....\$29.95
- Jukebox Art, Pearce. *The evolution of the jukebox from the coin-operated record changer to the flashing lights of the rock-and-roll generation.* 250 photos, 128 pgs. .... (hardcover only) \$29.95
- Jukebox Art Postcard Deck. *30 colorful photos from Pearce's book.* ....\$9.95
- Lawlor's Radio Values. *Price guide for radios in Collins & Sideli books.* 1991, no photos. 32 pgs. ....\$12.50
- Made in Japan, Handy. *A stunning book on the development and growth of the transistor radio featuring 175+ transistor radios in full color.* 1993, 108 pgs. ....NEW \$16.95
- The Mechanics of Television, Yanczer. *History and explanation of mechanical television, plus construction details for a working system.* 1987, 5 1/2" by 7 1/2", 170 pgs. ....\$20.00
- Most Often Needed 1926-38 Radio Diagrams and Servicing Information (reprint). *600+ diagrams for mostly AC radios from '26-'38.* 240 pgs. ....\$11.95
- Novelty Radios, Breed. *500+ transistor novelty radios in full color with current prices.* 1990, 217 pgs. ....\$24.95
- Official Radio Service Manual (reprint). *100s of pre-1930 circuits & notes.* 356 pgs. ....\$24.95
- Old-Time Radios! Restoration and Repair, Carr. *How to repair vacuum-tube and transistor radios. A self-paced training guide.* 200 illustrations, 256 pgs. ....\$16.95
- Philco Radio: 1928-1942, Ramirez. *A reference book on Philco. Shows receivers and company history year-by-year.* 464 color photos, 364 black & white photos and drawings. 160 pgs. 1993. .... (Avail. Dec.) NEW \$29.95
- Portable Radio In American Life, Schiffer. *Traces the development of the portable radio and how it affected American culture and society.* 450 photos and drawings, 259 pgs. .... (hardcover: \$45.00) \$24.95
- Price Guide to Plastic Collectibles, McNulty. *Describes types of plastics, etc. (Radio is 8 of 207 pgs.)* ....\$17.95

# COLLECTOR BOOKS AVAILABLE FROM ANTIQUE RADIO CLASSIFIED

BOOKS MARKED WITH "ES" ARE THE MOST POPULAR AND ARE ESPECIALLY RECOMMENDED FOR NEW COLLECTORS!

- RCA Radiolas, Radiotrons, and Accessories (reprint). Twenty-page booklet summarizing RCA's 1926 product line including the Radiolas III, 20, 25, 26, 28, etc. .... \$4.50
- Radio Art, Hawes. This outstanding book is a chronological, illustrated history of radio that celebrates the technical and stylistic progress of the radio. Although the coverage is mostly British, many American sets are featured as well. 9 1/4" by 12", 250 photos, 150 in color, 128 pgs. .... (hardcover only) Low Price! \$19.95
- Radio Art Postcard Deck. 30 full-color photographs from Hawes' book. .... Low Price! \$7.50
- Radio Collector. (Videotape, VHS). The five-part Emmy-nominated PBS series combined on one 130-minute videotape. Meet collectors, see collections, attend swap meets, learn about radio restoration. .... \$29.95
- Radio Collector's Guide, McMahon. Listing of 9,000+ radios made by some 1200 companies from 1921 to 1932. Gives manufacturer, year, model name and other info. No photos, 264 pgs. .... \$11.95
- Radio Craft - 50 Years of Radio (reprint). March 1938 issue of Radio Craft magazine. Numerous articles on the development of radio, then 50-years old, and on early radio pioneers. 144 pgs. .... \$15.95
- Radio Enters the Home, RCA (reprint). A 1922 catalog including the Aerials Jr. and Sr., the RA, DA, RC, Grand, etc., plus parts and accessories. 128 pgs. .... \$16.95
- Radio Equipment & Supplies, Robertson-Cataract Electric Company (reprint). 1922 catalog of radios, accessories and other equipment. Includes RCA, Clapp-Eastham & others. 168 pgs. .... \$19.95
- ES Radios-The Golden Age, Collins. Full-color book on the colorful Catalin and Bakelite radios from the late 1930s to the early 1940s. 128 pgs. .... (hardcover \$25.00) \$14.95
- ES Radio Manufacturers of the 1920's, Douglas. Three comprehensive volumes.  
 Vol. 1 covers A-C Dayton thru Ferguson. 225 pgs. .... (softcover only) \$24.95  
 Vol. 2 covers Freed-Eisemann thru Priess. 266 pgs. .... (hardcover: \$39.95) \$29.95  
 Vol. 3 covers RCA thru Zenith. 292 pgs. .... (hardcover: \$39.95) \$29.95
- Radio! Radio!, 2nd Ed., Hill. Revised easy-to-read subject index, separate A-Z directory listing of 1,000+ radio models with clearer photographs than first edition. 978 photos, 244 pgs. .... (hardcover only) NEW \$44.95
- Radio Redux, Collins. Subtitled "Listening in Style." This book showcases the sleek lines and luscious colors of over 80 glowing sets from the collection of Philip Collins. 120 pgs. .... (hardcover: \$29.95) \$17.95
- Radio/TV Finder, Okolowicz. This handy guide provides a ready reference to nearly 7000 pictures of collectible radios and TVs found in 24 popular collector books. No photos, 110 pgs. .... \$13.95
- Radio & T.V. Collector's Guide Book, Biraud. The "Vintage Radio" illustrated guide to European sets (very few British sets) from early wireless to the 1930s (a few later). Text is in both French and English.  
 Vol. 1 - Early History & Manufacturers A to P. 256 pgs. .... \$49.95  
 Vol. 2 - P to Z & T.V., Speakers, Tubes, Loops, Parts & Novelties. 256 pgs. .... \$49.95
- Radio & Television Price Guide, 1920 - 1990, 2nd Ed., Poster. 875+ TV's, 650 transistor radios and 2,200 other radios listed. 600 sets illustrated, 75 in color. 1993. 7" x 10". 264 pgs. .... (Avail. Jan.) NEW \$17.95
- Radios of the Baby Boom Era. Pictures and info from Sams Photofacts. 3494 radios illustrated plus 3275 additional radios listed. 274 brands. 1946 thru 1960. Six volumes, 300+ pages per volume. Order by volume:  
 Vol. 1: Admiral - Clearsonic. Vol 2: Co-op - Geloso. Vol 3: GE - Monitoradio. Vol 4: Motorola - RCA. Vol 5: Realtone - Stratovox. Vol 6: Stromberg-Carlson - Zenith. .... (Per Volume) \$16.95
- Radio Trouble Shooting, Haan (reprint). 1928 guide to troubleshooting battery sets. 317 pgs. .... \$14.95
- Refinishing Old Furniture, Wagoner. Written by a furniture restoration instructor. A step-by-step guide to furniture (or radio) restoration, from removal of finishes right up to the final polish. 178 pgs. .... \$13.95
- Syntony and Spark, Aiken (reprint). Subtitled "The Origins of Radio." Describes the development of radio from Maxwell's work in the 1860s through the contributions of Hertz, Lodge and Marconi. 1976. 347 pgs. .... \$13.95
- S. Gernsback Radio Encyclopedia (reprint). 1927 classic encyclopedia on radio. From "A" Battery to Zirconium, with 1000s of entries in between. 100s of illustrations, 175 pgs. .... \$11.95
- 70 Years of Radio Tubes and Valves, Stokes. The story of the radio tube from the laboratory to the commercial market. 247 pgs. .... \$25.95
- 75 Years of Western Electric Tube Manufacturing, Magers. A log book history of over 750 Western Electric tubes. Illustrated. 133 pgs. .... \$16.95
- Tomart's Price Guide to Radio Premium and Cereal Box Collectibles, Tumbusch. Includes comic character, pulp hero, TV and other premiums. 1991, 3000+ illustrations, 176 pgs. .... \$22.95
- ES Vintage Radio, McMahon. The classic photo reference guide for collectors of radios prior to 1930. Crystal sets, battery sets, tubes, horns, parts, etc. Over 1000 pictures, 263 pgs. .... \$11.95
- The Weekend Refinisher, Johnson. A complete guide to stains and finishes and tips for setting up your own workshop. A handy furniture "first aid" kit for quick repairs. Illustrated. 296 pgs. .... \$10.00
- Westinghouse Catalog (reprint). 1920s catalog of the RA-DA and other early Westinghouse equip. 8 pgs. .... \$4.00
- Wireless Communication in the U.S., Mayes. Early development of American radio operating companies. Alternators, coherers, stock promotions, unpublished letters, etc. 160 illustrations, 240 pgs. .... \$29.95
- Zenith Radio Corporation (reprint). The instructions for installation and operation for Models 39-39A Models 392-392A, and Electric Zenith Receivers. 3 schematics, 3 photos, 7 1/2" by 5", 16 pgs. .... \$4.50

U.S. Orders - Enclose \$2.50 per order for packing & book-rate shipping if total order is under \$35.00. If using VISA or MasterCard, include name on card, card number and expiration date. Send payment with order. Mass. residents please add 5% sales tax. Money back return policy. Most orders shipped the same day received, but allow 2-4 weeks to receive order. Foreign orders - write for shipping costs, or use credit card and specify air or surface (allow 2-3 months for surface shipping).



Send Order To: A.R.C., P.O. Box 2, Carlisle, MA 01741  
 or Call: (508) 371-0512 Fax: (508) 371-7129



(Dec-93)

BUYING TRANSISTOR & DECO RADIOS

VINTAGE TELEVISIONS  
BUY • SELL • RENT • REPAIR • PARTS



HARRY  
POSTER

DAYS: (201)794-9606

24 HRS: (201)410-7525

FAX: (201)794-9553

P.O. Box 1883 • South Hackensack, NJ • 07606

## MERRY CHRISTMAS AND HAPPY HOLIDAYS

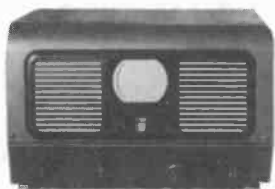

**FOR SALE:** Pilot TV-37, unusual 3" television from 1947, this one will turn everyone's head! It's **electronically restored**, works great, and best of all it has the original white picture tube! Priced at only \$315 postpaid! Harry Poster, PO Box 1883, South Hackensack, NJ 07606.



**FOR SALE:** General Electric, Model 810, from about 1948. Wooden table top with 10" CRT, a metallized 10FP4. Electronically restored and works well, nice low styling, the veneer is clean and original \$205+UPS. Harry Poster, Box 1883, South Hack., NJ 07606. (201)794-9606.

**WANTED: TRANSISTOR RADIOS.....**  
**We're adding to our 1000+ collection!**  
Any style, any condition, from: Mantola, Raytheon, Regency, Mitchell, DeWald, DuMont, Hoffman, plus many from: Bulova, Sony, Hitachi, Toshiba, Global, Realtone, Emerson! Buying tube/transistor sets, and sub-mini tube sets! **We pay \$100-\$500** for many sets in great condition. Harry Poster(201)794-9606

**FOR SALE: Plastics Institute 3-Volume reference set.** Printed in the 1940's--over 600 pages total--this lists it all! Has diagrams, blue prints and photos of machinery, processes and ingredients of plastic manufacturing, and **ACTUAL SAMPLES** of raw materials for plastics. A great reference source for every plastics/Catalin collector and a great starting point for the restorer/do-it-yourselfer. \$65 postage paid. Harry Poster: FAX (201)794-9553/Phone (201)410-7525.

**BOOKS FOR SALE!** A complete **PLASTICS** library! All clean hardcovers: **Modern Plastics**, 1949. 780 pages of chemicals, techniques, equip. **Plastics Problems and Processes** 1938 primer on use of various chemicals and projects. **Source Book Of New Plastics**, 1961. 300 pages of chemical companies, trade names and processes. **Plastics: Scientific and Technological**, 360 pages. 1946 discourse on chemical processes, equations, etc. **Plastics Molding**, 1933. Shows equip, calculating stresses, examples. **Plastics Business**, 1946. 440 pages of company information, methods, systems. Six books-3000pages **\$69 postpaid**. Harry Poster, Box 1883, South Hackensack, NJ 07606.

## Poster's RADIO AND TELEVISION Price Guide, 1920-1990 Second Edition

**3,500 prices including:**

650 Transistor radio prices  
2,200 Battery&AC tube radio prices  
875 Vintage Television prices

With 600 sets illustrated.

**Release by...Year's end!?!**



**Orsend \$18 to the author for your copy,  
shipped postpaid, when issued.**

256 page soft cover book  
Large 7" x 10" format  
ISBN #0-87069-687-4  
Publisher: Chilton Book Company  
\$17.95 from your local bookseller

# CLASSIFIED ADVERTISING POLICY

**ONE FREE 20-WORD AD** for subscribers in each issue; additional words are 17¢ each. See details below. Classified ads must be received (not just postmarked!) by **Noon Eastern Time** on the ad deadline. Late ads are held for the following issue. Please enclose correct payment with all ads. Stamps or cash are OK for small amounts. (Canadian and other foreign advertisers, please see "Payment" on page 2 for methods.) "Free words" cannot be accumulated from month to month; free words must be requested when ad is submitted.

**Please write each ad on a separate sheet of paper**, especially when included with other A.R.C. correspondence. Include SUB# with ad. Ads may be sent in advance; but, write each ad on a separate piece of paper and indicate the month (or successive two months) you want the ad to run.

**Please write legibly and use both capital and small letters. Do not use dashes between words.** Some numbers and letters can look alike, for example 1, l and I (the number one, the capital i and the small L.) Write the following characters clearly (especially in model numbers): 1, l and I; 0, O, o, Q and D; r and n; 6, b and G; V, U, u, v and Y; A and R; 5, S and s; 2, Z and z. We try to correct spelling errors, so when using an uncommon word or manufacturer which looks similar to a common word or manufacturer, note it so that we do not "correct" it. Editor's comments are in [brackets].

**Advertising is accepted only for early items related to radio, communication, etc. All items must be described fairly; reproductions, reprints and not-original items must be so identified. Advertisers agree to respond promptly to inquiries and orders, to resolve problems promptly if the buyer is not satisfied, and to comply with a buyer's refund request on unaltered returned items.**

Publisher reserves the right to edit ads without notification to the advertiser and to reject ads for any reason. Publisher is not responsible for errors due to illegibly written ads or for any other reason. Since club activities receive free advertising on the *Coming Radio Events* page, the free 20 words may not be used for club activity ads. See inside front cover for additional information.

## CLASSIFIED AD DETAILS

**Deadline: NOON ET—10th of the month!**

Classified ads must have a standard heading such as **WANTED, FOR SALE, FOR TRADE, FOR SALE/TRADE, SERVICES, MESSAGE, HELP, AUCTION, MEET**, etc. This heading is the only bold or all-capitalized words allowed in the ad. Capitalize only manufacturer names, model names, etc. Wanted and For Sale ads are mixed together to encourage the reading of all ads, including the Wanted ads. This standard ad format makes scanning the ads easier.

Before writing your ad, please look over the ads in a recent issue of A.R.C., and try to write your ad in the same style. Full name (or company name) and address is required in all classified ads; we will add it if you forget.

To encourage varied content of the ads, the same classified ad may be run only once per issue and for only two consecutive months. (To run an ad longer, use a boxed classified or display ad.)

### Classified Ad Rates per Month

Subscribers:

First 20 words: **FREE\***

17¢ per word for extra words over 20 **plus**

10¢ per word for a shaded ad (count all words including free words).

\* Subscribers may take 20 free words on only one ad each month.

Non-Subscribers:

33¢ per word **plus**

10¢ per word for shaded ad.

Please do not forget to send in the extra 17¢ per word when your classified ad runs over the free 20 words; your payment will be appreciated, and it will help to keep A.R.C. healthy.

## BOXED CLASSIFIED AD DETAILS

**Deadline: 1st of the month!**

Boxed classified ads can run unchanged for three months or more. No words are free. Ads may be shaded and may include bold and all-capitalized words freely. The ad need not begin with For Sale, etc. Minimum run is 3 months, prepaid. Discount: 5% for 6 months; 10% for 12 months.

### Boxed Classified Ad Rates per Month

Nonshaded ads:

28¢ per word for all words, \* none free, **plus**

10¢ per word for each bold word **plus**

10¢ per word for each all-caps word.

Shaded Ads (All words are bold at no charge):

38¢ per word for all words\* **plus**

10¢ per word for each all-caps word.

Non-Subscribers:

Add 20¢ per word to above costs.

\*Three words can be bold-all-caps at no extra charge.

## PHOTO & DRAWING DETAILS

**Deadline: 1st of the month**

**for all ads with drawings or photos!**

Drawings and photos are encouraged as the response to your ad is much larger and the reader knows better what you want or are selling. Send in your drawing or photograph, and A.R.C. will reduce it or enlarge it as needed.

### Photo and Drawing Rates per Month

\$10.00 per month for each photo or drawing

(If ad is canceled, this amount cannot always be refunded.)

## CHANGES & CANCELLATIONS

Please check your ads carefully before sending them in. Once ads are received, it is not always possible to refund the amount sent, pull the ad or make changes.

## IMPORTANT — COUNTING WORDS — IMPORTANT

The **standard headings**: WANTED, FOR SALE, etc., count as **one word** each time used in an ad. **Name, address** and (one) **telephone number**, count as **6 words**, regardless of length. Ham call letters and business name can be included in the 6 words and do not count extra. Full name (or company name) and address is required in all classified ads. Each additional word, abbreviation, model number or number group, extra telephone numbers, etc. count as **one word** each. Hyphenated words count as two words.

A.R.C., P.O. Box 2, Carlisle, MA 01741  
SECOND CLASS MAIL — RETURN POSTAGE GUARANTEED

