



# ANTIQUE RADIO CLASSIFIED



VOLUME 8

DECEMBER 1991

NUMBER 12



This is a Radio  
Season



THE NATIONAL PUBLICATION FOR BUYERS AND SELLERS  
OF OLD RADIOS AND RELATED ITEMS - PUBLISHED MONTHLY

## ANTIQUE RADIO CLASSIFIED

Antique Radio Classified (ISSN:8750-7471) is published monthly, 12 times per year, by John V. Terrey, 498 Cross Street, P.O. Box 2, Carlisle, MA 01741. Second-class postage paid at Carlisle, MA, and additional mailing offices. Telephone: (508) 371-0512, 9:00 AM to 5:00 PM ET weekdays; machine answers phone at other times.

Annual subscription rates within the U.S. are \$27.00 by Second Class mail and \$40.00 by First Class mail.

Annual foreign rates. By air: Canada - \$43.00; Mexico - \$43.00; Other foreign countries - \$75.00. Surface mail: Canada - \$35.00; Other foreign countries - \$38.00 (Surface delivery to countries other than Canada may take two or more months and cannot be guaranteed.)

Two-year subscriptions are twice these rates and receive an extra month. Sample issues are available free on request.

© Copyright 1991 by John V. Terrey.

POSTMASTER: Send address changes to Antique Radio Classified, P.O. Box 2, Carlisle, MA 01741.

### STAFF

Publisher and Editor:  
Production Manager:  
Publishing Staff:

Dick Desjarlais  
Bobby Lyman  
Shirley Sauer

Founding Publisher/Editor:

Contributing Writers:

Richard L. Arnold  
Paul J. Bourbin  
Dave Crocker  
Richard C. Foster  
Jim Kreuzer  
Henry Rogers  
Gil Schlehman  
Frank R. White

John V. Terrey  
Scott J. Young  
Dave Crocker  
Chris Frederickson  
Lisa A. Nelson  
Dorothy Schecter  
Gary B. Schneider  
Mike Adams  
Ray Bintliff  
Norman S. Braithwaite  
Alan S. Douglas  
David W. Kraeuter  
Ron Ramirez  
Ian L. Sanders  
Gary B. Schneider  
Ralph Williams

**PURPOSE.** Antique Radio Classified is published for people involved in the radio collecting hobby. Its purpose is to stimulate growth of the hobby through the buying, selling and trading of radios and related items, and to provide a monthly forum for the interchange of ideas and information.

**CONTACTING ANTIQUE RADIO CLASSIFIED.** All correspondence should be sent to:

A.R.C., P.O. Box 2, Carlisle, MA 01741.

Send only UPS, Federal, etc. items to 498 Cross St.

Telephone: (508) 371-0512; Fax: (508) 371-7129

Please no classified ads by telephone, thanks.

Your ads, renewals, letters, etc. can be handled faster and more efficiently if (1) each is on a separate piece of paper, and (2) your name, address and SUB# is written on each.

Unfortunately, A.R.C. is not staffed to answer letters

with questions about antique radios or requests for advice. However, A.R.C. does solicit letters of interest to its readers and publishes them as space permits. A.R.C. assumes that permission is given to edit and to publish all correspondence and articles received unless otherwise indicated.

**GUARANTEE.** You may cancel your subscription at any time and receive a pro rata refund for issues not yet mailed. If errors to ads are made by A.R.C., upon request a free correction will be run in the next available issue.

**PAYMENT.** Payment send in full payment with your order or ad. A.R.C. does not carry accounts; all subscriptions, ads, etc. must be prepaid. Pay in U.S. funds. Checks drawn on a U.S. bank, money orders, VISA or MasterCard (\$10.00 min.) are preferred. Make check out to "A.R.C." U.S. stamps or cash are OK for small amounts. Canadian payers may send a Canadian check in U.S. funds, but please add \$1.00 (U.S.) for bank charges. Subscriptions will be prorated to amount sent if amount is incorrect.

**CHANGE OF ADDRESS.** Please notify us 4 weeks in advance of a change of address. Send both your new and old address, and include your SUB# and effective date of your new address. Temporary address changes can be made also.

**SUBMISSION OF MATERIAL.** Antique Radio Classified welcomes and solicits information that pertains or relates to radio history or collecting. This may include articles, book reviews, photos, information on upcoming radio events, meetings, antique radio organizations, radio auctions and price reports, sources of old radio and restoration supplies, and other related and interesting material. All material submitted should be neat and verified for accuracy. Unless prior arrangements are made, all submitted materials may be edited, become the property of Antique Radio Classified and will not be returned.

**MAILING OF ISSUES.** U.S. subscribers can receive A.R.C. by First or Second Class mail (Second Class is the way most magazines are mailed). The mailing of First Class copies is staggered over one to four days with faraway copies mailed before local copies. Non-U.S. copies are mailed on the first day. Second Class copies are mailed on the last day. Mailing dates change each month, but mailing is usually completed by the 26th of the month. First Class copies usually are received by the fifth of the month; copies by Second Class mail, by the tenth.

**ETHICS.** No person involved in the production of A.R.C. is to act on any information in the magazine until the day after local copies are mailed.

**DISCLAIMER.** The publisher is not responsible for any buying and selling transactions incurred, or for any other use of the contents of this publication.

Antique Radio Classified subscription rates, frequency of publication, content, policies, size and ad details, and rates are subject to change at any time by A.R.C.

## DISPLAY AND BUSINESS CARD ADS - DETAILS AND RATES

*The deadline is the first of the month for display and business card ad artwork, payment and repeat requests.*

Advertising is accepted only for early items related to radio, communication, etc. All items must be described fairly; reproductions, reprints and not-original items must be so identified. Advertisers agree to respond promptly to inquiries and orders, and to resolve problems promptly if the buyer is not satisfied.

All advertising must be prepaid; see "Payment" paragraph above. Late ads will be run only if space and time permit. Since artwork is reduced to 63% in the printing process, originals must be the artwork size listed below. Do not send in artwork on art board or send negatives. Ads should be typeset or typed neatly with a carbon ribbon, black printing on white. No reverse type if A.R.C. is to make up the ad. If you want us to prepare your ad, include the one-time cost below for A.R.C. to make up the ad.

Photos should be at an 85 line screen; otherwise, add \$8.00 per photo for screening. (Do not cut or trim photos or glue photos to artwork; submit separately.)

If you are confused by these requirements and terms,

Page	ARTWORK SIZE (SEND IN THIS SIZE)		As Printed (size in magazine)		Cost for 1-month	Cost for 3-months	Cost for 6-months	One-time Cost for A.R.C. to make up Ad (if requested)
	H x W (inches)		H x W (inches)					
Full	12 3/16 (or 10 1/2)	x 7 1/2	7 3/4 (or 6 5/8)	x 4 3/4	\$145.00	\$390.00	\$695.00	\$50.00
1/2 H		5 1/4 x 7 1/2		3 5/16 x 4 3/4	73.00	197.00	350.00	25.00
1/2 V	12 3/16 (or 11 13/16)	x 3 9/16		7 7/16 x 2 1/4	73.00	197.00	350.00	25.00
1/4		5 1/4 x 3 9/16		3 5/16 x 2 1/4	37.00	99.00	177.00	13.00
1/8		2 5/8 x 3 9/16		1 5/8 x 2 1/4	19.00	51.00	91.00	7.00
Business Card		2 x 3 3/4		1 1/4 x 2 3/8	not avail.	27.00	48.00	5.00

please contact A.R.C. before beginning to prepare your ad. We will be happy to advise you on your ad ideas, estimate how much the ad will cost, recommend an ad size, etc.

We assume that advertisers want all ads which are submitted to run without delay; therefore, we will run the ad and bill for any additional work required for the ad to meet these specifications. A late ad will be run beginning with the next month. "Tear sheets" will be sent only for 1/2 and full page ads, and if requested when the ad is submitted.

Business card ads are limited to one per advertiser. The 3-month rates represent about a 10% discount, the 6-month rates, 20%. Placement requests for display ads: add 15% but call first. Clubs: write for discount policy.



## EDITOR'S COMMENTS

1991 has been another growth year for the antique radio community. A.R.C. now covers 48 U.S. antique radio clubs and has announced 213 club events in 1991. Attendance at meets continues to increase, and this growth is reflected in auction activity. Two recent auctions (the Antique Wireless Association and the Vintage Radio and Phonograph Society) grossed over \$50,000 each!

A.R.C. continues to grow also. Circulation for September 1991 (shown below in the *Statement of Ownership, Management and Circulation* required for magazines by the U.S. Postal Service) was 7,008 — 654 more than a year ago. Issues have grown too: the number of article pages is up about 14%; classified, boxed classified and photo ads — with over 750 in this issue — are up about 12%. We greatly appreciate the support of our subscribers who spread the word about A.R.C. and made this growth possible.

**In This Issue.** The Gonset Company six-page feature is by Tom Marcellino, who interviewed the grandson of Gonset's founder to obtain information and photos for his article, the first of two.

Coverage of transistor radios continues with Fred Geer's article on the Regency TR-1, the first transistor radio. In *Collecting Foreign Sets* Ian Sanders presents a description of the British Western Electric 2-step amplifier.

Something new is in store for you in *The Vintage Quiz*. See if you can identify the radio terms suggested by the cartoons.

*Restoration Topics* this month features cleaning with ammonia. Jack Clark and Charles Conte herald ammonia as "Stronger Than Dirt and Just About Anything Else, Too!"

The second part of "Will The Real Radio Boys Please Stand Up" is included this month. Mike Adams presents synopses of the remaining books in the Chapman Radio Boys series.

We also have Alan Douglas' book review of Tom Lewis' *The Empire of the Air*, a triple-biography of de Forest, Armstrong and Sarnoff. Alan's conclusion: "...it is the best book on radio history ever written." Public television will present a two-hour documentary based on this book on January 29, 1992, at 9 P.M. (local date and time may vary).

**New Display Ad Rates.** Display and business card ad rates will be going up about 25% on January 1, 1992. However, until January 1, the current rates (see the opposite page) will be honored for prepaid ads running for up to six months.

**Thanks!** One of the most enjoyable facets of publishing *Antique Radio Classified* is reading the kudos about A.R.C. that many of you include with your ads and letters. We are pleased that A.R.C. is an exciting part of your radio collecting activities. Thank you again for your support, and please keep sending us your comments about A.R.C.

I join the A.R.C. staff — Bobby, Chris, Dave, Dick, Dorothy, Lisa, Scott and Shirley — in wishing all of you a happy holiday season and a prosperous new year,

John V. Terrey

## ON THE COVER

The cover illustration is from an early 1920s magazine in the editor's collection. In fact, it is from the very same issue which provided the cartoons for the *Vintage Quiz* in this issue. We will credit this magazine in a future issue.

## STATEMENT OF OWNERSHIP, MANAGEMENT AND CIRCULATION

(1) Title of publication: Antique Radio Classified. (1B) Publication No.: 37507471. (2) Date of filing: Oct. 31, 1991. (3) Frequency of issue: Monthly. (4) Complete mailing address of known office of publication: 498 Cross Street, P.O. Box 2, Carlisle, MA 01741. (5) Complete mailing address of general business offices of the publisher: Same as #4. (6) Full names and complete mailing address of publisher, editor and managing editor: John V. Terrey, 498 Cross Street, Carlisle, MA 01741; Same; Same. (7) Owner: Same. Known bondholders, etc.: None. (9) not applicable.

10. Extent and Nature of Circulation	Average No. Copies Each Issue During Preceding 12 Months	Actual No. Copies of Single Issue Published Nearest to Filing Date
A. Total No. Copies (Net Press Run)	8688	8506
B. Paid and/or Requested Circulation		
1. Sales through dealers and carriers, street vendors and counter sales	0	0
2. Mail Subscription (Paid and/or requested)	6824	7008
C. Total Paid and/or Requested Circulation (Sum of 10B1 and 10B2)	6824	7008
D. Free Distribution by Mail, Carrier or Other Means (Samples, Complimentary, and Other Free Copies)	1375	949
E. Total Distribution (Sum of C and D)	8199	7957
F. Copies Not Distributed		
1. Office use, left over, unaccounted, spoiled after printing	489	549
2. Returned from News Agents	0	0
G. Total (Sum of E, F1 and 2 — should equal net press run shown in A)	8688	8506
11. I certify that the statements made by me above are correct and complete.	Signature and Title of Editor, Publisher, Business Manager, or Owner	
		

# COMMUNICATION RECEIVERS

## The Gonset Story — Part 1

BY F. T. MARCELLINO, W3BYM

*A.R.C. begins a two-part article on the history of the Gonset Company. F.T. Marcellino's careful research reveals the fascinating story of the Gonsetts, a father and son whose combined inventive genius contributed greatly to the electronics industry throughout the twentieth century. It is interesting to note that the final "t" in the family name is dropped in the company name. (Editor)*



Figure 1. The civil defense version of the famous Gonset 2-meter Communicator.

The adventure that lies ahead is the story of two men, Robert R. Gonsett and his son Faust R. Gonsett, and their numerous inventions and significant contributions to mankind.

Many of you probably remember the famous Gonset Communicator, alias the "Gooney Box" or "Gooney Bird," and how it expanded amateur radio's use of the VHF spectrum. The civil defense version is shown in Figure 1. You may also remember how the Gonset 10-meter converter found popularity in mobile use. These are but two examples of the many products produced by the Gonset Company for radio amateurs, the military, and the general public.

The research effort connected with this article was a pleasure because it put me in contact with many people who knew, and some who worked with, Faust Gonsett. Among them is Faust's son, Robert F. Gonsett, WA6QQQ, a major contributor to this effort. Bob's recollections about his dad and his companies were intensely clear. I am grateful for his assistance and cooperation.

The story of the Gonsetts is long overdue and fills a void in the history of early radio and electro-mechanical technology. To the best of my knowledge, most of the information contained in this story has never been published formally.

### ROBERT R. GONSETT — THE FATHER

Our story begins with Robert R. Gonsett, 1891–1951, who at the age of sixteen left his native land of Romania to seek a new beginning. He arrived in Canada in 1907, with only two dollars in his

pocket, and settled in the small village of Edmonton in the province of Alberta.

R. R. was an exceptional individual, inquisitive and very mechanically minded. At the age of eight, he built a musical instrument, and at age nine, he made a tricycle for himself.

In Edmonton, he used his carpentry skills, following the line of work his father had taught him in Europe. Recognizing his need for additional training, he completed a correspondence school course in architectural drawing

and studied electrical engineering at night school.

He made his first investment in 1908 by purchasing a plot of land for \$300. Two years later, during which Edmonton experienced a real estate boom, he sold the land for the sizable profit of \$9,000. He used the proceeds to buy another lot, construct a building and open a furniture store. However, the furniture business was a failure.

Undaunted, at the age of twenty, he started another business, a partnership in a motion-picture theater. This venture was short-lived because he lost the business to his partner in a game of chance. Then, due to his skill as a projectionist, he was hired by a theater in Edmonton.



Figure 2. The first Gonset laboratory, ca. 1910, in Edmonton, Canada.



Figure 3. R. R. Gonsett in 1920 with his combination phonograph, radio, and lamp.

In those early days, changing reels of film took a fair amount of time, and the audience became impatient with the delays. R. R. solved this problem by inventing a self-threading motion-picture projector which revolutionized the industry. His first model was made in the laboratory building shown in Figure 2. The building previously served as a chicken coop. Yes, a real chicken coop, complete with insect infestation. So, he moved the coop to a friend's lot, fumigated it and opened his laboratory.

In 1916, Gonsett and his family left Canada for the United States where he believed greater opportunities awaited. They lived in several places, including Chicago and Detroit, before settling in Los Angeles in 1923. While living in Detroit, R. R. developed and manufactured an electric phonograph, among other things. Figure 3 shows R. R. in 1920 with his combination phonograph, radio and lamp.

In Los Angeles, the family first purchased a small lot and built a two-car garage. One garage was used for living quarters, while the other unit served as a small laboratory for R. R.

After this modest beginning, Gonsett estab-



Figure 4. F. R. Gonsett at work in the plant in the early years.

lished his own place of business under the name of Gonsett Research Laboratory. In this new facility, he conducted research, developed his own inventions, and fabricated the inventions of others. Some of these inventions were not accepted readily because his concepts were ahead of their time. For example, he developed electrically operated shears for cutting fabrics, but it was difficult to market this product during the Great Depression. However, he later entered into a patent licensing agreement with the Singer Sewing Machine Company.

R. R. was a prolific inventor and had fifty patents to his credit, including such diverse products as a soap dispenser and a vibrator used in health and grooming products. Although these patents expired many years ago, consumers are still enjoying the fruits of his fertile mind. It is noteworthy that R. R. Gonsett was always self-employed. He created not only products, but jobs for others as well.

### FAUST ROBERT GONSETT — THE SON

Our story continues with the introduction of Faust Robert Gonsett, 1916–1963, the designer



Figure 5. A Beverly Hills patrolman and F. R. Gonsett with a two-way mobile radio in 1939.

of the famous Gonset 10/11-meter mobile converter and the Communicator line of amateur radio transceivers. Figure 4 shows Faust Gonsett at his desk in the Gonset plant.

Faust became interested in radio at an early age and learned much from his father, the engineer and inventor. In 1930, at the age of fourteen, he became a licensed amateur radio operator. His call sign was W6DIZ, later changed to W6VR. He enjoyed operating his amateur station on both code (CW) and voice modes.

After graduating from Los Angeles High School, Faust studied at the Frank Wiggins Trade School, also in Los Angeles. He earned two FCC commercial radio licenses — a First Class Radio Telephone and a First Class Radio Telegraph.

In the late 1930s, Faust became associated with the Beverly Hills Police Department as a radio

(Continued on following page)

*(The Gonset Story, continued)*

technician. He designed and installed two-way VHF radios in the department's motorcycles and patrol cars. A typical motorcycle installation is shown in Figure 5. Prior to the installation of Gonsett's equipment, the Police Department was limited to one-way communication with its motorcycles and patrol cars; radio messages could be transmitted to these field units, which could not reply because they carried only receivers.

The Gonset two-way radios all operated on the 8 1/2-meter band (35 MHz), contained five tubes, and weighed about seven pounds. The January 14, 1940, issue of the *Los Angeles Times* stated that "...the police radio equipment is the most up-to-date in the United States and Beverly Hills has the only Police Department in the world completely equipped with two-way radios on motorcycles as well as 'prowl' cars."

In addition to the mobile radios, Faust was responsible for the installation of radio equipment at police headquarters for which he designed and built a soundproof radio operating room. An unusual feature of the Gonsett-designed system was its ability to relay transmissions from the Los Angeles police radio to the Beverly Hills police radio. This feature resulted in improved coordination between the two police departments.

While serving as Chief Engineer for the Beverly Hills Police Department, Faust also worked for *Radio* magazine, a predecessor of *CQ* magazine. From 1936 to 1940, he contributed articles dealing with the construction of dozens of pieces of radio equipment. Probably his most popular articles dealt with the construction of a 10-meter mobile rig. He also wrote several articles for *Popular Science* and other hobby magazines. At the age of 26, he co-edited the 1942 edition of *The Radio Handbook*, published by Editors and Engineers of Santa Barbara, California.

From 1942 to 1951, the year R. R. died, the father and son team were active in the design and production of electronic equipment. They made significant contributions to military electronics and developed a reputation as manufacturers of quality amateur radio equipment.

### THE WAR YEARS

Founded by a group of investors early in 1942, Aircomp Ltd. (short for "air computer") had its headquarters and shop facilities in Burbank, California. See Figure 6. The company's primary



Figure 6. Aircomp Ltd., Burbank, California, 1942, where the Gonsetts developed the Aircomp computer.



Figure 7. Waterproof remote control switch box with special spring bands around the rubber to prevent water entrance.

product was a device used to compute load weight and load distribution for aircraft. Proper distribution of cargo and the calculation of gross weight were important considerations for flight safety. Aircomp's computers were used extensively in the Douglas DC-3 and saw service during World War II in support of the DC-3's military version.

Aircomp had received a government contract to refine the aircraft load computer, but its efforts were not successful. The company was experiencing financial difficulties and sought the managerial and technical expertise needed to complete this project. The Gonsetts offered their help and were given the responsibility for the computer project.

The agreement between the two parties was quite novel. The Gonsetts agreed to develop the computer and to work without compensation until the government accepted the computer model. Aircomp management granted the necessary authority to the Gonsetts and agreed to provide the resources necessary to complete the project.

The Gonsetts prevailed. After months of hard work, the first working model of their computer was submitted to Wright Field for testing and evaluation. The unit performed flawlessly. As a result, Aircomp received a production contract. This contract brought badly needed financial help and breathed new life into the company. Special tooling and equipment were developed, and production of the computers began.

The contract was completed on schedule and led to additional contracts. Some simple statistics show the results of the Gonsetts' labors. In 1942, Aircomp employed only eight people. During the production phase, employment soared to more than 100 workers.

The Gonsetts left Aircomp in early 1944 and formed a company of their own, the Waterproof Electric Company. This company, as the name implies, engaged in the production of military radios which required protection from the elements.

The company successfully designed, developed and produced military radio communication



Figure 8. R.R. Gonsett with his toroid coil winder, now on display in the museum of the University of Alberta, Canada.

sets capable of reliable performance under harsh environmental conditions. The sets were used on motor vehicles, barges, and other amphibious craft throughout the world. Reliable performance was paramount because the sets were used to pass vital command orders and emergency communications.

These radio sets were housed in waterproof aluminum boxes. The fabrication techniques used in the manufacture of these boxes, including the welding process, were developed by Waterproof Electric and were later applied to amateur radio equipment.

When installed in Jeeps, the radio sets employed a remote control box which featured waterproof covers for switches and microphone/headphone jacks, as seen in Figure 7. Although Faust held patents for these covers, the patents were not as important to the company's success as the product's timeliness in the marketplace.

Government contracts were responsible for the company's rapid growth. At one time, the compa-

ny was working on five U.S. Navy contracts, two prime contracts and three sub-contracts.

Faust's son, Robert (Bob) F. Gonsett, recalls rows of Jeeps parked at the plant awaiting the installation of radio sets, as well as a pool through which outfitted Jeeps were driven for immersion testing. This testing approach was characteristic of the Gonsett philosophy: Keep all tasks simple and practical.

In addition to his activities at Waterproof Electric, Faust was employed as the Technical Supervisor of Radio Equipment for the city of Beverly Hills and as a consulting engineer for the T.W.T. Company of Los Angeles, a prime contractor of military equipment.

During World War II, R.R. Gonsett made a major contribution to the production of radar equipment by developing a toroid coil winding machine. Toroid

coils consist of multiple turns of wire wrapped around a ring-shaped form called the torus. In this case, the government requirements called for an automatic coil winder capable of wrapping wire the size of a human hair around the form.

Working with such fine gauge wire called for great precision. For example, if the exact wire tension was exceeded, the wire would break and the coil would be rejected. And there were other difficulties. Because some of the parts were extremely small and delicate, the builders had to wear powerful magnifying glasses. In addition, locating some needed materials was very hard because of shortages created by the war.

R. R. persisted, and after several redesigns, he developed a coil winder capable of producing the much needed toroid coils. His coil winder could automatically wind a toroid in ten minutes — less time than it took an operator to set up the machine for the next coil. R. R. and his coil winder appear in Figure 8. The coil winder is now on display in the Provincial Museum and Archive of the University of Alberta, Canada.

In recognition of their contributions to the war effort, the Gonsetts were awarded the U.S. Navy Certificate of Commendation shown in Figure 9.

#### AMATEUR RADIO — THE POSTWAR YEARS

After World War II had ended, the Gonsetts stepped up the design and production of amateur radio equipment under the Gonsett name. They purchased the physical assets of Aircomp, and their Waterproof Electric Company became the manufacturing facility, while the Gonsett Company served as the sales organization. A picture of Gonsett's main plant appears in Figure 10. The front of a smaller secondary plant displayed both the "Gonsett" and "Waterproof Electric" signs.

Prior to the war, Faust had designed and manufactured a popular converter using the name

(Continued on following page)



Figure 9. U. S. Navy Certificate of Commendation awarded to F.R. and R.R. Gonsett in 1947.



Figure 10. The Gonset Company main plant in Burbank, California.

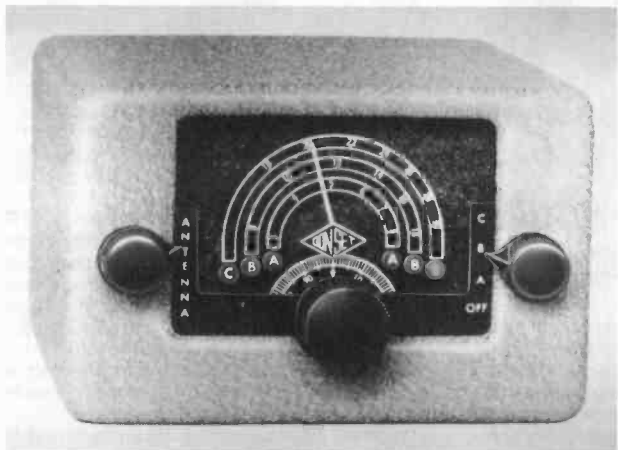

Figure 11. The Gonset 3-band converter, tuning from 3 to 30 MHz.

(The Gonset Story, continued)

"GON-SET." With the end of the war and renewed interest in amateur radio, he introduced the 10/11-meter converter. Designed to extend the range of surplus military receivers, whose upper frequency limit was typically 18 MHz, this version of his converter was extremely popular. Sales numbered in the thousands. This unit first appeared for sale in the September 1946 issue of *QST*. It was priced at \$39.95. The ad copy read "GON-SET converters have been manufactured since 1938 and are used worldwide. Long experience together with precision design and construction assures a superior product. Ideal for surplus receivers." An optional noise silencer was available for \$8.25.

A new converter, the GONSET 3-30 Mobile Converter, was introduced in 1948. It carried the same price tag as its predecessor but provided coverage on the 80- to 10-meter amateur bands.

Illustrated in Figure 11 is another of the company's converters. This 3-band converter tuned from 3 to 30 MHz. In the April 1965 issue of *73* magazine, William Kennedy, W3ZFJ, an avid ham, wrote how he had built a complete receiver around his Gonset 3-band converter. His article "The Converted Converter" demonstrates the versatility of a ham operator, as well as of this converter.

The November 1952 issue of *CQ* magazine carried an advertisement for "The new GONSET 2-meter XMTR-Receiver" priced at \$189.50. My research indicates this is about the time frame of the introduction of the famous Gonset Communi-

cator. Could Faust have known how popular this transceiver would become?

## THE GONSET COMMUNICATOR

The Gonset Communicator featured a single frequency crystal-controlled transmitter and receiver. The Communicator was comparatively small, measuring 8.5" x 10.25" x 6", and contained a dual power supply which permitted operation on either 120 vac or 6 vdc. Power output was rated at 12 watts on Amplitude Modulation (AM).

It appears that two models of the Communicator may have been available at that time. The same issue of *CQ* carried a second ad for a communicator which differed from the unit described above, although it carried the same price tag. The power output was rated at 15 watts, and it was larger in size, measuring 10.25" x 9.25" x 7".

Bob Gonsett is fortunate to possess the prototype of one of these units. The prototype had been the property of his father, Faust, who kept the unit under lock and key.

From 1952 until 1960, Gonset produced a series of 2-meter communicators beginning with Model I and progressing to Model IV. The Model II is shown in Figure 12. The Communicator IV was produced after Gonset became part of the Altec Lansing Company in 1961. This model, the last of the Communicator line, was a completely repackaged set. It boasted a 6360 tube in the final amplifier and produced a higher output of 12 to 14 watts. Variations of the Communicator series were produced.

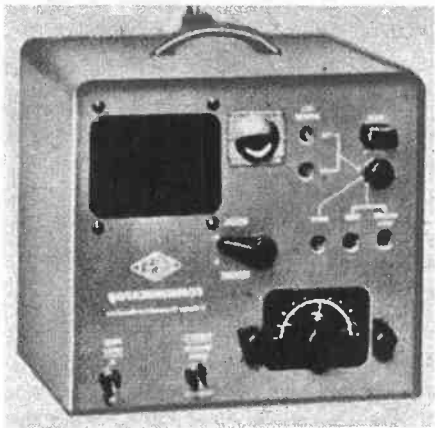

Figure 12. The Gonset Communicator II, from a 1954 Allied Radio Catalog.



for civil defense, the Civil Aeronautic Patrol (CAP) and for industrial use.

Six-meter and 10-meter versions were also manufactured. Designated the G-50 and the G-28 respectively, these transceivers offered the flexibility of VFO control and higher power (48 watts input). These units used a 6146 tube in the final amplifier while the smaller 2E26 was used in the 2-meter communicators.

### GONSET AMPLIFIERS

Following the end of World War II, the surplus market was flooded with military radio equipment and vacuum tubes. One tube, the 826 power triode, was available in substantial quantities and priced accordingly. While its specifications were not particularly impressive, Faust Gonsett, in his typical fashion, could not ignore this large source of supply. So, he utilized the 826 tubes in a popular line of 2-meter and 6-meter linear amplifiers. When hooked up to one of the company's communicators, these amplifiers increased the RF power output to 50 or 60 watts on AM and 80 to 100 watts on CW.

These extremely rugged units were built on a  $\frac{3}{16}$ "-thick welded aluminum chassis and mounted in a steel case similar to those developed by the Waterproof Company. Taking the simple approach that we discussed earlier, Faust omitted meters from the amplifier, but provided a window through which the plates of the two 826 tubes could be viewed for tuning purposes. He also provided a rear-panel jack into which a meter could be plugged to monitor plate current.

Without the plug-in meter, amplifier tuning was accomplished simply by watching the color of the tube plates. When adjusted properly, the plates glowed orange. If the color changed to yellow, the operator knew that retuning was required. Again, instead of a meter, a #47 pilot lamp served as a modulation monitor with the lamp glowing more brightly as the modulation level increased.

The appearance of the amplifiers changed along with that of the companion communicators. The early amplifiers were painted grey and used red knobs to match the Communicator Models I and II. The second series was painted white and used blue knobs just like the Communicator III. Amplifiers and communicators were also produced for civil defense use. A companion amplifier to the CD version of the Communicator is shown in Figure 13. These ubiquitous models were painted a bright yellow.

Another Gonset-produced amplifier failed to gain the popularity of the VHF units, possibly because of a \$399 price tag and because Faust tried to stuff too much into one box. This amplifier, produced in the mid-1950s, covered nine amateur radio bands from 160-meters to 2-meters.



Figure 13. The Gonset CD Amplifier.

The inclusion of both VHF and HF coverage in a single amplifier was a departure from the customary amateur radio practice. The amplifier used four 807 tubes rated at 250-300 watts peak envelope power (PEP) on single-sideband (SSB), 220-240 watts on CW and 80-100 watts on AM. This rack-mounted amplifier was extremely bulky and heavy.

(To be continued)

(F. T. Marcellino, 13806 Parkland Dr., Rockville, MD 20853)

A.R.C. is grateful to Robert F. Gonsett for supplying most of the photographs in this article. We apologize for the quality of some, as photocopies were the only ones available.

#### References and Consultants:

- Allied Radio Catalog, 1954
- ARRL Handbooks, 1940 through 1960
- CQ Magazine, November 1952
- CQ Magazine, 1954
- Robert F. Gonsett, Fallbrook, CA
- Mickey McDaniel, San Diego, CA
- 73 Magazine, April 1965
- 73 Magazine, July 1965
- QST Magazine, September 1946

F.T. (Tom) Marcellino, a Senior Test Engineer, has been involved with component screening and inspection of high reliability space electronics for the past 30 years. A licensed amateur for 36 years, he holds an Extra class ticket. Since 1980, Tom has been collecting and restoring antique radios, specializing in vintage communication receivers. He has contributed many amateur radio construction articles to magazines.

# WITH THE COLLECTORS

## Evolution of the Transistor Radio Smaller Is Better

BY FRED GEER

*Fred Geer traces the beginnings of solid-state devices which led to the development of the first transistor radio. As Fred puts it, transistors revolutionized radio, but transistor radios personalized the way we listen to radio. (Editor)*

Nearly all radios today, of course, use solid-state devices. But, it may not be commonly known that radios used solid-state devices as early as 1907 when Pickard invented the mineral or crystal detector. Vacuum tubes sidetracked solid-state development until Bardeen and Brattain of Bell Laboratories developed a point contact transistor in 1948. Their transistor would revolutionize radio, but it was first used in hearing aids as the audio output.

A first is hard to document. But, the first all-transistor radio project began in June 1954 and was cloaked in secrecy. Many companies were involved under the umbrella of I.D.E.A. Inc., of Indianapolis. Painter, Teague & Petertil, industrial designers, who worked in secret with their suppliers, achieved miniaturization of components for the first all-transistor radio, the TR-1.

This set shown in Figure 1 was sold under the Regency label. Sanford Electronics in New York and Gough Industries, Inc., in Los Angeles were the first distributors. The selling price in December 1954 was \$49.95. The available colors were green, red, blue, ivory, gray and a red-dish walnut.

Texas Instruments was the first to develop a mass produced, low cost, high gain, high frequency germanium transistor. These NPN transistors provided the 30-40 decibel gain needed in the IF and audio stages. Defects plagued the first mass-produced transistors and diminished the public's confidence. As with any new technology that develops defects, the company replaced the first few thousand defective transistors. Public assurance that transistors were dependable was restored.

The Regency Model TR-1 used four transistors and a germanium diode. It was 3" x 5" x 1.25" and used a 22.5-volt battery that lasted

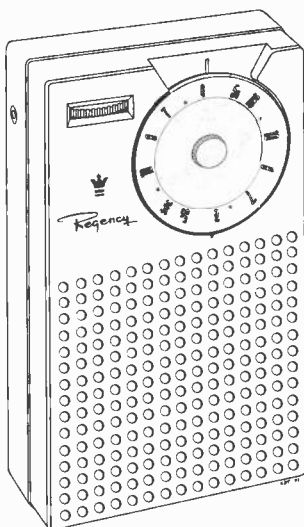

*Figure 1. Regency Model TR-1. This first all-transistor radio, announced in the fall of 1955, changed the way we listen to radio.*

about forty-five hours. Each transistor had a specific job. The first transistor is a TI223 which is the oscillator and converter. Radio Condenser Co. of Camden, New Jersey, made the miniature two-ganged tuning condenser. The IF stages used two TI222 transistors and three tiny IF transformers made by the Vokar Corp. of Dexter, Michigan.

The audio signal is developed across a 1000-ohm volume control made by Chicago Telephone Supply Corp. of Elkhart, Indiana. Centralab of Milwaukee provided the tiny ceramic capacitors. A TI210 developed enough audio power to drive the diminutive Jensen permanent magnet speaker seen in Figure 2. Components were assembled by a semiautomatic process using printed wiring and dip soldering techniques.

Claims made for the first all-transistor set were the following: long battery life, reduction in weight, lower operating cost, and long-lasting transistors.

Time has tested those early radios and only a

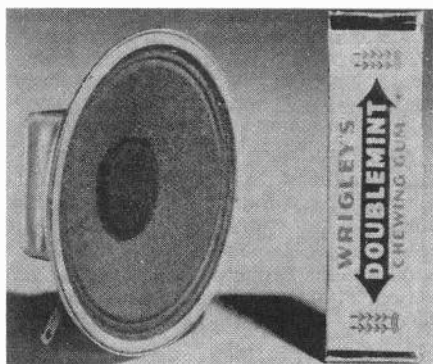
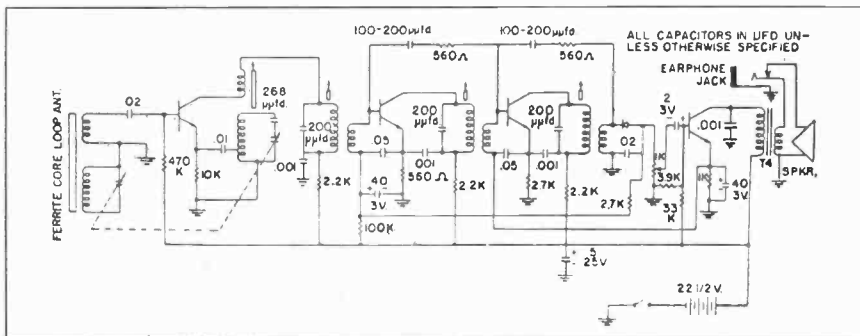

*Figure 2. This P275-Y Jensen speaker, 2.75 inches in diameter, was developed for the Regency TR-1. It has a 16-ohm voice coil and weighs less than 2.75 ounces. (Photo from "Radio and Television News," March 1955.)*

## A New Pocket Radio

"Slightly smaller than a teacup...this all-transistor broadcast receiver weighs less than twelve ounces and is the first available for consumer use."

"Another advantage claimed by the manufacturer is the elimination of tubes and the problem of tube replacement. While the hot filament or cathode in a vacuum tube is continually consumed during operation, no similar phenomenon occurs in transistors. Except for physical damage, transistors will last indefinitely."



Complete schematic for the Regency Model TR-1.

A.R.C. is grateful to Gene Claus for a reprint of the January 1955 issue of "Radio & Television News" from which we culled the schematic and this boxed information.

few defects, such as the following, have shown up: open interstage transformers, broken power switches, rusty battery contacts, and missing cabinet parts. Keep in mind that transistor radios did not sit in a protected living room, but went everywhere that people went. Transistors changed the way we listen. Radio became personal. Smaller is better!

I want to thank Harold Herp for furnishing me information on the Regency TR-1.

#### References:

McMahon, M. E., *Vintage Radio*, 1973, p. 66.

*Radio & Television News*, May 1956, April 1956, Jan. 1955.

(Fred Geer, 6042 Brookridge Rd., Jacksonville, FL 32210)

Fred Geer's radio collecting began in 1953 with a Shure microphone and an RCA R-32. Through his articles in A.R.C., he likes to help others explore various aspects of collecting and radio history. In addition to his radio collection, Fred owns around two thousand old-time radio programs, which he can broadcast to any radio in the house.

## LETTERS - RESTORING WOODEN RADIOS

Dear Editor:

Here is another "Restoring Wooden Radios" tip. Reading the letter on restoring wooden radios in the January 1990 issue prompted me to write.

About 20 years ago, I acquired a Majestic lowboy, Model 90B. The top of the cabinet was quite dirty and had several scratches. The sides were in good condition.

I had never undertaken the challenge of restoring the finish on an old radio, and as far as that goes, this was my first real "antique radio." I spotted a can of automotive rubbing compound on the shelf in the basement. I pondered for some time. I reasoned, "If it is safe enough for auto finishes,

what will it do for varnish?"

First, I made a small pad with some cloth, and then I got started, working a small area at a time. (You will feel a gritty sensation as the compound works; then, all of a sudden, the surface will feel slick.) This process requires a lot of elbow grease, and you will want to stop and do something else for a time. I even go over the cabinet a second time.

The resulting finish is clean and shiny, so much so that you do not even need to follow up with a wax or polish. I might add though that I do hide the small scratches with "Old English Scratch Cover and Polish."

Glen M. Nichols, Lynnwood, WA

## The Western Electric Loudspeaking Power Amplifier

BY IAN L. SANDERS

*In his continuing series on radios produced in Great Britain, Ian Sanders introduces equipment manufactured by the Western Electric Company, Ltd., to suit the British market. (Editor)*

The radio products manufactured and distributed by Western Electric in the U. S. between 1920 and 1927 were covered in an excellent, two-part article by Charles Fisher in the April and May 1989 issues of A. R. C. In the United Kingdom, however, the Western Electric Company, Ltd., manufactured a different range of radio equipment tailored to the British market.

This product line included the Model 44001 crystal receiver (1922), the 44002 battery super-het (1924), and a family of "Weconomy" receivers and amplifiers using the miniature, dry cell-operated Weco valve, the British-made adaptation of the 215A peanut tube. A 2-valve and 3-valve Weconomy receiver, as well as 1-, 2-, and 3-valve versions of the Weconomy amplifier (Models 44011, 44012, and 44013, respectively), were introduced in 1923. The 2-valve Model 44014 amplifier is the subject of this article.

---

**"The volume of sound could be adjusted 'from a quiet conversational tone to an intensity sufficient for dance purposes or garden parties...'"**

---

The 2-valve loudspeaking power amplifier, Model 44014, which used U. S. manufactured WE 216A tubes, was also introduced in 1923. It provided greater amplification than the Weconomy models, but at the expense of significantly higher filament power consumption.

Designed for both domestic and commercial operation, the loudspeaking amplifier, as described

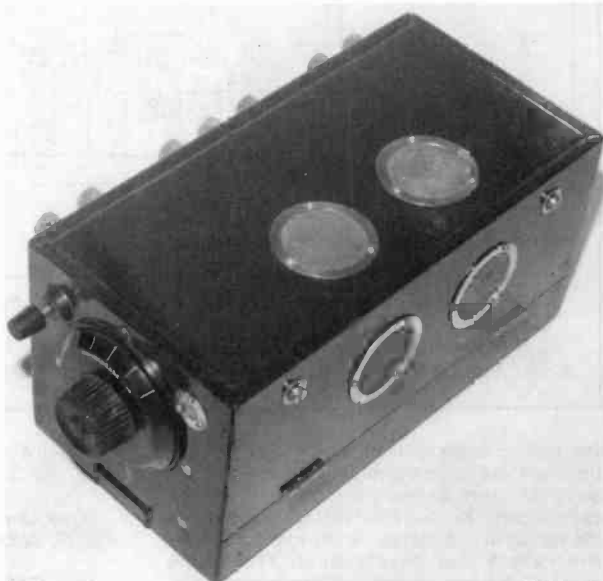

Figure 1. The Western Electric power amplifier.



Figure 2. View showing the controls of the Western Electric power amplifier.

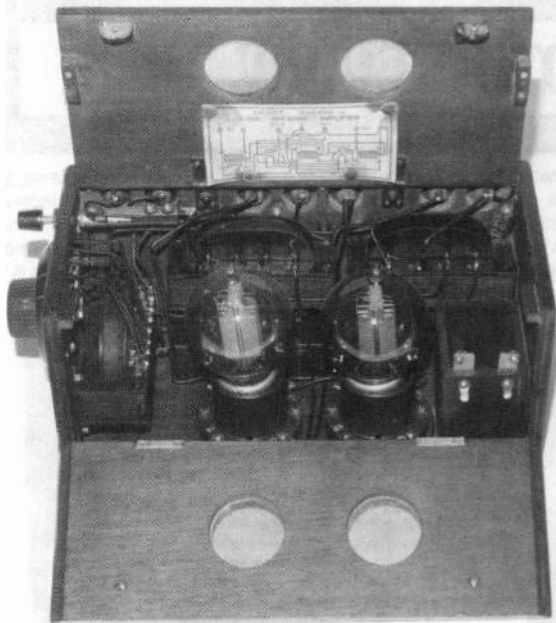

Figure 3. Internal view of the Western Electric amplifier with the top and frontpiece opened showing the two Western Electric Type 216A tubes.

in an early advertisement, was "primarily for private use, but its power is such that it has been used with success in hotels and public buildings..." The volume of sound could be adjusted "from a quiet conversational tone to an intensity sufficient for dance purposes or garden parties..."

The power amplifier is shown in Figures 1 and 2. The set is built in a highly polished mahogany cabinet measuring 5" x 5" x 10", with a lift-up lid and hinged drop-down frontpiece. Brass-trimmed portholes for observing the valve filaments are provided in the lid and front. The amplifier carries the ubiquitous BBC stamp of approval, and the set in this author's collection bears the Post Office Registration Number 3006 on the front panel beneath the volume control. (Interestingly, the unit described by Jonathan Hill in his reference

speaker appears to be the British equivalent of the well-known 518W horn loudspeaker distributed in the U. S.

The selling price of the unit in 1923, including two 216A tubes, less batteries, was £24 — about \$45 at today's exchange rates. If we bear in mind that an average working person's wage in Britain at that time was around £2 per week, the Western Electric loudspeaking amplifier was definitely a luxury item!

Reference:  
Hill, Jonathan. *Radio, Radio*. Sunrise Press, 1986.

(Ian L. Sanders, 16725 Wild Oak Way, Morgan Hill, CA 95037)

Ian Sanders started collecting in 1974 when he was still living in the United Kingdom. His first homebuilt, 2-valve (tube) set he bought for £2 — about \$4. From then on, he was hooked on crystal sets and battery receivers of the early 1920s, and he has continued to collect them since moving to the U. S. in 1977. His collection contains both European and North American sets, although he favors British sets for the quality of the cabinet workmanship.

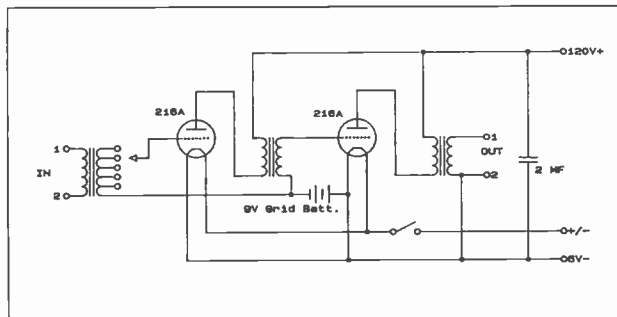

Figure 4. Circuit diagram of the Western Electric amplifier.



# PHOTO REVIEW



This column presents in pictorial form many of the more unusual radios, speakers, tubes, advertising, and other old radio-related items from our readers' collections. The photos are meant to help increase awareness of what's available in the radio collecting hobby. Send in any size photos from your collection. Photos must be sharp in detail, contain a single item, and preferably have a light-colored background. A short, descriptive paragraph **MUST** be included with each photo. Please note that receipt of photos is not acknowledged, publishing is not guaranteed, and photos are not returned.



**RCA VICTOR MODEL 121** - Built in 1932, this is one of the most impressive RCA cathedrals. The band selector is a pull switch. Unlike so many RCA models of the early 1930s, the chassis on this model is more accessible. (Fred Geer - Jacksonville, FL)



**EARLY CROSLY** - This is a 1922 two-step amplifier. The construction is rather crude with non-Crosley (but correct) knobs. Even the binding posts are different from the familiar Crosley type. The cover lid overhangs the panel, which did not have the Crosley name. (Dave Crocker - Duxbury, MA)

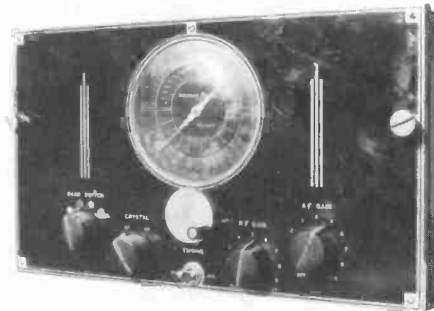

**WESTERN ELECTRIC TYPE 20A** - The serial number on this communications receiver is 175, and the newest patent listed is 1933. I date the radio in 1935. The set uses five standard radio receiver tubes (not Western Electric) and runs from a separate power supply through a connector like the one used in Scott radios of that era. It covers long wave, the AM band, and shortwave up to 18 MHz. (Ron Boucher - Goffstown, NH)



**SILVERTONE MODEL 132-018** - A metal cabinet painted ivory with a maroon dial and red lettering made this 4-tube superhet AC/DC set a real buy in 1946. (Fred Geer - Jacksonville, FL)

---

## PHOTO REVIEW

---

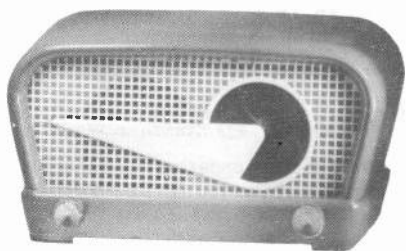

**PHILCO TRANSITIONE MODEL 48-703** - This radio came in a maroon, glass-like, plastic cabinet that was easily broken. Its cabinet was also used in Model 49-503 and came in black and green. *(Fred Geer - Jacksonville, FL)*

---



**PHILCO MODEL 20** - Also known as the "Baby Grand," this AC-operated TRF set, made in 1930, was Philco's first cathedral radio. It uses seven tubes and covers the broadcast band. *(Ron Ramirez - Providence, KY)*

---

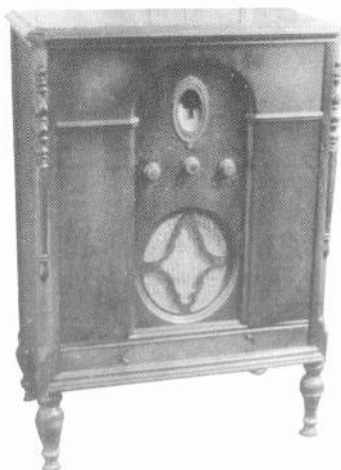

**MAJESTIC MODEL 71** - The Grigsby-Grunow Co. of Chicago, Ill., made this TRF receiver in 1928. It uses eight tubes, including a Type 80 receiver in the separate power supply, mounted at the bottom of the cabinet. *(Ron Ramirez - Providence, KY)*

---

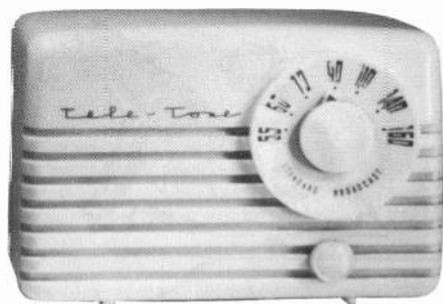

**TELE-TONE** - Produced in 1947, the Tele-Tone has an ivory plastic cabinet with black lettering. This 4-tube superhet radio shows what can be done with very few materials and parts. *(Fred Geer - Jacksonville, FL)*

---

**HERALDYNE** - Manufactured in the mid-1920s by Brenard Manufacturing Company of Iowa City, Iowa, this is a typical five-tube, three-dial Neutrodyne set of the period. Battery operated, the set was in working condition when I acquired it. Brenard was just one of several radio companies that came and went in the 1920s. *(Ron Ramirez - Providence, KY)*

---

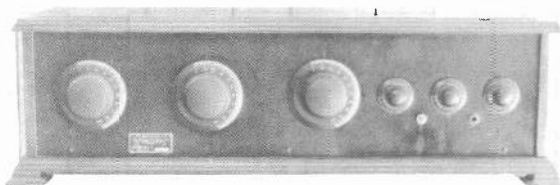

# VINTAGE QUIZ

## Enter A Rare Holiday Quiz

For a bit of holiday fun, A.R.C. is rerunning this radio term quiz which appeared in a magazine of the 1920s. Can you identify the radio terms suggested by these cartoons? Can you name the publication and issue in which the contest ran? Mail your answers, along with your name and address, to A.R.C., P. O. Box 2, Carlisle, MA 01741. In a later issue, we will print the answers, as well as the names of those who sent in the largest number of correct answers. Try for a perfect score! This must have been a very popular contest in its time because the first prize was \$190 worth of radio — a lot of radio in those days!

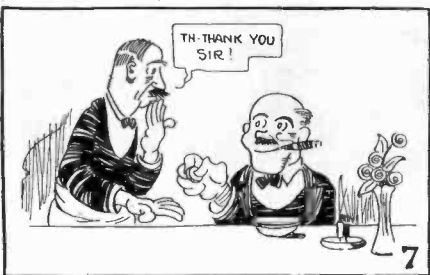
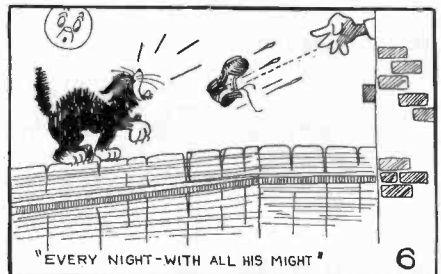



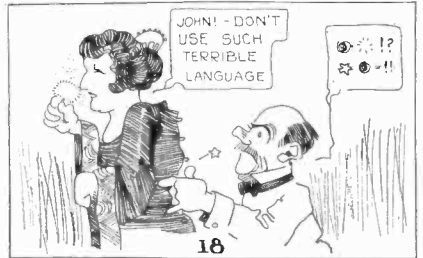
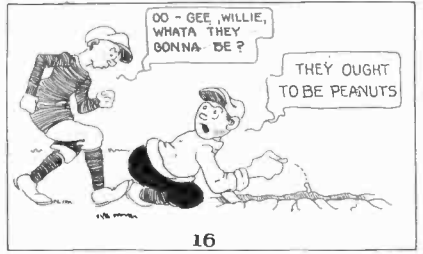
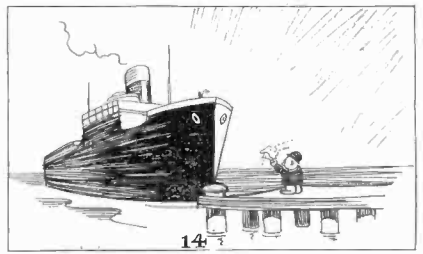
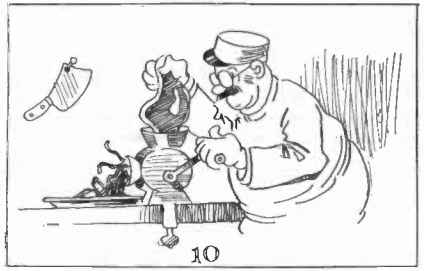

# RESTORATION TOPICS

## Cleaning With Ammonia

Stronger Than Dirt, and Just About Anything Else, Too

BY JACK CLARK & CHARLES CONTE

Remove the tarnish from brass without hours of bone-wearying polishing! Strip away paint from thermoplastics! Watch the milky lacquer coatings fall away from brass and plastic before your eyes.

How? — you ask. With that miracle solvent,  $\text{NH}_3$ . That's right — common household ammonia.

Most radio restorers are familiar with the benefits of ammonia as a cleaner and brightener of brass es-cutchions. A leisurely soak in an ammonia bath will remove dirt and tarnish from brass parts and will prepare the surface for polishing with Brasso, or your favorite metal polish. Any clear coating on brass will also lift off easily after a good soak. (Brass plating will be removed as well, so be sure to soak only pure brass.)

Two facts are clear about ammonia: (1) A leisurely soak in an ammonia bath will remove just about anything from anything, and (2) ammonia is one great solvent. In many cases, it's the only solvent that does the job without harming the surface you're restoring or refinishing.

An example involves stripping paints from delicate thermoplastics. Never use a paint stripper for this job. If you've ever tried it, you won't try it again. Paint strippers will melt these plastics in an instant. However, ammonia, while not really a paint solvent, will attack the bond between paint and plastic so that you can scrape away the paint with little effort. You can remove most paints this way after a bath of one to four hours.

Using ammonia as a paint "stripper," we have restored a number of radios and jukeboxes ruined by some "Pete Pliers" who thought he could spruce up the old box with a quick brush-paint job.

Another restoration problem not easily solved, unless you know about the powers of  $\text{NH}_3$ , involves clear lacquer coatings on brass inserts in plastic knobs that have turned milky and fogged. Some manufacturers used clear lacquers to cover the brass inserts. However, they usually coated the inserts as well as the plastic knobs. Years later, the finish has chipped and fogged, leaving tarnished areas on the brass and milky-looking splotches on the plastic. Zenith Trans-Oceanics often demonstrate this problem. A one-hour soak will remove the clear-coating and expose the surfaces for cleaning and polishing.

A variation on both of these uses for ammonia-paint stripping and brass finish renewal is remov-



ing brass paint from real brass. When, you may ask, would such a situation arise? We have stripped brass paint from the real brass center section of at least four Westinghouse Little Jewel radios this way. Our forefathers, in their very peculiar wisdom, would go to any lengths to avoid unsightly tarnish or oxidation — the patina of age, as we call it from our more so-

phisticated perspective. Hence, brass paint over real brass.

You *could* use paint stripper to remove brass paint from brass; however, we can't tell you how paint stripper might affect brass. We *can* tell you that after an hour's dip in ammonia, the dull brass paint literally slides off the Little Jewel's brass center section, leaving a clean, bright brass surface exposed for polishing. And besides, ammonia is roughly ten to fifteen times less expensive than paint stripper.

A note: it's best to submerge a brass piece for stripping entirely in ammonia. Turning the piece in a shallow pan of ammonia will leave hard-to-remove stain lines on the piece. If you don't wish to buy enough ammonia to completely submerge your brass object for stripping, don't cap or cover

**Caution: When following restoration procedures using ammonia or other cleansers, be sure to work in a well-ventilated area.**

the basin in which you're soaking the brass part. The fumes from the ammonia will stain the brass exposed to the "ammonia air," making it necessary for you to turn the part again to remove the stain from the newly exposed brass surface. Obviously, if you don't catch on really quickly, this process could be repeated almost endlessly, or at least until you pass out from the fumes. This tip comes from someone once too cheap to invest in a second half-gallon of ammonia.

Another unrelated application of ammonia in radio restoration — but perhaps the most frequently used — is for the initial cleaning of Bakelite cabinets. Once you remove the chassis and dial face, drop the box in the sink and spray it with any ammoniated household cleaner, like 409 or Top Job. Then stand back and watch the old Bakelite exude streams of its brown, oxidized self. (This

discharge is often referred to by knowledgeable restorers as Bakelite "doogee," though the layperson may refer to it simply as "disgusting.")

Lastly, and most spectacularly, we have used ammonia to remove chrome plating from some thermoplastic knobs found in an electronic surplus store. These knobs were shaped just like knobs used on some miniature plastic and metal radios from the 1940s and 1950s. Unfortunately, they were chrome-plated plastic and therefore unsuitable as proper looking replacement knobs.

The chrome plating was over a copper-plated base, and both looked as if they were there to stay. We took a few of these knobs, submerged them in a jar of ammonia, capped it and set it aside. Sure enough, after about two weeks, we could pull off small bits of plating. A month of soaking and chipping, and the knobs were completely stripped and in perfect condition. Although they were grey plastic and still not authentic looking, a coat of black vinyl paint resulted in a finish good enough to pass the closest inspection.

If all this isn't enough to convince you of the glories of ammonia, then maybe its value will. At

eighty-nine cents a gallon, you can't beat it.

Bring along a gallon next time you're invited to a local radio club social function. That, along with copies of this article for distribution, is guaranteed to earn you the respect and admiration of your fellow radio restorers

*(Jack Clark, 642 Netherlands Dr., Hermitage, TN 37076. Charles Conte, 7 Parklawn Dr., Bethel, CT 06801.)*

*Jack Clark worked for 10 years as a technician in a well known Swiss company, makers of professional audio electronics, and for 17 years in the electronics field. He now works as an audio consultant in the Nashville music industry.*

*Charles Conte is Public Relations Administrator and an advertising writer for Siemens Audio, Inc. (Bethel, CT) — American headquarters for the Neve series of audio consoles and the AMS digital audio editing and recording systems.*

*Together they are completing a book entitled "Vintage Decorative Radios: Collecting and Restoring Classic and Art Deco Sets from the 30s, 40s and 50s."*

## Duplicating Stenciled or Painted Brand Names and Logos

BY SPENCER J. DOGGETT

We all realize tubes, caps, and basic electrical components are easily obtained. It's the parts that are unique to a particular set that challenge our ingenuity. Although we can purchase a limited offering of decals through suppliers, such as Antique Electronics Supply, located at 6221 S. Maple Ave., Tempe, AZ 85283, there is money to be made by expanding this selection. What about sets with stenciled or painted logos or brand names? A decal certainly would not be suitable for them. I'd like to share a solution I have used.

For example, I was restoring a wooden Aldens radio. Actually, it was a Detrola Model 579 manufactured for Aldens (I assume that Aldens was a department store chain). The word "Aldens" was painted on the front in a stylish type font. The set needed a complete refinish, but for certain, the stripper would remove the brand name.

I had heard of masking off the area and trying to match the new finish to the remaining section of old. I had never tried it, but I doubted my ability to succeed. I'm no artist; therefore, I could never achieve the right effect freehand. I felt the following process might yield a better appearance while taking less time and effort. Indeed it does!

The first step is to make a tracing of the original. Cut a piece of thin paper large enough to cover the name you are attempting to duplicate. Tape it in place, if necessary, over the logo. Hold a pencil at an angle allowing you to rub the side of the lead over the letters. Since the letters are slightly raised from the surface of the radio, you now have a tracing of the original. This will be your guide to reproduce exactly the style of type.

Continue your refinishing to the point where you've applied the first coat of lacquer. Now you're ready to replace that brand name.

Obtain some typewriter correction paper wide enough to cover the rubbing area. I have white, one-inch wide paper which is just what is needed!

Lay the correction paper, white side down, on a clean work surface. You may have to trim your tracing, and then tape it to the correction paper.

Now position this "sandwich" on your radio and once again tape it in position. By carefully following the tracing with a somewhat dull pencil, you will transfer the white correction paper to the radio. Then remove the tracing/correction paper sandwich, and you've duplicated the original.

The final step is to spray a coat of lacquer. This is very important; otherwise the correction paper would be easily scraped off.

I have looked into the availability of other colors, but correction paper is available only in white. Therefore, I am experimenting with Liquid Paper. For those not familiar with it, Liquid Paper is basically the modern replacement for correction paper. You merely brush it over your typing mistakes.

What I have done is brush it on a piece of paper, and then use it as I would correction paper. I have not attempted to spray clear lacquer over it yet, but feel it will work.

Liquid Paper is available in several colors such as pink, goldenrod, off-white and blue. At the moment I am in need of black. My next step is experimenting with tinting the Liquid Paper. The materials discussed are readily available at office supply stores.

The name on the radio used in this example was written in script; therefore, the tracing didn't have to be exact, since there were no perfectly straight lines in any of the characters. Printed characters would require more skill. I also suggest experimenting on a scrap piece of wood to acquire the feel and the confidence.

I hope this may help someone else or even lead to other ideas!

*(Spencer J. Doggett, 61333 North Ridge Trail, Romeo, MI 48065)*



# RADIO ADVENTURES

## “Will The Real Radio Boys Please Stand Up?”

### The Chapman and Breckenridge Radio Boys Stories — Part 2

BY MIKE ADAMS

*Of all the early adventure stories about radio for boys and girls, the most sought after by collectors today are the thirteen Chapman and the ten Breckenridge books. A.R.C.'s September 1991 issue contains Mike Adams' background information on these books and synopses of the Chapman Series, Books 1-4. We continue here with books 5-13 (Editor)*

#### The Alan Chapman Radio Boys Stories (continued)

**5. The Radio Boys Trailing a Voice or Solving a Wireless Mystery, 1922.** This episode begins as the Buck Looker bullies get the



Radio Boys in trouble over a broken window. This minor brouhaha is soon resolved, but just as the boys are enjoying a radio concert, the stuttering voice of Crook Dan Cassey interrupts the broadcast and utters a seemingly meaningless collection of coded words. The cover illustration depicts the boys

listening to those strange emissions from the forest. Then the story begins in earnest. Can bars not hold this fiend?

Enter Forest Ranger Bentley, and a discussion ensues of how radio is used by the Forest Service to transmit news of fires from one station to another. Soon, Radio Inspector Frank Brandon appears, and Cassey's mysterious coded transmissions are connected to a series of automobile robberies. Finally, the boys go into the woods to help the Forest Service look for Criminal Cassey's cars. Of course, in the end, they find the secret transmitter, capture Cassey (for the third time) and get the autos back.

**6. The Radio Boys with the Forest Rangers or The Great Fire on Spruce Mountain, 1923.** Jack Binns talks about sound-on-film and the promise of television in his foreword. The story begins as the boys save Bob's father from the aftermath of an ammonia explosion at

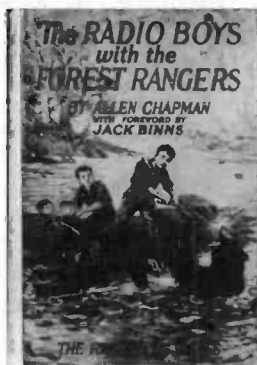

the drugstore. Then, the boys listen to a radio talk by their friend Bentley of the Forest Service, learn more about radio from Dr. Dale, and beat up the same three bullies for the sixth time in the series.

Radio Inspector Brandon and Forester Bentley drop by for several chapters of

discussion on radio. As a result, the boys are invited to spend their summer vacation on Spruce Mountain with the rangers and their radio operators. While there, the boys encounter fires, wild animals, underground caves, and yes, Buck's bullies. In a climactic final fire, the boys actually end up saving Buck from flames and bears, and although surrounded by the hot fire, they manage to raise an antenna and use radio to save everyone. Again.

**7. The Radio Boys with the Iceberg Patrol or Making Safe the Ocean Lanes, 1924.** In his foreword, Binns elaborates on famous sea rescues. The story begins as the boys rescue

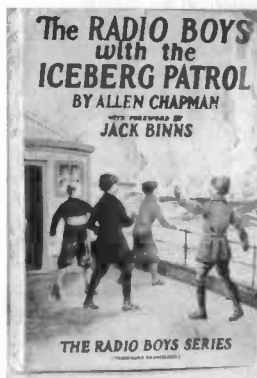

Navy Captain Amos Springer from an out-of-control auto. Next, Dr. Dale arranges for the boys to go by ship to Halifax, Nova Scotia, whereupon they collide with a lumber schooner and begin to sink. After fruitless hours of SOS by the ship's wireless operator, everyone gets into lifeboats and waits to be rescued as the big

ship sinks. A Navy ship arrives, and the boys discover that its captain is none other than

Amos Springer.

On board the ship, they hear a radio news broadcast telling of a major fire burning in their hometown of Clintonia. Some icebergs that are in the way are blown up. When a serious illness befalls the ship's radio operator, guess who takes over? Then, the ship hits an iceberg, bears chase the boys, and finally, they hear the news over the ship's radio that their families are safe in Clintonia. All are rescued in the end, thanks to radio.

**8. *The Radio Boys with the Flood Fighters or Saving the City in the Valley, 1925.***

Binns is back with another inspirational message about boys and radio. A new adventure begins with Dr. Dale's auto stalled on the rail-

road tracks just seconds away from being crushed by an oncoming train. The boys save him just in time and are hailed as heroes. Back home, they listen to their friend Larry's bird call show on WEAF; they beat up Buck Looker and his gang again, and save Jimmy from inside their burning high school.

Uncle Lon appears, and since there won't be any school for a while, he invites them to visit him in Bottville in the Horseshoe Valley. Many exciting chapters are devoted to life in the valley where even the Looker gang shows up for its usual fight. But heavy rains come, the dam breaks, and a flood results. You can guess the rest. The Radio Boys use their equipment to transmit to the outside world, thus saving Bottville and even the hapless Looker gang from the flood.

**9. *The Radio Boys on Signal Island or Watching for the Ships of Mystery, 1926.***

Binns expounds on ships, and the story starts as the boys plan a radio booth for a local benefit fair. They talk about UX-120s and UV-199s while watching a circus procession passing through town. Suddenly, the circus wagons tip over, tigers escape, people scatter, and our boys shoot one of the threatening animals seconds before it devours Bully Buck.

At the fair, a Mr. Fordyce arrives from Bottville to congratulate the boys for saving his family in the previous story. As a reward, he asks the boys to accompany him to a property he owns called Signal Island. When they are preparing to leave, ominous messages urge Fordyce to stay away from the island and sell it to a man named Joe Brown.

Once on Signal Island, they explore hidden buildings and caves, and discover strange people coming and going by boat. As it turns out,

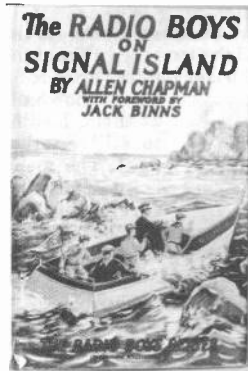

the island is being used by a den of thieves for the storage of contraband. The boys discover the secret, and after two of them get caught, the remaining two use their radios to summon help from the mainland.

Help arrives, the criminals are caught, and the boys discover the hideout. The boys get the money, and they'll probably spend it all on radios.

rate treasure hidden near the boys get the money, and they'll probably spend it all on radios.

**10. *The Radio Boys in Gold Valley or The Mystery of the Deserted Mining Camp, 1927.***

Binns' foreword is about the use of radio in the mining of ore. The four boys plan a trip West with Radio Inspector Brandon to visit an abandoned mine left him by a relative. As luck would have it, the bus on which Brandon is to arrive is struck by a cliff, as the boys watch in horror. But within minutes, they run to the rescue and save the passengers.

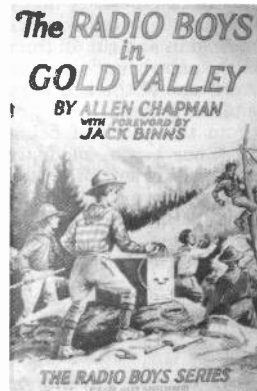

Time out to beat up the Looker gang again, and then, the boys are off to Gold Valley and the allegedly dormant mine.

Upon arriving, they realize that obviously they are not wanted. Snakes attack, and gunshots threaten the peace of the valley. They explore the maze of tunnels in the mine, get lost, and even discover a gang of Indians hired by bad guys to keep Harvey from a newly discovered rich vein of gold. They get captured, but they quickly turn the tables and tie up their Indian guards.

In the end, as the boys are surrounded by many Indians, they discover an electric wire nearby to which they hook up the radios they happen to have with them. They signal for help, and the United States Cavalry arrives in the nick of time. Brandon Harvey is now rich, the bad guys are rounded up, and once again, radio has saved the day.

**11. *The Radio Boys Aiding the Snowbound or Starvation Days at Lumber Run,***

*(Continued on following page)*

(Radio Boys, continued)

1928. Binns' foreword discusses hams. As the Radio Boys ride a sleigh along the banks of the Shagary River, the Looker bullies throw rock-

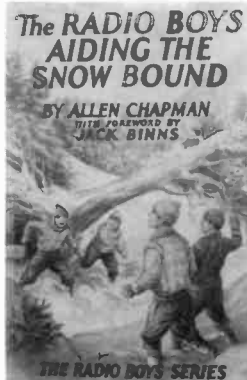

filled snowballs at them, leading to still another fight. The melee is interrupted by screaming ice skaters falling through thin ice.

After the usual rescue, there is the typical technical discussion of radio with Dr. Dale. Jimmy announces that his father plans to go to Lumber Run to search for Jason

Pelton, a criminal who owes him two thousand dollars. The rest of the boys decide to go along. Buck and his gang are beaten up again for good measure, and the Radio Boys skate off for Lumber Run.

At the lumber camp, they set up their radios, meet swarthy lumberjack-types, see many fights, run from wolves, tangle with bad guys and are eventually snowed in and cut off from the outside world. As the snowbound workers listen to a radio concert, one of the bad guys burns the storehouse to the ground.

After recovering from the shock of being snowed in without food, our heroes suddenly remember they have a sending set. But, they discover that the bad guys have stolen it. Of course, they soon find it again. Along the way, they kill a bear for a few good meals. A distress call brings airplanes that drop food on the camp, Criminal Pelton is captured, and Jimmy's father's money is returned. From Bob, the last line — "Score once more for radio, the greatest thing in the world!"

12. *The Radio Boys on the Pacific or Shipwrecked on an Unknown Island, 1929.* Binns' introduction is on radio guidance for planes and ships. Another adventure begins with telegrams announcing that the boys have each won first prizes in the International Radio Gazette essay

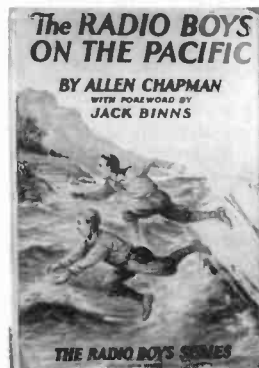

contest. The prize is a trip to Hawaii, so the boys board a train for San Francisco. So does Bully Buck Looker, who also won the contest by stealing the entry of another hapless youth from Clintonia. In San Francisco's Chinatown, the boys encounter Buck, and for the ump-

teenth time, beat him up.

On board the ship Golden West, our boys meet the other contest winners and save one from drowning during a fall overboard. They land in Hawaii, where they visit a friend of Dr. Dale's, the wealthy Commodore Rowland. While they are on the Rowlands' yacht, a storm wrecks the boat. The boys, including Buck, become castaways on a volcanic island. Of all the luck!

For several days, they attempt to signal ships, using clothing as flags. Then, the once sleeping volcano begins to rumble ominously. Just when all seems bleak, a lost yacht with no one aboard drifts into the island's bay. The boys discover it has a broken wireless set, repair it, and send out an SOS — all this just seconds before molten lava from the erupting volcano reaches them. Whew! Saved again!

13. *The Radio Boys to the Rescue or The Search for the Barmore Twins, 1930.* Binns discusses police radio. In this final adventure, the boys are camped at Cedar Lake, talking as usual about radio, when they see what appears to be dinner perched on a nearby fence. They

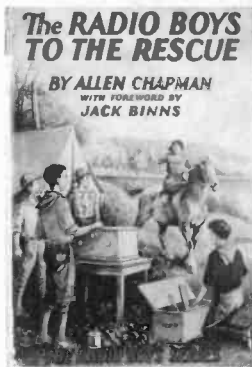

shoot and three black chickens' owner, Farmer Barmore, runs up shaking his fist. The boys apologize to the old man and meet the farmer's wife and twin boys. Later they save two local electric company executives from a bridge accident, and are rewarded by being given

access to the lines near their camp for power for their transmitters.

Meanwhile, the Barmore twins are kidnapped, the farmer accuses the boys, the boys offer to help find the children, and a ransom note arrives. Luckily, the power lines have been tapped, and daily pleas for help in what now is a statewide dragnet are sent out to New York City stations to relay. Now the whole world knows about the case of the kidnapping of the Barmore twins.

Dr. Dale shows up with a car and joins the search through back country and woods. The boys, along with the population of the entire county, follow clues, finally surround the bad guy, and the twins are saved. These Radio Boys live happily ever after. Really.

(To be continued)

(Michael H. Adams, 112 Crescent Ct., Scotts Valley, CA 95066)

Mike, a regular contributor of A.R.C. articles, is a producer of the PBS television series "Radio Collector." He is also a professor of radio/TV film at San Jose State University, a member of the Board of Directors of the Foothill Electronics Museum, and a former president of the Southern California Antique Radio Society (SCARS).



## The Empire of the Air The Men Who Made Radio By Tom Lewis

REVIEWED BY ALAN DOUGLAS

Quite simply, it is the best book on radio history ever written. While others have covered the technical background or the development of broadcasting more thoroughly, no one has told the tale as well as Tom Lewis in his *The Empire of the Air: The Men Who Made Radio*. Lewis focuses on three men who played key roles in the development of radio — Lee de Forest, who devised the vacuum tube, Edwin Armstrong, who invented the circuits, and David Sarnoff, who put it all into practice.

Lewis has chosen to relate the story of radio's development through biographical accounts of these three men.

Each has been the subject of biography before, but usually tainted by hero worship, or even self-worship. Lewis' book is the first account where all three men are treated equally.

I can't quarrel with any of the author's opinions. There are a few factual errors of the sort that keeps reviewers in business. For example, on page 50, Lewis speaks of Carborundum having "much the same property as the quartz later used in crystal sets" when he meant *silicon*. On page 52, he

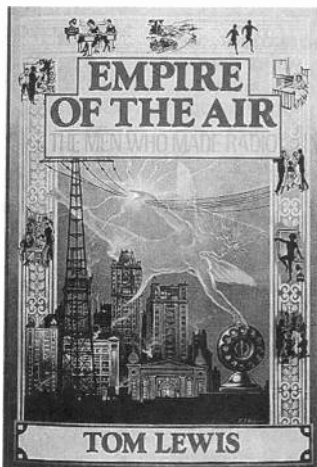

mentions Marconi's interest in developing galena crystal as a detector when, in fact, galena was not popular that early. Also the reference on page 346 to Gene McDonald is inaccurate, since McDonald died in 1958 and was probably not still setting Zenith policy in 1961 (although if anyone could have pulled it off, McDonald was the man).

What more needs to be said? It's an engrossing story that will give you an accurate view of the industry whose products you collect. For the price of a Catalin knob, you can own a copy.

*The Empire of the Air: The Men Who Made Radio* by Tom Lewis is published by Harper-

Collins Publishers. It has 362 pages with an additional 32 pages of photographs. The book is currently printed in hardcover only and is presented in a 9 1/2" x 6 1/2" format. It is priced at \$25 in the U. S. and \$35 in Canada, and is available from HarperCollins Publishers, 10 East 53rd St., New York, NY 10022-5299, from bookstores, and from A.R.C.

(Alan Douglas, PO Box 225, Pocasset, MA 02559)

From a Review by Chris Goodrich in *Publishers Weekly*, June 14, 1991, on *The Empire of the Air: The Men Who Made Radio...*

Lewis calls *Empire of the Air* "a biographical history of radio" and much of it concerns, in Lewis' words, "how large corporations took over these inventions and forgot about the inventors."

...radio is not just a precursor of television...it's a phenomenon with a distinct culture and history of its own.

"Radio was the first national medium, and it created a national unity," Lewis says, citing the 30 million Americans who heard the broadcast of Lindbergh's post-flight reception in Washington, D. C., in 1927.

Lewis set himself the formidable task

of "trying to show how radio changed all our lives, and profoundly," while simultaneously capturing the individuals and the inventions as well.

Lewis' editor, Wendy Wolf, says, "Empire of the Air is an adventure of discovery and a deeply American book because it's full of larger-than-life figures, cutthroat competition, daredevil stunts, stock fraud and the like. Not to mention litigation — Armstrong filed unsuccessful lawsuits against both de Forest and Sarnoff's RCA that would go on for decades and would eventually lead to his suicide..."



# CLASSIFIED ADVERTISEMENTS

**FOR SALE:** Weston 785 industrial circuit tester, AC-DC-amps-ohms, front panel has been repaired, works good, port. case, with papers - \$45. RCA WA44-C audio generator - \$30. Philco 7030 dynamic signal tracer untested - \$25. RCA WT115-A color pix tube tester, untested - \$25. B&K 466 CRT tester port. 9 sockets, papers - \$45. Rider's Radio Serv. manuals #6 to #13 - \$14 ea. Model 1-177 mil tube tester, meter has been replaced, bad hinge on lid, with papers, heavy, works good - \$40. B&K Model 970 transistor eqpt. analyst 3 units in one sig. gen., volt ohmmeter power supply - \$75. ARRL 1988 Handbook large hard cover - \$10. (50) assd. glass radio fuses - \$7.50. VT 129/304 TL tube - \$15. The Oscilloscope, Gernsback - \$6.50. TV Radio Tube Troubles, Gernsback - \$6.50. Servicing Transistor Radios, Gernsback - \$6.50. How to Fix Transistor Radios and Printed Circuits, Gernsback - \$7.50. Heath Model IM32 large meter VTVM, works good, leads, papers - \$40. Profitable Radio Troubleshooting, Marcus-Levy - \$15. The Fundamentals of Radio 1945 - \$6. The Oscillator At Work, Rider - \$8. Vacuum Tube Voltmeters Rider - \$8. Int. Corrs. Schools 7 course study booklets - \$8.50/all. (50) National Radio home study booklets - \$15/all. Radio Simplified 1922 - \$10. Everymans Guide to Radio 1927, 178 pages - \$20. Sams Radio Receiver Tube Placement Guide 1938 to 1947 sets - \$10. RCA Triple Pindex Tube Base Guide - \$8. Philco 1928 to 1936 Xerox Bound Service Data - \$30. These 2 sets last of the made in USA tube sets Admiral white AM Model Y6743, N.O.S. - \$32.50. N.O.S. Admiral 5B42 clock radio - \$32.50. Also have 1000's of new and used parts, tubes, service data, write wants, SASE. All plus hand. and shipping. Min. parts orders - \$8. Sales service since 1930. Krantz, 100 Osage Ave., Somerdale, NJ 08083

**FOR SALE:** Baldwin 51P church organ, 63 tubes - \$95, BO. Pickup only. Jim Gaudin, 134 Hawthorne Dr., Danville, VA 24541. (804) 791-2286

**FOR SALE:** Am. Bosch Model 5; Crosley 56TN; Fada 106. SASE for list. Leo Vanderpot, Apt. 17D, 765 N. Broadway, Hastings-on-Hudson, NY 10706. (914) 478-4092

**WANTED:** Quad II amplifier. Prioro serial #17000. Also Bogen DB20DF. Must be in A-1 condition. Charles A. Goddard, Mount Harmony, Asbury, WV 24916

**WANTED:** Eveready #2 speaker. Eveready radios, flashlights, catalog. Subscribe to Flashlight Newsletter - \$12 year. Bill Utley, PO Box 3572, Downey, CA 90242. (213) 861-6247

**FOR SALE:** Crosley sales lit., sales poster for Crosley Shelvador, Savamaid - \$5 ea. Michael D. Morrell, Rt. 2, Box 5026, Williston, FL 32696

**WANTED:** Old mechanical, electrical and optical demonstration apparatus. Early microscopes. Allan Wissner, PO Box 102, Ardsley, NY 10502. (914) 693-4628

**FOR SALE:** Old radio books - \$5 & up. Jackson oscilloscope with manual, overhauled, asking - \$40. Heath Laboratory oscilloscope, triggered, factory wired with schematic, overhauled, asking - \$50. Sidney Goldhor, 2147 Trombas Ave., San Leandro, CA 94577. (415) 357-3788

**FOR SALE:** Newcomb-Hawley 83 speaker, exc cond, Westinghouse Mazda lamp tin - \$15. Postage extra. Jeff Gentry, 708 Locust Ave., Charlottesville, VA 22901-4913. (804) 979-0698

**AUCTION:** Quality consignments for April 1992 radio auction. Merry Christmas to All. Water Village Promotions, Water Village, NH 03864. (603) 539-5126

## SELLERS ... PLEASE NOTE

### A.R.C. ADVERTISING POLICY...

- ALL ITEMS MUST BE DESCRIBED FAIRLY.
- REPRODUCTIONS, REPRINTS AND NOT-ORIGINAL ITEMS MUST BE SO IDENTIFIED.
- ADVERTISERS AGREE TO RESPOND PROMPTLY TO INQUIRIES AND ORDERS.
- AND TO RESOLVE PROBLEMS PROMPTLY
- IF THE BUYER IS NOT SATISFIED.

**WANTED:** Early camelback keys, registers, or-nate relays or sounders. Prefer oddball manufacturers before 1870. Gil Schlehman, K9WDY, 335 Indianapolis, Downers Grove, IL 60515. (708) 968-2320

**WANTED:** Sony TR-63 and other early Japanese transistor radios. Roger Handy, PO Box 24527, Los Angeles, CA 90024. (213) 451-4040

**FOR SALE:** N.O.S. and used tubes, more than 1,000 tubes in 450 different types - SASE for lists. C. Elmer Nelson, 11 S. Church St., Princeton, IL 61356

**WANTED:** Sell me your Western Coil & Electric Co. Radiodyne, or Lewis battery radios. I will buy or trade for basket cases or mint. Let me know your wants. Eric Sanders, 3295 W. 246th St., Sheridan, IN 46069. (317) 758-4988

**WANTED:** Leader oscilloscope Model LBO-310HAM or similar model with direct-deflection input terminals waveforms up to 450MHz. Telematic VHF/UHF sub-tuner Model JG-775. EICO sweep/marker generator Model 369. EICO signal tracer Model 150. Caswell Davis, Jr., 601 Delmar, Apt. 2, San Antonio, TX 78210. (512) 532-9378



**FOR SALE:** Used technical books; radio, electronics, military, magazines, catalogs, etc. List - \$1, stamps OK. Softwave, Dept. ARC, 1515 Sashabaw, Ortonville, MI 48462

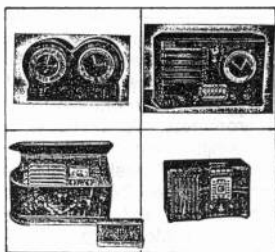

**WANTED:** The pictured Emerson radios and other unusual Emerson wood sets manufactured prior to WWII, especially cone-shaped dial models. Also seeking Zenith 6-D-317 (w/glass rods) and 6-D-316 (mini-console), Bunis p. 166. Have Walton set to trade (for Mae West) and other trade sets including AX-212, Westinghouse Repwood, Zeniths, metals, transistors, etc. Mark V. Stein, 822 Guilford Ave, Suite #130, Baltimore, MD 21202. (301) 366-3823

**FOR SALE:** Don C. Wallace, W6AM - Amateur Radio's Pioneer, The History of Amateur Radio by Jan Perkins, N6AW, hardbound. 320 pages, 200 photos - \$29.95 + S&H (\$3 U.S., \$5 foreign). Wallace & Wallace, 11823 E. Slauson Ave., Suite 38, Santa Fe Springs, CA 90670

#### CLASSIFIED AD NOTICE

Please check your ads carefully before sending them in. Once ads are received, it is not always possible to refund the amount sent, pull the ad or make changes.

**FOR SALE:** One Sears mid 70's desktop calculator with instruction book in near mint condition - \$105 or BO + UPS. Old Army MSG CTR 24-hour clock, excellent \$95 + UPS. Zenith DeLux Royal 755 transistor and leather case, handle missing - \$98 + UPS. **WANTED:** (2) five-inch speakers with field coil. R. A. Matias, 9206 Pitcairn, San Antonio, TX 78250

**WANTED:** Sony Model CRF5090 Earth Orbiter in any condition. John Stitzer, 708 Roberts Ter., Marshalltown, IA 50158. (515) 752-6351

**WANTED:** Model 11-103U orange Crosley. Emerson 888 red Vanguard, white Atlas. Phono needle tins. Preston Meeks, 2811 Kenross, Houston, TX 77043. (713) 460-5369

**FOR SALE:** Parting out over 200 tubes, all collectibles: Western Electric, Blue Arcturus, RCA, Cunningham, DeForest, and more. VT-1, VT-2, VT-4, VT-5, 280's, 245's, brass base 01-A's. 101, 102, 104 tennis balls. This is a new list current as of 1 Oct 91. Send LSASE to: Jeff Arndt, 1215 Division St., Manitowoc, WI 54220-5734

**FOR SALE:** 1963 Corvette AM radio with Wonder Bar minus knobs, untested - \$160 postpaid. Ray Renart, 2226 Palmer Ave., New Rochelle, NY 10801

**FOR SALE:** Coke cooler radio (Collins, p. 89), mint, no cracks, chips, works, correct knobs. Delmore Zirzow, 1309 Madison St., Onalaska, WI 54650. (608) 783-1268

**FOR SALE:** Stock certificates: Admiral Radio \$10. Collins Radio - \$10. Sentinel Radio - \$10. Western Union - \$10. Plus Baird Television 1930's (John Baird, Inventor of 1st TV Scanners) - \$55. J. J. Papovich, 53 Magnolia Ave., Pitman, NJ 08071. (609) 582-8279

**WANTED:** Any information on Premier Electric Co. (Chicago) 4-tube regen., factory set, circa 1922, two front panels, four portholes. E. E. Hite, 2625 Colecreek Ln., Rock Hill, SC 29732. (803) 366-9998

**FOR SALE:** Telegraph items, parts, memorabilia, tubed code practice oscillator USN flameproof Keys N.O.S. 1962 RCA, 1972 TEL Nuvox portable, older empty microphone, galvanometer, pillow speakers, etc. SASE. Joe Jacobs, 60 Seaview Ter., Northport, NY 11768

**WANTED:** Original pre-1924 literature. Amrad, Cutting Washington, Tuska, Grebe, Paragon, Kennedy. Possibly others. Ed Bell, 5311 Woodsdale Rd., Raleigh, NC 27606. (919) 851-1517

**HELP:** I need a detector transformer for a Philco Model 70 or someone to rewind my coil. **WANTED:** Truetone small console with round green dial with push buttons all around dial. Roger Quickel, 6194 Kirkwall St., Madison, OH 44057. (216) 428-2006

**WANTED:** Reasonably priced small transistor radios. Will buy all you have. Write or call. Doug Ferrero, WB8YNZ, 33673 Chatsworth, Sterling Heights, MI 48312. (313) 268-3677

## 1930'S GRILLE CLOTH

AS GOOD AS THE ORIGINAL  
SEND LSASE FOR SAMPLES

### Patterns currently in stock:

- #3 *Philco 70/90*
- #4 *Small Diamond (as in Peter Pan)*
- #5 *RCA/Zenith/Echophone*
- #6 *Philco 'V' (Green)*
- #7 *Philco 'V' (Brown)*
- #8 *Philco "Ribbed" (for late '30s)*
- #9 *Atwater Kent Yellow (165, 217, etc.)*
- #10 *Basic "Generic" pattern*

### Other patterns on order:

- *LARGE DIAMONDS PATTERN*
- *HERRINGBONE*
- *EMERSON AU-190 CATALIN*

WATCH THIS SPACE FOR FURTHER DEVELOPMENTS!!

MICHAEL KATZ  
3987 DALEVIEW AVENUE  
SEAFORD, NY 11783  
(516) 781-6202 (EVENINGS)

**FOR SALE:** 3-Mu-Rad radio V100 coils - \$15/all. Hammarlund 2 var. cond. and 4 var. coils fair - \$25/all. Grimes SE7 N.O.S. of 2 RF coils, both - \$8. Air King N.O.S. RF coil - \$6. Assd 1-2-3 circuit coils, price from - \$4 up. Set of 3 matched RF spider web coils - \$16. N.O.S. Air King 2 coil kit, loose coil - \$15. (New) Hammarlund 23 plate var. cond. - \$9.50. (3) assd. Hammarlund var. cond. - \$24/all 3. Remler 639-631 var. book cond. - \$12 ea. Also have other coils. Var. cond. Write wants - SASE for price. Ham coil base 3 plug-in coils - \$20/all. Set of 5 5-pin plug-in coils with handles (like Pilot), set of 5 with box - \$35. (8) Scott plug-in coils 4-5-6 pin - \$45/all. Set of 3 coils, var. cond., dials, from a Gilfillan Neutrodyne - \$30/all. Weston 2" panel meter 0-7-140 dual scale - \$19. Hoyt 2" 0-6v - \$8. Have other panel meters. Heath impedance bridge IB-2 will test resistance, cap., inductance - \$45. (12) assd. spider web coils - \$20. Old style tube sockets for 201-A tubes plastic - \$2, metal shell - \$3, glass - \$4. Junking Majestic 90, 7-70, Radiola 17-18-33-20-25. Have some small coils. Rolls of small gauge wire, write wants - SASE. New and used tubes, speakers, RF, IF, osc., coils, audios, power transformers. Dial belts, 1000's of other items. Last call for Ace Radio prints in color - \$15 ppd U.S.A. (12) old plastic AC cords w/plugs, used - \$1. Kleertone units - \$4. Tube vibration dampers - \$4. 2 pounds mixed radio hardware - \$4. Old AC line cords, plugs, used - 75¢ ea. Ant. insulator small - 75¢, large - \$1. Lightning arrestors - \$4. Have 1000's of unlisted items. Write wants. SASE. All items plus hand and shipping. Sales service since 1930. Krantz, 100 Osage Ave., Somerdale, NJ 08083

**WANTED:** Spkr, 4" x 4" sq., 45 ohm, lw; for GE clock radio #7-4300F. T. R. Apple, 1498 Cobblegate Ln., Reynoldsburg, OH 43068. (614) 864-3634

**SERVICES:** Quality repairs of vintage audio components, radios, TVs & guitar amplifiers. Test equipment, too. UPS or walk-in. Salt Marsh Electronics, PO Box 715, 19 Millfield St., Woods Hole, MA 02543. (508) 457-9220

**FOR SALE:** Howard Sams schematics from 200 up to 2600. Kay multisweep UHF-VHF generator, carostat, boxed R+V regular types. Needles by Walco. Over 5,000 different type tubes, boxed resistors & grommets, micas, 100 per box. Wilcox Gay, AM transmitter, ham crystals, Precise III tube tester. Telectro, new 7" reel-to-reel tape recorder. Eico cap checker Model 2-955. Two Du Mont old scopes, Models 208, 323. SASE required on all inquiries. James J. Mogavero, 117 Maple Ave., Irvington, NJ 09111. (201) 642-8683, daytime; (201) 373-7653, after 6 pm

**FOR SALE:** New 1L6 tube in original boxes - \$10 ea., \$49/6, add \$5 postage per order. Will send tube price list with order. Also used test equipment list. Hurry, limited quantities. Maurer TV, 29 S. 4th St., Lebanon, PA 17042

**WANTED:** Antenna, electromagnetic, and/or propagation books, related items, and test equipment. Antenna's, PO Box 454, Milan, OH 44846

**WANTED:** Radio & wireless magazines from the 1920's. Jan Perkins, N6AW, 524 Bonita Canyon Way, Brea, CA 92621

**FOR SALE:** Vacuum tubes and service information. Carl Howard, 2351 Egremont Dr., Orange Park, FL 32073. (904) 264-7056, phone anytime





**FOR SALE:** Old ARRL and Radio Amateur Handbooks, new stock. Send LSASE for list. Charles Simmons, W6PDH, PO Box 6238, Buena Park, CA 90622. (714) 994-6843

**NEW**  
**REPAIR**  
1932-42  
& post war

*Capehart*  
**available again**

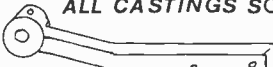
**REPRO**  
**PARTS**  
limited time

ALL CASTINGS SOLID BRASS MACHINED READY TO INSTALL

	record reverse arm	p/n 6228	49.95
	phono mech. fork		59.95
	1941 & 42 model 400 M & K tuning shaft pulley bracket		69.95
	record reverse guide spring	p/n 39130	16.00
		postage per order	3.00

STEPHEN M. ANTOL CO.

3650 silverside road suite 251      wilmington, delaware 19810

tel: 215 744-1506

**FOR SALE:** Velvet vernier dial mechanisms, used/good condition - \$5 ea. Litsche, PO Box 191, Canandaigua, NY 14424. (716) 394-9099

**SERVICES:** Radio repair by collector. Expert work guaranteed. **WANTED:** Coil winding machine. Progressive Edakits. Dave Dameron, KG6BP, 819 Boundary Pl., Manhattan Beach, CA 90266-6621. (213) 318-5311

**WANTED:** Clapp-Eastham audio transformer for Radak A-4. Please help! Ed Bell, 5311 Woodsdale Rd., Raleigh, NC 27606. (919) 851-1517

## HAS YOUR SUBSCRIPTION

### EXPIRED?

It has if your mailing label reads  
"EXP=DEC91" or earlier.  
Renew now!

**BONUS:** Renew before  
your "EXP" month and receive  
13 issues per year instead of 12!

Renewal rates are:

\$27.00 for Second-Class Mailing

\$40.00 for First-Class Mailing

(Two-year renewals are twice above rates.)

**WANTED:** 77DX RCA mike, unusual 7" TV. Neil Dorfman, 7028 Clements, West Bloomfield, MI 48322. (313) 661-8770

**WANTED:** Swan 160X, 7JP4, 7GP4. **FOR SALE:** Atwater Kent 55C, all tubes untested - \$60. J. N. Meade, 12711 Pinebrook Ln., Hudson, FL 34667

**FOR SALE:** Heathkit HW-16 w/HG10B - \$100. Set of new tubes for HW-16 & other parts - \$50. University Classic hi-fi speaker - BO. **WANTED:** Old/unusual telegraph keys. David Combs, W5VJW, 2000 Victory, Wichita Falls, TX 76301. (817) 767-0077

**WANTED:** Solar transistor radios, unusual or early transistor and novelty radios. Bozo? Old Crow? Lee and Carolyn Bruton, 1140 S. Reed Unit E, Lakewood, CO 80226. (303) 937-7325

**WANTED:** Dial pointer for Emerson U5A. **FOR SALE/TRADE:** Sony 2pc portable Beta recorder. Peter Oppenheim, 146 E. 49th St. 3A, New York, NY 10017. (212) 752-1635

THE  
*Lincoln*  
SYMPHONIC

**WANTED**

- 1935 20-tube, 2 speaker
- Any information appreciated

Don Hauff—  
Box 16351, Minneapolis, MN 55416

**WANTED:** Volume knob for Zenith 7-S-363 (Bunis, p. 168). Also need Zenith tube shields and a speaker cloth and speaker output transformer for Philco 650 console. Steven Wasser, 521 High Blvd., Shillington, PA 19607. (215) 777-4356

**SERVICES:** Will repair American-made early transistor portable radios. David Headley, 651 S. Yale, Wichita, KS 67218. (316) 684-0050

**WANTED:** Detrola plastic radios or advertising. Mark Lucas, PO Box 192, Finleyville, PA 15332. (412) 348-6174

**FOR SALE:** 10,000+ tubes - \$6,000 or LSASE for price list of over 1300 different types. Jeff Moskow, WA11, Rustic Trl., Groton, MA 01450. (508) 448-5516

**WANTED:** For AK-10, 3-tube section and potentiometer can. for display only, need not work. Carlton R. Nevins Museum of Radio; Ken Nevins, 406 Jipson St., Blissfield, MI 49228. (517) 486-3019, eves.

**WANTED:** Champion Spark Plug radio with stand. Jim Martes, 1022 E. Hayward, Independence, MO 64050. (816) 836-0668

**FOR SALE:** Blaupunkt Granada, black walnut, mint - \$100. Stromberg-Carlson's from my collection: 430M, 235L, 68, 925L, all very good to excellent - \$125 ea., you ship or pickup. **WANTED:** Stromberg-Carlson advertising, paper, clocks, etc.; also very seriously seeking S-C early to prewar sets, other S-C sets; please inquire. John M. England, Jr., PO Box 1674, Alexandria, VA 22313. (703) 841-9498

**WANTED:** Dial glass for the 3-band Crosley radio Model 24. Jethro F. Perry, Box 488, Lewisporte, Newfoundland, Canada A0G 3A0

## BUYING

Early battery sets

Crystal sets

Early tubes and parts

Cathedrals

Catalins

Zenith and Stromberg-Carlson  
(20's & 30's)

## I PAY TOP DOLLAR

I also buy whole collections.  
Will pick up anywhere in U.S.

Ken Smith  
903 River Road  
Eugene, Oregon 97404

(503) 485-8676 days (Mon-Fri)  
(503) 485-0319 eves & weekends  
(503) 689-6316 FAX

**WANTED:** World Equiv. Tubes Vade-Mecum by Bran. Gary Cain, 1775 Grand Ave., #302, St. Paul, MN 55105

**WANTED:** Wave Magnet loop antenna and cables for my Zenith H500 Trans-Oceanic. Also looking for an owners manual for same. Thank! Doug Kurtz, 2500 Astral Dr., Los Angeles, CA 90046. (213) 874-5827

**FOR SALE:** Hallicrafters speakers R44 and R46B - \$45 ea. **WANTED:** Power supply 697 AC for HRO 5. F. W. Nicholas, PO Box 37094, Phoenix, AZ 85069. (602) 864-9987

**WANTED:** Atwater Kent 555, good speaker and T1 coil a priority, cabinet secondary. Sid Greenspan, 500 S. Ocean Blvd., Boca Raton, FL 33432. (407) 368-2019

**FOR SALE:** Grundig TK-46 audio tape recorder, 7" reels, tube amp, stereo - \$15. Dave Sica, 1459 St. Georges Ave., Rahway, NJ 07065. (908) 382-0618

**WANTED:** Tube Type EL-11 or EL-12 for Grundig. Michael K. Tremper, 965 Newark St., Aurora, CO 80010. (303) 343-4642

**FOR SALE:** RCA Superette #R7. Zenith cathedral #4T26. Firestone #4A20. Eico tube tester #625. Supreme tube tester #589A + manual. T. Gasirek, 201 Golden Ave., Briggsville, WI 53920. (608) 981-2051

**WANTED:** Fada Model P80 (Bunis, p. 68), need not work. Dan Howard, 2940 S.E. 118th Ave., Portland, OR 97266. (503) 761-7799

**WANTED:** RCA 103 speaker frame in good or restorable condition. Don Peck, 23319 Harland Dr., Moreno Valley, CA 92557. (714) 242-9818

**WANTED:** Help. Need documentation for British Murphy 186 LW/MW/SW table radio and documentation/sources for the tubes in it: British (Mazda) mini octals 6C9, 6F15, 6LD20, EZ41. Steve Shepard, 6313 Mendius NE, Albuquerque, NM 87109. (505) 821-5652

**FOR SALE:** Books, TVs, radios, parts, data, etc. Send want list with SASE. Don Weiler, 4641 Kawanee Ave., Metairie, LA 70006

**WANTED:** Scott 210C or D amplifier. Early Radio Shack Realist integrated amplifier. Jack Smith, 288 Winter St., N. Andover, MA 01845. (508) 686-7250

**FOR SALE:** GE shirt pocket radio P850E - \$35. Japanese Roll Royce - \$45. Munchie Tunes Lunch Box radio - \$20. Philco Model T902-124 - \$15. Santa Maria ship radio, Japanese - \$60. Telegraph Key radio with sounder, Japanese - \$75. Wall Phone transistor radio, Japanese - \$35. Bosch Cruiser 76 - \$45. **WANTED:** Pilot radios, prewar, any condition. Bill Moore, 1005 Fieldstone Ct., Huntsville, AL 35803. (205) 880-1207

**WANTED:** Top-mounting call letter plates for RCA 44BX and 77DX microphones. Mike Lewis, 5549 Holmes Run Pkwy., Alexandria, VA 22304. (703) 823-3364

**FOR SALE:** Crosley Coloradio, dark blue (Collins, p. 97) - \$65. Zenith 5-S-29 tombstone (Bunis, p. 165) - \$85. UPS extra. Karl Stegman, 4 Cresthaven Dr., Belleville, IL 62221. (618) 234-7992

**WANTED:** Fleming valve. Marc Gottlieb, Box 1112, South San Francisco, CA 94083-1112

**WANTED:** Curved dial glass for Zenith 12-H-695 console, 1942. Stan Coulson, 1911-28th, Longview, WA 98632. (206) 425-4690

## Attention Collectors !!

This 1930 style cathedral AM/FM radio comes with 3 control knobs:

- AM/FM/Tone
- Tuning
- Volume

*Beautiful Sounds !!*

All in a genuine wood cabinet with quality stain and solid-state for electronics. Best gift, or collection your money can buy.

1 pc. - \$50/pc.

3 pc. (one case) - \$45/pc.

Plus C.O.D. charge & freight - No Tax (volume discount available)

**For order, call or Fax:**

Peace Electronics, Inc.

PO Box 1103

Fremont, CA 94538

Telephone # (510) 438-0888

Fax # (510) 438-0889



**A Replica Of An Early American High Quality Antique Cathedral Radio**

**The Size Is 12" x 15" x 9"**

**FOR SALE:** Rider's 7, 8, 9, 10, 11, 12, 13, 14 & 15 - \$12 ea. 100 N.I.B. tube miniature size - \$27.50. Novelty radio purse-shaped Cabbage Patch Kids - \$12. All items plus UPS. Thomas Burnside, 4838 S. Westhaven Dr., Jackson, MS 39209. (601) 922-2235

**WANTED:** Wood handle for 1939 RCA San Francisco Expo radio. Bezel for Philco 16B cathedral. Bezel plus push buttons for Zenith 6D317. Tube chart for Simpson 330 tube tester. Steven P. Berglund, 617 S.W. 146th St., Seattle, WA 98166. (206) 244-6428

**FOR SALE:** Simpson 260 Series 5P overload protected VOM, good condition - \$35 plus UPS. Edward Povraznik, 9606 Biddulph Rd., Brooklyn, OH 44144

**FOR SALE:** Baldwin Spinnet vacuum tube organ, 68 tubes, 2 keyboards, works; with tubes, service manual and schematic - \$50. Pickup only. Last call before junking for parts and speakers. Bob Gordon, 18560 Jewel Crest Dr., Muskego (near Milwaukee), WI 53150. (414) 679-1232

**IF YOUR EXPIRATION DATE IS  
DECEMBER OR BEFORE, RENEW TODAY!  
EARLY RENEWALS  
RECEIVE AN EXTRA ISSUE!**

**WANTED:** McMurdo-Silver Masterpiece VI (six) power supply/amplifier and 18" loudspeaker. John Howes, 11 Crendon Park, Southborough, Tunbridge Wells, Kent, TN4 0BE, England. 0892 540022

**WANTED:** Crystal sets by Giblin, Wecco, Dymac, Frank B. Perry & Sons, Clearstone, Willwmin, Hargraves, Taylor and Branch. Leonard J. Arzooonian, 61 Columbus Ave., North Providence, RI 02911. (401) 232-0869

**FOR SALE:** TV equipment and parts. Service books, schematics, one cabinet, tubes, service jigs, etc. George Kay/Atom Radio, 5 Fiske St., Worcester, MA 01602. Call Chuck evenings: (508) 852-4089

**FOR SALE:** Crosley 58 Buddy Boy, Repwood - \$400. Rider's manuals - \$20 ea. RCA 74-B ribbon mike - \$250. Jensen 15" speaker - \$50. Warren Dasho, 26 Kingston St., Reading, MA 01867. (617) 944-0470

**WANTED:** Emerson red 888 Vanguard and any Raytheon transistor radio. Also want phono needle tins and packets and any advertising (original or copy) on the old phono needles. Preston Meeks, 2811 Kenross, Houston, TX 77043. (713) 460-5369

**FOR SALE:** Philco R/P M46-1203, wd. case, @ 9 - \$35. Clarion, Warwick Mfg. Co. U.S.A., R/P console, plays, @ 9 - \$65. Farnsworth R/P MCK58, @ 9, a/or - \$35. Emerson cl/rad M724 Series D, grey, a/or, @ 10 - \$25. Majestic International, no other #'s, heavy, 3 kn - \$45. Firestone Air Chief St. # 7426-8 Stbg rcvr, 3 kn, 6 P/B, @ 9 1/2, deco wd. case - \$70. Automatic cl/rad M C152, wd. case finish @ 6 - \$30. Automatic wd. case Deco M613X, plays - \$60. Pkging + UPS. Bernie Samek, 53 Old Palmer Rd., Palmer, MA 01069. (413) 245-7174

**FOR SALE:** Moved! 90% of 52 pages list remains: radios, televisions, military, instruments, catalogs, literature. Francis H. Yonker P.E., W2IBH, 1229 Inverary Pl., State College, PA 16801. (814) 857-1400

**FOR SALE:** Aerodyn Special Model #6, 1926 vintage CX 301A, CX 201A tubes, untested - \$50. **WANTED:** Copy or original manual for Solar Capacitor-Analyzer Type 1-60. Stephen L. Bonino, 107 Georgetown Rd., Glassboro, NJ 08028. (609) 881-0244

**WANTED:** Giant glazed ceramic tube sockets for Eimac 3-500Z, Johnson, Millen, or equivalent. D. M. Hilsabeck, W8YAH, 2343 Banyon Dr., Dayton, OH 45431

**WANTED:** Zenith Royal 1000 and 300 Series Trans-Oceanic junkers and super-junkers. **HELP:** Steve in Texas, I lost your phone number. Please call. Jack Philpot, 623 E. 160th Ct., South Holland, IL 60473. (708) 596-0580

**FOR SALE:** Hallicrafters TV 1000A portable (Bunis, p. 86), near mint appearance and performance - \$100. Bill Rogers, 13305 Court Ridge Rd., Midlothian, VA 23112. (804) 744-3955

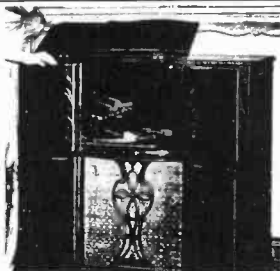

**WANTED:** Speaker for late 40's Capenart console pictured. Mark van Roojen, PO Box 83836, Lincoln, NE 68501-3836. (402) 438-3724

**FOR SALE:** Readrite set analyzer, plugs, has 2 meters, one moving coil type - \$25 + \$5. Alley cat radar detector, looks new - \$15 + \$2. RCP Dynoptimum tube tester, Model 309, tests 4-pin to loctal-octal, all papers included, case cover rough - \$25 + \$5. Eico Model 147 signal tracer - \$15 + \$4. Hy-Gain co-axial switch 3 inputs to one output switch selected - \$5 + \$2. Sencore Model CR125 CRT tester, papers, leads and adapters - \$20 + \$4. Police-alarm radio, as-is - \$15 + \$5. James Fred, R 1, Cutler, IN 46920. (317) 268-2214

**WANTED:** Zenith Royal 500, chassis 7XT40, and Admiral pocket transistor sets, 7M14, 7M16, 7M18. Jerald Hueber, 1368 King Richard Pkwy., W. Carrollton, OH 45449. (513) 866-6958

**FOR SALE:** Emerson Gemchest/Ingraham cabinet, beautiful - Offers. Heathkit VTMV, works - \$45. AK 175 gorgeous Art Deco wood with inlaid metal - Offers. Adam Schoolsky, 38007 Stenhammer Dr., Fremont, CA 94536. Phone/Fax: (510) 791-0584

**FOR SALE:** Westinghouse H-146 refrigerator radio - \$27 ppd. John Neal, 2221 5th St. S, St. Petersburg, FL 33705

**WANTED:** Jackson Bell Model 62 chassis, working or easily restorable. Richard Arnold, Box 275, Lone Grove, OK 73443

**WANTED:** Ten-Tec. State condition and price. Herman Schnur, Rt. 3, Box 151, Greenville, NC 27858

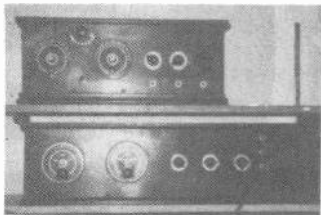

**FOR SALE:** Two homemade receivers. One has eight tubes, is complete with tubes untested and clean, with 7-201A's and 1-DeForest DL5 and a Peerless twin audio section; cabinet has nicks and scratches — \$200 plus shipping. The other is a three-tube with 2-301A's and 1-201A; the top is stained and the potentiometer is missing — \$100 plus shipping. Dennis Atkinson, Upper Park St., Phillips, ME 04966. (207) 639-3111

**WANTED:** Eagle Neutrodyne A, B or K1. Ted Depto, 913 5th Ave., Patton, PA 16668. (814) 674-8834

**FOR SALE:** 1938 Philco Radiobar, deluxe Deco model with two lights, excellent original condition, good chrome, no glassware — \$500. George Bosch, 2965 Knights Ave., W. Tampa, FL 33611. (813) 835-4048

**FOR SALE:** Selling off large collection of Radio News and Radio Craft magazines, send for magazine listing to: Ron Boucher, PO Box 541M, Goffstown, NH 03045. (603) 497-2988

**WANTED:** Crosley 5-75 chassis and knobs. Delco 1106 cabinet and knobs. Herman Gross, W9ITT, 1705 Gordon Dr., Kokomo, IN 46902. (317) 459-8308

**FOR SALE/TRADE:** Philco 53-301 table lamp clock radio, blonde with correct green shade; new, never sold — Best Offer. **WANTED:** Bendix 114, 115, 526C sets/parts. Fada 845 sets/parts. Emerson 520. Coke Cooler. Zenith advertising, literature. Bill Timoszyk, 35283 Leon, Livonia, MI 48150. (313) 421-2076

**FOR SALE:** Tubes XXFM, XXD, 6U5, K49B, L55B, used & N.O.S. guaranteed. Too many to list. Send LSASE with your requirements. Albert D'Ambr, 35-N Suffolk Dr., Rocky Point, NY 11778-9202

**WANTED:** Vintage Tube testers/sellers like Jewell Pattern 538 (A.R.C. 2/90, p. 11, A.R.C. 4/90, p. 12). Randolph Warren, 2911 Monroe Pl., Falls Church, VA 22042. (703) 241-4904

**FOR SALE:** Large Stromberg-Carlson power amp — \$28. Assorted Western Electric amplifier tubes. Advertising literature from October ad 1/2 price. **WANTED:** Atwater Kent 768Q junker or cabinet, Pilot Midget Model S-155 junker set with complete chassis. Bill Moore, 1005 Fieldstone Ct., Huntsville, AL 35803. (205) 880-1207

**WANTED:** DeForest sets DT-700, DT-900, DT-600 Everyman Crystal set; SP series, SP-1, SP-3, SP-4 sets. Richard Sharisky, PO Box 521, Belmont, MA 02178. (617) 484-5784

**WANTED:** I want to buy some Zenith black dial radios, Models 7S232, 8S232, 8S129, 9S30, 9S242, 10S130, 12S232 or any other 7-tubes up to 12-tubes tombstones. I will pay fair prices. Arnie Sanchez, 9615 Rockhurst, Houston, TX 77080. (713) 939-9221

**MESSAGE:** Thanks again to the transistor collectors who keep on calling and buying. To those who didn't call last month you missed: (3) TR1s, one red, (2) black, (1) TR63 yellow/red, an Emerson 808, an 849 in violet, a 500H, (3) 888s and many more of equally high collector value, and these were sales, not trades. And then there were the black Hoppy and the white U5A. **FOR SALE:** But, fortunately, I've a large collection of super sets almost all restored, and yes, I still want most of my house back so don't hesitate to call. And that also goes for you wood collectors. I'm still left with a few metals, and some novelty transistor sets as well. The goal is to reduce a collection that exceeded 450 sets to a more manageable 100 or so. For those who own TR1s or would like a copy, I'm selling Xeroxes of the official Regency Tech Data and Service Notes, from 1955, for — \$10 each postpaid. To those who sent for a list, I haven't been able to compile one because things are happening too fast. A phone call is a much better idea. Lastly, thanks to all who called and to those I'll hear from this month and, of course, happy holidays to all. Henry Cohen, 2459 Eighth St., Fort Lee, NJ 07024. (201) 585-0030



**FOR SALE:** General Radio & Television wooden grand piano radio — Best Offer. Scott Hagerman, 392 Ann St., Cary, IL 60013. (708) 639-7745

**WANTED:** Radios: Arvin Rhythm Baby 417, Arvin Rhythm Belle 467, Rhythm Junior 517 (F.O.S., p. 58). TVs wanted: Motorola 7-inch Model VT-71 (F.O.S., p. 114) and any 7-inch with wood cabinet. Mike Reynolds, PO Box 936, Rock Springs, WY 82902. (307) 382-6858

**WANTED:** Manual for RCA 3BX671 suitcase portable radio. Copy is acceptable. Cleo McAlexander, Box 4, Stanleytown, VA 24168. (703) 629-2972

**FOR SALE:** Large quantity of radio parts & tubes from 1930's to 50's — \$200. **WANTED:** Pre-1900 light bulbs, unusual early brass bladed fans. Gene Baudouin, Rt. 1, Box 206, Hahnville, LA 70057. (504) 783-2610

**FOR SALE:** Novelties: Big Bird, N.I.B. - \$30. Sinclair Gas Pump, N.I.B. - \$30. Mississippi Fire Pump - \$55. Mickey Mouse Head, PLT #110 - \$25. Blabber Mouth, N.I.B. - \$35. Cookie Time Clock radio - \$40. Bert & Ernie, PLT #149 - \$30. Mobil Oil Can - \$25. Old Parr Whiskey Bottle - \$35. Pillsbury Dough Boy - \$45. Wine Cask, no stand, PLT #377 - \$40. Pinch, PLT #386 - \$35. Seagrams Wine Cooler, N.I.B. - \$25. Wall Mount Wrist Watch - \$60. Hippie Love Medallion w/chain - \$35. GE Bicentennial radio - \$10. Wooden Globe - \$35. Constellation Golden Globe - \$60. Coke Can - \$25. Coke Bottle - \$25. Bud Can, N.I.B. - \$25. Cheeseburger - \$25. Locomotive AM radio, N.I.B. - \$40. Transistors: National Model R803, salmon - \$30. General Electric Sports Mate - \$30. GE 800 - \$15. Hitachi WH822 Marine - \$35. Plata 4-band, nice size with tuning light - \$35. Channel Mate 6506 with case - \$20. Motorola L12G, green - \$30. **FOR SALE/TRADE:** Zenith Trans-Oceanic 1000, 1000D and 7000. Harald Herp, 6615 Michele Court, Huntingtown, MD 20639. (301) 855-7071

Classified Ad Deadline Noon

Dec. 10 for Jan. 1992 Issue

Jan. 10 for Feb. 1992 Issue

Box & Photo Ads - 5th, Display Ads - 1st

**FOR TRADE:** Zenith 4R Tom Thumb Bike radio, extremely rare, 7" Tele-Tone TV, Signal Corps. BC-9A, AK 944, AK 944, AK 84, etc. **WANTED:** Western Coil & Electrical Co., Racine, Wisc., radios, parts, etc. Sets usually have Radiodyne or Lewis engraved on front panel. Also want parts for same. I will usually pay your price for a Western Coil set I need. Eric Sanders, 3295 W. 246th St., Sheridan, IN 46069. (317) 758-4988

**FOR SALE:** N.I.B. novelty transistors: Champion spark plugs (Breed, Plate 271) - \$30. Dodger baseballs (Breed, p. 441) - \$20. Alexandria Nelson, 9225 Evangeline NE, Albuquerque, NM 87111. (505) 291-9468

**WANTED:** Brown Bros. keys, paddles, semi-automatic, company brochures. And IC Keyer by Palomar Engineers. Gary Wagner, K3OMI, 11124 Oak Hollow Rd., Knoxville, TN 37932. (615) 690-4217, days - work



**FOR SALE:** RCA Nipper showroom dog, 3' high x 2 1/2' wide, electromechanical moving head to be sold December 4th, 220 San Bruno Avenue at 15th Street, San Francisco, CA 90046. Call Mr. Hill at (406) 258-6388 for information

**SERVICES:** Repairs for antique, old-time, and modern radios, 6v & 12v car radios. Ken Clarke, 1306 Winslow Ln., Madison, WI 53711. (608) 274-0790

**WANTED:** Good replacements for Zenith volume controls #63-1074, must have 2 taps, 5 lugs, & SPST switch & special shaft as original, need 5 units. Zenith used these in many chassis - the 3 shafts concentric type. Will swap original Zenith speakers, or sell outright, 49AB249, 49H415, 49H471. **FOR SALE:** N.I.B. power transformers, 4- thru 14-inch Electrodynamic speakers, N.I.B. vibrators. Write for lists, state your wants. (100) B/W TV sets, will give away, U haul, U take all; N.O.S. HC6/U xtals for your color generator: 189.000Kc, 3.563795Mc, 4.5Mc, 61.25Mc - \$3 ea. Good (1960's) screwbase capacitors: 2X24 MFD, common negative (not grounded!) - \$3 ea. Sams Auto Radio Manuals: AR 19, 21 thru 26, 28, 31, 35, 39, 43, 48, 51, 112, 115, 151 - \$3 ea., or swap for: AR 243, 266, 293, 299-311. Meissner, How to Build It books (includes analyst manual!) 1940, 1949 - \$20/both. (4) good meters for Hickock 156 traceometer - \$20/all. Nadiene and Jim Farago, 4017 42nd Ave. S, Minneapolis, MN 55406-3528. (612) 722-0708, call B-4 visiting

**FOR SALE:** Rider's Volume I, 1931, covers shop-worn but schematics good - \$60 ppd. Rider's Vol. III, printed for NU, very clean - \$50 ppd. George Greenberg, 1701 Andros Isle K-2, Coconut Creek, FL 33066. (305) 971-9053

**FOR SALE:** RCA, BP-10, w/tubes, some corrosion, repairable, #5 - \$20. Speaker, Philco, Mod H, w/output xfmr, cone bad, #16 - \$25. Weston, DMM, Mod 1240, parts only, #5 - \$5. Plus UPS, SASE for list. Wm. Arnold, 27832 Lincoln Rd., Bay Village, OH 44140. (216) 835-0520



*Craig L. Graybar  
Furniture Works Ltd.*

(414) 258-2390

SPECIALISTS IN RESTORING,  
REPAIRING AND REPRODUCING  
CLASSIC STYLED ANTIQUE TV,  
RADIO & PHONOGRAPH CABINETS

Send us your plans or your project  
via UPS for immediate price quotes



1535 S. 84th St.  
West Allis, WI 53214



*"We Turn Ideas Into Heirlooms"*

**FOR SALE:** EICO HF 60s w/Acro xfmsr & cages - \$300/pr.; HF 50 w/cage - \$125. Dyna MK IVs - \$300/pr.; PAS 3X - \$125. HK Citation II - \$450. McIntosh MR 55 mono FM tuner w/homemade cab. - \$125. Fisher 400C preamp w/cab. - \$100; 101R mono AM/FM tuner w/cab. - \$75.; 500 AM/FM rcvr - \$100. L. Gentieu, 10 Maple St., Andover, NJ 07821. (201) 786-6160, eves.

**FOR TRADE:** Guild telephone, excellent condition for Guild Town Crier lantern. Paul Fulton, 711 Jacquelyn Rd., Westwood, NJ 07675. (201) 664-5260

**IF YOUR EXPIRATION DATE IS  
DECEMBER OR BEFORE, RENEW TODAY!  
EARLY RENEWALS  
RECEIVE AN EXTRA ISSUE!**

**WANTED:** Knight-kit S/W rcvrs, Dxr, R-55A, R-100, Ocean Hopper, R-195, etc. **FOR SALE:** Allied Cats. Jack McCreary, 7783 Wilocreek Trl., Huntsville, AL 35802

**FOR SALE:** Radiola 60 - \$75. Crosley 435, tiny tombstone - \$65. Crosley Fiver tombstone - \$45. John Lyle, 1161 SW Mulvane, Topeka, KS 66604. (913) 232-0128

**FOR SALE/TRADE:** 1931 Telefunken - \$275. **WANTED:** Prewar Pilot radios, any condition. Bill Moore, 1005 Fieldstone Ct., Huntsville, AL 35803. (205) 880-1207

**FOR SALE:** Motorola Catalin, butterscotch, circle grille, 50XC (Sideli, Plate 158), unrestored, exc condition - \$3,500. Pilot TV Model TV37 with original carrying case, exc condition - \$425. Fada Bullet, yellow, Model 1000 - \$875. Eric Fogel, 87 Sandra Dr., Parsippany, NJ 07054. (201) 316-8461

**FOR SALE:** 1939 World's Fair radio - \$1,350. 1933 World's Fair radio - \$650. 1937 Snow White radio, both models - \$1,500. 1933 Mickey Mouse radio - \$1,500. Charlie McCarthy radio - \$1,350. Lone Ranger radio - \$1,350. Black Colonial Globe - \$1,500. Pepsi fountain dispenser, transistor - \$500. Al Kertesz, 3439 West Brainard Rd. Suite 260, Woodmere, OH 44122. (216) 831-4199, (216) 831-9110

**WANTED:** Marconi oscillator Type TF 1246, 40 kHz - 50 MHz. Dowdall O'Dacre, 548 Melton St., Pembroke, Ontario, Canada K8A 2S1. (613) 732-9597

**FOR SALE:** Supreme tube tester 89-D with 01-A rectifier, 12" x 11" x 5 1/2" in wood carrying case - \$55. Precision 10-54 tube & set tester, 14" x 18" x 7" in wood carrying case - \$45. AT Co. telegraph key - \$25. Groundulet Co. Ground meter - \$55. Four 1930's C batteries - \$6. Dandy 1918 wireless var. condenser - \$40. Three WWII acorn tubes with one socket - \$30. Two good filament WE 215-A peanut tubes - \$25. Open filament brass-base tipped 200, Bakelite UX-199, UX-301-A, and weak emm. UX-171, all four - \$10. Plus shipping. Always enclose SASE for reply. Arthur Harrison, 501 Arbor Dr., Columbia, MO 65201. (314) 474-8729

**WANTED:** HRO-60 accessories, crystal calibrator, NBFM adapter; coils E, F, G, H, J, AA, AB, AC, AD. Jim DeClercq, K8JUM, 17144 Dawn, Roseville, MI 48066. (313) 772-4687

**WANTED:** 15-tube 1938 Zenith chassis with speaker or will consider trading my nice 15-V-269 cabinet (orig. finish and gc) for a good condition Walton set cabinet. Jerry McKinney, 110 N. Franklin, Fayetteville, TN 37334. (615) 433-1198, after 6 pm CST

## FRONTIER ELECTRONICS

Everett Hoard

May to Oct. 15: Box 38, Lehr, ND 58460, phone (701) 378-2341

Nov. 1 to May: Box 1002, Apache Junction, AZ 85217, phone (602) 983-7114

### CAPACITORS

New Electrolytics (fully insulated with long leads - all prices include shipping)

Dual 33. uF./47. uF. @ 160.V. (for most table model radios)	each \$4.00	Four for \$10.00
Dual 22. uF./47. uF. @ 250.V.	each \$4.00	Four for \$10.00
Triple 33./33./47. uF. @ 160.V.	each \$4.00	Three for \$10.00
Triple 33./47. uF. @ 160.V. and 22. uF. @ 25.V. (Philco special)	each \$4.00	Four for \$11.00
Single 10. uF. @ 450.V.	each \$4.00	Four for \$8.50
Dual 10./10. uF. @ 450.V.	each \$5.00	Four for \$10.00
Single 22. uF. @ 450.V.	each \$4.00	Four for \$10.00
Single 33. uF. @ 450.V.	each \$5.00	Three for \$10.00
Single 47. uF. @ 450.V.	each \$6.00	Three for \$11.00
Single .1 or .22 uF. @ 630.V.	each \$4.00	Eight for \$10.00

### CAPACITOR REBUILDING

Send us your old round capacitor. We will rebuild it and return prepaid. Price \$8.00 to \$12.00 maximum.

### DIAL BELTS

N.O.S. dial belts for most sets (as available).	\$7.00 prepaid
New ZENITH belts	\$7.00 prepaid
New "O" ring, no stretch, belts	\$5.00 prepaid



**WANTED:** Under-the-lid loop antenna for Remler Scottie radio-phonograph. Junker OK. Paul Bourbin, 25 Greenview Ct., San Francisco, CA 94131

**WANTED:** Western Music and Radio Trades Journal magazines 1929, 1930, 1931 & 1932. Floyd A. Paul, 1545 Raymond Ave., Glendale, CA 91201. (818) 242-8961

**FOR SALE:** (4) Transmitters: Elmac A54H 80 thru 20 mtrs, Knight T60 80 thru 6 mtrs, 1 Lafayette HE 45 B6 mtrs, Adventurer 80 thru 10 mtrs. J. A. Ross, W6JPS, 5468 East Grant Ave., Fresno, CA 93727. (209) 255-7912

**WANTED:** Looking for any info and schematics for following: Bush & Lane console Model 12SG, National VFO 62. Also need Hallicrafters VFO for SR46 transceiver. Please, please help! Will answer all! Ed Turner, KB8MPR, 174 1/2 East Main St., East Palestine, OH 44413. (216) 426-4968

**FOR TRADE:** Have Federal Type 61. Want Pilot Superwasp, SW4, AGS, Silver-Marshall, REL, etc. Bob Mattson, KC2LK, 10 Jane Wood Rd., Highland, NY 12528. (914) 691-6247

**WANTED:** Nordemende Globe Traveller/Globe Trotter/a Globe Traveller II, 1964-1968, portable multiband radio. Joseph Taidriol, Rear 413, 4th Ave., Jessup, PA 18434. (717) 489-1054

**RATE FOR ADDITIONAL WORDS:**  
15¢ per word

**FIRST 20 WORDS FREE!**

*Cash or stamps OK for small amounts.*

*Your payment helps to keep A.R.C. healthy!*

**WANTED:** Anyone have a schematic for a 2" scope, Triumph Model 77, made in the mid thirties. Thanks. Alvin Abramowitz, 3327 Essex Rd., Baltimore, MD 21207

**MESSAGE:** Rock bound CW enthusiast desires QSO's with others of similar persuasion. Tracy "TR" Reese, WB6TMY, Box 4694, Santa Rosa, CA 95402. (707) 527-8124

**WANTED:** Cabinet for Philco Junior cathedral Model 80. Gerald Skoot, 2923 Mandalay Beach Rd., Wantagh, NY 11793. (516) 221-3535

**WANTED:** Latch for Trans-Oceanic H500, dial glass, pointer and escutcheon for Atwater Kent Model 206, operating manual for Philco Model 41-608 radio/phonograph/recorder. Glenn W. Stark, 428 W. 7th, Haysville, KS 67060. (316) 529-0109

## WANTED

*Speakers for Model 20  
Atwater Kent Radio or  
Speaker of Same Vintage.*

**Holme Hickman  
PO Box 6025-41  
Columbia, MO 65205**

**WANTED:** REL Precedence FM tuner. Art Greenia, 9531 Deering, Livonia, MI 48150. (313) 261-3032

**WANTED:** Clear, legible, four-band dial for Philco Model 16, Part No. 27-5064. D. K. Owens, 478 Sycamore Dr., Circleville, OH 43113. (614) 474-3408

**FOR SALE:** Western Electric 300B power triodes - \$150 ea. Art Greenia, 9531 Deering, Livonia, MI 48150. (313) 261-3032

**WANTED:** RCA Model 2B401 portable as pictured in C.G.A.R. p. 125. Dave Bertinot, 1445 S. Alameda Dr., Baton Rouge, LA 70815. (504) 925-2172

**WANTED:** Would like to purchase some 1931-32 era Philco knobs, rosettes and small bullet type (originals). Rudy Wiggins, PO Box 1133, Clewiston, FL 33440. (813) 983-5755

**MESSAGE:** Come back, whoever has Klystrons (X-12) for Prof. Zalewski. Please write or call: Gil Zalewski, 5100 Chingford Rd., Columbus, OH 43232. (614) 866-0094

**WANTED:** Zenith table model 5S126 and Zenith console 5S151. Please send price and condition. Mel George, 2597 Aragon Ct., San Jose, CA 95125. (408) 267-0697

**FOR SALE:** Atwater Kent vario-coupler, ex. cond. - \$40 + shipping. Charles Martin, 1407 Memory Ln., Lutz, FL 33549. (813) 949-1835

**WANTED:** Impedance bridge Mod 1606 Gen. Radio. F. Eckert, 10 Fairfield Ave., Albany, NY 12205. (518) 459-7407

**WANTED:** Cabinet for Philco 46-350 portable in good condition. Ray Sanders, 342 So. Third St., Cottage Grove, OK 97424

JOIN

A. W. A.



ONE OF THE WORLD'S LARGEST AND OLDEST  
HISTORICAL RADIO COLLECTOR ORGANIZATIONS.

- \* International "Meets"
- \* Nationwide "Meets"
- \* Sponsors world's largest radio Conference and Flea market
- \* Maintains unique radio and television museum
- \* Publishes quarterly journal featuring columns covering:
  - Battery & AC receiver restoration
  - Loudspeaker operation
  - Commercial receiver column
  - OT amateur transmitter operation
  - Vacuum tube collector's column
  - Early television receiver column
  - Current radio book & magazine reviews
  - Free Want-Sell-Swap column
  - Radio obituaries
  - Reports on public radio museums
  - Information on collector clubs in U.S.A. and foreign countries.

All this for only \$10.00 per year. Mail check to:  
Antique Wireless Association, Inc.  
Box 2-E, Breesport, New York 14816

**WANTED:** Radio chassis for Sparton Junior 410 (Bunis Collector's Guide, p. 145). Bruce E. Young, 4030 Quitman, Denver, CO 80212. (303) 458-7408

**FOR SALE:** Original manuals: 1948 Kaiser-Frazier custom auto radio and Silvertone Model 7009 — \$4 ea. ppd. Photocopies — \$2 ea. ppd. David Walker, 414 S. Library St., Waterloo, IL 62298. (618) 939-3214

**FOR SALE:** Rider's TV manuals #8, #6, #4 — \$15 ea. EICO #425 scope — \$25. Radiola III, mint — \$105. Homemade crystal set/phones — \$25. Rider's Radio Vol. #11 — \$20. **WANTED:** Inst. book, or copy, for Pyramid capacitor-resistor analyzer Mod CRA-2. Rider's Radio Vol. #1, #4, #5 & Vols. 21 & up. Dick Haynes, 12511 S. 83rd Ave., Palos Park, IL 60464. (708) 448-4577

**WANTED:** Top or whole cabinet for RCA 118. Cabinet and/or Basal for Airline 62-144. (2) White knobs for Emerson E-15WE. Complete 2 to 12 MHz. CAY-46706 Navy radio. Please help me finish these projects. Mark Partha, 213 S. Charles, Saginaw, MI 40602. (517) 793-9103

**FOR SALE:** (500+) books, magazines, manuals; (24) radios. Send SASE for 8-page list. P. Majewski, PO Box 92, Tamaqua, PA 18252

**WANTED:** Medical and scientific devices, violet rays, ozone generators, Tesla items, etc. Richard Cane, 8391 NW 21st St., Sunrise, FL 33322. (305) 741-6838

**WANTED:** TVs: Andrea 1-F-5, RCA TT5, DuMont RA103. "Chatham" offered week stay in our summerhouse; five guided trips in Belgium, Holland, Germany; house meals included. Rudi Sillen, Limberg 31, B-2230 Herselt, Belgium. 14.54.68.89

**WANTED:** Emerson Patriot trim as follows: blue knobs, red handle, white handle. Fada 5F60 trim, any color. I will pay generously for the above items. John Reid, PO Box 6183, Nashua, NH 03063. (603) 886-6700

**FOR SALE/TRADE:** Zenith 12-S-370 console, pickup only. Air King chassis, 3-knob airplane dial, 1935. Emerson library radio. Mark V. Stein, 822 Guilford Ave., Suite #130, Baltimore, MD 21202. (301) 366-3823

— WANTED —

**PICTURES FOR PHOTO REVIEW  
PHOTOS MUST BE SHARP IN DETAIL  
A SHORT DESCRIPTION IS A MUST!  
SEE PHOTO REVIEW PAGES FOR  
ADDITIONAL INFORMATION**

**FOR SALE:** Hardware, tubes and test equipment. LSASE for lists. **WANTED:** Basketcase test equipment. Ray Bintliff, K1YDG, 2 Powder Horn Ln., Acton, MA 01720. (508) 263-7435

**WANTED:** Western Electric amplifier 124, Dynaco MK III, PA amplifiers. Mamoru Ichino, 683 Hinoue, Gyoda, Saitama, 361 Japan

**WANTED:** Unused big RCA HC2000H output transistor. Mike Parker, 945 S.E. Linn St., Portland, OR 97202

**FOR SALE:** One ea. 26, 326; three ea. 30 tubes — \$9 for all ppd. Allen organ 50-watt transistor audio amplifier — \$50 plus UPS. JFD replacement cord for Motorola 600 ohm — \$1 for postage. Ancient Triplett Mod. 630 na VOM — free for postage and ad. Thomas F. Pollock, WB6ZYE, 243 West Lime Ave., Monrovia, CA 91016. (818) 359-8013

**WANTED:** Cabinet for Bendix 65P4U radio. Also, June and July 1937 issues of Modern Mechanix. Don Russell, 55 Bilodeau Ct., Burlington, VT 05401. (802) 860-7034

**FOR SALE:** Philco wood Model 38-12 — \$50. Gershon Super-Five battery radio with tubes — \$105. Freed-Eisemann Model #30 — \$110. Add UPS charges. Clark Trissell, 3530 Pawnee, Lincoln, NE 68506. (402) 488-5263

**FOR SALE:** Jackson oscilloscope with manual, asking — \$40. Heath Laboratory triggered oscilloscope, asking — \$50. Both oscilloscopes have been overhauled. Old radio books — \$5 and up. Sidney Goldhor, 2147 Trombas Ave., San Leandro, CA 94577. (510) 357-3788

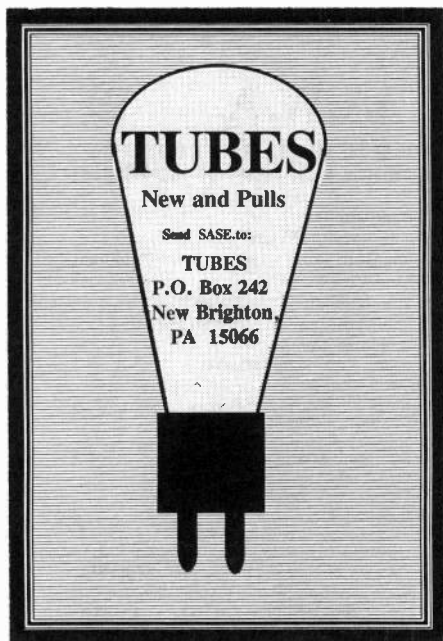

**TUBES**  
New and Pulls  
Send SASE to:  
**TUBES**  
P.O. Box 242  
New Brighton,  
PA 15066



*Antique Radio Service*  
508-653-2118

Auto Radio — Home Radio  
Buying auto radios 1928 to 1970  
And service literature, all kinds.

SASE Please:  
RICHARD C. FOSTER  
12 Shawmut Ave., Cochrutuate, MA 01778

**MESSAGE:** Wanted: The New England Antique Radio Club wants you! Join over 500 others and become a member of the best radio club in the country! Don't miss our big Winter Swap & Sell Meet, Saturday January 25, 1992, 8 am to 1 pm, Resurrection Center, Nashua, N. H. Over 100 tables! Hundreds of radios! 50/50 raffle! Two old equipment contests featuring clock radios (table) and clock radios (grandfather)! Be there for another great day of radio fun and excitement! For more swap meet or membership info, call or write and be sure to ask for a free sample copy of the club newsletter. NEARC, RR 1, Box 36, Bradford, NH 03221. (630) 938-5051

**FOR SALE:** RCA radio/phono RE-40-P (F.O.S.)—\$75 plus UPS. Kenneth Miller, 10027 Calvin St., Pittsburgh, PA 15235

**WANTED:** Knobs, plastic dial window for Meteor 16YA, brown Bakelite knobs for Fada 790. John A. Trosky, 247 Woodlawn Ave., Jersey City, NJ 07305. (201) 433-4784

**WANTED:** Instructions for Heath T-3 visual-aural signal tracer, copy OK. George Demeroukas, 1417 N. 36th, Melrose Park, IL 60160

**FOR SALE/TRADE:** Choice radios, jukeboxes, broadcasting & audio equipment; SASE. Want professional audio equipment, literature, microphones. Robert Van Dyke, Museum of Broadcasting, Film & Recording, 2 Squires Ave., East Quogue, NY 11942. (516) 728-9835

**FOR SALE:** Transistorizer receiver built a pair of eyeglasses (O.T.B. 2-87) — BO. Western Electric microphone 639 A desk stand II-A yoke ribbon OK —\$175. 1 sets knobs (4) for Philco 70—\$25. Marcel Vallee, 703 Boul. St. Germain Ouest, Rimouski, Quebec, Canada G5L 3S6

**WANTED:** Hallicrafters S-39 Sky Ranger/(military R-80/PR) AC-DC-battery radio. Mike Ceklovsky, 3116 Smoky Ct., Sacramento, CA 95826. (916) 363-3211

**WANTED:** Zenith 2-R, CRL Federal 58, 59, 102, and literature for same. Bill Wade, 657 14th Ave., Prospect Park, PA 19076. (215) 534-3477

**FOR SALE:** Following consoles restored: Philco Model 86 — \$125, Edison Model — \$250, Radiola Model 82 — \$250. Arthur Ownbey, Tom Cat Hill, Yoder, CO 80864. (719) 478-5611

**WANTED:** Western Electric 300A/D tubes manufactured before 1958 — \$220 new, \$110 used. H. Kato, c/o Mr. Shiraishi, 5639 Glen Haven Ct., San Jose, CA 95129

**WANTED:** Radiola 16 in need of restoration, but must be complete. Steve Zingmond, 6241 Radford Ave., No. Hollywood, CA 91606. (818) 769-9283, eves. PST

**FOR SALE:** Rider's Radio manuals 6 thru 14 plus 16 — \$12 ea. Philco Service Manual 55 thru 66 — \$8. Plus UPS. C. William Johnson, 34 Springlake Pl. NW, Atlanta, GA 30318. (404) 355-6308

**FOR SALE:** Radiola Model 103 cone speaker — \$40. Craftsmen Model 800 AM/FM tuner, chrome chassis, 14 tubes — \$30. GE Model J-62 — \$30. Send large SASE for list of others. Jeffrey Viola, 475-B Elitone Rd., Jackson, NJ 08527. (908) 928-0666

**MESSAGE:** Immediate delivery on Radio Manufacturers of the 1920's: Vol. I — \$25, Vol. II & Vol. III — \$30 ea. Crystal Clear — \$40. Less 10% on two or more. Price includes tax + postage. Check with order please. Paul Thompson, 315 Larkspur Dr., Santa Maria, CA 93455. (805) 934-2778

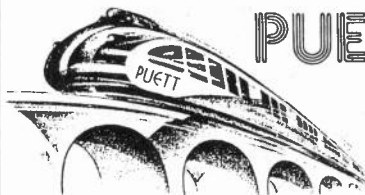

# PUETT ELECTRONICS

P.O. BOX 28572 DALLAS TX 75228

**NEW CATALOG 77**

OUR PAST CATALOGS AND PRICE LISTS ARE NOW OBSOLETE.

CATALOG 77 (20-PAGES) OUR BASIC CATALOG \$2.00 POSTPAID.  
YOU RECEIVE A \$3.00 DISCOUNT COUPON WITH CATALOG 77.

CATALOG 77/PLL-2 (56 PAGES) -- \$5.00 POSTPAID.  
YOU RECEIVE A \$6.00 DISCOUNT COUPON WITH CATALOG 77/PLL-2.

WE NOW HAVE MORE THAN 1,500 DIFFERENT ANTIQUE RADIO PUBLICATIONS AVAILABLE! CATALOG 77/PLL-2 LISTS EVERYTHING WE HAVE TO OFFER!

WE OFFER BOOKS, INSTRUMENT MANUALS, SERVICE DATA, SALES BROCHURES, ATWATER KENT, RCA, CROSLEY, ZENITH, ETC. FACTORY SERVICE MANUALS, STROMBERG CARLSON, CAPEHART, SCOTT, McMURDO SILVER, FISHER CLASSIC RADIO LITERATURE, DIRECTORY OF ANTIQUE RADIO SERVICES, SCHEMATIC DIAGRAMS ON NEARLY ANY RADIO, OLD-TIME RADIO PROGRAMS ON CASSETTES, TUBES, TUBE MANUALS, BOOKS ON WIRELESS AS OLD AS 1902, TUNING DRIVE BELTS, TUNING DIALS, TUNING-DIAL GLASS COVERS, KNOBS, OUR OWN PERIODICAL "ANTIQUÉ RADIO TOPICS" WITH THE ANTIQUÉ RADIO NEW ACQUISITIONS LIST, AND MUCH MUCH MORE!! ORDER OUR CATALOG TODAY!!!!!!!

GET THIS  
**WORLDS  
GREATEST  
RADIO  
CATALOG**

**WANTED:** Top price plus paid for Zenith bookcase, GE Georgian, Ozarka 95. Gordon Wilson, 11108-50 Ave., Edmonton, Alberta, Canada T6H 0H9. (403) 434-6257

**WANTED:** Vol. Cont. Radiola 17. Service manual or schematic for Seeburg Model 161 amplifier. Warren Adams, 608 N. G St., Imperial, CA 92251. (619) 355-4221

**FOR SALE:** Channel Master clock and fluorescent light. SASE for details. John Uscinowski, RR#1, Box 379, Greenwich, NY 12834-9519

**WANTED:** Orig. type radio & speaker for 1948 Crosley car, also other parts. John Wilson, RR1 Box 81M, Stoddard, WI 54658

**WANTED:** Tube caddy in excellent condition. All Marantz tube equipment. Acrosound amps. Fairchild amps and preamps. Hadley amps. Western Electric amps. N.O.S. Amperex Bugle Boy EL-34's and Mullard EL-37's. 1950's-1960's hi-fi books, catalogs, and magazines, including Audiocraft and Audio. Paul Creasy, 6216 Worlington Rd., Bloomfield Township, MI 48301. (313) 737-0429

**FOR SALE:** Knight general purpose oscilloscope, untested but all original - \$75 plus shipping or interesting trade. Ernest D. M. Yeaw, RR#3, Tatamagouche, Nova Scotia, Canada B0K 1V0. (902) 657-2554

**FOR SALE:** Edison diamond disc phonograph, Model C150, works well - \$275. Colonial, Model C399, 6-legged console - \$125. Fifty or more clean original sets available, thinning my collection. Sorry, no shipping; come see my inventory! Dickering done here. All inquiries to include SASE. Francis W. Pond, RFD 1, Box 660, Epping NH 03042. (603) 659-3831, no calls after 9 pm EST

**WANTED:** S-20-R, must be near mint and all original condition. Milton Kessie, WD8OFB, 16820 Hubbard Rd., Livonia, MI 48154-3154

**WANTED:** Information on Capehart record changer (flip over) mates with Model 413-P radio-AM-FM-SW. Ray Sanders, 342 So. Third St., Cottage Grove, OR 97424

**FOR SALE:** Coin-operated radio, very good physical and working condition - \$300 plus shipping. Rene Deschenes, 10329 Plaza Paseo Dr., Lakeside, CA 92040. (619) 443-7956

**WANTED:** Sams CB-1 thru CB-50 service manuals. James A. Weil, 15915 Armada Center Rd., Romeo, MI 48065. (313) 784-9860

**HAVE YOU MOVED? ARE YOU MOVING?  
PLEASE NOTIFY US A.S.A.P.  
SEND US YOUR...  
OLD ADDRESS  
NEW ADDRESS and  
SUB #  
MANY THANKS!!!!**

**WANTED:** Old magazines, old TV's, literature on Lincoln, McMurdo-Silver radios. Don Hauff, Box 16351, Minneapolis, MN 55416

**FOR TRADE:** Green Fada 700, mint, nice swirling, for another Catalin. John Reid, PO Box 6183, Nashua, NH 03063. (603) 886-9670

**WANTED:** Fairbanks Morse chassis 10-tube Model 90. Record player No. 169 for Zenith. Leon Gann, 1134 E. 50 Pl., N, Tulsa, OK 74126. (918) 425-3590

**FOR TRADE:** Excellent National SW-3 plus cash for Pilot Super Wasp or Grebe CR-18. Paul Christensen, 11142 Raley Creek South, Jacksonville, FL 32225. (904) 721-9111, 9 am - 5 pm

**FOR SALE:** Zenith radio Model 6G001, excellent condition, works - \$35 plus UPS. Thank you. Russell Schoen, E7340 Nietzsche Rd., Clintonville, WI 54929. (715) 823-6744

**WANTED:** Any B&K Models 300 thru 440 CRT tester/rejuvenator and manuals. Include prices. Russell Sound Systems, 720 College Dr., San Jose, CA 95128-2812. (408) 295-7110

**FOR TRADE:** A Ferranti UK-1945, nice Deco brown Bakelite, good shape & schematics. Make offer. Bruno Pinto, 251 W. 89th St., #12D, New York, NY 10024. (212) 724-9420

**OLD TECH** *Early*  
**BOOKS** *Technical*  
& **THINGS** *Books & Apparatus*

**Announcing - Catalog No. 1**  
**Available Soon\***  
**Write For Free Copy.**

**We Specialize In:**

Wireless - Radio - Television - Telegraph  
Telephone - Electricity - Computers - Slide Rules  
Electro-Medical - Calculators - Typewriters  
Atomic Energy - Astronomy - Skiing

**We Buy & Sell:**

Books - Juveniles - Catalogs - Magazines  
Manuals - Ephemera - Novelities - Apparatus  
Anything Related!

*Send us a list of your general & specific wants.*

**OLD TECH - BOOKS & THINGS**

John V. Terrey, Proprietor  
P.O. Box 803, Carlisle, MA 01741 U.S.A.  
*\*Still delayed, but eventually I will get it finished!*

**• LOUDSPEAKER REBUILDING •**

*Our customers across the country,  
and beyond,  
say that we are the best...*

If that is true, our goal of providing quality, professional, friendly service at reasonable prices has been met.

Ask around, then send your speakers to us.  
We guarantee your satisfaction.

Call toll free for information: 1-800-367-SPKR

**Lakes Loudspeaker Service**  
4400 W. Hillsboro Blvd.  
Coconut Creek, FL 33073



**WANTED:** 1927 or 1928 Fada radio with speaker in playing condition. Gerson Eisenberg, Belvedere Towers, Suite 108, 1190 W. Northern Parkway, Baltimore, MD 21210

**WANTED:** Dead or alive Stewart-Warner R1301A for parts - dial, knobs, etc. Hugh Coachman, Box 2345, Lakeland, FL 33806. (813) 644-6805, eve., (813) 439-6363, day

**FOR SALE:** I have 4 doz. radios in the box for sale. These radios are marked Polaroid 600 plus AM/FM radios - \$17. This will include shipping. J. Thurman, 3602 California, St., Louis, MO 63118. (314) 773-6744



**WANTED:** Plastic radios from the 30's in marbled or solid colors, whole or parts sets. Please write or call: Rain Buttignol, 214 State St., #7, Portsmouth, NH 03801. (603) 427-1384

**FOR SALE:** RCA Models R-44, R-46AC, R-47 or Graybar Models 500, 550 power transformer, N.O.S. - \$25. Bremer-Tully Models 8, 81 or Brunswick Models 14, 21, 31, S-31 audio input transformer, N.O.S. - \$15. Bremer-Tully Models 3, 81, S-81, S-82 or Brunswick Models 14, 21, 31, S-14, S-21, S-31, S-81, S-82 audio driver transformer, N.O.S. - \$15. Dennis Craft, 10513 E. Clinton, Scottsdale, AZ 85259. (602) 860-8951

**SERVICES:** Crank phonograph repairs, reasonable prices. **WANTED:** Old phonograph parts, incomplete machines, horns, any condition. Dave Faehrich, 8215 Stone Rd., Independence, OH 44131. (216) 447-0837

**FOR TRADE:** AK BB detector 1-stage TA unit for 2-stage amp green TA unit. **WANTED:** Single tube detector with posts. Does anyone sell repro AK BB blanks? Rick Peterson, 206 Longfellow Ln., Mandeville, LA 70448. (504) 624-9969

**WANTED:** Eveready Mod 3 in green aluminum case, S.B. decent cosmetically. **FOR SALE:** Philco 20 Deluxe restored - \$225. Philco 70 restored - \$275. RCA 1R81U Bakelite AM/FM - \$30. RCA 97X, nice wood case, plays - \$40. AK 310 restored - \$150. Philco 38-9 Deco, plays - \$85. AK 768, cabinet needs rest. - \$100. Magnavox TV in interesting corner-cupboard cabinet pickup - \$75. Books: Radio Retailing 1930-1941 - SASE for list. Gernsback Official Service Manual Vol. 1 - \$35. Rider's 1-5 abr. - \$20, 6-14 - \$5 ea. Some water damage. Sams Auto Radio - SASE for list. Sams one large binder of the very first folders - \$10. All above plus UPS. Finales for Philco mantel clocks set 3 - \$35 ppd. Richard C. Foster, 12 Shawmut Ave., Cochoituate, MA 01778. (508) 653-2418, days, 7-8 pm, ans. mach. 4th ring

**FOR SALE:** Microphone, Shure Bros. #97U29 - \$45. Headphone, single type, Western Elec. - \$20. Westinghouse #H-417T5 (Baby Boom, p. 190), corner broken - \$20. RCA 8BX5, parts set, chassis exc - \$15. Sky Rover #9002N - \$35. Radio Boys At Ocean Point, good - \$25. Stromberg-Carlson, brn., Model #?, looks like #1400, (Baby Boom, p. 8) - \$60. **WANTED:** Six Fleetwood Globe radio, cute - \$50. **WANTED:** Cone & driver, Tower Ship speaker Adventurer. Lid Radiola 20. Gum wood lid, Eveready #1. Bell Music Master horn. Will trade or buy wants. All sold as is, buyer assumes all responsibility. Plus UPS. Darrell Combs, 6587 Pacheco Way, Citrus Heights, CA 95610. (916) 969-0635

**FOR SALE:** LSASE for list of radios, tubes, parts, literature, and what have you. Stan Lopes, KB6LGV, 1201-74 Monument Blvd., Concord, CA 94520. (510) 825-6865

**WANTED:** Crosley 10-136E black/gold (Bunis, p. 45) and 10-139 aqua/chrome. **FOR SALE:** Fada 790 brown, missing knobs - \$50. Fada L96 wood - \$35. Tesla 308 very Deco Bakelite, Czech made, teardrop shaped - \$100. Tesla Minor, 2-tone portable, Czech made - \$35. Stewart-Warner C51T1 (G.O.R., p. 115) scratched paint, but works - \$25. Airline 05KR-1520B blue metal set - \$55. Shure 737A microphone - \$30. Sparton tombstone, good working condition except it's been painted - \$70. Emerson alligator covered portable - \$25. Sparton Bakelite - \$30. Mint case for Silvertone 07025 (G.O.R., p. 99) - \$12. Arvin Bakelite 544 (G.O.R., p. 99) repainted, wrong knobs - \$30. Japanese Kensington transistor, N.I.B. - \$35. Also have Emerson 511-red, swirled Bakelite - sell or trade. Brad Jones, 4107 Crabapple Ln., Greensboro, NC 27405. (919) 375-6340

**Classified Ad Deadline Noon**

**Dec. 10 for Jan. 1992 Issue**

**Jan. 10 for Feb. 1992 Issue**

**Box & Photo Ads - 5th, Display Ads - 1st**

**WANTED:** TV's: Dumont Chatham Model RA103, RCA 621 parts or complete sets. Call: Bruce Mager, Waves, 32 East 13th St., New York, NY 10003. (212) 989-9284. Fax: (201) 861-0914

**FOR SALE:** DeWald TR-910 CB, Gonset Communicator 1V base CB, Lafayette HE-45A 6 meter band amateur transceiver, RME Model VHF-126 converter. Nostalgia Radio, Frank D. Atwood, 117 E. Main St., Merrimac, MA 01860. (508) 346-8100

**WANTED:** Low frequency converter (Model 2-LF) for Drake 2B receiver. Also 160 meter xtals. Ed Barbacow, K3ZCY, 330 Ceylon Rd., Carmichaels, PA 15320

**WANTED:** Subminiature tube portable radios, such as Automatic T.T. 528 & 600. Belmont 5P113. Crosley JM8. Emerson 747, 838 & 856. Firestone 4C28 & 4C29. Flacco FM. Hastings FM Jr. Hoffman BP402. Micro Radio. Motorola 45P & 54L. Privat-ear. Silvertone 4212. Westinghouse H50 8P4. Noriyoshi Tezuka, 2-2-6-407 Ebisunishi, Shibuyaku, Tokyo 150, Japan. Fax: 011-813-3780-7029

**FOR SALE:** Attention General Radio collectors: 546-E audio frequency microvoltmeter, 1304-A beat frequency oscillator, 1931-A amplitude modulation monitor. D. Reginald Tibbetts, 2151 Camino Pablo, Moraga, CA 94556. (510) 376-5082

**FOR SALE:** Guild Grafonola tube stereo/radio combination with rare cabinet/extension speaker, excellent! - \$500. Gerald Schneider, 3101 Blueford Rd., Kensington, MD 20895-2726. (301) 929-8593

**WANTED:** WWII radio receivers, especially Navy types, working or not. Joseph R. Gordon, 3275 Central Ave., Alameda, CA 94501-3108. (510) 865-4608

**WANTED:** To buy an original copy of S.S. Kresge 1931-1932 Radio & Television Catalog and Service Men's Guide. Don Kresge, 4721 Overwood Cir., Birmingham, AL 35222. (205) 595-2856

**FOR SALE:** RCA 68R4 AM-FM wood table model. Westinghouse WR10 tombstone. Both excellent originals. Scott England, 6729 Bellefontaine, Kansas City, MO 64132. (816) 444-0809

**FOR SALE:** Dial glasses convex or flat, any size original new stock, order by size only - \$5 to \$24.99. Ernie Odeneal, 2710 Lee, Greenville, TX 75401. (903) 455-2113 or 5788

**WANTED:** Manual, original or copy for Signal Corp. keyer TG-34-A. Also Signal Corp. telegraph set TG-5-B. A. B. Chislowky, 2947 Ave. V, Brooklyn, NY 11229

**FOR SALE:** AK 92 cathedral - \$90. Majestic 70 highboy - \$75. SASE for list. Mike Prague, 40 Loomis Ave., Watertown, MA 02172. (617) 924-6146

BUY • SELL • TRADE

## CATALIN RADIOS

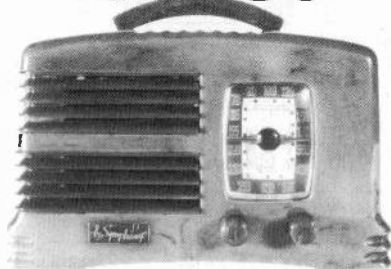

I'll buy single pieces or  
whole collections. Top prices paid.

### RADIOART

Jim Meehan  
P.O. Box 102 • Centerbrook, CT 06409  
(203) 767-2558

**FOR SALE:** Philco (rare) dual arm turntable Model 50-1421 in Sams 97-11. Vic Bang, 939 E. Guadalupe Ste. #1, Tempe, AZ 85283. (602) 491-1811

**WANTED:** Escutcheon for Silvertone 1720/1403 (Bunis, p. 138) - \$10 + ship or ?. Dan Merz, 312 Sierra, Richland, WA 99352. (509) 375-1334

**HELP:** Urgently need schematic/service info German Olympic Opta 5781 W rcvr. Ralph Michelson, 4538 Golfview, Brighton, MI 48116. (313) 229-8339

**FOR SALE:** Zenith Trans-Oceanic radio, Model H500, chassis 5H40, 1951 - Make Offer. Milton Obuch, 1308 N. 4th St., Sayre, OK 73662. (405) 928-3798

**FREE - 20 WORD AD EACH MONTH**  
To get your free 20 words,  
include your SUB# with your Ad.  
Additional words are 15¢ each.  
Read inside back cover for details.  
**MANY THANKS!!!!**

**WANTED:** Cabinet for 9S262 Zenith or other shutter dial 12-inch speaker console. Call or write with price. Charles McCombs, 259 Frisco St., Box 10, Georgetown, KY 40324. (502) 863-2996

**FOR SALE:** U.S. Forest Service radio rcvr, Coastalrad, air alert, alarm, Type BR2; mil. handsets, compact, WX prof, Type H169/GR & M80C/U, U/W PRC, VRC, URC, AIC, GRC, Dynamic mike, press to talk SW, cord, U229/U connector, SASE pse. George Belling, W6CTG, 3740 Atlas Ave., Oakland, CA 94619

**FOR SALE:** Kenwood R2000, new - \$525. BC348, new in box - \$150. BC453/AC - \$37.50. Sky Buddy 540-30Hz - \$55. Ernie Odeneal, 2710 Lee, Greenville, TX 75401. (903) 455-2113 or 5788

**FOR SALE:** I offer 100% refunds on any item that you are not pleased with. In fact I'm so confident that you will like my stuff that I will reimburse you for the return UPS charges if you are not satisfied (offer limited to packages weighing 35 lbs. or less). Every one of my sets have been thoroughly cleaned and polished and are ready to display or resale! I add new items often so please send SASE for updated lists. Some new items include two Jensen early hi-fidelity horns & one 8 1/4 cone speaker. Also have new radios, literature, parts, & test equipment. Please phone after 5 pm Mountain Time or send a SASE to: Neil O'Donnell, 1809 Sampson Ave., Butte, MT 59701. (406) 494-8162

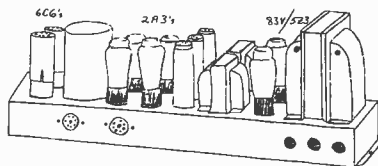

**WANTED:** Scott 8-tube power amplifier as shown. All leads appreciated and will pay generously. John Meredith, 1792 Nemoke Trl., Haslett, MI 48840. (517) 349-4348

**FOR SALE:** AK 51 console. Philco 65 console. Philco 41-844 breadbox. Will trade for old fountain pens. Del Tysdal, 812 Broadway, Fargo, ND 58102. (701) 293-9328

**FOR SALE:** Crosley Model 11-104-U orange, dial needs restring. Stromberg-Carlson Model 337 console. Two Western Electric 633A microphones. Zenith radio nurse with guardian ear. Vega wireless microphone system Model 01-00031. All excellent shape. Will take any reasonable offers. Patrick Shanahan, 489 Westford St., Lowell, MA 01851. (800) 786-1556

**WANTED:** Wire recorder wanted: Prefer good working condition, but will consider others. Bill Johnston, PO Box 370, White Sands, NM 88002. (505) 382-7804

**WANTED:** Hallicrafters SX-73 or Hallicrafters military radio R274/FRR. CBS/NBC call-letter plate for RCA 44 microphone. M. L. Harrington, PO Box 7619, Little Rock, AR 72217

**FOR SALE:** Sams Auto Series 11-171 - \$2 ea. Also Sams in binders Vol. 69-114 - \$13 ea. Nidu[?] 140 Trainers - \$15 ea. All + shipping. Harry Pewowaruk, 1535 No. 8th Ave., St. Cloud, MN 56303. (612) 252-9910

**WANTED:** Socket for 4-1000A tube, also low frequency plug-in converter for Drake 2B receiver. Ed Barbacow, K3ZCY, 330 Ceylon Rd., Carmichaels, PA 15320

**FOR SALE:** Crosley Model 124 grandfather clock radio, exc condition - \$300. Phil Guinan, 106 Page Rd., Litchfield, NH 03051. (603) 889-6213

**FOR SALE:** Mills Eagle parts, 10¢ jackpot chute & spacer top bonnet 25¢ escalator - \$235. Jay Mullikin, 113 Springer Ave., Edwardsville, IL 62025

**WANTED:** Philco Predicta tabletop TV in excellent condition. **FOR SALE:** 1928 Majestic Model 71 console - \$225 OBO. Robert Schrantz, 610 E. Juanita Ave., San Dimas, CA 91773. (714) 394-1194

**WANTED:** Radio keg, Philco and Lyric cathedrals. Novelty radios. Rick Stromberg, 700 N. Georgia St., Kennewick, WA 99336. (509) 783-5689

**FOR SALE:** National SW54 - \$55. Hallicrafters 6 meter trans/rec, nice - \$75. Emerson 888 & 704, RCA Stratoworld - \$75. Ernie Odeneal, 2710 Lee, Greenville, TX 75401. (903) 455-2113 or 5788

**FAX NUMBER FOR ANTIQUE RADIO CLASSIFIED (508) 371-7129 - 24 hours a day Ads - Subscriptions - Book Orders Charge to VISA/MasterCard Minimum Charge: \$10.00**

**FOR SALE:** Tektronix Model 524 D cathode-ray oscilloscope, excellent condition, works great. William Bradford, 3891 Seagull Dr., Salt Lake City, UT 84120

**FOR SALE:** 1929 Sparton Model 301 Equasonne, vg condition, working, (G.O.R., p. 53) - \$500. Ken Kamperman, 11 Grant St., Wellsboro, PA 16901. (717) 724-0192

**WANTED:** Zenith Model 9S262, need cabinet only. **FOR SALE:** Sparton Equasonne 301, vg. Jim Ryan, 471 E. 329th St., Willowick, OH 44095. (216) 943-4677

**FOR TRADE:** Will trade for other Catalins - yellow Emerson Aristocrat, green swirled Fada 700, maroon and white small Plaskon Addison. All mint. John Reid, PO Box 6183, Nashua, NH 03063. (603) 886-9670

\*\*\*\*\* OLD TIME RADIO BROADCASTS ON CASSETTES \*\*\*\*\*

MANY OF YOUR OLD TIME RADIO FAVORITES ARE AVAILABLE ON QUALITY CASSETTES AT A REASONABLE COST. YOU SELECT THE SHOWS YOU WANT AND PURCHASE THEM BY THE HOUR. FAST, FRIENDLY SERVICE TOO.

THE GREAT GILDERSLEEVE

THE SHADOW  
SUSPENSE  
JACK BENNY  
SHERLOCK HOLMES



AMOS 'N' ANDY

LUX RADIO THEATER  
FIBBER MCGEE & MOLLY  
SGT. PRESTON  
THE LONE RANGER

SEND FOR OUR CATALOG LISTING NEARLY 5,000 SHOWS ARRANGED BY SHOW CATEGORY AND TITLE, MANY INCLUDING ORIGINAL BROADCAST DATES. ONLY \$2.00 (P & H). SEND REQUEST TO:

ERSTWHILE RADIO  
P.O. BOX 2284  
PEABODY, MA 01960

\*\*\*\*\* OLD TIME RADIO BROADCASTS ON CASSETTES \*\*\*\*\*

**FOR SALE:** Crosley Coloradio - \$175. Philco plastic portable AC-DC with factory built-in flashlight - \$40. Mitchell bed lamp radio - \$60. Two Zenith Royal 500's - \$30 and \$50. Zenith 275 transistor - \$40. Airline 04BR 511A Bakelite hairline - \$60. Westinghouse Little Jewel, one blue mint, one stripped - \$120 each. Zenith 7000 American TV - \$50. Zenith 8G005YT1 TV - \$50. Several Zenith 3000-1 TV's, trade for metal radios, Arvins and Silvertones. Westinghouse Little Jewel - \$90 or trade for chrome metal radio. Jim Montague, 921 S. Cuba, Spokane, WA 99202. (509) 535-9576

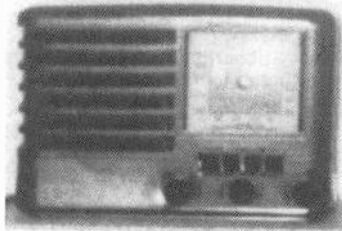

**WANTED:** Emerson BC-SW. 1948-50 model unknown if in mint condition. Work OK I will buy. Mr. Jean B. Desautels, 616 N. Silver Circle, Key Largo, FL 33037-3840. (305) 852-2109

**FOR SALE:** N.O.S. and used tubes, radios, speakers, radio books, magazines, pamphlets, sales brochures, parts. Have N.O.S. dial belts. Send LSASE 2-stamps. Rudy Hecker, 127 Weymouth Ct., Schaumburg, IL 60193. (708) 529-3560, after 6 pm

**FOR SALE:** AK breadboard Model 10C; AK Model 30; Kadette Jewel, brown w/tan marbled center panel; JCV Delmonico International, AM-FM and 3 SW bands. Manuals: Rider, Zenith and RCA Redbooks. Call for availability and prices. Vintage TV & Radio, 3498 W105 St., Cleveland, OH 44111. (216) 671-6712

**WANTED:** Young people's kit or plan-built radios or broadcasters, with 1 to 3 tubes or transistors, examples Revell, Meissner, Philmore, Remco. Thank you. Hugh Miller, 6400 Maltby Rd., Woodinville, WA 98072-8375

**WANTED:** RCA RAE 79 radio chassis, or junker set. John Johnson, 228 W. G. River, Fowlerville, MI 48836. (517) 223-8417

**FOR SALE:** Sparton 500, blue cloisonne front, as-is - \$1,250. Jackson Bell 62, peacock grille - \$225. Kadette Jewel, with crack - \$90. Empress Chalet radio, excellent condition - \$250. RCA R-74 10-tube tombstone - \$175. RCA B274, black Bakelite - \$35. Radiolette crystal set, as-is - \$125. Du Mont red Chinese design in-wall clock radio, 1950's, excellent condition - \$150. Motorola 52 Catalin, maroon and butterscotch, with crack - \$650. GE S-22 with tapestry grille cloth, very nice - \$200. Meissner FM converter - \$35. Victor RE-45 chassis, speaker - \$45. Radiola Sr. - \$160. Majestic 371 cathedral, refinished - \$125. Greg Farmer, 71 Rice Creek Way, Fridley, MN 55432. (612) 571-6062

**FOR SALE:** Emerson Vanguard 888 - \$50. Wrist-watch transistor radio - \$20. Channel Master 6515 w/case - \$35. David Pacitto, 40-133 West 4th St., Patchogue, NY 11772. (516) 758-2936

**FOR SALE/TRADE:** Knight VOM, complete Model 710 analyzer, front panel of Weston 547 analyzer. Steven Callahan, 2231 19th St. N., St. Petersburg, FL 33713. (813) 821-9549

**WANTED:** 30" Du Mont TV, 30" Du Mont TV, 30" Du Mont TV. 30" Du Mont Tv. Lambert Eulenfeld, 2376 Kirkwall St., Orange Park, FL 32065. (904) 272-9681. Aft. 6:30 wk nights, wk end anytime

**FOR SALE:** Radiola 3-3A-18. Ariola Sr. Freshman Masterpiece. Sony ICF2010. **WANTED:** Glass dial & brown plastic side speaker grille for Nordmende Sterling Tanhauser U.S.A. Model T.N.V. E338. P. G. Daniel, 5733 Warren St., Morton Grove, IL 60053

**MESSAGE:** New club forming in Central New York, Northern Pennsylvania. Interested collectors, send postcard with your name, address, and phone number. **FOR SALE:** Lots of stuff, just bought out a parts and radio/TV shop. Radios, literature, and parts. Send 2-stamp SASE for list. Mark Gilbert, 711 Elm St., Groton, NY 13073. (607) 898-3519

**FOR SALE:** OK you high dollar Catalin collectors jump on this one. Yellow AU190 Emerson. Best price over \$1,250 by Christmas. \$1 for 3 photos. Gerald Cromer, 1014 Summerland Dr., Cayce, SC 29033

**FOR SALE:** Mullard Model MAR 34 large wood table, made in U.S. for Canadian market, good orig. cond., plays, picture on request - \$85. Zenith 6D311, Deco, nice, plays - \$150. Rod Galloway, 2220 Woodbury Rd., Melbourne, FL 32935. (407) 254-0280

**WANTED:** Cabinets for Detrola 147, 193. Chassis for Detrola Jr. 216, 280, Silvertone 6195, 109, 216 is same. Chassis, knobs for Airline Rudolph or Lone Ranger. Someone must have one with cabinet beyond repair. **FOR SALE:** TV's, radios, misc. SASE for list. Dennis Smith, KN8H, Box 113, Trenton, MI 48183

**PHONE NUMBER FOR  
ANTIQUE RADIO CLASSIFIED  
(508) 371-0512**

**Best time to call is weekdays:  
9 am to 5 pm Eastern Time**

*(Please no classified ads by phone. Thanks!)*

**FOR SALE:** AK 20C, early type, working - \$70. Eveready speaker Model 3 - \$20. RCA 100A - \$15. Tower Meistersinger horn - \$12. Willard B power supply - \$8. Central Electronics CRT Rejuvenator - \$25. Sylvania tube manual - \$6. Rider manuals Vols. 6 and 13 - \$12 ea. **WANTED:** Grebe CR-12, Grebe literature. Frank Hagenbuch, 1440 Lafayette Pkwy., Williamsport, PA 17701. (717) 326-0932

**WANTED:** Copy of schematics for Lafayette KT 200. Will pay total cost, including mailing. A. J. Ossman, 99 Logan Ct., Bethany, WV 26032. (315) 829-4864



**FOR SALE:** Best offer takes any or all. All apparently working but no guarantees. Signal generators: HP606B 50 kHz-65MHz, HP8616A 1.6-4.5GHz, TS382F/U 20Hz-20kHz, Singer/Gertsh Freq/drv. Meter 151-164MHz, 2 AN/UPM-10B Radar test set/freq meters 8500-9600MHz, OAP-1 Radar test set 145-235MHz, BC221AX 125-20, 000kHz freq meter with AC power supply, TS-175/U 85-1000MHz freq meter. Al Yeager, Al's TV, 915 Sagamore Ave., Portsmouth, NH 03801. (603) 436-4501

**WANTED:** Original Crosley literature pertaining to the Pup and/or Bonzo. Will pay \$500 for a nice Bonzo. Ed Bell, 5311 Woodsdale Rd., Raleigh, NC 27606. (919) 851-1517

**FOR SALE:** Check out our growing inventory of High Voltage Capacitors. Many types and values. Plus N.O.S. and surplus parts. Visa/MC. Large SASE appreciated for six-page flyer. Two Fox Electrix, PO Box 721, Pawling, NY 12564. (914) 855-1829

**WANTED:** Radio Craftsman 500 power transformer. RC#19S212, Stancor PC8412, Merit P3155, Chicago PV200 or a junker with OK transformer. A. F. Yeager, 915 Sagamore Ave., Portsmouth, NH 03801. (603) 436-4501

**FOR SALE:** Reproduction Zenith dial glass, made from unbreakable Lexan poly-carb, better than original. Two rectangular sizes available: 6 3/4" x 7" and 5 3/4" x 7" - \$14 ea. including P&H. Dealer inquiries welcome. DH Distributors, POB 48623, Wichita, KS 67201. (316) 684-0050

**FOR TRADE:** Clearfield, 1925 6-tube battery set with plate glass cabinet, very nice, Guide To Old Radios says \$2,000+. Ed Bell, 5311 Woodsdale Rd., Raleigh, NC 27606. (919) 851-1517

**WANTED:** Pre-1940 ARRL Handbooks for my collection. **FOR SALE:** Several Hallicrafters S-38, ABCD's, very good, may need alignment - \$50 ea. Includes manual copy and shipping (48 states). Collins mech filter F455a2 for KWM-2 - \$60. (40) ARRL Handbooks 1943 to date plus other books - LSASE for list. Parting BC610, B&W5100. Robert Schafer, WA7IHN, PO Box 442, Aumsville, OR 97235. (503) 749-1149

**WANTED:** Highest prices paid for early British and other European crystal and battery sets. Ian L. Sanders, 16725 Wild Oak Way, Morgan Hill, CA 95037. (408) 778-7547

**FOR SALE:** Philco 70/90 grille cloth available at near 1930's prices: 10" x 10" - \$4, 12" x 12" - \$6, 54" x 36" - \$40. Quantity discounts available. SASE for free sample. John Okolowicz, 624 Cedar Hill Rd., Ambler, PA 19002. (215) 542-1597

**FOR SALE:** Rare military submin. pencil tubes type 5639, 5719, 6021, 6111, unused, tested - \$5. Tom Townsend, 3 Cobblers Ln., Dix Hills, NY 11746. (516) 499-8226

**WANTED:** Homebrews, must be early and unusual. Also want Blue Gem 01-A tubes. Rosenthal, 5 The Strand, New Castle, DE 19720

**WANTED:** Cabinet for Emerson 649A projection TV. Philco Predicta picture tube mask. Tom Swearingen, 7521N 200W, Uniondale, IN 46791. (219) 543-2567

**FOR SALE:** Many types of radio, TV, and industrial tubes. DH Distributors, PO Box 48623, Wichita, KS 67201. (316) 684-0050

**FOR SALE:** Tube-type vintage parts. Send stamp for flyer. B-E since 1954. Bigelow Electronics, Box 125, Bluffton, OH 45817-0125

## TUBES • PARTS • SUPPLIES YOUR COMPLETE SOURCE

### TUBES:

3000 audio, receiving and industrial types in stock, including early and foreign types. Discount prices!

### CAPACITORS:

High voltage electrolytic and mylar capacitors for tube circuits.

### TRANSFORMERS:

Hard-to-find power transformers, audio transformers, and filter chokes for tube equipment.

### SUPPLIES:

Chemicals, test equipment, wire, batteries, tools, etc.

### LITERATURE:

Extensive offering of literature and books on antique radios, hi-fi, communications equipment, tube data, and circuit diagrams.

### PARTS:

Resistors, lamps, tube sockets, potentiometers, grill cloth, knobs, vibrators and more.



*"Write or call for our 32 page wholesale catalog"*

ANTIQUE ELECTRONIC SUPPLY

6221 S. Maple Avenue, Tempe, AZ 85283, Phone (602) 820-5411, FAX (602) 820-4643

**FOR SALE:** Fada Bullet Model 1000, yellow, not perfect but case is not broken—\$350. Paul Zdinak, 10 Hemlock Dr., Candia, NH 03034. (603) 483-5872

**FOR SALE:** 1—6U5/6G5 GE, 1—6U5 Tungsol, in original boxes—\$20 for one, \$35 for both. Electric Eye tubes. Robert Hudgens, 515 Clarks Mill Dr., Sparta, TN 38583

**WANTED:** E and F broadcast band coils for National HRO 60 receiver. Cabinet for Silvertone 100.359 radio. RCA Victor radio with Slide-o-matic player Model 6-XY-5, any condition, complete unit or parts. Also non-working VCRs for parts JVC HR-D566U and Emerson VCS 966. Al Manieri, 384 Bates St., Phillipsburg, NJ 08865. (908) 454-3699

**WANTED:** Schematic or manual for Globe Electronics, Model Scout Delux transmitter. Frankenstein's Radio Lab., 4010 Fairmont Pkwy., Suite 285, Pasadena, TX 77504. (713) 998-0130

**FOR SALE:** Rider's manuals 6, 8, 11, 15 and 16 Sams Auto Radio Manuals 11 and 12. Donald McGrew, 1901 Tanglewood Dr., Mt. Vernon, IN 47620. (812) 838-6449

**FOR SALE:** Another Zenith console radio Model 12S265 shutter dial, electric dial motor. \$1.00 for photo. Russell or Irma Schoen, E7304 Nietzsche Rd., Clintonville, WI 54929. (715) 823-6744

**WANTED:** Cabinet for Philco cathedral Model 89 and chassis for Philco Model 42-340. Brian Kurrle, 208 Crafton Rd., Bel Air, MD 21014. (301) 592-6202, day

**FOR SALE:** 250 vintage radios. If interested, contact: Robert F. Fermazin, 26053 Highland Palm Dr., Homeland, CA 92548. (714) 926-3354

## CATALOG 0691

Play Things Of Past  
9511-23 Sunrise Blvd.  
Cleveland, OH 44133

Send \$2.00 for 32 page  
catalog of over 3000 items

**RADIO MAGAZINES:** Radio News, Popular Radio, Radio Broadcast, Radio, Wireless Age, Short Wave Craft, Radio Craft, others.

**RADIO LITERATURE:** Books, catalogs, Manuals, pamphlets, flyers, brochures.

**RADIO PARTS & TUBES;** 1920's to 1950's radio tubes, many parts such as sockets, dials, rheostats, coils, transformers, plugs, jacks, and many other types.

**WANTED:** Eagle Neutrodyne. Philco 44 cathedral. Antenna for Philco Predicta. Hickok E-38 tube tester. Ted Depto, 913 5th Ave., Patton, PA 16668. (814) 674-8834

**WANTED:** Schematic, parts list, instruction book for Western Electric "2A Current Supply." John B. Drew, 28 Babcock Rd., North Stonington, CT 06359

**FOR SALE:** RCA Victor 45-J-2 changer, needs repair—\$20. Heathkit GR-91 4-band comm. rcvr, needs repair—\$35. Knight-kit R55 5-band comm. rcvr, needs repair, w/manual—\$35. Above + UPS. Donald Sochurek, W191 S7500 Richdorf Dr., Muskego, WI 53150. (414) 679-0212

**WANTED:** Pilot amp AA901; HRO-60 coils Type G, H, J, AA, AB. Barry Nadel, Box #29303, San Francisco, CA 94129. (415) 346-3825

### PHONE NUMBER FOR ANTIQUA RADIO CLASSIFIED (508) 371-0512

**Best time to call is weekdays:  
9 am to 5 pm Eastern Time**

(Please no classified ads by phone. Thanks!)

**WANTED:** Old steel or brass mechanical gauges; pressure, temp, etc.; rust OK; any kind, any range 3 in. or bigger. I love these more than Catalins. Please save this ad. Mark Parthe, 213 S. Charles, Saginaw, MI 48602. (517) 793-9103

**FOR SALE:** Silvertone 1936 Model 4500, Bakelite, excellent condition—\$45. Coke bottle radio AM, original box—\$30. Zenith 1939 Model 7-S-533, looks like 6-S-892, push buttons, B/C & SW—\$85. Stromberg-Carlson Model 1400? or 1500?—\$40. Hallicrafters 1950 Model S-38-A metal 4-band—\$50. Philco cathedral 1933 Model 60/505, BC/SW, rough—\$65. Westinghouse 1946 Model H-126, Little Jewel—\$35. **WANTED:** Philco Model 54 or 54c, any condition. George Jones, Rt. 4, Box 31, Fernandina Beach, FL 32034. (904) 261-6533

**WANTED:** McIntosh MC30 output transformers. Marantz one wood cabinets. E. H. Scott 800B in Chippendale console, must be excellent or mint. **FOR SALE:** H.H. Scott LT10, 222D, Fisher FM200—\$45 ea. ppd. Al Wirtenberg, 15 Wilson Rd., Weston, CT 06883. (203) 544-9270

**WANTED:** AK chassis, knobs and spkr for Model #90 cathedral. **FOR SALE:** AK Model #944, AK Model 35. Frank D. Atwood, 117 E. Main St., Merrimac, MA 01860. (508) 346-8100

### The Audio/Video Trader

Now in our third year! We're your marketplace for good used stereo/video equipment.

Ad rates start at 30 cents/word, free ads for subscribers.

We have readers throughout the U. S. and Canada.

Subscriptions: \$15 yr., \$25/yr. foreign  
Try us today! Sample Issue: \$1 + LSASE

Dept. R, 1543 Hwy. 70 W  
Garner, NC 27529

**FOR SALE/TRADE:** Freshman Equaphase (G-4) chassis and power supply, RCA 5Q55, and RCA 3-5X-671. Stan Childress, Rt. 5, Box 290C, Ellijay, GA 30540. (404) 276-4093

**WANTED:** RCA 75 X series with oriental designs; green 75 X 1, Red 75 X 18, white 75 X 19, other oriental design or fire engine red AC radios! Sumter Hickman, KB5QHD, 1008 West 10th St., Plainview, TX 79072. (806) 293-5809

**FOR SALE:** Vacuum Tubes in Wireless Communication, 1919, Bucher - \$15. Propagation of Short Radio Waves, Kerr, Vol. 13, M.I.T. Rad. Lab - \$10. Basic Television, Grob - \$5. Radio Servicing, Marcus - \$5. Postage extra. Merry Christmas to all! Bob Dennison, W2HBE, 82 Virginia Ave., Westmont, NJ 08108. (609) 854-3301

## One Month Free!

### BONUS FOR EARLY RENEWALS

If you renew **before** the month shown on your mailing label (your expiration month), you will receive an extra month on your subscription: 13 months instead of 12! 26 months for an early 2-year renewal!

**FOR SALE:** Motorola red & black S-grille, 51 x 16, in new cond with original box, instructions & tags. I believe this to be maybe the only one in existence. Serious buyers only! Kent A. Ise, 224 Cowesett Rd., Warwick, RI 02886. (401) 885-7558

**FOR SALE:** Philco 42-400, vg condition - \$150. Philco 46-421, also vg - \$40. Zenith Trans-Oceanics: H-500, 5G40, Y600, all good - \$40 ea. **WANTED:** Dynamic speakers for Emerson Model R-153, Philco 37-620, Philco 511 and AK Model 35. Need good capacitor tester, maybe we can trade. Ken Kamperman, 11 Grant St., Wellesboro, PA 16901. (717) 724-0192

**WANTED:** Emerson Mae West, name your price. **FOR SALE:** Vibroplex key, Hammarland and Pilot variable capacitors, red Emerson 888 Vanguard - \$35. Black Trans-Oceanic L600 - \$45. Radio Finder - \$9. Philco grille cloth 12" x 12" - \$6. German Penguin U5A wood/leatherette portable - \$20. John Okolowicz, 624 Cedar Hill Rd., Ambler, PA 19002. (215) 542-1597

**FOR SALE:** GE 1973 tube manual, covers receiving tubes from the old 01-A up, with specs in convenient chart form for fast reference and comparisons; plus industrial, commercial, military, special purpose and picture tubes. Has basing diagrams, outline drawings, cross-reference, interchangeability, foreign and classification charts, more, 474 pages, originals (not copies), in fresh clean mint condition, a very handy reference and a nice collectible - \$9.95 ea., \$19/2, plus \$2.50 shipping. Don Diers, 4276 North 50 St., #A30, Milwaukee, WI 53216-1313

**FOR SALE:** Pilot 3" TV, excellent condition and working with magnifier and carrying case - \$475. Bill Ross, 875 Gordon Ter., Winnetka, IL 60093. (708) 441-6462

**SATISFACTION GUARANTEED**

INTRODUCING

# J.D.'S Radiowear

PHILCO 90 CATHEDRAL PRINTED FRONT AND BACK IN BROWN AND BLACK ON ECRU.

\$13.95 EA. POSTAGE PAID



ALL SHIRTS ARE A 50/50 COTTON BLEND.

RADIO DECO BEAUTIFULLY SILKSCREENED ON BLACK IN RED, YELLOW, BLUE AND WHITE.



ADULT SIZE T'S M, L & XL.

ABSOLUTELY ORIGINAL EXCLUSIVE DESIGNS © J.D.'S 1991

CATHEDRAL	QUANTITY	M	L	XL
RADIO DECO	QUANTITY	M	L	XL
TOTAL QUANTITY x \$13.95 =				
NAME: _____				
ADDRESS: _____				
CITY: _____ ST: _____ ZIP: _____				
SEND CHECK OR MONEY ORD. TO J.D.'S 1161 SW MULVANE TOPEKA, KS 66604 DISCOUNT & CLUB INFO CALL 913-232-0128.				

**WANTED:** Badly need knob with attached dial plate for radio frequency control on the 1925-26 Apex Super Five. Possibly the same knob as used on the fil. rheostat. Maurice Gillette, 1374 David Rd., Cloquet, MN 55720. (218) 879-7558

**FOR SALE:** RCA CT-100 TV, excellent complete original - \$750. Richard Jendrucko, 458 Hillvale Turn East, Knoxville, TN 37919. (615) 523-7323

**WANTED:** Marconi or DeForest stock certificate. Wurlitzer table or floor jukebox. Cylinder records 2 and 4 minutes. Predicta 17" or Barber Pole. Roger Ericson, 3460 Peninsula Rd., #106, Oxnard, CA 93035. (805) 382-1913

**WANTED:** Original AK breadboard, Model 10 A in working condition. U. Radtke, IM Fuchte 143, W-4830 Gütersloh 1, Germany

**FOR SALE:** (755) New electronic tubes - \$375. Send LSASE, 2 stamps, for electronic lists. Bob Horsley, 67 Theodore St., Buffalo, NY 14211

**WANTED:** Speaker for American Bosch 420. **FOR SALE:** Philco 37 cathedral, excellent \$325. George Friedrich, 7162 Lake Jacqueline, Custer, WI 54423. (715) 592-4901

**FOR SALE:** Tubes, radio, TV, 40's thru 50's. SASE for list. Lee C. Dickinson, 478 Main St., Cromwell, CT 06416

**FOR SALE:** Ham, shop and electronic books and magazines reasonable. Send 29¢ stamp for list. Dave Mantor, W9OCM, 2308 S. Fairlawn Way, Anderson, IN 46011. (317) 642-1103

**WANTED:** Automobile record players, any condition, or parts. Dan Schulz, PO Box 892, Crystal Beach, FL 34681. (813) 785-8733, (800) 933-4926

**FOR SALE:** Zenith Stroboscope Cobra Matic record changer, not tested, as-is - \$25 plus shipping. Kent Stolz, 1208 S.E. 5th Terr, Lee's Summit, MO 64063. (816) 524-1745

**WANTED:** Micronic Rubies by Standard Radio & Sony. Pay your price. Kent Ise, 224 Cowesett Rd., Warwick, RI 02886. (401) 885-7558

**FOR SALE:** BC-1306, clean - \$125. (50) Assorted meters AC-DC-MA-RF - \$150. (50) Assorted air var caps - \$60/lot. Tubes, 100TH 250.Th 807, (33) all new, write BC-946B.25-1500KC \$75. BC-1000 w/ACC, nice - \$189.50. Steve Bartkowski, 4923 W 28 St., Cicero, IL 60650. (708) 863-3090

**WANTED:** National SW3 Universal model, octal tubes. To complete my collection. Have other SW3 models for trade on above only. Parts and accessories for SW3-SW5 Series, especially low frequency coil sets and a National speaker of the early 30's. Brush crystal headphones. SX28A for parts. Milleu power supply, amplifier and blank rack panels. Dean Showalter, WA6PJR, 36308 Panorama Dr., Yucaipa, CA 92399. (714) 797-1782

**FOR SALE:** 1936 Lafayette catalog, excellent condition - \$15.50 ppd. Harry Blesy, N9CQX, 2409 Northgate, North Riverside, IL 60546. (708) 442-8855

**WANTED:** A legend showing resistor values and locations for early B.C. 348 with 41 as audio. Ray Larson, 12241 1/2 Gorham Ave., West Los Angeles, CA 90049-5214

**WANTED:** Restorable Zenith black dial and shutter dial radios, any condition. Basket cases OK. James S. Fisher, 344 Harrison Ave., Manville, NJ 08835. (908) 725-7476

## **WANTED WESTERN ELECTRIC TUBES, SPEAKERS, HORNS & AMPS**

**TUBES:** 300A, B, 274A, B, 262A, B, 275A, 350B, 284D, 252A, 271A, 242A, 348A, 349A, 301A, 339A, 205D, E, F, VT52, VT1, VT2, 211, 212, 104D, 216A.

**SPEAKERS:** 555, 594, 596, 597, 713, 754, 755, 728, 4151, 4153, 4181, 4194, 753, 757.

**HORNS:** 22, 24, 26, 25, 12, 6368, 15A, 13A.

**AMPLIFIERS:** 86, 1086, 91, 22, 94, 95, 105, 106, 120, 121, 130, 131, 124, 129, 142, 143.

### **VICTOR VICTROLAS, EDISON, ETC.**

**TUBES:** TELEFUNKEN, GENALEX, RCA, RADIOTRON, ETC.  
**GENERAL ELECTRIC, AMPEREX, JAN, SYLVANIA, GEC, NATIONAL UNION**

### **MCINTOSH, MARANTZ, DYNACO**

**CITATION, LANGEVIN, ROGERS, LEAK, TANNOY, ALTEC, EV,  
THORNES, EMT, JBL, .... AMPS, SPEAKERS, TURNTABLES**

**MAURY CORB**  
12325 ASHCROFT  
HOUSTON, TEXAS 77035

**TEL: (713) 728-4343**

**MESSAGE:** Attention Honor System graduates only! If you were one of our first customers for the swell Zenith Brochure Book and have not yet received your update, it is through oversight and nothing else. Please notify us. We have about six update pages for you, no charge. On your honor, please. If you don't yet own one, they're all the rage — \$28.95 ppd. **FOR SALE:** Zenith Walton's 9S232. Bakelite RCA 96X1 by John Vassos, minute hairline — \$375; RCA 143 — \$400; excellent wooden piano radio — \$325; Mastic wooden treasure chest — \$210; Sparton 1567 (F.O.S., p. 175, lower left) — \$550. Philco 16B, Deco — \$325. Murphy TA156, wooden English table radio — \$150; RCA 13K, near mint — \$350; Motorola 52 Catalin — \$1,100. Bendix 256C Catalin — \$650; Fada 1000, butterscotch — \$750; Fada 1000, butterscotch and red — \$950; Crosley 11-117U, green, hairline — \$125; Liberty Bell transistor — \$85; wooden wall phone transistor — \$75; Belmont repainted white 6D111, no cracks — \$225; Belmont 6D111 white, original with slight paint chips — \$180; white Delco, Belmont, 6D120, paint chips — \$185; black Hoppy — \$460; white microphone radio — \$195. Zenith wooden table models: 701 — \$120; 825 — \$150; 288 — \$385; 6D219 — \$165; 7D126, original black lacquer, worn — \$160; 5S127 — \$165; 5S220; 5S218; mint 6S229 — \$225; 6S223; 5R216; 6S322; mint 6V27; mint 9S30; 10S130. GE K-80, mint — \$435. Radios from Blast From The Past: RCA A-63, p. 155; RCA R 74 — \$325; RCA 128, p. 135; Dewald Dinette, p. 107 — \$90; GE Junior, p. 70 — \$225; Majestic, p. 95 — \$65. Philco remote tuner — \$55; EH Scott Allwave 15 in a fine Westminster cabinet — \$1,100; EH Scott Laureate, no cabinet, chrome excellent — \$500; EH Scott Allwave 15, Tasman cabinet — \$550; EH Scott Allwave 12 in early Tasman cabinet — \$700; EH Scott 12, 2-dial, chassis only, with knobs and escutcheon — \$225. Grunow 1101 with remote control box — \$250. N.O.S. Radio Girl Perfume, small — \$5, large — \$7, each plus \$2 shipping per order. Zenith 5S29, some veneer chips — \$140; Zenith Trans-Oceanics: 8G005 — \$175; 8G005, excellent — \$195; 1000 — \$175; 3000 — \$175; 7000 American — \$295. Zenith consoles: 15U269; 12S475; 12S471; 12U159; 12U158; 12A58; 12A57; 12H690; 12S265; 12S266; 12S268; 12S370; 11S474; 10S153; 10S155; 10S156; 10S464; 9S367; 9S55; mint 8S154 and others. RCA 811K — \$350; Stromberg-Carlsons: 150 L; 240 M; 350M; 68. 12-tube Airline 62-167 — \$175 and many others. If you're looking for a Zenith shutter dial or other hard-to-find set, we may have what you need. We ship anywhere. Please call, mornings best. Don't forget to send for our free updated and expanded merchandise catalog featuring T-shirts, mugs, posters, owner's manuals, restoration supplies etc. Satisfaction guaranteed, shipping extra unless noted. We do take Visa and Mastercard. Fax only please, 8 am to 10 pm CST only! (612) 727-1908. Alan Jespersen, PO Box 17338, Minneapolis, MN 55417. (612) 727-2489, 8 am to 8 pm CST, ans machine after 4 rings

**WANTED:** Chassis for GE T-12-C batt. or AC. W. L. Weeks, 108 Forest Hill Dr., Warner Robins, GA 31088. (912) 922-6533

**FOR SALE:** RCA 8X541 Bakelite, plays — \$38. Tele-tone Bakelite Model 195, crack on case — \$32. Hitachi AM-SW, plastic, Model H-501, low volume — \$35. Crosley clock radio, maroon and yellow, AM only, Model F-25MN — \$45. Detrola Pee Wee AM only, battery, cabinet basis wood covered by a plastic covering — \$65. Model 282 Heath RLC Bridge, mint — \$40. All radios Electronically complete. Jean B. Desautels, K4VGD. 616 N. Silver Circle, Key Largo, FL 33037-3840. (305) 852-2109

**WANTED:** WWII to 1960 military 3, CM radarsets, complete/incomplete test sets, field sets parts. Jim Krajovic, 546 Sheridan Ave., Pittsburgh, PA 15206. (412) 665-0916

**FOR SALE:** Atwater Kent 67 radio chassis complete battery powered. Rodney Schrock, 402 Lincoln St., Somerset, PA 15501

**FOR SALE:** Clough-Brengle 3" scope, nice appearance, gets green line, 906 CRT. Robert Larson, 1325 Ridge Way, Medford, OR 97504

**WANTED:** Schematics for Crosley 52, Arvin 720, Silvertone 95 Neutrodyne. Jack Tiggelman, 2782 Floral Dr., Zeeland, MI 49464

**FOR SALE:** Radiola II in nice original condition — \$350. Kevin Eftink, 16 Edgewood Dr., Quincy, IL 62301. (217) 228-2221

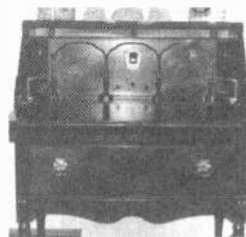

**WANTED:** Ident and chassis/spkr. to fit this empty lonely Pooler slant-front desk/cabinet. Thanks. Bill Horn, Rt. #2, Box 181, Bealeton, VA 22712. (703) 439-9781

**FOR SALE:** EICO 1171A resistance decade box new in box, factory wired .1 to 99,999 ohms, 5 decade, 1 watt .05%, can be used as a leg for AC and DC bridges with instruction manual and construction book — \$25 plus shipping. Call or write: Mark Steel, KB5NCY, Rt. 1, 6534 S.F.A. Rd., Freeport, TX 77541. (409) 233-8845

**FOR TRADE:** Crosley 11-111U, 11-113U, rare Coloradios made for jewelers of America, Abbottwares clock radio, Echophone S-5 cathedral, Viking 599, green Emerson AU-190 Catalin, blue and chrome Sterling Deluxe, Ecko M23, Crosley Buddy Boy, GE L-50 Repwood, Murdock variable condensers. **WANTED:** International Kadette Classic, topper, red Jewel, clockette; and pocket sets; Cutting and Washington II; Radiodyne WC-15; Huffy Radio-Bike; Miraco one-tube set; Scott Philharmonic; unusual horn speakers. If you don't have these items to trade, what else could you offer? Greg Farmer, 71 Rice Creek Way, Fridley, MN 55432. (612) 571-6062

# ORDER THESE SELECTED Old Radio Collector Books FROM ANTIQUE RADIO CLASSIFIED!

*Every radio collector from the novice to the experienced should have a copy of this book:*



## GUIDE TO OLD RADIOS

A primer to collecting. 128 pages, 350 photos and 3300 current prices. 7" x 10". Johnson.

Softcover .....\$16.95

*A NEW guide to repairing vacuum tube and transistor sets:*

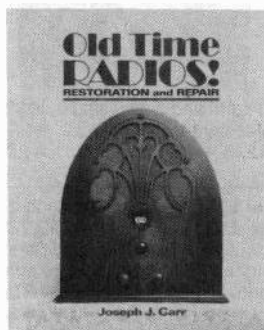

## OLD-TIME RADIOS! RESTORATION AND REPAIR

A self-paced training guide. History, theory and practical operation of antique and classic radios.

256 pages, 200 illustrations. 7" x 10". Carr.  
Softcover .....\$16.95

*Send payment with order. Enclose \$2.50 shipping for orders under \$35. VISA and MasterCard accepted; include card number, expiration date and name on card. Money back return policy. Most books shipped within 4 days, but allow 2 to 4 weeks to receive order. PRIORITY MAIL: \$5.00 per book. Mass. residents add 5% sales tax. Foreign orders - Write for shipping costs or use credit card and specify surface or air (foreign surface shipping is \$4.00 per book).*



**Send Order To: A.R.C., P.O. Box 2, Carlisle, MA 01741  
or Call: (508) 371-0512**

*Price guide for over 5000 battery & AC sets from 1920-1959:*



## A COLLECTOR'S GUIDE TO ANTIQUe RADIOS.

Collectors Marty & Sue Bunis have consolidated data from auctions, ads, flea markets, etc. in this beautifully illustrated price guide. Over 400 color photos. 8 1/2" x 11". Bunis. Softcover .....\$16.95

*A book to help every collector get those old battery and AC sets playing again:*

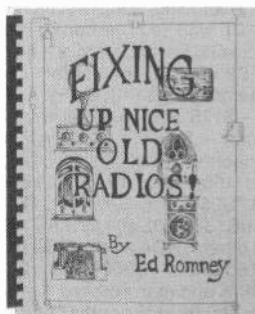

## FIXING UP NICE OLD RADIOS

Written by an old radio instructor. 185 pages, 300+ figures. 8 1/2" x 11", plastic binding. Romney.

Softcover .....\$25.00



(Nov-91)

# ORDER THESE SELECTED Old Radio Collector Books FROM ANTIQUE RADIO CLASSIFIED!

*This book is a must for anyone collecting radios and crystal sets from the 1920s:*

*This book is a must for anyone collecting radios from the 1930s to the 1950s:*

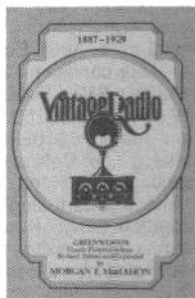

**NEW!**  
*Empire of the Air*  
by Tom Lewis  
Triple Biography of  
de Forest, Armstrong  
& Sarnoff  
421 pages - Illustrated  
**SHIPPING NOW!**  
\$25.00



## VINTAGE RADIO

Standard photo reference guide for radios before 1930. 1000+ pictures. 5" x 8". McMahon.  
Softcover. ....\$11.95

## FLICK OF THE SWITCH

Standard photo reference guide for 1930s to 1950s radios. 1000+ pictures. 5" x 8". McMahon.  
Softcover. ....\$11.95

*A must for collectors of 1920s battery sets:*

*For collectors of '30s & '40s plastic and other collectible radios:*

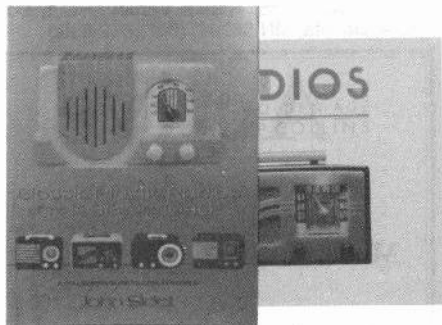

**RADIO MANUFACTURERS OF THE 1920s.** Douglas.  
1920s battery sets. 8 1/2" x 11".

Vol 1. A-C Dayton - Ferguson.....(\$34.95\*) \$24.95  
Vol 2. Freed-Eisemann - Priess .....(\$39.95\*) \$29.95  
Vol 3. RCA - Zenith (Shipping Nov.). (\$39.95\*) \$29.95  
(\* Hardcover Prices)

**CLASSIC PLASTIC RADIOS FROM THE 1930s AND 1940s.** Sidel. 200+ Catalin models in full color. 8 1/2" x 11". .....(29.95\*) \$19.95

**RADIOS - THE GOLDEN AGE.** Colkns. Full color. 10" x 8 1/2". .....(\$25.00\*) \$14.95  
(\* Hardcover Prices)

*Send payment with order. Enclose \$2.50 shipping for orders under \$35. VISA and MasterCard accepted; include card number, expiration date and name on card. Money back return policy. Most books shipped within 4 days, but allow 2 to 4 weeks to receive order. PRIORITY MAIL: \$5.00 per book. Mass. residents add 5% sales tax. Foreign orders - Write for shipping costs or use credit card and specify surface or air (foreign surface shipping is \$4.00 per book).*



**Send Order To: A.R.C., P.O. Box 2, Carlisle, MA 01741  
or Call: (508) 371-0512**



(Nov-91)

**FOR SALE:** Fluke differential voltmeter, Model 803 with instruction manual, schematics, requires repair - \$30. Plus UPS. Jack Shaymow, Vintique Electronics, 52-C Tilford, Deerfield Beach, FL 33442. (305) 427-1222

**FOR SALE:** Neutrowound radio Super 6 Series, 1926. Kent A. Ise, 224 Cowesett Rd., Warwick, RI 02886. (401) 885-7558

**WANTED:** Crosley crystal set. Pay any price with-in reason for a nice piece! Ed Bell, 5311 Woodsdale Rd., Raleigh, NC 27606. (919) 851-1517

**FOR SALE:** RCA 9PC41 projection TV - \$150 or trade for cathedral radio etc. Thank you. Steve Sideroff, 46 Dutch Lane Rd., Marlboro, NJ 07746

**FOR TRADE:** Zenith 10S464 console, radio sounds great, good restorable cabinet. A. J. Long, 11830 Heath Rd., Chesterland, OH 44026. (216) 729-8451

**WANTED:** Atwater Kent Type F-4 electrodynamic speaker for Models 55 or 60. John Chidgey, 13833 Eisenhower Ave., Poway, CA 92064. (619) 748-8055

**FOR SALE:** Small Emerson wood tombstone uses USA chassis - \$200. GE plastic table radio #202, fair - \$30. Pocketscope #S-10-A, works - \$35. W.F. Main Standard Splendid, one-tube battery set - \$395. **WANTED:** Instructions & tube data for Mercury 1000 tube tester, copy OK. Rick Yerke, PO Box 392, Moscow, PA 18444. (717) 842-4857

**FOR SALE:** S-108 vg cond. - \$65. Chromo amp 2-6L6's type unknown - \$40. Zenith 9H885 chassis complete front, old FM - \$20. 1930's, NRI Radio Study Course, 90+ books, looks complete - \$80. All plus UPS. Robert Varney, Rt. 1, Box 192-A, Dakota, MN 55925. (507) 643-6388

**WANTED:** Hallicrafters or Hammarlund general coverage receiver, must be working and in good condition. Clarence Lozano, 413 Western Hills, Coralville, IA 52241. (319) 645-2802

**FOR SALE:** New recession prices include shipping. Elvis 50's microphone, EV Mercury 611, N.I.B. - \$99. Some great Emersons: 578A Continental small teakwood - \$69; 713 miniature wood Pyramid - \$65; ebony plastic, 514 - \$69. Air-King A-511 brown airplane dial plastic - \$49. Jewel miniature brown plastic - \$29. Shortwave sets: Drake R2C w/spkr, Q multiplier - \$150. Collector's sets: Small metal case, 1937 Echophone EC-1 0.5-30MHz, gorgeous condition - \$119. Hallicrafters 1939 Sky Buddy - \$129, S40B - \$125. Philco 89-123 AM/SW cathedral - \$159. 1924 Standardyne 3-dial less tubes - \$105. Repros: Shure microphone catalog 154, Collins 51J3 brochure, Hallicrafters catalogues - \$6 ea. Wide selection unusual sets, vintage parts, tuning-eyes, transmitting, and restoration tubes. Rush \$1 cash for 10-page Christmas super pixlist, the best buy of all. Antique Technology Ventures, Steve Lipsky, W2VVN, 1254 Cox Rd., Jenkintown, PA 19046-1207. (215) 884-1817

**WANTED:** Radio collections of all kinds: early battery sets, crystal sets, vintage radios of 1930's, Catalins. No collection too big. Send list & details to Kent Ise; will travel anywhere, shipping arranged. Kent A. Ise, 224 Cowesett Rd., Warwick, RI 02886. (401) 885-7558, (401) 769-9000

**WANTED:** Main tuning dial, grid-leak and condenser for Crosley 51. Buying: small metal case and push-button plastic radios, cosmetically good, no cracks original knobs please, need repaint OK, need not work. Steve Lipsky W2VVN, 1254 Cox Rd., Jenkintown, PA 19046-1207. (215) 884-1817

# Active Antenna

**Model AA10**

**Only \$34.95**

Allows antique radios which were designed for a long wire outdoor antenna to operate on a 42" indoor whip antenna. Operates from 9 volt battery.

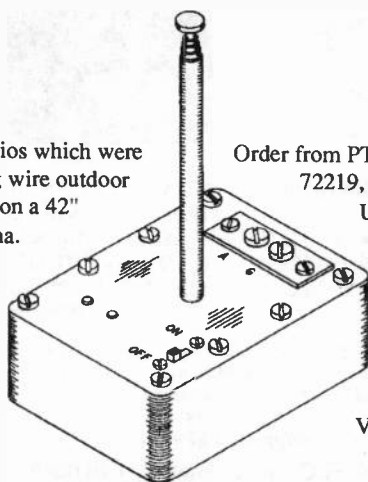

Order from PTI, Box 191117, Little Rock, AR 72219, (501)568-1995. Orders shipped UPS, prepaid in continental U.S. Please allow 3 weeks for delivery. Arkansas residents add 5% sales tax.

Visa and MasterCard accepted



**FOR SALE:** Edison Ediphone No. S50452 both cabinets look fine mechanically, no dents misc. rust spots. Silvertone wire recorder, radio & record player, fine shape all works Mod 101-814. Knight R-55 receiver, vg, works. Bids rec'd till Nov. 30. Owen Orndorff, RR2, Box 237, Danville, IL 61832. (217) 442-6812

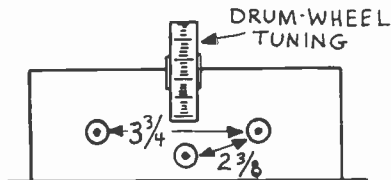

**WANTED:** It's out there! Somewhere one of you collectors has a chassis that fits the description above. If you can find a nameplate, it might say Delco. The model number may be either RB-3 or RA-3. I think it's a 6-tube set with drum-dial tuning like the Radiola 18. If you have a chassis like the one described, or a complete junker set - give it a good home. Write me; I'll write back. Thank you. Dave Crocker, 60 South St., Duxbury MA 02332. (617) 582-2052

**FOR SALE:** Stereo amplifier printed circuit board from Bill Lear's auto tape player factory, compact, 7 1/2" long overall, 1 5/8" wide, 1 3/8" high; includes transformer coupling to output stage; off/on switch, tapped volume control and tone control are on coaxial shafts; schematic and hookup furnished - \$5 ppd. Same with damaged controls - \$3 ppd. Elmer H. Thom, 11717 Kingfisher Ln., Saint Marys, OH 45885-9335. (419) 394-1104

**WANTED:** National speaker to match Model 173 receiver. Hallicrafters SX 73. Gernsback Manuals 5, 6 & 7. Riders Vol. 21, 22 & 23. **FOR SALE:** Hallicrafters SX111 - \$90. Hammarlund 170A - \$120. AK 76 console - \$100. Zenith 10S567 console - \$60. Zenith 6D030 - \$45. Vance Rayburn, 2718 Homestead Rd., Madison, WI 53711. (608) 274-3002

**WANTED:** Band switch #38541 for Grunow 5U or 5P, parts chassis okay. Thomas Peters, PO Box 3925, McAllen, TX 78502

**FOR SALE:** Hopalong Cassidy radio, very good original red paint, needs some touch-up of black paint on foil front - \$350. Dwight Church, 2258 S. 64th St., West Allis, WI 53219. (414) 545-6972

# SONY®

50's & 60's radio,  
TV, reel-to-reel, etc.  
The earlier the better.

Jay Lewin, Richard Lewin  
400 E. 54th St.  
New York, NY 10022  
212-935-5656

**FOR SALE:** We duplicate in plastic almost any knob or push button from your original. Catalin with swirl or wood knob - \$12. Solid knobs - \$8. Send knob to be duplicated. Formed plastic dial lenses. (See ad in Sept. issue of A.R.C., p. 54 for details. Many Catalin lenses on hand. Let us know of any other parts: wood, plastic or metal that you might need. L.W. Terrell, 7109 E. Arbor Ave., Mesa, AZ 85208. (602) 830-7849

**WANTED:** Miller high fidelity AM crystal tuner, same one as featured in this magazine, page 12, November. Please send price and information to: Jim Snow, PO Box 746, Darien, GA 31305

**FOR SALE:** WWII BA-38 batteries, made with modern replaceable 9-volt cells, complete - \$21.95 + \$3 shipping. Sam Hevener, W8KBF, The Signal Corps, 3583 Everett Rd., Richfield, OH 44286-9723

**WANTED:** Speaker for Atwater Kent Model 75 Type P chassis. Need technical information for same. Dale Taylor, 3714 Edgemont, Wichita, KS 67208. (316) 684-9124

**FOR SALE:** Must dispose of 40-year collection of 1920's-1960's radios including 1950's-1970's transistors; 1949-1951 televisions; and two home built radios, with tubes, that pre-date manufactured sets. Also all sorts of test equipment. Send LSASE for list. Make offer any or all. Best time to call after 7:30 Central Time. John Enigl, Sr., K9HJL, 5425 Cherry Ln., Egg Harbor, WI 54209. (414) 743-3672

**SERVICES:** Repair/replacement of meters. **FOR TRADE:** Trades welcome. Older meters/galvo's plus cash if required. Ye Olde Meter Cellar, Leonard W. Cartwright, 113 Sea Terrace Way, Aptos, CA 95003. (408) 662-2977

## RCA-103 LOUDSPEAKER



(For Sale)

Immediate delivery of the following items:

- Tapestry Grille Cloth
- Rear Fiber Canopy Cone
- Rear Canopy Silk Cover Cloth

Kenneth Ericksen, 1049 Felspar #33  
San Diego, CA 92109-2844  
Phone: (619) 483-2183

Call after 6:30 PM Pacific Standard Time

**FOR SALE:** Philco 70B, restored, working - \$250. Majestic 71 console, original finish, working - \$150. Ron Ramirez, 811 Maple St., Providence, KY 42450. (502) 667-5440

**FOR SALE:** Plastic reproduction dial cover for Emerson 520 or 375 for - \$12.50 ppd. Doyle Roberts, HC63 Box 236-1, Clinton, AR 72031. (501) 745-5750

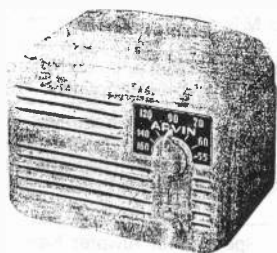

**WANTED:** This Arvin 444 in original red, green, turquoise, yellow, and persimmon. Also old, colorful, off-brand tube boxes. Carl R. Shirley, 824 Fairwood Dr., Columbia, SC 29209. (803) 776-6850

**FOR SALE/TRADE:** TV flyback transformers, new; two Edison machines, cylinder type; Learavian, RM 402; Nordemende 104. Paul Recupero, 265 Union St., Portsmouth, RI 02871

#### CLASSIFIED AD NOTICE

Please check your ads carefully before sending them in. Once ads are received, it is not always possible to refund the amount sent, pull the ad or make changes.

**WANTED:** Copy of manual and any information concerning 1943 to 1945 Army Air Force/Army receiver R-100/URR. Who manufactured it? Any problems associated with it? Thanks. Also looking for Echophone Models EC-1A, EC-2, EC-3, EC-4. Also need back for S-41G. Thanks to all who have responded to my ads in the past. Loren H. Dudley, KA1PRV, 14 Valley Rd., Bath, ME 04530. (207) 442-8419

**WANTED:** Emerson 747, Hoffman BP402 or similar all-subminiature-tube portable. Paul J. Anderson, 82 Lowery Dr., Southington, CT 06489. (203) 628-0618

**FOR SALE:** B&K television analyzer (1077B) and sweep generator (415). Call or write if interested. Dwain Ludlow, PO Box 552, Stigler, OK 74462. (918) 967-8002

**FOR SALE:** Complete Zenith 12B2 chassis, speaker, and loop. J. M. Stueber, 8920 Lexington Ave., NE, Albuquerque, NM 87112. (505) 299-2414

**WANTED:** Violet ray and old diathermy electrical-medical equipment of the 1950's or before. Old books and literature on these also. H. Andreoni, 150-D So. Lyon Ave., Hemet, CA 92343

**FOR TRADE:** Aeriola Jr. crystal set. See my "Buying" ad elsewhere this edition for wants. Ed Bell, 5311 Woodsdale Rd., Raleigh, NC 27606. (919) 851-1517

**WANTED:** Edison, Columbia & Victor outside horn phonographs. Also Nipper and related advertising items. Bernie Seiberg, K3RSW, 801 Sand Wedge Ct., Warrington, PA 18976. (215) 343-7743

**FOR SALE:** Kolster 6D - \$100. Porto Baradio - \$60. N.O.S. tubes (half Antique Electronic Supply price). Metal radios: white Silvertone - \$45; red Motorola 5A7A - \$45. Eleven small Emersons, wood: Majestic 44B, Monarch, Lark 4, Spanton 601, Stewart-Warner shortwave converter (F.O.S., p. 176), Ladybug, Stagecoach, Grandfather Clock. Zenith Royal 50 with case - \$40. Radio phonographs, Emerson 988, white - \$40. Tube type hi-fi, Precision tube tester 612, EICO transmitter 723 - \$35. Magnavox R3C horn, works - \$100. Hallcrafters 25+. RCA tombstone 118 - \$45. AK 55 parts. Radio News. SASE 13-page picture list. David J. Grace, 20 Oneida St., Johnston, RI 02919. (401) 331-6641

**WANTED:** Radiola VII, VIIB, IX. Serious buyer. Pay your price for nice examples. Ed Bell, 5311 Woodsdale Rd., Raleigh, NC 27606. (919) 851-1517

**FOR SALE:** Atwater Kent 84. Atwater Kent 627. Call or write for prices. Waves, 32 E. 13th St., New York, NY 10003. (212) 989-9284. Fax: (201) 861-9659

**FOR SALE:** Freed-Eisemann NR7, clean, solid cabinet - \$90. Philco Jr., Model 80 rectangular cabinet, very nice - \$55. Crosley 14AG wood cabinet, v. good - \$40. Clinton AC portable 3-tube, 1936-37, v. good - \$40. Radiola 33 clean, works - \$45. Steinite 1-tube repro w/tube, works - \$55. Triplett 1210A tube tester, works - \$40. Lots more, send SASE. **WANTED:** Horns only for Stromberg-Carlson 1A, Thompson, Borkman, Brandes H, Frost Musette, and Rex. Bases only for Stromberg-Carlson 2A, Magnavox R2 and Charmvox, also Saal. Complete Utah Superflex (mushroom shaped) speaker. I need (1) 2 1/2" Freed-Eisemann #385 dial knob. I'll swap items from my radio picture list for speakers or speaker parts or will purchase parts. Bob Barnes, Box 275, 511 N. Chestnut, Monroe City, MO 63456. (314) 735-2945

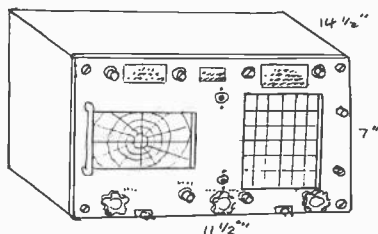

**WANTED:** BC1151 dual scope indicator as pictured. Uses two each 5FP7 and 6H6. Jeary Vogt, 3 Brampton Rd., Malvern, PA 19355. (215) 296-2162

**FOR SALE:** Original lead plates for 1920's newspaper ad, two different Freed-Eisemann - \$50/both. Evan Haydon, 4308 N. 15, Lincoln, NE 68521. (402) 435-4083

**WANTED:** Working 45 rpm phonograph (large spindle), any make. Cartridges must be readily available. Steve Guss, 1536 S. Hillcrest Ave., Clearwater, FL 34616. (813) 443-2587

**WANTED:** Zenith farm radio 4V59, 6V27, or 6V62. George M. Bonanno, 34 Charles St., Clifton, NJ 07013. (201) 746-5953

**SERVICES:** Person with technical abilities to help design and build chassis for FM radios to be marketed by small electronics firm. Must have E.E. degree or equivalent. Garnier Radio & TV, PO Box 971, Warsaw, MO 65355. (816) 438-2320

**FOR TRADE:** Crosley Repwoods. Buddy Boy cathedral. New Buddy tombstone. Both nice originals. Working. See my buying ad elsewhere this edition for wants. Ed Bell, 5311 Woodsdale Rd., Raleigh, NC 27606. (919) 851-1517

**NOTICE TO ALL  
CLASSIFIED ADVERTISERS!  
OUR CLASSIFIED AD DEADLINE IS  
12:00 NOON  
ON THE 10th OF EACH MONTH**

**FOR SALE:** RCA Technicians Handbooks: Above handbooks carried by men into homes on service calls. CTC 2 through CTC 17. CTC 18 through CTC 38. Contains our personal tips + RCA tips & servicing data, 1967-68 data, copy - \$10. 1970 Solid-State Hndbk CTC40 & Quick Checks CTC88 & 38X - \$10. 1971 Updated service tips on CTC 12 through CTC 39 - \$10. 1973 Updated service tips on CTC 12 through CTC 50 - \$15. Tips are on 4 in. x 7 in. sheets of paper, easy setup. GE Tube Manuals 1958 - \$12. 1953 Tube Sub. Guide, copy - \$5. RCA Tube book #1275J, 1959 - \$10. RCA Tube Manuals '56 & '61 - \$15 ea. RCA Tube Manual, 1961 RC21 - \$12. RCA Tube Manual 1964 RC22 - \$12. RCA Tube Manuals '71 & '73 - \$10 ea. RCA Trans + 01o [?] + Thyr '71 Guide - \$10. Rider educational books: FM Radio, 1940, e, hc - \$10. Basic Electronics Vol. 2 - \$10. Basic Electronics Vol. 4 - \$10. Tape Recorders '54's - \$20. Basic Radio, Vol. 8 - \$10. J. J. Papovich, 53 Magnolia Ave., Pitman, NJ 08071. (609) 582-8279

**FOR SALE:** Tubes: Hard-to-find specialties. 211A, sold in pairs only - \$70 pair. 845 used, test good - \$50 ea. 6BG6, photo tubes 868, 918 good used - \$3 ea. SASE for our large list of hard-to-find parts and tubes. All prices add UPS. Wisconsin residents add 5% tax. PR Novelty, PO Box 1366, Milwaukee, WI 53212-1366. (414) 964-3392, Paul

**WANTED:** Rider's Vol. 1. Buy or trade for one of my duplicates. John Webb, W6RCW, 12736 Erin Dr., Auburn, CA 95603. (916) 885-9556

**FOR SALE:** Attention! J.D.'s Radiowear is now offering XXL T-shirts - \$14.95 ppd. 2 styles available. See ad in this publication. J.D.'s Radiowear, 1161 S.W. Mulvane, Topeka, KS 66604. (913) 232-0128

**FOR SALE:** Sony TR3230 pocket transistor - \$20. Tempest pocket transistor, white RCA Victor 1-X-57, Philco Transitone 46-200, Admiral 5S23 - \$10 ea. Free photos. James S. Looney, Rt. 1, Box 54, Grundy, VA 24614-9705. (703) 531-8677, after 6 pm

**WANTED:** Philco 90. Have several cathedrals. Will talk trade on. AK, Crosley, Aztec, Rada Cron. Jimmie Ashbraner, 1070 S. College, Mtn. Home, AR 72653. (501) 425-5060

**WANTED:** Brass fans. **FOR SALE:** Mitchell bed-lamp - \$45. Knight cap tester - \$20. Weller solder station - \$15. Heath transistor tester - \$25. Zenith rotor wavemagnet N.O.S. - \$20. RCA alum. portable - \$20. Dave Friedlund, 36006 S.W. Bald Peak Rd., Hillsboro, OR 97123. (503) 628-1439

**FOR SALE/TRADE:** Thinning collection. Send for list. **WANTED:** Emerson 572, Bendix 115, Majestic 51. Victor Zummo, 20344 Mobile St., Canoga Park, CA 91306. (818) 883-8468, after 6 pm Pacific Time

**FOR SALE:** Aerodyne Special Model #6, 1926 vintage CX301A, CX201A tubes, untested - \$50. **WANTED:** Copy or original manual for Solar Capacitor - Analyzer type 1-60. Stephen L. Bonino, 107 Georgetown Rd., Glassboro, NJ 08028. (609) 881-0244

**New!**  
1991-92  
**RADIO  
CATALOGUE**

ANTIQUE RADIO PARTS  
RADIO AND TV SUPPLIES  
REPRODUCTION KNOBS  
RADIO'S TV VACUUM TUBES  
TELEVISION NOS PARTS  
BOOKS AND LITERATURE  
REFINISHING SUPPLIES

**VINTAGE TV & RADIO SUPPLY**  
3498 WEST 105TH STREET, CLEVELAND, OHIO 44111

**Our New Catalog  
Is Finally Available!**  
Call or write for one.  
216-671-6712

**WANTED**

**Model 620/630  
Philco Radio.**

**Cabinet must be  
restorable.**

**Holme Hickman  
307 E. Ash #41  
Columbia, MO 65201**

**FOR SALE:** Bargain book list: To give away for shipping of \$10: Household Electric Refrigeration, 2nd edition by Wostrel and Praetz, 1948, McGraw-Hill, in dust jacket. Fluorescent Lighting Manual by Amick, 1947, McGraw-Hill, in dust jacket. Refrigeration Applications, 1946, American Society of Refrigerating Engineers. **FOR SALE:** National Electrical Code Handbook, 1947 Code, McGraw-Hill, water damage, good text - \$1, plus shipping. American Electricians Handbook, water damage, good text - \$1, plus shipping. Mathematics for Electricians and Radiomen, by Cook, 1942, McGraw-Hill, good text, poor condition - \$1, plus shipping. Radio Engineering Handbook, Henney, 3rd edition, 1941, McGraw-Hill, good text, poor condition - \$1, plus shipping. Principles of Radio, Henney, 4th edition, Wiley 1942, good text, excellent condition - \$5, plus shipping. The Radio Handbook, 11th edition, 1947 by Editors and Engineers, good info and good condition - \$5, plus shipping. Vacuum Tube Voltmeters by Rider, in dust jacket, Rider, 1941, good text, water damage - \$5, plus shipping. Understanding Microwaves, Rider publication 1942, excellent condition, excellent text, hardback - \$10, plus shipping. Visual Alignment Techniques for FM Servicing, General Electric, 1947 - \$5, plus shipping. SA-6 Electric Desolder Sucker, by OK, vgc, in catalog at \$35.75, yours for - \$20, plus shipping; printed circuit board holder PCBH-50, swivels, holds any size PCB, rotates 360° with solder gun holder by OK, vgc, in catalog for \$66, yours for - \$40, plus shipping. Lloyd Spivey, WLLS AM/FM, Highway 231 S, Hartford, KY 42347. (502) 298-3268; Fax (520) 298-9326

**WANTED:** Emerson Model 540, in green, will pay top price for mint example. Eric Fogel, 87 Sandra Dr., Parsippany, NJ 07054. (201) 316-8461

**WANTED:** Old electric fan with exposed coils. **FOR SALE:** National NC-140 multiband receiver - \$30. Steve Lange, 1351 N 58, Milwaukee, WI 53208. (414) 259-1031

**FOR SALE:** OK, you battery set collectors, I'm up to my neck in 30s & 40s vintage consoles, tombstones & table mod. batt. sets-Philco batt. cathedral probably 33 mod., rough cabinet - \$25. Pilot Pt 1040 console hi-fi with matching S131 aux. speaker, big & heavy, sounds tremendous - \$75. Hammond MI Organ, rough - \$100. Columbia Victrola Type 2, works - \$110. PU only. John Balliett, RD #3, Box 497, Muncy, PA 17756. (717) 649-5926

**FOR SALE:** Several novelty railroad crossing signal radios, N.I.B. - \$27. Shipping included. Alan Piorek, 1050 N. Paulina, Chicago, IL 60622. (312) 235-1523

**WANTED:** Pay \$200 for knobs and small trim piece for red on yellow small Addison. Cliff Watts, 51 Glendale Rd., Brantford, Ontario, Canada N3T 1P5. (519) 753-9049

**FOR SALE:** Victrola Model XIV, fully restored and working, needs only one wooden castor for bottom of unit, and four satin finish steel knobs for front - Make Offer. Ken Marcus, Rt. 1, Box 99C, South Royalton, VT 05068. (802) 763-2168

**FOR SALE:** Graybar 310 table set (Radiola 18 clone), plays great, cabinet good, finish fair, wrong knobs - \$70. Sentinel 220T460 table set, approx. 1942, good condition, plays great, 1 SW band - \$45. General Electric S42B battery console, approx. 1930, untried, bit rough - \$25. Shipping extra, no shipping on console. John G. Bayusik, 178 East Side Dr., Wallingford, CT 06492. (203) 265-6521, 6-10 pm

## WANTED

### *Top Prices Paid*

**Radio & Audio Tubes:** 2A3, 45's, 50's, 845, 8005, KT66/88, etc.

**Western Electric Tubes:** 101, 102, 104, 203, 305, 211, 212, 242, 244, 252, 262, 264, 271, 274, 275, 276, 284, 285, 300, 301, 310, 339, 345, 347, 348, 349, 350, 421, 422, VT25A, VT52, etc.

**W.E. Speakers & Tweeters:** 555, 594, 595, 596, 597, 713, 728, 754, 755, 756, 757, TA4151, 4153, 4181, 4191, 4194, etc.

**W.E. Consoles & Amps:** 25B, 41, 42, 46, 86, 91, 92, 94, 95, 105, 106, 117, 118, 120, 121, 124, 129, 130, 131, 142, 143, etc.

**W.E. Horns:** 22, 24, 25, 26, KS-6368, 12024, 12025, 12027, etc.

**W.E. Microphones & Parts,** etc.

*Also looking for:*

*Tube-type equipment by McIntosh, Marantz, Westrex, ARC, Leak, Quad, Langevin, Altec, Telefunken, Siemens, Neuman, etc.*

*Vintage speakers, units, by Tannoy, Jensen, Altec, JBL, EV, Telefunken, Siemens, etc.*

**Audio City USA, PO Box 802, Northridge, CA 91328-0802  
(818) 701-5633**

**WANTED:** 1958 Allied Radio Catalog Supplement #175. Also, AK 10C breadboard. Jerry Brannon, 22324 100th Ave. SE, Kent, WA 98031. (206) 854-4234

**FOR SALE:** N.R.I. National Radio Institute Lessons, misc. items and equipment - SASE for info. Michael J. Doback, 592 E. Southlawn, Birmingham, MI 48009

**FOR SALE:** Turner microphone Model 999, 50 ohms, Serial 41270. Jerry, Television Exchange, 932 N. 4th St., Grand Forks, ND 58203

**WANTED:** 1946-1950 AM/FM Bakelite radios, Firestone, Fada, Philco, Sentinel, Airline, etc. Steve Puryea, 815 Stetson St., Orlando, FL 32804. (407) 841-3239

**FOR SALE:** Radio magazines and other radio publications - SASE for list. Charles J. Stinger, 404 Ross Ave., Hamilton, OH 45013. (513) 867-0079

## One Month Free!

### BONUS FOR EARLY RENEWALS

If you renew **before** the month shown on your mailing label (your expiration month), you will receive an extra month on your subscription: 13 months instead of 12! 26 months for an early 2-year renewal!

**FOR SALE:** Blatz Beer Can novelty radio. **WANTED:** Crank phonographs, ports, horns and junk machines, any condition. Dave Faehrich, 8215 Stone Rd., Independence, OH 44131. (216) 447-0837

**WANTED:** Antenna coil for Philco 60, or source for rewinding the one I have. Lee D. Warner, PO Box 5007, Massena, NY 13662

**FOR SALE:** Crosley 56TD-W (Bunis, p. 47) - \$55. GE 611 portable - \$25. Both work, shipping extra. Rick Lindquist, KX4V, Rt. 2, Box 530, Radford, VA 24141. (703) 639-5098

**FOR SALE:** Emerson 507 (Bunis, p. 59) - \$55. Motorola 58X (Bunis, p. 102) - \$60. Philco 48-250 (Bunis, p. 115) - \$55. **WANTED:** Charley McCarthy, Truetone D2661 (Collins, p. 71). Airline 93WG604A (Collins, p. 71). Jim Ciulla, 2224 Virginia Rd., Fullerton, CA 92631. (714) 879-0177, am B-4 2:30 pm PST

## ★ TUBES - PARTS ★

MANY PRICE CHANGES & MORE TUBES, CAPACITORS, ETC. ARE IN ALL-NEW ILLUSTRATED 1991-92 FLYER #47

SEND \$1.00 (cash, check or stamps)  
REFUNDABLE - FOR YOUR COPY NOW!

DON DIERS  
4276 North 50 St. #AD7  
Milwaukee, WI 53216-1313

*Personalized Courteous Service*

**WANTED:** Telegraph instruments and parts of all kinds made prior to 1900. Also desire later telegraph keys if uncommon or odd-looking. Larry Nutting, 4025 Slate Ct., Santa Rosa, CA 95405. (707) 539-1883

**FOR SALE:** Tubes: #10, #45, #2A3 - \$12 ea. #112A - \$10. #222 - \$6.50. #224, #42 - \$3.25. #26 - \$3.50. #226 - \$5.50. #227 - \$3. #71A - \$6. #71A globe - \$8. #76, #6C6, #606 - \$1.75 ea. Hundreds of tubes from 1930's & up - 75¢ ea. All plus shipping. SASE for list. **WANTED:** Good WE 216A. Bruce Harbeck, PO Box 452, Boystown, NE 68010. (402) 333-9013

**FOR SALE:** Tubes! Tubes! Tubes! 2500 tubes, more or less. New in box, mismatched boxes, loose pulls, all unsorted and untested; receiving tubes, TV tubes, VR's and industrials, acquired from estate - 10¢ per tube if you take the entire lot. Galbraith, 1214 S. Alford, Evansville, IN 47714. (812) 476-7601

**WANTED:** Catalin collector, interested in buying all models for my collection, condition is important. Very serious collector. I am not a dealer! Please leave message w/details and/or send any photos w/price to: Albert Molinaro, 7404 Sunset Blvd., Los Angeles, CA 90046. (213) 288-1557

**WANTED:** The following items must be in mint original condition for my personal collection. Paragon RA-10/DA-2. AK 10, 4340 Radiodyne. Philco Model 37-690X. Music Master horn, 21" dia. bell. Baldwin Nathaniel Concert. Orchestron DeLuxe. I'm also looking for wind-up phonograph items, such as Bell Tainter, Berliner, Bettini, Lambert cylinders and unusual items. Keith Cenedella, PO Box 6763, Thousand Oaks, CA 91359. (818) 991-6553

## Please Save This Want List!

### CLAPP-EASTHAM

Baby Emerson, Blitzner ZRC  
Models: D, Z, ZRFDA, ZRFD, HRF, ZRC3,  
C63, C64, R23, A23, A3, RHM

### ACME

1-Tube Units:

Y-2 (AF Amp), Y-0 & Y-00 (RF Amps)  
AcmePhone (3-Tube Receiver)  
DY-14 (3-Stage RF Amp)

### AMRAD

2331 (Crystal Set), 3290 (3-Stage RF Amp)  
3071 (Vertical Cabinet, 2-Stage Amp)  
3366 (Reflex Receiver), 2766 (1-Stage Amp)

As it may be a long time before I find some of the sets listed in these ads, remember to call me when you can part with yours. I am putting together a collection of early broadcast and wireless equipment and adding to it each month. I buy single sets or collections, also - books, catalogs, manuals and other related documentation.

*Call and surprise me; make my day!*  
John V. Terrey, 498 Cross Street  
Carlisle, MA 01741 - (508) 369-9770

**FOR SALE:** Collection of novelty radios; black microphone radio; white microphone radio; Coke Cooler, excellent; piano radio; whiskey bottle, Metz Beer bottle; Hopalong Cassidy, car battery, actual size. Send LSASE for list to: Jerry Finamore, 87 Stonewood Pl., Catasaugua, PA 18032. (215) 264-8412

**FOR SALE/TRADE:** Garod Catalin 6AU-1, yellow with red trim - BO. Garod Catalin 1450, pea green, peak top - BO. Emerson Catalin 9TX2 Little Nipper, yellow with red knobs - \$675. Arvin metal 522A, white with maroon knobs - \$125. Garod 5A-2, mint with dark green trim - \$200. Garod 5A-2, white with red trim - \$150. RCA Victor 2-C-513, red clock radio - \$25. General Electric J-501, brown with white knobs - \$25. Also Crosley sets for sale: Kitchen Coloradio with round dial: Model #s 10-135, 10-136, 10-137, 10-138, 10-139 and 10-140, sold as a set - \$1,195. Kitchen Coloradio with rectangular dial: Model #s E-15 BE, E-15 CE, E-15 WE, E-15 SL and E-15 TN, sold as a set - \$795. Setchell-Carlson Frog radio Model #416, black/white, red/white, grey/white, all white, all brown, and white/brown, sold as a set - \$995.

**WANTED:** Emerson AX-235 Little Miracle with white trim or Spartan 500 Cloisonne red. Call: Hood, 140 Riverside Dr., Apt. 11F, New York, NY 10024. (212) 496-2306, 6-9 pm EST

**WANTED:** Pre-1929 Buffalo, N.Y. radio: Aragan, Branston, Federal, King, Larkin, Palmer & Palmer, USL, Wilson, Wurlitzer; (Silvertone & Adler-Royal); radios, catalogs, accessories. Joseph Pawell, 6 Augustine Ave., Ardsley, NY 10502. (914) 693-9374

**WANTED:** Wood radios by Majestic, Grunow, etc. with chrome grilles. Jay Malkin, 1250 Galapago, #206, Denver, CO 80204. (303) 623-6451



Colorful metal reproductions of original advertising. Excellent addition to your collection. Approximately 9" X 12" (Have red Hopsy only) \$16 ppd

Jim Sargent, 1010 Chepstow Lane  
Sherwood, AR 72116

**WANTED:** Horn radio speakers. Knox Lee, 630 Shadowbrook Dr., Columbia, SC 29210. (803) 772-6593

**WANTED:** Emerson Model CH chassis, working or not. This is a AC/DC table model chassis (ref Riders, 10-18). Dick Hagman, 3429 W. Berry Pl., Littleton, CO 80123. (303) 794-6674

**FOR SALE:** (180) Transmitting/industrial tubes, over \$1400 catalog value - \$350 or best offer. Caranco, 2724 N. 27th St., Sheboygan, WI 53083

**CLASSIFIED AD NOTICE**

Please check your ads carefully before sending them in. Once ads are received, it is not always possible to refund the amount sent, pull the ad or make changes.

**FOR SALE:** (2) 14" Magnavox horn bells, goose-neck, one gold, one black. James Cucci, 23 Clark Creek, Clayton, CA 94517. (510) 672-2415

**WANTED:** Bendix radios, need not work. Call or write. Aaron Mall, 903 Dropleaf Ct., Baltimore, MD 21208. (410) 486-8813

**WANTED:** Early American and Japanese transistor radios. I prefer the shirt pocket size. John Hoffnagel, 10 Sunset Ave., New Oxford, PA 17350. (717) 624-8894

**FOR SALE:** 15 tubes made for U.S. Army, Navy; 81's in original boxes - \$4 ea., \$50/all. Joseph Gambaccini, 192 Division Ave., Shelton, CT 06484. (203) 924-0271

**FOR SALE:** GE cathedral Model K-80, very nice and massive. Kent Ise, 224 Cowesett Rd., Warwick, RI 02886. (401) 885-7558

**WANTED:** Edison-Victor, Columbia disc, and cylinder machines, parts, etc. Have items to trade or will buy. Richard L. Estes, 3166 Ridgewood Rd., Medina, OH 44256. (216) 278-2944

**WANTED:** Operating manual & schematic for Heath Model I/O-4560 oscilloscope and ID-101 electronic switch. James Patton, 2820 Sterling Way, Birmingham, AL 35242. (205) 980-8110

**FOR SALE:** Small Belmont Bakelite - \$60. Belmont Bakelite, RGA - \$130. Belmont Bakelite, RGA, brown - \$145. White refrigerator radio - \$85. Blue refrigerator radio - \$85. Globe transistor - \$30. Mitchell radio lamp - \$135. Philco Jr. cathedral - \$145. AK cathedral - \$250. Zenith Zenette cathedral - \$175. AK cathedral - \$150. Philco 90 cathedral, painted - \$295. Philco 71 large cathedral, bad speaker - \$150. Philco large cathedral, battery set - \$165. Philco 70 cabinet only - \$110. Zenith 4-tube battery tomb. - \$135. Zenith 3-knob cube - \$125. Zenith 4-knob large cube - \$140. Zenith tombstone, 1936 - \$130. Zenith large cube, small face - \$115. Zenith Waltons, rough - \$450. Radio Lamp Corp, brass, rare - \$500. Zenith 2-knob cube - \$105. Crosley New Buddy Repwood tomb., nice - \$235. Mike Headley, 19962 Bentwood Ct., Yorba Linda, CA 92686. (714) 693-7454

**FOR SALE:** Mounted honeycomb coils - \$7.50 ea. Art Brittingham, 9450 S. Tropical Trl., Merritt Island, FL 32952. (407) 773-0774

**FOR SALE:** FADA 652 yellow Catalin, no cracks or chips, Philco 89B cathedral, AK 30, SW 300A, Radiola 18, Porto Baradio & many others on brand new picture list of radios & parts - Long SASE (2-stamp). J.L. Acciavatti, PO Box 231, Southborough, MA 01772. (508) 476-3229, EST eves.

**WANTED:** Dial glass for General Electric J-64 & Firestone S-7403-8 Code A-341. John Sampson, 75 Glenwood Dr., Leominster, MA 01453. (508) 537-0092

**FOR SALE:** Atwater Kent Radio Instruction Book, Vol. 1, copyright 1924, good cond. Sanborn DC coupled preamp Model 150-13002. (2) Brown Bakelite knobs, Deco, with set screw - Best Offer. Bill Cherenky, 784 Pfeiffer Blvd., Apt. 1-H, Perth Amboy, NJ 08861. (908) 442-2410

**WANTED:** Radio & Television, October 1940; Radio Age, June/July 1927; Old Timer's Bulletin, V1N1 (1st issue); Radio News, May 1928. **FOR SALE:** 100's of radios, etc. - just purchased large collection, too much to list here. Send LSASE w/ 52¢ postage to Jim Clark, 1292 Starboard, Okemos, MI 48864. (517) 349-2249

**WANTED:** Sketch or photos of what early '60's Admiral transistor portable radios, Models # Y2082A and #Y2252, look alike. Mike Hanke, 1036 So. 15th Ave., Wausau, WI 54401

**FOR SALE:** Philco cathedral #37-61 - \$85. Hickok microvolt generator #292X - \$35. Dytronic Model 240 phase sensitive voltmeter - \$35. Hewlett-Packard VTVM Model #400H - \$15. Eico signal generator Model 324 w/inst. - \$30. Accurate Instrument CRT tester #159 w/inst. - \$15. Crosley Deco radio #9-103 - \$21. Crosley Deco radio #56XTW - \$35. Admiral wood radio Model #4220-D5 - \$15. RCA portable #7-BX-7L - \$35. RCA #65X1, very nice - \$30. Central Electronics Rejuva-tube #RE-1 - \$10. American Trans. cube radio - \$10. National Panasonic Trans. radio #R-8 - \$10. Panasonic Toot-A-Loop, red - \$15. All the above in good working order. All plus UPS. Call or write: Dave Wiggert, 1025 Oak Ave. S, #B-21, Onalaska, WI 54650. (608) 783-1852

**FOR SALE:** RCA 103 loudspeaker - \$75. Philco 41-250, all new tubes - \$100. Steel Knights head transistor novelty, unique - \$40. GE J-62 - \$35. Send large SASE for list of others. Jeffrey Viola, 475-B Eltone Rd., Jackson, NJ 08527. (908) 928-0666

**HAVE YOU MOVED? ARE YOU MOVING?  
PLEASE NOTIFY US A.S.A.P.  
SEND US YOUR...  
OLD ADDRESS  
NEW ADDRESS and  
SUB #  
MANY THANKS!!!!**

**MESSAGE:** After 20 years of advertising you probably know I collect EH Scott, Scott Transformer Co. and World's Record radios and literature. If you have anything related for sale, contact me. Also regarding Scott News, I am willing to trade 2 original issues for any original issue I do not have. Jim Clark, The EH Scott Radio Collector, 1292 Starboard, Okemos, MI 48864. (517) 349-2249

**FOR SALE:** Thomas A. Edison Pro-Technic Ediphone (Floor model wax cylinder dictaphone) - Best offer or possible trade for Catalin radios. Plastictable radios: Philco 51-531 - \$90. Zenith A-510-W, white w/green knobs - \$75. Silvertone 7025 brown & black Bakelite toaster - \$100. Philco P-885 twin speaker - \$60. Admiral 5R12N - \$80. Sonora RBU-175 w/big green dial - \$90. Zenith J-506-C w/illustrations - \$70. RCA Victor AM-FM 8X71 Golden Throat - \$150. Westinghouse AM-FM H-204, ivory & gold (Bunis, p. 159) - \$150. Tube tuners: Silvertone 2028 - \$50, Realistic 204-A - \$75, Heathkit FM gold cabinet - \$75, Heathkit AM gold cabinet - \$40, Craftsman 10" AM-FM 12-tube chrome plated - \$150. All plus UPS. Chuck Bray, 1322 Ivy Rd., Bremerton, WA 98310. (206) 373-1013

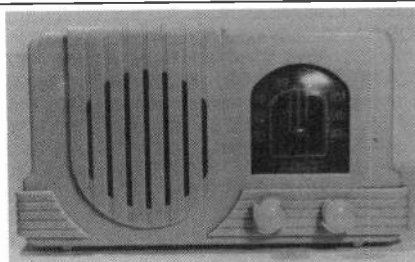

**WANTED:** Addison radios in solid or marbled colors, whole or in part. Please write or call collect: Rain Buttignol, 214 State St., #7, Portsmouth, NH 03801. (603) 427-1384

**FOR SALE:** Radiola III diagrams, professionally drawn with itemized parts list giving all values - \$2 ppd. WD-11 substitutes - details/prices for SASE. David P. Smith, Box 81, Olney, IL 62450. (618) 392-6601

**WANTED:** Dynaco PAS 3X & Mk III amps. SASE HiFi list of Books & Magazines #10. Ernest Naaz, 1905 Second Ave., #2E, New York, NY 10029

**FOR SALE:** Military Batteries BA-4890 volts & 1.5 volts 10" x 2" x 5" 6CD, 60A cells good - \$7.95 incl. S.H. Walter Johns, 40 Swarthmore Rd., Wellesley, MA 02181. (617) 237-9277

**WANTED:** Audio transformers and Bakelite chassis panel for DeForest F-5. **FOR SALE:** Radiola III - \$65. AK 67 chassis - \$60. RCA 56X2 - \$45. RCA 9X571 - \$45. RCA 65X1 - \$40. Newcomb Hawley spkr. - \$45. Operadio spkr. - \$45. Several cathedral style spkrs. - \$25 ea. Several headphones - \$20 ea. Don Sturzenbecher, Rt. 3, Box 28, Sioux Falls, SD 57106. (605) 368-2135

**FOR SALE:** Philco tube-type radio, red and white plastic Art Deco - \$30. GE tube-type radio, gray, red and white plastic, Art Deco - \$25. Zenith chassis 10S669 with tubes, escutcheon, knobs and wave magnet - \$40 plus UPS. M. B. Gaskins, 227 Risen Ave., Campbellsville, KY 42718. (502) 465-3755

**WANTED:** Help: Anyone happen to have a spare front lid for Zenith 7G605, first Trans-Oceanic? Dennis Schrank, 3129 S. Quincy, Milwaukee, WI 53207. (414) 744-3374

**FOR TRADE:** Remler Scottie 5500A, rare model, brown with red marbled grille and white Scottie dog, for your International Kadette, Detroit Super Pee Wee or other unusual Plakson set. Adam Schoolsky, 38007 Stenhammer Dr., Fremont, CA 94536. Phone/Fax: (510) 791-0584

**MESSAGE:** Will person who left box of books with us at Rochester, please contact: Rainy Day Books, PO Box 775, Fitzwilliam, NH 03448. (603) 585-3448

**WANTED:** Boston Terrier novelty radio. Joan Hiller, if you've found two, please share. Thanks. Mick Catalano, 317 W. 11th, Mitchell, SD 57301. (605) 996-5925

**FOR SALE:** Transistor radios, some old. Send SASE for list. Serge L. Krauss, 141 Homan Ave., Elkhart, IN 46516-5027

**FOR SALE:** Early straight neck horn - \$80. Tombstones: Philco 610 - \$85. Rare Howard - \$75. RCA 5T - \$80. GEM-50 - \$75. Portables: Motorola loop ant - \$30. Emerson maroon - \$30. Philco AM-SW 53656 - \$35. Zenith Royal 2000 - \$45. Gloriton - \$10. Zenith 6G001YX - \$40. Zenith Trans-Oceanic A-600 - \$50. Table models RCA Art Deco wood - \$50. Philco 57C - \$50. Airline 04BR-729A - \$30. Kellogg wall phone, excellent - \$300. R. Burick, 21 N. Earl St., Shippensburg, PA 17257. (717) 530-5040

**BOXED CLASSIFIED ADS WORK!** This is a boxed classified ad. These ads can be run more than two months. See the inside back cover for details. Boxed ad deadline: the 5th of the month.

**WANTED: LIGHT BULBS,** tipped, pre-1900, Edison, Thomson-Houston, Westinghouse, and all others, bases, books, literature, advertising postcards, description, best price. Mel Kirchner, 276 Riverdale Road, Pompton Lakes, NJ 07442. (201) 839-4358. After 7 pm.



**WANTED:** Early tube Hi-Fi components and studio equipment by Marantz, McIntosh, Tannoy, Acrosound, Brook, Brociner, Fairchild, Hadley and others. Also want Western Electric theater amplifiers, speakers, tubes, & microphones. Richard Sharisky, PO Box 521, Belmont, MA 02178. (617) 484-5784

**BRUNSWICK TOPICS** magazines Wanted. All issues wanted. John Newton, PO Box 7191, Wilmington, DE 19803

**FOR SALE/TRADE:** Novelties, California Raisin - \$30. Avon Skin-So-Soft - \$23. 1920's microphone, AM/FM - \$30. Chrome microphone, AM/FM - \$30. Big Bird face - \$20. Big Bird leaning on 1930's radio (Breed, p. 142) - \$33. Mickey in chair (Breed, p. 117) - \$25. Mickey face 3D AM (Breed, p. 116) - \$20. Same but FM - \$23. Stanley tape measure FM walkman - \$30. Polaroid 600 Plus film pack - \$30. Cathedral - \$18. Punchy AM/FM - will trade for N.I.B. Tropicana orange. Will trade for the following: Bozo, Fred Flintstone, Popeye, Green Sprout, Ice Cream Bar. All radios listed N.I.B. and prices ppd. Nick Carrieri, 11 Kunigunda Pl., Islip Terrace, NY 11752. (516) 277-6438

**WANTED:** Paragon RA 120, DA 2. Pay \$1,200 if nice. Also want 10R. Ed Bell, 5311 Woodsdale Rd., Raleigh, NC 27606. (919) 851-1517

**FOR SALE:** Large collection of radio, TV, transmitting tubes. What numbers do you need? SASE for list. Harry Cap, 190 Beech St., Bridgewater, MA 02324. (508) 697-8648

**FOR SALE:** Conar 400 transmitter - \$12. Precision 960 transistor-crystal diode tester/manual - \$20. Shell tube tester, bright yellow panel, out of gas station - \$22. Heathkit CT-1 cap. tester - \$7. Heathkit IT-11 cap. tester - \$25. National speaker - \$15. Hallicrafters R48A speaker - \$10. Army frequency meter TM11-300, original canvas carrying bag - \$40. Knight tube tester, roll type chart - \$20. All as-is. No checks. UPS extra. Jerry & Debbie Schliepp, 831 Berlin Rd., Ripon, WI 54971. (414) 748-2471

**FOR SALE:** Reproduction dial glasses for Catalans. FADA 652 and Sentinel 284 - \$35 ea. plus \$2 postage. Radioart, Box 102, Centerbrook, CT 06409

**SOLID STATE VIBRATORS** for most automobile radios 1932-57. Exact duplicates of originals in metal cans. Synchronous, Non-sync, European. One-year guarantee. Dealer prices. Free catalog. Order toll free: 1-800-WE FIX AM. Visa, Mastercard. Antique Automobile Radio, Box 892, Crystal Beach, FL 34681. (813) 785-8733

**EXPERT ANTIQUE RADIO REPAIR.** All makes. Ken Keiter, 106 Boulder Rd., Plymouth Meeting, PA 19462. (215) 828-2027.

**WANTED: Amateur Radio Callbooks.** Govt. or Private. From Whenever Thru 1936. Bob Arrowsmith, W4JNN, PO Box 166, Annandale, VA 22003, or call collect (703) 560-7161

**WANTED:** Crosley Super Trirdyn Regular; RCA 10T tombstone; AK 32; Telefunken Elite portable; Zenith 7D127 tombstone. Robert Perlstein, 17 Vine Street, Medford, MA 02155. (617) 391-3026

**TUBES: (OLD STOCK from RADIO/TV STORES).** Extensive Listings \$1.00 (refundable). Don Diers, 4276 North 50 Street #BC2, Milwaukee, WI 53216-1313



**FOR SALE:** Fada 740 dark brown, very good condition. Sentinel 195ULT? White cabinet cracked and piece missing. Pete Putra, 1429 Lawndale Ave., Racine, WI 53403. (414) 622-2543

**WANTED:** RT and AR units for Westinghouse RC. Original literature for RC and Radiola RS. Mike Heffner, 724 Elmira St., Williamsport, PA 17701. (717) 323-3647

**WANTED:** Trans-Oceanic slide rule dial scale or junker. Admiral 6P32 with palm tree grille. Robert Perlstein, 17 Vine St., Medford, MA 02155. (617) 391-3026

**WANTED:** Astatic JT-30, Shure 55S microphones. Rider PA manuals. Jensen, Alnico, Special Design speakers. Warren Dasho, 26 Kingstown St., Reading, MA 01867. (617) 944-0470

**FOR SALE:** Collector quality vintage & classic consoles. All radios completely restored, chassis & cabinets. Stromberg-Carlson 10A fancy wood. Silvertone R7752-A fancy wood. Silvertone 7100 flip-top. Silvertone 1671 table. Brunswick 15 Fancy. Philco 91X porch light. Philco 38-60. Philco 46-1209. Philco 39-116 World's Fair Mystery Control w/2 remotes. Philco 16X-126. Midwest 170 17 tubes, others. **WANTED:** Selectivity es-cutcheon and dial for Scott AM Philharmonic, will trade complete panel from Phantom AM/FM Deluxe. Need manuals for: General Radio 516-C (1930's) and 1606-A RF bridges; Navy RAO-2 (National NC-120X) receiver. Replacement 1-amp thermocouple and standard LF coils for Bounton 260-A Q-meter. Victor L. Miller, WA2RCC, 43 Amberson Ave., #3F, Yonkers NY 10705. (914) 476-8915

**FOR SALE:** AK Kiel table, excellent - \$250. Shamrock radio & speaker - \$95. Day-Fan - \$75. Browning Drake - \$65. Zenith VII on legs - \$85. Radiola AR812 - \$65. Pickup all for \$500. Mark DeFrancisco, 108 Mystic Rd., Marlton, NJ 08053. (609) 985-2974

**WE'RE STILL HERE!** Tubes: "Oldest," "Latest." Schematics. SASE for lists to Steinmetz Electronics, 7519 Maplewood Ave., Hammond, IN 46324

**COLONIAL "NEW WORLD GLOBE"** High quality reprint of the rare 1933 sales reps. presentation brochure promoting this beautiful radio. Includes full color prints of the 3 models, write-up and photo of the designer & engineer, promotional info, technical data & newspaper ad tear sheets. Not a Xerox copy! The cover is imprinted in gold like the original. 8 1/2 x 11". Very limited quantity. \$29.95 ppd. Sunshine Technical Services, 14407 NE Fremont St., Portland, OR 97230. (503) 254-9296

**WANTED:** (1) Volume control with off-on switch, Zenith part No. 63-995 made by C-H, for a 1939 Ford auto radio, mfg., by Zenith. Model 6M-390. Also (1) station selector PB switch, part No. 85-169. Send price and cost of mailing. Russell Sound Systems, 720 College Dr., San Jose, CA 95128-2812. (408) 295-7110

**WANTED:** Schematic for Philco Model 81. Also Weathers cart & arm. P. Spiker, 3970 Kumquat Ave., Miami, FL 33133

**WANTED:** Crystal detector parts for an Aeriola Jr., Model RE, good repros OK. Peter Frei, PO Box 500, Brimfield, MA 01010. (800) 942-8968

**FOR SALE:** Silvertone 8005, gold - \$25. Power Tronic Blabber-Mouth transistor set, Panasonic Toot-A-Loop - \$12. Arvin 61R58 transistor set - \$10. Fixer-uppers: Motorola 5R1 - \$20, Mantel and Monarch small 1960's Japanese tube sets - \$20/both, Silvertone 2001 - \$20. Plus shipping. Randy Bender, 1720 Kinsella Ave., Belleville, IL 62220. (618) 277-5623

**FOR SALE:** Beautiful reproduction advertising display stand for Sparton 406 7-sided mirrored radio. Send SASE for photo and information. **FOR TRADE:** I want Zenith Royal 500D in coral (pink) and Emerson 888 Vanguard in white or light blue. I have lots of other Emerson 888's and Zenith Royal 500's to trade. Doug Heimstead, 1349 Hillcrest Dr., Fridley, MN 55432. (612) 571-1387

**WANTED:** Directions/schematic for a Supreme radio analyzer, Model 339 Deluxe. **FOR SALE:** Fada Special - \$125 w/tubes. Philco 16B \$160. Philco 41-608 - \$130. AK 944 - \$150. Crosley 148 - \$160. Crosley 150 - \$160. Fada 790, brown - \$70. RCA RE45 - \$130. Send SASE for additional list of 50+ radios. Geoff Shearer, 13115 Rounding Run Cir., Herndon, VA 22071. (703) 860-1617

**WANTED:** Broadcast-type MICROPHONES. Early carbon, condenser, ribbon, dynamic, etc. Cash or trade. James Steele, PO Box 620, Kingsland, GA 31548-0620. (912) 729-2242

**TELEGRAPH KEY COLLECTOR'S** illustrated references: "Introduction to Key Collecting," \$9.95. "Vibroplex Collector's Guide," \$14.95. Add \$2.00 s/h to total. Arifax, Box 88-A, Maynard, MA 01754

**WANTED:** PLASTIC RADIOS BY KADETTE, DETROLA, SPARTON, MAJESTIC, also RCA LITTLE NIPPERS. SOLID COLORS or MARBLEIZED. Jon Steinhauer, 636 Westminster Rd., Baldwin, NY 11510. (516) 223-9873

**WANTED:** AN/TRC-10 radios; AN/PRC-1; AN/PRC-5; M-209 Cipher machines; any radios beginning with letters "SS" (example "SSR-5"). Keith Melton, Box 5755, Bossier City, LA 71171. (318) 747-9616

Radio Transcriptions and VITAPHONE synchronous discs, 1926 to 1935, Wanted by avid collector. Also Columbia, Paramount, MGM, etc. John Newton, PO Box 7191, Wilmington, DE 19803

**WANTED:** For Truetone Model D-925-B. The (6) push-button knobs. Send price, will pay for shipping and cost. Russell Sound Systems, 720 College Dr., San Jose, CA 95128-2812. (408) 295-7110

**WANTED:** Working Zenith Trans-Oceanics Model 6A40, A600L brown case, 8G005, 8G005Y; very good condition minimum. Instruction sheet or copy to Zenith 7G605 found on lid. Ribbon cord to 8G005YT Wavemagnet. Skyriver antenna for Hallicrafters TW1000. **FOR SALE:** For parts RCA Strato World 1MBT6. Lid broken at hinges. Works intermittently. Gregory Sheppard, KA3DBG, 4402 Jupiter St., Rockville, MD 20853. (301) 946-6460

**WANTED:** Radios by Doolittle Radio Corp., Zimmerman Radio Corp., Elkay (Langbein-Kaufman). **FOR SALE:** RCA ACR-136 ham receiver - \$95. Rider's #3 - \$30; #6, 8, 11, 12, 14 - \$12 ea.; #7, damaged cover - \$6. Plus UPS. Ron Trench, Jr., 12 Virginia Rd., East Haven, CT 06512-1230. (203) 469-7340

**FOR SALE:** Cathedrals: Kennedy, Model 52A, nice original - \$300. Philco 19, nice original - \$200. Philco #91, very good & working - \$310. GE Model T-12, refinished, needs speaker re-cone - \$105. Howard green diamond, professionally refinished cabinet, not working - \$175. Buckingham tombstone, working - \$60. Zenith chassis and speaker for #6S321 - \$25. Postage included. Bill Egan, 5004 S. Talman, Chicago, IL 60632. (312) 778-6922

**FOR SALE:** DeWald Plaskon - \$75. Microphone radio (Collins, p. 102) - \$115. All-Timer plastic clock-radio (like Continental) - \$75. Bendix Catalin (Sideli, p. 39), mint - \$600. Scott Hagerman, 392 Ann St., Cary, IL 60013. (708) 639-7745

**WANTED:** Working Jackson Bell Model 62 chassis. Lamp post for Sesame Street novelty, Plate #140. Any information on Radiola RS. Richard Arnold, Box 275, Lone Grove, OK 73443

**FOR SALE:** Belmont (Coronado) 6D111 brown, no cracks - \$185. Canadian Spartan, black Bakelite, gold grille & knobs - \$75. Plus UPS. Adam Schoolsky, 38007 Stenhammer Dr., Fremont, CA 94536. Phone/Fax: (510) 791-0584

**ELECTRONIC ITEMS FOR SALE:** Radios, tubes, books, test equipment, audio equipment, records, knobs, meters, ham items and crystals, components, vibrators, software, etc. For a letter of lists for sale, send a LSASE properly stamped (no postcards) to: Richard and Rose's Radio Mart, PO Box 691443, Tulsa, OK 74169



**WANTED: CATALINS & 1930's BAKELITES:** radios, cases, knobs, louvers, handles, chassis, dials, damaged sets. Ross Litrenta, 1 Wilton Rd., Eastchester, NY 10709. (914) 337-7176

**FOR SALE:** Radiola Model 18, inside reconditioned, plays, case nice - \$95. Atwater Kent Big 20, inside reconditioned, plays, case finish nice - \$125. Freed-Eisemann FE-15, good tubes, looks like new - \$120. Westinghouse Aeriola Sr., 8 1/2" x 8 1/2" box, with good WD-11 tube, fine - \$160. Philmore metal case black, 2-199 tubes, 7 1/2" x 10", extra nice - \$165. Crosley Model 1122 Tridyn Special, nice, good tubes - \$125. Crayley 52 square box with 3 good tubes, fine, full card - \$150. Hammarlund amateur, metal case H-110, plays, like new - \$85. Hallicrafters S-38, fine, plays - \$55. Ford Manual 1919, v-fine - \$35. Hitachi 1959 transistor-6 vest pocket-size radio, mint in leather carrying case, earphone in leather case, in box with dated warranty, plays, white metal grille - \$65. General Television and Radio Co. piano wood radio Model 534, extra nice, all original, plays, nice finish, like new - \$425. Majestic Melody Cruiser Model 1549 wood, chrome sails, real nice, plays - \$425. GE 12" brass blade, fan, not made to oscillate, nice, runs - \$45. Eskimo 10" brass blade, fan, oscillates ex-fine, runs - \$45. Ovation guitar in hard leather case, sold for \$700, will sell - \$300. Guitar not made now. Eveready Model 3, 12" square wood speaker, works, looks nice - \$35. Red Ferrari car transistor, 10 1/2", mint-box - \$35. (16) QST amateur radio magazines in 1940, nice - \$38. (15) QST amateur radio magazines, 1950 and 1960, nice - \$22. Tom Thumb Model TT-600 pocket radio in box, doesn't play, fine - \$55. Atwater Kent Model E speaker, fine - \$60. Model F, fine - \$60. Philco AM-FM table radio record player Model 42-1001 excellent, works, all original, nice - \$135. The Radio Amateur Handbook, 1950, 1952, 1957, ex-fine - \$15 ea. Radio Amateur Callbook Magazine 1961, 1965-66, 1968-69, ex-fine - \$20 ea. The ARRL Antenna Books 1949 and 1968, nice - \$8/both. Edison Mabry, 715 W. Longview, Mansfield, OH 44906. (419) 526-1175

**FOR SALE:** Rose-colored Philmore crystal set, excellent condition. **WANTED:** Still looking for British crystal and battery sets of the early 20's. Ian L. Sanders, 16725 Wild Oak Way, Morgan Hill, CA 95037. (408) 778-7547

**WANTED:** Green knob for Westinghouse Little Jewel. Duane Doel, 280 Kohler St., Tonawanda, NY 14150. (716) 692-2017

**WANTED:** RCA aircraft radios. AVT-112 Transmitter, AVT-15 Transmitter, AVR-20A Receiver, AVA-126 Power Supply, and Bliley Crystal type MC7 any frequency. Douglas Damiano, 4131 Denver, Yorba Linda, Calif. 92686

**WANTED: LIGHT BULBS,** tipped, pre-1900 anything pertaining to. Best price, description. Mel Kirchner, 276 Riverdale Road, Pompton Lakes, NJ 07442. (201) 839-4358

**BRUNSWICK RADIO TRANSCRIPTIONS** and Radio Records wanted, especially "Brunswick Brevities" programs. 12- or 16-inch Brunswick pressings. Avid collector pays good prices. Please describe discs. John Newton, PO Box 7191, Wilmington, DE 19803

**FOR TRADE:** Berkey Television Studio mike phone Boom with dolly, will trade for old broadcasting equipment, radios, televisions. Philip Biagioli, 6 South Broadway, Nyack, NY 10960. (914) 358-5722

**FOR SALE:** Connecticut Telephone midget mic with copy of paper - \$45. 120 plus new Dumont TV tubes - \$40. Large assortment N.I.B. TV parts - \$35. Cleaning workshop (again). Large list next month, along with supplement #2. **WANTED:** Copy of Philco 7051 tube tester data, door for Grunow teledial, any Ct. mfg. radio parts or literature, more dud 4-pin tubes. Thanks! Support your local radio club!! Dick Mackiewicz, 1549 N. River Rd., Coventry, CT 06238. (203) 742-8552

**WANTED:** AK 228, 447, 567, others. AK Q chassis with speaker. AK F-6 speaker. Breadboard parts. Bob Nicholson, 3423 S. Long, Topeka, KS 66605. (913) 266-9473

**WANTED:** Help! Need tubes tipped UV201A-5X and WD-M-5X, all in good condition. Send price list. R. Staffeldt, Tempelhofer Damm 183, 1000 Berlin 42, Germany

**FOR SALE:** Antique radio battery eliminators, any voltage you might need. SASE for information. Prices start at \$54. Chuck Humphreys, PO Box 598, New Haven, WV 25265

**FOR SALE:** Rare: National SW-58, similar SW 3-4-5, w/doghouse pwr sup. - \$250. Three Type 27 blue tubes - \$30. Chester Wisner, W1VSR, 1014 Main St., Dalton, MA 01226.

**WANTED:** SP-400 for parts, SP-600 tuning condenser cover. Howard Hartzell, RD #1, Box 1022, Glen Rock, PA 17327. (717) 227-0459

**WANTED:** Manual for Hammarlund HQ110. Xerox OK. H. Hoopes, 10 Bassett Ave., Mine Hill, NJ 07801

**TELEGRAPH INSTRUMENTS WANTED**, pre-1900, any type, any condition. Reinke, 5301 Neville Ct., Alexandria, VA 22310-1113

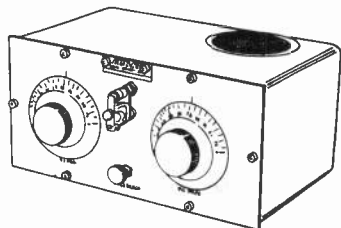

**WANTED:** Pre-1926 radios by AMRAD. Also, Amrad radio parts, accessories, and literature. Richard Sharisky, PO Box 521, Belmont, MA 02178. (617) 484-5784

**WANTED:** PRE-1925 X-RAY TUBES and apparatus, early high-voltage Tesla, Oudin, Ruhmkorff coils, static generators, Lenard, Crookes, Hittorf, Geissler tubes, radium devices, etc. Ely Silk, 7616 NW 68th Terrace, Tamarac, FL 33321. (305) 726-0967

**FOR SALE:** MercRadio 14 transistor radio, leather case, headphone, plays, vg - \$25 + shipping. Jim Tasa, 50 Lombardy St., Lancaster, NY 14086. (716) 882-7323 days, (716) 684-4620, evenings

**WANTED:** Zenith Wavemagnet, (Collins, p. 38), & Ribbonaire fan. Wade Jacobs, 8 Croyden Rd., Mineola, NY 11501. (516) 741-8409

**FOR SALE:** Raggedy Ann & Andy, Annie, Mouse/Cheese, Calif. Raisin AM-FM; all exc - play - BO by Christmas. Don May, 16 Gully Dr., So. Windsor, CT 06074

**FOR SALE:** Bendix 526C Catalin - \$525. AK 84 cath. - \$425. Majestic 15 grandfather clock radio - \$495. GE 140 port. - \$45. Scott amp #222D - \$145. All mint. List LSASE. Richard L. Bednarcik, 28 Steele Ave., Lincoln Park, NJ 07035. (201) 694-6374, eves.

**WANTED:** Pedersen Electronics Model W-15 amplifier, basket case OK. Remo J. Vinassa, HCR 61, Box 222, Norfolk, AR 72658. (501) 499-7685

**WANTED:** Book: How to Fix Transistor Radios & Printed Circuits Vol. 2, Lane. Thomas Bisel, 2266 Halyard Ct., St. Louis, MO 63129

**FOR SALE:** Hallicrafters #120 & Philco Transistone #48-200, vg - \$40 ea. Thanks. Harry C. Nuss, 47 Gravel Hill Rd., Huntingdon Valley, PA 19006. (215) 357-5061

**WANTED:** Dial face for Fada 1000. Irwin Moritz, 10726 Santa Rosa Dr., Boca Raton, FL 33498. (407) 479-2509

**WANTED:** For DeForest Interpanel: manual, parts information. I would appreciate your call. Ross Litrenta, 1 Wilton Rd., Eastchester, NY 10709. (914) 337-7176

**FOR SALE:** PHONO NEEDLES & CARTRIDGES (ceramic - magnetic). What do you need? Send SASE. J. J. Papovich, 53 Magnolia Ave., Pitman, NJ 08071. (609) 582-8279

**WANTED:** Hallicrafter Sky Riders with entire front panel silver color, also S-30, S-33, S-35, SX-112, SX-1000, HT-2, HT-3, HT-8, HT-12, HT-14, Hallicrafter advertising signs, parts, manuals, and other old or unusual Hallicrafter items. Also want RCA Model ACR-111. Chuck Dachis, The Hallicrafter Collector, 4500 Russell Drive, Austin, Texas 78745

**INDIVIDUAL PHOTOFAC TOLDERS.** From sets under #1400 - \$5. Over #1400 - \$7. Prepaid First Class postage included. Also full stock Sams specialized books. Allen J. Loeb, 414 Chestnut Lane, East Meadow, NY 11554. (516) 481-4380

**REPRODUCTIONS:** CHARLIE McCARTHY character (identical in appearance to the original seated on the Majestic radio) - \$95. Large PEPSI BOTTLE RADIO "peel & stick" label set - \$42.50. POSTAGE INCL. (USA). SUNSHINE TECHNICAL SERVICES, 14407 NE Fremont St., Portland, OR 97230. (503) 254-9296

**FOR SALE/TRADE:** Atwater Kent 84 cathedral exc - \$385. (2) Emerson 520 Catalins - \$135 ea. Westinghouse refrigerator radio, fair - \$45. Crosley 10-135 - \$75. Fada Bakelite 209 - \$85. Emerson 587A white marbled exc - \$60. Zenith A513R maroon with white front - \$45. Teleking RK-41A marble brown with white knobs - \$50. Crosley Duette white with gold grille - \$75. Brunswick 1700 highboy with doors and drawer, great celluloid bezel with push buttons, exc - \$220. Stewart-Warner 62T36 Catalin, exc. General Electric L572 Catalin maroon with yellow grille and handle. **WANTED:** Any Kadette plastic radios, solid colors or marbled sets by Detrola, RCA, Sparton, and Majestic. I also need a junker General Television radio for parts. Please call or write: Jon Steinhauser, 636 Westminster Rd., Baldwin, NY 11510. (516) 223-9878

**WANTED:** Sylvania loctal tube type 3D24, new or used OK, will pay fair price. Alan Schreiber, WA5DJU, 12805 Powderhorn St., Austin, TX 78727. (512) 835-2056

**FOR SALE/TRADE:** Catalin yellow Aristocrat 400, Scott All-Wave two-dial in Plymouth cabinet 1931 (complete), Philco 49-501 (Boomerang), Fada 790 (Bunis, p. 67), Zenith 5R312 (R.G.A., p. 71), Philco 54 wood (Bunis, p. 117), GE F-51 (B.F.T.P., p. 203), Emerson green Catalin 520, Radiola III & IIIA. Radiola 30 condenser bank with brackets. **WANTED:** Early Bakelites & Catalins. Ross Lintrenta, 1 Wilton Rd., Eastchester, NY 10709. (914) 337-7176

**WANTED:** Dial glass for Philco 42-321 (G.O.R., p. 94). Please, no flakes or chips; also, speaker & knobs for same. Paul Rosen, 30 Cherrystone Dr., Willowdale, Ontario, Canada M2H 1S1. (416) 493-6962, eves.

## ALL A.R.C. BACK ISSUES AVAILABLE

Feb. '87 to current issue: Originals available  
32 to 92 pages each.

Oct. '86 to Jan. '87: Reprints available  
*Reprinted from original artwork; 28 to 32 pages each.  
Quality and appearance same as an original copy.*

June '84 to Sept. '86: Photocopies available  
Not original quality, useful for info.; 16 to 28 pages ea.

The above availability is as of December 1991. As stocks of original copies are exhausted, reprints will be substituted for the issues after January 1987. Publication of *Antique Radio Classified* began in 1984 which had only five issues: June, Sept., Oct., Nov. & Dec. 1984. 1985 through 1989 have had 12 issues each.

**\$3.50 each - Postpaid to  
U.S., Canada and Mexico.**

*Orders of 6 issues or more may take a 10% discount. Foreign orders other than Canada and Mexico: \$5.50 each by air. Massachusetts residents, please add 5% sales tax.*

Send Order with Payment to:  
**ANTIQUÉ RADIO CLASSIFIED**  
P.O. BOX 2, CARLISLE, MA 01741

**WANTED:** Radio magazine for January 1935, or photocopy of McElroy article in it. Tom French, 120 Great Rd., Maynard, MA 01754. (508) 897-2226

**FOR SALE:** Paper-mache Nipper dog, 36" - \$175 prepaid cont. USA. Photo \$1. Other Nipper items. Jack's Vintage Radios, 621 Trinidad Bend, Coronado, CA 92118. (619) 429-0165

**FOR SALE:** McMurdo-Silver Masterpiece III, needs TLC, complete, with cabinet, no rust - Best Offer. Brent, c/o Arts, 625 West 100 S, Herber City, UT 84032. (801) 424-1981

**WANTED:** I have Zenith chassis 5709, need cabinet such as 7S204, 7S232, 7S240, 7S242, 7S258, 7S260, 7S261. chassis for 6S27 or 6S52, or speaker for 6V27. Power transformer for Grunow 471 or chassis 4C. Any products by Wengel Radio. Larry Schiebel, 818 W. Lakeside St., Madison, WI 53715. (608) 255-0459

### CLASSIFIED AD NOTICE

Please check your ads carefully before sending them in. Once ads are received, it is not always possible to refund the amount sent, pull the ad or make changes.

**WANTED:** Help me restore my AK 75, need phonograph pick-up and arm. Also looking for driver and base for a Jewett Super speaker. Rich Elskamp, PO Box 27, Centerville, MA 02632. (508) 428-6677, eves.

**FOR SALE:** Trade for WE tubes, Jan 6161, huge Amperex 6445, 810, other trans. tubes. V. Vogt, 330 S.W. 43rd St., #247, Renton, WA 98055. (206) 251-5420, x247

**FOR SALE:** Rider's 10-5 abridged - \$30. Beitman's Radio Diagrams 1926-1938 - \$11. Both excellent. Lewis M. Owens, 2824 Dan Patch Dr., Lexington, KY 40511. (606) 252-5072

**WANTED:** Junker Radiola AR-812 for parts. Don't need the cabinet or the catacomb. Don Caha, 1222 Fairview Dr., Tacoma, WA 98465. (206) 564-1127

**SERVICES:** Flea market home brew dead? Bypass bad controls, transformers, or replace tube with crystal diode. Neat datapack, diagrams and text, explains how. Works like a charm! \$5 plus LSASE. Dave Smith, Box 81, Olney IL 62450. (618) 392-6601

**FOR SALE:** Cyart (as seen in Bunis book), butter-scotch color, a little faded, small stress cracks, no back - \$450 firm. Midget Traveler, brown Bakelite, great condition - \$35. Bob and Tia Trueb, PO Box 127, Indianola, WA 98342. (206) 297-3327 or 297-2053

**FOR SALE:** Best offer before December 31, 1991, for Philco 48-1000 television (F.O.S., p. 139). Bob Shivers, 1233 W. Vine St., Taylorville, IL 62568. (217) 824-9546

**MESSAGE:** Overland Park Auction - Would whoever got that little AC set, toward end of auction, with thumbwheels sticking through slots on top, please write? I'd like to know make and model. Dave Smith, Box 81, Olney, IL 62450. (618) 392-6601

**WANTED:** Western Electric tubes and parts: 101, 102, 104, 205D/E/F, 211D/E, 212D/E, 216A, 242C, 252A, 262A/B, 271A, 274A/B, 275A, 276, 284D, 300A/B, 310A/B, 339A, 347A, 348A, 349A, 350B, 421A, 422A, VT1, VT2, VT3, VT25/A, VT52, etc. Also **WANTED:** Western Electric's amp, speaker, transformer, socket wire, parts, data sheet, etc. European tubes: PX4, PX25, DA30, DA60, DA100; Telefunken: ECC81, 82, 83, EL156, etc. Others: 50/250/350. 845, VT62/801A. Will pay top \$\$\$  
Jun Mizuno, 6711 Mt. Leneve Dr., San Jose, CA 95120. (408) 268-4016

**WANTED:** Mitchell, Mitchell, Mitchell, Mitchell brand radios and other appliances. Speaker for National NC-125 receiver. And radios in shape of musical instruments. Lee Mitchell, The Mitchell Collector, 875 North Michigan Ave., 3412, Chicago, IL 60611. (312) 337-3123, 266-7100

**FOR SALE:** Collectible tubes or will consider trade for other collectible tubes. SASE for list. Sam W. Wrenn, 2314 Seminole Dr. 1207, Arlington, TX 76010

**SEND ALL A.R.C. MAIL TO**  
**Antique Radio Classified**  
**P.O. Box 2, Carlisle, MA 01741**

**WANTED:** TV's, TV's, TV's, TV's 5", 7", 9" table-top, consoles, projections, portholes, wood or Bakelite. Lambert Eulenfeld, 2376 Kirkwall St., Orange Park, FL 32065. (904) 272-9681, aft. 6:30 pm, wkends anytime

**WANTED:** Prewar FCC Amateur License application form, blank or otherwise. James Schliestett, PO Box 93, Cedartown, GA 30125, (404) 748-5968

**FOR SALE:** Copies of instructions, schematic, tube charts for Precision 910, 912, 915. LSASE - \$15. Bruce Hoven, 120 S.E. 11 Ct., Deerfield Beach, FL 33441

**WANTED:** Old Wurlitzer jukeboxes, Coke, slots, popcorn, pedal planes, classic bicycles, 45/78 records, studio disc-recording equipment (Fairchild, Neumann, Presto, etc.) Kim Gutzke, 7134 15th Ave. S, Minneapolis, MN 55423. (612) 866-6183

**WANTED:** Gosnet Communicator 2B 6-meter transceiver, green tuning eye & 4 crystals positions. J. M. Roseman, 2716 West 3rd St., Coal Valley, IL 61240

**FOR SALE:** DeWald A-502 Catalin, mint cond. - Offer. **WANTED:** E.H. Scott radios. Mike Greene, 19113 Alpenglow Ln., Brookeville, MD 20833. (301) 774-3203

**FOR SALE/TRADE:** Zenith Super VIII Spinnet; Fada 160; Freshman Masterpiece 5F4; Victor RE57; several others. Roger Hart, 4551 Kensington Ave., Montreal, Quebec, Canada H4B 2W5. (514) 483-3857

**WANTED:** Photocopies of owners' manuals for Zenith 5R312, Fada RN, Philco 70, Crosley 515. Doug Fox, 1324 N. Russell Ave., Aurora, IL 60506. (708) 896-5490

**MESSAGE:** Holiday Greetings from the Antique Radio Club of Illinois! Radiofest '92 will be held Thurs., Fri., & Sat., Aug. 6th, 7th & 8th at the Holiday Inn, Elgin, Illinois. ARCI expects next year's Radiofest to be the biggest and best ever! Watch this publication for the new "Early Reservation Discount Package." Dave Johnson, Pres., 2336 S. Kenilworth, Berwyn, IL 60402. (708) 484-2743

**WANTED:** TV's 1946, TV's 1946, TV's 1946. Any TV made in 1946. Du Mont Clifton, RCA 621, Airing, Teletone, Firestone, Emerson, Crosley, etc. 1946 Du Mont Clifton, 1946 Du Mont Clifton, 1946 Du Mont Clifton - \$400 to \$700. I'll pay for shipping. Lambert Eulenfeld, 2376 Kirkwall St., Orange Park, FL 32065. (904) 272-9681, aft. 6:30 pm, wkends anytime

**WANTED:** Original operators' manuals for Day-Fan 5069, Majestic 72 and 132, Grebe AC-6 and Stromberg-Carlson 1A. Victor Leader and AK Model L horn bases. Ken Martin, 12667 Eckard Way, Auburn, CA 95603. (916) 885-0243

**FOR SALE:** Rider's Volumes 1 to 5 abridged - \$35; Volumes 6 thru 17 - \$17 each. Modern Radio Servicing by Ghirardi - \$20. Richard Haneline, 3600 Cuba Blvd., Monroe, LA 71201. (318) 387-6764

**WANTED:** A good power toggle switch from your AK 40, 43, 46, 47, etc. junker completes my AK 46 restoration. Jeffrey Gilbert, 8621 Honeycomb Path, Cicero, NY 13039. (315) 699-2353

**FOR SALE:** Dynaco FM3 tuner, PAS3 preamp, stereo 70 amp, mint with orig. sales literature - \$450. Pick up only. I'm 1 hr. from Detroit. Fred Hamlin, 299 Tawny Rd., Sarnia, Ontario, Canada, N7S 5K1. (519) 542-1521, evs.

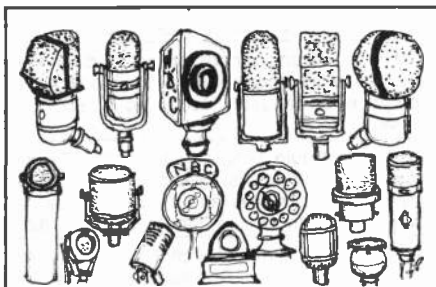

#### WANTED

##### FOR MY BROADCASTING MUSEUM

Microphones, stands, call letter plates. Tube amplifiers, mixers, compressors, Hi-Fi equipment. Speakers, air-line lights, equalizers. Disk, wire & tape recorders. Blank recording disks. Catalogs, magazines, manuals. 16" transcriptions, turntables, arms, pickups. Early TV cameras & receivers. Elaborate console, deco, plastic, mirror, novelty & wireless radios. Jukeboxes & parts. Acoustic phonographs.

We are looking for all makes of equipment, and especially *Western Electric*, Telefunken, Neufmann and RCA. The museum contains various duplicates and items surplus to our needs, and many of these articles are available for sale or trade. The collection is located in my Victorian seaside inn, The Caffrey House, situated on a bay next to the ocean, in the Southampton resort area of Long Island. A trade of equipment for a stay at the hotel is always encouraged.

Robert Van Dyke, 2 Squires Ave., East Quogue NY 11942  
516-728-9835

**FOR SALE:** 1947 Model 504 Magic-Tone radio in a glass bottle, decals good, (Boom, Vol. 3, page 195) - \$250. Fred Geer, 6042 Brookridge Rd., Jacksonville, FL 32210. (904) 771-7828

**WANTED:** Metal radios: Arvins, Silvertones & Kents. Also need Zenith Trans-Oceanic 7000v foreign. Jim Montague, 921 S. Cuba, Spokane, WA 99202

**WANTED:** Old magazines, radio and wireless books, brochures, pamphlets, wooden radio knobs, old radio tubes, advertising pieces, Little Nipper items, and odd radio items. Write or call: Rudy Hecker, 127 Weymouth Ct., Schaumburg, IL 60193. (708) 529-3560, after 6 pm

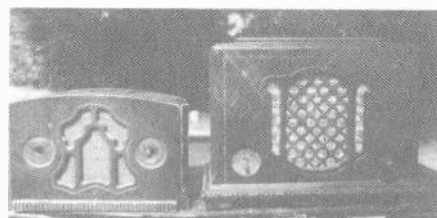

**HELP:** Help identify these radios, the one on the left has a Repwood cabinet, believed to be an RCA Victor; the other has no markings. Willing to pay for your efforts. Robert Turner, 11649 Co. Rd. 48, Fairhope, AL 36532. (205) 928-0051

**WANTED:** Junker set or brass bezel for Grunow teledial Model 568. Dial for RCA Model 96T1. Dial pointers for Crosley Model 5-38. Please help. I will help you. Larry Porter, 4115 Beam Rd., Crestline, OH 44827. (419) 683-2540

**FOR SALE:** Atwater Kent Model 20, complete and original, like new inside - \$100. Bill Smith, Rt. 3, Box 49, Gretna, VA 24557. (804) 656-1658

**WANTED:** Edison phonograph, pref. Edison Fire-side. Also radios and speakers from the 20's. Pay good price. G. Faassen, Heideweg 7, 5953 T. L. Reuver, Holland

**FOR SALE:** Audio, power, vertical, and IF transformers, yokes, flybacks, TV knobs, boxes of RCA TV parts. No lists, write wants, SASE for reply. Jim Moffett, 218 Shannon Lee, San Antonio, TX 78216

**WANTED:** Copies or Xerox copies of Upper Midwest Radio Guide. AM radio listings and programming of 1937 to 1940. Sonnek, K0JM, 914 S. Jay Street., Aberdeen, SD 57401. (605) 225-5648

**FOR SALE:** B&K Model 850 Color Analyst, color and pattern generator - \$30. **WANTED:** GE/RCA K-64 chassis w/wo tubes in repairable condition. Jerry Wiley, 2680 Old Adobe Rd., Petaluma, CA 94954. (707) 763-8410

**FOR TRADE:** Restored American Bosch Model 565 chassis & spkr for Crosley 124 or Majestic 15A chassis. A. Bruno, 24 Butternut Dr., New City, NY 10956. (914) 354-8899

**WANTED:** Heath DC supply for 2er or 6er. 2m SSB. C. Schiotz, K2PGB, 15 Runyon Mill Rd., Ringoes, NJ 08551

**FOR SALE:** Philco 37-84, cabinet has two holes drilled - \$60. Philco 89 good condition, works - \$135. Philco 60 minor veneer damage on bottom front, hums - \$100. Philco 60 cabinet poor - \$60. Philco 87 console works - \$70. Philco 610 console works, cabinet needs refinishing - \$40. Atwater-Kent M horn no driver, nice cond - \$35. Zenith Royal 500 transistor maroon round speaker - \$75. National HRO-50T1 with speaker and 4 coils - \$365. AK 33 chassis decent condition - \$35. Hallicrafters Skyriver 32 - \$225. Hallicrafters SX-28A no cabinet, untested - \$115. Stewart-Warner mirror in the lid TV #AVC-1 - \$225. Hallicrafters S-38B poor cond - \$15. SASE UPS extra. Joe Szabat, 1019 Hiland Ave., Coraopolis, PA 15108. (412) 264-7498

**WANTED:** Gumby novelty set, need not be in box or cosmetically perfect, just working and reasonably priced. Dave Smith, Box 81, Olney, IL 62450. (618) 392-6601

**FOR SALE:** Silvertone AM/FM tuner tube type, Mod 7404 black, 72 & 300 ohm inputs, very nice condition - \$20. VM tuner Mod 1416 has CD diamonds on dial, tan impregnated cloth finish, AM/FM - \$20. One pound Beldon Form-Var 32 GA. wire - \$7. Also transformers, var., caps., coils and other hard to find items. Add UPS. SASE for list. C. F. England, 98 Montague Ave., Zanesville, OH 43701

**FOR TRADE:** My extra Rider's XIII for your extra Rider's XII. Ross Ellis, 206 Gregg Dr., Battle Creek, MI 49017. (616) 962-1514

**WANTED:** 24CP4 or 24CP4A black and white picture tube. Or need to know where I can get the one I have rebuilt. Also yoke for TV Zenith #95-1359. Thank you. David Lyons, 623 Carlson St., Sycamore, IL 60178-2401. (815) 895-6862

**FOR SALE:** Reproduction of the 1929 "Official Blueprint of the Pilot A.C. Super Wasp B.P.-115" sold by Radio Design magazine. Shows mechanical and electrical construction in a detailed 36" x 21" blueprint. Shipped rolled in a tube, suitable for framing - \$5 plus \$3 shipping U.S.A. John Kelly, N3GVF, 19133 Stedwick Dr., Gaithersburg, MD 20879

**FOR SALE:** Sams Photofact 500-1500 - Best Offer. Greg Hase, 8607 San Miguel Pl., Cucamonga, CA 91730. (714) 989-9780

**WANTED:** Allied Radio Catalogs 1951 through 1958. Stanley Caesar, 512 Country Club Cir., Midwest City, OK 73110

**FOR SALE:** Philco Safari, excellent condition, no missing parts, receives sound but no picture - \$150. Michael Kerr, 1445 W. 19th St., Merced, CA 95340. (209) 723-2642

**FOR SALE:** Air King A-600 green/yellow Catalin - \$1,100. FADA 659 pea green Catalin - \$600. Jack Sacra, 1720 Solomon Rd., Charlottesville, VA 22901. (804) 293-9985

**WANTED:** Pocket size radios: Tube, transistor, or crystal. **FOR TRADE:** Zenith Royal 500's—all models. Eric Wrobbel, 20802 Exhibit Ct., Woodland Hills, CA 91367. (818) 884-2282

**WANTED:** HQ 140 X and speaker. Craig Zitterich, 1725 Oak Hill, Corinth, TX 76205

**WANTED:** Philco Service sheets for Model 46-431, original or photocopy. Jack A. Freeman, 1206 Sunnycrest Dr., Reidsville, NC 27320

**WANTED:** A-K breadboard parts, for Model 10 #4560. Will pay any reasonable price for the following: Potentiometer and 2nd RF amplifier assembly complete and in good condition. Please call me collect. Thanks. George R. Francis, Jr., Suite 801, NCNB Plaza, 7 North Laurens St., Greenville, SC 29601-2744. (803) 235-1025

**WANTED:** Owner's manual for Atwater-Kent Tune-O-Matic console. Model #509. Also interested in original knobs, and reproduction decals, and any AK advertisements for Tune-O-Matic. Will buy any ads for Grand Ole Opry, WSM Radio or National Life Insurance Company related to the Opry. Wade Jessen, WSM Radio, 2644 McGavock Pike, Nashville, TN 37214. (615) 662-1378 or (615) 889-6595

**FOR SALE:** For the Audio/Hi-Fi collector or enthusiast, Vintage HiFi Spotter's Guide, Volume I, 2nd edition, 450 illus., specs, index of 1947-62 American tube hi-gi gear - \$17.95 ppd. **WANTED:** Brook 12A3 triode amp, will pay up to \$250 cash. Power xfmr for H.H. Scott LK-150 amp. C. Kittle-son, PO Box 691, Belmont, CA 94002

**FOR TRADE:** Antique radio collection, test equipment, parts, etc. for your Model A Ford automobile. Henry Trabold, 1508 Tenth Ave., Toms River, NJ 08757. (908) 244-2345

**HELP:** Need Tektronix #157-0107-00 vertical input nuvistors 453 & 454 scopes. #26 magnet wire 1-5 pounds. Alan J. Kriss, 1872 Portsmouth Way, Union, NJ 07083. (908) 688-2092

**WANTED:** Rider's, new in box or excellent, Volumes 14-23. John Sudduth, 1842 Hwy. 92, Fairburn, GA 30213

**FOR TRADE:** The Radio Shop, Model S, 1922, one-tube set, very nice. Ed Bell, 5311 Woodsdale Rd., Raleigh, NC 27606. (919) 851-1517

**FOR SALE:** Craftsman AM/FM tuner #800 with amp - \$100 pick up only. Crosley 10-145M - \$45. Emerson G1701 light blue - \$25. Firestone 4A24 Air Chief, hums - \$30. Fada 855, hums and crack - \$10. RCA B52 - \$20. RCA 9X561, crack - \$35. RCA 68RL AM/FM - \$30. Stewart-Warner 024C1 chassis - \$10. Stromberg-Carlson 1500HR - \$40. Zenith 4K016 - \$40. Zenith 6G501M - \$40. Zenith G503 - \$45. Dennis Atkinson, Upper Park St., Phillips, ME 04966. (207) 639-3111

**NOTICE TO ALL  
CLASSIFIED ADVERTISERS!  
OUR CLASSIFIED AD DEADLINE IS  
12:00 NOON  
ON THE 10th OF EACH MONTH**

**WANTED:** 7" TV Admiral Model 19A11-SN/1950, need knobs and back, buy unit if necessary. Tom Gwilt, VE7BYZ, 3430 Highland Dr., Port Coquitlam, British Columbia, Canada V3C 3V4

**FOR TRADE:** Early TV iconoscope tube for vintage broadcast microphone on my wanted list. Write for details. James Steele, Box 620, Kingsland, GA 31548

**FOR SALE:** Cleaning out storage area. Old radio and TV tubes, 41 new untested, boxed - \$60; 114 used untested, some boxed - \$38. Misc. microphones, transformers, tuning condensers, resistors, vol. controls, etc. SASE for list. Lew Miller, 4772 Hilltop Ave., Cheyenne, WY 82009

## TUBES WANTED

We need the following tubes to replenish our stock (first digit on 3 digit types is optional). You may ship your tubes to us by UPS or Parcel Post. We'll mail our check upon receipt and testing of tubes. We pay prices shown plus shipping charges.

### USED GLOBE OR BALLOON SHAPE TUBES - ALL MUST TEST GOOD

WD-11*..... \$35.00	184..... \$ 6.00	227..... \$ 2.00	247..... \$ 6.50
WD-12*..... 20.00	UV-199*..... 10.00	230..... 5.00	250..... 27.00
WX-12*..... 15.00	UX-199*..... 9.00	237..... 6.00	256..... 6.00
112A..... 8.00	200A..... 6.00	240..... 5.00	280..... 7.00
120*..... 10.00	UV-201A..... 5.50	245..... 12.00	281..... 7.00
171/A..... 6.50	UX-201A..... 5.00	246..... 7.00	403 KELLOG.. 15.00
183/483..... 6.00	210..... 10.00	*Tubular	

### NEW TUBES URGENTLY NEEDED

O1A(ST).... \$7.00	6A3..... \$9.00	10..... \$6.00	45..... \$15.00
2A3..... 15.00	6B5..... 6.00	12A..... 8.00	50..... 30.00
2B6..... 5.00	6CD7..... 8.00	15..... 8.00	71A..... 5.50
5AR4..... 5.50	6F6G..... 3.00	42..... 5.00	864..... 6.00

We buy all types of receiving and transmitting tubes. Send us your list for our bid.

**ANTIQUÉ ELECTRONIC SUPPLY  
6221 S. MAPLE AVE., TEMPE, ARIZONA 85283  
PHONE (602)820-5411 FAX (602)820-4643**

**FOR SALE:** RME-70, works, needs restoring - \$140. HRO F coil - \$45. HRO speaker - \$85. 1926 First Edition ARRL Handbook - \$95. January 1945 Vol. 1 No. 1 CQ magazine - \$22. ICS Radio Course, early 1950's - \$20. Rider's VI and XXI - \$18 ea. All plus shipping. William Ernst, 1619 Campbell Rd., Comins, MI 48619

**FOR SALE/TRADE:** Scott Masterpiece in Warrington cabinet. AK cathedral #89, excellent cond. Zenith chrome tombstone #809, excellent cond. Zenith photo-finish tombstone #6S229, excellent cond. Philco 70, excellent cond. - \$285. Philco, good cond. - \$185. Please write or call: Roger Buttignol, 214 State St., #7, Portsmouth, NH 03801. (603) 427-1384

**MESSAGE:** Thanks to everyone who replied before, but Santa must be out there. Help me fill my wife's Christmas list or there won't be any holiday cheer for me or anything else! Happy Holidays!  
**WANTED:** Kennedy and Kellogg headphones, Kellogg loudspeaker, speaker assembly for a Philco 71 Code 121 cathedral. Advertising information, owner's manuals, etc., anything on a Kennedy V, Kellogg Wavemaster, and Sparton Equanone 301 AC set. James W. Walcher, 1311 Janet Drive, Wilmington, IL 60481. (815) 476-9184

**FOR SALE:** Eico 633 CRT tester w/manual, chart and 6 adaptors - \$25. Winston Elect. Model 250 color conv. dot gen. - \$10. (19) Xceiver tubes - \$5. (14) Radio and Television News Mags, 1949-1955 - \$10. Add \$5 shipping for each item. TV Tubes, 174 N.O.S., 338 used/tested and 60 untested - \$100 + \$10 shipping. Terry Meyers, 14615 Madison Circle, Omaha, NE 68137. (402) 895-3904, after 6 pm

**FOR SALE:** Zenith Trans-Oceanics: A600L leather model good condition, crack in chart cover door hinge - \$110. A600 good condition, works - \$65. T600 good condition, works - \$70. H500 good condition, with manual, works - \$45. H500, fair condition, works - \$25. Gary Pirkkala, 2306 Audley Avenue, New Castle, PA 16105. (412) 658-0534

**FOR SALE:** New! A white beverage mug with a 1930 Philco escutcheon and a hand logging station call letters on the dial - \$8.50 ppd. This is the same design as our Philco T-shirt. An 11 x 17 book featuring pictures of 97% of all the Zenith radios produced from 1920 through 1946, including 40 years of Trans-Oceanics, is now available. Nearly all the graphics are from the dealer brochures from each year. Photocopy - \$24.95 plus \$4 shipping. We also have brochures from companies from AK to Zenith to aid the collector, such as 1936 Grunow brochure with the Teledial models - \$6 ppd. SASE for complete updated list. In addition to our two black Zenith T-shirts, a silver Philco T-shirt, very Art Deco - \$12.95 ppd., XXL - \$14.95 ppd. 1936 Zenith poster replica, 25" x 38" - \$19.95 ppd. Closeout on 1991 Passport To World Band Radio - \$15.50 ppd. Zenith 12A57 and 12A58 reproduction dial glass - \$59 ppd. Zenith Royal 3000 and 7000 owner's manual copies, color laser cover - \$10. We do take Visa/Mastercard on phone orders. Fax only please on this number: (612) 727-1908, 7 am to 10 pm CST. Alan Jerspenson, PO Box 17338, Minneapolis, MN 55417. (612) 727-2489, 8 am to 8 pm CST, ans mach after 4 rings

**FOR TRADE:** (2) Fada Bullets & (1) Emerson Mickey Mouse. Johnny Johnson, 2201 Newton St., Denver, CO 80211. (303) 455-3421

## ABBREVIATIONS USED IN CLASSIFIED ADS

### MISCELLANEOUS

amp = amplifier  
BC = Broadcast  
BO = Best Offer  
ca. = circa (approx. date)  
ea. = each  
IB = Instruction Book  
LSASE = A Long SASE (see SASE)  
LW = Long Wave  
MO = Money Order  
Mod = Model  
N.I.B. = New In Original Box  
N.O.S. = New Old Stock (An original, unused vintage item)  
NT = No Tubes  
OB = In Original Box  
OBO = Or Best Offer  
P&H = Postage & Handling  
ppd = postage paid (shipping included)  
PS = Power Supply, also "pwr sup"  
PU = Pick Up Only  
rcvr = receiver  
SASE = Self Addressed Stamped Envelope (Send a long, # 10, envelope)  
spkr = speaker  
SW = Shortwave  
UPS = United Parcel Service  
vol = volume  
w/ = with  
w/o = without  
xcvr = transceiver  
xfmr = transformer  
xmtr = transmitter  
xstr = transistor  
xtal = crystal

### BOOKS USED AS REFERENCES

(V.R., p 30) means *Vintage Radio*, page 30  
Blast = *Radio - A Blast From The Past*  
Bunts = *Collector's Guide to Antique Radios*  
Collins = *Radios - The Golden Age*  
Douglas V1, V2 or V3 = *Radio Manufacturers of the 1920s, Volumes 1, 2 or 3*  
F.O.S. = *Flick of the Switch*  
Grinder/Fathauer = *Radio Collector's Directory and Price Guide*  
G.O.R. = *Guide to Old Radios*  
Johnson's A.R. = *Antique Radios - Restoration & Price Guide*  
O.T.B. = *Old Timer's Bulletin* published by Antique Wireless Assoc. (AWA)  
Sidell = *Classic Plastic Radios*  
V.R. = *Vintage Radio*

### CONDITION

(IF GOOD OR BETTER, MENTION NON-ORIGINAL PARTS)

p = poor f = fair  
g = good vg = very good  
exc = excellent

A.R.C. does not encourage abbreviations except those listed here. Please spell out all other words. Special note for hams - most subscribers are not hams so we do not recommend ham-type abbreviations.



**FOR SALE:** Hopalong Cassidy radio in red, complete with back and paper label - \$425. Peter Lyons, 133 Central St., Hingham, MA 02043. (617) 749-3275

**FOR SALE:** Knight Kit 83YV726 amateur receiver - \$50. 7-Band Hallicrafters World Wide portable, looks like a Trans-O. Both sets work exceptional. Fred Hegel, 1901 Frank Pl., Daytona Beach, FL 32119. (904) 760-7632

**WANTED:** Collins 51J-2 receiver, and chassis for Philco 70, Philco 37-116 and AK 84. M. L. Harrington, PO Box 7619, Little Rock, AR 72217

**FOR SALE:** 30's Weston tube checker - \$60. Drake TR4 - \$110. 1931 Wavemeter - \$50. 20's tubes, antique switches. **WANTED:** 6146, 6146A tubes. S. Mount, K20A, 35 Grand St., Highland NY 12528. (914) 433-7714

**FOR SALE:** Zaney Gill Music Box cathedral 2445, exc - \$200. Dale Kinstler, W1361 Aasen Rd., Bangor, WI 54614. (608) 486-2589

**FOR SALE/TRADE:** Crosley 51, Radiola IIIA with manual, Philco 70 cathedral (needs work). FADA 652 open face maroon/yellow. For Catalins, Plascons, unusual plastics. Mark Alzapiedi, 21 Peach Tree Ln., Leominster, MA 01453. (508) 840-0466

**WANTED:** Zenith 5-S-327, small tombstone. RCA Tube Manuals #RC 12, #RC 13, and #RC 14. Heathkit tube tester #TT-1A. Thanks. Bob Schafbuch, 2811 Highland Ave., Carrollton, KY 41008. (502) 732-6718

**MESSAGE:** Notice: To all those who have sent a SASE for our list of radios for sale - the list is still not ready! You will be contacted as soon as possible. If in Cleveland visit our retail store - Play Things Of Past, 3552 W. 105th St., Cleveland, OH 44111. Hours: Wed. 5-9 pm and Sat. 12-6

**WANTED:** Knobs and small trim piece for small red on yellow Addison (Sideli, cover). Also right trim piece for yellow on black marbled small Addison (Sideli, Fig. 3) or sell or trade for novelty radios. Clifford Watts, 51 Glendale Rd., Brantford, Ontario, Canada N3T 1P5. (519) 753-9049

**FOR SALE/TRADE:** Hallicrafters S-38EB, S-120, SX62, HA-1, Drake 2-B, 2BQ AK 40-F RAD 100A spkr. Raymond B. Williams, 4521 Whitfield Ln., St. Louis, MO 63134-3821. (314) 428-1963

**MESSAGE:** The next meeting of the Antique Radio Club of Illinois will be held at 8:00 am, Sunday, Dec. 15th, at the Holiday Inn, Elgin, Illinois. Following the indoor swap meet there will be a buffet brunch free to all paid up ARCI members. Join ARCI and plan to attend. For further information and reservations contact: Carolyn Knipfel, Sec'y., Rt. 3, Veterans Rd., Morton, IL 61550. (309) 266-9440

**FOR SALE:** 220 Sams CB Photofact #7-291. **WANTED:** Schematic Jewel 505 Pin-up, Sams 18-21, Art Bilski, 208 Green Mountain Dr., Bolingbrook, IL 60440. (708) 739-1059

**WANTED:** Complete set Rider's radio manuals. Bill Lowe, 10 Meadow Brook, Candler, NC 28715. (704) 665-2727, collect call OK

**FOR SALE/TRADE:** Radiola 16 - \$75. A-C Dayton XL-25 - \$85. Crosley 56-TU, unusual Deco set - \$70. Paul Ernst, 3465 Eddy Rd., Marion, NY 14505. (315) 589-9471

**MESSAGE:** Thanks to everyone who replied before, but Santa must be out there; must fill my wife's Christmas list or there won't be any holiday cheer for me or anything else. Happy holidays. **WANTED:** Kennedy and Kellogg headphones, Kellogg loudspeaker, speaker assembly for a Philco 71 Code 121 cathedral. Advertising information, owner's manual, etc., anything on a Kennedy V, Kellogg Wavemaster, and Sparton Equasonne 301 AC set. James Walcher, 1311 Janet Dr., Wilmington, IL 60481. (815) 476-9184

**WANTED:** Zenith Stratosphere in any condition as pictured. I'm not bargain hunting - rather radio hunting. Will pay cash or trade Scott or McMurdo-Silver radios. Craig Korpak, 9130 Silver Lk. Rd., Linden, MI 48451. (313) 735-7264

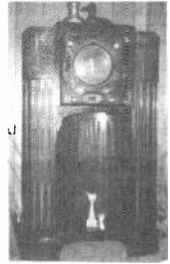

**FOR SALE:** Zenith equipment and parts: Mint Walton's 9S-232 stamped chassis, Zenith speaker with golden bell cover, Walton's grille cloth enough for four, 1938 cabinet, (5) Zenith speakers, Walton-type tubes with Zenith logos, two original Zenith output transformers, Zenith headphones - \$75. (35) Back issues of A.R.C. - \$1.75 ea. postage paid. Zenith, Philco, Grunow call letter tabs. Bill Coolahan, 1450 Miami Dr., NE, Cedar Rapids, IA 52402. (319) 393-8075

**HELP:** Information and/or schematics for a SABA Telerama projection TV, Model #P1026H. Dave Abramson, 1649 Yellow Springs Rd., Chester Springs, PA 19425. (215) 827-9757

**FOR SALE:** Good used pre-tested tubes, no early types - 25¢ to \$2. LSASE for list. Michael Dalzell, 5073 Winfield Ct., Bensalem, PA 19020. (215) 638-3889

**FOR SALE:** RCA AM/FM Dynamic Factory Demonstrator tin 3' x 4' sign - \$125. Philco 1930's wood Decos, #38-40, #37-62, A 38-7, #37-610, - \$45 ea. Small floor Philco #29, Crosley #605 - \$65 ea. Airline small tin #84GCB - \$30. Novelties, McDonald's Fries, Orphan Annie, Barbie, Coke Cooler - \$20 ea. Wood push-buttons, Philco #42-350, RCA #16T3 - \$40 ea. Fada Bakelites: push-button and large brown - \$40 ea. Small Bakelites: Traveler #5051 Westinghouse, Telephone, Philco #46-200, GE L512, Emerson #641, Motorola #67X - \$30 ea. Firestone wood Deco #57398 - \$40. Mohawk 1925 battery - \$45, Motorola Christmas window display adv - \$65. Hallicrafters Sky Buddy #S119, Skyrider Jr. Model H - \$40 each. Hallicrafters ham set #HT37 - \$65. Arvin, Philco pocket transistors - \$15 ea. Ed MacFalls, 310 2nd Ave., Lakemont, PA 16602. (814) 944-0797

**WANTED:** AK 80 or 90 cathedral cabinet parts or junk cabinets. Merrill Bancroft, 169 S. Row Rd., Townsend, MA 01469. (508) 597-6623

**WANTED:** Tube CB's/ham transceivers: Tram, Demco, Browning, Siltronix, Lafayette. Hallicrafters S-27, S-20R receivers. Charles Zafonte, N1FRX, RR #1, Box 75, Fort Kent, ME 04743. (207) 834-6273

**FOR SALE:** Philco radio/phono 53-1350, virtually mint - \$120 + ship. GE H-54 '39 custom-made for NYC bar, covered in blue naugahyde, Deco & unique, plays - \$150 or BO. Don May, 16 Gully Dr., S. Windsor, CT 06074. (203) 644-0258, no calls after 9 pm EST

**FOR SALE/TRADE:** Early superhets - Receptor & Boulder, WWI wavemeter, & others. SASE. Rosenthal, 5 The Strand, New Castle, DE 19720

**WANTED:** Philco plastic dial Model 89, Code 123 Part #27-5105. Philco 40-150 dial glass Part #27-5508. Charles Childs, Box 15, Gotham Rd., Watertown, NY 13601. (315) 788-2487

**WANTED:** 75A4. Viking Navigator. Vibroplex bug. **FOR TRADE:** GE K50, AK 164 cathedrals. Rider's 1-14. Brian Roberts, 3068 Evergreen Rd., Pittsburgh, PA 15237. (412) 931-4646

**WANTED:** Zenith Royal 500's, any model, any color, 7" & 10" TVs from the 40's. RCA clock radio Model # 1-RD-61. Fada 799 TV. RCA 630 TV. **FOR TRADE:** RCA 8T241 TV & Crosley 9-408 TV. Tony DeMara, 40231 Day, Mt. Clemens, MI 48044. (313) 263-0325

**FOR SALE:** Hallicrafters: Receiver S-20 - \$50; HA-8 modulation indicator - \$10; HA-19 100 KC calibrator - \$10. Ward Becht, 625 Tufts Ave., Burbank, CA 91504. (818) 842-3444

## rainy day books

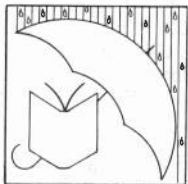

PO Box 775  
Fitzwilliam, NH 03447  
(603) 585-3448  
frank bequaert  
lucia bequaert

### Radio and Other Technical Books, Catalogs and Magazines Bought and Sold

Specializing in Wireless,  
Broadcasting, Electric Power,  
Computers, Electronics,  
Microscopes,  
Civil Engineering and Steam

*Send for our list of catalogs*

**FOR SALE:** Philco 70 cabinet - \$95. Edison Standard phonograph - \$450. Skyrover cathedral cabinet. 4 pair old type headphones - \$25. RCA 117 speaker - \$5. Wizard microphone. Post. extra. Jeff Gentry, 708 Locust Ave., Charlottesville, VA 22901-4913. (804) 979-0699

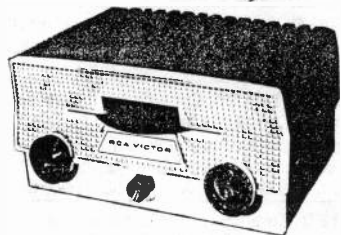
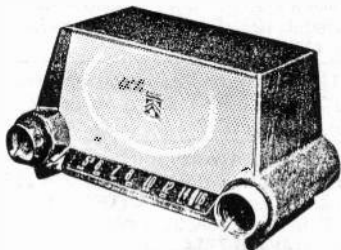

**WANTED:** Motorola #53 H1, 1954, and RCA Victor #6 XY 5A, 1956. Philip Collins, 450 N. Rossmore Ave. #406, Los Angeles, CA 90004. (213) 466-2546

**HELP:** Need instruction manual for Precision Model 912 tube tester. Copy OK. Rich Crispi, KA1EGE, 143 Franklin Rd., #1, Hamden, CT 06517. (203) 230-8189

**FOR SALE:** Rider's 1-5 abridged - \$30, 6-16 w/#9 missing - \$120. Rider's Index 1-10 & 15 - \$8. Triplett 3434A TV-FM sweep-marker generator - \$40. Hallicrafters Sky Champion older mod, no lid - \$30. (5) transistor leather covered AC-DC radios - \$25/all. CREI Radio Engineering Course, 12 vol. - \$10. Speco signal tracer & amp tester - \$15. Hallicrafters CB-7 - \$18. R.C. Products 322A tube tester & roll chart - \$20. RCA 45 R/P, radio ch. missing - \$15. Echophone commerial rcvr, 3-band - \$35. (10) old radio books - \$12.50 prepaid. (46) QST asst. 35-49 - \$8. I.R.C. resistor chest w/ old style resistors - \$5. Tube caddy w/300 boxed tubes - \$30. John Martin, 817 Cook Ave., Billings, MT 59101. (406) 252-4287

**SEND ALL A.R.C. MAIL TO**  
Antique Radio Classified  
P.O. Box 2, Carlisle, MA 01741

**WANTED:** My RCA Aeriola Sr. needs one binding post cap-nut. Tim Healy, 18 Abby Ln., Syosset, NY 11791. (516) 496-7206

**FOR SALE:** Motorola 65X13A - \$15. Hallicrafters S38 - \$55. AK 82Q cathedral cabinet - \$25. **WANTED:** Rider's Radio Volumes #1, #23. Walt Ikes, N8NXT, 12485 Concord Ct., Plymouth, MI 48170-3036. (313) 459-1859

**WANTED:** Tube socket for Eimac 1500T. Industrial/special purpose tube manuals or pamphlets. Eimac 300T. Also any odd or out-of-the-ordinary tube types. John H. Walker, Jr., 16112 W. 125th St., Olathe, KS 66062. (913) 782-6455

**Classified Ad Deadline Noon**

**Dec. 10 for Jan. 1992 Issue**

**Jan. 10 for Feb. 1992 Issue**

**Box & Photo Ads - 5th, Display Ads - 1st**

**FOR SALE:** Du Mont oscilloscope 304 DC-50 kHz with manual - \$50. Hyperion H4-W1-40.05A 0-40 vdc .05a metered power supply - \$35. HP211A squarewave generator 1Hz-1 MHz - \$50. HP-302A wave analyzer 20Hz-50 kHz - \$100. HP-5210A frequency meter 3Hz-10 MHz - \$50. Krohn-Kite 430AB audio oscillator 50Hz-500 kHz - \$50. HP-400D AC voltmeter - \$25. HP-400H AC voltmeter - \$25. HP-616A signal generator 1.8-4.2 GHz - \$150. HP-618B signal generator 3.8-7.6 GHz - \$150. HP-620A signal generator 7-11 GHz - \$150. HP-626A signal generator 10-15 GHz - \$150. HP-628A signal generator 15-21 GHz - \$150. Spencer-Kennedy 504 squarewave generator DC-1 MHz - \$40. Weston DC amperes meter 0-30ain 3 ranges, as-is - \$15. Sierra 125B selective voltmeter 1 kHz-600 kHz - \$75. Sierra wattmeter and dummyload ME - 82/U 50 MHz-600 MHz, 0-120 watts - \$60. Call or write for a free list of test equipment. **WANTED:** Manual for a Heathkit HW-101. Mark Steel, KB5NCY, Rt. 1, 6534 S.F.A. Rd., Freeport, TX 77541. (409) 233-8845.

**WANTED:** Zenith bookcase, GE Georgian, Ozarka 95. **FOR SALE:** Six 8321 (4CX350) two N.I.B., plus sockets and plate connector - \$60, for all plus shipping. Gordon Wilson, 11108-50 Ave., Edmonton, Alberta, Canada T6H 0H9. (403) 434-6257

**FOR SALE:** Tube sets: Motorola T6, 1939 beautiful wood table, works, original finish, 3-band, Philco B6-52 green, Mitchell 1258 bright red, works, 1280 intercoms, Traveler 5356, Emerson white (Very similar to page 54 Nov.), Commodore miniature pocket tube. Transistors: Nova Tech RDF-404 4-band-bar type directional antenna with folding peep sight and degrees of bearing on top. Windsor 2 trans Boy's radio, Silvertone 4204, Toho (Toshiba) 6, cloisonne logo, Zenith Royal 90, 50L, RCA 4-band, plastic & heavy metal, 1970. Novelty: Happy Face, Cabbage Girl, Mayflower ship, 75 more. Battery reel-to-reel; Mafair plastic & Model 1602 (boxed); Concord F90 with radio, F88 Sound Camera - small, Tempest plastic, Bell Futura 400-1961-new, Mission Impossible-Channel Master Small Talk-largely metal-5 3/8" x 3 5/8", Extra reels marked Edison Envoy. American Flyer electric train-works, Sencore Mighty Mite II tube tester with books, Johnson Messenger 120A-new. Need power plug or diagram of same for Polytronics SR23, schematic available? Robert Rogers, 1407 Riverside Rd., Old Hickory, TN 37138. (615) 847-2475, 6 pm CST

**WANTED:** Bretinge 6, 40, 49. Also Patterson PR-16. Dan Mason, 1325 N. Lima St., Burbank, CA 91505. (818) 848-9474

**FOR SALE:** New in box TV parts, controls, yokes, transformers, coils, over 2,000 unopened boxes. Bill Coolahan, 1450 Miami Dr., NE, Cedar Rapids, IA 52402. (319) 393-8075

**FOR SALE:** Motorola 51A - \$75. Airline 93BR-508A - \$75. (Both on page 92, Johnson's G.O.R.) Zenith 6D311 - \$175. Climax 15D5 - \$110. All radios postpaid. Money orders only. Richard Barnes, 14365 SR120, Bristol, IN 46507. (219) 848-4637

**WANTED:** WW2 radio equipment of German, Japanese, Italian forces, anything related. Some models of U.S.A. 1930-1945 military mobile, Forest Service, Coast Guard. Armed Forces Radio Service memorabilia, programs, recordings, military electronics training films. Thank you! Hugh Miller, 6400 Maltby Rd., Woodinville, WA 98072-8375

**FOR SALE/TRADE:** Philco Predicta 20 Deluxe, 84 or Belmont 6D111 for breadboard, crystal, Philco 90, Catalin or high-end early battery & horns. SASE. Doug Koehn, 609 S. 15th, Quincy, IL 62301. (217) 228-2115

**FOR SALE:** Radiola II (AR 800), nice! Radiola AR812, very nice real clean! Magnavox horn, Western Electric horn. Freed-Eisemann NR5, nice. Erla Battery set with Ballow coils, Great Royal Neutrodyne battery set, real nice! DeForest Everyman's crystal set, needs work. Radiola III without tubes, good. Freshman Masterpiece V, good cond. \*Still need Standard Micronic Rubies (transistors), Crosley Ace excellent! Crosley Treasure Island book radio, good. Kent Ise, 224 Cowesett Rd., Warwick, RI 02886. (401) 885-7558

**WANTED:** Hi-fi tube gear amps, preamps, tuners from Marantz, McIntosh, Dynaco, Heath, Scott, Radio, Altec Craftsman, etc. Speakers & horns from Altec, E.V., J.B.L., & Western Electric. Also Gustan amps (tube). Please contact: Sonny Goldson, 1413 Magnolia Ln., Midwest City, OK 73110. (405) 737-3312, after 9 pm CST or leave message

**FOR SALE:** RCA Strato-World 3BX-671, mint with manual - \$125. Zenith 5S127 excellent - \$225.

**WANTED:** RCA Strato-World 1-MBT-6, must be in excellent condition. Gary Stejskal, 1200 26 St. NW, Cedar Rapids, IA 52405. (319) 396-0341, after 7:30 pm

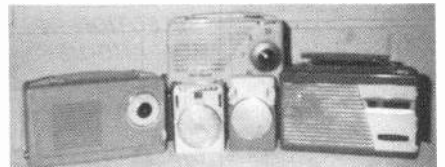

**WANTED:** Small tube portables and small transistor radios. Steven D. Martin, 815 N. Hayden Rd., Apt. B-204, Scottsdale, AZ 85257. (602) 994-3162

**FOR SALE:** LSASE for list of new/used receiving tubes; octal, loctal, miniature, some older. Will also trade for old or unusual tubes or related material for my collection. John H. Walker, Jr., 16112 W. 125th St., Olathe, KS 66062. (913) 782-6455

**WANTED:** (2) Tortoise shell Catalin knobs for a Motorola 50-XC. Richard O. Gates, PO Box 187, Chesterfield, VA 23832. (804) 748-0382 or 794-5146

**WANTED:** Manual for EMC Battery Eliminator and Charger Model 905. Also probe for Heathkit Oscilloscope Model 10-12. Late model CRT checker, must check late model color tubes. Ross "Doc" Ellis, 206 Gregg Dr., Battle Creek, MI 49017. (616) 962-1514

**FOR SALE:** Heathkit IT-3117 tube tester, exc, manual - \$65. Eico 324 RF generator, 150 kHz - 145 MHz, manual - \$25. Military TV-7/U tube tester, vg - \$75. Heathkit T-3 signal tracer - \$25. Hewlett Packard 200CD oscillator, 5 Hz-600 kHz, 0-20V output, manual, vg - \$68. EICO 710 GDO, manual - \$40. Tenma 72-320 20 MHz dual trace oscilloscope, solid-state, 3 years old, exc - \$195. Staco 10A 0-140VAC variac - \$25. Military ZM-30/U RLC/Q bridge - \$48. More test equipment. List - LSASE. Kirk Ellis, KK4YP, 18 Foxfire, Selma, NC 27576. (919) 965-9577, evenings

**FOR SALE:** Zenith Royal 500, tan - \$125. Real-tone TR-970, red, 3-band, near mint - \$75. Zenith 6S511, Bakelite, push buttons - \$75. Emerson 581-A, white urea, handle on top - \$60. Two Delco Trans-portables - \$75 ea. Emerson 713A, wood with plastic front - \$35. Rare tube: RCA DeForest 800 - \$45. J.V.C. Videosphere, red - \$120. Michael Sovic, 1053 E. 11000 South, Sandy, UT 84094. (801) 572-6836

**WANTED:** Information on the Machlett Co., producers of X-ray and transmitting tubes. Also copies of the company magazine, The Cathode Press. John H. Walker, Jr., 16112 W. 125th St., Olathe, KS 66062. (913) 782-6455

**WANTED:** Turns counter for rotary inductor from a BC-375 WWII transmitter. Dial 0-40 and on back number GE 7464561. Will purchase junk transmitterless tubes and tuning unit. Neil Spencer, W4PC, 4665 75th Ave., North Pinellas Park, FL 34665. (813) 546-8711

**WANTED:** Will pay \$50 to \$100 bounty on the following nice, small transistor radios: Regency; Raytheon; Sony TR63, TR86; Crown TR-333; Sonora 610; Sentinel; Sparton; Hoffman P410; GE 675-8; Bulova 250, Mitchell 1101; Toshiba 5TR-193; Standard SR-F22; Truetone D-3716 or Emerson 999. Jerry Wilson, 2007 Water Edge, Birmingham, AL 35244. (205) 985-4254

**FOR SALE:** McIntosh MR55 tuner - \$115. CBS tubes decal - \$12. Shure 55S microphone - \$95. Radio Physics by Ghirardi - \$12. Mark van Roojen, POB 83836, Lincoln, NE 68501-3836. (402) 438-3724

**WANTED:** Catalin radios by Emerson, Fada, Motorola, Garod, etc. . . Free, tripto Hawaii!!! For details, please write or call collect: Rain Buttignol, 214 State St., #7, Portsmouth, NH 03801. (603) 427-1384

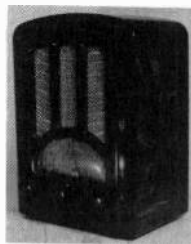

**FOR SALE:** Philco Mod 70 cathedral, working cond. - \$270. Town Crier, working cond. - \$120. Philco Mod 60 cathedral, 5-tube, working - \$150. Crosley Mod 148 cathedral, working - \$185. Westinghouse tombstone, 5-tube, unknown model, WR-205?, working - \$90. Ralph Howard, 1 Church St., Dansville, NY 14437. (716) 335-7916, 6-9 pm eve.

**WANTED:** Metal radios: Arvins 440T, 842J, 444, 840T, 242T, 422A, 341T. Silvertones and Kent 422. Jim Montague, 921 S. Cuba, Spokane, WA 99202. (509) 535-9576

**FOR SALE:** Westinghouse refrigerator radio, no cracks, white, very good condition - \$39. N.O.S. Pilot Super Wasp, uses 201A battery tubes - \$500. Crescent crystal radio, complete - \$85. Arlington type loose coupler with unique detector - \$190. Excellent red metal Arvin, original finish - \$39. Western Electric horn - \$95. Spark transmitter coil, National Union - \$50. Coke Cooler, refinished, it was repaired by expert refinisher, the cabinet had hairline crack - \$375. (100)+ Radio magazines, 80% 30's Radio News, Radio Craft, MSC - \$45. Free shipping, continental USA. **FOR TRADE:** Zenith 12U158 and 12S265 and 15U269 for Navy type loose coupler radio station. Joe Nocera, 1222 Finch St., New Castle, PA 16101-4840. (412) 658-7805

**FOR SALE:** Heathkit IT 21 and manual - \$60. Heathkit PS2 power supply and manual - \$50. Knight V.T. voltmeter - \$30. T. Gasiorek, 201 Golden Ave., Briggsville, WI 53920. (608) 981-2051

**TUCKER SURPLUS STORE**  
1717 RESERVE STREET  
GARLAND, TX 75042

---

**TEST INSTRUMENT MANUALS  
FOR SALE!**

---

**WRITE US WITH MANUFACTURER AND  
MODEL NUMBER.**

**TUBES**

Tucker Electronics has a large inventory of new & "puller" Tubes at attractive prices. Please send for prices and availability.

**LARGE  
SELECTION OF  
NEW AND USED  
TEST  
INSTRUMENTS.**

**WE SPECIALIZE  
IN  
HARD-TO-FIND,  
OLDER TEST  
INSTRUMENTS.**

---

**WRITE FOR INFORMATION AND  
FREE CATALOG!**

**FOR SALE:** RCA Radiola 30, cabinet only, excellent condition, large highboy style, circa 1926 - \$75. Gary A. Micanek, 226 Henry Ave., Manchester, MO 63011. (314) 227-7046

**FOR SALE:** Crosley 124 grandmother clock radio, five of tubes blue bulb type, all original. John W. Weyer, RR 1, Box 175C, Sperry, IA 52650. (319) 985-2405

**SERVICES:** Electronic repairs for table radios. Guaranteed and reasonable. New list of plastic and wood radios. L.S.A.E. Lloyd A. Noel, 494 Clark St., Galesburg, IL 61401

**FOR TRADE:** RCA 103 speaker-cone excellent, frame needs refinishing. For cathedral, any model, or nice tombstone. Jeffrey Viola, 475-B Eltone Rd., Jackson, NJ 08527. (908) 928-0666

**FOR SALE:** Novelty radios: Wristwatch - \$45. Knight Helmet - \$35. Guild Teapot - \$100. Pound Puppy - \$12. Sinclair Gas Pump - \$25. **WANTED:** A-Team, Dukes of Hazard, Bee-Gees, The Fonz. Joe Matuska, 2523 Sunset Blvd., Steubenville, OH 43952. (614) 264-7806

**WANTED:** I love character radios. No repros please. Howard Whitelaw, 9400 Steinway, Cleveland, OH 44104. (216) 439-2159

**FOR SALE:** 1940 Fada Bullet, Model 115 Streamliner, yellow with red knobs & handle, mint condition - \$1,400. 1946 Bendix Model 526C, marbled green & black, mint condition - \$950. Call Bill Cuculich, 6651 N. Campbell, Tucson, AZ 85718. (602) 299-6332

**FOR SALE:** Axial lead electrolytics, fresh new Nichicon miniature 10 mfd at 450 VDC - 98¢ each for 10 or more, includes P&H. DH Distributors, PO Box 48623, Wichita, KS 67201. (316) 684-0050

**WANTED:** Hickok tester roll chart dial knob, part or complete junker. Wanted: U shape housing cover and original knobs for Breting receiver or junker with above. Base size is 17 1/4 x 12 1/4. Cleo McAlexander, Box 4, Stanleytown, VA 24168. (703) 629-2972

**FOR SALE:** TAB #532 TV Imports '70 - \$20. TAB #576 '71 Vol. 2 Japanese TV - \$20. TAB #536 GE TV 1970 - \$15. TAB #562 Zenith TV '71 Vol. 2 - \$15. TAB #668 Zenith TV '73 Vol. 3 - \$15. TAB #502 Zenith TV '68 color - \$15. 21223 Sony TV Man. Vol. 1 '74 - \$25. 21224 Sony TV Man. Vol. 2 '75 - \$25. TAB #496 RCA color CTC12-40 - \$15. TAB #663 Serv New Mod TV '73 - \$15. TAB #522 '70 Philco color TV - \$15. TAB #526 '70 Magnavox color - \$15. J. J. Papovich, 53 Magnolia Ave., Pitman, NJ 08071. (609) 582-8279

**WANTED:** Still wanted: Zenith Stratosphere, 25- or 16-tube model. Also wanted 7S261 bookcase model Zenith, 15U272, 15U270 or any other 12- or 15-tube Zeniths. We also buy EH Scott, McMurdo-Silver, Capehart and other classic radios. If you wish to trade, we have a fabulous inventory of select radios from which to choose. Check us out. Alan Jespersen, PO Box 17338, Minneapolis, MN 55417. Fax only on: (612) 727-1908. Phone (612) 727-2489, ans. mach. after 4 rings, 8 am to 10 pm CST, 7 days

**FOR SALE:** (2) B&W video cameras, single lens (16mm), all tubes, including Vidicon - \$125 + 30 lbs. shipping. John Nosbaum, 2743 Wilmette Ave., Wilmette, IL 60091. (708) 256-0547

**FOR SALE/TRADE:** Delco #78 chassis, Sears 101.583-2 chassis, Freed chassis/spkr 1928, GE radio S-22, Musicaire cabinet 57218, Westinghouse console 312, GE radio console F-86, new Triad transformers (B/W). Send SASE for list. Dick Boiler, 3108 NW 91 St., Seattle, WA 98117. (206) 782-8318

**WANTED:** Telegraph keys, sounders, speed bugs & keys, any make. F. W. Nicholas, PO Box 37094, Phoenix AZ 85069

**WANTED:** Non-working Crosley Model 515 with good power transformer and restorable cabinet. Conrad Gwaltney, Route 1, Box 55, Hiddenite, NC 28636. (704) 632-2921

**FOR SALE/TRADE:** Emerson Aristocrat brownish green with yellow marbleizing, case in nice condition no cracks, plays good, grille warped needs to be replaced, no back cover - accepting offers till Jan. 1 or trade for Fada Bullet any color! Vernon Shatwell, Rt. 5, Box 195, Sapulpa, OK 74066

## One Month Free!

### BONUS FOR EARLY RENEWALS

If you renew **before** the month shown on your mailing label (your expiration month), you will receive an extra month on your subscription: 13 months instead of 12! 26 months for an early 2-year renewal!

**FOR SALE:** Reproduction Zenith dial glass, made from unbreakable Lexan poly-carb, better than original, two rectangular sizes available: 6 3/4" x 7" and 5 3/4" x 7", price including P&H is - \$14 ea. Dealer inquiries welcome. Willard Bogard, 4825 W. Central, Wichita, KS 67212. (316) 943-8145

**WANTED:** Working phonograph with shifting arm for a Stromberg-Carlson with a Model 14A radio chassis. Also Philco 70 cathedral cabinet and tube shield with or without speaker. Marion Van Hal, 1328 Orchard, Pella, IA 50219. (515) 628-2347

**WANTED:** All radio and speaker parts for the Federal radio Model F-40 (Radio Manufacturers of the 20's, Vol. 1, p. 217). Teri Futrell, 241 South 12th St., San Jose, CA 95112. (408) 288-5963

**FOR SALE:** Crosley Coloradio 11-117U, green, excellent condition. Crosley Coloradio 11-119U, tan, no knobs. GE 10-inch TV, 1948, mint. Airline 13-tube "movie-dial" console - \$185. Emerson Model #38 (Bunis, p. 58) Emerson Model 107 (Bunis, p. 58). (2) Dahlberg pillow radios, white & green, mint. Please write or call: Roger Buttignol, 214 State St., #7, Portsmouth, NH 03801. (603) 427-1384

**WANTED:** Carbon arc street lamps. Also radar equipment and early TV cameras. Allan H. Weiner, 14 Prospect Dr., Yonkers, NY 10705. (914) 423-6638

**FOR SALE:** Reproduction warranty tags and model number tags for Atwater Kent breadboards and cabinet sets up to Number 24 - \$2.50 per tag plus SASE. Please state the model number you want on the model number tag. Satisfaction guaranteed. **WANTED:** RF coils and TA unit for Atwater Kent breadboard, cover or entire cabinet for Radiola II, Zenith 3 R radio or chassis. Richard Bury, PO Box 25, Gurnee, IL 60031. (708) 623-7746

**WANTED:** Detrola, 1937 wood clock/radio, Model 302, any condition. Tom Ducro, 6805 Palmetto St., Cincinnati, OH 45227. (513) 271-0156

**FOR SALE:** Uniden DX-1000 N.I.B. condition - \$295. Drake R4-B, clean with manual - \$175. Blaupunkt floor model AM, FM, SW, phono - \$40. U.S.N. RAK-7 rcvr - \$35. Zenith Trans-Oceanic - \$35. Harman Kardon FM tuner - \$30. Firestone Airchief - \$40. Airline Model 62-315 AM-SW table radio - \$45. John F. Dubino, KA1SBN, 73 Devens St., Greenfield, MA 01301. (413) 774-5826

**FOR SALE:** Fada 652 Catalin, damaged - \$300. Stewart-Warner horn, no driver - \$10. Several transistors, cheap. **WANTED:** Red bezel for a Fada 1000 Bullet. Bob Furtado, 23 Garden Rd., Alameda, CA 94501. (510) 521-3084

**WANTED:** Tubes wanted: Duds okay. Raytheon Kino lamp. Sodian 21 and others. CECO P-1. Amrad S. DeForest Singer Audion. Marconi V24 valve. Musselman Type 3VA. English R valves. Aeriotron Type WR21. Magnavox Type A. WE 282A. British CV-125. Marconi DER and DE6. Sam W. Wrenn, 2314 Seminole Dr. 1207, Arlington, TX 76010

**FOR SALE:** Novelty radios: Polaroid transistor, mint, have several left, looks like a "600" film pack; Snoopy type small dog radio; Lion radio, sim. to dog - \$15 ea. + \$4 S&H. Sonny Clutter, 14407 NE Fremont St., Portland, OR 97230. (503) 254-9296

**WANTED:** IF transformers T4, T5, coil L4 for Hammarlund H,Q 180A. Theo. Stegeman, 4621 W. Mitchell Ave., Cincinnati, OH 45232

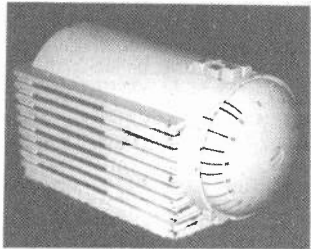

**FOR SALE:** Silvertone vacuum cleaner radio - Best Offer. Scott Hagerman, 392 Ann St., Cary, IL 60013. (708) 639-7745

**FOR SALE:** Beautiful Philco 90, original v. good finish, works perfectly, only - \$420. Zenith 6B129 Walton tombstone, big black dial, 5 original wood knobs, perfect grille cloth, original finish - \$190. Send SASE for list of other stuff. **WANTED:** Rola horn only, Frøed-Eisemann #385 2 1/2" knob. Thanks. Bob Barnes, PO Box 275, 511 N. Chestnut, Monroe City, MO 63456-1217. (314) 735-2945

**FOR SALE/TRADE:** Portable Wheatstone bridge, military model, doubles as resistance substitution box. **WANTED:** Jackson 636 tube tester information for 4-pin tubes. Ross Wollrab, 1201 N. Underhill C2, Peoria, IL 61606. (309) 674-3309

**RATE FOR ADDITIONAL WORDS:**

**15¢ per word**

**FIRST 20 WORDS FREE!**

*Cash or stamps OK for small amounts.*

*Your payment helps to keep A.F.C. healthy!*

**WANTED:** TV studio camera, early TV studio camera, early TV camera. Lambert Eulenfeld, 2376 Kirkwall St., Orange Park, FL 32065. (904) 272-9681, aft. 6:30 pm, w/kends anytime

**WANTED:** Free: AK breadboard or \$500 + cash as finders fee for 25-tube Stratosphere. Also wanted: Zenith/Zenette cathedrals, Zenith window dial tombstones, Zenith chrome grille tombstones 9S30 & 109S130 tombstones, Zenith Aviatrix console, Zenith 7S261 bookshelf. Jim Peters, 983 Chapel Ct. S, Glen Ellyn, IL 60137. (708) 790-9699

**FOR SALE:** Vacuum formed dial lenses. Many models now in stock for immediate shipment. Arvin, Belmont, Emerson, Fada, Garod, Motorola, Zenith, top quality, satisfaction guaranteed. Mike Duea, 13173 Glenhurst Ave., Savage, MN 55378. (612) 894-7256

**WANTED:** 25 ft. Stanley tape measure. Will trade 2 Polaroid 600 film AM/FM units. J. Thurman, 3602 California, St. Louis, MO 63118. (314) 773-6744

**FOR SALE:** Stromberg-Carlson, very impressive console 1121 with doors, round grille, phono, ex. original condition, but does not work - \$150 or Best Offer. Philip Brunais, 14185 Pleasanton Hwy., Bear Lake, MI 49614. (616) 864-3143

**WANTED:** Knob 1" round, pinwheel front for Hamilton-Loyd cathedral. Knobs for 37-636 Crosley tombstone, 1 1/4" round, 8-petaled daisy front. Peter Jaber, Box 134 UVAH, Charlottesville, VA 22908

**FOR SALE:** Johnson S.S.B. adapter - \$125. Swan VX-1 vox unit - \$35. Ben Deovlet, W6FDU, 933 Robin Ln., Campbell, CA 95008. (408) 374-0372

**WANTED:** Emerson 888 pocket transistors, any model, color, or condition. **FOR TRADE:** Zenith Royal 500H. Mike Duea, 13173 Glenhurst Ave., Savage, MN 55378. (612) 894-7256

**FOR SALE:** The Home Radio - \$1200. Most Often Needed 40 to 58 - \$7. GE Transistor Manual - \$4. Belmont 636, no cardboard back - \$75. **FOR TRADE:** Small brown Addison with original butter-scotch Catalin knobs (Collins, p. 51). Robert Nicholson, 4 Superior Ave. #47, Toronto, Ontario, Canada M8V 2M4. (416) 252-4838

**WANTED:** Radiola III junker, or following parts: Audio transformer (open okay), tube sockets' assembly, grid leak. Peter J. Bertini, 20 Patsun Rd., Somers, CT 06071. (203) 749-7186

**FOR SALE:** 1000 tubes, new or tested at - 50¢ each in lots of 10 or more plus CB's. SASE for list. Phil Whitney, Rt. 2, Box 231, Stephens City, VA 22655

**FOR SALE:** No early battery sets, no cathedrals, no Catalins. I do have Zenith Trans-Oceanics, Hallicrafters and National NC-125. Also used and unused tubes - 25¢ and up. American-made capacitors for AC and AC/DC radios. Seven-page list available. Sue Coulter, 4200 Prince St., Bakersfield, CA 93301

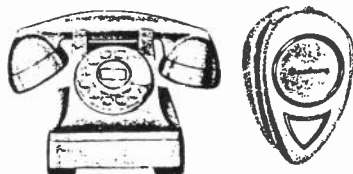

**WANTED:** Colored Western Electric telephones, as above, in ivory, red, pink, green, blue & clear. Also: Seeburg teardrop speakers, as above, in any condition. Mark Rathbun, 1817 Arbutus Ave., Chico, Ca 95926. (916) 342-2655

**FOR SALE/TRADE:** Drake R4C w/SW xtals, AM filter, spkr, manual. Levy, 8 Waterloo, Morris Plains, NJ 07950. (201) 285-0233

**FOR SALE:** Book of circuit diagrams and part numbers for RCA 1950-51 TVs - \$15 ppd. R. J. Eastwick, N2AWC, 224 Chestnut St., Haddonfield, NJ 08033. (609) 429-2477

**WANTED:** Older speakers by Altec, Electro Voice, JBL, Jensen, Stevens, Tannoy, or Western Electric. Tube hi-fi gear, any condition. Literature from '50's & '60's: Allied or Lafayette catalogs, High Fidelity or Audio Engineering magazines. Rick Graves, 4500 Ninth Ave., #300, Seattle, WA 98105-4762. (206) 632-9929, leave message; Fax (206) 633-6049

**FOR SALE:** Tube tester 1-177-B - \$30. Fresnel lens 16" x 20" - \$25. Both plus shipping. Joe Lisaius, 116 Orton Rd., West Caldwell, NJ 07006. (201) 226-7943

**FOR SALE:** Majestic 511 Bakelite with Catalin grille and knobs, circa 1938. 1949 Truetone, futuristic shape resembles Philco 49-501. Philco 42-22CL, circa 1942 clock radio. Zenith 7000 Trans-Oceanic, mint. Polaroid Film Box novelty transistor, N.I.B. - \$20 ppd. Charles Harper, 2081 Harmony Ct., Lexington, KY 40502. (606) 268-8549



**WANTED:** Seriously seeking, any Carron Mfg. Co. crystal radio, cash and/or trade. Thanks! Richard R. Spratley, 2112 McLain St., Chesapeake, VA 23324. (804) 545-2402

**FOR SALE:** Arvin 250P Heater, exc cond - \$50. 5UP4, 5ADP7 scope tubes, new - \$15 ea. Copies of Hickock 533A obsolete tube chart - \$12 ea. Precision E-200-C RF gen. - \$24. 1 1/2 Philco 46-1201 radio-phonos, fair - \$55. Shipping paid. Mark Parthe, 213 S. Charles, Saginaw, MI 48602

**FOR TRADE:** Radio brands: Philco, Zenith, RCA, Crosley. **WANTED:** Antique fountain pens by Parker, Sheaffer, Wasterman, Mont Blanc, Conlin. Franklin Weissman, 4 Shadbush Ln., Westport, CT 06880. (203) 454-1265, after 8:30 pm EST

**WANTED:** Stromberg-Carlson 225H. National HRO-5 with coils. Johnson Viking Vantiant transmitter. Spencer Cromwell, 7607 Stevenson Way, San Diego, CA 92120. (619) 562-8280

**FOR SALE:** National SW-5 - \$180. Collins 62S1 VHF converter - \$700. BC221F frequency meter - \$20. KWM-1 manual - \$20. ARRL Handbooks, 1949, 1950, 1952, 1954 - \$15 ea. First 50 Years of Collins, new - \$23. Radiola 60 manual reprints - \$5 ppd. **WANTED:** ARRL Handbooks, 11th and 12th editions. Mark Hovda, NØJWI, PO Box 10091, Cedar Rapids, IA 52410. (319) 364-4048, 7-9 pm CST

**FOR SALE:** Atwater Kent breadboard 4700. Atwater Kent breadboard 4550. Atwater Kent 20C. Atwater Kent 30. Crosley 50P. Crosley 51. Crosley 52. Crosley Trirdyn 3R3. Claraico 3 in 1. Echo-Phone. Ferguson TRF3. Federal 59. Federal 141. Freed-Eisemann NR5. Kennedy 440, parts. Lambert crystal set. Magnavox AR2 amp. Radiola III. Radiola IIIA. Radiola III and balanced amp. Aeriola Sr. Aeriola Sr. and two-stage amp. Arbo-Phone. Wopler RF5. Sonora. Call or write for prices. Waves, 32 E. 13th St., New York, NY 10003. (212) 989-9284. Fax: (201) 861-9659

## Attention Radio Collectors

**A Free Access BBS  
2 Lines In - Live Chat  
(508) 635-9921, 635-0249  
300/1200/2400 Baud, 8/N/1  
23 hrs, 7 days**

- Q/A Forum, Tips, Techniques
- Classified Ads, Articles
- Powerful Keyword Search
- Real time access/update
- User-driven special forums available

**Are you computer shy?  
Have no computer?  
Send SASE Now!**

**C.E.C.  
Suite 317, 56-A Main St.  
Maynard, MA 01754**

**WANTED:** Output transformer for Crosley Dynacone Type F. Paul Barlows, 4741 Seibert Ave., St. Louis, MO 63123. (314) 352-6916, Fax (314) 241-6948

— WANTED —

**PICTURES FOR PHOTO REVIEW  
PHOTOS MUST BE SHARP IN DETAIL  
A SHORT DESCRIPTION IS A MUST!  
SEE PHOTO REVIEW PAGES FOR  
ADDITIONAL INFORMATION**

**FOR SALE:** McMurdo-Silver Model 5C, fair condition — \$50. Philco Model 20 cathedral, rough, parts — \$35. Philco Model 84B, rough, restorable — \$40. Radiola 18, parts set — \$30. RCA 100A speaker, fair — \$20. Radio City Products, Model 802N tube tester, wood case as-is — \$25. Gary Pirkkala, 2306 Audley Ave., New Castle, PA 16105. (412) 658-0534

**FOR SALE:** Zenith Trans-Oceanic Model H500 with power converter and original manuals, excellent condition — \$125. **WANTED:** Help! I am looking for an old broadcast ribbon microphone, RCA 44, 77, EV, etc. Please! Just would like one to set next to my old Philco. David Ball, 5794 Calico Ct., Lithonia, GA 30058. (404) 981-3766

**FOR SALE/TRADE:** Over 100 novelties: Knight Rider Trans AM — \$35. Pound Puppy — \$25. Raggedy Anne and Andy — \$35. Sesame Street Center Stage — \$25. Blabber Mouth — \$45. Blabber Puppy — \$35. FM Coke Bottle — \$40. McDonalds Fries — \$40. Columbia Space Shuttle — \$40. Most are N.I.B. **FOR TRADE:** Pepsi Fountain Dispenser, Duesenberg, Snoopy on Doghouse, Club Screwdriver. Larry Anderson, 1015 Main St., Wheeling, WV 26003. (304) 232-1170, (304) 243-1170, evening

*This Holiday Season...*

*Give A Gift Subscription to  
Antique Radio Classified*

*BONUS: December 1991 Free!*  
*All gift subscriptions received before  
December 31 will be sent the December  
1991 issue free!\**

*To Order:*

1. Fill out the card in this issue with the recipient's name and address.
2. Enclose a gift card which we will send along with the bonus issue. (We will enclose our card with your name if you wish.)
3. Include payment or charge to VISA or MasterCard, and send to:  
A.R.C., PO Box 2, Carlisle, MA 01741

*Or Call (508) 371-0512.*

*P.S. There are more gift ideas from  
A.R.C. on pages 46 & 47.*

*\* If already a subscriber, a 13-month extension  
will be made to the recipient's subscription.*

**WANTED:** Western Electric loop antenna, crystal detectors, crystal sets, early regenerative receivers, horns using headphones for driver. Jerry Finamore, 87 Stonewood Pl., Catasaugua, PA 18032. (215) 264-8412

**FOR SALE:** Thinning my collection. Many radios, mainly first generation Majestic, tubes & paper. High quality reprints: 1942 Zenith dealers sales brochure & sales promotion booklet, 59 pp., only — \$7.50. 1928 Atwater Kent Service Manual & supplements covering everything thru 1932, 182 pp. — \$10. I pay postage on both. Send SASE for 5-page list. Chip Taylor, PO Box 20132, Bradenton, FL 34203. (813) 745-2821, 7-10 pm EST

**FOR SALE:** National NC-200 communications receiver — \$50 + UPS. **MESSAGE:** Will Laten Fetters please contact me? I lost your address. Mike Duckworth, W9OCT, 2415 Broadnax Cir., Chesapeake, VA 23323. (804) 424-7920

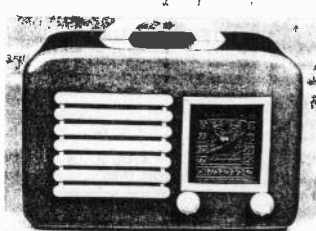

**WANTED:** General Television Radio (pictured) in wood or plastic, any condition, junker set OK. Also wanted: Parts for Continental or Lester piano radio: Music stand, top curved lid, brass pedals, trim around dial. **FOR SALE:** Emerson 520 Catalin brown, no cracks — \$225. Fada 652 Temple yellow with red trim and knobs, open mouth with original grille cloth, mint — \$1,050. Lee Alder, PO Box 6735, San Rafael, CA 94903. (415) 499-9228

**FOR SALE:** Seeburg jukebox amplifier, transistorized stereo Model TSA1 — \$75. Heathkit transistor tester IT-121 — \$60. 12-Volt automobile 8-track tape deck — \$40. A real antique circuit breaker, switchboard type by Roller-Smith, 1 amp, 115 volt — \$35. Delta capacitive ignition system for older cars with breaker points, easier starting and better gas mileage, puts up to 45,000 volts on plugs, used on my 1973 Pontiac — \$40. Are you plagued by low voltage? I have one booster stepup transformer 105 volts to 115 volts, 12 amps, 10 pounds — \$35, plus shipping; it has linecord and plug-in socket. Selling out my junk box: loads of stuff! stuff! stuff! all kinds of goodies, capacitors, resistors, transistors, heatsinks, hardware, wire and more — \$25 for 15 pounds, plus shipping. Build your own stereo amplifier, set of power transformer and two output transformers; each can handle (2) 6BQ5 tubes; used, weight 15 lbs. — \$45. One amplifier chassis and beautiful modern cabinet, most components installed and wired, weight 10 lbs. Transformers and relays all different voltages, out of pinball machines, etc. Welders leather apron, new, never used and gloves — \$25. Write for details. Jack Naimann, 365 Bronx River Rd., Yonkers, NY 10704



**FOR SALE:** Novelty transistors: N.I.B. Polaroid 600 film AM/FM - \$20. M. H. Smith, 1102 Webber St., LaPorte, IN 46350. (219) 324-0393

**WANTED:** Victrola record player outside horn or table top with lid. Harry MacMullan, 2662 Bancroft Dr., Aston, PA 19014

**FOR SALE:** Zenith Trans-Oceanic Royal 1000, works - \$30. As is, plus shipping. R. Chenez, RFD 2, Box 437-J, Plymouth, NH 03264

**MESSAGE:** Survey: Interested in restoring Marconi's Highlands, N.J. ship-to-shore station? Send ideas to: H. Seesselberg, WB2IMR, 22 Christy Dr., Warren, NJ 07059

**WANTED:** Pay your price (I mean it!) for following transistors: Toshiba's 6TP-31A, 7TP-303, 5TR-193, 6TP-309Y, 6TP-304, Realtone's TR-555, TR-801; TR-1088, Candle 6-trans, Traveler 287B, 284, Continental 160, and Sony TR-55. David Mednick, 1450 Palisade Ave., #5-H, Fort Lee, NJ 07024. (201) 461-3082, until 10 pm EST

**WANTED:** Dynaco tube amps pre-amps and tuners, working preferred, but will consider all. Send list and prices. B. Brown, RR 1, Box 50, Valley Springs, SD 57068

**FOR SALE:** Military receiver manuals: Zenith Trans-Oceanic multiband (op./maint.) + all schematics, copy - \$9. R-390A, BC-348, (maint.) copy - \$19 ea. Emerson record recorder #529, rare, new old stock, w/manuals - \$80 ea./Best Offer. D. Testa, PO Box 9064, Newark, NJ 07104

**FOR SALE:** Victor Electrola 7-26 with electrodynamic speaker (only 1446 made), immaculate restored condition - \$850. Delivery possible. Richard Collins, 8722 Reamer St., Houston, TX 77074. (713) 778-0271

## PBS Miniseries

Now available on home video:

*RADIO COLLECTOR*, the five-part PBS series on the history, collection, and restoration of antique radios. Meet dozens of antique radio collectors. See hundreds of radios. Watch '30s radio actors perform. Visit antique radio club swap meets. Learn how to restore antique radios.

Written, produced and directed by collector Mike Adams, *RADIO COLLECTOR* was nominated for an EMMY for best informational series.

Total time: 128 minutes.

VHS Only.

**FOR SALE:** Majestic radio neon sign. This is a reproduction of the one used by dealers during the latter 20's and the early 30's. Dimension is 24" x 34" and was made from the original Majestic blueprint dated 3-23-29, glass and transformer mounted on solid 1/2" thick back board. Price is \$650. I pay shipping. Harry M. Hatcher, 1103 Whispering Pines, Friendswood, TX 77546. (713) 482-7642

**WANTED:** Knight-kits: DXer, DXer II, prewar Ocean Hopper, R-100, Span Master II Star Roamer II, R-195, T350A plus any assembly manuals. Also want Allied catalogs for 1932-1935, 1938, 1944 & 1945. Jack McCreary, 7783 Wildcreek Trl., Huntsville, AL 35802. (205) 882-0037

**FOR SALE:** Philco 46-1201 - \$35. Zenith T-600 - \$35. Playtape 2-track player w/tapes - \$35. 1948 Columbia record catalog - \$5. 1960 Decca - \$4. 1958 Mercury records - \$4. M. H. Smith, 1102 Webber St., LaPorte, IN 46350. (219) 324-0393

**FOR SALE:** Electronic World, 116 issues, 1961 to 1971 - \$1 ea. Send SASE for list. Chuck Vaccaro, 708 Booth Ln., Ambler, PA 19002. (215) 646-3641

**SERVICES:** Radiola III series, stacked capacitors expertly restored to look like old, work like new - \$6 ea., \$25/all, ppd. Joseph Mente, 916 Olive Rd., Homewood, IL 60430. (708) 957-9455

**WANTED:** Junk Jackson Bell #62. Junk ship parts for Majestic Melody Cruiser #921. James A. Di Ruzza, 2607 Old Troy Pike, Dayton, OH 45404. (513) 233-5004, eves.

**FOR SALE:** Table radios + S-38. Want Silvertone R1171. Thanks. Jerry Schaefer, 932 No. 4th St., Grand Forks, ND 58203. (701) 772-2991

## RADIO COLLECTOR

The Electronics Museum's New Building Fund benefits from videotape sales. Thanks for your support.



## MIRACLES IN TRUST

To buy this historic video, send check or money order for **\$29.95**, plus **\$3.00** S&H (\$10 overseas airmail), to:

**ARC Video Offer**  
The Perham Foundation  
101 first Street, Suite 394  
Los Altos, California 94022

**WANTED:** Novelty radios, old or new, one or a collection. Also trade. Cliff Watts, 51 Glendale Rd., Brantford, Ontario, Canada N3T 1P5. (519) 753-9049



**FOR SALE:** Capehart Radio-Phono Console with flip-over changer Model 406E Serial 8011E, 21 tube - \$850. Pick up only. Robert Knack, 428 Linden St., Bellefontaine, OH 43311. (513) 593-0649

**WANTED:** Info: Heard that a fellow in Arizona makes push buttons for Philco radios— Anybody knows? Earle Drake, Box 1808, Hyannis, MA 02601

**FOR SALE:** HOR12 output transformers, Grundig transformers, Philmore S meters. Radios, parts. SASE for list. Art Collatz, 2127 Market St., Blue Island, IL 60406

**FOR SALE/TRADE:** Scottie, Detrola, DeForest neck & bell (LS-300), National Radio News, 1932-39 bound. Floyd A. Paul, 1545 Raymond Ave., Glendale, CA 91201. (818) 242-8961

**WANTED:** Fada 845 red knob. Set of large red temple knobs. Will pay what I have to or trade Catalin parts. Ray Carroll, 158 Oakwood Dr., Wayne, NJ 07470. (201) 696-1149

**FOR SALE:** Communication gear: National speaker, National 188, (3) National knobs with metal SKRit(?), Hallicrafters S-38A, S-38D, SX-140, SX-25, S-27, Heathkit DX-40, VFO, HR-10B. Manuals: S-38C, HQ-140X, RAS-5, Super Pro, Heathkit Q meter, SP-600 power transformer. Bill Coolahan, 1450 Miami Dr., NE, Cedar Rapids, IA 52402. (319) 393-8075

**WANTED:** Dial glass, reproduction acceptable, and back for Stewart-Warner 62T36 Catalin. Bob Lutz, 9041 Gillette St., Lenexa, KS 66215. (913) 894-1327

**FOR SALE:** RCA Transmitting Tubes Manual 1962, RCA Receiving Tube Manual 1961 - \$6 each plus shipping. Carl Smith, 3203 Route 60, Vermilion, OH 44089

**FOR SALE:** Xmas Specials. Zenith 9-tube Shutter Dial Walton radio Model #95232 chassis, 8" spkr or 12" included, not originals, looks and works fine, price - \$145. 8-Tube Zenith portable #8G005-Y, cabinet fair, set good, special - \$50. Zenith #7000 SS portable, U.S. made, 11 bands inc: FM, weather, tunable SS, batteries inc + AC; looks good, works fine, special - \$295 or BO. Wm. S. Key, W1DWD, 58 Sycamore Dr., Halifax, MA 02338. (617) 294-1831

**WANTED:** Grebe Synchrophase MU1 MU2, including parts, chassis, cabinets, literature, anything Synchrophase. Fred Schultz, 1246 Lincolnway S., Ligonier, IN 46767. (219) 894-3092

**FOR SALE:** Zenith Royal 675, good condition, working - \$25. Zenith Royal 1000, works, fair condition - \$45. Audition novelty transistor wall phone radio, works - \$25. Blue vinyl lunch box radio, works, with papers, original box - \$25. Brass Rolls Royce transistor, works, missing battery door and hood ornament - \$25. (45) Volt B batteries, tapped at 22 1/2 volts, recent stock, all tested - \$6 ea. Add UPS, call for details. Rick Weibezahl, 305 Belvidere Ave., Washington, NJ 07882. (908) 689-3276

**FOR SALE:** Collins radio equipment and parts: 51J-4, R-392-URR, knobs for 51J's, 75A's, KWM's, etc. Color coded wire, wire racks, 4" military speaker, rack mount 50 volt, 15 amp power supply, rack mount 51Q-1 speaker, laboratory power supply, metal logo's, 50th year anniversary book, tube shields with Collins logo. Collins manuals: KWM-1, KWM-2, 51J-4, 75A-2, 75A-4, 51V-3, AN-GRC-19, R-392-URR. (6) Collins panel meters. Instructions to make mechanical filters for 51J-4. Bill Coolahan, 1450 Miami Dr., NE, Cedar Rapids, IA 52402. (319) 393-8075

**WANTED:** 5 Megohm volume control with on/off switch with 2 3/4- to 3-inch shaft. Also need Sparton 5" speaker Part No. C-2280-25 or 5" round speaker with 1500 ohm field coil, complete with output transformer. Karl Jostmeyer, 613 N. 6th St., Kansas City, KS 66101. (913) 342-6565

**FAX NUMBER FOR  
ANTIQUÉ RADIO CLASSIFIED  
(508) 371-7129 - 24 hours a day  
Ads - Subscriptions - Book Orders  
Charge to VISA/MasterCard  
Minimum Charge: \$10.00**

**FOR SALE:** Atwater Kent 10C - \$850. RCA AVR-1 tombstone - Inquire. Radio Queen 1922 cigar label, framed - \$75. Joni TV lamp/planter, ceramic, 50's, N.I.B. - \$45. GE 1930-35 service manual - \$30. WD-11 Bakelite, Gm = 350 - \$37. WWI Barclay Wireless Soldier, repainted w/repro loop - \$30. Alls Fair Radio Game, colorful/rare - \$175. (2) gold Airline 201A's - \$25 ea. Santa postcard, shows battery radio - \$7. Ideal Co. 1950's plastic desk telephone-shaped 1-tube radio, N.I.B. - \$50. Philco rollout-type portable - \$30. Baldwin phones w/new cord - \$17. Jackson 652 audio signal generator - \$37. Jackson TVG-1 TV/FM sweep generator - \$45. Jackson 641 Universal signal generator - \$45. Precision E-400 TV/FM sweep generator - \$30. Heathkit DX-60B final amp - \$45. BC-224 military radio, heavy - \$50. Universal audio interstage transformers, similar to Stancor A-53 - \$20/for 4. 40-Page catalog of parts, tubes, magazines & literature - \$2 ppd. Play Things Of Past, 9511-23 Sunrise Blvd., Cleveland, OH 44133. (216) 582-3094, 9:45 pm to 10:45 pm only

**FOR TRADE:** Original promo literature and price lists from Midwest and McMurdo-Silver for novelty radios. Cliff Watts, 51 Glendale Rd., Brantford, Ontario, Canada N3T 1P5. (519) 753-9049

**WANTED:** Drum type celluloid dial scale for a Philco radio Model 89-123, Part #31-1590. Thanks. William Seiler, R 1, Box 272A, Pekin, IN 47165. (812) 883-1453

**FOR SALE:** Rider's Vol. 1 through 20 - \$15 each and UP. 1930's Radio News magazines - \$3 ea. Radio Retailing - \$7 ea. Audio Engineering - \$4 ea. Hi-Fi Magazines - \$4 ea. Old American Telephone & Telegraph Stock Certificates - \$5 ea. RCA Redbook - \$35. Radar Fundamentals, 1944 - \$7. Large microphone radio - \$35. Buddy Boy cabinet - \$200. RCA 9TX-31 Little Nipper radio - \$75. Bill Rolf, 30131 Center Ridge, Westlake, OH 44145. (216) 871-4547

**WANTED:** To talk with collectors or old radio repair person in Atlanta area. Thanks. Warren Clarke, 4309 E. Conley Rd., Conley, GA 30027. (404) 361-0500

**FREE - 20 WORD AD EACH MONTH**

To get your free 20 words,  
include your SUB# with your Ad.  
Additional words are 15¢ each.  
Read inside back cover for details.  
**MANY THANKS!!!!**

**FOR SALE:** (3) Lamp radios. Stewart-Warner Baradio, (2) extra bottles for same. Zenith Royal 2000. Grundig Satellite 1000. Motorola xstrs X-11, X-19 and X-31. Lafayette HA350 comm. rec. Bell 2256, Bogen H30, Eico HFT92 & AF4, H.H. Scott 320 and 99d, all tube types. Zenith 6S229 buried cab., very clean, working. Philco Jr. cathedral, looks good, works good. Trade any or all of the above for old or unusual keys and bugs. Carl L. Elkins, 1701 Woodland St., Nashville, TN 37206. (615) 227-7972

**WANTED:** Argonaut QRP transceiver. **FOR SALE:** RCA ribbon microphone, excellent. John White, 1920 S. First St., 1404, Minneapolis, MN 55454. (612) 333-5719

**FOR SALE:** Philco 17 cathedral, rare 17-tube model with only 2350 produced, good shape - \$395. Philco 51 cathedral - \$65. Philco 42-345T in original box - \$65. Philco 18 console with phono. Emerson BT214 Deco table set - \$50. Zenith 6-S-27 tombstone, plays - \$295. Early 50's Magnavox TV, excellent with original manuals - \$95. Phonographs: Edison Gem - \$325. Columbia Model B open works cylinder phonograph, excellent original Edison B-200 Diamond Disc Machine - \$250. Oak cylinder cabinet - \$375. Victor Orthophonic 4-7, 4-40, and VE-120 cylinder records 30) 2-minute for - \$100; (18) 4-minute for - \$65. Wurlitzer 61 counter top juke box consoles: Zenith 775 and 53, Sparton 610 with Repwood grille, Scott 800B in Regent console, AK 20C in Pooley 1600B console. Excellent. 4000+ used radio tubes - \$500 for the lot. **WANTED:** Zenith 10-S-130 and AK 447 tombstones, McMurdo-Silver V or VI, AK 10- to 12-tube console. John Hayes, 27 Highland Dr., Heniker, NH 03242. (603) 428-3053

**WANTED:** Bang & Olufsen and Tandberg radios and hi-fi speakers. Also seeking Braun T-1000 portable radio. Daryl Jorud, R#1, Box 180, Battle Lake, MN 56515. (218) 864-5725

**FOR SALE:** Original old time radio shows on cassettes! Jack Benny, Sherlock Holmes, Hopalong Cassidy, and many more! Hundreds available! Send SASE for mail order list. Great for gifts! Blast From the Past! PO Box 9337, Santa Rosa, CA 95405

**FOR SALE:** 1926 A-C Dayton Model XL-25, no tubes - \$75. Claratone, 20's?, made by Equitable Radio Corp., needs work - \$50. 1926 Crosley Model 5-38, basket case - \$25. 1942 Emerson Model FH467, nice wood case SW/BC, not working - \$30. Magnavox speaker Model M-20, front grille gone - \$20. Speaker? Model 612, works - \$20. Military Collins radio Model R-388/URR. George M. Jones, Rt. 4, Box 31, Fernandina Beach, FL 32034

**MESSAGE:** Special thanks to Larry Babcock from the Antique Radio Club of Illinois for his unsolicited but very complimentary report on Radiofest '91 in the October issue of The Old Timer's Bulletin: Radiofest '92 will be held Aug. 6th, 7th & 8th at the Holiday Inn, Elgin, Illinois. Watch this publication for further details. Bill Ross, 875 Gordon Ter., Winnetka, IL 60093. (708) 441-6462

**FOR SALE:** Thanks to all that purchased over 2600 filter capacitors from me at Rochester this year. 220 mfd x 385 volts. Small size 1" x 2" - 50¢ ea., 21 pc. for \$10, box of 50 pc. - \$22. Power resistors 1.8K 5 watt 6-pc. - \$1. 270 ohms 5 watt 6-pc. - \$1. 75 ohms 10 watts 4-pc. - \$1. 20 AWG cloth covered wire 100H - \$5. 200 ft. - \$9.50. All items plus shipping. Gerald Cromer, 1014 Summerland Dr., Cayce, SC 29033. (803) 794-1483

**FOR SALE:** Buying and selling Bakelite radios under \$35. Send your list or send for mine. Radios, 1600-M Glenwood Ave., Raleigh, NC 27608

## BUYING!

### ★ 1920-1924 Battery Sets ★

Amrad, Clapp-Eastham, Cutting & Washington, De Forest, Federal, Grebe, Kennedy, Marconi, Paragon, Radiola and Tuska, AK Breadboards and AK Cathedrals.

Serious collector. Will consider others and entire collections. Can travel.

**Ed Bell - 5311 Woodsdale Rd.  
Raleigh, NC 27606  
PH: 919-851-1517**



### **NEW YORK - Dec. 1**

**GREATER N.Y. VINTAGE WIRELESS ASSOC.  
SWAP MEET - 9 am**  
Info: Steve Coughlin (516) 324-3012 or  
Chris Bacon (516) 981-6538

### **ARKANSAS - Dec. 5**

**ANTIQUe RADIO COLLECTORS CLUB  
OF FT. SMITH - CLUB MEETING - 7:30 pm**  
Ft. Smith, AR - Creekmore Park  
Magnolia Room, Greenwood and Rogers  
Info: Wanda Conatser - (501) 646-7147

### **CONNECTICUT - Dec. 7**

**CONN. AREA ANTIQUe RADIO COLLECTORS  
SWAP MEET**  
Willimantic, CT - E.S. Eldredge  
Warehouse Gallery, 90 South Park St.  
8 am - noon  
Table space limited - Bring your own  
Info: Walt Buffinton - (203) 228-9888

### **FLORIDA - Dec. 7**

**ANTIQUe WIRELESS ASSOCIATION  
4th ANNUAL FLA. AWA FALL MEET**  
Bradenton, FL - Stewart Elementary School  
7905 15th Ave. West  
8 am - 2 pm  
Info: Norman Smith, 7203 17th Ave. NW  
Bradenton, FL 34209 - (813) 792-0003

### **WEST VIRGINIA - Dec. 7**

**ANTIQUe RADIO CLUB OF AMERICA  
WEST VIRGINIA CHAPTER  
MEET**  
Huntington, WV - Museum of Radio and  
Technology, Inc., I-64, Exit 6 - Follow Signs  
8 am - 7 pm - Traders Market  
1-2:30 pm - Auction  
Old Equipment Contest - Museum Tours  
On Site Camping - All Day Seminars  
Christmas Program - Radio Reruns WWII  
Large Indoor Traders Market  
Rain or Shine  
Info: Geoff Bourne, 405 8th Ave.  
St. Albans, WV 25177 - (304) 722-4690

**Mention A.R.C. when contacting clubs!**

### **ARIZONA - Dec. 7**

**ARIZONA ANTIQUe RADIO CLUB  
WINTER SWAP MEET**  
Tempe, AZ - Antique Electronic Supply  
6221 S. Maple Ave., back parking lot  
8-11 am  
Info: George A. and George H. Fathauer  
(602) 820-5411

### **WASHINGTON - Dec. 9**

**PUGET SOUND ANTIQUe RADIO ASSN.  
SWAP MEET/MEETING**  
North Seattle, WA - Ronald School  
North 175th St., 1 mile W. of I-5, exit 176  
11 am - Swap Meet; 1 pm - Meeting  
Info: Al Atworth, PO Box 125  
Snohomish, WA 98290-0125 - (206) 568-2698

### **CALIFORNIA - Dec. 10**

**CALIF. HISTORICAL RADIO SOCIETY  
NORTH VALLEY CHAPTER - MEET**  
Redding, CA - 7 pm  
Info: Norm Braithwaite - (916) 246-4209

### **CALIFORNIA - Dec. 11**

**SACRAMENTO HIST. RADIO SOCIETY  
MEETING**  
N. Highlands, CA - SMUD Foothill - 7 - 9 pm  
Service Center, Room D, 5026 Don Julio  
Info: Secretary SHRS, PO Box 162612,  
Sacramento, CA 95816

### **ARKANSAS - Dec. 12**

**ARKANSAS ANTIQUe RADIO CLUB  
CLUB MEETING**  
Little Rock, AR - The Auditorium  
S.W. Bell Bldg., 120 W. 8th St. - 7 pm  
Info: Tom Burgess - (501) 565-1750

### **MARYLAND - Dec. 14**

**MID-ATLANTIC ANTIQUe RADIO CLUB  
MEETING**  
Burtonsville, MD - 15121 McKnew Rd.  
New Hope 7th Day Adventist Church  
6:30 pm  
Info: Joe Koester - (301) 725-4229

## TEXAS - Dec. 14

### HOUSTON VINTAGE RADIO ASSN. CHRISTMAS PARTY/ESTATE AUCTION

Houston, TX - Dos Paises Restaurant  
(the old Chang's Restaurant)  
1 pm - Estate Auction, grounds of Chang's  
5 pm - Christmas Party  
Info: Richard Collins, 8722 Reamer St.,  
Houston, TX 77074 - (713) 778-0271

## OREGON - Dec. 14

### NORTHWEST VINTAGE RADIO SOCIETY MEETING/CHRISTMAS DINNER

Portland, OR - Rasada Museum  
7675 SW Capitol Highway, at 32nd St.  
4 pm - Meeting; 6 pm - Christmas Dinner  
Info: Dick Dielschneider - (503) 246-1062  
John Otterstedt - (503) 244-6571

## ILLINOIS - Dec. 15

### ANTIQUÉ RADIO CLUB OF ILLINOIS WINTER MEETING

Elgin, IL - Holiday Inn, 190 and Rt. 31  
8 am - 1 pm  
Indoor Swap Meet - Junker Auction  
Info: Dave Johnson, 2336 S. Kenilworth Ave.  
Berwyn, IL 60402 - (708) 484-2743

## NEW YORK - Dec. 15

### ANTIQUÉ RADIO CLUB OF SCHENECTADY MEETING - 2 pm

Info: Jack Nelson, W2FW, 915 Sherman St.,  
Schenectady, NY 12303

## OHIO - Dec. 17

### ANTIQUÉ RADIO COLLECTORS OF OHIO MEETING

Kettering, OH - First Natl. Bank Basement  
Corner of Rt. 48 and Stroop Rd. - 7:30 pm  
Info: Karl Koogle, 2929 Hazelwood Ave.,  
Dayton, OH 45419 - (513) 294-8960, after 6 pm

## FLORIDA - Now thru 1993

### CYPRESS GARDENS EXHIBIT "WHEN RADIOS WERE RADIOS"

Cypress Gardens, FL - off U.S. 27  
(Near Winter Haven - In Park's  
Southern Crossroads Area)  
Daily: 9 am - 6 pm

A GRAND COLLECTION OF  
ANTIQUÉ RADIO MEMORABILIA  
The William Miller Radio Collection

Info: Robyn DeRllder - (813) 324-2111, x362

## MARK YOUR CALENDAR

Nov.-Dec. - CT, New Britain - Exhibit  
Nov. 4-'93 - FL, Cypress Gardens - Exhibit\*  
Dec. 1 - NY, ??? - GNYVVA Swap Meet\*  
Dec. 5 - AR, Ft. Smith - ARCCFS Meeting \$\*  
Dec. 7 - AZ, Tempe - AARC Swap Meet\*  
Dec. 7 - CT, Willimantic - CAARC Swap Meet\*  
Dec. 7 - FL, Bradenton - Florida AWA Meet\*  
Dec. 7 - PA, Forest Hills - PARS Meeting  
Dec. 7 - WV, Huntington - ARCA/WV Meet\*  
Dec. 9 - WA, Seattle - PSARA Meet \$\*  
Dec. 10 - CA, Redding - CHRIS-NVC Meet\*  
Dec. 11 - CA, N. Highlands - SHRS \$\*  
Dec. 12 - AR, Little Rock - AARC Meeting \$\*  
Dec. 14 - MD, Burtonsville - MAARC \$\*  
Dec. 14 - OR, Portland - NWVRS \$\*  
Dec. 14 - TX, Houston - HVRA Party \$\*  
Dec. 15 - IL, Elgin - ARCI Winter Meeting\*  
Dec. 15 - NY, Schenectady - ARCS Meeting \$\*  
Dec. 17 - OH, Kettering - ARCO Meeting \$\*  
Jan. 12 - CO, Lakewood - CRC Meet\*  
Jan. 16 - NY, Goshen - HARPS Meeting  
† Jan. 25 - NH, Nashua - NEARC Meet\*  
Feb. 2-Jul. 12 - MA, Lexington - NEARC Display  
Feb. 4 - TX, Houston - HVRA Meeting \$  
Feb. 15 - CA, Torrance - SCARS Meeting  
Feb. 22 - IN, Indianapolis - IHRS Meet  
Apr. 18 - NH, Nashua - NEARC Meet  
Apr. 25-26 - TX, Houston - HVRA/AWA '92  
Apr. 30-May 1-2 - IN, Kokomo - IHRS Meet  
May 16 - CA, Torrance - SCARS Meeting  
May 29-30 - MN, Bloomington - NARC Radio Daze  
Aug. 6-8 - IL, Elgin - ARCI - Radiofest '92  
Sep. 23-26 - NY, Rochester - AWA

\* See expanded listing this month. \$ Monthly Meeting.

† = Changed Date

## COLORADO - Jan. 12

### COLORADO RADIO COLLECTORS MEETING - SWAP MEET

Lakewood, CO - Jefferson Co. Public Lib.  
10200 West 20th Avenue - 1 pm  
3 pm - Swap Meet  
Info: Rick Ammon - (303) 224-5446

## CENTRAL N.Y. - NO. PENN.

### NEW CLUB FORMING

Info: Mark Gilbert, 711 Elm Street  
Groton, NY 13073 - (607) 898-3519

## TENN. - KENTUCKY S. INDIANA - S. ILLINOIS

### NEW CLUB FORMING

### MID-SOUTH ANTIQUÉ RADIO COLLECTORS

For radio/TV collectors in Kentucky,  
Tenn., Southern Indiana & Southern Illinois  
Organizational meet planned for April 1992

Info: Ron Ramirez, 811 Maple St.  
Providence, KY 42450 - (502) 667-5440

## RADIO CLUB LISTINGS

**CLUBS:** Send antique radio club and meet information to A.R.C. for free listing here, as space permits. Sorry, we don't have room for hamfests. **Always send a SASE when writing to clubs!**

### NATIONAL CLUBS:

**Antique Wireless Association (AWA).** P.O. Box "E", Breesport, NY 14816. Pub: *The Old Timer's Bulletin*, quarterly. Dues: \$10.00. National and regional conventions. Museum.  
**Antique Radio Club of America (ARCA).** Jim and Barbara Rankin, 3445 Adaline Dr., Stow, OH 44224. Pub: *The Antique Radio Gazette*, quarterly. Dues: \$12.00. National and regional conventions. Regional chapters.

### REGIONAL CLUBS:

**Niagara Frontier Wireless Association (NFWA).** Gary Parzy, 135 Autumnwood, Cheektowaga NY 14227. Pub: *NFWA Chronicle*, quarterly. Dues: \$9.00. Regional meets. Permanent antique radio display and research center at the Amherst Museum, Amherst, N. Y.  
**Northland Antique Radio Club (NARC).** P.O. Box 18362, Minneapolis, MN 55418. Pub: *The NARC Newsletter*, six/year. Dues: \$10.00. About six meets/year.  
**Northwest Vintage Radio Society (NWVRS).** P.O. Box 82379, Portland, OR 97282-0379. Pub: *The Call Letter*, monthly. Dues: \$15.00.

Monthly meetings.

**Old Time Radio Club.** New Minnesota club forming. Bob Ruble, (507) 288-3082.

**Pittsburgh Antique Radio Society, Inc. (PARS).** Richard J. Harris, Jr., Secretary, 407 Woodside Rd., Pittsburgh, PA 15221. Pub: *The Pittsburgh Oscillator*, quarterly. Dues: \$10. Quarterly meetings.

**Puget Sound Antique Radio Association (PSARA).** PO Box 125, Snohomish, WA 98290-0125. Pub: *The Horn of Plenty*, monthly. Dues: \$20.00, \$15.00 for out-of-state. Monthly meetings.

**Rhode Island Antique Radio Enthusiasts (RARE).** New club forming. Len Arzoomanian, (401) 232-0869. Informal monthly meetings.

**Sacramento Historical Radio Society (SHRS).** PO Box 162612, Sacramento, CA 95816-9998. Pub: *The Announcer*, quarterly. Dues: \$10. Special meets & monthly meetings.

**Southeastern Antique Radio Society (SARS).** New club forming. David Martin, 1502 Wood Thrush Way, Marietta, GA 30062. Dues: \$10.00. Spring and fall swap meets. Mini-meet before bi-monthly meetings.

**Southern California Antique Radio Society (SCARS).** Edward Sheldon, 656 Gravilla Pl., La Jolla, CA 92037. Pub: *California Antique Radio Gazette*, quarterly. Dues: \$10.00. Meets: 3rd Sat. in Feb., May, Aug. & Nov.

*(To be continued in coming months)*

## BUSINESS CARD ADS - \$27.00 FOR 3 MONTHS

Free Estimates

Tel. (203) 928-2628

ANTIQUE RADIO  
RESTORATION & REPAIR  
1920 - 1960's

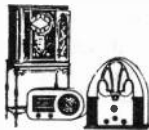

BOB ESLINGER Portmret Center, CT 06259



Buy & Sell

Reasonable Rates. Tubes,  
Parts & Service on all  
Antique Car, Console &  
Table Radios, Tube Amps  
& Phonos

20 Gary School Road

"The Early Sound Man"

Mr. John Andolina, Jr.

Antique Phonographs

Collect - Repair - Restore  
Edison, Victor, Columbia  
Cylinder - Disc Records  
Phonograph Advertising



28 GLEN OAKS DRIVE  
ROCHESTER, N.Y. 14624

WANTED  
ANTIQUE WIRELESS ITEMS

REPRODUCTION  
DIALS  
CABINETS  
METAL AND WOOD  
FABRICATION

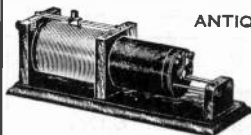

JAMES A. DiRUZZA  
MEMBER A.W.A.

PHONE (513) 233-5004  
2607 OLD TROY PIKE  
DAYTON, OHIO 45404



WANTED: UTC KIT AMPLIFIERS,  
lit, or transformers. Also interested  
in these companies:

ACROSOUND - PEERLESS - TRIAD  
STANCOR - DYNACO - EICO

KIT  
AMP  
COLLECTOR

Leif Blackmon - 508-664-0174  
4 Larson Road - North Reading  
Massachusetts - 01864

REPAIRS  
TO ALL TUBE TYPE  
RADIOS

George Huntley  
R.R. 4, Rockwood, Ontario. NOB 2K0  
(519) 856-4580

RNI Electronics

RADIO  
NEW YORK



INTERNATIONAL

14 Prospect Drive  
Yonkers, NY 10705

Military surplus  
Broadcast Electronics  
Buy & Sell  
Repair of all old radios, TV's,  
and Auto Radios

Send SASE for catalog

914-423-6638  
914-376-0759 FAX

**BUSINESS CARD ADS - \$27.00 FOR 3 MONTHS**

**INVENTORY SOFTWARE  
For the IBM PC**

Catalog Radios, Literature, Tubes  
SASE for details — \$27.00 ppd.

Andrew Mooradian  
5 Priscilla Lane  
Winchester, MA 01890



If you buy, sell or like jukeboxes you need ALWAYS JUKIN--THE MONTHLY JUKEBOX MAGAZINE!! Subscribers in 25 countries, ALWAYS JUKIN LEADS THE WAY: Articles, photos, show reports, ads, new products, price guides, restoration tips, repairs--everything you need to know about JUKEBOXES--the fastest appreciating collectible in the world!!! Fun & a great investment. Sample copy, \$3. \$27.00 per year. ALWAYS JUKIN, 221 YESLER WAY AR, SEATTLE, WA. 98104. (206) 233-9480. Master/Visa ok.

**Blade & Cage Inc.**

Electric Brass Desk  
Fans Bought, Sold, Restored



M.L. YOUNG  
4200 Sunshline Rd.  
Miami, FL 33133

Member A.F.C.A.  
(305) 661-6245

Pre WWII Zenith  
AC & Battery Sets  
Old Advertising  
Sales & Service Goods



**RADIO COLLECTORS**

JIM & KATHY PETERS  
(708) 790-9699

983 CHAPEL CT. SOUTH, GLEN ELLYN, ILLINOIS 60137

(717) 697-5227  
Evenings 6-10 PM

**ANTIQUE RADIO COLLECTOR**

"Early Battery Radios Exclusively"

T.V. PROWELL, BSEE, W3URG

1073-15 Lancaster Blvd.  
Mechanicsburg, PA 17055

RELIABLE - PROMPT - GUARANTEED

**SOUND REMEDY  
LOUDSPEAKER REPAIR SERVICE**

881 Virginia Avenue  
Collingswood, New Jersey 08108

Telephone  
(609) 869-0288

Authorized Waldom Dealer

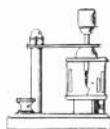

**CRYSTAL SETS**

PARTS - PLANS - KITS - BOOKS  
CATALOG \$1.00

Largest source of Vintage and New  
Variable Air Condensers, Variometers,  
Vario-Couplers, Tap Switches, Tap  
Points, Galena and Germanium  
Detectors, Detector Stands, Cat  
Whiskers, Terminals, Sliders,  
Headsets, Dial Knobs, Coil Forms,  
Magnetic Wire, etc.

MIDCO  
P.O. Box 2288  
Hollywood, FL 33022  
(305) 925-3670  
B.A. Turke, Ph.D.E.E.

**TUBES - CAPACITORS - ETC.**

**OLD STOCK FROM  
CLOSED RADIO - TV STORES**

Send \$1 (cash, stamps, check) — *Refundable*

FOR ILLUSTRATED FLYER WITH  
EXTENSIVE LISTINGS & PRICES

DON DIERS 4276 North 50 St. #AB6  
Milwaukee, WI 53216-1313

"Dead Radios Brought Back to Life"

**FRANKENSTEIN'S  
RADIO LABORATORY**

Specializing in Antique Radios,  
Old Radio Cadavers and Parts Bought and Sold.  
Mail Order Sales of New, N.O.S. and Used Parts.

MAIL ORDER SALES:  
4010 Fairmount Pkwy., Suite 285  
Pasadena, Texas 77504

Gordon R. Rolston  
Repairs by Appointment  
(713) 998-0130

**DAN'S SCHEMATIC SERVICE**

RADIO DIAGRAMS

1921 to 1960 - \$2.50 PPD

T.V. DIAGRAMS

1938 to 1960 - \$3.50 PPD

Send make and model number or chassis  
layout sketch with make and tube types if model  
number is unknown, to: P.O. Box 53061  
San Jose, CA 95153

**VINTAGE TV and RADIO  
REPAIR and RESTORATION**  
ELECTRONICS and COSMETICS

DAVID B. JOHNSON

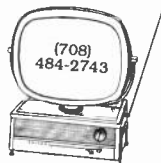

(708)  
484-2743



2336 S. KENILWORTH AVE.  
BERWYN, IL 60402 • (708) 484-2743

Buy Trade Sell

**STEVE THE "RADIO & RADAR" MAN**

Army - Navy - Air Corp's  
Military Radios From 1939 - 1945

STEVE BARTKOWSKI  
Cicero, IL 60650

AWA - ARCI  
MVPA #1894

Phone  
1-708-983-3090

**BUSINESS CARD ADS - \$27.00 FOR 3 MONTHS**

**WANTED**  
PRE 1900  
**ELECTRICITY**  
MEDICAL • X-RAY  
TELEGRAPHY • TELEPHONE  
PRE 1925  
RADIO • WIRELESS  
PRE 1940  
TELEVISION

BOOKS • TUBES • ARTIFACTS  
MAGAZINES • AUTOGRAPHS  
CATALOGS • EPHEMERA



**NEW WIRELESS  
PIONEERS**  
P.O. BOX 398  
ELMA, NY 14059  
716-681-3188



**ANTIQUE RADIO and  
PHONOGRAPH SERVICE**

*Expert Repairs • Buy • Sell • Appraisals*

Zenith • C11 Scott • Mulardo Silver • Lincoln • Atwater Kent  
Spartan • Radio • Addison • Remler • Qerod • Sentinel

Adam Schoolsky  
Radio Historian  
Flours by Appointment  
(415) 791-0330

Wood Plastic & Mirror Radios  
Horn Speakers, Tubes & Parts  
Early Radio Store Advertising  
Radio Books, Magazines & Flowlies

Toll free (800) 321-RADIO • FAX (415) 791-0584

**ANTIQUA RADIO REPAIR**

*Repair - Restore - Buy & Sell*

Schematic Diagrams \$2.00

**DAMASKE ELECTRONICS**

S74-W16834 Janesville Road

Muskego, WI 53150

Phone: (414) 679-0838

**RADIOS & STRANGE MISCELLANEA** IF YOU VISIT THE BRIMFIELD FLEA MARKET... STOP BY FIRST!

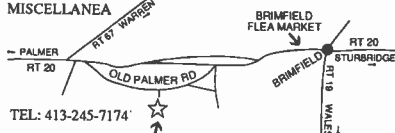

TEL: 413-245-7174

COUNTRY ROAD BARN - BERNIE SAMEK  
OLD PALMER ROAD, BRIMFIELD, MASS.

50 years **CHUCKS** of service!

Any Tube Radio Repaired and

Guaranteed to work good.

\$26.00 plus large parts & UPS

**CHUCKS**

167 LYNN DRIVE - PO Box 598  
NEW HAVEN, WV 25265 - PH (304) 882-2220

**ELECTRON TUBE ENTERPRISES**

Box 311  
Essex, Vt. 05451  
Tel: 802-879-0611  
FAX: 802-879-7764

**FREE 1991 CATALOG AVAILABLE**

*(Dealers in Surplus Electron Tubes)*

Are You Looking For Antique Radios, Parts, Tubes, Schematics and Restoration Services? For Free Flyer, a 2-Stamp LSASE is required to insure a response to your request. Send to:

*Olde Tyme Radio Company*  
2445 Lyttonville Road, Suite 317, Silver Spring, MD 20910

Wish to contact us by phone?

Our number is (301) 585-8776.

Please call 10 am to 10 pm (Local Time)

**Antique Radios**



David & Nancy Snow

P.O. Box 6352

Jackson, MI 49204

(517) 787-2985

We Buy, Sell, Repair

ARBE - III Battery Eliminators

WANTED: Tube Hi-Fi Components & Studio Equipment of the 1950's and 60's

Marantz, McIntosh, Scott, Fisher, Brook  
Acrosound, Brociner, Western Electric  
Fahrehid, Altec, Tannoy, JBL

Richard Sharisky

P.O. Box 521

Belmont, MA 02178

(617) 484-5784

**Avenue Antiques**

5815 College Avenue

Oakland, CA 94618

510/658-7778

Donald L. Shelman

1920-1970  
SCHEMATICS + PAGES OF INFO  
\$5.00 POSTPAID

MANUAL PRICES - SASE

RADIO/TV/HAM/MISC.

"IF I DON'T HAVE IT, YOU  
PROBABLY DON'T NEED IT."

ALTON H. BOWMAN - 4172 EAST AVENUE  
CANANDAIGUA, NY 14424-9564

**Antique Radios**

COLLECT, BUY, SELL, TRADE & REPAIR

**BOB GOAD** (813) 885-1258

8441 FLAGSTONE DR. TAMPA, FLORIDA. 33615



**BUSINESS CARD ADS - \$27.00 FOR 3 MONTHS**



**Wiesner Radio & Electronics**

Antique Radio and Amplifier Repair  
Professional Restoration • All Makes & Models  
Basket Case Amps Rebuilt

(518) 438-2801  
(518) 371-9902

149 Hunter Avenue  
Albany, NY 12206

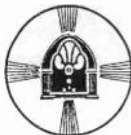

**ANTIQUE RADIO RESTORATIONS**

635 S. Lincoln Ave.  
O'Fallon, IL 62269  
618-632-7423

Collectors of Old Radios  
Electronic Consultant  
Dial Reproductions

Clinton Blais, P.E.  
Life Member I.E.E.E.  
AWA, ARCA

Ron Blais



**Wanted: Old Telephones  
Parts & Signs**  
WILL PICK UP IN NORTHEAST

**Norman Mulvey**  
COLLECTOR BUY - SELL - TRADE

Anything Dated 1877-1890  
\$1,000.00 For Any Telephones with  
Crank in the Front Door

1 RUDOLPH LANE  
NORWALK, CT 06851

Alt. 5 P.M.  
(203) 847-1155



**john d. eckland**

vintage american & european radio repair

969A ADDISON AVENUE PALO ALTO CALIFORNIA 94301  
415/323-0101

**ANTIQUE RADIO RESTORATION**

Since 1936 Repair - Buy - Sell  
Complete Restorations • Prompt Service

**COOPER'S RADIO SERVICE**

425 Court Street  
Rockwell City, Iowa 50579



**LARRY COOPER**  
712-297-7232

**SPY EQUIPMENT  
WANTED!**

- Code Machines
- Secret Cameras
- Secret Radios
- OSS, SOE, CIA, KGBI
- Clandestine Weapons
- I Buy or Trade!

Keith Melton  
P.O. Box 5755 Bossler City, LA 71171  
(318) 747-9616 Days: FAX (318) 747-9010

**RAY'S  
ANTIQUE ELECTRONICS**

Repair or Full Restoration

1920 to 1960

Guaranteed Satisfaction

342 South Third St.  
Cottage Grove, OR 97424 (503) 942-0866

**Old Time Replications**

"TURN TO US WHEN YOU NEED KNOBS"  
KNOBS • PUSHBUTTONS • ESCUTCHEONS  
PLASTIC GRILLS • HANDLES

**LARRY BOROONARO**  
5744 TOBIAS VAN NUYS, CA 91411 (818) 786-2500

**Victorian Talking Machine, Company**  
281 Robinson Ave. Newburg, NY 12550



914-561-0132  
SHOP HOURS  
BY APPT.  
6-9 PM Best Time To Call



Antique Phonographs  
Cylinders, Discs,  
Buy, Sell, Restore & Repair

100 Needles.....\$3.00  
Book & Parts Catalog..\$3.00  
TELEPHONE ORDERS  
MC/VISA

**ANTIQUE RADIO  
REPAIR**



**BETA-TEK**

2 POWDER HORN LANE  
ACTON, MA 01720  
508 263-7435



**THE RADIO MAN**  
Buy-Sell-Trade  
Antique Radios • Tubes • Parts

DICK MORGAN  
RES: (214) 231-3099

TEL: (214) 276-5458  
FAX: (214) 272-1831  
P.O. BOX 461485  
GARLAND, TX 75046-1485



**WAVES**  
ANTIQUES  
EARLY RADIOS  
&  
PHONOGRAPHS  
78 RECORDS  
BOUGHT • SOLD  
REPAIRED  
OPEN 12 - 6  
SAT. 12 - 5  
CLOSED SUN. & MON.

32 EAST 13TH ST., NEW YORK, N Y 10003 212 989-9284  
PROPRIETORS Bruce and Charlotte Mager

# ARBE\* — III

## \* Antique Radio Battery Eliminator



➤ FEATURING:

- Adjustable high current "A" supply
  - 8 different "B" and "C" voltages
  - All outputs electrically isolated
  - 5-year limited warranty
  - Short circuit protection

*Terrific Christmas Gift Idea !!*



\$139.95 Shipped  
within continental U.S.A.  
*(Michigan Residents add 4% sales tax)*

Call or write for complete data sheet:

Antique Radios Inc.  
P.O. Box 6352  
Jackson, Michigan 49204  
Phone 517-787-2985  
After 7:00 PM EST

# COLLECTOR BOOKS AVAILABLE FROM ANTIQUE RADIO CLASSIFIED

BOOKS MARKED WITH "\*" ARE THE MOST POPULAR AND ARE ESPECIALLY RECOMMENDED FOR NEW COLLECTORS

- Antique Radios - Restoration and Price Guide, Johnson. *Beginner's introduction to collecting antique radios, how radios work, radio repair & restoration.* 1982. 99 pgs. .... \$14.95
- The Auto Radio: A Romantic Genealogy, Matteson. *Information, photos & ads from the early days of the automobile radio through the 1950's.* 316 pgs., *hardcover.* ..... \$34.95
- \* Classic Plastic Radios of the 1930s and 1940s - A Collector's Guide to Catalin Models, Sidell. *Over 200 models from 25 manufacturers are illustrated in full color.* 127 pgs. .... (hardcover: \$29.95) \$19.95
- \* The Collector's Guide to Antique Radios, Bunis. *This 175-page price guide covers radios from 1920 to 1959. Over 5000 prices and over 400 full color photos are included.* ..... \$16.95
- Communication Receivers, Moore. *Information on 700 vacuum tube receivers by 51 manufacturers produced from 1932 to 1981. 330 radios are illustrated.* 115 pgs. ... REVISED (200 more radios illustrated than 1st ed.) \$17.95
- Crosley Catalog (reprint). *1923 catalog covering the early Harko through the XX models.* 32 pgs. .... \$4.50
- Crystal Clear - Vintage American Crystal Sets, Crystal Detectors and Crystals, Sievers. *Comprehensive reference with over 700 illustrations of crystal sets, crystal detectors and crystals.* 282 pgs. .... NEW \$39.95
- Fixing Up Nice Old Radios, Romney. 1990. *Written by an old radio instructor, this book covers Ohm's law, through battery sets, superhets and communications receivers.* 185 pgs., 300+ figures. .... \$25.00
- \* Flick of the Switch, McMahon. *The standard photo reference guide for collectors for radios from the 30's to the 50's.* 1000+ photos of radios. 263 pgs. .... \$11.95
- Great Radio Personalities (reprint). *Black & white portraits and info on all the favorites from the golden days of radio - Abbott & Costello, Baby Snooks, and more.* 128 pgs. .... \$11.95
- \* Guide to Old Radios - Pointers, Pictures & Prices, Johnson. 1989. *The latest book by the Johnsons describes the history of radio and includes 350+ photos and a price guide to 3300 sets.* 128 pgs. .... \$16.95
- Hake's Guide to TV Collectibles. *Price guide and illustrations for 1600 TV program collectibles.* 185 pgs. .... NEW \$14.95
- Hallcrafters Co. 1932-1982: A Partial Product Listing, Dachis. *Over 500 products listed; no photos.* 41 pgs. .... NEW \$12.50
- Hertz: The Beginning of Microwaves, Bryant. *Photos and descriptions of Hertz's apparatus and experiments. A book prepared for the IEEE Hertz Centennial exhibit.* 50 pgs. .... \$15.00
- Illustrated Price Guide to Vintage Televisions and Deco Radios, Poster. *100+ illustrations.* 77 pgs. NEW \$15.95
- Lawlor's Radio Values. *Price guide for radios in Collins & Sidell books. No photos.* 32 pgs. .... NEW \$12.50
- Most Often Needed 1926-38 Diagrams (reprint). *600+ diagrams for common radios from '26-'38.* 240 pgs. .... \$11.95
- Official Radio Service Manual (reprint). *100's of pre-1930 circuits & notes.* 356 pgs. .... \$19.95
- Old-Time Radios! Restoration and Repair, Carr. *How to repair vacuum-tube and transistor radios. A self-paced training guide.* 256 pgs, 200 illustrations. .... NEW \$16.95
- Price Guide to Plastic Collectibles, McNulty. *Describes types of plastics, etc. Radio is 8 of 207 pgs.* \$17.95
- Radio Collector. (Videotape, VHS). *The five-part Emmy-nominated PBS series combined on one 130-minute videotape. Meet collectors, see collections, attend swap meets, learn about radio restoration.* ..... \$29.95
- Radio Collector's Guide, McMahon. *Listing of 9,000+ radios made by some 1200 companies from 1921 to 1932. Gives manufacturer, year, model name and other info. No photos.* 264 pgs. .... \$11.95
- Radio - A Blast from the Past, Wolf/Jacobson. *Reprints of advertising from 1927 to 1942. Useful for identification of cathedrals, tombstones, consoles and table model radios of the period.* 321 pgs. .... \$25.00
- Price List, Wolf/Jacobson. *Keyed by page number to Radio - A Blast from the Past.* ..... \$6.50
- Radio Craft - 50 Years of Radio (reprint). *Reprint of Golden Jubilee issue of 1938.* 144 pgs. .... \$14.95
- Radio Enters the Home, RCA (reprint). 1922. *The Aeriola Jr. and RC era.* 128 pgs. .... \$12.95
- Radio Equipment & Supplies, Robertson-Catacart Electric Company (reprint). *1922 catalog of radios, accessories and other equipment. Includes RCA, Clapp-Eastham & others.* 168 pgs. .... \$13.95
- \* Radios-The Golden Age, Collins. *Full-color book on the colorful Catalin and Bakelite radios from the late 1930's to the early 1940's.* 128 pgs. .... (hardcover \$25.00) \$14.95
- Radio Horn Speaker Encyclopedia, Paul. *Listing of horn speakers for over 320 manufacturers for the 1920's. Expanded information on ten manufacturers.* 80 pgs. *Over 145 photos.* ..... \$12.90
- \* Radio Manufacturers of the 1920's, Douglas. *Three comprehensive volumes.*
- Vol. 1 covers A-C Dayton thru Ferguson. 225 pgs. .... (hardcover: \$34.95) \$24.95
- Vol. 2 covers Freed-Eisemann thru Priess. 266 pgs. .... (hardcover: \$39.95) \$29.95
- Vol. 3 covers RCA thru Zenith. 292 pgs. .... (Shipping November) NEW (hardcover: \$39.95) \$29.95
- Radio & T.V. Collector's Guide Book, Biraud. *The "Vintage Radio" illustrated guide to European sets (very few British sets) from early wireless to the 1930's (a few later). Text is in both French and English.*
- Vol. 1 - Early History & Manufacturers A to P. 256 pgs. .... \$49.95
- Vol. 2 - P to Z & T.V., Speakers, Tubes, Loops, Parts & Novelties. 256 pgs. .... \$49.95
- Radio Trouble Shooting, Haan (reprint). *1928 guide to trouble shooting battery sets.* 317 pgs. .... \$14.95
- Radios of the Baby Boom Era. *Pictures and info from Sams Photofacts. 3494 radios illustrated plus 3275 additional radios listed. 274 brands. 1946 thru 1960. Six volumes, 300+ pages per volume. Order by volume: Vol. 1: Admiral - Clearsonic. Vol 2: Co-op - Geloso. Vol 3: GE - Monitoradio. Vol 4: Motorola - RCA. Vol 5: Realtone - Stratovox. Vol 6: Stromberg-Carlson - Zenith. (Per Volume) NEW All In Stock! \$16.95*
- S. Gernsback Radio Encyclopedia (reprint). *1927 classic encyclopedia on radio.* 175 pgs. .... \$11.95
- Saga of the Vacuum Tube, Tyne. *Standard reference to vacuum tubes prior to 1930. 100+ photos.* 495 pgs. .... \$15.95
- \* Vintage Radio, McMahon. *The standard photo reference guide for collectors for radios prior to 1930. Over 1000 pictures.* 263 pgs. .... \$11.95
- Westinghouse Catalog (reprint). *Early 20's catalog featuring the RA-DA and other early Westinghouse equip.* 8 pgs. .... \$4.00
- Wireless Communication in the U.S., Mayes. *Early development of American radio operating companies. Alternators, coherers, stock promotions, unpublisher letters, etc.* 240 pgs, 160 illustrations. .... \$29.95

All books softcover except those marked "hardcover." Send payment with order. Enclose \$2.50 shipping for orders under \$35. VISA and MasterCard accepted; include card number, expiration date and name on card. Money back return policy. Most books shipped within 4 days, but allow 2 to 4 weeks to receive order. Mass. residents add 5% sales tax. Foreign orders - write for shipping costs or use credit card and specify surface or air.



Send Order To: A.R.C., P.O. Box 2, Carlisle, MA 01741  
or Call: (508) 371-0512



(Nov-91)

# SHIPPING NOW!

## CRYSTAL CLEAR

By Maurice L. Sievers

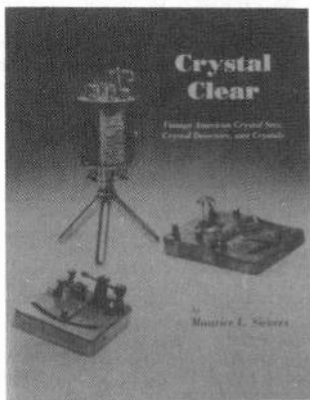

750 Illustrations – 537 Crystal Sets  
341 Detectors – 207 Crystals  
Perfect for the beginning collector!  
Useful for the experienced too!

*Crystal Clear* is a comprehensive reference for collectors, historians and anyone interested in early radio. In addition to the many excellent photos and reproductions of ads, *Crystal Clear* includes lists showing all sets by manufacturer, set name, selling price and year of manufacturer. 8 1/2" x 11", 282 pages.

**\$39.95 (Softcover)**

## COMMUNICATIONS RECEIVERS

### 2nd Edition— Revised & Expanded

By Raymond S. Moore

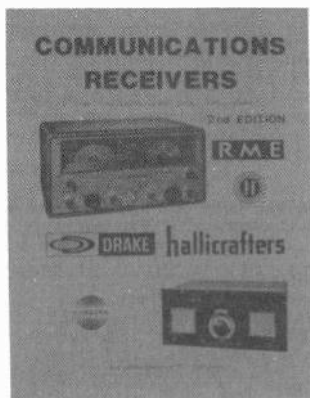

330 radios pictured!  
200 more than in the 1st Edition!

A comprehensive guide to 700 vacuum tube communications receivers from 1932 to 1981. In addition to Collins, Hallicrafters, Hammarlund and National, over 40 other manufacturers from Allied to Tobe are included.

The description of each set includes years, band coverage, type, filters, tubes, a photo in many cases and other info. 8 1/2" x 11", 115 pages.

**\$17.95 (Softcover)**

Send payment with order. Enclose \$2.50 shipping for orders under \$35. VISA and MasterCard accepted; include card number, expiration date and name on card. Money back return policy. Most books shipped within 4 days, but allow 2 to 4 weeks to receive order. PRIORITY MAIL: \$5.00 per book. Mass. residents add 5% sales tax. Foreign orders – Write for shipping costs or use credit card and specify surface or air (foreign surface shipping is \$4.00 per book).



Send Order To: A.R.C., P.O. Box 2, Carlisle, MA 01741  
or Call: (508) 371-0512



(Nov-81)

# NEW TV BOOK

**Classic TVs** with price guide  
To be released December 13, 1991

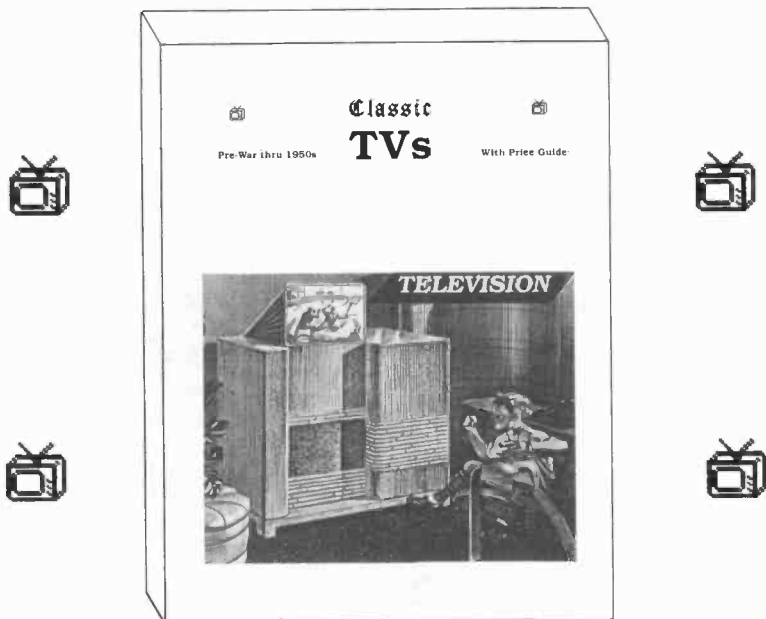

**8 1/2" X 11" Softbound - 92 pgs., 52 in color**  
**Old Catalog pages, Magazine Ads & Color Photos**  
**Accurate Price Guide**

**Dealers Call: 317-674-6450 for quantity prices**

**Visa, Master Card or C.O.D. orders Call: 1-800-777-6450**

**Or Send Check or Money Order for \$16.95 + \$2.00 Shipping to:**  
**L-W Book Sales**  
**P. O. Box 1**  
**Gas City, IN 46933**

**Available November 1, 1991 !!**

**"Evolution of the Radio"**

**227 pages, 118 in color,  
more than 800 radios pictured & priced**



**\$22.95 + \$2.00 Shipping**  
**(Quantity Prices Available)**

**Send Check or M.O. to: L-W Books, Box 1, Gas City, IN 46933**

**or**

**Visa, Mastercard or C.O.D. orders call:**  
**1-800-777-6450**

# SHIPPING NOW!

## Volume 3!

### Radio Manufacturers of the 1920's

BY ALAN DOUGLAS



*"The definitive book on American broadcast receivers of the 1920s"*

**Volume 3:** RCA - Scott - Silver-Marshall - Slagle - Sleeper - Sonora - Sparton - Splitdorf - Steinite - Stewart-Warner - Stromberg-Carlson - Thermiodyne - R.E. Thompson - Thorola - Tri-City - C. D. Tuska - Ware - Western Coil - Western Electric - Workrite - Zenith. 292 Pages.

**Volume 3: \$29.95 (hard cover: \$39.95) - Shipping Now!**

**Volume 2:** Freed-Eisemann - Eisemann - Freshman - Garod - Gilfillan - Grebe - Howard - Jones (Lester/Melco) - Jones (Jos.) - Kellogg - Kennedy - King - Kodel - Kolster - Leutz - Magnavox - Majestic - Marti - Metro - Klitzen/Michigan - Midwest - Mu-Rad - Murdock - Music Master - Neutrowound - Operadio - Ozarka - Pfanstiehl - Philco - Pilot - Priess. 266 Pages.

**Volume 2: \$29.95 (hard cover: \$39.95) - Shipping Now!**

**Volume 1:** A-C Dayton - Adams Morgan - Air-Way - All-American Mohawk - American Bosch - Amrad - Amrad S-Tube - Apex - Atwater Kent - Bremer Tully - Browning-Drake - Clapp-Eastham - Crosley - Cutting & Washington - Day-Fan - DeForest - Eagle - ERLA - FADA - Federal - Ferguson. 225 Pages.

**Volume 1: \$24.95 (\$34.95 in hard cover) - Shipping Now!**

*Send payment with order. Enclose \$2.50 shipping for orders under \$35. VISA and MasterCard accepted; include card number, expiration date and name on card. Money back return policy. Most books shipped within 4 days, but allow 2 to 4 weeks to receive order. PRIORITY MAIL: \$5.00 per book. Mass. residents add 5% sales tax. Foreign orders - Write for shipping costs or use credit card and specify surface or air (foreign surface shipping is \$4.00 per book).*



**Send Order To: A.R.C., P.O. Box 2, Carlisle, MA 01741  
or Call: (508) 371-0512**



# NEW! Radios

of the Baby Boom Era

Six Volumes — 2000 pages — From Sams' Archives

1946 to 1960 — 274 Brands — 3494 Illustrations (B&W)

6769 Models — Catalin, Bakelite, Wood, Transistor Radios & More

**All Volumes Available!**

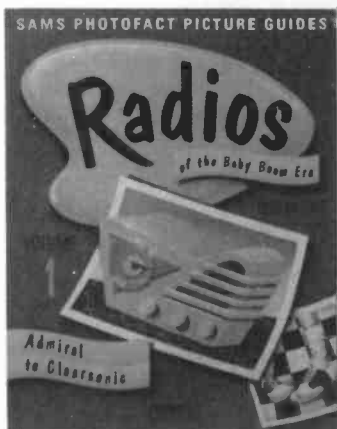

Vol.	Brands	Included
1	56	Admiral to Clearsonic
2	54	Co-op to Geloso
3	58	GE to Monitoradio
4	36	Motorola to RCA Victor
5	35	Realtone to Stratovox
6	35	Stromberg-Carlson to Zenith



## 1/2 Page for each illustrated radio including:

- Large illustration of the radio including knob functions
- Short description of the radio
- Number of tubes
- Power supply type (AC, Battery, etc.)
- Tuning range
- Manufacturer
- Sams Photofact Set number & year
- Photofact published.

## ALSO

- Index by model number listing tubes in radio
- List of similar radio models indexed to pictured radio
- List of manufacturers and suppliers indicating their brand names
- Basic trouble-shooting hints

Each Volume: \$16.95 — Softcover  
8 1/2" x 11" — Approx. 328 pages

Coming Soon: Volumes on TVs,  
Car Radios and HI-FI Components.  
WATCH FOR ADS IN A.R.C.

Send payment with order. Enclose \$2.50 shipping for orders under \$35. VISA and MasterCard accepted; include card number, expiration date and name on card. Money back return policy. Most books shipped within 4 days, but allow 2 to 4 weeks to receive order. PRIORITY MAIL (2-days): \$4 for 1st book + \$1 for each additional. Mass. residents add 5% sales tax. Foreign orders — write for shipping costs or use credit card and specify surface or air.



Send Order To: A.R.C., P.O. Box 2, Carlisle, MA 01741  
or Call: (508) 371-0512



(Sep-91)





## VACUUM TUBE DEALER PRICE LIST Nov. '91



		SOVTEK, USSR			
5U4G	\$4.30 each	12 at \$3.90 each	25 at \$3.50 each		
12AX7WA/7025	4.35	3.75	3.60		
6922 (military 6DJ8)	5.75	5.20	4.75		
EL84/6BQ5	2.60	2.25	1.75		
EL84M/6BQ5WA	5.20	4.50	3.50		
6V6GT	3.90	3.35	2.95		
6L6GC	3.50	2.95	2.60		
5881/6L6WGC	6.75	6.20	5.75		
The 5881 is Russia's selected military 6L6WGC and is regarded as the very best 6L6 type in the world. Eric Clapton recently replaced the Philips/Sylvania 6L6 STR's in the custom Soldano amp which he uses live, with SOVTEK 5881's because of their milky smooth sound. Discriminating musicians thruout the world are retubing with the SOVTEK 5881/6L6WGC.					
					50 CALL FOR SPOT QUOTE 100 CALL FOR SPOT QUOTE

		SINO, CHINA			
5U4G	\$4.60 each	10 at \$4.15 each	25 at 3.75 each		100 CALL FOR SPOT QUOTE
EL34	4.90	4.30	3.90		
6L6GC	4.70	3.95	3.70		
12AX7a	3.85	3.25	3.10		
12AT7	3.90	3.40	3.25		
6146B	11.50	10.60	9.80		
6550	9.40	8.95	8.35		
KT88	11.60	10.50	9.95		

		EI, YUGOSLAVIA			
EL34/6CA7	\$5.10 each	10 at \$4.65 each	25 at \$4.10 each		100 CALL FOR SPOT QUOTE
6DJ8	3.15	2.75	2.35		
12AU7/ECC82	3.15	2.75	2.35		
12AX7/ECC83	3.15	2.75	2.35		

		SIEMENS, GERMANY			
EL34	\$7.25 each	10 at \$6.75each	25 at \$6.20 each		100 CALL FOR SPOT QUOTE

		TESLA, CZECHOSLOVAKIA			
EL34	\$6.75 each	10 at \$6.25 each	25 at \$5.70 each		100 CALL FOR SPOT QUOTE

		GE, USA			
5U4GB	\$11.85 each	10 at \$11.25 each	6550a	\$17.95 each	10 at \$16.50 each
6CA7	14.95	13.50	7025	14.75	13.25
6L6GC	14.95	13.50	7027a	16.95	16.25
6LF6	18.50	16.95	7591a	14.75	13.50
12BH7	9.95	9.50	7868	16.95	16.25
12AT7	6.85	6.40	8417	15.75	14.25

**SOLID STATE RECTIFIER**  
 Built into tube socket. Direct plug-in replacement for all 5Y3, 5U4 and 5AR4 types. \$6.25 each 10 at \$5.90

		ODD BALL TUBES (MOSTLY USA STOCK)							
4CX350A	\$79.00 each	6AV6	\$1.95 each	6GW8	\$6.90 each	6X4	\$3.90 each	6189W	\$4.15 each
5AR4	7.95	6AX5	4.90	6J5	4.50	6X5	3.90	(12AU7W industrial)	
5BC3/9	1.95	6BA6	1.95	6J7	5.50	6X8	2.25	6267	2.80
5V4GT	5.50	6BK11	6.90	6K11	6.90	12AY7	5.95	6973	11.90
5Y3GT	3.95	6C4	2.80	6SC7	6.90	12AZ7	2.90	7189	5.90
6AL5	2.40	6CSGT	2.75	6SG7	3.50	12D78	4.95	7199	17.80
6AN8	4.95	6C10	4.90	6SJ7	4.45	12DW7	13.95	7247	13.95
6AQ5A	4.25	6CA4	3.50	6SK7	2.90	12FQ8	4.75	OA2	3.75
6AS7	3.90	6CG7	6.90	6SL7	4.35	5749	3.90	OA3	1.95
6AT6	3.25	6EU7	11.80	6SN7	3.95	(6BA6W industrial)		OB2	1.95
6AU6	2.25	6FH8	9.25	6U10	4.90	5879	6.50	OC3	3.75

**GIVE US A CALL ON ANY TOUGH-TO-GET TUBE. WE'LL FIND IT FOR YOU!**  
**ALL TUBES GUARANTEED! QUANTITY DISCOUNTS AVAILABLE!**

**MATCHING AVAILABLE ON ALL OCTAL POWER TUBES \$1.00 extra per tube.**  
**"PLATINUM" MATCHING ALSO AVAILABLE WITH 24 HOUR**  
**TEST AND BURN-IN, ENSURING PREMIUM MATCH. PAIRS OR QUADS \$2.00 extra per tube.**

MINIMUM ORDER \$50.00  
 ADD \$5.00 SHIPPING (\$10.00 OUTSIDE UNITED STATES)  
 SEND CHECK OR MONEY ORDER TO:

## NEW SENSOR CORPORATION

133 FIFTH AVENUE, NEW YORK, NY 10011  
 CONTACT: MIKE MATTHEWS TELEPHONE: (212) 529-0466 TOLL FREE: 1-800-633-5477 FAX: (212) 529-0486

PARTS • SETS • ACCESSORIES  
VINTAGE TV'S & RADIOS  
BUY • SELL • TRADE • REPAIR • RENT



HARRY  
POSTER (201) 794-9606

P.O. Box 1883 • South Hackensack, NJ • 07606

# I BUY TV'S AND RADIOS !

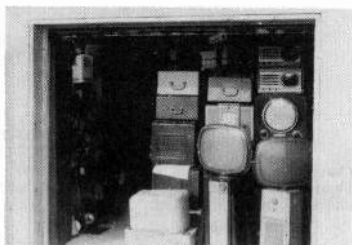

Any Condition...  
Any Quantity!

TV'S – Early or Unusual  
RADIO'S – Catalin, Mirror  
Unusual & Novelty  
Early & Novelty Transistors

---

Re-Built Predicta 17"/21" CRT's – \$125. Postpaid !!

---

## OUR STORAGE IS FILLING - FAST! HELP!

Selling...

- RCA Blonde 721, 8TS30. 15" Color monitor - 1954.
- Predicta - Barber pole console, table tops.
- Raytheon and Zenith Portholes. HaloLite's.
- Emerson Pop-Up tube, Model 608.
- 7" Motorola, 7" National, 7" Hallicrafter.
- Philco Projection 48-2500 - have 5! \$200 picked-up.

Buying...

- We buy Pre-Wars! Paying \$1,000 - \$10,000. CASH.
- Early Color - 9", 15", 16", 19" circa 1950-1954.
- Any 7", 10" or 12" with "unusual" cabinet.
- Buying "EMPTY" TV cabinets - 16" or smaller

Repairing...

- B&W TV's, 1946 to 1975 and Predicta's.

# CLASSIFIED ADVERTISING POLICY

**ONE FREE 20-WORD AD** for subscribers in each issue; additional words are 15¢ each. See details below. Classified ads must be received (not just postmarked!) by **NOON** on the ad deadline. Late ads are held for the following issue. Please enclose correct payment with all ads. Stamps or cash are OK for small amounts. (Canadian and other foreign advertisers, please see "Payment" on page two for methods.) "Free words" cannot be accumulated from month to month; free words must be requested when ad is submitted.

Please write each ad on a separate sheet of paper, especially when included with other A.R.C. correspondence. Include SUB# with ad. Ads may be sent in advance; but, write each ad on a separate piece of paper and indicate the month (or successive two months) you want the ad to run.

**Please write legibly and use both capital and small letters. Do not use dashes between words.** Some numbers and letters can look alike, for example 1, l and I (the number one, the capital i and the small L.) Write the following characters clearly (especially in model numbers): 1, l and I; 0, O, o, Q and D; r and n; 6, b and G; V, U, u, v and Y; A and R; 5, S and s; 2, Z and z. We try to correct spelling errors, so when using an uncommon word or manufacturer which looks similar to a common word or manufacturer, note it so that we do not "correct" it. Editor's comments are in [brackets].

**Advertising is accepted only for early items related to radio, communication, etc. All items must be described fairly; reproductions, reprints and not-original items must be identified as such. Advertisers agree to respond promptly to inquiries and orders, and to resolve problems promptly if the buyer is not satisfied.**

Publisher reserves the right to edit ads without notification to the advertiser and to reject ads for any reason. Publisher is not responsible for errors due to illegibly written ads or for any other reason. Since club activities receive free advertising on the *Coming Radio Events* page, the free 20 words may not be used for club activity ads. See inside front cover for additional information.

## CLASSIFIED AD DETAILS

### **Deadline: NOON - 10th of the month!**

Classified ads must have a standard heading such as **WANTED, FOR SALE, FOR TRADE, FOR SALE/TRADE, SERVICES, MESSAGE, HELP, AUCTION, MEET**, etc. This heading is the only bold or all-capitalized words allowed in the ad. Capitalize only manufacturer names, model names, etc. Wanted and For Sale ads are mixed together to encourage the reading of all ads, including the Wanted ads. This standard ad format makes scanning the ads easier.

Before writing your ad, please look over the ads in a recent issue of A.R.C., and try to write your ad in the same style. Full name and address is required in all classified ads; we will add it if you forget.

To encourage varied content of the ads, the same classified ad may be run only once per issue and for only two consecutive months. (To run an ad longer, use a boxed classified or display ad.)

### **Classified Ad Rates per Month**

Subscribers:

First 20 words: **FREE\***

15¢ per word for extra words over 20 **plus**

10¢ per word for a shaded ad (count all words including free words).

\* Subscribers may take 20 free words on only one ad each month.

Non-Subscribers:

30¢ per word **plus**

10¢ per word for shaded ad.

Please do not forget to send in the extra 15¢ per word when your classified ad runs over the free 20 words; your payment will be appreciated, and it will help to keep A.R.C. healthy.

## BOXED CLASSIFIED AD DETAILS

### **Deadline: 5th of the month!**

Boxed classified ads can run unchanged for three months or more. No words are free. Ads may be shaded and may include bold and all-capitalized words freely. The ad need not begin with For Sale, etc. Minimum run is 3 months, prepaid.

### **Boxed Classified Ad Rates per Month**

Nonshaded ads:

25¢ per word for all words,\* none free, **plus**

10¢ per word for each bold word **plus**

10¢ per word for each all-caps word.

Shaded Ads (All words are bold at no charge):

35¢ per word for all words\* **plus**

10¢ per word for each all-caps word.

Non-Subscribers:

Add 20¢ per word to above costs.

\*Three words can be bold-all-caps at no extra charge.

## PHOTO & DRAWING DETAILS

**Deadline: 5th of the month for classified and boxed classified ads with drawings or photos!**

Drawings and photos are encouraged as the response to your ad is much larger and the reader knows better what you want or are selling. Send in your drawing or photograph, and A.R.C. will reduce it or enlarge it as needed.

### **Photo and Drawing Rates per Month**

\$8.00 per month for each photo or drawing (if ad is canceled, this amount cannot always be refunded.)

## CHANGES & CANCELSATIONS

Please check your ads carefully before sending them in. Once ads are received, it is not always possible to refund the amount sent, pull the ad or make changes.

## IMPORTANT — COUNTING WORDS — IMPORTANT

The **standard headings: WANTED, FOR SALE**, etc., count as **one word** each time used in an ad. **Name, address** and (one) **telephone number**, count as **6 words**, regardless of length. **Ham call letters** and **business name** can be included in the 6 words and do not count extra. Full name and address is required in all classified ads — it does not cost extra! Each additional word, abbreviation, model number or number group, extra telephone numbers, etc. count as one word. Hyphenated words count as two words.

SECOND CLASS



A.R.C., P.O. Box 2, CARLISLE, MA 01741  
 RETURN POSTAGE GUARANTEED

GCB SUB# 24-9214  
 MARY E HUDSON  
 14300 RIDGEMONT MI 48137  
 GREGORY

**CLASSIFIED AD  
 DEADLINE DEC. 10TH**