



VOLUME 7

DECEMBER 1990

NUMBER 12



**THE NATIONAL PUBLICATION FOR BUYERS AND SELLERS
OF OLD RADIOS AND RELATED ITEMS - PUBLISHED MONTHLY**

ANTIQUE RADIO CLASSIFIED

Antique Radio Classified (ISSN:8750-7471) is published monthly, 12 times per year, by John V. Terrey, 498 Cross Street, P.O. Box 2, Carlisle, MA 01741. Second-class postage paid at Carlisle, MA, and additional mailing offices. Telephone: (508) 371-0512, 9:00 AM to 5:00 PM ET weekdays; machine answers phone at other times.

Annual subscription rates within the U.S. are \$24.00 by Second Class mail and \$36.00 by First Class mail.

Annual foreign rates. By air: Canada - \$38.00; Mexico - \$36.00; Other foreign countries - \$70.00. Surface mail: Canada - \$31.00; Other foreign countries - \$36.00 (Surface delivery to countries other than Canada may take two or more months and cannot be guaranteed.)

Two-year subscriptions are twice these rates and receive an extra month. Sample issues are available free on request.

© Copyright 1990 by John V. Terrey.

POSTMASTER: Send address changes to Antique Radio Classified, P.O. Box 2, Carlisle, MA 01741.

STAFF

Publisher and Editor: Production Manager: Publishing Staff: Dick Desjarlais Chris Frederickson Shirley Sauer Founding Publisher/Editor: Contributing Writers: Richard L. Arnold Norman S. Braithwaite Alan S. Douglas David W. Kraeuter Ron Ramirez Gil Schlehman Howard Stone Ralph Williams	John V. Terrey Scott J. Young Dave Crocker Betsy Dumka Bobby Lyman Dorothy Schecter Gary B. Schneider Mike Adams Paul J. Bourbin Dave Crocker Richard C. Foster Jim Kreuzer Henry Rogers Gary B. Schneider Frank R. White John P. Wolkowicz
--	--

PURPOSE. Antique Radio Classified is published for people involved in the radio collecting hobby. Its purpose is to stimulate growth of the hobby through the buying, selling and trading of radios and related items, and to provide a monthly forum for the interchange of ideas and information.

CONTACTING ANTIQUE RADIO CLASSIFIED.

All correspondence should be sent to:

A.R.C., P.O. Box 2, Carlisle, MA 01741.

Send only UPS, Federal, etc. items to 498 Cross St.

Telephone: (508) 371-0512; Fax: (508) 371-7129

Please no ads by telephone; thanks.

Your ads, renewals, letters, etc. can be handled faster and more efficiently if (1) each is on a separate piece of paper, and (2) your name, address and SUB# is written on each.

Unfortunately, A.R.C. is not staffed to answer letters

with questions about antique radios or requests for advice. However, A.R.C. does solicit letters of interest to its readers and will publish them as space permits. A.R.C. assumes that permission is given to edit and to publish all correspondence received unless otherwise indicated.

GUARANTEE. You may cancel your subscription at any time and receive a pro rata refund for issues not yet mailed. If errors to ads are made by A.R.C., upon request a free correction will be run in the next available issue.

PAYMENT. Please send in full payment with your order or ad. A.R.C. does not carry accounts; all subscriptions, ads, etc. must be prepaid. Pay in U.S. funds; checks drawn on a U.S. bank, money orders, Visa or MasterCard charges are preferred. Make check out to "A.R.C." U.S. stamps or cash are OK for small amounts. Canadian payers may send a Canadian check in U.S. funds, but please add \$1.00 (U.S.) for conversion costs. On request, subscriptions will be prorated to amount sent; minimum term is one year.

CHANGE OF ADDRESS. Please notify us 4 weeks in advance of a change of address. Send both your new and old address, and include your SUB# and effective date of your new address. Temporary address changes can be made also.

SUBMISSION OF MATERIAL. Antique Radio Classified welcomes and solicits information that pertains or relates to radio history or collecting. This may include articles, book reviews, photos, information on upcoming radio events, meetings, antique radio organizations, radio auctions and price reports, sources of old radio and restoration supplies, and other related and interesting material. All material submitted should be neat and verified for accuracy. Unless prior arrangements are made, all submitted materials will be edited, become the property of Antique Radio Classified and will not be returned.

MAILING OF ISSUES. U.S. subscribers can receive A.R.C. by First or Second Class mail (Second Class is the way most magazines are mailed). The mailing of First Class copies is staggered over several days, faraway copies mailed on the first day, and local copies mailed the last day. Non-U.S. copies are mailed on the first day. Second Class copies are mailed on the last day. Mailing dates change each month, but mailing is usually completed by the 26th of the month. First Class copies usually are received by the fifth of the month; copies by Second Class mail, by the tenth.

ETHICS. No person involved in the production of A.R.C. is to act on any information in the magazine until they receive their copy through the mail.

DISCLAIMER. The publisher is not responsible for any buying and selling transactions incurred, or for any other use of the contents of this publication.

Antique Radio Classified subscription rates, frequency of publication, content, policies, size and ad details, and rates are subject to change at any time by A.R.C.

DISPLAY AND BUSINESS CARD ADS - DETAILS AND RATES

The deadline is the first of the month for display and business card ad artwork, payment and repeat requests.

Advertising is accepted only for early items related to radio, communication, electricity, etc. All items must be described fairly; reproductions, reprints and not-original items must be so identified. Advertisers agree to respond promptly to inquiries and orders, and to resolve problems promptly if the buyer is not satisfied.

All advertising must be prepaid; see "Payment" paragraph above. Late ads will be run only if space and time permit. Since artwork is reduced to 63% in the printing process, originals should be the artwork size listed below. Do not send in artwork on art board or send negatives. Ads should be typeset or typed neatly with a carbon ribbon. If you want us to prepare your ad, include the one-time cost listed below for A.R.C. to make up the ad.

Photos should be at an 85 line screen; otherwise, add \$8.00 per photo for screening. (Do not glue photos to artwork; submit separately.)

If you are confused by these requirements and terms, please contact A.R.C. before beginning to prepare your ad.

Page	Artwork Size (send in this size)		As Printed (size in magazine)		Cost for 1-month	Cost for 3-months	Cost for 6-months	One-time Cost for A.R.C. to make up Ad (if requested)
	H x W (inches)	H x W (inches)	H x W (inches)	H x W (inches)				
Full	12 3/16 (or 10 1/2)	x 7 1/2	7 3/4 (or 6 5/8)	x 4 3/4	\$145.00	\$390.00	\$695.00	\$50.00
1/2 H	5 1/4	x 7 1/2	3 5/16	x 4 3/4	73.00	197.00	350.00	25.00
1/2 V	12 3/16 (or 11 13/16)	x 3 9/16	7 7/16	x 2 1/4	73.00	197.00	350.00	25.00
1/4	5 1/4	x 3 9/16	3 5/16	x 2 1/4	37.00	99.00	177.00	13.00
1/8	2 5/8	x 3 9/16	1 5/8	x 2 1/4	19.00	51.00	91.00	7.00
Business Card	2	x 3 3/4	1 1/4	x 2 3/8	not avail.	27.00	48.00	5.00

We will be happy to advise you on your ad ideas, estimate how much the ad will cost, recommend an ad size, etc.

We assume that advertisers want all ads which are submitted to run without delay; therefore, we will run the ad and bill for any additional work required for the ad to meet these specifications. A late ad will be run beginning with the next month.

"Tear sheets" will be sent only for 1/2 and full page ads, if requested when ad is submitted.

Business card ads are limited to one per advertiser.

The 3-month rates represent about a 10% discount, the 6-month rates, 20%. Placement requests for display ads: add 15% but call first. Clubs: write for discount rates for meets.



ANTIQUE RADIO CLASSIFIED



EDITOR'S COMMENTS

Another incredible year has gone by — a year of meets, collecting and growth. This 90-page issue, with 24 more pages than a year ago, is indicative of the increased interest in radio collecting and history. The number of classified ads exceeds 650 — another new high, and over nineteen article pages appear. Although there are fewer radio events during the holiday season, we now follow over three-dozen clubs and have announced over 170 meets this past year.

A.R.C.'s circulation growth is shown in the *Statement of Ownership, Management and Circulation*, shown at the bottom of this page (the U.S. Postal Service requires this of all magazines). This statement reports that A.R.C.'s paid circulation for the September 1990 issue was 6,354 subscribers, which is an increase of 1,519 over September 1989. And, A.R.C. is still growing at over 100 new subscribers each month. You — our subscribers — are the driving force for this continued growth! Thanks.

The lead article is our third photo feature on the Atlantic Radio Company. Contributor Ron Boucher escorts us through its exhibits at the May 1922 radio show in Boston, Mass.

George Potter covered the October Vintage Radio and Phonograph Society meet and auction near Dallas, Texas, where the auction totaled over \$35,000! Murray Shapiro reports on another radio auction in Binghamton, New York.

The prototype of a 1939 RCA portable radio is described by Kurt Nauck. Also in these pages, Clint Springer relates his approach to crystal set construction and experimenting.

This issue includes the third chapter of Stan Dryer's "The Antique Radio Boys and the Garrulous Grebe." In real life Stan Dryer is Frank Bequaert of Rainy Day Books. In addition, Part Three of the *Olde Tyme Radio Services Directory* appears along with the popular *Photo Review*.

Over this past year, we at A.R.C. have gotten to know many of you — either in person, by phone or through the mail; we look forward to meeting more of you in 1991.

I join the A.R.C. staff — Betsy, Bobby, Chris, Dave, Dick, Dorothy, Scott and Shirley — in wishing all of you a happy holiday season and a prosperous new year,

John V. Terrey

PRINTED WITHOUT COMMENT

During 1989, A.R.C. received complaints from over 36 individuals who never received paid-for items that had been ordered from Mike Kirby of Panama City, Fla.

We just received documentation of Mr. Kirby responding to a recent wanted ad and receiving payment for the quoted items; after almost three months, the purchaser has received nothing.

ON THE COVER

The cover illustration is from a 1920's vintage postcard in the editor's collection.

Santa is working on his list while listening to an RCA Radiola Model V playing through an RCA Model FH horn speaker. The card reads: "A Merry Christmas. You're in my Christmas circuit, and on the waves of thought. A happy Christmas and New Year to you is gladly brought."

STATEMENT OF OWNERSHIP, MANAGEMENT AND CIRCULATION

(1) Title of publication: Antique Radio Classified. (1B) Publication No.: 37507471. (2) Date of filing: Nov 13, 1990. (3) Frequency of issue: Monthly. (4) Complete mailing address of known office of publication: 498 Cross Street, P.O. Box 2, Carlisle, MA 01741. (5) Complete mailing address of general business offices of the publisher: Same as #4. (6) Full names and complete mailing address of publisher, editor and managing editor: John V. Terrey, 498 Cross Street, Carlisle, MA 01741; Same; Same. (7) Owner: Same. Known bondholders, etc.: None. (9) not applicable.

10.	Extent and Nature of Circulation	Average No. Copies Each Issue During Preceding 12 Months	Actual No. Copies of Single Issue Published Nearest to Filing Date
A.	Total No. Copies (Net Press Run)	7038	8025
B.	Paid and/or Requested Circulation		
1.	Sales through dealers and carriers, street vendors and counter sales	0	0
2.	Mail Subscription (Paid and/or requested)	5641	6354
C.	Total Paid and/or Requested Circulation (Sum of 10B1 and 10B2)	5641	6354
D.	Free Distribution by Mail, Carrier or Other Means (Samples, Complimentary, and Other Free Copies)	933	1142
E.	Total Distribution (Sum of C and D)	6574	7496
F.	Copies Not Distributed		
1.	Office use, left over, unaccounted, spoiled after printing	464	529
2.	Returned from News Agents	0	0
G.	Total (Sum of E, F1 and F2 — should equal net press run shown in A)	7038	8025
11.	I certify that the statements made by me above are correct and complete.	Signature and Title of Editor, Publisher, Business Manager, or Owner <i>John V. Terrey</i>	



WITH THE COLLECTORS

The Atlantic Radio Company – Part III

CONTRIBUTED BY RON BOUCHER

This is the third in a series of articles featuring photographs and information about the Atlantic Radio Company. These articles are made possible through the courtesy of Ron Boucher, who discovered an extensive collection of photographs, original correspondence and advertising materials at an estate sale near Goffstown, N. H.

Part I, in the May 1990 A.R.C., showed photographs of the Atlantic Radio Co. dealership on Boylston Street as it existed in the early 1920s. Part II, in the August 1990 A.R.C., showed more photos of the interior and exterior views of the Boylston Street headquarters.

Here, in Part III, Ron takes us on a whimsical flashback to various radio trade shows, including one held May 3 to 6, 1922, in Mechanics Hall in Boston. Although Mechanics Hall has long since been replaced by the Prudential Center, it lives on in these photographs of Atlantic Radio's trade show setups. (Editor)

This is not your typical article giving technical information on a specific radio or test instrument, nor is it a history of a radio manufacturer or dealer. It is, rather, an invitation to join me on a whimsical, wistful journey to various radio trade shows attended by the Atlantic Radio Co. during

the period 1922-1924. The accompanying trade show photos were carefully chosen to stimulate your imagination as we travel back in time to an antique radio fantasy land!

Look at the eyes of the radio salesmen in the first photo in Figure 1. The salesmen were just staring into the camera, trying to look right for the photograph – a memento of a special event. They seem proud of what they were doing and wanted a record of it. It never occurred to them that in a distant, unimaginable future, countless people would be staring back at them – people who would look at all their latest technical marvels and consider them primitive antiques, people who would collect the very things with which they made their living – radios!

I've often taken a magnifying glass and looked for details in these photos. The fabulous lives I see were simply part of the everyday items of these salesmen. Their displays and booths were the result of hard work, using hand tools, wood, paper and cloth. As noted in Figures 2 and 3, their booths do not look much fancier than what you would see at one of today's local bazaars.

When you look closely at these pictures, it is not hard to get really into them. You begin imagining yourself being there. Can you picture your-



Figure 1. This photo shows the exhibit in the Atlantic Radio Company's store in Boston. It was installed at the Mechanics Building radio show during May 3-6, 1922. It was then reinstalled at the store, where there were demonstrations every afternoon. A few of the items from left to right are: a Federal Type 9 amplifier; an RCA Concert receiver; a Radiola RA receiver; a DA detector; and an AR 3-stage amplifier.

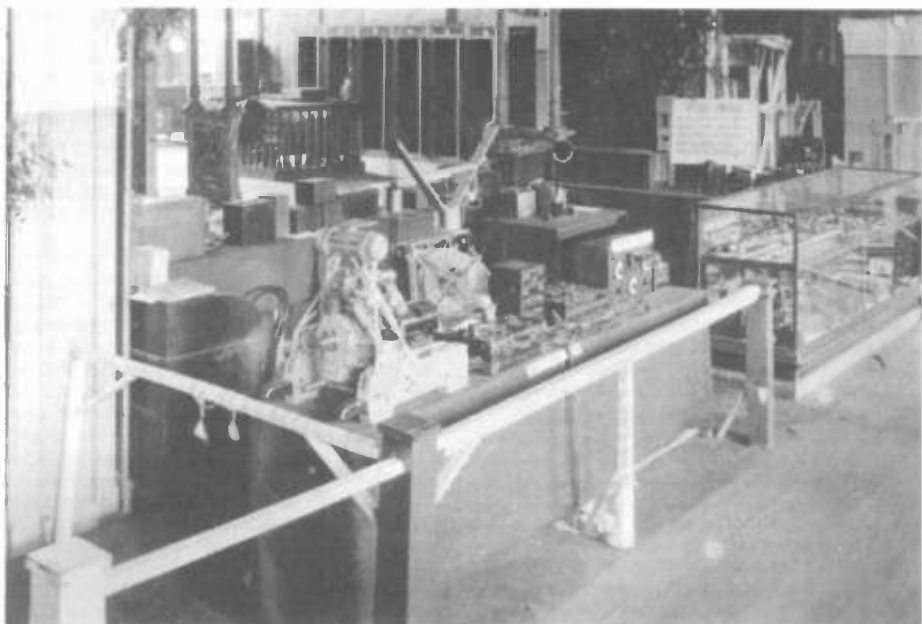

Figure 2. Typical Atlantic Radio display booths under construction. A few of the items from left to right are a Type Q-S-252 gasoline engine generator, a Type Q-S-250 portable transmitter and receiver and a DeForest receiver with coils.



Figure 3. Another view of the Atlantic Radio display booth. Among the items shown here are an IP-501, matching Triode Type B 2-step amplifier, a Clapp-Eastham F.A.R. receiver, an IP-500 with matching Triode Type A amplifier and a 1/2 KW Type Q-S-500 transmitter.

self going back to that time? 1922 is really a long time ago! The end of World War II is 45 years in our past. World War I was only four years into the past of our radio salesmen! They had not even given the war a number because they did not expect a second one.

What if it were actually possible to travel back to 1922? Imagine that time travel was possible, and you had the opportunity to go back to that trade show – only once and for one day! Is your imagination good enough? Let's get ready for the trip!

Those times were much less tolerant than today, so we have to be careful. Our appearance, speech and behavior have to be right. We don't want someone telling the policeman at the door to keep an eye on those "suspicious looking characters." People went to these things in suit coats and ties, so we have to get the right clothing. An antique clothing dealer? No – that stuff would probably fall apart and smell like a basement; we'll have to have a costume made to look and fit right.

With an opportunity like this we're going to want to buy something, so we need money. Remember, our modern money would be counterfeit in 1922. We'll have to go to a dealer who sells old currency; this is getting expensive! Remember, bring nothing modern, no digital watch, no modern eyeglasses, no *Vintage Radio* reference books.

Let's go...

OK, we've arrived. What do we do first? There's so much to see. Do we go to look at the Grebes? the DeForests? Amrads? Wireless Specialty? Clapp-Easthams? Do we concentrate on the rare ones? Do we go to talk to the designers? There's Charles Leutz at the Atlantic Radio booth! What a chance to ask some questions for a historical article! Let's go see if we can find any

rare prototypes on display. How about picking up a case of new WD-11 tubes?

Let's have some fun and go look outside; the world of 1922 is out there. It looks like a Charlie Chaplin movie, only in color, drab colors but still not black and white, and the people walk at normal speed! Is this air really less polluted than in 1990? Look into the restaurants, offices, stores. People are using antiques for everyday work. If we could stick around longer, we could "invent" some things and become famous.

But let's go back in and see some more of what we came here for. Listen to those old radio stations! Horn speakers sound pretty bad on modern stations, but they are much worse with these old stations and their primitive mikes and transmitters. How can these people stand for this? It must really still be a novelty! Let's load up on free brochures; these are great. But calm down, that cop has been keeping an eye on us!

Are you having fun in 1922? Did you notice the prices? The everyday stuff in the stores seems cheap enough, but the radio prices are right up there. But you have to realize that this is still all new technology; remember what computers cost not too long ago?

You have to look at how many work hours it took to buy something then. The actual dollar figure doesn't mean much. You almost have to consider these prices as though they were in a different currency. And besides, these people accomplished less with one hour's work. For example, they worked longer for a loaf of bread than we do in 1990. But, considering how many average work hours it took to pay for one of these radios, they cost a fortune. We're no better off either; we're here spending antique money on these things.

But then again, all this stuff is new and unused with all manuals and original shipping boxes.



Figure 4. Note the elaborate lighting as you enter the display area. The Atlantic Radio Company booth is shown to the left.



Figure 5. The wicker chairs, fringed lamp, and tables tastefully complement the RCA radio receivers in this display. Along with the Music Master horn speaker on the left can be seen an RCA Regenoflex. A Radiola AR-812 Superhet portable with RCA UZ1325 horn and loop antenna is at the center. To the right can be seen a Radiola X receiver.



Figure 6. The Radiola Grand is framed by a trellis, while several Crosleys are prominently displayed on the right. Among the Crosley sets are the Models Ace Type V, Model XJ atop its battery box, Ace 2-step amplifier and Ace Type 3B receiver.

Wouldn't that improve your collection? We could stand to spend some of this money for that.

People at the show are marveling at how advanced this equipment is. This is the leading edge of technology. But it seems so primitive to us. Are you tempted to tell them about jet planes, computers, TVs? Better hold it in; they'll put you away. Merely running a radio from an electrical outlet would be way ahead of this time. A Type 6A8 tube would stop the show.

Well, I guess we'll leave you now, so you can spend the rest of the day where you want. But before we go, how about some advice?

THINGS TO AVOID

- Don't ask for beer at the restaurant (prohibition).
- Don't say, "Boston sure is quiet without Logan Airport."
- Don't laugh too loud when you hear someone talk about the stock market.
- Don't ask, "Are those the original knobs?"
- Don't let your eyes bug out whenever someone gives you some change, and all you see are these great antique coins. And don't exclaim, "They must spend this stuff!"
- Don't ask, "Is there an outlet handy so I can plug this radio in, to try it out?"
- Don't say, "Is that what they looked like when they were new? My refinishing jobs are pretty authentic after all!"

THINGS TO DO

- Warn them about making gears and other parts out of pot metal which was later found to deteriorate rapidly.
- Ask them to put model numbers and manufacturing dates on the radios.
- Have them make a time capsule with radios in it, to be opened in 1990 by Ron Boucher.

Obviously there will never be time machines; someone from the future would have returned to tell us about it! But how can someone collect old radios – or anything else old – and never think about the possibilities?



Figure 7. Various horns and RCA 104 speaker cabinet at the radio show display. Quite possibly a comparison of the old horn technology and the new Radiola 104 speaker. (Photo by Thomas Coke Knight of New York City)

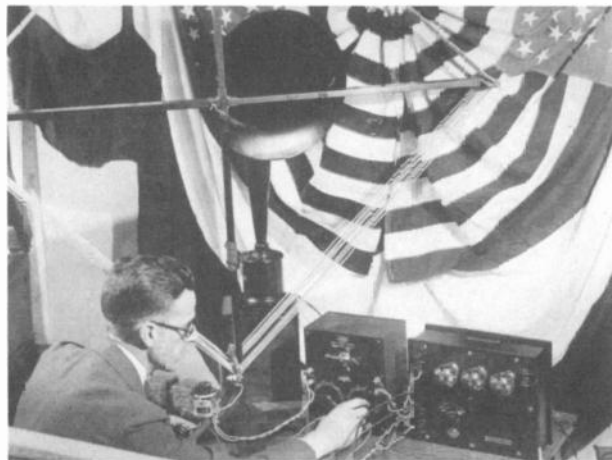

Figure 8. Note the antenna loop used in this working display, to bring in stations on the Radiola crystal set and 7A amplifier.

(Ron Boucher, P.O. Box 541, Goffstown, NH 03045. Ron often has radios for sale, and his lists are sent upon request by writing to this address. Repeat mailings go to people who place orders.)

MEET & AUCTION REPORT

VRPS/AWA Convention and Auction October 19, 1990 - Duncanville, Texas

CONTRIBUTED BY GEORGE POTTER

The Vintage Radio & Phonograph Society (VRPS) and the Antique Wireless Association (AWA) held their Convention '90 on October 19-21, 1990, at the Holiday Inn, Dallas Southwest in Duncanville, Texas. Nearly 300 attended.

Two auctions were held again this year. At Friday's auction, 160 collectors attended and 422 items sold for a total of \$7,527. At Saturday's auction, 210 collectors attended and bought 546 items for a total of \$27,540! The grand totals, new highs, were \$35,067 and 968 items — that's one item every 57 seconds!

Programs on early color TV and one on radio and phonograph values drew crowds. The latter program had all the audience participating, including a number of spouses.

Sunday morning's flea market started early with a packed crowd indoors. An Atwater Kent breadboard 10C, an early Radio Craft Interpanel and several early Moorhead tubes appeared.

The following is a selection of auction items. Some of the high bids were a Pilot 3" TV with original case at \$325, an RCA 621TS TV at \$400, a Philco 70 cathedral at \$325, a DeForest Interpanel at \$850, a Tower ship speaker at \$220, and a Silver-Marshall cathedral at \$200.

e=excellent, vg=very good, g=good, f=fair, p=poor, NT=no tubes

Vacuum Tubes:

01-A's in Triad boxes, g, (3)	\$35
45 tubes, g, (3)	25
200 w/box, g	20
201 brass/tip, g	18
201A Bakelite, g	(2), 12; (4) 33; (4) 38
201A brass/tip Rainbow, g	33
201A, Wards, gold, g, (2)	55
215A peanut, g, (3)	15
Arcturus 26, g, (3)	22
Arcturus Blue, 56, 58, 46's, g, (6)	18
Box of 100+ radio & TV tubes	55
Brass/tip 201, f, (3)	26
Kellogg 401, g, (2)	34
Light bulb, early, tipped, g	26
RCA lighted tube sign	12
Sodion S-13 dud?	25
Spherical audion (original?) double wing w/base and socket	190
UV 199 Bakelite, g, (2)	23
UV-199 w/box, g	16
VT 52, g, (2)	10
WD-11 Bakelite, g, (2)	60
WD-11 Bakelite/tip, w/box, g	35
WD-11 brass/tip in box, dud	24
WD-11 brass/tip, g	55



Consoles lined up for Saturday auction.

Radios/Miscellaneous:

Abbottsware horse radio, g	\$140
Air King plastic, e	48
AK 20 Big Box, g	70
AK 30, f	42
AK 33, g	80
AK 43 w/tubes, g	110
AK 110 console, g	50
AK F-2 speaker, g	70
AK ignition coil, g	24
AK variocoupler	48
Amberola blue wax cylinders, g, (11)	39
Arborphone receiver, g	40
Arvin 440T metal, g	24
Arvin AC/DC metal, white, g	46
Arvin, white metal, g	46
Atlas Type B drivers, g	18
Baldwin driver, g	14
Belmont A-5D118, white, e	75
Brunswick cathedral, g	170
Carborundum detector, g	12
Cleartone tuner in box, e	16
Columbia brown wax cyl., (2)	12
Columbia Graphonola	90
Crosley 50 portable w/tube, f	75
Crosley 50 w/tube	70
Crosley 51, e	160
Crosley 157 Buddy Boy, g	170
Crosley 561 portable, f	10
Crosley Ace 3B, g	55
Crosley car radio, metal, e	75
Crosley cathedrals	e, 160; g, 125
Crosley cone speaker, g	30

(Continued on following page)

(VRPS Auction, continued)

Crosley Duette, purple plastic, g	42
Crosley Fiver, g	46
Crosley Showbox w/speaker, g	120
DeForest 3-coil unit, e	40
DeForest 1919 catalog, g	75
DeForest Interpanel w/tubes, g	850
Dictograph horn, e	85
Edison business cyl. phono	60
Edison cylinder shaving machine, g	150
Edison Music Machine catalog	22
EICO cats whisker	25
Emerson bank, metal	28
Farnsworth end table radio, f	40
Federal 1920's microphone, g	44
Garod 5A2, restored	44
GE 61 cathedral, g	100
Globe transistor map radio	24
Gloritone cathedral, f	48
Grunow 470 semi-cathedral	45
Guild Country Belle telephone radio, g	70
Guild Town Crier novelty radio	70
Hallicrafters S-38, f	26
Hallicrafters S-80, e	45
Hallicrafters S-94, f	17
Hallicrafters S-108, g	38
Hallicrafters S-120, f	20
Hallicrafters Sky Buddy, f	32
Hallicrafters SX-17, f	65
Hallicrafters SX-85, g	26
Hammarlund HQ receiver, g	60
Home brew xtal set, e	60
Hopalong Cassidy, red, g	160
Jackson Bell cathedral, g	95
Jefferson tube rejuvenator	24
Jessie French cathedral, g	190
Jewel tube checker, early, g	44
Kolster K-6, f	44
Little Wonder mike w/box	15
Logodyne battery receiver, f	80
Loose coupler, early, g	150
Magnavox horn only, g	24
Magnavox R3B horn, g, (2)	100 & 120
Magnavox spkr. w/power supply, ornate, e	42
Majestic 50, 1932, g	190



This Tower ship cone speaker sold for \$220.

Manhattan wood speaker, f	190
Merry-Go-Sound phono, g	110
Midway Tiny Tone xtal set, in box	60
Minerva 1940's mahogany radio, g	24
Motel coin-op radio, f	24
Motorola 57X plastic, g	25
Motorola 77X M21, AM/FM, plastic, g (2)	25 & 25
Motorola AM/SW, 1930, g	20
Motorola Catalin, cracked	350

Murdock 358 phone condenser w/box	14
Music Master, wood, speaker, g	48
Na-Aid midget cone speaker, in box	50
National FB7, f	50
National HRO, e	120
National speaker, g	24
Neutrowound, parts set	26
Nipper salt/pepper shaker	20
Operadio speaker, metal	39
Peerless speaker, wood	44
Philco 20 cathedral, (2)	f, 90; g, 185
Philco 38-35 tombstone, g, (2)	60 & 60
Philco 38-62 restored, g	40
Philco 41-221, SW, g	32
Philco 51-924 AM/FM plastic, f	10

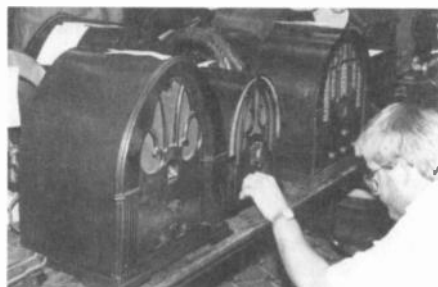

A variety of nice cathedrals in the auction.

Philco 60 battery cathedral, (2)	f, 50; g, 130
Philco 70 cathedral, e	325
Philco 75 tombstone, e	65
Philco 84 cathedral, g	120
Philco 89, f	70
Philco 90 cathedral, e	375
Philco A-36 table radio, g	60
Philco AC-DC 38-35, f	22
Philco Baby Grand, cathedral	160
Philco Bing Crosby phono	160
Philco Jr. cathedral, g	85
Philco lowboy console, g	70
Philco midget cathedral	50
Philco Model 1201 radio/phono., g	80
Philco Predicta TV, 17", g	100
Philco Transitone, wood, f	10
Philmore xtal set w/box, g	41
Pilot 3" TV w/case, e	325
Pilot coils, (3)	14
Plastic radio bank	18
QSTs, 1922, (8)	24
Quack spark xmtr., f	28
Radio Service Repair sign, original	80
Radiotron tube design manual	16
Radsco 1926 catalog	10
RCA 9T tombstone	75
RCA 9TC41 projection TV, remote, g	200
RCA 55X, f	15
RCA 61-3, f	16
RCA 77X7 Catalin, g	280
RCA 78 rpm turntable	16
RCA 100 speaker, g	32
RCA 100A speakers, (5)	e, 60; g, 38; g, 55; g, 60; g, 25
RCA 103 speakers, (3)	e, 90; f, 45; f, 45
RCA 106 speakers, lowboy, g, (2)	75 & 80
RCA 621TX, e	400
RCA cathedral, 1933, e	190

RCA console, f.....	22
RCA Model 1433 console, 1934, e.....	290
RCA Radiola 16 w/tubes, g.....	140
RCA Radiola 17, g.....	65
RCA Radiola 18, g.....	75
RCA Radiola 20, w/tubes.....	200
RCA Radiola 21, g.....	70
RCA Radiola 25 w/antenna, g.....	95
RCA Radiola 26 w/tubes, e.....	230
RCA Radiola 33 w/spkr., g.....	90
RCA Radiola 44 w/tubes, g.....	100
RCA Radiola 60, g.....	90
RCA Radiola 80 console, e.....	150
RCA Radiola advertisement, standup.....	44
RCA Radiola III, g, NT.....	55
RCA Radiola III-A, NT, e.....	140
RCA Radiola Regenoflex, NT, e.....	150
RCA Radiola UZ1325 horn, g.....	100
RCA Service Data, 1938-42.....	18
RCA Service Notes 1934/36/38-39, g.....	55
RCA sign, lighted, modern.....	10
RCA Victor RE 45 rpm phono, e.....	150
RCA Victor Service Notes, 1933, (3).....	30
RCA X-11 Bakelite.....	13
Rider's Vol. 12 & 13.....	29
Robot transistor radio w/clock, e.....	50
Rocket xtal, in box, e.....	65
Royal transistor radio w/box, g.....	14
Sears radio catalog, 1929.....	20
Signal Corp buzzer key, 1917, g.....	55
Silver-Marshall cathedral.....	200
Silver-Marshall console, g.....	48
Silver-Marshall console, g.....	75
Sparton lowboy, g.....	190
Superior Inst. Co. tube checker, f.....	10
Thordarson, 1/2KW, g.....	60
Tom Thumb camera radio, g.....	120
Tower ship speaker, e.....	220



A Clapp-Eastham HR, a Wards Tri-City one-tube and a Metz Beer radio going to the auction.

Truetone tele-dial console, g.....	50
TV plastic salt/pepper shaker.....	10
Ultratone cathedral speaker, g.....	50
Victor VV-VI phono, g.....	140
Wards 1926 catalog.....	24
Watterson 1940 farm set.....	10
WE headphones, (2).....	20
WE tube checker, g.....	25
Westinghouse Aeriola Sr., NT.....	95
Westinghouse refrigerator style radio, f.....	28
White porcelain rheostat, early, g.....	28
Zenith 3R, e.....	450
Zenith 805 cathedral, e.....	195
Zenith 5808 console, restored.....	250
Zenith AH cathedral, e.....	190
Zenith black dial console.....	75
Zenith console 1934, g.....	80
Zenith Owl portable, e.....	55
Zenith tombstone (F.O.S., p. 195).....	145
Zenith tombstone 6S229, g.....	80
<i>(George Potter, P.O. Box 165345, Irving, TX 75016)</i>	

Radio Auction

October 4, 1990 - Binghamton, New York

CONTRIBUTED BY MURRAY SHAPIRO

An estate auction at the former home/neighborhood bar of an antique radio collector included over 60 radios and test equipment from 1923 to 1960+. Bob Connelly conducted the auction on a stormy evening on October 4, 1990, in Binghamton, New York. Over 100 people attended the auction held under two open tents after heavy rain and in 50-degree weather. Some auction highlights appear below:

e=excellent, vg=very good, g=good, f=fair, p=poor

Vacuum Tubes:

Older types, 5, 6, 7-pin, lg. box, new/used ...	\$15
TV type tubes, 2 boxes, new/used.....	each, 15
TV type tubes, 2 boxes.....	1 & 17.50

Radios/Miscellaneous:

AK 20 & AK L horn spkr, 1-tipped tube, vg...\$75	
Edison Model A cylinder phono, w/o horn....	150
Emerson U5S, dirty but all original, vg.....	35
ERLA Thorola Model 58, doughnut coils, console, battery drawer, very nice w/tubes..	12.50
Freed-Eisemann NR-20, w/tubes, vg.....	25

Heath IT-12 signal tracer, g.....	2.50
Heath scope, early, g.....	5
Hickok 288-X signal generator, complete.....	5
Hickok 600 tube tester, in red case, vg.....	15
Kenman Five, w/tubes, vg.....	35
Majestic brown Bakelite, curved Deco, vg.....	30
RCA console R-1 w/rcvr. unit RC3, nice, slight veneer chip.....	25
RCA Radiola Superheterodynes, w/o handles:	
(1) with 4 type UX99 tubes, vg.....	45
(1) with 6 type UX99 tubes, vg.....	35
Setchell Carlson 427, maroon w/white trim, plastic, like new.....	50
Supreme TW-11 tube tester, g.....	17.50
Table lots: WWII electronic equip., test equip., radios w/o cabinets and misc. items.....	each, 10
Thompson Neutrodyne, 3-dial, w/tubes, vg.....	60
Zenith 5-G-601-M, sailboat grille, w/o handle, g.....	15
Zenith Trans-Oceanic, black (2):	
(1) dirty but complete.....	50
(1) vg complete.....	42.50

(Murray Shapiro, 2931 Northwood Dr., Endwell, NY 13760)



WITH THE COLLECTORS

The RCA 1939 Portable Prototype

BY KURT NAUCK

The RCA portable radio pictured in Figure 1 is owned by Joyce Bates, whose father was employed by RCA from 1930 to 1940. According to Joyce, RCA developed this prototype radio to meet the steady demand for smaller, lighter portable radios.

This radio was formally introduced at the 1939 World's Fair, held in Flushing Meadows, New York. Because her father worked in research and development, Joyce had the privilege of demonstrating the prototype at the RCA display. She reports that the set enthralled the public. However, before production could actually begin, America entered World War II, and the project was shelved.

IDENTIFICATION

Although no model number appears on or inside the radio, the number 20 is written on several parts of the chassis, which could indicate that at least twenty were produced. In Figures 2 and 3, you can see the number 20 on the variable gang condenser and on the chassis frame.

Scribe marks are also located around screw holes and joints.

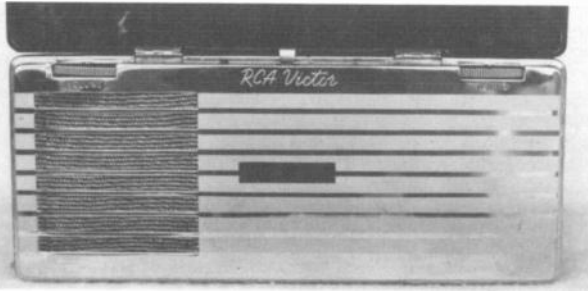

Figure 1. The front panel of the RCA prototype set with the cover lid in the open position. Note the spring-loaded cover tab above the RCA label. This activates the on/off switch when the lid is opened and closed. The metal case is 3" x 3.5" x 9", with black leatherette covering, plastic lid and chrome-plated front. A carrying strap once attached to one end of the case is now missing.

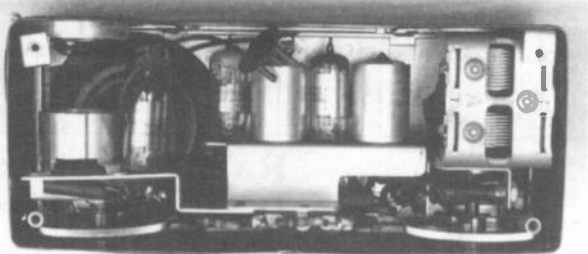

Figure 2. Rear interior view of the RCA portable prototype radio with the metal back cover removed.

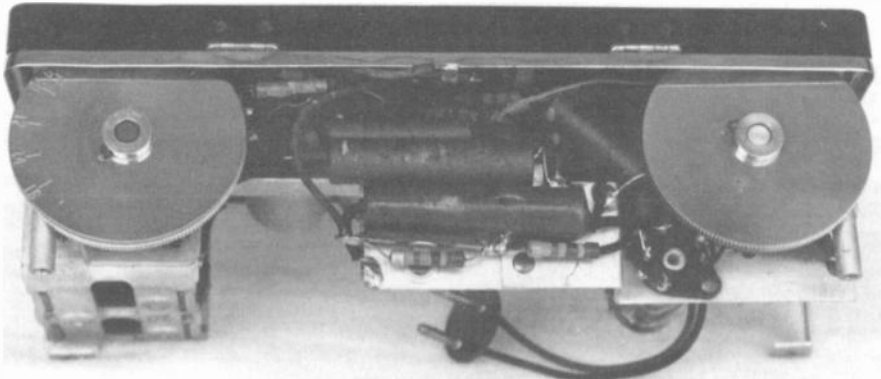

Figure 3. Another interior view of the RCA portable showing the tuning and volume control wheels.

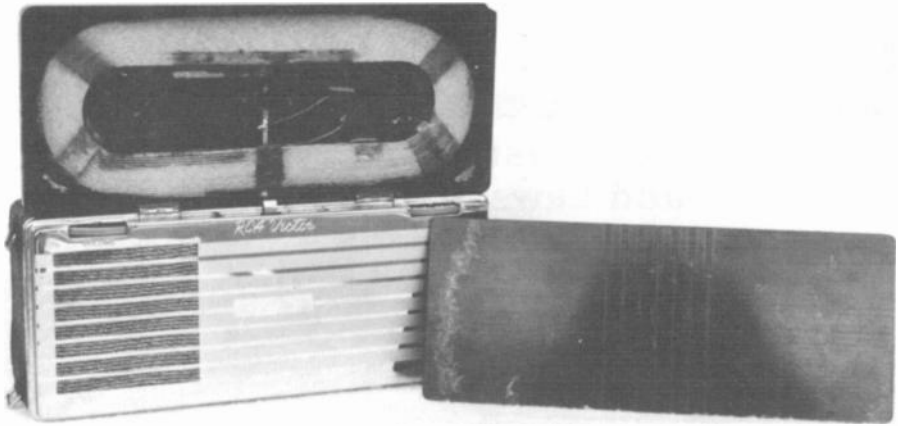

Figure 4. The RCA portable with the cover lid up and its panel removed showing the loop antenna.

These marks obviously indicate that this is a prototype radio and not a production set.

In Figure 4, the lid is up and the lid cover is off, showing the otherwise covered loop antenna.

I appeal to A.R.C. readers for more informa-

tion on this historically significant prewar portable receiver.

(Kurt Nauck, 1940 E. Allegro, Houston, TX 77080)

The RCA Model BP-10 Portable

The RCA Model BP-10 seems to be the production version of the prototype set in the accompanying article. The RCA Victor Service Data "Red Book," Volume II, 1938-1942, pages 297-C and 298-C, indicates that, during its production, several significant changes were made in Model BP-10, shown below. These changes included power switch assemblies, speaker designs and mountings, as well as moulded lid and loop antenna assemblies.

A 1941 model of the BP-10 is shown in *Flick of the Switch*, page 157, and a 1940 version, with no model number, appears in *A Blast from the Past*, page 280. In both models, the dials are on one end, instead of on top of the set, as noted in the prototype. Interest-

ingly, the 1940 model has the carrying strap located at the speaker end, while the 1941 model BP-10 has the carrying strap on the end where the dials are located. In each case, it is probable that the sets may have been produced in the fall of the year prior to the advertised "model year."

Are there A.R.C. readers "out there," who know of any other production versions of Joyce Bates's prototype? We would appreciate receiving information and photographs, preferably in black and white, showing the same angles that appear in the above article, for effective comparisons.

If reader response warrants, we will feature additional production designs in an RCA portable prototype sequel. (Editor)

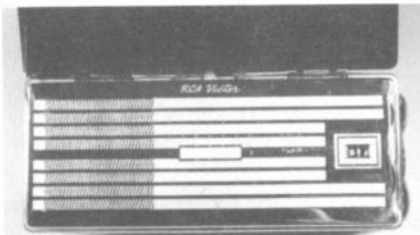

Front panel view of the RCA Model BP-10 production radio. Compare this set with Figure 1 of the prototype portable.

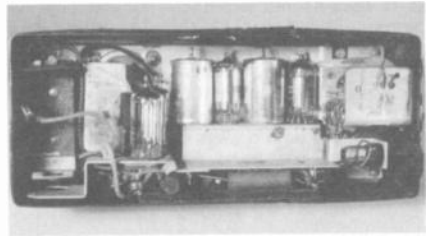

Rear interior view of the RCA Model BP-10 production radio. Compare this set with Figure 2 of the prototype portable.

WITH THE COLLECTORS

The Demonstrator Crystal Set and Laws of Tinkering

BY CLINT SPRINGER

"The difference between a man and a boy is the price of his toy," my wife has said more than once. She may be about right. Others suggest that most senior citizens get to a stage of second childhood, but some of us never left the first one!

Whatever category you may fit, chances are you're interested in crystal set radios or you would not have even seen this article. So much has been said lately about the lowly mineral detector used in crystal sets, why shouldn't I add my nickel's worth to the commentary?

Carl Ferdinand Braum, a German physicist, discovered in 1874 that certain crystal substances have the very peculiar phenomenon of rectification. Evidently General Henry Harrison Chase Dunwoodie in 1906 was the first to obtain a patent on such a detector. This device used carbondum (a trade name for a compound of carbon and silicon). This compound was used by the De-Forest Company in 1913, after the "Responder" was determined to be an infringement on the patent Fessenden had been granted for his electrolytic detector. Most crystal detectors were too unstable for commercial use at that time.

THE DEMONSTRATOR

Now that we know the *when* and *who*, a little dab of *how* seems expedient. I have built an arrangement called "The Demonstrator," (see Figure 1), which allows jumper changes to demonstrate the different crystal set circuits. The schematic of the Demonstrator is shown in Figure 2.

The unit will tune a ways on either side of the standard broadcast band. A few possibilities are listed:

1. Fundamental: 1 to 11; 2 to 7.
2. Improved: 1 to 10; 2 to 9.
3. Link Coupled: 1 to 4; 2 to 3; 5 to 9; 6 to 10.
4. Direct Coupled: 1 to 4; 3 to 8; 2 to 7.
5. You can think up a number of others.



Figure 1. The Demonstrator crystal set.

After building and testing the apparatus, my "Laws of Tinkering" were observed. For your benefit and instruction these laws, although not found in any other radio book, are now printed for the benefit of all mankind.

SPRINGER'S LAWS OF TINKERING WITH CRYSTAL SET RADIOS

1. A crystal set radio works, but not too well.
2. Some circuits work better than others, but not very much better.
3. You can probably tune in several stations, usually two at a time.
4. Your spouse will keep insisting that your time could be better spent. She/he is probably correct.
5. Regardless of the preceding, periodically you'll get the urge to build and/or test another set.

I, therefore, wish you good health and happy tinkering for many years to come. Who knows, one of you may find a circuit that breaks one of the above laws. If so, please let me know.

(Clint Springer, Route 11, Box 243-C, Tyler, TX 75709)

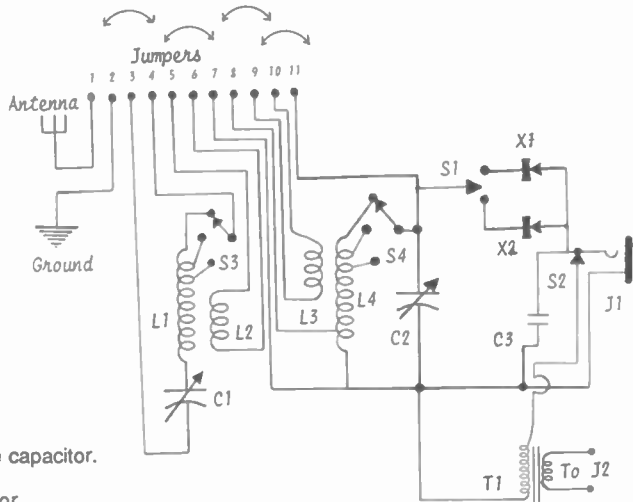

L1, L4: 120 turns with taps at top, 40 & 80 turns down. L4 has a tap at 20 turns up from bottom.

L2, L3: 20 turns each, overlapping coils with paper in between.

C1, C2: 365 pfd variable capacitor.

C3: .005 bypass capacitor.

X1: Galena Cats Whisker.

X2: Germanium Diode (1N34)

S1: DPDT crystal selector.

S2: A part of J1.

S3, S4: Tap selector (homemade)

J1: Phone jack with disconnect switch.

J2: Standard phone jack.

T1: Output transformer for 8-ohm headphones.

Figure 2. The Demonstrator crystal set radio diagram.

Construction Tips

For those readers who may wish to construct the Demonstrator, I have provided the following guidelines. However, I should stress that most of the parts are arbitrary, both physical and electrical. But, as "Springer's Laws of Tinkering with Crystal Set Radios" indicates, if you are somewhere in the ball park, it probably won't make a lot of difference anyway.

The cabinet I designed is 10.5-inches wide, 8-inches tall, and 8-inches deep. The construction is of one-inch oak board at the top and bottom, oak posts at each corner, and quarter-inch oak plywood for the front and sides. The solid top, bottom and posts are decoratively routed, but the coil-tap knobs are fashioned from round cabinet knobs. The tap contacts are cut from tin, the knobs having springs inside the cabinet to make them rigid enough to stay in place. In this design, some parts are constructed directly into the cabinet. However, a slide-in chassis might be more advantageous.

The tuning capacitors are single gang, 365 pfd. The ones used in my set are rather small physically, and were bought from Radio Shack, but I don't think they are available now. Those taken from an old junked-out TRF radio are ideal, but usually physically larger.

The best headphones in early days were

rated at 3,000 ohms, and that was their actual DC resistance. For modern low-impedance headphones, any output transformer designed for a single-ended vacuum tube will work, the secondary of which should have an eight-ohm tap. One designed to load a type 6V6 tube at about 5,000 ohms would be ideal.

The coils are wound on 1.5-inch outside diameter pvc plastic pipe, and the wire is 22 gauge or smaller, standard enameled. At the rear of the set, I placed a setscrew terminal strip, and spadelug jumpers are used to choose (demonstrate) the different circuit arrangements. At the front you will notice the galena crystal and cat whisker, homemade, and the switch below that selects either the cat whisker or the small diode inside the cabinet.

As a rule of thumb, an outside antenna as long and as high as you can construct is desirable, although the optimum length would be about one hundred feet, including the lead-in wire. An antenna longer than that tends to become directional off the end, and would reflect a gain only to stations in that direction. A good earth ground is necessary. Your antenna should be from twelve or fourteen gauge wire, although whether it is stranded or solid is of little consequence. (Bear in mind that all my statements relate to the standard broadcast band.)



PHOTO REVIEW



This column presents in pictorial form many of the more unusual radios, speakers, tubes, advertising, and other radio-related items (covering the years 1900-1950's) from our readers' collections. The photos are meant to help increase awareness of what's available in the radio collecting hobby. Send in any size photos from your collection. Photos must be sharp in detail, contain a single item, and preferably have a light-colored background. A short description must be included with each submitted item. Please note that receipt of photos is not acknowledged, publishing is not guaranteed, and photos are not returned.

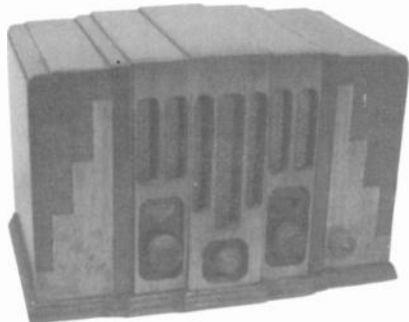

RCA 115 - The unique off-set knob is an application of an Art Deco rule - expect the unexpected. The 1934 Model 115 represents one of the true Deco designs put out by the usually conservative RCA Victor Co. (Fred Geer - Jacksonville, FL 32210)

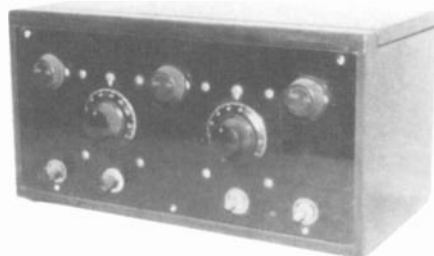

KODEL MODEL C13 - In 1924, Kodel produced this three-tube reflex set with two compression condensers for tuning. It has a well marked panel and terminal connection tags, a trademark of Kodel. (Walter Worth - Wollaston, MA)



WIRE RECORDER - This is a Silvertone wire recorder sold by Sears & Roebuck Co. in the late 40s. The wire take-up spool also functions as a 78 rpm turntable. (Mike Adams - Scotts Valley, CA)



PARIS CRYSTAL RADIO - This crystal set was made in the 1920s by the Paris Radio Products Company of Philadelphia, Pa. The radio is in a metal can painted green. Its original box is covered in red paper with the original label. It is about 4-1/4 inches in diameter and four inches high. (Erich E. Brueschke - Hinsdale, IL)

PHOTO REVIEW



THREE-WAY PORTABLE - The Stewart Warner Mocol A61P1 is a six-tube, three-way portable with built-in battery charger. Manufactured in 1947, this radio has a black leatherette-covered case and a handle that looks like that of a Zenith Trans-Oceanic. (Walter Worth - Wollaston, MA)

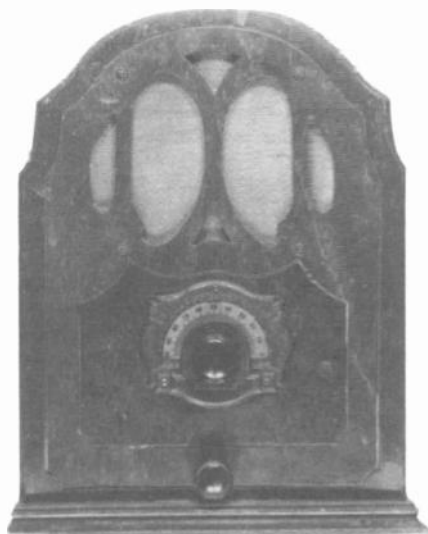

MIDGET CATHEDRAL - This Steinite is thirteen inches tall. It has a two-tone effect finish on the cabinet. It is a five-tube TRF receiver. The dial escutcheon is identical to that of the Avalon cathedral that appeared on the October 1987 cover of A.R.C. Steinite was made by the Warwick Mfg. Co. which produced some 40 trade names including Beverly, Clarion, Steinite and possibly Avalon. (Curtis P. Schreiber - Rochester, MN)



MCMURDO CONVERTIBLE - This classic console was manufactured by McMurdo-Silver as the 1935 Masterpiece VI. It can be played with the speaker doors wide open, or closed with the center panels partially open, with or without the top chassis cabinet, with the chassis cabinet doors retracted, with the top cover lid open, or with the chrome-plated chassis fully exposed atop the massive speaker cabinet. (Robert Gates - Mendham, NJ)





Olde Tyme Radio Services Directory 1990 A.R.C. Edition, Part 3

COMPILED BY ANDREW MOORADIAN, 5 PRISCILLA LANE, WINCHESTER, MA 01890

Antique Radio Classified has obtained permission from Andrew Mooradian to serialize the latest edition of his "Olde Tyme Radio Services Directory," with a few additions entered by A.R.C. Every month or so, another excerpt will be printed in A.R.C.

With the help of readers, A.R.C. hopes to make this directory the most comprehensive list of radio services available. Write to A.R.C. if you have a service you can provide, if you know of one that you can suggest, if you wish to change or delete your listing, or if you have any other suggestions. The 1990 edition of his directory contains 74 service categories with 249 entries, plus a list of radio clubs (some suppliers appear in several categories). A copy of the directory can be obtained by sending \$2.50 to Andrew Mooradian at the above address. © 1989 by Andrew Mooradian.

When writing to a service listed, please include a long SASE for reply and tell them that you saw their listing in the *Olde Tyme Radio Services Directory* in A.R.C.!

Within each category, the listings are alphabetical by two-letter state code.

INVENTORY SERVICE:

DRK Computer Consultants
886 Eggert Dr.
N. Tonawanda, NY 14120
(716) 692-3455

KNOB DUPLICATION:

Larry Bordonaro
5744 Tobias
Van Nuys, CA 91411

Edward Delano
4923 Ridgeview Ln.
Bowie, MD 20715
(301) 464-2303
(wood knobs only)

Alan Jespersion
P.O. Box 17338
Minneapolis, MN 55417
(612) 727-2489
(Zenith knobs only)

Tesla Electronics
835 Bricken Pl.
St. Louis, MO 63122
(wood knobs only)

METAL PARTS FABRICATION:

Tesla Electronics
835 Bricken Pl.
St. Louis, MO 63122

METERS/REPAIR & CALIBRATION:

Leonard Cartwright
113 Sea Terrace Way
Aptos, CA 95003
(408) 662-2977

Steven Pazar
4950 Deerwood Dr.
Santa Rosa, CA 95403

MIRROR RESILVERING:

Clear Impressions
1160 N. Eastman Rd.
Kingsport, TN 37664
(615) 246-5471

Olympia Mirror Resilvering Co.
1609 Springwood Ave.
Olympia, WA 98506

MISCELLANEOUS ITEMS:

Gerald Schneider
8750 Georgia Ave. Suite 1410-B
Silver Spring, MD 20910
(301) 656-3840
(videotape on radio collecting)

Alan Jespersion
P.O. Box 17338
Minneapolis, MN 55417
(612) 727-2489
(Zenith logo tee shirt)

Tesla Electronics
835 Bricken Pl.
St. Louis, MO 63122

Sue Bunis
RR1, Box 36
Bradford, NH 03221

Michael Sabodish, Sr.
28 Middlesex St.
Matawan, NJ 07747
(tie clasps & lapel pins)

Vintage TV & Radio
3552 West 105 St.
Cleveland, OH 44111
(216) 671-6712
(needlepoint kit of Nipper)

Dick Kaduce
940 Gilbert St.
Eau Claire, WI 54703
(715) 834-6020
(hats, shirts)

MUSEUMS:

(Since most museums are private, please contact the museums before visiting.)

Foothill College Museum
12345 El Monte Rd.
Los Alto Hills, CA 94022

Ralph Muchow
107 Center St.
Elgin, IL 60120
(312) 742-0183

Antique Wireless Association Electronic
Communication Museum
Village Green, Routes 5 & 20
East Bloomfield, NY
(716) 657-6260

Voice of the Twenties Museum
Ralph Williams
Rt. 1, Box 44, Main Rd.
Orient, NY 11957

N.E. Wireless & Steam Museum
Tillinghast Rd.
E. Greenwich, RI 02818
(410) 894-1710

NAMEPLATES:

G & M Design Service
P.O. Box 23730
Jacksonville, FL 32241

PARTS/RESTORATION SUPPLIES:

Antique Electronic Supply
6221 S. Maple Ave.
Tempe, AZ 85283
(602) 820-5411

Circuit Specialists
P.O. Box 3047
Scottsdale, AZ 85257
(602) 966-0764
(capacitors, resistors, etc.)

Sue Coulter
4200 Prince St.
Bakersfield, CA 93301

Daily Electronics
P.O. Box 5029
Compton, CA 90224
(213) 774-1255
(tubes only)

Stan Lopes
1201-74 Monument Blvd.
Concord, CA 94520

The Critics Choice
39120 Argonaut Way, #195
Fremont, CA 94538
(415) 797-2733

Yeary Communications
12922 Harbor #800A
Garden Grove, CA 92640

Norman Braithwaite
PO Box 2443
Redding, CA 96099
(916) 246-4209
(E.H. Scott parts only)

Gilbert Smith
248 So. 36th St.
San Diego, CA 92113
(619) 233-8646
(AC parts only)

E&E Enterprises
954 Johnston Dr.
Aurora, IL 60506

Steinmetz Electronics
317 Pulaski Rd.
Calumet City, IL 60409
(219) 931-9316

C. Elmer Nelson
11 S. Church St.
Princeton, IL 61356

Midwest Supply Electronics
1165 Lafayette Ave.
Terre Haute, IN 47804
(812) 232-0187

Formulation Development Laboratories
14110 W. 107th St.
Lenexa, KS 66215
(cleaning & refinishing products)

Artell-Guy Co.
Accessories & Parts Div.
P.O. Box 52645
New Orleans, LA 70152-52645

Tyger Electronics
P.O. Box 750
Clinton, MD 20735
(301) 248-7302

Olde Tyme Radio Co.
Howard Granoff
2445 Lyttonsville Rd.
Silver Spring, MD 20910
(301) 585-8776

Mark Oppat
167 Caster
Plymouth, MI 48170
(special volume controls)

Jim Farago
P.O. Box 6313
Minneapolis, MN 55406
(612) 722-0708

Craig J. Larson
2122 45th Ave. NE
Minneapolis, MN 55421

Frontier Antiques
Box 38
Lehr, ND 58460
(701) 378-2341

Frank Krantz
100 Osage Ave.
Somerdale, NJ 08083
(609) 783-0400

Eddie Electronics
2700 Hempstead Turnpike
Levittown, L.I., NY 11756
(516) 735-3330

Vintage TV & Radio
3552 West 105 St.
Cleveland, OH 44111
(216) 671-6712

(To Be Continued)



"Terry was right. He had gone barely a hundred yards down the drive, when the woods behind him were lit with the glow of an electric arc."



RADIO ADVENTURES

The Antique Radio Boys and the Garrulous Grebe – Chapter 3

BY STAN DRYER

The story so far: The Antique Radio Boys – Terry Johnson, Jimmy Carver and Gary Staunton – rescue Lucinda Beaucart from a fire and save the radio collection belonging to her millionaire father, Frank Beaucart. A Grebe CR-4 is missing and their search for the suspected thief, Verton Gridelek, takes them to the barn of the bully, Barton Sneer, where they barely escape when a disk-scanning television set is pushed down the stairs they are ascending. Consulting with the government agent, Dick Wood, they discover that the evil Dr. Krull may be trying to corner the market on CR-4's. With the excuse of helping Krull's daughter Karmella with her act for the Old Tyme Radio Performance Competition, Terry visits Krull Castle. While searching for the missing CR-4's, he is discovered by Dr. Krull. One of Krull's goons grabs him and forces him to the edge of a pool full of alligators.

"You'll never get away with this," cried Terry defiantly. "My friends know exactly where I am." Krull laughed, a sound as ugly as a motorboating amplifier. "I just hope your friends come looking for you," he said. "More tasty morsels for my pets."

With an impatient nod of his head, he indicated that his henchman should push Terry into the pool. But before the man could act, the door to the room burst open and Karmella rushed in. A quick glance at Terry told her the situation.

"Daddy!" she cried. "You stop that this minute!"

Krull raised his hand, and the goon pulled Terry a couple of inches back from the pool.

"Now Karmella," said Krull, "this is none of your affair."

"It is too," Karmella screamed at her father. "You promised me you wouldn't feed any more of my dates to your alligators."

"Oh," said Krull, his voice full of slimy unction, "I never realized he was your friend." And to the goon, he barked, "Release him!"

Reluctantly, the goon let go of Terry.

"Terry came over to help me practice for the Old Tyme Radio Performance Competition," said Karmella.

"But I've explained to you," said Krull with an evil smile, "you do not need to practice. I guarantee you will win."

"I don't need your help," Karmella sneered at her father. She grabbed Terry by the hand. "Come on," she said, "let's finish my rehearsing."

"Daddy can be a real naughty at times," said Karmella, as she led the way back to the Music Room. She sat down on the couch and patted the seat beside her. "Come sit and let's chat."

Reluctantly, Terry seated himself. "Your father does show a lot of disrespect for our radio heritage," he said. "He shouldn't have fed those radios to the alligators."

"Oh, those are just old Catalins and stuff," said Karmella. "Daddy wouldn't destroy a really good old radio."

"You mean like a Grebe CR-4?" asked Terry.

Karmella, who had been leaning close to him, jerked away as if she had stuck her finger on a B+ supply terminal. "What do you mean by that?" she demanded.

"Oh nothing," Terry replied. "I mean a CR-4 is a typical, valuable old radio."

"I don't know anything about any CR-4's," said Karmella. The obvious deceit in her voice confirmed Terry's suspicions. This young lady knew plenty about the missing Grebes.

Terry was faced with a dilemma. He knew he should put his arm around Karmella, kiss her once or twice, and after vowing his love for her, try to wheedle from her the location of the radios.

But that kind of prevarication was not in the nature of this straightforward lad. He would no more tell a girl untruthfully that he loved her than misrepresent the pedigree of an antique radio to a customer.

He glanced at his watch. "I'm awfully sorry, Karmella," he said, "but I've got to get home. I have to get my notes together for the Carlisle High Antique Radio Club meeting tomorrow."

"Can't you forget your old radios for just a few minutes?" Karmella pouted.

But at the door, she smiled up at him. "Hope you can come again sometime," she said, her voice filled with promise."

Terry hurried to the spot where he had concealed his bicycle. A cloud obscured the moon, but he saw the dim shape of his bicycle in the woods. As he was about to grasp the handlebars, the moon came out from behind the cloud, and he saw that the bicycle was suspended from a tree by what looked like insulated wires!

It took him but a moment to discover that a wire led from the bicycle frame to the high tension end of a large arc transmitter coil hidden in the bushes nearby. Terry quickly found and opened the knife switch controlling the power to the primary coil. He freed his bicycle and detached the high tension wire from its frame. He then ran this wire back and wrapped it around the handle of the knife switch. When Krull's henchman discovered he had escaped, they would most likely turn on the switch to see if the coil was working properly!

(Continued on following page)

(Radio Boys, continued)

Terry was right. He had gone barely a hundred yards down the drive, when the woods behind him were lit with the glow of an electric arc. A sizzling sound and a cry of pain informed him that his rewiring had achieved its purpose.

Terry pedaled furiously to Agent Wood's barn where Gary and Jim were waiting. He quickly filled them all in on the events of the evening, including the rewiring of the transmitter coil.

"I guess that henchman of Krull's was really burned up when he found you had escaped," said Gary.

"I'm afraid that I've failed in my quest," said Terry, too down to respond to the pun.

"Not a bit," said Dick Wood. "The events at Krull Castle this evening have erased any doubts in my mind that Krull is the man behind the disappearance of the CR-4's."

"I agree," said Jim to Terry. "You've performed a risky assignment and come away with valuable information."

"But he missed his chance to kiss Karmella Krull," said Gary.

"That's too much," cried Terry. "Come on, Jim." The two Antique Radio Boys grabbed the protesting Gary and tumbled him onto the floor where they sat on his back until he cried "Uncle" and promised to mend his ways.

"Now we must get serious," said Agent Wood. "Krull and his associates are dangerous men who will stop at nothing to achieve their nefarious ends. I want you boys to say nothing to anyone of the events of this evening, nor of what we have learned or what we suspect."

The three lads gave their solemn promises before they headed home to bed.

Terry had the honor of introducing the guest speaker at the Carlisle High School Antique Radio Club the next afternoon.

"We are pleased," he said, "to have as a speaker a renowned authority on the history of radio. He is well known for his erudition and integrity in the field. Today he will be speaking to us on Lee DeForest's development of the triode vacuum tube, which can truly be said to be the foundation of modern radio. It gives me great pleasure to introduce Douglas Allenby."

As those of you who have read *The Antique Radio Boys at Canandaigua* know, our three chums had heard Douglas Allenby lecture on a previous occasion. They were looking forward to a clear and articulate presentation of a most interesting subject.

They were sadly disappointed. Allenby seemed distracted during his talk. He hesitated a great deal and lost his train of thought several times. The applause when he finished was less than resounding.

"A most interesting talk," said Terry. "Now are there any questions?"

When no one else came forward, Gary raised his hand. "Wouldn't you say," he asked, pointing to the diagram of a triode tube on the blackboard, "that this was DeForest's prime evil?"

The audience groaned at this bit of humor, but no smile crossed Douglas Allenby's features.

The three Antique Radio Boys escorted Allenby out to his car. "I understand that you are

going to be judging the Old Tyme Radio Performance Competition," said Terry by way of light conversation.

"Who told you that?" exclaimed Allenby. His face took on a wary expression.

"I think I read it in the paper," replied Terry, surprised by this reaction. "Is it true?"

"Yes," said Allenby. "I wish it were not, but it is true."

Suddenly, Terry remembered what Dr. Krull had said about guaranteeing that Karmella would win the competition.

"Are you," Terry asked, "by any chance acquainted with Dr. Krull?"

At the mention of the evil doctor's name, a look of abject terror passed across Allenby's features. "I have to go now," he cried. Without so much as a handshake, he jumped into his car and sped out of the parking lot.

"Did you see the look on his face when you mentioned Dr. Krull?" asked Jim.

"Yes," said Terry. "There is no doubt in my mind that Krull has Douglas Allenby in his power. He is threatening an action of dire consequences unless our friend votes Karmella Krull the winner of the competition."

"We must discover how he has ensnared Allenby," said Jim.

"Right," said Gary. "I think we should head right over to Terry's house and discuss this matter over some apple pie."

As the three boys started for home, they met Lucinda Beaucart crossing the parking lot. But she showed no sign of recognition and would have walked past them without a greeting if Terry had not spoken up. "Good afternoon," he said and smiled.

Lucinda did not return his smile. "Good afternoon," she said curtly.

"How are you coming along with your piece for the Old Tyme Radio Performance Competition?" asked Terry.

"Well," said Lucinda, "I'm surprised you're even interested."

"Just what does that mean?" Terry replied.

"I understand from Karmella Krull that you've been spending a lot of time helping with her performance," said Lucinda. "Now, Karmella's prone to falsehoods at times, so just tell me it isn't true."

"Well, it is true," Terry said, "but..."

"But what?" demanded Lucinda.

Terry was about to tell this lovely, open-faced girl how he had only gone to Krull Castle to obtain information about the missing CR-4's, but suddenly he remembered the promise he had made to Agent Wood. "I, er...it was just a social visit to help her with her singing. I mean she asked me if I would..."

His words struck Lucinda as if a 1929 Monroe AC-TR10 Dynamik console receiver had fallen on her. "Well, at least now we know where we stand," she said proudly. She turned and rushed off before Terry could see the tears welling in her eyes.

To be continued...

The real Stan Dwyer is Frank Bequaert who, along with his lovely wife Lucia, runs Rainy Day Books, P.O. Box 775, Fitzwilliam, NH 03447.



CLASSIFIED ADVERTISEMENTS

FOR SALE: All items this ad pickup only. Zenith 6740 Trans-Oceanic - \$60. Philco 16-B - \$175. Victor Victorola VVIX - \$150. RCA Q44, 8-band, 11-tube - \$90. RCA 12Q4, 8-band, 12-tube - \$90. Hallicrafters R42 speaker, needs repaint and rewire - \$40. Midwest 816 16-tube AM/FM chassis - \$35. RCA 9T 256 10" B&W table model, needs repairs - \$75. Philco 50T1104 12" B&W TV - \$50. Philco Model 1001 10" B&W TV - \$125. Hallicrafters Model SX42 - \$70. RT-91/ARC-2, 2 to 9 MC - \$40. RAK-8 15 to 600 Kc rec. and power unit - \$75. 4-tube home brew batt. radio - \$50. Du Mont Model 208 5" scope, less tube - \$25. Type CAY 46077-A-RBM-5 hi freq. rec. - \$40. Kellogg 507 - \$200. Stromberg-Carlson 602, needs drive gears - \$60. AC Dayton Type XL-5 batt. set - \$90. Kellogg Code 516 AC rec. 7 Kellogg overhead heaters - \$150 (Ad 11-12-90-B). Krantz, 100 Osage Ave., Somerdale, NJ 08083

WANTED: Original or reproduction of paper label for the Aeriola Jr. crystal set. Robert Stapleford, 1800 Randolph, Topeka, KS 66604

WANTED: 814 tubes - Pay \$10 N.I.B., others - \$7.50. Check filament (0.2 ohms). Write: Bill Downs, 4805 Sullivan, Wichita, KS 67204

FOR SALE: B&K E200D RF signal generator, solid-state, metered and calibrated outputs, with 400 Hz AF output, 100 kHz-216 MHz, includes manual - \$85. EICO 324 RF generator, 100 kHz-435MHz - \$20. Sencore TC142 tube tester with manuals - \$28. More - LSASE. Add shipping. E. Kirk Ellis, 18 Foxfire, Selma NC 27576. (919) 965-9577, after 4:30 pm

WANTED: Old transistor radios, pocket-sized Japanese type. Send photo or sketch with price to: Roger Handy, PO Box 24527, Los Angeles, CA 90024. (213) 451-4040

WANTED: Early spark keys on wooden bases, slate, marble, Marconi, Massie, United Wireless, etc. Gil Schlehman, K9WDY, 335 Indianapolis Ave., Downers Grove, IL 60515. (312) 968-2320

FOR TRADE: Have 46-tube oscilloscope Tektronix 585A 85 MHz, mint condition with probes, manual, cart. Want similar 1936-39 Philco or Zenith console with RF stage. Local pickup. John Gibson, 1075 Sterling Ave., Berkeley, CA 94708. (415) 849-1051

WANTED: Small Zenith portables. P.S. Did anyone see the Zenith Trans-Oceanic (Royal 1000) hidden in the movie "Uncle Buck"? Jack Philpot, 632 E. 160th Ct., South Holland, IL 60473. (708) 596-0580

FOR SALE: Zenith TV Service Manual Volume 1, 1948 to 1953, good condition - \$35. Supreme manuals by Beitman, 1940 Radios - \$15, 1942 Radios - \$15, 1949 TV's - \$20. J. J. Papovich, 53 Magnolia Ave., Pitman, NJ 08071. (609) 582-8279 ND

WANTED: DeForest T-100 or T-200 tuner, not MT-200. Have trade items. Will Jensby, W0EOM, 645 Giannini Dr., Santa Clara, CA 95051. (408) 296-6071

FOR SALE: Wheel type band switch knobs for early 1940's Zenith radios - \$12.50 including shipping. Arie E. Breed, 1595 N. Van Buren, Ottumwa, IA 52501. (515) 682-6925

SELLERS ... PLEASE NOTE A.R.C. ADVERTISING POLICY...

ALL ITEMS MUST BE DESCRIBED FAIRLY.
REPRODUCTIONS, REPRINTS AND NOT-
ORIGINAL ITEMS MUST BE SO IDENTIFIED.
ADVERTISERS AGREE TO RESPOND
PROMPTLY TO INQUIRIES AND ORDERS.
AND TO RESOLVE PROBLEMS PROMPTLY
IF THE BUYER IS NOT SATISFIED.

WANTED: AK cathedrals: 82, 90, 92, 206, 558, 567, 735; nice original condition. Ed. Bell, 5311 Woodsdale Rd., Raleigh, NC 27606. (919) 851-1517

FOR SALE: All items this ad (# 11-12-90-A) can ship via UPS. Buyers pay for shipping and handling. Supreme 333 Deluxe analyzer, untested - \$30. Precision 920 tube tester - \$45. Weston 777 tube checker - \$40. RCA WR 49-B signal gen. - \$35. RCA WA 44-C audio gen. - \$35. Have some pix tube testers and other test eqpt.; write wants SASE. N.O.S. made in U.S.A. tube sets w/carton. Admiral YG743 - \$27. Admiral 5B4Z - \$27. Motorola 5-tube - \$25. GE transistor clock radio - \$18. (Used items) Wall phone radio - \$40. Wonder Talking Machine 78 rec. hand-wound phono. - \$100. RCA PA amp type SA202, 20 watts - \$25. David Bogan amp Series G55 - \$35. Midwest 816 chassis, 16 tubes - \$35. Jenson metal case sp., 12" x 12" - \$15. Metal case sp., 16" x 11 1/2" sp., logo Hallicrafters - \$22. Have service items: tubes, vol. controls, dial belts, coils, speakers. Rider's, Howard Sams test eqpt. 1000's of unlisted items. Write wants - SASE for replies. Science and Invention, July 1927, July 1928, Nov. 1930 - \$5 ea. 7 mixed copies 1932 to 1935 - \$15/all. Sales, service since 1930. Krantz, 100 Osage Ave., Somerdale, NJ 08083

CLASSIFIED ADVERTISEMENTS

FOR SALE: I offer 100% refunds on any item that you are not pleased with. Zenith Trans-Oceanic A600, working but needs TLC - \$25. Many plastic, Bakelite, portable, wood, transistor and metal radios priced to sell. New items added to list on a regular basis. All of my items are in good to excellent condition! Call after 5 pm, or send SASE to: Neil O'Donnell, 1809 Sampson Ave., Butte, MT 59701. (406) 494-8162

WANTED: Rider's manuals Volumes 1, 2, 3, and 5. Also 15, 17 and on. Dennis E. Craft, 10513 E. Clinton, Scottsdale, AZ 85259. (602) 860-8951

WANTED: Mint 51J-4, will trade reloading gear of equal value. Bobby Ridge, 1210 18th St. SW, Hickory, NC 28602

FOR SALE: Freshman AC power supply G-60-6 - \$30. Westinghouse Rectigon 7.5-15 VDC charger - \$30. Plus shipping. J. Lisaius, 116 Orton, W. Caldwell, NJ 07006. (201) 226-7943

WANTED: Help. Need info on tubes used in Dynakit Stereo 70, 7-tube amplifier. William Smith, 16001 Dusty Ln., Accokeek, MD 20607

FOR SALE: Tubes: radio, TV and industrial, over 10,000 stocked, over 2000 types available. Largest discounts. Free list. Chuck Adamson, Box 640367, El Paso, TX 79904

FOR TRADE: Have EIS/Leutz RF xfrmr. Model C, 3.5" dia., aluminum base. Want Model C-7. Gordon Symonds, 26 Ossington Ave., Ottawa, Ontario, Canada K1S 3B4. (613) 232-2198

CLASSIFIED ADVERTISEMENTS

FOR SALE: Sprague orange caps .022, .033-1600v - 50¢ ea. Harry Pewowaruk, 1535 North 8 Ave., St. Cloud, MN 56303. (612) 252-9910

FOR SALE: Military crystals, CR-1A/AR, FT-241A, FT-243. SASE. Paul Wipperman, PO Box 81, Elmwood, MA 02337

WANTED: Chassis #74 for a Crosley Model 52TA, must be complete w/ or w/o tubes. Also chassis for Hallicrafters S-38B w/ or w/o tubes, or complete radio to fix another. Carlos Gimenez, 15091 Shamrock Dr., Fort Myers, FL 33912. (813) 482-0198

SEND ALL A.R.C. MAIL TO
Antique Radio Classified
P.O. Box 2, Carlisle, MA 01741

FOR SALE: Pocket tube tester, tests old/new tubes, new - \$8.50 ea. Zenith Trans-Oceanic gov't. (7-bands) technical manual, (copy) op./maint., all schematics - \$9 ea. Philco radio table Type 52, 121 code, restorable - Offer. D. Testa, PO Box 9064-ARC, Newark, NJ 07104

WANTED: Manual for Lafayette signal generator Model TE-20. **FOR SALE:** Heath SB1400 w/PS, mint, new, 160-10 meters - \$750. Arnold C. Price, 35 Hillview Rd., Monocacy Station, PA 19542. (215) 385-3343

WANTED: British GEC, Brimar or Mullard-Osram tube manuals and literature. Jim Phillips, Box 4467, Shawnee Mission, KS 66204

NEW!

Now available on home video for the first time:

RADIO COLLECTOR, the five-part PBS series on the history, collection, and restoration of antique radios. Meet dozens of antique radio collectors. See hundreds of radios. Watch '30s radio actors perform. Visit antique radio club swap meets. Learn how to restore antique radios. Written, produced and directed by collector Mike Adams, *RADIO COLLECTOR* was nominated for an EMMY for best informational series.

Total time: 128 minutes.

VHS Only.

R A D I O C O L L E C T O R

The Perham Foundation sponsors the sale of this videotape to help support the Electronics Museum.



**MIRACLES
IN
TRUST**

To purchase this historic video, send check or money order for **\$29.95**, plus **\$3.00** shipping & handling, to:

ARC Video Offer
The Perham Foundation
101 first Street, Suite 394
Los Altos, California 94022

SPARTON BLUEBIRD

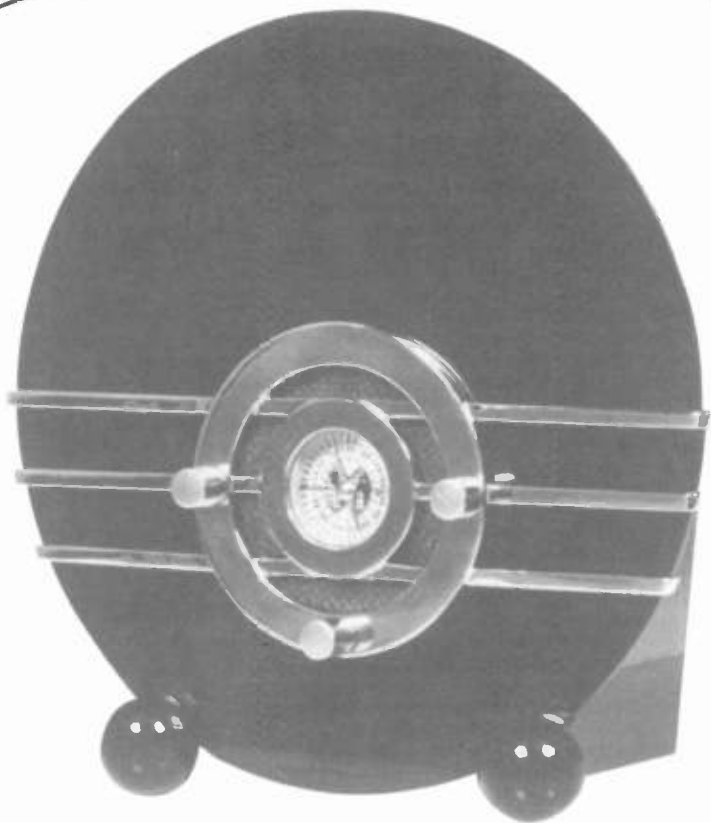

THE PERFECT RECREATION OF BLUE MIRROR MODEL 506 WITH SONY STATE OF THE ART TECHNOLOGY. DESIGNED, ENGINEERED AND CRAFTED BY HAND IN FRANCE. HARDWOOD CASE PERMITS THE ULTIMATE RESONANCE IN AM OR FM RECEPTION WITH AFC. LIMITED ADVANCED PRODUCTION AT \$250.00 PER SET. LESS THAN 100 PIECES AVAILABLE THIS YEAR. FREE FREIGHT WITH PREPAID ORDERS ON A FIRST COME BASIS. (OHIO RESIDENTS ADD 7% SALES TAX.) XONEX INTERNATIONAL INC., 750 BETA DRIVE, MAYFIELD VILLAGE, OHIO 44143 (216)442-1600

CLASSIFIED ADVERTISEMENTS

FOR SALE: AK 33, works, with tubes - \$100. AK 35, works, with tubes - \$90. AK 67 battery set, no tubes, needs audio xfmr., all shields in place, fair - \$40. AK Model L and M horns, no drivers, good shape - \$30 ea. AK 48 parts set, mouse damage - \$25. Rogers Majestic table farm set, vg playing - \$65. Westinghouse Model 6504 Deco wood table, playing good cond. - \$85. Silvertone brown Bakelite table 6-tube chassis, vg playing - \$65. Zenith H511 Consultone, vg playing - \$130. Tele-tone aqua-blue plastic table, cracked - \$20. More table sets of the 30's and 40's. **WANTED:** Hallicrafters Model SX-71, must be good cond. Will trade any of the above. UX-247 tubes, must test good, will pay - \$8 ea. Greg Bilodeau, PO Box 716, Redwater, Alberta, Canada T0A 2W0. (403) 942-2737

FOR SALE: Beckman E-put meter and timer, Model 7370, basically a frequency counter to 10 MHz, circa 1960, pickup only (it's a beast) - \$45 or offer. Sam Sullivan, 20565 Fifth East, Sonoma, CA 95476

WANTED: Fada radio promotional literature, especially product line catalogs from any year between 1938 and 1950. I will pay your price! Please call. Michael Lawlor, PO Box 179, Santa Barbara, CA 93102. (805) 682-2336

FOR SALE: As is automobile radios: British-Leyland Model IBM1131-5362, no knobs; Fiat by Automatic Radio, Roosevelt Motors Inc., no knobs; Mack truck Model IMK1132, no knobs; Peterbilt truck radio by Motorola. All - \$25 ea. + UPS. James Fred, R1, Cutler, IN 46920

CLASSIFIED ADVERTISEMENTS

FOR SALE: Hammarlund, model number unknown, lights up, photo 50c. Bob Shivers, 1233 W. Vine St., Taylorville, IL 62568. (217) 824-9546

WANTED: Meissner Traffic Master 1938-40, 5 bands kit radio, 14 tubes, 1853, 6K8, 6J7 front end. Ray Larson, 12241 1/2 Gorham Ave., W. Los Angeles, CA 90049-5214

WANTED: Two Federal #226W AFT's, rear terminal nuts and cabinet cards (2) for F.E. #NR-5, L&N small size tapered shorting plugs, tangent and sine galvanometers. Lane Upton, PO Box 875, Pine Grove, CA 95665

FOR SALE: Delco 32-volt Model 3201, excellent - \$85. Hallicrafters HT-32, complete, good transformers, not working - \$75 or BO. **WANTED:** Collins 32S1 or 3 from parts to excellent. G. Stevens, W0ATA, PO Box 704, Longmont, CO 80502. (303) 776-9036

WANTED: Schematics & instruction F for RCA sig. gen. WR49B, Eico VOM #511 & instructions for Supreme scope #535 - copy OK. John Anthony, PO Box 10, Sautee, GA 30571. (404) 878-2940

WANTED: Wireless era gear, Paragon, Grebe, Murdock, Clapp, WSA, Duck, or ?, antique tubes. Marc Gottlieb, Box 1112, South San Francisco, CA 94083-1112

FOR SALE: James Millen equipment and parts. Available: James Millen Electronics, PO Box 4215, Andover, MA 01810

New Wireless Pioneers

Books, Magazines, Literature Bought and Sold

New Wireless Pioneers buys and sells books, catalogs, magazines and other literature from the 1800's to 1950 that deal with early radio, wireless and electricity. A selection from our list of specialties:

Pre-1900 Electricity
Pre-1925 Radio or Wireless
Pre-1950 Computers

Pre-1900 Telegraphy
Pre-1940 Television
Early X-Ray

Magazines, Catalogs, Autographs or Ephemera related to the above topics. Also: Pre-1920 Wireless and Telegraph Apparatus - Radio-Related Novelties and Advertising - Early Vacuum Tubes and Electrical Devices.

Some items available in other technical subject areas also.

Several catalogs featuring items for sale are published each year.

New Wireless Pioneers - Jim & Felicia Kreuzer

P.O. Box 398, Elma, NY 14059

(716) 681-3186

CLASSIFIED ADVERTISEMENTS

WANTED: Karas Company information kits, transformers, condensers, catalogs. Parts new in box. Letters answered. Stephen Short, 1590 Union St., Schenectady, NY 12309. (518) 346-2245

FOR SALE/TRADE: For sale or to trade for radios: Heathkit frequency counter Model #IB-1102, 120/240 VAC, 50/60 Hz, 30 watts. Antenna rotator Model 9512 Channel Master. Norman Dupas, Box 911, Redwater, Alberta, Canada T0A 2W0. (403) 942-3270

One Month Free!

BONUS FOR EARLY RENEWALS

If you renew before the month shown on your mailing label (your expiration month), you will receive an extra month on your subscription: 13 months instead of 12! 26 months for an early 2-year renewal!

WANTED: Philco Mystery Control sets. **FOR SALE:** 10 issues Radio Craft magazine 1933-1945 - \$30. Larry Cooper, 425 Court St., Rockwell City, IA 50579. (712) 297-7232

WANTED: DeForest crystal set. Acme Model Y-1 detector and Y-2 amplifier units. Tuska 222, 224, 227. Richard Sharisky, PO Box 521, Belmont, MA 02178. (617) 484-5784

HELP: Is Crosley 5-50 chassis same as 575? **WANTED:** Chassis and knobs for Crosley 575. 5" dynamic speaker with 1.7k field coil. Delco radios. Dial glass and knobs for Delco R-1229. Herman Gross, W9ITT, 1705 Gordon Dr., Kokomo, IN 46902. (317) 459-8308

SEVICES: Antique radio repair by collector, reasonable rates, work guaranteed. Steve Pazar, WA4DUT, 4950 Deerwood Dr., Santa Rosa, CA 95403. (707) 544-8142

WANTED: Rider's binders only, not contents. John Snow, 4539 Bartlett, Shorewood, WI 53211

WANTED: Parts for Victor phonographs: wood bases, horns. Ross Litrenta, 1 Wilton Rd., Eastchester, NY 10709. (914) 337-7176

★ TUBES - PARTS ★

OVER 300 MORE TUBES & PARTS
HAVE BEEN ADDED TO NEW
ILLUSTRATED 1990-91 FLYER #46

SEND 25¢ STAMP
FOR YOUR COPY NOW!

DON DIERS
4276-AD6 North 50 St.
Milwaukee, WI 53216-1313

Personalized Courteous Service

CLASSIFIED ADVERTISEMENTS

WANTED: Pre-1950 telephones of any kind - wall phones, desk phones, pay phones. Also want related items such as signs, catalogs, paper advertising, etc. Also want anything manufactured by Western Electric. Lee Thompson, 596 Daisy Nash Dr., Lilburn, GA 30247. (404) 923-6385

WANTED: Hallicrafters S-36A. Delco 5300, RS-6, D2-FS, D3-5F, TCH. Collins TD-1. Hallicrafters FPM-200. Gary P. Cain, 1775 Grand Ave., #302, St. Paul, MN 55105. (612) 698-4851

FOR SALE: Fisher 1265-X metal detector with Nicads, charger, used 30 minutes - \$300. I ship. John Snow, 4539 Bartlett, Shorewood, WI 53211. (414) 964-0194

WANTED: Slide rules, all types antiques and specialties, books, instructions, related items, etc. Bob Hill, 200 Agnes Ln., N. Linthicum, MD 21090. (301) 789-4772

WANTED: Pre-1900 light bulbs, such as Maxium, Swan, Edison plaster rings. Rob Simon, 333 N. Garfield, Lombard, IL 60148. (708) 620-4770

FOR SALE: Quality crystal set radio kits with complete easy-to-read instructions, Basic Kit - \$15, DeLux Kit - \$30. We pay shipping in the U.S.A., foreign extra. SASE for information. Charles Graham, K6KDJ, Regeneration Radio Co., 20335 Casa Loma Rd., Grass Valley, CA 95945

WANTED: AK power supply for my Model 46. Dan Hays, 4 Monterey Dr., Newark, DE 19713. (302) 368-2138



WAVES
ANTIQUES
EARLY RADIOS
&
PHONOGRAPHS
78 RECORDS
BOUGHT & SOLD
REPAIRED
OPEN 12-6
SAT 12-5
CLOSED SUN & MO

32 EAST 137th ST. NEW YORK, N.Y. 10003 212 969-9284

PROPRIETORS Bruce and Charlotte Mager

THIS MONTH'S SPECIALS:

1. A large Chambers loose coupler\$400
2. Radiola 5425
3. Spencer pocket crystal set75
4. Super grandfather clock radio395
5. Magnavox air horn and amp325
6. Tom Thumb portable125
7. Scott Phantom, no cabinet,
excellent chrome395

SEE NEXT MONTH'S LIST FOR MORE !



CLASSIFIED ADVERTISEMENTS

FOR SALE: Japan Radio NRD-93 commercial shortwave receiver, NDH-93 scanner, cables, manuals, accessories, mint. Paul Hammond, 3200 Lakepark Way, Longmont, CO 80503. (303) 651-1548

FOR SALE: Drake SPR4 receiver with MS-4 matching speaker - \$250 + UPS. Wayne Dimmler, 13 Midtown Rd., Carle Place, NY 11514. (516) 747-1325, after 6 pm

WANTED: Westinghouse Aeriola amplifier in vg or better condition. Roger Hart, 314 Kensington Ave., Westmount, Quebec, Canada H3Z 2H3. (514) 933-8009, after 6 pm

WANTED: Wilcox-Gay Recordios, parts, advertisements, manuals, needles, blank discs, etc. Tim Verthein, 310 3rd Ave. SE, Grand Rapids, MN 55744

FOR SALE: Best offer on Federal 61, excellent until December 30, 1990. Bob Shivers, 1233 W. Vine St., Taylorville, IL 62568. (217) 824-9546

WANTED: Help: Need bandswitch plate and indicator, large tuning knob, for Crosley Olympia 655 tombstone. Ted Cohen, 8603 Conover Pl., Alexandria, VA 22308. (703) 780-6397

FOR SALE: Rider manual #4 in good cond. - \$15. Bulova radio, Model 300, nice green with gold grille & knobs - \$20. Sams Photofacts Number 39-169, not all app. 60 - \$1.25 ea. Plus UPS. Thomas Burnside, 4838 S Westhaven Dr., Jackson, MS 39209-4711. (601) 922-2235

CLASSIFIED ADVERTISEMENTS

WANTED: Military BC-604/684 crystals, channels 68-333-334-345 and 360, white on top. Sam Hevener, W8KBF, 3583 Everett Rd., Richfield, OH 44286. (216) 659-3244

WANTED: Zenith Bakelite table models 6D520 - 6D538 - 6D525 or 6D526 with handle on top. Thanks. P. Burton, 39 E. Walnut St., Belchertown, MA 01007. (413) 323-5019

FOR SALE/TRADE: Have 7 portables, looking for working plastic radios. Send SASE for details to: Paul Fulton, 711 Jacquelyn Rd., Westwood, NJ 07675. (201) 664-7628

WANTED: Paying \$3,500 for Zenith Louis XV. Gordon Wilson, 11108-50 Ave., Edmonton, Alberta, Canada T6H 0H9. (403) 434-6257

WANTED: Copy of card in lid of Radiola I (ER-753-A). Is there a Spanish version? Robert Lozier, 600 E. Green St., Monroe, NC 28112

FOR SALE: Milton Berle Special, RCA 8-T-241 1948 table model TV, 9 inch, excellent picture and sound, cabinet vg plus-excellent, quality set - \$400 or BO. Photo 50¢ & SASE. Sams Photofacts, No. 1 - 1944 to No. 47. List 50¢ & SASE. Ray Bedford, 3232 Clifton- 39051, St. Louis, MO 63139

FOR TRADE: Absolutely gorgeous Fada L-56 (Model 149 version), yellow body and gumdrop knobs with nicely marbled blue grille. A very, very rare set. Michael Lawlor, PO Box 179, Santa Barbara, CA 93102. (805) 682-2336

TUBES WANTED

We need the following tubes to replenish our stock. You may ship your tubes to us by UPS or Parcel Post. We'll mail our check upon receipt and testing of tubes. We pay prices shown plus shipping charges.

USED GLOBE OR BALLOON SHAPE TUBES - ALL MUST TEST GOOD

WD-11*.....	\$30.00	UV-201A.....	\$ 6.00	247.....	\$ 6.00
WX-12*.....	15.00	UX-201A.....	5.00	250.....	20.00
112A.....	6.50	210.....	8.50	256.....	4.50
120.....	9.00	222.....	4.00	280.....	6.00
171A.....	6.00	226.....	4.00	281.....	5.50
183/483.....	6.00	227.....	2.00	401 KELLOG.....	12.00
184.....	6.00	237.....	5.00	403 KELLOG.....	15.00
UV-199*.....	10.00	240.....	5.00	482.....	6.00
UX-199*.....	9.00	245.....	10.00	876 BALLAST.....	5.00
200A.....	5.00	246.....	6.00	877 BALLAST.....	3.00

*Tubular

We buy all types of receiving and transmitting tubes. Types not listed above must be new and in original boxes. Send us your list for our bid.

ANTIQUÉ ELECTRONIC SUPPLY
6221 S. MAPLE AVE., TEMPE, ARIZONA 85283
PHONE (602)820-5411 . FAX (602)820-4643

CLASSIFIED ADVERTISEMENTS

FOR SALE: Excellent selection of M.I.T. Radiation Laboratory series books. Send 25¢ stamp for list. Rainy Day Books, PO Box 775, Fitzwilliam, NH 03447-0775. (603) 585-3448

WANTED: 1936 Atwater Kent Model 810 (F.O.S., p. 69), badly in need of cabinet. Kevin D. Silva, 4620 N. Elmhurst, Indianapolis, IN 46226. (317) 542-1023



FOR SALE: General Radio precision wavemeter Type 724A, complete with full set of coils and framed charts. Please write or call: Rain Buttignol, 214 State St., #7, Portsmouth, NH 03801. (603) 427-1384

WANTED: One (1) knob 0526C Bendix green Catalin; set if you have them. Paul Barlows, 4741 Seibert, St. Louis, MO 63123. (314) 352-6916, Fax (314) 241-6948

FOR SALE: Individual Photofacts folders 200 thru 1200, some missing. **WANTED:** Rider's Volume #4. Don McGrew, 1901 Tanglewood Dr., Mt. Vernon, IN 47620. (812) 838-6449

WANTED: Utah Radio Co. Type UAT Jr., transmitter schematic. Have cash or WE tubes. Bob Mattson, KC2LK, 10 Janewood Rd., Highland, NY 12528. (914) 691-6247

WANTED: Military radios: AN/ARC-2, BC-966, R-61/ARQS, APA-10, ID-S9/APA11. Can pick up in southern Calif. Leroy E. Sparks, W6SYC, 924 W. McFadden Ave., Santa Ana, CA 92707. (714) 540-8123

WANTED: Help. Need one reddish colored knob for Westinghouse refrigerator radio. Carleton Gamet, 2307 W. 131, Olathe, KS 66061. (913) 764-3430

FOR SALE: Revox A77 reel-to-reel recorder complete, excellent, heavy - \$235 plus UPS. R. A. Matias, KP4GO, 9206 Pitcairn, San Antonio, TX 78250. (512) 680-5450

FOR SALE: Parts for Philco Models 39-70 and 39-116. Zenith chassis 5634 used in Models 6-S-128, 6-S-137, 6-S-147, 6-S-152 and 6-S-157, and Zenith chassis 5801 used in Models 8-S-129 and 8-S-154. For price list send long SASE to: Herbert Harper, Rt. 1, Box 315, Mize, MS 39116. (601) 733-9907, after 5:30 pm CST, weekdays

FADA

BULLET PEN

TOPS

• IN BEAUTY

• IN DURABILITY

BUTTERSCOTCH CATALIN PLASTIC

Handmade from actual radio material.

Retractable twist ballpoint. Takes Cross refills. Only 20 pcs.

available. Packaged in leather carrying pouch.

\$100.00 includes shipping & handling. OH Res add 7% sales tax. (Pen is actual size)

PLACE YOUR FAITH IN

FADA

Famous Since Broadcasting Began!

XONEX INTERNATIONAL
750 Beta Drive, Mayfield Village, Ohio 44143
(216)442-1600

CLASSIFIED ADVERTISEMENTS

FOR TRADE: Transistor radios. Trading Zeniths, Emersons, Sonys, novelties, etc. for pocket-size models. Eric Wrobbel, 20802 Exhibit Ct., Woodland Hills, CA 91367. (818) 884-2282

FREE – 20 WORD AD EACH MONTH

To get your free 20 words,
Include your SUB# with your Ad.
Additional words are 15¢ each.
Read inside back cover for details.
MANY THANKS!!!!

FOR SALE: Retiring. 50-year collection of early Sams, Riders, wire recorder, Grundigs, tubes, parts, hardware, scope, frequency counter, generators, meters, etc. What are your needs? Reply sent for \$2 which includes my bargain-priced inventory list. Jack Stollman, 132-02 Jamaica Ave., Richmond Hill, NY 11418

WANTED: Heathkit GR-43A, GR-24 portables. Also Fisher R-200 B tuner. Please state price and condition. Scott D. Prather, KB9Y, 2776 S. Monroe St., Denver, CO 80210. (303) 758-9381 or (303) 649-8529

FOR SALE: Zenith Trans-Oceanic H500 – \$65. Channel Master Model 6506 transistor – \$40. Many Westinghouse refrigerator radios. Royal 500 parts radio working – \$39. Jim F. Montague, 921 S. Cuba, Spokane, WA 99202. (509) 535-9576

FOR SALE: 1953 Buick #50/70 Model #981323 radio, complete. C. R. Powell, 15 Marinette St., Tomahawk, WI 54487. (715) 453-5230

This Holiday Season...
Give A Gift Subscription to
Antique Radio Classified

BONUS: December 1990 Free!
All gift subscriptions received before
December 31 will be sent the December
1990 issue free!*

To Order:

1. Fill out the card in this issue with the recipient's name and address.
2. Enclose a gift card which we will send along with the bonus issue. (We will enclose our card with your name if you wish.)
3. Include payment or charge to VISA or MasterCard), and send to:
A.R.C., PO Box 2, Carlisle, MA 01741

Or Call (508) 371-0512.

P.S. There are more gift ideas from
A.R.C. on pages 46 & 47.

* If already a subscriber, a 13-month extension
will be made to the recipient's subscription.

CLASSIFIED ADVERTISEMENTS

WANTED: Majestic Model 15 chassis. A. Bruno, 24 Butternut Dr., New City, NY 10956. (914) 354-8899

FOR SALE: Thrifty TV – the tri-states' largest antique radio/TV dealer. Walk-in business invited. Dec. specials included Lyric Wurlitzer cathedral Model P-8 – \$400. Philco 60 – \$250. Heath W-5 mono amps – \$200/pr. Clean working Emerson 888 – \$50. Tons of compactrons new and used, take all – \$100. Thrifty TV and Radio, 11 E. Marie St., Hicksville, NY 11801

FOR SALE: Transistors: First RCA transistor portable 7-BT-10K; Emerson Vanguard 888, 558; Magnavox 2-AM 80 N.I.B.; Japanese Orion JIS. Bakelite: Emerson 330, 641, 646; black Arvin 450 TL – \$35; 6-volt and 9-volt transistor power supply; 6- and 12-volt power supplies. Military: BC-603, BC-683, BC-732-A, BC-1171A; Air Force combat headphones; USAAF receiver RA-10DA remote control; 1943 and 1948 Super Pros; radar tuning unit TN/19 AP4-4; 5 Dynamotors and Navy parts box – \$35. Bill Coolahan, 1450 Miami Dr. NE, Cedar Rapids, IA 52402. (319) 393-8075

WANTED: Copies of manuals for EICO kits. Models 324RF (signal generator), 147A (signal tracer) and 232 (VTUM). Will pay. Richard Leizure, PO Box 245, Granby, CT 06035. (203) 653-6477

FOR SALE: Fada 652, butterscotch – Best Offer. Rider's 6, 9 – \$11 ea. plus UPS. Ron Trench, Jr., 21 Virginia Rd., East Haven, CT 06512. (203) 469-7340

WANTED: Mint, original condition Gloritone #27 cathedral. GE J-100 cathedral. **FOR SALE:** Philco 70, very good, working – \$250. Joe Yanul, 9606 Troy Ct., Mentor, OH 44060. (216) 255-1952

FOR SALE: Zenith Trans-Oceanic R1000D – \$150. McIntosh MC-240 – \$900, MI-3 – \$490, MR-71 – \$500. Gary Stejskal, 1200 26 St. NW, Cedar Rapids, IA 52405. (319) 396-0341, after 7 pm CST

WANTED: Metal radios: Arvin, Silvertone, etc. Carl R. Shirley, 824 Fairwood Rd., Columbia, SC 29209. (803) 776-6850

FOR SALE: Zenith K622 early clock radio, white, beautiful – \$35. Send SASE for radio list. Tony Schroeder, 703 Pears Ave., Lima, OH 48505. (419) 224-1128

FOR SALE/TRADE: Catalin radios: Sentinel 284 (Sideli, p. 119), marbled burgundy with yellow grille and knobs. This radio is in incredible condition, as crisp and fresh as the day it came out of the box. Also, Garod Model 1450 (Sideli, p. 93), yellow with bright red grille, knobs and handle, an extremely rare and attractive set. Michael Lawlor, PO Box 179, Santa Barbara, CA 93102. (805) 682-2336

CLASSIFIED ADVERTISEMENTS

FOR SALE: Automatic 613X, 1941 table model wood set with spherical dial. Zenith 5724 7-tube tombstone. Coronado 05RA 22-43 unique Bakelite, airplane dial, (G.O.R., p. 121). Philco 37-610 tombstone. Philco 42-22CL wood 1942 clock radio. Rare GE K51 table model, carved ornate doors, unique. Bendix 753 MX clock radio-lamp. Unusual Crosley refrigerator with built-in radio. Raytheon early T2500 transistor radio. Crosley JM8 WEA transistor Book Radio. Many early transistor radios, send SASE for list. Crosley 516 tiny tombstone. Dick Tracy radio, nice. Charles Harper, 2081 Harmony Ct., Lexington, KY 40502. (606) 268-8549

WANTED: Crosley 11-100 Series radios (Collins, p. 97). I have an orange one in excellent condition to trade for a color I don't have, or will buy yours. Bill Lettow, 2025 E. La Jolla, Tempe, AZ 85282. (602) 730-6058

One Month Free!

BONUS FOR EARLY RENEWALS

If you renew **before** the month shown on your mailing label (your expiration month), you will receive an extra month on your subscription: 13 months instead of 12! 26 months for an early 2-year renewal!

FOR SALE: 30+ Bakelite and plastic radios. All complete no cracks. Send LSASE to: Michael Kerr, 1445 W. 19th St., Merced, CA 95340. (209) 723-2642

FOR TRADE: Philco 96H chassis and speaker for Grunow 580 cabinet and speaker, RCA R7 cabinet or Airline 62-313 chassis and speaker. Does this Airline have 2 speakers? Phil Brunais, 14185 Pleasanton Hwy., Bear Lake, MI 49614. (616) 864-3143

WANTED: Pilot Super-Wasp or other shortwave radios, 1-4 tubes and using plug-in coils from 1920's to 1930's. Trade crystal sets for above items. Martian Big 4 Howe in box, Philmore in box, World, Star, some new novelty sets and others. Trade or sell German 1-tube battery radio circa 1925, Phywe. Carl Bocock, 414 Brookside Ter., Moore, OK 73160. (405) 794-8033, eves. 1-800-537-3870, days

FOR SALE: Truetone D1016 white (R.G.A., p. 71) - \$70. **WANTED:** Crosley 10-140 Coloradio. Keith Borden, 991 Pond View Ct., St. Paul, MN 55127. (612) 653-9086

FOR SALE: Fada #1000, yellow; yellow/red. RCA w/grille. Anthony Scarfogliero, 13 4th St., Brooklyn, NY 11231. (718) 858-1231

WANTED: Philips Philetta 1939-1941 in good condition. Herrmann Weber, 119 Saturn Rd., Etobicoke, Canada M9C 2S8. (416) 621-2556

CLASSIFIED ADVERTISEMENTS

FOR SALE: Crosley Showbox, original speaker set - \$80. Crosley Trirdyn 3R3, all original - \$65. Plus postage. John Porter, 702 N. Main, Osceola, IA 50213

WANTED: Round or rectangular meter for the Millen 90800 exciter in good condition. James T. Schliestett, W4IMQ, PO Box 93, Cedartown, GA 30125. (404) 748-5968

WANTED: Excellent to mint Motorola X15 6-transistor shirt pocket radios. Colors other than tan preferred. Will pay up to \$100 for fine examples. Larry Mitchell, 7963 Depew, Arvada, CO 80003-2527. (303) 428-8760

FOR SALE: Old Ansaphone Mod. KH85F, looks complete, untested - Offer plus shipping. SASE with inquiry. J. R. Mullikin, 113 Springer Ave., Edwardsville, IL 62025

FOR SALE: Hallicrafters S-94 30-50MHz FM receiver, fine condition - \$50 plus shipping. John Osborne, 2 Lake St., Winthrop, ME 04364. (207) 377-2519

WANTED: Remler, Remler, Remler radios. Model #26 or #28, etc. Will buy or trade. Don Catton, 609 10th St., Silvis, IL 61282

FOR SALE: Crosley 4-29 battery set with cathedral speaker, headphones, and extra tubes, excellent original condition. Send SASE and \$1 for photos. Best offer over \$100 by 2/1/91. You pay shipping or pick up. Ted Williams, 247 Red Acre Rd., Stow, MA 01775. (508) 897-1906

The Greater Boston Antique Radio Collectors

**The people who have brought
you TWENTY-ONE meets in the
past, NOW BRING YOU:**

RADIO XXII

An Indoor Radio Flea Market

Sunday - February 24, 1991

9 am to 1 pm

Rivers School, Weston, Mass.

For Information:

**Richard Foster, 12 Shawmut Ave.,
Cochituate, MA 01778 - (508) 653-2418**

**John Terrey, 498 Cross St.,
Carlisle, MA 01741 - (508) 369-9770**

Directions: Take Exit 24 (Rt. 30) off Rt. 128 West for three miles. Turn left on Winter St (at sign for Rivers School) for 1.5 miles. Rivers School is on the right.

CLASSIFIED ADVERTISEMENTS

WANTED: Zenith 6S128 in top working condition. Walter J. Maier, 6 San Mateo Rd., Rochester, NY 14624. (716) 247-5197

FOR SALE: Realistic DX200, mint, with manual - \$65 + UPS. Moon Mullin, 520 Fifth St. SE, Auburn, WA 98002. (206) 833-3023

FOR SALE: Millen dip meter with coils and a second Millen useful for replacement parts - \$35. General Radio audio power meter 683A - \$40. International Kadette Model F two-tube AC/DC pocket portable, tubes 6F7 12A7 good, plastic case mint with line cord and technical information - \$50. All plus shipping. SASE for details. Henry Kuhn, W8ERG, 1397 Washington Cir., Forestville, OH 45255 [3-23]-0935

WANTED: GE 60 clock radio (F.O.S., p. 95). Carl Larsen, 3872 Amboy Rd., NY 10308. (718) 984-2150

WANTED: Kennedy V junker, really only need front panel corner escutcheon and 1st stage jack. Jim Creedon, 496 Trenton Ave., Utica, NY 13502. (315) 735-1100

FOR SALE: Pilot battery TRF, single-dial tuning, mahog. cabinet, quality homebuilt construction - \$60 shipped. Robert Rathbone, RD #1, Box 127, Ossipee, NH 03864. (603) 539-2762

WANTED: TV's! Collector buying 7" TV's by Republic, Raytheon, Viewtone, National, Automatic, others. Don Hauff, Box 16351, Minneapolis, MN 55416. (612) 425-0089

rainy day books

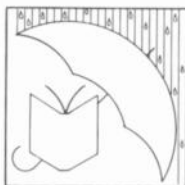

PO Box 775
Fitzwilliam, NH 03447
(603) 585-3448
frank bequaert
lucia bequaert

**Radio and Other Technical
Books, Catalogs and
Magazines Bought and Sold**

Specializing in Wireless,
Broadcasting, Electric Power,
Computers, Electronics,
Microscopes,
Civil Engineering and Steam

Send for our list of catalogs

CLASSIFIED ADVERTISEMENTS

WANTED: Grille/case, 3" CRT for Pilot TV. Steve Snyderman, 4147 Lenox Dr., Fairfax, VA 22032. (703) 978-3086

FOR SALE: Zenith 807 tombstone with original instruction card - \$145. Philco 38-10 (F.O.S., p. 124, like 10T) Deco - \$100. Aetna Model 500 tombstone with unusual wood inlay - \$95. Radiola balanced amp - BO. Grebe MU-1 synchrophase - \$250. Kevin Eftink, 16 Edgewood Dr., Quincy, IL 62301. (217) 228-2221

Classified Ad Deadline Noon

Dec. 10 for Jan. 1991 Issue

Jan. 10 for Feb. 1991 Issue

Box & Photo Ads - 5th, Display Ads - 1st

WANTED: The following CRT's and pickup tubes: DuMont, K1003P4, 144-9-T, 14AP4, 20AP4, 20BP4. RCA, 903, 904, 907, 908, 909, 910, 912, 914, 1803P4/12AP4, 1800, 1801, 1847, 1848, 1854, 1898, 1899, 3KP4, 5AP4/1805P4, 15GP22. National Union: 2303, 2003, 2005, 2109. Also would like interesting image Dissectors, Emitrons and other pickup tubes. David B. Johnson, 2336 S. Kenilworth, Berwyn, IL 60402. (708) 484-2743

FOR SALE: Fall Specials: RCA Model 6T tombstone, 6-tubes, 2-band, new power xfmr., cabinet refinished, looks, works FB, (looks like RCA Model 10T, F.O.S., p. 152), a steal at only - \$125. Clarion Model 80 cathedral, 7-tubes, scarce radio, refinished, looks, works fine!, special - \$225. Zenith portable Model #1000 with batts., clean, runs well, only - \$130. A collection of Zenith yokes, flybacks, xfms., etc., new - \$45. Wm. J. Key, W1DWD, 58 Sycamore Dr., Halifax, MA 02338. (617) 294-1831, before 9 pm please

FOR SALE: Western tube checker 685, N. I. Bk. - \$50. Weston 547 set analyzer for 4- & 5-pin tubes, N. I. Bk. - \$95. B&K tube tester Model 600, W. I. Bk. - \$35. B&K 465 CRT checker W. I. Bk. - \$35. J. J. Papovich, 53 Magnolia Ave., Pitman, NJ 08071. (609) 582-8279



WANTED: Hamilton Electric wristwatches, the world's first electric watch! Want any style, including odd-shaped ones above, running or not. Also want: movements, parts, dials, boxes, advertising displays; anything Hamilton Electric! Please write or call: Mark Rathbun, 1817 Arbutus Ave., Chico, CA 95926. (916) 342-2655

CLASSIFIED ADVERTISEMENTS

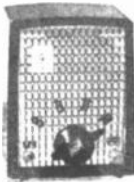

WANTED: Emerson pictured or also one with a "sunburst" grille. Any color. Flaws acceptable. Wood or Bakelite OK. I will pay for the call. I will even pay calls not leading to a sale. Wait for the beep. I will answer all calls. Clip the ad. Call me if you get one. What are you waiting for? Scottie McElroy, 2309 Driftwood, Apt. 1007, Mesquite, TX 75150. (214) 279-6138

FOR SALE: Old radios, phonographs, magazines, tubes & tube tester. Send SASE for current stock list. Don's Radios, PO Box 8111, Garden City, NY 11530. (516) 481-7255

WANTED: Any type of WW-II Army-Navy aircraft and base operations communications gear, must be clean to excellent appearance for display, but does not have to work. I am assembling a collection for the new Confederate Air Force Museum at Midland, Texas. You can donate your gear for a permanent credit marker on your radio or sell to me for cash and I will donate in my name. K. Gunter, W5ZJ, 26 W. Concho, San Angelo, TX 76903. (915) 655-6791

FREE - 20 WORD AD EACH MONTH
To get your free 20 words,
include your SUB# with your Ad.
Additional words are 15¢ each.
Read inside back cover for details.
MANY THANKS!!!!

WANTED: Attention Canadian collectors: Information on Canadian Crosley radio Model C-5. Need cabinet (or details for constructing same), tuning knobs, schematics, advertisements, and company catalog. **WANTED:** Metal base for a three-tube AK amplifier. James A. Di Ruzza, 2607 Old Troy Pike, Dayton, OH 45404. (513) 233-5044, eves.

FOR SALE/TRADE: Catalin radios. Send SASE for list. Lairy Wilcox, 5 Gravatt Dr., Berkeley, CA 94705. (415) 548-7099

FOR SALE: Radio magazines, following are all postpaid prices. Service Magazine, 12 issues for 1935 - \$28. Service Magazine, 11 issues for 1938 - \$24. Communications Magazine, 14 issues for 1938/39 - \$28. Radio Engineering Magazine, 12 issues for 1934 - \$26.75. Radio Magazine, 7 issues for 1930, edges taped - \$16. Radio Craft, 14 WWII issues 1943-45 with covers by artist Alex Schomburg - \$35. Gary Schneider, 9511-23 Sunrise Blvd., North Royalton, OH 44133. (216) 582-3094, machine answers on 5th ring

CLASSIFIED ADVERTISEMENTS

WANTED: AK breadboards excluding Model 10 series, and any good condition parts for same. AK cathedrals, must be complete and in at least restorable condition, working or not. Will pay top-dollars for models wanted. Write or call collect. M. D. Bergan, Jr., 2011 E. Flynn Ln., Phoenix, AZ 85016-1113. (602) 248-0356

FOR SALE: Westinghouse VCM 2001 (video control module) for any TV cable ready or not, new - \$150. I ship. John Snow, 4539 Bartlett, Shorewood, WI 53211. (414) 964-0194

WANTED: Motorola table radios, wood, plastics, Catalins. Tube types only. Must be complete. Not working is OK. Plastic and Catalin cabinets must be undamaged. M. D. Bergan, Jr., 2011 E. Flynn Ln., Phoenix, AZ 85016-1113. (602) 248-0356

HELP: Is Crosley 5-50 chassis same as 575? **WANTED:** Chassis and knobs for Crosley 575. 5" dynamic speaker with 1.7k field coil. Delco radios. Dial glass and knobs for Delco R-1229. Herman Gross, W9ITT, 1705 Gordon Dr., Kokomo, IN 46902. (317) 459-8308

FOR SALE: Many types of radio, TV and industrial tubes. DH Distributors, PO Box 48623, Wichita, KS 67201. (316) 684-0050

FOR SALE: Sony ICF-2010. Magnavox DL 2999. Radiola III & IIIA, Radiola 18, crystal radios. **WANTED:** Glass dial & brown plastic side grille for Nordemende Sterling table radio. Call. P. G. Daniel, 5733 Warren Ave., Morton Grove, IL 60053. (708) 470-1502



*Craig L. Graybar
Furniture Works Ltd.*

(414) 258-2390

SPECIALISTS IN RESTORING, REPAIRING AND REPRODUCING CLASSIC STYLED ANTIQUE TV, RADIO & PHONOGRAPH CABINETS

Send us your plans or your project via UPS for immediate price quotes



1535 S. 84th St.
West Allis, WI 53214



"We Turn Ideas Into Heirlooms"

CLASSIFIED ADVERTISEMENTS

FOR SALE: Telefunken Jubilee. Blaupunkt Super Hi-Fi Ballett. Grundig Model 101-U. Zenith S-17366. Western Electric TP85-1 power amp. Philco 39-30 radio. Your choice - \$35/ea. plus shipping or all 6 for \$150. Vince Bomba, 331 Akron Ave., Pittsburgh, PA 15216. (412) 344-7926, ask for Vince

WANTED: Pillow speaker for Dahlberg Pillow Speaker Radio (Collins, p. 101). Also any info on same. Peter Oppenheim, 146 East 49th St., 3A, New York, NY 10017. (212) 752-1635

FOR SALE/TRADE: Restored Hallicrafters SX-24 - \$250 or your two Zenith consoles. Garrard record changer Model RC-88/4 with Pickering P/AC 1 cartridge, exc. cond. - \$100 or your Zenith console. Philco 70 or 90 cathedral cabinet also considered. A. Bruno, 24 Butternut Dr., New City, NY 10956. (516) 354-8899

WANTED: Crosley Model 10-137, D-25-BE, 11-112U Bakelite, good condition, no cracks. Scott Blair, 83 Bright St., Jersey City, NJ 10166. 1-800-323-7788. (212) 503-1145

WANTED: RCA 45 rpm record changer/players. With or without amplifier and speakers. As seen in the May 1990 issue of A.R.C. Ken Neal, 9638 Ironmaster Dr., Burke, VA 22015

FOR SALE: Atwater Kent breadboard 3945 - Best Offer over \$700. Victor Model E front mount phonograph - BO over \$900. Edison Suitcase standard cylinder phonograph - BO over \$500. Kurt Nauck, 1940 E. Allegro, Houston, TX 77080

CAPACITORS
All new and guaranteed

- Dual 33/47 μ f @160 wvdc.....\$3.00 ea.
Four for \$10 - Tubulars
- Dual 22/47 μ f @250 wvdc.....\$3.50 ea.
Four for \$12 - Tubulars
- 10 μ f @450 wvdc.....\$2.50 ea.
Four for \$8 - Epoxy Dips
- .1 μ f @600 wvdc.....\$3.00 ea.
Eight for \$10 - Epoxy Dips
- .22 μ f @600 wvdc.....\$3.00 ea.
Eight for \$10 - Epoxy Dips

All capacitors are fully insulated & w/7" leads

GRILLE CLOTH - free samples

- 14" x 18"\$ 7.00
- 26" x 36"12.50
- 36" x 54"20.00

DIAL BELTS

- N.O.S. as available\$10.00 ea.
- New "O" ring type, non-stretch\$5.00 ea.

All prices are postpaid

FRONTIER ANTIQUES - Everett Hoard
Box 38, Lehr, ND 58460 • (701) 378-2341

CLASSIFIED ADVERTISEMENTS

FOR SALE: Fada Model 1005 blue-white swirl, grille rough, 2 cracks repaired - \$250. Rich Hale, 6833 Grace Ave., Cincinnati, OH 45239

FOR SALE: Excellent working receivers: HQ-129X - \$110. 1939 General Electric portable Model HB 403 - \$48. Ward Becht, 625 Tufts Ave., Burbank, CA 91504. (818) 842-3444

WANTED: Antenna coil for AK 10 breadboard. Dan Kirkham, Box 611, Pierceton, IN 46562. (219) 594-5286

NEW RATE FOR ADDITIONAL WORDS:
15¢ per word

FIRST 20 WORDS STILL FREE!

We are sorry - but this is our first classified ad rate increase since 1984.

WANTED: Brass escutcheon for Philco 90, and WE black candlestick phone with dial. M. L. Harrington, PO Box 7619, Little Rock, AR 72217

FOR SALE: 1913 edition of ABC/XYZ Bee Culture in fair cond. - \$27.50 ppd. E. J. Reaser, 1005 Hinton St., Princeton, WV 24740. (304) 425-2093

WANTED: The New England Antique Radio Club wants you! Make plans now to attend our big Winter Swap & Sell Meet, January 19, 1991, Resurrection Center, Nashua, N. H., 8 am to 1 pm. Over 75 tables! Hundreds of radios! Two Old Equipment Contests featuring cathedrals and old tubes! Philco seminar! 50/50 raffle! Be there for another great day of radio fun and excitement! For more swap meet or membership info, call or write and be sure to ask for a free sample copy of the club newsletter. NEARC, RR 1, Box 36, Bradford, NH 03221. (603) 938-5051

FOR SALE: Dynamotor DY-17A/ART-13A NOSB - \$45 F.O.B. Houston. Connectors available. Robert Downs, WA5CAB, 2027 Mapleton, Houston, TX 77043. (713) 467-5614

FOR SALE: Factory or copies of radio service manuals 1933 to 1960 - \$1 and SASE for list of any one of the 5 categories: home, auto, test, television, or books and collectors items. W. Horton, 1132 Connway Dr., Heath, OH 43056

COLLECT KEYS...?



You'll enjoy WIMQ's illustrated references. "Introduction to Key Collecting," 64 pages, \$9.95. "Vibroplex Collector's Guide," 87 pages, \$14.95. Add \$2 s/h to total. (Mass. add 5% tax.)

ARTIFAX BOOKS

Box 88-A, Maynard MA 01754

CLASSIFIED ADVERTISEMENTS

FOR SALE: Crosley 10-135 – \$60. Zenith 5S127 AC set, like 7D127 in F.O.S. – \$150. John Lyle, 1161 S.W. Mulvane, Topeka, KS 66604. (913) 232-0128

MESSAGE: I am happy to inform our American collectors that in the near future we will celebrate the grand opening of the first Antique Radio and Broadcasting Museum here in Tel-Aviv, Israel, after a long plan since 1984. We will appreciate any support in the form of: magazines, books, posters, tubes, and other related items for the museum. Send in your donation to: Bruno Pinto, 24 Remez St., #7, Tel-Aviv, 62192, Israel

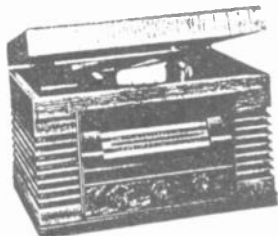

WANTED: Philco 42-1003 table-model radio-phonograph. Robert Wiczkowicz, PO Box 86, Craryville, NY 12521. (518) 325-5307

FOR SALE: Rubber mounting for Radiola 111/111A tube sockets, c/w installation instructions – \$4 U.S. ppd. Gordon Wilson, 11108-50th Ave., Edmonton, Alberta, Canada, T6H 0H9. (403) 434-6257

SEND ALL A.R.C. MAIL TO
Antique Radio Classified
P.O. Box 2, Carlisle, MA 01741

WANTED: Supreme Model 666 signal generator with schematic diagram & operating instructions. Wave band switch for Philco Model 66, Part #42-1066. (2) compensating condensers, 1st IF, prim. to sec. Part No. 04000M for Philco Model 71. Troubleshooting with oscilloscope by Robert Middleton. Paul M. Williams, 2364 Beaver Valley Pike, New Providence, PA 17560-9622. (717) 786-3803

FOR SALE: Hallicrafters SX71. National N.C. 57. Hammarlund Super Pro. RCA RAK7. Ray Jefferson 483 12v. Call: Harry Moore, 221 Park Ave., Box 63, Dighton, MA 02715. (508) 669-5449

FOR SALE: Hallicrafters T-54 TV, correctly restored, in good working order. Jim Hagerty, 64 Nonquit Ln., Tiverton, RI 02878. (401) 624-4739

WANTED: Help: Need oscillator coil for Stromberg-Carlson Model 1101, S-C Part No. 114002 or Meissner Part No. 14-1040. Sidney Allen, Jr., 1908 Rosecrest Dr., Greensboro, NC 27408. (919) 288-4115

CLASSIFIED ADVERTISEMENTS

FOR SALE: Legendary old-time radio programs on audio cassettes. Lowest prices nationally. Big free catalog. Galore, Box 7431, Baltimore, MD 21227

WANTED: Chassis for Bosch 5-A. Chassis cover for Splitdorf Abby Jr. Kolster iron paw foot speaker. Sonora SO-1 tubes and 886 ballast tube. Ken Martin, 12667 Eckard Way, Auburn, CA 95603. (916) 885-0243

FOR SALE: Signal Corps volt-ohmmeter Model 1-166 – \$15 plus shipping. Kenneth Miller, 10027 Calvin St., Pittsburgh, PA 15235. (412) 242-4701

FOR SALE: Crosley Fiver tombstone, model unknown, good cond., works – \$60 plus UPS. Call: Thomas Burnside, 4838 S. Westhaven Dr., Jackson, MS 39209. (601) 922-2235

WANTED: Dial escutcheon for Kolster K-21. IF oscillator coil assembly for U.S. Radio Model 7. Both IF coils and one knob for Sparton 557. Douglas Daniels, 10833 Socorro Rd., El Paso, TX 79927. (915) 859-2239

FOR SALE: Radios, meters, test equipment, tubes – \$1 stamps or bill for large list. Large items cannot be shipped. Erland Babcock, K1GPH, 38 Lantern Ln., Burlington, MA 01803.

WANTED: Mint, original condition Gloritone #27 cathedral. Speaker for AK 80 cathedral. **FOR SALE:** Philco 70, very good, working – \$250. Joe Yanul, 9606 Troy Ct., Mentor, OH 44060. (216) 255-1952

E.H. SCOTT



RADIOS
(1931-1941)

★ **WANTED** ★

Also Wanted: World's Record (1925-1927), Scott Transformer Co. (1928-1930), Crosley WLW, and Zenith Stratosphere Radios.

Jim Clark
1292 Starboard
Okemos, MI 48864
(517) 349-2249

CLASSIFIED ADVERTISEMENTS

FOR TRADE: (2) good WD-11 bl. base tubes for 2 Echophone S5 radios as per picture on front page of 1987 May A.R.C. **WANTED:** Tuning condenser with dial for 70 Philco 55-150 scale. Want Vol. 4 Hugo Gernsback, not Rider's. Want 2 new 400-ohm potentiometers Yakly or equal. Want Majestic chassis and speaker for Model 195 or 59. WD-11 tubes on trade. Want 3 red dials for Workrite radio. Want Philco 70 cabinet. Will pay cash or trade your terms. Call collect: Rudy Hof-fart, 19380 Newton Ave., Euclid, OH 44119. (216) 531-4697, best time 10:30 pm

WANTED: Crystal set collection now at 188 pieces, looking for more sets. Erwin Macho, Ambrosweg 17/A/8, A-1230 Vienna, Austria

WANTED: Bakelite/brass knobs for 1949 Bakelite Zenith 6D815. Knob P/N 46-744. Dennis Craft, 10513 E. Clinton, Scottsdale, AZ 85259. (602) 860-8951, collect

FOR SALE: Philco Model 38-4 two-band slant-front console, good condition - \$95. Pickup only. Zenith Model 7H822Z AM/FM brown Bakelite radio, nice - \$45. Plus shipping. **WANTED:** Original equipment mike, crystal phono cartridge, cutting head stylus and blank recording discs for Wilcox-Gay Recordio Model 6B30. Frank Buzzell, 218 N. Jackson, Spring Lake, MI 49456. (616) 847-0069

WANTED: Magnavox A2-R combination horn and amplifier (Radio Horn Speaker Encyclopedia, p. 4). Bill Fitch, RD #2, Pottstown, PA 19464. (215) 469-6082

CLASSIFIED ADVERTISEMENTS

WANTED: Early mono tube hi-fi equipment for collection. Integrated amps, tuners, etc. Especially early Realist by Radio Shack. Jack Smith, 288 Winter St., N. Andover, MA 01845. (508) 686-7250

FOR SALE: Quality reproduction Regency TR-1 transistor radio owner's manuals - \$4 ea. Norman Smith, 7203 17th Ave. NW, Bradenton, FL 34209. (813) 792-0003, evenings

**NEW FAX NUMBER FOR
ANTIQUE RADIO CLASSIFIED
(508) 371-7129 - 24 Hours per day
Ads - Subscriptions - Book Orders
Charge to Visa/MasterCard
Minimum Charge: \$10.00**

WANTED: Novelty radio microphones 417-418, page 159. Jukebox 415, p. 158. Radios 430, 431, 432, 433. Page 163 in Breeds Novelty Radios Guide. Bill Fitch, RD #2, Pottstown, PA 19464. (215) 469-6082

FOR SALE: Selling Hallicrafters all-band receivers S-38C (1953?), S52 (1948?). Both pick up signals but need work. Send Offers. Ed Noll, PO Box 1042, Doylestown, PA 18901

WANTED: Technical manual/schematic for U.S. Navy oscilloscope OS-8B/U, repro OK. Bob Smith, 14779 Kogan Dr., Woodbridge, VA 22193

WANTED: NC-125 instruction manual or copy, will pay. National speaker. John Manges, Box 132, Lyndonville, VT 05851. (802) 626-8236

WANTED

Top Prices Paid

Radio & Audio Tubes: 2A3, 45's, 50's, 845, 8005, KT66/88, etc.

Western Electric Tubes: 101, 102, 104, 203, 305, 211, 212, 242, 244, 252, 262, 264, 271, 274, 275, 276, 284, 285, 300, 301, 310, 339, 345, 347, 348, 349, 350, 421, 422, VT25A, VT52, etc.

W.E. Speakers & Tweeters: 555, 594, 595, 596, 597, 713, 728, 754, 755, 756, 757, TA4151, 4153, 4181, 4191, 4194, etc.

W.E. Consoles & Amps: 25B, 41, 42, 46, 86, 91, 92, 94, 95, 105, 106, 117, 118, 120, 121, 124, 129, 130, 131, 142, 143, etc.

W.E. Horns: 22, 24, 25, 26, KS-6368, 12024, 12025, 12027, etc.

W.E. Microphones & Parts, etc.

Also looking for:

*Tube-type equipment by McIntosh, Marantz, Westrex, Langevin, Altec, etc.
Vintage speakers, units, by Jensen, Altec, JBL, Tannoy, etc.*

**Audio City USA, PO Box 802, Northridge, CA 91328-0802
(818) 701-5633**

CLASSIFIED ADVERTISEMENTS

WANTED: Coca Cola or Pepsi Cola bottle radios, Coca Cola cooler radio. State condition & price, photo if possible. Write or call: Joe Lipscombe, PO Box 9151, Richmond, VA 23227. (804) 264-1582

WANTED: Beginner-type radios, transmitters, broadcasters, multi-kits, 1930's-1940's, with 1-3 tubes or transistors: Remco, Revell, Matell, Knight, etc. Hugh Miller, 6400 Maltby Rd., Woodinville, WA 98072-8375

FOR SALE: RCA 100 speaker, good - \$50. GR cap. bridge, Model 740 - \$25. 6-volt Buick radio, 1952 - \$25. Westinghouse brass blade fan - \$15. Many other items and literature. LSASE for list. Douglas Ripka, 1367 University Dr., State College, PA 16801-6446

CLASSIFIED AD NOTICE

Please check your ads carefully before sending them in. Once ads are received, it is not always possible to refund the amount sent, pull the ad or make changes.

FOR SALE: 1933 GE Model F, shockproof, small portable x-ray unit, excellent condition in attractive wooden case - \$295. Pair of Vocatron wireless intercoms - \$35. R & IE insulator test kit, elaborate set of probes and gauges in leatherette case - \$75. Douglas Daniels, 10833 Socorro Rd., El Paso, TX 79927. (915) 859-2239

WANTED: Schematic or manual for Boonton UHF probe/indicator Model 101-B/101-I. Chet Kruczek, 29 Brookhaven Dr., E. Longmeadow, MA 01028

WANTED: R9 SIGSI, book by A. L. Munzig and Candler System publications. Bob Becker, 17020 16th SW, Normandy Park, WA 98166

FOR SALE: Two Radiola 33's. Crosley 601 Band-box parts set. Lyric 90-95 chassis and knobs. Curt Schreiber, 1621 16th Ave., NW, Rochester, MN 55901. (507) 282-8818

WANTED: Telephone parts, scraps, bits, pieces, busted boxes, cheap. Large old magnetic phonograph arms. M. S. Small, 110 South Broadway, Leitchfield, KY 42754. (502) 259-3765

WANTED FOR COLLECTION

★ 50's RADIOS ★

- ✓ Crosley
 - ✓ Motorola
 - ✓ Zenith
 - ✓ Westinghouse
- etc...

David Lasseron
707 Amoroso Pl., Venice, CA 90291
(213) 578-5253

CLASSIFIED ADVERTISEMENTS

FOR SALE: Butterscotch Catalin Telechron clock - \$50. Fairbanks-Morse Model 9A chassis w/ speaker - \$65. Philco 60 cabinet only, needs work - \$15. Zenith Royal 800, mint - \$100. Zenith Royal 790 Super-Navigator - \$40. Philco 39-226 Deco wood table model, 3-bands - \$60. Wollensak T-1515 stereo-tape magnetic recorder - \$30. Ristaucrat Dial-O-Matic 45 player w/radio, wood case - \$75. Hallicrafters S-38C - \$35. Satchell-Carlson Model 524 aircraft radio - \$25. Motorola Handbag portable - \$50. Johnson Viking Messenger tube type C. B. - \$25. Emerson Transistor II, hybrid, rare - \$75 as is. Send or call for list of approx. 60 pocket transistor radios. **WANTED:** Any Arvin pocket transistor. Michael Sovic, 1053E 11000 South, Sandy, UT 84094. (801) 572-6836, evenings

WANTED: WW2 German, Japanese, Italian radio equipment or parts, any condition. My special interest is in collecting, restoring to original operation, and using on the air. Interested also in U.S. radios of Coast Guard, Forest Service, 1930's-1940's aviation and ships, WW2 aircraft radar jammers, counter measures receivers, plus specific Models ARR-16, ARQ, AXR, MBM, PRC-1, PRC-5, RAX, TRC. Manuals or handbooks on any of above! Thank you! Hugh Miller, KA7LXY, 6400 Maltby Rd., Woodinville, WA 98072

FOR SALE: Choice console radios & jukeboxes, trade for microphones & broadcasting equipment for my museum. SASE. Robert Van Dyke, Museum of Broadcasting, Film & Recording, 2 Squires Ave., East Quogue, NY 11942. (516) 728-9835

ALL A.R.C. BACK ISSUES AVAILABLE

Feb. '87 to current issue: Originals available
32 to 80 pages each.

Oct. '86 to Jan. '87: Reprints available
Reprinted from original artwork; 28 to 32 pages each.
Quality and appearance same as an original copy.

June '84 to Sept. '86: Photocopies available
Not original quality, useful for info.; 16 to 28 pages ea.

The above availability is as of April 1990.
As stocks of original copies are exhausted, reprints will be substituted for the issues after January 1987. Publication of *Antique Radio Classified* began in 1984 which had only five issues: June, Sept., Oct., Nov. & Dec. 1984. 1985 through 1989 have had 12 issues each.

\$3.00 each - Postpaid to U.S., Canada and Mexico.

Orders of 12 issues or more may take a 10% discount. Foreign orders other than Canada and Mexico: \$5.00 each by air. Massachusetts residents, please add 5% sales tax.

Send Order with Payment to:
ANTIQUE RADIO CLASSIFIED
P.O. BOX 2, CARLISLE, MA 01741

CLASSIFIED ADVERTISEMENTS

FOR SALE: Christmas stocking stuffers: World War I Wireless Radio Operator lead soldier, repainted with repro loop antenna – \$30 ppd. Postcard with Santa listening to old 1920's radio (see A.R.C. Dec. 1986 front cover) – \$6 ppd. Vegetable can label titled "Radio Diced Carrots," from 1930's, looks great framed – \$15 ppd. The Standard Radio Game with box, bingo type game, 1920's ? – \$27 ppd. Tune In Radio Game, a very colorful board game, comes with the small original box containing the pieces – \$115 ppd. Gary Schneider, 9511-23 Sunrise Blvd., North Royalton, OH 44133. (216) 582-3094, machine answers on 5th ring

FOR SALE: MTY slant-front 22 1/2 x 130w x 10h Pan. 19 x 8 1/2. Stancore QWR trans. P5002, 10v @ 12A. 12#. John A. Myers, PO Box 98, Wilson, NY 14172-0098. (716) 751-6053, evenings

WANTED: Electric microscope patented by W. Kidder in 1884, #295.770. Other rare, unusual microscopes. Allan Wissner, PO Box 102, Ardsley, NY 10502. (914) 693-4628

WANTED: 2 3/4" diaphragm for Trimm concert model horn speaker. Also 1 1/8" round wooden knob for Zenith radio. David Millard, 4578 St. Anthony Ln., Columbus, OH 43213. (614) 237-0214

FOR SALE: Dial glass (7 1/8" x 6 9/16") convex & knobs for Zenith 8S661. Cabinet for Zenith A600L. Hitachi TH666. Thanks. Jim Dolensky, 14N755 Covered Bridge Rd., Dundee, IL 60118. (708) 428-4488

CLASSIFIED ADVERTISEMENTS

FOR SALE: Paco G-30-PC by Precision RF sig. gen., new, factory sealed – \$65. I ship. John Snow, 4539 Bartlett, Shorewood, WI 53211. (414) 964-0194

WANTED: Volumes 19, 20, 21, 23 Rider's radio manuals. Slide rule type dial scale about 10" x 14" for Hallicrafters 38D. Will purchase entire radio at reasonable price. Information pertaining to Triad radios, name of manufacturer, location, etc. **MESSAGE:** Collectors interested in formation of club/association southern Louisiana and Mississippi Gulf coast area contact: F. V. Bernauer, 1503 Admiral Nelson Dr., Slidell, LA 70461. (504) 649-5453

FOR SALE: RCA, Heath RF generators – \$15. Knight oscilloscope – \$25. Knight VFO – \$15. Knight sweep oscillator – \$20. Sencore TV analyst – \$25. Heath cap tester – \$15. Approx. 250 min. tubes – \$20 + UPS. Dave Friedlund, Rt. 2, Box 560, Hillsboro, OR 97123. (503) 628-1439

SERVICES: Cabinet-chassis exchange. Send model or chassis number wanted/for sale with SASE and \$2 per radio. Get matching collector list. N. Westman, 11209 Hwy. U, Wausau, WI 54401

WANTED: Braun radio. Daryl Jorud, R#1, Box 180, Battle Lake, MN 56515. (218) 864-5725

WANTED: Auction: quality items wanted on consignment for specialty radio auction to be held June 1991. Water Village Auction Co., Water Village, NH 03864. (603) 539-5126

WANTED!

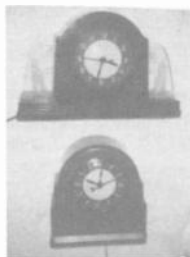

Bakelite & Catalin "Lackner" brand neon clocks. These clocks have toggle switches and stickers that say: "Lackner Neon Clock, Cinn. OH."



Collector desperately seeking NEON CLOCKS, porcelain enamel and tin signs with advertising, neon window signs with manufacturers' logos (Zenith, Motorola).

PLEASE SEND PHOTO & PRICE: Robert Newman, 10809 Charnock Road
Los Angeles, CA 90034 (213) 559-0539



Please Clip and Save This Ad!
Coca-Cola bottle radios wanted!



CLASSIFIED ADVERTISEMENTS

WANTED: Old transistor radios, small portables. Send photo or model number, condition with price. John Hoffnagle, 10 Sunset Ave., New Oxford, PA 17350. (717) 624-8894

WANTED: Phillips AG1002 record changer, used in Grundig 7063W3D console. Driver for velvet (Borkman Radio Corp.) horn speaker. Alexander Kruedener, Jr., 161 East 89 St., Apt. #4E, New York, NY 10128. (212) 831-0662

FOR SALE: Knobs, 900 radio & TV, 1930's to 1960's, 15% new - \$350 for lot only. John Snow, 4539 Bartlett, Shorewood, WI 53211

WANTED: HRO-5, HRO-7, HRO-50, coils and matching speakers, bugs and straight keys. Jerry Bowes, W9CQG, 5005 Bahama Ln., Fort Wayne, IN 46815. (219) 749-0840

FOR SALE: Originals manuals for HP, Tektronix, Phillips, General Radio, etc. 50¢ stamps for inquiry. Gordon Wilson, 11108-50 Ave., Edmonton, Alberta, Canada T6H 0H9. (403) 434-6257

WANTED: 7 in. & 10 in. TV's from the 40's. Color TV's from the 50's. Radio & Television, May 1939. Brass fans. **FOR SALE:** .0047 & .001 capacitors at 6000 volts for early televisions - \$2.25 ea. & shipping. Tony DeMara, 40231 Day, Mt. Clemens, MI 48044

FOR SALE: DeWald #A-502 Catalin insert grille and knobs any color, also dial glass. Fada 652 chassis. Ray Carroll, 158 Oakwood Dr., Wayne, NJ 07470. (201) 696-1149

CLASSIFIED ADVERTISEMENTS

WANTED: Photos, instructions and/or information on: Cassco radio, Industrial Instruments DK-2AA decade capacitor, General Radio 804-L signal generator, General Electric TC-3 tube tester, Jackson 636 tube tester (also roll chart). Alexander Kruedener, Jr., 161 East 89 St., Apt. #4E, New York, NY 10128. (212) 831-0662

FOR SALE: Sencore TF-30 Super Cricket, as new, never used, original packing box - \$150. I ship. John Snow, 4539 Bartlett, Shorewood, WI 53211. (414) 964-0194

FOR SALE: RCA reel-to-reel recorder 8TRC. **WANTED:** Tube tester and Hallicrafters S-38. Les Mathews, 8908 Tar Hill Ln., Orlando, FL 32819. (407) 239-6804

WANTED: 1950's and earlier lighted/neon radio, TV and automotive advertising signs and clocks. Keith W. Peters, 5049 13th Ave. S., Minneapolis, MN 55417. (612) 825-9219

FOR SALE: RCA III with (2) WD-11 tubes. 3-tube home brew with MX 199's. Freed-Eisemann battery FE15. Pfanstiehl battery Model 20. Philco Model 60. White and chrome Crosley Model 10-135. GE console Model S-29. (3) microphones - @\$20. Russell Schoen, E. 7340 Neitzke Rd., Clintonville, WI 54929. (715) 823-6744

WANTED: Manual or copy of instructions for Superior Model TD-55 tube checker. Does anyone have a few old recording cylinders for a Dictaphone Model AE, ca. late 40's, early 50's? Coy Benton, Box 1472, Searcy, AR 72143

WANTED

OLD RADIOS + TUBE EQPMT. DEAD OR ALIVE • HIGHEST COLLECTOR'S \$\$ PAID

McINTOSH C11 C20 C22 MR65B 67 71. M1200, 350, 3500, 275, 240, 225 75 60 40 50W, 20W, A116 MA5 6 parts

ACROSOUND
ALTEC A340 350 250 1570 ACOUSTAVOICE
AMPEX MR 70
AR 1 3a, LST
ARC D76A, D50 D51, D79, D100, D150 SP1-3
AUDIOSTATIC
BARCLAY-CROCKER and 1/2 track tapes
BEVERIDGE RM1/2 slat panels
BOGEN DO 70

BROCKNER
CASTAGNE Arm
COTTER PRODS
DYNA MK III, IV, ST70
DYNABECTOR Tube eqpt
EICO HF 60, HF 89
ELECTROVOICE Circlotron, Patricians 15 TRX
EMI
ESS Transar, Heil Elite Tweeters
FAIRCHILD PRODS
FINAL Turntable
GARRARD 601
GRAY 50, 100
GROMMES 216 212A

BROOK

FR 66 arm

GOTT 50

EXAMPLES Fisher 125A \$500 Scott 4100 \$500 Regency amps to \$800 Hartsfields \$5 000 RCA 10K11 radio \$5 000 Spartan Nocturne \$25,000 Crosley WLW 37-tube \$10,000 Zenith Stratosphere \$8 000

FIsher ALL MONO AMPS SA1000 800B KA1000, FM 1000, MF 320, MF 300 R200B Fisher-Lincoln 1930's Philharmonic

HADLEY
HEATH W-6
HARMON KARDON CIT II V B
IONOVAC

JBL Paragon, Hartfields Energizer 150-4 etc
JENSEN 18" field G610 Trax, Imperial
JM 149
KT 66 77, 88, TungSol 6550 300B, 8005 50, 8111

LAFAYETTE LA70 120 550
LEAK 50
LECSON

LEE Chair
LEVINSON JC2 ML1 ML2 ML3 LNP2
LOWTHER Spkrs

LUXX Tube Eqpt
MOSCODE 600
PHILLIPS Powered spkrs

ONM A
PILOT 216, 260, 908 913

MARANTZ ALL TUBE UNITS - Models 14 15 16, 18 19 20 120 150 500, 510M 2500 2600, cabinets cages parts

PLASMATRONICS
PURE-SOUND
QUAD II, ESL
QUICKSLIVER 190
RADIOCRAFTSMEN 500
RCA Amps Speakers Pro turntable etc
REL Precedent FM Criteria w/ MPX

SCOTT 121 208 232B, 240 250 265 272 280, 290, 296 310E 335 355 380 4120 4310 4312, cabinets

SEQUERRA FM1, T1 Tweeters
SME 3012 Arm

STEPHENS Eames design spkrs
STROMBERG-CARLSON Amps RF475 Woofer
SYNTHESE (Belgium)

TANNAY GRF, Signature, drivers amps
THETA Tube Amps
THORENS 224

TRI-CHANNEL
UTC LS-Xlms
WE Amps, Tubes, Spkrs

AUDIO SALES LITERATURE, CATALOGS & ANNUALS

Call me (LAST!) with your highest offer before you sell. NY SOUND INVESTMENTS 718 377-7282

CLASSIFIED ADVERTISEMENTS

WANTED: Copies of owner's manuals for: Triplett 3434A TV FM sweep generator, EICO 360 TV FM sweep signal generator, Precision 912 tube tester. Jim Wilson, 35 Belgard St., Rochester, NY 14609-7213. (716) 726-0952

FOR SALE: If you've never sent for our list, you're missing out. If you haven't gotten a new list for a few months, we've added a lot. Examples: Cabinets, Day Craft, Freed-Eisemann Neutrodyne; Radios from a Fada 10 to a Philco 48-482 and more. We have five gauges of cloth-covered wire, old style N.O.S. potentiometers, all sorts of parts and supplies. We are adding early tubes starting with O1-A. Have a great supply of locals. Send two-stamp large SASE for latest picture list. Dick Mackiewicz, 1549 N. River Rd., Coventry, CT 06238. (203) 742-8552

WANTED: Crosley Model 56TU dial glass, 6" x 1 1/12", has name Crosley across the middle. Roland Emerick, 7257 Jones Rd., Baldwinville, NY 13027. (315) 635-3864

FOR SALE: 4-tube (exposed 199's) batt. phono panel set - \$70. Plus UPS. Crocker, 41 Kingstown Way, #6, Duxbury, MA 02332. (617) 582-2052

WANTED: Specs for Grunow Teledial Model 588, cha. 5-W. Also circa. Wm. Stayduhar, 394 Hoffman Rd., Pittsburg, PA 15212

FOR SALE: Rider's #1 - \$45; #2 - \$25; #6, 8, 9, 10, 11, 12, 13, 14, 15 - \$10 ea. All plus shipping. Tony DeMara, 40231 Day, Mt. Clemens, MI 48044-2535. (313) 263-0325

Please Save This Want List!

BRISTOL

4-Tube Receiver

CUTTING & WASHINGTON

Models 8A, 9A, 11, 12

FIRTH

Models 15-A, 16-A, 17-A, 18-A, 19-A, 20-A
37-A, 39-A, Vocaphones B, AA & Deluxe

FEDERAL

Models 8 (RF Amp.), 56 (RF Amp.)
60 (Tuner), 142, 143, 144, 417

WESTERN ELECTRIC

Models 4-A, 2-A (antenna tuner)

As it may be a long time before I find some of the sets listed in these ads, remember to call me when you can part with yours. I am putting together a collection of early broadcast and wireless equipment and adding to it each month. I buy single sets or collections, also - books, catalogs, manuals and other related documentation.

Call and surprise me; make my day!

John V. Terrey, 498 Cross Street
Carlisle, MA 01741 -- (508) 369-9770

CLASSIFIED ADVERTISEMENTS

WANTED: Power transformer for Day-Fan Model 5091. Secondaries: 1.5v @ 5.25A, 2.5v @ 1.75A, 2.5v @ 3A, 5v @ 2A, 600v @ 200mA. Filaments for (5) Type 26, (1) Type 27, (2) Type 45, and (1) Type 80 tubes. Prefer 2.75 x 3.00 mtg centers. Dennis E. Craft, 10513 E. Clinton, Scottsdale, AZ 85259. (602) 860-8951

HAS YOUR SUBSCRIPTION

EXPIRED?

It has if your mailing label reads
"EXP=DEC90" or earlier.
Renew now!

*BONUS: Renew before
your "EXP" month and receive
13 issues per year instead of 12!*

Renewal rates are:

\$24.00 for Second-Class Mailing

\$36.00 for First-Class Mailing

(Two-year renewals are twice above rates.)

WANTED: Fly-back transformer, Philco 32-8709-1 or Thordarson Fly-5021. Gary B. Schneider, 9511 Sunrise Blvd., #J-23, North Royalton, OH 44133

WANTED: Dial escutcheons for GE A-65 and GE Studio Lowboy (F.O.S., p. 86). Spencer Doggett, 61333 North Ridge Trl., Romeo, MI 48065. (313) 651-3811

FOR SALE: Zenith 12" speaker, reconed, 49AB249, 1250 ohm field - \$35. Jim Farago, 4017 42nd Ave. So., Minneapolis, MN 55406. (612) 722-0708

FOR SALE: Philco All-wave Aerial, never used, still in original box. Make me an offer. Cam Boggs, 514 S. Alp St., Bay City, MI 48706

WANTED: B&K CB signal generator Model 2040 and Hickok CB/RF generator Model 256. Caswell Davis, Jr., 601 Delmar, Apt. 2, San Antonio, TX 78210. (512) 532-9378



FOR TRADE: Unusual set Red Star made in USSR in 50's for U.S. Catalins. J. Komon, Tirsh-enreutherstr. 4, 8000 Munich 90, West Germany

CLASSIFIED ADVERTISEMENTS

WANTED: Wooden hornspeakers. Premium paid for top condition. Victor Baker, 1450 East Ave., Rochester, NY 14610. (716) 442-3507

FOR SALE: Don C. Wallace, W6AM. This book describes the history of amateur radio, as experienced by Don Wallace. By Jan D. Perkins, N6AW, hardbound, 350 pages. Pre-publication price - \$19.95, plus \$2 S&H. Ca. residents add \$1.35 sales tax. Available from Wallace & Wallace, 11823 E. Slauson Ave., Suite 38, Santa Fe Springs, CA 90670

WANTED: Wanted or will trade for Vibroplex Blue Racer, upright or Model X bugs. F. W. Nicholas, PO Box 37094, Phoenix, AZ 85069

FOR SALE: Our new literature list will be available this month. Lots of early Grebe, Crosley, ERLA, and AK original paper plus much, much more. Send SASE to Dick Mackiewicz, 1549 N. River Rd., Coventry, CT 06238. (203) 742-8552

WANTED: Dial glass for Royal 97 Super Navigator or junker set with good glass. Stephen Scheel, 4013 Providence, Garland, TX 75043. (214) 840-6452

FOR SALE: Delco R-1229 (G.O.R., p. 105) - \$30. Emerson Bakelite Model 518 - \$20. Emerson (similar to EC301, Collins, p. 54) - \$35. GE Model 102 - \$20. Zenith 6D510 - \$25. Philco 47-204 (A.R., p. 66) - \$15. Philco 38-12 Bakelite - \$30. All plus UPS. **WANTED:** Type F-4 speaker for AK Model 55. Karl Stegman, 4 Cresthaven Dr., Belleville, IL 62221. (618) 234-7992

CLASSIFIED ADVERTISEMENTS

FOR SALE: AK 20 and 33. AC Dayton XL5. Many novelties. Candlestick phone. Testing equipment. Norman Landis, 1315 Marbendale Ct., Kirkwood, MO 63122. (314) 821-7933

FOR SALE: (10) hardback books of Sams with 10 folders ea. - \$20 ea. (22) binders of Sams with 4 folders - \$5 ea. (20) Beitmans Most Often Needed - \$5 ea. (20) Radio Craft Library of Practical Math - \$2.50 ea. (80) Sams single folders - \$1.50 ea. (22) Sams auto radio series - \$2.50 ea. **WANTED:** Trans-Oceanic 7000 in near mint. Owen Orndorff, RR2, Box 237, Danville, IL 61832. (217) 442-6812

WANTED: One white knob for Emerson 520. Also one black or two white knobs for Emerson 587 (whole radio OK). Also Emerson AU190 green. Bob Brooks, 2205 Boston Rd., J-93, Wilbraham, MA 01095. (413) 596-4629

WANTED: Philco 43B cathedral, complete, good or better cond., need not work. Dave Montgomery, 13500 Pacific Hwy. S, Seattle, WA 98168. (206) 243-6419

FOR SALE: (2) Heathkit W5M, 1 with replaced output w/T untested. AR 1300 - parts - woodgrain, cond., XL holder, coil socket, panel w/dials. John A. Myers, Wilson, NY 14172-0098. (716) 751-6053, evenings

WANTED: New collector seeks appropriate speakers for: Philco 65, Atwater Kent 42. Jim Wilson, 35 Belgard St., Rochester, NY 14609-7213. (716) 726-0952

WANT MORE BANG FOR YOUR COLLECTING BUCKS? JOIN THE MID-ATLANTIC ANTIQUE RADIO CLUB (MAARC)

Almost 800 collectors from most every state and three continents have done so. Why? Because the \$12 annual dues is a bargain! It gives you...

- **Monthly Newsletters**, up to 20 pages each, packed with radio history, restoration guidelines, and service tips, *plus* a free classified section for members! Some mailings also include supplemental radio booklet reprints.
- **Monthly Meetings**, in Laurel, Maryland, (except August and December) that include a mart and auction every time, *plus* educational programs!
- **Special Annual Picnic Meeting** as large or larger than most meets!
- **Knob Exchange & Schematic Service** (only \$3.00 for any schematic supplied!).
- **Publication, and Club Paraphernalia Sales!** • **Extensive Library for Members' Use!**
- **Membership Card** good for the whole immediate family! • **Fellowship and Friendship!**
- **Widow Assistance Program** involving sale of radio collection for surviving widow(er) at no profit to MAARC.
- **Assistance in transport** of radios to and from major meets.

FREE: Copy of "The Zenith Story: A History From 1918 to 1954," a professionally done 28-page booklet, for new members.

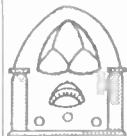

Mid-Atlantic
Antique Radio Club

**Don't be left out! Join MAARC.
Send your \$12 payable to "MAARC" to:**

Nevell Greenough (ARC) - MAARC Membership Chair
62 Nancy Drive, Hamilton Square, NJ 08619

CLASSIFIED ADVERTISEMENTS

WANTED: European multiband auto radios from the 1950's-1960's. Becker, Blaupunkt, Telefunken, etc. Early European auto radio service manuals. Tubes needed: ECH3, EBF2, EF43, EF11, ECH11, EBF11. Wilford Wilkes, 101 Swoope St., Brisbin, PA 16620. (814) 378-8526

FOR SALE: B&K 400 pix tube tester & rejuv. - \$15. Arvin 61R39 tr. radio with case, plays - \$10. Zenith CH5H40 Trans-Oceanic, plays - \$30. Raytheon TWR3 tube-type CB - \$15. Knight KN2580 tube-type CB - \$10. Sparks Withington bat. set Model ?, could be 6-26 less 6 tubes, poor-fair cond. - \$40. Hallicrafters TW1000, plays - \$60. **WANTED:** Antique microscopes, lenses & parts. Good AL-4 tube. Checks for cost only. Items shipped UPS trans. collect. John Martin, 817 Cook Ave., Billings, MT 59101. (406) 252-4287

WANTED: Eveready Model 42 console cabinet to help complete my Eveready collection. Have good chassis. Must be in restorable condition. Ed Mondor, 121 Gateway Dr., Greenville, SC 29615. (803) 268-0952

WANTED: U.S. Army BC-611/SCR 536 handy talkie. Personal lasting interest in these sets. Prefer good condition, will pay top dollar. Please call collect or write. Don Spencer, 14715 107th Ave. NE, Bothell, WA 98011. (206) 747-5618, days. (206) 488-6228, evs.

FOR SALE: Zenith 6G605 Trans-Oceanic portable, excellent working condition - \$185 ppd. David S. Kendall, KE9WI, 401 Himes St., Huntington, IN 46750. (219) 356-5096, after 6 EST

Vintage and Communications Radio Museum of Connecticut

665 ARCH STREET
NEW BRITAIN, CT.
06051

(203) 224-3853



DEDICATED TO THE PRESERVATION OF OLD TIME
COMMUNICATION DEVICES AND THEIR HISTORY

ANNUAL MEMBERSHIPS

INDIVIDUAL \$20.00

FAMILY \$25.00

SENIOR CITIZEN \$10.00

SIX DISPLAYS PER YEAR, LECTURE AREA FOR
SPECIAL EVENTS, AND A BIMONTHLY NEWS LETTER

CLASSIFIED ADVERTISEMENTS

FOR SALE: Rubicon potentiometers, museum condition, untested. Cat. #2733 - \$20 plus 25 lbs. UPS. Cat. #2714 - \$15 plus 20 lbs. UPS. Or both - \$30 plus UPS. John Uscinowski, RR#1, Box 379, Greenwich, NY 12834-9519

WANTED: Cathedral: New hobbyist wants a restorable cathedral. Write with manufacturer, model, specific condition of case, electronics, chassis, missing parts and price. A sketch and dimensions will be helpful. Loren Greenwood, 18447 N.E. 196th Pl., Woodinville, WA 98072

WANTED: Crosley 5-50 slope-front chassis or entire radio. **FOR SALE:** RCA 7-11, mint. Kenneth A. Armstrong, Box 216, IA 50588

**HAVE YOU MOVED? ARE YOU MOVING?
PLEASE NOTIFY US A.S.A.P.
SEND US YOUR...
OLD ADDRESS
NEW ADDRESS and
SUB #
MANY THANKS!!!!**

FOR SALE: Complete set of ten Hawkin's Electrical Guides, copyright 1917, impression 1927, 3,367 pp., fully illustrated, flexible binding, gold edges, excellent condition except No. 1 - \$22.50. Contact at Sea, A History of Maritime Radio Communications by Peter B. Schroeder, 1967, 148 pp., illus., with extensive appendices, new, mint - \$24. Cardwell Condenser, Type X-750-ES, 23 tapered plates, 750 uufd maximum capacity, unused, perfect in original box - \$12.50. Hammarlund Type TC-440-L transmitting condenser, 440 uufd, unused, perfect, in original box - \$12.50. General Radio output transformer, P-P plates to magnetic speaker, Type 541-B, unused in original box - \$10. General Radio audio inter-stage transformer, Type 585-H, one plate to one grid, 1:3.2, unused, mint in original box - \$10. Transformer windings test continuous. Please include allowance for UPS. Henry E. Wenden, K8IKO, 55 Riverglen Dr., Worthington, OH 43085

WANTED: Dial escutcheon for Airline 62-197 (Wells Gardner 6F), any condition acceptable. George C. Harris, 3212 36th St., Lubbock, TX 79413. (806) 795-5604

Paying \$450 for ZENITH RADIO NURSES!



HARRY POSTER
(201) 794-9606
PO Box 1883, So. Hackensack, NJ 07606

CLASSIFIED ADVERTISEMENTS

WANTED: Help: Need 2 green Catalin knobs for Bendix 526C. Tom Reynolds, 5260 McCandish Rd., Grand Blanc, MI 48439. (313) 695-0160

FOR SALE: Selling collection: old/antique radios, TV's, test equip., medical equip., paper, etc. SASE w/\$1 for list. Don Silver, RD 5, Box 187, Towerville, PA 19320-4142

WANTED: Wurlitzer jukeboxes wanted, Models 500 to 1100, 1700 to 2104, 2300, 2304, 2500, 2504. Seeburg Models V200, VL200, 100C, 100G, 100R, 100W, 161, 201, KD200, 161. AMI Models A, I-200, H-200, Singing Tower model, Packard Manhattan Pla-mor. Filben Maestro, Rockola 1413 to 1418 Premier & Presidents, Mills Empress, and others. Also buying speakers and wallboxes. Chuck Listrom, Box 12081, Kansas City, MO 64152. (816) 741-2578. John Mallinak, 6012 Scarlet Oak Ct., Galloway, OH 43119. (614) 878-8848

FOR SALE: Marconiphone I and II, HMV Gramophone. Sale or trade. A. R. Nolf, 539 Kastelic Pl., Burlington, Ontario, Canada L7N 3S9. (416) 333-4557

WANTED: Bottom cover for a Majestic Model 90 chassis or entire parts chassis. Alan Schreier, 12805 Powderhorn St., Austin, TX 78727. (512) 835-2056

FOR SALE: GR 723G 1000 cycle tuning fork. Heath IG72 audio osc., mint. Precision E200C sig. gen. Rodney Schrock, 402 Lincoln St., Somerset, PA 15501

CLASSIFIED ADVERTISEMENTS

FOR SALE: H.H. Scott tuner; (2) Heathkit A-9B amps; Knight amp; Pr. Bozak spkrs.; (2) Craftsman chrome tuners – Best Offer on above pieces. McIntosh C-8 preamp – \$100. Radiola 20, less tubes – \$160. Westinghouse WR-8 grandfather clock radio – \$275. Gloritone cathedral – \$195. Majestic semi-cathedral – \$125. RCA Model 128 large cathedral type, amateur cabinet restoration – \$145. Aeriola Jr., no cabinet; Tom Thumb, Automatic Radio Co. – \$115. Dicto-grand horn speaker, repainted – \$125. Stewart-Warner mirror-in-the-lid TV – \$250. **WANTED:** Chassis for Grebe cathedral, Kennedy V, Radiola IV, & cabinets for Aeriola Jr., Fed. 59 & Philco 20. SASE. Pics. – \$1, 100% return priv. Joe Szabat, 1019 Hiland Ave., Coraopolis, PA 15108. (412) 264-7498

WANTED: Information on Stewart-Warner 6-tube (SW 17's) with gold dancing girls, slant front. Jim Creedon, 496 Trenton Ave., Utica, NY 13502. (315) 735-1100

FOR SALE: Make offer. Iconoscope. 27 issues Wireless World: 10-'30, 16-'31, 1-'32. Magnavox chassis TRF-5 Model A, ganged pancake inductors, missing AFT w/wo tubes. Kit chassis, variocoupler, condenser with vernier, variometer missing AFT, w/wo tubes. Also transistors, transformers, meters, controls, resistors, sockets, belts, etc. Ervin S. Priem, 4289 NW 16 St., Gainesville, FL 32605. (904) 378-1959

FOR TRADE: Zenith repairman's large empty suitcase, exc. – for Best trade offer. Otto W. Niil, 192 Grant Ave., Islip, NY 11751

You Know It's Done Right When You've Done It Yourself
With The

CUSTOMIZED
CLASSIC RADIO SERVICE®
KIT

FOR FREE INFORMATION CONTACT

CLASSIC RADIO SERVICE®
25 MAPLE RD., P.O. BOX 764
WOODACRE, CALIFORNIA 94973

TELEPHONE: 415-488-4596

WANTED CATALIN RADIOS



MOTOROLA
Model 51X16



MOTOROLA
Model 50-XC



FADA "BULLET"
Model 1000 w/insert grill



FADA
Model L-56



EMERSON TOMBSTONE
Model AU 190 or BT 245
(Blue or Red)



AIR KING
Skyscraper
(Any color)



GAROD or AMC
Model 126



SENTINEL
Model 284-N (Blue)

Collector crazy for catalin!
Get your very best price, then call me.
No one pays more. I also trade.

ROD SMITH

(617) 423-3796 P.O. Box 1061, Boston MA 02117

© 1990 Rod Smith

WANTED: Crosley D-25 clock & three burgundy clock knobs or complete parts set. Robert Nicholson, 4 Superior Ave., #47, Toronto, Ontario, Canada M8V 2M4. (416) 252-4838

FOR SALE: 1986 Phillips (Sylvania) tube retail price schedule (copy), includes tubes & parts flyer - \$1 ppd. Don Diers, 4276-A19 North 50 St., Milwaukee, WI 53216-1313

WANTED: Western Electric and Northern Electric receivers, amplifiers, tubes, tuning units, antennas, literature, parts or junkers. Marc Ingenthron, 9748 Outlook, Overland Park, KS 66207. (913) 642-4767

FOR SALE: Supreme Most Often Needed radio books, lots of Sams, D. A. Moores. RCA 24 with loop ant. frame, much more. Send for list - large SASE. F. Brewster, PO Box 615, Baxter Springs, KS 66713. (316) 856-3220

— WANTED —
**PICTURES FOR PHOTO REVIEW
PHOTOS MUST BE SHARP IN DETAIL
A SHORT DESCRIPTION IS A MUST!
SEE PHOTO REVIEW PAGES FOR
ADDITIONAL INFORMATION**

FOR SALE: VM tape recorder Model 722 with 1688 speaker amplifier unit - \$75. Webster Chicago 180-1 wire recorder - \$50. Wilcox-Gay reel-to-reel recorder - \$35. Above units untested. H. H. Scott stereo tuner Model 312 - \$60. Rider's Manuals #9 and #16 - \$12 ea. Solder 5 lb. rolls .062 - 60/40 - \$20/roll. Plus shipping all items. J. J. Papovich, 53 Magnolia Ave., Pitman, NJ 08071. (609) 582-8279

WANTED: Radio Craft 4/30, 4/35. Radio News 8/25, 6/28, 3/29. Any 1920's Radio Progress. Leonard J. Arzooanian, 61 Columbus Ave., North Providence, RI 02911. (401) 232-0869

FOR SALE: (3) RCA clock-radios Model 4C-8C-8C, works - \$60/all. AE dial candlestick telephone with ringer box - \$95. Hickock Model 600A tube tester - \$45. Zenith wood 5D627 TM - \$55. Emerson wood TM - \$25. Motorola 6-volt auto radio #309 - \$30. RCA T75 chassis speaker & knobs & escutch., only - \$25. Add UPS shipping. Clark Trissell, 3530 Pawnee, Lincoln, NE 68506. (402) 488-5263

FOR SALE: Grunow 1291 (G.O.R., p. 74), cabinet excellent, untested, missing one knob, but otherwise seems complete, gorgeous unit - \$175. Mick Catalano, 317 W. 11th, Mitchell, SD 57301. (605) 996-5925

WANTED: Buick Selectronic auto radio models: #980899 (1950), #980980 (1951/52), #981323 (1953), #981551 (1954). Alan Kriss, 1872 Portsmouth Way, Union, NJ 07083. (201) 688-2092

CLASSIFIED ADVERTISEMENTS

FOR SALE: AK 33 chassis - \$35. Radiola III - \$75. Radiola 100 speaker - \$35. Crosley Super-Tirдын Special, no pointers - \$65. AK E speaker - \$45. Radiola 25 parts. AK 67 parts. All plus UPS. Don Sturzenbecher, Rt. 3, Box 28, Sioux Falls, SD 57106. (605) 368-2135

**IF YOUR EXPIRATION DATE IS
DECEMBER OR BEFORE, RENEW TODAY!
EARLY RENEWALS
RECEIVE AN EXTRA ISSUE!**

FOR SALE/TRADE: It's bizzarriana time, read carefully, some once every five years stuff here. Souvenir cast iron paperweight from the N.E.L.A. Electrical Conference that brought all of us electric meters in 1925, shape of meter, dated tag - \$85. Mahler electric wart remover, dovetailed oak case, old, very nice - \$75. Oak radio keg - \$225. RCA Victor transistor radio display case - \$175. Radio questionnaire game, flashes the answer by wireless, from 20's - \$85. Radio quiz game - \$60. Set of eight WE 211 - \$200. Four N.I.B. GE 316A/VT191 - Best Offer. Nice H.B. crystal set in case, styled like Crosley 51 - \$65. Zenith solid-state Trans-Oceanics 1000 & 3000 - \$125 ea. Pink Dahlberg pillow radio, trade only for white mic in following AM freqs.: 670, 720, 760, 780 or 1000. Pair of Dahlbergs, 1 green, 1 pink, trade for white Emerson USA. Truetone boomerang, very small hairline - \$150. E.V. 630 mic - \$45. Howe crystal set, a little rough - \$135. 10 channel Radio Shack programmable handheld scanner - \$65. 200 channel Radio Shack handheld with cellular - \$185. Minolta MD-90 Maxum motor drive N.I.B. - \$80. Always looking for Royal 500H (oval speaker) small stand-up Zenith portables, Deco styled solid (not painted) white Bakelites (urea), factory crystal sets, 2 transistor radios, working matched pairs of Motorola VHF H.T.'s, solid-state digital shortwaves, Deco lamps, and a good night's sleep. Please call with any deal on the above you can cook up, with cash up or down. Please don't call looking for Catalins (I'll call you), to discuss your equipment that is not for trade or sale, or to answer questions about things I've never heard of (a vast field in itself). Calls on radios only between 6 pm to 8 pm Central Time. Bill Jenkins, 4335 N. Damen, Chicago, IL 60618. (312) 528-1341

BUYING RADIO COLLECTIONS & ESTATES

We specialize in purchasing radio collections, accumulations, or estates of all sizes anywhere in the country. Contact us in confidence.

Jim Clark Enterprises
1292 Starboard
Okemos, MI 48864
(517) 349-2249

CLASSIFIED ADVERTISEMENTS

WANTED: Millen coils for Millen 50-watt exciter 90800. Also Millen Variarm VFO. R. L. Kurth, W5IRP, 403 Mantooth, Lufkin, TX 75901

FOR SALE: (3) D01-A DeForest tubes in original car, three duds, one good one. Also gold 01-A tubes. Russell Schoen, E7340 Neitzke Rd., Clintonville, WI 54929. (715) 823-6744

WANTED: Old candlestick telephones. Collector. Melvin Snead, 1902 Belleville Rd., Roanoke, VA 24015

FOR SALE/TRADE: Crosley Type SR-8 (with CX12 tube) rare portable made for Sears - \$125. Atwater Kent Model 60 chassis, working, with tubes - \$30. Speaker for the Model 60 - \$20. No. 4 Mesco? Home medical (quack) apparatus - \$30. Shipping extra. SASE for list. Want antique kaleidoscopes. Arthur Harrison, 501 Arbor Dr., Columbia, MO 65201. (314) 474-8729

FOR TRADE: Mint GPR-90, spkr. & manual, for your Philco 90 & 70. A Bruno, 24 Butternut Dr., New City, NY 10956. (914) 354-8899

WANTED: Urgently need two (2) sets Octo two winding, 4-prongs plug-in coils covering 16 to 510 meters with 140 or 150 MMF. tuning capacitor. Call Plans, Ltd., Charles E. Barnes, PO Drawer 918, Clearwater, SC 29822. (803) 279-8570, anytime, leave message

WANTED: Packard Bell table model radios. Carl L. Elkins, 1701 Woodland St., Nashville, TN 37206. (615) 227-7972

JOIN

A. W. A.



ONE OF THE WORLD'S LARGEST AND OLDEST
HISTORICAL RADIO COLLECTOR ORGANIZATIONS.

- * International "Meets"
- * Nationwide "Meets"
- * Sponsors world's largest radio Conference and Flea market
- * Maintains unique radio and television museum
- * Publishes quarterly journal featuring columns covering:
 - Battery & AC receiver restoration
 - Loudspeaker operation
 - Commercial receiver column
 - OT amateur transmitter operation
 - Vacuum tube collector's column
 - Early television receiver column
 - Current radio book & magazine reviews
 - Free Want-Sell-Swap column
 - Radio obituaries
 - Reports on public radio museums
 - Information on collector clubs in USA and foreign countries

All this for only \$10.00 per year. Mail check to:
Antique Wireless Association, Inc.
Box 2-E, Breesport, New York 14816

Do Your Holiday Shopping This Season From These Selected Books from Antique Radio Classified!

(IT'S OK TO SHOP FOR YOURSELF, TOO!)

1. Every radio collector from the novice to the experienced should have a copy of this book.



GUIDE TO OLD RADIOS

A primer to collecting. 128 pages, 350 photos and 3300 current prices. 7" x 10". Johnson.

Softcover\$16.95

2. A book to help every collector get those old battery and AC sets playing again.

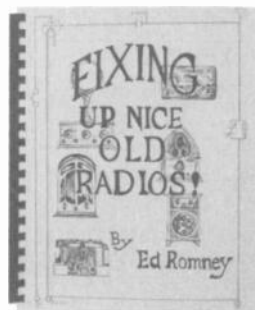

FIXING UP NICE OLD RADIOS

Written by an old radio instructor. 185-pages, 300+ figures. 8 1/2" x 11", GBC binding. Romney.

Softcover.....\$25.00

3. These two books belong in the library of all collectors of plastic and other collectible radios from the 1930's and 1940's.



CLASSIC PLASTIC RADIOS FROM THE 1930s AND 1940s

Collectors guide to Catalin models. Over 200 models shown in full color. 8 1/2" x 11". Sideli.

Softcover\$19.95

Hardcover\$29.95



RADIOS - THE GOLDEN AGE

Full color book on the colorful Catalin, Bakelite & other collectible radios from the 1920s to the 1940s. Full color. 10" x 8 1/2". Collins.

Softcover\$14.95

Hardcover\$25.00

Send your order to P.O. Box 2, Carlisle, MA 01741 or Call: (508) 371-0512. We accept VISA and MasterCard; please include name on card, card number and expiration date. Payment is required with order. Add \$1.50 for orders under \$35 for shipping. Mass. residents please add 5% sales tax. Foreign orders - write for shipping costs or use credit card. Most books shipped within 4 days but allow two to four weeks to receive order.

Do Your Holiday Shopping This Season From These Selected Books From Antique Radio Classified!

(IT'S OK TO SHOP FOR YOURSELF, TOO!)

4. This book is a must for anyone collecting radios and crystal sets from the 1920's.

5. This book is a must for anyone collecting radios from the 1930's to the 1950's.



VINTAGE RADIO

Standard photo reference guide for radios before 1930. 1000+ pictures. 5" x 8". McMahon.

Softcover.\$11.95



FLICK OF THE SWITCH

Standard photo reference guide for 1930s to 1950s radios. 1000+ pictures. 5" x 8". McMahon.

Softcover.\$11.95

6. These two books belong in the library of all collectors of early broadcast sets from the 1920s. (Volume 3 is expected in early 1991.)



RADIO MANUFACTURERS OF THE 1920s - VOLUME 1

American broadcast receivers of the 1920s. A-C Dayton to Ferguson. 8 1/2" x 11". Douglas.

Softcover\$19.95

Hardcover\$29.95



RADIO MANUFACTURERS OF THE 1920s - VOLUME 2

American broadcast receivers of the 1920s. Freed-Eisemann to Priess. 8 1/2" x 11". Douglas.

Softcover\$24.95

Hardcover\$39.95

Send your order to P.O. Box 2, Carlisle, MA 01741 or Call: (508) 371-0512. We accept VISA and MasterCard; please include name on card, card number and expiration date. Payment is required with order. Add \$1.50 for orders under \$35 for shipping. Mass. residents please add 5% sales tax. Foreign orders - write for shipping costs or use credit card. Most books shipped within 4 days but allow two to four weeks to receive order.

CLASSIFIED ADVERTISEMENTS

WANTED: Dial escutcheon for Philco Model 70 or 21 cathedral radio. Dave Markley, 6702 Ravenna Ct., Reynoldsburg, OH 43068. (614) 861-0642

WANTED: Battery base for a Grebe Synchro-phase MU-1, any condition OK. Call Kevin Keinert, 4010 Loch Lomond Dr., Santa Maria, CA 93455. (805) 937-8881 or 928-4343

SERVICES: Out-of-print books on radio-wireless searched for. Send author, title to: Jerry Simkin, 10 Avalon Ln., Matawan NJ 07747

WANTED: AK 5 with tags - pay up to \$3000. AK 50 - pay up to \$600. Ed Bell, 5311 Woodsdale Rd., Raleigh, NC 27606. (919) 851-1517

FOR SALE: RCA 44, 77, KB2A, WE 639A mics, tubes 6336, 5868, Z1000A, 4S, WE. Vernon Vogt, 330 S.W. 43rd St., #247, Renton, WA 98055. (206) 251-5420 x247fc

WANTED: Winchester D cell batteries, No. 1511, exp. '51/'52, blue/red lettering on blue/cream. Lutsky, 31 Longfield Dr., Neshanic, NJ 08853

FOR SALE: Tektronix Model 503 5-inch oscilloscope with two probes, perfect working order and calibrated by major company lab, excellent for radio servicing, no manual, but is available - \$200 including UPS. M. D. Bergan, Jr., 2011 E. Flynn Ln., Phoenix, AZ 85016-1113. (602) 248-0356

FOR SALE: RCA 3X534. Transitone TP-4. GE T-1110A. H.P. scope 120B. Tubes - 75¢ ea. Joseph Zambri, RD 4, Box 216, Towanda, PA 18848

CLASSIFIED ADVERTISEMENTS

FOR SALE: Radio catalogs - the following are all \$7.75 ea. ppd: Federated Purchaser 1936, 136 pp.; 1937, 164 pp.; Radolek Co. 1935, 146 pp., no rear cover; 1936, 162 pp.; 1937, 162 pp.; 1938, 162 pp.; 1939, 160 pp.; Allied 1936, 136 pp., spring/summer; 1937, 152 pp.; 1938, 160 pp.; 1939, 176 pp. Other catalogs priced ea. ppd.: Lafayette 1936, 192 pp. - \$10; Lafayette 1938, 172 pp. - \$10; Wholesale Radio Co., Lafayette, 1935, 192 pp. - \$10; Barawik Co. 1929, 264 pp. - \$18; Allied 1930, 192 pp. - \$18. Also have 7 Allied Industrial Electronics catalogs from 1964 to 1971 - \$23/whole lot ppd. Gary Schneider, 9511-23 Sunrise Blvd., North Royalton, OH 44133. (216) 582-3094, machine answers on 5th ring

FOR SALE: Electric Radio magazine, in our second year, articles on vintage ham and military gear; repair/restoration, history and AM operation, large classified section - \$2 for a sample copy. Electric Radio, 145 CR 123, Hesperus, CO 81326

WANTED: Crystal sets by Ericsson, Ediswan, Belling - Lee and Burndept. Ian L. Sanders, 16725 Wild Oak Way, Morgan Hill, CA 95037. (408) 778-7547

FOR SALE: Scott 800B in light-finish cabinet, working. Write/call for details. Ken Sleger, 2924 Taylor Ave., Alexandria, VA 22302. (703) 836-7242

FOR TRADE: Sams Photofacts set 224 thru 1549 complete for complete set of Rider manuals with index. Jim Hensen, 4196 Pheasant Dr., Carson City, NV 89701. (702) 885-0347

★ WE HAVE A U.S. SHIPPING ADDRESS !! ★
— WANTED —

WESTERN ELECTRIC LOUDSPEAKERS

750A\$100

ELECTRON TUBES - ST SHAPE

50, ST19, large size\$35
 45, ST1415
 80, ST14\$4
 2A3, VT-52, VT-626

ANTIQUA GLOBAL SHAPE TUBES

37/2375
 250,350,45035
 80/280/38010
 UV201, Tip, Brass Base12
 145/245/34515
 210/31010
 UV202, Tip, Brass Base25
 UV216, Tip, Brass Base20

TRANSMITTING TUBES

211/VT-4C/RS23715
 845/845W30

WESTERN ELECTRIC TUBES

101D, F, G/102D, F, G, E/216A/104D/D86326/D86327 Tennis Ball			30
VT1/203B	20	350B	30
205D, E, Tennis Ball	50	242C/261A/276A	25
244A	6	212D/212E	70
252A	100	VT2/205B	35
271A	30	101D, F/102D, F/104D, ST 10	10
275A	30	205F, ST	20
348A	10	262A/262B	10
		274A/274B	40
		300A/300B	80
		339A	20
		349A	10
		211D/211E	50
		284D	80

TRIAL ELECTRIC PRODUCTS, INC.

201 Common City Yotsuya, 4-13 Suga-Cho, Shinjuku-Ku, Tokyo 160 Japan

CLASSIFIED ADVERTISEMENTS

WANTED: Plans, books, etc. for crystal radios and wind generators. K. A. Ladd, 5240 44th Ave. S, Minneapolis, MN 55417. (612) 722-6786

WANTED: Help: Need 2 green Catalin knobs for Bendix 526C. Tom Reynolds, 5260 McCandlish Rd., Grand Blanc, MI 48439. (313) 695-0160

FOR SALE: RCA Victortabletop Model RJC 42W, walnut grain, 15 x 7 x 8 inches, ca. 1962, vg condition - \$30 plus shipping. Joe Jacobs, 60 Seaview Terr., Northport, NY 11768. (516) 261-1576

**NOTICE TO ALL
CLASSIFIED ADVERTISERS!
OUR CLASSIFIED AD DEADLINE IS
12:00 NOON
ON THE 10th OF EACH MONTH**

FOR SALE: Tubes, have a large selection of rare collector types. Send SASE for current list. D & C Electronics, 3089 Deltona Blvd., Spring Hill, FL 34606

WANTED: Atwater Kent breadboard radios or parts. Have Crosley Pup for trade on same. Paul Thompson, 315 Larkspur Dr., Santa Maria, CA 93455. (805) 934-2778

FOR SALE: American Bosch 206 (25Hz), needs work - \$30. Kolster (6D ?), battery set for parts - \$25. **WANTED:** Knobs for: RCA 110 cathedral (wood rosette), DeWald A502 (yellow Catalin pinwheels), Westinghouse H126 refrigerator. Speaker for Philco 20 cathedral, will recone if necessary. Green Catalin case for Bendix 526 MC. Tim Fuss, 573 Grand Ave., Rochester, NY 14609. (716) 482-8963

FOR SALE: Radio Boys books, with dust jackets: At Mountain Pass, At the Sending Station, In Gold Valley, any of the above - \$15 ea. ppd. At the Sending Station, no dust jacket - \$12 ppd. Radio and Television by Coyne Radio-TV School 1950, (5) books excellent condition - \$25 ppd. Elements of Radio by Marcus, 1945 - \$15 ppd. Basic Radio by Hoag, 1942, e - \$20 ppd. J. J. Papovich, 53 Magnolia Ave., Pitman, NJ 08071. (609) 582-8279

• LOUDSPEAKER REBUILDING •

Custom rebuilding, with special attention to original appearance and quality.

Field coils: We rewind them.

Obsolete cones: If we don't have a replacement, we will try to fabricate one for you.

In business for 18 years, we are authorized service for most major speaker manufacturers.

Call toll free for information: 1-800-367-SPKR

Lakes Loudspeaker Service

4400 W. Hillsboro Blvd.

Coconut Creek, FL 33073

We ship UPS and Greyhound



CLASSIFIED ADVERTISEMENTS

WANTED: National C-200 communications receiver. RCA Transmitting Tube Manual, 1950's red cover. 35Z5, 50LGGT, 12SJ7 and 6AC7 N.O.S. tubes. Mike Duckworth, W9OCT, 2415 Broadnax Cir., Chesapeake, VA 23323

FOR SALE: Hammarlund HQ 100 - \$125. DSI 5600A frequency counter, 50Hz 512MHz, real good - \$75. Harry Lysak, 39 Clover St., Ansonia, CT 06401

FOR SALE: Thirty radios from 1927-1950. Woods, Bakelites, plastic. No junkers. Pickup only. Reasonable. George Friedrich, 7162 Lake Jacqueline, Custer, WI 54423. (715) 592-4901

WANTED: Fada four-pin, panel mount tube socket for battery radio. Randolph Warren, 2911 Monroe Pl., Falls Church, VA 22042. (703) 241-4904

FOR SALE: Dial Cord Stringing Guide, 1938 to 1947 radios, 552 diagrams, photocopy - \$10 prepaid. Jim Cook, PO Box 20368, Columbus, OH 43220

FOR SALE/TRADE: Zenith shutter-dial chassis for Models 9S203 through 9S264, vg and working. James Kroegel, 856 Old Farm Rd., Columbus, OH 43213. (614) 864-8327

FOR SALE: RCA Model 16K. Airline Model 93WG-1000A. Heathkit lunchbox test equipment. Priced to sell. John Poland, 3001 Scotts Hill Loop Rd., Wilmington, NC 28405. (919) 686-4236

BUYING!

★ 1920-1924 Battery Sets ★

Amrad, Clapp-Eastham, Federal, Grebe, Kennedy, Leutz, Paragon, Radiola, Tuska, Crystal Sets, AK Breadboards and Cathedrals.

Serious collector. Will consider others and entire collections. Can travel.

Ed Bell
5311 Wooddale Rd.
Raleigh, NC 27606
PH: 919-851-1517

CLASSIFIED ADVERTISEMENTS

FOR SALE: HQ180 rcvr. - \$200. Westinghouse RC RX - \$175. 1931 GR wavemeter - \$75. 1920 spark transmitter - \$850. Grebe CR18 special/coils - \$700. S. Mount, K20A, 35 Grand St., Highland, NY 12528. (914) 433-7714

WANTED: Amplion wood petal horn speaker Model AR114 or other small Amplion wood petal horn. Will buy or trade for same. Sonny Clutter, 14407 NE Fremont, Portland, OR 97230. (503) 254-9296, home; 233-0049, work

WANTED: AK breadboard components: tube sockets, TA's, RF's, potentiometers, any condition. Contact me last before you sell. AK-567, 50, 228, others. Bob Nicholson, 3423 S. Long, Topeka, KS 66605. (913) 266-9473

FOR SALE: (2) Zenith Trans-Oceanic R3001 - \$50 and \$115. Yago wine bottle, trans., N.I.B. - \$35. S.S. Cookie Time radio - \$30. Spider Man, round - \$20. Crank-style telephone radio, wood - \$30. Amoco gas pump - \$20. Early RCA gold/char. grey, Model #1T45 - \$35. All metal knight head - \$35. Harald Herp, 6615 Michele Ct., Huntingtown, MD 20639. (301) 855-7071

FOR SALE: List #4 of 60 transistor novelty radios. LSASE to R. F. Breed, 5110 Los Altos Ct., San Diego, CA 92109. (619) 274-0712

FOR SALE: 10,000+ items. 70 years accumulation: radios, televisions, phonographs, catalogs, parts, 48 pages - \$1. F. Yonker, W21BH, 7 Old Farms Rd., Saddle River, NJ 07458. (201) 825-1895

OLD TECH BOOKS & THINGS



*Early
Technical
Books &
Apparatus*

**Announcing - Catalog No. 1
Available - Fall 1990
Write For Free Copy.**

We Specialize In:

Wireless - Radio - Television - Telegraph
Telephone - Electricity - Computers - Slide Rules
Electro-Medical - Calculators - Typewriters
Atomic Energy - Astronomy - Skiing

We Buy & Sell:

Books - Juveniles - Catalogs - Magazines
Manuals - Ephemera - Novelties - Apparatus
Anything Related!

Send us a list of your general & specific wants.

OLD TECH - BOOKS & THINGS

John V. Terrey, Proprietor
P.O. Box 803, Carlisle, MA 01741 U.S.A.

CLASSIFIED ADVERTISEMENTS

FOR SALE: Airline wooden tombstone - \$150. 1889 Diehl ceiling fan - \$250. Steinway piano - \$50. Warren Dasho, 26 Kingston St., Reading, MA 01867. (617) 944-0470

FOR SALE: Radiola III with (2) 199 tubes plus extra audio transformer, tube socket and indicator dial - \$200. J. J. Papovich, 53 Magnolia Ave., Pitman, NJ 08071. (609) 582-8279

CLASSIFIED AD NOTICE

Please check your ads carefully before sending them in. Once ads are received, it is not always possible to refund the amount sent, pull the ad or make changes.

WANTED: Original equipment automobile radios, control heads, knobs, and antennas pre-1963, automobile phonographs. Dan Schulz, PO Box 892, Crystal Beach, FL 34681. (813) 785-8733

FOR SALE: Zenith Trans-Oceanic radios, A600, B600, H500, 8G005Y, all near mint - \$80 ea. Jack McCreary, 7783 Wildcreek Trl., Huntsville, AL 35802. (205) 882-0037



WANTED: Phonographs, & wood & metal horns. Ross Litrenta, 1 Wilton Rd., Eastchester, NY 10709. (914) 337-7176

FOR SALE: 1949 Teletone TV-208 N.I.B. - \$395. Tubes - N.I.B., 12LP4, 10FB4 - \$60 ea. Bill French, 7104 H. Kensington, Indianapolis, IN 46226. (317) 545-5784

WANTED: Want to buy: or will trade for Federal DX 58 cabinet. What do you need? Merrill Bancroft, 169 S. Row Rd., Townsend, MA 01469. (508) 597-6623

WANTED: Schematic for Scott receiver Mod. R33S. Hector O. Rivera, 549 Main Rd., Tiverton, RI 02878

FOR SALE/TRADE: Fada 260. (2) Fada 350's. Motorola 7" TV. Arvin 242-T. Catalin poker chip set. (2) damaged Catalins. David Mednick, 1450 Palisade Ave., Apt. 5-H, Fort Lee, NJ 07024. (201) 461-3082

FOR SALE: Philco Model 90 tube shield - \$15. J. A. Schehrer, 508 Gray, Joplin, MO 64801. (417) 781-4028, evenings

CLASSIFIED ADVERTISEMENTS

WANTED: Electronic calculators from 60's and 70's, handheld or desktop, working or nonworking, Robert Armstrong, 3500 Tree Tops, #303, San Bruno, CA 94066. (415) 355-9788

FOR SALE/TRADE: Philcos: 70 cathedral - \$200, 45 table - \$60. Crosley 655C tombstone - \$85. Consoles: American Bosch 48A, Silver-Marshall 41 (36A), Airline 62-181; Zenith 6S254. Western Electric speaker R540C, incomplete - \$40. RCA Radiola 44 and 17. Emerson 336, ivory. Arvin 664A, ivory, painted. **WANTED:** Zenith 39A, 230, 250, 288, 15U270, 12S471 and other prewar models. Phonograph for 1930 Zenith. Dial parts for Models 908, (960, 1117) and also for 12S568. Cabinet for a 16A61. I have Zenith parts to trade for the above parts or will buy outright. Martin Blankinship, Box 157, Leocompton, KS 66050. (913) 887-6681, 10:30 am - 2:30 pm weekdays or anytime weekends

WANTED: The plug-in crystal filter, meter, and tube shields for an early National HRO. Also, a pair of audio transformers for a Tuska 225 dead or alive. In addition, will pay top dollar plus 25% for a National AGS. Jim Allen, 1653 Newcastle Dr., Los Altos, CA 94024. (415) 968-0640

FOR SALE: (30) back issues of A.R.C. from 3/87. (30) Radio Age, from 1/88. (30) MAARC from 3/87. Each pkg. - \$4 ppd. Send SASE and \$1 (refundable with purchase) for list of chassis and comm. rcvrs. Need pwr. xfms.? Send SASE with tube and dimension requirements. C. A. Gehman, RFD 2, Winsted, CT 06098. (203) 379-2441, evenings

CLASSIFIED ADVERTISEMENTS

WANTED: CB Sams, please send list and price. Gary Capoen, 18025 NE Chehalem Dr., Newberg, OR 97132

FOR SALE: Philco Model 40-135 chassis, spkr. cone & grille bad - \$20. Philco 40-165 complete set - \$90, chassis - \$75. Philco 39-25 chassis with tubes, speaker, front plate and knobs - \$75. Philco 37-93 chassis, no tubes, no knobs, spkr. (bad cone) - \$50. Philco Dynamic speakers: 36-1612, 15" - \$30; 36-1437, 10" - \$25; 32-9055, 10" - \$25. J. J. Papovich, 53 Magnolia Ave., Pitman, NJ 08071. (609) 582-8279

FOR SALE: Sparton 558 Blue Mirror radio. Chrome and mirror excellent. Contact David Snow, PO Box 6352, Jackson, MI 49204. (517) 787-2985, after 7 pm EST

WANTED: Acme D unit coil assembly. Francis Emrich, W2VDI, 441 Swaggertown Rd., Scotia, NY 12302

FOR SALE: Old radios, odd parts, phono parts, earphones, AK, Grunow, Crosley radios, vibrators, car radios, some GM parts. L. Luke, LB415, Coshocton, OH 43812

FOR SALE: Wire recorder, wire reels, QST & audio magazines, parts. Send SASE for lists. M. Clifford Agress, 891 Fulton St., Valley Stream, NY 11580

WANTED: Dial glass & bezel for Philco Mod. 610, five tube, 3 band. M. S. Beatty, 504 Blue Valley Dr., Austin, TX 78748. (512) 282-5615

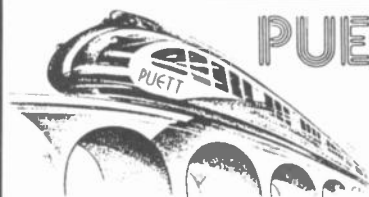

PUETT ELECTRONICS

P.O. BOX 28572 DALLAS TX 75228

NEW CATALOG 77

OUR PAST CATALOGS AND PRICE LISTS ARE NOW OBSOLETE.

CATALOG 77 (20-PAGES) OUR BASIC CATALOG \$2.00 POSTPAID.
YOU RECEIVE A \$3.00 DISCOUNT COUPON WITH CATALOG 77.

CATALOG 77/PLL-2 (56 PAGES) -- \$5.00 POSTPAID.
YOU RECEIVE A \$6.00 DISCOUNT COUPON WITH CATALOG 77/PLL-2.

WE NOW HAVE MORE THAN 1,500 DIFFERENT ANTIQUE RADIO PUBLICATIONS AVAILABLE! CATALOG 77/PLL-2 LISTS EVERYTHING WE HAVE TO OFFER!

GET THIS
**WORLDS
GREATEST
RADIO
CATALOG**

WE OFFER BOOKS, INSTRUMENT MANUALS, SERVICE DATA, SALES BROCHURES, ATWATER KENT, RCA, CROSLEY, ZENITH, ETC. FACTORY SERVICE MANUALS, STROMBERG CARLSON, CAPEHART, SCOTT, McMURDO SILVER, FISHER CLASSIC RADIO LITERATURE, DIRECTORY OF ANTIQUE RADIO SERVICES, SCHEMATIC DIAGRAMS ON NEARLY ANY RADIO, OLD-TIME RADIO PROGRAMS ON CASSETTES, TUBES, TUBE MANUALS, BOOKS ON WIRELESS AS OLD AS 1902, TUNING DRIVE BELTS, TUNING DIALS, TUNING-DIAL GLASS COVERS, KNOBS, OUR OWN PERIODICAL "ANTIQUÉ RADIO TOPICS" WITH THE ANTIQUÉ RADIO NEW ACQUISITIONS LIST, AND MUCH MUCH MORE!! ORDER OUR CATALOG TODAY!!!!!!

CLASSIFIED ADVERTISEMENTS

FOR SALE: Over 500 manuals, magazines, books, paper items, some radios. Send SASE for list. P. Majewski, PO Box 92, Tamaqua, PA 18252

FOR SALE: RCA T6-9 and Crosley tombstones - \$90 ea. Atwater Kent 20C, early model - \$90. Philco Bakelite 54-890 - \$25. Colombia oak table Victrola - \$150. Zenith Bakelite 7H918, FM only - \$25. RCA 75X1 - \$40. Gramophone picture advertising, 27" x 20" - \$60. Book by Charles Leutz - Shortwave - \$25. Emerson Bakelite with handle knobs missing - \$15. Air King Motorola, Mirror-tone miniatures - \$50 ea. R. Burick, 21 N. Earl St., Shippensburg, PA 17257. (717) 530-5040

WANTED: Transistor radios. Motorola Models 6X31C, 6X32E, 66T1, 76T1 and 76T2. Hoffman Models P410 or P411. Could someone out there please send me a listing/description of the Zenith Trans-Oceanic line - tube and transistor? I'll pay. Also, something on the age of the Zenith Radio 500H Series, either by chassis number or description. Some seem to be a little different from others. Also want Volumes 2 and 3 of Sams Servicing Transistor Radios. Help! P. L. Meeks, 2811 Kenross, Houston TX 77043. (713) 460-5369

FOR SALE/TRADE: TV's, Motorola Bakelite TS-18, RCA metal 14PD9930 and 170T123. **WANTED:** Rider 1 thru 5, 17 thru 20. Ray Kushnir, 2213 Alpine Dr., Colorado Springs, CO 80909. (719) 634-5861

FOR SALE: Tubes; radio, TV, 40's thru 50's era - SASE for list. Lee C. Dickinson, 478 Main St., Cromwell, CT 06416

AUDIO GOLD FROM THE '40s AND '50s!



AUDIO ANTHOLOGY volumes contain *Audio Engineering's* best articles from 1947-55. From preamps to tuners to power amps to speakers, the exciting world of this golden era comes to life on every page. Vol. 1: 38 articles; Vol. 2: 45; Vol. 3: 43. Complete with many classic photos and diagrams.

Please send me:

QTY.			TOTAL
_____	BKAA-3/1 Audio Anthology Vol 1	\$16 95	_____
_____	BKAA-3/2 Audio Anthology Vol 2	\$16 95	_____
_____	BKAA-3/3 Audio Anthology Vol 3	\$16 95	_____
_____	BKAA-3/S Audio Anthology Vols 1-3	\$42 00	_____

MC VISA CK/MO

POSTAGE TOTAL _____

NAME _____ **POSTAGE & HANDLING:** In US, please add \$1.75 per book for the first book and 50¢ each additional book. Canada add \$4.50. Overseas: please include 20% of total order for shipping.

STREET & NO _____

CITY _____ **STATE** _____ **ZIP** _____

MC/VISA NUMBER _____ **EXP** _____

Old Colony Sound Lab

PO Box 213, Dept AR, Peterborough, NH 03458-0213
 (603) 924-6371 / 924-6526 FAX (603) 924-9467

Answering machine for credit card orders only, before 8:00 a.m., after 4:00 p.m. and weekends. Have all information plus MC/VISA available.

CLASSIFIED ADVERTISEMENTS

WANTED: Information on tuning mechanism on Philco 44. Have dial on capacitor, shaft thru cabinet. What's in between? Earle Drake, Box 1808, Hyannis, MA 02601

WANTED: Ballast tube L55B. Chassis and spkr. for GE Model J-86. Wayne Himel, 5230 August Ave., Marrero, LA 70072

FOR SALE: RCA Globe Trotter (F.O.S., p. 157), working - \$25 ppd. SASE for list of others. M. H. Smith, 1102 Webber St., La Porte, IN 46350. (219) 324-0393

PHONE NUMBER FOR ANTIQUE RADIO CLASSIFIED (508) 371-0512

Best time to call is weekdays: 9 am to 5 pm Eastern Time

(Please no classified ads by phone. Thanks!)

WANTED: For Emerson Jewelry Box, speaker grille wood bars and dial (same as Collins, p. 29) or will buy junker, your price. Wanted from Collins - Zenith 6D315U Truetone D2661 (p. 71) Airline 93WG604A Airline 62-472 telephone dial (G.O.R., p. 92) Belmont 636. Jim Ciulla, 2224 Virginia Rd., Fullerton, CA 92631. (714) 879-0177, 9 am - 1 or leave message

WANTED: Escutcheon for Philco 89. **FOR SALE:** Escutcheon for Philco 70, Motorola 68L11 basketweave - \$65. Teletone 109, B&W - \$40. Emerson 571, white - \$30. DeWald B-504, red/white - \$25. Philco 89 - \$60. Swiss Jewel Box transistor - \$80. Telefunken Gavotte - \$80. Grundig 4192 - \$125. Normandie Tannhauser - \$125. Korting 1036 - \$30. Emud 196 - \$35. Lowe Opta 5710 - \$35. Grundig 4040 - \$50. John Okolowicz, 624 Cedar Hill Rd., Ambler, PA 19002. (215) 542-1597

FOR SALE: Rider's 1-5 abridged - \$45 + UPS. Dick Hagrman, 3429 W. Berry Pl., Littleton, CO 80123. (303) 794-6674

FOR SALE: TSM transistor manuals 25, 26, 30, 34, 40, 42, 50, 57, 58, 59, 79, 86, 89 - \$3.50 ppd. J. J. Papovich, 53 Magnolia Ave., Pitman, NJ 08071. (609) 582-8279



Antique Radio Service

508-653-2418

Auto Radio - Home Radio

Buying auto radios 1928 to 1970

And service literature, all kinds.

SASE Please:

RICHARD C. FOSTER

12 Shawmut Ave., Coquituate, MA 01778

CLASSIFIED ADVERTISEMENTS

FOR SALE: Conar DC-6MHz oscilloscope, solid-state - \$88. Hickock 752 tube tester - \$25. Exact 123 function generator, .1Hz-3MHz - \$88. Army technical manuals - 50¢ - \$6.50; eg. TM-11-662, Application of Electron Tubes - \$6.50. RCA Radiola 44 manual - \$3. RCA Receiving Tube Manual - \$5. ME 25A/U VTVM - \$22. Simpson Capacohmmeter - \$25. RF signal generators, tube testers, more. 3-page list - LSASE. Kirk Ellis KK4YP, 18 Foxfire, Selma, NC 27576. (919) 965-9577, evenings

WANTED: Collins KW-1, 30K, 32V3, 75A3, 270G speaker for 75A4, KWM-2 late W/E for my collection. Will pick up or pay shipping. Call or write: Joe Rose, WA2PJP, 60 Sunset Ave., Selden, Long Island, NY 11784. (516) 736-0261

WANTED: Philco Models D734 in gold, red, emerald and ivory. Also C723, C724. Donald Trimarchi, 200 Main St., Williamstown, MA 01267. (413) 458-4492

FOR SALE: Original issues of the McMurdo-Silver Masterpiece Forum - \$25 ea. Philco 37-116, 37-690. E.H. Scott SLR-M. Sparton 1867, RME 69. Hammarlund SP-400. Craig Korpak, 9130 Silver Lake Rd., Linden, MO 48451. (313) 735-7264

WANTED: Instructions and schematics for RCA signal generator WR49B, Eico VOM 512, Espey tube checker 105, mercury in-circuit cap. checker 1400 and instructions for Supreme Scope 535. John Anthony, PO Box 10, Sautee, GA 30571. (404) 878-2940

CLASSIFIED ADVERTISEMENTS

WANTED: International Kadette 1 13/16" round foil station selector tag and glue on tag from back of cabinet. Crosley Repwood Model 58 Buddy Boy tuning wheel with dial. 1 3/8" wood Zenith knob. Zenith and Zenith battery sets. **FOR SALE:** AK 20 Big Box - \$30. AK 20 Compact - \$40. Bestone MX battery set - \$40. Crosley Victory - \$115. Crosley 125 cathedral - \$125. GE 60 radio/alarm - \$30. GE 202 - \$15. Philco 38-12 wood mantel set - \$75. Radiola III with 864 socket conversions - \$50. Radiola 100 loudspeaker - \$55. Zenith 7H921 AM/FM - \$25. Jim Peters, 983 Chapel Ct. South, Glen Ellyn, IL 60137. (708) 790-9699

FOR SALE: Zenith 7S240 chairside (see G.O.R., p. 86) - \$275. Zenith 5S218, 1938 cube - \$100. Zenith 6G601M (see G.O.R., p. 93), restored - \$75. Zenith 5416 (see G.O.R., p. 87), restored - \$75. All radios excellent or better condition. Tom Swift boy inventor volumes by Victor Appleton, Sr. - SASE for list. **WANTED:** Zenith 7S261 shutter dial, with shelves. Stromberg-Carlson unusual sets, paper items, etc.; all responses answered. John England, PO Box 1674, Alexandria, VA 22313. (703) 548-2952

WANTED: Wood cabinet for Freed-Eisemann Model #50, battery set. Mostly need top, bottom. Michael Koch, 495 Dallas Dr., Thousand Oaks, CA 91360. (805) 497-4379

FOR SALE: Antique type loop antennas with tuner - \$150. Purple insulators - \$15 & \$20. Above delivered. 1923 Ace, nice - \$175 + shipping. Howard Page, 2250 Page Rd., Port Angeles, WA 98362. (206) 452-2407

Active Antenna

Model AA10

Only \$34.95

Allows antique radios which were designed for a long wire outdoor antenna to operate on a 42" indoor whip antenna. Operates from 9 volt battery.

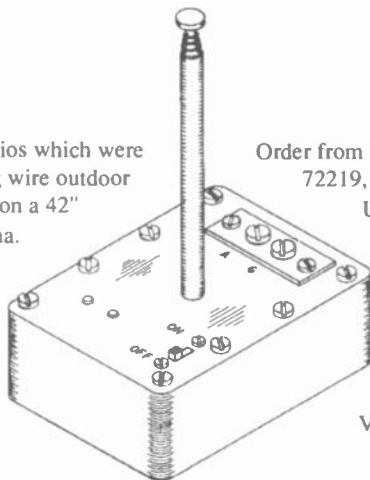

Order from PTI, Box 9769, Little Rock, AR 72219, (501)568-1995. Orders shipped UPS, prepaid in continental U.S. Please allow 3 weeks for delivery. Arkansas residents add 5% sales tax.

Visa and MasterCard accepted

CLASSIFIED ADVERTISEMENTS

FOR SALE: Cathedrals: American Bosch 440T, Gloritone #99A - \$345 ea. Stromberg - \$375. Majestic 90B console - \$300. Crosley 56TU - \$65. Arvin 664A - \$65. Zenith Royal 400 - \$50. RCA 6T - \$160. All mint. LSASE list. Richard L. Bednarcik, 28 Steele Ave., Lincoln Park, NJ 07035. (201) 694-6374, eves.

WANTED: Sony tube number 02JM for an FD20A TV Serial 159017 and a small knob for a Stromberg-Carlson 1-A. In need also of an antenna tuning coil for a Crosley Trirdyn. Peter Pitcher, 54 Meteterriane Ave., Wakefield, RI 02879. (401) 783-4392

WANTED: Radio flower petal horn speakers, Burns N.O.S. 205D 205B; Amplion Models 19, 23 and 27. Tom Hanks, 3480 S. Mt. Zion Rd., Decatur, IL 62521. (217) 864-4419

FOR SALE: Addison reproduction dial glass, green - \$35. DeWald A501 reproduction dial glass - \$27. **WANTED:** RCA Little Nipper II dial knob, will buy or pay to borrow. David Brenner, 71 Burdette Rd., Atlanta, GA 30327. (404) 257-1665

WANTED: Broadcast-type **MICROPHONES**. Early carbon, condenser, ribbon, dynamic, etc. Cash or trade. James Steele, PO Box 620, Kingsland, GA 31548-0620. (912) 729-2242

UNIVERSAL TRANSFORMER SAVER: The ultimate "bolt on" for TRF receivers. Restores dead interstage coupling transformers instantly. Just solder across bad transformer's terminals. Works with any transformer in any 20's TRF receiver and its appearance is proper. With instructions just \$8.63, \$16.06 per pair, ppd. Hidyne Research, Box 3342, Williamsport, PA 17701. (717) 326-2148

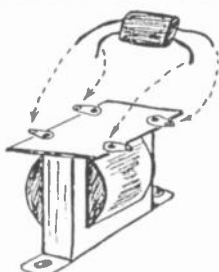

WANTED: Top prices paid for certain Blue Arcturus tubes. Please send SASE for my priced want list which includes my duplicate list of 33 different Blue Arcturus types available for trade only. Bill Condon, 3642 McLaughlin Ave., Los Angeles, Calif. 90066. (213) 398-3956

BOOKS, MAGAZINES WANTED: Modern Electrics, Experimenter, Science Invention, Radio News, Radio Retailing, Radiocraft, M.I.T. Radiation Laboratory Books, OTHER TECHNICAL BOOKS, MAGAZINES, also CRYSTAL SETS, MICROPHONES. State lot price for resale. Delton Lee Johnson, WBGMY, 14 McKeveett Heights, Santa Paula, CA 93060. (805) 525-8955, evenings

CLASSIFIED ADVERTISEMENTS

WANTED: Speaker, headphones, accessories for Hallicrafters S16. Cabinet and dial for Wilcox-Gay A53. C. Blatter, 610 West Sunset Dr., Redlands, CA 92373. (714) 792-4184

FOR SALE: Zenith Royal 1000-1 Trans-Oceanic, good, complete - \$120. Rod Galloway, 2220 Woodbury Rd., Melbourne, FL 32935. (407) 254-0280, after 5

FOR SALE: Crosley Treasure Island book radio, 2 trans., 3 pencil tubes, Model JM-8WE - Offer. Philco Mod. 40-155, built to receive TV the wireless way, (G.O.R., p. 90) - \$160. Gonset G66 with power supply - \$50. Echophone Model EC-1 - \$50. Knight Kit SW rec. 83YU726 - \$35. All sets are clean and work good. Will send C.O.D. Fred Hegel, 1901 Frank Pl., South Daytona, FL 32119. (904) 760-7632

FOR SALE: Tektronics 504 scope - \$95. **WANTED:** RF 9000. Jerry Schaefer, 932 North 4th St., Grand Forks, ND 58203. (701) 772-2991

WANTED: Cabinet and speaker for Philco 45/28C or junker set. Wooden Zenith Z knobs. James S. Fisher, 344 Harrison Ave., Manville, NJ 08835. (201) 725-7476

FOR SALE: Folder - How To Make SW Rcvr., 1932, all intact - \$10. Folder - Silver Radio 1929 w/booklets on 60-95 & 60B & 95B w/1932 radio map & log - \$30. W/house wd. case MH130 chV2103, STBG rcvr., finish an 8, cov. a 10 - \$60. Emerson M851 Deco blk. w/white knobs, all orig., hums, a 9 - \$40. CBS L.I.C. M5169 ebony big dial - \$30. Admiral rad/phone M7RTUI-N ch6LL, no damage, brn. mottle, all orig. - \$35. Port. GE P777A grn. int. leather, plays AM, A-orig., an 8 1/2 - \$30. Bernard Samek, RFD#1, Palmer, MA 01069. (413) 245-7174

FOR SALE: Rider's Volumes 6 thru 13 - \$20 ea. ppd. Also, send LSASE for price list of over 1500 different tubes. Jeff Moskow, WA11, Rustic Trl., Groton, MA 01450. (508) 448-5516

WANTED: LIGHT BULBS, tipped, pre-1900 anything pertaining to. Best price, description. Mel Kirchner, 276 Riverdale Road, Pompton Lakes, NJ 07442. (201) 839-4357

WE'RE STILL HERE! Tubes: "Oldest," "Latest." Schematics. SASE for lists to Steinmetz Electronics, 7519 Maplewood Ave., Hammond, IN 46324

WANTED: WWII RCA radio equipment AVA-120 reel antenna. MI-8412 transmitter crystal any frequency. Douglas Damiano, 4131 Denver, Yorba Linda, CA 92686

WANTED: AK-50. AK-BREADBOARD PARTS, any condition. Bob Nicholson, 3423 S. Long, Topeka, KS 66605. (913) 266-9473

CLASSIFIED ADVERTISEMENTS

FOR SALE: Fada Model 790, brown (G.O.R., p. 111), near mint - \$100. GE K-63 (F.O.S., p. 89), excellent condition - \$295. Rick Yerke, PO Box 392, Moscow, PA 18444. (717) 842-4857

FOR SALE: Hammarlund HQ129X - \$75. Best 5-tube table set - \$25. 5-tube radio in pottery keg on stand - \$80. Realistic Astronaut 8, 8-band portable - \$30. (2) 5-tube kit sets - \$30 ea. Fada 252 chassis only with tubes - \$25. All plus UPS. SASE for new list of 35 more items. Walter Worth, 2 W. Elm Ave., Wollaston, MA 02170

FREE - 20 WORD AD EACH MONTH
To get your free 20 words,
include your SUB# with your Ad.
Additional words are 15¢ each.
Read inside back cover for details.
MANY THANKS!!!!

FOR SALE: Magazines, QST, Radio, CQ, etc. Tube manuals, ARRL Handbooks, books, lots of amateur reading material, different radio courses, misc. Tubes: receiving, transmitting, industrial (new & used). **WANTED:** Knobs & escutcheon plate for Zenith 5R236 (G.O.R., p. 80). Send LSASE for list to: Kenneth Gregory, 1525 Driskill, Beaumont, TX 77706. (409) 898-7270, after 6 pm CST

FOR SALE: Philco 37-84 service bulletin - \$2.80 copy ppd. Royce 1-655 mobile CB N.I.B. - \$50 ppd. George Cortelyou, 1409 Madison NE, Albuquerque, NM 87110. (505) 255-3347

WANTED: Setchell Carlson #416 (small frog) all color combinations. Blue/white, green/white etc. Wayne Ross, 1487 Homestead Rd., Santa Clara, CA 95050. (408) 241-0460

WANTED: Dictogrand horn bell, chassis cover for Splittorff Abby Jr. Ken Martin, 12667 Eckard Way, Auburn, CA 95603. (916) 885-0243

FOR SALE: Reprint manuals for WWI SDR-54 & SCR-54-A (BC-14A) - \$7 ea. ppd. Ron Lawrence, PO Box 220094, Charlotte, NC 28222-0094. (704) 289-1166, after 6 pm

Johnson's Old Radios, Pointers and Prices. \$16.95 postpaid. Homebiz Books, 2919 Mistwood Forest Dr., Chester, VA 23831-7043

WANTED: MICROPHONES MICROPHONES. Chuck Listrom, Box 12081, Kansas City, MO 64152. (816) 741-2578

TELEGRAPH INSTRUMENTS WANTED, pre-1900, any type, any condition. Reinke, 5301 Neville Ct., Alexandria, VA 22310-1113

WANTED: Pre-1926 radios by AMRAD. Also, Amrad radio parts, accessories, and literature. Richard Sharisky, PO Box 521, Belmont, MA 02178. (617) 484-5784

CLASSIFIED ADVERTISEMENTS

WANTED: All kinds of Mitchell, Mitchell, Mitchell, Mitchell, Mitchell, Mitchell, Mitchell brand radios and appliances. Mitchell Mfg. Co. was founded by my late father, and with your help, I'm trying to assemble a mini-museum of the various models Mitchell made in radios, TVs, phonographs, lamps, intercoms, tape recorders, speakers, etc. Still many, many models or product types left to get. Thanks! Lee Mitchell, The Mitchell Collector, 875 North Michigan Ave., 3412, Chicago, IL 60611. (312) 337-3123, (312) 266-7100

HELP: Looking for a source of reproduction tapes - try grille cloth for Radiola 103 spkr., and close replacement cloth for Philco 70. Brian Wolf, 8502 Pennwood, Sherwood, AR 72116. (501) 834-5387

WANTED: Buying: Send for FT-241 crystal want list, top price paid. SCR-608/628/BC-684, transmitter; PE-117, PE-120, power supply; BX-40, BX-49, CS-131-* spare/crystal, parts box; BC-746 tuning unit; CS-131-* spare, crystal/parts box; BC-746 tuning unit; FT-234, FT-250, FT-317, FT-346, FT-506, FT-508, mounting. Contact Wm. A Stokesbury, Rt. #3, Box 200B, Selbyville, DE 19975-9519

FOR SALE: Magnacord PT6A tape transport, no case. Have several N.O.S. Ampex 807 tubes, would like to swap for 8417 tubes. Need at least four, preferably ones made in the 60's. **WANTED:** Another Zenith R7000 Trans-Oceanic. This is the one made by Zenith Taiwan and by far the best one they ever made. RCA 45 rpm phonos 9-EY-3 Series, 9-Y-7, 45-EY-4 and 6-XY-5 single play with radio. Will consider all models. Al Manieri, 384 Bates St., Phillipsburg, NJ 08865. (201) 454-3699

FOR SALE: PHONO NEEDLES & CARTRIDGES (ceramic - magnetic). What do you need? Send SASE. J. J. Papovich, 53 Magnolia Ave., Pitman, NJ 08071. (609) 582-8279

WANTED: Hallicrafter Sky Riders with entire front panel silver color, also S-30, S-33, S-35, SX-112, SX-1000, HT-2, HT-3, HT-8, HT-12, HT-14, Hallicrafter advertising signs, parts, manuals, and other old or unusual Hallicrafter items. Also want RCA Model ACR-111. Chuck Dachis, The Hallicrafter Collector, 4500 Russell Drive, Austin, Texas 78745

INDIVIDUAL PHOTOFAC T FOLDERS. From sets under #1400 - \$4. Over #1400 - \$6. Pre-paid First Class postage included. Also full stock Sams specialized books. Allen J. Loeb, 414 Chestnut Lane, East Meadow, NY 11554. (516) 481-4380

WANTED: Detrola, Sparton, Majestic, or Cadette, plastic or Catalin radios, by serious collector. Larry Spilkin, PO Box 5039, Southfield, MI 48086-5039

CLASSIFIED ADVERTISEMENTS

FOR SALE: Antenna tuning unit BC-306-A Army Signal Corps, by GE - \$15. Army Fullerphone Mark V No. PX-1944 with Morse key, no headphones in wood box - \$15. GE Mod. 423 ivory plastic, almost mint - \$25. Ferdinand Estree, 660 Fineview Ave., Kalamazoo, MI 49007. (616) 344-0231

FOR SALE: Hallicrafters S-120 and S-200 receivers, gc. National NC-100A, modified, good parts - \$30 ea. Steve Johnston, WD8DAS, 2321 Calvin Ave., Norfolk, VA 23518. (804) 583-8525

WANTED: Wav-O-Dyne 1925-26 battery set. Chassis for GE E61 BC/SW. Mike Parker, 945 S.E. Linn St., Portland, OR 97202

WANTED: Telechron table radios. State model, condition & price. A. J. Long, 11830 Heath Rd., Chesterland, OH 44026. (216) 729-8451

FOR SALE: Reproduction dial glasses for Catalins. FADA 652 and Sentinel 284 - \$35 ea. plus \$2 postage. Radioart, Box 102, Centerbrook, CT 06409

SOLID STATE VIBRATORS for most automobile radios 1932-57. Exact duplicates of originals in metal cans. Synchronous, Non-sync, European. One-year guarantee. Dealer prices. Free catalog. Order toll free: 1-800-WE FIX AM. Visa, Mastercard. Antique Automobile Radio, Box 892, Crystal Beach, FL 34681. (813) 785-8733

EXPERT ANTIQUE RADIO REPAIR. All makes. Ken Keiter, 106 Boulder Rd., Plymouth Meeting, PA 19462. (215) 828-2027.

WANTED: HOWARD RADIOS. Howard Model W, the Explorer, vintage 1933/1934. Howard Model Grand, vintage 1935/1936. Both sets use multiple chassis and have nineteen tubes. Want literature, partial sets, firsthand information, etc. Thanks. Thomas Peters, PO Box 3925, McAllen, TX 78502

FOR SALE: Reproduction Dial for all SENTINEL Model 284 Catalin radios. Chuck Listrom, Box 12081, Kansas City, MO 64152

WANTED: (Car radios or parts) 1930-1990, factory original only. Call or write with brand name, model number, phone number and hours you can be reached. Radio & Wheel-cover World, 2718 Koper, Sterling Hgts., MI 48310. (313) 977-7979

DAN'S SCHEMATIC SERVICE. Radio diagrams, 1921 to 1960 - \$2.50 ppd. T.V. diagrams, 1938 to 1960 - \$3.50 ppd. Send make and model number of set, or chassis layout sketch with tube types, if model number is unknown, to: Dan's Schematic Service, P.O. Box 53061, San Jose, CA 95153.

CLASSIFIED ADVERTISEMENTS

FOR SALE: Trans-Oceanic H500 complete, with spare tubes - \$75. Crosley Model 124 Playtime grandfather clock - Best Offer. Aeriola Sr., less tube - \$85. RCA Radiola III less tube - \$125. AK Model 53 metal console - \$175. Radiola V - \$600. French IA crystal set, 1916 - Best Offer. **WANTED:** Old amateur transmitters by Collins, National, R.E.L., Harvey Radio Labs, Gross, Utah. Bakelite panels 19" wide by 3 1/2" or more high. Parker Heinemann, W1YG, 87 Cove Rd., Lyme, CT 06371. (203) 434-7783

FOR TRADE: Garod red and yellow Catalin Model 6AU-1 (near perfect). Pepsi dispenser transistor novelty. Sonny Clutter, 14407 NE Fremont, Portland, OR 97230. (503) 254-9296, home, 233-0049, work

FOR SALE: Hammarlund HQ-110, 12-tube, fine, plays - \$265. FM Pilotuner, fine, adapter - \$30. Kodak Supralife, other side of can Pepsi AM-FM novelty transistor, mint in box - \$27. Care Bears clock AM/FM with alarm, mint in box - \$20. More novelties. Trophy official league ball tube radio, novelty. Home Brew crystal wood front and bottom coil 1A around Mother's oat box complete with headphones - \$45. **WANTED:** Heat, fan Lake-breeze or thermal runs from heat from lamp or alcohol burner, fair price paid. Edison Mabry, 715 W. Longview Ave., Mansfield, OH 44906. (419) 526-1175

WANTED: Nice complete Crosley Trirdyn, quote price. William Smith, 16001 Dusty Ln., Accokeek, MD 20607. (301) 292-6710

WANTED: AK 93, 112, 155, 275, 612, 812 and cabinet for 735. Jeff Aulik, 803 N. Chicago Ave., Rockford, IL 61107. (815) 399-1902

BOXED CLASSIFIED ADS WORK! This is a boxed classified ad. These ads can be run more than two months. See the inside back cover for details. Boxed ad deadline: the 5th of the month.

WANTED: Radiola UZ1325 horn, Radiola AG814 loop antenna; UX301 UX201 tubes; Baldwin "baldy" phones; VU magnemite 610 tape recorder; case for Radiola III; Zenith 7G605 Trans-Oceanic. Robert Perlstein, 17 Vine St., Medford, MA 02155. (617) 391-3026

WANTED: LIGHT BULBS, tipped, pre-1900, Edison, Thomson-Houston, Westinghouse, and all others, bases, books, literature, advertising postcards, description, best price. Mel Kirchner, 276 Riverdale Road, Pompton Lakes, NJ 07442. (201) 839-4358. After 7 pm.

ALAN RADIO CORP. NYC, made shortwave receivers, in the 1930s. I would like to acquire the models Ace, Prizewinner, International, The Byrd and any other items from this company. Alan Schreier, 12805 Powderhorn St., Austin, TX 78727. (512) 835-2056

CLASSIFIED ADVERTISEMENTS

FOR SALE: Mallory TV-101 UHF converter — \$15. B&K 400 CRT rejuvenator — \$15. Precision 356G VOM, wood case — \$20. Silvertone Powr. Shifter A-B battery eliminator — \$10. Zenith 11M20 chassis w/knobs, works — \$15. (100) boxed TV tubes N.O.S. — \$50. All above for \$100 plus shipping. **WANTED:** Horn speaker for Radiola 18. David E. Evans, Box 605, Salado, TX 76571. (817) 947-5493, evenings

WANTED: Front arch veneer (whole or pieces) from Philco 70 or 90 cathedral, Philco 60, 70, 90 cathedral cabinet and speakers. Dial escutcheon from Philco 19 w/meter, Zenith 705 and any catseye tube. Lids for Majestic 71 powerpack, Crosley 4-29 and Radiolas 18 and 33. Tuning and veneer knobs for RADA. Cabinets for Radiola 30A and 28. AF transformer for Crosley 51. Chassis for Philco -44, 37-630, 42-390 horse radio, Silvertone cathedral Mod. ?. Battery cover for yellow Mickey Mouse radio. Dial pointer for Crosley Colorado H-103V. Base for Magnavox R-3C, RCA UZ 1320 or 25, AKL & R, transformer assembly for Radiola 18. **FOR SALE:** RCA Silverama TV Counterpart(?) — \$10. Brian Wolf, 8502 Pennwood, Sherwood, AR 72116. (501) 834-5387

FOR SALE: Novelty transistor radios advertising Polarine motor oil, pop can size — \$22 including shipment. Arie E. Breed, 1595 N. Van Buren, Ottumwa, IA 52501. (515) 682-6925

FOR SALE: New additions include 1924 Fada Neutroleite 192-A, many others added to list. Send LSASE to John Enig, 5425 Cherry Ln., Egg Harbor, WI 54209. (414) 743-3672

CLASSIFIED ADVERTISEMENTS

WANTED: National NC-125 receiver. A large, of Sams Photofacts. Radios in the shape of n cal instruments or featuring musicians. Lee Mitchell, The Mitchell Collector, 875 North Michigan Ave., 3412, Chicago, IL 60611. (312) 337-3123, (312) 266-7100

FOR SALE: Sony TR812 AM/SW transistor portable, works, needs repair, poor handle — \$35. Zenith Z-400L AC/batt. AM 4-tube portable, unbreakable case, working — \$20. Wards Airline antique car radio 14BR-682A w/spkr., cables, instructions, less control head — \$35. Above + UPS. Donald Sochurek, W191 S7500 Richdorf Dr., Muskego, WI 53150. (414) 679-0212

FOR SALE/TRADE: Will trade 40's, 50's Bakelite radios for good scope. **FOR SALE:** Lots of small Bakelites and portables, also RCA 45 rpm record players. SASE list. Photos — \$1. Chuck Humphreys, PO Box 598, New Haven, WV 25265. (304) 882-2220

WANTED: Speed-X bug. WRL 755 VFO and manual. Prewar ham receiver. Aeriola Junior. Brian Roberts, 3068 Evergreen Rd. Pittsburgh, PA 15237. (412) 931-4646

WANTED: Help! Does anyone have schematic/service info for Hoffman color TV using 19VP22 picture tube? Mark E. Roberts, 1724 East Broad St., Louisville, OH 44641

WANTED: Westinghouse units RE and DR for my RC. W. E. Schreiber, 514 N. Market St., Marion, IL 62959. (618) 993-5170

EXPERT RADIO COLLECTORS PRAISE ED ROMNEY'S LATEST BOOK

FIXING UP NICE OLD RADIOS

"Ed Romney has written an important book, one that should encourage many collectors to approach radio repair with knowledge and confidence."—Ted Hannah in a three page review in the July MAARC Bulletin

"My copy of FIXING UP NICE OLD RADIOS arrived promptly and I fell in love with it from the start...I think you have done a great job."—Kenneth Miller

"I've wanted to thank you for the copy of your book—I've had some time to go through it and I am most impressed. Good work!"—Joe Koester

"Received your book, FIXING UP NICE OLD RADIOS and I am more than pleased with it. Your book is clearly written in easily understood language—even when you are explaining some of the more complicated electronic theory. Your experience as an instructor does come through in your publication."— F. V. Bernauer

FIXING UP NICE OLD RADIOS has 185 pages with over 300 schematics and photographs of your favorite radios from crystal sets to the Scott 800-B. Zenith, AK, Radiola, Philco, Grebe, Pilot, National, Hammarlund and Hallicrafters are all in it—and many more! It is spiral bound 8½x11. Due to high printing costs it is now \$25 but there is nothing else like it! Order today! Satisfaction guaranteed. Visa/MC OK. Phone orders accepted any time. Autographed if you wish. Add \$1.50 shipp.

ROMNEY BOX 96 EMLENTON, PA 16373 (412) 867-0314

DEALER AND PUBLISHERS REPRESENTATIVE INQUIRIES INVITED. ESTABLISHED 1974

ADVERTISEMENTS

38. Arvin 956T 1581, 954P, radio. Belmont 636. Coke U5A, 109, BA199, 502, Fada, Grunow Teledial. Hoppy. Howard site 43. Musicaire 576. Motorola 41A. 42-KR3, 53-561. Sonora TW49. Setchell-Carlson 458R. Smokerette. Spartan console. Stromberg-Carlson 249R or chassis for same. Zenith 1938 brochures; 5S327, 6D326, 5S319, 6D410-414, 11S474, 12S265, 12S267, consider other 1935-1947 table or floor models. Buy outright or trade up/down/even from my trading group, which includes Belmont 6D111, Emerson 400, Philco 49-901, Zenith 1937 brochure, 5S127, 8S463, 12S453, 7G605, 3000-1; Westinghouse 126. What do you have for what do you want? All replies answered. **FOR SALE:** Motorola 59L11 tweed suitcase, portable, dial in handle, rare DC-3 emblem version, works but needs TLC - \$75. Phillips transistor. Thank you. Bill Timoszyk, 35283 Leon, Livonia, MI 48150. (313) 421-2076

FOR SALE: Precision signal generator E-220-C with operating manual, very good condition - \$45. Dwain Ludlow, POB 552, Stigler, OK 74462

FOR SALE: Modern Radio Servicing book by Alfred Ghirardi, copyright 1935, first edition - \$10. Howard Lash, 2679 Glenwood-Dyer Rd., Lynwood, IL 60411

WANTED: For Victor 9-55. All radio components and mounting hardware. Antenna loop, front panel. Doug Houston, 3441 South Hadley Ln., Ortonville, MI 48462. (313) 627-4141

BUY • SELL • TRADE

CATALIN RADIOS

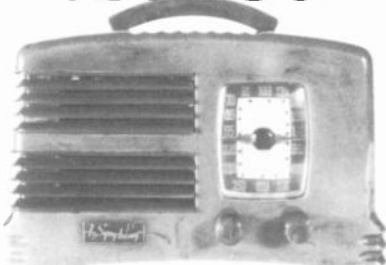

I'll buy single pieces or
whole collections. Top prices paid.

RADIOART

Jim Meehan
P.O. Box 102 • Centerbrook, CT 06409
(203) 767-2558

CLASSIFIED ADVERTISEMENTS

FOR SALE: Salt & pepper set - TV - \$25. Zenith #K622, ivory - \$35. Silvertone #7004 - \$25. Emerson # ?? brown - \$35. Philco #49-504, nice - \$40. RCA #8-X-71 - \$35. Stewart-Warner #A61P1 - \$65. Ship light - \$45. Gallery clock - \$90. All sold as is. Buyer assumes all responsibility. Plus UPS. Darrell Combs, 6587 Pacheco Way, Citrus Heights, CA 95610. (916) 969-0635

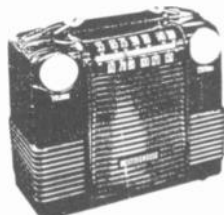

WANTED: Westinghouse H-185 plastic 4-tube AC/battery portable radio. Jim Zacher, 39W345 Central, Elgin, IL 60123. (708) 697-0245

FOR SALE: 70 radios - Aeriola to Scott Phantom, old test instruments. SASE for list. Ray Miner, 1215B, Ft. Madison, IA 52627. (319) 372-1271

FOR SALE: Thanks for tremendous response to new picture list. Sale prices this month. Superola 1924 battery set w/501-A tubes, RCA 98K and two 86T's, Andrea G6B 6-volt battery AM/SW 1940 table model. Really gorgeous Emerson's, Philco's cathedrals, plastic Decos, etc. I am now selling radios that are easy for you to restore, and will supply with essential parts and diagnosis. My problem is time. Call or SASE for Pix Super List. Steve Lipsky, W2VVN, Antique Technology Ventures, 1254 Cox Rd., Jenkintown, PA 19046-1207. (215) 884-1817

WANTED: Schematic Navy CCT46076. **FOR TRADE:** My Pilot Wasp coils for Pilot Super Wasp coils. Niel Wiegand, WA5VLZ, 911 North Bend Dr., Austin, TX 78758. (512) 837-2492

FOR TRADE: My beautiful, rare Remler Scottie 5510 for your Catalin radio of equal condition. Adam Schoolsky, 38007 Stenhammer Dr., Fremont CA 94536. (415) 791-0330, evens. or message

WANTED - I would like to purchase the following Shortwave Receivers:

SONY

- 1: Sony 330K (with tape recorder)
- 2: Sony 320K (without tape recorder)
- 3: Sony CRF-1

PANASONIC

- 1: Panasonic RF-9000

Mathew Wolf - 1001 Fannin
Suite 2000, Houston, Texas 77002-6709
(713) 650-3330

CLASSIFIED ADVERTISEMENTS

WANTED: Manual or schematic and function switch for Heathkit Seneca VHF-1, 6146Ws and National NC-303. Vance Gildersleeve, K5CF, 206 Michelle Dr., Poteau, OK 74953. (918) 647-9044

WANTED: Early quack medical devices, especially violet rays and pre-1900's scientific items. Richard Cane, 8391 NW 21st St., Sunrise, FL 33322. (305) 741-6838

MESSAGE: Notice: Puget Sound area - good listening to enliven you and your classic radio during the dreary monsoon season, Oct.-May. Mystery Playhouse, Sun. 2206-2300 KIRO 710. Great! Garrison Keillor's variety show American Radio Company Sat. 1700-1900, Swing Years and Beyond, Sat. 1900-2400 (This Day in History, newscast 2225), Radio Drama weekdays 2230-2300, book readings weekdays 2200-2230, all KUOW 94.9. 1920's-1940's jazz, Thurs. 1400-1600 KBCS 91.3. Enjoy! There's a world of fine info and entertainment out there! Paid for by Hugh Miller, KA7LXY, who collects old military, aviation, and beginner's kit radios. (Ad elsewhere). Hugh Miller, 6400 Maltby Rd., Woodinville, WA 98072

WANTED: Old crank phonographs, horns, parts and junk machines, any condition. Dave Faehrich, 8215 Stone Rd., Independence, OH 44131. (216) 447-0837

WANTED: National HRO-60T accessories: HRO-60TS speaker, SOJ-3 Select-O-Ject; coils: AA, AB, AC. I will pay top \$ for any or all of the above. Frank DeCoito, Star Rt. #2, Box #242, La Honda, CA 94020. (415) 948-2045

CLASSIFIED ADVERTISEMENTS

WANTED: Basic Electricity, John F. Rider publisher, 5 volumes. Frank Potts, 435 W. 12th St., Traverse City, MI 49684. (616) 941-8068

WANTED: International Kadette Jr. pocket radio, ca. 1933. J. M. Stueber, 8920 Lexington Ave. NE, Albuquerque, NM 87112

FOR SALE: Eico Model 955 capacitor checker, no manual - \$25 plus UPS \$5. Ed Povraznik, 9606 Biddulph Rd., Brooklyn, OH 44144. (216) 661-0032

FOR SALE: N.O.S. VM record changer parts. SASE for part no. wanted. Gordon Van Allen, 5822 Knollwood Dr., Ashtabula, OH 44004. (216) 998-0723

WANTED: Toshiba transistor radio, round, ivory top hemisphere with oriental designs, red lower hemisphere. Gerald Schneider, 3101 Blueford Rd., Kensington, MD 20895. (301) 929-8593

WANTED: Zenith knobs for console #12S265. I need two to complete restoration. Samuel Zuckerberg, 7241 Bergen Ct., Brooklyn, NY 11234. (212) 354-7407, 11-4 pm

FOR SALE: Motorola TV73, good case, CRT, complete - \$75. Philco 89, nice cabinet, complete - \$225. Dale Parsons, 5312 Koontz Dr., Cross Lanes, WV 25313. (304) 776-2180

WANTED: Schematics: Grundig 254OU, 88U, Telefunken Jubilate 5351W. Richard Lang, 25 Bancroft St., Pepperell, MA 01463



**Vintage
Radio**

AND ELECTRONICS ©

SCOTT WEBSTER
OWNER

1414 17th STREET
ROCKFORD, IL 61104

(815) 229-6900



ASTATIC

Phonograph Cartridges:

- | | | |
|-------|---|---------|
| 51-1 | .7 volt Ceramic 1 mil. saphire
General Purpose Replacement | \$12.00 |
| 97-1 | Zenith Cobra Replacement
1 mil. saphire Radionic (33-45) | 10.00 |
| 97-2 | Zenith Cobra Replacement
2 mil. saphire Radionic (78) | 10.00 |
| 146-1 | 2.7 volt Crystal 1 mil. saphire
General Purpose Replacement
(33-45) #62 needle for 78 RPM | 6.50 |

Needles for above Cartridges:

- | | | |
|--------|--|--------|
| #29-1S | 1 mil. saphire for 51 cart. | \$4.95 |
| 152-D3 | 3 mil. diamond for 51 (78) | 9.95 |
| #62 | 1 mil./3 mil. saph. (33-45-78)
for use with 146-1 cart. | 2.00 |

**OUR MOST POPULAR CARTRIDGES FOR 78 PLAYERS
AND RCA 45 PLAYERS AND ZENITH ALL IN STOCK.
INCLUDE \$4.00 SHIPPING
WITH YOUR ORDER.**

CLASSIFIED ADVERTISEMENTS

FOR SALE: Sparton 557, plays, needs veneer work - BO. Grebe console, nice, 30's. Don May, 16 Gulley Dr., South Windsor, CT 06074. (203) 644-0258

WANTED: The Audio Cyclopedia by Howard Termaine. Pioneer 838 or 1010 receiver. Allied Radio Catalogs 1940-1965. Ernest Naaz, 30 Charlton, Apt. #4C, New York, NY 10014. (212) 627-1894

FOR SALE: Porto Baradio, Edison Amberola 30, table & console radios, etc. SASE for list. Walt Sanders, 15 Todd Pl., Terre Haute, IN 47803. (812) 877-2643

FOR SALE: Pocket, table, and novelty transistors. Motorola Pixie 45-P1. Spica ST-6E. Coronet 2 trans. Arvin 62R13, 66R58, 87R79 (SW). RCA 1-RJ-19, 8PT-7031 (TV). Bert & Ernie, rubber. G.P. tissue dispenser. Zenith 50, 50L, 50FL, 265, 6G001-ZYX. AMC TRB-821. Channel Master 6210, 6515. Philco NT600. Sylvania 4P19W. Admiral YH1313. Sony 8-301W, TV. Many more each week. Send large SASE for list of 60 more. Thank you. Robert Rogers, 1407 Riverside Rd., Old Hickory, TN 37138. (615) 847-2475, 6 pm CST

WANTED: A circuit on a Heathkit Model IG-102 RF signal gen. ~1960? Ray Larson, 12241 1/2 Gorham Ave., W. Los Angeles, CA 90049

WANTED: First IF transformer for Philco Model 38-4, P/N 32-2643. Conrad Gwaltney, Route 1, Box 55, Hiddenite, NC 28636. (704) 632-2921

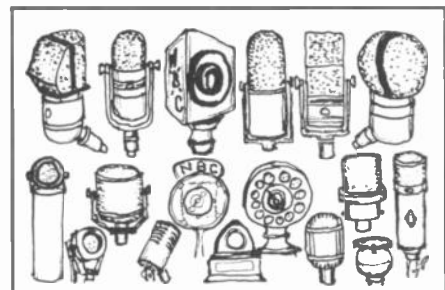

WANTED

FOR MY BROADCASTING MUSEUM

Microphones, stands, call letter plates. Tube amplifiers, mixers, compressors, Hi-Fi equipment. Speakers, on-air lights, equalizers. Disk, wire & tape recorders. Blank recording disks. Catalogs, magazines, manuals. 16" transcriptions, turntables, arms, pickups. Early TV cameras & receivers. Elaborate console, deco, plastic, mirror, novelty & wireless radios. Jukeboxes & parts. Acoustic phonographs.

We are looking for all makes of equipment, and especially *Western Electric*, *Telefunken*, *Neuhann* and *RCA*. The museum contains various duplicates and items surplus to our needs, and many of these articles are available for sale or trade. The collection is located in my Victorian seaside inn, The Caffrey House, situated on a bay next to the ocean, in the Southampton resort area of Long Island. A trade of equipment for a stay at the hotel is always encouraged.

Robert Van Dyke, 2 Squires Ave., East Quogue NY 11942
516-728-9835

CLASSIFIED ADVERTISEMENTS

FOR SALE: Radio News magazines for years 1922 thru 1932, except for Aug., Dec. 1922, Mar. 1923, Nov. 1929. Radio Broadcast magazines for years 1925 thru 1929 except for June, Oct. 1926; Sept. 1927; Jan., July 1929. Plus have Jan., Feb., Mar. 1930. Popular Electricity and Modern Mechanics, July thru Dec. 1914. Popular Electricity and World Advance, Jan. thru May 1914. Popular Electricity for year 1912, except for Apr., Dec. Prefer to sell as one lot. Roy K. Hackbarth, 2080 S.W. Wynwood, Portland, OR 97225. (503) 641-2183



WANTED: Philco 90 cathedral as shown in photo. Thanks. James Young, Rt. 14, Box 593, Florence, AL 35630. (205) 764-5969

FOR SALE: N.O.S. and used tubes, electrolytic capacitors, cone speakers. Send SASE for lists. C. Elmer Nelson, 11 S. Church St., Princeton, IL 61356

FOR SALE: Hawkins Electrical Guide, Numbers One through Nine - \$100. Ed Bell, 5311 Woodsdale Rd., Raleigh, NC 27606. (919) 851-1517

WANTED: Philco Transitone 610T 1936, 37 (bullet shaped - F.O.S., p. 124), excellent condition only, blonde, original knobs & dial, restoration acceptable. Joe Varadi, 278 Bloor St. E, #T-09, Toronto, Canada M4W 3M4. (416) 963-4900. Leave message days, collect calls accepted late evenings

WANTED: Mint 40's portable picnic radio/phone combination. Simply the best will do. Ed Sage, PO Box 1234, Benicia, CA 94510. (707) 746-5659

FOR SALE: Two Champion spark plug transistor novelty radios, one excellent, one fair, both - \$100 shipped. Steve Melkisetian, c/o Angela Instruments, 8600 Foundry St., Savage, MD 20763. (301) 725-0451 or (301) 724-5645

SONY®

50's & 60's radio,
TV, reel-to-reel, etc.
The earlier the better.

Jay Lewin, 400 E. 54th St.
New York, NY 10022
212-935-5656

CLASSIFIED ADVERTISEMENTS

WANTED: Metrodyne Super 7. **FOR SALE:** Radiola Grand, gwc, refinished - \$500. Neutrowound 1926, gwc, no caps. - \$175. Brad Benson, 109 Scarborough Ct., Apt. 81, Chesterton, IN 46304. (219) 926-4052

FOR SALE: Navy Type CNR-23442 radio transmitter control & keying unit with manual, excellent cond. - \$25 + UPS. **WANTED:** Instruction manual or copy. Precision E-200-C signal generator. Warren Adams, 608 N. G St., Imperial, CA 92251. (619) 355-4221

WANTED: Metal or plastic "Broadcast thru your own radio" toy microphones. Remember those cheap little things sold through novelty catalogs and magazine ads in the 30s, 40s, and 50s. I've got a bunch of them, but want more! Send a rough sketch and description of what you have. Also interested in any literature, magazine, or catalog advertising these toy mikes. Ferris Jennings, 18337 Vanderbilt Dr., Saratoga, CA 95070

FOR SALE: Cathedral, Viking #91, not working - \$100 or BO. James Gettelman, N63 W15695 Claremore Cir., Menomonee Falls, WI 53051. (414) 252-3101

FOR SALE: Old radios, wireless books, parts, miscellaneous odds and ends, loop antennas. LSASE for list. Hydnyne Research, PO Box 3342, Williamsport, PA 17701. (717) 326-2148

WANTED: Philco Model 89 or 19 chassis and speaker. Fred Geer, 6042 Brookridge Rd., Jacksonville, FL 32210. (904) 771-7828

CLASSIFIED ADVERTISEMENTS

FOR SALE: The following items are from the estate of a former New England Antique Radio Club member and are being offered for sale to benefit the family: Philco Predicta TV, Model G4710, 2-piece remote, working. Radios: Ozarka Senior console w/record player, ceramic speaker. Motorola 5P32E, portable, black. RCA Radiola 18 console w/record player. RCA 54B1, portable. Arvin 558, radio/record player. AK 33, chassis and front panel. AK 40, no tubes. AK 45. Radiola III, no tubes. Radiola 17. Radiola 18. Freshman Master-piece w/built-in speaker. Amplex DeExer. Philco 40-145. Clarion 260, console, lowboy. Madison-Moore table set. Silver-tone #1906, tombstone. Speakers: Trimm home speaker, Cat. #836-1C. Temple, Model 50, pressed wood feet and grille. AK, horn speaker, Model H. Test equipment: Leeds & Northrup Co., Microfarad. Westinghouse portable Ammeter. Weston Model 771 tube tester. All reasonable offers considered. Pickup only. For more info call club president, Marty Bunis at (603) 938-5051. New England Antique Radio Club, RR1, Box 36, Bradford, NH 03221

WANTED: Tube sockets for Eimac 1500TH, Western Electric 212D. Industrial/special purpose tube manuals or pamphlets. Eimac 300T. Also any odd or out-of-the-ordinary tube types. John H. Walker, Jr., 16112 W. 125th St., Olathe, KS 66062. (913) 782-6455

FOR SALE: Magnet charger, suitable for charging speaker and earphone magnets, factory made, good condition - \$125. D. L. Hollar, 8407 W. 98 Ter., Overland Park, KS 66212. (913) 341-9532

XMAS GIFT FOR NOSTALGIA BUFFS!

QTC

(I HAVE A MESSAGE FOR YOU)

*A Seagoing Officer's Scrapbook
—By Ray "Sparks" Redwood*

A sketch of the history of radio focusing on the radio shack operator.

A grab bag of autobiographical anecdotes, historical background, SOS rescues and travel tales - as told by a ship's radio operator.

376 Pages • 109 Illustrations • 6" x 9"
Hardcover \$15.00 — Softcover \$8.95
Add \$2.00 shipping
(Texas residents add sales tax)

SEQUOIA PRESS • (512) 442-1311
2502 Cockburn
Austin, Texas 78745



CLASSIFIED ADVERTISEMENTS

FOR SALE: Silvertone Model 101-808 wood radio (F.O.S., p. 173) - \$30. Silvertone Model 8005 Bakelite radio (F.O.S., p. 172) - \$25. Detrola Super Pee Wee Model 199 wood radio - \$95. Sentinel Model 286P AC/DC or battery portable - \$25. All plus UPS. M. B. Gaskins, 227 Risen Ave., Campbellsville, KY 42718

WANTED: Still looking for those cheap, commercially made crystal and diode/loopstick radios from the 30s, 40s, 50s, and 60s. I had great response from my previous ad - thanks all! Looking for various configurations and colors of Rocket Radios, Pen Radios, Little Wonder, Little Giant, etc. etc. Ferris Jennings, 18337 Vanderbilt Dr., Saratoga, CA 95070

FOR SALE: Stewart-Warner Model 300 TRF (V.R., p. 138) - \$50. Stewart-Warner Model 385 TRF (V.R., p. 138) - \$50. Freshman Masterpiece 3-dial - \$50. AK-30 - \$55. Hallicrafters S38D - \$20. Silvertone metal, no knobs - \$25. Elgin 5-band 15-transistor portable - \$25. Heathkit IG-102 signal generator - \$15. Hickok TV3/BU tube checker - \$25. Jackson 648 dynamic tube checker - \$25. Sylvania 220 emission tube checker - \$15. Philco G8002 UHF signal generator - \$12. Radio City Products 123 flyback/yoke tester - \$15. Narco avionics manuals for Escort 110 and UDI-2 DME - \$10 ea. Gonset oscillator/monitor - \$10. Gonset GSB-100 transmitter - \$85. Gonset 6-meter Communicator - \$30. Johnson Adventurer transmitter - \$20. Case for HQ-180 receiver - \$10. Add UPS. Raymond Filozof, 339 Howertown Rd., Catasauqua, PA 18032. (215) 264-4733

ALL ANTIQUE RADIO BBS

**Classified Ads, Articles,
Equipment, etc.**

★ AN ON-LINE MAGAZINE ★

- Instant access to lists
- Hundreds of radios for sale
- Continuously updated
- Tech, paper, parts, etc.
- Yearly subscription fee
- No charge to "take a look"

Modem Access (415) 491-0214

8/N/1 - 300/1200/2400 Baud

**Hours: 6 am to 12 midnight
7 days PST**

**For more info send SASE to:
PO Box 6735
San Rafael, CA 94903**

CLASSIFIED ADVERTISEMENTS

WANTED: Dial glass and dial for Coronado Model 686. Pluto (Disney) plastic child's record player, approx. 1970. Zenith Model 7S530. Zenith Trans-Oceanic 7G605. Jon Daffer, 8324 San Francisco NE, Albuquerque, NM 87109. (505) 821-3702

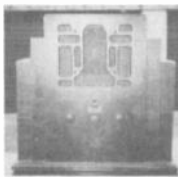

FOR SALE: Silvertone Chicago World's Fair radio - A Century of Progress. Please write or call: Rain Buttignol, 214 State St., #7, Portsmouth, NH 03801. (603) 427-1384

WANTED: Help. Need power transformer or someone to rewind one for Spartan Model 931, has 300-volt CT, 5-volt and 6-volt CT, 3-volt at 8 amp. Vernon Blaine, Rt. 5, Box 322, Canby, MN 56220.

FOR SALE: National NC-173 rcvr. - \$115. HH Scott and Fisher tube audio. SASE for new list. **WANTED:** 1950-63 Allied, Newark, Lafayette catalogs. EICO HF 50/60 tube amps. C. Kittleson, PO Box 691, Belmont, CA 94002. (415) 595-4164

FOR SALE: Dynamotor DY-17A/ART-13A NOSB - \$45 F.O.B. Houston. ART-13 connectors, manuals available. Robert Downs, WA5CAB, 2027 Mapleton, Houston, TX 77043. (713) 467-5614

WANTED: Weston Model 412 thermomilliameter. RF thermomilliameter with 50 Ma full scale. Del Guyot, 3585 Beverly Glen, Sherman Oaks, CA 91423. (818) 789-6009

FOR SALE: (3) Weston meters: Model 45 oak cabinet with 1901 patent, Model 155 mahogany box with glass arc dial patent 1898, Model 622 black Bakelite. Philco 38-116 slant front console with resonators complete and works nicely. **WANTED:** Good tuner from an RCA 630 chassis, uses (3) 6J6 tubes and has channel one. Front panel to a 3" Pilot television whole or broken. Also a good 3KP4 picture tube. Postwar GE FM tuner. Craig Roberts, 35-L Ridge Rd., Greenbelt, MD 20770. (301) 474-3506

SALES LIST & PRICE GUIDE

Each month we publish our "Sales List & Price Guide" with 100s of photos and prices of items we have for sale. This is used by many as a price guide to determine values. Send \$4 for current issue and subscription information to:

**Jim Clark Enterprises
Dept. ARC
1292 Starboard
Okemos, MI 48864**

CLASSIFIED ADVERTISEMENTS

FOR SALE: Original Zenith Factory Service Manual, Volume 1, covers Models A thru 16A33, circa 1930/1940, 610 pages - \$35. Original Zenith Factory Service Manual, Volume 2, for model years 1940 thru 1942, 310 pages - \$35. Original Atwater Kent Radio Service Manual, 1924 to 1932, 463 pages of very detailed information - \$60. Satellite television equipment, new old stock, Hitek/Dexcel integrated receiver/dish positioner with infrared remote control, 75 degree LNB, matching feedhorn, heavy duty dish actuator arm, instruction books, circa 1987 - \$395 plus UPS. Ellsworth O. Johnson, 364 Coeurdalene St., Spokane, WA 99204. (509) 838-2161

FOR SALE: Excellent early RCA collection - includes Radiola I through V, X, Special; over 25 items. Accepting bids, will not separate. SASE for list. Rosenthal, 5 The Strand, New Castle, DE 19720

WANTED: National HRO's, NC-200, NC-240, Hallicrafters SX-28, SX-42, SX-73, silver dials. John Orahood, 5819 Miller Vly., Houston, TX 77066. (713) 440-5598

FOR SALE: LSASE for list of new/used receiving tubes, octal, miniature, some older. N.I.B. Admiral 30 tubes - \$2.50 ea. Will also trade for old or unusual tubes or related material for my collection. John H. Walker, Jr., 16112 W. 125th St., Olathe, KS 66062. (913) 782-6455

FOR SALE: Early Mohawk single dial 01-A battery set - \$85 + shipping. Floyd A. Paul, 1545 Raymond Ave., Glendale, CA 91201. (818) 242-8961

CLASSIFIED ADVERTISEMENTS

FOR SALE: Beautiful Kadette Clockette green Catalin Deco radio in excellent condition - BO. Stellar Mantle/Maris baseball radio - BO. Jim Clark, 1292 Starboard, Okemos, MI 48864. (517) 349-2249

WANTED: A small folded horn speaker. Also one good Catalin radio for my personal collection. Looking for vintage cameras. SASE for my Pix Super List. Steve Lipsky, W2VVN, Antique Technology Venture, 1254 Cox Rd., Jenkintown, PA 19046. (215) 884-1817

FOR SALE: 1969 Eico Electronic Instrument Co. catalog, 32 pages, shows photos and specifications of all their products, good quality photocopies - \$10 ea. ppd. Ellsworth Johnson, 364 Coeurdalene St., Spokane, WA 99204. (509) 838-2161

FOR SALE: Military tech manuals, old callbooks, ARRL Handbooks, old transmitter tubes and transformers, misc. military test gear, old equipment and components. List for SASE. Geo. H. Goldstone, 1010 Burnham Rd., Bloomfield Hills, MI 48304. (313) 647-3399

SERVICES: Wanted: Radios to repair by collector, low rates, expert work guaranteed. David Dameron, K6GBB, 819 Boundary Pl., Manhattan Beach, CA 90266. (213) 318-5311

FOR SALE: 1934 Amateurs handbook - Brown-ing Golden Eagle Mark II. Ferguson wood radio Model 238-A. Sony TFM-122. Hallicrafters SX-100, SX-96. Gerald E. Perkins, RFD #2, Box 34, Milo, ME 04463. (207) 943-2050

TUBES • PARTS • SUPPLIES YOUR COMPLETE SOURCE

TUBES:

3000 audio, receiving and industrial types in stock, including early and foreign types. Discount prices!

CAPACITORS:

High voltage electrolytic and mylar capacitors for tube circuits.

TRANSFORMERS:

Hard-to-find power transformers, audio transformers, and filter chokes for tube equipment.

SUPPLIES:

Chemicals, test equipment, wire, batteries, tools, etc.

LITERATURE:

Extensive offering of literature and books on antique radios, hi-fi, communications equipment, tube data, and circuit diagrams.

PARTS:

Resistors, lamps, tube sockets, potentiometers, grill cloth, knobs, vibrators and more.

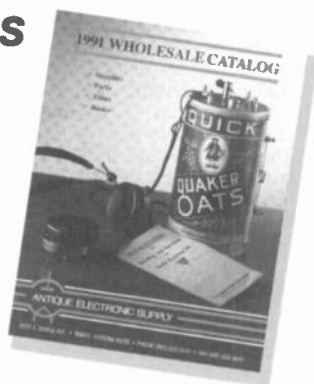

"Write or call for our 28 page wholesale catalog"

ANTIQUE ELECTRONIC SUPPLY

6221 S. Maple Avenue, Tempe, AZ 85283, Phone (602) 820-5411, FAX (602) 820-4643

CLASSIFIED ADVERTISEMENTS

WANTED: Dial for Philco 3610. (4) knobs Airline 62-336. Your price. Pete Gamache, Box 35, Leaf Rapids, Manitoba, Canada R0B 1W0

FOR SALE: New transistor radio parts. Old TV knobs. Russell or Irma Schoen, E7340 Nietzsche Rd., Clintonville, WI 54929. (715) 823-6744



HELP: Need to locate wooden speaker base cabinet (as shown) for Hallicrafters receiver. Should have either a 12" or 15" Jensen speaker in it. Jim Clark, 1292 Starboard, Okemos, MI 48864. (517) 349-2249

FOR SALE: All radios excellent to mint, working. Cathedrals: Skyrover, large 8-tube - \$345; Philco 60 - \$175; Philco 60 - \$155; Philco 60 brass escutcheon - \$225; Philco 71, brass escutcheon - \$325; Crosley 167 - \$195; Philco 20 - \$250; Philco 70, brass escutcheon - \$350; Philco 70 - \$325; Philco 90 - \$525; Zenith 715 Gothic roundtop - \$275; Stewart-Warner 102A - \$240; Silvertone 125 - \$195; AK 84 - \$400; RCA 128 roundtop (similar to 143 F.O.S., p. 148) - \$265; Belmont miniature, mint - \$260. Tombstones: Westinghouse WR10A - \$195; Sparton rare small Art Deco - \$175; Sonora unique brass escutcheon - \$175; Arvin 617 (F.O.S., p. 58) - \$295; Zenith 5S-127 - \$195; GE E81 - \$145; Crosley 5M3, stripes on front, (similar to Fiver F.O.S., p. 75) - \$125. Special mint Sparton 567, blue glass with matching blue glass table - Best Offer over \$2,500. Special Peter Pan rare Gothic tombstone - \$550. Country Belle telephone novelty - \$45. Wood table models: Silvertone - \$75; Westinghouse - \$75; Emerson small chest radio - \$95; Philco 37-610 Transitone (F.O.S., p. 124) - \$145; Halston 55 Art Deco - \$75; Firestone Air Chief - \$75. Zenith 5J-217 (style of 6S222 F.O.S., p. 192) - \$175. Philco 47-205 (F.O.S., p. 137) - \$65; Philco 48-482, huge radio, AM/FM, SW - \$95; GEL 740 (F.O.S., p. 93) - \$75; Majestic 60, unusual knobs and cabinet - \$95; Stewart-Warner R180A - \$85. Bakelites: Fada 220, white - \$85; Philco 42-200-125, white - \$65; Philco 46-250, brown - \$55; Mirrortone, white - \$45; Emerson 813, green - \$45; Zenith G510, brown - \$50; Philco PF 26, brown - \$45. Consoles: Pickup only, have over 60 restored: (10) Zeniths; GE K106 (same as K126 F.O.S., p. 90) - \$195; AK 612 12-tube, 2 spkr., (similar to 711 F.O.S., p. 65) - \$225; Stromberg-Carlson 84 - \$125; Stromberg-Carlson 145L, 10-tube - \$195; RCA C15-3, 15-tube, (similar to C13-2 F.O.S., p. 151) - \$350; GE G106, lid opens, clock on top - \$175; Motorola, clock in front, (F.O.S., p. 110) - \$125; Fada 413C, 13-tube - \$275; Philco 655 (same as August A.R.C., p. 11) - \$225; RCA 10K (similar to 9K2 F.O.S., p. 152). +UPS. Free photos. Joe Milano, 61 Furman Dr., Wayne, NJ 07470. (201) 694-3721

CLASSIFIED ADVERTISEMENTS

WANTED: DeForest/Radio Craft. Interpanel, DT700, DT800, DT900, D4, D5, D6, D7, D14. Or, what else do you have? Good originals. Ed Bell, 5311 Woodsdale Rd., Raleigh, NC 27606. (919) 851-1517

FOR SALE: Radiola 28 Superhet, legs, antenna, original unrestored condition - \$225. Ken Slegler, 2424 Taylor Ave., Alexandria, VA 22302. (703) 836-7242, after 10 pm or weekends

WANTED: Philco paper, service bulletins, advertisements and anything related to early Philco home radios. **FOR SALE:** Philco 42-340 - \$75. Westinghouse H-122 - \$65. Both electronically restored and shipping is included. Robert Schrantz, 610 East Juanita Ave., San Dimas, CA 91773. (714) 394-1194

FOR SALE: Sentinel Model IU-358 and Philco Model 41-220. Both play. Cabinets fair shape. George T. Reid, 1306 Pine Dr., Killeen, TX 76543

FOR SALE: GE F96 console, TV's: Zenith Royal R chassis R2229R, RCA Victor 21-T-6083. G. Hase, 8607 San Miguel Pl., Cucamonga, CA 91730

FOR TRADE: Bendix 526C green/black Catalin. **FOR SALE:** McIntosh amp, 20 W-2 - Offer. Heathkit amp, WA-1 (2 chassis), doesn't work - \$25. Two Eico ST40's - \$15 ea. Two Sherwood FM multiplexers - \$6 ea. Three tube CBs, 2 Hallicrafters, 1 Globe - \$17/all. Robuk (England) tube reel-reel recorder - \$10. Variety of electromagnetic speakers - ask. Add UPS. As-is. Jerry & Debbie Schliepp, 831 Berlin Rd., Ripon, WI 54971. (414) 748-2471

FOR SALE: Radios, test equipment, tubes, parts, related items. Thousands to choose from. First catalogue already in the mail. More to come. Don't miss out. \$3 puts you on the mailing list. C-2-C (Crystals to Computers, Coast to Coast), 77 County Rd., E. Freetown, MA 02717-1613

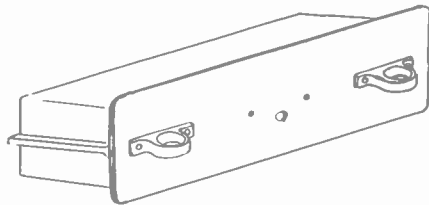

HELP: I'm looking for a plug-in coil set for a National AGU receiver. The coil set will look something like the above drawing. The coil panel is 9 1/2 in. x 2 3/4 in. & contains three coils which each have six connecting prongs. Has anyone seen one of these plug-in coils anywhere? Does anyone know the history of the National AGU or have a schematic? Henry Rogers, WA7YBS, PO Box 501, Minden, NV 89423. (702) 267-2725

CLASSIFIED ADVERTISEMENTS

FOR SALE: VHF arc equip. and A.R.C. 5 equip. Heathkit Apache TX-1, RA-10 w/control head Globe Hi Bander 2- and 6-meter transmitter. Hallicrafters S-27, good shape. Collins TCS. Trans. parts only. Collins 18S4 transceiver complete with tubes, no control head. 3-5002 Eimac tubes N.I.B. New 4-125A tubes. **WANTED:** Old quack medical devices, Tesla equipment, old physics and lab equip., open frame motors, old carbon filament light bulbs, old surgical equipment, communication radio junk chassis receiver and transmitter, old Bakelite telephone and related equipment. John Lippincott, PO Box 712, Salome, AZ 85348. (602) 859-3693

WANTED: WE candlestick telephone with dial. M. L. Harrington, PO Box 7619, Little Rock, AR 72217

FOR SALE: Very ornate 1929 Sparton Model 301 Equasonne (G.O.R., p. 53), very good/excellent condition - Best Offer over \$500. Western Electric 7A amplifier with tubes - \$225. Ray Moore, 12 Pavilion St., Rochester, NY 14620. (716) 461-3205

NEW RATE FOR ADDITIONAL WORDS:

15¢ per word

FIRST 20 WORDS STILL FREE!

We are sorry - but this is our first classified ad rate increase since 1984.

FOR SALE: Zenith 6S321, refinished, good working - \$80. Silvertone #1954, not working - \$60. Philco 80 cathedral, working, needs tube - \$85. Postage included. Bill Egan, 5004 S. Talman, Chicago, IL 60632. (312) 778-6922

WANTED: Mitchells wanted! Any model Mitchell radio from tube to transistor. Will pay more than other Mitchell collectors for choice radios. I will pay up to \$150 for a Mitchell short pocket transistor radio. The Mile High Mitchell Collector, Larry Mitchell, 7963 Depew St., Arvada, CO 80003-2527. (303) 428-8760

FOR SALE: Antique and modern electronics items. 5,000+ tubes! N.I.B. Mallory, Radiart and Delco vibrators. N.O.S. dials and glasses. N.I.B. Zenith, Philco, and RCA parts. Test equipment, variable capacitors. Knobs, 275+ crystals. Commodore computer items. Car radios. 175 panel meters. Tube hi-fi stuff. Radios: Kadette, AK, Emud 713, Radiola, Silver-Marshall 710, Ozarka 90, etc. Speakers: Crosley, RCA 100A, Symington. (95) plastic & wood table radios. (1000) 78 and 45 rpm records. Edison disks. Send \$2, \$5 outside U.S.A., in American cash or stamps (no checks) with long SASE for thirteen-plus lists. Refundable with order. Richard and Rose's Radio Mart, PO Box 691443, Tulsa, OK 74169

WANTED: Drawing or schematic of a Tuska 224 one-tube receiver. Don Swanson, 630 Burgess Rd., Pensacola, FL 32504

CLASSIFIED ADVERTISEMENTS

FORSALE/TRADE: Over 25 radios from 20's thru 60's, no Catalans. Send SASE for list. Paul Ernst, 3465 Eddy Rd., Marion, NY 14505.

WANTED: Help. I desperately need a white pillow speaker for Dahlberg pillow speaker radio. Please call: Jon Steinhauser, 636 Westminister Rd., Baldwin, NY 11510. (516) 223-9878

FOR SALE: TV's of various vintages: Emerson 12BP10 12" B&W. Sears 8104 12" B&W. Emerson T1826 19" B&W with shutoff timer, works! Newer Zenith 12" B&W manufactured 12/79, poor sound. Motorola 23T4BR 23" B&W tabletop. Sears 562-50700002 12" B&W. Will ship smaller sets, you pick up the larger ones! Call Tuesday or Thursday evenings, or weekends only, please. Doug Alderdice, KA2WFT, 126 Mercer Ave., Buffalo, NY 14214. (716) 833-8375

WANTED: Martian Beauty, Western Electric 4A or 4B, 3A or 3B, 2A or 2B tuner, and 1A loop antenna. Ray Moore, 12 Pavilion St., Rochester, NY 14620. (716) 461-3205

FOR SALE: N.O.S. 5TP4 proj. tube - \$200. Rebuilt 21CYP22A; 12KP4A, unused - \$100. Defunct 1950 Du Mont console - \$100. Joe Anderson, Box 204, Weymouth, MA 02188

FOR SALE: Arvin 36R07, AM-FM, white-gray plastic, plays - \$15. Juliette APR 1404D, transistor, brown leather case, plays - \$15. James S. Long, Rt. 1, Box 54, Grundy, VA 24614-9705. (703) 531-8677

WANTED: WE N, BA rectifier, VT-2, VT-6, VT-7, VT-8, #876, #886, UV-199, UV202, UC-302, C-299, duds OK on all of the above. Special tubes: Tone-Beam lamp for AK Model 612 console. H.P. #5083-4052 CRT for H.P. Model 1710B scope, good working condition. Sam W. Wrenn, 2314 Seminole Dr. 1207, Arlington, TX 76010

FOR SALE: X-mas specials for new collectors: Small Hallicrafters Columbia radio, 4-tube leather case-handle, BC-SW, loop, looks-works fine only - \$45. Stromberg-Carlson 6-tube superhet RF stage metal tubes, 1933 model, loop, looks good, works fine, only - \$75. Wm. J. Key, W1DWD, 58 Sycamore Dr., Halifax, MA 02338. (617) 294-1831

FOR SALE/TRADE: AK 46 - \$80. AK Model E speaker - \$40. Philco Jr. 80 cathedral - \$70. Bendix 0526E - \$50. Original advertisements from 20's and 30's - \$10-\$25 ea. Send SASE for list or call. Charles Hyman, 3804 Wildwood Ct., Monmouth Junction, NJ 08852. (201) 422-8774

WANTED: Desperately seeking: Cabinet and speaker for McMurdo-Silver Worldwide Nine, or anyone in need of chassis and knobs will consider sale/trade. Ray Moore, 12 Pavilion St., Rochester, NY 14620. (716) 461-3205

CLASSIFIED ADVERTISEMENTS

FOR SALE: Prerecorded dictaphone cylinders used in school dictation courses. Have both Blue Amberola and standard Edison Wax cylinders. Send long SASE for list. Doug Alderdice, KA2WFT, 126 Mercer Ave., Buffalo, NY 14214

FOR SALE: Some 1920's radio parts in original boxes, transformers, coils, etc. SASE for list. Serge L. Krauss, 141 Homan Ave., Elkhart, IN 46516-5027

WANTED: Sinclair 1" personal TV complete, working and in excellent original condition. Bill Ross, 1124 Tower Rd., Winnetka, IL 60093. (800) 621-0687

FOR SALE: Drake 1-A communications receiver, with matching speaker, near-mint condition - \$300 ppd. Richard Wood, 155 Avery Dr., Atlanta, GA 30309. (404) 847-2919

FOR SALE: HQ129 with speaker. General Radio inductance bridge Type 667-A. Pete Putra, 1429 Lawndale Ave., Racine, WI 53403. (414) 632-2543

WANTED: Paying \$100 or more for decent Raytheon T-100, Regency TR-1, or Sony TR-63 transistor radios. Also want Sony TR-2K, TR-6, TR-33, TR-52, TR-55, TR-62, TR-66, TR-67, TR-86, TR-610, TR-620, TR-650, TR-714, TRW-621; Raytheon T-2500; Regency TR-1G, TR-4, and TR-5; Zenith Royals 200, 300, 475, 800, and 500 in white or light pink; Mitchell 1101, 1102, and 1103; Motorola 56-T1; and Sylvania Thunderbird, as well as most other smaller American or Japanese transistor sets with CD or triangle at 640 and 1240 on the dial. Bill Burkett, PO Box 1204, Peoria, AZ 85380. (602) 878-7386

FOR SALE: Make offer. Westinghouse receiving tuner Type RA plus detector amplifier Type DA, (combined unit) operating condition, with tubes. Nearly complete set JFD woven fabric dial belts. Over 1200 tubes, Audion to Z-1000, peanuts to miniatures, acorns to subminiatures, 1918 to 1980. Send \$1 + LSASE for list. Ervin Priem, 4289 NW 16 St., Gainesville, FL 32605. (904) 378-1959

FOR SALE: DeForest Interpanel - \$1350. Dictograph horn - \$125. Buddy Boy - \$300. Buddy Boy cabinet - \$85. Westinghouse refrigerator radio - \$50. **FOR TRADE:** Zenith 9S232. **WANTED:** Federal Jr. amp 8, 9, 55, 56, 60, 161, 141 cabinet. Mike Otten, 3120 Madison, Little Rock, AR 72204. (501) 664-7158

WANTED: Chassis and plastic faceplate for Philco 41-280. Bill Synek, 2014 Quail Ridge Dr., Plainsboro, NJ 08536. (609) 275-7403

WANTED: RCA speaker Model 103, speaker for AK Model L, dial escutcheon, knobs, and dial for Radiola 60. Charles Hyman, 3804 Wildwood Ct., Monmouth Junction, NJ 08852. (201) 422-8774

CLASSIFIED ADVERTISEMENTS

FOR SALE: Battery radios and a few cathedrals. **SERVICES:** Radio repair. SASE. Ron Ramirez, 811 Maple St., Providence, KY 42450. (502) 667-5440

FOR SALE: Realistic 40 channel Navaho TRC 433 O.B. - \$50 or trade. Kenneth Miller, 10027 Calvin St., Pittsburgh, PA 15235. (412) 242-4701

WANTED: Altec Lansing amplifiers, #1570B-1592B-1593B & 1594B, must be complete with good power transformers, need not be working. Vernon E. Potts, 202 Hillside Dr., Sand Springs OK 74063

WANTED: Owner/operator/repair manuals for: Johnson-Viking I, Type 240-101. Mike Anderson, PO Box 62, Cecil, WI 54111. (414) 855-2313

FOR SALE: Galena crystal sets and parts. Write: L. Gardner, 458 Two Mile Creek Rd., Tonawanda, NY 14150. (716) 873-0447

**HAVE YOU MOVED? ARE YOU MOVING?
PLEASE NOTIFY US A.S.A.P.
SEND US YOUR...
OLD ADDRESS
NEW ADDRESS and
SUB #
MANY THANKS!!!!**

FOR SALE: Mdl. 412 heavy duty rotary switch round, 4" dia. 1 3/4 deep, 12 taps mounts with screws on front - \$20. 3AG fuse 1-2-5-8 amp - \$1.25/5. 10 watt ceramic resistors, 400 and 500 ohm - \$1/5. Webster electric magnetic head regular needle and set screw has 2.4" leads with phone tips, new condition - \$15. N.O.S. JFD set of wiring Harness #513 for old portable radios, with instructions - \$6. Zenith Trans-Oceanic CH. 6R40 Mdl. 600 complete except line cord reel has large schematic, works but has scuffs on leatherette cover, some into the wood - \$60. GE 115-230v calibration wattmeter in metal case - \$50. Scott kit audio amp in wood cab. Soundmaster LK60 - \$50. Attn. hearing impaired: have 3 models TTY (TDD) demonstrator machines cheap; write for details. Please add shipping charges. C. F. England, 98 Montague, S. Zanesville, OH 43701

HELP: Can anyone tell me where to get a power cable rebraided, circa 1924? R. Haworth, 112 Tilford Rd., Somerdale, NJ 08083. (609) 783-4175

WANTED: Pre-1927 Adler-Royal and Silvertone radios, speakers, etc. As manufactured by King-Hinners of Buffalo, N. Y. Joseph Pawell, 6 Augustine Ave., Ardsley, NY 10502. (914) 693-9374

FOR SALE: Complete Rider's 1 thru 16, average cond. - \$240. Also, 5,000 good used tubes, no early types; write needs for quote. Curt Lutz, 1021 N. Hickory Pl., Broken Arrow, OK 74012. (918) 251-8282

CLASSIFIED ADVERTISEMENTS

WANTED: For Eatons 1936 Viking 2-volt radio Model #6B60A, 6" 4-wire lead speaker. Ernest D. M. Yeaw, RR #3, Tatamagouche, Nova Scotia, Canada, B0K 1V0. (902) 657-2554

WANTED: Old meters/galvos, scientific instruments, working or not before 1925. Trade/cash paid. Ye Olde Meter Cellar, Leonard W. Cartwright, 113 Sea Terrace Way, Aptos, CA 95003. (408) 662-2977

FOR SALE: Philco Predictas TV, metal case, gold color, working, good condition - \$100. Don Chandler, 1100 N. Grant, Lexington, NE 68850. (308) 324-3301

FOR SALE/TRADE: A small quantity of used, tested 45 & 50 tubes, globe and ST. Other globes: 24, 26, 27, 80, 01-A, 99. **WANTED:** Early tubes: Marconi/Moorhead, A.P., DeForest, early Independents, 200/201 in original boxes. Early receivers including unique home brews. Victor Smith, 147-29 Hoover Ave., Briarwood, NY 11435. (718) 523-7059

WANTED: Help! I maintain a small radio collection and am seeking the following radios to add to it: Zenith Stratosphere 25-tube console radio; Crosley WLW 37-tube console radio; Scott Quaranta 40 or 48-tube console radio; World's Record Super 10 w/2 panel meters, 1926; World's Record Super 8, Radio Age Ideal Model, 1927; World's Record Shield Grid 9, front panel marked in upper right-hand corner, 1927; Scott Symphony, AC (5-tube) or DC (4-tube) model, 1929; and Scott AC Nine, 1929. Jim Clark, 1292 Starboard, Okemos, MI 48864. (517) 349-2249

FOR TRADE: Majestic Melody Cruiser, early model, for WE mics, others. Raymond Filozof, 339 Howertown Rd., Catasauqua, PA 18032. (215) 264-4733

FOR SALE: AK, RCA, and RCA Victor advertising items (signs, displays, etc.). Send SASE. Raymond Thompson, 7422 Cherry Tree Dr., Fulton, MD 20759. (301) 490-4448

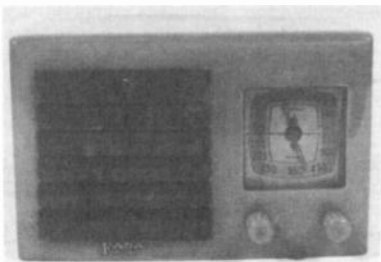

WANTED: Fada 5F60 with colored grille. I am a collector and will pay top dollar for this Catalin radio. Please call or write: Michael Lawlor, PO Box 179, Santa Barbara, CA 93102. (805) 682-2336

CLASSIFIED ADVERTISEMENTS



FOR SALE: Motorola Model 66L11. Make offer. Russell or Irma Schoen, E7340 Nietzke Rd., Clintonville, WI 54929. (715) 823-6744

WANTED: Schematic and other information for 1924 Thompson Model 60. Loop antenna and MS-4 speaker for Drake Model SW-4A. Jay Kinnard, 623 Amesbury Ln., Austin, TX 78752. (512) 452-7018

FOR SALE: Atwater Kent Model 40, good condition - \$65. Radiola 18, fair condition - \$55. Delmonico Novum Model 1047, very large German set, excellent condition - \$95. Zenith Royal 50 - \$15. Gary Pirkkala, 2306 Audley Ave., New Castle, PA 16105. (412) 654-8481

WANTED: Manuals, copies OK, for Lafayette HA700 and Exploraire. Tom Provost, 19 Ivanhoe Dr., Robbinsville, NJ 08691. (609) 259-7634

FOR SALE: Radio literature, all prices are postage paid. Catalogs: Coast-to-Coast Fall 1932, 100 pp. - \$8.75; Radio & Short Wave Treatise, 1934, 104 pp. - \$7.50; W.C. Braun Co. 1929, 200 pp. - \$13.50; American Auto & Radio 1927, 94 pp. - \$13.75; American Sales Co. 1932, 130 pp. - \$9.25; Burstein Applebee 1937, 162 pp. - \$9.50; Lafayette 1940, 120 pp. - \$8.25; Wholesale Radio Service, Lafayette, 1935, 192 pp. - \$13; Federated Purchaser 1936, 136 pp. - \$7.75; Radiolek 1937, 164 pp. - \$9.25; Radiolek 1938, 162 pp. - \$9.25; Radiolek 1937, 162 pp. - \$9.25; Radiolek 1939, 160 pp. - \$9.25; Barawik Co. 1929, 264 pp. - \$18. Allied 1949, 1954, 1955, 1956, 1958 - \$12.50 ea. Magazines: 37 issues of Radio Television Service Dealer 1949-55 and 8 issues of Radio Service Dealer 1940-43 - \$45; Communications & Broadcast Engineering, 15 issues from Vol. 1 #1, Oct. '34, to Vol. 2 #12, Dec. '35 - \$32.50; Service Magazine, 12 issues for 1936, 6 have edges taped - \$28; Service Magazine, 10 issues for 1937 - \$24; 90 issues of Cornell Dubilier The Capacitor - \$12.75; Electronics, 12 issues for 1934 - \$22. Gary Schneider, 9511-23 Sunrise Blvd., North Royalton, OH 44133. (216) 582-3094, machine answers on 5th ring

WANTED: Information on the Machlett Co., producers of x-ray and transmitting tubes. Also copies of the company magazine, The Cathode Press. John H. Walker, Jr., 16112 W. 125th St., Olathe, KS 66062. (913) 782-6455

CLASSIFIED ADVERTISEMENTS

WANTED: Original instruction book for Leutz Super Pliodyne 9. Modern Radio Reception by Leutz. Ed Bell, 5311 Woodsdale Rd., Raleigh, NC 27606. (919) 851-1517

FOR SALE: BC-728 receiver. WWII portable reconditioned for the Italian Army. With AN-75 whip antenna, FT-338A vehicular mount and CD-618A battery cable - \$90 plus UPS. James Treherne, 11909 Chapel Rd., Clifton, VA 22024. (703) 830-6272



WANTED: For my collection, E.H. Scott pictured with or without chassis. Call or write with condition and price. Mike Greene, 19113 Alpenglow Ln., Brookeville, MD 20833. (301) 774-3203

FOR SALE: Mercury tube tester the kind that used to be in the drug store - \$65. Antique Electro dwell meter - \$35. Pilot cathedral restorable - \$135. Hallicrafters S-108 - \$90. (2) B&W CCTV monitors, both work - \$20 ea. Heathkit SW-717 - \$45. 5-tube kit radio - \$45. Portable 8 track stereo tape player - \$20. John F. Dubino, KA1SBN, 73 Devens St., Greenfield, MA 01301. (413) 774-5826

WANTED: Case and corresponding knobs for Stewart-Warner B51T2, variation of Air Pal. Will buy junker, dial glass American Bosch 604 (G.O.R., p. 71), Packard Bell 5R1 (G.O.R., p. 121). State color and condition. **FOR SALE/TRADE:** Philco 16B (G.O.R., p. 67) - \$180. Buyer to pick up. Will not ship. Ken Burton, 19266 28th Ave. S, #3, Seattle, WA 98188. (206) 824-5821

WANTED: Pre-1922 wavemeters, early breadboards, x-ray, (2) gold Airline 01-A tubes, galvanometers, Tesla coils, transmitters, unusual loose couplers. Rosenthal, 5 The Strand, New Castle, DE 19720. (302) 322-8944

FOR SALE: Atwater Kent 40(?) chassis, no cabinet, fair - \$15. Popular Electronics magazines: 10/65-2/66, 4/66, 6/66-12/66, 2/67, 4/67, 6/67, 9/67-12/67, 2/68-9/68, 11/68, 1/69, 2/69, 7/69, 9/69-8/70, winter '72 - \$18/all. Lafayette KT-135 Explorer-Air with cabinet, less knobs, complete - \$20. Dave Minchella, KE2GE, 80 Campfire Rd. N, Henrietta, NY 14467. (716) 359-3337

FOR SALE: 3-page list of plastic and wood radios, test gear, parts, etc. - 50¢ and SASE. Chester Wisner, 1014 Main St., Dalton, MA 01226

WANTED: Tubes: 45, 50, 274A/B. Make offer. No call. H. Kato, c/o Mr. Shiraiishi, 5639 Glen Haven Ct., San Jose, CA 95129

CLASSIFIED ADVERTISEMENTS

FOR SALE: Jukebox service manuals: 1960-1970's Seeburg, AMI, Rock-ola, Wurlitzer. Seeburg transistorized stereo amplifier mod: TSA1 - \$85. Heathkit transistor tester IT 121 - \$75. TV Theory & Service techniques books (black & white) by General Electric, Rider & Buchsbaum. Pinball power transformers, different sizes and voltages, plastic encased relays, octal base plug-in, 24-volt DC coil, 5-amp contacts, reduction gear motors 1/40 h.p., 100 rpm, 3/8" shaft. (2) Hi-fi loudspeakers: Utah Celeste coaxial 8-ohm mounted in homebuilt cabinets of solid 3/4-inch mahogany 24" high, 16" wide, 11" deep, each speaker weighs 29 1/2 lbs. - \$125. Garrard record changer Lab Series Type A - \$35. Acme PS 13 regulated laboratory power supply, used, input 115v, output 12v, 8 amps, weight 22 lbs. - \$70. Zenith Trans-Oceanic for parts, very good cabinet, dial missing, 16 lbs. - \$25. Panasonic Model SE-4708 stereo receiver/amplifier with built-in 8-track tape recorder, weight 19 lbs. - \$75. Write for details. Jack Naimann, 365 Bronx River Rd., Yonkers, NY 10704. (914) 237-4650

WANTED: Chassis for Fada #189, #115, #1000, or #652; Outside Horn phonographs & parts. **FOR SALE:** Radiola #20 floor model, vg - \$90 w/o tubes, can't ship. Silvertone grandfather clock/radio, clock works, radio chassis missing, cab. nice - \$75. (10) blue Amberla cyl. records, vf - \$40. (100) 1/4" Edison diamond disc records, vf - \$200. Heavy shipping on last. J. L. Acciavatti, PO Box 231, Southborough, MA 01772. (508) 476-3229



FOR SALE/TRADE: Trade or sell: This rare Baird prewar television. The set is complete, working and original, except for some new capacitors nec. to restore the set to working order. The set is a direct view 12" electronic type made in 1938. Sonny Clutter, 14407 NE Fremont, Portland, OR 97230. (503) 254-9296, home, 233-0049, work

WANTED: Lamp shade for an Atwater Kent table lamp. Also speaker assembly for Philco Model 71 Code 121 cathedral. James W. Walcher, 1311 Janet Dr., Wilmington, IL 60481. (815) 476-9184

WANTED: Langbein & Kaufman Variable Clarifying Selector (variometer), preferably mint, describe condition fully. Henry Rosenblatt, 603 Commonwealth Ave., Newton Center, MA 02159. (617) 527-4895

CLASSIFIED ADVERTISEMENTS

FOR SALE: Several tube-type portables, several transistor portables, several wood table radios. Please send SASE for each list. I need dial face for Hoffman Model 205; will buy broken radio if face is good. Thanks. Mike Sovic, 1053 E. 11000 South, Sandy, UT 84094. (801) 572-6836

MESSAGE: Collectors in Kentucky, Tennessee, southern Illinois and Indiana interested in forming a club, please write or call: Ron Ramirez, 811 Maple St., Providence, KY 42450. (502) 667-5440

WANTED: Philco Model 70 dial ass'y. or junker chassis. David Headley, 651 S. Yale, Wichita, KS 67218. (316) 684-0050

FOR SALE: Federal B-30 Orthosonic - \$185. Radiola 20, no loop - \$95. Burnam Tully - \$325. AK's #20 - \$85, #30 - \$140, #33 - \$110. AK horn Md. H driver, thread broken - \$95. All untested. Richard Lauber, PO Box 51, Alplaus, NY 12008. (518) 399-0080

FOR SALE: Wilcox-Gay Recordio 6B30 with microphone & 4 blank disks - \$35. Royal 500, black - \$25. N.I.B., never assembled Rek-O-Kut K-33H 12" turntable, no instructions - \$40. RCA 3-BX-671 Stratoworld - \$40. Zenith 6D510 Bakelite - \$20. Dennis Schrank, 3129 S. Quincy, Milwaukee, WI 53207. (414) 744-3374

WANTED: Philmore pocket radio, state price. Have several novelty radios, Mickey in chair trade. Otto Nill, 192 Grant Ave., Islip, NY 11751

FOR SALE/TRADE: Philco 20A cathedral, all original, works fine - \$200. Magnavox AI-R combination amplifier horn speaker, all one unit, tests OK - \$250. Tinyrite crystal diode red plastic radio with matching old style small headset; Kearney, Nebraska on diode - \$150 ppd. AK 19, all original with underneath cabinet paper tag, metal nameplate on lid with matching chassis serial number, good audio - \$400. Zenith Trans-Oceanic G500, parts/restore - \$25. Majestic AM portable 4705 - \$20. All plus UPS, except crystal set. **WANTED:** Two Magnavox tubes with stickers. White Charlie McCarthy with undamaged original condition cabinet. Tuning knobs for Kennedy VI. Wallace Geary, 209 W. Saunders, Mt. Pleasant, IA 52641. (319) 385-2389

FOR SALE/TRADE: Belmont 6D121. Emerson 708. Silvertone 6002, 7024. Philco 46-420, 41-226. Fada 790. Zenith 5R312, R615G. Mitchell 1251 bed lamp. Bendix Bakelite. Gen. Elect. H-620U. RCA 75X15. Majestic 90. Zenith Royal 1000-1 T.O. mint. Royals 500H, 500E, 265, 20, 16. Motorola X21, XP23DEP. Toshiba 8TH-428R N.I.B. HTR-800 N.I.B. RCA 4RG52G N.I.B. Marantz 3800 preamp. Dynaco ST-70. PAS-3X. FM-3. Russian-made Gramophone radio, Aud-I-Tone Globe radio AM/SW. JVC Videosphere TV. Mike Farganus, 9225 E. Apache Trl., Mesa, AZ 85207. (602) 984-2836

CLASSIFIED ADVERTISEMENTS

WANTED: 1939 early 40 Silvertone radio in working condition with tuning eye tube. State price and condition. Newman Young, 722 Reed St., Monroe, GA 30655

WANTED: Bottle opener for Pepsi Cola Cooler radio, or good reproduction. AK 82 cathedral cabinet. DeForest loop antenna, knobs & trophy nameplate for baseball radio. Clock for Detroit egg shape radio, Model 302. All in good to excellent cond. Don Hovde, 1000 Ashland Ave., #2, St. Paul Park, MN 55071. (612) 459-9135

FOR SALE: Radio-Craft/Radio-Electronics, miscellaneous issues from 1947-55 - \$1 ea. SASE for list. Al Smith, 25 Stonehedge Rd., Lincoln, MA 01773. (617) 259-9351

FOR SALE/TRADE: 1933 Mickey Mouse Surrocco wood radio, Coke Cooler restored, black mike radio. Catalin, excellent condition. Emerson tombstone, butterscotch and brown. Bendix 526 green. Small Addisons plum & white, white & brown, brown & brown. Fada 652 Temple, butterscotch and Patriot red case. L. Grove, 4584 W. Ivanhoe St., Chandler AZ 85226. (602) 961-4281

WANTED: Unbuilt Heathkits, Knight-Kits, and Radio Shack P-Box kits. Want 60's & early 70's vintage Heathkit catalogs. Also looking for: Heathkit Mohican GC-1A, dark green Heathkit spray paint, grille cloth with airplane for Zenith 7G605. **FOR SALE/TRADE:** Zenith 6G501M, excellent - \$45 UPS ppd. 48. Scott D. Prather, KB9Y, 2776 S. Monroe St., Denver, CO 80210. (303) 758-9381 or (303) 649-8529

WANTED: Colonial Globe external parts: knobs, ring, top "bullet" nut; Aeriola Jr.; Regency TR-1. Carl Baxter, 1133 South Clinton Ave., Rochester, NY 14620. (716) 473-5322

FOR SALE/TRADE: Novelty Melody beer bottle radio, 1934, RGA-17, exc. shape, works. Sale or trade for Catalin! Call: Tim Saloff, 3440 RT 6N, Edinboro, PA 16412. (814) 734-5189

FOR SALE: Freshman Masterpiece with tubes - \$95. Radiola III with Brandes headphones - \$100. Bert Dincau, RR2, Box 146, Mountain Lake, MN 56159. (507) 427-3239

WANTED: Chassis for Westinghouse WR15 grandfather clock, working or repairable. Don Reinsma, 720 N. 18th Ave., Pensacola, FL 32501. (904) 433-2309

WANTED: Tuning drive bands (metal?) and service manual for an AK 40. Write to: Frank L dell, 8100 Kispiox Rd., Blaine, WA 98230

WANTED: Detrola 105C with round cabinet. Detrola cathedral clock radio. Zenith cathedral. Tandem Predicta. Dennis Smith, KN8H, Box 113, Trenton, MI 48183

CLASSIFIED ADVERTISEMENTS

FOR SALE: Philco Predicta 17" Debutant model, exc. original, plays - \$450. RCA 6-T tombstone, works - \$70. Zenith 5-R-216 block dial - \$80. GE J82 cathedral, requires wood work - \$95. Radiola 60 - \$75. AK 44 - \$70. AK L horn - \$75. Philco 37-10T - \$120. Philco Service Notes 1930-37 - \$20. Ghirardi's Modern Radio Servicing 1st edition, 1935 - \$15. Ghirardi's Radio Troubleshooters Handbook 3rd Edition, 1943 - \$20. All above plus UPS. John Hayes, 27 Highland Dr., Henniker, NH 03242

FOR SALE: BC-950, BC-456, BC-450, BC-451, BC-442, BC-1206A, BC-1206-CM, BC-602, BC-AE-231, TCS remote, ARB control box, CS-41 bag, ARC-3 power supply, ARA/ATA, Type 12 (R-19, T-11b) connectors, dynamotors, EICO 950B, OS-8, RME-VHF-152A converter, BG-96, ABA-1 remote, #19 Mark II power supply, #4A microphone, FL-8, RU-11 tuner CD 786, and more! SASE for list. Henry Engstrom, PO Box 5846, Santa Rosa, CA 95402

WANTED: Manuals (copies) for Heath HR-10B. Grid dippers Barker & Williamson 600 and Paco G-15. Alvin Bernard, PO Box 690098, Orlando, FL 32819. (407) 351-5536

FOR SALE: Cathedrals; U.S. Apex, Model 3072, very good condition - \$150. U.S. Apex Model 7A, very good condition - \$150. Kennedy Coronet, Model 42, very good condition - \$275. AC sets: RCA tombstone, Model 5T, good cond. - \$100. Zenith cube with round black face dial, Model SR216, good cond., works - \$125. Zenith tombstone with round black face dial, Model 6S229, wrong knobs, works, good cond. - \$125. Oriental Face Du Mont (G.O.R., p. 20-C), Model RA346, white & gold, very good cond. - \$100. AK Models 55 & 60 chassis for Kiel table, good cond. includes tubes & speakers - \$125 ea. Novelty: Rare pink Dahlberg pillow speaker radio, includes speaker, bed clamp & keys, very attractive, mint cond., all original - \$325. White Dahlberg pillow speaker radio, original speaker, bed clamp, crack on top by coin mechanism, easy to fix - \$150. Dahlberg chassis & dial scale parts, no coin mechanism - \$40. Battery sets & misc.: Magnavox Jr. battery set with original instruction car, good cond. - \$140. Western Electric 7A amp with 216A tubes, good cond. - \$400. Musette very small straight neck horn, restored, works - \$95. Western Electric oak wooden wall phone, restored - \$250. Kellogg wooden wall phone - \$200. Western Electric candlestick phone with small oak box desk ringer & bells - \$135. (25) pear-shaped 01-A's, test good - \$6 ea. Prices do not include shipping. Don Hovde, 1000 Ashland Ave., #2, St. Paul Park, MN 55071. (612) 459-9135, machine after 4 rings

WANTED: Any information on American Bosch console radio Model 73, 1929 (?). Roger Jarvinen, 225 Santa Rita Ct., Vallejo, CA 94590. (707) 554-6395

CLASSIFIED ADVERTISEMENTS

FOR SALE: Stan's surplus radio stuff for tubes, radios, novelties, parts and paper. LSASE. Want Zenith 7000 Trans-Oceanic in trade for Sonora Globe Navigator restored. Stan Lopes, KB6LGV, 1201-74 Monument Blvd., Concord, CA 94520. (415) 825-6865

WANTED: For Mitchell 1250 Lullabye, knob and lamp lens. Used, working 3U4, 1U5, and 1L6 tubes. For Yaesu FR-101S; 2m, 6m, and FM boards, HC-25/u crystals from 7.52 to 35.52 MHz in 500 kHz increments. Matching speaker. SSG John E. Berkovitz, 905 Camel Dr., #319, Gillette, WY 82716. (307) 682-1620

WANTED: Chassis for AK Model 84. Rider's Vols. 2, 3, 4, 5. Also would like to buy AK cathedrals Models 80, 90, 567, 627, 165, 708 and RCA Models R-37, R-5. Would consider trades for my Philco 70, Patterson 10-tube cathedral, or GE Model H-600 (Collins, p. 43). Jerry McKinney, 110 N. Franklin, Fayetteville, TN 37334

**NEW FAX NUMBER FOR
ANTIQUÉ RADIO CLASSIFIED**
(508) 371-7129 - 24 hours a day
Ads - Subscriptions - Book Orders
Charge to VISA/MasterCard
Minimum Charge: \$10.00

FOR SALE: Zenith Trans-Oceanics Model 8G005YF, good cond. - \$85, also Model G500 - \$80. Zenith portable long distance - \$45. RCA Strato World Model 7BX10, exc. playing cond. - \$95. Fada Bullet 115 maroon & yellow, hairline crack on bottom of case, no harm gouge on grille, playing cond., all complete - \$495. Philco Mod. 71B, nice original - \$195. Philco Jr. - \$60. Gloritone cath. Mod. 26 - \$60. AK Mod. 37, exc. clean cond. - \$70. Stewart-Warner Mod. 1251A - \$45. Battery: case radio 3-dial 5-tube - \$110; Air Wax Mod. 51, all complete, plus exc. cond. - \$150. AK Mod. 20, exc. cond. - \$95. AK Mod. 33, exc. cond. - \$90. Philco 90, exc. original, plays, will trade for or toward a good tube type character or novelty radio. Silvertone cath. Mod. 36, exc. - \$130. Westinghouse refrigerator radio, color green, working - \$85. Westinghouse Aeriola Sr., 1- and 2-tube, have WD-11 tubes, no lids for either - \$140 ea. Motorola Mod. 10-135 color white, nice clean cond. - \$55. Atwater Kent Mod. E speaker - \$45. Crosley Super Musicone speaker - \$75. Zenith Mod. H511W, as pictured in Guide to Old Radios, color green - \$75. Lamp radio, rocket shaped, Mitchell Mod. 1260, plays, all original - \$165. Have several good radio magazines such as Radio World, a weekly mag. 1924, have several issues - \$3 ea. Radio 1923-1924 issues - \$4 ea. Radio Broadcast mid-1920's - \$5 ea. Radio Guide 1930's issues - \$2 ea. Radio In the Home, mid-1920's - \$4 ea. Popular Radio, mid-1920's - \$3 ea. Motorola white plastic Mod. 51X12 - \$50. AK Mod. 40 - \$60. Ralph D. Howard, 1 Church St., Dansville, NY 14437. (716) 335-8746, eve.

CLASSIFIED ADVERTISEMENTS

FOR TRADE: Crosley split grille Catalin, black and yellow, for a Crosley Coke bottle only. Cliff Watts, 51 Glendale Rd., Brantford, Ontario, Canada N3T 1P5. (519) 753-5087

WANTED: WWII type ATK iconoscope TV camera and monitor. Also WWII vintage radar equipment. Allan H. Weiner, 14 Prospect Dr., Yonkers, NY 10705. (914) 432-6638

FOR SALE: Rider's Vols. 6, 8 and 12 - \$20, \$10, \$10. Gernsback service manual for 1931 & 1932 - \$20. Rider's 1 thru 5 Abridged - \$30. Early radios including 1920's & 30's. Crystal sets, horn speakers. Send SASE for list. **WANTED:** Magnavox M4 base, horns for Thorola Sr., Utah, Trimm and Rex (made by Trimm). Thanks. Bob Barnes, Box 275, Monroe City, MO 63456. (314) 735-2945

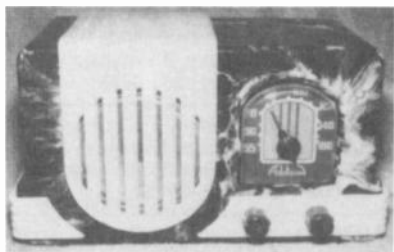

WANTED: Addisons in Catalin or plastic. I am willing to pay "too much" for these radios. Please write or call collect: Rain Buttignol, 214 State St., #7, Portsmouth, NH 03801. (603) 427-1384

FOR SALE: Book list #6 - SASE. Craftsmen chrome changer - \$65. **WANTED:** AK 55 metal case & lid, Revere 400. T. Wickstorm, 1664 E. Shore Dr., St. Paul, MN 55106. (612) 771-4741

WANTED: WE tubes. Will trade mine for yours, lots of tube hi-fi gear. V. Vogt, 330 S.W. 43rd St., #247, Renton, WA 98055. (206) 251-5420, x247

FOR SALE: Stephens Trusonics 206AXA 15" coaxial speaker, mint - \$100. Jensen JAP-60 15" dual-unit - \$65. Sheldon Rubin, 117 N. Ridge St., Rye Brook, NY 10573. (914) 937-2535

WANTED: Crosley fantasy book radio. Coke crystal set, Mickey Mantle, Magicitone whiskey bottle. Novelty transistors. **MESSAGE:** Still looking for more collectors to add to a transistor novelty collectors list. Send name, address, phone number as well as any particular interests to: Cliff Watts, 51 Glendale Rd., Brantford, Ontario, Canada N3T 1P5. (519) 753-5087

WANTED: Brown speaker grille louvers for Fada 5F60 (R.G.A., p. 32). Have Catalin knobs for possible trade. **FOR SALE:** Hallicrafters S-85, good condition, working - \$50 plus postage. Mike Keller, 609 Westphal Ave., Columbus, OH 43213. (614) 231-3489

CLASSIFIED ADVERTISEMENTS

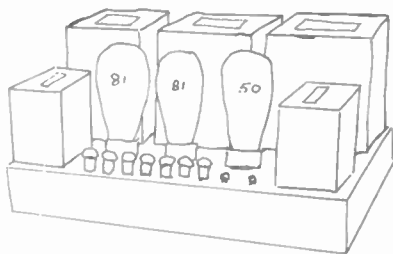

WANTED: Selectone power supply as shown. Black finish, 3 tubes - (2) 81's and (1) 50. Selectone nameplate. John Meredith, 1626 Lake Rd., #188, Haslett, MI 48840

FOR SALE: Radio collection. 43 items. Recession prices. Call or write for list: Leo Vanderpot, 132 Grand St., Croton-on Hudson, NY 10520. (914) 271-5417

FOR SALE: Electronic junk, a basement full, moving, must sell, tubes, PM and field coil speakers, transformers, meters, PC boards, enameled copper wire size 22 and smaller - \$5 pound, 35¢ ounce. Send needs and SASE. Elmer H. Thom, 1209 Alta Vista Dr., Dayton, OH 45420. (513) 254-5169

WANTED: A.R.C. books prior to Sept., 1987. Radio Boys and Girls books, Grunow-501, GE-45 console chassis, RCA BP-10 for parts and Radio Course I and II booklets by Knights of Columbus, 1923. **FOR SALE:** Earlier transistor radios and radio-TV related books. LSASE appreciated. Scott Oldham, RR2, Box 14, Elwood, IL 60421. (815) 423-6339

FOR TRADE: RCA WA-44C audio generator. Knight KG-600B tube tester for any type Hallicrafters receiver. **WANTED:** Cabinet for Hallicrafters S-86 receiver. HA-5 external VFO. Crystals Type CR-23/U for CB-3A Littlephone Channels 1 to 23. Type FT-243 crystals for 80 and 15 meter bands. Loren Dudley, 14 Valley Rd., Bath, ME 04530. (207) 442-8419

CLASSIFIED AD NOTICE

Please check your ads carefully before sending them in. Once ads are received, it is not always possible to refund the amount sent, pull the ad or make changes.

FOR SALE: Now available - catalog of books on computer history and technology. Much material before 1960. Send 50¢ stamps to: Rainy Day Books, PO Box 775, Fitzwilliam, NH 03447-0775

WANTED: Beitman's Vol. 13 for 1953. **FOR SALE:** New American-made 450 VDC, 600 VDC capacitors. New and used tubes and components for repairing AC and AC/DC sets. Offering holiday discounts on some items. List available. Sue Coulter, 4200 Prince St., Bakersfield, CA 93301

CLASSIFIED ADVERTISEMENTS

WANTED: Brown radio, Tandberg radio. **FOR SALE:** Jewel Wakemaster, ivory and maroon. Daryl Jorud, R#1, Box 180, Battle Lake, MN 56515. (218) 864-5725

WANTED: Music Master Type 100, working or not working. Also need schematic of radio. Ellis Hayeem, 85 8th Ave., Apt. #5T, New York, NY 10011. (212) 727-0572

FOR SALE: RCA 648 PTK projection TV - \$600. RCA 8 TV 323 - \$250. Ansley Dynaphone combination electric piano, phonograph, radio, very rare and unique item, spinet size - \$1,200. Kolster K-45 with remote control - \$700. Jewel "Pinup" plastic wall-hung clock with radio - \$250. Pete Griffin, Box 150403, San Rafael, CA 94915-0403. (415) 454-0734

FOR SALE: Rider's 3 through 20 - \$15 ea. and up. Service manuals: GE, Philco, RCA, Redbooks, Zenith. Radio Retailing - \$10 ea. Audio Engineering, Hi-Fi - \$6 ea. N.R.I. kit radio - \$50. William B. Duck battery radio - \$500. Several Lionel electric train sets - \$60 ea. Zenith cathedral - \$150. Crosley Buddy Boy, AK Treasure Chest, Emerson Catalin - \$250. Zenith black dial tombstone. RCA 128. Many Philco cathedrals: 16B, 20B, 60B, 70B, 71B, Junior, 84B, 89B, 90B, 118B - \$110 ea. and up. American Flyer train set - \$50 ea. RCA Little Nipper radio - \$100. Champion spark plug radio - \$70. Bill Rolf, 30131 Center Ridge, Westlake, OH 44145. (216) 871-4547

WANTED: Call book between 1935 and 1940. Bill Ray, W4CUP, PO Box 278, Dandridge, TN 37725

ABBREVIATIONS USED IN CLASSIFIED ADS

amp. - Amplifier
 BC - Broadcast
 BO - Best Offer
 ca. - circa
 ea. - each
 (F.O.S., p. ?) - See page ? in the book *Flick of the Switch*
 LSASE - A Long SASE (see SASE)
 LW - Long Wave
 MO - Money Order
 N.I.B. - New In Box
 N.O.S. - New Old Stock (Unused, that is new, original, vintage items)
 O.T.B. - *Old Timer's Bulletin* published by Antique Wireless Assoc. (A.W.A.)
 OB - Original Box

ppd. - Postage Paid (included in price)
 PS - Power Supply, also "pwr sup"
 rcvr. - Receiver
 SASE - Self Addressed Stamped Envelope (Suggest sending a long, No. 10, envelope)
 SW - Shortwave
 UPS - United Parcel Service (V.R., p. ?) - See page ? in the book *Vintage Radio*
 w/ - with
 w/o - without
 xcvr. - Transceiver
 xfmr. - Transformer
 xmtr. - Transmitter
 xstr. - Transistor

BY POPULAR REQUEST

CLASSIFIED ADVERTISEMENTS

FOR SALE: (100) Avon novelty bottles. Collins Radio 50th Year Book. Collins 75A's side panels. B&K tube rejuvenator - \$10. Majestic 7P6 power supply. Hallicrafters SX-16, S-20R. RCA Globetrotter portable. Silvertone all-band portable. Grundig 4- and 9-tube portable. RCA Navy power amplifier. Rack-mount table cabinets. Rider's original 1 to 5 Index. Motorola 5A5 personal radio. Grundig extension speakers. Bell Laboratory gas tube noise generator. Bill Coolahan, 1450 Miami Dr. NE, Cedar Rapids, IA 52402. (319) 393-8075

HAVE YOU MOVED? ARE YOU MOVING? PLEASE NOTIFY US A.S.A.P. SEND US YOUR... OLD ADDRESS NEW ADDRESS and SUB # MANY THANKS!!!!

WANTED: R4C in excellent cond., SW xtals., AM filters. Cash/trade. Levy, 8 Waterloo Dr., Morris Plains, NJ 07950. (201) 285-0233

FOR SALE: Latest military TV-7 tube tester data, approximately 4000 tubes, 55 pages - \$10. Walter M. Chambers, PO Box 17091, Memphis, TN 38187-0091. (901) 725-6995

WANTED: 45 rpm automobile type record player. NOMA brand series type Christmas bubble lights and trees. Lighted beer and soda signs, especially those with outdoor scenes or moving scenes. Bob Carlson, 815 Third Ave., International Falls, MN 56649. (218) 283-2543

FOR TRADE: Silvertone 8085 wire recorder/recorder player/radio for interesting wood radio. Dan Billings, 102 Plymouth Ln., Dothan, AL 36301. (205) 793-1343

WANTED: Farrand or Western Electric cone speakers. Type '50 globe tube, dud is OK. Douglas D. Fox, 1324 N. Russell Ave., Aurora, IL 60506. (708) 896-5490

WANTED: Information on Silver radios. Have a round wooden set, resembles Ekco round sets. Gary Redfield, 214 Bailey Rd., Crystal City, MO 63019. (314) 933-0542

FOR SALE: Collection of 150 choice AC radios including many large cathedrals and Zenith black dials. Prices negotiable - \$1 for list. Several Lionel and American Flyer train sets - \$60 ea. Philco 90 B, rough - \$150. AK 84, excellent - \$450. Crosley Trirdyn - \$75. Microphone radio - \$60. Bill Rolf, 30131 Center Ridge, Westlake, OH 44145. (216) 871-4547

FOR SALE/TRADE: Amrad 3500-3. Steinite 6. Freed-Eisemann 40-N. Radiola 20. AK 456 3-color dial. Crosley 179 3-tier. Novelty transistors. Jack Stafford, 2308 Stardust Ln., Grand Island, NE 68803. (308) 384-8104

CLASSIFIED ADVERTISEMENTS

FOR SALE: National dials, "N" silver vernier - \$15. HRO tuning - \$25. Philco 70 chassis, spkr., less tubes - \$50. Belmont 6D111, excellent, with original sales brochure, (Collins, p. 69) - \$200. Emerson 109 (Collins, p. 31) - \$50. HRO 50T coils B, D - \$25 ea. RME VHF 152 converter - \$50. Sparton 10" silver cone speaker with cabinet wood grille - \$50. Ghirardi Radio Physics Manual - \$15. Sterling Radio Manual - \$15. Brunswick cathedral mantel speaker - \$75. Pausen Engineering Co. octagon speaker - \$50. Bosch cathedral speaker - \$50. Amplion large cathedral speaker - \$75. Western Electric horn speaker 518W - \$125. Trimm Home horn speaker - \$75. Zenith Trans-Oceanic 3000-1 - \$75, 1000-1 - \$35. Rider's 7, 8, 10, 12, 14 - \$13 ea. TV 1, 2 - \$20 ea.; 3, 4, 5 - \$15 ea. Philco 1940 Factory Book - \$25. Hallicrafters TW202A green cowhide leather portable - \$25. ARRL 1944 Handbook - \$15. Radio Handbook 1942 - \$15. Atwater Kent E speaker, no cone - \$25. RCA 1947, 1964 tube manuals - \$7 ea. Zenith Art Deco H5116 - \$50. Emerson large pocket portables 508, black - \$50; 569 ivory - \$50. 3-band curved wood 459B - \$50, large wood 539 - \$35. Zenith small chairside 5R236 - \$75. Beautiful clock radios. Majestic gold face, ivory. Du Mont maroon, Sylvania red - \$35 ea. Aluminum chrome face pocket transistors. Emerson 31P56 - \$50. Sears 5215 - \$50. Zenith Royal 280 - \$50. Sony TR 630 - \$75. RCA portable chrome brown marble - \$35. RCA pocketbook chrome - \$25. Zenith portable 5G41 - \$50. Beitman Master Index 1926, 1957 - \$15. 1941, 1942 books - \$8 ea. Sams transistor books 2, 6, 9, 10 - \$10 ea. Arcturus 27 6T good - \$20. RCA 45 player two-tone, fabric-covered suitcase mfg. by Crescent excellent - \$45. RCA Transmitting Tube Manual - \$15. RCA broadcast band modulated oscillator microphone or pickup - \$50. Large table radio with chrome front, green leatherette covered wood, private mfg. - \$35. Arvin portable cowhide case - \$25. Eimac 250T tubes with sockets, good - \$30/pair. Johnson CB white face - \$25. Globe CB100 less cabinet - \$25. Polycorn four-channel - \$25. All item shipping extra. Joe Santomas, W2FXM, 653 Broadway, Hammonton, NJ 08037. (609) 561-1161, after 7 pm



WANTED: Catalin radios - whole or parts sets, including Motorola 50X series pictured. I am willing to pay "too much" for these radios. Please call collect or write to: Rain Buttignol, 214 State St., #7, Portsmouth, NH 03801. (603) 427-1384

CLASSIFIED ADVERTISEMENTS

WANTED: Emerson U5A white plastic tombstone (Collins, p. 18), pair Catalin pinwheel knobs for DeWald A501, knobs back for Emerson 520, back for Fada 148, one knob brown marbled for Fada 845. **FOR SALE/TRADE:** Original instruction sheet for Fada 1000, excellent. Offers or trade towards wanted items. Mike Schultz, 820 Willow St., Southampton, PA 18966. (215) 364-1727

FOR SALE: Radiola 18 Victrola combination: Mode VV7-11. Please write or call: Rain Buttignol, 214 State St., #7, Portsmouth, NH 03801. (603) 427-1384



WANTED: The following novelty radios: Pepsi bottle, Heinz ketchup, Gulden's mustard, Budweiser bottle, Kent and Marlboro cigarettes flip-top box, Stanley tape measure, baseball, Gumby, Hamburger Helper hand, Wilson football with tee, N.Y. Giants helmet. State price and condition. Wanted: Cabinet and knobs for Fada 845. Don't need dial face. Dial face cover and white knobs for Emerson 520. Imprinted dial face cover, dial pointer and knobs for Emerson 507. **FOR SALE/TRADE:** General Radio 650A impedance bridge (see Oct. 89 A.R.C.) and 544B megohm bridge - Make Offers. Supreme 589A tube tester - \$25. Superior TV10 tube tester - \$20. GE P1711 pocket transistor, 1965, N.I.B. - \$17. Nuvox pocket micro-transistor runs on one AA - \$20. Marvel 6YR15A pocket transistor, 1961, small crack - \$7. Hallicrafters S38DB, mint - \$65. Ladies high heel shoe FM radio, white, N.I.B. - \$30. California Raisin radio, N.I.B. - \$25. Mickey Mouse FM radio, 3D face on blue case, new - \$22. Nick Carrieri, 11 Kunigunda Pl., Islip Ter., NY 11751. (516) 277-6438

FOR SALE: Eico Model 377 audio generator with manual, untested - \$20. Eico Model 360 TV-FM sweep signal generator, untested, with manual - \$20. Sparton Model 89 console, vg condition, untested, you pick up - \$200. Greene Model S-6-7 B power supply, working, no lid - \$35. GE Model K-55 mini floor model, good condition, untested - \$100, you pick up. Hallicrafters Model S-38, okay condition, untested - \$25. National Model 57, good condition, untested - \$50. Standardyne Model 7, okay condition, untested - \$45. AK Model 185 tombstone, needs refinishing, untested - \$100. Stromberg-Carlson Model 11-A chassis, no speaker - \$20. Front panel press wood grille - \$20. D. Chad, Mania Antiques, 402 Maple Ave., Hawley, PA 18428. (717) 226-3095

WANTED: Majestic Model 20 chassis. Radiola 17 power supply or power transformer. Jack Hofeld, 61 Trinidad Bend, Coronado, CA 92118. (619) 429-0165

CLASSIFIED ADVERTISEMENTS

FOR SALE: Send for our free catalog of reproduction parts, owner's manual reprints, dealer model flyer reprints, T-shirts, mugs, etc. **WANTED:** Vintage Zenith items, Philco 680, EH Scott FM tuner. Will consider trades from our sales list. **FOR SALE:** Get out the Collins book: Globe, p. 15 - \$825; Charlie original, p. 35 - \$1000; Zenith, p. 38 - \$200; Sonora repainted, p. 47 - \$110; Mitchell excellent original, no shade, p. 55 - \$120; Westinghouse original green, replacement dial, p. 63 - \$85; Fada wooden, cloth covered maroon and white, p. 67 - \$450; Bendix green, piece broken from rear black, p. 70 - \$350; Zenith 6D015 with original box, p. 71 - \$135; Truetone good original white, p. 71 - \$100; Zenith 5R312, p. 71 - \$125; Coke Cooler, gorgeous repainted, complete, p. 89 - \$600; DeWald 501 butterscotch, repro knobs, p. 87 - \$625; Silvertone cowboy radio, pointer missing, p. 96 - \$400; Arvin 840T, very good original white, p. 100 - \$85; Dahlberg, no pillow speaker, excellent light green - \$200; Mic radio, black, FM., excellent, p. 102 - \$175. Televisions: 3-legged floor model Predicta - \$400; Hallicrafters T54 metal - \$225; Raytheon console 19" round screen - \$125; Philco Safari, lid missing - \$125. Advertising: Atwater Kent papier mache ship wall plaque, excellent condition - \$450; Zenith neon - \$400; Philco neon - \$500; GE small baselit countersign - \$185; Sentinel sign - \$100; 40's Philco backlit clock - \$200; two Stromberg gold foil wall plaques - \$100/pair. Imperial 7-tube round-top tombstone, 7" round dial - \$175; 7-tube Jesse French semi-cathedral - \$250; Philco 38-690 owner's manual reprint - \$6; 1931 Philco radio timer clock designed by Norman Bel Geddes - \$125; 1938 Philco radio timer clock - \$125; Play Pal Art Deco wooden table bar radio - \$250; RCA 54B2 small portable, no cracks - \$65; Zenith 6D311 - \$135; RCA R7 - \$165; GE 80 tombstone, cabinet, escutcheon and dial glass only - \$160; very nice Zenith 807 tombstone - \$195; 32-volt Zenith 5X230, same cabinet as 6S229 - \$175; Bakelite Stewart-Warner Portobar radio with complete glassware, hairline crack, rebuilt chassis - \$225; new in box Zenith drinking glasses, 2 sizes, 8 to a box - \$30 per box. Portable AM/shortwave radios in good to excellent condition: Capehart 88P66NL, missing one knob - \$110; RCA Transworld - \$125; Hallicrafters TW1000 - \$190; Hallicrafters TW1000 parts set - \$95; Zenith 8G005 - \$150; Zenith G500 - \$120; Zenith Y600 black - \$125, cowhide - \$160; Zenith Royal 1000 - \$150. Newin box Diner transistor radio - \$35; new in box Coca Cola Cooler radio, AM/FM - \$50. Pepsi Dispenser transistor radio, 1960's, incredible new in box, mint - \$550. Zenith beverage mugs, black with white lightning bolt logo - \$8 ppd.; buy four or more and save \$5 per four. We have many high quality, high end and good condition console radios including Zenith, EH Scott, Philco, RCA, GE, Stromberg-Carlson and others. We are glad to ship consoles, and we do an excellent packing job. Normal console shipping cost \$50 to \$85. Please

CONTINUED ON TOP OF NEXT COLUMN

CLASSIFIED ADVERTISEMENTS

CONTINUED FROM BOTTOM LEFT

call for detailed information 8 am - 8 pm CST, or leave message and we will return your call. Satisfaction guaranteed, shipping extra. Alan Jespersen, PO Box 17338, Minneapolis, MN 55417. (612) 727-2489, ans. mach. after 4 rings

FOR SALE/TRADE: Trading/selling some AKS for fine woods, Catalins and Bakelites, what-have-you. Henry B. Cohen, 2459 Eighth St., Fort Lee, NJ 07024. (201) 585-0030

FOR SALE/TRADE: AK 40 with E3 speaker - \$90. Stewart-Warner 301A SW converter (F.O.S., p. 176) - \$100. Scott 800B, no cabinet - \$120. Philco cathedral Model 60 Code 121 unusual, not in F.O.S. or October Photo Review - \$125. Echophone EC-1 - \$25. Webster Chicago wire recorder with mic and spools - \$50. Crosley F-25BE, looks like television, original metallic blue paint, excellent - \$175. Edison Standard cylinder Model D phonograph with Model C reproducer and original horn - \$400. All plus UPS. **WANTED:** Old advertising signs any material, lighted and neon especially. Old microphones. Rare and unusual tubes. Old telephone stuff. Benjamin Rose, PO Box 1409, Murray Hill Station, New York City, NY 10156-0606. (212) 545-1288

WANTED: Good to excellent Hallicrafters SX-88, Hammarlund SP-600, American Bosch 595, 695, Westinghouse WR306. Jim Comeau, 3007 North Coronado Dr. Fullerton, CA 92635. (714) 773-9320

**NOTICE TO ALL
CLASSIFIED ADVERTISERS!
OUR CLASSIFIED AD DEADLINE IS
12:00 NOON
ON THE 10th OF EACH MONTH**

FOR SALE: Philco 49-501 (F.O.S., p. 140), original white paint, original back, working, no chips or cracks, a few small chips in the paint - \$550 ppd. and insured. (U.S.) Dan Howard, 2940 S.E. 118th Ave., Portland, OR 97266-1602. (503) 761-7799

FOR SALE/TRADE: Freed-Eisemann NR-45 - \$75. Steinite Model AC junker - \$30. Tektronix scopes, plug-ins. Anthony Matt, 425 Waltham St., West Newton, MA 02165. (617) 527-4794

WANTED: Help! Need modulation transformer and mounting hardware for HT-4 (BC-610) Hallicrafter Part #55B028. Chuck Dachis, The Hallicrafter Collector, 4500 Russell Dr., Austin, TX 78745

WANTED: Elkay (Langbein-Kaufman Radio Co.) and Zimmerman Radio Co. radios. **FOR SALE:** GE M-67 chassis - \$25. Motorola 9Y chassis - \$30. Philco 39-36 chassis - \$30. Zenith 6G001YX portable - \$25. All play. Plus UPS. Ron Trench, Jr., 12 Virginia Rd., East Haven, CT 06512. (203) 469-7340

CLASSIFIED ADVERTISEMENTS



FOR SALE: English Ultra Lynx – \$300. Other interesting mantel radios. Echophone 14 – \$200. Mantola (Sentinel 108A) – \$150. Avon – \$120. All are in excellent condition & work. **WANTED:** Chassis for General Motors Little Corporal 211B, Audiola 23-S-8, GE K-63, RCA 120, Remler Cameo 14, Crosley 54 or 58, Premier Home-Pal. Cabinets: Majestic 290, Kennedy 72, Audiola 1931 Jr., Philco 90. Frank Heathcote, 1235 N. 3rd St., Logansport, IN 46947. (219) 722-3612

WANTED: Will buy or trade for the following items: RF coils with or without wire and TA cover or entire TA units for Atwater Kent breadboards; Radio News, May 1920 and June 1920 issues; the book Modern Radio Reception by Charles Leutz, 1928 edition; cover or entire cabinet for a Radiola II. Dick Bury, PO Box 25, Gurnee, IL 60031. (708) 623-7746

WANTED: Philco 37-690X. Vernon Oehlke, Box 307, Solar Heights Rd., Ghent, NY 12075. (518) 392-4945

FOR SALE: Japanese transistor radio, Nanaola 8TP-902 – \$15 ppd. John Neal, 2221 5th St. South, St. Petersburg, FL 33705. (813) 821-8375

WANTED: Cash or trade National NHU, VHF receiver & SW-4 needed badly. Robt. Enemark, W1EC, Box 1607, Duxbury, MA 02331. (617) 934-5043

WANTED: Manual for Heathkit T3 signal tracer. Copy OK. Chuck Hemphill, W102 Brierwood, Spokane, WA 99218. (509) 467-0826

FOR SALE: Beitman TV-17, 1960 TV's – \$8 ppd. HRO-60 manual photocopy – \$10 ppd. R. J. Eastwick, N2AWC, 224 Chestnut St., Haddonfield, NJ 08033. (609) 429-2477

FOR SALE: Clapp-Eastham HR with 1 knob of dubious original – \$250. Pilot (?) 4-tube with 199s and adaptors – \$75. RCA voltohmyst – \$25. Scott 99A amplifier – \$40. Philco authorized service decal – \$15. Books: Rider's I-V abridged, VI-XVIII – \$175/all. Volume 23 – \$75. Philco Auto Radios 1931-37 – \$15. Sams auto radios Volume 32 – \$10. Rider's Servicing by Signal Tracing – \$12. **WANTED:** Guitar and theatre amps. Mark van Roojen, 127 Moore St., Princeton, NJ 08540. (609) 921-8171

CLASSIFIED ADVERTISEMENTS

FOR TRADE: McMurdo-Silver Masterpiece V in Norwich cabinet. Chrome bad and veneer bad on one side of cabinet. Want pre-1930 aircraft radios or pre-1940 Pan AM Airlines radios, ground or air. IP-501 or early Collins transmitter. James Treherne, 11909 Chapel Rd., Clifton, VA 22024. (703) 830-6272

FOR SALE: Precision E200 generator 120Kc, 44Mc. Philco generator 150Kc, 35Mc, both work great – \$35 ea. + UPS. Phil Guinan, 106 Page Rd., RFD 7, Litchfield, NH 03051. (603) 889-6213

WANTED: Jackson-Bell 84 (Peter Pan) whole or parts. Have radios to trade or cash. Richard Gray, 9181 Chesapeake Dr., San Diego, CA 92123. (619) 560-4162

FOR SALE: Send LSASE for price list including Fada, Emerson, Garod Catalins, many Bakelites, others. Jack Sacra, 1720 Solomon Rd., Charlottesville, VA 22901. (804) 293-9985

FOR SALE: Jefferson tube rejuvenator (G.O.R., p. 13), museum quality – \$95. Knight capacitor checker with Eye indicator – \$45. Talk-A-Phone #LM10, very nice – \$55. Crosley C529A small push button, Bakelite – \$40. Jewel TR1 leatherette transistor – \$30. Precision 10-12 Tube Data Manual – \$8.50. SASE for photographs. **WANTED:** Knob for AK 184. Inexpensive tube tester, wooden case. AC cathedrals. G. A. Gilardi, 119 Moss Ln., Waggaman, LA 70094. (504) 431-9630

FOR SALE: Radios 1930's-1970's American, Japanese, German. Send large SASE for 2-page list. Bill Aiken, 19183 Country Estates Cir., Flint, TX 75762

FOR SALE: H.H. Scott stereo amplifier, Model 299, EC – \$110 plus UPS and shipping of \$10. Harry C. Nuss, 47 Gravel Hill Rd., Huntingdon Valley, PA 19006. (215) 357-5061



WANTED: Fada 652/252 Catalin with green or maroon body and yellow trim, or yellow body with red trim. Also need Fada 115/1000 Bullets in same colors. Nobody pays more! Michael Lawlor, PO Box 179, Santa Barbara, CA 93102. (805) 682-2336

CLASSIFIED ADVERTISEMENTS

FOR SALE: Novelty transistor radios. Large Champion spark plug AM, Sinclair N.I.B., (2) Globes (one case cracked), Kodak copier - \$130/ all plus UPS or trade for Regency TR-1. James Treherne, 11909 Chapel Rd., Clifton, VA 22024. (703) 830-6272

FOR SALE: Transistor radios. RCA P-339 (similar to TIJE), Silvertone 2223, GE P795, GE P807E, GE P1704, GE P9106, Arvin AM/FM 62R98 - \$50/all plus UPS. James Treherne, 11909 Chapel Rd., Clifton, VA 22024. (703) 830-6272

WANTED: Crystal sets, any condition, any quantity! Erwin Macho, Ambrosweg 17/A/8, A-1230 Vienna, Austria

FOR SALE: Super General miniature cathedral - \$75. Philco 70 cathedral - \$75. Majestic Model 15 semi-cathedral - \$50. RCA Model 100 cathedral - \$65. Tom Ducro, 6805 Palmetto St., Cincinnati, OH 45227. (513) 271-0156

FOR SALE/TRADE: Collection of Bakelite portable & novelty transistors. Send SASE or call. **WANTED:** Early plastics & Pilot 3" TVs. Jon Steinhauer, 636 Westminster Rd., Baldwin, NY 11510. (516) 223-9878

FOR SALE: Bendix green and black Catalin Model 526C - \$450. Jim Shirreff, 1016 W. Thomas, Oak Park, IL 60302. (708) 848-7142

FOR SALE: Zenith 15-U270, floor console, fine original finish - \$1700. Mike Kaplan, 61 Clayton St., Denver, CO 80206. (303) 377-8521

SERVICES: Custom Record Service: Send me your favorite recordings and I'll make you a 78 rpm or 45 rpm record. I buy disk equipment, blanks. Kim Gutzke, 7134 15th Ave. S, Minneapolis, MN 55423. (612) 866-6183

FOR SALE: Phono-panel receiver w/4 199's exposed. Manufacturer unknown, but sold through discount outlet - \$75 plus UPS. Crocker, 41 Kingstown Way, #6, Duxbury, MA 02332. (617) 582-2052



WANTED: Tuning motor for 1938 Zenith. Or junk 9-tube chassis with motor. Gilbert Smith, 248 South 36th St., San Diego, CA 92113-1613. (619) 236-7990

FOR SALE: Radiola III restoration, operation, 5-page booklet, exploded diagrams and more. Philmore 15-page manual, circa mid-1950's, details one- & two-tube sets - \$10 ea. ppd. David P. Smith, Box 81, Olney, IL 62450

CLASSIFIED ADVERTISEMENTS



FOR SALE: Radiola 32 with rear wicker doors. Big. Very big! Please write or call: Rain Buttignol, 214 State St., #7, Portsmouth, NH 03801. (603) 427-1384

WANTED: Help. Need copy of instructions for my JIL scanner radio, Model SX200. Harry Blesy, N9CQX, 2409 Northgate, North Riverside, IL 60546. (708) 442-8855

FOR SALE: (35) Sams folders numbers between 1306 and 1969 - \$1 ea. plus postage or offer for all. Art Collatz, 2127 Market, Blue Island, IL 60406

**IF YOUR EXPIRATION DATE IS
DECEMBER OR BEFORE, RENEW TODAY!
EARLY RENEWALS
RECEIVE AN EXTRA ISSUE!**

FOR SALE: Stromberg-Carlson: Neutrodyne Model 1A - \$150 or BO. B power supply 45v, 90v, 180v - \$40. Tripod speaker 21-inch flat cone. Radiola 20 - \$150. Radiola III - \$75. Steinite 1927 AC table models - \$100. Thorola Isodyne w/ doughnut coils Model 50 - \$150. Freshman Masterpiece, fancy - \$125, and 8-tube Victoreen kit. Ray Moore, 12 Pavilion St., Rochester, NY 14620. (716) 461-3205

MESSAGE: Mr. Bill Tesla, Brooklyn, N. Y., let me know your complete address. Kunio Okura, 8-3-7 Urawa, Saitama, Japan 336

FOR SALE: Hammarlund SP-600-JX-17-SPC-10SSB converter. Hallicrafters SW-500 & S-38E-BC-344D. RME UHF-126 converter. Joe Overmyer, 1212 Main St., Evanston, IL 60202. (312) 663-0150 days

WANTED: To correspond with any former employees of Karadio, Eckstein, and ATR. Thank you. Dennis Hilberg, 804 Ravine St., Decorah, IA 52101

FOR SALE: Motorola Model X 16G, green, all transistor, with chrome stand, plays - \$45. RCA Victor Model T1D, black-silver with stand, plays - \$45. Westinghouse Model H-619P7, 6" x 3", red - \$45. Drakes Radio Cyclopeda by Harold Manley 1927 - \$12. Television Video Handbook, 1949, by Scheraga and Roche - \$12. Edison Mabry, 715 W. Longview, Mansfield, OH 44906. (419) 526-1175

CLASSIFIED ADVERTISEMENTS

FOR SALE: Precision 920P tester (Mil. I-157) manuals - \$7.50 ppd. M-357A Gibson Girl kites, used - \$30. Signal generators URM-25D, used - \$55. URM-25F, used-ex. - \$95. CA plug-ins, used - \$15. CX-1597 power cable for R392, N.O.S. - \$25. T-195 manuals, orig. - \$20 ppd. Radio mounts, FT-285 table, N.O.S. - \$135. FT-514/BC-1335, used - \$25. MT-1236/VRC-19, N.O.S. - \$10. MT-768/GRR-5, used - \$10. Collectors special, all of above four mounts - \$150. Antenna bases, used, AB-15 - \$7.50. AB-558/R442 - \$10. AB-652/GRC-106 - \$20. TS-383 motor-driven strobe teletype distortion testers, pre-scrap sale of these 40's cast iron monsters, 90 lbs., UPS 2 pkgs., used - \$35. Manual, copy - \$10. Add for shipping. Tartan Electronics, Inc., Box 36841, Tucson, AZ 85740. (602) 577-1022

FOR SALE: Heathkit IG72 audio oscillator, mint w/book, GR723C 1000 cycle osc. Name your price. **WANTED:** National Type N dial. See picture Oct. A.R.C., page 29. Rodney Schrock, 402 Lincoln St., Somerset, PA 15501

WANTED: Fada bullets, Model 1000 or 115, all colors. Call me before you sell. Tom Ducro, 6805 Palmetto St., Cincinnati, OH 45227. (513) 271-0156

WANTED: Tubes wanted: Dud 01-A's, globe type, silvered. Will buy in lots of ten or more or trade for good tubes. Self-addressed envelope please for reply. List amount of tubes and price or trade in reply. John B. Drew, 28 Babcock Rd., North Stonington, CT 06359

FOR SALE: Original mail in guarantee registration card for Fada 652 Catalin - \$20. Philco 45, complete, needs restoration - \$50. Don Howland, 4621 S. Shawnee, Spokane, WA 99208. (509) 466-0939

FOR SALE: (18) RCA 874 in boxes - BO. Howard F. Newton, 1008 Smith Ridge Rd., Bridgeport, NY 13030. (315) 633-5780

WANTED: Knobs for Emerson 541. Chassis, speaker knobs for RCA R-70. John Neuman, 822 Laurelwood Ct., San Marcos, CA 92069-1851. (619) 471-0034

The Audio/Video Trader

Now in our second year! We're your marketplace for good used stereo/video equipment.

Ad rates start at 30 cents/word, free ads for subscribers.

We have readers throughout the U.S. and Canada

Subscriptions: \$15 yr., \$25/yr. foreign
Try us today! Sample Issue: \$1 + LSASE

Dept. R, 330 S. Main Street
Wake Forest, NC 27587

CLASSIFIED ADVERTISEMENTS

FOR SALE: Zenith portable H-503-Y. Horn speaker The Golden Bear. Bakelite RCA BC-1023-A. Stewart-Warner 400 (Paul? 54) horn speaker. 1929 Radio News Copper Clad Special Short Wave Receiver. Motorola Top Dial 52X11. Arvin 8573 turquoise portable. Motorola 66L1U Antenna Handle portable. Novelty Hatchback E type Jaguar (Breed 20). Spartan Bluebird chassis. Belmont 5D118. Motorola 5J1U portable w/green grille. C. A. Bray, 1322 Ivy Rd., Bremerton, WA 98310

WANTED: Zenith 7-S-232, 9-S-232, or 12-S-232 Waltons tombstone, any condition but must be complete. Roger Muir, 2911 Lapsley, Dallas, TX 75212. (214) 905-0822

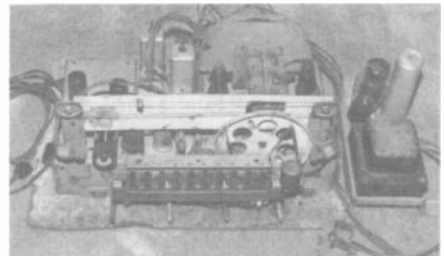

FOR SALE: 1955 RCA Victor color TV set, Model 21-CT-661U, Director 21, 2 service manuals, very good condition - Offers. **HELP:** Can anyone identify the motor-tuned chassis shown in photo, identifying marks RC427F and 0A12? Help: Who made a 5-tube 6 push-button wooden cased table radio with a model called the Meteor? Model # is 7215. Help: Need information on Timmons Aviation Phone manufactured by Callophone Co. of N. Y. Bryan Hodgson, 14 Evergreen Dr, Voorhees, NJ 08043. (609) 424-0312

WANTED: Radio Retailing magazines, top prices paid. **FOR SALE:** 78 rpm record Radio Lady-O Mine - \$15. White Bakelite Sonora (Collins, p. 1939), refinished beautifully, original push buttons & plays - \$165. Philco 60B Art Deco tombstone (F.O.S., p. 119), excellent original condition & works - \$95. Doug Heimstead, 1349 Hillcrest Dr., Fridley, MN 55432. (612) 571-1387

FOR SALE: Boudette Sonochorde loudspeaker, working, some rust on base, cloth fair - Make Offer. Zenith Y600 Trans-Oceanic, good condition - \$80. Homemade 1920's superegen, good hardware - \$30. 970 mike radio, working, missing back - \$30. Rene Jaeger, 25 Barberry Hill, Woodstock, VT 05091. (802) 457-2821

WANTED: Field strength meter, must have UHF and VHF. Fred Schultz, 1246 Lincolnway S, Ligonier, IN 46767. (219) 894-3092

WANTED: Gonset 220MHz Communicator IV, dead or alive. J. M. Roseman, 2716 West 3rd St., Coal Valley, IL 61240



FLORIDA - Dec. 1

**NEW CLUB FORMING
FLORIDA ANTIQUE WIRELESS GROUP
FLEA MARKET**

Orlando, FL - VFW Hall
Edgewater Dr., 1/4 mile North of Fairbanks
8 am - 1 pm

Door Prizes - Demonstrations
Dealer Tables

Info: Dennis Williams - (407) 291-6673,
or Paul Currie - (407) 365-9305

CALIFORNIA - Dec. 10

**SACRAMENTO HIST. RADIO SOCIETY
MEETING**

North Highlands, CA - SMUD Foothill
Service Center, Room D, 5026 Don Julio
7 - 9 pm

Info: Secretary SHRS, PO Box 162612
Sacramento, CA 95816

ARKANSAS - Dec. 6

**ANTIQUE RADIO COLLECTORS CLUB
OF FT. SMITH - CLUB MEETING**

Ft. Smith, AR - Creekmore Park
Magnolia Room, Greenwood and Rogers
7:30 pm Meeting

Info: Wanda Conatser - (501) 646-7147

CALIFORNIA - Dec. 11

**CALIF. HISTORICAL RADIO SOCIETY
NORTH VALLEY CHAPTER
MEET**

Anderson, CA - Goodtimes Pizza Parlor
6:30 pm

Info: NVC-CHRS, PO Box 2443
Redding, CA 96099 - (916) 246-4209

OREGON - Dec. 8

**NORTHWEST VINTAGE RADIO SOCIETY
MEETING - CHRISTMAS PARTY**

Oregon City, OR - Buena Vista Clubhouse
16th and Jackson Streets
10 am - Meeting

Info: Dan Howard, 2940 SE 118th Ave.
Portland, OR 97266 - (503) 761-7799

ARKANSAS - Dec. 13

**ARKANSAS ANTIQUE RADIO CLUB
CLUB MEETING**

Little Rock, AR - The Auditorium
S.W. Bell Bldg., 120 W. 8th St. - 7 pm

Info: Tom Burgess - (501) 565-1750

FLORIDA - Dec. 8

**ANTIQUÉ WIRELESS ASSOCIATION
FLORIDA MEET**

Bradenton FL - Stewart Elementary School
7905 15th Ave., N.W. - 8 am - mid-afternoon

Info: Norman Smith, 7203 17th Ave., N.W.,
Bradenton, FL 34209 - (813) 792-0003,
after 4:30 pm

OHIO - Dec. 18

**ANTIQUÉ RADIO COLLECTORS OF OHIO
MEETING**

Kettering, OH - First Natl. Bank Basement
Corner of Rt. 48 and Stroop Rd. - 7:30 pm

Info: Karl Koogle, 2929 Hazelwood Ave.
Dayton, OH 45419 - (513) 294-8960

WASHINGTON - Dec. 9

**PUGET SOUND ANTIQUÉ RADIO ASSN.
SWAP MEET/MEETING**

North Seattle, WA - Ronald School
North 175th St., 1 mile W. of I-5, exit 176
11 am - Swap Meet; 1 pm - Meeting

Info: Frank Banks, 28232 27th Ave. S
Federal Way, WA 98003 - (206) 941-2965

CONN. - Nov. 3 - Dec. 30

**VINTAGE RADIO & COMMUNICATIONS
MUSEUM OF CONNECTICUT
CATHEDRAL CRAZY EXHIBIT**

New Britain, CT - 665 Arch Street
Sat.: 11 am - 5 pm - Sun.: 1 pm - 5 pm
Weekdays by appointment only
Info: (203) 224-3853

*Attend a club event near you,
learn, meet others in the hobby,
and perhaps find an item or
two for your collection!*

Mention A.R.C. when contacting clubs!

ISRAEL

MUSEUM FORMING ANTIQUE RADIO AND BROADCASTING MUSEUM

Tel-Aviv, Israel

Items Needed: Magazines, Books, Posters,
Tubes, Related Items

Info: Bruno Pinto, 24 Remez St., #7,
Tel-Aviv, Israel 62192

NEW YORK

NEW CLUB FORMING MID-HUDSON NEW YORK RADIO AND PHONOGRAPH CLUB

Info: Campbell Hall Antiques, PO Box 207
Campbell Hall, NY 10916

LA. & MISS. GULF COAST

NEW CLUB/ASSOCIATION FORMING For Collectors in S. La.-Miss.

Gulf Coast Area

Info: F.V. Bernauer, 1503 Admiral Nelson Dr.
Slidell, LA 70461 - (504) 649-5453

WISCONSIN

MUSEUM FORMING WISC. ANTIQUE RADIO & PHONO. SOC.

Wautoma, WI - Vintage Radio
112 S. Ste. Marie St.

Info: Jerome Schliepp, 831 Berlin Rd.
Ripon, WI 54971 - (414) 748-2471

RADIO CLUB LISTINGS

CLUBS: Send antique radio club and meet information to A.R.C. for free listing here, as space permits. Sorry, we don't have room for hamfests. Always send a SASE when writing to clubs!

NATIONAL CLUBS:

Antique Wireless Association (AWA). P.O. Box "E", Breesport, NY 14816. Pub: *The Old Timer's Bulletin*, quarterly. Dues: \$10.00. National and regional conventions. Museum.

Antique Radio Club of America (ARCA). Jim and Barbara Rankin, 3445 Adaline Dr., Stow, OH 44224. Pub: *The Antique Radio Gazette*, quarterly. Dues: \$12.00. National and regional conventions. Regional chapters.

REGIONAL CLUBS:

Alabama Historical Radio Society (ALHRS). 4721 Overwood Circle, Birmingham, AL 35222. Meetings 4th Mon. evening each month but Dec.

Antique Radio Club of Illinois (ARCI). Carl Knipfel, Rt. 3 - Vererans Rd., Morton, IL 61550. Pub: *ARCI News*. Dues: \$12.00. Annual Radio-fest and additional meets each year.

Antique Radio Collectors Club of Ft. Smith,

MARK YOUR CALENDAR

Nov. 3 - Dec. 30 - CT, New Britain - Exhibit*
Dec. 1 - FL, Orlando - FAWG Flea Market*
Dec. 6 - AR, Ft. Smith - ARCCFS Meeting §*
Dec. 8 - FL, Bradenton - AWA/Fia. Meet*
Dec. 8 - OR, Oregon City - NWVRS §*
Dec. 8 - PA, Forest Hills - PARS Meet
Dec. 9 - WA, Seattle - PSARA Meet §*
Dec. 10 - CA, N. Highlands - SHRS §*
Dec. 11 - CA, Anderson - NVC-CHRS*
Dec. 13 - AR, Little Rock - AARC Meeting §*
Dec. 18 - OH, Dayton - ARCO Meeting §*
Jan. 9 - CA, Palo Alto - CHRS Meeting
Jan. 13 - CO, Lakewood - CRC Meeting
Jan. 19 - NH, Nashua - NEARC Meet
Jan. 19 - TX, Irving - VRPS Meeting
Jan. 26 - MI, Grand Rapids - MARC
Jan. 28 - AL, Birmingham - ALHRS §
Feb. 24 - MA, Weston - GBARC Radio XXII
Jun. 13-15 - MD, Baltimore - ARCA '91

*See expanded listing this month. § Monthly Meeting.

MINNESOTA

NEW CLUB FORMING OLD-TIME RADIO CLUB

Rochester, MN

Radio programming emphasis

Info: Bob Ruble - (507) 288-3082

NEBRASKA

NEW CLUB LISTING NEBRASKA RADIO COLLECTORS ANTIQUE RADIO CLUB

Monthly Newsletter - Monthly Meetings
Omaha Area Members Welcome

Info: Steve Morton

905 West First North Platte, NE 69101

Arkansas. Wanda Conatser, 7917 Hermitage Dr., Ft. Smith, AR 72903. Monthly Meetings.

Antique Radio Collectors of Ohio (ARCO). Karl Koogler, 2929 Hazelwood Ave., Dayton, OH 45419. Pub: *The ARCO Code*, quarterly. Dues: \$10.00. Monthly meetings.

Arkansas Antique Radio Club (AARC). Tom Burgess, P.O. Box 9769, Little Rock, AR 72219. Pub: None. Dues: \$5.00. Monthly meets.

Arizona Antique Radio Club (AARC). Treasurer, 8311 E. Via de Sereno, Scottsdale, AZ 85258. Pub: *Arizona Antique Radio Club News*, quarterly. Dues: \$15.00. Monthly meetings.

Belleville Area Antique Radio Club (BAARC). Karl Stegman, Treasurer, 4 Cresthaven Dr., Belleville, IL 62221. (618) 234-7992. Newsletter. Dues: \$10.00. Bi-monthly meetings.

California Historical Radio Society (CHRS). Paul Bourbin, 25 Greenview Ct., San Francisco, CA 94131. Pub: *CHRS Journal*, quarterly. Dues: \$15. Quarterly swap meets.

Enclose a SASE when requesting info.

BUSINESS CARD ADS - \$27.00 FOR 3 MONTHS

WANTED - OLD RADIOS BEFORE 1930



- Early Crystal Sets
- Battery Radios
- Horn Speakers
- Radio Magazines & Books
- Radio Tubes & Parts
- Early Radio Advertising

G.B. Schneider Phone: 216-582-3094
9511-23 Sunrise Blvd. North Royalton, Ohio 44133

JOHN V. TERREY
498 Cross Street
Carlisle, Mass. 01741
(508) 369-9770

COLLECTOR:
Early Radio, Wireless,
Television and Telegraph

Early Calculators, Slide
Rules, Typewriters and
Computers

Related Books, Magazines,
Catalogs, Juvenile Books,
Novelties, etc.

W5DTQ

JERRY'S VINTAGE RADIO

Buy • Sell • Trade • Restore



Vintage T.V
Novelty Items

(805) 251-7829
17663 1/2 Sierra Hwy.
Canyon Country, CA 91351

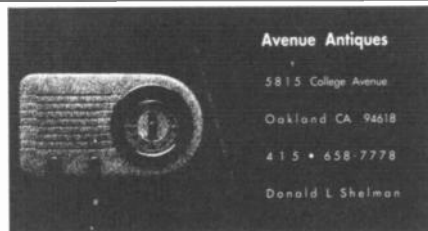

Avenue Antiques

5815 College Avenue

Oakland CA 94618

415 • 658-7778

Donald L. Shelman

ELECTRONS PAST

Vintage Radio

Restoration



BUY - SELL - TRADE - REPAIR

Mike Lynch



851 ENCHANTED DR
MIDVALE, UT 84047

(801) 282-3211

SPY EQUIPMENT WANTED!

- Code Machines
- Secret Radios
- Clandestine Weapons
- Secret Cameras
- OSS, SOE, CIA, KGB!
- I Buy or Trade!

Keith Melton

P.O. Box 5755 Bossier City, LA 71171
(318) 747-9616 Days: FAX (318) 747-9010

WANTED: Tube-type Guitar, PA & Theatre Amplifiers, Guitars,
Microphones and Related Literature.

FENDER, K & F, WHITE, GIBSON, VOX,
AMPEG, MARSHALL, RCA, W. E.,
ALTEC, SHURE, ETC.

Mark van Roojen
127 Moore Street
Princeton, NJ 08540

(609) 921-8171



ANTIQUE RADIO RESTORATOR

Since 1936 Repair - Buy - Sell
Complete Restorations

COOPER'S RADIO SERVICE

425 Court Street
Rockwell City, Iowa 50579



LARRY COOPER
712-297-7232

Victorian Talking Machine, Company

281 Robinson Ave. Newburg, NY 12550



914-561-0132
SHOP HOURS
BY APPT



Antique Phonographs
Cylinders, Discs,
Buy, Sell, Restore & Repair

100 Needles \$3.00
Book & Parts Catalog ..\$3.00
TELEPHONE ORDERS
MC/VISA



WANTED!

MITCHELL TV's,
radios, hi-fi's, and all
other appliances (made
by Mitchell Mfg. Co.,
Chicago, in 30's to 50's).

'The Mitchell Collector'

Lee Mitchell, 875 N. Michigan, 3412
Chicago, IL 60611 - (312) 337-3123, 266-7100



JUKE BOXES D'EPOCA

SLOT MACHINES - PINBALLS VENDING MACHINES
GUMBALLS-RECORDS PHONOGRAPHS RADIOS
BUY - SELL RESTORATION

FAX 011 39 11 8126553

10138 TORINO ITALY
VIA DUCHESSA JOLANDA 13 A
Tel 011 39 11 830417

WANTED: Tube Hi-Fi Components & Studio
Equipment of the 1950's and 60's

Harantz, McIntosh, Scott, Fisher, Brook
Aerocord, Brechmar, Western Electric
Fairchild, Altec, Tannoy, JBL

Richard Sharisky
P.O. Box 521
Belmont, MA 02178

(617) 484-5784

BUSINESS CARD ADS - \$27.00 FOR 3 MONTHS

WANTED

Dud or weak Type 80 tubes.
Pear or ST shape.
Send quantity and price in 1st letter.

Andrew Mooradian
5 Priscilla Lane
Winchester, MA 01890



If you buy, sell or like jukeboxes you need **ALWAYS JUKIN**—THE MONTHLY JUKEBOX MAGAZINE!! Subscribers in 25 countries, **ALWAYS JUKIN LEADS THE WAY:** Articles, photos, show reports, ads, new products, price guides, restoration tips, repairs—everything you need to know about **JUKE-BOXES**—the fastest appreciating collectible in the world!! Fun & a great investment. *Sample copy, \$3. 12 Issues, \$24.* **ALWAYS JUKIN, 221 YESLER WAY AR, SEATTLE, WA. 98104. (206) 233-9460. Master/Visa ok.**

Blade & Cage

Electric Brass Desk
Fans Bought, Sold, Restored



M L YOUNG
4200 Sunshine Rd.
Miami, FL 33133

(305) 661-6245



john d. eckland

antique radio repair

969 ADDISON AVENUE PALO ALTO CALIFORNIA 94301
415/323-0101

Schematics Repair Notes History

Radio Schematic Service
And Research Information

Don Davis K4ZDB
8833 Brucewood Drive
Richmond, VA 23235
(804) 272-4452

\$2.00 Per Schematic
Provide Mfr., Model,
and/or Tube Layout.
Quotes on other info

RELIABLE - PROMPT - GUARANTEED

SOUND REMEDY
LOUDSPEAKER REPAIR SERVICE

881 Virginia Avenue
Collingswood, New Jersey 08108

Authorized Waldom Dealer

Telephone
(609) 869-0838

RALPHS

Repairs any tube radios
\$25.95 - Guaranteed to work good
UPS and large parts extra
SASE required for answer

Ralph Kilsheimer - 50 years of service!
107 Robins Road, New Rochelle, NY 10801
(914) 632-4371

TUBES & STUFF

EXTENSIVE STOCK OF **NEW AND GOOD USED TUBES ETC.**

(plus capacitors & misc.)

SEND 25¢ STAMP

FOR ILLUSTRATED FLYER

DON DIERS 4276-AB4 N. 50 St.
Milwaukee, WI 53216-1313

"Dead Radios Brought Back to Life"

**FRANKENSTEIN'S
RADIO LABORATORY**

Specializing in Antique Radios,
Old Radio Cadavers and Parts Bought and Sold
Mail Order Sales of New, N.O.S. and Used Parts

MAIL ORDER SALES
4010 Fairmount Pkwy., Suite 285
Pasadena, Texas 77504

Gordon R. Rolston
Repairs by Appointment
(713) 998-0130

DAN'S SCHEMATIC SERVICE

RADIO DIAGRAMS

1921 to 1960 - \$2.50 PPD

T.V. DIAGRAMS

1938 to 1960 - \$3.50 PPD

Send make and model number or chassis

layout sketch with make and tube types if model

number is unknown, to: P.O. Box 53061

San Jose, CA 95153

**VINTAGE TV and RADIO
REPAIR and RESTORATION**
ELECTRONICS and COSMETICS

DAVID B. JOHNSON



(708)
484-2743



2336 S. KENILWORTH AVE.
BERWYN, IL 60402 • (708) 484-2743



RADIO ACTIVITY

Old Radios Repaired
And Purchased
Repairs Guaranteed

JIM BERG

(303) 937-1399

2648 W. Arkansas Ave Denver, CO 80219

BUSINESS CARD ADS - \$27.00 FOR 3 MONTHS

WANTED

**RADIO — WIRELESS
Pre-1925
ELECTRICITY — TELEGRAPHY
Pre-1900**

Books, Magazines, Autographs, Catalogs, Ephemera
One Item or Entire Collection

New Wireless Pioneers
6270 Clinton, Elma, NY 14059 USA
(716) 681-3186

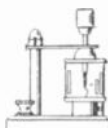

CRYSTAL SETS

PARTS - PLANS - KITS - BOOKS
CATALOG \$1.00

Largest source of Vintage and New Variable Air Condensers, Variometers, Vario-Couplers, Tap Switches, Tap Points, Galena and Germanium Detectors, Detector Stands, Cat Whiskers, Terminals, Sliders, Headsets, Dial Knobs, Coil Forms, Magnetic Wire, etc.

MIDCO

P O Box 2288
Hollywood, FL 33002
(305) 925-3670
B A Turke, Ph D E E

ANTIQUE RADIO REPAIR

Repair - Restore - Buy & Sell
Schematic Diagrams \$2.00

DAMASKE ELECTRONICS
S74-W16834 Janesville Road
Muskego, WI 53150
Phone: (414) 679-0838

IF YOU VISIT THE BRIMFIELD FLEA MARKET...
STOP BY FIRST!



TEL: 413-245-7174

COUNTRY ROAD BARN - BERNIE SAMEK
OLD PALMER ROAD, BRIMFIELD, MASS.

50 years **CHUCKS** of service!

Any Tube Radio Repaired and
Guaranteed to work good.
\$26.00 plus large parts & UPS

CHUCKS
167 LYNN DRIVE - PO BOX 598
NEW HAVEN, WV 25265 - PII (304) 882-2220

RADIO-TV TUBES

Dick Bergeron
Box 311
Essex Center, Vt. 05451
Tel: 802-879-0611

FREE PRICE CATALOG

Over 1400 types, all new in original boxes

Are You Looking For Antique Radios, Parts,
Tubes, Schematics and Restoration Services?
For Free Flyer, a 2-Stamp LSASE is required to insure a
response to your request. Send to:

Olde Tyme Radio Company
2445 Lyttonsville Road, Suite 317, Silver Spring, MD 20910

Wish to contact us by phone?
Our number is (301) 585-8776.
Please call 10 am to 10 pm (Local Time)

Antique Radios

David & Nancy Snow
P.O. Box 6352
Jackson, MI 49204
(517) 787-2985



We Buy, Sell, Repair
ARBE - III Battery Eliminators

E.H. Scott Radio

Collector Historian Admirer



JIM CLARK
1282 STARBOARD
OKEMOS, MI 48864
(517) 349-2249

WRIGHT ELECTRONIC SERVICE THE RADIO DOCTOR

"You Don't Have To Worry When it's Done Wright"

1920-1960'S RADIOS-PHONOS-CAR RADIOS-TUBE AMPS
COMPLETE CHASSIS REFURBISHMENT
N.O.S. & USED PARTS - SEND FOR PRICE QUOTES
SCHEMATICS \$2.00 PER COPY

WRIGHT ELECTRONIC SERVICE
(206) 858-3592

P.O. BOX 8252
FEDERAL WAY, WA. 98003

1920-1970
SCHEMATICS \$3.50 & POSTAGE
MANUAL PRICES - SASE
RADIO/TV/HAM/MISC.
"IF I DON'T HAVE IT, YOU
PROBABLY DON'T NEED IT."

ALTON H. BOWMAN
4172 EAST AVE.
CANANDAIGUA, NY 14424-9564

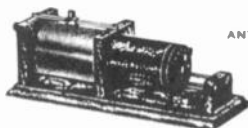

WANTED
ANTIQUE WIRELESS
ITEMS

JAMES A. DiRUZZA
MEMBER A W A

PHONE 15131 233 5004
2607 Old Troy Pike
DAYTON OHIO 45405

John Sideli

Art & Antiques

author of
Classic Plastic Radios of the 1930s and 1940s

will be offering for sale a selection of over
sixty rare and choice Catalin sets
as well as an outstanding
group of
eight Model 52 Air Kings
at the

New York Antiques Show/From Pilgrim to Pop
(see ad below for details)

Catalin sets offered will include:
Emerson Model AU190 in tomato red, brown, yellow, and green
Fada Model L56 in blue, green, yellow & red,
maroon & yellow, all yellow
Motorola Model 50X in red, green, cream
and many other rare sets.

17 Central Square, Chatham, New York 12037 (518) 392-6711

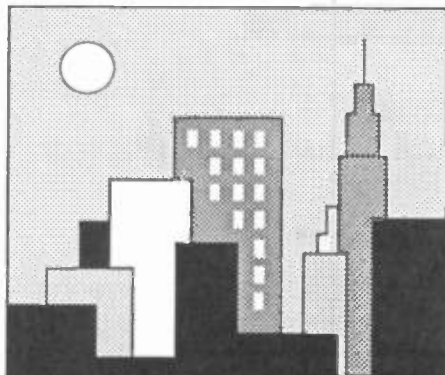

New York

Antiques Show

January 24-27, 1991

Thursday, January 24, 6-10pm
Early Buyer's Preview
\$25 per person

Friday & Saturday
January 25-26, 10am-9pm

Sunday, January 27
10am-5pm

Daily admission, \$8

Sheraton Centre Hotel & Towers
52nd St. & Seventh Ave.
New York, New York

From Pilgrim to Pop

Managed by Sidell & Sideli, Inc. Chatham, New York 12037 (518) 392-6711

THE COLLECTOR'S GUIDE TO ANTIQUE RADIOS

BY
MARTY AND SUE BUNIS

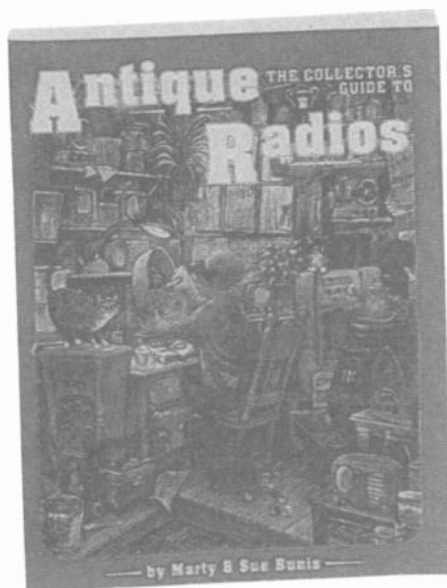

Only
\$16.95

No
Shipping
Charges

176 Pages
Over 5,000 models – over 400 full color photos
Current Prices

8 1/2 x 11 Softcover

Welcome to the wonderful world of antique radios! Covering the years 1920 to 1959, this new beautifully illustrated price guide with its easy-to-use format and detailed descriptions will eliminate the frustration and confusion in identifying old radios.

**BUY DIRECTLY FROM THE AUTHORS
AND SAVE SHIPPING CHARGES**

Send check or money order for \$16.95 for each book ordered to:

Marty Bunis
RR1, Box 36
Bradford, NH 03221

ARBE* — III

* Antique Radio Battery Eliminator



FEATURING:

- Adjustable high current "A" supply
 - 8 different "B" and "C" voltages
 - All outputs electrically isolated
 - 5-year limited warranty
 - Short circuit protection

Terrific Christmas Gift Idea !!



\$139.95 Shipped
within continental U.S.A.
(Michigan Residents add 4% sales tax)

Call or write for complete data sheet:

Antique Radios Inc.
P.O. Box 6352
Jackson, Michigan 49204
Phone 517-787-2985
After 7:00 PM EST



1991 Vintage Radio Calendar



Included in this year's calendar are:

- 1933 Emerson Mickey Mouse
- 1934 Best Model LW-4
- 1924 Crosley Model 51
- 1927 Stewart Warner 520
- 1947 Wards Airline
- 1939 Coronado 527 A
- 1946 RCA Globetrotter
- 1940 Zenith Consolone
- 1940 Grand Piano
- 1941 Black Bullet
- 1935-40 Log Cabin
- 1931 Philco 70 Cathedral
- and the beautiful cover shot:
- 1943 Sonora WAU 243.

BOYCE PUBLISHING CORP. • P.O. Box 24019 • Milwaukee, WI 53224 • (414)358-2828

TERMS

1991 EDITION

Quantity Price \$11.95 ea. \$ _____
 Shg & Hdlg. \$2.50 ea. for one \$ _____
 Add \$1.00 for each add'l. \$ _____
 Wis. res. add \$.60 ea. \$ _____
Total: \$ _____
 Call for discounts on quantities of 6 or more

Order your 1991 VINTAGE RADIO WALL CALENDAR

Name: _____
 Address: _____
 City: _____ State: _____ Zip: _____
 Phone: _____

SERENDIPITY*

***Discover Gems of...**

HISTORY, TECHNOLOGY and ENTERTAINMENT

from sparks to compact disks

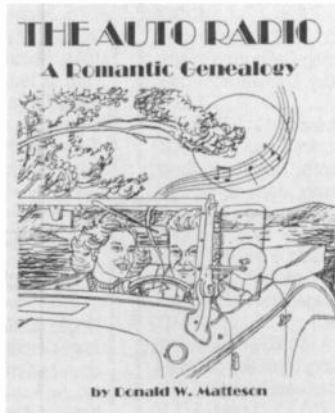

Read about the famous investigators whose work unwittingly paved the way for the development of the auto radio, one of the greatest success stories ever witnessed.

The auto receiver helped save the radio industry during the great depression and rose from a hang-on novelty to become a sophisticated accessory that helped shape the styling and engineering of the automobile.

Stories of radio broadcasting's halcyon days featuring big bands, drama and outstanding announcers who kept the listeners in tune with the times.

A definitive reference book in a handsome hardbound 8-1/2" x 11" edition of over 300 pages. Profusely illustrated. Includes a listing of manufacturers, a glossary and an extensive index.

Available from:

Antique Electronic Supply, 6221 S. Maple Ave., Tempe, AZ 85283

Antique Radio Classified, P.O. Box 2, Carlisle, MA 01741

Classic Motorbooks, P.O. Box 1, Osceola, WI 54020

Henry Ford Museum Gift Shop, Dearborn, MI 48121

Vestal Press Ltd, P.O. Box 97, Vestal, New York 13850

Vintage TV & Radio, 3552 W. 105th St., Cleveland, OH 44111

PRICE: \$34.95

For further information write: Thornridge Publishing
P.O. Box 11, Jackson, MI 49204-0011
Telephone (517) 784-1420 or 784-8920

REPRINT BOOKS ON EARLY RADIO - WIRELESS - TELEVISION TELEGRAPH - TELEPHONE

RADIO

- Blake, G.C., *History of Radio Telegraphy and Telephony*. Early wireless schemes, developments and patents to 1928. 50-page bibliography. 449 pgs.\$35.50
- Codel, M., *Radio and Its Future*. 1930. A 1930's look into the future. A collection of articles including DeForest, Grunow, Kolster, Sarnoff, Maxim, Colpitts, Paley, Durstine and Codel. 375 pgs.\$28.00
- Dunlap, O.E., *Radio's 100 Men of Science*. 1944. Biographical narratives of pathfinders in electronics & television including Gilbert, Galvani, Faraday, Loomis, Hughes, Dolbear, Tesla, Hertz, Popoff, Nipkow, Branly, Jenkins, Conrad, Weagant, Kolster, DuMont, Olson. 330 pgs.\$25.00
- McNicol, D., *Radio's Conquest of Space*. 1946. A chronological treatment of the early days of radio, the scientists and their inventions. A few of the chapters: Spark Gaps & Oscillators, Wireless Spans the Atlantic, Regenerative Receivers, The Advent of Commercial Radio. 388 pgs.\$29.00
- Military Signal Communications*. A two-volume anthology of early documents covering the history of military communication, the Civil War to WWII. Includes visual signaling, telegraph, telephone and radio. 2 vols., 750 & 625 pgs. ...\$71.50
- Report of the Chief Signal Officer: 1919*. A record of the telegraph, telephone and radio in WWI.\$46.50
- Signaling and Communicating at Sea*. A two-volume anthology of over 50 articles. Semaphores, pigeons, flashing lights, flags, radio, teletype. 2 vols., 480 & 524 pgs. ...\$73.00
- Summers, H.B., ed., *Radio Censorship*. 1939. Collection of excerpts from articles & books + brief bibliography.\$23.50

TELEVISION

- Abramson, A., *Electronic Motion Pictures: A History of the Television Camera*. Mechanical TV to Zworykin to 1940's. 228 pgs.\$24.50
- Dunlap, O.E., *The Outlook for Television*. 1944. Records the evolution of television from 1925 to 1932. Includes 22-page chronology of Radio/TV from 640 b.c. 310 pages.\$24.50
- Hess, G.N., *An Historical Study of the Du Mont Television Network*. 1960. A search for why the fourth television network failed.\$19.00

TELEGRAPH TELEPHONE

- Bright, C., *Submarine Telegraphs: Their History, Construction and Working*. 1898. An account by a chief engineer, of early cable attempts, failures & successes, starting with the 1850 cable between England & France. 819 pgs.\$57.50
- Development of Submarine Cable Communications*. A two-volume anthology of over 50 articles. The 1858 and later trans-Atlantic cables, cable-laying ships, cable routes, technology thru 1973. 2 vols., 500 & 480 pgs. ...\$71.50
- Electric Telegraph: An Historical Anthology*. The rise and progress of the electric telegraph from the late 19th century to recent times. A collection of early writings. 625 pgs.\$54.00
- Eyewitness to Early American Telegraphy*. Reprints of reports and letters of Alfred Vail from the 1830's and 40's. An invaluable primary resource. 288 pgs.\$25.50
- Fahie, J.J., *A History of Electric Telegraphy to the Year 1837*. 1884. A definitive history of the earliest telegraph systems preceding Morse. 566 pgs.\$38.50
- Kingsbury, J.E., *The Telephone and Telephone Exchanges: Their Invention and Development*.\$40.00
- Prescott, G.B., *Bells 's Electric Speaking Telephone*.\$38.50
- Smith, Willoughby, *The Rise and Extension of Submarine Telegraphy*. An engineer's and designer's autobiographical account of cable laying in the mid-1900s including the 1856-66 Great Eastern missions. 409 pgs.\$32.00

THE FAMOUS M.I.T. RADIATION LAB. SERIES AVAILABLE AGAIN

- #13. *Propagation of Short Radio Waves*, 746 pgs. \$29.95
- #15 *Crystal Rectifiers*, 457 pgs.No longer available
- #17 *Components Handbook*, 640 pgs.\$29.95
- #18 *Vacuum Tube Amplifiers*, 761 pgs.\$29.95
- #19 *Waveforms*, 799 pgs.\$29.95
- #20 *Electronic Time Measurements*, 546 pgs.\$24.95
- #21 *Electronic Instruments*, 735 pgs.\$29.95
- #22 *Cathode Ray Tube Displays*, 764 pgs.\$29.95
- #23 *Threshold Signals*, 400 pgs.\$19.95
- #25 *Theory of Servomechanisms*, 383 pgs.\$19.95
- #27 *Computing Mechanisms & Linkages*, 371 pgs. \$19.95

The above are quality reprints. Send for free list of over 80 reprints of books on early radio, television, broadcasting and telegraph available from A.R.C.

Send payment with order. Mass. residents add 5% tax. Allow 4 to 6 weeks to receive books. Add \$1.50 for shipping in U.S. Outside of U.S., please add 10% for shipping.

Send order with payment to: Antique Radio Classified, P.O. Box 2, Carlisle, MA 01741

Sep-90

COLLECTOR BOOKS AVAILABLE FROM ANTIQUERADIO CLASSIFIED

☞ BOOKS MARKED WITH "☞" ARE THE MOST POPULAR AND ARE
ESPECIALLY RECOMMENDED FOR NEW COLLECTORS!

- Antique Radios – Restoration and Price Guide, Johnson. *Beginner's introduction to collecting antique radios, how radios work, radio repair & restoration.* 1982. 99 pgs.\$14.95
- The Auto Radio: A Romantic Genealogy, Matteson. *Information, photos & ads from the early days of the automobile radio through the 1950's.* 316 pgs., hardcover.\$34.95
- ☞ Classic Plastic Radios of the 1930s and 1940s – A Collector's Guide to Catalin Models, Sideli. *Over 200 models from 25 manufacturers are illustrated in full color.* 127 pgs.NEW (hardcover: \$29.95) \$19.95
- ☞ Communications Receivers, Moore. *Information on 700 vacuum tube receivers by 50 manufacturers produced from 1932 to 1981 are included in this 112-page book.* 100+ radios are illustrated.\$14.95
- Crosley Catalog (reprint). *1923 catalog covering the early Harko through the XX models.* 32 pgs.\$4.50
- Fixing Up Nice Old Radios, Romney. 1990. *Written by an old radio instructor, this book covers Ohm's law, through battery sets, superhets and communications receivers.* 185 pgs., 300+ figures.NEW \$25.00
- ☞ Flick of the Switch, McMahon. *The standard photo reference guide for collectors for radios from the 30's to the 50's.* 1000+ photos of radios. 263 pgs.\$11.95
- Great Radio Personalities (reprint). *Black & white portraits and info on all the favorites from the golden days of radio – Abbott & Costello, Baby Snooks, and more.* 128 pgs.\$11.95
- ☞ Guide to Old Radios – Pointers, Pictures & Prices, Johnson. 1989. *The latest book by the Johnsons describes the history of radio and includes 350+ photos and a price guide to 3300 sets.* 128 pgs.\$16.95
- Hertz: The Beginning of Microwaves, Bryant. *Photos and descriptions of Hertz's apparatus and experiments. A book prepared for the IEEE Hertz Centennial exhibit.* 50 pgs.\$15.00
- Los Angeles Radio Manufacturing, Paul. *History of radio manufacturers in the Los Angeles area from 1922 to 1942. Features Echophone, Gilfillan, Jackson Bell & 9 others.* 88 pgs.\$10.50
- Most Often Needed 1926-38 Diagrams (reprint). *Circuit diagrams for 600 of the most common radios of the period.* 240 pgs.\$11.95
- Official Radio Service Manual (reprint). *100's of pre-1930 circuits & notes.* 356 pgs.\$19.95
- Price Guide to Plastic Collectibles, McNulty. *Describes types of plastics, etc. Radio is 8 of 207 pgs.*\$17.95
- Radio Collector's Guide, McMahon. *Listing of 9,000+ radios made by some 1200 companies from 1921 to 1932. Gives manufacturer, year, model name and other info. No photos.* 264 pgs.\$11.95
- Radio – A Blast from the Past, Wolf/Jacobson. *Reprints of advertising from 1927 to 1942. Useful for identification of cathedrals, tombstones, consoles and table model radios of the period.* 321 pgs.\$25.00
- Radio Craft – 50 Years of Radio (reprint). *Reprint of Golden Jubilee issue of 1938.* 144 pgs.\$14.95
- Radio Enters the Home, RCA (reprint). 1922. *The Aeriola Jr. and RC era.* 128 pages.\$12.95
- Radio Equipment & Supplies, Robertson-Catatract Electric Company (reprint). 1922 catalog of radios, accessories and other equipment. Includes RCA, Clapp-Eastham & others. 168 pgs.\$13.95
- ☞ Radios-The Golden Age, Collins. *Full-color book on the colorful Catalin and Bakelite radios from the late 1920's to the early 1940's.* 128 pgs.\$14.95
- Radio Horn Speaker Encyclopedia, Paul. *Listing of horn speakers for over 320 manufacturers for the 1920's. Expanded information on ten manufacturers.* 80 pgs. Over 145 photos.\$12.90
- ☞ Radio Manufacturers of the 1920's, Vol. 1, Douglas. *The first of three comprehensive volumes. Vol. 1 covers A-C Dayton thru Ferguson.* 225 pgs.(hardcover: \$29.95) \$19.95
- ☞ Radio Manufacturers of the 1920's, Vol. 2, Douglas. *Second of three comprehensive volumes. Freed-Eisemann thru Priess.* 266 pgs.(hardcover: \$39.95) \$24.95
- Radio & T.V. Collector's Guide Book, Biraud. *The "Vintage Radio" illustrated guide to European sets (very few British sets) from early wireless to the 1930's (a few later). Text is in both French and English.*
- Vol. 1 - *Early History & Manufacturers A to P.* 256 pgs.\$49.95
- Vol. 2 - *P to Z & T.V., Speakers, Tubes, Loops, Parts & Novelties.* 256 pgs.NEW \$49.95
- Radio Trouble Shooting, Haan (reprint). 1928 guide to trouble-shooting battery sets. 317 pgs.\$14.95
- S. Gernsback Radio Encyclopedia (reprint). 1927 classic encyclopedia on radio. 175 pgs.\$11.95
- Saga of the Vacuum Tube, Tyne. *Standard reference to vacuum tubes prior to 1930. Several 100 photos.* 495 pgs.\$15.95
- 70 Years of Radio Tubes and Valves, Stokes. *The story of the radio tube from the laboratory to the commercial market.* 256 pgs. Over 400 photos and illustrations.\$19.95
- ☞ Vintage Radio, McMahon. *The standard photo reference guide for collectors for radios prior to 1930. Over 1000 pictures.* 263 pgs.\$11.95
- Westinghouse Catalog (reprint). *Early 20's catalog featuring the RA-DA and other early Westinghouse apparatus.* 8 pgs.\$4.00
- Wireless Communication in the U.S., Mayes. *Early development of American radio operating companies. Alternators, coherers, stock promotions, unpublisher letters, etc.* 240 pgs., 160 illustrations.NEW \$29.95

All books are softcover except those marked "hardcover." Most books in stock and shipped within 4 days. Send payment with order. Enclose \$1.50 shipping per order for orders under \$35. If using Visa or Master Card, include name on card, card number and expiration date. Allow 2 to 4 weeks to receive books. Mass. residents please add 5% sales tax. Foreign orders – write for shipping costs or use credit card.



Send Order To: A.R.C., P.O. Box 2, Carlisle, MA 01741



(October-90)



**HARRY
POSTER**

(201) 794-9606

P.O. Box 1883 • South Hackensack, NJ • 07606

I BUY TV'S AND RADIOS !

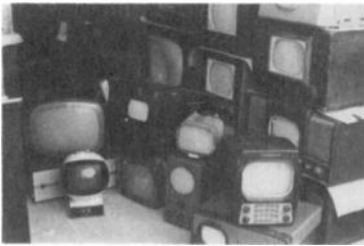

**Any Condition...
Any Quantity!**

TV'S – Early or Unusual

RADIOS – Catalin, Mirror

Unusual & Novelty

Early & Novelty Transistors

**Paying Too Much For Your TV's?
Try Me!**

TV's for under \$400....

RCA 630TS (\$250), 21CT55 – early color (\$250)

Philco 48-700 (\$325)

CBS #205 – early 19" color (\$250)

Emerson 608 w/pop-up tube (\$350)

Stewart-Warner – mirror in lid (\$275)

TV's for under \$200....

RCA 721 (\$199), 8TS30 (\$199)

Philco 48-2500 projection (\$199)

Hallicrafters metal 7"-Raymond Loewy (\$175)

Mid-1950's metal portables – various colors (\$49)

Member AWA – ARCA – PARS – MAARC – MARC – VRPS
NFWA – NZVRS – HRSA – IHRS – NEARC – GNYVWA

CLASSIFIED ADVERTISING POLICY

ONE FREE 20-WORD AD for subscribers in each issue; additional words are 15¢ each. See details below. Classified ads must be received (not just postmarked!) by noon on the ad deadline. Late ads are held for the following issue. Please enclose correct payment with all ads. Stamps or cash are OK for small amounts. (Canadian and other foreign advertisers, please see "Payment" on page two for methods.) "Free words" cannot be accumulated from month to month; free words must be requested when ad is submitted.

Please write each ad on a separate sheet of paper, especially when included with other A.R.C. correspondence. Include SUB# with ad. Ads may be sent in advance; but, write each ad on a separate piece of paper and indicate the month (or successive two months) you want the ad to run.

Please write legibly and use both capital and small letters. Do not use dashes between words. Some numbers and letters can look alike, for example 1, l and I (the number one, the capital i and the small L.) Write the following characters clearly (especially in model numbers): 1, l and I; 0, O, o, Q and D; r and n; 6, b and G; V, U, u, v and Y; A and R; 5, S and s; 2, Z and z. We try to correct spelling errors, so when using an uncommon word or manufacturer which looks similar to a common word or manufacturer, note it so that we do not "correct" it. Editor's comments are in [brackets].

Advertising is accepted only for early items related to radio, communication, electricity, etc. All items must be described fairly; reproductions, reprints and not-original items must be identified as such. Advertisers agree to respond promptly to inquiries and orders, and to resolve problems promptly if the buyer is not satisfied.

Publisher reserves the right to edit ads without notification to the advertiser and to reject ads for any reason. Publisher is not responsible for errors due to illegibly written ads or for any other reason. Since club activities receive free advertising on the *Coming Radio Events* page, the free 20 words may not be used for club activity ads. See inside front cover for additional information.

CLASSIFIED AD DETAILS

Deadline: 10th of the month!

Classified ads must have a standard heading such as WANTED, FOR SALE, FOR TRADE, FOR SALE/TRADE, SERVICES, MESSAGE, HELP, etc. This heading is the only bold or all-capitalized words allowed in the ad. Capitalize only manufacturer names, model names, etc. Wanted and For Sale ads are mixed together to encourage the reading of all ads, including the Wanted ads. This standard ad format makes scanning the ads easier.

Before writing your ad, please look over the ads in a recent issue of A.R.C., and try to write your ad in the same style. Full name and address is required in all classified ads; we will add it if you forget.

To encourage varied content of the ads, the same classified ad may be run only once per issue and for only two consecutive months. (To run an ad longer, use a boxed classified or display ad.)

Classified Ad Rates per Month

Subscribers:

First 20 words: FREE*

15¢ per word for extra words over 20 plus

10¢ per word for a shaded ad (count all words including free words).

* Subscribers may take 20 free words on only one ad each month.

Non-Subscribers:

30¢ per word plus

10¢ per word for shaded ad.

Please do not forget to send in the extra 15¢ per word when your classified ad runs over the free 20 words, your payment will be appreciated, and it will help to keep A.R.C. healthy.

BOXED CLASSIFIED AD DETAILS

Deadline: 5th of the month!

Boxed classified ads can run unchanged for three months or more. No words are free. Ads may be shaded and may include bold and all-capitalized words freely. The ad need not begin with For Sale, etc. Minimum run is 3 months, prepaid.

Boxed Classified Ad Rates per Month

Nonshaded ads:

25¢ per word for all words,* none free, plus

10¢ per word for each bold word plus

10¢ per word for each all-caps word.

Shaded Ads (All words are bold at no charge):

35¢ per word for all words* plus

10¢ per word for each all-caps word.

Non-Subscribers:

Add 20¢ per word to above costs.

*Three words can be bold-all-caps at no extra charge.

PHOTO & DRAWING DETAILS

Deadline: 5th of the month for classified and boxed classified ads with drawings or photos!

Drawings and photos are encouraged as the response to your ad is much larger and the reader knows better what you want or are selling. Send in your drawing or photograph, and A.R.C. will reduce it or enlarge it as needed.

Photo and Drawing Rates per Month

\$8.00 per month for each photo or drawing (if ad is canceled, this amount cannot be refunded.)

CHANGES & CANCELSATIONS

Please check your ads carefully before sending them in. Once ads are received, it is not always possible to refund the amount sent, pull the ad or make changes.

IMPORTANT — COUNTING WORDS — IMPORTANT

The standard headings: WANTED, FOR SALE, etc., count as one word each time used in an ad. Name, address and (one) telephone number, count as 6 words, regardless of length. Ham call letters and business name can be included in the 6 words and do not count extra. Full name and address is required in all classified ads — it does not cost extra! Each additional word, abbreviation, model number or number group, extra telephone numbers, etc. count as one word. Hyphenated words count as two words.



A.R.C., P.O. Box 2, CARLISLE, MA 01741
RETURN POSTAGE GUARANTEED

SECOND CLASS

CLASSIFIED AD
DEADLINE DEC. 10TH