



ANTIQUE RADIO CLASSIFIED



VOLUME 7

MARCH 1990

NUMBER 3

EKCO

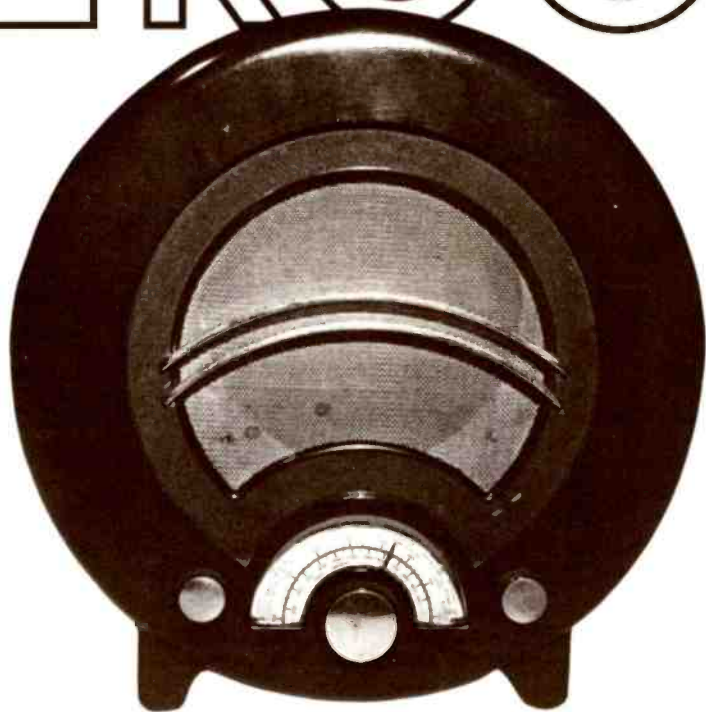

*The Round Radios*

THE NATIONAL PUBLICATION FOR BUYERS AND SELLERS  
OF OLD RADIOS AND RELATED ITEMS - PUBLISHED MONTHLY

## ANTIQUE RADIO CLASSIFIED

Antique Radio Classified (ISSN:8750-7471) is published monthly, 12 times per year, by John V. Terrey, 498 Cross Street, P.O. Box 2, Carlisle, MA 01741. Telephone: (508) 371-0512; 9:00 AM to 5:00 PM ET; machine answers phone at other times.

Annual subscription rates within the U.S. are \$20.00 by Second Class mail and \$30.00 by First Class mail.

Annual foreign rates. By air: Canada - \$32.00; Mexico - \$30.00; Other foreign countries - \$60.00. Surface mail: Canada - \$27.00; Other foreign countries - \$30.00 (Surface delivery to countries other than Canada may take two or more months and cannot be guaranteed.)

Two-year subscriptions are twice these rates and receive an extra month. Sample issues are available free on request.

© Copyright 1990 by John V. Terrey.

POSTMASTER: Send address changes to Antique Radio Classified, P.O. Box 2, Carlisle, MA 01741.

### STAFF

Production Manager:	John V. Terrey
Publishing Staff:	Scott J. Young
Betsy Dumka	Dave Crocker
Bobby Lyman	Chris Frederickson
Founding Publisher/Editor:	Shirley Sauer
Contributing Writers:	Gary B. Schneider
Paul J. Bourbon	Richard L. Arnold
Dave Crocker	Norman S. Braithwaite
Richard C. Foster	Alan S. Douglas
David W. Kraeuter	Frank Heathcote
Ron Ramirez	Jim Kreuzer
Gil Schlehman	Henry Rogers
Howard Stone	Gary B. Schneider
Ralph Williams	Frank R. White
	John P. Wolkowicz

**PURPOSE.** Antique Radio Classified is published for people involved in the radio collecting hobby. Its purpose is to stimulate growth of the hobby through the buying, selling and trading of radios and related items, and to provide a monthly forum for the interchange of ideas and information.

### WRITING TO ANTIQUE RADIO CLASSIFIED.

All correspondence should be sent to:  
Antique Radio Classified  
P.O. Box 2, Carlisle, MA 01741.

Your ads, renewals, letters, etc. can be handled faster and more efficiently if (1) each is on a separate piece of paper, and (2) your name, address and SUB# is written on each.

Unfortunately, A.R.C. is not staffed to answer letters with questions about antique radios or requests for advice. However, A.R.C. does solicit letters of interest to its readers

and will publish them as space permits. A.R.C. assumes that permission is given to edit and to publish all correspondence received unless otherwise indicated.

**GUARANTEE.** You may cancel your subscription at any time and receive a pro rata refund for issues not yet mailed. If errors to ads are made by A.R.C., upon request a free correction will be run in the next available issue.

**PAYMENT.** Please send in full payment with your order or ad. A.R.C. does not carry accounts; all subscriptions, ads, etc. must be prepaid. Pay in U.S. funds; checks drawn on a U.S. bank or money orders are preferred. Make check out to "A.R.C." U.S. stamps or cash are OK for small amounts. Canadian payers may send a Canadian check in U.S. funds, but please add \$1.00 (U.S.) for conversion costs. On request, subscriptions will be prorated to amount sent, minimum term is one year.

**CHANGE OF ADDRESS.** Please notify us 4 weeks in advance of a change of address. Send both your new and old address, and include your SUB# and effective date of your new address. Temporary address changes can be made also.

**SUBMISSION OF MATERIAL.** Antique Radio Classified welcomes and solicits information that pertains or relates to radio history or collecting. This may include articles, book reviews, photos, information on upcoming radio events, meetings, antique radio organizations, radio auctions and price reports, sources of old radio and restoration supplies, and other related and interesting material. All material submitted should be neat and verified for accuracy. Unless prior arrangements are made, all submitted materials may be edited, become the property of Antique Radio Classified and will not be returned.

**MAILING OF ISSUES.** A.R.C. is available by subscription in the U.S. either by First or Second Class mail (Second Class is the way most magazines are mailed). First Class copies usually are received by the fifth of the month; copies by Second Class mail, by the tenth. The mailing of First Class copies is staggered, with those living farthest away mailed on the first day, and local copies mailed the last day. All non-U.S. copies are mailed on the first day. All Second Class copies are mailed on the last day. Mailing is usually completed by the 25th of the month.

**ETHICS.** No person involved in the production of A.R.C. is to act on any information in the magazine until they receive their copy through the mail.

**DISCLAIMER.** The publisher is not responsible for any buying and selling transactions incurred, or for any other use of the contents of this publication.

Antique Radio Classified subscription rates, frequency of publication, content, policies, size and ad details, and rates are subject to change at any time by A.R.C.

## DISPLAY AND BUSINESS CARD ADS - DETAILS AND RATES

Advertising is accepted only for items related to antique radios, communication, electricity, etc. All items must be described fairly; reproductions, reprints and non-original items must be so identified. Advertisers agree to respond promptly to inquiries and orders, and to resolve problems promptly if the buyer is not satisfied.

The deadline for display and business card ad artwork, payment and repeat requests is the first of the month. All advertising must be prepaid; see "Payment" paragraph above. Late ads will be run only if space and time permits. As artwork is reduced to 63% in the printing process, originals should be the artwork size listed below. Do not send in artwork on art board or send negatives. Ads should be typeset or typed neatly with a carbon ribbon. If you want us to prepare your ad, include the one-time cost listed below for A.R.C. to make up the ad.

"Tear sheets" will be sent only for 1/2 and full page ads, if requested when ad is submitted.

Business card ads are limited to one per advertiser.

Photos should be at an 85 line screen; otherwise, add

\$8.00 per photo for screening. (Do not glue photos to artwork; submit separately.) If you are confused by these requirements and terms, please write or call A.R.C. before beginning to prepare your ad.

We will be happy to advise you on your ad ideas, estimate how much the ad will cost, recommend an ad size, etc.

We assume that advertisers want all ads which are submitted to run without delay; therefore, we will run the ad and bill for any additional work required for the ad to meet these specifications. A late ad will be run beginning with the next month.

The 3-month rates represent about a 10% discount, the 6-month rates, 20%. Clubs, write for discount rates.

Page	Artwork Size (send in this size)		As Printed (size in magazine)		Cost for 1-month	Cost for 3-months	Cost for 6-months	One-time Cost for A.R.C. to make up Ad (if requested)
	H x W (inches)	H x W (inches)	H x W (inches)	H x W (inches)				
Full	12 3/16 (or 10 1/2) x 7 1/2	7 3/4 (or 6 5/8) x 4 3/4	3 5/16 x 4 3/4	3 5/16 x 4 3/4	\$110.00	\$295.00	\$530.00	\$40.00
1/2 H	5 1/4 x 7 1/2	3 5/16 x 4 3/4	3 5/16 x 4 3/4	3 5/16 x 4 3/4	55.00	148.00	265.00	20.00
1/2 V	11 13/16 x 3 9/16	7 7/16 x 2 1/4	3 5/16 x 2 1/4	3 5/16 x 2 1/4	55.00	148.00	265.00	20.00
1/4	5 1/4 x 3 9/16	3 5/16 x 2 1/4	3 5/16 x 2 1/4	3 5/16 x 2 1/4	28.00	75.00	135.00	10.00
1/8	2 5/8 x 3 9/16	1 5/8 x 2 1/4	1 5/8 x 2 1/4	1 5/8 x 2 1/4	15.00	40.00	72.00	4.00
Business Card	2 x 3 3/4	1 1/4 x 2 3/8	not avail.	not avail.	not avail.	22.00	39.00	4.00



# ANTIQUE RADIO CLASSIFIED



## EDITOR'S COMMENTS

Yes, another fat A.R.C. Instead of fourteen pages of index, this month's bulk consists of over 525 classified ads – a new peak – and seventeen article pages. The 5500+ subscribers buying and selling through these pages continue to push A.R.C. to new heights. A.R.C. is where radio collectors advertise; no other monthly antique radio publication has even one-fourth A.R.C.'s readership.

### In this issue...

Howard Stone returns with another article on radios from Great Britain, this time on the round Bakelite Ekco receivers appearing from 1935 to 1945. (Howard wrote the five-part *Collecting British Crystal Sets* series which began in A.R.C. in January of 1987.) The Ekco Model AD 36 appears on our cover this month. A note and a photo from Klaus Beckmann complements the British "round ones" with an American "round one" from Stewart-Warner.

A significant article on the RCA Radiola Grand comes from William Boyd. Not only are details of his restoration process included, but the operating results of both his Grand and Henry Rogers' are tabulated. William and Henry logged forty different stations on their Radiola Grands!

We have two *Museum Musings* this month. The first reports on the tragic situation with the Foothill Electronics Museum in the San Francisco area; it has been ordered to vacate the building housing its collection. Next is a follow-up on the upcoming television exhibit at the New Museum of Contemporary Art in New York City. One of the items sought – a DuMont Duoscope – is pictured and described.

Richard Foster in *Restoration Topics* lists nineteen pitfalls to avoid when restoring old radios. This is only a start; we have others from Richard and invite readers to send in their favorites too. Two general auctions including radios are reported by Ray Chase and John Hayes. A butterscotch Fada Catalin at over \$450 brought the highest bid.

The *Club Spotlight* features the New England Antique Radio Club which has grown to over 300 members in about a year and a half. Items in the *Photo Review* range from crystal sets and novelties to U.S. and German superhets.

Several reader letters are included this month. Two address the isolation transformer issue. We have another California earthquake report, and a question about my January 1990 "Editor's Comments" on preserving the recollections of early pioneers. Which brings us to an excellent example of such preservation ...

**Thorn Mayes' Book.** I just received a copy of *Wireless Communication in the United States* by the late Thorn Mayes, published by the New England Wireless and Steam Museum. Thorn was a teenager during the spark days and a General Electric engineer until he retired. The museum has put together a comprehensive history from Thorn's papers written over some thirty years, along with photos and other information. We hope to have a review of this fine book soon. (It is advertised on page 59.)

**A.R.C. Index Coming.** Soon, an index covering A.R.C. from June 1984 to December 1989 will be available. Frank White has compiled this index, and hopefully we will have it printed soon. It includes over 3500 entries covering 65 issues of A.R.C.

**Names and addresses now required.** Please note a new stated policy for classified ads. A last name (or business name) and address will now be required in all classified ads. This is not a change for most of you who have been including it. Actually, this formalizes a procedure whereby we have added most names and/or addresses when they were missing. From now on, this is a policy. This should help communication, especially when a problem in buying or selling between readers occurs.

**Complete List of Radio Clubs.** The "Radio Club Listings" this month include all of the U.S. clubs that have provided us with information. If your club is not listed, please send us information so we can list it; if you are listed and there is an error, let us know and we will correct it.

The *Coming Radio Events* section hints at a very active month of March – over a dozen old radio gatherings. Also, note the dates in "Mark Your Calendar" for the upcoming large multi-day meets. It is not too soon to make your plans and lodging reservations for these popular events.

Happy collecting,

John V. Terrey

## ON THE COVER

The cover photo is the Ekco Model AD 36, a 4-tube British TRF AC/DC set manufactured in 1935. Howard Stone has contributed an article on these Bakelite "round ones" from Ekco, and has illustrated it with photos furnished by Jonathan Hill from his book *Radiol! Radiol!*. The stan-

dard cabinet color for this set was brown Bakelite, but black with chrome detailing and non-standard colors could be special ordered.

*Radiol! Radiol!*, a 242-page book with over 900 figures of British sets, is available from Howard Stone, 2825 6th Ave., Fort Worth, TX 76110, and from Antique Electronic Supply and Vestal Press.

# WITH THE COLLECTORS

## Ekco Receivers The Round Radios

BY HOWARD STONE

When one thinks of a Bakelite radio in Britain, the round Ekcos come to mind. While they are the most popular of Bakelite sets and perhaps of all mains (AC) sets in that country, Ekcos are also desirable for collectors in the United States.

In 1932, the architect Wells Coates won the competition sponsored by E. K. Cole Ltd. (hence the name Ekco) for a new radio cabinet design using Bakelite as the material. In 1934, the winning entry was manufactured as Model AD 65, shown in Figure 1. It was the first of five models of Coates' design that would be released between 1934 and 1945.

The AD 65 was the first round Ekco. The black version, sold for £11.11s.0d. (approx. \$58 U.S.). This four-tube superhet could work AC or DC and covered the broadcast band and long wave.

In 1935, two additional round Ekcos were introduced: the AD 36, shown in Figure 2 and on our cover, and the AD 76 in Figure 3. The AD 36 was

a four-tube TRF set that worked on AC or DC, and also covered the long wave and broadcast bands. The walnut version cost £8.8s.0d. (approx. \$40 U.S.). The AD 76, a five-tube superheterodyne set operating on AC or DC, covered the broadcast and long wave bands. The black with chrome version sold for £12.1s.6d. (approx. \$60 U.S.) with an AC-only version selling for £11.11s.0d. (approx. \$58 U.S.).

In 1940, the AD 75, shown in Figure 4, was released. A four-tube AC/DC superhet, it covered

the long wave and broadcast bands. Because of the wartime economy, the set sold for only £7.7s.0d. (approx. \$30 U.S.). After the war in 1946, it was released with slight modifications and an increased price tag.

The last round Ekco, the A22 shown in Figure 5, was marketed in 1945. This four-tube superhet operated from AC only. Like the others it had both long wave and broadcast bands, with the addition of a shortwave band. It cost £14.14s.0d. plus £3.3s.3d. purchase tax, (approx. \$71 U.S.).

Most round Ekcos that are to be found now are walnut colored or black, but several other colors were available for the consumer willing to wait for the special order to be filled by the factory. Such non-standard colors are rather rare, and some of the existing colored Ekcos have actually been painted.

If you find a round Ekco, look it over carefully. Since it is such a prized set to collectors, with widely recognized value,

some of them have been restored poorly or not to original condition. Use some resource to help you identify originality of the radio and its parts. A good reference book is Jonathan Hill's *Radio! Radio!*, which is full of pictures and useful background information on British radios.

Now for a strange confession: When I first wrote this article I did not own a round Ekco. I had seen a number of them in collections. The ones I saw were either not for sale or not restored to original condition. I did not have the advantage of



Figure 1. The black version of Model AD 65.



Figure 2. 1935 AD 36.



Figure 3. 1935 AD 76.



Figure 4. 1940 AD 75.



Figure 5. 1945 A22.

living in Britain full-time, where one has a chance to find one in the neighbor's attic or Aunt Bessie's cellar. Just before I prepared the last rewrite of this article, I was able to secure a nice black and chrome AD 76. I hope you will be fortunate

enough to find a round Ekco too.  
(Howard Stone, 2825 6th Ave., Fort Worth, TX 76110)

Photos courtesy of Jonathan Hill, Devon, England, author of "Radio-Radio."

## Stewart-Warner's Round One

BY KLAUS BECKMANN

America's entry into the "round radio" market was by the Stewart-Warner Corporation of Chicago, Illinois. Introduced in 1936 as the "Good Companion," this Model R-192 compact four-tube mantle set was offered in several finishes – all-chrome with silver grille, antique copper, and black leatherette with chrome facing. The base is of painted wood, about thirteen inches long. The tilt angle is adjustable as well. Unfortunately, this set does not have the original knobs. (Klaus Beckmann – General Delivery, Tofield, Alberta, Canada T0B 4J0)



Figure 1. Stewart-Warner Model R-192

# WITH THE COLLECTORS

## The RCA Radiola Grand

BY WILLIAM M. BOYD

"The finest principles of radio detection, amplification, and loud speaking are embodied in the new Radiola Grand" states an RCA ad from *Radio News*, March 1923. The Radiola Grand, shown in Figure 1, was manufactured by Westinghouse Electric Manufacturing Co. for RCA of Camden, N. J., from Jan. 1923 to 1924. The Radiola Grand was introduced after the production of the similar-looking Aeriola Grand was stopped. The rare Aeriola Grand, which used four triode tubes and four WB-800 ballast tubes, apparently was not a successful receiver due to unsatisfactory performance, and it was ultimately withdrawn from the market. The Radiola Grand's circuitry, however, was an excellent performing design for that early period. The instruction manual says, "The instrument has been designed by the makers to give a strong signal without distortion and to be sensitive, compact, efficient, free from disagreeable tube noises, and simple to operate."

### CIRCUIT DESCRIPTION

The Grand employed a regenerative circuit consisting of a transformer-coupled detector, first audio and output push-pull stages employing four WD-11 Style No. 319533 Radiotron tubes. The Grand represented a new design for this time period as it included a self-contained loudspeaker. The manual suggests that if weak signals are to be received, one may use a headset plugged into the jack on the left-hand side of the cabinet. The controls, shown in Figure 2, included a filament rheostat, volume, tuner, tuner vernier, and tickler. This circuitry was accessible by lifting up the veneered control panel. The B batteries were installed in the lower compartment of the set with the C batteries mounted in a clip on the under side of the panel. The heavier A batteries were external to the set, and consisted of separate dry cell batteries to feed



Figure 1. The Radiola Grand shown with the cover open.

each tube – the connections made by feed-through terminals at the cabinet back. A heavy cast horn speaker (Westinghouse Type FL) was mounted inside the cabinet (see Figure 3). The receiver housing as described in the manual "consists of a well-finished mahogany cabinet..." A suitable stand, with storage space for the A batteries, was available for the Grand if desired. Figure 4 shows the Radiola Grand on its stand as advertised in *The Literary Digest* for September 8, 1923.

The plate voltage for the detector is +22v with

## RESTORATION

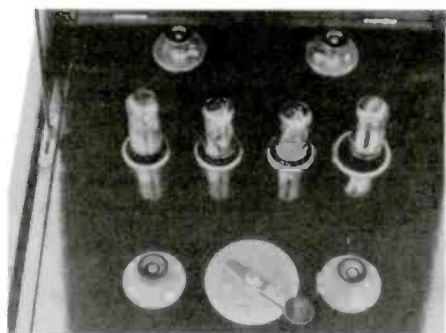

Figure 2. The Radiola Grand instrument panel showing the controls and four Type 864 tubes.

the audio plate voltages operating at +90v. The audio tubes are biased at -3v. Filament voltages for the WD-11 tubes are typically set at 1.1v (maximum). The serial number of my Grand — which is stamped under the panel at the left rear area as well as handwritten inside the case with chalk — is F105. The metal nameplate on the back indicated Style 365102, Type RG, Serial #146890.

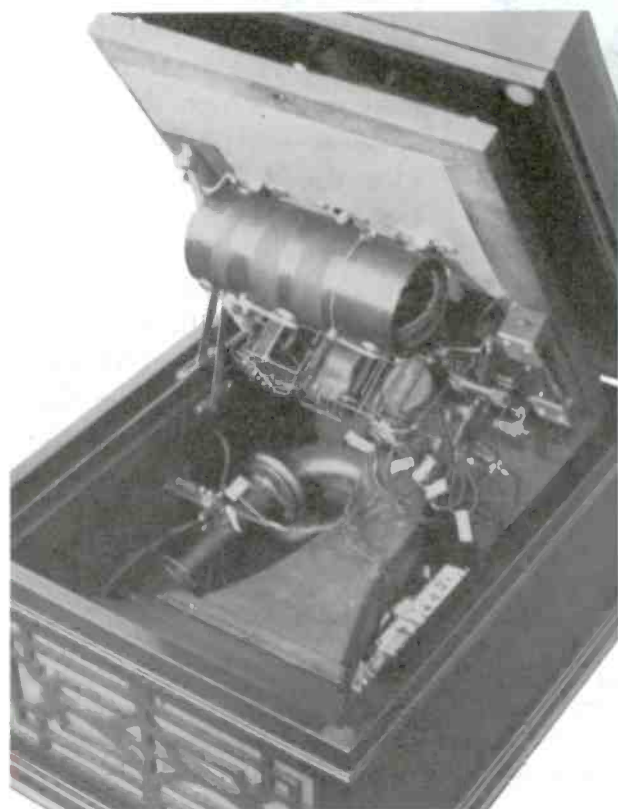

Figure 3. The panel of the Radiola Grand raised to show the chassis and cast metal Type FL horn.

I purchased this hard-to-find set from a collector friend in Maryland in May 1989. The case, finish, and chassis were in good condition but required a fair amount of cleaning. The panel and chassis were complete except for the B battery capacitor, wooden battery compartment, bias battery contacts, and a battery terminal nut. Electrically, the output audio transformer had an open primary winding, and the filament rheostat had been rewound. The detector and first audio transformers were good but not original; the windings were enclosed unlike the open type originals. It was interesting to note that these audios were apparently installed many years ago and, in fact, appeared to be factory installed.

During the next few months I had the output transformer rewound, changed the rheostat to the required four ohms, and purchased some WD-11 and 864 (VT-24) tubes. [The 864 (VT-24) or 215-A (VT-5) tubes in socket adapters, may be used in place of the more difficult to find WD-11]. The insulated wiring in the set was very brittle from age and required a combination of repair and taping to correct. The uninsulated nickle-plated wiring was soldered in very neatly (with straight runs); appearance apparently was important (see Figure 5). The silver-plated screws and terminals were cleaned with a silver cleaner. The front panel grille had been poorly stained (apparently a factory job) and did not have the quality appearance of the cabinet. I therefore restained the wood and also added a gold grille cloth behind the panel to match the gold color of the controls.

### CIRCUIT CHECKOUT

The main problem encountered when I first started to check out the receiver was that no complete schematic was available showing individual component values. I could locate no information to check for correct transformer (DC resistance) measurements, RF capacitor values, resistor values, etc. I completed measurements on my set and contacted a number of collectors regarding schematic values and other information. Henry Rogers was very helpful, providing me with measurements on his Radiola Grand (SN 0427) which was also a working unit. Refer to the chart in Figure 6, which lists measured component values from our two Grands. This chart, along with the schematic, Figure 7, should be helpful to anyone attempting to determine typical Radiola

(Continued on following page)

# Radiola Grand



Radiola Grand and mahogany finished stand with "B" batteries and 4 Radiotron WC-11 dry-cell vacuum tubes, \$350.00.

**W**ITH the Radiola Grand, radio takes on new meaning. The simplicity of tuning in—just a knob or two to turn. The big distances it covers—picking up far-away stations with volume enough to fill a room. The perfection of tone with which the loudspeaker—carefully built in like the horn of a fine phonograph—gives forth the music and speech. All this—combined in a cabinet of skillful workmanship and tasteful design—places radio in the home where beauty counts—and performance.

## Points to Note :

All the batteries—dry cells—are hidden away inside.

You can regulate the volume of sound by a control that governs the loudspeaker.

For long distance, plug in the

headphones. Coast to coast reception is no unusual record for Radiola Grand!

Famous for true reception, undistorted. For keen sensitivity. And for beauty.

Figure 4. Advertisement of the Radiola Grand as it appeared in the September 8, 1923, issue of "The Literary Digest". (From the collection of Dave Crocker)





Figure 5. The circuitry and wiring of the Radiola Grand mounted under the panel.

(Radiola Grand, continued)

Grand or similar Radiola design circuit values. This data is somewhat different between the two Grands presumably due to design variations/changes or perhaps due to changes over time. Refer to Note 1 in Figure 6, to show which transformer data is taken from original units and which data is from replacement transformers.

When I first turned on the set, I found, as expected, variations in performance with the WD-11 and the 864 tubes.

I ended up using the 864's (with adapters) due to somewhat better performance. The 864 is an ideal substitute for the lower gain and sometimes microphonic WD-11. Both tubes operate at 1.1v @0.25A. The amplification factor for the 864 is 8.2 compared to 6.6 for the WD-11 as noted in the 1937 *Radio Data Handbook*. The receiver initially sounded distorted which was attributed to poor grounding and operating the detector at +45v. H. Rogers pointed out that the detector tube should be operated at +22v to avoid clipping and resulting distortion. I also noted in the Grand's manual that the detector should operate at +22v and not +45v as the schematics show. The enclosed schematic was modified by me to reflect the manual's recom-

mended connections; the B- and (+A1, Gnd) should be connected together, and +22v should be used for the detector.

Distortion was also present in the horn speaker due to the diaphragm in the drive unit requiring adjustment. The diaphragm was centered by carefully inserting thin rubber washers to set the correct spacing.

### GRAND PERFORMANCE

The Grand worked great after the above changes were incorporated! I used a metal window frame for an antenna, and the ground was the house ground. The set initially tuned slightly low from about 500-860 kHz (long wave) and about 720-1350 kHz (shortwave). The manual indicated the unit should operate over 566 kHz to 1667 kHz. I decided to make a minor addition and added a Hi-Q 3 mhy coil

across the tuner coil to push the overall tuning range higher in frequency. This resulted in a final tuning range of 550-900 kHz (long wave) and 850-1410 kHz (shortwave). Refer to the chart in Figure 8 for a list of 31 stations I received and for the corresponding tuner and tickler settings. These many Northeast Coast stations were received during the day; nighttime receiving was not possible in my area of New Jersey due to evening line interference. The

(Continued on following page)

	W. Boyd <u>SN F105</u>	H. Rogers <u>SN 0427</u>
<b>TRANSFORMERS</b> , See Note 1:		
Detector (Pri/Sec)	1.05K/15.3K	-
Input Audio (Pri/Sec)	1.2K/8.3K & 5.0K	-
Output Audio (Pri/Sec)	.74K/.91K & .97 K	.44K/.62K & .93K
<b>INPUT CAPS:</b>		
Shortwave:	17 pf.	22 pf.
Longwave:	124 pf	84 pf
<b>GRID LEAK/CONDENSER:</b>	3.5 Meg./216 pf	3.3 Meg./159 pf
<b>BYPASS CAPS:</b>		
Input Transformer:	-	920 pf
Output Transformer:	8000 pf	5000 pf
<b>FILAMENT RHEOSTAT:</b>	3 Ohms (not orig.)	4.2 Ohms
<b>HORN COIL (DC Resistance):</b>	1.08 K	0.43 K
<b>NAMEPLATE INFORMATION:</b>		
Style	365102	148426
Type:	RG	-
Serial No.	146890	-
Date:	10-16-22	-
Note 1: DC Resistance. SN F105 detector and 1st audio transformers are not original type; however, they appear to be factory installed. Output audio transformer data is from a rewound unit. SN 0427 output transformer is original type.		

Figure 6. The measured component values from the two Radiola Grands owned by William Boyd and Henry Rogers.

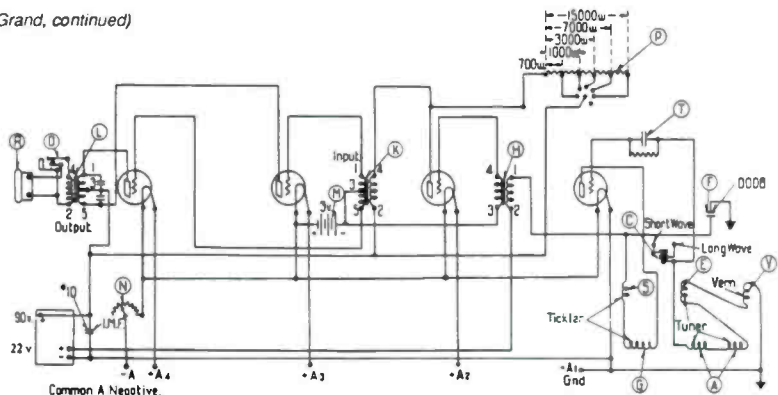

Figure 7. Schematic diagram of the Radiola Grand. (From the RCA Service Notes for 1923-1928)

STATIONS RECEIVED ON RADIOLA GRAND							
SN F105 By W. Boyd							
SHORTWAVE			(Shortwave, continued)				
STATION	FREQ(kHz)	TUNER	TICKLER	STATION	FREQ(kHz)	TUNER	TICKLER
WPOP	1410	0.0	0.5	WTTM	920	7.1	3.0
WHWH	1350	1.4	0.9	WURD	900	7.7	3.0
WSSJ	1310	1.9	1.2	WCBS	880	8.3	3.0
WIMG	1300	2.0	1.2	WTEL	860	9.3	2.9
WJBR	1290	2.2	1.3				
WBUD	1260	2.3	1.5	LONGWAVE			
WCAU	1210	2.9	1.9	STATION	FREQ(kHz)	TUNER	TICKLER
WOBM	1160	3.3	2.2	WURD	900	0.0	4.9
WDEL	1150	3.4	2.2	WCBS	880	0.8	5.0
WNEW	1130	3.7	2.3	WTEL	860	1.2	5.1
WNAV	1110	3.9	2.4	WTMR	800	2.3	5.4
WBAL	1090	4.2	2.5	WABC	770	2.9	5.5
WTIC	1080	4.3	2.6	WVCH	740	3.4	5.5
KYW	1060	4.7	2.7	WOR	710	3.9	5.5
WBZ	1030	5.2	2.8	WFAN	660	5.0	5.3
WZZD	990	5.8	3.0	WIP	610	6.4	5.0
WWDJ	970	6.2	3.0	WARM	590	7.1	5.0
WPEN	950	6.6	3.0	WMCA	570	8.0	4.8
				WFIL	560	8.8	4.6

STATIONS RECEIVED ON RADIOLA GRAND							
SN 0427 By H. Rogers (Note: Stations logged over a 1/2 hour period)							
SHORTWAVE			LONGWAVE				
STATION	FREQ(kHz)	TUNER	TICKLER	STATION	FREQ(kHz)	TUNER	TICKLER
KEX	1190	3.5	3.7	KOMO	1000	1.0	6.0
KSL	1160	3.9	3.7	KDXU	890	2.7	6.2
CKWX*	1130	4.1	3.9	KRVN*	880	2.9	6.2
KNX	1070	4.9	4.0	KOA	850	3.1	6.5
KOMO	1000	5.8	4.0	KGO	810	3.7	6.5

\* Vancouver, Canada (Best DX)                      \* Lexington, Nebraska (Best DX)

SN F105 By W. Boyd		SN 0427 By H. Rogers	
Tubes:	4, 864's	2, WD-11s (Det, 1st Audio)	
Filament Volts:	0.85 to 1.1v	2, 864s (Output)	
Bias Voltage:	-1.6 to -3.0v		-3.0v
Detector Plate:	+22v		+22v
Audios Plate:	+90v		+90v
Power:	Solid State P.S.		Batteries
Antenna:	Window Frame		75' Wire
Ground:	House Ground		House Ground

Figure 8. Operating results by William Boyd and Henry Rogers on their Radiola Grand receivers.

chart also shows a list of strong signal stations recently received by Henry Rogers on his Grand over a half-hour time period. Henry noted during the operation of his set that stations could be tuned every 10 kHz! Stations were received as far away as Canada and Nebraska; he lives in Nevada.

As always, the tuner and tickler settings of the Grand (or any similar receiver design) is very dependent upon the particular tube characteristics, filament voltage, circuit tolerances, and most importantly the antenna and ground system used. I found, for example, the 864's operated at about half the tickler setting when compared to the WD-11's due to gain differences. The volume level was more than sufficient for most stations and loud for many. The horn speaker sounds very nice. As noted in the schematic, volume is controlled by simply switching in a shunt resistance across the first audio stage. The manual points out that the receiver will work with only three tubes (if one tube fails) – by rearranging the remaining tubes leaving only one tube in the push-pull stage. When I tried this, the volume dropped only slightly.

Overall, the Radiola Grand performs very nicely considering it was designed in 1922; its regenerative circuit is highly sensitive as well as selective. The mahogany cabinet exhibits the well known craftsmanship by Westinghouse (RCA) and presents a quality appearance.

In summary, the Grand can best be described by an advertisement from *The Saturday Evening*

*Post* on December 22, 1923. It reads:

"With the Radiola Grand, radio takes on new meaning. The simplicity of tuning in – just a knob or two to turn. The big distances it covers – picking up far away stations with volume enough to fill a room. The perfection of tone with which the loudspeaker – carefully built in like the horn of a fine phonograph – gives forth the music and speech. All this – combined in a cabinet of skillful workmanship and tasteful design – places radio in the home where beauty counts – and performance."

Special thanks to Henry Rogers for information and measurements taken on his Radiola Grand. Thanks also to Ray Thompson and Tod Prowell for the Radiola manuals and material and to Alan Douglas for *The Saturday Evening Post* advertisements.

#### References:

"RCA Part VIII" by Alan Douglas, *Radio Age*, May 1983.

"Radiola Grand Restoration" by Henry Rogers, *Radio Age*, Nov. 1985.

"A Contribution to Aeriola/Radiola Grand History" by Ralph G. Thorn, M.D., *Radio Age*, March/April 1988.

*RCA Victor Service Notes for 1923-1928. Radiola Grand Instruction Manual.*

(William Boyd, 74 Atsion Ct., Medford, NJ 08055)

---

## LETTERS – ISOLATION TRANSFORMERS

Dear Editor,

In a previous issue, you had an article expressing the importance of using an isolation transformer when attempting to repair old radios. However, you failed to mention what specifications should be considered when purchasing such a transformer and the approximate price of these units. Please address these concerns in an upcoming issue.

Thank you, Richard Bell, Kirkland, Wa.

*The use of an isolation transformer, especially with AC/DC sets, was emphasized in: "All You Need To Know About Repairing AC Radios," Part 2 (April 1988) and Part 7 (June 1989). Because one side of the line cord in an AC/DC set is usually connected to the chassis, an extreme shock hazard exists; the use of an isolation transformer is the ONLY way to reduce this shock hazard!*

*Isolation transformers are rated in "VA" or volt-amps; the volt-amp value of the transformer used should be greater than the watt draw of the radio being tested.*

*A 35 VA isolation transformer is available from Antique Electronic Supply (688 W. First St., Tempe, AZ 85281, tele: 602-894-9503) for \$12.59. This transformer has pigtail leads.*

*Isolation transformers also are available from "You-do-it" Electronics Center, 40 Franklin St.,*

*Needham, MA 02194, tele: 617-449-1005). They have a 100 VA model which includes line cord and 110v plug for \$37.80 and other models from 15VA to 1500 VA ranging in price from \$13 to \$180.*

*Check with the supplier as shipping and/or minimum order amounts may apply. Also, please mention "Antique Radio Classified" if you contact these suppliers for transformers.*

*In the January 1989 issue of A.R.C., Orval Parker reported on an adjustable isolation transformer constructed from a dual-primary (two 110v windings so that it could be used at 220v) filament transformer found in the surplus electronics catalogs. The output voltage could be increased or decreased by the amount of the filament, or lower voltage, winding.*

*A letter with another suggestion follows.*

*(Editor)*

Dear Editor,

Why all the fuss about an isolation transformer. Fair Radio Sales Co., P.O. Box 1105, Lime, OH 45802 sells a transformer for \$9.95 that is rated as follows: 2/55VCT, 4 amp, .440 VA, measures 4.5" x 4.5" x 4" and weighs 10 lbs. Catalog number is 701-205. If the two secondaries are connected in series, the output voltage is 110v at around 400 to 500 watts.

Yours truly, John Nosbaum, Wilmette, Ill.

# MUSEUM MUSINGS

## Foothill Museum Ordered to Close

BY MIKE ADAMS

It was a dark day in Northern California radio history. On Monday, January 22, 1990, the Foothill Electronics Museum on the San Francisco Peninsula was ordered closed by the Foothill Community College Board of Trustees. In operation since 1965, the museum has displayed the internationally-respected Douglas Perham collection including early broadcast station KQW and the papers of Dr. Lee de Forest. As a response, the trustees of the museum's contents, the Perham Foundation, filed a complaint to prevent closure in the nearby Palo Alto division of the Santa Clara County Superior Court.

How could this happen? How, in Silicon Valley – home of de Forest, Shockley and Farnsworth – could a museum be prevented from sharing its rich, local electronics history with the several million citizens of the San Francisco Bay Area? Why would this venerable institution that has for decades been the center of activity for dozens of amateur radio organizations and the permanent home of the California Historical Radio Society (CHRS) be told to pack its bags and go away? And most important, how could a building that was sponsored and paid for by private donations be "taken over" by a college? These are the questions that our shocked and disbelieving community is asking the courts to answer.

Try to understand the long and complex relationship between the Foothill Community College District and the Perham Foundation. In 1964, the Foundation raised \$180,000 from the likes of Ampex, Hewlett-Packard, Varian and others. As a result of this success, matching federal funds were obtained, and a museum was constructed by the College on its campus. In the original contract, Foothill agreed to house a permanent museum for 99 years, and we, the Foundation, agreed to administer its contents in perpetuity. All went well until 1978 when Proposition 13 severely limited the amount of property tax collection; the college laid off all museum employees, and we took over the operation of the facility using volunteer docents from the community. While financial exigencies forced us to modify the original agreement, it was still our col-

lection in our building...or so we thought.

More changes. The California community college student is about 30 years old, works all day and attends night classes. Foothill College, unable to construct more buildings, wanted the museum building for a classroom. You see, more students mean more state money, and this has become the main issue. To the college, it was simple: "return the building to instructional use..." Did the college say that? It did, but nothing could be further from the truth. First, the museum has never been a classroom; if you've ever seen it, (see Figures 1 and 2), you realize that it could only be a museum. Second, even though it's on college property, money for its construction was donated by private industry specifically to build a public museum to permanently house the Perham collection.

Now the lawsuit. On one side, the Foothill Community College District, and on the other, the non-profit Perham Foundation, both educational entities. Because the college will not be satisfied until it gains control of the building and because we of the Foundation have a public trust to display the Perham archives and artifacts, we got a good lawyer. Bart Lee, an attorney and fellow radio collector, has donated his time to the museum board during the long process of crafting a complaint. Basically, we are saying the construc-

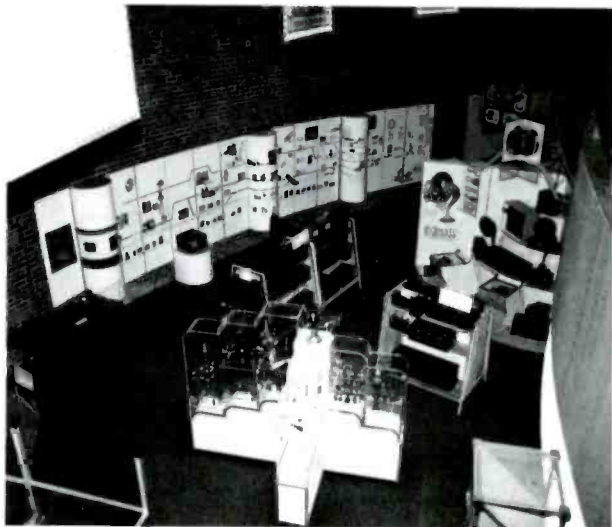

Figure 1. Interior view of the Foothill Electronics Museum. Notice the unusual curved display areas which are open to the floors above.



Figure 2. One of the many static displays of early electronic items inside the Foothill Electronics Museum.

tion of the museum that houses our important collection of historic radio stuff was only made possible because in soliciting funds for its construction, we agreed that it would be permanent. Closure of the museum would be a breach of our public trust.

There are several likely outcomes of this suit, some probable, others remotely possible. Perham will likely get back all the museum and library contents. This was stated in the resolution by College President Tom Clements: "offer the artifacts and archives to the Foundation..." Another possibility is that we will have to move out but get our original 1964 donated construction funds back in 1990 dollars. In our suit we are asking for 1.5 million dollars, but whether a judge would force a public college to pay this amount is

open to speculation. A less likely possibility is that the court will force the college to revert to its original contract and allow the museum to remain at Foothill. We are asking for some combination of these options.

So maybe the courts will stop the closure of the museum. At least we can delay it, but since the college owns the land, we eventually may have to relocate. But can we afford to move? This is one of the richest areas in the world, ten minutes from Stanford University, surrounded by educated and affluent people, most of whom owe their good fortunes to the radio pioneers of yesterday. The real irony is that

what made Silicon Valley successful, electronics, has made it too costly for a museum of its history to exist. We of the Perham Foundation believe that closure of the museum is a bad precedent to set for the future of historical documentation and the wrong message to present to our young people. This important resource, this major collection of antique radio devices on the West Coast, must survive.

If you would like to donate money to the "museum fund for justice," contact Foundation President Don Kojane at (415) 941-0247 or write to the Perham Foundation, 101 1st St., Suite 394, Los Altos, CA 94022.

(Mike Adams, 112 Crescent Ct., Scotts Valley, CA 95066. Mike Adams is a member of the board of the Perham Foundation).

## The Big One - Another Report

BY JOHN FIELD

*In the January issue of A.R.C., we published the experiences of California radio collectors from the earthquake of October 17, 1989. Here, John Field relates how his collections fared even when prepared for such a disaster.*

Except for a damaged chimney, my home and shop buildings in Santa Cruz, California, survived the October 17, 1989, earthquake fairly well. My collectibles are, for the most part, stored on shelves. Surprisingly, many casually placed items, such as stacks of 78 rpm records on top of consoles, stayed put. My basic shelves did fine, for they have always been earthquake prepared by having braces across from each one.

When the tremor hit, most items stayed on the shelves. Most of what did fall did not break, such as a collection of old hi-fi equipment shown in Figure 1. This fell because one of the earthquake shelf braces broke. Unfortunately, a mint condition 1920's radio had its Bakelite panel shattered.

My collection of old electric trains on tracks was on shelves with lucite edges. Some trains fell off their tracks, but none fell to the floor.

(John Field, 117 Arroyo Pl., Santa Cruz, CA 95060)



Figure 1. A pile of old hi-fi equipment shaken from shelves because of a broken brace.



# PHOTO REVIEW



*This column presents in pictorial form many of the more unusual radios, speakers, tubes, advertising, and other radio-related items (covering the years 1900-1950's) from our readers' collections. The photos are meant to help increase awareness of what's available in the radio collecting hobby. Send in any size photos from your collection. Photos must be sharp in detail, contain a single item, and preferably have a light-colored background. A short description must be included with each submitted item. Please note that receipt of photos is not acknowledged, publishing is not guaranteed, and photos are not returned.*



**NOVELTY RADIO** - The Model R447 radio was produced by the Stewart-Warner-Alemite Corp. of Belleville, Ontario, Canada, about 1939. Decal pictures of the famous Dionne Quintuplets are featured on both ends of the molded case. (George Fount - Kitchener, Ontario, Canada)

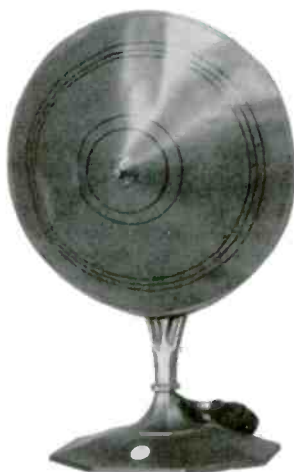

**CONE SPEAKER** - The label on the bottom of the base identifies it as a Tower Scientific cone speaker manufactured by the Tower Manufacturing Corp. of Boston, Mass. The semi-rigid cone is mounted only at the center with the edges entirely free. It is sixteen inches high. (Walter V. Worth - Wollaston, MA)

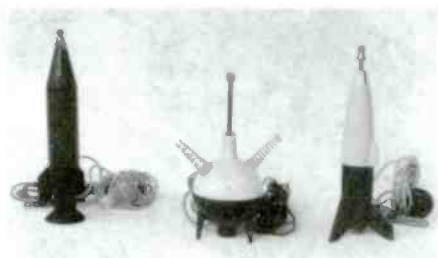

**ROCKET RADIOS** - These Germanium radios were made by various Japanese companies in the late 1950s. The tuning is similar in all three, consisting of a small metal stick at the top of the rockets. Each is equipped with a small headphone plug inserted into the ear. (Erwin Macho - Vienna, Austria)

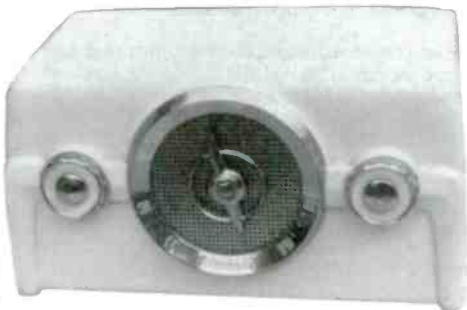

**CROSLEY MODEL 10-135** - This radio is typical of the plastic style of radios of the early 50s. This one has a white plastic cabinet with gold and chrome trim grille. The last three digits of the model numbers indicated the cabinet colors. (Dave Crocker - Lyndonville, VT)

---

## PHOTO REVIEW

---



**1949 PHILCO** - The five-tube Model 49-1401 was one of the last of the radical radio/phonograph designs. Just open the front door, slide in the record, close the door, and the music poured forth. It featured an automatic shut-off at the end of the record play. (Fred Geer - Jacksonville, FL)

---



**MARTIANS IN EUROPE** - This Type "Special" crystal set was manufactured by the Martian Mfg. Co. of Newark, New Jersey. It was exported and sold in Austria in 1925 by Wireless Radio Ges.m.b.H. (Erwin Macho - Vienna, Austria)

---

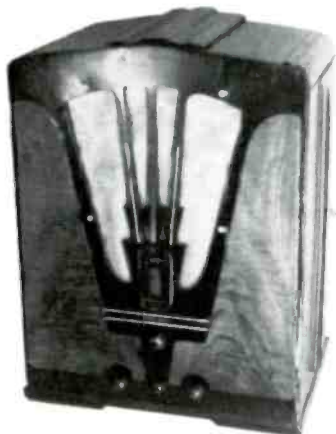

**PHILCO SUPERHET** - This Model 16B was produced in 1933, and was an eleven-tube giant in an Art Deco cabinet. It was the first to use a tone compensating loudness control which boosted the bass at low volume settings. (Fred Geer - Jacksonville, FL)

---



**PHILCO SUPERHET** - The Model PT69 was one of the first clock radios to be offered in a small table model version. The wood veneer cabinet is of a Deco style and was offered in 1939. (Fred Geer - Jacksonville, FL)

---



**GERMAN-MADE SABA AUTOMATIC 125 STEREO** - This is the largest and heaviest table set I own! It is 28 inches wide and weighs 102 pounds. This radio utilizes a scanning-type motorized tuning, with a built-in rotary antenna. There are five speakers in all, including: (2) 12-inch woofers, (2) 7x9-inch mid-ranges, and a 4x6-inch tweeter. Thirteen tubes are needed to power all this, but it only has four bands. This was probably the last gasp of the tubed radios in Germany. (Walter Worth - Wollaston, MA.)

---

# AUCTION REPORT

## Liberty Antique Warehouse General Auction Parkville, New York – January 1, 1990

CONTRIBUTED BY RAY CHASE

A general auction at Liberty Antique Warehouse, Parkville, New York, on January 1, 1990, included about seventeen radio items. Ken Saltzman, phone (914) 292-7450, was the auctioneer.

Zenith console, 3 concentric knobs and push buttons, BC, SW, and old FM band (model number not avail.), cabinet very good, some rust on chassis and spekaer, dial belts all rotted, smaller black dial series ..... \$45  
 Philco 46-1209 console with fold-out front record changer, 4 knobs and push buttons, loctal and octal tubes, cabinet fair to good ..... 10  
 Philco 38-3 slope-front large console, 5 knobs and telephone style station selector, Deco style, cabinet and chassis very clean ..... 45  
 Philco small console 48-1262 with fold-out front record changer, no SW band, cabinet fair, speaker not bolted in ..... 10  
 Silvertone small console 4548 farm radio with vibrator power supply for 6-volt storage battery use, 4 knobs & airplane dial, cabinet and chassis very clean ..... 45  
 Philco chairside or end table radio, walnut & very nice shape, uses a car radio chassis (1942 vintage ?) ..... 70

WE 10D horn speaker, good condition ..... 45  
 Browning Drake 4-tube model in superb ornate burlled walnut table cabinet, built-in American Electric driver & folded horn, missing one section of the horn, Bakelite panel nicely engraved; has 4 tubes, 4 spares, 2 headphones & battery cables; outstanding ..... 220  
 Philco 89 cathedral, 6 tube, 4 knobs, very good condition ..... 85  
 Sentinel 6" portable TV in leatherette case, very good but two knobs missing ..... 90  
 Philco 37-610 wood table model, rounded end, Deco style, 4 knobs, good ..... 55  
 DeForest loop antenna, good ..... 32.50  
 Admiral large square table radio w/record changer in top, 1940's model, good ..... 40  
 GE GD-600 small wood table w/waterfall front, cabinet very good ..... 25  
 Philco 52-641 small green plastic portable, min. tubes, battery and AC use, good shape ..... 25  
 Philco Transitone plastic, red w/gold grille, Model 48-225, good shape ..... 25  
 Motorola red plastic, holes and burn marks in case ..... 25

*(Ray Chase, 1350 Marlborough Ave., Plainfield, NJ 07060)*

## Pioneer Mountain General Auction Keene, N.H. – Jan. 27, 1990

CONTRIBUTED BY JOHN HAYES

A general auction held at Pioneer Mountain Auction Barn in Keene, N.H., on January 27, 1990, included several radio items. A Fada Catalin, which had been advertised, brought the highest bid.

Atwater Kent Model 44, complete, rusty, f .... \$30

RCA 100 speaker, f ..... 20  
 RCA UZ-1325 horn, vg ..... 50  
 Fada 652, butterscotch Catalin, bottom cracked and felt covered, otherwise good ..... 462.50  
 Lyric S-7 cathedral, knobs missing, f ..... 110  
*(John Hayes, 27 Highland Dr., Henniker, NH 03242)*

### LETTERS – EARLY PIONEERS

Dear Editor,

In your "Editor's Comments" [Jan. 1990, page 3], you made reference to the thinning of the ranks of those who were there in the early radio era, and urged us to do something to preserve their recollections. However, you did not elaborate on what to do with the written or recorded information of this senior group of radio men. What are your suggestions?

Robert D. Burses, Philadelphia, Pa.

*I have received several letters in response to my comments; my suggestions are threefold:*

1. *If the information is significant and lengthy, a book may be a possibility. The New England Wireless and Steam Museum has just published an excellent compilation of Thorn Mayes' papers on early wireless (see ad in this issue).*

2. *Shorter items can be submitted as an article to A.R.C. or another publication. Magazines are always looking for interesting items for their pages, and have the editing skills to turn the remarks into finished articles.*

3. *Information, written or on tape, can be "archived" by selling or giving it to a private collector or museum.*

*(Editor)*



# RESTORATION TOPICS

## Restoration Pitfalls to Avoid – Part I

BY RICHARD C. FOSTER

*Richard C. Foster is a professional wood-worker who specializes in the restoration of antique radios. He has written many articles in A.R.C. and elsewhere on the proper procedures of rebuilding and refinishing wooden radio cabinets and also repairing the electronic components.*

*Richard is also knowledgeable in identifying, collecting and restoring Philco receivers. Many collectors have called upon his services, and his expertise is widely known.*

*This is published to assist the collector in obtaining better results when restoring antique radio equipment to its original condition.*

**Listed here are a number of pitfalls to avoid in restorations that everyone has seen at some time or another:**

1. Do not clean tubes with a damp cloth. This can remove the tube numbers. My boxes are full of tubes without numbers. Did you know that 0000 steel wool used carefully will clean tubes perfectly? If you go over the number very lightly, it will barely affect it.

2. Do not buff the gold finish from Grebe Synchrophase escutcheons. This leaves them too "brassy-looking" and non-original.

3. Do not buff the gold finish from AK labels and the decorative buttons on sets like the AK Models 20 and 35. The experienced collector can spot this effect instantly. The original plating was thinly applied and difficult to duplicate.

4. Do not use a crocus cloth to revive dirty nameplates. This may brighten them but leaves them unrestorable because of scratches.

5. Do not fail to use a wood filler before cabinet finishing. Omitting this step results in a rough final finish, unlike that of the original.

6. Do not remove and discard parts (like filter condensers) that leave gaping holes in the chassis. The defective parts can be cut out of the circuit wiring and left in place to retain the original look. Modern replacements can be wired in place, out of sight under the chassis.

7. Do not clean celluloid dials with a wet cloth. This can often bring disastrous results, as the lettering can easily wash away. It seems that Philco dials are especially prone to this.

8. Do not buff the bronze finish from the dial plate or escutcheon on a 30's set. This usually leaves the metal design less pronounced, and again, brassy-looking.

9. Do not oil or wax a Bakelite panel with a brushed finish, such as an early Crosley or a Leutz, to jazz it up. These were originally sold without a glossy finish.

10. Do not use those modern self-adhesive square rubber feet to replace the missing or broken originals. These are not proper design, and they tend to stick to shelves and other radios.

11. Do not make sets too new without regard to old finishes on chassis, dials or cabinets. The restorer should do some research first to see what the set looked like in its original finish.

12. Do not strip and then brush on a polyurethane or Tung oil finish. Polyurethane is difficult to remove. Try to use the manufacturer's original choice of finish.

13. Do not use black paint to replace the very dark tinted lacquer along bases and around openings. Paint just cannot duplicate the delicate affects of lacquer.

14. Do not use vinyl zip power cord when reproduction cloth-covered cord is available. This is evidence of a poor restoration and one of the first to be noticed.

15. Do not use dishwashing liquid or cleaners on knobs. They etch the plasticizer from Bakelite, leaving the finish dulled on many kinds of knobs. Try mild hand soap and lukewarm water and a soft brush. Five minutes of soaking and all the grime will come right off.

16. Do not take a set apart totally. New solder and its method of application are telltale signs of a recent repair job. Try to work around these tricky areas.

17. Do not use a white lacquer stick alone to fill in dials. Tone down the pure white color to keep the antique appearance.

18. Do not use a wire wheel or steel wool to clean nickel-plated parts, or for the sanding of screw-heads. This always brings out the brass along the edges. You also risk bending them when they escape and fly across the room. TSP (from the paint store) is a remarkable metal cleaner with good results. Some metal-cleaning recipes are available in Guy Biraud's book *Restoration and Preservation of Scientific Apparatus for Collectors*.

19. Do not unnecessarily rewire a DC set. With the inexpensive solid state devices that are available today, you can operate a DC set and keep it looking original.

I'd love to publish your favorite restoration hint. Send them to me at my address below, and I'll compile them for future articles. I won't tell you how many of these pitfalls I have fallen into, but one thing is sure; sets that have not had these things happen to them are more likely to increase in value.

To be continued....  
(Richard C. Foster, 12 Shawmut Ave., Cohituate, MA 01778)

# MUSEUM MUSINGS

## DuMont Duoscope TV – Help Wanted

BY MATTHEW GELLER

"Television Apparatus," a major exhibition about the history of the television set, opens at the New Museum of Contemporary Art in New York City in September 1990. (For a detailed description, see *Museum Musings*, A.R.C., February 1990, page 15.)

The museum has requested assistance in displaying items relative to the history of television. A number of people have already responded to the A.R.C. article with offers to lend an assortment of equipment for the exhibition. One such request concerns the display of a unique DuMont Duoscopic television receiver.

The Duoscope allows two people to simultaneously watch different television shows on the same TV. Each viewer has to wear polarized

glasses, as shown in Figure 1, (or look through a polarized screen as shown in Figure 2) and use separate earphones. The Duoscopic, made in 1950, would not have been designed if there wasn't a real concern that the TV set would cause family conflict or were it conceivable that a family might own more than one set.

If you know anyone who might be able to build a working Duoscope or a simulation, please contact Matthew Geller at the address below.

The museum has also requested photographs, drawings and stories pertaining to early television for a museum exhibition catalog.

Please send any of the following to be considered for publication in the exhibition catalog:

Black & white photographs of people watching television at home (you are welcome to send old or new pictures of your family watching TV).

Photographs, drawings or diagrams of unusual, unique or imaginative television set installations in the home. Please include any information you have about the drawing or photograph; photographer's, artist's or engineer's name, date, location, manufacturer & model number of the TV set in the picture, etc.

Short fictional stories about the TV set or watching TV. If it is an original story you have written, please include: title, author, date and any previous publication information. If it is a story you have read, include: title, author, and the name and date of the newspaper, magazine or book where it was published.

All materials will be returned (please help us out by including a label with your name and address). Sending us original photographs, drawings or stories constitutes permission to publish them.

Mail to:

Matthew Geller, Television Apparatus Guest Curator, 4 White St., New York, NY 10013-2443. Tel. (212) 925-1247.

(Special thanks to Nat Pendleton of the Smithsonian for his information on the DuMont Duoscopic).



Figure 1. Twins wearing polarized glasses and separate hearing devices, watching different television programs on the same screen.



Figure 2. Two family members watch different programs on the same television screen by looking through polarized screens.

# CLUB SPOTLIGHT

## New England Antique Radio Club – NEARC

In June of 1988, three members started what has become the New England Antique Radio Club (NEARC). From that start, the club has rapidly grown from the New England Radio Club (the club's original name) to an organization of over 300 members. Membership encompasses all six New England states, eleven states countrywide, and Canada.

The club is dedicated to the collection, restoration, preservation and enjoyment of antique and collectible radios, TVs and related items. Members' collections run the entire gamut of radio collection – from the earliest crystal sets all the way to the novelty transistors of today and everything in between. Many members are highly skilled in radio repair and restoration while others are just beginning to learn the excitement of restoring a worn-out set. Still others collect purely for the aesthetic value of the cabinets alone. NEARC welcomes all new members – from the retired radio repairman to the beginning collector.

The club publishes a quarterly twenty-page newsletter – the *Escutcheon*. The illustrated newsletter regularly features articles of interest, member spotlights, classified ads free to members, letters to the editor, restoration notes, swap meet reports, reprints of articles from other newsletters and radio magazines, and many pictures of swap meet happenings. The editors welcome radio and TV related articles. Back issues of the *Escutcheon* are \$1.45 per issue postpaid.

Attendance generally tops 400 at the club's quarterly Swap & Sell Meets. Held in January, April, July and October at the Resurrection Center, 449 Broad St., Nashua, N. H. (Exit 6 from Rt. 3), these meets feature over 70 tables of antique and collectible radios, TVs, parts, books, magazines and related equipment for sale or trade. Table space is available to club members only by advance reservation. The meets also include seminars, old equipment contests, 50/50 raffles and occasional auctions. The Resurrection Center offers plentiful space for buyers and sellers,



free parking, a catering service, wheelchair access, and easy accessibility from major highways.

The club sells T-shirts and golf shirts with the club logo.

### New England Antique Radio Club NEARC

Yearly dues: \$10.00

Publication: *Escutcheon*, published quarterly in March, June, September and December

#### Officers:

President: Marty Bunis

Vice Presidents: Aime Beaudry

Jeff Gowan

Secretary/Treasurer: Sue Bunis

Contest Chairmen:

Len Arzoomanian

Dave Grace

Editors: Marty and Sue Bunis

Publisher: Jeff Gowan

#### For information:

NEARC

PO Box 809

Contoocook, NH 03229

(603) 746-6127





# CLASSIFIED ADVERTISEMENTS

**FOR SALE:** AK E-2 speaker - \$40. Radiola 100A, shell only - \$10. Tube substitution handbook - \$5. Jeff H. Gentry, 708 Locust Ave., Charlottesville, VA 22901. (804) 295-1841

**WANTED:** Zenith 835 tombstone, complete restorable to exc. cond., will pay or trade accordingly. Dave Montgomery, 13500 Pacific Hwy., Seattle, WA 98168. (206) 243-6419

**FOR SALE:** Grab bags, boxes filled with junk and gems, take a chance - \$25 potluck Tracy Sands, 2166 W. Broadway #119, Anaheim, CA 92804-2446

**WANTED:** Source for German tubes type VCL11 and VY2. Robert Stapleford, 1800 Randolph, Topeka, KS 66604

**FOR SALE:** 1N23E/R series microwave diodes - \$5/3. SASE required. Bill Downs, 4805 Sullivan, Wichita, KS 67204

**WANTED:** Some of the post-WWII telegraph books such as Brown CSA, Codetrol, Apex. Gil Schlehman, K9WDY, 335 Indianapolis Ave., Downers Grove, IL 60515. (312) 968-2320

**FOR SALE:** 100+ old radios, 20's thru 50's, battery and AC sets, all types, includes home brew, tombstone, beehive, consoles, and plastics - \$2,500/all. Brenton Swearingen, PO Box 872, Franklin, WV 26807. (304) 358-7740

**WANTED:** Midwest, Regal, Royale radios. Televisions. Espeys, Viewtone, Transvisions, projection sets, television mags and books. Bernard Sampson, 2905 Rusk, Houston, TX 77003. (713) 228-6741

**FOR SALE:** Used radio and TV tubes in boxes; 50's, 60's and 70's vintage; all tubes - 25¢ plus shipping. Quantities limited. Send for your free listing. J. R. Piekarz, 111 E. 29th St., LaGrange Park, IL 60525. (312) 352-0648

**WANTED:** Transistor radios, older small or shirt-pocket size type. Send close-up photo, Xerox image, or rough sketch with price to: Roger Handy, Box 24527, Los Angeles, CA 90024. (213) 451-4040

**MESSAGE:** We have moved. Our new address is Arie E. Breed, 1595 N. Van Buren, Ottumwa, IA 52501-2144. Phone remains the same - (515) 682-6925. I'm still looking for some Zeniths, especially Models 5-R-226 and 15-U-272. Arie E. Breed, 1595 N. Van Buren, Ottumwa, IA 52501-2144. (515) 682-6925

**FOR SALE:** Radio Station, AM, Florida. 24 hour license. Inexpensive! Joint venture. Active or inactive with \$10,000 minimum. I am broadcast engineer and ham for many years. M. Gottesman, PO Box 632, Rocky Ford, CO 81067-0632. (719) 254-7427

**WANTED:** Pre-1940 pumps used for evacuation of vacuum tubes and scientific vacuum equipment. Ed Graper, 5960 Mandarin Ave., Goleta, CA 93117. (805) 964-7117

**FOR SALE:** Antique lighting system circa 1910 / w 32VDC tungar charger, 16 exide KX65 cells. Casey Norrisey, 1319 Kenwood Ln., Charlottesville, VA 22901. (804) 293-5068

.....  
**SELLERS ... PLEASE NOTE**  
**A.R.C. ADVERTISING POLICY...**  
 ALL ITEMS MUST BE DESCRIBED FAIRLY.  
 REPRODUCTIONS, REPRINTS AND NOT-  
 ORIGINAL ITEMS MUST BE SO IDENTIFIED.  
 ADVERTISERS AGREE TO RESPOND  
 PROMPTLY TO INQUIRIES AND ORDERS.  
 AND TO RESOLVE PROBLEMS PROMPTLY  
 IF THE BUYER IS NOT SATISFIED.  
 .....

**FOR SALE:** Tubes, new in box. Please send \$1.00 for list of 300+ tubes. Refundable. Wilson Hauck, 6820 Stout Rd., Memphis, TN 38119

**WANTED:** Vintage aviation, naval, portable military radios, parts, connectors, manuals and films. Charles DiCecca, 501 Mystic Valley Pkwy., Medford, MA 02155

**FOR SALE:** I will be selling my radio collection that was on display in my attic. Some items I can ship. Some pick up only. List(s) will cost \$5 to cover Xerox and mail costs. Will include radios batt-home-ports., speakers all types. Headphones, old test eqpt. loops, books, magazines, service manuals, catalogs, N.O.S. boxed parts, display signs, 1000's of old and new repair parts to repair or build sets. Also many unlisted items. Krantz, 100 Osage Ave., Somerdale, NJ 08083

**WANTED:** FADA Model 460-A (1926) or 475-A (1927) or 480-B (1927) fold-in loop antenna radio. Must be in excellent condition. Will pay top price for this item. Lloyd Kendall, 1312 Deep Run Ln., Reston, VA 22090. (703) 471-6143

**FOR SALE:** Serviceable tested receiving tubes - \$1. Write for availability. Dick Still, AA5OG, 9226 Raleigh, El Paso, TX 79924

## CLASSIFIED ADVERTISEMENTS

**WANTED:** Zenith Trans-Oceanic 7G605 sailboat model. Gary Pirkkala, 2306 Audley Ave., New Castle, PA 16105. (412) 654-8481

**SERVICES:** Is your copy of F.O.S. falling apart? We can permanently VeloBind it, and other paperbacks, reference books, manuals worth salvaging. Only \$4.50 ppd./book. Original manuscripts (up to 2" thick), or even 12 issues of A.R.C., bound in an attractive cover - \$7.50 ppd./each. Dean R. Kazmierczak, D.R.K. Computer Consultants, 886 Eggert Dr., N. Tonawanda, NY 14120. (716) 692-3455

### NEW PHONE NUMBER FOR ANTIQUÉ RADIO CLASSIFIED (508) 371-0512

**Best time to call is weekdays:  
9 am to 5 pm Eastern Time**

(Please no classified ads by phone. Thanks!)

**FOR SALE:** Lots of new goodies, parts, sets, speakers - something for everyone. Radiola, AK, Crosley, tombstones, Bakelite. Send large 2-stamp SASE for super list. **WANTED:** Base and driver for Sterling/Audiovox horn. Dick Mackiewicz, 1549 N. River Rd., Coventry, CT 06238. (203) 742-8552

**FOR SALE:** Cathedrals: Philco Jr. - \$110. RCA R8 - \$85. Crosley 125, mint cond. - \$185. Freshman Masterpiece - \$100. Peerless speaker - \$65. **WANTED:** Zenith 7S-240 chairside. Earl Christiansen, 1428 Arden View Dr., Arden Hills, MN 55112. (612) 631-9560

**WANTED:** Service manual on AN/ARC1 transceiver. Rodney Schrock, 402 Lincoln St., Somers, PA 15501

**SERVICES:** Desktop publishing your antique radio needs - inexpensively! Display tags, want lists with pictures, club membership forms, name tags, newsletters. SASE for samples. Rick Ammon, 1249 Solstice, Fort Collins, CO 80525

**FOR SALE:** Hallicrafters SX110 rcvr., very good - \$60. BC221AK Signal Corp. freq. meter w/PS, manuals - \$45. Navy LM10 (Bendix) freq. meter w/manual - \$45. All plus UPS. **WANTED:** 1966 Allied Electronics catalog, spkr. for HRO 60, Knight Ocean Hopper. Doug Thomas, Rt. 8, Box 257A, Live Oak, FL 32060. (904) 658-2378



**WANTED:** Brass handle pictured above to finish last step in a restoration. Can sometimes be found on old test equipment boxes. Please check your extra parts. Greatly appreciated. Dave Crocker, 2 Wheeler Circle, Canton, MA 02021

## CLASSIFIED ADVERTISEMENTS

**WANTED:** Grebe Synchrophase MU 1, MU 2, battery boxes, parts, signs, owner's manuals, etc. Fred Schultz, 1246 Lincolnway W., Ligonier, IN 46767. (219) 894-3779, days. (219) 894-3092, evenings

**WANTED:** Wood bell for a Music Master speaker. Base for a Saal speaker. Bell for a Dictograph speaker. Fine tuning knob for AK metal box radio w/w/o 'o' ring. Good 1st and second IF xfmr. for a Majestic 15A (466 Kc). Picture of inside and outside of Airline 1-tube set. Good cabinet for a Stewart-Warner 102A. Thanks. Bob Barnes, Box 275, Monroe City, MO 63456. (314) 735-2945

**FOR SALE:** Westinghouse Columette WR10A - \$75. GE M61 - \$65. GE S22A - \$125. Gloriton Model 27 - \$125. AKAI reel-to-reel tape recorder, works - \$75. Don Reinsma, 720 N. 18th Ave., Pensacola, FL 32501

**FOR SALE:** Gov. Winthrop desk w/RCA Special Little Giant MAC 523-524 spkr. - bottom drawer (@ 9) - \$300. Westinghouse refrig. AMMH211-CHV-2144, grey, plays, West. Home Prod. Div., Sudsbury, Pennsylvania - \$75. Bosch eliminator (power supply) Springfield, Massachusetts, Type BAN-M501 (@ 9) - \$50. Bernie Samek, 53 Old Palmer Rd., Palmer, MA 01069. (413) 245-7174

**FOR SALE:** Shurite meters, N.I.B., Model 850 0-1 MA, 0-10 MA, 0-500 MA, (2) pocket meters, used, 0-7v, 0-50v - \$5 ea. plus UPS. Heathkit DX 60 xmtr. with manual, clean, works - \$55 plus UPS. Ed Povraznik, W8YIR, 9606 Biddulph Rd., Brooklyn, OH 44144

## Antique Radio Club of Illinois Presents: RADIOFEST 1990

AUGUST  
9th, 10th, & 11th

The Holiday Inn  
Holiday  
and  
Convention  
Center

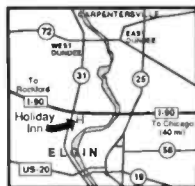

345 River Road, Elgin, IL 60123  
Call: (708) 695-5000

- Auction
- Special Exhibit
- Hospitality Suite
- Donation Auction
- Three-Day Flea Market
- Afternoon Presentations
- Friday Evening Awards Banquet
- Old Equipment Contest
- Ralph Muchow's Radio Museum

Info: Dave Johnson, 2336 S. Kenilworth,  
Berwyn, IL 60402 - (708) 484-2743

## CLASSIFIED ADVERTISEMENTS

**WANTED:** Need a good original type speaker assembly for a Philco Model 71 Code 121 cathedral. James W. Walcher, 1311 Janet Dr., Wilmington, IL 60481. (815) 476-9184

**WANTED:** Dial glass, Zenith 10S669, case for Fafa 1000, speaker for Dahlberg pillow radio. Case for Belmont push button. Cabinet for 1938 Zenith 12S262 console. Palm size speaker for hospital bedside radio. Knobs for Crosley E15. FADA 845 radio. FADA & Zenith literature. **FOR TRADE:** Westinghouse radios: 126 refig., 130 (GOP 98), 171 chairside (AR 66), Emerson 640, some Dahlberg 430-D1 parts, Emerson 561B, knobs for Crosley D25. Original catalogs: Coast to Coast (radio and amp), 1934, Lafayette radio 1934, 1937, 1938; Mallory-Yaxley 1937; NAALD 1934; RCA Cunningham Radiotron tube manual with wall chart, 1934. **FOR SALE/TRADE:** Philco 40-130 AM/SW wood, decent TT inop. - \$50. Philco PT33 AM TT plastic (ROG 92), nice, inop - \$40. Working Hallicrafters S-38, S-41G - \$37 ea. All replies answered. Bill Timoszyk, 35283 Leon, Livonia, MI 48150. (313) 421-2076

**WANTED:** Ham gear: Hallicrafters SX-28A, SX-101 Mk II or III w/160m; Johnson Viking Valiant, Viking 500; Collins 75A-2, 32V-2. Excellent to mint condition. Richard L. Evans, PO Box 491, Souder-ton, PA 18964. (215) 257-8906

**WANTED:** Lafayette tube audio, KT/LA600A preamp, KT/LA550 stereo amp., KT/LA70 mono amps. Also Knight KB85 stereo amp. C. D. Maples, 1623 Saddle Dr., Murfreesboro, TN 37130. (615) 893-0255

**WANTED**  
**RADIOS**  
**TUBES**  
**614-267-0316**

### BUY, SELL and TRADE:

- Tube Radios from the 1930's - 1950's
- Novelty Transistor Radios
- Collectible Tubes or Box Lots
- Radio-Related Literature and Collectibles
- Test Equipment, Repair Information and Parts
- Radio Repair Available

**Brett P. Gundlach**  
276 East Como Avenue  
Columbus, Ohio 43202  
(614) 267-0346

## CLASSIFIED ADVERTISEMENTS

**WANTED:** Photos, instructions or information on: Industrial Instruments DK-2AA Decade capacitor. General Radio 804-C signal generator (also test leads). General Electric TC-3 tube tester. Jackson 636 tube tester (also roll chart). And spindle for Dual 1019 turntable. Phillips AG1002 record changer for Grundig 7063W3D console. Alexander Kruedener, 161 East 89 St., New York, NY 10128. (212) 831-0662

**WANTED:** Zenith Black dial 7S28, 5S29, AK cathedrals, Philco cathedrals, tube audio gear (power amps, pre-amps 1955-64). Cash paid or trade. Charley Kittleson, PO Box 691, Belmont, CA 94002. (415) 959-4164

**Classified Ad Deadline Noon**  
Mar. 10 for Apr. 1990 Issue  
Apr. 10 for May 1990 Issue  
Box & Photo Ads - 5th, Display Ads - 1st

**WANTED:** Swing handle and knobs for Westinghouse fridge style portable Model H-124. Paul Zdinak, 10 Hemlock Dr., Candia, NH 03034. (603) 483-5872

**WANTED:** Pre-1941 televisions. Generous finders fee paid for information leading to purchase. Don Hauff, 9988 107th Ave., N., Maple Grove, MN 55369. (612) 425-0089

**FOR SALE:** Best offers. AFCO Deluxe 10 transistor radio. Tempest 4-band portable. Panasonic R-1159 pocket. Norman M. Landis, 1315 Marbendale Ct., Kirkwood, MO 63122. (314) 821-7933

**FOR SALE:** Elementary Electricity and Elementary Industrial Electronics, both by Wellman - \$15/both pd. R. J. Eastwick, 224 Chestnut St., Haddonfield, NJ 08033. (609) 429-2477

**WANTED:** Arvin 502. Belmont 5D128. Crosley 11 100U. Emerson FU427. Columbia 600BX. Jefferson-Travis JTF211, pocket transistors. Sears and Arvin metal. Zenith wave magnet, Royal 500, Royal 755. Any transistor radio. Richard Bell, 721 20 Ave., W., Kirkland, WA 98033. (206) 822-5435

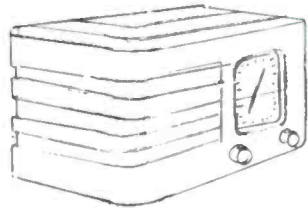

**HELP:** Trying to identify brown plastic table model drawn from memory. Bought in 1940, Chicago, 5-tube Super 12SA7-35L6 etc. Loop Ant. B.C. only, thought to be Stromberg. Chassis may be copper color. Ray Larson, 12241 1/2 Gorham Ave., W. Los Angeles, CA 90049

## CLASSIFIED ADVERTISEMENTS

**FOR SALE:** Selling fast but have new goodies! Unusual Emerson 908/974 simulcast AM/FM mahogany table stereo radio. Just received lot of Tektronix letter plug-in's, including unusual types, call! Nelson Ross spectrum analyzer plug-in, PSA 311 0-300 MHz - \$199. Hallicrafters SX99 just aligned - \$100. Zenith 7F01 AM/FM table, AC/DC 402Y portable, plus others, cheap. Great RCA 86T1 3-band AM/SW to 22 MHz wood table model and 98K console. Crosley 5M355 miniature tombstone - \$55. Clean Collins 75A1 receiver with narrowband mechanical filter and special superbands spread knob - \$199. Great performing Pacific Electronics 610A, 0.5-18 MHz receiver with tuned RF stage. European AM/FM table plastics: Grundig 87, Phillips bright red and white. KUHN 26 to 174 MHz miniature 5-tube superregenerative receiver. Scott all-triode preamplifier, Scott FM solid state receiver, steal at - \$80, also Scott solid state FM stereo receiver. Fisher 50R AM/FM receiver with stereo adapter - \$99. Variacs, good prices. Measurement Models 80 AM, 202B FM signal generators, also 202A RX meter and Megacycle meter. Pair Western Union toy telegraph sets, N.O.S., KY-116/U Knee Key. **WANTED:** Collins 51J4, 651S receivers, 4H4 Amperite ballast. SASE for super list. Steve Lipsky, W2VVN, Vintage Technology Associates, 1254 Cox Rd., Rydal, PA 19046-1207. (215) 884-1817

**WANTED:** Jukeboxes: Wurlitzer, Seeburg, Rockola and others, any condition. Also buying wall boxes, wall speakers and literature or anything related to jukeboxes. Finders fees paid so ask your friends. Mark Miller, 4223 Yorba Linda, Royal Oak, MI 48073. (313) 647-4510

## CLASSIFIED ADVERTISEMENTS

**FOR SALE/TRADE:** Grunow 470, plays good - \$110. Stewart-Warner 325, N/T - \$75. Emerson 520. Stewart-Warner speaker - \$35. **WANTED:** AK items: 50, 93, 155 and others. RF coils, single tube island #4204, other breadboard parts. K-speaker. Bob Nicholson, 3423 S. Long, Topeka, KS 66605. (913) 266-9473

### CLASSIFIED AD NOTICE

**Full name and address is now required in all classified ads - it does not cost extra! We will add it if you forget.**

**FOR SALE:** Electrical Engineering, 1895, Slinger 753 pp. - \$22. Elementary Lessons in Electricity & Magnetism, 1895, Thompson, 625 pp. - \$22. Alternating Current Circuits, 1948, Corcoran, 552 pp. - \$14. Electricity & Magnetism, 1939, Whitehead, 221 pp. - \$11. Elements of Notes on Mechanism, 1895, Schwamb MIT Test, 170 pp. - \$26. IRE Standard on Electronic Tubes, 1962, 159 pp. - \$12. The Radio Amateur's License Manual, ARRL, 1947 & 1968 - \$13 both. Operating an Amateur Radio Station, ARRL, 1946 & 1957 - \$9 both. How to Pass U. S. Gov. Radio License Exams, 1932, 178 pp. - \$12. All ppd. **WANTED:** Loan to copy Hickock 820 Caddy Pal manual. Joe Koosman, K2GFH, RD 1, Box 130, Hopewell, NJ 08525. (609) 466-0136

**FOR SALE:** Supreme Model 599 tube and circuit tester with manual and chart, no lid, works - \$30. Radio Training Assoc. of America circuit tester with leads, works - \$25. Both include UPS. Jack D. Hortman, PO Box 456, Biglerville, PA 17307. (717) 677-6336

## Coming Soon... Fixing Up Nice Old Radios The definitive antique radio repair book

- Covers everything from crystal sets to the Scott 800-B
- Easy to understand. No higher math. All terms explained. Fix most radios with a \$20 multimeter! Adapt an old Hallicrafters for a signal generator!
- Uses actual photos of the insides of your favorite radios, some as big as 8x10. Covers actual repair jobs in detail. Many schematics. Your favorite radios are in it. AK, Zenith, Bosch, Scott, National, Hallicrafters, Crosley 50, Radiola III, 17, 25, R28-p, Philco and many others. Thousands of dollars worth of radios were tested, fixed and photographed for this book.
- For the advanced worker, too. Explains Wunderlich AVC, crystal filters, Scott and Zenith push buttons and band-switches. Shows how to align old radios with a digital scanning receiver and look at RF waveforms of autodyne detectors with a dual trace scope.
- Written by Ed Romney, former Mass Radio instructor, broadcast engineer and experienced technical writer. Professionally typeset and printed.

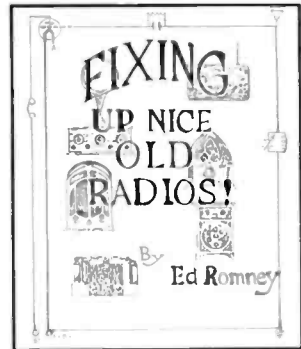

**Only \$19 - Coming soon - Look for announcements...  
Romney Publishing, Box 96, Emlenton, PA 16373**

**CLASSIFIED ADVERTISEMENTS**

**WANTED:** Schematics for Jackson tube tester Model 435-A and Gross standby shortwave receiver. Charles Ahr, 2291 Sylved Ln., Cincinnati, OH 45238

**WANTED:** Would like to correspond with employees of past low radio companies. Also Eckstein (Karadio) of Minn. Dennis Hilberg, 804 Ravine St., Decorah, IA 52101. (319) 382-2012

**WANTED:** Hallicrafters Continental AC/battery shortwave rcvr., 4 tubes. Models 5R40, 5R41, 5R42 only. Jim Zacher, 39W345 Central Dr., Elgin, IL 60123

**FOR SALE:** Round convex glass. State diameter, make and model of radio. SASE for quote. R. Miner, 1215 B., Ft. Madison, IA 52627

**WANTED:** Crystal sets multiband or selective type. Also need crystal headphones. Harry Mac Mullan, 2662 Bancroft Dr., Aston, PA 19014

**WANTED:** Dahlberg Pillow speaker radio (Collins R.T.G.A., p. 101), any condition, working or not. Collector pays top dollar. Mark Miller, 4223 Yorba Linda, Royal Oak, MI 48073. (313) 549-9406

**FOR SALE:** Golden Age Catalin radios. SASE for list. David Brenner, 71 Burdette Rd., Atlanta, GA 30327

**WANTED:** Tannoy anything. Books on acoustics, hi-fi, amps, speakers, etc. Barry Nadel, Box #29303, San Francisco, CA 94129. (415) 346-3825

**CLASSIFIED ADVERTISEMENTS**

**FOR SALE:** 1930 ARRL Handbook, vg - \$35. 1920's, 30's QST's, Ghirardi's Radio Physics book - \$15. Vacuum Tubes in Wireless Communication, Bucher, 1919 - \$25. Mint GE/sure studio mic circa 1947 - \$40. Collins 32V2 xmtr. for restoration or parts - offers. R-390/URR original manual & schematics - \$35. SASE for info. **WANTED:** Original loose coupler, wireless gear, Federal parts, radios, cabinets & restoration info. VT-2's, good. QST's: 7/21, 5/25 & 1, 2, 3, 6, 12 of 1922. Glen Fritz, 1516 1st Pl., Vero Beach, FL 32962. (407) 569-0587, eves.

**HELP:** Need Philco Model 87 chassis, junker OK. **WANTED:** In dash auto radio with CB, AM, FM. Steve Balog, 11 Oak St., Avenel, NJ 07001. (201) 634-1539

**FOR SALE:** Bakelite dial, good condition, with center push button, Gee Haw trademark, 100 to 1 reduction with 0 to 100 calibrated 4-inch metal disk backplate. Made by Gischow, New York - \$50, Canadian. Henry McGee, 8 Gillespie Cr., Ottawa, Ontario, Canada. (613) 521-8640

**WANTED:** Crosley animated advertising sign, Crosley Color Radios, as seen in Philip Collins book. Any condition or parts. Will pay top dollar. Mark Miller, 4223 Yorba Linda Blvd., Royal Oak, MI 48073. (313) 549-9406

**WANTED:** Philco wireless remote control box, compatible with Philco Model 40-216. Must be complete. Contact Rich Holm, 818 E. Pennsylvania Dr., Boise, ID 83706. (208) 386-9259, collect, evenings

**NORTHLAND  
ANTIQUE  
RADIO  
CLUB**



**AND**



**ANTIQUE  
WIRELESS  
ASSOCIATION**

**Proudly Announce**

**RADIO DAZE '90  
May 18th and 19th, 1990**

**★ SPECIAL FEATURE: A visit to the Pavek Museum of Wonderful Wireless ★**

**HOTEL SEVILLE**

**NARC**

8151 Bridge Rd • Bloomington, MN 55431

P.O. Box 18362 • Minneapolis, MN 55418

☎ 612-830-1300 ☎

☎ Jim Thompson: 612-822-4000 ☎

**SWAP MEET • PROGRAMS • CONTEST • LUNCHEON**



**CLASSIFIED ADVERTISEMENTS**

**WANTED:** Tubes 6A7-M 8 pin 6F7-M 8 pin. **FOR TRADE:** RCA BK 5A ribbon OK, for your loud-speaker type gooseneck Magnavox Model M6 or other. Marcel Vallee, 703 Boul. St. Germain Ouest, Rimouski, Quebec, Canada G5L 3S6

**FOR TRADE:** My AK Radiodyne 10 for your AK Model 4454A with 5-wire cable. Also have bread-board parts for trade. Jerald Hueber, 1368 King Richard Pkwy., W. Carrollton, OH 45449. (513) 866-6958

**WANTED:** WWII surplus conversion manuals plus schematics and other info for BC-348B and BC-312M. Also seeking Hallicrafters SX-28 and S-76 receivers. **FOR SALE/TRADE:** Emerson, Bakelite table Model #641, circa 1948/49. Hallicrafters S-120. Lafayette Radio Catalogs, 1935 and 1938. First RCA Broadcasting Equipment Catalog, 1938. Bill Groves, 100 N. Whisman Ave., #136, Mountain View, CA 94040. (415) 961-1128

**WANTED:** DeWald yellow harp. Near virgin cabinet wanted. I will buy cabinet or complete radio. **FOR SALE:** Near perfect green and black Bendix 526C - \$550. Scottie McElroy, Apt. 1007, 2309 Driftwood, Mesquite, TX 75150. (214) 279-6138, anytime

**WANTED:** Anyone having a one-tube Reinartz 3 circuit radio of either home brew or kit wired. Uses feedback, aerial, secondary coil, all on same form. I need a good drawing or photo of front panel, set hookup, for my own construction. Also .0005 mfd variable, 200/400 ohms rheostat, switch points. D'Arcy Brownrigg, PO Box 292, Chelsea, Quebec, Canada J0X 1N0. (819) 827-0128

**FOR SALE:** RCA 1942 Victrola Anniversary Model V-215/RP-160. Has AM, shortwave and phono player. Exterior excellent, new tubes, electrical needs some work. Mike DeVivo, 231 Park Rd., Waterbury, CT 06708

**WANTED:** Stromberg-Carlson glass top chair-sides #231R, 240R and 420R half-round consoles. Must be excellent or better. Also need knobs for Zenith 6S-229 tombstone. John England, PO Box 1674, Alexandria, VA 22313. (703) 548-2952

**★ FOR SALE ★**

I have 1000's of unlisted items for sale. Will not be put onto lists due to lack of time. If you need or want something, write wants and SASE.

Krantz  
100 Osage Ave.  
Somerdale, NJ 08083

**CLASSIFIED ADVERTISEMENTS**

**FOR SALE:** LSASE gets new pictured list of 75+, 30's - 50's, table models, no Catalin. Bill Burkett, PO Box 1204, Peoria, AZ 85380. (602) 979-0452

**WANTED:** Radio, electronics, communications books, magazines, catalogs, manuals, handbooks; Popular Communications, General Radio Experimenter, Capacitor, Radio, Monitoring Times, Hands On Electronics, Hints and Kinks, etc. Send your list with prices. Joe Holstein, N8EA, 1515 Sashabaw, Ortonville, MI 48462. (313) 628-7455

**SEND ALL A.R.C. MAIL TO**  
**Antique Radio Classified**  
**P.O. Box 2, Carlisle, MA 01741**

**WANTED:** Any crystal set for the largest crystal set collection in Europe! Erwin Macho, Am-brosweg, 17/A/8, A-1230 Vienna, Austria

**FOR SALE/TRADE:** Kadette Topper 1940 (B.F.T.P., p. 278), white urea (?) body with brown top/knobs, 1 1/4 inch hairline, otherwise perfect and working - BO in cash or trade. **WANTED:** Catalins (even damaged), Kadette Jewels, very early Bakelites (especially white - not painted, and tombstones), and Philco 49-501's. David Mednick, 1450 Palisade Ave., Apt. 5-H, Fort Lee, NJ 07024. (201) 461-3082

**WANTED:** One stereo or two matching mono E.H. Scott preamps, good cosmetic condition. Scott Guthrie, 307-234 Willow Rd., Guelph, Ontario, Canada N1H 7C6. (519) 767-0159

**LATE 40's**  
**AUDIO**  
**GOLD MINE**

**AUDIO ANTHOLOGY:**

Volumes 1 and 2 are 124-page (8 1/2 x 11) reprints of major *Audio Engineering* articles published from 1947-52. All are hands-on projects with complete construction details for everything from preamps to tuner, and power amps to speakers, plus much more in between. Valuable info on early phono reproduction. Vol. 1 has 38 articles, Vol. 2 has 45. A gold mine of authoritative information on tube-based audio.

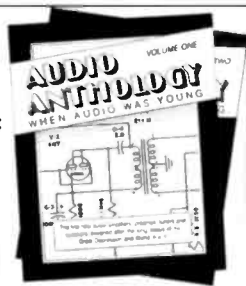

**Send me:** \_\_\_\_\_ copies Volume 1 @ **\$16.95** each \$ \_\_\_\_\_  
 \_\_\_\_\_ copies Volume 2 @ **\$16.95** each \$ \_\_\_\_\_

Shipping \$ \_\_\_\_\_  
 TOTAL \$ \_\_\_\_\_

NAME \_\_\_\_\_  
 STREET & NO \_\_\_\_\_  MC  VISA  CK

CITY \_\_\_\_\_ STATE \_\_\_\_\_ ZIP \_\_\_\_\_  
 Shipping per book: \$1.75/  
 USA; \$4.50/Canada; \$7.00/  
 elsewhere. 50% each addi-  
 tional book.

**Old Colony Books** MC/VISA phone orders:  
 PO Box 243, Dept. AR0 (603) 924-6371 - 924-6526  
 Peterborough, NH 03458 FAX: (603) 924-9467

## CLASSIFIED ADVERTISEMENTS

**FOR SALE/TRADE:** Coke cooler, FADA 209, 254 black & chrome, Dahlberg Pillow, Smokerette 1947, Crosley Coloradios, Chrome Midgets, Emerson 520s. **WANTED:** Hopalong Cassidy, novelties and Catalin. L. Grove, 4584 W. Ivanhoe St., Chandler, AZ 85226. (602) 961-4281

**WANTED:** Gonset car radio shortwave converter in useable condition. Ciro DeGennaro, R. 1, Box 64, Feura Bush, NY 12067. (518) 768-2922

**FOR SALE:** Want to operate that neat old Trans-Oceanic or other suitcase portable without being tied to a line cord? Just install a Porta-Power converter. You'll be surprised how good that radio will sound. Those were good sets. Porta-Power works on any radio with 1.4-volt tubes. It fits in the battery compartment with six D cells supplying all the power the radio needs. You can even use it in more than one set. Works on farm radios too. Order the CVA-1 for sets requiring a 1.5v A battery and the CVA-9 for all others. Either type, including battery holders is only \$89.95 plus \$3.50 UPS. Guaranteed. What are you waiting for? Order from: Peter Yanczer, 835 Bricken, St. Louis, MO 63122

**WANTED:** CW filter F455B-08, Xtal calibrator 8R1 for Collins 75A3. Robert Schafer, WA7IHN, 11004 James Way Dr., Aumsville, OR 97325. (503) 749-1149

**FOR SALE:** Tubes - \$.75. Zenith K725, National RAO-7, Conar 250, HP-400E AC meter. Joseph Zambri, RD 4, Box 216, Towanda, PA 18848

## CLASSIFIED ADVERTISEMENTS

**WANTED:** Studio TV cameras, iconoscope camera, Farnsworth camera, Flying Spot scanners, 35mm motion picture projectors, cameras. Carey Williams, 206 N. Broadway, Joliet, IL 60735. (815) 727-0123

**WANTED:** Power pack and speaker complement Scott Deluxe AVC Super 1933. George Demeroukas, 1417 N. 36th Melrose Park, IL 60160

**FOR SALE:** One lot of 75 assorted tubes - \$45. I pay shipping. SASE for list. Wilbert Kimple, 3015 Kelsey Creek Rd., Spartanburg, SC 29302. (803) 585-6465

**SERVICES:** Radios refinished, table models to consoles. R. Yerke, PO Box 392, Moscow, PA 18444. (717) 842-4857

**FOR SALE:** Sams TSM 24 to 109, AR 20 to 72, Photofacts 475 to 765. Above items - \$2.50 each ppd. For book list send LSASE with 50¢ postage. J. J. Papovich, 53 Magnolia Ave, Pitman, NJ 08071. (609) 582-8279

**FOR SALE:** Phono needles for 45 players - \$4 ea. ppd. Needles for RCA/Philco players. J. J. Papovich, 53 Magnolia Ave., Pitman, NJ 08071. (609) 582-8279

**WANTED:** Knobs. One set for a 1942 Admiral 4203-B6 table model made by Continental Radio and TV Corp. One set for a 1948 Westinghouse H-126 Little Jewel or as we call it the refrigerator. Pete Pederson, 4748 SE 41st., Del City, OK 73115. (405) 672-1748

## WANTED WESTERN ELECTRIC TUBES, SPEAKERS, HORNS & AMPS

TUBES: 300A, B, 274A, B, 262A, B, 275A, 350B, 284D, 252A, 271A, 242A, 348A, 349A, 301A, 339A, 205D, E, F, VT52, VT1, VT2, 211, 212, 104D, 216A.

SPEAKERS: 555, 594, 596, 597, 713, 754, 755, 728, 4151, 4153, 4181, 4194, 753, 757.

HORNS: 22, 24, 26, 25, 12, 6368, 15A, 13A.

AMPLIFIERS: 86, 1086, 91, 22, 94, 95, 105, 106, 120, 121, 130, 131, 124, 129, 142, 143.

## VICTOR VICTROLAS, EDISON, ETC.

TUBES: TELEFUNKEN, GENALEX, RCA, RADIOTRON, ETC.  
GENERAL ELECTRIC, AMPEREX, JAN, SYLVANIA, GEC, NATIONAL UNION

## MCINTOSH, MARANTZ, DYNACO

CITATION, LANGEVIN, ROGERS, LEAK, TANNOY, ALTEC, EV,  
THORNES, EMT, JBL, .... AMPS, SPEAKERS, TURNTABLES

MAURY CORB  
12325 ASHCROFT  
HOUSTON, TEXAS 77035  
TEL: (713) 728-4343

MAURY CORB  
12325 ASHCROFT  
HOUSTON, TEXAS 77035

---

**CLASSIFIED ADVERTISEMENTS**

---

**FOR SALE:** Zenith R511W Art Deco - \$25. Philco 52-540 - \$30. Sonora RBU-176 - \$25. Philco 42KR5 (Dec. '89 A.R.C.) - \$60. Zenith H724Z2 - \$40. SASE for additional similar radios, literature, and test equipment. Rod Galloway, 2220 Woodbury Rd., Melbourne, FL 32935. (407) 254-0280

**WANTED:** Members! Are you interested in old electric ceiling and desk fans? Join the American Fan Collectors Association. Write for free details to A.F.C.A., POB 804, South Bend, IN 46624

---

**CLASSIFIED AD NOTICE**

Full name and address is now required in all classified ads - it does not cost extra! We will add it if you forget.

**FOR SALE:** Collection of early AC radio-phonographs. Victor VE9-40, Borgia II style, uses Radiola 28AC with large Orthophonic Victrola, nice original cabinet - \$1,750. 1931 Victor custom-built, has Victor R-35 type radio. RCA commercial power amp. with 50's, second type Victor Orthophonic changer, twin speakers, remote control, huge and unique; the ultimate Electrola. Victor RE-57 - \$150. RCA Victor 381 and D11-2, both use record ejector changers, shortwave. 1931 Earl, plain combination - \$100. 1940's Capehart 13K-2, 15-tube, twin 12" speakers, no FM, conventional changer - \$200. All need some restoration. Credenza Victrola, excellent. Westinghouse WR-7, same as Radiola 86, for parts - \$40. Brunswick S-31 chassis and motor. 1931 Majestic motor board with rebuilt pick-up - \$60. Radio and speaker for same. Radiola 47 parts. Radiola 62 chassis and speaker. R. L. Callahan, 814 Chestnut Tree Dr., Annapolis, MD 21401. (301) 757-7193, after 7 pm

**WANTED:** Sams CB Photofacs 229 thru 251 and any above 274. George Manter, 5782 N. 4th St., Fresno, CA 93710. (209) 432-5176

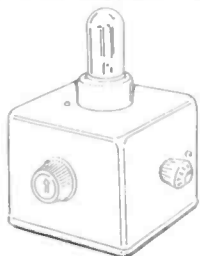

**FOR SALE:** March special. \$50.00 bonus for a basket case Crosley Pup. See picture. Need not work. If not complete, less money. 1923 FADA Model 167-A 3-dial Neutrodyne, works great! Fully restored with nice dials and cabinet, very selective 600-14.70 Kc, a steal at - \$145. Radiola III 2-tube radio, tubes not incl., xfmr. OK, looks good, works F.B., instr. book inc. - \$100. William J. Key, W1DWD, 58 Sycamore Dr., Halifax, MA 02338. (617) 294-1831

---

**CLASSIFIED ADVERTISEMENTS**

---

**FOR SALE:** Philco 70, vg - \$325. GE K-52, good condition - \$110. Ellsworth cathedral - \$80. **WANTED:** Philco 51B. Kennedy Coronet 42. GE J100. Speaker for AK Model 80 cathedral. Joe Yanul, 9606 Troy Ct., Mentor, OH 44060. (216) 255-1952

**FOR SALE:** Jensen C3781ST600Ω 15" Duplex, radio client's linefeed - \$180. RCA MI-11723 sound effect filter - \$150. RCA BK-6B early lavalier, complete, original, collectible - \$120. Gray Research 108B viscous-damped tone arm, GE VR11 & RCA MG cartridges. Old broadcast connectors: P-3 1" cable & chassis, UA-3-11, 'D' shaped, Cannon ribbed w/screw-on ends. Tubes: receiving, transmitting & ceramic sockets. Hickock #670 video scanner w/video & RF outs. \$ Best offer. Paul R. Dowie, 171 Drexel Ave., Lansdowne, PA 19050-1313. (215) 626-9322

**WANTED:** Test equipment: Hickock 288A or AX, RCA WR-50A, Weston 565 analyzer. Good or better condition. Richard L. Evans, PO Box 491, Souderton, PA 18964. (215) 257-8906

**FOR SALE:** Pink Motorola clock radio C2P6, cracked cabinet. White GE clock radio C600A. White Westinghouse H745T5, cracked cabinet. All play - \$9 ea. plus postage. James S. Looney, Rt 1, Box 54, Grundy, VA 24614-9705. (703) 531-8677

**FOR SALE:** Weston Model 590 oscillator from 1931 radio service shop with original instruction book - \$125 plus UPS. Steve Sholand, 6152 Murray Rd., Whitehall, MI 49461. (616) 894-8369

**WANTED:** McIntosh amps. 15-W1, 50-W1, MR65-A, MC-75 tube cage. Dave Carver, 43 Jewett St., Ansonia, CT 06401. (203) 734-4641, after 6 pm EST

**WANTED:** General Electric K-82 chassis and speaker to fit a Georgian grandfather clock radio. John Kern, 2320 Rosedale Rd., Quakertown, PA 18951. (215) 538-2128

**FOR SALE:** Quality reel-to-reel tape recorders - just in, please call. Harry Poster, Box 1883, S. Hackensack, NJ 07606. (201) 794-9606

---

**COLORADO RADIO COLLECTORS SHOW & SWAP MEET**

April 21st & 22nd, 9:am - 5:pm

At the Western Stock Show Complex  
Denver, Colorado

April 20th setup - Indoor spaces  
Show & Swap - April 21st dinner

**For information contact:**

Bruce Young, 4030 Quitman Street  
Denver, CO 80221 - (303) 458-7408

## CLASSIFIED ADVERTISEMENTS

**WANTED:** Heathkit DX35. Please state price and condition. Lea Staller, KC4BDF, 310 S. Park Dr., Spartanburg, SC 29302

**FOR SALE/TRADE:** Warehouse find, original RCA Radiotron spare tube holders for the back of your favorite battery tube set. These chromed advertising premiums available in 2-piece set of 1- and 2-tube models - \$10/set ppd. while they last. Programmable scanners: Radio Shack Pro-32 20-channel hand held - \$100. Pro-32 200-channel hand held - \$160. Regency MX-5000 25-500 full coverage base - \$185. (3) Amperex 5894 transmitting tubes, (2) N.I.B. - \$60/all. Dial cord stringing books #1 & 2 - \$15/both. Abbottsware horse & base only - \$50. Panasonic remote mic controlled CB - \$60. Tubes: UX-199, good filaments - \$15 ea. Dud Kellogg 401 in box - \$6. (3) original different Hopalong Cassidy coffee cups - \$35. Swirled brown plastic RCA portable w/ chrome grille - \$65. Booklets, old - \$12 ea., ppd. Dustons Log & Call Book, Radio Questions Answered, Troubleshooting AC & Battery Sets, Standard Radio Guide, Wincharger Assembly Instructions, Loud Talkers & How to Build Them, Marantz 2215 Manual, Precision Tube Test Models 612 Through 654. The Electric Word, The Rise of Radio, 1928 - \$30. Bremer Tully 6-tube counterphase with Clarodyne horn, offers, no ship. Edison battery jar with lid - \$75. **WANTED:** White Bakelites, Urea. White mic. radio, only following AM frequencies, 720, 760, 780, 1000. Junker, ugly & beater Arvin 540T and/or chassis RE 278 with knobs for same. Bill Jenkins, 4335 N. Damen, Chicago, IL 60618. (312) 528-1341, 6 to 8 pm Central only please



### Antique Radio Service

508-653-2418

#### A Complete Restoration Shop

Home radio, auto radio, chassis, cabinet, veneer, wood and finish restoration.

Buying auto radios and parts pre-1960.

Service literature, all kinds.

RICHARD C. FOSTER  
12 Shawmut Ave.  
Cochituate, MA 01778

Call or Write for Quotes

## CLASSIFIED ADVERTISEMENTS

**FOR SALE:** Cream Sparton Bakelite radio, near mint, made in Michigan, 1939? - \$70 ppd. George Friedrich, 7162 Jacqueline Lake, Custer, WI 54423

### CLASSIFIED AD NOTICE

Please check your ads carefully  
before sending them in.

It is difficult to make changes to ads  
once they are received.

**FOR SALE:** Juliette Vox mic. Model MKV 60, N.O.S., use 9v batt. - \$7.50. Silvertone radio ch. Model R111, 10-tube + tune eye, have dial trim, no spkrs., no output xmfr., one push-button missing, untested - \$15, or will sell major parts. H.P. sq. wave gen. Model 210A - \$20. Bogan tube stereo amp. Model DB 212, looks good, works good - \$50, or BO. Optic lenses, new - \$1/3. Tube sockets N.O.S. wafer type 7- or 9-pin, screw holes 1 7/8" or 1 1/8" - \$1/4. Local wafer screw holes, center-to-center 1 1/2" - 60¢ ea. Ceramic octal holes, 1 1/2" c.-to-c. - \$1.50. Phenolic octal screw holes, 1 1/2" brown, 1 1/4" black - 90¢ ea. Add shipping. **WANTED:** Knob for Philco Model 40 or 41 for vol. cont., is brown, 10 flats, sides, has 3/4" dia. flange that goes against panel. Also need ham gear in working condition for novice. C. England, 98 Montague Ave., S. Zanesville, OH 43701. (614) 452-1335

**FOR SALE/TRADE:** Emerson #520 brown/white w/blue dial. Heath HW-16 xcvr. w/HG-10B VFO, 80-2m. Radiola III. Stromberg-Carlson #654A chassis. CCT-46217 military rcvr. with P/S. Bearcat III scanner. Star dual conversion ham rcvr. Coke bottle xstr. Mickey Mouse head. Early headphones. P. Currie, Box 738, Chuluota, FL 32766-0738

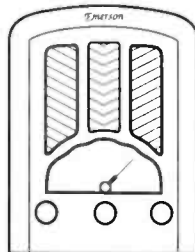

**WANTED:** Emerson AU190 Catalin tombstone. Any color, in excellent condition. Sam Juliano, 15718 Falmouth Dr., Houston, TX 77059. (713) 486-8726, please leave message

**FOR SALE:** Detrola radio, record player, recorder & public address system, Model 6528, year? - \$75. RCA console Model 111K, nice - \$150. Philco metal table, Model 65, 1929, TRF, nice - \$125. Coca Cola radio, cooler, Model 5A410A - \$250. Other consoles and parts. George Jones, 310 Centre St., Fernandina Beach, FL 32034. (904) 261-2182

**HELP:** Any suggestions for restoring badly corroded Kennedy Silver dial knobs skirts? Robert Enemark, W1EC, Box 1607, Duxbury, MA 02331

---

**CLASSIFIED ADVERTISEMENTS**

---

**FOR SALE:** Exceptional AK 40 with original matching E-3 speaker, looks and plays like it did in 1928 - \$100 plus UPS. Robert Rathbone, Rt. #1, Box 127, Ossipee, NH 03864. (603) 539-2762

**FOR SALE:** 1949 RCA Victor TV Model 6-T-65, beautiful solid mahogany floor console, 13" screen - \$210. C. Schwarzkopf, Harvard Rd., Stow, MA 01775. (508) 897-7417

**WANTED:** 8AP-4A CRT. Fred Emerson, 627 Illinois Ave., Elgin, IL 60120

**WANTED:** Top dollar paid for old National sets like SW-4, SW-34, SW-45, SW-58 & access. or will trade old choice sets. Also need good Type 6199 photomultiplier tube. Robert B. Enemark, W1EC, Box 1607, Duxbury, MA 02331. (617) 934-5043

**HELP:** Need info on Espey Mfg. Co., NYC, for article. Made 3" TV kit, Model 517K in late 40's, also radios and hi-fi gear. Claimed to be 25 yrs. old in 1953. Formerly of 528 E. 72nd. Will interview you at your location. Also will buy Espey radios & TV. Richard L. Evans, PO Box 491, Souderton, PA 18964. (215) 257-8906

**FOR SALE:** Radiola 100A(?) speaker cabinet only, cloth torn - \$15. GE Model #226 - \$45. Dan Hays, 4 Monterey Dr., Newark, DE 19713. (302) 368-2138

**WANTED:** Philco Transitone Model 49-501 (F.O.S., p. 140). Alan Brooks, 623 S. Pine St., Seneca, SC 29678. (803) 885-0364, after 7 pm

---

**CLASSIFIED ADVERTISEMENTS**

---

**FOR SALE:** Strange looking RCA 867 tube, DeForest DV-5, and Westinghouse WD-12, brass base with tip. Fred Geer, 6042 Brookridge Rd., Jacksonville, FL 32210. (904) 771-7828

**FOR SALE:** Thousands of used vacuum tubes, tested good - 50¢ and up. Write for quotation. C. A. Lutz, 1021 N. Hickory Pl., Broken Arrow, OK 74012

**WANTED:** Back cover, volume knob, and owner's manual (Xerox copies OK), for Zenith 5R312. Douglas D. Fox, 1324 N. Russell Ave., Aurora, IL 60506. (708) 896-5490

**FOR SALE/TRADE:** Ambassador-Allied 3-tube battery 1920 radio, good condition. Paul Fulton, 711 Jacquelyn Rd., Westwood, NJ 07675. (201) 664-7628

**FOR SALE/TRADE:** AMRAD 3366, WE 2A power supply (216 rectifiers), Clapp-Eastham HZ. Bob Wallace, W1HH, 146 Westford St., Chelmsford, MA 01824. (508) 256-6777

**WANTED:** Radiola Horn UZ-1325, Westinghouse tuner Type-RA and two-stage amplifier Type-DA, Hallicrafters Model S-53. H. Vernon Lee, 6601 Sausalito Ave., West Hills, CA 91307. (818) 346-6984

**FOR SALE/TRADE:** DeWald A-502, brown, highly marbled, butterscotch knobs. **WANTED:** E. H. Scott radios, parts and literature. Jack Sacra, 1720 Solomon Rd., Charlottesville, VA 22901. (804) 293-9985



★ ANNUAL ★  
CONVENTION

**HOUSTON VINTAGE RADIO ASSOCIATION  
AND  
ANTIQUÉ WIRELESS ASSOCIATION**

April 7-8, 1990 - Astrodome Marriott, Houston, TX  
(713) 799-8362, Special Rate \$49

**Events include:**

Old equipment contest • Auction banquet with featured speakers "Hudson and Harrigan" Team, morning show hosts of KILT-FM • Door prizes will be awarded • Flea market - Swapmeet

**Family activities:**

Astroworld Fun Park (free Marriott shuttle) • Houston Museum of Natural Science: Planetarium, IMAX Theater • Herman Park Zoo. (All within minutes of the Astrodome Marriott)

**More information: Bob or Cathy Botto,  
3505 Del Sur Dr., Baytown, TX 77521 - (713) 468-4911**

**CLASSIFIED ADVERTISEMENTS**

**FOR SALE:** All excellent to mint cathedrals: AK 626 - \$450. Philco 70, brass escutcheon - \$375. GE K60 (F.O.S., p. 89) - \$240. GE A52, roundtop - \$145. Philco 37-61 - \$150. Tombstones and roundtops: Sparton 617, large round black dial - \$185. Detrola, small round dial - \$140. Fairbanks-Morse M70, round dial - \$185. AK 337 - \$285. Philco 116 (F.O.S., p. 124) - \$300. Novelties: Radiokeg, large barrel - \$225. Abbottsware horse w/saddle - \$175. Dumont, small white, Chinese - \$85. Wood chest radios, small maple Emerson - \$185. American-Bosch, large chest, ornate moldings, brass handles - \$335. Small wood table models: Emerson (similar to F.O.S., p. 82), 1933 - \$125. FADA, square flat-top - \$125. Crosley Playtime grandfather clock, complete original - \$245. Consoles: Philco 38-690 roll top, 6 speakers, super mint - BO. Sparton 301 (G.T.O.R., p. 53), ornate carvings with doors - \$350. Free photos. Joe Milano, 61 Furman Dr., Wayne, NJ 07470. (201) 694-3721, call between 6-9 pm

**FOR SALE:** Old tubes, radio parts, books and diagrams. Large SASE w/2 stamps for list. Glenn Blizzard, PO Box 1364, Suffolk, VA 23434

**WANTED:** Aircraft radios WWII and earlier, U.S., Japanese or German. Command xmtrs. BC457/8 and rcvrs. BC453/4/5. BC348, BC433 radio compass, BC375, ART13, Navy RU3-RU19. Any companion pieces such as tuning units, coil sets, etc. Western Electric Models 9-20. Interested in anything aviation related. Also want Regency TR-1 and Philco T7 transistor radios. James Treherne, 11909 Chapel Rd., Clifton, VA 22024. (703) 830-6272

**CLASSIFIED ADVERTISEMENTS**

**WANTED:** Chassis and speaker for Philco 89B or Philco 37-60. Should be complete, working or not, tubes not required. Dial glass, knobs, and output transformer, with or without speaker for Zenith 4F133. Doug Robertson, Rt. 2, Box 905, Kings Mountain, NC 28086. (704) 484-0822

**FOR SALE:** Viscount twin speaker, tuning eye AM/FM, table model, works, very good shape - \$35. RCA #56X5 wood table model AM/SW tubes lite, cabinet needs cleaning up - \$20. Realistic Pro-2 Hi/Lo bands, manual tuning receiver, good shape, works - \$25. Zenith #MH910 green Bakelite top & sides, white plastic grille cloth, table model, like new, FM only - \$35. Emerson #895 Series B, larger wood table model, AM/FM, mint condition - \$60. GE, no model number, Bakelite, wood grain sides, white front, table model, AM only, no cracks - \$20. Bradford, small plastic portable, IO transistor, AM/FM, good shape - \$10. Shaun, AM/FM, AC/DC, portable, black leather case, built-in battery charger, clean, works - \$25. Lafayette Model Lo-Hi-U, hand held scanner, 4-channel, 3-band, priority 1, w/manual & ducky, very good shape, works - \$45. Sears Model 5028, TV, clock, radio, wood, table model, junker, all parts including CRT - \$15. **WANTED:** TV picture tube #9WP4, must be new or as good as new. All above plus shipping. Dan De Marco, 8 Florence St., Auburn, NY 13021. (315) 252-4579, eve.

**FOR SALE:** Radio Manufacturers of the 1920's, Vol. 1 - \$19.95, Vol. 2 - \$24.95. Add \$1.50 each postage. Large SASE for list of current books about radio. Sound Box, PO Box 226, Ettrick, WI 54627

**Are you missing.....SIGHT SOUND STYLE ??**

**SSS gives you:**

- Original Articles
- Current Prices Given
- Lots of Photos
- Classified and Display Ads

**SSS is exclusively devoted to:**

- Vintage TV's - From 1925 to 1965 Mechanical to Transistor!
- Catalin, Plaskon, Mirror and other valuable radios!

1 year (4 issues) USA 1st class ....\$14  
 Overseas Via Air .....\$34  
 Back Issues .....\$4 each

**SSS — PO Box 2224,  
 South Hackensack, NJ 07606**

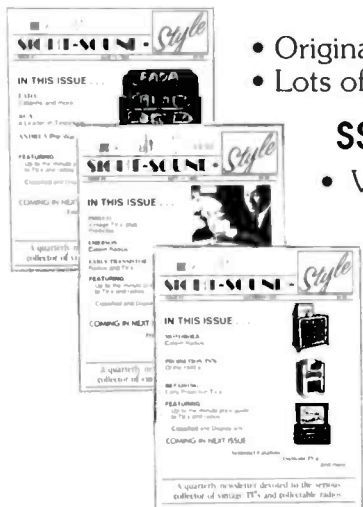

## CLASSIFIED ADVERTISEMENTS

**FOR SALE:** Blaupunkt Santos Deluxe - \$30. B+O int. stereo amp, Type 608 - \$150. Murphy, Type A262, English set - \$22. RCA 100A speaker, cabinet needs work - \$10. GE Model 428, plastic - \$10. GE Model 422, plastic - \$15. Setchell Carlson Model 427, plastic - \$25. Philco twin speaker, turquoise plastic - \$17. Motorola Model 61L12, leatherette - \$14. Zenith Bakelite, dark brown, handle on top - \$22. Admiral, Bakelite, maroon, taller, side knobs, handle on top - \$20. Airline, Bakelite, Model 54BR-1504A - \$15. Stromberg-Carlson Model 1400H, Bakelite - \$25. GE Model 202, Bakelite - \$15. Grain Belt radio/baseball scoreboard - \$30. Philips tuner/wood cabinet, mono, AM/FM/SW1/SW2 - \$45. All plus UPS. No checks. Please call first. Jerry & Debbie Schliepp, 831 Berlin Rd., Ripon, WI 54971. (414) 748-2471

### One Month Free!

#### BONUS FOR EARLY RENEWALS

If you renew **before** the month shown on your mailing label (your expiration month), you will receive an extra month on your subscription: 13 months instead of 12! 26 months for an early 2-year renewal!

**FOR SALE:** Howard Model 909 - Tom Thumb camera radio. Westinghouse Model H127. Tube tester Model 700 BK. Martin Kirk, 801 Washington Ave., Bakersfield, CA 93308

**WANTED:** Wilcox-Gay Model A-17. Cabinet is drum style (round). Other round sets also wanted. Scott Hagerman, 392 Ann St., Cary, IL 60013. (708) 639-7745

**FOR SALE:** FADA Model 790, brown, (G.O.R., p. 111), excellent original condition - BO. Rick Yerke, PO Box 392, Moscow, PA 18444. (717) 842-4857

**WANTED:** RCA 9-EY-3 45 rpm record changer, first of its kind, ca. 1949, excellent condition. Also big premium for original boxed introductory collection of multi-colored translucent records. Richard L. Evans, WA3FOQ, PO Box 491, Souderton, PA 18964. (215) 257-8906



**TIMELESS RADIOS**  
87 Stonewood Place  
Catasauqua, PA 18032  
(215) 264-8412  
Jerry Finamore

— **FOR SALE** —

**QUALITY RADIOS**

**LARGE SELECTION OF ALL TYPE  
RADIOS AND ACCESSORIES.**

**SEND SASE TODAY FOR LIST!**

## CLASSIFIED ADVERTISEMENTS

**WANTED:** RCA Red Book for RCA Model 18 radio. Also information on repairing it. Also owner's manual for it. Mark Twarozek, 11760 Mile Block Rd., North Collins, NY 14111

**FOR SALE:** Elmac transmitter Model A54H and Elmac Rec. Mod. PMR 6A with books. Also a Knight T60 transmitter 80 thru 6 mtrs., no book. Call or write. J. A. Ross W6JPS, 5468 East Grant Ave., Fresno, CA 93727. (209) 255-7912

**HELP:** Need driver and handle for Radiola 26 portable receiver. Will buy outright or will trade Radiola X or Atwater Kent Type 5V driver. Ernie Nagy, 1599 Boxford, Trenton, MI 48183. (313) 676-6491

**WANTED:** Faceplate, outer dial glass, escutcheon and magic eye bracket for later E.H. Scott Philharmonic. Scott Guthrie, 307-234 Willow Rd., Guelph, Ontario, Canada N1H 7C6. (519) 767-0159

**FOR SALE:** Say Happy Birthday to Frankenstein's and take 10% off of your next order, excluding shipping. Limited stock of Eveready #738 dual 45-volt B batteries and #761-T 4 1/2 volt multi-taped C batteries. Sold out of Marconi stock. LSASE. FRL, 4010 Fairmont Pkwy., 285, Pasadena, TX 77504

**FOR TRADE:** Radio News, Radiocraft/Radio-Electronics 1945-57. Want to trade my duplicates for issues I need. Let's exchange lists. Al Smith, 25 Stonehedge Rd., Lincoln, MA 01773. (617) 259-9351

## WANTED WWII GERMAN

**ELECTRONICS, OPTICS,  
AND FIELD EQUIPMENT**

**Historical Display Being Assembled**

**"Not to glorify, but to preserve  
and remember  
the U.S.'s great struggle"**

CALL OR WRITE: Steve Puntillo  
1911 Rowley Avenue  
Madison, Wisconsin 53705  
(608) 233-1569 Home, 251-6121 Work

Call either number between  
11:00 a.m. & 11:00 p.m. Central Time.

**Send photo of your unit if possible.**

**CLASSIFIED ADVERTISEMENTS**

**WANTED:** 50's transistor portables and clock radios: Zenith Golden Triangle, Admiral 810 and 808, RCA TC-1 and 7-BT-9J, Philco T-1000 and TC-47, Emerson Transtimer 3, GE P715. Michael Arken, 1427 Diamond St., San Francisco, CA 94131. (415) 648-6727

**WANTED:** E. H. Scott and McMurdo-Silver sets, any set in Imperial Grande or Napier console. Mike Green, 19113 Alpenglow Ln., Brookeville, MD 20833. (301) 774-3203

**Classified Ad Deadline Noon**

**Mar. 10 for Apr. 1990 Issue**

**Apr. 10 for May 1990 Issue**

**Box & Photo Ads - 5th, Display Ads - 1st**

**FOR SALE:** New and used tubes, electrolytic capacitors, cone speakers. Send SASE for lists. C. Elmer Nelson, 11 S. Church St., Princeton, IL 61356

**WANTED:** RCA 242 chassis w/good power xfmr. Henry Brown, 2 Central Ave., Morris Plains, NJ 07950. (201) 538-2014

**FOR SALE:** FADA Model 740, white plastic, hums, missing knob, excellent condition - Best Offer. Tony J. Schroeder, 703 S. Pears Ave., Lima, OH 45805. (419) 224-1128

**HELP:** Information on five-tube battery set with panel markings Airline Roamer. John Webb, 12736 Erin Dr., Auburn, CA 95603. (916) 885-9556

**CLASSIFIED ADVERTISEMENTS**

**WANTED:** Speaker for Philco 20. Cabinet for Zenith 6S321. Crosley 167 cathedral. **FOR TRADE:** Zenith R-600, 5R312, Crosley D-25, 58TC maroon swirl. Royal "Skip" Shaw, 2095 North Ford St., Clarksville, TN 37042. (615) 647-7220

**WANTED:** Power supply or plans for building one for AK 70 radio. Voltages are 45, 67.5, 135, 180. L. M. Ransdell, 533 S. Maple St., Winchester, KY 40391. (606) 744-6368

**FOR SALE:** Surplus electronics: BC-375/191 tuning units - \$50. Sony 5" TVs - \$35. Military resistance bridge - \$35. Digital frequency counters - \$35. Bell and Howell 614 sound projector - \$100. Zexon arc lamps - \$35. Original complete RCA image orthicon studio camera chain B&W from TV's Golden Age. Radar collectors: WWII design radar indicator TPS-1 - \$125. We buy and sell, SASE for list. Duplication services from old video or audio formats to new, CV, AV, recording wire, etc. Note our new address: RNI Surplus, Allan H. Weiner, 14 Prospect Dr., Yonkers, NY 10705. (914) 423-6638

**WANTED:** RCA Model 816K, any condition including parts. Chuck Dachis, The Hallicrafter Collector, 4500 Russell Dr., Austin, TX 78745

**WANTED:** Capehart motor, RCA R-99 Electrola, Victor 8-35 Orthophonic Victrola, Radiola 67, E.M.G. or Ginn Expert phonograph, and Capehart postwar 400 combination. Kenneth Snowden, 1238 Grove St., San Francisco, CA 94117. (415) 921-1326

**WANTED**

**ELECTRON TUBES - ST SHAPE**

50, ST19, large size .....	\$30	80, ST14 .....	\$4
45, ST14 .....	15	2A3, VT-52, VT-62 .....	6

**ANTIQUE GLOBAL SHAPE TUBES**

37/237 .....	5	145/245/345 .....	15
250,350,450 .....	30	210/310 .....	10
80/280/380 .....	10	UV202, Tip, Brass Base .....	25
UV201, Tip, Brass Base .....	12	UV216, Tip, Brass Base .....	20

**TRANSMITTING TUBES**

211/VT-4C/RS237 .....	15	845/845W .....	30
-----------------------	----	----------------	----

**WESTERN ELECTRIC TUBES**

101D, F, G/102D, F, G, E/216A/104D/D86326/D86327 Tennis Ball .....	20	VT2/205B .....	35
VT1/203B .....	20	101D, F/102D, F/104D, ST .....	6
205D, E, Tennis Ball .....	40	205F, ST .....	15
244A .....	6	262A/262B .....	10
252A .....	100	274A/274B .....	30
271A .....	30	300A/300B .....	80
275A .....	30	339A .....	20
348A .....	10	349A .....	6
350B .....	30	211D/211E .....	40
242C/261A/276A .....	25	284D .....	70
212D/212E .....	70		

**TRIAL ELECTRIC PRODUCTS, INC.**

201 Common City Yotsuya, 4-13 Suga-Cho, Shinjuku-Ku, Tokyo 160 Japan



## CLASSIFIED ADVERTISEMENTS

**WANTED:** FADA 1000 Bullet dial face to complete my prize. Please write or call. Paul Fulton, 711 Jacquelyn Rd., Westwood, NJ 07601. (201) 664-7628

**FOR SALE:** Available again History of Philco 1892-1961, unbound, 106 pages - \$20 ppd. John P. Wolkowicz, 11 Hartford Rd., Worcester, MA 01606

**WANTED:** Set of coils for Peerless Courier 65, United Reproducers Corp. Would consider complete chassis. Also need schematic and manual for RCA oscilloscope Model WO-56A. Xerox would be fine. Don Smith, 1323 North B St., Hamilton, OH 45013. (513) 894-5489

**WANTED:** On-off knob and speaker for a Charlie McCarthy radio #2 (Majestic). Also wanted an antenna tuner knob for a Zenith 4R (black). David McCartney, 1616 South Lincoln, Grand Island, NE 68801. (308) 384-0129

**FOR SALE:** Dyna ST 800 - \$50. Sony PS-X5 turntable - \$100. **WANTED:** Gonset Commander with 160 mtr. coil. Jack Troup, WA6JYU, 15 Rica Vista, Novato, CA 94947. (415) 897-3987

**WANTED:** Vogue picture records - buying Vogue picture records. Best prices paid for Vogues, Mercury, and Philco picture records, advertising or promotional picture records, any unusual or rare picture records, Vogue children's records, and any information on the Vogue company. Call or write: Michelle Manganaro, PO Box 535, Coopersburg, PA 18036. (215) 965-5538

## CLASSIFIED ADVERTISEMENTS

**WANTED:** Trophy baseball radio - pay \$400. Also Charlië McCarthy. Ed Levin, 13826 Ventura, Sherman Oaks, CA 91423. (818) 981-5325

**WANTED:** RCA record changers Model 45-J-2 or 9-JY, for 45's. Must be excellent/working. Tim Verthein, Box 44, Cohasset, MN 55721

**FOR SALE:** Audio, radio, tape recording and video magazines. Large list - \$1. Also 24 other collections that will be up for sale in 1990. Frank Toth, PO Box 45077, Westlake, OH 44145

**WANTED:** Authentic NBC chime set. S-38 in good working condition. Write or call. Bob Greenlee, 2060 Broadway, Suite 300, Boulder, CO 80302. (303) 444-0206, business hours

**WANTED:** Working IF transformer 175 Kc (mister #616-6600 175 Kc IF winding) or a working Majestic Model 15 chassis. Michael Koch, 495 Dallas Dr., Thousand Oaks, CA 91360. (805) 497-4379

**FOR SALE:** RCA 77-D ribbon microphone - \$1,000. Smokerette radio - \$200. Shure 55-S microphone - \$100. TeleTone television 5" screen - \$150. Philco 70 cathedral - \$250. Philco 38-15 chairside - \$100. Emerson (R.T.G.A., p. 31) - \$75. Catalin knobs, one yellow, two red - \$25 ea. Warren Dasho, 26 Kingston St., Reading, MA 01867. (617) 944-0470

**WANTED:** Pennsylvania Wireless Mfg. (Penn-C), Doolittle Radio Corporation, Claravox reproducers, radios, etc. George A. Freeman, W1K1, 102 E. Main St., Madison, IN 47250. (812) 265-6878

## 1990 PRICE GUIDE

\$40. USA

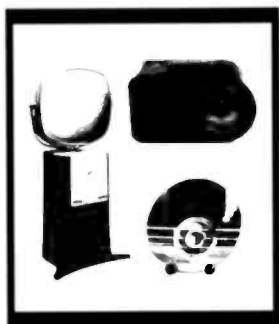

VINTAGE TV's, 1935 - 1960's  
— plus —  
CATALIN, NOVELTY and MIRROR  
RADIOS, 1935 - 1950's

Over 25 pages of  
Catalin & Mirror Radio  
descriptions and prices,  
plus vintage TV's - from  
prewars to Predictas.

**\$10 prepaid**

**\$14 C.O.D.**

**SSS - Box 2224**  
South Hackensack, NJ 07606  
201-794-9606 days  
(or leave message)

**CLASSIFIED ADVERTISEMENTS**

**WANTED:** General Radio Type 650P1 oscillator amplifier for General Radio impedance bridge 650A. Mickey Deems, 13114 Weddington St., Van Nuys, CA 91401. (818) 763-1055

**FOR SALE:** Two sets Navy mic. and headphones with manual - \$25 plus UPS. Kenneth Miller, 10027 Calvin St., Pittsburgh, PA 15235. (412) 242-4701

**NOTICE TO ALL  
CLASSIFIED ADVERTISERS!  
OUR CLASSIFIED AD DEADLINE IS  
12:00 NOON  
ON THE 10th OF EACH MONTH**

**FOR SALE:** Black Hopalong Cassidy radio - Best Offer. Will trade for Catalin radio. Bill or Scott England, 6729 Bellefontaine, Kansas City, MO 64132. (816) 444-0809

**WANTED:** Zenith tombstones; Models 835, 829, and 809. Will pay fair price/trade. Scott Meyer, 1205 E St., So. Sioux City, NE 68776. (402) 494-2079

**FOR SALE:** Atwater Kent Model 33 receiving set, excellent condition - \$100. Atwater Kent cathedral Mod. 84, complete, not playing - \$225. FADA Bakelite Mod. 203 Deco style, excellent condition & playing - \$85. JVC Videosphere TV, excellent condition & playing, unique and unusual - \$350 or offer. **WANTED:** Transistor radio, Crown, blue, Model TR-777. Rocket radio, crystal, red & white. Joseph Gambaccini, 192 Division Ave., Shelton, CT 06484. (203) 734-0271

**CLASSIFIED ADVERTISEMENTS**

**WANTED:** Atwater Kent AK 41 set, chassis, parts, literature. Jim Wilson, 861 Whitney Dr., Schenectady, NY 12309. (518) 372-9625

**WANTED:** RCA Series 77 microphone. Richard Hagerty, 3306 S. Dayfield Ave., Milwaukee, WI 53207. (414) 482-3995

**HELP:** Need instruction manual for Eico scope Model H25. Will pay \$20 plus costs. Rod Kennedy, 2 Teodora Ct., Moraga, CA 94556. (415) 376-7885

**WANTED:** RCA 143 & 128 cathedrals, in very good original shape, unrestored. Gilbert Smith, 248 South 36th St., San Diego, CA 92113. (619) 236-7990

**WANTED:** Parts for Zenith Model 3R. Will purchase junk chassis. Bill Boehly, 92 Salem Rd., Rochester, NY 14622. (716) 338-7613

**FOR SALE:** Kellogg Wave Master receiver with Kellogg The Symphony Reproducer, exc. cond. Zenith Trans-Oceanic, Model G500, vg. SASE for tubes and other radios. R. L. Ludlum, PO Box 1308, Martinez, CA 94553. (415) 228-1142

**WANTED:** Tech manuals, or copies of, for the R808/GRC14 ITT teletype receiver and the CRV 46123 VLF receiver, part of the DZ1 aircraft radio made by RCA. Also DZ1 components. Still need knobs for the Suitcase Trans-Oceanics, a spherical audion, a Philco Model 90 and tube type hearing aid radios. Bruce Ashcraft, 1300 Burrows Rd., Campbell, CA 95008. (408) 374-5228

**You heard it right.**

**The newest audio magazine  
is all about vacuum tubes!**

*Glass Audio* features the best vacuum tube designs for audio reproduction—past and contemporary. The new designs take advantage of improved components and control techniques that make the end results far superior to anything possible during the early days of audio's rebirth after World War II.

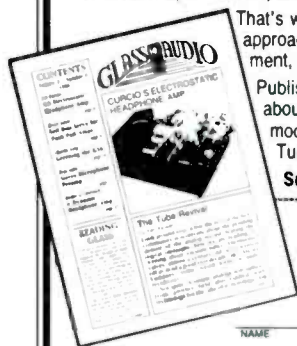

That's why tubes are having such a renaissance of interest as a perfectionist approach to good sound. And that's why tubes are reappearing in original equipment, in high end consumer and professional audio systems.

Published twice a year, in June and December, *Glass Audio* will inform you about new innovations in the field and about parts sources. We'll also include modification projects, reviews of technical basics and regular columns such as Tube Troubles, Tube Tips and much more.

**Subscribe today!**

**GLASS AUDIO**, PO Box 176, Dept. AR0, Peterborough, NH 03458

- Two years @ \$18 (SAVE \$2 on 4 issues)
- One year @ \$10 (2 issues) Canada add \$2 per year postage

Payment enclosed:  Check  MO  MC  VISA

NAME \_\_\_\_\_  
STREET & NO. \_\_\_\_\_  
CITY \_\_\_\_\_ STATE \_\_\_\_\_ ZIP \_\_\_\_\_ MC OR VISA NUMBER \_\_\_\_\_ EXPIRE \_\_\_\_\_

**CREDIT CARD ORDER LINES: VOICE:** (603) 924-9464; M-F, 9-4 EST  
**ANSWERING MACHINE:** (603) 924-9464 4 p.m.-8 a.m. **FAX:** (603) 924-9467—24 hours

## CLASSIFIED ADVERTISEMENTS

**FOR SALE:** Tubes, new and used. **WANTED:** Clear glass tube sockets, Burns, Majestic horns and parts. R. Dobush, 3554 W. 105, Cleveland, OH 44111. (216) 228-4953

**FOR SALE:** Radios, test equipment, speakers, tubes & parts - \$3 for introductory list and spring catalogue. Laurence Johnson, C-2-C, 77 County Rd., E. Freetown, MA 02717

**WANTED:** Giblin audio transformer or specifications for its reproduction. If you have one for sale or not, please contact me. I will take one in any condition or use specifications from yours to make reproductions. Thanks. Leonard Arzoomanian, 61 Columbus Ave., North Providence, RI 02911. (401) 232-0869

### HAS YOUR SUBSCRIPTION

### *EXPIRED?*

It has if your mailing label reads  
"EXP= MAR90" or earlier.  
Renew now!

*BONUS: Renew before  
your "EXP" month and receive  
13 issues per year instead of 12!*

Renewal rates are:

\$20.00 for Second-Class Mailing

\$30.00 for First-Class Mailing

(Two-year renewals are twice above rates.)

**HELP:** I need manual or service information and schematic for Philco Model 37-11 console. Charles Knight, 2102 Leona Dr., Greensboro, NC 27406. (919) 674-5950

**WANTED:** Vertical blocking transformer for Sony TV5-307UW Part #1-435-008-11 or non-working TV. Ron Palluth, 1917 Hamilton Dr., Flower Mound, TX 75028. (214) 539-9387

**WANTED:** Radar books, parts and historical info, especially equipment manuals. Morgan McMahon, 26356 Eastview Ct., San Juan Capistrano, CA 92675. (714) 364-1587

## WANTED

### Chicago Symphony Orchestra Broadcasts, pre-1965

Radio Acetate Cut Discs

Transcription Discs

TV appearance,

any format

Films

Steven Smolian  
8807 Postoak Road  
Potomac, Md. 20854  
(800) 228-7833

## CLASSIFIED ADVERTISEMENTS

**WANTED:** Chassis for Silvertone No. 140-743. Philco 89 cabinet. Silvertone 1965. Transformer for Majestic 50. (Power transformer). Dial glass for FADA 212. Also IF transformers 460 Kc, oscillator-antenna coils, pots. Wave magnet (antenna) for Zenith 7B02. Tom Hasija, 7167 N. Park Ext., Cortland, OH 44410. (216) 638-5508

**FOR SALE:** Rider's TV Volumes 1 thru 27 complete with index - \$200 plus shipping. Walt Curry, 10035 Country View Rd., La Mesa, CA 92041. (619) 461-9327

**WANTED:** Eveready 54, Scott Allwave 12, two mono or one stereo tubed amplifier(s), Dynaco, E.H. Scott etc. Scott Guthrie, 307-234 Willow Rd., Guelph, Ontario, Canada N1H 7C6. (519) 767-0159

**WANTED:** Motorola Ranger 700 portable radio (6P34, 6P25). RCA 9-C-7 clock radio. Motorola Astronaut TV. Michael Arken, 1427 Diamond St., San Francisco, CA 94131. (415) 648-6727

**FOR SALE:** Hallicrafters SX110, vg, plays well, both BC and ham bands - \$60 plus UPS. Doug Thomas, Rt. 8, Box 257A, Live Oak, FL 32060. (904) 658-2378

**WANTED:** Driver for Crosley Super Musicone (have cones for Super and regular Musicones for trade), good driver for Brandes cathedral speaker, base for Victor Leader horn, Kolster paw foot speaker, Kilograd vernier dial (mahogany color), and chassis for Bosch 5A. Ken Martin, 12667 Eckard Way, Auburn, CA 95603. (916) 885-0243

## JOIN

## A. W. A.



ONE OF THE WORLD'S LARGEST AND OLDEST  
HISTORICAL RADIO COLLECTOR ORGANIZATIONS.

- \* International "Meets"
- \* Nationwide "Meets"
- \* Sponsors world's largest radio Conference and Flea market
- \* Maintains unique radio and television museum
- \* Publishes quarterly journal featuring columns covering:
  - Battery & AC receiver restoration
  - Loudspeaker operation
  - Commercial receiver column
  - OT amateur transmitter operation
  - Vacuum tube collector's column
  - Early television receiver column
  - Current radio book & magazine reviews
  - Free Want-Sell-Swap column
  - Radio obituaries
  - Reports on public radio museums
  - Information on collector clubs in U.S.A. and foreign countries

All this for only \$10.00 per year. Mail check to:  
Antique Wireless Association, Inc.  
Box 2-E, Breeseport, New York 14816

**CLASSIFIED ADVERTISEMENTS**

**FOR SALE:** Vega FM mike receiver, 25-45 MHz - \$20. (6) Early transistor radios; GE, RCA, etc. - \$65/all. (4) Record changers - \$6/all. Auto radio, 1955 Ford, plays - \$35. **WANTED:** Tube or tube type number for German Mende 5-tube radio; it has AZ1, AB2, AK2, and AF3. Control heads, remote for Motorola 352 & 701 auto radios. **FOR TRADE:** Cardon 373, (V.R., p. 188), for Sodian, Moorhead or on other rare tube w/good filaments. Checks for item only; shipped UPS collect. John Martin, 817 Cook Ave., Billings, MT 59101. (406) 252-4287

**FOR SALE:** Eico 666 tube checker - \$25 plus UPS. Kenneth Miller, 10027 Calvin St., Pittsburgh, PA 15235. (412) 242-4701

**WANTED:** Instruction booklet or Xerox copy for RCA WT-110A automatic electron tube tester and plastic cards. State cost! E. Barbacow, 330 Ceylon Rd., Carmichaels, PA 15320

**WANTED:** Top blue mirror for 4-knob Spartan table model radio. Warren, 1606 Idylwild Dr., Prescott, AZ 86301. (602) 778-1608

**FOR SALE:** Old military radios and parts. Some command sets. Lg. SASE for list. Walt Hutchens, 3123 N. Military Rd., Arlington, VA 22207

**FOR SALE:** Langevin amplifier Model 108C. Audio and power transformers. Dial glass for 6516 Crosley. General Telephone CB MC-5. BC-348-L AC Model Fresham Q. Send SASE for details. Henry Kuhn, W8ERG, 1397 Washington Circle, Forestville, OH 45255

**VIBROPLEX  
Collector's Guide**

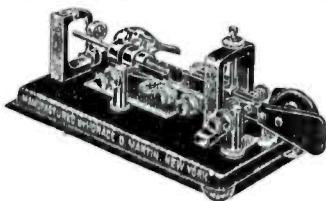

- ✓ **HISTORY OF EVERY KEY**
  - ✓ **IDENTIFICATION GUIDE**
  - ✓ **COMPLETE KEY PATENTS**
- and much more ---

Softbound, 87 pages.  
**ONLY \$14.95 plus \$2.00 S&H (U.S.)**  
 Foreign orders: \$5.00 S&H  
 Mass. residents add 75¢ tax

**ARTIFAX BOOKS**  
 Box 88-A, Maynard, MA 01754

**CLASSIFIED ADVERTISEMENTS**

**WANTED:** 2 ea. Eimac 3-500z. Also QSL card W1ZO. 1930's-40's Fellsway Radio Club, Medford, Ma. C. Anderson, RFD 1, Box 663, Hampden, ME 04444

**FOR SALE:** Best-Tone 2 transistor boy's radio, Japanese, vest pocket, ivory plastic, plays - \$85. Happy Time vest pocket Model No. 649-23020, blue, fine, plays, Silvertone, 9v transistor, U.S.A., in leather case, vest size - \$55. Westinghouse Model H-58787 vest pocket, fine, plays, black plastic, U.S.A. - \$55. Chanel Master Model 6506, Japanese, 6 transistor, black, fine, plays, vest pocket in leather case - \$45. Global 6-transistor, 9v, black and gold, fine, plays, Japanese, in handstitched leather case - \$55. Edison Mabry, 715 W. Longview, Mansfield, OH 44906. (419) 526-1175

**HAVE YOU MOVED? ARE YOU MOVING?  
 PLEASE NOTIFY US A.S.A.P.  
 SEND US YOUR...  
 OLD ADDRESS  
 NEW ADDRESS and  
 SUB #  
 MANY THANKS!!!!!**

**FOR SALE:** Drake 1-A receiver with matching speaker, mint condition - \$250 plus shipping. Dan Graham, 104 1/2 W. District St., Tucson, AZ 85714-2528. (602) 294-3748

**WANTED:** Power unit, audio unit, Dynamic speaker, could also use tuner for Sonora Model A-32. Mike Cherry, HCO 3, Box 326, Pocahontas, AR 72455

**WANTED:** H. H. Scott 120A mono preamplifier and H. H. Scott 310A mono tuner. Robert Langer, 277 Main St., Marlborough, MA 01752

**FOR SALE:** Large selection of N.O.S., good used tubes and other parts. LSASE for list. Jeff Moskow, WA11, Rustic Trail, Groton, MA 01450. (508) 448-5516

**WANTED:** Ulric Childs amps. Info old tube audio, broadcast gear literature. V. Vogt, 330 S.W. 43rd St., #247, Renton, WA 98055. (206) 251-5420, ext. 247

NEEDS MORE 40's, 50's, 60's COLORFUL PLASTICS



LES WAGENHEIM (216) 442-1600  
 XONEX 750 Beta Drive Mayfield Village, Ohio 44143

CLASSIFIED ADVERTISEMENTS

**FOR SALE:** Bendix wood #636C - \$65. Hallicrafters #8R40 - \$75. Lafayette 11-band #8812 - \$150. Plus shipping & handling, all nice, list. Richard L. Bednarcik, 28 Steele Ave., Lincoln Park, NJ 07035. (201) 694-6374, evenings

**FOR SALE/TRADE:** AK 19. FADA 652, needs restoration but no cabinet cracks. AK 10C, needs restoration. **FOR TRADE:** For trade only: Emerson AU 190, orange. **WANTED:** Zenith 12-S-232 or 9-S-232. Timbretone violin speaker. Mickey Mouse 411. Factory Quaker Oats crystal set. Amplion speaker AR-23. Kennedy 521 amplifier. Pilot Dragon cathedral. Voice from Sky speaker. Emerson Charlie McCarthy. Wallace Geary, 209 W. Saunders, Mt. Pleasant, IA 52641. (319) 385-2389

**FOR SALE:** Novelty transistor radios, N.I.B. Mickey Mouse armchair, N.I.B. Red High Heel Shoe, N.I.B. radio which changes into a Robot, new Coke Can radio, new Big Bird, new Mickey Mouse (square), new Lunch Box radio, Green Giant Sprout, Snoopy, Cabbage Patch Girl, Schlitz Beer Can, Mork from Ork, older Metal Knight with face, 1931 car radio, small cathedral radio. Shipping extra. John Miller, 7437 Jeffrey Ln., S., Cottage Grove, MN 55016. (612) 459-0939, call after 6:30 p.m.

**WANTED:** Speaker. Help. My speaker for Philco 46-1201 was lost at reconing co. for radio (shown F.O.S., p. 135 and p. 136 with Bing Crosby). Four wires red to brown, white to white, black to black, blue to blue. John D. Hubble, 1105 W. Dartmouth, Flint, MI 48504

CLASSIFIED ADVERTISEMENTS

**FOR SALE:** Fisher Stereo Master control amplifier, Model X-101, clean with 11 good tubes - \$25 plus UPS. Neil Spencer, W4PC, 4665 75th Ave., North Pinellas Park, FL 34665. (813) 546-8711

**FOR TRADE:** Original FADA maroon butter-scotch streamliner, working. For 1939 World's Fair or Snow White Dwarfs radio. Otto W. Nill, 192 Grant Ave., Islip, NY 11751

**WANTED:** Two chrome-plated knobs for my Sparton 506 Bluebird. Knobs for a burgundy FADA 1000 Bullet. Lyle Scheid, RR 2, Box 17, Iroquois, SD 57353

**FOR SALE:** RCA UZ 1325 horn speaker in good condition, works - \$85. Western Electric 540-AW cone speaker, needs cone repair or for parts - \$35. Peerless cathedral speaker, needs some wood repair and refinish - \$20. Kevin Eftink, 16 Edgewood Dr., Quinoy, IL 62301. (217) 228-2221

**FOR SALE/TRADE:** Highway hi-fi car record player with 6 records - BO. Signal Corps RA-42-B power supply, works - \$20. Atwater Kent 20 in Pooley cabinet - \$150. Hawkins Electrical Guide Vols. 1-10, 1927 - \$25. N.O.S. 4CX250K tubes - BO. Also many other new/used, send wants. LSASE for list of much more! **WANTED:** Crystal sets, BB/TT 01-A's, WD-11's, WD-12's, etc. Echophone cathedral chassis, Model S-5. U.S. Gioritone cathedral cabinet, Model 99A. Switch (?) and plate on right side of Steinite cabinet radio. Xtal detector assembly for Steinite xtal set. Thanks! Michael Crain, RR 1, Box 472, Harveys Lake, PA 18618. (717) 639-2794, after 5:30

## Radio Collection at Auction Saturday, March 31st, 10 am

Over 100 radios from a Minnesota collection including **Atwater Kent** breadboards, **Metrodyne** w/fancy silk panel, **McMurdo-Silver** Masterpiece II Super Tuner & speaker, **Priess** Straight Eight, **Crosley** Model 51, Radio receiving set Model AN/GRR-5, **Neutrowound** Superpower, **Grebe** Synchrophase Model 1, **Philmore** crystal set, **Radiola** Senior, R.S., **Radiola** III, **Radiola** IIIA, **Scott** Deluxe tuner, **Scott** 16 Model 1938, **Scott** Phantom AM, & others, 20 speakers 15 consoles, choice radios accepted.

Call today for details. Write for listing.

On display Monday-Friday, 9-5

**Gene Harris Antique Auction Center**

203 South 18th Avenue, PO Box 476  
Marshalltown, Iowa 50158 - (515) 752-0600



---

**CLASSIFIED ADVERTISEMENTS**

---

**WANTED:** Philco knobs, brown, used on many 1936-38's and knobs for Detrola 571L. Spencer Doggett, 61333 North Ridge Trail, Romeo, MI 48065. (313) 651-3811

**WANTED:** Info on Radiola 17. Intermediate frequency, alignment, speaker info. Type, impedance, etc. Parts. List. Anything. I have the schematics. Charles O'Connor, 4520 S. Gregory, Saginaw, MI 48601

**FOR SALE:** Comet Super Pro receiver, eight coils - \$35 plus shipping. Jim Barrows, 15121 41st Ave., SE, Bothell, WA 98012. (206) 337-4880

**WANTED:** Good magnetic pick-up head for Radiola RE-45. Burt, 1000 Plaza del Sol, Roswell, NM 88201

**WANTED:** Complete set of knobs for a National NC-300. H. Galbraith, 1214 S. Alvord, Evansville, IN 47714. (812) 476-7601

**HELP:** Back for Majestic Charlie McCarthy No. 1, complete tracing or rubbing of same! Don Mier, 4009 N. Foxdale Ave., Covina, CA 91722. (818) 338-9225

**WANTED:** Horn speakers, complete or parts. Zenith 8-tube chassis, ca. 1936. Richard Anthony, 2551 Andler Rd., Placerville, CA 95667

**WANTED:** Professional recording lathes, blank discs, accessories, old jukeboxes, Coke machines, 50's R&R-R&B records, etc. Kim Gutzke, 7134 15th Ave., S., Minneapolis, MN 55423

---

**CLASSIFIED ADVERTISEMENTS**

---

**FOR SALE:** SASE w/2 stamps gets large list of cheap radios, magazines, Riders, parts, literature. P. Majewski, PO Box 92, Tamaqua, PA 18252

**WANTED:** Brunswick 5NO (V.R., p. 147). Complete set or empty cabinet OK. Pete Rusch, 2711 Struher Dr., Rocky River, OH 44116. (216) 333-6035

---

**CLASSIFIED AD NOTICE**

Please check your ads carefully before sending them in.

It is difficult to make changes to ads once they are received.

---

**FOR SALE:** Cathedrals: Philco 37-84, AK 217.

**WANTED:** Jackson Bell Peter Pan. Tom Dell, 55 Carson Ave., Hanover, PA 17331. (717) 637-8875

**WANTED:** Dual dial pointers: 1-red & 1-white from a 5S or 6S Zenith radio with airplane dial. Earle Drake, Box 1808, Hyannis, MA 02601

**FOR SALE:** Power, filament transformers, chokes (low). Advise size, voltage, amps, resistance. Include SASE for reply. Leon Horsted, 6616 CTH I, Waunakee, WI 53597. (608) 846-3287

**WANTED:** B&W 40TVH plug-in coil. James T. Schlietstett, W4IMQ, PO Box 93, Cedartown, GA 30125. (404) 748-5968

**FOR SALE:** Spark xmtr., complete - \$350. Radiola IIIA, excellent - \$150. **WANTED:** Any pre-WWII xmtr. S. Mount, K20A, 35 Grand St., Highland, NY 12528. (914) 691-7957

## RADIO AGE is moving ahead.

*Have you ever wished you could have a fresh source of new ads every two weeks? Now you can! After 17 years, RADIO AGE is moving its publication date forward two weeks to come out around the 12th of each month. Why not give it a try and see what you've been missing!*

- Each monthly issue contains 50% classified advertising.
- Subscribers get a FREE 50-word "For Sale" ad and FREE 25-word "Wanted" ad each issue.
- Bigger and better photos than ever . . . and more pages, too.
- Original articles by noted experts and historians.

Write for a FREE sample copy. Or, if you prefer, we'll add you to the mailing list at our special two-year rate: First Class (mailed in an envelope) \$37/2 years or \$20/year (U.S.) \$40/2 years or \$21/year (Canada), or Second Class (slower delivery) \$32/2 years or \$17/year. Foreign subscriptions are \$38/year.

RADIO AGE · 636 Cambridge Road · Augusta, GA 30909 · 404/738-7227

**CLASSIFIED ADVERTISEMENTS**

**FOR SALE:** Pinball, Gottliebs Surf Champ - Best Offer. Jukebox, Rockola Model 1452 - \$1,950. Bruce Hoven, 120 S.E. 11 Ct., Deerfield Beach, FL 33441. (305) 428-5463, 7-10 pm

**WANTED:** Polleroyal Gem of the Air radio parts. Anything from the front panel back, including tuning caps, tuning coils, tube sockets, knobs, and schematic. I have a good case and front panel but only half a chassis. Radiola 30 power unit Model AP947. Good Bakelite base, no tip WD-11. Leonard Arzoomanian, 61 Columbus Ave., North Providence, RI 02911. (401) 232-0869

**Classified Ad Deadline Noon**  
**Mar. 10 for Apr. 1990 Issue**  
**Apr. 10 for May 1990 Issue**  
 Box & Photo Ads - 5th, Display Ads - 1st

**WANTED:** Atwater Kent horn speaker base 8.5" dia. steel. R. Chenez, 47 Lake St., A605, Gardner, MA 01440

**FOR SALE:** BK oscilloscope Model 1472C, 15 MHz - \$200. Simpson Model 479 TV-FM signal generator - \$45. Eico Model 460 oscilloscope - \$35. Realistic Model RP 148/175 communications receiver - \$35. Philco Model 7001 electronic circuit master test meter with probe - \$30. Weston Model 665, Type 3 selective analyzer - \$50. Link Electronic Engineers Type 410 test meter unit - \$50. All plus UPS. Carl Greenbaum, 9 Old Coach Rd., Hudson, NH 03051. (603) 889-6853

**WANTED:** Majestic power pack 9-P-6 for console Model 91. Chassis Model 90. Stan Kleen, 200 Castle Dr., Kettering, OH 45429. (513) 293-3194

**WANTED:** 4 knobs for Zenith Royal 760 chassis 8AT4222, or reproduction. Mario A. Portalatin, 1628 NW 16 St., Suite No. 3, Miami, FL 33125. (305) 545-9121, call collect

**FOR SALE:** B&K Model 415 sweep marker gen. - \$75. Bendix green, black Catalin - \$400. Grebe CR8 - \$400. Elvis singles with sleeves. Call Vaughn Rudisill, 222-22 Edmore Ave., Queens Village, NY 11428. (516) 822-4501, days. (718) 465-6702, eves.

**WANTED**

- NEUTROWOUND RADIOS
- UNUSUAL HORN SPEAKERS
- CRYSTAL SETS
- WIRELESS
- OLD TELEPHONES

TIMELESS RADIOS - Jerry Finamore  
 87 Stonewood Place  
 Catasauqua, PA 18032 (215) 264-8412

**CLASSIFIED ADVERTISEMENTS**

**WANTED:** Velvet vernier dials types A, B, BM. N.O.S. phenolic plug-in coil forms. George Flanagan, W2KRM, 42 Cygnet Dr., Smithtown, NY 11787. (516) 360-9011

**WANTED:** DeForest rectifier Type HR, Schicklering tubes and iconoscope. U. Radtke, ImFuechtei 143, D-4830 Guetersloh, DJ5KG, West Germany

**FOR SALE:** Admiral action radio, Cleveland Browns 6-transistor Model Y701R vest pocket, plays, black and silver, mint in box - \$75. Julette Model APR-206-A, Miami, Fla., transistor, grey plastic, plays, solid-state, mint in box - \$55. Omega Deluxe 8-transistor, ivory plastic, plays - \$55. GE Spirit of 76 Model 7-2753D, mint in box - \$45. Emerson Model 93400B, 9v, U.S.A. nj (?) with emblem on back, fine, plays, lg. Emerson emblem front, grey-white plastic transistor - \$55. Zenith Royal 50 red plastic 2 penlite AA bat. transistor plays, in fine, U.S.A. - \$55. Contineal transistor 6 Model TR182, fine - \$55. Edison Mabry, 715 W. Longview, Mansfield, OH 44906. (419) 526-1175

**WANTED:** Zenith Royal 475 and 250 portables. Sams 613-16 and 520-17 originals. Jack Philpot, 632 E. 160th Ct., South Holland, IL 60473. (708) 596-0580

**WANTED:** Push-button assembly and/or scrap chassis for Belmont (R.T.G.A., p. 69) Model 6D111, or will accept complete junker radio with push buttons. Kim Stephenson, 1185 Potters Wheel Cres., Oakville, Ontario, Canada L6M 1J3. (416) 827-2135

**FOR SALE: New Capacitors!**  
**Fully Insulated, With 7" Leads**  
**All Postpaid**

33 µf/47 µf dual units @160 volts.....	\$3 ea.
Four .....	\$10
22 µf/47 µf dual units @250 volts..	\$3.50 ea.
Four .....	\$12
10 µf single units @450 volts .....	\$2 ea.
Five .....	\$8

**DIAL BELTS** for most radios. Send all data available, cut length, width, model number, chassis number, brand name, or old belt.  
 New or N.O.S. .... \$10 pppd.

**GRILLE CLOTH** loose tweed like, light brown & sand color. Sample 50¢ stamps or coin.

14" x 18" postpaid.....	\$7.00
26" x 36" postpaid.....	12.50
36" x 54" postpaid.....	24.00

**FRONTIER ANTIQUES - E. Hoard**  
**PO Box 38, Lehr, ND 58460**  
**Snow Birds - No Phone**

## CLASSIFIED ADVERTISEMENTS

**HELP:** I have a Clinton Model 216 receiver built in Chicago plant A. Does anyone have information on this company or receiver? Jay Kinnard, 623 Amesbury Ln., Austin, TX 78752. (512) 452-7018

**FOR SALE:** RCA Drum speaker 100, excellent condition - \$100 + \$5 UPS. George Friedrich, 7162 Lake Jacqueline, Custer, WI 54423

**WANTED:** N.I.B. tubes: 1620, 5692, 6006, 6073. Manuals or photocopies for the following: Barker & Williamson 410 distortion meter, General Radio 544B megohm bridge & 740B capacitance bridge, Hewlett-Packard 202C oscillator & 410B VTVM, Waveforms 512 oscillator, Webster-Chicago 288-1R wire recorder. Clarostat Type 58 4-watt wire-wound pots, 7.5K & 50K values. Alan Kriss, 1872 Portsmouth Way, Union, NJ 07083. (201) 688-2092

**FOR SALE:** Interesting collector tubes N.I.B.; VU111S Canadian GE, large ST shape, spray-shielded top. 2C40, 2C44 lighthouse, 2C34 dual triode, two plate caps on top - \$2.50 ea.

**WANTED:** Tube sockets for Eimac 1500TH, Western Electric 212D. Industrial/Special purpose tube manuals or pamphlets. Eimac 300T. Also any strange or out-of-the-ordinary tube types. John H. Walker Jr., 16112 W. 125th St., Olathe, KS 66062. (913) 782-6455

**WANTED:** HRO-60T accessories: HRO-60TS speaker, NFN-83-50 N.B.F.M. adapter, SOJ-3 Select-O-Ject; coils: F, AA, AB, AC with dial scales preferred. Frank DeCoito, Star Rt. #2, Box 242, La Honda, CA 94020. (415) 948-2045

## CLASSIFIED ADVERTISEMENTS

**WANTED:** Majestic 91 or 92. Philco 89 chassis. Old microphones. Ben Mast, 3253 O St., NW, Washington, DC 20007. (202) 338-7145

**FOR SALE:** QST full 1964 year 50th Anniversary in QST binder, excellent condition - \$15 plus 14 lbs. UPS. John Uscinowski, RR#1, Box 379, Greenwich, NY 12834-9519

**FOR SALE/TRADE:** TV's: RCA 8PT7034, RCA 14PT8022, Westinghouse 14S 204, Sony 8-301W, Dumont console with FM tuner. Stereo: MacIntosh MX-110, Scott 355, A208, Fisher collection series amp & FM/SW tuner, Dynaco PAT-5, PAS-2, ST-70, FM-2 KLH #27 rec. Table radios: Emerson U5A (R.G.A., p. 18), Silvertone 3551 Catalin, Arvin 544 (G.O.R., p. 99), GE 65 (red G.O.R., p. 123), Crosley D-25MN (G.O.R., p. 128), Zeniths H511B (G.O.R., p. 128) H-615 (G.O.R., p. 122), 6G-601 (sailing), R615G (gray), Stewart-Warner 07-5B (F.O.S., p. 176). Large transistors: GE port. (all chrome front), Philco 308 (leather case with dial cover), Emerson (triangle handle salmon color), Zenith Royal 710. Small transistors: Zenith Royal 500's maroon 7XT40, black 8AT4022, Arvin-61R35 (blue), 63T45 (brown), Sony TR1014, Magnavox AM-60, Motorola (flip-top dial cover, blue), Panasonic R-72 (red), R-70 (green), R-1662 (black). Multibands: Zenith Royal 3000-1, Royal 790 Navigator, Sony ICF-7600W, Panasonic RF-1600, Realtone 8812 Globepacer 11 band, Realistic DX-400. Novelty radios: Guild Country Belle wall phone, California Raisin, Fonz jukebox, Electro Dice, much more. Mike Farganus, 9225 E. Apache #59, Mesa, AZ 85207. (602) 984-2836

# WANTED



AMC or GAROD  
Model 126  
Catalin

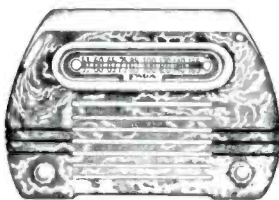

FADA  
652, 252 or 659  
Catalin

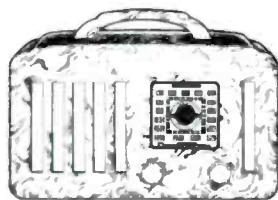

EMERSON  
Model 375  
Catalin

I PAY ABSOLUTELY TOP PRICES !!!

Michael Lawlor  
P.O. Box 50  
South Pasadena, CA 91031  
(818) 799-2921



## CLASSIFIED ADVERTISEMENTS

**FOR TRADE:** My Radiola 33 or AK 60, both consoles restored, for your Zenith console. A. Bruno, 24 Butternut Dr., New City, NY 10956. (914) 354-8899

**WANTED:** One Dynamotor DM28 with filters attached for my BC348 – paying \$20 plus shipping. Bill Seaby, 9727 Britinay Ln., Baltimore, MD 21234-1863. (301) 661-5734

**FREE – 20 WORD AD EACH MONTH**  
To get your free 20 words,  
include your SUB# with your Ad.  
Additional words are 10¢ each.  
Read inside back cover for details.  
**MANY THANKS!!!!**

**FOR SALE:** Many early transistor and tube portables, all working and in very good to excellent condition. Kolster K-6 speaker, 1924 Airline battery charger, Arvin clock radio, RCA Victor 9-JY phonograph – \$15 ea. Astatic microphone (excellent), Trav-Ler phonograph (excellent) – \$20 ea. Airline 14BR-913A (9-tube, 6 push buttons, 6 control knobs, acoustical chamber for speaker) large wood table radio with BC/SW, excellent condition! – \$65. Silvertone Model 1923 built in 1936 (large stepped battery tombstone in excellent condition), 1937 Detrola Glen-172A wooden table radio in very good to excellent condition – \$65 ea. Emerson 512 wood table radio – \$37. General Electric Musaphonic – \$22. General Electric 408 Art Deco – \$40. 1926 RCA Radiola 100A speaker good working condition, Motorola Art Deco clock radio (can be hung on a wall), Hallicrafters S-41G Skyrider Jr., good condition, works great! – \$35 ea. Stewart Warner 62TC16 (6 push buttons, 4 control knobs, inductive tuning, eye tube BC/SW) beautiful wooden table radio that plays great – \$70. Sony Micro TV with complete new accessory kit – \$60. Telechron 8H67 clock radio with thumbwheel tuning, Zenith 6D060-Z Art Deco wood table radio in excellent condition – \$45. Philco 40-155 circa 1939 wood table set with sloped front – \$75. Philco 53-566 (unique design) Transitone – \$55. Many more wood, plastic, and Bakelite radios. I also have a fair selection of literature and parts for sale. Please send SASE to: Neil O'Donnell, 1809 Sampson Ave., Butte, MT 59701. (406) 494-8162

## WANTED

### TRANSMITTING TUBES FOR MUSEUM

Do you have any old amateur or commercial transmitting tubes worthy of saving for posterity? If yes, help us do same. Contact:

*Ye Olde Transmitting  
Tube Museum*

P.O. Box 97, Crescent City, CA 95531  
(707) 464-6470

## CLASSIFIED ADVERTISEMENTS

**FOR SALE:** Mint Grebe Type CR-18 Special, 10-180 meters. Les Rayner, 5512 N. 71st Pl., Scottsdale, AZ 85253. (602) 947-1375

**WANTED:** Junker chassis for Kennedy Model XXX Type 435, dirty OK, rusty OK, bad audios OK, but must be complete. Steve Zingmond, 6241 Radford, North Hollywood, CA 91606. (818) 769-9283

**SERVICES:** Make your old set have better tone, be more sensitive, and operate without fear of burning out the power transformer or starting a fire. Anyone who can solder can make these simple changes at very little expense. To bring the luster and shine back to old radios without hard work. Listen to old music on your radio at any time for less than \$20.00. For complete instructions, send \$5.00 for fast reply to: Adventek, 1647 Willow Pass Rd., Suite 357, Concord, CA 94520

**FOR SALE/TRADE:** For early Grebe equipment: QST complete Dec. 1915-1969. Federal DX58 – \$450. Jim Collings, 12005 Victoria Pl., Oklahoma City, OK 73120. (405) 755-4139

**FOR SALE:** Farnsworth table TV Model 651P (see Rider's Vol. II) – \$100. RME-45 – @ \$45. Call days til 0300Z. PU only. Ted K. Clifton, W9TC, 5621 Union Chapel Rd., Fort Wayne, IN 46845. (219) 627-5960

**WANTED:** Dial pointer for Crosley radio phono Model 83CQ. I can send actual size drawing. George Bittner, 147 Longvue Dr., Pittsburgh, PA 15237

## *Please Save This Want List!*

### CUTTING & WASHINGTON

8A, 9A, 11, 12, 12A, 15, Teledyne

### KENNEDY

311 Portable with built-in Amplifier  
V, X, XI, VI

### ADAMS MORGAN

RA-6 Receiver, RB-2 Receiver, III Receiver

### WESTERN ELECTRIC

4-A Receiver, 2-A Tuning Unit, 20-A Filter

### TUSKA

220, 221, 222, 223, 224, 226  
225 (2-panel version with straps)

As it may be a long time before I find some of the sets listed in these ads; remember to call me when you can part with yours. I am putting together a collection of early broadcast and wireless equipment and adding to it each month. I buy single sets or collections. Also: books, catalogs, manuals and other related documentation.

*Call and surprise me; make my day!*

John V. Terrey, 498 Cross Street  
Carlisle, MA 01741 – (508) 369-9770

## CLASSIFIED ADVERTISEMENTS

**FOR SALE:** National HRO50T coils: B, C, D — \$25 ea. Phiico Factory Book 1928-36 — \$35. Meissner FM tuner — \$35. Rider's 2, 3, 4, 5 — \$30 ea. DeForest crystal detector holder — \$25. Flame-proof radiokey J5 — \$50. UX 199 tubes, good — \$12 ea. UX201 tubes — \$7 ea. Arcturus tubes 47, 24, 27 — \$7. Baldwin phones — \$25. RCA 100-A speaker — \$25. Postage extra. Joe Santomas, 653 Broadway, Hammononton, NJ 08037. (609) 561-1161, after 7 pm

**SERVICES:** Make your old set have better tone, be more sensitive, and operate without fear of burning out the power transformer or starting a fire. Anyone who can solder can make these simple changes at very little expense. To bring the luster and shine back to old radios without hard work. Listen to old music on your radio at any time for less than \$20.00. For complete instructions, send \$5.00 for fast reply to: Adventek, 1647 Willow Pass Rd., Suite 357, Concord, CA 94520

**FOR SALE:** Zenith Trans-Oceanic, The Radio Powered to Tune the World; book has history, pictures, old ads and more — only \$7; please add \$1 for first class. Bob's Books, PO Box 27232, Lakewood, CO 80227

**WANTED:** Rider's Radio Vol. 21, 22 & 23 to complete my set. Frank DeCoito, Star Rt. #2, Box #242, La Honda, CA 94020. (415) 948-2045

**FOR SALE/TRADE:** Novelty swirl Bakelite shaped like a pair of binoculars, excellent condition. Oscar Smith, Jr., Rt. 9, Box 16, Dublin, GA 31021. (912) 275-3657, call after 6

## CLASSIFIED ADVERTISEMENTS

**FOR SALE:** Novelty coachlight radio — \$125. GE Model K52 cathedral — \$150. FADA Model 195A — \$150. Cigarette dispenser in shape of Majestic radio — \$95. RCA tombstone — \$75. Atwater Kent tombstone 185A — \$175. Atwater Kent tombstone 545 — \$150. Magnavox Model B corn speaker — \$100. RCA Victor 721TS television — \$50. Stan Greear, 904 E. Florida, Urbana, IL 61801. (217) 344-2678

— WANTED —

**PICTURES FOR PHOTO REVIEW  
PHOTOS MUST BE SHARP IN DETAIL  
A SHORT DESCRIPTION IS A MUST!  
SEE PHOTO REVIEW PAGES FOR  
ADDITIONAL INFORMATION**

**WANTED:** Tone arm with head for phonograph used in 1928 RCA Model 7-26 electric radio with electric phonograph. The head has a small tag on the back side that reads, "supplied to Victor Talking Machine Co. by Radio Corp. of America." Also would someone have the pewter tuning gears for a Bremer Tully Counterphase 7-tube TRF radio. Also I have a Crescentyne 6-tube TRF radio, that needs some work. Does anyone have any service information on these? Arnold G. Schmidt, Rt. 5, Box 59, Jamestown, ND 58401. (701) 252-5291

**WANTED:** WW2 military transceiver BC-659 or BC-620. E. A. Conover, 42 Comanche Dr., Oceanport, NJ 07757

**FOR SALE:** Tubes for early electric radios. SASE for free price list. Sam Faust, 246F Musconetcong River Rd., Changewater, NJ 07831

## WANTED

### *Top Prices Paid*

**Radio & Audio Tubes:** 2A3, 45's, 50's, 845, 8005, KT66/88, etc.

**Western Electric Tubes:** 101, 102, 104, 203, 305, 211, 212, 242, 244, 252, 262, 264, 271, 274, 275, 276, 284, 285, 300, 301, 310, 339, 345, 347, 348, 349, 350, 421, 422, VT25A, VT52, etc.

**W.E. Speakers & Tweeters:** 555, 594, 595, 596, 597, 713, 728, 754, 755, 756, 757, TA4151, 4153, 4181, 4191, 4194, etc.

**W.E. Consoles & Amps:** 25B, 41, 42, 46, 86, 91, 92, 94, 95, 105, 106, 117, 118, 120, 121, 124, 129, 130, 131, 142, 143, etc.

**W.E. Horns:** 22, 24, 25, 26, KS-6368, 12024, 12025, 12027, etc.

**W.E. Microphones & Parts,** etc.

*Also looking for:*

*Tube-type equipment by McIntosh, Marantz, Westrex, Langevin, Altec, etc.  
Vintage speakers, units, by Jensen, Altec, JBL, Tannoy, etc.*

**Audio City USA, PO Box 802, Northridge, CA 91328-0802  
(818) 701-5633**

**CLASSIFIED ADVERTISEMENTS**

**WANTED:** IF transformer for Model 57 Philco. Will buy junker to get it. Also models will work 81, 58, 59. This xfmr. has two feedback taps extra. **FOR SALE:** Rider's. Small wood and plastic radios. N. C. 183 National SW radio, orig. speaker. Chuck, PO Box 598, New Haven, WV 25265. (304) 882-2220

**FOR SALE:** Telefunken Orchestra #53 in excellent condition. Also old radio and TV tubes. Mary Notaris, 1100 Welsh Rd., Ambler, PA 19002. (215) 646-3631

**WANTED:** Grebe CR18 front panel or junker set with good panel. Also book Radios. Barry Janov, 2454 Dempster, Suite 416, Des Plaines, IL 60016. (708) 827-9100

**WANTED:** Speaker and cabinet for an AK 55C. Also copy or original owners manual and any supplemental tube data releases for Sylvania 219 tube tester. Mike Keller, 609 Westphal Ave., Columbus, OH 43213. (614) 231-3489

**FOR SALE:** Conar Model 510 transistor power supply (0-24 volts) - \$15. Zenith 7000, no front cover, works some - \$50. Harald Herp, 6615 Michele Ct., Huntingtown, MD 20639. (301) 855-7071

**FOR SALE:** National NC-125 and matching speaker - \$90. National NC-57 - \$65. **WANTED:** Schematic or manual for BC 946B made by Colonial Radio for Army Signal Corps. Henry Rogers, PO Box 501, Minden, NV 89423. (702) 267-2725, evenings

**CLASSIFIED ADVERTISEMENTS**

**FOR SALE:** FADA chocolate marbled miniature - \$90. Three early transistor radios - \$35. Silvertone miniature pre-WWII - \$50. Crosley miniature tombstone, early 30's - \$60. Radiola III - \$90. Atwater Kent 40 - \$35 + others. R. Burick, 21B North Earl St., Shippensburg, PA 17257. (717) 530-5040

**WANTED:** Little Jewel or Westinghouse refrigerator radios, also need parts. Want RCA Model 54B2. Jim Montague, 921 S. Cuba, Spokane, WA 99202. (509) 535-9576

**WANTED:** RCA Model 75X oriental-style radio in green base color, and other orientals. Gerald Schneider, 8750 Georgia Ave., #1410-B, Silver Spring, MD 20910. (301) 565-2840

**FOR SALE:** RCA R37 - \$325. GE K43 - \$195. Zenith Trans-Oceanic, mint, A600 - \$95. Detrola Midget cathedral, very small - \$325. Belmont 6D111, all decals - \$250. Green Crosley E15CE - \$125. American Bosch radio sign - \$85. Raytheon 3D sign - \$125. Sylvania radio tube sign - \$85. Blonde 21" table Predicta, working - \$350. Blonde 21" remote tandem stereophonic Predicta, working - \$650. Motorola neon sign - \$350. Eric Fogel, 87 Sandra Dr., Parsippany, NJ 07054. (201) 316-8461

**WANTED:** 7 in. & 10 in. TVs. **FOR TRADE:** Edison R-5 radio. Thompson S-70 radio. Music Master horn speaker. Will trade for small TVs. **FOR SALE:** Schematics - \$2 & SASE. Tony DeMara, 40231 Day, Mt. Clemens, MI 48044-2535. (313) 263-0325

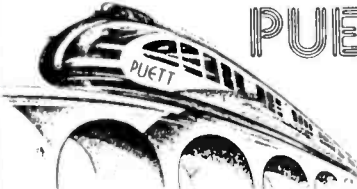

# PUETT ELECTRONICS

P.O. BOX 28572 DALLAS TX 75228



OUR PAST CATALOGS AND PRICE LISTS ARE NOW OBSOLETE.

CATALOG 77 (20-PAGES) OUR BASIC CATALOG \$2.00 POSTPAID.  
YOU RECEIVE A \$3.00 DISCOUNT COUPON WITH CATALOG 77.

CATALOG 77/PLL-2 (56 PAGES) -- \$5.00 POSTPAID.  
YOU RECEIVE A \$6.00 DISCOUNT COUPON WITH CATALOG 77/PLL-2.

WE NOW HAVE MORE THAN 1,500 DIFFERENT ANTIQUE RADIO PUBLICATIONS AVAILABLE! CATALOG 77/PLL-2 LISTS EVERYTHING WE HAVE TO OFFER!

WE OFFER BOOKS, INSTRUMENT MANUALS, SERVICE DATA, SALES BROCHURES, ATWATER KENT, RCA, CROSLEY, ZENITH, ETC. FACTORY SERVICE MANUALS, STROMBERG CARLSON, CAPEHART, SCOTT, MCMURDO SILVER, FISHER CLASSIC RADIO LITERATURE, DIRECTORY OF ANTIQUE RADIO SERVICES, SCHEMATIC DIAGRAMS ON NEARLY ANY RADIO, OLD-TIME RADIO PROGRAMS ON CASSETTES, TUBES, TUBE MANUALS, BOOKS ON WIRELESS AS OLD AS 1902, TUNING DRIVE BELTS, TUNING DIALS, TUNING-DIAL GLASS COVERS, KNOBS, OUR OWN PERIODICAL "ANTIQUÉ RADIO TOPICS" WITH THE ANTIQUÉ RADIO NEW ACQUISITIONS LIST, AND MUCH MUCH MORE!! ORDER OUR CATALOG TODAY!!!!!!

**GET THIS  
WORLD'S  
GREATEST  
RADIO  
CATALOG**

43

**CLASSIFIED ADVERTISEMENTS**

**FOR SALE/TRADE:** For trade or BO: McMurdo Silver 5C, Radiola II, 1/4 KW rotary spark xmtr., W.W. Oliver toy dynamo, AK three-tube TA green. Also crystal detectors and early tubes. SASE for reply. Michael Payne, 803 S. Taylor, Alvin, TX 77511. (713) 331-9217

**IF YOUR EXPIRATION DATE IS MARCH OR BEFORE, RENEW TODAY! EARLY RENEWALS RECEIVE AN EXTRA ISSUE!**

**WANTED:** Freshman Masterpiece in very good to exc. condition. Also stock certificates from 1900 thru 1930, reasonable. Tom Wagner, 45 Windsor Rd., Hamden, CT 06517. (203) 248-1659

**WANTED:** HP-400A manual or copy. Please contact Nick Spitzø, 9280 Knoll Dr., Galena, OH 43021

**FOR SALE:** National HRO/RAS receiver, needs work - \$50. Sencore-PS120 oscilloscope, 12 Mc B.W., as new - \$60. Ward Becht, 625 Tufts Ave., Burbank, CA 91504. (818) 842-3444

**FOR SALE:** Metrodyne Super 5, vg - \$110. Kolster 6K, vg - \$90. Clarion Jr. tombstone, vg - \$100. AK 30, excellent - \$80. All plus UPS. **WANTED:** 2 running knobs for Kodel C13, 3 tube reflex. Wally Worth, 2 W. Elm Ave., Wollaston, MA 02170. (617) 479-4512

**FOR SALE:** 1990 Olde Tyme Radio & TV Services Directory - \$2.50 ppd. Andrew Mooradian, 5 Priscilla Ln., Winchester, MA 01890

**CLASSIFIED ADVERTISEMENTS**

**FOR SALE:** Tubes. Huge N.O.S. supply, much variety, limited quantities, good prices. LSASE for list, including radios. **WANTED:** Arvin 253T, ch. RE 252, other metals. Carl Shirley, 824 Fairwood Rd., Columbia, SC 29209. (803) 776-6850

**FOR SALE:** Selling all Crosleys: Model 124 clock radio - \$500. Cathedral top 167 - \$150. RFL-60 - \$100. F-51Y, white - \$20. 66 TC - \$75. 56TW free with purchase of any of above. L. S. Colebank, 742 Albany Dr., Bismarck, ND 58504. (701) 258-7646

**WANTED:** Kardonstrip 3-dial, Kardon Carnival 3-dial, compete sets or parts and info. Mike Parker, 945 S.E. Linn, Portland, OR 97202

**WANTED:** Decal for DeForest antenna. Carl Knipfel, Route 3, Morton, IL 61550. (309) 266-9440

**FOR SALE:** 65 old tubes. For list call or write. Joe Overmyer, 1212 Main St., Evanston, IL 60202. (312) 663-0150, days

**WANTED:** The New England Antique Radio Club wants you! Join over 300 others and become part of one of the best radio clubs in the country! Don't miss our big Spring Swap & Sell Meet Saturday, April 21, 1990, at Resurrection Center, Nashua, N. H. 8 am to 1 pm. Over 70 tables! Hundreds of radios! Two old equipment contests! 50/50 raffle! Radio repair seminar! For More Swap Meet details or membership info, call or write, and be sure to ask for a free sample copy of the club newsletter. NEARC, PO Box 809, Contoocook, NH 03229. (603) 746- 6127



**WAVES**  
ANTIQUES  
EARLY RADIOS  
&  
PHONOGRAPHS  
78 RECORDS  
BOUGHT • SOLD  
OPEN 12 6  
CLOSED SUN & MON.

32 EAST 13<sup>TH</sup> ST. NEW YORK, N. Y. 10003 212 989-9284  
PROPRIETORS Bruce and Charlotte Mager

**THIS MONTH'S SPECIALS:**

1. Radio Retailing 40 assorted issues 1935-1940 ..... \$235
2. Cunningham C11, RCA WD11, new in box ..... 45 ea.
3. FADA 1000 yellow ..... 700
4. Acme double face floating cone speaker ..... 75
5. RCA 100A speaker, fair condition ..... 35
6. RCA advertising fan ..... 45

**SEE NEXT MONTH'S LIST FOR MORE !**



**ALL A.R.C. BACK ISSUES AVAILABLE**

Feb. '87 to current issue: Originals available  
32 to 64 pages each.

Oct. '86 to Jan. '87: Reprints available  
*Reprinted from original artwork; 28 to 32 pages each.  
Quality and appearance same as an original copy.*

June '84 to Sept. '86: Photocopies available  
Not original quality, useful for info.; 16 to 28 pages ea.

The above availability is as of March, 1990.  
As stocks of original copies are exhausted, reprints will be substituted for the issues after January 1987. Publication of Antique Radio Classified began in 1984 which had only five issues: June, Sept., Oct., Nov. & Dec. 1984. 1985 through 1989 have had 12 issues each.

**\$3.00 each - Postpaid to U.S., Canada and Mexico.**

*Orders of 12 issues or more may take a 10% discount. Foreign orders other than Canada and Mexico: \$5.00 each by air. Massachusetts residents, please add 5% sales tax.*

Send Order with Payment to:  
**ANTIQUE RADIO CLASSIFIED**  
P.O. BOX 2, CARLISLE, MA 01741

## CLASSIFIED ADVERTISEMENTS

**FOR SALE:** Radio Amateur handbooks, 1944 to 1949 - \$15, 1954 to 1957 - \$12, 1977 - \$10. Radio handbooks, hard cover, 1942-1946 - \$15. All plus \$2 shipping. Postpaid photocopies - RCA ARC-111 - \$10. Radiola superhet - \$10. Harknes counterflex - \$15. WE vacuum tubes data, 56 pages, 101D to 284A - \$18. Test equipment schematics, radios scopes - \$2 ea. Send with SASE. **WANTED:** Wire recorders. Pye radios. Small wood table radios. Peter Dieguez, 36-48 34th St., Long Island City, NY 11106

**WANTED:** 650 transistor novelties and looking for: Bozo, Safe Guard soap, big mouth cannon, Gulden's mustard, Woolite, Bigfoot, Camus Cognac, tomato, Suntory whiskey, Bass Fiddle, tombstone, baseball hat, bowling ball w/pins, balance scale, metal grenade, ricksha, Ship's telegraph, Garfield, Little Lulu, Huckleberry Hound w/Yogi bear, Pacman, Hulk, cameras, film boxes, Surf detergent, and a can of Boobs. Lee Bruton, 1202 So. Pratt Parkway, Longmont, CO 80501. (303) 651-0254

**WANTED:** Man from Mars Radio Hat, circa 1950. CK703 crystal triode and CK722 transistors, knobs for Zenith H500 and L600 Trans-Oceanics. Information of any kind on McMurdo-Silver 15-17 radio, tech manual and post-1952 roll charts for TV3B/U tube tester, subminiature tube pocket radios, #50 Branston coil and Sargent Model 11/UA receiver. Write or call giving the condition and the price asked to: Bruce Ashcraft, WD6GNM, 1300 Burrows Road, Campbell, CA 95008. (408) 374-5228, leave a message; I will return all telephone calls.

## CLASSIFIED ADVERTISEMENTS

**FOR SALE:** Philco Model 42-22 CL clock radio with wood cabinet. Philco 38-14 Bakelite. Philco 38-62 wood table, very good. Arvin Phantom Baby, (F.O.S., p. 59), looks and plays great. Coronado 05RA243 AM-FM 1950 Bakelite, very good. Silvertone 6012 ivory w/push buttons, nice. Crosley 66TA wood Victory table model, very good. Sanborn Model 51, early 50's, EKG machine. Zenith 75 tube type hearing aid. Silvertone Model 1 metal, brown, (R.G.A., p. 100, top right). Arvin 451TL, much prettier version of set on p. 94, R.G.A. Meissner 8C FM tuner, nice. Viking 2 transmitter. Many early transistors, send SASE for transistor list. Lots of N.O.S. blank videotapes, 1" and 1/2", SASE for list. Charles Harper, 2081 Harmony Ct., Lexington, KY 40502. (606) 268-8549

**FOR SALE:** New and old collectors, SASE brings Stan's Surplus Stuff - three pages of radios (no Catalins or battery sets), new and used tubes, paper, parts, free advice, etc. Stan Lopes, KB6LGV, 1201-74 Monument Blvd., Concord, CA 94520. (415) 825-6865

**WANTED:** AK Radiodyne and 12, good shape. Will pay \$\$ and/or trade AK 10A. Marc Gottlieb, Box 1112, South San Francisco, CA 94083-1112

**WANTED:** 1K field coil for Zenith speaker 49-205X for Model 95244. A. J. Long, 2653 Post Rd., Twinsburg, OH 44087. (216) 425-9662

**FOR SALE:** RME pre-selector, 40's, works, reasonable. Bob Higgins, 3642 NW 52nd St., Ft. Lauderdale, FL 33309. (305) 485-5913

# Active Antenna

## Model AA10

Allows antique radios which were designed for a long wire outdoor antenna to operate on a 42" indoor whip antenna. Operates from 9 volt battery.

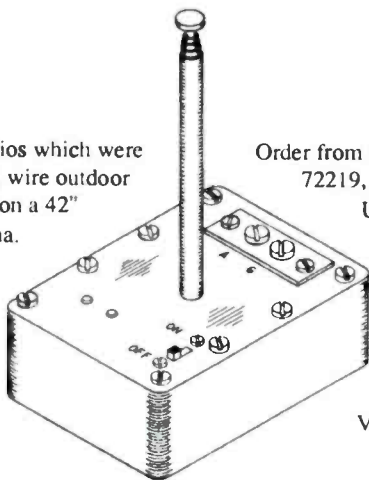

Only \$34.95

Order from PTI, Box 9769, Little Rock, AR 72219, (501)568-1995. Orders shipped UPS, prepaid in continental U.S. Please allow 3 weeks for delivery. Arkansas residents add 5% sales tax.

Visa and MasterCard accepted

---

**CLASSIFIED ADVERTISEMENTS**

---

**FOR SALE:** Vintage electronics lists - \$2 (\$5 outside U.S.A.), cash/stamps & LSASE (no checks). Richard & Rose's Radio Mart, PO Box 691443, Tulsa, OK 74169

**WANTED:** Old tube-type CB radios. Indicate model, condition, price. **WANTED:** Information on Relydyne. Harry Blesy, N9CQX, 2409 Northgate, N., Riverside, IL 60546. (708) 442-8855

---

**NEW PHONE NUMBER FOR  
ANTIQUÉ RADIO CLASSIFIED  
(508) 371-0512**

**Best time to call is weekdays:  
9 am to 5 pm Eastern Time**

(Please no classified ads by phone. Thanks!)

---

**FOR SALE:** UHF converters: Bakelite, Styrene - \$10 ea. shipped. Jim Farago, PO Box 6313, Minneapolis, MN 55406. (612) 722-0708

---

**FOR SALE:** Radiola II, excellent - \$350. Have AK breadboards to trade for Collins 1930's Bakelite panel transmitter. Want AK5. Want copies of Collins signals, documentation for any Pre-WWII amateur transmitters. H. P. Heinemann, 87 Cove Rd., Lyme, CT 06371. (203) 434-7783

---

**WANTED:** Delco tube and hybrid auto radios, all GM marques. Wonderbars in any condition. Vince Creisler, 13241 SE 261st St., Kent, WA 98042. (206) 630-4735

---

**FOR SALE:** Plastic, portable and wood radios. LSASE for list and photo. David Borino, 1480 Glenaire Dr., Casper, WY 82609

---

**FOR SALE:** Sennheiser MKH 104 condenser microphones - \$200 ea. NRI electronics course complete, early '40's - offers. Johnson Messenger I CB - \$45 ea. Dynaco ST70 stereo power amp. with PAS preamp. - \$150. Dynaco Mark III, 60-watt power amp. - \$70. Early magnetrons, new, 2J32, 2J49 and 2J61 - \$25 ea. Used tubes, filaments good: 833A - \$25, 813 - \$10, 845 - \$20. New tubes: JAN 832A - \$20, 814 - \$25, 837 - \$10, 956 Acorn - \$8, 6X5GT - \$1.50, 6B8 - \$2.50, 78 - \$3. CRT's 2APIA - \$5, 2AP1 sockets - \$4. Textronix 5" Type T-5330-2, Part #154-0289-01 - \$50. Type T-5260-31, Part #154-0289-01 - \$50. Bathtub capacitors - \$4 ea. Dual 365 mmf. variable capacitors - \$10 ea. Have small quantity of early European tubes, write needs. Bc-221-d frequency meter - \$40. RM-13-D control unit, Daven and Co. - \$50. Eico 5T40 amplifier - \$50. Shipping extra. **WANTED:** Owner's manual for Hickock #5348 tube checker. Knobs for Pilot B-1, Kennedy LS61, RCA Q11. Heathkit or Eico signal tracer. Cathedral radio, prefer rough, but must be restorable and complete. NRI Service manuals Vol. 1 & 2. Custom car radios from 1930 to 1964, prefer not working. Peter Koopmans, Box 123, Mount Pearl, Newfoundland, Canada A1N 2C2. (709) 364-9526

---

**CLASSIFIED ADVERTISEMENTS**

---

**FOR SALE:** AC radios: GE S42, tapestry front, g - \$175. Victor International, small mantle clock shaped, AC DC, g - \$85. Philco 49-10 (F.O.S., p. 140) Deco style, radio phono, vg - \$135. Philitian electric painted Bakelite-pay, headboard radio, made in Ft. Wayne, Ind., w/pillow spkr. and cash box has crack, otherwise vg - \$95. Dahlberg pillow spkr. radio, w/orig. headboard clamp, vg - \$175. Crosley Buddy Boy, good orig., good dial scale, has crest, missing tube shield, works - \$275. ERLA semi-cathedral, very unusual, g - \$150. Dumont RA346, Chinese white and gold, needs filters - \$100. RCA 6T large tombstone w/ tuning eye, g, working - \$125. Zenith SR216, cube-shaped, black dial, g, working - \$140. 1932 King, 4-tube TRF tbl. set, very striking, working - \$125. Philco 70B, vg orig. cond. and working - \$350. Philco 70B, refinished and working - \$300. Hallicrafters S-40B, g - \$75. Hallicrafters S-53, g, missing one knob - \$40. Coronado AC DC tbl. set, thin, ornate, lattice grille, works, g - \$75. Philco 54 AC DC tbl. set, Deco style, has mint photo finish - \$95. Philco 71B, vg, orig. - \$250. Philco 45 (F.O.S., p. 123), vg orig. cond., exc. photo finish - \$150. Stromberg-Carlson 225H (F.O.S., p. 180) Electronically restored, looks and works great - \$225. RCA T4 cathedral, g, working - \$125. Battery sets: Radiola AR 812, vg orig. cond. w/ paper work - \$160. AK 20 BB, g, orig. - \$100. Radiola III, g, missing cabinet decal - \$100. Zenith Super VIII, vg, restorable - \$165. Speakers & misc.: RCA UZ 1325 horn, g, working - \$95. Western Electric 100, needs minor rest., working - \$90. Peerless cathedral-shaped spkr, g, working - \$35. (6) Cunningham Bakelite 01-A's, N.I.B. - \$12 ea. Hickock 6000 tube tester, vg, w/all charts, tests antique tubes - \$75. N.O.S. Sentinel picture-sealed TV sign from late 40's., very colorful, 8-sided - \$60. N.O.S. CBS two-sided dealer sign, approx. 2'x4', vg. - \$60. Trimm horn, small version, cracked bell, working - \$60. 1956 metal TV banks, promotional, cute - \$16 ppd. 1950's Nipper & phonograph salt & pepper shakers, N.I.B., very nice - \$17.50 ppd. Kelvinator stop-sign-shaped neon clock, excellent, w/new xfmr. - \$250. Rider's TV manuals 1-27 with all indexes, vg - \$300. All prices do not include shipping. Photos - \$1. Call or write. Dave Christensen, 1732 W. Minnehaha Ave., St. Paul, MN 55104. (612) 646-0908

---

**WANTED:** Paragon IIIA cabinet, top price paid or will trade. Grebe RORD amp, DeForest D-10 cabinet. Large outer tuning knob for Scott Philharmonic. Cabinet lid for Scott Tasman cabinet. Call or write. Don Hovde, 1000 Ashland Ave., #2, St. Paul Park, MN 55071. (612) 459-9135

---

**FOR TRADE:** I will trade my 7-sided Sparton 409, blue mirrored radio for your International Kadette Catalin Clockette radio, Emerson Mickey Mouse radio with metal grille, painted Emerson Snow White radio, or other mirrored radios. Greg Farmer, 71 Rice Creek Way, Fridley, MN 55432. (612) 571-6062

## CLASSIFIED ADVERTISEMENTS

**WANTED:** Crosley Pup 1-tube radio, willing to pay \$175-\$250 depending upon condition. Jim Clark, 1292 Starboard, Okemos, MI 48864. (517) 349-2249

**FOR SALE/TRADE:** Beautiful Brunswick Model 1700 highboy with RCA chassis 7 tubes, push button mint. Jon Steinhauser, 636 Westminster Rd., Baldwin, NY 11510. (516) 223-9878

### Classified Ad Deadline Noon

Mar. 10 for Apr. 1990 Issue

Apr. 10 for May 1990 Issue

Box & Photo Ads - 5th, Display Ads - 1st

**WANTED:** Atwater Kent breadboard radios and parts, any condition, basket cases OK. Get my price. Paul Thompson, 315 Larkspur Dr., Santa Maria, CA 93455. (805) 934-2778

**FOR SALE:** Rare Disney characters GE clock-radio, yellow color, mint - \$150. Kenny Fullerton, 2341 E. Livingston Ave., Columbus, OH 43209. (614) 237-2621

**FOR TRADE:** Anyone interested in trading novelty transistors? Send me your name or list for mine. I have 50+ to sell or trade. No SASE's. Cliff Watts, 51 Glendale Rd., Brantford, Ontario, Canada N3T 1P5. (519) 753-5087

**WANTED:** World's Record Super 8 or 9 battery superhet, must be identified as such on front panel. Jim Clark, 1292 Starboard, Okemos, MI 48864. (517) 349-2249

## CLASSIFIED ADVERTISEMENTS

**FOR SALE:** All Pilot items in this ad. Behind panel fan dial 0 to 100 Pilot light socket - \$10. 4" black dials - \$4. 4 prong sockets - \$12/6. Isograd mica con - \$1.50 ea. Brown knobs - \$3 ea. Var. con 7-5 plate - \$3.50, 23 plate - \$4.50, centerline var. con. - \$8. 387 power xfmr. - \$12. 396 filter block - \$7. Pilot 411 A&B power xfmr. - \$15. Min. order - \$7.50. All plus shipping. Krantz, 100 Osage Ave., Somerdale, NJ 08083

**WANTED:** Need schematics for Aircraft Radio Corporation ARC-32 receiver and ARC-23 transmitter. David Freeman, N4UJN, 1891-53 Access Rd., Covington, GA 30209. (404) 934-3610, ext. 105

**WANTED:** Programs, records, memorabilia from the 1940's radio program The Adventures of Sam Spade. Chuck Sundgren, 1519 S. Tacoma, Kennewick, WA 99337. (509) 586-8157

**FOR SALE:** Paper items. QST 1922 (8) - \$45/all, 1925 (5) - \$20, 1928 (5) - \$16, 1926 (8) - \$25. Radio Craft 46-47-48 - \$1.50 per copy. Radio News 1950 to 1958 - \$2.50 per copy. RCA tube manuals, Howard Sams, Rider, service notes bundles by RCA, Philco, GE, Motorola and mixed. 1000's of unlisted items. Write SASE for replies to your wants. Min. orders - \$7.50 plus shipping. Krantz, 100 Osage Ave., Somerdale, NJ 08083

**WANTED:** E.H. Scott pointer-dial AM Philharmonic radio, need not have cabinet or be working, but otherwise must be complete and with mint chrome. Jim Clark, 1292 Starboard, Okemos, MI 48864. (517) 349-2249

## Your Tubes, Parts and Supplies Headquarters

### TUBES:

3000 audio, receiving and industrial types in stock, including early and foreign types. Discount Prices!

### CAPACITORS:

High voltage electrolytic and mylar capacitors for tube circuits.

### TRANSFORMERS:

Hard-to-find power transformers, audio transformers, and filter chokes for tube equipment.

### SUPPLIES:

Chemicals, test equipment, wire, batteries, tools, etc.

### LITERATURE:

Extensive offering of literature and books on antique radios, hi-fi, communications equipment, tube data, and circuit diagrams.

### KITS:

Radio, transmitter, stereo amplifier and power supply kits for learning and experimentation with vacuum tube circuits.

### PARTS:

Resistors, lamps, tube sockets, potentiometers, grill cloth, knobs, vibrators and more.



**"Write or call for our 26 page wholesale catalog"**

# ANTIQUE ELECTRONIC SUPPLY

688 W. First Street, Tempe, AZ 85281, Phone (602) 894-9503, FAX (602) 894-0124

**CLASSIFIED ADVERTISEMENTS**

**FOR SALE:** Round taps. Jackson Bell. 90 Philco Canada 245 push-pull. 2 Philco 60. AK 84. Radio King. Geneva. GE K50P. Clarion tombstone. Jackson Bell tombstone. Halowat and Waston battery set 1924. Stromberg-Carlson battery set 601, 1924. Echophone. Hammarlund HQ160. Radiola 21. Crosley Show Box with speaker. Crosley 5-38 with speaker. Northern Electric radio M56. Thordarson battery set 1920. Grebe Synchrophase MU1. Northland Radio battery set 1920. Philco 66. Airline 6 battery set. Sparton AMFmic battery set slap front with power pack with tall horn 1920?. AK 35. Philco 511 with speaker. Grebe Synchrophase 7 with power pack. 2 AK 20 long box. Airline Model 62-617. Western Air Patrol tombstone. Crosley tombstone. Kadette wood. International Radio Corp. Grunow 6B. Radiola 3. Radiola 18 with speaker. Rider manuals 2, 1-5 abridged; also number 1-2-3-4-5, two ea.: 6-7-8-9-10-11-12-13-14, one ea.: 16-17-19. Jim Stratton, N6902 Post, Spokane, WA 99208. (509) 328-8471

**FOR SALE:** Zenith 6-S-128 tombstone, big black dial, shutter tuning, original and working - will consider any serious offer. Kevin Eftink, 16 Edgewood Dr., Quincy, IL 62301. (217) 228-2221

**WANTED:** Old jukeboxes from the 1940's-1960's, within 100 miles. Joe Matuska, 2523 Sunset Blvd., Steubenville, OH 43952. (614) 264-7806

**WANTED:** Correspondence with anyone who has a Westburr 6 portable made in 1923-24. Merrill Bancroft, 169 S. Row Rd., Townsend, MA 01469. (508) 597-6623

## HELP ARCA KEEP BILL & JANE BUSY

Bill & Jane, our secretary/treasurer are retired and love to get mail! Help us keep them busy by writing them for information on our nearly 1000-member club, our quarterly bulletin (the 24- to 30-page *Gazette*) and our annual conventions. Letters enclosing the \$12.00 annual dues are especially nice to receive.

So, do your part - write:



**Bill & Jane Denk  
ARCA  
81 Steeplechase Road  
Devon, PA 19333  
(Please enclose an SASE)**

**CLASSIFIED ADVERTISEMENTS**

**FOR SALE:** List now available from estate purchase of books, manuals, etc. Majestic, Freed-Eisemann, Stewart-Warner, RCA, etc. SASE for list. Vintage TV & Radio, 3552 West 105, Cleveland, OH 44111. (216) 671-6712

**WANTED:** Military AN/GRR-5 receiving set, 1.5 to 18 MHz, with R-174 receiver and PP-308 power supply in CY-615 cabinet, in good working condition. D. L. Eynon, 106K N. Roberts Rd., Bryn Mawr, PA 19010. (215) 525-0516

**FOR SALE:** Coil winding machine, home built, with foot switch, resettable turns counter, was used to wind solenoid coils and small transformers - \$100. 10 lb. coil of 27 gauge enameled magnet wire - \$45. Television training courses by RCA, GE and Philco - \$15 ea. Write for details. Jack Naimann, 365 Bronx River Rd., Yonkers, NY 10704. (914) 237-4650

**WANTED:** Sales literature, photos and dial es-cutcheon for 1930 Sparks-Withington Models 410 & 420 AC table radio. Kent Oakley, 1008 Mormon St., Folsom, CA 95630

### NEW PHONE NUMBER FOR ANTIQUÉ RADIO CLASSIFIED (508) 371-0512

**Best time to call is weekdays:  
9 am to 5 pm Eastern Time**

(Please no classified ads by phone. Thanks!)

**WANTED:** Speaker for Philco 20. 2 small knobs and/or junker chassis. David R. Wagner, K8DW, 2045 Maginnis Rd., Oregon, OH 43616. (419) 691-1625

**FOR SALE/TRADE:** 1939 RCA TRK 12 television, restored, complete, authentic - best offer cash or Catalin. Rain Buttignol, 214 State St., Portsmouth, NH 03801. (603) 427-1384

**FOR SALE:** Speakers & horns: Bristol Super C - \$75. RCA 100 - \$30/2. AK E spkr. - \$45. Thorola horn - \$160. Magnavox M-3, no driver - \$70. Magnavox R-3 w/18" bell - \$175. Metro electric cone - \$35. Music Master horn - \$150. Burns horn - \$175. Tele-Tone spkr. - \$100. Pathe cone - \$125. RCA flower spkr. - \$100. Pacent spkr. - \$100. Amplion minihorn - \$150. Naald Midget in box - \$55. Sonochorde - \$45. Murdock horn - \$95. Radios: Ar. Sr. w/dud - \$150. AK 35 w/E2 spkr. - \$90. Radiola 17 w/100A spkr. - \$90. AK 40 - \$15. Radiola 26 w/batt. box - \$450. Scott All-wave 2 dial, Plymouth cab. - \$1000. Scott Allwave Deluxe, Westerly Grand - \$950. Scott Super 12, Breamer - \$600. Marwol, 3 dial batt. set - \$65. Home brew, 1 dial w/brass 201, in case - \$125. Home brew, 3 dial w/brass 201's, no case - \$85. Grundig AM FM - \$50. Radiola AR12 w/1325 horn - \$160. Zenith Trans-Oceanic - \$100. Boxes of used radio & TV tubes, tube testers, test equip. - BO. Hand. & UPS extra. Ed Gardner, 103 Lordship Rd., Stratford, CT 06497. (203) 381-9619



## CLASSIFIED ADVERTISEMENTS

**WANTED:** Information on RCA SC-88 receiver. Looks similar to RCA AR-88 and has Army Signal Corps R-320/FRC on tag. Does anyone know the history of this set? Looking for schematic and alignment information. Henry Rogers, PO Box 501, Minden, NV 89423. (702) 267-2725, evenings

**WANTED:** Information, schematic or other literature for Philcotron DC power supply. J. A. Jenkins, 4970 Dunkeith Woods NW, Canton, OH 44708. (216) 477-9501

**FOR SALE:** Philco 42-1008 console radio-phonograph - \$115. Send SASE for radio list. Robert Wiczkowicz, PO Box 86, Craryville, NY 12521. (518) 325-5307

**FOR SALE:** Radiola Model #33, missing lid - \$20. AK speakers, mint condition, working, found on p. 207 V.R. - \$45 ea. Philco chassis 42-1012 - \$12, with tubes - \$15. Sonora lowboy console chassis #47 - \$25. General Television portable leatherette chassis #185, white louvers, no knobs - \$35. American Bosch tabletop wooden, Model 505 - \$45. Guild Town Crier, AM FM, 1950's, very good condition, chassis restored - \$195. Sterling Little Symphony cathedral, plays poorly - \$150. D. C. Mania, 402 Maple Ave., Hawley, PA 18428. (717) 226-3095

**WANTED:** Still looking for a set of three knobs (any or all) for an Eveready console. (See Radio Manufacturers of the 1920's, p. 38). Ed Mondor, 121 Gateway Dr., Greenville, SC 29615. (803) 268-0952

## CLASSIFIED ADVERTISEMENTS

**WANTED:** Hammarlund tuning dials for HQ-120 or HQ-129. Dial numbers are 6050 and 6051. Junker set with good dials would be perfect, but not very realistic, so any help would be appreciated. Henry Rogers, PO Box 501, Minden, NV 89423. (702) 267-2725, evenings

**WANTED:** Transistor portables with Buick, Oldsmobile, Pontiac, or Trans-portable nameplates, prewar factory automobile radios. Dan Schulz, PO Box 892, Crystal Beach, FL 34681. (813) 785-8733

**FOR SALE:** Early spring cleaning. Empty cabinet sale. Don't send money unless you also enclose SASE. DeForest one-tube home brew - \$25. DeForest D-12 - \$35. Atwater Kent Model 20 large - \$35. Atwater Kent Model 20 compact - \$25. DeForest Everyman crystal set - \$30. Aeriola Sr. - \$25. Federal 57 left-side split but OK - \$40. Gilfillan GN3 - \$40. All prices plus UPS. Phil Weingarten, 67-61 Alderton St., Rego Park, NY 11374. (718) 896-3545

**WANTED:** Volume 2 AWA Review, mint condition. **FOR SALE:** Atwater Kent Model 20, excellent condition with tubes - \$125. Gerald Skloot, 2923 Mandalay Beach Rd., Wantagh, NY 11793. (516) 221-3535

**WANTED:** Dial gear Grunow Part #34461 for 5G chassis. Information on Loomis Radio College, Mary Texanna Loomis, Dr Robinson Stenode radio, tombstone cabinet for Bosch 585, cabinet to use Zenith 6S-229 chassis or sell same. Romney, Box 96, Emlenton, PA 16373. (412) 867-0314

# New Wireless Pioneers Books, Magazines, Literature Bought and Sold

New Wireless Pioneers buys and sells books, catalogs, magazines and other literature from the 1800's to 1950 that deal with early radio, wireless and electricity. A selection from our list of specialties:

Pre-1900 Electricity  
Pre-1925 Radio or Wireless  
Pre-1950 Computers

Pre-1900 Telegraphy  
Pre-1940 Television  
Early X-Ray

Magazines, catalogs, autographs or ephemera related to the above topics. Also: Pre-1920 Wireless and Telegraph Apparatus - Radio-Related Novelties and Advertising - Early Vacuum Tubes and Electrical Devices.

*Some items available in other technical subject areas also.*

Several catalogs featuring items for sale are published each year.

**New Wireless Pioneers - Jim & Felicia Kreuzer**

**P.O. Box 398, Elma, NY 14059**

**(716) 681-3186**

**CLASSIFIED ADVERTISEMENTS**

**FOR SALE:** Prewar radios - \$20 to \$30. 1950 table radios - \$15. Sprague capacitor bridge - \$20. Zenith Trans-Oceanic 3000-1 - \$70. Harmon Kardon Award Series #300 two chassis tubes - \$80. Hickock tube tester for early tubes - \$40. RF generator - \$20. TV degausser - \$10. B&K VOM #290 - \$80 with probes. Jackson oscilloscope with manual - \$50. Test picture tube - \$15. Scala low capacity oscilloscope probe - \$10. Auto radio power supply 12 & 6v - \$20. Rider book prewar - \$15. Audio encyclopedia - \$30. RCA Signal generator prewar - \$30. Johnson CB tester & SWR meter with special coaxial connector - \$40. Small transistor radios - \$10. Multiband portables, transistor - \$20. Aero tech for airplane band short-wave & broadcast - \$30. Good meters - \$3 ea. 50u A meter 3 1/2 in. new - \$15. Rubicon wheatstone bridge - \$20. Earphone sets - \$10. Wallensack tape recorder - \$20. Triumph oscilloscope - \$30. General Radio signal generator WWII - \$70. B&K picture tube tester - \$30. Heath VOM with manual - \$20. Heath solid state oscilloscope & manual - \$100. Blaupunkt auto radio stereo FM & AM - \$30. Sidney Goldhor, 1014 B St., Hayward, CA 94541. (415) 537-5149

**FOR SALE/TRADE:** Western Electric Standard signal generator, Model 78B, good condition - \$50 or a Supreme #501 or #502 tube tester. Ernest D. M. Yeaw, RR#3, Tatamagouche, Nova Scotia, Canada B0K 1V0. (902) 657-2554

**WANTED:** Philco 49-501, 90, other Philcos, and Belmont 6D-111. Nice. Original. Also Philco advertising. Claude Poletti, 17940 Harman, Melvindale, MI 48122. (313) 389-2662

**ARBE\* - III**

\* ANTIQUE RADIO BATTERY ELIMINATOR

- \* ADJUSTABLE HIGH CURRENT A SUPPLY
- \* 8 DIFFERENT B & C VOLTAGES
- \* 5 YEAR LIMITED WARRANTY

\$139.95 SHIPPED WITHIN CONTINENTAL U.S.A.  
MICHIGAN RESIDENTS ADD 4% SALES TAX

ANTIQUE RADIOS INC.  
P.O. BOX 6352  
JACKSON, MICHIGAN 49204

PHONE 517-750-4992  
AFTER 7:00 P.M. EST.

**CLASSIFIED ADVERTISEMENTS**

**MESSAGE:** To those who have sent in \$5 in reply to my ads in A.R.C. Lists will be slow in replies. Krantz, 100 Osage Ave., Somerdale, NJ 08083

**CLASSIFIED AD NOTICE**

Please check your ads carefully before sending them in. It is difficult to make changes to ads once they are received.

**FOR SALE:** Have asssd. tube shields, no chrome, price - \$3 to \$5 ea. Panasonic 5 1/4" TV, AM-FM, port. Model TR425-R batt. or 120 AC, needs some repairs - \$25. Sony Model 4-203-UW port., 3 1/2", needs some repairs - \$40. Western Electric, case only & panel for Model 24-A amp - \$20. #112-A audio - \$10, #117-A audio - \$12, #227A audio - \$12. #518-W driver, base unit only - \$25. WE volt ohmmeter, Bakelite case, works - \$18. Heathkit 1G102 signal gen. - \$20. Pair G-R Type 271 MF xfms. - \$15/both. AK 1st audios for early batt. & elect. sets. Round case w/leads - \$9 ea. Granco 604 N.O.S. tube FM set - \$17. Admiral YG743 tube N.O.S. radio - \$18. GE N.O.S. transistor AM radio - \$12. RA-DA MT cab. - \$10. Precision Model E400 FM-AM TV sweep gen. - \$49. Precision large meter 8"x5" counter tube tester Model 10-15 metal upright case - \$70. Precision counter metal case Model 10-12, needs some clean up - \$48. Model 10-12 port. case - \$65. These were the best tube testers made by Precision. Have some old flash photo bulbs. Edison base - 25¢ ea. Smith Corona mail call tape player and recorder N.O.S., (2) - \$10 ea. Kleer Tone N.O.S. - \$4. RCA amp model SA-202, 20 watts - \$20. Heathkit WA-P2 pre-amp - \$12. David Bogan G-55 amp - \$45. Bel-Conto AM-FM tuner chassis - \$30. Harmon Kardon AM-FM tuner-amp D200 - \$30. DeWald hi-fi tuner Model M1000 - \$20. DeWald hi-fi mixer unit and amp - \$30. Lafayette 236 amp, needs clean up - \$30. Lamp and fuse tester type used in hardware stores - \$4. Eico 324 signal gen. - \$25. UTC audio xfmr. PP output - \$8. Mic input - \$8. PP input - \$8. AK Model 788 power xfmr. - \$20. Thordarson T31-M amp - \$40. RCA monitor amp Type BA-4-C - \$30. Min. orders - \$7.50. All plus shipping. Krantz, 100 Osage Ave., Somerdale, NJ 08083. (609) 783-0400

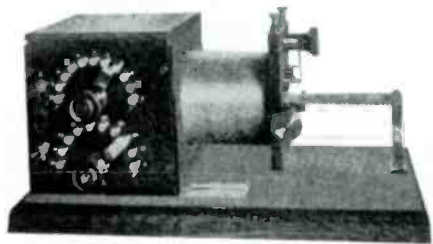

**WANTED:** W.S.A. coupler or one similar to set shown in photo. Trades available if desired. Michael Payne, 609 N. Fairview Cr., Alvin, TX 77511. (713) 331-9217

## CLASSIFIED ADVERTISEMENTS

**WANTED:** Square tube shields and filter capacitor mounts for 1937 Philcos. Thomas Bisel, 2266 Halyard Ct., St. Louis, MO 63129

**WANTED:** Zenith 6V27 or 6S27 (F.O.S., p. 192). GE K-80 (F.O.S., p. 90). John Lyle, 1161 S. W. Mulvane, Topeka, KS 66604

**FOR SALE:** Cross index of Army VT numbers and commercial numbers. SASE plus \$1. H. Galbraith, 1214 S. Alvord Blvd., Evansville, IN 47714

**WANTED:** Wicker Philco Jr. as seen in Driving Miss Daisy. Eric Rhoads, 1212 U.S. Highway One, North Palm Beach, FL 33408. (407) 626-3774, days. (407) 575-5981, nights EST

**WANTED:** Chassis for Magnavox radio-phono 240B. P. Burton, 39 E. Walnut St., Belchertown, MA 01007. (413) 323-5019

**WANTED:** Small knob for Hallicrafters S40B. 1" d. x 7/8" l. Harlow Beene, PO Box 25824, Albuquerque, NM 87125

**FOR SALE:** Reproduction dial glasses for Catalins. FADA 652 and Sentinel 284 - \$35 ea. plus \$2 postage. Radioart, Box 102, Centerbrook, CT 06409

**SOLID STATE VIBRATORS** for most automobile radios 1932-57. Exact duplicates of original styles in metal cans. Long SASE for catalog, dealer pricing on request. Antique Auto Radio, Box 892, Crystal Beach, FL 34681. (813) 785-8733.

**EXPERT ANTIQUE RADIO REPAIR.** All makes. Ken Keiter, 106 Boulder Rd., Plymouth Meeting, PA 19462. (215) 828-2027.

**WANTED:** (2) SPARTON 301 AC #A-3238-W Grid Choke, identified by red dot on bobbin. Send price and cost of mailing. Russell Sound Systems, 720 College Dr., San Jose, CA 95128-2812. (408) 295-7110

**SCOTT NEWS:** I will pay \$20 for any original issue that I do not have. Jim Clark, "The EH Scott Collector," 1292 Starboard, Okemos, MI 48864. (517) 349-2249

**WANTED:** Howard Model W, also known as Explorer, vintage 1933/1934, and Howard Model Grand, vintage 1935/1936. Both sets use multiple chassis and have nineteen tubes, though they utilize different circuitry. Any literature, partial sets, firsthand information would be appreciated. Thomas Peters, PO Box 3925, McAllen, TX 78502

**WANTED:** GE Model K85 cabinet with or without chassis, in any condition. Fred Smead, 31 Chapel Rd., Amherst, MA 01002. (413) 253-2784

## CLASSIFIED ADVERTISEMENTS

**WANTED:** Zenith Model 6D630 AM table radio with 6B05 chassis. Roger Reader, 526 13th Ave., N., Onalaska, WI 54650. (608) 783-0723

**WANTED:** Heath AT-1, Brown Bros. keys and paddles. Tom French, 120 Great Rd., Maynard, MA 01754. (508) 897-6622. (508) 897-2226

**FOR SALE:** EMUD Model Junior 196, excellent - \$75. Zenith 7H820UZ large Bakelite, early FM, nice - \$25. Zenith Model 94 Inner Oceanic - \$30. Westinghouse wood Deco 1-457T6 - \$15. Auditorion WGAY-FM plastic novelty set - \$15. All plus UPS. Gary Pirkkala, 2306 Audley Ave., New Castle, PA 16105. (412) 654-8481

**WANTED:** Pepsi cooler radio (blue plastic). Gary Glazier, 3031 El Caminito, La Crescenta, CA 91214. (818) 248-1693

**BOXED CLASSIFIED ADS WORK!** This is a boxed classified ad. These ads can be run more than two months. See the inside back cover for details. Boxed ad deadline: the 5th of the month.

**WANTED: SONY Radios and small TV's...** the older the better! Please call or send details: Jay Lewin, 400 East 54th St., New York, NY 10022. (212) 935-5656



**WANTED:** Scott radio as pictured above. I will pay up to \$1,000 for this set. Jim Clark, 1292 Starboard, Okemos, MI 48864. (517) 349-2249

**FOR SALE:** Riders, Howard Sams, other service data. Tubes, parts, 1000's of unlisted items. Write wants. SASE for reply. Sales/Service since 1930. Krantz, 100 Osage Ave., Somerdale, NJ 08083

**COLLECTING:** National regenerative receivers SW3-4-5, etc. Also parts and accessories for them. Glad to correspond with "Thrill Box" enthusiasts. Dean Showalter, WA6PJR, 36308 Panorama Dr., Yucaipa, CA 92399. (714) 797-1782

**WANTED: (Car radios or parts) 1930-1990, factory original only.** Call or write with brand name, model number, phone number and hours you can be reached. Radio & Wheel-cover World, 2718 Koper, Sterling Hgts., MI 48310. (313) 977-7979

**WANTED:** Edison two-speed cylinder machine with Cygnet or Music Master horn; wire for Webster Chicago recorders; RCA sound tape cartridges; Astatic M-41 magnetic cutter head; blank recording disks; Radiotron WD-11 Bakelite base. Robert Perlstein, 17 Vine St., Medford, MA 02155. (617) 391-3026

**CLASSIFIED ADVERTISEMENTS**

**FOR SALE:** (17) audio transformers for battery radios. Twelve are good, five have an open winding - \$50 ppd. Duane Bylund, 5153 W. 5400 South, Salt Lake City, UT 84118. (801) 251-4949

**WANTED:** Working radios - RCA Tambour 28D. Atwater Kent 40. Brass base/Top Tip good WD-11 tubes. Kunio Okura, JA8BI, 8-3-7 Tokiwa, Urawa, Saitama, Japan, 336

**FOR SALE:** Mint Scott Allwave 12. Waverly Grand cabinet. All chrome chassis. All coils. Les Rayner, 5512 N. 71st Pl., Scottsdale, AZ 85253. (602) 947-1375

**FOR SALE:** One vg electric clock Adivetize Regency 2-way radio authorized sales & service, metal - \$25. Plus UPS. Thomas Burnside, 4838 S. Westhaven Dr., Jackson, MS 39209. (600) 922-2235



**WANTED: SILVERTONE RADIO** as pictured above. E. Brill, 405 Wire Mill Road, Stamford, CT 06903. (203) 329-2254

**FOR SALE: PHONO NEEDLES & CARTRIDGES** (ceramic - magnetic). What do you need? Send SASE. J. J. Papovich, 53 Magnolia Ave., Pitman, NJ 08071. (609) 582-8279

Desperately needed: Skyriders Commercial, S-30, S-33, S-35, EC-4, EC-6, HT-8, HT-12, HT-14, silver panel Skyriders, other old or unusual gear, parts manuals, memorabilia of the Hallicrafters Co., and 1934 "H", "Z", "K", "J", line of Silver-Marshall radios. **The Hallicrafter Collector** - Chuck Dachis, 4500 Russell Drive, Austin, TX 78745

**WANTED: QST-S** for 1916 and 1917. R. Arrowsmith, W4JNN, 3505 Woodburn Rd., Annandale, VA 22003. (703) 560-7161

**TUBES AND MISC.** Large stock of **NEW** and **GOOD** used radio tubes, etc. Send \$1 (stamps OK) - **REFUNDABLE** for latest flyer. Don Diers, 4276 - BC1, North 50 St., Milwaukee, WI, 53216-1313

**FOR SALE:** 100's of vintage radios, TVs, speakers, radio magazines, etc. Send \$1.50 (stamps OK) for America's best monthly **SALES LIST** to: Jim Clark Enterprises, Dept. ARC, 1292 Starboard, Okemos, MI 48864

**CLASSIFIED ADVERTISEMENTS**

**WANTED:** Zenith Royal 500 transistor radios. Color, chassis number, and condition are important. Karl Ayer, PO Box 665, Thiensville, WI 53092. (414) 242-0571

**FOR SALE:** Schematics: 1920-1960 radio/TV/ham/misc./Canadian/electronic organ - \$3.50 and postage. Quotes on manuals - SASE. Alton Bowman, 4172 East Ave., RD 2, Canandaigua, NY 14424

**FOR SALE:** Philco battery cathedral Model 37-34 - \$90. Rola horn speaker - \$100. Abbottsware horse radio - \$300. Dictography copper horn speaker - \$150. Owen Orndorff, RR2, Box 237, Danville, IL 61832. (217) 442-6812

**FOR SALE:** Riders 1st Edition Vol. 1 - \$65. Riders 1st Edition Vol. 2 - \$55. Metal Arvin (Phil Collins' R.T.G.A., p 93) - \$65. Metal Silver-tone (R.T.G.A., p. 100) - \$55. Radiola 61-10 - \$25. Telefunken Concerto - \$125. **WANTED:** Pilot and German sets. Bill Moore, 1005 Fieldstone Ct., Huntsville, AL 35803. (205) 880-1207

**WANTED:** Zenith S-829 tall tombstone with chrome grille, 7 glass tubes. Metrodyne Super-7 or Super-6 with decorative front panels. Lloyd B. Zimmerman, 8448 N. Harding Ave., Skokie, IL 60076

**WE'RE STILL HERE!** Tubes: "Oldest," "Latest." Schematics. SASE for lists to Steinmetz Electronics, 7519 Maplewood Ave., Hammond, IN 46324

**WANTED:** Early tube hi-fi components and studio equipment by Acrosound, Brook, Broclner, Falchild, Hadley, Marantz. Also want Western Electric amplifiers, speakers, tubes, microphones. Richard Sharlsky, PO Box 521, Belmont, MA 02178. (617) 484-5784

**DAN'S SCHEMATIC SERVICE.** Radio diagrams, 1921 to 1960 - \$2.50 ppd. T.V. diagrams, 1938 to 1960 - \$3.50 ppd. Send make and model number of set, or chassis layout sketch with tube types, if model number is unknown, to: Dan's Schematic Service, P.O. Box 53061, San Jose, CA 95153.

**.01 MICROFARAD 1 KV long lead DISK CERAMICS** - \$12 per 100 postpaid. Quantity discounts available. For quantity discount info or to order write to: Paul Graziani, PO Box 5028, Little Rock, AR 72225

**WANTED: Pre-1926 radios by AMRAD.** Also, radio parts, accessories, and literature. Richard Sharlsky, PO Box 521, Belmont, MA 02178. (617) 484-5784

**TELEGRAPH INSTRUMENTS WANTED,** pre-1900, any type, any condition. Reinke, 5301 Neville Ct., Alexandria, VA 22310-1113

## CLASSIFIED ADVERTISEMENTS

**WANTED:** DeWald A-501 dial glass. Radiola 60 foot. Majestic 15 chassis for parts. Steven P. Berglund, 617 S. W. 146th, Seattle, WA 98166. (206) 246-8045

**WANTED:** Manual for HP 330B distortion analyzer, urgent. Can copy and return. Charles Rhodes, 64 S. River Rd., Edgewater, MD 21037. (301) 266-3691

**WANTED:** Western Electric 201A and 217A tubes and any WE receiver working or junker. Marc Ingenthron, 9748 Outlook, Overland Park, KS 66207. (913) 642-4767

**FOR TRADE:** TRK-9 chassis (2) needs work but defl. yoke, xfms. OK. Brewster, 454 Diablo Dr., Pittsburgh, PA 15241. (412) 833-4287

**WANTED:** Desperately seeking a 1933 Crosley Coke bottle radio. Also Coke cooler crystal set and early transistor Coke machine radios. Have some great trades. Cliff Watts, 51 Glendale Rd., Brantford, Ontario, Canada N3T 1P5. (519) 753-5087

**DAN'S SCHEMATIC SERVICE** now has NEW and GOOD USED TUBES, parts, RADIOS, test equipment, books, magazines and lots of miscellaneous. Send large SASE for lists to: Dan's Schematic Service, PO Box 53061, San Jose, CA 95153

**FOR SALE:** Rare Farnsworth Image Dissector TV camera tube (1940, XA-361) with 11-state electron multiplier. Original factory engineering specs included. Best offer over \$2,000. F. A. Everest, 2661 Tallant Rd., #619, Santa Barbara, CA 93105

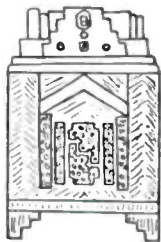

**WANTED:** EH Scott radio in cabinet pictured to left. Jim Clark, 1292 Starboard, Okemos, MI 48864. (517) 349-2249

**WILSON ANTENNA'S:** Transmits and receives farther than any other mobile antenna it replaces, 26.9 MHz to 28.5 MHz. MC/Visa accepted. Price Electronic Sales, 35 Hillview Rd., Monocacy Station, PA 19542. (215) 385-3343

**WANTED:** WWII RCA aircraft radios. AVT-112A transmitter, AVT-15 transmitter, AVR-20A receiver, AVA-126A power supply. George Damiano, 4131 Denver, Yorba Linda, CA 92686. (714) 993-1052, after 5 pm

## CLASSIFIED ADVERTISEMENTS

**WANTED:** Eight original colors of Radio Shack Flavoradios. N.O.S. or used excellent. Dean R. Kazmierczak, D.R.K. Computer Consultants, 886 Eggert Dr., N. Tonawanda, NY 14120. (716) 692-3455

**WANTED:** Manual, circuitry, miscellaneous parts for Harvey Radio Laboratories 90-T transmitter. Leland Smith, HCR-31, Box 147, Jasper, AR 72641. (501) 428-5967

**FOR SALE:** Empty Aeriola Senior cabinet with all hardware in excellent condition. Harry Cap, 190 Beech St., Bridgewater, MA 02324. (508) 697-8648

**WANTED:** Crosley Pup radio, in non-working condition, but complete with tube. Tony Piccoro, 3261 Park Forest Dr., West Bloomfield, MI 48033. (313) 363-1017

**WANTED:** Fisher SA-1000 amplifier. Also collecting other Fisher equipment from the sixties. Bill Luginbuhl, 103 N. Lawn, Bluffton, OH 45817. (419) 358-1741

**FOR SALE:** Thirteen antique radios 1921-1936. Detailed list available on request. All radios in functional condition. John K. Fulton, MD, 236 S. Terrace Dr., Wichita, KS 67218

**WANTED:** Broadcast-type MICROPHONES. Early carbon, condenser, ribbon, dynamic, etc. Cash or trade. James Steele, PO Box 620, Kingsland, GA 31548-0620. (912) 729-2242

**SERIOUSLY SEEKING EDISON** electric radio/phono Model C-1. Will pay top dollar in excellent original condition. Same goes for an Edison authentic "Tin Foil" phono or Bell-Tainter Graphophone. Also, early light bulbs (not collectibles) in bulk. Call Bo Broock. (313) 681-7133 after 8:00 pm evens.

Johnson's Old Radios, Pointers and Prices. \$15.00 postpaid. Homebiz Books, 2919 Mistwood Forest Dr., Chester, VA 23831-7043

### UNIVERSAL TRANSFORMER SAVER:

The ultimate "bolt on" for TRF receivers. Restores dead interstage coupling transformers instantly. Just solder across bad transformer's terminals. Works with any transformer in any 20's TRF receiver and its appearance is proper. With instructions just \$8.63, \$16.06 per pair, ppd. Hidyne Research, Box 3342, Williamsport, PA 17701. (717) 326-2148

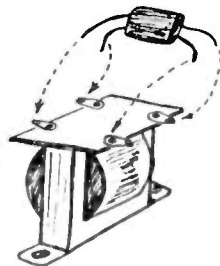

---

**CLASSIFIED ADVERTISEMENTS**

**WANTED:** Stromberg-Carlson 82 chassis, speaker. Info, pictures on Majestic M-100 or M-300 console. Klaus Beckmann, General Delivery, Tofield, Alberta, Canada T0B 4J0. (403) 662-3518

**FOR TRADE:** Hallicrafters S-38E for Knight Span Master or Heath GR-81. Al Bernard, PO Box 690098, Orlando, FL 32869-0098. (407) 351-5536

**WANTED:** RCA 281 console, any RCA communications receivers. C.L. Zitterich, 1725 Oak Hill, Corinth, TX 76205

**FOR SALE:** Cathedrals, (refrigerator), novelty sets, etc. Send LSASE for large list. J. L. Acciavatti, PO Box 231, Southboro, MA 01772. (508) 476-3229

**HELP:** Need vernier knob with arrow for King #80, 81, etc. or junk radio to repair shipping damage. J. M. Pawell, 6 Augustine Ave., Ardsley, NY 10502. (914) 693-9374

**FOR SALE:** Eico HFT-90 FM tuner w/Sams and repro manual. Heathkit EA-3 hi-fi amp. w/manual. Knight KG-70 stereo tuner and KG-870 stereo amp. w/manuals. HP Model 122A oscilloscope w/repro manual. Heathkit-Daystrom Mohawk RX-1 receiver w/repro manual, partial. Make offer on all above. Sams #547 complete - \$12 ppd. Bob Jackson, 1720 Bowline Rd., Houston, TX 77062. (713) 488-0065

**FOR SALE:** Airline #6D12 - \$40. Zenith AM-FM T723 - \$45. Zenith AM J615 - \$40. GE Bakelite 226 - \$40. RCA Victor 8-X-71 - \$45. Philco Transitone 49-504 - \$45. Westinghouse wire legs, different, #H-41875? - \$30. Silvertone Catalog #7004 - \$25. Sentinel #10-356 - \$25. Motorola #5P31A portable - \$25. Heathkit amp. Model #A-9 - \$25. British turntable unit - \$20. Decca, record player, Bakelite - \$30. Stewart-Warner A61P1 - \$75. Sky Rover 900ZN - \$50. Silvertone, ivory basketweave grille, nice, - \$60. All sold as is, buyer assumes all responsibility. All plus UPS. Darrell Combs, 6587 Pacheco Way, Citrus Heights, CA 95610. (916) 969-0635, after 5 pm PST

**WANTED:** Speaker for National NC-100 or NC-101; dial plate for Philco Model 60. Dave Jorgenson, 2804 Klondike Ct., Las Vegas, NV 89117. (702) 254-2238

**FOR SALE:** Western Electric 14A speaker with tubes - \$200. Stromberg 14A combination - \$200. Bill Wiley, 968 W. Market, Akron, OH 44313. (216) 867-7505

**FOR SALE:** Small metal 1957 Emerson 1232 radio TV combo, works - \$40. Emerson 1949 TV, 7", missing a knob - \$60 ppd. Jerry Traub, 806 McDonald Ave., Santa Rosa, CA 95404. (707) 545-9425

---

**CLASSIFIED ADVERTISEMENTS**

**WANTED:** Schematics German radios: Grundig stereo 3192U. Grundig Type 2120. EMUD, Record Junior 196. Graetz, Komtess 1111 Tr. Also Kolster-Brandes Model FB-10FM, mfg. Kent, England. Also pix tube Sony transistor TV Model 5-307W Tube No. GM-40 or 140CB4, Part 873110510. 12v power plug. Don Nordboe, 3220 W. Broadway, Council Bluffs, IA 51501. (712) 322-2255

**WANTED:** Large loose couplers. Long wave types. Also want Goniometer receiver and V24 vacuum tube receiver and amplifier. Richard Groshong, 6604 Kent Dr. NE, Cedar Rapids, IA 52402. (319) 377-3144

**FOR SALE:** Kadette Jr. pocket radio, near mint - offers. Kolster 6K cabinet only, good - \$30. Stromberg-Carlson 600B restorable chassis, good but dirty, missing meter and two audios, (V.R., p. 206) - \$30. Western Electric cone speaker, base, frame and good driver, no cone - \$20. Stewart-Warner Our World Today book radio, case only, fair - \$10. A.A. Mohawk Cherokee one dial TRF, looks good, electrically poor - \$25. Philco 12" electrodynamic speaker #45-0006-3, N.I.B. sealed! - \$25. Prices are negotiable, do not include shipping. J. M. Pawell, 6 Augustine Ave., Ardsley, NY 10502. (914) 693-9374

**WANTED:** ElKay, Langbein-Kaufman Radio Co., battery or AC sets. Detrola console. Dial face and call letter inserts for Philco 37-675. Dial glass for Zenith 12H689. Ron Trench, Jr., 12 Virginia Rd., East Haven, CT 06512. (203) 469-7340

**WANTED:** Will pay up to \$400 for a WD-12 version of a Crosley Pup, up to \$750 for a Grebe CR-18, up to \$400 for a Collins 32V3, and up to \$100 for a National NC-33. Units must be complete, all original, in operating condition, and excellent cosmetically. Jim Allen, 1653 Newcastle Dr., Los Altos, CA 94024. (415) 968-0640

**FOR SALE:** Clapp-Eastham Boston key - \$150. AK 35 - \$80. Radiola 100A - \$30. Magnavox R4D - \$90. Horn only - \$40. George Goldstone, W8AP, 1010 Burnham, Bloomfield Hills, MI 48013. (313) 647-3399

**FOR SALE:** Over 3000 N.I.B. vacuum tubes - \$500. Old transistor radios. Send SASE. Ask for tube list or transistor list. Richard Groshong, 6604 Kent Dr. NE, Cedar Rapids, IA 52402. (319) 377-3144

**WANTED:** Oscillator coil assembly for Zenith 6S229. Dial glass for Philco 48-482 and Stromberg-Carlson 1135. Roger Muir, 2911 Lapsley, Dallas, TX 75212. (214) 905-0822

**WANTED:** DeForest oscillion rectifier. Small rare tube collection. Have commercial wireless gear to trade. Richard Groshong, 6604 Kent Dr., NE, Cedar Rapids, IA 52402. (319) 377-3144

**CLASSIFIED ADVERTISEMENTS**

**WANTED:** Remler Scottie mirrored radio. Have following possible trade items: 1936 Zenith 12-A-58 twin speaker console, two 1938 Zenith 12-S-265 shutter dial consoles, Brunswick Model 11 tombstone (B.F.T.P., p. 63), Howard Model SG-B Green Diamond (B.F.T.P., p. 48), Climax Duke tear drop tabletop (B.F.T.P., p. 196 except no tuning eye) and Addison 2A maroon/butterscotch Catalin. Steve Neal, 3472 Stancrest Dr., Glendale, CA 91208. (818) 248-3169

**FOR SALE:** Colonial 1935 #236X tombstone - \$125. Sonora 1940s #LLS179 wood horiz., tic-tac-toe grille, square gold dial - \$30. Zenith 1946 #6D2614 dome top wood horiz., arched black dial - \$42. Truetone 1941 #D2211 wood horiz., large rose & gold dial - \$52. Bendix 1946 #0526E wood horiz., rippled wood grille - \$52. Clarion Jr., 1932 5-tube #320 tombstone, church window shaped grille, peep window dial - \$80. Motorola 1950's #56L2A bright red & black portable - \$36. Tiny radios: Mirrortone 1940's ivory Bakelite - \$35. Meck 1950 #DB502 ebony with large gold escutcheon - \$45. Emerson 1950's #708 gray cube plastic - \$45. Meck 1940's #DB602 ivory Bakelite, maroon knobs - \$30. Arlington late 1950's 5-tube black/white plastic - \$30. As is cathedrals: Philco 1930's #84, dial lens gone - \$40. Philco 1933 #60-505 painted, chassis complete - \$45. Long SASE. Ripley, Box 9374, North St. Paul, MN 55109. (612) 777-6791

**WANTED:** Knobs for an Emerson 520. This one is especially difficult to reproduce, so will appreciate all leads! Ray Miller, Box 306, Avalon, CA 90704. (213) 510-1700, call collect. Thanks!

**CLASSIFIED ADVERTISEMENTS**

**WANTED:** HS[?]-215, Drake R-4C, 8X-115, NC-400. Levy, 8 Waterloo, Morris Plains, NJ 07950. (201) 285-0233

**FOR SALE:** Jensen Concert speaker Model A-12, reconed, 15 lbs. - \$25. Peerless cathedral sprk., excellent - \$30. Blaupunkt auto radio service manuals 1957, 1958 complete, 59-60 3 models plus 7 models unknown years - \$20. Sams Auto Radio manuals like new 300+ manuals - \$300. Beitman MON radio 1941, 1947, TV service - \$12. Over 100 xmtr. and special tubes for offer, SASE for list. Above plus UPS. **WANTED:** RCA Red-book 1922-1937, Sams TSM2 also 12 thru 23, Grebe MU1 bead chains, Music Master horn driver. Gene Claus, 2305 W. Rice, Sioux Falls, SD 57104. (605) 332-3747

**FOR SALE:** GE SCR 515A, Navy ABA-1, operating manual, in original export box - \$100 ppd. GR Resistance Limit Bridge Type 1652A - \$35 ppd. Century antenna line tester Model ALT-1 - \$7.50 ppd. Superior Instrument Genometer TV50A - \$15 ppd. NRI Prof. RC tester, Model 112 as is - \$25 ppd. Roller-Smith ohmmeter Type COM, zero center meter for bridge balance. James Fred, R1, Cutler, IN 46920

**FOR TRADE:** Sams TSM Vol. 1 for Vol. 2. **FOR SALE:** Westinghouse H770P7 - \$15. Zenith Royal 790 - \$15. Elgin R-1500 - \$10. J. Wilson, 2007 Water Edge, Birmingham, AL 35244

**WANTED:** Zenith 15" color TV, their first color set, 1953-1954. Jim Clark, 1292 Starboard, Okemos, MI 48864. (517) 349-2249

**TUBES WANTED**

We need the following tubes to replenish our stock. You may ship your tubes to us by UPS or Parcel Post. We'll mail our check upon receipt and testing of tubes. We pay prices shown plus shipping charges.

**USED GLOBE OR BALLOON SHAPE TUBES - ALL MUST TEST GOOD**

WD-11* .....	\$25.00	UV-199* .....	\$10.00	227 .....	\$2.00
WD-12* .....	15.00	UX-199* .....	9.00	245 .....	10.00
112A .....	6.00	200A .....	5.00	250 .....	20.00
120 .....	8.00	201A .....	5.00	280 .....	5.50
171/A .....	5.50	210 .....	8.50	281 .....	5.50
183/483 .....	6.00	222 .....	3.50	401 .....	12.00
184 .....	6.00	226 .....	4.00	403 .....	15.00

\* Tubular

We buy all types of receiving and transmitting tubes. Types not listed above must be new and in original boxes. Send us your list for our bid.

**ANTIQUE ELECTRONIC SUPPLY**

688 W. First St., Tempe, Arizona 85281, 602/894-9503

---

**CLASSIFIED ADVERTISEMENTS**

**WANTED:** Cabinets, Zenith H725Z1, Airline 04BR513A brown Bakelite, Zenith T405P green/ivory plastic cabinet. Philip Burnais, 14185 Pleasanton Hwy., Bear Lake, MI 49614

**FOR SALE/TRADE:** For any original condition AK breadboards, I offer the following: DeForest D-12 with loop, Michigan MRC-12, Radiola 26, Spittdorf R-500, Power A. Send large SASE for other radios, horns, speakers, cathedrals, novelty tube and transistor radios and other AC sets for sale/trade. Antique Radios, PO Box 6352, Jackson, MI 49204. (517) 750-4992

**FOR SALE:** SASE for multipage list of radio, telegraph and ham publications. Dick Randall, K6ARE, 1263 Lakehurst Rd., Livermore, CA 94550-1851

**WANTED:** Zenith radios, glass tube sockets (Garod, Duray, etc.) **FOR SALE:** Tubes from 20's thru 60's. Thanks. Bob Dubush, 3554 W. 105, Cleveland, OH 44111. (216) 228-4953

**FOR SALE:** RCA 9X572, (G.T.O.R., p. 116) - \$60. Manuals: Heathkit, Tek 561 A/B. **WANTED:** Tatro. Jim Kelley, 4469 Sundburst Dr., Ocean-side, CA 92056. (619) 941-1582

**FOR SALE:** 1926 Zenith Opera set. Bremer Tully AC counterphase. 1937 Mallory Radio Service Encyclopedia. Dial belts for Scott, Silver-Marshall, Hallicrafters, Sparton, RCA, Crosley, FADA. Speakers for GE H-87, RCA 98K, Philco 39-36, 37-370. Books on 2-KW radio + and + transmitter Type Rt-10-S. Dynamic 6", 8" and 12" speakers and output transformers. Bill Coolahan, 1450 Miami Dr. NE, Cedar Rapids, IA 52402. (319) 393-8075

**WANTED:** Tuska sets, parts & literature. Also looking for Knight-Kit C11 CB radio. Glenn Hoch-walt, 8899 Cypressgate Dr., Huber Heights, OH 45424. (513) 667-4030

**FOR SALE:** AR turntable in original box, Acoustic Research's original model - \$30. Parts also available. Al Smith, 25 Stonehedge Rd., Lincoln, MA 01773. (617) 259-9351

**FOR SALE:** Many types of radio, TV, and industrial tubes. DH Distributors, PO Box 48623, Wichita, KS 67201. (316) 684-0050

**WANTED:** USL, King, Wurlitzer and other Buffalo, N. Y. area radios, speakers, parts and misc. pre-1930. (Federal, too). J. M. Pawell, 6 Augustine Ave., Ardsley, NY 10502. (914) 693-9374

**WANTED:** Postwar GE FM converter. Craig Roberts, 35-L Ridge Rd., Greenbelt, MD 20770

**WANTED:** Tandberg transistor portable. Daryl Jorud, R#1, Box 180, Battle Lake, MN 56515. (218) 864-5725

---

**CLASSIFIED ADVERTISEMENTS**

**FOR SALE:** RME69, 75A2, SW54, EC-1B, 11 Arcturus blue tubes, tested. Pete Putra, 1429 Lawndale Ave., Racine, WI 53403. (414) 632-2543

**FOR SALE:** February 1990 catalog of radio broadcasting books now available. Send 25c stamp. Rainy Day Books, PO Box 775, Fitzwilliam, NH 03447. (603) 585-3448

**WANTED:** Tuning wheel for Crosley 54G New Buddy Repwood in good condition. Dennis Schrank, 3129 S. Quincy Ave., Milwaukee, WI 53207. (414) 744-3374

**WANTED:** Chassis and speakers for the following radios; GE K-50-P, K-51 or RCA R28 Series. RCA 100, 101, 103 or 301. Sonny Clutter, 14407 NE Fremont, Portland, OR 97230. (503) 254-9296, eves.

---

**NEW PHONE NUMBER FOR  
ANTIQUÉ RADIO CLASSIFIED  
(508) 371-0512**

**Best time to call is weekdays:  
9 am to 5 pm Eastern Time**

(Please no classified ads by phone. Thanks!)

**FOR SALE:** Rider's encyclopedia on oscilloscopes, 10 lbs. - \$25. Rider's TV Manuals 5-6-7-9, 15 lbs. - \$20 ea. Radio News 1950's in hard cover binders. Health and age, must sell. List SASE. R. Olmsted, 608 W. Thompson Ln., Murfreesboro, TN 37129

**WANTED:** Saba (German) radios, speakers, consoles, receivers, catalogs/literature. Pay/arrange shipping. Bob Lauritsen, 33195 Case St., Lake Elsinor, CA 92530. (714) 678-5927

**FOR SALE/TRADE:** ART-13, GRC-14, SX-117, SX-43, NC-57, NC-183D, HQ-129X, AT-1, AF-54, 75A2, 75A4. Ron Follmar, 1409 W. Willis, Alvin, TX 77511. (713) 331-1074

**FOR SALE:** Quantity of test equipment, tubes, plastics, floor models, books, Sams, Rider's, etc. Send SASE. Doug McManus, 20 Deland Park A, Fairport, NY 14450

**WANTED:** 1934-5 Zenith shadowgraph unit, or whole chassis. 1938 Zenith motor drive knob (have other Zenith knobs to trade). Steve Baron, 435 Park Ave., Lexington, KY 40502. (606) 269-2832

**FOR TRADE:** Blue glass Sparton 557 for Emerson Mickey Mouse 410, has metal Mickey in octagonal grille. Ken Zander, 447 N. Second St., San Jose, CA 95112. (408) 286-1104

**FOR SALE:** E. H. Scott All-Wave 12 Deluxe in Wellington cabinet, 1933 - \$875. Daryl Jorud, R#1, Box 180, Battle Lake, MN 56515. (218) 864-5725



## CLASSIFIED ADVERTISEMENTS

**WANTED:** Johnson Navigator and speed key. LF coils for HRO-5. Hammarlund Super Pro 110/210. Brian Roberts, 3068 N. Evergreen Rd., Pittsburgh, PA 15237. (412) 931-4646

**WANTED:** Front panel nameplates for Western Electric 4-D radio. Rick Peterson, 603 Tournament, Berwick, LA 70342. (504) 384-5619

### CLASSIFIED AD NOTICE

Full name and address is now **required** in all classified ads – it does not cost extra! We will add it if you forget.

**WANTED:** Desperately need amplification selector cam and lever switch for Federal 59 or 61. James S. Fisher, 344 Harrison Ave., Manville, NJ 08835. (201) 725-7476

**FOR SALE:** Closeout on antique electronics, radio collection. Call, write after March 5. List LSASE. John Enigl, 5425 Cherry Ln., Egg Harbor, WI 54209. (414) 743-3672

**FOR SALE/TRADE:** Bing Crosby junior jukebox, decent – \$175. **WANTED:** Early battery sets. Ed Bell, 5311 Woodsdale Rd., Raleigh, NC 27606. (919) 851-1517

**WANTED:** Coil winder, to use not show. Dial glass RCA 19K. Richard Radke, POB 451, Wautoma, WI 54982

**WANTED:** McIntosh stereo equipment and speakers. Gary Stejskal, 1412 26 St., NW, Cedar Rapids, IA 52405. (319) 396-0341, after 7 pm

**WANTED:** Belmont Deco radios and Crosley color radios, any condition except cracked. Will pay your price. Mark Miller, 4223 Yorba Linda, Royal Oak, MI 48073. (313) 549-9406

**FOR SALE:** (10) metal radio such as Atwater Kent, etc. – \$350, F.O.B., no shipping. Pat Cutini, 2114 Main Rd., Pembroke, NY 14036. (716) 762-8270

**FOR SALE:** Cabinets only: Crosley 6-60, good – \$25; Zenith 11-12, good – \$25; Crosley console Happy Hour Model 1T – \$25; Majestic Model 210 chassis, no tubes – \$20. All plus shipping. Paul Gunzenhauser, Rt 1, Box 133, Garden Grove, IA 50103. (515) 443-2161

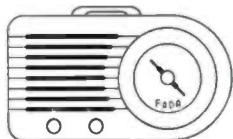

**WANTED:** Blue and white FADA Bullet (or dark green and yellow) in excellent condition. Sam Juliano, 15718 Falmouth Dr., Houston, TX 77059. (713) 486-8726, please leave message

## CLASSIFIED ADVERTISEMENTS

**WANTED:** Philco 29TX, 1934, picture tube 16EP4. **FOR SALE:** AK H horn – \$75. Westinghouse refrigerator, tan – \$45. Motorola 7" TV – \$125. Nice Silvertone cathedral – \$135. FADA 263W, brown – \$50. Philco Mystery control with batteries – \$50. Richard C. Foster, 12 Shawmut Ave., Cochituate, MA 01778

**WANTED:** Front nameplate emblem for Crosley 54. Merrill Mabbs, 709 Pluma Dr., Rapid City, SD 57702. (605) 342-4090

**FOR SALE:** Zenith 715 large-domed cathedral AM, 1933 – \$150. Zenith Model 6J322, large gold airplane dial, 2-band, 6 push buttons, AC+6v DC – \$85. Crosley Model 61-6H2, Art Deco 2-color walnut true tombstone, large, 2-band hemisphere dial, 1935 – \$135. All excellent, plus postage. John Porter, 701 N. Main, Osceola, IA 50213

**FOR SALE/TRADE:** Repwood cathedrals, choice battery sets, and cylinder phonographs. Want early Ace sets, Firth Vocophone 235-B, Globe Duodyne 815, Cutting Washington II, glass Clearfield TRF6, matching amp for CRL type PAR tuner (pre-Zenith), or cash. Coming to the March radio auction? Craig Ball, 204 N. 5th St., Marshalltown, IA 50158. (515) 752-0406

**WANTED:** Three Pigs radio & Lone Ranger. Pay \$300 plus UPS. Ed Levin, 13826 Ventura, Sherman Oaks, CA 91423. (818) 981-5325

**SERVICES:** Repair old auto or home radios. Fielding Grigsby, 2525 Rogers Ave., Fort Smith, AR 72901. (501) 785-4605

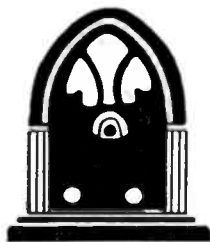

*Craig L. Graybar  
Furniture Works Ltd.*

(414) 258-2390

SPECIALISTS IN RESTORING, REPAIRING AND REPRODUCING CLASSIC STYLED ANTIQUE TV, RADIO & PHONOGRAPH CABINETS

Send us your plans or your project via UPS for immediate price quotes

1535 S. 84th St.  
West Allis, WI 53214

*"We Turn Ideas Into Heirlooms"*

---

**CLASSIFIED ADVERTISEMENTS**

---

**WANTED:** Philmore 2-tube w/3525 and 12SK7 tubes. Simpson 355 tube checker, need op. manual. Stanley Caesar, 512 Country Club Cir., Midwest City, OK 73110

**WANTED:** A manual and circuit on a Tektronics dual beam 502 scope. Ray Larson, 12241 1/2 Gorham Ave., W. Los Angeles, CA 90049

**FOR SALE:** WWII aircraft receivers and transmitters with the following model prefixes: APR, ARC, ARR, APQ, APT, ARQ, APA. Also General Radio P-540 and SCR-587. Anything related to Pan American Airline. James Treherne, 11909 Chapel Rd., Clifton, VA 22024. (703) 830-6272

**FOR SALE:** Meistersinger horn, complete and working, resembles Music Master w/woodgrain bell, frayed cord, but no dents or scratches, logo intact - \$75 plus UPS. Robert Rathbone, Rt. 1, Box 127, Ossipee, NH 03864. (603) 535-2762

**WANTED:** Regency TR-1. Early transistor radios. Point-contact transistors. Richard Groshong, 6604 Kent Dr. NE, Cedar Rapids, IA 52402. (319) 377-3144

**FOR SALE:** Hammond Novachord electronic organ, circa 1939, only approx. 200 manufactured. Full keyboard, 200 tubes - BO over \$500. **WANTED:** TV knobs circa 1940's & 50's. 15GP22 or 15HP22 picture tubes and color TV's or chassis using same picture tube. John Folsom, 450 Golden Dove Ave., NE Palm Bay, FL 32907. (407) 725-3462, evenings weekends (machine will answer after 4 rings if not home)

**FOR SALE:** Rider's Vol. 2 through 6 - \$15 ea. and up. Beitman 1939, 1941, 1942 - \$8 ea. Coyne Television Cyclopeda, 789 pp. - \$15. Everybody's Radio Handbook - \$12. Television Video Handbook, 890 pp. - \$10. Radio Handbook (amateur) 14th edition, 760 pp. - \$12. Mallory Encyclopedia - \$25. Radio News Magazines - \$3 ea. Radio Craft - \$4 ea. Communications 1940's - \$3 ea. Short Wave & Television - \$6 ea. Radio (Shortwave & Experimental) - \$3 ea. Service 1930's - \$3 ea. FM & Television - \$5 ea. Radio Engineering '35-'36 - \$3 ea. Radio World - \$5. Radio Service Dealer - '48-'58 - \$1 ea. Photofact Reporter '58-'62 - \$1 ea. Lionel diesel train set - \$100. Marx train set - \$50. Lionel Catalogues - \$2 ea. Crosley & Freed-Eisemann battery radios - \$100 ea. Heathkit hi-fi catalogue 1957. SASE with reply. **WANTED:** Riders Vol. 18-23. Will trade above. Bill Rolf, 30131 Center Ridge, Westlake, OH 44145. (216) 871-4547

**WANTED:** Model K526 Zenith tabletop Bakelite. Clarence Smith, 17845 144th Ave., Spring Lake, MI 49456. (616) 842-8517

**WANTED:** Crosley RFTA schematic diagram, and RCA Radiola V name tag. Frank R. White, PO Box 2012, Olathe, KS 66061

---

**CLASSIFIED ADVERTISEMENTS**

---

**FOR SALE:** Encyclopedia of Cathode-Ray Oscilloscopes and Their Uses by Rider and Uslan, copyright 1955, 998 pp., good condition - \$18 including UPS shipping. James F. Crews, HC63, Box 4, Arbovale, WV 24915. (304) 456-4798

**WANTED:** ARC-50, AN/ARW-4, AN/CRW-8 equipment, manuals, etc. Richard Groshong, 6604 Kent Dr. NE, Cedar Rapids, IA 52402. (319) 377-3144

**FOR TRADE:** Coronado by Belmont for interesting small metal or Bakelite radio, or sell. Jim F. Montague, 921 S. Cuba, Spokane, WA 99202. (509) 535-9576

**SERVICES:** Replace those lost grilles on your radios, phonographs & speakers. I'll scrollsaw, (from your pattern) flat replacement grille work from 1/8" or 1/4", A3 grade walnut or oak plywood, (the best grade available). 18"x18" maximum size. You sand and finish. Cost is 25¢ per square inch. Call before ordering for guidelines about your patterns. Shipping & packing will be a flat rate of \$6.00 ea. anywhere in the original 48 states. Darrell Combs, 6587 Pacheco Way, Citrus Heights, CA 95610. (916) 969-0635, after 5 pm PST

**WANTED:** Spark transmitters. Manufactured quenched gap panel and rotary gap types. Have commercial wireless gear to trade. Richard Groshong, 6604 Kent Dr. NE, Cedar Rapids, IA 52402. (319) 377-3144

**FOR SALE:** Gonset Communicator III, all orig. paperwork, fair cosmetics - \$75. Heathkit Ma-ruder, green & chrome knobs, beautiful - \$200. Knight KU-2560 CB transceiver, very nice - \$50. Bendix LM-13 frequency counter, navy - \$25. Signal Corps TG-34A code set, exc. - \$35. AK E cone speakers, fair - \$35. Sound recorder; Navy IC-XRW-7 wire recorder, 1953 - \$50. RCA 3" scope, fair - \$20. Heathkit IG-62 color bar generator, very nice - \$20. Dynaco hi-fi system; ST-70 tube amp PAS-2 preamp, FM tuner - \$400/all; could add pair AR2's, cabs. need refinish but sound great for - \$200 for Killer 60's tube system. Eric 357 FM tuner, Eric Engineering, Santa Monica, ? - \$40. Bolex 16mm pro movie camera from 50's - \$50. Always looking for vintage tube & cond. & ribbon mics by Altec, RCA, Newmann. Tube compressors EAs[?] by Altec, Pultec, Fairchild, UREI, etc. Will the fellow who ordered the Arcturus blues call me, collect? Ward Kremer, 301 SW 16 St., Ft. Lauderdale, FL 33315. (305) 524-5052

**FOR SALE:** Sams Auto Radio #20, 34, 36, 45, 48, 54, 70, 80, 81. Offers. Steve Hissong, Rd. 1 Box 370D, Vestal, NY 13850. (607) 748-5896

**WANTED:** RV-7 for Drake TR-7, 508 VFO for Swan 1270 and 1200-W linear. Dwain Ludlow, POB 552, Stigler, OK 74462. (918) 967-8002

## CLASSIFIED ADVERTISEMENTS

**WANTED:** Zenith Stratosphere, Crosley WLW, McMurdo-Silver and E.H. Scott radios wanted. Also want Scott literature. Jim Clark, 1292 Starboard, Okemos, MI 48864. (517) 349-2249

**WANTED:** Radiola 60, Trans-Oceanics. Dial glass for GE LF(C) 115, 116. Photo OK. Jack Hofeld, 61 Trinidad Bend, Coronado, CA 92118. (619) 429-0165

**SEND ALL A.R.C. MAIL TO**  
Antique Radio Classified  
P.O. Box 2, Carlisle, MA 01741

**FOR SALE:** Radiola 20 console - \$200. Philco 70 restored - \$350. Vaughn Rudisill, 222-22 Edmore Ave., Queens Village, NY 11428. (516) 822-4501, (718) 465-6702, eves.

**WANTED:** Zenith radios, Models 6D118, 6D221, 5S218 and 5S119. Dennis Choinski, 1435 Oakes Rd. #5, Racine, WI 53406. (414) 886-3968, call after 3 CST

**WANTED:** Tabletop cabinet for battery set, panel 26" w x 7" h, 11.5" deep. Good trade or cash for this! Kent King, 402 York Ave., Delaware, OH 43015. (614) 363-0445

**FOR SALE:** Restorable Majestic Model 50 cabinet w/o baseboard, (see Jan. A.R.C., p. 9) - \$10. Thordarson PP interstage audio xfmr. Model 5741 5 watt?? - \$10. 1" CRT 913 metal - \$10. All plus shipping. Thomas F. Pollock, WB6ZYE, 243 West Lime Ave., Monrovia, CA 91016. (818) 359-8013

## CLASSIFIED ADVERTISEMENTS

**WANTED:** Sams CB Vols. CB-56, CB-58, CB-249, CB-251, CB-27, CB-79, CB-39, CB-129, CB-119, CB-155, CB-258, CB-263. Al Neff, Sr., 4037 Parthenia Ave., Louisville, KY 40215

**FOR SALE:** 1926 Miraco Ultra 5 by Midwest Radio - \$75. Jerry Boles, 14857 Redbud Ln., Piedmont, OK 73078. (405) 373-2228

**WANTED:** Oscillator coil for Philco 37-84, Part Number 32-311 or rewind mine. Also want Philco Model 80 for parts. Ross Ellis, 206 Gregg Dr., Battle Creek, MI 49017. (616) 962-1514

**FOR SALE:** New Highway Radio Guide lists over 8500 AM and FM stations by state and cities. Lists frequencies, power, coverage and format. Great for traveling or DXing. \$5.95 ppd. Jack's Vintage Radios, 61 Trinidad Bend, Coronado, CA 92118. (619) 429-0165

**FOR SALE:** Unused, power, output xfms. American-made 450v and 600v capacitors. Tubes and other components for AC and AC/DC sets. Schematics 1930-1952 sets. Veneer and spray crinkle paint. Small, repaired sets: Hallicrafters and Zenith. Don't write me for cathedrals or battery sets. Sue Coulter, 4200 Prince St., Bakersfield, CA 93301

**WANTED:** Set of adapter sockets for BAK picture tube tester Model 467. Chassis for Echophone, 53 antenna for DeForest D10. **FOR SALE:** Photocopy of manual for Zenith 3R & 4R - \$10 ppd. Peter Dieguez, 36-48 34th St., Long Island City, NY 11106

## WIRELESS COMMUNICATION IN THE UNITED STATES

The Early Development of American Radio  
Operating Companies

BY THORN L. MAYES, W6AX  
240 Pages - 160 Illustrations

The glory days of high powered wireless, 300,000 watt spark transmitters, 1,000,000 watt arc transmitters and mighty Alexanderson alternators with antennas as long as nine miles.

Factual accounts of alternators, arcs and sparks, and of coherers, barretters and tikkers!

Unscrupulous stock promotions that by chance yielded technical breakthroughs.

Excerpts from unpublished letters of pioneers and early drawings of quenched gap spark transmitters.

Prepared for publication by Westinghouse engineer, Arthur C. Goodnow, W1DM.

Softcover - Expected shipping date: Dec. 31, 1989

Send \$29.95 plus \$3.00 for shipping & handling to:  
The New England Wireless and Steam Museum, Inc.  
697 Tillinghast Road, East Greenwich, RI 02818

WIRELESS COMMUNICATION  
IN THE UNITED STATES  
THE EARLY DEVELOPMENT OF AMERICAN RADIO OPERATING COMPANIES  
BY THORN L. MAYES



THE NEW ENGLAND WIRELESS AND STEAM MUSEUM

---

**CLASSIFIED ADVERTISEMENTS**

**WANTED:** Need photo or sketch with dimensions of the wood pieces that hold down leather straps on a Majestic Treasure Chest radio Model G25A. Thank you: R. Haworth, 112 Tilford Rd., Somerdale, NJ 08083

**FOR SALE:** Working Radiola 26 – \$200. Victoreen – \$200. Junking; Radiolas, Super XIII & 28. Riders: 5, 6, 7, 8, 9, 10, 12, 20. Richard Gray, 9181 Chesapeake Dr., San Diego, CA 92123. (619) 560-4162

**FOR SALE:** SABA B/W projection TV Model P1026H, floor, 120 VAC, U.S. frequencies, fine cond. – BO. Ken Ketner, Box 65135, Lubbock, TX 79464. (806) 794-3031, evenings

**WANTED:** Repairable chassis for Radiola Model 60, 103 speaker. Power transformer for RCA Model K130 or U46. Ray Moore, 12 Pavilion St., Rochester, NY 14620. (716) 461-3205

**WANTED:** Echophone 80 or 60 chassis and speaker. **FOR SALE:** Burns horn – \$125. Kennedy coronet – \$175. Scott 800B w/wo cabinet – \$150. Gary Hill, 1507 Ridge Ave., New Castle, PA 16101. (412) 654-9335

**FOR SALE:** Tubes antique, new, used. Over 800 different types. Send \$2 for list. Kad Tek Co., 11 Olympus Dr., Macedon, NY 14502

**FOR SALE:** Hallicrafters SX71, S58, and 8R40. All work but need a little cleaning – \$150/all 3, or make me an offer. Large six-page copies of the Crosley 51 operating manual – \$2.50 plus two stamps. Also 16-page Stromberg-Carlson Model 635/636 – \$7.50. **FOR TRADE:** Near mint Kennedy 281 for AK breadboard or Neutrowound in same condition. Can bring to New Jersey Meet in May. Brian Rhodes, RD 6, Box 215A, Newton, NJ 07860. (201) 579-1463, evenings

**WANTED:** Crosley Gembox chassis to fill my empty cabinet. Alan Schreier, 12805 Powderhorn St., Austin, TX 78727. (512) 835-2056

**WANTED:** Old transistor radios, small portables. Send photo or sketch with price. John Hoffnagle, 10 Sunset Ave., New Oxford, PA 17350. (717) 624-8894

**FOR SALE:** Hallicrafters SX99 – \$85. Hallicrafters SX110 – \$125. National 173D with speaker – \$175. Slim Goodwin, 1712 Alvarado, NE, Albuquerque, NM 87110. (505) 265-9359

**FOR SALE:** Battery sets, all are excellent originals. Clapp-Eastham RADAK R-4 – \$300/offer. Crosley Model 52 with pair of Crosley headphones – \$130. AK Model 32 – \$120. Bulb-shaped 01-A tubes – \$6 ea. Trimm entertainer horn, driver replaced – \$45. Above plus UPS. John Hayes, 27 Highland Dr., Henniker, NH 03242. (603) 428-3053

---

**CLASSIFIED ADVERTISEMENTS**

**FOR SALE:** Atwater Kent Model 40, good condition. WWII aircraft radios, tubes, etc. SASE. R. L. Ludlum, W6NHT, PO Box 1308, Martinez, CA 94553. (415) 228-1142

**FOR SALE:** McMurdo-Silver literature for Masterpiece VI, photocopied in pamphlet form, included in pamphlet are installation and operation instructions plus schematic of Masterpiece VI. Your Magic Carpet, a 19-page synopsis of McMurdo-Silver technical data, specifications, and description of four types of cabinets. Instructions and schematic for McMurdo-Silver designed diversity coupler for Masterpiece VI – \$4.95 for entire package. Ray Moore, 12 Pavilion St., Rochester, NY 14620. (716) 461-3205

**WANTED:** WWII unmodified military communications equipment. Sam Hevener, W8KBF, 3583 Everett Rd., Richfield, OH 44286. (216) 659-3244

**WANTED:** Cabinet for Western Auto Truetone Model D731, 4-lever, 1939 (see Riders 11-9, Fig. 2). Will trade. Jim DiRuzza, 2607 Old Troy Pike, Dayton, OH 45404. (513) 233-5004

**FOR SALE/TRADE:** National RBL-5 low frequency receiver, fair. John Webb, W6RCW, 12736 Erin Dr., Auburn, CA 95603. (916) 885-9556

**MESSAGE:** Free new publication with photos, descriptions and prices of radios for sale/trade, and wanted. Send SASE or call. Western Radio Exchange, PO Box 161566, Cupertino, CA 95016-1566. (408) 252-2871

**FOR SALE:** Stewart-Warner mirror in the lid TV, untested – \$375. Aeriola Jr., real nice, Hallicrafters SX-28 chassis & panel, untested – \$100. Hammarlund HQ-170 – \$125. Radiocraftsman #10 tuner, untested – \$50. Pilot FA-540 tuner – \$40. Garard turntable 1950's – \$15. RCA 103 spkr., has tears – \$70. Ken-Rad lighted sign – \$95. RCA 128 cathedral – \$145. SASE. Pics – \$1 ea. UPS extra. Joe Szabat, 1019 Hiland Ave., Coaropolis, PA 15108. (412) 264-7498

**FOR SALE:** GE console H116, Catalin escutcheon (F.O.S., p. 92) – \$135. Zenith console, Model 1005, 10 tubes – \$175. Consoles overhauled and in working order. Pick up only. Many Bakelites for sale. Ray Moore, 12 Pavilion St., Rochester, NY 14620. (716) 461-3205

**WANTED:** 5" dynamic speaker for Delco R1125, about 1200 ohm coil. Chassis for Delco R1227, R1228 or R1229, inop. OK. Herman Gross, 1705 Gordon Dr., Kokomo, IN 46902. (317) 459-8308

**FOR SALE:** Radio tubes, N.I.B. and pulls. Will sell singles and lots. 01-A, 112, 24A, 27, 45, 47, 57, 58, 71A, 80, etc. Many more radio and TV tubes, supply is limited. Ray Moore, 12 Pavilion St., Rochester, NY 14620. (716) 461-3205

## CLASSIFIED ADVERTISEMENTS

**WANTED:** WE 216A tube, early or unusual tubes. Also, early light bulbs (pre-1900), any style base, working or not. Old Edison electrical equipment, books. Will buy or trade for good used tubes. Bruce Harbeck, PO Box 452, Boystown, NE 68010

**FOR SALE:** H.H. Scott 299C, 399. **WANTED:** H.H. Scott (LK150 amps), Fisher K1000. Any HiFi mags 1955-1965. Ernest Naaz, 30 Charlton, Apt. #4C, New York, NY 10014. (212) 627-1894, or (212) 998-4331

**FOR SALE:** 69 years collection: 10,001 items, antiques, radios, televisions, phonos, sound, military, ham, flyers, books, catalogs - 48 pages - \$1 refundable. F. Yonker, W21BH, 7 Old Farms Rd., Saddle River, NJ 07458. (201) 825-1895

**WANTED:** Blue 01-A's or gold 01-A's. Floyd Paul, 1545 Raymond, Glendale, CA 91201. (818) 242-8961

**FOR SALE:** Books: Tom Swift juvenile books, Rider's Theory Books - \$7.50 to \$35. Sams books - \$5 to \$10. TV Tab books - \$15 ea. RCA Tube Manuals, average - \$7.50 ea. Plus many others. Send LSASE 50 cents postage. J. J. Papovich, 53 Magnolia Ave., Pitman, NJ 08071. (609) 582-8279

**FOR SALE:** Silver Marshall literature collection - \$25. Freshman Model O. Browning-Drake 5E - \$125. **WANTED:** Early mono tube hi-fi. Jack Smith, 288 Winter St., N. Andover, MA 01845. (508) 686-7250

## rainy day books

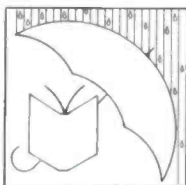

OUR NEW ADDRESS:  
Box 775  
Fitzwilliam, NH 03447  
(603) 585-3448  
frank bequaert  
lucia bequaert

### Technical Books Catalogs and Magazines Bought and Sold

Wireless - Radio - Telephone  
Broadcasting - Telephone  
Electronics - Computers  
Electric Power - Electric RR  
Civil Engineering - Machine Tools  
Metallurgy - Mining

*New Lists Always Being Issued  
Let Us Know Your Interests*

## CLASSIFIED ADVERTISEMENTS

**FOR SALE:** Trans-Oceanics: 3000-1 - \$115, Y600 - \$75, A600L - \$165, Royal 500 - \$65, 8G005 - \$85. Jim F. Montague, 921 S. Cuba, Spokane, WA 99202. (509) 535-9576

**FOR SALE:** AK 20C, AK 32, AK 37; QST's - SASE. **WANTED:** Early ham transmitters, schematics, manuals, Grebe RORD. Parker, W1YG, 87 Cove Rd., Lyme, CT 06371. (203) 434-7783

**FOR SALE:** Philco leather case AC, battery portable, not working, case good - \$20. Rick Yerke, PO Box 392, Moscow, PA 18444. (717) 842-4857

**WANTED:** Dial escutcheon and knobs for Majestic Model 92 highboy. Nick Spitzer, 9280 Knoll Dr., Galena, OH 43021

**FOR SALE:** Philco 50B cathedral, loud hum, needs filter condensers, cabinet restored, grille cloth not original - \$150. Philco 38-7T wood table model with shortwave to 19 MHz, 1938, works very weakly, cabinet very good - \$100. Also many other radios, books & tubes. Send 2 stamps for complete listing to: Ron Boucher, PO Box 541, Goffstown, NH 03045. (603) 497-2988

**FOR SALE:** New flier with new and used (tested pull-outs) tubes for radio, TV, industrial and communications equipment - competitively priced. Expanded stock of government surplus components - resistors, capacitors, xtms. and more. New stock still available. "Bits and Pieces" flier, six pages of original parts salvaged from AK to Zenith. LSASE to Frankenstein's Radio Lab, 4010 Fairmont Pkwy., Suite 285, Pasadena, TX 77504

## ANTIQUE RADIO TUBES

THOUSANDS IN STOCK  
LOW PRICES - NO MINIMUM

Antique Radios Repaired  
- Reasonable Rates -

Write or Call for prices.

### MIDWEST SUPPLY ELECTRONICS

1165 Lafayette Avenue  
Terre Haute, IN 47804  
(812) 232-0187

---

**CLASSIFIED ADVERTISEMENTS**

---

**FOR SALE/TRADE:** Catalin radio. Large Addison, Model R5A3, yellow body with maroon grille bars and knobs (Collins, p. 56/57). Very clean and all original. Michael Lawlor, PO Box 50, South Pasadena, CA 91031. (818) 799-2921

**WANTED:** AK 318, 447 tombstones. AK 708 and GE J-100 cathedrals. **FOR SALE:** Philco 39-7, small Deco set, exc. cond. - \$50. Philco 37-630 Deco, works - \$85. RCA Model 100 cathedral, exc. cond., plays - \$160. Above plus UPS. John Hayes, 27 Highland Dr., Henniker, NH 03242. (603) 428-3053

**FOR SALE:** Zenith Trans-Oceanics H500 - \$50. G500, missing dial pointer, plays - \$25. Philco, Deco, 37-630 - \$75. Philco 1201, missing turntable platter, otherwise excellent - \$35. Police alarm, 30-50 MC FM Rxer, missing knobs, Bakelite case - \$20. Hallicrafters S-41G, Skyrider Jr. - \$50. National NC-46, needs dial cord and pointer - \$45. Army BC-457A Txer - \$40. Fisher 600 stereo Rxer - \$35. Bell Carillon 6060, 30w per channel amplifier - \$25. Bell Carillon 6070 AM/FM tuner - \$25. Zenith "Color TV" sign, background sparkles - \$20. Zenith "Chromacolor TV" sign, ad rotates around spools - \$10. Coyne Applied Practical Radio-TV, Volumes 1, 2, 5 and Cyclopedica - \$10. Beitman Most Often Needed 1926-1938 - \$10. 1939 thru 1952 - \$7 ea. **FOR TRADE:** Rider's Volume 4 or 5 for your early Rider's Volume 2. Brian Dunlop, 2715 Hanovertown Dr., Colorado Springs, CO 80919. (719) 531-7920

**MESSAGE:** Will the guy from Livonia, Michigan, please call me back about the trade for your Arvin TV L1080 (F.O.S., p. 66) for my Edison R-5. I lost your phone #. Tony DeMara, 40231 Day, Mt. Clemens, MI 48044. (313) 263-0325

**WANTED:** Braun T-1000 transistor portable. Daryl Jorud, R#1, Box 180, Battle Lake, MN 56515. (218) 864-5725

**FOR SALE:** AMI jukebox amplifier Model AA, 25 lbs. - \$150. Steinite 990 panel w/bezels, meter, 3 lbs. - \$10. RCA Radiola 67 power amp. w/tubes, 60 lbs. Wilcox-Gay Educational Recordio, 50 lbs. - \$10. Zenith H500 Trans-Oceanic, 20 lbs. - \$25. Columbia 360 hi-fi phono blonde, 20 lbs. - \$10. Doug Houston, 3441 Hadley Rd., S, Ortonville, MI 48462. (313) 627-4141

**FOR SALE:** Some good old goodies, surprises and useful stuff. LSASE for list. Hidyne Research, PO Box 3342, Williamsport, PA 17701. (717) 326-2148

**FOR SALE:** Majestic 1050 console - \$95. Philco 37-640 console, original and beautiful - \$75. RCA 8PCS41 projection TV - \$180. Wilcox-Gay console Recordio-radio combo w/blanks - \$35. These items cannot be shipped. Doug Houston, 3441 Hadley Rd., S, Ortonville, MI 48462. (313) 627-4141

---

**CLASSIFIED ADVERTISEMENTS**

---

**WANTED:** For 1950 Zenith television Model G3173R2 (chassis 23G24) vert out transformer 95-1226 deflection yoke 95-1217 flyback #S-16204. Also any parts for record changer S14025 and radio 8G22. Marvin R. Randolph, 2708 Grand, St. Louis, MO 63125. (314) 892-7839, leave message

**WANTED:** Dial scale for Philco 40-195. Horn for Magnavox PM-4 speaker. Arborphone Model 27 and Stewart-Warner Model 300 battery radios. Prewar shortwave receivers. **FOR SALE:** ICOM R71A-HP communications receiver, upgraded - \$800. Many wooden and plastic radios. Tektronix plug-in units, all kinds. Send for lists. David Beers, 5443 New London Park Dr., Fairfax, VA 22032. (703) 503-8018

**FOR SALE:** 1947 Magnavox radio Model CR198. GE electric radio sign. Russell Schoen, E. 7340 Nietzsche Rd., Clintonville, WI 54929. (715) 823-6744

**FOR SALE:** Set of Rider's manuals 1 thru 20. Many Sams including color TV manuals. B&K tube tester Model 650. Hickock signal generator Model OS-10. Can deliver to most Midwest meets. Arie E. Breed, 1595 N. Van Buren, Ottumwa, IA 52501. (515) 682-6925

**WANTED:** Construction details and photo of wood box for Radiola I crystal set. Of course if anyone has a box for sale, that would be great. Also need the upper crystal. Also looking for Bakelite tube socket for 1st RF amplifier for AK 21C. Bill Geibel, 545 Missouri Ave. S, Salem, OR 97302. (503) 370-7245

**WANTED:** Nordmende Globe Traveler II or Pro transistor portable. Daryl Jorud, R#1, Box 180, Battle Lake, MN 56515. (218) 864-5725

**FOR SALE:** Crosley black Bakelite tan grille, Model 56 PB, not playing - \$40. Zenith Universal leather handle - \$25. Crosley Model E30 AM FM, red, plays - \$30. Capehart black plastic Model 2T55E - \$20. Philco brown Bakelite Model 48-460, playing - \$25. GE wood table radio w/plastic grille, AM FM, Model 212, not playing - \$20. Battery sets Crosley Model 51 - \$75. Crosley Trirdyn 3R3 - \$65. R.C. RADA - \$200. Grebe Synchronphase MU1 - \$200. Tubes 01-A's old style, tested - \$7.50 ea. 80's new st. - \$4 ea. 27's used, old style - \$3, st. - \$2. Postage & ins. extra. Gary Staley, 641 W. 7th St., Flora, IL 62839. (618) 662-7074

**WANTED:** Rider's Volumes 20, 22, 23. Meter for Precision 10-12 tube tester. Nick Carrier, 11 Kunigunda Pl., Islip Terrace, NY 11752. (516) 277-7730

**WANTED:** Grundig Satellit transistor portable. Daryl Jorud, R#1, Box 180, Battle Lake, MN 56515. (218) 864-5725

---

**CLASSIFIED ADVERTISEMENTS**

**WANTED:** Power cord for Tiny Tim Jr. 4-tube radio. Edmund De Cann, 307-3rd Ave. W, Osakis, MN 56360

**FOR SALE:** Predicta info. Xerox copies of 8 pages from Philco newsletter, summer 1958. Tells all about the Predicta and has lots of interesting pictures - \$4 ppd. Kevin Eftink, 16 Edgewood Dr., Quincy, IL 62301. (217) 228-2221

**FOR SALE:** AK 84 cathedral - \$285. Detrola small cathedral - \$150. Philco Jr. Model 80 - \$85. Olympic Model 6A-501, (Collins, p. 71) - \$75. Trav-Ler 5022 green leatherette w/white front - \$40. Arvin 664 brown Bakelite w/handle - \$40. RCA 8X-542 ivory - \$47.50. Hallicrafters T-54 metal 7" TV - \$175. Admiral 7" black Bakelite. Admiral 22X12 Bakelite console TV - \$85. Shipping not included. Vintage TV & Radio, 3552 West 105, Cleveland, OH 44111. (216) 671-6712

**WANTED:** Capehart, Scott, RCA, Midwest McMurdo-Silver, etc., radios & radio-changer combinations. Broadcast microphones, equipment, transcriptions, literature. Blank recording discs. Western Electric speakers & amplifiers. Tube hi-fi equipment. Robert Van Dyke, The Caffrey House, Squires Ave., East Quogue, NY 11942. (516) 728-1327

**FOR SALE/TRADE:** RCA 96T1 - \$40. RCA 84BT6 tombstone - \$60. Sparton 410 chassis & speaker, n/t - \$30. Philco 38-116XX, refinished & working, pick-up only - \$225. Hickock 605A tube tester - \$45. **WANTED:** Zenith 75 radio-phono console (F.O.S., p. 188). Zennette cathedral. Zenith 12S232 and other Zenith tombstones, cathedrals, chairsides and console models. Chassis or dial scale for Zenith 6S222. Martin Blankinship, Box 157, Lecompton, KS 66050. (913) 887-6681

**FOR SALE:** Jukebox service manuals, 1960. 1970 Wurlitzer, AMI, Seeburg, Rock-Ola. Seeburg transistorized stereo amplifier TSA 1 - \$80. Heathkit transistor tester IT 121 - \$65. Open power transformers w/soldertabs, primary 115 volts, secondary 30 volts & 6 volts, weight 7 lbs., also other voltages. Relays, plastic encased with octal plug 24-volt DC coil d.p.d.t. Type Sigma 50R02, 5 amp contacts - \$4.50 and others. Write for details. Jack Naimann, 365 Bronx River Rd., Yonkers, NY 10704. (914) 237-4650

**WANTED:** Manuals, copy OK, for Precision Model 912 tube tester & Hallicrafters World-Wide Model TW-2000 portable. Sayre E. Winkie, 1836 Washington Ave. SE, Cedar Rapids, IA 52403. (319) 364-1414

**HELP:** Need info for Blaupunkt radio/hi-fi/bar. Back marked Arkansas 59 Type 4530/4531. Chassis labeled 2530 6674493. Schematic, history, any other literature available. Original or Xerox. Paul M. Caudell, R5 Box 406, Nashville, IN 47448

---

**CLASSIFIED ADVERTISEMENTS**

**FOR TRADE:** Garod Commander, cherry red body w/yellow trim, for your 2-colored Catalin. Also have cash for trade. UPS. All offers considered. Robert Regua, 332 Lytton Ave., Palo Alto, CA 94301. (408) 267-5066, evenings

**WANTED:** KHL Model Twenty-One, working condition, also Accessory speaker. Will consider KLH Twenty. Lance Baker, 3561 Truman Rd., Lot 68, Perrysburg, OH 43551

**FOR SALE/TRADE:** 1920 Grebe RORH detector, rare - Best offer by March 20th. **WANTED:** AK 708, Crosley Wildgit, other nice, unusual cathedrals. Jim Mahon, 5340 Brandon, Toledo, OH 43615. (419) 531-5996

**WANTED:** Zeniths from the 1930's, any condition for restoration or parts. I collect Zenith lighted advertising and will trade for good pieces. **FOR SALE:** Incredibly super clean Zenith Trans-Oceanic 7G605. Stewart-Warner Magic keyboard chrome-front, black with burl maple, cabinet refinished. Mint condition Mitchell Lumitone lamp-radio, playing with original shade, some stains on shade. Sonora Model TW 49, repainted white with maroon knobs - \$100. Zenith 5R312, crack on bottom - \$90. Small Crosley 11-100 in original orange - \$150. Wilcox Gay Art Deco tombstone, DC, refinished - \$200. Arvin original white, metal, 444 AM - \$80. Arvin original, black, metal, 442 - \$75. Zenith 5R 317 glass rod set, excellent, cabinet refinished, '39 World's Fair Special - \$165. Emerson 706 Series B, red - \$75. Emerson AV190 Catalin, green, crack - \$700. Atwater Kent 465Q 6-volt cathedral, original finish same cabinet as AK 206 - \$260. RCA 120 cathedral, refinished, complete - \$210. GE K50 cathedral, refinished - \$160. GE E61 cathedral, mint original - \$135. Majestic 460 chrome front, needs refinishing. Super cute miniature cathedral cabinet 9 1/2" x 7", needs some cabinet work - \$75. Small Airline Bakelite - \$55. RCA R74 tombstone, refinished - \$200. Audiola cathedral - \$295. Super-Radyne cathedral, Western Coil & Electric, original - \$210. Zenith consoles: 5808, 15U270 twin speaker refinished, 12A57; 975; 6S361 Stars & Stripes; 6S362 Stars & Stripes; 9S365 Stars & Stripes; 7S557; 12H670; 9S263; 9S54; 6S52, cabinet only; 8S154; Philco 38-690, either original mint or one needing refinishing; 37-116 Philco. Many other consoles & chairsides available. Please call daytime for complete information. Shipping extra. Satisfaction guaranteed. Alan Jespersion, POB 17338, Minneapolis, MN 55417. (612) 727-2489, answ. mach. after 4 rings

**FOR SALE:** Admiral Model 6J21N Bakelite radio-phono (G.O.R., p. 125), excellent, working - \$45. Silvertone Model 07025 (G.O.R., p. 99), clean, hums, very Deco - \$30. Philco Model 40-81 battery portable (similar to F.O.S., p. 126 Pal model), excellent - \$40. Zenith Royal 50 P.T., beige, excellent - \$12. Tony J. Schroeder, 703 S. Pears, Lima, OH 45805. (419) 224-1128



# COMING RADIO EVENTS

## **ARKANSAS - Mar. 1**

**ANTIQUE RADIO COLLECTORS CLUB  
OF FT. SMITH - CLUB MEETING**

Ft. Smith, AR - 622 South 18th  
Home of Illa & Dale Davenport - 7:30 pm  
Info: Wanda Conatser - (501) 646-7147

## **MARYLAND - Mar. 17**

**MID-ATLANTIC ANTIQUE RADIO CLUB  
MEETING**

Laurel, MD - Applied Physics Lab  
6:30 pm  
Snow date - March 24

Info: Joe Koester - (301) 725-4229, or  
Glen Hartong - (301) 997-8413

## **ARKANSAS - Mar. 8**

**ARKANSAS ANTIQUE RADIO CLUB  
CLUB MEETING**

Little Rock, AR - The Auditorium  
S.W. Bell Bldg., 120 W. 8th St. - 7 pm  
Info: Tom Burgess - (501) 565-1750

## **FLORIDA - Mar. 17**

**ANTIQUÉ WIRELESS ASSOCIATION  
FLORIDA MEET**

Bradenton, FL - Stewart Elementary School  
7905 15th Ave. NW  
8 am - Flea Market and Swap Meet  
Info: SASE, Norm Smith, 7203 17th Ave. NW  
Bradenton, FL 34209 - (813) 792-0003

## **OREGON - Mar. 10**

**NORTHWEST VINTAGE RADIO SOCIETY  
MEETING**

Oregon City, OR - Buena Vista Clubhouse  
16th and Jackson Streets  
10 am - Meeting and Auction  
Info: Dan Howard, 2940 SE 118th Ave.  
Portland, OR 97266 - (503) 761-7799

## **PENNSYLVANIA - Mar. 17**

**PITTSBURGH ANTIQUE RADIO SOCIETY  
MEETING**

Forest Hills, PA - Westinghouse "Hill Station"  
(Just off the 900 block of Greensburg Pike)  
10 am - Flea Market; 1 pm - Meeting  
Talk by Dr. G. Ray Fitterer: Reginald  
Fessenden's Role in the History of Radio  
Novelty Radio Contest  
Info: David Kraeuter, 506 E. Wheeling St.,  
Washington, PA 15301  
(412) 222-6678, or (412) 241-1085

## **MICHIGAN - Mar. 10**

**MICHIGAN ANTIQUE RADIO CLUB  
BI-MONTHLY CLUB MEETING**

Clare, MI - Doherty Hotel  
7 am - 2 pm  
Info: John Hutchins - (517) 463-1512

## **TEXAS - Mar. 17**

**VINTAGE RADIO & PHONO. SOCIETY  
SPRING AUCTION**

Irving, TX - Garden & Arts Bldg., 906 Senter  
9 am - Doors open; 1 pm - Auction  
Info: VRPS, PO Box 65345, Irving, TX 75016

## **ILLINOIS - Mar. 12**

**BELLEVILLE AREA  
ANTIQUÉ RADIO CLUB  
MEETING**

Belleville, IL - Nichols Center  
6:30 pm - 9 pm  
Info: Randy Bender - (618) 277-5623

## **WASHINGTON - Mar. 18**

**PUGET SOUND ANTIQUÉ RADIO ASSN.  
ANNUAL AUCTION**

North Seattle, WA - Ronald School  
North 175th St., 1 mile W. of I-5, exit 176  
10 am-1 pm - Swap Meet  
10-12 am - Setup  
12-12:30 am - Silent Auction  
1 pm - Oral Auction  
Info: Frank Banks, 28232 27th Ave. S  
Federal Way, WA 98003 - (206) 941-2965

## **NEW CLUB FORMING**

### **Ohio - Mar. 15**

**ANTIQUÉ RADIO COLLECTORS OF OHIO  
MONTHLY MEETING**

7:30 pm  
Dayton, OH - 2929 Hazelwood Ave.  
Info: Karl Koogle, 2929 Hazelwood Ave.  
Dayton, OH 45419 - (513) 294-8960



## N. CAROLINA - Mar. 23-24

ANTIQUE WIRELESS ASSOCIATION  
1990 S. EAST REGIONAL CONFERENCE

Monroe, NC - The Holiday Inn  
15 Miles East of Charlotte

Swap Meet - Old Equipment Contest  
Collecting & Restoring Old Radios  
Open House at Local Collector's Home

Info: Ron Lawrence, PO Box 220094  
Charlotte, NC 28222-0094

(704) 289-1166, home - (704) 845-2002, work

## TEXAS - Apr. 7-8

HOUSTON VINTAGE RADIO ASSOC.  
ANTIQUE WIRELESS ASSOC.  
ANNUAL CONVENTION

Houston, TX - Astrodome Marriott  
Contest - Banquet - Awards

Flea Market - Door Prizes - Swapmeet

Info: Bob or Cathy Botto, 3505 Del Sur Dr.  
Baytown, TX 77521 - (713) 468-4911

## COLORADO - Apr. 21-22

COLORADO RADIO COLLECTORS  
SHOW & SWAP MEET

Denver, CO - Western Stock Show Complex  
April 21 & 22: 9 am - 5 pm

April 20th Setup - Indoor Spaces  
Show & Swap - April 21st Dinner

Info: Bruce Young, 4030 Quitman St.  
Denver, CO 80221 - (303) 458-7408

## RADIO CLUB LISTINGS

*CLUBS: Send antique radio club and meet information to A.R.C. for free listing here, as space permits. Sorry, we don't have room for hamfests. Always send a SASE when writing to clubs!*

### NATIONAL CLUBS:

Antique Wireless Association (AWA). P.O. Box "E", Breesport, NY 14816. Pub: *The Old Timer's Bulletin*, quarterly. Dues: \$10.00. National and regional conventions. Museum.

Antique Radio Club of America (ARCA). William Denk, 81 Steeplechase Rd., Devon, PA 19333. Pub: *The Antique Radio Gazette*, quarterly. Dues: \$12.00. National and regional conventions. Regional chapters.

### REGIONAL CLUBS:

Alabama Historical Radio Society (AHRs). 4721 Overwood Circle, Birmingham, AL 35222. Meetings 4th Mon. evening each month but Dec.

Antique Radio Club of Illinois (ARCI). Carl Knipfel, Rt. 3 - Vererans Rd., Morton, IL 61550. Pub: *ARCI News*. Dues: \$12.00. Annual Radio-fest and additional meets each year.

Antique Radio Collectors Club of Ft. Smith, Arkansas. Wanda Conatser, 7917 Hermitage Dr., Ft. Smith, AR 72903. Monthly Meetings.

## MARK YOUR CALENDAR

Thru Sep. 30 - PA, Philadelphia - Exhibit  
Mar. 1 - AR, Ft. Smith - ARCCFS Meet §\*  
Mar. 8 - AR, Little Rock - AARC Meeting §\*  
Mar. 10 - MI, Claire - MARC Meeting\*  
Mar. 10 - MN, St. Louis Park - NARC Party  
Mar. 10 - OR, Oregon City - NWVRS §\*  
Mar. 12 - IL, Belleville - BAARC\*  
Mar. 15 - OH, Dayton - ARCO Meeting\*  
Mar. 17 - FL, Bradenton - AWA Meet\*  
Mar. 17 - MD, Laurel - MAARC §\*  
Mar. 17 - PA, Forest Hills - PARS Meeting\*  
Mar. 17 - TX, Irving - VRPS Auction §\*  
Mar. 18 - WA, Seattle - PSARA Auction §\*  
Mar. 23-24 - NC, Monroe - AWA\*  
Mar. 26 - AL, Birmingham - AHRs §  
Apr. 7-8 - TX, Houston - HVRA/AWA\*  
Apr. 15 - WA, Seattle - AWA Regional Meet  
Apr. 21 - NH, Nashua - NEARC Meet  
Apr. 21-22 - CO, Denver - CRC Show\*  
May 4-5 - IN, Plymouth - IHRS/AWA Meet  
May 18-19 - MN, Bloomington - Radio Daze  
May 20 - OH, Toledo - MARC Swap Meet  
Jun. 14-16 - OH, Cincinnati - ARCA Conf.  
Jul. 12-14 - MI, Lansing - Extravaganza  
Aug. 9-11 - IL, Elgin - Radiofest 1990  
Sept. 10-15 - NY, Rochester - AWA Conf.  
\*See expanded listing this month. § Monthly Meeting.

Antique Radio Collectors of Ohio (ARCO). Karl Koogle, 2929 Hazelwood Ave., Dayton, OH 45419.

Arkansas Antique Radio Club (AARC). Tom Burgess, P.O. Box 9769, Little Rock, AR 72219. Pub: None. Dues: \$5.00. Monthly meets.

Arizona Antique Radio Club (AARC). Treasurer, 8311 E. Via de Sereno, Scottsdale, AZ 85258. Pub: *Arizona Antique Radio Club News*, quarterly. Monthly meetings. Dues: \$15.00.

Belleville Area Antique Radio Club (BAARC). Karl Stegman, Treasurer, 4 Cresthaven Dr., Belleville, IL 62221, (618) 234-7992. Newsletter. Dues: \$10.00.

California Historical Radio Society (CHRS). Paul Bourbin, 25 Greenvue Ct., San Francisco, CA 94131. Pub: *CHRS Journal*, quarterly. Dues: \$15. Quarterly swap meets. North Valley Chapter: Norm Braithwaite, PO Box 2443, Redding, CA 96099.

Cincinnati Antique Radio Collectors (CARC). Tom Ducro, 6805 Palmetto, Cincinnati, OH 45227. Informal organization. Write to be put on mailing list. Two meets per year.

Colorado Radio Collectors (CRC). New club forming. Johnny Johnson, 2201 Newton St., Denver, CO 80211. Pub: Not yet. Dues: \$10.00. Quarterly meets.

Greater Boston Antique Radio Collectors (GBARC). Richard Foster, 12 Shawmut Ave., Cohituate, MA 01778. Informal organization. Write to be put on mailing list. One winter and one spring meet each year.

Greater New York Vintage Wireless Association (GNVVA). Bob Scheps, 12 Garrity Ave., Ronkonkoma, NY 11779. Pub: Meeting Notices. Dues: \$4. Six meets/year.

Houston Vintage Radio Association (HVRA).

Kathy Botto, 3505 Del Sur Dr., Baytown, TX 77521. Pub: *The Grid Leak*, monthly. Dues: \$10.00 (\$15.00, local). Regional meets.

**Indiana Historical Radio Society (IHRS)**. 245 N. Oakland Ave., Indianapolis, IN 46201-3360. Pub: *IHRS Bulletin*, quarterly. Dues: \$8.00. Quarterly swap meets in various areas of state.

**Michigan Antique Radio Club (MARC)**. Larry Anderson, 3453 Balsam NE, Grand Rapids, MI 49505. Pub: *MARC Newsletter*, quarterly. Dues: \$12. Annual Extravaganza and other bi-monthly meets.

**Mid-America Antique Radio Club (MAARC)**. Sheldon Wheaton, 14708 Murray Ln., Olathe, KS 66062. Pub: *The Broadcaster*. Dues: \$8.00. Two auctions and additional meets each year.

**Mid-Atlantic Antique Radio Club (MAARC)**. Joe Koester, 249 Spring Gap South, Laurel, MD 20707. Pub: *MAARC Newsletter*, monthly. Dues: \$12.00. Monthly meetings.

**New England Antique Radio Club (NEARC)**. Marty Bunis, PO Box 809, Contoocook, NH 03229. Dues: \$10.00. Pub: *Escutcheon Newsletter*, quarterly. Quarterly meets and auctions.

**Niagara Frontier Wireless Association (NFWA)**. Art Albion, 440 69th St., Niagara Falls, NY 14304. Pub: *NFWA Chronicle*, quarterly. Dues: \$9.00. Regional meets.

**Northland Antique Radio Club (NARC)**. P.O. Box 18362, Minneapolis, MN 55418. Pub: NARC Newsletter, six/year. Dues: \$10.00. About six meets/year.

**Northwest Vintage Radio Society (NVR)**. P.O. Box 82379, Portland, OR 97282-0379.

Pub: *The Call Letter*, monthly. Dues: \$15.00. Monthly meetings.

**Pittsburgh Antique Radio Society, Inc. (PARS)**. David W. Kraeuter, Secretary, 506 E. Wheeling St., Washington, PA 15301. Pub: *The Pittsburgh Oscillator*, quarterly. Dues: \$10. Quarterly meetings.

**Puget Sound Antique Radio Association (PSARA)**. PO Box 125, Snohomish, WA 98290-0125. Pub: *The Horn of Plenty*, monthly. Dues: \$15.00, \$12.00 for out-of-state.

**Sacramento Historical Radio Society (SHRS)**. William Howell, 5724 Gibbons Dr., Carmichael, CA 95608. Pub: *The Announcer*. Dues: \$10. Special meets & monthly meetings.

**South-East Antique Radio Club**. J. Sherrod, 4419 15th Ave. S., St. Petersburg, FL 33711. Club being formed.

**Southern California Antique Radio Society (SCARS)**. Edward Sheldon, 656 Gravilla Pl., La Jolla, CA 92037. Pub: *California Antique Radio Gazette*, quarterly. Dues: \$10.00. Meets: 3rd Sat. in Feb., May, Aug. & Nov.

**Southern Vintage Wireless Association (SVWA)**. Bill Moore, 1005 Fieldstone Ct., Huntsville, AL 35803. Quarterly meetings with flea market/swap meet.

**Vintage Radio & Phonograph Society (VRPS)**. Larry Lamia, P.O. Box 165345, Irving, TX 75016. Pubs: *The Reproducer*, quarterly. *Sound Waves*, monthly. Dues: \$13.50. Monthly meetings, Spring Auction, Annual Convention.

## BUSINESS CARD ADS - \$22.00 FOR 3 MONTHS



**WANTED...RADIOS**

Collectors needs old Cables and plates 1930 - 1950's 1 tube Diamond Sencora Air King, Airtec, Newbury, Spartan, 1, Marwood, Emerson, Magister, Omega, Intermex, General, Ariston, Benika, Colorado, Casa Cola, Chomey, Flare, Jewel, Hopalong, Galsby, Samson, Tom Thumb, Low Range.

Purchased for cash or trade. Reasonable prices. Collectors purchase. Estate Assurances.

**Bill Cress • (201) 694-5154**  
28 Worcester Drive • Wayne, New Jersey 07470

RADIOS & STRANGE MISCELLANEA

IF YOU VISIT THE BRIMFIELD FLEA MARKET... STOP BY FIRST!

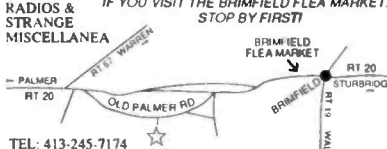

TEL: 413-245-7174

COUNTRY ROAD BARN - BERNIE SAMEK  
OLD PALMER ROAD, BRIMFIELD, MASS.

### WANTED - OLD RADIOS BEFORE 1930



- Early Crystal Sets
- Battery Radios
- Horn Speakers
- Radio Magazines & Books
- Radio Tubes & Parts
- Early Radio Advertising

G.B. Schneider Phone: 216-582-3094  
9511-23 Sunrise Blvd. North Royalton, Ohio 44133

**ANTIQUE JUKEBOXES, MICROPHONES**

Deco & Deluxe Console & Table Radios  
Broadcasting, Hi Fi & Recording equipment  
16" Transcriptions & Blank recording disks

*Buy, Sell & Trade*

Robert Van Dyke 516-728-1327  
2 Squires Ave., East Quogue NY 11942



REPAIR RESTORATION REFINISHING

### ANTIQUE RADIO

Al Rozenstraten  
Re: 842-8095  
Bu: 893-1028

SPRINGDALE TV, 15782 SPRINGDALE, HUNTINGTON BCH, CA

WANTED: Tube Hi-Fi Components & Studio Components of the 1950's and 60's

Marantz, McIntosh, Scott, Fisher, Brook Acrosound, Brociner, Western Electric Fairchild, Aftac, JBL

Richard Sharisky  
P.O. Box 521 (617) 484-5784  
Belmont, MA 02178



**BUSINESS CARD ADS - \$22.00 FOR 3 MONTHS**

**WANTED**

**RADIO — WIRELESS**  
*Pre-1925*  
**ELECTRICITY — TELEGRAPHY**  
*Pre-1900*

Books, Magazines, Autographs, Catalogs, Ephemera  
 One Item or Entire Collection

**New Wireless Pioneers**  
 6270 Clinton, Elma, NY 14059 USA  
 (716) 681-3186



(201) 794-9606

VINTAGE TV'S  
 & RADIOS

**HARRY  
 POSTER**

P.O. Box 1883 • South Hackensack, New Jersey 07606

**ANTIQUe RADIO REPAIR**

*Repair - Restore - Buy & Sell*  
 Schematic Diagrams \$2.00

**DAMASKE ELECTRONICS**  
 S74-W16834 Janesville Road  
 Muskego, WI 53150  
 Phone: (414) 679-0838

**Victorian Talking Machine, Company**

261 Robinson Ave.

Newburg, NY 12550



914-561-0132  
 SHOP HOURS  
 BY APPT.



*Antique Phonographs*

*Cylinders, Discs,*

*Buy, Sell, Restore & Repair*

100 Needles ..... \$3.00  
 Book & Parts Catalog ..\$3.00  
 TELEPHONE ORDERS  
 MC/VISA

50 years **CHUCKS** of service!

Any Tube Radio Repaired and  
 Guaranteed to work good.  
 \$26.00 plus large parts & UPS

**CHUCKS**  
 167 LYNN DRIVE - PO Box 598  
 NEW HAVEN, WV 25265 - PH (304) 882-2220

**RADIO-TV TUBES**

Dick Bergeron  
 Box 311  
 Essex Center, Vt. 05451  
 Tel: 802-879-0611

**FREE PRICE CATALOG**

*Over 1400 types, all new in original boxes*

Are You Looking For Antique Radios, Parts,  
 Tubes, Schematics and Restoration Services?

For Free Flyer, a 2-Stamp LSASE is required to insure a  
 response to your request. Send to:

*Olde Tyme Radio Company*  
 2445 Lyttonville Road, Suite 317, Silver Spring, MD 20910

Wish to contact us by phone?  
 Our number is (301) 585-8776.  
 Please call 10 am to 10 pm (Local Time)

**Antique Radios**



**David & Nancy Snow**  
 P.O. Box 6352  
 Jackson, MI 49204  
 (517) 750-4992

We Buy, Sell, Repair  
 ARBE - III Battery Eliminators

**E.H. Scott Radio**

Collector Historian Admiree



JIM CLARK  
 1292 STARBOARD  
 OKEMOS, MI 48864  
 (517) 349-2249

**Professionally  
 DeskTop Publishing**

Your Antique Radio Needs  
**INEXPENSIVELY**

Display Tags - Wants/Needs Lists with Pix - Business Cards  
 Club Membership Cards, NameTags, & Forms

SASE For **Richard T. Ammon**  
 Samples **1249 Solstice Lane**  
**Fort Collins, CO 80525**

Radio  
 Collector  
 Over  
 20 Years



**SCHEMATICS 1920-1960**  
**RADIO/TV/HAM/MISC.**  
 FULL DESCRIPTION OF SET IN  
 FIRST LETTER PLEASE - \$3.50 EA.

**ALTON H. BOWMAN**  
 RD2 (CHAPIN VLG.)  
 CANANDAIGUA, NY 14424

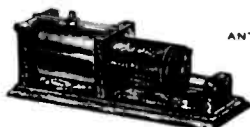

**WANTED**  
 ANTIQUE WIRELESS  
 ITEMS

**JAMES A. DiRUZZA**  
 MEMBER A.W.A.

PHONE (513) 233-5004  
 2607 OLD TROY PIKE  
 DAYTON, OHIO 45405



# DISPLAY ADVERTISEMENTS



## COLLECTOR'S BOOKS

Antique Radio Restoration & Price Guide by David & Betty Johnson .....	\$12.95
Guide To Old Radios, 225 pgs., by David & Betty Johnson .....	NEW 15.95
Seventy Years of Radio Tubes & Valves By John W. Stockes (SC) .....	19.95
Radio Enters The Home, 128 pgs. 8 1/2 X 11 .....	12.50
Radio Equipment & Supplies - 168 page reprint .....	13.95
1927 Radio Encyclopedia - Gernsback, 179 pgs. ....	11.95
Crosley Radio Catalog, circa 1923, 32 pages .....	4.50
Westinghouse Apparatus, circa 1920's, 8 1/2 X 11 .....	4.00
Short Wave Radio Manual, Official 1934, 260 pages .....	14.95
How To Repair Old-Time Radios, 162 illus., 252 pages .....	9.95
Vintage Radio Handbook, 263 pages, 1000 illus. ....	11.95
Flick Of The Switch 1930-1950, 312 pgs., 1000 illus. ....	11.95
Most Often Needed Diagrams 1926-1938, 600 models .....	11.95
1921-1932 Collector's Guide, 264 pg., 9,000 models .....	11.95
Atwater Kent Radio Parts Book, 24 pages, Model 9 plus 50 speakers .....	4.95
ARVIN. . . The First Sixty Years, 263 pgs. ....	NEW 7.95
Radio for the Millions, a fun book, 192 pages, PB .....	NEW 8.95
Wireless & Electrical Encyclopedia, The Electro Importing Co. ....	4.95
Early Wireless by Anthony Constable, HB .....	15.95
Instructions for Operating Grebe Radios, 64 pages pocket size .....	4.95
Radiola Super - Hetrodyne 2nd Harmonic .....	4.95
Atwater Kent Instruction Book Vol. II, an exact color duplication of the original .....	8.95
Grebe Synchronphase Instruction Manual, 70 pages, an excellent reproduction .....	DISC 10.95
Official Radio Service Manual, 1930 Gernsback, 8 1/2 X 11, 356 pages .....	19.95
The Story of Nipper and His Master's Voice, 64 pages, illustrated .....	6.50
The Cat's Whisker, 50 Years of Wireless Design, HB (rediscovered copies) .....	14.95
Radio Station Treasury 1900-1946 — 8 1/2 X 11 176 pgs. ....	12.95
Gernsback's Shortwave Library, 5 books, Vols. 1-5 .....	NEW SET 11.25
Tesla's Experiments, 170 pages, with alternate current .....	NEW 9.95
Los Angeles Radio Mfg., by Floyd Paul — P.B. ....	9.95
Radio Speaker Encyclopedia, 8 1/2 X 11, by Floyd A. Paul .....	11.90
Fifty Years of Radio, March 1938 issue of Hugo Gernsback's famous publication - 134 pgs. ....	14.95
Radio Manufacturers of the 1920's, Vol. 1, Very Large, by Alan Douglas .....	19.95
Radio Manufacturers of the 1920's, Vol. 2, by Alan Douglas, New & Super now in stock .....	22.95
Radios — The Golden Age, 120 pgs. Full Color, by Phil Collins .....	14.95
David Sarnoff, biography, HB, 372 pages, The RCA Story .....	14.95
Man of High Fidelity, <i>Edwin H. Armstrong</i> , PB, 272 pages .....	3.50
Vision by Radio! by <i>C. Francis Jenkins</i> , 140 pages .....	NEW 9.95
Thomas A. Edison - A Stroke of Luck, PB, 562 pages .....	13.95
Saga of the Vacuum Tube by <i>Gerald Tyne</i> , 494 pages .....	15.95
Nikola Tesla, Inventions, Researches, Writings, 496 pgs. P.B. ....	16.95
Tesla Coil Secrets, PB .....	6.95
The Complete Talking Machine, 8 1/2 X 11, 183 pages .....	19.95

All orders under \$35.00 enclose \$1.50 postage — Orders over \$35.00 shipped free. (USA Only)

WE HAVE DETERMINED THAT ALL OF THESE PUBLICATIONS ARE THE VERY BEST OFFSET QUALITY.

ALLOW 3-4 WEEKS FOR DELIVERY

ORDER FROM

**Antique Radio Club of America, Inc.**

Chapter Bookstore

4204 Thorn Apple Lane

Charleston, West Virginia 25313

Revised 2/1/90

# REPRINT BOOKS ON EARLY RADIO - WIRELESS - TELEVISION TELEGRAPH - TELEPHONE

## RADIO

- Blake, G.C., *History of Radio Telegraphy and Telephony*. Early wireless schemes, developments and patents to 1928. 50-page bibliography. 449 pgs. ....\$35.50
- Codel, M., *Radio and Its Future*. 1930. A 1930's look into the future. A collection of articles including DeForest, Grunow, Kolster, Sarnoff, Maxim, Colpitts, Paley, Dursline and Codel. 375 pgs. ....\$28.00
- Dunlap, O.E., *Radio's 100 Men of Science*. 1944. Biographical narratives of pathfinders in electronics & television including Gilbert, Galvani, Faraday, Loomis, Hughes, Dolbear, Tesla, Hertz, Popoff, Nipkow, Branly, Jenkins, Conrad, Weagant, Kolster, DuMont, Olson. 330 pgs. ....\$25.00
- McNicol, D., *Radio's Conquest of Space*. 1946. A chronological treatment of the early days of radio, the scientists and their inventions. A few of the chapters: Spark Gaps & Oscillators, Wireless Spans the Atlantic, Regenerative Receivers, The Advent of Commercial Radio. 388 pgs. ....\$29.00
- Military Signal Communications*. A two-volume anthology of early documents covering the history of military communication, the Civil War to WWII. Includes visual signaling, telegraph, telephone and radio. 2 vols., 750 & 625 pgs. ...\$71.50
- Report of the Chief Signal Officer: 1919*. A record of the telegraph, telephone and radio in WWI. ....\$46.50
- Signaling and Communicating at Sea*. A two-volume anthology of over 50 articles. Semaphores, pigeons, flashing lights, flags, radio, teletype. 2 vols., 480 & 524 pgs. ...\$73.00
- Summers, H.B., ed., *Radio Censorship*. 1939. Collection of excerpts from articles & books + brief bibliography. ....\$23.50

## TELEVISION

- Abramson, A., *Electronic Motion Pictures: A History of the Television Camera*. Mechanical TV to Zworykin to 1940's. 228 pgs. ....\$24.50
- Dunlap, O.E., *The Outlook for Television*. 1944. Records the evolution of television from 1925 to 1932. Includes 22-page chronology of Radio/TV from 640 b.c. 310 pages. ....\$24.50
- Hess, G.N., *An Historical Study of the Du Mont Television Network*. 1960. A search for why the fourth television network failed. ....\$19.00

## TELEGRAPH TELEPHONE

- Bright, C., *Submarine Telegraphs: Their History, Construction and Working*. 1898. An account by a chief engineer, of early cable attempts, failures & successes, starting with the 1850 cable between England & France. 819 pgs. ....\$57.50
- Development of Submarine Cable Communications*. A two-volume anthology of over 50 articles. The 1858 and later trans-Atlantic cables, cable-laying ships, cable routes, technology thru 1973. 2 vols., 500 & 480 pgs. ...\$71.50
- Electric Telegraph: An Historical Anthology*. The rise and progress of the electric telegraph from the late 19th century to recent times. A collection of early writings. 625 pgs. ....\$4.00
- Eyewitness to Early American Telegraphy*. Reprints of reports and letters of Alfred Vail from the 1830's and 40's. An invaluable primary resource. 288 pgs. ....\$25.50
- Fahie, J.J., *A History of Electric Telegraphy to the Year 1837*. 1884. A definitive history of the earliest telegraph systems preceding Morse. 566 pgs. ....\$38.50
- Kingsbury, J.E., *The Telephone and Telephone Exchanges: Their Invention and Development*. ....\$40.00
- Prescott, G.B., *Bells' s Electric Speaking Telephone*. ....\$38.50
- Smith, Willoughby, *The Rise and Extension of Submarine Telegraphy*. An engineer's and designer's autobiographical account of cable laying in the mid-1900s including the 1856-66 Great Eastern missions. 409 pgs. ....\$32.00

## THE FAMOUS M.I.T. RADIATION LAB. SERIES

- #13. *Propagation of Short Radio Waves*. 746 pgs. \$29.95
- #15. *Crystal Rectifiers*. 457 pgs. \$19.95
- #17. *Components Handbook*. 640 pgs. \$29.95
- #18. *Vacuum Tube Handbook*. 674 pgs. \$29.95
- #19. *Waveforms*. 799 pgs. \$29.95
- #20. *Electronic Time Measurements*. 546 pgs. \$24.95
- #21. *Electronic Instruments*. 735 pgs. \$29.95
- #22. *Electronic Measurements*. 747 pgs. \$29.95
- #23. *Threshold Signals*. 400 pgs. \$19.95
- #25. *Theory of Servomechanisms*. 383 pgs. \$19.95
- #27. *Computing Mechanisms & Linkages*. 371 pgs. \$19.95

The above are quality reprints. Send for free list of over 80 reprints of books on early radio, television, broadcasting and telegraph available from A.R.C.

Send payment with order. Mass. residents add 5% tax. Allow 4 to 6 weeks to receive books.

Add \$1.50 for shipping in U.S. Outside of U.S., please add 10% for shipping.

Send order with payment to: Antique Radio Classified, P.O. Box 2, Carlisle, MA 01741

Mar-90



22,000 people attended NECX 3 at Bayside.  
If you missed it, here comes another. . .

# Northeast Collectibles Extravaganza

1990 Spring Edition

## SUNDAY, APRIL 1st

Show Hours: 10 A.M. - 5 P.M. — \$3.50 admission  
(Dealer Preview: Saturday, March 31st Noon-5 p.m. - \$25)

## Northeast Trade Center Woburn, Massachusetts

(Conveniently located at Exit 35 off Rte. 128 (I-95))

Antique Toys \* Dolls \* Electric Trains \* Disneyana \* Advertising  
Ephemera \* Postcards \* Autographs \* Comic Books \* Collectible Movie,  
T.V. & Music Memorabilia \* Elvis \* Marilyn \* Beatles \* Monkees  
Kiss \* Records \* Posters \* Sheet Music \* Souvenirs \* Mementos  
Baseball Cards and Memorabilia \* Non-Sport Cards \* Jukeboxes \* Arcade  
Vending Machines \* Games \* Teddy Bears \* Paperweights \* Fiestaware  
Trays \* Pins \* Buttons \* Jewelry \* Coins \* Stamps \* Books  
Bottles \* Military \* Science Fiction \* Photographs \* Breweriana  
Vintage Clothing \* Premiums \* Lunch Boxes \* Political

Produced by

Wex Rex Collectibles  
(508) 568-0856  
Fax (508) 562-1196

for

Show Promotion Inc.  
P.O. Box 873  
Burlington, MA 01803  
(617) 229-2414

# NEW IN 1989

## GUIDE TO OLD RADIOS POINTERS, PICTURES AND PRICES

By David & Betty Johnson

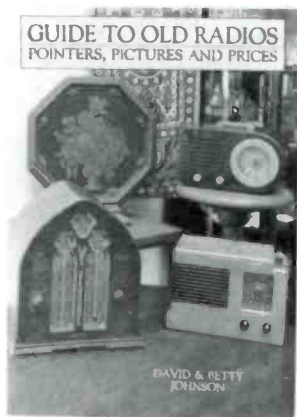

350 Illustrations – 3300 Prices

Completely New Book

Perfect for the beginning collector!  
Useful for the experienced as well!

From early crystal sets to AC sets, David and Betty Johnson explore the evolution of radio from its infancy to its heyday. The authors help collectors identify and date radios and provide pointers on where to find the best buys.

The price guide comprises half of the book and includes 3300 collectible radios and related items.

**\$16.95 (Softcover)**

## RADIO MANUFACTURERS OF THE 1920's VOLUME 2

By Alan Douglas

(Volume 1 published in 1988 is also available)

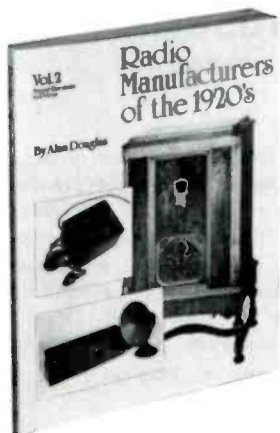

"The definitive book on American broadcast receivers of the 1920's." 40 more pages covering radio manufacturers than in Volume 1.

Volume 1 covers 23 manufacturers from A-C Dayton to Ferguson.

**Volume 1: \$19.95**

**(\$29.95 in hard cover)**

Volume 2 covers 31 manufacturers from Freed-Eisemann to Priess.

**Volume 2: \$24.95**

**(\$39.95 in hard cover)**

*U.S. Orders: Enclose \$1.50 shipping per order if under \$35.00. Mass. residents please add 5% sales tax. Allow 2-4 weeks to receive order.*

*Foreign Orders: Surface shipping per book: \$6.00 (\$8.00 hard cover); allow 2-3 months.*

**Send order with payment to:**

**Antique Radio Classified, P.O. Box 2, Carlisle, MA 01741**



# COLLECTOR BOOKS AVAILABLE FROM ANTIQUE RADIO CLASSIFIED

☞ BOOKS MARKED WITH "☞" ARE THE MOST POPULAR AND ARE  
ESPECIALLY RECOMMENDED FOR NEW COLLECTORS!

- Antique Radios – Restoration and Price Guide, Johnson. *Beginner's introduction to collecting antique radios, how radios work, radio repair & restoration.* 1982. 99 pgs. .... \$14.95
- The Auto Radio: A Romantic Genealogy, Matteson. *Information, photos & ads from the early days of the automobile radio through the 1950's.* 316 pgs., hardcover. .... \$34.95
- ☞ Communications Receivers, Moore. *Information on 700 vacuum tube receivers by 50 manufacturers produced from 1932 to 1981 are included in this 112-page book. 100+ radios are illustrated.* .... \$14.95
- Crosley Catalog (reprint). *1923 catalog covering the early Harko through the XX models.* 32 pgs. .... \$4.50
- ☞ Flick of the Switch, McMahon. *The standard photo reference guide for collectors for radios from the 30's to the 50's. 1000+ photos of radios.* 263 pgs. .... \$11.95
- Great Radio Personalities (reprint). *Black & white portraits and info on all the favorites from the golden days of radio – Abbott & Costello, Baby Snooks, and more.* 128 pgs. .... \$11.95
- ☞ Guide to Old Radios – Pointers, Pictures & Prices, Johnson. 1989. *The latest book by the Johnsons describes the history of radio and includes 350+ photos and a price guide to 3300 sets.* 128 pgs. .... NEW \$16.95
- Hertz: The Beginning of Microwaves, Bryant. *Photos and descriptions of Hertz's apparatus and experiments. A book prepared for the IEEE Hertz Centennial exhibit.* 50 pgs. .... \$15.00
- Los Angeles Radio Manufacturing, Paul. *History of radio manufacturers in the Los Angeles area from 1922 to 1942. Features Echophone, Gilfillan, Jackson Bell & 9 others.* 88 pgs. .... \$10.50
- Most Often Needed 1926-38 Diagrams (reprint). *Circuit diagrams for 600 of the most common radios of the period.* 240 pgs. .... \$11.95
- Official Radio Service Manual (reprint). *100's of pre-1930 circuits & notes.* 356 pgs. .... \$19.95
- Price Guide to Plastic Collectibles, McNulty. *Describes types of plastics, etc. Radio is 8 of 207 pgs.* .... \$17.95
- Radio Collector's Guide, McMahon. *Listing of 9,000+ radios made by some 1200 companies from 1921 to 1932. Gives manufacturer, year, model name and other info. No photos.* 264 pgs. .... \$11.95
- Radio – A Blast from the Past, Wolf/Jacobson. *Reprints of advertising from 1927 to 1942. Useful for identification of cathedrals, tombstones, consoles and table model radios of the period.* 321 pgs. .... \$25.00
- Radio Craft – 50 Years of Radio (reprint). *Reprint of Golden Jubilee issue of 1938.* 144 pgs. .... \$14.95
- Radio Enters the Home, RCA (reprint). 1922. *The Aeriola Jr. and RC era.* 128 pages. .... \$12.95
- Radio Equipment & Supplies, Robertson-Cataract Electric Company (reprint). 1922 *catalog of radios, accessories and other equipment. Includes RCA, Clapp-Eastham & others.* 168 pgs. .... \$13.95
- ☞ Radios-The Golden Age, Collins. *Full-color book on the colorful Catalin and bakelite radios from the late 1920's to the early 1940's.* 128 pgs. .... \$14.95
- Radio Horn Speaker Encyclopedia, Paul. *Listing of horn speakers for over 320 manufacturers for the 1920's. Expanded information on ten manufacturers.* 80 pgs. Over 145 photos. .... \$12.90
- ☞ Radio Manufacturers of the 1920's, Vol. 1, Douglas. *The first of three comprehensive volumes. Vol. 1 covers A-C Dayton thru Ferguson.* 225 pgs. .... (hardcover: \$29.95) \$19.95
- ☞ Radio Manufacturers of the 1920's, Vol. 2, Douglas. *Second of three comprehensive volumes. Freed-Eisemann thru Priess.* 266 pgs. .... NEW (hardcover: \$39.95) \$24.95
- Radio & T.V. Collector's Guide Book, Biraud. *The "Vintage Radio" illustrated guide to European sets (very few British sets) from early wireless to the 1930's (a few later). Text is in both French and English.*
- Vol. 1 - Early History & Manufacturers A to P. 256 pgs. .... \$49.95
- Vol. 2 - P to Z & T.V., Speakers, Tubes, Loops, Parts & Novelties. 256 pgs. .... NEW \$49.95
- Radio Trouble Shooting, Haan (reprint). *1928 guide to trouble shooting battery sets.* 317 pgs. .... NEW \$10.00
- S. Gernsback Radio Encyclopedia (reprint). *1927 classic encyclopedia on radio.* 175 pgs. .... \$11.95
- Saga of the Vacuum Tube, Tyne. *Standard reference to vacuum tubes prior to 1930. Several 100 photos.* 495 pgs. .... \$15.95
- 70 Years of Radio Tubes and Valves, Stokes. *The story of the radio tube from the laboratory to the commercial market.* 256 pgs. Over 400 photos and illustrations .... \$19.95
- ☞ Vintage Radio, McMahon. *The standard photo reference guide for collectors for radios prior to 1930. Over 1000 pictures.* 263 pgs. .... \$11.95
- Westinghouse Catalog (reprint). *Early 20's catalog featuring the RA-DA and other early Westinghouse apparatus.* 8 pgs. .... \$4.00

All books are softcover except those marked "hardcover". Most instock books shipped within 4 days.  
Enclose \$1.50 shipping per order for U.S. orders under \$35. Foreign Orders – write for quote first.  
Send payment with order. Allow 2 to 4 weeks for shipping. Mass. residents please add 5% sales tax.

ANTIQUE RADIO CLASSIFIED, P.O. Box 2, Carlisle, MA 01741

(December 89)



# I BUY TV'S AND RADIOS !

## PAYING...

### TV's .....Need NOT work!

Pre-1943 .....\$1,000 (min.) to \$10,000 and up!  
 1945 - 1950 TV's .....\$20 to \$800  
 Early color TV's & attachments ..\$300 to \$3,000  
 Unusual 1950 -1970's - tube or  
 transistor .....\$40 to \$250

★ *NOT sure of your TV's age? Call me today...*

### RADIOS.....

Sparton Mirror radios .....\$900 to \$16,000!  
 Catalin & unusual radios .....\$50 to \$2,500  
 Regency TR-1, Sony TR-63 + other early  
 transistor radios, ca. 1954-1957 . \$50 to \$175

★ *FINDER'S fee paid for leads on  
 vintage TV's and Radios!*

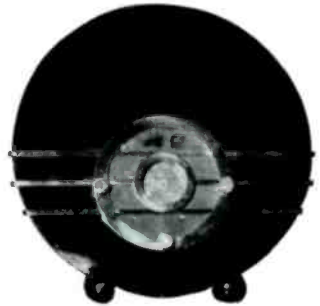

## SELLING...

- Prewar TV's: TRK-12, See-All scanning disk, Meissner 5" kit.
- 1940's and 1950's: National, Hallicrafters, RCA, Muntz, Philco, Dumont, Temple, Motorola, Predictas and lots more!
- Deco Radios: Sparton Blue Bird, Addison.
- Unusual Radios: Philco Bar-radio, Silvertone 6110, Mir-ray, Pepsi Dispenser, Kodak "Film" radio, Brass Equestrian radio.
- We also buy CAMERAS: Any "3D" stereo item, View Master, Tru-Vue, colored and Deco Kodaks, plus Leica, Canon and Nikons.

**TV REPAIRS — Most vintage TV's  
 fixed for about \$100 plus UPS**

Member AWA - ARCA - PARS - MAARC - MARC - VRPS  
 NFWA - NZVRS - HRSA - IHRS - NEARC - GNYVWA

# CLASSIFIED ADVERTISING POLICY

**ONE FREE 20-WORD AD** for subscribers in each issue; additional words are 10¢ each. See details below. All classified ads must be received (not just postmarked!) by the ad deadline. Late ads are held for the following issue. Please enclose correct payment with all ads. Stamps or cash are OK for small amounts. (Canadian and other foreign advertisers, please see "Payment" on page two for methods.) "Free words" cannot be accumulated from month to month; free words must be requested when ad is submitted.

Please write each ad on a separate sheet of paper, especially when included with other A.R.C. correspondence. Include SUB# with ad. Ads may be sent in advance; but, write each ad on a separate piece of paper and indicate the month (or successive two months) you want the ad to run.

**Please write legibly and use both capital and small letters. Do not use dashes between words.** Some numbers and letters can look alike, for example 1, l and I (the number one, the capital i and the small L.) Write the following characters clearly (especially in model numbers): 1, l and I; 0, O, o, Q and D; r and n; 6, b and G; V, U, u, v and Y; A and R; 5, S and s; 2, Z and z. We try to correct spelling errors, so when using an uncommon word or manufacturer which looks similar to a common word or manufacturer, note it so that we do not "correct" it. Editor's comments are in [brackets].

**Advertising is accepted only for items related to antique radios, communication, electricity, etc. All items must be described fairly; reproductions, reprints and not-original items must be identified as such. Advertisers agree to respond promptly to inquiries and orders, and to resolve problems promptly if the buyer is not satisfied.**

Publisher reserves the right to edit ads without notification to the advertiser and to reject ads for any reason. Publisher is not responsible for errors due to illegibly written ads or for any other reason. Since club activities receive free advertising on the *Coming Radio Events* page, the free 20 words may not be used for club activity ads. See inside front cover for additional information.

## CLASSIFIED AD DETAILS

*Deadline: 10th of the month!*

Classified ads must have a standard heading such as **WANTED, FOR SALE, FOR TRADE, FOR SALE/TRADE, SERVICES, MESSAGE, HELP, etc.** This heading is the only bold or all-capitalized words allowed in the ad. Capitalize only manufacturer names, model names, etc. Wanted and For Sale ads are mixed together to encourage the reading of all ads, including the Wanted ads. This standard ad format makes scanning the ads easier.

Before writing your ad, please look over the ads in a recent issue of A.R.C., and try to write your ad in the same style. Full name and address is required in all classified ads; we will add it if you forget.

To encourage varied content of the ads, **multiple insertions of the same classified ad are limited to two successive months.** (To run an ad longer, use a boxed classified or display ad.)

### Classified Ad Rates per Month

Subscribers:

First 20 words: **FREE\***

10¢ per word for extra words over 20 plus

10¢ per word for a shaded ad (count all words including free words).

\* Subscribers may take 20 free words on only one ad each month.

Non-Subscribers:

20¢ per word **plus**

10¢ per word for shaded ad.

Please do not forget to send in the extra 10¢ per word when your classified ad runs over the free 20 words; your payment will be appreciated, and it will help to keep A.R.C. healthy.

## BOXED CLASSIFIED AD DETAILS

*Deadline: 5th of the month!*

Boxed classified ads can run unchanged for three months or more. No words are free. Ads may be shaded and may include bold and all-capitalized words freely. The ad need not begin with For Sale, etc.

Minimum run is 3 months, prepaid.

### Boxed Classified Ad Rates per Month

Nonshaded ads:

16¢ per word for all words,\* none free, plus

10¢ per word for each bold word plus

10¢ per word for each all-caps word.

Shaded Ads:

26¢ per word for all words\* plus

10¢ per word for each all-caps word.

Note: All words in shaded ads are bold.

Non-Subscribers:

Add 15¢ per word to above costs.

\*Three of the total words can be bold-all-caps at no extra charge.

## PHOTO & DRAWING DETAILS

*Deadline for classified and boxed classified ads with drawings or photos: 5th of the month.*

Drawings and photos are encouraged as the response to your ad is much larger and the reader knows better what you want or are selling. Send in your drawing or photograph, and A.R.C. will reduce it or enlarge it as needed.

### Photo and Drawing Rates per Month

\$6.00 per month for each photo or drawing

## IMPORTANT — COUNTING WORDS — IMPORTANT

The standard headings: **WANTED, FOR SALE, etc.**, count as **one word** each time used in an ad. Name, address and (one) telephone number, count as 6 words, regardless of length. Ham call letters and business name can be included in the 6 words and do not count extra. Full name and address is required in all classified ads — it does not cost extra! Each additional word, abbreviation, model number or number group, extra telephone numbers, etc. count as one word. Hyphenated words count as two words.



SECOND CLASS  
POSTAGE PAID  
at Carlisle, MA

A.R.C., P.O. Box 2, CARLISLE, MA 01741  
RETURN POSTAGE GUARANTEED

**TO:**

POSTMASTER: Deliver Promptly

**CLASSIFIED AD  
DEADLINE MAR. 10TH**