

ANTIQUE RADIO CLASSIFIED

VOLUME 6

JUNE 1989

NUMBER 6

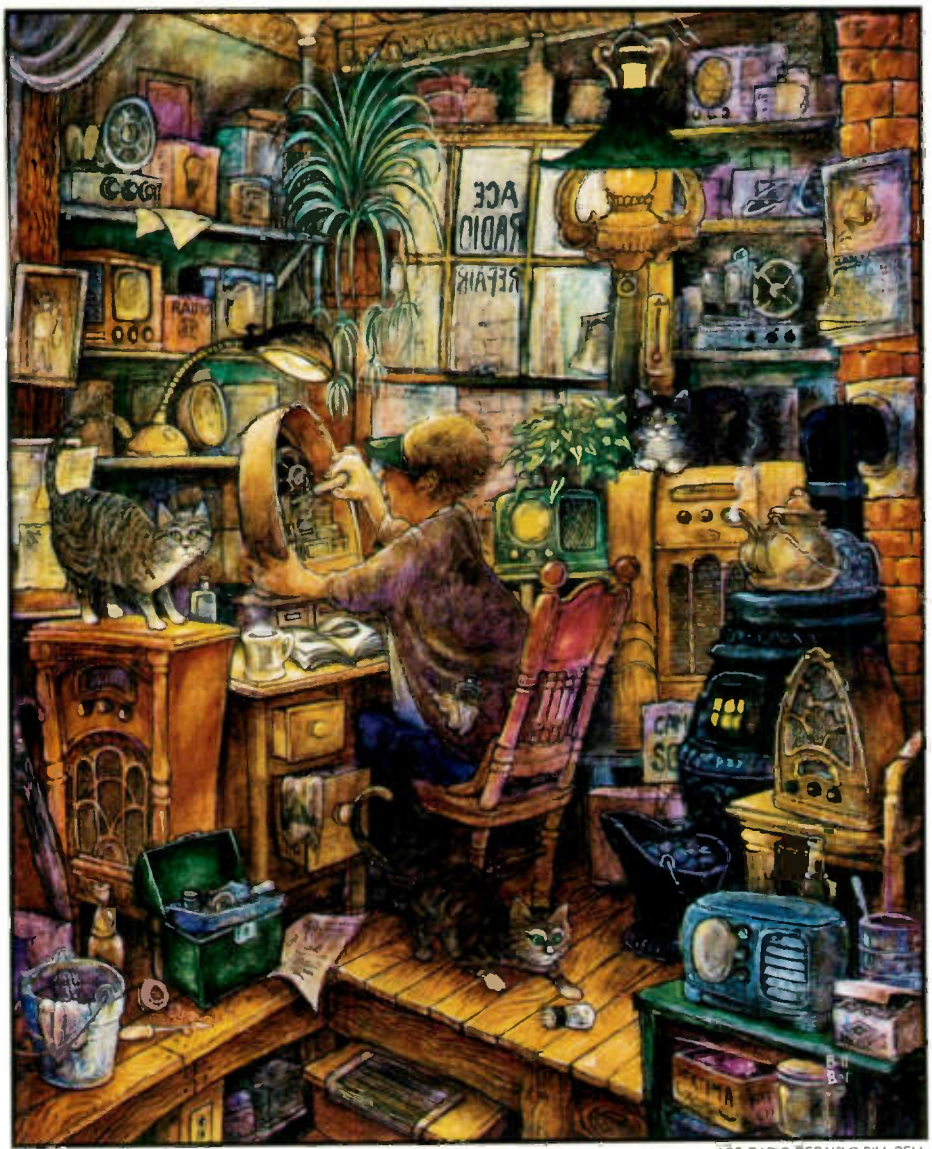

ACE RADIO REPAIR © BILL BELL

FIFTH ANNIVERSARY ISSUE

ANTIQUE RADIO CLASSIFIED

Antique Radio Classified (ISSN:8750-7471) is published monthly, 12 times per year, by John V. Terrey, 498 Cross Street, P.O. Box 2, Carlisle, MA 01741. Telephone: (508) 371-0512; 9:00 AM to 5:00 PM ET; machine answers phone at other times.

Annual subscription rates within the U.S. are \$19.00 by Second Class mail and \$28.00 by First Class mail.

Annual foreign rates. By air: Canada - \$30.00; Mexico - \$28.00; Other foreign countries - \$55.00. Surface mail to Canada, Mexico & other foreign countries - \$25.00 (Surface delivery to countries other than Canada may take two or more months and cannot be guaranteed.)

Two-year subscriptions are twice these rates and receive an extra month. Sample issues are available free on request.

© Copyright 1989 by John V. Terrey.

POSTMASTER: Send address changes to Antique Radio Classified, P.O. Box 2, Carlisle, MA 01741.

STAFF

Publisher and Editor:

John V. Terrey

Publishing Staff:

Betsy Dumka

Bobby Lyman

Founding Publisher/Editor:

Chris Frederickson

Scott J. Young

Gary B. Schneider

Richard L. Arnold

Contributing Writers:

Norman S. Braithwaite

Alan S. Douglas

Richard C. Foster

David W. Kraeuter

Ron Ramirez

Paul J. Bourbin

Dave Crocker

Mike B. Feher

Frank Heathcote

Jim Kreuzer

Henry Rogers

Gary B. Schneider

Frank R. White

John P. Wolkonowicz

Gil Schlehman

Howard Stone

Ralph Williams

PURPOSE. Antique Radio Classified is published for people involved in the radio collecting hobby. Its purpose is to stimulate growth of the hobby through the buying, selling and trading of radios and related items, and to provide a monthly forum for the interchange of ideas and information.

WRITING TO ANTIQUE RADIO CLASSIFIED. All correspondence should be sent to:

Antique Radio Classified

P.O. Box 2, Carlisle, MA 01741.

Your ads, renewals, letters, etc. can be handled faster and more efficiently if (1) each is on a separate piece of paper, and (2) your name, address and SUB# is written on each.

Unfortunately, A.R.C. is not staffed to answer letters with questions about antique radios or requests for advice. However, A.R.C. does solicit letters of interest to its readers

and will publish them as space permits. A.R.C. assumes that permission is given for publication of all correspondence received unless otherwise indicated.

GUARANTEE. You may cancel your subscription at any time and receive a pro rata refund for issues not yet mailed. If errors to ads are made by A.R.C., upon request a free correction will be run in the next available issue.

PAYMENT. Please send in full payment with your order or ad. A.R.C. does not carry accounts; all subscriptions, ads, etc. must be prepaid. Pay in U.S. funds; checks drawn on a U.S. bank or money orders are preferred. Make check out to "A.R.C." U.S. stamps or cash are OK for small amounts. Canadian payers may send a Canadian check in U.S. funds, but must add \$1.00 (U.S.) for conversion costs. On request, subscriptions will be prorated to amount sent, minimum term is one year.

CHANGE OF ADDRESS. Please notify us 4 weeks in advance of a change of address. Send both your new and old address, and include your SUB# and effective date of your new address. Temporary address changes can be made also.

SUBMISSION OF MATERIAL. Antique Radio Classified welcomes and solicits information that pertains or relates to the radio collecting hobby. This may include articles, book reviews, radio photos, information on upcoming radio events, meetings, antique radio organizations, radio auctions and price reports, sources of old radio and restoration supplies, and other related and interesting material. All material submitted should be verified for accuracy and typewritten if possible. Unless prior arrangements are made, all submitted materials become the property of Antique Radio Classified and will not be returned.

MAILING OF ISSUES. A.R.C. is available by subscription in the U.S. either by First or Second Class mail (Second Class is the way most magazines are mailed). First Class copies usually are received by the fifth of the month; copies by Second Class mail, by the tenth. The mailing of First Class copies is staggered, with those living farthest away mailed on the first day, and local copies mailed the last day. All non-U.S. copies are mailed on the first day. All Second Class copies are mailed on the last day. Mailing is usually completed by the 25th of the month.

ETHICS. No person involved in the production of A.R.C. is to act on any information in the magazine until they receive their copy through the mail.

DISCLAIMER. The publisher is not responsible for any buying and selling transactions incurred, or for any other use of the contents of this publication.

Antique Radio Classified subscription rates, frequency of publication, content, size and ad details and rates are subject to change at any time by A.R.C.

DISPLAY AND BUSINESS CARD ADS - DETAILS AND RATES

Advertising is accepted only for items related to antique radios, communication, electricity, etc. All items must be described fairly; reproductions, reprints and not-original items must be so identified. Advertisers agree to respond promptly to inquiries and orders, and to resolve problems promptly if the buyer is not satisfied.

The deadline for display and business card artwork, payment and repeat requests is the first of the month. All advertising must be prepaid; see "Payment" paragraph above. Late ads will be run only if space and time permits. As artwork is reduced to 63% in the printing process, originals should be the artwork size listed below. Do not send in artwork on art board or send negatives. Ads should be typeset or typed neatly with a carbon ribbon. If you want us to prepare your ad, include the one-time cost listed below for A.R.C. to make up the ad.

"Tear sheets" will be sent only for 1/2 and full page ads, if requested when ad is submitted.

Business card ads are limited to one per advertiser.

Photos should be at an 85 line screen; otherwise, add

Page	Artwork Size (send in this size)		As Printed (size in magazine)		Cost for 1-month	Cost for 3-months	Cost for 6-months	One-time Cost for A.R.C. to make up Ad (if requested)
	H x W (inches)	H x W (inches)	H x W (inches)	H x W (inches)				
Full	12 3/8 (or 10 1/2)	x 7 1/2	7 3/4	(or 6 5/8) x 4 3/4	\$70.00	\$189.00	\$355.00	\$24.00
1/2 H	5 1/4	x 7 1/2		3 5/16 x 4 3/4	35.00	94.00	178.00	12.00
1/2 V	11 3/4	x 3 9/16		7 7/16 x 2 1/4	35.00	94.00	178.00	12.00
1/4	5 1/4	x 3 9/16		3 5/16 x 2 1/4	18.00	48.00	91.00	6.00
1/8	2 5/8	x 3 9/16		1 5/8 x 2 1/4	9.00	24.00	46.00	3.00
Business Card	2	x 3 3/4		1 1/4 x 2 3/8	not avail.	15.00	28.00	2.00

\$5.00 per photo for screening. (Do not glue photos to artwork; submit separately.) If you are confused by these requirements and terms, please write or call A.R.C. before beginning to prepare your ad.

We will be happy to advise you on your ad ideas, estimate how much the ad will cost, recommend an ad size, etc.

We assume that advertisers want all ads which are submitted to run without delay; therefore, we will run the ad and bill for any additional work required for the ad to meet these specifications. A late ad will be run beginning with the next month.

The 3-month rates represent about a 10% discount, the 6-month rates, 15%. Clubs, write for discount rates.



ANTIQUE RADIO CLASSIFIED



EDITOR'S COMMENTS

Five years of *Antique Radio Classified*! Let's celebrate! This Fifth Anniversary Issue is that celebration.

Five years seem short when compared with the 100 years of radio itself, the 50 years of television or even the 37 years of the Antique Wireless Association, the largest collector club. But A.R.C.'s significance in reaching now over 4,500 antique radio enthusiasts each month is unequalled by any other publication in the hobby.

So, we celebrate our five years. Gary Schneider, who had the idea for A.R.C. and put together that first issue in June of 1984, has contributed his thoughts on this fifth anniversary. Without his hard work and insight, A.R.C. would not be here today.

A celebration deserves a super cover - *Ace Radio Repair* in full color. When I first saw this picture, I knew it belonged on the cover of A.R.C. Inside, there are 60+ pages of articles, ads and information.

Articles on AC, battery and foreign sets highlight the issue. The lead article is Alan Douglas' "The Radiola Model 44" which includes vintage photos, performance curves from an early *Citizen's Radio Call Book* and patent information. Frank Heathcote, who unfortunately has been spending more time with his old Triumph sports cars than with radios recently, has written about a French Lemouzy receiver. Another installment of *Collecting British Crystal Sets* (yes, it has been over two years since Part 4) appears in this issue. The *Crosley Review* by Richard Arnold covers the Crosley Model X.

After announcing a few months ago that our series on repairing AC radios would not continue, Richard Foster has agreed to carry on the work Jim Fred began. In Richard's first installment (Part 7 of the series), he covers some basics and

(Continued on following page)

FOUNDER'S COMMENTS

I am very pleased that *Antique Radio Classified* has progressed and grown into what I had envisioned over five-and-a-half years ago. With A.R.C.'s present circulation greater than 4,500, I would assume that over half of the readers do not know who I am.

At this point, perhaps a little background on myself and the conception of A.R.C. would fill in the many new subscribers.

My interest in the radio collecting hobby started in 1969, with the acquisition of a 1925 Western Coil & Electric Model WC14 Radiodyne Junior battery radio at an antique shop. With that purchase the collecting disease was instilled into my blood. (As most of you know, this infliction has no known cure.)

A few more visits to antique shops resulted in the buying of some more battery sets. My fascination with these sets, their large tubes and abundance of knobs, made me feel that these relics of the past were an enjoyment to acquire, restore, and get into working condition. Slowly my collection grew in size and so did my desire to find more radios. (Just wish I knew what a Catalin radio was way back then!)

Like so many other collectors who first started in the hobby, I wondered if there were others who collected old radios. By chance I came across an article in one of the electronic magazines describing a collector and his collection of radios. At last I knew I wasn't alone in the desire to collect radios.

One thing led to another, and I learned of a publication for radio collectors. What an enjoyment this was as it gave me the opportunity to meet other collectors through the mail. I even learned of a radio club called the Antique Wireless Association. Over the years I found out about other radio clubs and two more

(Continued on following page)

PRINTED WITHOUT COMMENT

The file on Mike Kirby of Panama City, Fl. (see A.R.C., April and May pages 3) is growing:

Summary of reports so far:

Persons receiving quotes:	44
Persons sending money:	27
Persons receiving refunds:	18
Refund checks which bounced:	9
Bounced checks not yet replaced with a money order:	4
Persons receiving merchandise:	0

Several readers report that a strong letter requesting a refund resulted in their receiving a prompt money order refund. Please keep A.R.C. up-to-date on the status of your orders.

ON THE COVER

We are fortunate to receive permission to print *Ace Radio Repair* by Bill Bell on our cover this month. Although A.R.C. ran the same print on the October 1985 cover, this time it is in full color!

Bill Bell is a full time painter. His acrylic works "teem with activity, color and organized clutter. The viewer is led to explore the entire canvas in a colorful search for the joyous details of life." Bill's works have been exhibited from New York City to Montreal to Cape May to Dallas.

A full color, 7 1/2" x 9" copy of the print is available from Frank Krantz, 100 Osage Ave., Somerdale, NJ 08083. The price, ppd., is \$15.00 unmounted, and \$19.00 mounted on a white mat.

(Editor's Comments, continued)

then proceeds to describe how to troubleshoot AC radio power supplies.

In *Radio Ramblings*, Dean Kazmierczak suggests that today we should have the foresight to preserve articles of the present so that they can become the antiques of the future. Also, Emil Cosentino shows how by leg work, you can still build a collection without paying sky-high prices.

We have reports on five auctions this month, including two at recent club meets. A glance through the listings shows again that many sets can be purchased for well under \$100.

Part 3 of the *Olde Tyme Radio Services Directory* is included (25 parts & restoration supply vendors are listed), as well as the *Photo Review*.

Last month, I hinted that a small subscription price increase would come. As of August 1, A.R.C. will cost an extra dollar or two per year. All of the U.S. and foreign rates are detailed on the coupon in the center spread. Now is the time to save by renewing or extending your subscriptions before the new rates go into effect.

Responses to the *Horn Speaker Survey* have been good. If you have not responded yet, send in yours. Don't worry if you have only a few horns; just complete it for those you do have. Also, please fill in any prices you know; you don't have to own the horn to price it!

Soon after I mail this issue, I will be off to the ARCA-89 Convention in Mystic, Conn. Here is one last plug: three-day flea market - seminars - two museums - banquet - Mystic Seaport - Marinelife Aquarium - Wow! See you there - June 1-2-3. See page 65 for more information.

Happy collecting,

John V. Terrey

OOPS

The price for the *Radio Horn Speaker Encyclopedia* was incorrectly quoted in last month's issue in the *Horn Speaker Survey*. The correct price is \$11.90 plus \$2.00 shipping when ordered from the author, Floyd Paul, 1545 Raymond Ave., Glendale, CA 91201. It is also available from *Antique Radio Classified*, Antique Radio Supply, Vestal Press and the Antique Radio Club of America - West Virginia Chapter.

RADIOS STOLEN FROM VAN

On April 15, Dick Desjarlais' van, containing about 60 radios, was stolen while parked in Boston. The van was later recovered, but without the radios. Dick is requesting that collectors be on the look out for any suspicious deals.

Some of the sets missing are: Poly Royal, Crosley 5-50 (no back), Radiolas 17 & 18 (no hoods), Crosley tombstone 6-35, RCA RC-348 tombstone, FADA 9152-C (chrome handle), original carton only for Crosley Band Box 601, Motorola emerald-green bakelite. Some of the sets had been purchased at the Eldridge auction on April 15: Trans-Oceanics (4), Emerson black bakelite, Motorola 57R, Philcos 42-350 & 42-844.

Please contact Dick directly at (508) 486-9018 (or A.R.C.) if you have any information.

(Founder's Comments, continued)

independent hobby publications, and I also became acquainted with many new collectors.

During the late 1970s and early 1980s, I was firmly entrenched in the hobby. I subscribed to almost every publication and radio club. However, something did not seem right to me. Each publication seemed to address a particular area of the country or to cater to a specialized aspect of the hobby, and, even to a lesser degree, to segregate beginning from advanced collectors. And then there was the problem of reaching collectors through the classified ad. In order to get the maximum amount of exposure, this meant the placing of the same ad in each of the five to ten publications and clubs serving the hobby. Even worse yet was the three-month wait for the ad to come out, in the case of quarterly publications.

I knew there had to be a better way to reach other collectors. So in December 1983, I had the idea of a publication to serve and unite all the collectors in the whole country, one that was not biased to any one group of collectors or area of the country. The basic idea was to provide a forum for the collector to buy, sell, and trade on a national level. Hopefully one ad would reach the majority of all collectors in the hobby - a very simple idea but very difficult to achieve unless the number of subscribers was at a high level.

With this simple plan in mind, I went full steam ahead. The task in starting a publication from zero subscribers was the most difficult aspect. I won't go into detail as that is a story in itself. However, to state it briefly, what I did was create a sample issue of the proposed publication. I mailed over 2,000 sample copies to collectors in June of 1984. Of that amount, 400 had faith in my venture. From that base of subscribers, *Antique Radio Classified* was born. In September 1984, the first regular issue was mailed to all those who had subscribed so far. Through much work and extremely high start-up cost, the number of subscribers increased each month. Finally after a year of uncertainty and personal sacrifice, the results were very encouraging. As word spread that A.R.C. was indeed a good idea and served a useful purpose, the publication grew with a steady increase of subscribers each month.

But after two-and-a-half years of publication by myself, the amount of work and cost to print A.R.C. each month was just too much for me to handle. In October 1986, A.R.C. was acquired by John Terrey, the present owner and publisher. As you can see, he has done a superb job in carrying out the dreams and goals I envisioned over five-and-a-half years ago. I am proud of what A.R.C. has accomplished over the years. The many collectors I still meet often ask me this question, "Do I miss not being a part of A.R.C.?" The answer is YES!

Good collecting,

Gary B. Schneider



RADIO IN THE TWENTIES

BY ALAN S. DOUGLAS, P.O. BOX 225, POCASSET, MA 02559

The RCA Radiola 44



Figure 1. The RCA Radiola 44.

"RCA has set a new standard of radio enjoyment." "The sensation of the radio year," proclaimed the ads. But what was the real story behind the Radiola 44 in 1929? All we can do now is speculate.

Put yourself back in 1928, as an RCA strategist. You have a total lock on the radio industry. After years of litigation, you have finally bullied nearly every major manufacturer into accepting a patent license and into paying you royalties that give you, theoretically, a 15% price advantage. All the new types of tubes, and many circuitry innovations, are originating with RCA and therefore should be appearing first in RCA models. RCA should be clobbering the competition.

But what's this? RCA an also-ran? Atwater Kent grabbing the lion's share of sales, Crosley sweeping the low-price field, and that upstart Majestic, which had never built a single radio in its life, selling thousands of expensive consoles every week?

Well, what do you do? To counter Atwater Kent, who was well into his second million "tin can" model with the immensely successful 40, RCA developed its Radiola 33. In a metal rather than a wooden cabinet, the 33 at \$77.50 could compete directly with the \$77 Model 40 (except that it was nearly a year too late – the 33 did not appear until April 1929).

The Superheterodyne, that Rolls Royce (Armstrong's words) of circuits which was inherently more complex than the common TRFs, would

take care of RCA's high-end models. RCA reserved the superhet for itself, refusing to license any other makers to use it. Its cheapest model, the Radiola 60, sold for \$175, and various console versions sold for much more.

Since the 33 did not come in any console styles (except in after-market cabinets by other furniture makers), that left a "hole in the middle" of RCA's line. And that's where the \$110 Radiola 44 fit in.

But what a strange radio! Not suited at all for its assigned role. It did have an attractive wooden cabinet, and some interesting innovations like concentric-knob control and a projection dial scale, and it looked at least \$30 better than the 33. But its circuitry and internal construction did not fit. The advertising copy read: "Only five tubes – yet gives you the performance of sets employing a far greater number." What kind of sales pitch was this? Buyers wanted more tubes, not fewer. Higher fidelity? "You get the freedom from distorting noises and electrical hum without the costly sacrifice of loss infidelity and tone range." Quite true: the 44 did have exceptional treble range, because it used no audio transformers and had rather broad RF selectivity. But did buyers care? The same buyers who went nuts over Majestic's boom-boom bass, with no treble at all? Not likely.

The 44's mechanical design doesn't quite add up, either. The RF chassis looks, at first glance,

(Continued on page 7)

Trio of Curves
Taken on Radiola 44
Citizen's Radio Call Book
 March 1930

1,816,718. SHIELDED RADIO RECEIVING APPARATUS AND THE LIKE. WILLIAM L. BOND, Schenectady, N. Y., assignor to General Electric Company, a Corporation of New York. Filed Feb. 19, 1930. Serial No. 429,757. 15 Claims. (Cl. 250-16.)

A rather unusual sensitivity curve is that shown for the Radiola 44 illustrated in Figure 3. Most sensitive at 600 kc. and 1400 kc., least sensitive at 1100 kc. Measurements were made with the local switch and the distance switch on.

In the selectivity curves shown in Figure 2, the broadest is the 1400 kc., and the 600 kc. is the sharpest. The 600 kc. curve gives somewhat satisfactory selectivity, while the 1000 and 1400 kc. curves would not in an area of strong locals.

Fidelity curves on these receivers, especially the 1000 and 1400 kc. curves are exceptionally good. They are shown in Figure 4. The 600 kc. curve falls off rather rapidly which is due to the increased selectivity at 600 kc.

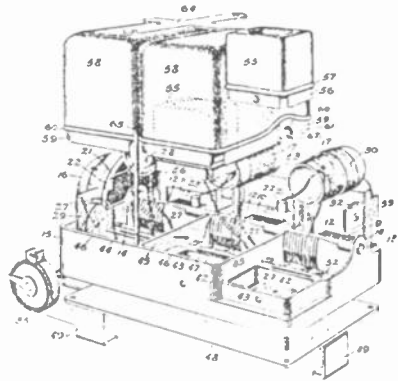

1. A shield for radio receiving apparatus and the like including in combination, an open metallic frame having integral transverse and longitudinal partitions dividing it into section, a well in one of said sections communicating with an adjacent section of said frame, a removable shield mounted in said well, a second removable shield mounted on said frame and providing a closure means for said adjacent section, and an enclosing means for one of said shields.

10. The combination with a tuning capacitor having a plurality of sections and a common control shaft, a plurality of inductances associated therewith, and tube sockets for a plurality of amplifier tubes, of a common support and shielding means including a metallic frame for said tuning capacitor providing bearings for said shaft and a support for said tube sockets, transverse and longitudinal metallic partitions in said frame arranged to separate and shield said tube sockets and tuning capacitor sections from each other, a shield can adapted to surround and with the base to enclose an inductance, a tuning capacitor section and a tube socket, and means for holding said can in a seated position on said frame.

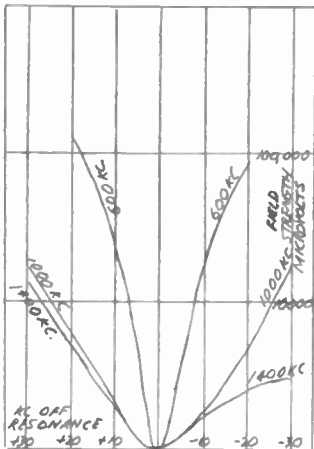

Figure 2. Selectivity in uv/m as a function of KC off resonance.

Figure 5. The patent for the receiver assembly.

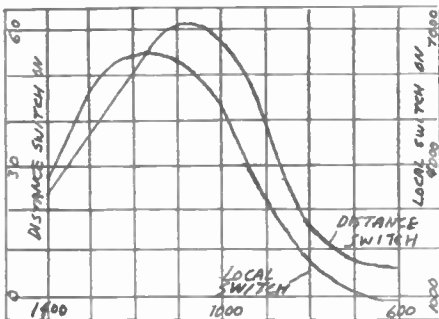

Figure 3. Sensitivity in uv/m. Left scale is the distance switch on; right scale, local switch on.

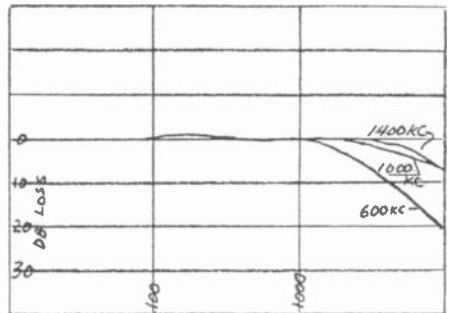

Figure 4. Frequency response curve, DB loss as a function of frequency in cycles.

(Radiola 44, continued)

like a very clever job, with its die-casting serving as both chassis and tuning-condenser frame. Certainly it was compact, but it couldn't have been cheap to make, particularly with the elaborate shielding boxes used. Now in the battery model Radiola 21, this compact RF chassis made good sense, but in the 44, no matter how small the RF chassis was, there was still the immense power pack that sat next to it. And besides, would a prospective buyer be impressed with a small chassis? Especially in a spacious console cabinet? Majestic built its chassis of what was practically battleship armor plate!

It would seem that the 44 had originally been intended as a low-priced design. Every effort was made to reduce the circuitry and the number of tubes at a bare minimum. Perhaps the GE engineering team that developed it was competing with the Radiola 33 team, exploiting the extra amplification of the new screen-grid tube. But the die-cast chassis and fancy shielding must have cost more than other designs, since no other large maker ever adopted it. And apparently the power pack never lent itself to "compaction." Or perhaps RCA executives decreed that the screen-grid tube must go into their high-end models and not be wasted in cheap ones – otherwise how could they convince the public it was such a great advance? They would need fresh sales features, to persuade the public to scrap last year's Atwater Kents.

At any rate, the Radiola 44 did not exactly

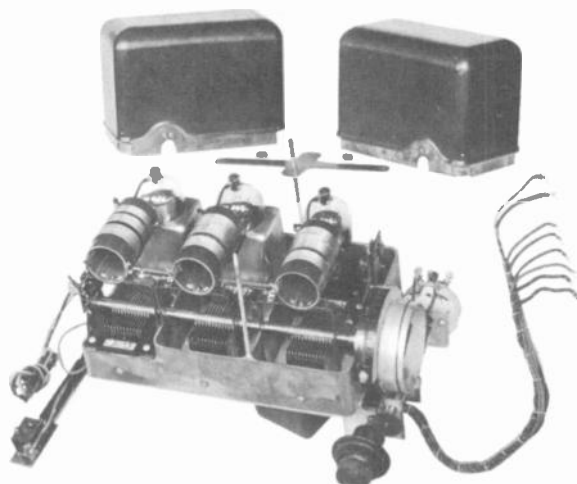

Figure 6. The receiver assembly which uses three UY-224s.

propel RCA to the head of the industry. While RCA dithered, Atwater Kent, Crosley, and Majestic forged ahead, and when they slipped, it was not RCA that filled the vacuum but yet another upstart that had never before built a radio – Philco. ©1989 Alan Douglas.

(Alan S. Douglas, Box 225, Pocasset, MA 02559)

This story on the Radiola 44 contains photos and material from the RCA chapter to appear in Volume 3 of "Radio Manufacturers of the 1920's" by Alan Douglas. Volume 1 was published in 1988, and Volume 2 is expected in a few months.

Alan has been interested in old radios since the age of ten and still has his first "collectible" set, his grandparents' Atwater Kent 20.

Alan has written over 100 articles on old radio subjects. (Editor)

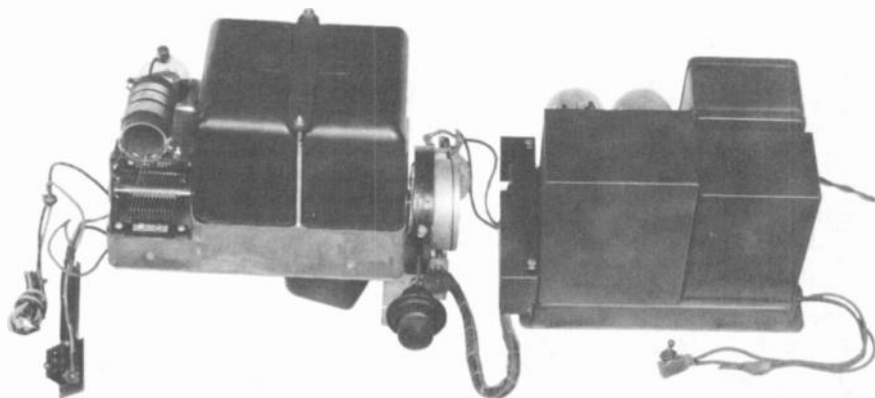

Figure 7. On the left is the three-tube receiver assembly. On the right is the power unit which includes the power supply (UX-280) and the audio output amplifier (UX-245).



COLLECTORS CORNER

CONTRIBUTED BY: FRANK HEATHCOTE, 1235 N. 3RD ST., LOGANSPORT, IN

Lemouzy Super Resonance

BY FRANK HEATHCOTE

In France, in the late 1920s and 30s, the domestic radio industry lagged behind that of many countries. The general impression of the public was that French sets did not measure up to sets imported from the U.S.A., Holland (Philips was the European radio giant), and Germany. Many French sets included foreign parts and tubes.

On the evening of July 28, 1932, a demonstration of two new sets was given to the board of *France Radio News* magazine by M. Lemouzy and representatives of Radios Lemouzy, 121 Blvd. St. Michel,

Paris, France. The sets were the seven-tube Super Resonance, a Superheterodyne, and the five-tube Super Impedance, a tuned radio frequency receiver. Both sets were touted as being

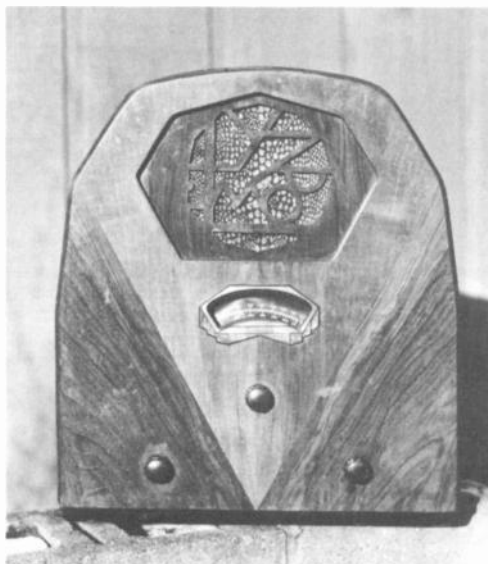

Figure 1. The Lemouzy Super Resonance receiver.

totally French made and comparing very favorably to foreign competitors. Much ado was also made of the single dial tuning which did not require any tuning compensators. Evidently this was a first for a French set.

The Super Resonance covers the European medium and long wave broadcast bands, 195-650 meters and 750-2000 meters, approximately 1550-500 kHz and 450-150 kHz. Reception in the demonstration to *France Radio News* was quite good with twenty-nine stations being received; remember this was in 1932, and there wasn't the prolif-

eration of radio stations as exists today. From Paris were received stations throughout France, Holland, Germany, England, Russia, Poland, Algeria, Lithuania, and others.

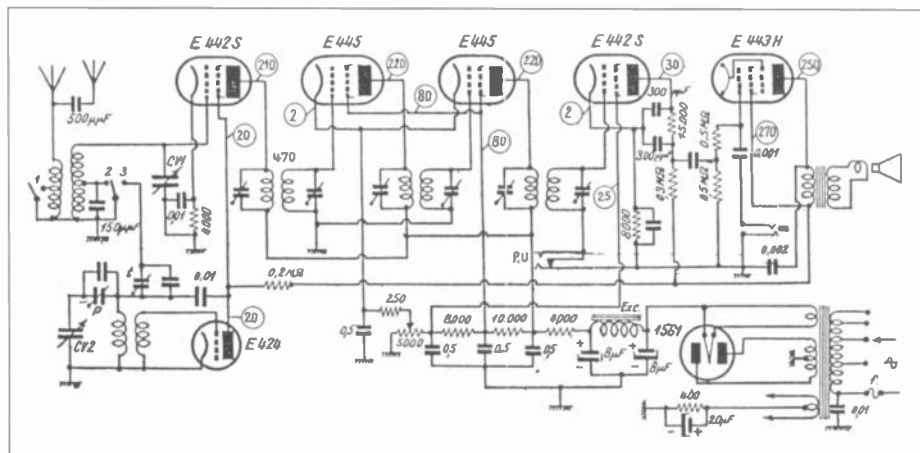

Figure 2. Circuit diagram for the The Lemouzy Super Resonance receiver.

Seven Fotos et Radiotechnique tubes are used in the Super Resonance. A variable mu E442S functions as RF amplifier, 2 E445 screen grid tetodes serve as 1st detector and IF amplifier tubes, and E443H serves as the power output pentode, and the full wave rectifier is a 1561. The tubes would correspond roughly to American types as follows: E442S = 35, E445 = 24, E424 = 27, E443H = 47, and 1561 = 80. The E442S and E445 have a spray shield similar to Majestic tubes, and all operate on four volts at the filament.

The Lemouzy Super Resonance is a good sized set weighing 32 lbs. and measuring 20" tall, 17" wide, and 9" deep. The chassis is conventional, but the cabinet is quite unusual. The arch is 7/32" thick veneered wood and all one piece with no bracing at all. It is glued to the front panel and base without any glue blocks. It is amazing that it has not come apart. The bottom panel has a removable cover to gain access to the underneath of the chassis for servicing the set without removing the chassis from the cabinet. If you look closely at the speaker grille, the letters which make the name "Lemouzy" are all found.

The Lemouzy compares favorably to a Kennedy 72 and a U.S. Apex 7A, both seven-tube superhets of the same era. Selectivity and sensitivity on the Lemouzy are very good, and tone quality is fine due to a good eight-inch electrodynamic speaker. I obtained my Lemouzy from a dealer in London while attending the BVWS Convention a few years back. He sold it for a very reasonable price as he said the English collectors looked down on it because it was French. It is one of my favorites.

Many thanks to Jean-Yves Laviolle of Sartroville, France, for the articles on Lemouzy, and to Paulette Shilling, retired French teacher at Logansport (Indiana) High School for the translations.

LA DÉMONSTRATION

À bord du « FRANCE-RADIO » du 28 juillet 1932 a prouvé que la construction actuelle LEMOUZY égale en qualité musicale les récepteurs étrangers les plus réputés tout en assurant une sélectivité exquise et une sensibilité remarquable.

LE SUPER RESONANCE



Montage Superhétérodyne à 7 lampes dont une valve, précédé d'une résonance, il constitue le récepteur le plus sensible et le plus sélectif. Il permet de capter la majorité des stations européennes même à proximité des stations locales d'émission. Les sifflements d'hétérodyne sont complètement supprimés.

Prix en ordre de marche avec lampes et licences. fr. 3.300

LE SUPER IMPEDANCE



Montage à amplification directe à 3 circuits sélecteurs, fonctionne sur courant 110, 130, 220, 250 volts. Récepteur très musical, sensible et sélectif. Assure sur petite antenne même intérieure la réception des stations européennes. Montage peu sensible aux parasites industriels.

Prix complet avec lampes. fr. 2.500

CARACTÉRISTIQUES COMMUNES

Cadran lumineux à lecture directe des longueurs d'ondes. Diffuseur dynamique de haute qualité. Circuits blindés. Châssis métallique

GARANTIES

Remboursement après essai de 6 jours. Réparations gratuites pendant un an. Lampes garanties 3 mois. Notice détaillée sur demande

LEMOUZY

121, Bd St-Michel - PARIS

Téléphone : Odéon 12.08

THE DEMONSTRATION

to the board of *France Radio* on July 28, 1932, proved that the Lemouzy construction actually equals in musical quality the most reputed foreign receivers while assuring an exquisite selectivity and a remarkable sensitivity.

THE SUPER RESONANCE

Superheterodyne receiver with seven lamps and one valve, preceded by a resonance, its receiver constitution is the most sensitive and the most selective. This permits capturing the majority of European stations even in the neighborhood of transmitting local stations. The heterodyne whistlings are completely eliminated. Price in working order with lamps and license, 3,300 Fr.

THE SUPER IMPEDANCE

Direct amplification receiver with three tuned circuits functions on a current of 110, 130, 220, or 250 volts. Very musical receiver, sensitive and selective. Assures even on small antenna the reception of European stations. Receiver is not very sensitive to industrial parasites. Complete price with lamps, 2,500 Fr.

COMMON CHARACTERISTICS

Lighted dial with direct reading of wave lengths. Dynamic speaker of high quality. Plated circuits. Metallic chassis.

GUARANTEES

Reimbursement after six-day trial. Free repairs for one year. Tubes guaranteed three months. Send for information.

LEMOUZY

121, St. Michel Blvd., Paris
Telephone: Océan 12.06

Figure 3. An advertisement for the Super Resonance in French on the left and English on the right.

We are pleased to have Frank contribute this "Collectors Corner" article for the Fifth Anniversary issue. Frank's first of over thirty "Collectors Corner" articles appeared in the second issue of A.R.C., September 1984.

The "Collectors Corner" is an attempt to build knowledge and interest of radio collectors primarily in AC home receivers of the late 1920s to the 1940s. The emphasis is on the lesser known and more unusual styles and brands. (Editor)

(Frank J. Heathcote, 1235 N. Third St., Logansport, IN 46947)

RADIO RAMBLINGS...

Radio Collecting – Going Nowhere Real Fast?

BY DEAN R. KAZMIERCZAK

Although I had been fascinated by old radios since I was a child — and have been collecting them for nearly as long — it wasn't until quite recently that I met other, real, live collectors at the Elma 1988 Summer Meet. From that encounter, I left with numerous impressions, conjectures, and conclusions.

Collectors, at least the majority of them, seem to spend much time and effort in pursuit of the ever elusive Crosley Pup, Coca-Cola cooler chest radio, or spinning disc TV as though these were some sort of Holy Grails. Don't misunderstand me. I, too, enjoy the challenge and surprise of locating a rare piece, and the pleasure of acquiring it for my collection.

However, we have failed to realize the one common "thread" which binds together every piece comprising one collection with every other piece in everyone else's collection. That "thread" is the fact that somebody, somewhere bothered to *keep* that piece around ...in service, or not...in good condition, or not...working, or not. It may have been banished to the attic or the garage as the decades rolled by but it was *kept*.

Looking back at the times and lifestyles which were common from the infancy of radio through its Golden Age, and most of the Golden Age of TV as well, household appliances and furnishings were regarded as an investment. This investment was not merely a monetary one, but also one of utility, serviceability, and even inheritability.

A radio, for example, was purchased as an end in itself. There was no intent of ditching it when the next model year came around. The word "upgrade" didn't even exist in our vocabulary. If the radio broke down, we had it repaired. Those knowledgeable in electronics did their own repairs.

The same principle applied to other household appliances, furniture, and personal possessions — particularly cars.

Then, there was a warped change in attitude. The world did a 180 degree turn. Disposability of a product became the most desirable quality of that product. People no longer cared how long a product would last, or how well it performed its function, just as long as it could be thrown away when it stopped working or when we got tired of having it around.

This attitude seemed to reach a measurable level in the mid-1960's, and has reached fanatical proportions today. Hundreds of products we never dreamed would be disposable are now commonplace in that form — dinnerware (not just paper, but sturdy plastics), medical equipment, cameras, contact lenses, digital watches, radios.

Even "big ticket" items have fallen prey to the same craze. Although no manufacturer would attest that their products are designed in such a way that makes disposal after failure inevitable, nor would any dealer impugnt that the products he sells have no repairability, the fact remains that the public thinks nothing of pitching out a console color TV, or an electric typewriter, or even a car after a few years of use.

Therein lies the how's and why's of collecting going nowhere real fast. Think about this — in thirty years, the Crosley Pup may be easier to find than the original Sony Walkman.

Just for fun, let's have a show of hands of how many readers have or know someone who has an original Sony Walkman, the industry's first pocket-sized AM/FM stereo (circa 1980)? How about a Mura Hi-Stepper, Model HI-3, once acclaimed by *High Fidelity* magazine to be industry standard in performance specs for a pocket-sized AM/FM stereo unit (I can vote *yea* on this one, and I still use it, too!)?

Trick question — how many readers have a Philco Predicta? It's a trick question because, relatively speaking and despite its few model years, there are tons of them around.

Let's try for some bonus points now — how many have the very first Motorola color TV model to have a rectangular CRT (which was also an industry first, circa 1965)? How about the very first all solid state color TV, the Motorola Quasar (circa 1968)?

Not very many hands. And these are all rather recent dates. Not to mention the products I named, with the exception of the Predicta, were latter-day turning points in engineering for the radio and TV industry.

Then why the poor show of hands? *The attitude of disposability*. These pieces aren't regarded as collectible, but instead as potential landfill.

So what are we going to be doing thirty years from now? Fifty years from now? We might just be trading and selling the same old Atwater-Kents, and Crosley 50's, and Zenith Trans-Oceanics amongst each other and our successors. There might very well be no "new" collectible items to be included in our collections. At some point in the future, a suitcase-sized boom box with subwoofers, or a first-generation model CD player might be rarer and more valuable than any spinning disc TV or Edison phonograph could ever be.

Ah, but where will we find any of these treasures? Will we ever find any of these products? Or will they be only photos in some manufacturer's product line catalog, lost forever to the real

world? Unless we plan now, there will be no such hobby as antique radio and TV collecting in the future...at least not in the sense we know it...or maybe only in the sense we know it, depending on one's point of view. We are the lucky ones who stumbled into a "ready-made" hobby because of the attitudes of the past. Because we are collectors, only we have — or should have — the foresight to preserve articles of the present, which will become the antiques of the future.

This brings me to a dilemma, which I can best express with a line from a Bob Seeger song ("Running Against The Wind") — "...Deadlines and commitments/What to leave in/What to leave out..." I cannot predict what products from the present will be a prized possession in the future. Lord, I wish I — or anyone — could!

Will the JVC AM/FM/cassette stereo boom box (Model RC-N5) be a collector's dream quest fifty years from now because it had the unique feature of telescoping in on itself so in the "travelling mode" it's only 2/3 of its normal length? Or will the Quasar "Delta Series" of video monitors be the Predicta of the next collector generation (aside: Quasar was the end result of Motorola selling off their TV line to Matsushita, the parent company of Panasonic, many moons ago) because of its similar appearance? What about the Sinclair ZX-81 computer...the first, and possibly only, fully-functional PC to sell for under \$100?

Unfortunately, I can only make recommendations based on observations of the past. The popularity of a product is no accurate gauge of its future value. The world's best example of this would be the Ford Edsel. By 1959, the dealers couldn't even give them away. Today, a fully restored 1958 Edsel can cost up to \$25,000! On the other end of the spectrum, Beatles singles on the Tully label were snatched up so fast during

the 60's, the record company couldn't keep up with the demand. Today, they are even more highly prized, cherished, and valuable. Ironically, the disco albums that fueled a segment of the music industry, which grew by unprecedented leaps and bounds, grossing billions of dollars per annum in the 1970's, nowadays aren't even worth the vinyl they're pressed on.

Uniqueness and an identifiability with parts of American Pop Culture (a.k.a. Americana) are usually a safe bet for a product that should appreciate in value as it ages. Radio Shack's little logo radio is one example, and their Burger King radio — with the headphones shaped like micro-sized Whoppers — would be another. Anything Elvis. Anything Disney.

Firsts-of-a-kind seem always to spark interest in collectors. They usually have desirability, even if their appreciation rate doesn't sky rocket in later years. How many can remember a red plastic Walkman-like device made by Audio Technica, which clamped onto the hub of an LP record, and could play in any position...even hanging from a doorknob? That turned out to be a first and last of a kind!

Unfortunately, I don't have a crystal ball to help me identify sure bets...despite the fact that my younger brother dabbles heavily in psychic research. The only advice I can offer is that a change in attitudes and a change in lifestyles is sorely needed to insure the perpetuation of our collecting hobby — both from the aspect of providing a source of interesting, exciting, and historical pieces, as well as from the aspect of igniting the imaginations and interests of potential new collectors. If things remain status quo, we might very well be going nowhere real fast.

(Dean R. Kazmierczak, 886 Eggert Dr., N. Tonawanda, NY 14120. 716 692-3455)

There Will Always Be Radios To Be Found!

BY EMIL COSENTINO

I have been a radio collector for ten years now. I would like to share with the readers some of my thoughts and ideas, and what has worked for me and is still working.

First of all I am out of the western suburbs in the Illinois area. Few estate and garage sales are to be found during the winter months. But since Jan. 15, this is what I have found:

Radio Glo, yellow & red, basement sale\$35
 Motorola console 7R, antique store45
 Philco 84, antique store40
 Zenith console 105689, beautiful, *Trader Times* newspaper45
 Majestic 90 console, restaurant bar & grille50
 Majestic 44 Dew Chief, *Trader Times*15
 Emerson 520, choc. swirl, basement sale5
 Stewart-Warner Companion, estate sale10
 Zenith 707, through a phone call to my home 20
 And I missed two consoles.

Now I am an outside salesman, and that puts me in a better position to haunt sales than most people with 9 to 5 jobs. But here is also what works for me — business cards, 1000 for \$19.95, with your logo — radio collector — buy & sell etc. ..

and leave them everywhere!! — jewelry stores, cigarette machines, bulletin boards; and give them to people who run garage and estate sales, music stores, and yes antique stores. Not all antique stores are into radios. Talk to older people, senior citizens, neighbors; explain your hobby to them; give them your cards. My \$20 investment has already paid for itself 100 times.

I also use my retired brother-in-law and sister. I explained to them the type of radios I'm looking for. And they have found some beautiful radios for me, and now every garage sale they go to, they ask, "Any old radios?" The people who have them may not sell them at the moment, but be sure they get your card. Open your mouth to everyone — resale shops, retirement homes. The other day I went to a doll house furniture store to buy some small radios for my related collection and left my card. A lady called me, and I bought three boxes of tubes, a plastic Philco, and an RCA tube carrying case all for \$20.

There will always be radios to be found, and I hope in some way this is of some help.

(Emil Cosentino, 1443 Ashbel Ave., Berkeley, IL 60163)



All You Need To Know About Repairing AC Radios - Part 7

BY RICHARD C. FOSTER, 12 SHAWMUT AVE., COCHITUATE, MA 01778

A Return To Basics And Power Supplies

This is the seventh part of a series on basic AC radio repair. This series presents useful hints for both the new collector and the veteran.

Yes, in Part 6, we announced that Part 6 would be the last. However, Richard Foster has taken on the task of continuing this very popular series which Jim Fred began. Richard has collected, restored and repaired old radios for some seven-teen years and has contributed numerous articles to A.R.C. in the past. Antique Radio Classified is pleased to have Richard pen this series.

*Refer to Parts 1 and 2 of this series (Feb. and Apr. 1988) for details on tools, test equipment, safety, etc. **IMPORTANT: do not plug the radio in until you have read the safety tips and warnings in these two installments!** (Editor)*

In Parts 1 through 6, Jim Fred has taken us through many aspects of troubleshooting and has made radios far less mysterious. Beginning with Part 7, we will discuss some important techniques, and talk about where to begin. Because of requests from friends who want to learn to fix their own radios, we will be quite basic in our approach, with apologies to those who are already experienced technicians or engineers.

This series will cover how to troubleshoot the sections of radios in general, beginning with power supplies, and will cover techniques and problems that may be encountered. We will also publish case histories on common problems and on sets that turn up frequently.

We will proceed under certain assumptions: That you have soldering equipment; that you have basic tools like cutting pliers; that you have a volt-ohm meter (see Part 1, Feb. 1988); that you have a tube tester; that you have procured a schematic diagram of your set; and that you will **NOT** plug in your set until you have inspected it thoroughly and have done the work outlined below.

WORK AREA

Some people work in closets, others on hollow-core doors or on the kitchen table. Many work in the basement on a workbench. There are some requirements that are common to all areas that you will want to observe.

Light: You need good lighting. It's amazing how hard it can be to see into corners of a chassis, to read values on small capacitors, to find the contact points between leaves of a variable tuning capacitor, or to find the end of the fine wire of an RF choke.

Antenna: In order to test radios, a source of signals is necessary. My solution to this was to

run some fine magnet wire (any kind will do) upstairs into the attic (height is more important than length). At a terminal block on your workbench, attach it to a length of hook-up wire with an alligator clip on its end.

Space: A Radiola 80 chassis with its separate socket (AC) power unit and separate speaker can occupy four or more feet of bench space. Add to that your soldering iron and your VOM (which I keep on a shelf above the bench), and you have no room left on your kitchen table. About six feet is minimum.

Power: AC outlets should be available. An outlet strip is a nice option since it allows several things to be powered up at one time. A VTVM (vacuum tube voltmeter), a soldering iron, the radio and a signal generator may all be required at once. Be sure your outlets are grounded properly!

Safety: 110v AC is life threatening! Reread Part 2, April 1988. Electricians and technicians will tell you, "Don't make yourself part of the circuit." To protect yourself, there are important things to do.

First, remember that the AC in your house wants to flow to ground, or to the neutral wire which is supposed to be at ground potential. If you work on a metal table, near a radiator, close to pipes, you are courting trouble. Stay clear of conductive things such as pipes and heating ducts which are grounded and can conduct electricity (or build wood boxes around them so you will not touch them).

Second, insulate yourself from the floor, especially if you work in the cellar. Dampness is conductive. Rubber pads on the floor are minimum for safety. A wooden platform with a rubber pad or a lexan carpet protector is better. Dip the handles of your tools in vinyl insulating compound as further protection.

Third, use an isolation transformer (See Part 2.) When working on a set whose chassis is connected to one side of the line, this will protect you.

Fourth, if you insist on a ground to test battery sets or to improve performance of early TRFs or superhets, put a .05 mfd. at 600 volts capacitor in series with it. Although it may attenuate signal strength a bit, the set will still work. The capacitor will not conduct enough current to hurt you.

Fifth, remember the old Navy adage, and train yourself to keep one hand in your pocket at all times. You don't want to become part of a power supply circuit or a path for high voltage DC to return to a chassis. In the path formed by your arms and hands is your heart, which can be shut off by electricity, especially by 110v AC.

Sixth, don't work on a set that's plugged in except to do alignments or basic tests. Pull the plug when you're soldering or changing parts.

POWER SUPPLY

We will use three main techniques. We'll do a visual check for defective parts and wiring; we'll do a voltage check (often omitted but very informative); we'll use continuity checks.

Broadly speaking, radios can be divided into three sections which are best considered separately: RF to tune and amplify incoming radio frequency signals; AF to take the audio frequency information separated by the detector and amplify it further so that it can drive a speaker; a power supply to provide the voltages necessary to operate the set. Only a crystal set can operate without power.

In most of the sets we encounter, the power supply has the job of converting alternating current to direct current. Important: read the set labels to make sure that you are not dealing with a 32-volt farm or a DC set.

Figure 1 shows the objective: to change AC (D in the figure) that is fluctuating or changing 120 times a second into a steady voltage (A in the figure) to allow tubes to function and to eliminate the hum caused by the varying voltage. In actual practice we get the voltage (B) which is close enough to DC for normal purposes.

A rectifier performs this conversion. It is a device that allows current to flow in one direction only, from its plate(s) to its filament. Typical vacuum tube rectifiers are the 80, 5Y3, 35Z5, etc. (The letters W, X, Y and Z in the tube number indicate rectifiers.) A varying voltage is applied to the plate (see Figure 1) and when it swings positive, current will flow from the plate to the filament or cathode (To confuse the reader, note that the electron flow is in the other direction, from the heated filament/cathode to the plate.) When the voltage on the plate swings negative, the current flow is blocked. However, the second plate now is positive, and current flows to the filament/cathode from it.

The varying voltage on the rectifier plates is derived from one of two sources: in Figure 2, it comes from a step-up winding on the power transformer which transforms 110VAC to about 750VAC across the high voltage winding. In the AC-DC set in Figure 3 it comes directly from the AC line feeding the set.

Let's analyze the circuit using a power transformer, Figure 2, first. The AC supply is to the left.

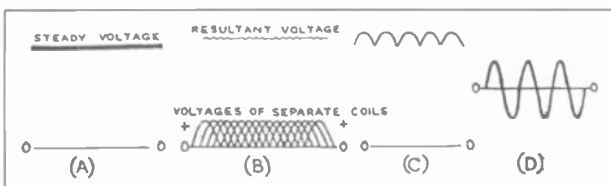

Figure 1. Various types of voltage: (A) Steady direct current, D.C. (B) Slightly rippled D.C. (C) Pulsating D.C. (D) Alternating Current, A.C.

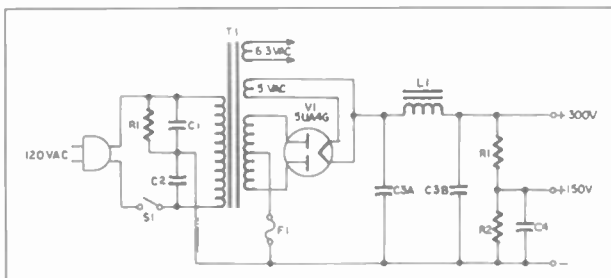

Figure 2. Vacuum-tube full-wave power supply using a power transformer.

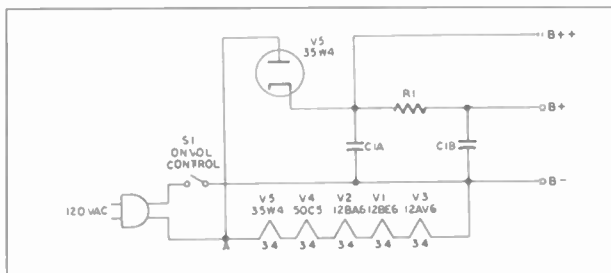

Figure 3. Universal AC-DC power supply, not using a power transformer.

The transformer, represented by the coils and the iron core, comes next, followed by the rectifier (5U4). The filament is powered by the five-volt winding, and the high varying voltage comes from the winding connected to the plates.

Further to the right is a filter circuit, consisting of C3A, L1 and C3B, to smooth out the AC. The filter is called a "Pi section" filter because it resembles the Greek letter "pi." The top is either a large resistor or a choke coil (L1 in this case), and the two legs are large capacitors (C3A and C3B). Simply put, these capacitors are large electrical tanks that release a flow any time the voltage at either end of the resistor or choke begins to drop a bit and that recharge when it rises. Their action tends to fill up the low points in ripples (See Figure 1) to give smoother current.

In the AC-DC set in Figure 3, the situation is similar, but the 35W4 tube has a sleeve around the filament called a cathode, indirectly heated by the filament. The current here flows from the plate to the cathode, instead of to the filament.

In 50- to 60-year-old power supplies, the filter

(Continued on following page)

(Repairing AC Radios, continued)

capacitors are almost always dried out or defective in some way. A glance at the circuit will show that since they are directly across the power supply output, they can cause serious trouble. If they short, the DC output voltage is short circuited also. (This is the reason for the fuse in the center tap.)

The next steps are to test the rectifier tube and replace the filter capacitors if necessary. Illustrations are included here to help in the location of these parts. Figure 4 shows a chassis and the location of the various power supply components. Figure 5 shows some styles of filter capacitors. Typical values are 8, 10 or 16 mfd. (microfarads) at 450 volts DC; in AC/DC sets they typically are 30 to 50 mfd. at 150 volts. If desired, tubular capacitors with the same electrical specifications can be used as replacements for the chassis-mounted styles, with strict attention paid to polarity.

In some books and articles on servicing we read about "reforming" electrolytic capacitors, which can be done if they are in good physical

condition. Most tubular and can style capacitors ought to be replaced. If they short, you cannot reach the switch quickly enough to avoid the resultant damage to your power transformer, which is harder to replace than filter capacitors. They also can cause lots of noise. Conclusion: if the filter capacitors are bad, replace them.

A digression... There are so many configurations of power supplies that it would take a whole issue to describe them. In general, the power supply negative goes to common and the positive, to the B+ (high voltage). This is frequently one end of a filter choke (note, in many sets, the field winding of the speaker serves as the filter choke). Although conventional wisdom says that the chassis is the common, this is often NOT the case. Examples are the Philco 60 and 70. A quick reference to their circuit diagrams (not printed here) shows that the B- may be negative with respect to the chassis to obtain negative voltages for grid bias. The AK 43 diagram is a classic with the power transformer B+ winding center tap tied to the chassis. In the AC-DC set in Figure 3, the chassis is used for the common and the AC is tied to the chassis also - careful!

Find the filter capacitors. Choose a replacement of similar capacitance value (a bit over or under won't matter; values within 20% of the original are acceptable for capacity), but BE SURE that the voltage rating meets or exceeds that of the original.

Locate the positive ends of the filter capacitors. You MUST disconnect the original positive terminal. Tie the positive ends of your new capacitors to the wires removed from the positive ends of the original capacitors.

Locate the negative ends of the filter capacitors. Inspect the old cans (negative, usually) for a cardboard sleeve, an insulating washer or a separate negative terminal. If there is, don't hook this to the chassis; use the separate terminal for your negative. If the cans are connected to the chassis, you can connect your new capacitors there. Make good mechanical joints before soldering.

No mention has been made of the line cord to encourage you not to plug the set in until you have made the checks described here. One shorted filter will kill a power transformer in the twinkling of an eye. Replace the line cord now, if you want.

The next installment will cover dividing the set, checking the amplifier for operation and running a voltage check to look for defective resistors, capacitors and open transformers.

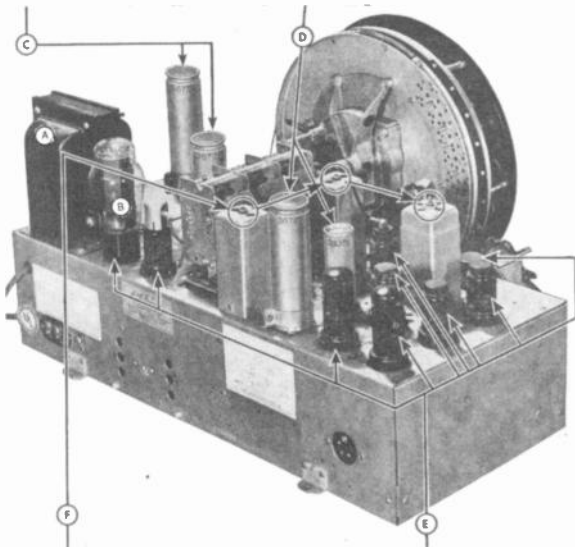

Figure 4. A typical AC radio chassis with the filter capacitors, power transformer, and rectifier tube identified. A = power transformer, B = rectifier tube, C & D = filter capacitors, E = tubes, F = IF transformers.

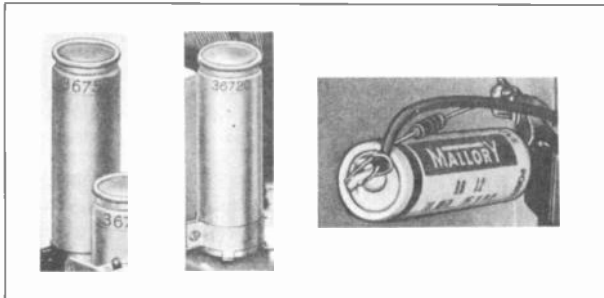

Figure 5. Typical filter capacitors. Figures 4 & 5 are from the Malloy Radio Service Encyclopedia.



CROSLLEY REVIEW

BY RICHARD ARNOLD, P.O. BOX 275, LONE GROVE, OK 73443

CROSLLEY *Model X*

\$ 55

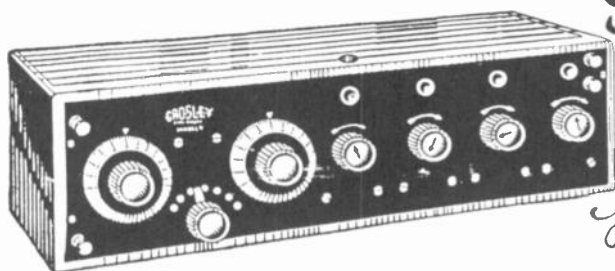

*A 4 tube
Radio
Frequency Set*

**THE HIT OF THE RADIO WORLD
FOR SALE by Good Dealers Everywhere
Catalog on request to Dealer or Consumer**

CROSLLEY MANUFACTURING COMPANY

516 ALFRED STREET

CINCINNATI, OHIO

In the early 1920s, radio was rapidly becoming a public servant of great value. This was due in part to the efforts of the Crosley Manufacturing Company in the making of such radio receivers like the Model X.

The Model X exemplified efficiency, simplicity of operation, neatness, staunchness and a high degree of selectivity. Loud local stations could be tuned out completely in order to receive long distance stations with remarkable clarity and volume. It was the hit of the radio world.

When the Crosley Manufacturing Company of Cleveland, Ohio, introduced the Model X in the summer of 1922, little did it realize that the receiver soon would become one of the biggest, if not the biggest, selling radio on the market.

Powell Crosley Jr. knew the set he was making was going to be a good one from the very start. Extensive testing prior to its announcement showed the unit's ability to hear distant stations even during the static dog days of summer. It was better than any other type of apparatus they had ever used.

The Crosley X incorporated one stage of tuned radio frequency amplification before the detector. This was a common Crosley feature, and is said to be the secret of its wonderful success. This

amplified the signal to the detector manifold and thus allowed the detector to operate more efficiently.

The radio consists of one stage of tuned radio frequency amplification, a tuner, a detector and two stages of audio frequency amplification. Ample volume, even on distant stations, is controlled by filament rheostats.

The cabinet is Adam brown, mahogany finished, and compares favorably with the finest piece of furniture in the most particular housewife's parlor.

The Model X sold for \$55 by itself, and for \$112.50 with the following accessories, necessary of course:

- | | |
|------------------------------|-------|
| 1. Model X receiver | \$55 |
| 2. Detector tube | 5 |
| 3. Three amplification tubes | 19.50 |
| 4. A battery (6 volts) | 17 |
| 5. B battery (45 volts) | 6 |
| 6. Aerial | 4 |
| 7. Headphones | 6 |

The Crosley sets were manufactured, not merely assembled, in their large factories in Cincinnati, Ohio. Production on a large scale permitted the sale of its products at a low price.

Crosley's Slogan was: "Better . . . Costs Less."



COLLECTING BRITISH CRYSTAL SETS



Collecting British Crystal Sets is a multi-part series of articles designed to acquaint the reader with this specialized aspect of the radio hobby, one that many collectors find interesting due to the many unusual types of sets produced in England. The author, Howard W. Stone, welcomes additional comments or information concerning British Crystal Sets. When writing please enclose a S.A.S.E. for reply. Howard W. Stone, 2825 6th Avenue, Fort Worth, Texas 76110... (Copyright 1986 - Howard W. Stone)

PART V. A BRITISH CRYSTAL SET PHOTO REVIEW

Part 5 of the British Crystal Set Review has been a long time in coming. Parts 1 through 4 appeared in the December 1986 and January, March and April 1987 issues of A.F.C. Howard Stone sent these additional photos, but we never put them together in article form. Although a bit tardy, here they are.

An article on British crystal sets is timely, however, in another way. This June, the Antique Wireless Association and the British Vintage Wireless Society are holding a joint meeting in London, England on June 21 - 29.

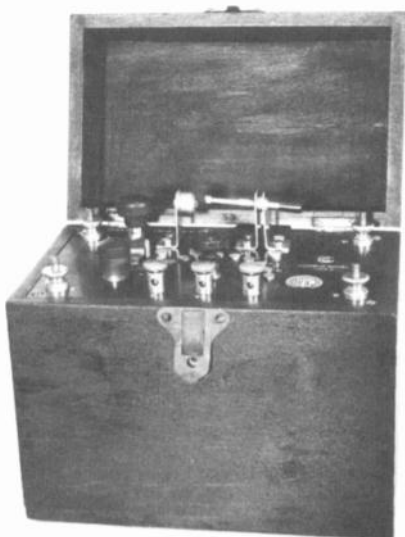

Figure 1. Ediswan Model 1923B. G.P.O. #433. Manufactured by Ediswan, 123 Queen Victoria St., London. First produced in 1923, it has a mahogany case with a lid. It is 4 3/4" x 8" x 7 1/2". The knob on the left front holds spare crystals. It has tapped inductance tuning. An ad in the October 10, 1923, issue of "The Wireless World and Radio Review" said, "Clear and loud reception is readily obtained over a range of 25 miles under favourable conditions. Receives on wavelengths between 200 and 500 metres." It cost £3.7.6 including headphones.

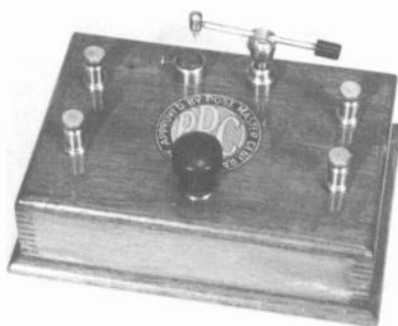

Figure 2. Master Junior. G.P.O. #899. It was manufactured by Master Radio, 30 Rosamond St. East, All Saints, Manchester. The date is 1923-24. The small simple case is finished in a light tan color. It receives 250 to 600 meters. It has an open detector. The size is 5 1/4" x 4" x 1 1/2". It has slide coil tuning. It cost £0.7.6.



Figure 3. Model A. G.P.O. #0373. It was manufactured by the British Thomsom-Houston Co., Crown House, Aldwych, London. The date was 1922. It is in a walnut case with lid and sloping panel inside. It is 5 1/4" x 8 1/4" x 11 1/4". It has variometer tuning, and for £0.3.6 extra, a loading coil be purchased. It cost £7.15.0. It is an excellent performing set.



Figure 4. Bijou. G.P.O. 861. It was manufactured by the British Thomson-Houston Co., Crown House, Aldwych, London. It first came out in 1923. It has a walnut case with a lid. It is $4\frac{3}{4}'' \times 5\frac{1}{4}'' \times 7\frac{1}{4}''$. It uses variometer tuning. It cost £3.10.0 including a set of headphones. A 5XX loading coil was £0 3.6 extra. It is a very well made set.



Figure 6. The Lady's Companion. This is a home-built crystal set of very fine craftsmanship. The case is red leather with gold lettering. It has an enclosed glass crystal detector. It is tuned by moving the lever in and out. The date is circa early 1930's. It is quite small, $3\frac{1}{2}'' \times 2\frac{1}{4}'' \times 1''$.

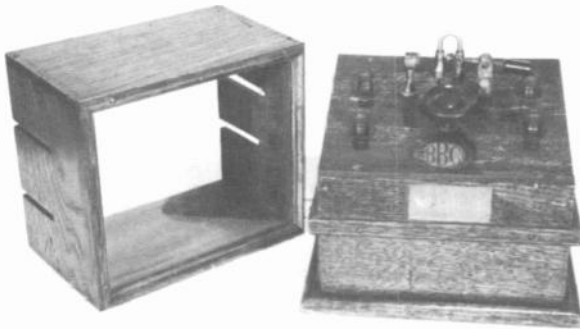

Figure 5. The Walmore Set. The manufacturer is unknown. The date is circa 1923. The case is made of oak, and has a removable glass cover. The panel slopes to the front. A removable u-shaped link can be replaced by a loading coil for other frequencies one might wish to tune. Size is $7'' \times 6\frac{1}{4}'' \times 7\frac{1}{4}''$.



Figure 7. Another view of the Lady's Companion.

Membership in the BVWS is still £15. The address is BVWS, Gerald Wells, 23 Rosendale Road, West Dulwich, London SE21, England. The BVWS publishes a quarterly bulletin.

AUCTION REPORT

CONNECTICUT, KANSAS, NEW YORK, PENNSYLVANIA & TEXAS GENERAL, RADIO & CLUB MEET AUCTIONS

Waterford, New York – April 1, 198 Reported by Ray Chase

An auction including about 100 radios was held at Sonney's Auction Barn, Waterford, New York, April 1, 1989. The auctioneer was Sonney Doin. Most of the radios ranged from good to poor condition with a few exceptional items. An Arvin Hopalong Cassidy radio sold at \$180. A GE "Georgian" Model K82 grandfather clock radio went for \$270.

Philco 37-650 console, 4 knobs, fair	\$30
RCA 9K2 console, 5 knobs/tuning eye, good	30
Airline Movie Dial small console, chrome chassis, gd.22.50	
Philco 80 cathedral, 2 knobs, good	85
Jewel cream & maroon plastic portables, Deco style, 2 each, good	18
GE console, 5 knobs, good	30
News Sport Radio, mike-shaped plastic radio, 1540 KC on case, black, fair	22.50
Midwest chairside radio, Deco style with unique dial, entire dial rotated, pointer was stationary, 2 eye tubes, f	40
Silvertone Model 1919 stepped tombstone, 4 knobs, one missing, good	32.50
Westinghouse Model WR169 small wood table model, 2 knobs, vg	20
Am. Bosch small console model 650, 4 knobs, one missing, big dial	17.50
Victor console, dual chassis, heavy, good	12.50
Farnsworth chairside with record player, blonde color, 3 knobs, Deco	20
Radiola 17, no hood, fair with good radio table & sprk.	35
Radiola shelf speaker	5
Monarch tombstone, 3 knobs, round dial, good	70
Radiola 17, fair to good	45
Arvin Hopalong Cassidy small table radio, rust around back of metal case, no back cover, fair	180
Airline console, 3 knobs, has police band, good shape ...	35
GE Georgian Model K82 grandfather clock radio, door in front hides the radio controls; this was the star of the auction; outside of a broken finial and need of some new grille cloth, the piece was in superb condition ...	270
Stromberg-Carlson 585M big console with 19-tube chassis, top of the line prewar set/old FM band, vg	35
AK 55 in highboy console, chassis poor with much rust, cabinet good but not correct grille cloth	22.50
Philco 40-195 console, 4 thumbwheels, 8 tubes, vg	35
Airline 62-307/407 small console, 4 knobs and eye tube, small chrome chassis; cabinet fair	22.50
Airline 62-472 large wood table model, 4 knobs, waterfall front, vg	25
2 slide homemade xtal set with condenser and xtal holder, very dirty	25
RCA console, 2 knobs, police band	12.50
Zenith fabric-covered battery portable, handle gone	20
Crosley Fiver brown plastic, piece out of grille, knob missing	10
Truetone porthole TV table model, good	22.50

GE metal case wet cell portable, 4 knobs, cell missing ...	10
GE Mickey Mouse white plastic clock, modern	35
Wurlitzer small wall speaker (for jukebox?)	32.50
Silvertone large wood table model, 4 knobs, f to gd	20
Sparton large console/record changer, 40s or 50s, gd	10
Am. Bosch wood table model, 2 knobs, grille in center, split in front of cabinet, poor over-varnish job	25
Jukebox, 50s or 60s	180
Philco large table model, wood with slope front, push buttons, good	27.50
Emerson brown wood table model with handle on top, double waterfall style case, no back panel, fair	15
Philco large low console with record changer, 50s style ...	2
Carillon Bell brown plastic table, 3 knobs	10
Box of tubes, 12 in cartons, 201, 24, 45, 27, etc.	15
Box of tubes, about 40 or so, many 4 and 5 pin	40
Radio poster 2"x3", WABY silhouette of mike and church, fair	17.50
Headphones	5
Zenith small wood table, 2 knobs	20
Large wood table model/slope front, 4 knobs, good	25
Telechron small clock radio built into a table lamp, 50s, fair	10
Emerson small plastic, Deco style	22.50
Emerson green marbled plastic with white knobs, nice ...	20
Radiola small shelf speaker, about 10" dia., good	7.50
Fire Reporter police monitor radio, small plastic, 50s	5

About ten other wood table radios that were in fair to poor condition sold for \$5 to \$15 each. Twenty-two other plastic radios sold from \$1 to \$20 each.

Hereford, Pennsylvania – April 21 Reported by Ray Chase

A general auction at the Upper Milford Fire Co., Hereford, Pa., on April 21, 1989, included about thirty-five radio items. Sam Morgan was the auctioneer.

Philco 44 console, lowboy, 4 knobs, some delamination on top, otherwise good	\$45
AK 55 metal case coffin, fair to poor	20
Barradio, complete with all glassware, vg plastic trim not warped	140
GE K52 cathedral, vg	170
AK 55 metal coffin/speaker, black and green, good	60
Music Master horn, wood bell, minor repairs to bell, otherwise vg	60
Philco 18 large cathedral, 3 knobs, columned sides, vg	200
Box of tubes, 2-199s, 216, 3-WDs plus others	24
Battery set, no name, 4 dialer, 4 tubes with 3 Cosmopolitan Phisiformer tuners, good condition, no tubes	32.50
Kiel table with AK 55 in super condition; table has been restored; but one of the best Kiel tables I've seen	225
Admiral 20X122 small bakelite console TV, vg	60
Majestic 15 grandfather clock radio; chassis ruff but cabinet well restored and in vg condition; clock gd ..	150
Large empty cathedral cabinet, make and model unknown, fair	25

Outside hanging lighted shop sign, 2.5'x4', RCA Victor Radio TV with nipper	50
Philco brown plastic table model, 2 knobs	8
RCA brown plastic table radio with 45 record player	14
Motorola small plastic portable with flip-up door	9
Emerson small brown plastic table model, 2 knobs	7
Delco brown plastic, 2 knobs	10
Arvin Voyager red plastic batt. & AC portable	3
GE modern clock radio	25
Grantline 606 blue Deco style plastic table model, 6 push buttons, good	50
Small Arvin, 2 knobs	9
RCA table mike, black plastic	5
Arvin brown plastic table radio, normal size	25
Arvin small chrome-plated table radio, case has been rechromed	130
Arvin small chrome-plated table model, later model than above, case also rechromed	90
Box of 2 dozen phenolic wafer tube sockets, N.O.S.	25
Magnavox One Dial battery set, no tubes, good	27.50
Philco wireless remote control box for a console set, looks like a telephone dial	22
Home brew 1-tube battery radio, no tube	12.50
Peerless wood cabinet speaker, good	15

(Ray Chase, 1350 Marlborough Ave., Plainfield, NJ 07060)

**MAARC Spring Antique Radio Auction
Overland Park, Kansas – April 16, 1989
Reported by Randy King**

Over 200 sets changed hands during the annual spring auction of the Mid-America Antique Radio Club (MAARC) on April 16, 1989, in Overland Park, Kansas. About eighty people attended the three-and-a-half hour auction. MAARC member Gary Ward served as auctioneer. Among the notable items sold were an "Elks Nickel" beer bottle radio, in excellent condition, for \$130, and a Hammarlund clock in good condition for \$60. Bidders came from Kansas, Missouri, Iowa, Illinois, Texas, and Nebraska.

MAARC has an annual spring and an annual fall auction, open to members as part of their membership, or to the public for a \$5 bidding fee. For more information on MAARC, contact Sheldon Wheaton, 1120 Virginia Ln., #1, Olathe, Kansas 66061.

e = excellent, g = good, f = fair, p = poor

Zenith tombstone, f	\$45
Coronado tombstone, f	30
Horse novelty set, e	27.50
Philco 38-62 console, g	45
Zenith tombstone, g	55
Floor tube tester, signal generator, box of tubes, f	10
Freed-Eisemann console, Majestic console, f	15
Majestic console, f	15
Graetz Musica table set, German, p	25
Admiral bakelite TV with UHF converter & original rabbit ears, extra tuner, g	40
RCA Nipper dog, 14" tall, g	27.50
Philco 306 console, g	85
Scott console, 1950s, g	25
Arvin small metal table set, p	25
Admiral TV Service sign, f	10
Blaupunkt table set, 50s, f	62.50
Kolster spindle leg console, g	55

Continental chrome microphone, e	60
Crosley spindle leg console, e	70
Zenith bakelite tabletop with handle, g	22.50
Airline console, 32 volt, g	10
Horn spkr., unknown, g	37.50
Zenith 6G501 with lid, works, e	20
Philco 38-10 console, p	10
6" TV, portable, metal cabinet, e	15
Zenith Allwave portable, g	10
Majestic tombstone, chrome grille, g	60
Scott Majestic, w/power supply, chrome rough, f	30
Radiola 18 console, e	105
Zenith console, airplane dial, g	80
Traveler portable, alligator type leatherette cover, g	13
Westminster cathedral, e	85
Johnson Smith crystal set, blue swirled base, works, e ..	47
Rider's Volume 6 & 9, pair, e	40
1929 Zenith automatic console, e	110
Wood-cased Supreme tube tester/inst. manual, e	60
Wire recorder, e	10
Philco 16 cathedral, works, cabinet rough, f	75
Hallicrafters SX 42, f	27.50
Box of tubes: 6L6, 42, 37, etc.	35
Philco rooftop portable, g	15
Reproduction cathedral, modern, g	30
Zenith tombstone, p	10
Rider's Volume 2, e	35
Rider's Volume 3, e	30
Steinitz cathedral, cabinet only, f	15
Crosley tombstone w/domed top, e	120
Majestic tombstone, chrome grille, e	60
RCA Stratoworld, inside lid warped, leatherette cover in excellent condition	35
Silvertone brown metal small table	20
Box of 3 horns and asst. parts, f	77.50
Zenith Royal 500 early transistor/leatherette case, g	10
National HRO 100, f	35
AK 40 with speaker, not working, f	40
Erud Junior, without tubes, f	25
Coronado tombstone, 32 volt, g	35
Crosley Fiver small tombstone, unchecked, p	35
Hallicrafters Civic Patrol SX-92, g	10
Motorola portable, tan leatherette/old A & B batts, g	10
Box of 4 bakelite sets, fair to poor	10

(Randy King, KBØECH, 3017 Orwell St., Lincoln, NE 68516)

**E. S. Eldridge Radio Auction
Brooklyn, Connecticut – April 15, 1989
Reported by Ray Chase**

The Eldridge auction at the Brooklyn Grand Hall, Brooklyn, Ct., on April 15, 1989, had the largest collection of radios I have seen outside of the Canandaigua A.W.A. meet. Some box lots of radios and many boxes of assorted parts and junk were auctioned. Many paper and ad items did not draw opening bids; opening bids were seldom dropped below \$5. The auction went quickly, starting at 11 a.m. and ending at 2:30 p.m. when the crowd had thinned out. Towards the end of the sale radios and box lots were being sold by the tabletop. Considering the amount of advertising done, the audience was not large. The auctioneer was Ernest S. Eldridge, 201 Church St., Willimantic, Ct. 06226, (203) 423-0525

(Continued on following page)

(Auction Reports, continued)

A selection of items auctioned follows. Item descriptions and condition are as described by the auction house.

ut = untested, w = working, c = clean, vc = very clean

National NC-88 receiver, ut	\$12
Hallcrafters S-38E, ut	22.50
Heathkit HR1680, ut	50
Code Key, oak case w/brass trim to sounder	30
Wood base sounders, ut	12 & 5
Navy receiver RAS-5 w/CNA 46080, rack mount & coils	20
Precision tube tester in oak case with 2 boxes of tubes	30
Atwater Kent 70 console, complete, ut	30
Philco 37-650 console, missing knobs, c	30
Philco Jr. beehive, c, ut	155
RCA 19K console, c, ut	75
Atwater Kent 60 console, missing tubes, c	25
Zenith 10-S-454 black dial console, missing tubes	85
Grunow console, complete, refinished cabinet	80
Westinghouse WR-306 console, missing knobs, ut	22.50
E. H. Scott Phantom in Stratford cabinet, c, ut	425
Majestic 50 cathedral, vc, ut	55
Philco 41-225 slant-front table set, vc, ut	60
Silvertone 4638 tombstone, large farm radio, c, w	10
Magnavox Model J, c, ut	60
Lytic console, by All American Mohawk, c, w	55
Victor Victrola oak tabletop player, w	60
Sky Rover 224 console, c, w	40
Homebrew battery set w/walnut case, complete, c	30
Victor Victrola oak stand-up, w	95
Silvertone 101.487 2-band table set, c, w	27.50
Airline 93BR tombstone farm radio, vc, w	45
Majestic 70 Highboy console, c, w	90
General Electric KL-4B AM wood table set, c, w	15
Silvertone 4626 2-band wood table set, c, w	17.50
Philco 41-95 AM wood table set, w	22.50
Howard 580 2-band wood table set, ut	27.50
Silvertone 6044 AM table set, farm radio	17.50
Silvertone 7508/7108 AM wood table set, farm radio	10
RCA 94BT2 2-band w/PB wood table set, farm radio	12.50
Hamilton Lloyd cathedral, cabinet refinished, ut	90
Glorton 26 cathedral, cabinet refinished, ut	110
Halson Beehive, no tubes, shorted power transformer	50
Truetone A 12 console, c, w	35
Sentinel console/ette, tombstone w/table base, w	70
S-W Porto-Baradio, no decanter, bad handles, w	70
Majestic 90 console, refinished cabinet, ut	45
Emerson 520 wood table set, c, w	13
Lot of 5 Zenith Trans-Oceanics, all loose chassis, ut	40
Zenith 6-D-826 AM wood table set, ut	25
Philco 38-93 semi-beehive, ut	37.50
Philco 42-844 portable w/rolltop, w	15
Musicaire 2-band midget tombstone, w	40
Automatic Tom Thumb portable 1947, ut	25
Zenith Consoltone wood table set, ut	32.50
RCA 66X3 2-band wood table set, ut	35
Philco 42-335 2-band wood table set, w	30
Emerson R-167 2-band Deco wood table set, ut	45
Silver-Marshall 3-band tombstone, c, ut	42.50
RCA T5-2 tombstone, w	45
Crosley 66TC 2-band, big dial wood table set, w	42.50
Service/tube Caddy	5
Philco Radio Aerial Kit 1937, complete	20
6 issues Radio magazine 1941	9
A. C. Gilbert Yearbook 1923	5
What's On The Air Magazine, Jan. 1931	12
Coyne Radio School Information Packet, 1931	9

Game of Radio Card Game, 1924, complete	15
General Electric Service Instructions, 1936, 36 folders	15
Construction instructions for 5-bulb Duston neodydyne	5
Aunt Sammy's Radio Recipes Revised, 1931	8
WWVA Family Album, 1950	10
Pacent electric tonearm for Victrola	10
Book: Radio for the Millions, Popular Science 1945	5
Book: The ABC of Vacuum Tubes by E. H. Lewis, 1922	11
FADA Sales Radio magazine, Oct. 1931	3.50
RCA Radiola 18 Service Notes, April 1928	10
WADA radio ad, Dec. 1925	3.50
Atwater Kent ad, Sept. 1926, AK 30 in color	9
Philco ad, 1947, Bing Crosby w/1201	15
Zenith 15E w/power supply and filter block, vc	55
Music Master 100, c	105
Colin B. Kennedy VI, vc	350
RCA Radiola III, c	55
Atwater Kent 20C, vc	65
Crosley 51SD, vc	80
Freed-Eisemann NR-7, exc.	70
Freed-Eisemann FE-15, exc.	75
Atwater Kent 2000 console, exc. w/all original papers	210
X-Laboratories 3-dial, New York Mfg., c	50
Gilfillan GN-2, case rough	70
Steinite AC coffin box, c	20
Airline 30, c	40
Home brews, 2- to 4-tube sets, each	20 to 40
Atwater Kent 44, ut	40
Atwater Kent 46, ut	75
RCA Radiola 17, complete w/light hood	20
RCA Radiola 18, complete, ut	12.50
Atwater Kent Type E speaker, ut, lot of 2	65
Crosley Dynacone, ut	32.50
Telephone paper cone, w	22.50
Sonochord speaker, w	17.50
Amplion horn speaker, 3 chips out of horn, w	80
Music Master cabinet speaker, c, ut	45
Philco B eliminator, w/glass bottle cells, c	22.50
Atwater Kent 55C console, c, w	40
American Bosch 242 console, w/twin speakers, w	50
Victor R-32 console, ut	70
Philco 37-89 console, ut	60
Atwater Kent 70 console, c, ut	30
Airline 14BR-736A 2-band wood table set, w	22.50
Silvertone 4437 tombstone, 1 1/2 volt farm set	15
Kadette 87 Deco 2-band wood table set, ut	10
Emerson 503 AM wood table set, ut	15
Silvertone 7106 wood table set, 1 1/2 volt farm set	5
2, Zenith Long Distance portables, 1 working	15
Zenith AM/FM 7F04 brown bakelite, w	15
Emerson 515A brown bakelite, ut	5
Philco Transitone AM bakelite painted white, ut	27.50
Zenith 53 console, 1929, w/hidden push buttons, c, ut	55
Eveready 52 console, 1929, doors w/repwood front, w	160
Victor RE-75 radio/phone, 1929, ut	105
Philco 660 console, 1936, c, exc. w	30
Vitaphone tabletop Victrola, missing crank, c	275
American Bosch 4-band tombstone, 1 knob missing, ut	50
Automatic Radio AM wood table set, c, ut	15
2 RCA TV tuners, w	10
BC-348R military WWII comm. receiver	25
King, Buffalo, 3 dialer	60
TV/Radio lighted store sign, outside, hanging type	40
SX-140 Hallcrafters	25
2 books, RCA service notes	40
Rider's Vol. I, II, III	65
Greybar 330, very good cond.	70
WE 560 AW large paper cone speaker, perfect cond.	140

Spring VRPS Auction
Irving, Texas – March 18, 1989
Reported by George Potter

At this year's Vintage Radio and Phonograph Society's (VRPS) spring auction on March 18, 1989, over \$7,600 was sold in 542 lots over a four-hour period. Over eighty people attended this auction, at the Garden and Arts Building, 906 Senter, Irving, Texas. Lew Magrish and Mike Sherman served as auctioneers. A Canadian Everyman crystal set and a very nice Grebe Synchrophase each went for \$230. Atwater Kent partially complete breadboards, numerous AK parts, and some nice Crosley equipment were included. In addition to the results reported here, many pieces of test gear, loctal tubes by the boxful and 1950's plastic five-tube sets were sold. To all who attended, we thank you for making it another successful auction.

e = excellent, g = good, f = fair, p = poor, bb = brass base, bt = brass/tipped

Grebe Synchrophase, w/tubes, e	\$230
Canadian Everyman crystal set, g	230
Magnavox brass horn, f	15
Loose coupler, small, g	75
Federal 146, g	60
DeForest 01-A in can, g	30
National SW3, e	110
Radiola 60, g	75
AK breadboard, homemade	160
Burns horn, p	45
RCA RA unit, f	45
Crosley 51, g	70
Philco Model 17, cathedral, f	75
Philco banner 2'x6', g	65
Zenith display sign, g	34
Kolser speaker, f	45
Hammarlund HQ110, f	60

AK variometers, e, (2)	30
Crosley RFL 75, g	80
Crosley Fiver, g	40
Crosley Model X, f	100
AK 60 chassis, f	20
UV200, UX199, UV201, dud	15
Super Speaker horn, no base	9
Crosley 51, g	70
Kolster batt. radio, e	135
Radiola III, parts, p	35
AK variometers, g, (2)	26
Zenith 500 Trans-Oceanic, g	80
Garod bakelite set, g	45
WE microphone/speaker, g	15
Crosley Model 6, g	110
Oldsmobile car radio, g	5
Little John novelty radio, e	12
Radiola UZ 1325 horn, f	42
GE AC/DC table radio, g	35
Music Cave table radio, g	33
Crosley Duet, restored, g	75
Majestic Treasure Chest, novelty radio, g	150
Telegraph keys, f, (3)	24
Delco R-12 radio, f	10
Lab-type spark coil, g	11
Magnavox small horn, no base	10
Tube rejuvenator for 01-As, g	32
Box of 10 meters	15
12 tipped light bulbs	30
1920s nickel hand-held radio	19
Philco alligator case radio, g	27
Cleartone new antenna tuner	30
Signal Corps HF signal generator	5

For VRPS membership information and a free sample newsletter, write to: VRPS, PO Box 165345, Irving, TX 75016.

(George Potter, 2069 Sienna Trail, Lewisville, TX 75067)

AUCTION REPORTS - COMMENTS BY THE EDITOR

Why do we publish so many auction reports? Since most of us do buy items for our collections, prices are always of interest. The problems with auction prices are numerous and are acknowledged, but they still are an important ingredient in determining the value of an item. Here are a few comments which apply to all auction reports in A.R.C.

Auction reports show that not all radios go for thousands or even hundreds of dollars! There is a lot of collecting out there of under \$100 sets.

Auction reports are not meant to be price

A warning: Auction prices are not current values. A listing such as this cannot adequately include the condition of cabinets, chassis, transformers, tubes, the operating status of the set, and the inclusion of incorrect, restored or replica components, etc. Auction prices are the result of the excitement of the auction process, the skill of the auctioneer and the specific interests of the participants. Nevertheless, auction prices serve as useful references and as another element in the value determining process.

guides (see the box on the left).

Auction prices are often lower than market. An observation by some is that many items placed in auctions were no-sales in the flea market, often because of defects. The best items often are sold privately or go fast in the flea market.

Auction prices often are above market. When two energetic bidders both refuse to give up, they often bid an item well over its going price.

The listings are "selected" since, because of limited space, all items cannot be listed. Items are often deleted if the description is not complete, for example no model number. Items in poor condition are often deleted because the degree of problem with these items is unknown; the low price these items usually bring would be misleading. We try to leave in representative items, however.

Auction reporting, as with all A.R.C. articles, is by the readers. So, if you attend an auction, send in the results ASAP. Always, send in the report in the order of the auction. Skipping items is OK, if you missed some, we can combine your information with other reports, as we often get multiple reports on the same auction. (Editor)



Olde Tyme Radio Services Directory

1989 A.R.C. Edition, Part 3

COMPILED BY ANDREW MOORADIAN, 5 PRISCILLA LANE, WINCHESTER, MA 01890

Antique Radio Classified has obtained permission from Andrew Mooradian to serialize the latest edition of his "Olde Tyme Radio Services Directory," with a few additions entered by A.R.C. Every month or so, another excerpt will be printed in A.R.C.

With the help of readers, Andrew hopes to make this directory the most comprehensive list of radio services available. Write to Andrew directly if you have a service you can provide, if you know of one that you can suggest, if you wish to change or delete your listing, or if you have any other suggestions. The 1989 Fourth Edition of his directory contains 69 service categories with 209 suppliers, plus a list of books and radio clubs (some suppliers appear in several categories). A copy of the directory can be obtained by sending \$2.50 to Andrew Mooradian at the above address. © 1988 Andrew Mooradian.

When writing to a service listed, please include a long SASE for reply and tell them that you saw their listing in the *Olde Tyme Radio Services Directory* in A.R.C.!

Within each category, the listings are alphabetical by two-letter state code.

MIRROR RESILVERING (CONTINUED):

Olympia Mirror Resilvering Co.
1609 Springwood Ave.
Olympia, WA 98506

MISCELLANEOUS ITEMS:

Gerald Schneider
8750 Georgia Ave. Suite 1410-B
Silver Spring, MD 20910
(301) 656-3840
(videotape on radio collecting)

Alan Jespersion
P.O. Box 17338
Minneapolis, MN 55417
(612) 727-2489
(Zenith logo tee shirt)

Tesla Electronics
835 Bricken Pl.
St. Louis, MO 63122

Michael Sabodish Sr.
11-A Matawan Ave.
Cliffwood, NJ 07221
(201) 566-1486
(tie clasps & lapel pins)

Dick Kaduce
940 Gilbert St.
Eau Claire, WI 54703
(715) 834-6020
(hats, shirts)

MUSEUMS:

(Since most museums are private, please contact the museums before visiting.)

Foothill College Museum
12345 El Monte Rd.
Los Alto Hills, CA 94022

Ralph Muchow
107 Center St.
Elgin, IL 60120
(312) 742-0183

Pavek Museum of Wonderful Wireless
3515-17 Raleigh Ave. S.
St. Louis Park, MN 55416

Antique Wireless Association Electronic
Communication Museum
Village Green, Routes 5 & 20
East Bloomfield, NY
(716) 657-6260

Voice of the Twenties Museum
Ralph Williams
Rt. 1, Box 44, Main Rd.
Orient, NY 11957

N.E. Wireless & Steam Museum
Tillinghast Rd.
E. Greenwich, RI 02818
(410) 894-1710

NAMEPLATES:

G & M Design Service
P.O. Box 23730
Jacksonville, FL 32241

PARTS/RESTORATION SUPPLIES:

Antique Electronic Supply
688 W. 1st St.
Tempe, AZ 85281
(602) 894-9503

Circuit Specialists
P.O. Box 3047
Scottsdale, AZ 85257
(602) 966-0764
(capacitors, resistors, etc.)

Sue Coulter
4200 Prince St.
Bakersfield, CA 93301

Stan Lopes
1201-74 Monument Blvd.
Concord, CA 94520

Yeary Communications
12922 Harbor #800A
Garden Grove, CA 92640

Norman Braithwaite
PO Box 2443
Redding, CA 96099
(916) 246-4209
(E.H. Scott parts only)

Gilbert Smith
248 So. 36th St.
San Diego, CA 92113
(619) 233-8646
(AC parts only)

E&E Enterprises
954 Johnston Dr.
Aurora, IL 60506

Steinmetz Electronics
317 Pulaski Rd.
Calumet City, IL 60409
(219) 931-9316

C. Elmer Nelson
11 S. Church St.
Princeton, IL 61356

Vintage Radio & Electronics
1414 17th St.
Rockford, IL 61104

Midwest Supply Electronics
1165 Lafayette Ave.
Terre Haute, IN 47804
(812) 232-0187

Artell-Guy Co.
Accessories & Parts Div.
P.O. Box 52645
New Orleans, LA 70152-52645

Tyger Electronics
P.O. Box 750
Clinton, MD 20735
(301) 248-7302

Olde Tyme Radio Co.
Howard Granoff
2445 Lyttonsville Rd.
Silver Spring, MD 20910
(301) 585-8776

Mark Oppat
167 Caster
Plymouth, MI 48170
(special volume controls)

Jim Farago
P.O. Box 6313
Minneapolis, MN 55406
(612) 722-0708

Craig J. Larson
2122 45th Ave. NE
Minneapolis, MN 55421

Frank Krantz
100 Osage Ave.
Somerdale, NJ 08083
(609) 783-0400

Edlie Electronics
2700 Hempstead Turnpike
Levittown, L.I., NY 11756
(516) 735-3330

Vintage TV & Radio
3552 West 105 St.
Cleveland, OH 44111
(216) 671-6712

Gary Schneider
9511 Sunrise Blvd. #J-23
No. Royalton, OH 44133
(battery set parts)

Pan American Electronics
814 Houston St.
Laredo, TX 78040

Don Diers
4276-ADI North 50th St.
Milwaukee, WI 53216-1313

Fala Electronics
PO Box 1376
Milwaukee, WI 53201
(tubes only)

PHILCO CONDENSER KITS:

Fred Geer
6042 Brookridge Rd.
Jacksonville, FL 32210

PHILCO TUNING DIALS:

Antique Radio Restorations
635 S. Lincoln Ave.
O'Fallon, IL 62269

Tesla Electronics
835 Bricken Pl.
St. Louis, MO 63122

PHONO NEEDLES & CARTRIDGES:

J. J. Papovich
53 Magnolia Ave.
Pitman, NJ 08071
(609) 582-8279

PLASTIC CASTING SUPPLIES:

Castolite Co.
Woodstock, IL 60098
(815) 338-4670 CST

POWER TRANSFORMERS:

Sue Coulter
4200 Prince St.
Bakersfield, CA 93301

Tesla Electronics
835 Bricken Pl.
St. Louis, MO 63122

Vintage TV & Radio
3552 West 105 St.
Cleveland, OH 44111
(216) 671-6712

PUBLICATIONS:

Radio Age
636 Cambridge Rd.
Augusta, GA 30909

Antique Radio Classified
PO Box 2
Carlisle, MA 01741

Sight-Sound-Style
P.O. Box 2224
So. Hackensack, NJ 07606

Puetts Antique Radio Topics
P.O. Box 28572
Dallas, TX 75228

(To Be Continued)



PHOTO REVIEW



This column presents in pictorial form many of the more unusual radios, speakers, tubes, advertising, and other radio-related items (covering the years 1900-1950's) from our readers' collections. The photos are meant to help increase awareness of what's available in the radio collecting hobby. Send in any size photos from your collection. Photos must be sharp in detail, contain a single item, and preferably have a light-colored background. A short description must be included with each submitted item. Please note that receipt of photos is not acknowledged, publishing is not guaranteed, and photos are not returned.

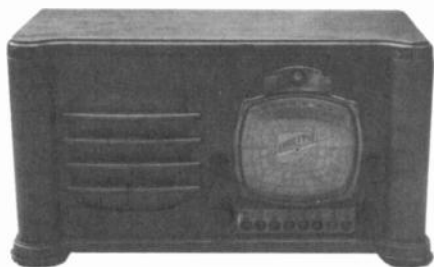

TRUETONE MODEL D-727 - Detrola made this set for Western Auto. It has 9 tubes and 3 bands, with motorized tuning. The colorful dial is backlit. (John Neuman - San Marcos, CA)



CLINTON RADIO MFG. - This all metal radio has a light green wood grain front and top and black sides. It was manufactured in Chicago, Illinois, ca. 1936. The BC/SW dial has several different colors. The radio features 6 tubes, with the speaker mounted in the top. (Jimmy Downes - Covington, LA)



BLUE BIRD - This tube set of the early 20's was manufactured by the Automatic Radio Company of Boston. It has bakelite paneling and is in a leatherette-covered wood case. The TRF design has no regeneration. Note the bluebird on panel. (Walter V. Worth - Wollaston, MA)

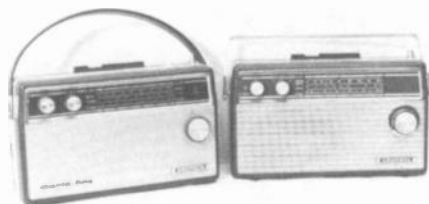

TWO GERMAN GRUNDIG TRANSISTOR PORTABLES WITH SAME CHASSIS - These are 4-band sets with excellent tone and volume, at a time (1958) when U.S. sets were weak and scratchy. The push buttons are used for bandswitching. (Walter V. Worth - Wollaston, MA)

PHOTO REVIEW



RCA 721 TS - This TV uses about the same chassis as the 621 TS except that it employs a 10-inch CRT. Manufactured in 1947, the 721 TS retailed for \$325 plus installation charges. Despite its expense, it was still a success in the marketplace. This stylish TV should not be very difficult to find in the northeastern U.S., or California. Let's see more TVs! (*Nat Pendleton - Washington, DC*)



RCA 621 TS - The picture is great, but small! Designed in 1941 by John Vassos, this noteworthy TV was actually manufactured in the fall of 1946 for 45 days. At a retail price of \$250 plus installation (NY Times advertisement), it was quickly overshadowed by the famous 10-inch RCA 630 TS. This is the only TV using a 7-inch electro-magnetic deflection CRT. Interestingly, all TVs before mid-1948 have channel 1. (*Nat Pendleton - Washington, DC*)

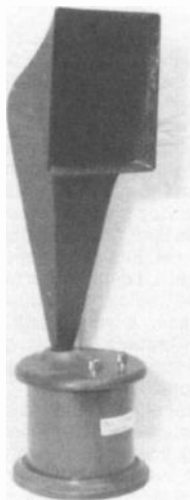

TRINITY RADIO COMPANY OF BOSTON, MA - This is a 1925 short square horn speaker painted maroon crackle. The driver in the base has been replaced with a 3" PM speaker. (*Walter V. Worth - Wollaston, MA*)

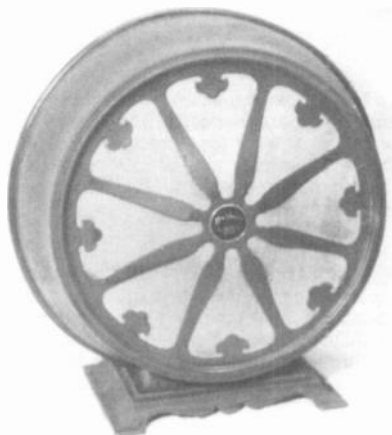

BALDWIN "99" HORN SPEAKER IN AN ALUMINUM DRUM - This speaker has a coiled up horn of 38 inches in length, made of plaster and fabric. It was originally cloth, but the case has been refinished in A.K. wrinkle brown paint. There is very good tone from this 1925 speaker. (*Walter V. Worth - Wollaston, MA*)

CORRESPONDENCE

At the end of an article a few months ago, I suggested that we get our children interested in some aspect of old radios. Well, here are two readers who are starting their kids out young! (Editor)

Dear Editor,

In response to your challenge to interest sons or daughters:

Two of our children, ages five and four, love our their radios. We find them an old, worthless chassis and give them screwdrivers and wire cutters, and away they go. They sit for hours. We are teaching the five-year-old how to solder already. If they see an old radio at a garage sale or Goodwill, they are sure to point it out to us. Hopefully, their interest will stay so we have someone to pass these radios down to, years to come. (Don't worry. We watch them closely so they don't "scrap" the wrong things!)

Jerry & Debbie Schliepp, Ripon, Wisconsin

Dear Editor,

My son Todd is now three years old. One day while Todd was sleeping I removed a tuner from a home brew set that I had built. A few days later Todd happened to look at the set and knew something was wrong. He picked up a screwdriver, stuck it in the set, and said, "Fix it." This coming from someone who up to that time had never seen me work on a radio!

Dennis Hilberg, Decorah, Iowa

I often get telephone calls from collectors, both novice and experienced, who simply want information or want to contact other collectors with interests similar to theirs. Of course, I may be biased, but I suggest an A.R.C. ad; they really work! (Editor)

Dear Editor,

In the February 1989 issue of A.R.C., I requested help in the form of a sketch, for restoring the shock mounting on a Westinghouse RC (RADA) 3-tube socket panel.

Shortly thereafter I received the information from a young college student in New Jersey, and his help was greatly appreciated.

Within a week another large envelope arrived from the opposite end of the nation in Grass Valley, California. This man was a retired engineer who had worked a number of years for Westinghouse.

The combined data volunteered by these two men amounted to what could pass for factory assembly drawings, which assured completion of my restoration project to its original configuration.

It is this kind of spirit and response we should all practice to help keep our hobby viable and exciting. Thank you Henry and Bob.

William H. Stuber, Woodward, Iowa

Heathkit Manuals:

Dear Editor:

I frequently see ads in your publication from someone looking for copies of Heathkit owners manuals. I have found that these copies can be ordered directly from Heathkit Parts Department. They charge 10¢ per page which I think is a fair price. The address is: Heath Company, Benton Harbor, Michigan 49022. They always answer inquiries promptly and advise the number of pages and the price and postage.

Vic Marett, Miami, Florida

Never give up! (Editor)

Dear Editor,

Maybe you will have interest in this story. It is a true story; it happened to me.

One afternoon I was looking out the window. I saw this cathedral radio on the back of a truck heading toward the dump. After getting permission to look at the dump, I went down about an hour later. It wasn't there. I figured someone else beat me to it. It looked to be a beauty, with all the chrome and knobs and its size and shape. The find of a lifetime! After driving around for an hour and a half, checking all possible places it could have ended up, I came home emptyhanded and heartbroken.

After all the worry and stress, I decided to go to a town twenty miles away and take care of some business, to get my mind off it. After getting halfway there, I spotted that ever elusive cathedral radio in that truck going in the opposite direction! I turned around at the nearest, safest place. Not wanting to go much faster than 65 or 70 to catch up, I had to gain on him slowly. I finally caught up at a stop sign four blocks from where I live, nine miles later. There, I got the best look at the cathedral yet. Figuring on stopping the gentleman that had it, I decided not to after that look. To my surprise and disappointment, I didn't want that piece of junk! It was an old, rusty cathedral welder!! The chrome setting dial still shone brightly in the sun; the five black jacks and on/off switch still shone shiny black!

This is a true story. It goes to show that if you look hard enough and long enough, you'll find what you think you want or have to have. Every now and then, we'll see our ever elusive cathedral go by and laugh. We haven't given up; our find of a lifetime still waits for us. And we will find it!

I hope you enjoyed our true story. It makes us laugh every time we think of it. It may be odd, but I suppose these things happen. This is not a fictional story, but I do think it may bring some laughs. As you say, we can all use a good laugh now and then. Keep it up!!

Jerry & Debbie Schliepp, Ripon, Wisconsin



WANTED: Manual for Knight RF generator. Rider manual #147 "How to Use Signal and Sweep Generators." Will pay for original or good copy. Bob Crawford, PO Box 685, Troy, MI 48099

FOR SALE: Tube checker (old, new tubes), pocket size, unused with instruction manual, quantity avail. - \$8.50 ea. ppd. Large surplus electronics catalog - \$1. D. Testa, PO Box 9064, ARC, Newark, NJ 07104

WANTED: Pocket-sized transistor radios. Early Japanese type. Send close up photo, Xerox image, or rough sketch with price to: Roger Handy, PO Box 24527, Los Angeles, CA 90024. (213) 451-4040

WANTED: Broadcast microphones, equipment, literature, transcriptions, blank disks, speakers. Elaborate table/console radios. Jukeboxes. Robert Van Dyke, 2 Squires Ave., East Quogue, NY 11942. (516) 728-1327

FOR SALE: All sorts of odds and ends from the past. Send SASE for list. T. Walker, N2GIG, 19 Woodside Ave., Westport, CT 06880

WANTED: John Trowbridge's juvenile fiction book, The Story of a Wireless Boy. Robert Stapleford, 1800 Randolph, Topeka, KS 66604

FOR SALE: Send 45¢ stamps for next NFWA club publication. Classifieds, meets, other info included. Niagara Frontier Wireless Assn., 440 69th St., Niagara Falls, NY 14304

WANTED: Brass dial bezel for Zenith 6S-222. Dial glass w/numbers for Zenith 12-A58 (chassis 1202). Plastic dial panels for Philco Models 41-250/255/280/290, 42-355/380/390. Dave Montgomery, 13500 Pacific Hwy. S, Seattle, WA 98168. (206) 243-6419

FOR SALE: Collins Military Surplus is joined with Mil-Spec Communications. The best in surplus. Paul Zecchino, PO Box 461, Wakefield, RI 02880

WANTED: Crosley V, early model marked. Crosley Type V, Cincinnati on front panel. Ronnie Kaczmar, 5747 Williamson, Dearborn, MI 48126

FOR SALE: Good used tubes - 75¢ ea. plus shipping. Motorola 55X11A. GE P-807JAM radio. Joseph Zambri, RD4, Box 216, Towanda, PA 18848. (717) 265-4825

WANTED: Browning amplifier for a Browning Golden Eagle Mark III, CB radio. Mike Manter, 5782 N, 4th, Fresno, CA 93710. (209) 432-5176

WANTED: Cash for Western Electric (WECO) 518W horn, 2A current supply set, old boxed 100 and 200 series WECO tubes, WECO amplifiers, receivers from the 1920's. Send price and details. Thanks. Nick Tonkin, 6610 NW Dogwood Dr., Vancouver, WA 98663. (206) 696-2501, eves.

FOR SALE: Power transformers PRI. 117v, sec. 125v 15 MA, 6.3v 0.6 amp Stancor boxed - \$6 plus UPS. Art Albion, 440 69th St., Niagara Falls, NY 14304

WANTED: Hallicrafters "silver panel" Skyriders, Super Skyriders; other very old, unusual, novelty items, parts, memorabilia, etc. of the Hallicrafters Co. Also needed is the entire 1934 H and Z line of Silver-Marshall radios and parts. Chuck Dachis, WD5EOG, The Hallicrafter Collector, 4500 Russell Dr., Austin, TX 78745

.....
SELLERS ... PLEASE NOTE
A.R.C. ADVERTISING POLICY...
 • ALL ITEMS MUST BE DESCRIBED FAIRLY.
 • REPRODUCTIONS, REPRINTS AND NOT-
 • ORIGINAL ITEMS MUST BE SO IDENTIFIED.
 • ADVERTISERS AGREE TO RESPOND
 • PROMPTLY TO INQUIRIES AND ORDERS.
 • AND TO RESOLVE PROBLEMS PROMPTLY
 • IF THE BUYER IS NOT SATISFIED.
 •

WANTED: Mechanical TV's. Pre-WWII electronic TV's. Kit TV's 1945-1948. Midwest radios. Bernard Sampson, 2905 Rusk, Houston, TX 77003. (713) 228-6741

FOR SALE: Hook up wire, cloth covered or rayon covered. 20 AWG stranded tuned. 100 ft. - \$5 plus \$1.50 postage. 200 ft. - \$9.50 plus \$2 postage. SASE for sample. Gerald Cromer, K4NHN, 1014 Summerland Dr., Cayce, SC 29033

WANTED: Crystal set collection now at 135 pieces, looking for more sets. Erwin Macho, Ambrosweg 17/A/8, A-1230, Vienna, Austria

FOR SALE: Moving to retirement home. Large collection of ham gear, electronics and parts from the 30's. Please write for list. Allen Sherk, ex W1MBF, 17 Island View Ave., Branford, CT 06405

WANTED: Crosley 124 chassis with or without speaker for Playtime grandfather clock radio, junker considered; knob for Radiola 16. Will trade battery or AC radios, tubes, test equipment and/cr cash. Dan King, 1230-B Juniper St., Gilroy, CA 95020. (408) 847-1345

CLASSIFIED ADVERTISEMENTS

WANTED: WWII military radios, accessories, DM43 and Art 13 dynamotor supplies, 16 mm documentary films, manuals. Charles Dicecca, KA1GON, 501 Mystic Valley Pkwy., Medford, MA 02155. (617) 396-9354

FOR SALE: TS900 Kenwood P/S and speaker 80-10 meters - \$450, you ship. Arnold Price, 35 Hillview Rd., Monocacy Station, PA 19542. (215) 385-3343

WANTED: Hallicrafters Skyriider, SX73, SX88, TW-1000, SX111, SX115. Bob Mattson, KC2LK, 10 Jane Wood Rd., Highland, NY 12528. (914) 432-4854, days

SEND ALL A.R.C. MAIL TO
Antique Radio Classified
P.O. Box 2, Carlisle, MA 01741

WANTED: Fender, Gibson, Gretsch, amplifiers, electric guitars. Top dollar paid. Photo helpful. Brock, PO Box 751, Cheyenne, WY 82003. (307) 634-5638

FOR SALE: Victor floor model phonograph, ca. 1926; double sided, one for phono, one for radio of choice - \$150. Timothy E. Westman, RD#2, PO Box 275, Woodsville, NH 03785. (603) 747-3758

WANTED: RCA CT-100 or CTC-5 color TV, any condition OK but please a good CRT. Also 1" and 2" oscilloscopes. WE 600A microphone in the brass ID case. WE condenser, microphones also. Al Weiner, Monticello, ME 04760. (207) 538-9538

CLASSIFIED ADVERTISEMENTS

FOR SALE: Radio Electronics 1948 thru 1967 not complete. QST full years 1929 thru 1959 not complete. Radio random issues 1934 thru 1944, CQ full years 1950 thru 1962, random issues 1946 thru 1976, DX, RTTY, GE, RCA, PF Index, more. Call books, books. Please make offers. 45¢ SASE for list. Mrs. A. R. Marcy, 461 Third Ave., Satellite Beach, FL 32937

WANTED: Schematic/literature for Precision B12 power supply & Simpson 315 sig. gen. Harry Pewowaruk, 1535 N. 8th Ave., Saint Cloud, MN 56303

FOR TRADE: Garod Commander Model 6AU-1 Catalin, maroon/butterscotch trim, handle and knobs, plays, (R.T.G.A., p. 58 upper rt.), good decal, mint. For Addison Model A2A (R.T.G.A., p. 50-51). Jimmy Downes, 607 East 12th Ave., Covington, LA 70433. (504) 893-7057

HELP: National NTE. Majestic Super B. All American Constant B. Need schematics, instruction manuals. Tracy Sands, 2166 W. Broadway, #119, Anaheim, CA 92804-2446. (714) 525-5223

WANTED: Zenith collectors? Ever see a rare 6D815-D? I have one. White with yellow swirls, chrome front, excellent, very unusual! \$135 ppd. George Friedrich, 7162 Jacqueline, Custer, WI 54423. (715) 592-4901

FOR TRADE: DeForest DV type tubes for AK factory advertising items, breadboard parts, boxes, etc. Raymond Thompson, 7422 Cherry Tree Dr., Fulton, MD 20759. (301) 490-4448



PUETT ELECTRONICS
P.O. BOX 28572 DALLAS TX 75228



GET THIS
WORLD'S GREATEST
RADIO CATALOG



CATALOG NO. 77

THE ANTIQUE RADIO CATALOG

HOW TO ORDER

WE ACCEPT CHECKS, MONEY ORDER, OR VISA/MASTERCARD/PLUS CREDIT CARD CUSTOMERS PLEASE STATE NAME ON CARD, COMPLETE CARD NUMBER AND EXPIRATION DATE. ALL ITEMS ARE SHIPPED POSTPAID AND INSURED WITHIN THE U.S. AT AN EXTRA CHARGE, BUT PLEASE ADD \$2.00 SHIPPING WITH EACH ORDER. MINIMUM ORDER \$10.00. YEARS RESIDENTS ONLY. ADD STATE SALES TAX AT THE PROPER RATE IN YOUR LOCALITY. INTERNATIONAL CUSTOMERS: SEE CATALOG ENSEY PAGE FOR INTERNATIONAL ORDERS. GUARANTEE: ALL ITEMS ORDERED IN OUR CATALOG ARE GUARANTEED TO MEET YOUR SATISFACTION OR THEY MAY BE RETURNED WITHIN 30 DAYS FOR EXCHANGE OR CREDIT.

IN A HURRY? PHONE: (214) 351-8927 OR 507-8720

1900 P. OR. OR. TO 10:00 PM CENTRAL, 24 HOURS A DAY

WE ARE IN AND OUT BUT SHIP OUT FOR LONG PERIODS. 10-15 DAY DELIVERY TIMES!

\$2.00 POSTPAID

OUR PAST CATALOGS ARE OBSOLETE. A \$3.00 DISCOUNT COUPON WILL BE SENT WITH YOUR NEW CATALOG 77!!

WE HAVE MORE THAN 1,400 DIFFERENT ANTIQUE RADIO PUBLICATIONS, BOOKS, INSTRUMENT MANUALS, SERVICE DATA, SALES BROCHURES, RIDER INDEXES, HUNDREDS OF TYPES OF ANTIQUE RADIO TUBES, CLASSIC RADIO LITERATURE, SCHEMATIC DIAGRAMS ON NEARLY ANY SET, DIRECTORY OF ANTIQUE RADIO SERVICES, AK FACTORY MANUALS, OLD TIME RADIO PROGRAMS ON CASSETTES, THE ENCYCLOPEDIA OF ANTIQUE RADIO, THE ANTIQUE RADIO RESTORATION HANDBOOK, ANTIQUE RADIO TOPICS, CLASSIC RADIO COLLECTORS HANDBOOK, ETC.!!!



CLASSIFIED ADVERTISEMENTS

FOR TRADE: WD-11 bakelite tubes for AK factory literature and advertising items. Raymond Thompson, 7422 Cherry Tree Dr., Fulton, MD 20759. (301) 490-4448

WANTED: 1950-1956 high-end FM mono tuners. Specs and price first letter. David Collins, 115 Chestnut St., Medina, NY 14103

FOR SALE: Readrite 550 service test oscillator (SX230 tube) - \$30. Beitman 39, 47, 48 - \$5. Evan Haydon, 4308 N. 15, Lincoln, NE 68521. (402) 435-4083

WANTED: Marantz tube gear, Tannoy, Electro-voice, and other vintage audio equipment. I will not be outbid on clean items, so call me last! Ed Schneck, N.Y.S.I., 1401 Ocean Ave., Brooklyn, NY 11230. (718) 377-7282

WANTED: Small knob for Philco 86 Neutrodyne Deluxe lowboy (Vintage, p. 186). Mike Koste, 57 Tennis Ave., Ambler, PA 19002. (215) 646-6488, after 6 pm

WANTED: Aeriola Jr. Radiola 17. Regency TR-1, Bulova 250 transistors. Complete, original, excellent condition. Baxter, 1133 South Clinton Ave., Rochester, NY 14620. (716) 473-5322

FOR SALE: Zenith collectors please note. 12-page Xerox copy booklet, Operating Instructions and Station Log for Zenith chassis 1203 receiver 1937, - \$2.75 ppd. Donald J. Sochurek, W191, S7500, Richdorf Dr., Muskego, WI 53150. (414) 679-0212

CLASSIFIED ADVERTISEMENTS

FOR SALE: Tubes, new and used - from \$1 up. Send SASE for list. Henry Nessler, 136-26 61 R., Flushing, NY 11367

**RENEW NOW
AND SAVE TWO WAYS!**

1. SAVE \$: Rates go up August 1. If your subscription expires within the next twelve months, extend your subscription now for up to two years at the current rates.

2. BONUS ISSUE: If you renew before the end of the month shown on your mailing label (your expiration month), you will receive an extra month on your subscription: 13 months instead of 12; 26 months instead of 24 on a 2-year renewal.

FOR TRADE: Trade scarce radios for unusual typewriters. Type 33 or 233 (four pins) tubes wanted. Peter Frei, PO Box 500, Brimfield, MA 01010. (800) 942-8968

WANTED: RCA 9K or 9K-2 chassis for parts, specifically need the frequency dial. Tom Farland, NOJMY, 10501 Hawks Haven Rd., Cedar Rapids, IA 52402. (319) 393-3209

HELP: Need info on an Armoozi set made in France. Runs on European 220v; is there a way of running it here? Larry Schiebel, 5834 Balsam Rd. #3, Madison WI 53711. (608) 276-7768

WANTED: Original A.C. Dayton XL5 3:1 audio interstage transformer in good/working condition. Bart Rydzynski, 2608 Millie St., Metairie, LA 70003. (504) 888-4616

LARGE COLLECTION AVAILABLE MUST GO AS ONE LOT

(Donation of the collection to a museum would be considered)

240 Sets - 45 Speakers - 40 Headsets - Magazines - Tubes - Parts - etc.

Speakers: AK, Peerless, Atlas, WE, Crosley, RCA, Thorola, Burns & more...

Sets: Airline (10), Amrad, Apex, AK (23 including a Model 5), Brandes, Best, Coca Cola Cooler Radios (2), Crosley (16 including pups, 51A), Crystal Sets (Federal Jr., FADA, Pandora, Home & more), FADA, Globe, Grebe, Hammarlund, Hopalong Cassidy, Kennedy, Operadiola, Philco (15 including cathedrals), RCA (16), Scott Console Special, Zenith (24), Dumont RA-346 & more...

The above is a selection from a 6-year-old inventory list; a comprehensive inventory will be available before the collection is disposed of.

If Interested, Individuals and Museums Should Contact:

Myron B. Peterson
71 Oak Avenue, Belmont, MA 02178
(617) 489-0667

CLASSIFIED ADVERTISEMENTS

FOR SALE: DeForest F-5 - \$185. National NC183D - \$175. Philco 19 - \$195. Zenith 8D525, celluloid handle, wood case, nice - \$145. Zenith 7G605 - \$165. Hallicrafters TW1000 - \$165. McMurdo-Silver 800 HF rcvr. - \$75. Pilot 3" TV - \$275. Stromberg-Carlson projection TV - \$450. Home brew 1" scope - \$85. Small Meteor cathedral - \$175. GE floor model with clock - \$200. **WANTED:** Cabinet for Federal 59 and Grøbe CR-13 (or dimensions). SASE please. Pics - \$1 ea. Joe Szabat, 1019 Hiland Ave., Coraopolis, PA 15108. (412) 264-7498

CLASSIFIED AD DEADLINES

Jun. 10 for Jul. 1989 Issue

Jul. 10 for Aug. 1989 Issue

Aug. 10 for Sep. 1989 Issue

WANTED: HT32B, will pay fair price or can trade R4B or AK46. David Sackett, Rt. 6 Box 233B. Darlington, SC 29532. (803) 395-0414

FOR TRADE: HRO 60 coils (no rcvr.) A, B, C, D, E, G & AC for your Philco 90 or 70. A. Bruno, 24 Butternut Dr., New City, NY 10956. (914) 354-8899

WANTED: SE1414 receiver. SE 1370, 1380, 1390 transmitter. Other 1917-1922 Navy airborne. Also 1917-1942 Signal Corps airborne. Correspondence on military radio collecting welcome - let's trade notes! **FOR SALE:** Still have some SCR-68 mics - see April A.R.C., p. 23. August J. Link, 2215 Faraday Ave., Ste. A, Carlsbad, CA 92008. (619) 438-4420, days

CLASSIFIED ADVERTISEMENTS

WANTED: Paper-based recording tape Scotch #101 on 7-inch metal reels. Hallicrafters S-29/R-80 Sky Traveler. Zenith 7G605 first Trans-Oceanic. **FOR SALE:** Magnecord PT7 HT switch - \$25; PT6 D3 mixer/amp - \$50. Robert Perlestein, 17 Vine St., Medford, MA 02155. (617) 391-3026

WANTED: Dead S-38A and HQ-100 for parts. James E. Inglett, Route 1 Box 206, Midway, AR 72651. (501) 431-8430

FOR SALE: Zenith Trans-Oceanic Royal 3000-1, near mint with log book - \$130. **WANTED:** Tuning knob or junker for Roland 66 transistor radio. Harald Herp, 6615 Michele Ct., Huntingtown, MD 20639. (301) 855-7071

WANTED: Transistors. Mike Kaplan, 1438 S. Broadway, Denver, CO 80210. (303) 266-3406

MESSAGE: Free: Send 2-stamp LSASE for just released Flyer, No. 189A to: Olde Tyme Radio Co., 2445 Lyttonville Rd., Silver Spring, MD 20910

FOR SALE: Peter Pan with all new tubes, plays, outside antenna required, nice but not restored - make offer. Will accept small early battery sets in trade. Julian Young, 11 Willow Ct., Totowa, NJ 07512. (201) 256-1342

WANTED: Atwater Kent 32 in good condition. Cabinets for GE K-80 and Zenith 860/861 tombstones. Need steel chassis, black wrinkle finish, 5x10x3 in. Lloyd Zimmerman, 8448 No. Harding Ave., Skokie, IL 60076

Radio Addict

NEEDS MORE 40's, 50's, 60's COLORFUL PLASTICS.

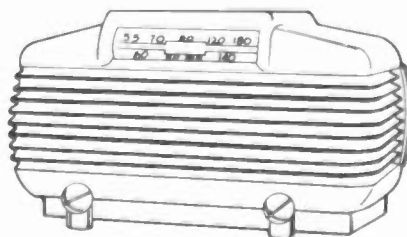

MOSTLY BUY, SOME TRADE, NEVER SELL.

LES WAGENHEIM
c/o LEADWORKS INC.
32400 AURORA RD.
SOLON, OH 44139
1-800-321-2863 EXT. 200
OHIO 216-349-5000

CLASSIFIED ADVERTISEMENTS

WANTED: Dial escutcheon for Stewart-Warner Model 715. Same part as on the Model 520 illustrated on page 30 of Puetts Encyclopedia of Antique Radio, Volume 1. Jim Peters, 983 Chapel Ct. South, Glen Ellyn, IL 60137

FOR SALE: Crosley AC power converter, for use with Band Box receiver Mod. 602-702 - \$40. Telefunken Opus 6 - \$55. QST mags. 1928, 29, 30, 31, 32, 33 37, 40, 41, 42; all in binders, excellent cond. - \$15 to \$20 per yr. or \$120 for all, plus postage. Rare, never used still in the original box & wrapper, a DeForest spherical audion bulb single wing - \$500. Several hundred electron tubes for sale - GE, Sylvania, RCA; new in box, sizes range from 37 CN to 17 J28[?], too many to list - \$1.25-\$2.50 ea., or so much a dozen.

WANTED: To buy: Coca Cola cooler radio. Postage & ins. extra. Ralph D. Howard, 1 Church St., Dansville, NY 14437. (716) 335-8746

WANTED: Remler Scottie radios including Pup/Junior plus Remler literature. Emerson 540 (F.O.S., p. 83) in red or green. Steve Neal, 3472 Stancrest Dr., Glendale, CA 91208. (818) 248-3169

FOR SALE/TRADE: Novelty transistors. Send LSASE for list. Still looking for unusual transistors we don't have. Lee and Carolyn Bruton, 1202 So. Pratt Parkway, Longmont, CO 80501. (303) 651-0254

WANTED: Remote control for RCA 816-K. Ken Rood, 87 Birnamwood Dr., Burnsville, MN 55337. (612) 890-3376

CLASSIFIED ADVERTISEMENTS

WANTED: Test equipment in good condition. Send complete description and price. Jeff Brandon, 1244 Old Highway 51 North, Hernando, MS 38632

FOR SALE: Trophy baseball radio, excellent condition - \$700 or best offer. Tin church music box from 1890's, mint condition - \$500 or best offer. Must sell immediately. Ken Brekke, 4167 S. 1st St., Milwaukee, WI 53207. (414) 483-4893

WANTED: Small clock knob (prefer black) for Crosley clock radio. See picture March A.R.C., p. 12. Michael Zentman, PO Box 212, Centerport, NY 11721

WANTED: Oscillator coil #04408 for Philco Model 91, or salvageable chassis. Ed Kreutter, Colonial Manor, B-3, Watertown, NY 13601. (315) 785-9161

WANTED: Zenith Trans-Oceanic radios, prefer tube type, must be reasonably priced, private collector. Thank you. Phil Van Praag, ON329 Willow Rd., Wheaton, IL 60187. (312) 665-5354

FOR SALE: Pre-WWII, 2 1/2 meter Abbot transmitter-receiver Model TR-4 - \$22. National illuminated calibration dial ICN, original box - \$8. RCA transistor Model TX1 - \$15. Joe Duffin, 4 West Central Ave., Moorestown, NJ 08057

WANTED: Hollywood Radio and Television Institute's course lessons or any publications, kits. Bob Ali, 710B Highpoint, Waterloo, Ontario, Canada N2V 1G9

New Wireless Pioneers Books, Magazines, Literature Bought and Sold

New Wireless Pioneers buys and sells books, catalogs, magazines and other literature from the 1800's to 1950 that deal with early radio, wireless and electricity. A selection from our list of specialties:

Pre-1900 Electricity
Pre-1925 Radio or Wireless
Pre-1950 Computers

Pre-1900 Telegraphy
Pre-1940 Television
Early X-Ray

Magazines, catalogs, autographs or ephemera related to the above topics. Also: Pre-1900 Wireless and Telegraph Apparatus - Radio-Related Novelties and Advertising - Early Vacuum Tubes and Electrical Devices.

Some items available in other technical subject areas also.

Several catalogs featuring items for sale are published each year.

New Wireless Pioneers - Jim & Felicia Kreuzer
P.O. Box 398, Elma, NY 14059
(716) 681-3186

CLASSIFIED ADVERTISEMENTS

FOR SALE: N.I.B. OB3 tubes - \$1 ea., \$10/12, \$50/100. Jim & Nadiene Farago, PO Box 6313, Minneapolis, MN 55406. (612) 722-0708

HELP: Collector needs manufacturer and technical information for 1928 model Allectric Neuro-wound. Can you help? Charles Combs, 508 E. Daniel, Albany, MO 64402. (816) 726-3038

WANTED: Hallicrafters SX-23, perf. w/spkr., good cond. please. Catalogs 40's, 50's. Ed Turner, 3536 Arden Blvd., Youngstown, OH 44511. (216) 782-6757

**HAVE YOU MOVED? ARE YOU MOVING?
PLEASE NOTIFY US A.S.A.P.
SEND US YOUR...
OLD ADDRESS
NEW ADDRESS and
SUB #
MANY THANKS!!!!!**

FOR SALE: Midwest #162 - \$25. Hallicrafters S-120 - \$60. Genral Super DX Multiwaveset, 1934 - \$50. Globe tops! Call or write for list. Jack Smith, 288 Winter St., N. Andover, MA 01845. (508) 686-7250

WANTED: Capehart Series H extended control box, also Capehart sales brochures and info. Bill G. Davis, 800 Rosemount Rd., Oakland, CA 94610. (415) 834-5708

HELP: Need schematic & tech. info for R-392. James A. Weil, 15915 Armada Ctr. Rd., Romeo, MI 48065

CLASSIFIED ADVERTISEMENTS

WANTED: Any or all equipment and literature on Thomas P. Giblin and the Standard Radio and Electric Company of Pawtucket, R. I. Also information on the first transatlantic flight by the Navy NC-4 in 1919 for which Giblin designed coils. Leonard J. Arzoomanian, 61 Columbus Ave., North Providence, RI 02911. (401) 232-0869

FOR SALE: Older Bally 3-reel slot machine - \$800. 75A4 - \$400. KWSI - \$8. All fine shape. Frank Anderson, 3801 Fifth Ave. So., Great Falls, MT 59405

WANTED: Schematic, plug-in coils for Collins 32RA and 32G. Also, pre-WWII amateur equipment. Parker, 87 Cove Rd., Lyme, CT 06371. (203) 434-7783

FOR SALE: 900+ receiving tubes, new in OB, from 0A3 to 50L6 and industrial numbers. Specials: Foreign, WE and professional TV camera pickup (no transmitting). Lot purchase desired. Shipping paid. Buyers market assured. Inventory available. P. R. Dowie, Good Sound, 171 Drexel Ave., Lansdowne, PA 19050-1313. (215) 626-9322

WANTED: Good or dud audios for Radiola RC, two small knobs for Day-Fan OEM7. Dave McClellan, 1086 Trailridge Ln., Atlanta, GA 30338. (404) 399-6704

WANTED: Old or new novelty radios. I have several transistor novelties and radio-related novelties to trade. Cliff Watts, 51 Glendale Rd., Brantford, Ontario, Canada N3T 1P5

AUCTION

Western Manufacturing, Out of Business

Sat., June 3, 10AM; Sun., June 4, 12:30 PM

1400 West 22nd, Kearney, Nebraska

Auction includes: Various collectable vacuum tube radios of the 1940's and 50' by Minerva, Air Kiong, Automatic Radio Manufacturing, Tomboy, and Belmont. Most are brand new, some still in boxes. ° (3) Tom Thumb camera/radios by Automatic Radio Mfg. ° (3) Dewald E157 radios, circa 1940, new, in box. ° New crystal sets by Western Manufacturing sold under the name of Tiny Tone, Tiny Mite, and Ti-Nee. Approximately 100 new and operable. ° (4) Kraftone model 351 phonographs. ° Test equipment from the late 1930's, 40's and 50's from Hammerlund, National, Collins, Hewlett Packard, McCauley Silver and Collins. Some are new and still in boxes.

Small inventory includes: (40) Walkie Talkie Kits; (225) carbon ear phones; (36) micro switches; (50) shortwave radio adaptors; (50) shortwave radio kits; (60) trap antennas, 10-160 meter bands; (32) 1/25hp Redman motors; (32) 2 hp 24V 90A Diehl motors; (100) ea. new, RCA 1626, 3Q4, 1U4, and Raytheon 3A5 vacuum tubes; (20,000) 1/2 watt resistors, various values; (360) spools AWG 44 Formex magnet wire #34-#40; (20,000) disc capacitors, 5%, 10%, 20%, various values; (45) 55 watt soldering irons; (1,000) 3A 250V DPST switches; (10,000) iron cores, 1" x 1/4" to 1/4" x 5/8"; (288) RK211 transformers; (2,000) Philco T1504 transistors.

This is a very brief list of the items available. There are nearly 3,000 lines of items to be sold at auction. Complete catalog, \$3. Western Manufacturing was engaged primarily in the production and assemblage of radio-related equipment since the mid 1920's. The company manufactured for government contracts during WWII and conducted an extensive mail order business for nearly 60 years. Most items are old, new stock.

**Estate of Paul Beshore, Pres.
Western Manufacturing**

**FICKE & FICKE, The Auctioneers
777 Terminal Bldg. Lincoln, NE 68508
(402) 475-1141**

CLASSIFIED ADVERTISEMENTS

WANTED: Restorable 20's or 30's set tester: Jewell, Supreme, etc. Gordon Symonds, 26 Ossington Ave., Ottawa, Ontario, Canada K1S 3B4. (613) 232-2198

FOR SALE: Hallicrafters S-38B, vg, 4 bands, BFO, bandspread, works fine - \$50 + UPS. Bob Rathbone, RD#1, PO Box 127, Ossipee, NH 03864. (603) 539-2762

WANTED: Table sets with tiger maple cabinets. Deco chrome fronts. Majestic 463. RCA Mexican scene 40X-53. Barry Friedman, 22725 Garzota Dr., Valencia, CA 91355. (805) 296-2318

FOR SALE: Radiola AR812, new handle - \$110. Zenith A600 T.O., plays - \$50. Philco console 630, 3 band, plays - \$35. Graybar Radiola 60 cabinet only, with escutcheons - \$30. Knight Ocean Hopper - \$20. Zenith AM/FM, 8 tubes, 3 speakers, plays - \$30. Apex Super Six, 199 tubes in leatherette case - \$80. Eveready Model 11 chassis and panel only, plays - \$50. Crosley Tridyn 3R3 - \$65. Radiola UZ1325, good - \$60. SASE for list. All plus UPS. Walter Worth, 2W. Elm Ave., Wollaston, MA 02170. (617) 479-4512

WANTED: 1925 Montgomery Ward Airline radio catalog, good photocopy okay. Also Tri-City information. Dennis Hilberg, 804 Ravine St., Decorah, IA 52101

WANTED: Front tag and cabinet for a Western Electric 4B. Echophone S-3 escutcheon and chassis. Marc Ingenthron, 9748 Outlook, Overland Park, KS 66207. (913) 642-4767

CLASSIFIED ADVERTISEMENTS

WANTED: Knobs for Hoffman A-300 table radio, 13/16"W x 9/16"D. Need up to four. Steve Ehrat, 2196 Homestead Rd., Santa Clara, CA 95050

WANTED: Need good Hallicrafters R-46A spkr. Jim Inglett, Rt. 1, Box 206, Midway, AR 72651. (501) 431-8430

FOR SALE: Lots of prewar consoles, bakelites, and small woods. Chuck, PO Box 598, New Haven, WV 25265. (304) 882-2220

WANTED: For Trans-Oceanic 3000-1, top front lid and plastic battery holder. Jim F. Montague, 921 S. Cuba, Spokane, WA 99202

**IF YOUR EXPIRATION DATE IS
JUNE OR BEFORE, RENEW TODAY!
EARLY RENEWALS
RECEIVE AN EXTRA ISSUE!**

WANTED: Owner's instruction manual for Freed-Eisemann Model NR-7. Henry Rosenblatt, 603 Commonwealth Ave., Newton, MA 02159

FOR SALE: Nice Philco roundtop 80B. Zenith tombstone 6S128 (F.O.S., p. 191). Monroe battery set. Don Howland, 4621 W. Shawnee, Spokane, WA 99208. (509) 466-0939

WANTED: Collector would like to buy Atwater Kent sets. Must be complete with no modifications. Prefer original condition sets. Please state price and condition first letter. Will reply if able to meet terms. Charlie Walker, 12506 Minuteman, San Antonio TX 78233. (512) 656-3040

NEW FOR 1989!



- **DECALS** — Emerson, Zenith, Atwater Kent, and Stewart Warner
- **ELECTRONIC BALLAST** — Replace resistance cords, tubes, etc.
- **SOLID STATE VIBRATORS** — 6-12 volt, 3 and 4 pin for auto radios
- **WOOD KNOBS** — Late 20's style repro knobs with metal insert and set-screw
- **BROWN PLASTIC KNOBS** — N.O.S. brown knobs for 30's-40's radios
- **CLOTH COVERED WIRE** — Custom manufactured 20 AWG hookup wire in 5 colors
- **BOOKS** — 65 titles available, including all the latest

Write or call for new 24 page wholesale catalog.

ANTIQUE ELECTRONIC SUPPLY

688 W. First Street, Tempe, AZ 85281, Phone (602) 894-9503, FAX (602) 894-0124

CLASSIFIED ADVERTISEMENTS

WANTED: Progressive Radio Edu-Kit, Build 15 Radios at Home, ca. 1950, complete, any condition. Richard L. Evans, PO Box 491, Souderton, PA 18964. (215) 257-8906

FOR SALE: Rider Television Manuals 1-27 with index, RCA Television Service Manuals 1947-1960 with index—\$300/all or best offer, + postage. Steve Ulmer, Star Rt., Chatham, NY 12037. (518) 392-6834

WANTED: Schematic or manual for Precision Apparatus Model EV-20 VTVM, also H.F. probe RF-10A. Barry Fuerst, 218 Flournoy St., Oak Park, IL 60304-1511

FOR SALE: 5 volume set Applied Radio and Television by Coyne plus Television Servicing Cyclopedica, all in mint condition, 1953—\$25 plus shipping. Edward E. Martin, 8816 Ansonia Ave., Cleveland, OH 44144. (216) 661-9999

WANTED: The New England Antique Radio Club wants you! Don't miss our big Summer Swap & Sell Meet and Auction Saturday, July 22, Resurrection Center, Nashua, N.H. 8 am to 12 noon—Swap & Sell Meet and Radio Contests. 1 pm to 5 pm—Radio Auction. Be there for a full day of radio fun! For all the details and auction consignment info, call or write: NEARC, 422 Day St., Manchester, NH 03104. (603) 623-8996

FOR SALE: Signal Corps receiver BC-344-D, keyer TG-10-F, frequency meter BC-221-AK, Pan-Oscillo receiver. Marion Van Hal, 1328 Orchard, Pella, IA 50219. (515) 628-2347

FLYER



RADIO & TV CATALOG

**Tubes · Books · Parts
Refinishing Supplies
Grill Cloth**

Call or write for free flyer.
Store open by appointment.

Vintage Tv & Radio

3552 West 105th St Cleveland, Ohio 44111
216-671-6712

CLASSIFIED ADVERTISEMENTS

WANTED: Pre-1950 7" TV's by Meck, Temple, Tel-Vision, Tradio, National, Hallicrafters, Automatic. Don Hauff, 9988 107th Ave. No., Maple Grove, MN 55369. (612) 425-0089

FOR SALE: 14,000 used radio & TV tubes. Metal, loctal, octal, 4-pin, etc. \$975. J. D'Airol, 424 Higbie Ln., West Islip, NY 11795

WANTED: 5 to One Day-Fan audio and a Simplex Kellogg tube B electric console. Gary Finzer, 413 Dover Rd., Sugarcreek, OH 44681. (216) 852-4010

FOR SALE: Grebe CR-5 and matching RORK with tubes and original instruction booklet, exc.—\$650 plus shipping. Bryan Laughlin, 3450 Chili Ave., Rochester, NY 14624. (716) 889-2341

WANTED: AK horn speaker, vg condition, to match my AK 10. Also audio transformer for Crosley 51. Carl Anderson, RFD 1, PO Box 663, Hampden, ME 04444. (207) 862-3925



WANTED: Japanese WW2 radios, accessories, manuals. Japanese electronics/audio magazines, new/old, any quantity. Alan Douglas, PO Box 225, Pocasset, MA 02559

FOR TRADE: McMurdo Masterpiece three tuner only for Masterpiece four tuner. **WANTED:** Chief Pontiac battery receiver made in Pontiac, Michigan. Also any chrome-plated radios in any condition. Craig Korpak, 840 S. Williams Lk. Rd., Union Lake, MI 48085

WANTED TRANSMITTING TUBES FOR MUSEUM

Do you have any old amateur or commercial transmitting tubes worthy of saving for posterity? If yes, help us do same. Contact:

*The Olde Transmitting
Tube Museum*

P.O. Box 97, Crescent City, CA 95531
(707) 464-6470

CLASSIFIED ADVERTISEMENTS

WANTED: Knob set (5 walnut and 1 metal lever) Zenith 12S265 console black 7" shutter dial. Verne Folk, 115 Randy, Butler, PA 16001. (412) 287-6987

FOR SALE/TRADE: Early or unusual landline telegraph instruments, including bugs and miniatures. LSASE for list. Roger W. Reinke, 5301 Neville Ct., Alexandria, VA 22310-1113. (703) 971-4095

HAS YOUR SUBSCRIPTION

EXPIRED?

It has if your mailing label reads
"EXP= JUNE89" or earlier.
Renew now!

*BONUS: Renew before the end of
your "EXP" month and receive 13
issues per year instead of 12!*

Renewal rates are:

\$19.00 for Second-Class Mailing

\$28.00 for First-Class Mailing

(Two-year renewals are twice above rates.)

WANTED: Photocopy of schematic and parts list or manual for Navy RBZ portable receiver. Mike Bittner, 27215 Sunnyridge Rd., Palos Verdes, CA 90274

FOR SALE: Scott Philharmonic, 5 cathedrals, 6 AK, 4 other early battery, 10 tombstones, 15 small wood and plastic, 3 metal box, 10 horns and speakers, test equipment and much more - \$2,500/all. **WANTED:** Ozarka V16 chassis. Ray Miner, 1215 Ave. B, Ft. Madison, IA 52627. (319) 372-1271

WANTED: Meissner signal shifter with plug-in coils and a Hallicrafters S-19R, Sky Buddy receiver in good physical condition. B&W 75W plug-in coils (5 prongs) models 80 JEL and 40 JEL end link. Also need a Stancor IOP AM/CW transmitter that was a kit in 1939. James Schlietstett, W41MQ, PO Box 93, Cedartown, GA 30125. (404) 748-5968



Frank Landman
Edenstraat 98
5615 GB Eindhoven
The Netherlands

Would like to trade his very special first Philips TV for the old American TV models on p. 35 of A.R.C. December '88 issue.

CLASSIFIED ADVERTISEMENTS

FOR SALE: Philco 38-10 Art Deco table set, beautiful refinished case, does not work, lacks station dial - \$40 ppd. David S. Kendall, 1610 Fruit St., Huntington, IN 46750. (219) 356-5096, after 6 pm EST

WANTED: The following to Scott radios: World's Record Super 9, World's Record Super 8, Scott Symphony, AW13, AW19, AW27, Quaranta (40 tubes or more), Shield Grid 9B, any Scott in Napier cabinet, and any original Scott literature. I can pick up in all 48 states. Jim Clark, 1292 Starboard, Okemos, MI 48864. (517) 349-2249

FOR SALE: Tubes, over 650 types, used and tested - \$2 ea. Five or more - \$1.50 ea. Send wants or 2-25¢ stamps for list. Winton Radford, 1408 Second Rd., Baltimore, MD 21220. (301) 391-3819

WANTED: Waveforms 512 oscillator manual. Barker & Williamson 410 distortion meter manual. New tubes: 1620, 6136. Alan Kriss, 1872 Portsmouth, Union, NJ 07083. (201) 688-2092

FOR SALE: Crosley Pup, good condition plus other items. Write for bid form. Allan Hibsich, 4 LaForet Ct., Oroville, CA 95966

WANTED: Hallicrafters base station mike with teardrop-shaped base. Glass dial for Hallicrafters SX-130. Heathkit SB-104, 604, 644, 614, 634, 230, HP-1144. P.S. Please state condition, price. A. J. Mignogna, 25432 Second St., El Toro, CA 92630. (714) 837-4173, before 1:30 pm PST Mon.-Fri.

SEE YOU AT ARCA-89

Thursday, June 1 - Sunup
Flea Market Opens! Don't miss it!

1989 Convention
The Antique Radio Club of America
Mystic, Conn. on June 1, 2 & 3, 1989.

HIGHLIGHTS

Flea Market	Steam Museum
Old Equip. Contest	Banquet
Seminars	Auction
Atwater Kent Museum	Aquarium
Wireless Museum	Mystic Seaport

For information on the Antique Radio Club of America, write and enclose 25¢. Also, consider joining ARCA by enclosing \$12.00. Bill & Jane love to get mail!



Bill & Jane Denk
ARCA
81 Steeplechase Road
Devon, PA 19333

Non-members are encouraged to attend ARCA-89.

CLASSIFIED ADVERTISEMENTS

FOR SALE: Edison Dictaphone cylinders for school business courses containing dictation and the like. Long SASE for details. Doug Alderdice, 126 Mercer Ave., Buffalo, NY 14214

WANTED: Antennae coil or chassis RCA radio 1936 Model 10T or 10K Part No. 12879. Elmer Mueller, 9815 Surrey Ln., St. Louis, MO 63137

FOR SALE: Hallicrafters S-38B, 4 bands, bandspread, BFO, mute, nice, clean working - \$45 plus shipping. Bob Rathbone, RFD#1, PO Box 127, Ossipee, NH 03864. (603) 539-2762

WANTED: Eveready radios & speakers. Old flashlights, old catalogs listing flashlights. Bulb lighted clocks. Bill Utley, 7616 Brookmill, Downey, CA 90241. (213) 861-6247

FOR SALE: Zenith 5S-29, 1936, square top with black dial, works, with moderate hum, vg, dial slips, dial glass broken (get one from Larose), "minute hand tuning," black dial with multi-colored lettering, 3 bands - \$110. Ramo Radio Products horn, 1925?, horn speaker (metal), works, some paint chips on base & neck, small dent on neck, decal OK, brown crinkle paint, a good cleaning would do wonders for it, quite small - \$80. Also many other radios, books & tubes. Send 2 stamps for complete listing to: Ron Boucher, PO Box 541, Goffstown, NH 03045. (603) 497-2988

WANTED: Early lineman's test sets, key and sounder. Other miniature keys, bugs or combinations. Gil Schlehman, K9WDY, 335 Indianapolis Ave., Downers Grove, IL 60515. (312) 968-2320

ALL A.R.C. BACK ISSUES NOW AVAILABLE

ORIGINALS or REPRINTS (marked *) available for:

Mar. 85 - Vol. 2, No. 3	Dec. 86 - Vol. 3, No. 12*
Jul. 85 - Vol. 2, No. 7	Jan. 87 - Vol. 4, No. 1*
Oct. 86 - Vol. 3, No. 10*	Feb. 87 - Vol. 4, No. 2
Nov. 86 - Vol. 3, No. 11*	through Current Issue

* Reprint (same quality as original)

Photocopies will be furnished for all other issues, and for the 1985 issues when originals are no longer available.

Note: Publication of A.R.C. began in '84, which had only five issues. 1985, '86, '87, and '88 had twelve issues each.

\$2.50 each - postpaid to
U.S., Canada and Mexico

Other foreign orders - \$4.00 each

Send Order with Payment to:
ANTIQUÉ RADIO CLASSIFIED
P.O. BOX 2. CARLISLE, MA 01741

CLASSIFIED ADVERTISEMENTS

WANTED: Electrolytic capacitors with flexible leads, 150v rating except triples which may be 25v, any mfrs. Charles D. Prater, Edna, KY 41419

NEW PHONE NUMBER FOR ANTIQUÉ RADIO CLASSIFIED (508) 371-0512

**Best time to call is weekdays:
9 am to 5 pm Eastern Time**

(Please no classified ads by phone. Thanks!)

FOR SALE: Hawkins Elect. Guides, set of 10 books - \$30. Marconi RCA stock certificate - \$35. Saga of the Vacuum Tube, hard cover - \$27. Radio-Craft 1939 to 1945, fair to good - \$2.50 ea. Antique style AM-FM cathedral, small repo - \$19. Practical TV by RCA, 1939 - \$5. The Servicing of Philco TV, 1946, fair - \$9. Heathkit tube tester, needs wiring, recheck, w/instr. book - \$25. Pocket watch case volt or amp meter - \$4 ea. Kleertone to improve your radio, N.O.S. - \$4. Radio Electronics 1950 to 1955 - \$1 ea. Three small buzzers, used - \$5. GR 4-amp 220v Variac, N.O.S., can be used on 120v - \$22. Bundle early Motorola service notes - \$8. Bundle early RCA service notes - \$8. Howard Sams TV service course - \$6. Have some Fider's Radio Service Manuals Vol. #6 to #15. Howard Sams by the bundle. Am junking following sets: RCA 20, 17, 18, 33. RCA RP190-45 changers. Radiola 33 chassis coils & audio transformer, no tune con. - \$15. S40 Hallicrafters parts set - \$20. Barker & Williamson 8 plug-in ham band coils - \$25/all. Assorted old style 201-A sockets plastic or bakelite - \$3 ea. Metal shell - \$4 ea. Acme CW unit hi-volt transformer 750v, 200 watts - \$15. National tone filter - \$8. National S-11 audio transformer - \$10. National S-51 audio - \$10. Assorted audio transformers, no choice - \$6 ea. SM-221 audio - \$12. SM-331 audio - \$12. 6 assorted audios transformer open coils - \$7.50/6. Jefferson train transformer voltages from 1 1/2 to 24v - \$6. Old N.O.S. brass key bulb sockets - \$3 ea. 01-A ST good fill - \$5. QST 1929 to 1936 - \$1.50 ea. Radio News 1945 to 1954 - \$2.50 ea. Have 1000's of all type repair parts, tubes, speakers, vol. controls, test eqpt. service manuals. Write wants, SASE for replies. Handling and shipping, extra on all items. Min. orders - \$7.50. Service and sales since 1930. SASE for list. Krantz, 100 Osage Ave., Somerdale, NJ 08083

RADIOPHILE

Vintage Radios

- Bought
- Sold
- Serviced

Brooklyn, NY



718-625-7254

Full One Year Warranty On All Our Radios

CLASSIFIED ADVERTISEMENTS

WANTED: Westinghouse Little Jewel refrigerator radios. Write Vaughn Rudisill, 85 Willis Ln., Muttontown, NY 11791. (516) 496-2339

FOR TRADE: A Spiro Agnew original wristwatch for a Catalin radio. **FOR SALE/TRADE:** Charley McCarthy 24" cardboard cut-out doll, eyes and mouth move, pull tab behind head. **WANTED:** Grille cloth from a red Hopalong Cassidy. Richard Arnold, PO Box 275, Lone Grove, OK 73443. (405) 657-3319

WANTED: Dial glass for Sparton 1567 or 1167. N. Jackson, 17435 SW Blanton St., Aloha, OR 97007-1340

WANTED: "Radio Tube Vade Mecum," published by Editors and Engineers, Ltd. Bob Deuel, PO Box 1181, Medford, OR 97501. (503) 482-8752

FOR SALE: Westinghouse WR209 radio, vg, table model - \$40 plus UPS. RCA radio T80, vg - \$60 plus UPS. Trubador portable AC battery radio, leatherette case good - \$15 plus UPS. Wallace's Admiral TV schematics 1947 to 1953 - \$9 prepaid. M. B. Gaskins, WB4MNZ, 227 Risen Ave., Campbellsville, KY 42718. (502) 465-3755

WANTED: Farnsworth Model P-860. State color, condition, price. Don Garbutt, 443 G. St., Idaho Falls, ID 83402

FOR SALE: Cathedrals: Philco 89, Airline 326, Knight. Also Philco 620 and Grunow 500 tombstones. Ben Montabana, 1133 Graham Dr., Birmingham, AL 35214. (205) 798-5289, mornings

CLASSIFIED ADVERTISEMENTS

FOR SALE: Heathkit Model SG-6 RF signal generator, works - \$15. Heathkit Model TC-1 tube checker with 1958 and 1962 roll charts, one lever knob missing, works - \$15. RCA test oscillator TMV-97-C, tubes good, needs batteries - \$35. No manuals. UPS included. Jack D. Hortman, PO Box 456, Biglerville, PA 17307. (717) 677-6336

WANTED: Early Crosley audio transformer, dud OK. R. Chenez, 47 Lake St., Apt. A605, Gardner, MA 01440

FOR SALE: Hallicrafters S41G - \$45 Hallicrafters Continental 5R40 - \$30. Good condition, plus UPS. Gary Pirkkala, 2306 Audley Ave., New Castle, PA 16105. (412) 654-8481

WANTED: Books on high fidelity, sound reproduction, audio, speakers. Heathkit W6 amps. Barry Nadel, PO Box 29303, San Francisco, CA 94129. (415) 346-3825

FOR SALE: All originals. Rider #244 Master Receiving - Picture Tube Substitution Guide, very good - \$15. Operating Guide for Zenith Trans-Oceanic Model H500, Chassis 5H40, excellent - \$12. Instruction manual for Eico Models 565-555 multimeter, fair condition - \$2.50. Instructions, IB16, for Radiola 16 plus advertising sheet with photo, both very good - \$14/pair. All plus shipping. Charley Combs, 508 E. Daniel, Albany, MO 64402. (816) 726-3038

WANTED: Collector wants Philco Predicta, any model, any condition. Mark Rathbun, 1817 Arbutus Ave., Chico, CA 95926. (916) 342-2655

TUBES WANTED

We need the following tubes to replenish our stock. You may ship your tubes to us by UPS or Parcel Post. We'll mail our check upon receipt and testing of tubes. We pay prices shown plus shipping charges.

USED GLOBE OR BALLOON SHAPE TUBES - ALL MUST TEST GOOD

WD-11*	\$25.00	UX-199*	\$9.00	246	\$4.50
112A	5.00	200A	5.00	247	4.75
171A	4.50	201A	5.00	250	20.00
UV-199*	10.00	210	8.00	280	5.50
* Tubular		245	10.00	281	4.50

MODERN (ST) STYLE TYPES - NEW ONLY

01A	\$5.50	45	\$15.00	71A	\$5.00
42	3.50	50	25.00	83	4.50

We buy all types of receiving tubes. Send us your list for our bid.
Also looking for 4, 5, & 6 pin tube sockets.

ANTIQUÉ ELECTRONIC SUPPLY

688 W. First St., Tempe, Arizona 85281, 602/894-9503

CLASSIFIED ADVERTISEMENTS

FOR SALE: Lots of older test equipment. Colored plastic radios, tubes from 1926 up. Parts etc. List 50¢ and SASE. R. Chester Wisner, W1VSR, 1014 Main St., Dalton, MA 01226

WANTED: Character, unusual (better) radios in wood, bakelite Catalin, plastic (1933-53) Deco etc. for highest competitive prices. Also damaged for photo/display use. Ed Schneck 1401 Ocean Ave., Brooklyn, NY 11230

WANTED: Tube testing values for Sonora RA-1 DE-1, RE-2, SO-1, SO-2. Audio transformer for Eveready Model 1, 2, or 3, or Bosch #28. Power transformer for Sonora Models 30, 32, or 40. John Swett, 8116 Olmway, Olmsted Falls, OH 44138 (216) 235-1463

WANTED: To purchase Mathews Challenger or Pioneer MJ Allwave receivers and factory literature. George Harris, 3212 36th St., Lubbock, TX 79413. (806) 795-5604

EXTEND OR RENEW YOUR SUBSCRIPTION NOW BEFORE RATES GO UP!

Details on coupon in centerfold.

FOR SALE: ATC (Transponder) radar beacon interrogator test unit, with manual, FAA Type CA1755 RD-65 Rawinsonde receiver system by Weathermeasure Corp., solid state. Bendix QB 706-3 bearing cleaning tool kit, in fitted box, new, elaborate, compact. George Belling, W6CTG, 3740 Atlas Ave., Oakland, CA 94619

AN EXCEPTIONAL OFFERING!

Private Collection

**Atwater Kent Breadboards,
Breadboard Parts (some in boxes),
T-11's, TA's, Variocouplers,
Sockets, Transformers**

**Other Sets Including
Kennedy 281/521, AC Sets,
Loose Couplers, Crystal Detectors
Numerous Parts - Hundreds of Tubes
Books and Magazines 1920's+30's
Catalogs, etc.**

**Radio List: \$1.00 + LSASE (3 stamps)
Book List: \$1.00 + LSASE (3 stamps)**

Phone: 6:30 - 8:00 pm EST only please

**Richard Foster, 12 Shawmut Ave.,
Cochituate, MA 01778, (508) 653-2418**

CLASSIFIED ADVERTISEMENTS

FOR SALE: Motorola #67X11, brown bakelite, nice - \$50. Westinghouse H-417T5, unusual - \$35. GE mahogany case #430 - \$45. Motorola 52X11 - \$45. Coronado, Custom 5 green color #RA48-8 158A - \$45. Karola 32-volt farm set, natural birch? wood case - \$60. Zenith #T723, brown bakelite - \$50. Setchell-Carlson #416, ivory, unusual - \$80. RCA Victor 5T6 - \$45. Farnsworth ET066, nice - \$50. **WANTED:** Chassis & speaker for Clarion Jr. AC60. Case for Radiola 20. Chassis & knobs, Kennedy Coronet #42. Speaker grille for Freshman Masterpiece, table model. Horn and base for Atlas speaker. All sold as is. Buyer assumes all responsibility. All + UPS. Darrell Combs, 6587 Pacheco Way, Citrus Heights, CA 95610. (916) 969-0635, after 5 pm PST

CLASSIFIED AD NOTICE
Please check your ads carefully
before sending them in.
We cannot make changes to ads
once they are received.

FOR SALE: Philco Model 49-501 (Jetsons) radio. Excellent condition. Scott Haggerman, 392 Ann St., Cary, IL 60013. (312) 639-7745

WANTED: Military radio communications. My special interest is WW2 German, Japanese, Italian equipment. I enjoy locating the far-scattered sets and pieces to reassemble complete operating systems. Also interested in 1940's and earlier mobile radio: some U.S. military equipments, Forest Service transceivers, civilian aircraft non-VHF radios, other? Sideband converters for receivers, YRS-1, MC, MCL, etc. Plus manuals on all above and practically any other communications equipment; also directories, advertising, training materials with photos or specs for reference. Radio stations listings 1935-45 of world's broadcast stations, military and airways stations, Berne, FBIS lists, what have you? Babani and Vade Mecam valve directories. 1940's electronic industries trade publications, union publications, other obscure paper for research, also 1940's aviation magazines. If you're still with me this far, you might be interested in **FOR SALE:** Transmitter, very compact RCA AVT-112 used with AVR-20 in Army spotter planes WW2, okay - \$15 or splendid - \$25, with data, shipped UPS. Power supply available Fair Radio. Thanks! Hugh Miller, KA7LXY, 6400 Maltby Rd., Woodinville, WA 98072-8375. Or try: (206) 487-3047, weekends or 10-11 am PDT weekdays

WANTED: Microphone, must say Crosley on case. Also Micro Vox wireless mike. MacLean, PO Box 2025 Toluca Station, N. Hollywood, CA 91602. (805) 947-7149

FOR TRADE: Grundig 7018 chassis & changer complete for 40's/50's table radio. A. J. Long, 2653 Post Rd., Twinsburg, OH 44087. (216) 425-9662

CLASSIFIED ADVERTISEMENTS

FOR SALE: Weston Model 312 current transformer, Model 155 AC ammeter, and Weston book "Electrical Measurements and Meter Testing in the Power Station, 1929" - \$30/all. Victor Baker, 1450 East Ave., Rochester, NY 14610. (716) 442-3507

One Month Free!

BONUS FOR EARLY RENEWALS

If you renew before the end of the month shown on your mailing label (your expiration date), you will receive an extra month on your subscription: 13 months instead of 12! 26 months for a 2-year renewal!

WANTED: GE Model M-61 chassis & speaker. GE Model M-51 speaker. Philco Type 16 chassis, need speaker & cabinet. Need chassis & eliminators for Zenith Super VIII. **WANTED:** Transistor & novelty radios. George E. Brehm, 13402 Leibacher Ave., Norwalk, CA 90650. (213) 864-8857

FOR SALE: 1921 Westinghouse RA/DA receiver, has 3 tubes and looks real nice - \$150 plus UPS. E. J. Reaser, 1005 Hinton St., Princeton, WV 24740. (304) 425-2093

WANTED: Boxed 201-A tubes. Crosley Trirdyns. State condition and prices. William Smith, 16001 Dusty Ln., Accokeek, MD 20607

WANTED: Ribbon microphones (RCA 77s/44s). Tube condenser mics (especially Neumann/Telefunken/AKG), also Pultecs, tube compressors, etc. Jeff Kreines, 5330 Kennedy Ave., Millbrook, AL 36054. (205) 285-6179, leave message

FOR SALE: Large selection new antique tubes, also individual Sams Photofacts - \$4 ea. prepaid. Neils Electronics, PO Box 182, Seabrook, NH 03874. (603) 474-5568

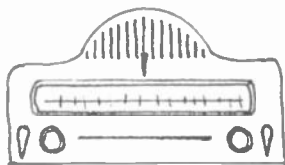

WANTED: This Sonora multi-band bakelite radio or info, ads, etc. Jimmy Downes, 607 East 12th Ave., Covington, LA 70433. (504) 893-7057

HELP: Need production information on Atwater Kent Pooley Cellerette #7800 Model 45. Have any sales pamphlets on this unit? Jay Volke, 7844 W. 41st Pl., Lyons, IL 60534. (312) 442-0817

WANTED: Power transformer for Grundig RF 255U/stereo. Larry Anderson, 3453 Balsam N.E., Grand Rapids, MI 49505. (616) 363-7889

CLASSIFIED ADVERTISEMENTS

WANTED: Atwater Kent breadboard parts, sets in any condition, basket cases OK. Paul Thompson, 315 Larkspur Dr., Santa Maria, CA 93455. (805) 934-2778

FOR SALE: Radiola loudspeaker Model Number UZ1325, in very good working order - \$75, shipping included. Dennis Atkinson, Upper Park St., Phillips, ME 04966. (207) 639-3111

WANTED: In good condition only, Baldwin Type E and Brush crystal headphones. Paul Luehr, PO Box 87, Taber, Alberta, Canada T0K 2G0

FOR SALE: Tektronix 603 storage display X/Y monitor #23 - \$225. Tektronix 604 X/Y/Z monitor, fine, #23 - \$?. R.F.L. Magnetreater 889B, pulse type, good - \$75. L&N resistance bridge cat. #4725, good - \$70. L&N % limit bg. cat. 4270, early 50's, good, #7 - \$25. Wm. Arnold, 27832 Lincoln Rd., Bay Village, OH 44140. (216) 835-0520

WANTED: Small audio transformers, designated line-to-grid input type, 500/600 ohm primary to 50K split secondary, UTC A-10 or equivalent. Thank you. Please write to: Todd Roberts, PO Box 21413, Hilton Head Island, SC 29925

HELP: Need source for .001, .0056KV caps, used in 1947 electrostatic deflection TV's. Roland Hall, 1704 Boyden St., Greensboro, NC 27403

WANTED: Westinghouse 185 portable, GE 665 and similar GE portables. Jim Zacher, 39W345 Central, Elgin, IL 60123

COMMUNICATIONS RECEIVERS

THE VACUUM TUBE ERA: 50 GLORIOUS YEARS 1932-1981

NEW SECOND PRINTING - REVISED
PRINTED ON COATED PAPER, IMPROVED
PHOTO REPRODUCTION, NEW PHOTCS,
CORRECTIONS, PERFECT BOUND, GLOSSY
COVER, SAME OLD PRICE.

- Book covers industry history
- Specs on 700 receivers
- 51 company histories
- 112 photos
- For collectors, connoisseurs and admirers of receivers

\$14.95 plus \$2 P/S, SASE for details.

RSM Communications
Box 218-A, Norwood, MA 02062

CLASSIFIED ADVERTISEMENTS

WANTED: Samples of grille cloth and the radio model numbers they were used in. I am able to duplicate most styles of cloth that were used in old radios. The cloth must have been used in numerous models or be in strong demand by collectors and dealers. First 5 samples received of any pattern I make up will receive free cloth in that pattern. Michael Katz, 200 East 30th St., Apt. 8E, New York, NY 10016. (212) 725-0736

FOR SALE: Quality crystal set radio kits with 15-page instructions—\$15 ppd. SASE. Regeneration Radio Co., 20335 Casa Loma Rd., Grass Valley, CA 95945

WANTED: Zenith Model 5R312. Pat Myers, 6738 Verona Rd., Verona, PA 15147. (412) 795-3991

WANTED: Zenith console Model 5808 (F.O.S., p. 194), in excellent condition. Robert Jenkinson, 10156 12 1/2 Ave., Hanford, CA 93230

FOR SALE: Technical books, test equipment, radios, tubes, trains & accessories, dynamotors, neon signs, electrical medical apparatus, geiger counters, fans, motors, lanterns, meters, Tesla coils, etc. Sorry no list yet. Ye Ole Electric Store, located in space #13 of The General Store, 2650 Alessandro, Riverside, CA 92008, and in Browning Antiques, 504 W. 6th St., Beaumont, CA 92223

WANTED: The following cathedrals: Philco Models 51, 44, 144. GE Model J-100. RCA Model 121. Joseph Yanul, 9606 Troy Ct., Mentor, OH 44060. (216) 255-1952

WANTED WWII

**GERMAN ELECTRONICS,
OPTICS AND FIELD EQUIPMENT
TO COMPLETE HISTORICAL DISPLAY**

**"Not to glorify,
but to preserve and remember
our great struggle"**

CALL OR WRITE: Steve Puntillo
1911 Rowley Avenue
Madison, Wisconsin 53705
(608) 233-1569 Home, 251-6121 Work

Call either number between
1:00 a.m. and 11:00 p.m. Central Time.

Send photo of your unit if possible.

CLASSIFIED ADVERTISEMENTS

FOR SALE: Radios from 30's to 60's, also early transistors, a few German sets, and electric clocks. 2 stamp LSASE for new list with pictures. Victor Marett, 3201 N.W. 18 St., Miami, FL 33125. (305) 634-9569

WANTED: Eveready floor model radio Model 10 or 20, 1928, 1929. Tom Clark, 38 Bissett Pl., Metuchen, NJ 08840. (201) 548-0117

NEW PHONE NUMBER FOR ANTIQUE RADIO CLASSIFIED (508) 371-0512

**Best time to call is weekdays:
9 am to 5 pm Eastern Time**

(Please no classified ads by phone. Thanks!)

WANTED: Rider's Volume III. Any one tube Crosley, pieces or basket case welcome. Duane Kopchak, PO Box 5212, Poland, OH 44514

SERVICES: Long Island N.Y. antique radio and TV serviced, bought, sold. Gardiners TV, 90 Gardiners Ave., Levittown, NY 11791. (516) 731-4600

WANTED: Silvertone 6110. Also these chassis: FADA 652, GE L-622 (Collins, p. 62). Steve Elkins, 445 S. Detroit #204, Los Angeles, CA 90036. (213) 935-5572

SERVICES: Repair/replacement of old meters. Cash or trade for old meters working/not. Leonard W. Cartwright, 113 Sea Terrace Way, Aptos, CA 95003. (408) 662-2977

FOR SALE: Selling excess gear: military & spy radios, antique, ham, test equip. LSASE for list. G. Cain, 1775 Grand Ave. #302, St. Paul, MN 55105

WANTED: Radio-related novelties such as radio banks, toys, puzzles, games, promotional items, advertising, etc. Gary B. Schneider, 9511 Sunrise Blvd., #J-23, North Royalton, OH 44133. (216) 582-3094

FOR SALE: Wurlitzer 3500 jukebox — \$325, or trade for arcade games, radios. Pick up only. Nick Fantetti, 9560 Miami Dr., Loveland, OH 45140. (513) 683-6093

ATTENTION! Collectors, Antique Dealers

Patent Dating Chart determines the dates of your favorite antiques and collectibles.

Convenient pocket guide is great for Flea Markets, Auctions, Tag Sales and wherever Attic Treasures may be found.

From 1836 to Present.

Send \$2.50 postpaid to:

**J.A.G.
P.O. Box 81
Shelton, CT 06484**

CLASSIFIED ADVERTISEMENTS

FOR SALE/TRADE: Telefonken Hymnus AM/FM/SW stereo Model 5116WK chassis only, Telefonken 205 Jubilate. Levy, 8 Waterloo, Morris Plains, NJ 07950. (201) 285-0233

WANTED: 1949 Motorola VT73A 7" TV back control knobs, feet, mask, antennae and base, manual. R. N. Traynham, 504 W. Henderson St., Bozeman, MT 59715. (406) 586-7776

FOR SALE: Wards Airline phono, Art Deco style - \$100. Warren Burdine, 1606 Idylwild Dr., Prescott, AZ 86301. (602) 778-1608

WANTED: Boxed 201-A tubes, horns, Westinghouse RC sets, Trirdyns, etc. William Smith, 16001 Dusty Ln., Accokeek, MD 20607

CLASSIFIED AD DEADLINES

Jun. 10 for Jul. 1989 Issue

Jul. 10 for Aug. 1989 Issue

Aug. 10 for Sep. 1989 Issue

WANTED: Old bicycle radios such as Motorola, Tom Thumb. Also battery packs. Cash or swap. Michael Payne, 609 N. Fairview Cr., Alvin, TX 77511. (713) 331-9217

FOR SALE: Philco wood portable Model 46-350 - \$40. Trans. radio candlestick phone, novelty - \$20. 18" magnafilter - \$45. 10 wire recorder heads, some used - \$10/all. 4 lb. roll cloth covered #36 copper wire - \$5. 2 audio transformers, open - \$5/both. 4 gang AM tuning condenser with coils - \$6. Add UPS charges. Clark Trissell, 3530 Pawnee, Lincoln, NE 68506. (402) 488-5263

WANTED: Paco T60 tube tester instruction manual, schematic and attached supplement for testing additional tubes. Copies OK. George Hawkins, 130 Rio Dr., Crescent City, CA 95531

FOR SALE: Philco Models 38-12 and 38-15 parts radios - \$25/both + UPS. Kenneth Miller, 10027 Calvin St., Pittsburgh, PA 15235. (412) 242-4701

WANTED: Copy of schematic and/or manual for Jackson tube checker Model 435-A. Charles Ahr, 2291 Sylveld Ln., Cincinnati, OH 45238

WANTED

Chicago Symphony Orchestra Broadcasts, pre-1965

Radio Acetate Cut Discs
Transcription Discs
TV appearance,
any format
Films

Steven Smolian
8807 Postoak Road
Potomac, Md. 20854
(800) 228-7833

CLASSIFIED ADVERTISEMENTS

WANTED: Still looking for good audio transformer, Sampson, Type HW-A3, 6:1 ratio. Also one Aristocrat vernier port dial, black, by Kurzkasch. Have good WD-11's for trade. H. K. Fredrickson, 218 Skeena Cres., Saskatoon, Saskatchewan, Canada S7K 4G8

FOR SALE: Custom-made radio-related tie clasps and lapel pins. Send LSASE 45¢ postage. Michael S. Sabodish, Sr., 28 Middlesex St., Matawan, NJ 07747

WANTED: Can anyone help me? Chrome cap. for neutrowound 1927 battery radio. Russell Schoen, E7340 Nietzsche Rd., Clintonville, WI 54929. (715) 823-6744

FOR SALE: Super Zenith VII, offer, pick up only. Kennedy Type 521 amplifier - \$300. J. H. Barrows, W7BCT, 15121 41st Ave. SE, Bothell, WA 98012. (206) 337-4880

WANTED: Power transformer for Supreme 504A tube tester, manual or complete one, good or junker. Ron Taylor, 12407 Mullins, Houston, TX 77035. (713) 726-0783

FOR SALE: Radiola 28DC, loop, 106 speaker, gc - \$300. Rider's #1, vgc - \$60 incl. shipping. Mike Shade, 1832 Heather, Northbrook, IL 60062

WANTED: Case and pillow speakers for pillow speaker radio 4130-D1, coin-operated radio. Also need case for Zenith A600. Rod Galloway, 2220 Woodbury Rd., Melbourne, FL 32935. (407) 254-0280



Craig L. Graybar Furniture Works Ltd.

(414) 258-2390

SPECIALISTS IN RESTORING, REPAIRING AND REPRODUCING CLASSIC STYLED ANTIQUE TV, RADIO & PHONOGRAPH CABINETS

Send us your plans or your project via UPS for immediate price quotes

1535 S. 84th St.
West Allis, WI 53214

"We Turn Ideas Into Heirlooms"

CLASSIFIED ADVERTISEMENTS

WANTED: Continental piano radio, case only, bakelite or wood. Melodee radio phone by D-AMCO, need parts set with good receiver. Crosley 30's Coke bottle radio and Coke cooler radio. Cliff Watts, 51 Glendale Rd., Brantford, Ontario, Canada N3T 1P5

FOR SALE: 3000+ new and used (checked) tubes, on lists. Antique radio tubes, books/parts. Ham radio items. Reconditioned Hallicrafters S85 receiver - \$85. Reconditioned test equipment - prices reduced. (On list). Commodore computer items: cables, printer interfaces, covers, modems, drive, software (on list). Variable capacitors, panel meters, crystals, knobs, satellite dish motors, vibrators. A garage full! Nine lists! Send LSASE with 85c. Richard Dreher, W5VTJ, PO Box 691443, Tulsa, OK 74169

WANTED: Good Type 4500 Coto-Coil Aft, also need picture of cabinet for Amrad Voice of the Air reflex set. Any other info on the above would be welcome, especially a picture of original chassis, will reimburse any costs. Andrew Mooradian, 5 Priscilla Ln., Winchester, MA 01890

WANTED: Canadian R.C.C. circuit manuals prior to 1937. Send details including price. Stan Marlin, PO Box 1035, Assiniboia, Saskatchewan, Canada S0H 0B0

FOR SALE: Chromed Arvin 440-T (Collins, p. 93) - \$200. Motorola Astronaut TV - \$200. Sony 8-301W TV - \$200. Walt Kiefner, 6233 51st Ave. NE, Seattle, WA 98115. (206) 524-1388

CLASSIFIED ADVERTISEMENTS

WANTED: Transistor novelty sets. I have collected 500 sets, and there is no end in sight. Wanted: Ice Cream Sundae, Wilson Tennis Can, Hot Dog, Old Crow, Quaker Oats crystal set (trans. radio!!), Film Boxes, John Wayne, John Lennon, Coffee Cup, Psycho (Shower Curtain), Faucet, Light Bulb, Big Mouth Cannon, Outhouse, Bird in Cage, Indy Race Car, miniature grandfather clock, Scale, Golf Bag, VW Fire Chief, Safequard Soap, Royal Oak Charcoal, Salem Cigarettes, Telegraph Key, and so on. I will pay top money for sets I don't have. Lee or Carolyn Bruton, 1202 So. Pratt Pkwy., Longmont, CO 80501. (303) 651-0254, answering machine after 3

FOR SALE: Manuals: DuMont scopes - \$10 ea. available. Tektronics 545, 535A/545A, 121 preamp, CA unit - \$15/all. RCA PT60 phototubes - \$5. Army: TM5-764 motors, 11-673 micro-waves, 11-678; Telephony, 11-679 repeater - \$6. MIT Lab Series 17, 19, 21, 22 - \$15. Locals phone/visit and bid low on miscellaneous test equipment/components. Joe Koosman, K2GFH, 130 RD1, Rte. 518, Hopewell, NJ 08525

WANTED/FOR TRADE: Langevin, Western Electric, other tube audio gear & speakers. WE caps, vitamin Q, quality audio xfms. Have Sams to #200, Rider's VI-XVII. Various radio lit. to trade for audio lit. Joe Roberts, PO Box 19302, Alexandria, VA 22320. (703) 683-2955, eves.

FOR TRADE: Rare Marconi flexible Velvetone phonograph record, pat. 1901; label pictures Marconi and signature. **WANTED:** Loop antennas. Otto W. Nill, 192 Grant Ave., Islip, NY 11751

WANTED

Top Prices Paid

Radio & Audio Tubes: 2A3, 45's, 50's, 845, 8005, KT66/88, etc.

Western Electric Tubes: 101, 102, 104, 203, 305, 211, 212, 242, 244, 252, 262, 264, 271, 274, 275, 276, 284, 285, 300, 301, 310, 339, 345, 347, 348, 349, 350, 421, 422, VT25A, VT52, etc.

W.E. Speakers & Tweeters: 555, 594, 595, 596, 597, 713, 728, 754, 755, 756, 757, TA4151, 4153, 4181, 4191, 4194, etc.

W.E. Consoles & Amps: 25B, 41, 42, 46, 86, 91, 92, 94, 95, 105, 106, 117, 118, 120, 121, 124, 129, 130, 131, 142, 143, etc.

W.E. Horns: 22, 24, 25, 26, KS-6368, 12024, 12025, 12027, etc.

W.E. Microphones & Parts, etc.

Also looking for:

*Tube-type equipment by McIntosh, Marantz, Westrex, Langevin, Altec, etc.
Vintage speakers, units, by Jensen, Altec, JBL, Tannoy, etc.*

**Audio City USA, PO Box 786, Northridge, CA 91328-0786
(818) 701-5633**

CLASSIFIED ADVERTISEMENTS

FOR SALE: Transistor Jewel Box radio by Crown – \$27.50 ppd. Newcomb headset, red and black plastic with quarter-inch plug – \$5 ea. ppd. Stewart-Warner 301A SW converter – \$18 ppd. **WANTED:** Chassis for Zenith 11-12 and Crosley 6-60 or 6-85 or will sell cabinets. Paul Gunzenhauser, Rt. 1, PO Box 133, Garden Grove, IA 50103. (515) 443-2161

WANTED: Theremin articles, recordings, schematics, programs, info, etc. RCA, Moog, Norlin theremins. Also Stanwyck LHO-2 TV coil (2) specs or equivalent. Also RCA 106 speaker. David McCornack, 613 9th Ave. #3, New York, NY 10036. (212) 757-3961

FOR SALE: Freshman Masterpiece with tubes near mint – \$125. Crosley Type D Music cone speaker, excellent – \$45. Transistors: GE 10 transistor black, P915D, pocket – \$10. GE 8 transistor, P856 small portable – \$10. Novelty, all metal Knight head – \$20. Sinclair Gas pump pocket – \$12. Tubular transistor speaker – \$10. Harald Herp, 6615 Michele Ct., Huntingtown, MD 20639. (301) 855-7071

WANTED: Westinghouse RA, RE, or Radiola AR-1375. National Electric, Marconi, or Wireless Specialty apparatus. Brian Roberts, 3068 N. Evergreen Rd., Pittsburgh, PA 15237. (412) 931-4646

FOR SALE: GE Catalin Jewel Box, maroon, complete original; has a line in back of case, rest is in very fine condition – \$375. Edison Mabry, 715 W. Longview, Mansfield, OH 44906

CLASSIFIED ADVERTISEMENTS

WANTED: Any good Western Electric tennis ball tubes. Set of knobs for RCA 8TS30 TV. **FOR SALE:** Schematics 1920-1960 – \$2.50 & SASE. Tony & Lynn DeMara, 40231 Day, Mt. Clemens, MI 48044-2535. (313) 263-0325

FOR SALE: One farm batt. set with crank type record player, made by Silvertone, chassis #101820 in good cond., wood – \$50 plus UPS. Tom Burnside, 4838 S. Westhaven Dr., Jackson, MS 39209. (601) 922-2235

WANTED: Novelty crystal sets, by specialist collector. Please write to: Erwin Macho, Ambrosweg 17/A/8, A-1230 Vienna, Austria

FREE – 20 WORD AD EACH MONTH
To get your free 20 words,
include your SUB# with your Ad.
Additional words are 10¢ each.
Read inside back cover for details.
MANY THANKS!!!!

WANTED: Cabinets for: Stromberg-Carlson Model 1-A, Majestic Model 70. Chassis for: 1933 Silvertone Centurn of Progress, Steinite, large Kennedy and Echophone cathedral. Anything for Thompson Minuet. Larry Porter, 4115 Beam Rd., Crestline, OH 44827. (419) 683-2540

FOR SALE: 5S-29, 9S-54, 9S-262, 8S-463, 10S-566. Zenith Anchor spkr. Starr speaker. Nipper dog. Nipper salt & pepper. Crosley 716. Splitdorf R-500. DayRad Type B checker. 1953 TonFunk. 3R/4R cabinet. Bill Coolahan, 1450 Miami Dr N.E., Cedar Rapids, IA 52402. (319) 393-8075

JIM CLARK ENTERPRISES
DEPT A.R.C.
 1292 Starboard
 Okemos, MI 48864
 (517) 349-2249



*** Specializing in E.H. Scott and Scott Transformer Co. radios, literature, etc. Contact me if you have any Scott items now, or in the future.**

– For Sale –

- 1. Andrea KT-E-5 prewar TV, restored \$ CALL
- 2. Transvision 16" TV, untested \$ 40
- 3. Addison Model A2A Catalin, maroon/yw \$ 795
- 4. Atwater Kent Cathedral, Model 84, works \$ 349
- 5. Zenith Model 6S439 with glass rods \$ 199
- 6. Atwater Kent in deluxe cabinet, super! \$ 350
- 7. RCA Radiola I crystal set, near mint \$ CALL
- 8. Western Electric Amp, Model 14A \$ 125
- 9. Western Electric Amp, Model 25B \$ 149
- 10. Hallicrafters S-95 Civic Patrol, very nice \$ 29

– Wanted –



Any Scott using this escutcheon

We publish America's best Monthly Sales List of radios, TV's, speakers, magazines, etc. for sale - Send \$1.50 (stamps OK) for current list.

CLASSIFIED ADVERTISEMENTS

WANTED: AM-FM car radios in the 1960's and early 1970's working or not. Also want AM signal seeking radios of the 1950's & 1960's. Write: Harold Sullivan, 15300 Prairie Rd. N.W., Andover, MN 55304

WANTED: Prewar factory automobile radios, control heads, antennas, footpedals. Postwar signal-seekers, automobile phonographs. Dan Schulz, PO Box 892, Crystal Beach, FL 34681. (813) 785-8733

FOR TRADE: Federal 57. Globe 610/615. Aeriola Sr. Radiola IIIA. Others. I need pre-1935 plug-in coil ham receivers or transmitters. Niel Wiegand, WA5VLZ, 911 North Bend, Austin, TX 78758. (512) 837-2492

WANTED: Heads for audio reel-to-reel tape recorders, 4 track, mono or stereo, side mount combo type, record play 550mh, erase 7.5mh approx. George Bittner, 147 Longvue Dr., Pittsburgh, PA 15237

FOR SALE: Grundig 4070u AM-FM-SW. Zenith Royal 500 transistor. Rare Roland A100 AM-SW portable, excellent. RadioMatic coin-op radio, wood cabinet. Unusual Emerson 402 wooden AC-batt. portable, early 40's. FADA AM-FM Deco bakelite. Farnsworth bakelite. Hallicrafters WR700 AM-FM, very good. Raytheon red bakelite. 2 Heathkit HW30 transceivers. Telechron Deco clock radio. **WANTED:** Teletone TV149 seven-inch TV. Emerson 610 or 636A radio (F.O.S., p. 83). Charles Harper, 2081 Harmony Ct., Lexington, KY 40502. (606) 268-8549

CLASSIFIED ADVERTISEMENTS

WANTED: Zenith 22H698 or 22H699. Will be at Elgin in August. Dennis W. Choinski, 1435 Oakes Rd. #5, Racine, WI 53406

FOR SALE: RCA 2X61 table radio - \$20. Heathkit WP-P2 preamp - \$10. Kenwood TR7950 2 meter rig. All mint condition. Rodney Schrock, 402 Lincoln St., Somerset, PA 15501

WANTED: Instruction manual and/or schematic for Weston Model 565 tube/multitester. Photocopies OK. Mark K. Gribble, 2209 Russell Rd., Alexandria, VA 22301. (703) 549-6437

SEND ALL A.R.C. MAIL TO
Antique Radio Classified
P.O. Box 2, Carlisle, MA 01741

WANTED: Vari-Coil shortwave tuner, mfg. early 1930's by A. J. Hurt & Co., Denver, Colo. F. Eckert, 10 Fairfield Ave., Albany, NY 12205. (518) 459-7407

FOR SALE: I-177 Sig. Corps tube tester, pre-1945 tubes - \$35. **WANTED:** Hammarlund Comet Pro. Wayne Steiner, NOTE, Rt. 1, PO Box 114, Burlington, KS 66839. (316) 364-5353

WANTED: Metal slide-button latch for wood case of my Radiola I crystal set. Carl Reinke, 2724 N. 27th St., Sheboygan, WI 53083

WANTED: Revox R-R 10" reel-to-reel or similar 10" R-R. E. L. Smith, 2649 Edgwood Ave., Schenectady, NY 12306. (518) 393-7473

HELP: Need a power supply for a Heathkit Cheyenne xfmr. or Comanche rcvr. Bob Methia, 182 Deane St., New Bedford, MA 02746. (508) 993-3091

WANTED: Pre-WWII E. H. Scott FM tuner. John Peterson, 4333 9th N.E. #D, Seattle, WA 98105

FOR SALE: 68 years collection: 10,000+ items, antiques, radios, televisions, phonos, sound, military, ham, catalogs, flyers, books, 48 pages - \$1 refundable. F. Yonker, W21BH, 7 Old Farms Rd., Saddle River, NJ 07458. (201) 825-1895



WAVES
ANTIQUES
EARLY RADIOS
&
PHONOGRAPHS
78 RECORDS
BOUGHT + SOLD
OPEN 12 - 6
CLOSED SUN & MON.

32 EAST 13TH ST. NEW YORK, N. Y. 10003 212 989 9284

PROPRIETORS Bruce and Charlotte Mager

THIS MONTH'S SPECIALS:

1. Radio Rex, no dog\$20
2. Scott All Wave in carved cabinet800
3. Cathedral-shaped Avon bottle20
4. "Disaster" radio, new in box65
5. Rider's Vols. 20 & 21, new in box35/ea.
6. "Get it better with a Grebe,"
only one side of crate45
7. Microphone-shaped Avon bottle,
with call letters "KAVN"20

SEE NEXT MONTH'S LIST FOR MORE!



TELEGRAPH All Instruments
WANTED



REINKE & SONS

5301 Neville Ct., Alexandria, Va., 22310

(703) 971-4095

CLASSIFIED ADVERTISEMENTS

WANTED: Speaker cabinet to match Collins 75A-4. Mike O'Brien, 1031 E. University St., Springfield, MO 65807. (417) 887-0373

WANTED: Sparto Nocturne, any condition, pay up to - \$18,000. Ed Schneck, 1401 Ocean Ave., Brooklyn, NY 11230. (718) 377-7282

WANTED: Hammarlund Super Pro receiver. R. D. Whipple, 3103 40th St., Lubbock, TX 79413. (806) 799-2308

FOR SALE: AK 32, restored, plays fine - \$85. Zenith tombstone, 6v, 4-V-31, good tubes - \$42. Crosley 129 chassis, speaker, no cabinet - \$27. Crosley 601 Bandbox, plays fine - \$30. Crosley 4-29, very fine condition, plays fine - \$155. **FOR TRADE:** AK 19. AK 10 breadboard. Aeriola Sr. and AC amp. Crosley Library Universal bookcase radio. Majestic Model G-25-A Treasure Chest radio. **WANTED:** AK breadboard tuner condenser unit, or bakelite front cover & variable condenser. AK 3-tube TA unit, or good bakelite top. UPS extra. No tubes unless stated. Wallace Geary, 209 W. Saunders, Mt. Pleasant, IA 52641. (319) 385-2389

WANTED: Hand-crank phonos and parts, horns, reproducers, etc. Cash or radio trades. J. L. Acciavatti, PO Box 231, Southborough, MA 01772. (508) 476-3229, eves.

FOR SALE: Hallicrafters S20 - \$50, 30 lbs. Hallicrafters S20R - \$40, 30 lbs. Motorola 59T5, like new - \$65, 18 lbs. Wurlitzer 506 amplifier for Mod. 1100 boxes, recapped - \$175, 20 lbs. Rek-O-Kut Challenger recorder - \$80*. Knight A-9707 3-band table set, 1937, recapped; refinished - \$95, 18 lbs. Delco 1937 Mod. R-1128 General Motors Sloan award table set recap/refinished - \$150, 20 lbs. RCA Radiola 46, 7 power supply - \$10, 18 lbs. RCA Radiola 46, 7 speaker - \$10, 15 lbs. Philco console cabinet for 37-10 - \$15*. *Items cannot be shipped. C. D. Houston, 3441 Hadley Rd., South Ortonville, MI 48462. (313) 627-4141

WANTED: Regency mono audio amp (2 chassis, 1955) for \$500 or more! Also Brook and Radio Craftsman amps. See full list next month. Ed Schneck, N.Y.S.I., 1401 Ocean Ave., Brooklyn, NY 11230. (718) 377-7282

WANTED: Wurlitzer 506 jukebox amp. Jukebox brochures. **FOR SALE:** Coca Cola cooler radio - \$500. David Brennen, 71 Burdette Rd., Atlanta, GA 30327. (404) 257-1665

FOR SALE: Hallicrafters SX-28, National 183; both cosmetically and electrically good - \$150 ea. Sheldon Kane, 360 RhineCliff Dr., Rochester, NY 14618. (716) 442-6338

WANTED: Tube deck for Meteor 3-tube regenerative made by The Radio Shop. Photo helpful. Frank White, PO Box 2012, Olathe, KS 66061

CLASSIFIED ADVERTISEMENTS

WANTED: Help! Need 78 rpm record changer, silver and maroon color, for Westinghouse radico/phono Model #H 110 A. Desperate! Lee D. Warner, PO Box 5007, Massena, NY 13662

CLASSIFIED AD NOTICE

Please check your ads carefully before sending them in.

We cannot make changes to classified ads once they are received.

FOR TRADE: My restored, working Zenith for your Zenith 6S321 or 6S322. Working or not. Otherwise will buy. Don Catton, 609 10th St., Silvis, IL 61282

Renew Now & Save!

Renew now before rates go up

PLUS

receive a bonus issue

for renewing early!

See coupon in centerfold.

WANTED: Schematic for 1931 Atlantic grandfather clock radio #31AC! **FOR SALE:** Philco 47-204 leatherette. Grebe Synchrophase MU-1. Philco 37-640. P. Currie, PO Box 738, Chuluota, FL 32766-0738

FOR SALE: Sams Photofacts, tubes. **WANTED:** Unusual U.S. or foreign tubes, Zeniths. Thanks. R. Dobush, 3554 W. 105, Cleveland, OH 44111. (216) 228-4953

ABBREVIATIONS USED IN CLASSIFIED ADS

amp. - Amplifier	ppd. - Postage Paid (included in price)
BC - Broadcast	PS - Power Supply, also "pwr sup"
BO - Best Offer	rcvr. - Receiver
ca. - circa	SASE - Self Addressed Stamped Envelope (Suggest sending a long, No. 10, envelope)
ea. - each	SW - Shortwave
(F.O.S., p. ?) - See page ? in the book <i>Flick of the Switch</i>	UPS - Unsorted Parcel Service
LSASE - A Long SASE (see SASE)	(V.R., p. ?) - See page ? in the book <i>Vintage Radio</i>
LW - Long Wave	w/ - with
MO - Money Order	w/o - without
N.I.B. - New In Box	xcvr. - Transceiver
N.O.S. - New Old Stock (Unused, that is new, original, vintage items)	xfmr. - Transformer
O.T.B. - <i>Old Timers Bulletin</i> published by Antique Wireless Assoc. (A.W.A.)	xmtr. - Transmitter
OB - Original Box	xstr. - Transistor

BY POPULAR REQUEST

CLASSIFIED ADVERTISEMENTS

FOR SALE/TRADE: Tube tester, Hickock 600 – \$50. N.O.S. tubes: 1622/6L6M, 6679/12AT7 – \$3, \$10/4. Want 5881's. Jay Myers, 1010 Graybar Ln., Nashville, TN 37214. (615) 297-5886

WANTED: Tube sockets for UV204A and Western Electric 212D. Zahl Radar tube VT-158 made by Eimac, rainbow colored UV201A, duds Ok. Pre-1930 RCA receiving/transmitting tube manuals. Industrial/special purpose tube manuals or pamphlets. Pre-1987 issues of A.R.C. I like to collect strange type tubes; what do you have? John Walker, 16112 W. 125th St., Olathe, KS 66062. (913) 782-6455

SEND ALL A.R.C. MAIL TO
Antique Radio Classified
P.O. Box 2, Carlisle, MA 01741

FOR SALE: Photofacts and manuals. Send \$2 for purchase refundable numbers list and price sheet. Lee Morrison, PO Box 199, Stony Point, NC 28678

WANTED: Hallicrafters Sky Buddy, S19 or S19R. Philco 37-84 chassis and speaker. Rider's Receiving Tube Substitution Guide. Rider's Volume 20. Jack Hofeld, 61 Trinidad Bend, Coronado, CA 92118. (619) 429-0165

FOR TRADE: My AK 55C chassis & spkr., seven HRO-60 coils (A, B, C, D, E, G & AC) and a Collins 75A3. Need a Crosley 124 chassis & spkr. and a Philco 70 or 90 cathedral. A. Bruno, 24 Butternut Dr., New City, NY 10956. (914) 354-8899

CLASSIFIED ADVERTISEMENTS

FOR SALE: Advent Videobeam Model 1000 projection TV, complete, as is – \$150 pick up only, located New York. Al Weiner, Monticello, ME 04760. (207) 538-9538

HELP: I will pay for time and effort to make me a Polaroid or sketch of the cabinet woodwork in front of speaker grille on a Zenith console Model 10S669. Thank you. William H. Stuber, PO Box 153, Woodward, IA 50276

FOR SALE: Hallicrafters Model S-36 receiver – \$100. Hickock 288X signal generator w/manual – \$55. Ward Becht, 625 Tufts Ave., Burbank, CA 91504. (818) 842-3444

WANTED: Grebe CR-9 cabinet or transformers and large knobs for Grebe CR-5, CR-8, CR-9. Tom Croley, 1808 Linwood Ave., Ann Arbor, MI 48103. (313) 665-7233

FOR SALE: Bulova #M-701 clock cathedral. Stewart-Warner #102A. Green 1950's AM/FM Motorola. 45¢ SASE. Ripley, PO Box 9374, N. St. Paul, MN 55109

WANTED: Portables, Hallicrafters Continental, Westinghouse 185 (F.O.S., p. 184), GE 666 or similar. J. M. Zacher, 39 W345 Central Dr., Elgin, IL 60123

SERVICES: Gardiners TV and Radio Services, Long Island, N. Y. Antique radios and TV's repaired, bought, sold. **WANTED:** Chassis and spkr. RCA 10B. Gardiners TV, 90 Gardiners Ave., Levittown, NY 11791. (516) 731-4600

AUCTION

Saturday, June 24, 1989, 11:00 AM (Preview 9:00 AM)
34555 Center Ridge Rd., N. Ridgeville, OH (10 miles W. of Cleveland)
From private collections we have purchased, we offer the following:

CATALINS, BAKELITES, METAL
Bendix, FADA, Emerson, RCA,
Crosley, Arvin, Zenith

HORNS & SPEAKERS
Western Electric, AK, Magnavox,
RCA, Thompson

COLLECTIBLE TUBES
Several lots including W.E., Welsh,
WD-11's, 12's, Arcturus, DeForest

RADIO & TV ADVERTISING
Banners, signs, neon, lighted

Many misc. books, catalogs, manuals, magazines, battery parts, etc. This is a partial listing due to printing deadline. Approx. 300 lots. Sales tax applies. Send \$1.00 for complete list.

TERMS: Cash. Checks w/approval of auctioneer or owner.

Jerry Canterbury, Auctioneer
5999 Avon Belden
N. Ridgeville, OH 44039
216-327-9394

BATTERY SETS
DeForest, Federal, RCA, Zenith,
AK Breadboard, Michigan,
Operadio, several 1 & 2 tube sets

TELEVISIONS
Floor & table model Predictas, Pilot,
Dumont, Zenith Porthole

**CATHEDRALS, TOMBSTONES,
CONSOLES**
Philco, AK, Zenith, Gloritone,
Stewart-Warner, Grunow, Majestic

Vintage TV & Radio, Owner
3552 West 105 Street
Cleveland, OH 44111
216-671-6712

CLASSIFIED ADVERTISEMENTS

WANTED: Small pocket portables with tubes, especially Belmont Boulevard, Hoffman BP402, Motorola 45P, Westinghouse H508P4, Automatic Tom Thumb 528 & 600, Emerson 838 & 856. Michael B. Schiffer, 2718 E. 10th St., Tucson, AZ 85716. (602) 325-3532, eves.

WANTED: Bearcat 210XL scanner schematic with voltages. Will buy or copy. Richard L. Evans, PO Box 491, Souderton, PA 18964. (215) 257-8906

FOR TRADE: 1936, 1937 Philco. 1933, 1935 Stromberg-Carlson. 1933, 1934 RCA Victor sales folders for 1933-50 Zenith same. Steve Hartwich, 4620 Belleview #2-S, Kansas City, MO 64112. (816) 753-2613, 7-midnight CDT

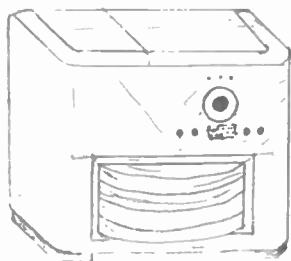

WANTED: Emerson BR224 console radio-phonograph. Robert Wiczkowicz, PO Box 86, Craryville, NY 12521. (518) 325-5307

WANTED: Rider's Volume 5 or 1-5 abridged, and Volumes 19, 20, 21, 22. Doug Burskey, 732 Pulver-List Rd., Mansfield, OH 44905. (419) 522-5669

FOR SALE: Radiola AR812 - \$175. Zenith Major AM/both FM bands - \$60. Thorns TD 224 automatic changer, plays 8 records, one at a time - \$175. H. H. Scott 99 amplifier - \$20. H. H. Scott 314 FM tuner - \$15. BC 348Q w/manual - \$65. RCA 45-J-2 changer - \$5. Zenith Trans-Oceanic 1000 and 1000D - offer. All plus UPS. **WANTED:** Dial glass and escutcheon for RCA T10-1. Leek TL/25 plus amplifier. Brian Dunlop, 2715 Hanovertown Dr., Colorado Springs, CO 80919. (719) 531-7920

WANTED: Hallicrafters T-54, 505 and National TV-7 B&W TV. Excellent or better condition. Richard L. Evans, WA3FOQ, PO Box 491, Souderton, PA 18964. (215) 257-8906

FOR SALE: SASE for list of radios, 40's to 60's. Carl R. Shirley, 824 Fairwood Rd., Columbia, SC 29209. (803) 776-6850

WANTED: Tube type VFO, Heath, Knight, Globe, Eico, etc. G. D. Van Nortwick, K8TTK, 145 N. Rocky River Dr., Berea, OH 44017. (216) 234-6324, collect

CLASSIFIED ADVERTISEMENTS

WANTED: WWII command sets receivers, xmtrs control boxes, mounts, racks, manuals, anything with ARC5 tags. New, junk, used. Joseph Zsak 262-D Paintertown Rd., RD2, Irwin, PA 15642

FOR SALE: Philco cathedrals 60 - \$200, 91 - \$350, 20 - \$375, 39-70 batt. - \$125 + P&H. All mint. List available. Richard L. Bednarcik, 28 Steele Ave., Lincoln Park, NJ 07035. (201) 694-6374

WANTED: Tuning dial escutcheon plate for General Electric model The Lowboy (F.O.S., p. 86). Alan Schreiber, 12805 Powderhorn St., Austin, TX 78727. (512) 835-2056

FOR SALE: Radiola superhet chassis, board mtd. less (7) 199's - \$40. RCA 45 R/P Mod. 93 in orig. small wood cab. - \$15. Geniac kit, so called first computer - \$15. Dictograph substation, 6 levers, single earphone - \$18. Yankee test panel, A & V meters - \$10. WE phono arm - \$8. Supreme 570 AM sig. gen. - \$20. Weston 978 tube tester - \$30.

WANTED: Chassis or circuit, Abbotwares horse radio. Large tuning coil & xtal setup for green Radiola V. Make checks for cost only. Items shipped UPS trans. collect. John Martin, 817 Cook Ave., Billings, MT 59101

FOR SALE: Radio/electronics as portrayed on worldwide postage stamps. List for SASE. Littlewood, PO Box 681, Brookfield, WI 53008

WANTED: Crosley 124 chassis and speaker, prefer working, but will consider restorable junker. P. Majewski, PO Box 92, Tamaqua, PA 18252

rainy day books



OUR NEW ADDRESS:
Bcx 775
Fitzwilliam, NH 03447

frank bequaert
lucia bequaert

Technical Books Catalogs and Magazines Bought and Sold

Wireless - Radio - Telephone
Broadcasting - Telephone
Electronics - Computers
Electric Power - Electric RR
Civil Engineering - Machine Tools
Metallurgy - Mining

*New Lists Always Being Issued
Let Us Know Your Interests*

CLASSIFIED ADVERTISEMENTS

FOR SALE: Majestic Brucewood grandfather clock radio. This set is almost mint and has nine-tube chassis totally restored and original grille cloth. Model 254. Best offer over \$600 will get it. Pick up only. Texaco Havoline Oil Can radio, N.I.B. - \$20 or trade for novelty. Send for Stan's Surplus Stuff to: Stan Lopes, KB6LGV, 1201-74 Monument Blvd., Concord, CA 94520. (415) 825-6865

WANTED: National receivers AGU, AGL, RIO, SW-58. Home brew equipment from ARRL/Radio Handbooks. John Nagle, 12330 Lawyers Rd., Herndon, VA 22071. (703) 620-3066

FOR SALE: Catalin RCA Model 66X8, ca. 1940, highly marbled red in perfect condition - \$950, shipped anywhere; first check owns it. Sparton, 4 knob, copper-colored mirror and metal work, ca. 1935; largest and most elaborate of Sparton mirrored table models, condition - magnificent, all original (wood repainted) - \$8,500. Full year warranty on electronics of both sets. Stephen Despres, PO Box 020775, Brooklyn, NY 11202-0017. (718) 625-7254

WANTED: Hallicrafters SX-88 receiver, working or not. Victor Gregowski, WD8DWR, 3635 Orvall Dr., Port Huron, MI 48060

FOR SALE: New 600v and 450v American-made capacitors. Tubes for AC and AC/DC radios, output xfms., wrinkle paint, veneer, speakers, terminal strips, schematics. Hallicrafters 5R10 and S-53A, both restored. List available from: Sue Coulter, 4200 Prince St., Bakersfield, CA 93301

CLASSIFIED ADVERTISEMENTS

FOR SALE: Akai X-1800SD - \$150. Ampex Micro Cass - \$75. RCA YHB-22T cartridge recorder/test tape - \$150. Uher 4000 Report L, needs work - \$100. Webster Chicago 80-1 wire - \$125. Ronald Palluth, 1917 Hamilton Dr., Flower Mound, TX 75028. (214) 539-9387

WANTED: Knob and dial pointer for red Capehart Model T522 plastic table radio. William Ross, 1041 11th St. N.E., Massillon, OH 44646

FOR SALE: Baird stock certificates, ca. 1930's; Baird Television Ltd. Mechanical television developed by Baird, 1929 (see A.R.C. article March '89). \$45 ea. ppd. Limited quantities. J. J. Papovich, 525 Magnolia Ave., Pitman, NJ 08071. (609) 582-8279

HELP: Need speaker assembly (speaker, output trans., and bracket) for Crosley 515 tombstone. Sidney Allen, Jr., 1908 Rosecrest Dr., Greensboro, NC 27408. (919) 288-4115

FOR SALE/TRADE: Zenith radio H6152, chassis 6G05, brown bakelite with large brass bezel - \$100. Wards Airline radio wood cabinet Model 93BR715A - best offer over \$100. Both sets in good condition. Crystal set Premier Jr. in factory-made wood cab.; this is a rare find - \$100. Stark tube checker Model 9-11, Canada, good working order - \$50. Old Time tube checker made by the Approved Technical Apparatus Co., New York, works OK, wood case - \$50. All prices quoted are F.O.B. Blaine. Mail all inquiries to: Frank Liddell, 8100 Kishiox Rd., Blaine, WA 98230. Or phone: (206) 371-0397

GRILLE CLOTH FOR SALE

#1 Authentic looking general purpose cloth for 1930's table sets and 1930's - 1940's consoles (color is brandy on black)

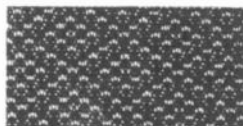

#2 Exact duplication of pattern used in many early 1930's table sets (color is gold on black)

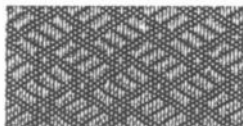

COST (All prices include postage):

(Patterns shown 76% actual size)

10" wide X 12" long	\$ 6.00	(120 sq. inches)
15" wide X 18" long	\$ 11.00	(270 sq. inches)
20" wide X 24" long	\$ 20.00	(480 sq. inches)
51" wide X 36" long	\$ 47.00	(1,836 sq. inches)

Send SASE for samples

Michael Katz
200 East 30th Street, Apt. 8E
New York, N.Y. 10016
(212) 725-0736

Additional patterns will be available after the summer

CLASSIFIED ADVERTISEMENTS

FOR SALE: 1949 TV/radio/phono console, Admiral #4H15-S. Everything complete, original and almost fully working, but TV needs a little work. Everything worked prior to putting in storage. Nice cabinet in excellent condition, but needs refinishing. \$225. Jack Castiglione, PO Box 17134, Long Beach, CA 90807. (213) 426-7916

WANTED: Zenith junker chassis 5714. Used in radio Models 7S323, 7S342, 7S363, 7S364, and 7S366. David Headley, 651 S. Yale, Wichita, KS 67218. (316) 684-0050

FOR SALE: Large quantity new, factory boxed mobile & base, w/T, 2-way radio parts. Motorola, RCA, GE includes 11 ea. RCA CC-701 controls (white), 5 GE solid state 24 to 32v DC inp. power supplies GE 4EP52A rev.e; Air Force navigation stop watch, Type A-8, about 50 years old, 9jewels, Swiss made, A-1, RF communications marine transceiver, 2-16mc xtal control, linear P.P.3-400z, 1 KW output, remote modem F/USB, LSB, AME, T T., C.W., facsimile, data push button operation change, operated from remote location, antenna tuner, 2 to 30 mc, compact, heavy duty power supply. George Belling, 3740 Atlas Ave., Oakland, CA 94619

WANTED: Early tube-type CB's and transistorized walkie-talkies, in good working condition. Gary Cappoen, 18025 NE Chehalem Dr., Newberg, OR 97132

FOR TRADE: RCA 10T11, black lacquer and chrome, restored to perfect. Gaëlle Reboul, 7010 S.W. 48th Ln., Miami, FL 33155. (305) 662-1986

CLASSIFIED ADVERTISEMENTS

FOR SALE: Eveready Book of Radio Stars, mint condition, no markings or tears - best offer. Don Moth, PO Box 73, Chittenango, NY 13037

WANTED: Atwater Kent Model 10 (#4600), or 10 (#4550, #4560 brown, straight coils). Also AK Model 19 (#4880). **FOR TRADE:** Atwater Kent 84, early production run, beautiful condition. Also Russian 4-transistor portable, with instructions. David Kechkaylo, 3935 Bristol Ct., Melbourne, FL 32904. (407) 723-0980

FOR SALE/TRADE: Echophone Superheterodyne cathedral radio Model 10, very good cond., works, no knobs - \$150. Kit of 75 assorted radio dial belts w/measure chart & replacement guide book in original box - \$25. Many Sams Photofacts #'s 1-300, originals and copies. Sign, 19"x19" "Authorized Dealer of G.E. Radio Tubes" - \$25. Rider's Index 1-10 - \$5. Joseph L. Gambaccini, 192 Division Ave., Shelton, CT 06484. (203) 734-0271

WANTED: Command Set receivers BC-946B (520-1500 kHz) and BC-454 (3-6 MHz). OK if converted to 12v but must be working. Paul D. Dilliard, WA8IBT, 1313 E. Wheeling St., Lancaster, OH 43130. (614) 653-5268

FOR SALE: Catalin radios: FADA bullet, maroon body with butterscotch trim - \$750. Rare General Electric, yellow body with maroon inset grille, knobs and handle - \$850. Sentinel radically marbled butterscotch - \$950. All radios in pristine condition. Michael Lawlor, PO Box 50, South Pasadena, CA 91031. (818) 799-2921

The Antique Radio Club Of Illinois And The Antique Wireless Association RADIOFEST '89 - August 10th, 11th, & 12th

**The Holiday Inn Holidome
& Convention Center
345 River Road
Elgin, Illinois 60120
Call (312) 695-5000**

- Auction
- Three-Day Flea Market
- Special Exhibit: Zenith
- Hospitality Suite
- Afternoon Presentations
- Friday Evening Awards Banquet



- Donation Auction
- Old Equipment Contest
- Ralph Muchow's Fabulous Radio Museum

Info: Carl Knipfel, Rt. 3-Veterans Rd., Morton, IL 61550, (309) 266-9440

CLASSIFIED ADVERTISEMENTS

FOR SALE/TRADE: Magnavox AC2C two-stage amp w/two good WE VT-2. Henry Brown, 2 Central Ave., Morris Plains, NJ 07950. (201) 538-2014

WANTED: Pilot TV-37 3" TV, excellent or better condition. Richard L. Evans, PO Box 491, Souder-ton, PA 18964. (215) 257-8906

FOR SALE: Recording wire - \$3.50 plus shipping per N.O.S. unused 7200 ft. reel. P. Majewski, PO Box 92, Tamaqua, PA 18255

WANTED: For 1932, Model 91, American Philco cathedral. Original type speaker. Ernest D. M. Yeaw, RR#3, Tatamagouche, Nova Scotia, Canada B0K 1V0. (902) 657-2554

FOR SALE: Kaydel vintage 40's wood moisture test set, uses #30 tube, in fitted case. Steve Imms, 541A Old Shannock Rd., Wakefield, RI 02879. (401) 783-5387

WANTED: Working RCA 45 changer only, or source for new rubber drive and cams. W. E. Rogers, KE4ND, 13305 Court Ridge Rd., Midlothian, VA 23112. (804) 744-3955

FOR SALE: Signal GE URM25D 10 kHz & 50 MHz AM w/ACC - \$65. ME 30 F/U similar to H-P 400F solid state - \$75. ME 30B/U older tube version - \$30. I-199 DC load up to 60 amps - \$85. Govt. rec. bridge ZM30 - \$75. Govt. rec. signal gen. URM 48 19.5 MHz 102 MHz FM - \$50. NATO markings - \$50. VOM TS-297 - \$25. Prices do not include shipping. Please add funds for shipping. Steve Barkowski, 4923 W. 28 St., Cicero, IL 60650

Please Save this Want List!

WIRELESS SPECIALTY APPARATUS CO.

Eaton Circuit Driver - Type Triode D
(The 1-tube unit with a meter)

ADAMS MORGAN CO.

RA-6, RB-2 & Type THREE

GREBE

The following small units:

RORC (2-step Amp)

RORD (Det/Amp with external rheostats)

RORG & RORL (Det/Amp)

RORJ (2-step Amp)

KT-1 (Portable Receiver)

CR-7 (Internal-tube version)

As it may be a long time before I find some of the sets listed in these ads, remember to call me when you can part with yours. I am putting together a collection of early broadcast and wireless equipment and adding to it each month. I buy single sets or collections. Also: books, catalogs, manuals and other related documentation.

Call and surprise me; make my day!

John V. Terrey, 498 Cross Street
Carlisle, MA 01741 - (508) 369-9770

CLASSIFIED ADVERTISEMENTS

FOR SALE/TRADE: Atwater Kent Model 37 with speaker. Sparton Jewel wood console. Color plastic table radios. SASE for list - tubes, germanium transistors, test equipment. Stephen E. Lipsky, W2VVN, 1254 Cox Rd., Rydal, PA 19046. (215) 884-1817

WANTED: Johnson Viking Valiant and Ranger ham xmtrs., excellent condition or better. Richard L. Evans, WA3FOQ, PO Box 491, Souder-ton, PA 18964. (215) 257-8906

CLASSIFIED AD DEADLINES

Jun. 10 for Jul. 1989 Issue

Jul. 10 for Aug. 1989 Issue

Aug. 10 for Sep. 1989 Issue

FOR SALE: Bosch Amerola - \$350. AK 40 - \$125. RCA 810T big tombstone - \$125. RCA T6-9 tombstone. RCA 7-T-1 tombstone - \$135. Air-line 62-148 tombstone - \$100. Philco (sim. F.O.S., p. 124) Model 116 - \$100. Edison-Bell 5-33 - \$500. Admiral 1941 small AC-DC wood - \$60. Philco 39-25 slant-front - \$100. Automatic Radio 1940, big oval dial tuning eye - \$150. GE L660 Deco wood and chrome - \$125. Ace Model D Deco, black face, tuning eye - \$150. West. WR272 - \$85. RCA 26X4 - \$60. Blaupunkt Granada - \$125. RCA 87T - \$65. West. WR212 - \$125. Several AC-DC batt. portables. RCA Strato-World 3BX671 - \$125. Jukeboxes: Ristaurat table model selectable light-up - \$900, non-selectable model - \$400. All of the above radios are good to excellent, and all work fine. Pictures available. Chris Cuff, Old Colchester Tpke., P.O. Box 97, East Haddam, CT 06423. (203) 873-8762, no phone calls after 8 pm EST, or (914) 796-3425 from May 20 to May 29

WANTED: Manuals or photocopies for: Heathkit TC-3 tube checker, Clough-Brengle 26A Graphoscope. Simon Cloughton, PO Box 460, Port Credit Stn., Mississauga, Ontario, Canada L5G 4M1. (416) 826-0708

FOR SALE: Eico tube-type preamp HF-61, works, no manual - \$25 ppd. R. J. Eastwick, N2AWC, 224 Chestnut St., Haddonfield, NJ 08033. (609) 429-2477

WANTED

**Antenna Nameplate & Phone Post
Thumbscrew For AK10C**

**Information On Chelsea Radio
Regenerative Receiver No. 104.**

Paul R. Levesque
705 Oneawa Street
Kailua, Oahu, Hawaii 96734-2053
(808) 263-6398

CLASSIFIED ADVERTISEMENTS

FOR SALE: Marconiphone cabirets. Mercury cabinet. Marconi Jets. A. R. Nolf, 539 Kastelic Pl., Burlington, Ontario, Canada L7N 3S9. (416) 639-4768

WANTED: E. H. Scott and McMurdo sets, chassis, cabinets, literature, Tauscher sound boards. Mike Greene, 19113 Alpenglow Ln., Brookeville, MD 20833. (301) 774-3203

FOR SALE: Bendix Model 526C, green and black catalin, excellent, original with back - \$500 + UPS. John Kern, 2320 Rosedale Rd., Quakertown, PA 18951. (215) 538-2128

WANTED: Crosley crystal set. Ace Precision Equipment sets. **FOR TRADE:** All my repwoods. **FOR SALE:** Federal Jr. - \$135. Crosley 51 - \$50. Craig Ball, 204 N. 5th St., Marshalltown, IA 50158. (515) 752-0406, after dark

FOR SALE: All working: Hoffman A300 radio, 1946, knobs not original, refinished - \$30. Quasar BW video camera with power supply for VHS/Beta VCR, excellent - \$30. John Eng, 5151 Del Ester, LaPalma, CA 90623. (714) 220-1965

WANTED: Shortwave DX trophies, certificates, awards. Shortwave Scouts membership pins & badges. Shortwave broadcast station QSL's. Would like to own R.N.'s "Denton DX Trophy." Shortwave & Televisions "DX Trophy," "VAC" certificate. Any accessories from Radio News "Short Wave League." Between years. 1930-1941. Thanks! John R. Packer, 6426 N. Silvery Ln., Dearborn, Heights, MI 48127

CLASSIFIED ADVERTISEMENTS

FOR SALE: Large selection of old radio tubes, used and N.O.S. Also TV tubes. SASE for price list. Jack Hofeld, 61 Trinidad Bend, Coronado, CA 92118

WANTED: Radio Rider's 18 and up. QST before 1923. Broadcast type wire recorder. Tom Earnest, PO Box 603, San Angelo, TX 76902

FORSALE: Used and N.O.S. dial glasses, including Philco 27-5435, RCA 35124 & 33289, Detrola 3951, others, mostly 40's and 50's table sets. Send SASE. Most \$9 ea., plus \$1 shipping. Early hi-fi collectors - still some stuff left from my March '89 A.R.C. ad, p. 32 - make offers! True "dual mono" amp, 19" rack mount, PP 6L6's into Saratoga xfmr's., rusty but works - \$75. GE J86 chassis, rusty - \$15. Grunow 7B chassis - \$25. SASE for my famous volume control list and speaker reconing info! Mark Oppat, 167 Caster, Plymouth, MI 48170. (313) 455-4169

WANTED: RCA Model 75X17 with red base color, 1947. Also, Guild Corporation history/notes. Gerald Schneider, 8750 Georgia Ave., #1410-B, Silver Spring, MD 20910. (301) 565-2840

FOR SALE: Atwater Kent tombstone Model 545, working, nice - \$125. Arborphone chassis and front panel, 8 tube AC chassis, approx. 1928, appears complete, untried, 1 RF coil needs rewind, no tubes - \$15. **MESSAGE:** Will Mr. Chestnut contact me regarding conversation at last Nashua meet about Radiola AF transformers? John Bayusik, 178 Eastside Dr., Wallingford, CT 06492. (203) 265-6521, 6-10 pm

ARBE* - III

*

ANTIQUE RADIO BATTERY ELIMINATOR



- FEATURING -

- * 8 DIFFERENT 'B' AND 'C' VOLTAGES.
- * ADJUSTABLE HIGH CURRENT 'A' SUPPLY.
- * SHORT CIRCUIT PROTECTION.
- * ALL OUTPUTS ELECTRICALLY ISOLATED.
- * 5 YEAR WARRANTY.

CALL OR WRITE FOR COMPLETE DATA SHEET.
ANTIQUE RADIOS
P.O. BOX 6352
JACKSON, MICHIGAN 49204
517-750-4992 AFTER 7:00PM EST.
AND WEEKENDS.

CLASSIFIED ADVERTISEMENTS

WANTED: Complete antenna assembly and ivory on/off knob for Philco Predicta Debutante (H3408). Alexandria Nelson, 9225 Evangeline NE, Albuquerque, NM 87111. (505) 291-9468

WANTED: McIntosh, Fisher, Scott, J.B.L. speaker systems for top prices. Call me with your highest offers. Ed Schneck, N.Y.S.I. (718) 377-7282

WANTED: Micro-Vox toy transmitter. Also Philmore 2-tube regenerative set. Stanley Caesar, 512 Country Club Cir., Midwest City, OK 73110

WANTED: Philco R.M.S. yearbooks, all except 1941. Also Rider's Volumes 17, 18 and 20. Gregg Humanic, 540 Wicklow Ln., Monroe, OH 45050. (513) 539-8926

FOR SALE: Hallicraters S-39 Sky Ranger receiver, vg condition with manual copy - \$125 plus UPS. Murray Shapiro, 2931 Northwood Dr., Endwell, NY 13760. (607) 748-0233



PHILCO 38-690XXX

WANTED: Philco 38-690XXX, or 37-690X. Vernon Oehlke, Box 307, Ghent, NY 12075. (518) 392-4945

WANTED: Keys, bugs and telegraph instruments. Also related parts and publications. Will purchase or trade like kind. I am a collector not a dealer. This is an affair of the heart, not the wallet. Warren Berbit, K2UVV, 46A Mile Road, Suffern, NY 10901

INDIVIDUAL PHOTOFAC TOLDERS. From sets under #1400 - \$4. Over #1400 - \$6. Pre-paid First Class postage included. Also full stock Sams specialized books. Allen J. Loeb, 414 Chestnut Lane, East Meadow, NY 11554. (516) 481-4380

FOR SALE: Reproduction dial glasses for Catalins. FADA 652 and Sentinel 284 - \$35 ea. plus \$2 postage. Radioart, Box 102, Centerbrook, CT 06409

SOLID STATE VIBRATORS for most automobile radios 1932-57. Exact duplicates of original styles in metal cans. Long SASE for catalog, dealer pricing on request. Antique Auto Radio, Box 892, Crystal Beach, FL 34681. (813) 785-8733.

CLASSIFIED ADVERTISEMENTS

CLASSIFIED AD NOTICE

Please check your ads carefully before sending them in.

We cannot make changes to classified ads once they are received.

FOR SALE: Blue Racer Vibroplex bug, looks old, works fine, with case - \$35. Cathode ray tubes 2AP1, 913, 3KP1, 902A, (2) 902; believe good, but can't test, no guarantee - \$50/all. Three Johnson Messenger VHF transceivers, 30 MC range, with nice mikes - \$15/all 3. About 85 QST's, 1925 thru 1936, many in 1920's - \$60/all. Other dupes, some old. List SASE. Sylvania tube TV camera. Impressive looking, three very high quality lenses, can't guarantee - \$45. All plus UPS. Paul C. Crum, W9LC, 6272 N. Cicero, Chicago, IL 60646. (312) 282-3033

WANTED: Early quack medical violet ray devices and any other interesting types. Richard Cane, 8391 NW 21 St., Sunrise, FL 33322. (305) 741-6838

BOXED CLASSIFIED ADS WORK! This is a boxed classified ad. These ads can be run more than two months. See the inside back cover for details. Boxed ad deadline: the 5th of the month.

WANTED: SONY Radios and small TV's... the older the better! Please call or send details: Jay Lewin, 400 East 54th St., New York, NY 10022. (212) 935-5656

WANTED: Small wood radios 1948 and prior. Condition of cabinet (within reason), grille cloth, missing knobs etc. not important, but must play, be otherwise complete and be very reasonably priced. R.J. Hulbert, PO Box 37, Creston, CA 93432. (805) 239-7762

WANTED: Broadcast-type MICROPHONES. Early carbon, condenser, ribbon, dynamic, etc. Cash or trade. James Steele, 160 West 77th Street, New York, NY 10024-6942

WANTED: Collector searching for RCA combination radio-phonograph Model RAE 79 (don't laugh). Any in captivity that might be for sale? Jim Weston, 3750 - 21st St., San Francisco, CA 94114

WANTED: FADA, DEWALD, SONORA, and Mirror Sets. Bill Cress, 28 Worcester Dr., Wayne, NJ 07470. (201) 694-5154.

MILITARY RADIO BATTERY Adapter Units. No modifications required. Form-fit. Direct connect socket. Use standard batteries. For radio sets: BC-611, AN/CPRC-26, AN/JRC-68, AN/PRC-6, 8, 9, 10, 25, 28 & 77, AN/PRT-4, AN/PRR-9. We have operator technical manuals too. Act Now! Send \$1.00 for details: TNM Enterprises, P.O. Box 2330-AR, Anaheim, CA 92814-0330.

CLASSIFIED ADVERTISEMENTS

FOR TRADE: Magnavox M-1A base and driver for Magnavox R-3C base and driver. H. Brown, 2 Central Ave., Morris Plains, NJ 07950. (201) 538-2014

WANTED: Federal Type 65 audio transformers. Any information other than Fider's on Federal 59. James S. Fisher, 344 Harrison Ave., Manville, NJ 08835. (201) 725-7476

WANTED: Crosley chassis #123 and 54 for Super Buddy Boy and Buddy Boy. Also need chassis for Wigitt, don't know the chassis number. **FOR TRADE:** 24" beer bottle radio for Crosley Wigitt, Elf or Super Buddy Boy. **FOR SALE:** Kennedy Coronet, very good condition, works fine - \$350. Coronado 32 volt, really beautiful and different table model - \$75. Coronado tombstone, small set, very nice & works good - \$75. Crosley Fiver, refinished mahogany cabinet, works good - \$70. Early variometers, wood, bakelite - \$20 ea. Bob Barnes, Box 275, Monroe City, MO 63456. (314) 735-2945

WANTED: AK 55 chassis and speaker. I have wooden cabinet. James Alexander, 2304 W. Michigan, Fresno, CA 93705. (209) 227-8851

FOR SALE: Phono Needles & Cartridges (ceramic - magnetic). What do you need? Send SASE. J. J. Papovich, 53 Magnolia Ave., Pitman, NJ 08071. (609) 582-8279.

FOR SALE: Used tubes, tested good. Low prices. Send SASE for list. E&E Enterprises, 954 Johnston Dr., Aurora, IL 60506

WANTED: Metal detector, treasure finder, and geophysical prospecting instrument construction plans such as those advertised by Grepack Company or Technifax in the 1930's and 1940's. Also wanted are early technical papers, photographs, schematics, instruments and related information pertaining to metal detectors. B. Bart Henson, 7608 Teal Drive SW, Huntsville, AL 35802.

HIGHEST PRICES PAID FOR THE FOLLOWING GERMAN WWII ELECTRONIC EQUIPMENT: TONSCHREIBER b. Reel-to-reel tape recorder. Consists of two boxes. Will pay up to \$2,000. E53 or E54. VHF receiver. Made by TELEFUNKEN. 25 MHz to 70/120 MHz. Optical projection dial. Will pay up to \$1,500 for E53, to \$2,000 for E54. SG-220. CRT indicator. Uses two 3" CRT's. Size about 8x8x8 inches. Will pay up to \$500. EZ-6. Navigation receiver. 150 kHz to 1.2 MHz. Size about 8x7x8 inches. Will pay up to \$300. Also certain other German WWII aircraft communication and radar equipment. Prices depend on the completeness and condition of the equipment. **ONE MAN'S JUNK IS ANOTHER MAN'S TREASURE. FOR QUICK MONEY PLEASE SEND DESCRIPTION AND/OR PICTURE TO:** Steve Schreiner, Rte. 1, Box 342 A, Maricopa, AZ 85239. (602) 424-3247

CLASSIFIED ADVERTISEMENTS

WANTED: Pre-1926 radios, amplifiers, and horn speakers, complete or parts. Richard Anthony, 2551 Andler Rd., Placerville, CA 95667

WANTED: Photos of Cortland St., N.Y.C. (Radio Row) 1922-39. Correspondence from I.R.E. members listed in my 1927 I.R.E. yearbook or anyone who dealt with City Radio Co. Also want old I.R.E. assoc. pin. H. L. Schneck, c/o E. Schneck, 1401 Ocean Ave., Brooklyn, NY 11230

FOR SALE: Zenith Trans-Oceanic 3000-1, excellent - \$140 + UPS. **WANTED:** RCA Strato World 1-MBT-6. Zenith Trans-Oceanic R7000-1 (chassis 2WKR70 or 2WMMR). Gary Stejskal, 1412 26 St., N.W., Cedar Rapids, IA 52405. (319) 396-0341, eves.

FOR SALE/TRADE: DeForest D-7A, 3 tubes included, AM band tuning coils 3 included, no loop antenna. C. E. Leavenworth, 15591 Primrose Ln., Westminster, CA 92683. (714) 894-5672

WE'RE STILL HERE! Tubes: "Oldest," "Latest." Schematics. SASE for lists to Steinmetz Electronics, 7519 Maplewood Ave., Hammond, IN 46324

WANTED: Early tube hi-fi components and studio equipment by Acrosound, Brook, Brociner, Fairchild, Hadley, Marantz. Also want Western Electric amplifiers, speakers, tubes, microphones. Richard Sharisky, PO Box 521, Belmont, MA 02178. (617) 484-5784

WANTED CATALIN radios, no cracks or chippings, with original handles and knobs, with the original back, in mint condition. **WANTED** also BING CROSBY JUKEBOX for children. We accept only offers containing pictures and relative prices. Payments in U.S. cash. Write or call to: OLD snc. Mrs. Elizabeth De Angelis, Via Duchessa Jolanda 13/A, 10138 TORINO ITALY, ph. 011-39-11-830417.

WANTED: Two-color Catalin radios from the 30's and 40's. Top prices paid. I am not looking for bargains, just good radios for my collection. FADA, Motorola, Garod, Emerson, Addison, etc. Michael Lawlor, P.O. Box 50, South Pasadena, CA 91031. (818) 799-2921.

FOR SALE: ZENITH DIAL BELTS, new - \$10.00 ppd. Need model and/or chassis # or send old belt. E. Hoard, Box 38, Lehr, ND 58460

DAN'S SCHEMATIC SERVICE. Radio diagrams, 1921 to 1951 - \$2.50 PPD. T.V. diagrams, 1938 to 1952 - \$3.50 PPD. Send make and model number of set, or chassis layout sketch with tube types, if model number is unknown, to: Dan's Schematic Service, P.O. Box 53061, San Jose, CA 95123.

CLASSIFIED ADVERTISEMENTS

FOR SALE: Rider's 9 through 13 - \$12 ea. Large list old radio books & magazines - SASE. Bill Rolf, 30131 Center Ridge, Westlake, OH 44145. (216) 871-4547

WANTED: Freed-Eisemann 374, 375, and Thor-darson R-100 audio transformers. Mint cathedral, tombstone, and crystal sets. Bob Silva, PO Box 2364, Oak Bluffs, MA 02557. (508) 693-6436

FOR SALE: Numerous battery sets, some horns and speakers. QST from Aug. 1920 thru Aug. 1934. Send LSASE for list. David Elia, 132 E. Melton, Longview, TX 75602

WANTED: Popular Electronics: October, December 1954; January, February 1956; January, July, November 1958. Alvin Bernard, PO Box 690098, Orlando, FL 32819. (407) 351-5536

FOR SALE: Send SASE for our list of radio, TV books and mags. Ex-collector. Cliff Stout, 2241 E. Broadway, Muskegon, MI 49444

HAS YOUR SUBSCRIPTION***EXPIRED?*****It has if your mailing label reads
"JUN88" or earlier.**

RENEW NOW: Rates go up soon.
Renewals received after August 1
will be at new rates.

BONUS: Renew before the end of
your "EXP" month and receive 13
issues per year instead of 12!

Current renewal rates are:
\$19.00 for Second-Class Mailing
\$28.00 for First-Class Mailing

(Two-year renewals are twice above rates.)

WANTED: Uncle Sam tuning coil. AK 337, 825, and others. AK breadboards and parts, junkers OK. Bob Nicholson, 3423 S. Long, Topeka, KS 66605. (913) 266-9473

WANTED: WE amps highest offers. Paying: WE 211 - \$25, WE 300A/B - \$100, WE 350B - \$50, also 8005 - \$40. Need 811 and 812 also. Ed Schneck, 1401 Ocean Ave., Brooklyn, NY 11230. (718) 377-7282

FOR SALE: Junker chassis, all very rough. Majestic 90. G-2 speaker. FADA 762. RCA phono. Kolster. Chargers: Westinghouse, Majestic, White, Philco. \$7 ea. plus shipping. Anthony Matt, PO Box 584, Chelmsford, MA 01824

WANTED: Hallicrafters SX43, SX71; complete or parts. Popular Science. Radio For the Millions. Editors/Engineers - surplus conversion 1, 2. CQ - surplus conversion, surplus schematics. Paul Caudell, 420 East 9, Bloomington, IN 47408. (812) 339-3846

CLASSIFIED ADVERTISEMENTS

WANTED: Rider's Radio Manuals 19, 20 and 21. Power supplies for RCA Radiola 17 and AK 40. Dan King, 1230-B Juniper St., Gilroy, CA 95020. (408) 847-1345

WANTED: 1936 RCA radios with chrome trim (especially 10K11, 10T11, etc.) in any condition for top current price. Ed Schneck, 1401 Ocean Ave., Brooklyn, NY 11230. (718) 377-7282

WANTED: Early Magnavox tubes dead or alive. Tipped 01-A duds. Copy of label from bottom of Murdock spark coil. Spark trans. components to go with the Murdock. Larry Schiebel, 5834 Balsam Rd. #3, Madison, WI 53711. (608) 276-7768

FOR TRADE: Midwest radio catalog 1938. Trade for mid-late 30's TV literature. R. Brewster, 454 Diablo Dr., Pittsburgh, PA 15241. (412) 833-4287

WANTED: Scott World's Record radios manufactured by the Scott Transformer Co. in the late 20's. Also E. H. Scott radios, any Scott literature and parts. **FOR TRADE:** I have many rare and unusual sets including FADA, Garod, Emerson and Bendix Catalins, Hopalong Cassidy, Charlie McCarthy, RCA Mexican, Philco 70 and 90 and other cathedrals, etc. available for trade. Jack Sacra, 1720 Solomon Rd., Charlottesville, VA 22901. (804) 293-9985

WANTED: Colored Catalin and bakelite radios of 30's, 40's, 50's. I am a collector only, and will pay top price for good radios. FADA, Addison, Sonora, Garod, etc. Sandra Mills, 5782 Florence Terrace, Oakland, CA 94611. (213) 428-0431

WANTED: Zenith Stratosphere, 25 or 16 tubes. Other Zenith radio and stuff, will buy or trade. **FOR SALE:** GE Treasure Chest J-62 - \$100. Transistor radios: 2 Plush Poodles - one white, one black, Japanese, early 60's - \$60 ea., \$105/2; telegraph key, "waco" beeps like key, brass & plastic - \$90; Zenith Royal 500 w/case, salmon - \$95; Realtone 6-transistor, thin, mint, in flat jewelry case - \$85; Zenith 1000-D, very nice - \$175; Zenith R650L - \$35. Zenith Trans-Oceanic 6T412, cowhide - \$200; RCA Trans-Oceanic 3BX 671, cowhide - \$145; GE portable AM shortwave, Model 260 - \$120; its AM only look alike - \$65; Capehart - \$95. Cathedrals: RCA 120, 99% - \$200; Philco 20 refinished - \$175; Zenith 805 - \$200; Philco 37-89 - \$120. Tombstones: Zenith 5S127 - \$185; Zenith 6S128, 240; RCA R-74 - \$175; GE H-530, rare - \$135; Arvin Rhythm Maid - \$225. Plastics: Crosley Trouper (B.F.T.P., p. 309) - \$75; Detrola Pee Wee, swirly brown with white feet & knobs - \$190; Truetone Belmont D-731 - \$90. Catalin: Bendix 520 - \$175. **FOR TRADE:** Emerson green Catalin tombstone, as is; RCA green Catalin Little Nipper, as is; mint Philco 90 (F.O.S.) - \$11.95 + \$2 shipping. Shipping extra, satisfaction guaranteed. Alan Jespersion, PO Box 17338, Minneapolis, MN 55417. (612) 727-2489, ans. mach. after 4 rings

CLASSIFIED ADVERTISEMENTS

FOR SALE: Art Deco Crosley 60, has ladies on front panel, good, about 18" long - \$89. Radiola B battery eliminator, 19"x9", v. fine, Model AP 937 - \$58. Old radio batteries. Bed lamp white bakelite radio - \$55. 12" GE brass blade fan, oscillates, fine condition - \$85. Edison Mabry, 715 W. Longview, Mansfield, OH 44906. (419) 526-1175

WANTED: Index for Rider's Manual, Vol. 14. Paul Gunzenhauser, R.R. #1, PO Box 133, Garden Grove, IA 50103. (515) 443-2161

HELP: Hammarlund parts; where did they go? Need HQ-170 series 160-80m dual osc. coils in can, p/n K38935-2. Richard L. Evans, WA3FOQ, PO Box 491, Souderton, PA 18964. (215) 257-8906

FOR SALE/TRADE: Signal Corps U.S. Army BC 110 transmitter. Signal Corps U. S. Army receiver-transmitter BC 654A. Collins transmitter Type 30W with tubes and crystal, ca. 1932. Hammarlund-Roberts Comet Pro receiver with complete set coils and tubes. RCA TV Model T-100. Factory built heavy duty, mobile M.G. power supply. Phil Weingarten, 67-61 Alderton St., Forest Hills, NY 11374. (718) 896-3545

WANTED: Information on wooden table radio (Maximillian) R-50. Manufacturer and age. Thanks. D. Salerno, 1104 S. Main St., Taylor, PA 18517. (717) 562-1154

FOR SALE: Send SASE for free large list of magazines, dozen radio under \$40, etc. P. Majewski, PO Box 92, Tamaqua, PA 18252

CLASSIFIED ADVERTISEMENTS

WANTED: Glass dial or reproduction tubes: ECH21, EAF41, EF42, EF22, EL42, ITT (409) 5U4GB or substitute, circuit diagram, for Philips receiver Model 8X675V, made in Holland, 1949. Book that explains how to substitute tubes for transistors, and all the information could be obtained on this model. I'd like to contact an antique electronic supply for antique Philips parts in Holland, U.S.A., or other country. Mario Portalatin, 1628 N.W. 16th St., Suite 3, Miami, FL 33125. (305) 545-9121

HELP: I have a Leutz Seven Seas cabinet without a chassis and speaker. The chassis is a Model 7CS. If anyone can help me I'd appreciate hearing from you. The chassis need not be in working order. Thanks. Brian Durlup, 2715 Hanovertown Dr., Colorado Springs, CO 80919. (719) 531-7920

WANTED: Espey TV 3" ca. 1949, partial or complete. Also need company history, any other info. Richard L. Evans, PO Box 491, Souderton, PA 18964. (215) 257-8906

FOR SALE/TRADE: Wurlitzer S-7 cathedral - \$300. AK 84 grille - \$15. Zenith black dial tombstone - \$45. 1L6 tubes N.I.B. - \$10. 32-volt vibrator - \$15. Super Wasp coils, original box - \$35. Talking tape antenna, original box - \$10. Telefunken's Gavotte - \$45, and Heligo - \$75; both very nice. Large Philco Model 42-350 with old FM band - \$75. EverReady Model 20 chassis - \$12. Many 1940 to 1955 German sets, inquire. **WANTED:** Pilot tombstones and cathedrals, and pre-WWII German sets. Bill Moore, 1005 Fieldstone Ct., Huntsville, AL 35803. (205) 880-1207

WANTED

ELECTRON TUBES - ST SHAPE

50, ST19, large size	\$30	80, ST14	\$4
45, ST14	15	2A3, VT-52, VT-62	6

ANTIQUE GLOBAL SHAPE TUBES

37/237	5	145/245/345	15
250,350,450	30	210/310	10
80/280/380	10	UV202, Tip, Brass Base	25
UV201, Tip, Brass Base	12	UV216, Tip, Brass Base	20

TRANSMITTING TUBES

211/VT-4C/RS237	15	845/845W	30
-----------------------	----	----------------	----

WESTERN ELECTRIC TUBES

101D, F, G/102D, F, G, E/216A/104D/D86326/D86327 Tennis Ball	20	VT2/205B	35
VT1/203B	20	101D, F/102D, F/104D, ST	6
205D, E, Tennis Ball	40	205F, ST	15
244A	6	262A/262B	10
252A	100	274A/274B	30
271A	30	300A/300B	80
275A	30	339A	20
348A	10	349A	6
350B	30	211D/211E	40
242C/261A/276A	25	284D	70
212D/212E	70		

TRIAL ELECTRIC PRODUCTS, INC.

201 Common City Yotsuya, 4-13 Suga-Cho, Shinjuku-Ku, Tokyo 160 Japan



ARKANSAS - June 1

**ANTIQUÉ RADIO COLLECTORS CLUB
OF FT. SMITH - CLUB MEETING**

Ft. Smith, AR - Red Cross Bldg.
1709 S. Greenwood - 7:30 pm

Info: Wanda Conatser - (501) 646-7147

ARKANSAS - June 8

**ARKANSAS ANTIQUÉ RADIO CLUB
CLUB MEETING**

Little Rock, AR - The Auditorium
S.W. Bell Bldg., 120 W. 8th St. - 7 pm

Info: Tom Burgess - (501) 565-1750

CONNECTICUT - June 1-3

**ANTIQUÉ RADIO CLUB OF AMERICA
1989 CONVENTION - ARCA-89**

Mystic, CT - Ramada Inn - Exit 90 off I-95
PO Box 427, Mystic, CT 06355
(203) 536-4281

June 1: Sunup - Flea Market
Seminars - Contest

2-6 pm - Trip to N.E. Museum of
Wireless & Steam in R.I.

June 2: Sunup - Flea Market
Contest - Seminars - Banquet

June 3: Sunup to Auction - Flea Market
8:30 am - Old Equipment Auction

Noon-7 pm - Trip to
Voice of the 20's Museum

Hourly Van to Local Attractions

Info: ARCA, Bill & Jane Denk
81 Steeplechase Rd., Devon, PA 19333

TEXAS - June 17

**VINTAGE RADIO & PHONO. SOCIETY
SUMMER SWAPFEST**

Irving, TX - 906 Senter - All Day

Info: VRPS, PO Box 165345, Irving, TX 75016

WASHINGTON - June 18

**PUGET SOUND ANTIQUÉ RADIO ASSOC.
SWAP MEET - MEETING**

North Seattle, WA - Ronald School
N. 175th St., 1-mile W. of I-5

11 am: Swap Meet - 1 pm: Meeting

Info: Max Kaplan, 14902 84th Ave. Ct. NW
Gig Harbor, WA 98335 - (206) 851-4187

NEW YORK - June 3

**GREATER NEW YORK
VINTAGE WIRELESS ASSOCIATION.
CLUB MEETING & FLEA MARKET**

Orient, Long Island, NY - 1 pm
Ralph Williams' Voice of the 20's Museum

Info: Bob Scheps - (516) 928-1260, or
Chris Bacon - (516) 981-6538

MICHIGAN - July 21-22

**MICHIGAN ANTIQUÉ RADIO CLUB
EXTRAVAGANZA '89**

Lansing, MI - Dillon Inn, 525 W. Canal Rd.
For room reservations: (517) 627-8381

July 21: 8 am - Open-Air Flea Market
Programs - Women's Luncheon
7 pm - Equipment Auction

July 22: Dawn-Noon - Open-Air Flea Market
Programs - Luncheon & Contest Awards

2 pm - Donation Auction
50/50 Raffle Both Days - Equip. Contest

Info: Jim Clark, 1292 Starboard
Okemos, MI 48864 - (517) 349-2249

OREGON - June 3-4, 10

**NORTHWEST VINTAGE RADIO SOCIETY
BUSINESS MEETING - DISPLAY**

Oregon City, OR - Buena Vista Clubhouse
16th and Jackson Streets - 10 am - June 10

June 3-4: Display - Seaside Ham Convention

June 3: 9 am-4 pm - June 4: 9:30 am-1:30 pm

Info: Dan Howard, 2940 SE 118th Ave.
Portland, OR 97266 - (503) 761-7799

ILLINOIS - Aug. 10-12

**ANTIQUÉ RADIO CLUB OF ILLINOIS &
ANTIQUÉ WIRELESS ASSOCIATION
RADIOFEST '89**

Elgin, IL - Holiday Inn
345 River Rd. - (312) 695-5000
Exit Rt. 31 South on I-90

Flea Market - Old Equipment Contest
Ralph Muchow's Radio Museum

Info: Jeff Aulik, 803 N. Chicago Ave.
Rockford, IL 61107 - (815) 399-1902

Attend a club event near you and learn, meet others in
the hobby, and perhaps find an item for your collection!

RADIO CLUB LISTINGS

CLUBS: Send antique radio club and meet information to A.R.C. for free listing here, as space permits. Sorry, we don't have room for hamfests. Always send a SASE when writing to clubs!

Antique Wireless Association (AWA). P.O. Box "E", Breesport, NY 14816. Pub: *The Old Timer's Bulletin*, quarterly. Dues: \$10.00. National and regional conventions. Museum.

Antique Radio Club of America (ARCA). William Denk, 81 Steeplechase Rd., Devon, PA 19333. Pub: *The Antique Radio Gazette*, quarterly. Dues: \$12.00. National and regional conventions. Regional chapters.

Antique Radio Club of Illinois (ARCI). Carolyn Knipfel, Route 3, Morton, IL 61550. Pub: *ARCI News*. Dues: \$12.00. Annual Radiofest and additional meets each year.

Antique Radio Collectors Club of Ft. Smith, Arkansas. Wanda Conatser, 7917 Hermitage Dr., Ft. Smith, AR 72903. Monthly Meetings.

Arkansas Antique Radio Club (AARC). Tom Burgess, P.O. Box 9769, Little Rock, AR 72219. Pub: None. Dues: \$5.00. Monthly meets.

Arizona Antique Radio Club (AARC). Treasurer, 8311 E. Via de Sereno, Scottsdale, AZ 85258. Pub: *Arizona Antique Radio Club News*, quarterly. Monthly meetings.

California Historical Radio Society (CHRS). Paul Bourbin, 25 Greenview Ct., San Francisco, CA 94131. Pub: *CHRS Journal*, quarterly. Dues: \$15. Quarterly swap meets.

Cincinnati Antique Radio Collectors (CARC). Tom Ducro, 6805 Palmetto, Cincinnati, OH 45227. Informal organization. Write to be put on mailing list. Two meets per year.

Colorado Radio Collectors (CRC). New club forming. Johnny Johnson, 2201 Newton St., Denver, CO 80211. Pub: Not yet. Dues: \$10.00. Quarterly meets.

Greater Boston Antique Radio Collectors (GBARC). Richard Foster, 12 Shawmut Ave., Cohasset, MA 01778. Informal organization. One Winter and one Spring meet each year.

Greater New York Vintage Wireless Association (GNYVWA). Bob Scheps, 12 Garrity Ave., Ronkonkoma, NY 11779. Pub: Meeting Notices. Dues: \$4. Six meets/year.

Houston Vintage Radio Association (HVRA). Bill Moore, 805 Valerie, Pasadena, TX 77502. Pub: *The Grid Leak*, monthly. Dues: \$10.00 (\$15.00, local). Regional meets.

Indiana Historical Radio Society (IHRS). 245 N. Oakland Ave., Indianapolis, IN 46201-3360. Pub: *IHRS Bulletin*, quarterly. Dues: \$8.00. Quarterly swap meets in various areas of state.

London Vintage Radio Club. New club forming. For information, contact: Glen S. Lee, RR #2 Mt. Brydges, Ontario, Canada N0L 1W0.

Michigan Antique Radio Club (MARC). Larry Anderson, 3453 Balsam NE, Grand Rapids, MI 49505. Pub: *MARC Newsletter*, quarterly. Dues: \$10. Annual Extravaganza and quarterly meets.

Mid-America Antique Radio Club (MAARC). Sheldon Wheaton, 1120 Virginia Ln., Apt. #1, Olathe, KS 66061. Pub: *The Broadcaster*. Dues: \$8.00. Meets and two auctions each year.

Mid-Atlantic Antique Radio Club (MAARC). Joe Koester, 249 Spring Gap South, Laurel, MD 20707. Pub: *MAARC Newsletter*, monthly. Dues: \$12.00. Monthly meetings.

MARK YOUR CALENDAR

- June 1-3 - CT, Mystic - ARCA-89*
- June 1 - AR, Ft. Smith - ARCCFS §*
- June 3 - NY, Orient, LI - GNYVWA*
- June 3-4 - OR, Oregon City - NVRS Display*
- June 8 - AR, Little Rock - AARC §*
- June 10 - OR, Oregon City - NVRS §*
- June 17 - MD, Laurel - MAARC §
- June 17 - TX, Irving - VRPS Swapfest*
- June 18 - WA, Seattle - PSARA Swap Meets*
- June 21-29 - London, England Trip - AWA
- June 24 - CA, San Luis Obispo - CHRS Meet
- July 15 - CA, San Francisco - CHRS Meet
- July 21-22 - MI, Lansing - Extravaganza '89*
- July 22 - NH, Nashua - NEARC Meet
- Aug. 10-12 - IL, Elgin - ARCI Radiofest '89*
- Aug. 12 - CA, Los Altos - CHRS Swap Meet
- Aug. 19 - NY, Elma - NFWA/AWA
- Sep. 8-10 - TX, Duncanville - VRPS/AWA
- Oct. 4-8 - NY, Canandaigua - AWA
- Oct. 21 - NH, Nashua - NEARC Meet
- Nov. 5 - NY, Canandaigua - AWA
- Nov. 11 - CA, Los Altos - CHRS Swap Meet

*See expanded listing this month.
§ Monthly Meeting.

New England Antique Radio Club (NEARC). Marty Bunis, 422 Day St., Manchester, NH 03104. Dues: \$5.00. Pub: *Escutcheon* Newsletter, quarterly. Quarterly meets and auctions.

Niagara Frontier Wireless Association (NFWA). Art Albion, 440 69th St., Niagara Falls, NY 14304. Pub: *NFWA Chronicle*, quarterly. Dues: \$6.00. Regional meets.

Northland Antique Radio Club (NARC). P.O. Box 18362, Minneapolis, MN 55418. Pub: *NARC Newsletter*, six/year. Dues: \$10.00. About six meets/year.

Northwest Vintage Radio Society (NVRS). P.O. Box 82379, Portland, OR 97282-0379. Pub: *The Call Letter*, monthly. Dues: \$15.00 (beyond 100 miles). Monthly meetings.

Pittsburgh Antique Radio Society, Inc. (PARS). David W. Kraeuter, Secretary, 506 E. Wheeling St., Washington, PA 15301. Pub: *The Pittsburgh Oscillator*, quarterly. Dues: \$10 Quarterly meetings.

Puget Sound Antique Radio Association (PSARA). M.A. Kaplan, 14902 84th Ave. Ct. NW, Gig Harbor, WA 98335. Pub: *The Horn of Plenty*, monthly. Dues: \$15/yr, \$12/yr for out-of-state.

Sacramento Historical Radio Society (SHRS). William Howell, 5724 Gibbons Dr., Carmichael, CA 95608. Pub: *The Announcer*. Dues: \$10. Special meets & monthly meetings.

Southern California Antique Radio Society (SCARS). Edward Sheldon, 656 Gravilla Pl., La Jolla, CA 92037. Pub: *California Antique Radio Gazette*, quarterly. Dues: \$10.00. Meets: 3rd Sat. in Feb., May, Aug. & Nov.

Southern Vintage Wireless Association (SVWA). Bill Moore, 1005 Fieldstone Ct., Huntsville, AL 35803. Quarterly meetings with flea market/swap meet.

Vintage Radio & Phonograph Society (VRPS). Larry Lamia, P.O. Box 165345, Irving, TX 75016. Pubs: *The Reproducer*, quarterly. *Sound Waves*, monthly. Dues: \$13.50. Monthly meetings, Spring Auction, Annual Convention.

BUSINESS CARD ADS — \$15.00 FOR 3 MONTHS



Antique Radio Service

**REPAIR BUY
RESTORE SELL**
Woodwork a Specialty

RICHARD FOSTER
12 SHAWMUT AVE.
COCHITUATE, MA 01778

508-653-2418



J. Earl Scaramella
P.O. Box 1
Woonsocket, RI 02895-0001

RADIO DIVISION

215-435-8501
PA Transportation Co., Inc.
P.O. Box 112
Hellertown, PA 18055

mail-order
TUBES

\$1/list

PO BOX 541
GOFFSTOWN NH
03045



RON BOUCHER
(603) 497-2988

VINTAGE RADIO SERVICES

RADIOS BOOKS BUY
SCHEMATICS TUBES SELL TRADE

BASE FOR LIST



(815) 229-6900

ASTATIC

**VINTAGE RADIO
And Electronics**

SCOTT A. WEBSTER
Owner

1414 - 17th STREET
ROCKFORD, IL 61104

SHURE

- Radios
- 78 RPM Jukeboxes
- 78 RPM Turntables
- Radio Tubes
- Shure
- Needles & Cartridges
- Astatic
- Needles & Cartridges
- Parts & Accessories



ANTIQU Jukeboxes, MICROPHONES
Deco & Deluxe Console & Table Radios
Broadcasting, Hi Fi & Recording equipment
16" Transcriptions & Blank recording disks

Buy, Sell & Trade.

Robert Van Dyke 516-728-1327
2 Squires Ave., East Quogue NY 11942



Sales

Service

*Radiophile
The Vintage Radio Store*

Stephen Depres P.O. Box 020775
Brooklyn, N.Y. 11202-0017 (718) 625-7254
Call For Appointment

TUBES & STUFF

EXTENSIVE STOCK OF **NEW AND GOOD** USED TUBES ETC.

Send \$1 (stamps O.K.) — Refundable for latest lists now...

DON DIERS — 4276-AB2 N. 50 St.
Milwaukee, WI 53216-1313

Ed Romney N4DFX

Expert old radio repair by former
Massachusetts Radio School Instructor
Broadcast Engineer
Reasonable rates

Box 386 - Drayton, SC 29333
(803) 583-3081

WANTED

Radios - 40's and 50's
Colorful Plastic, Novelty,
or Transistors

Brenda Wilk
409 S. Fible
Kirksville, MO 63501
(816) 665-9304

**VINTAGE TV and RADIO
REPAIR and RESTORATION**
ELECTRONICS and COSMETICS

DAVID B. JOHNSON



(312)
484-2743



2336 S. KENILWORTH AVE.
BERWYN, IL 60402 • (312) 484-2743

CLASSIC RADIO SERVICE

Repair and Restoration

55 60 70 80 90 100 120 130 140 150

25 Maple Rd. - Box 764
Woodacre, CA 94973

415-488-4596

CLASSIC RADIO SERVICE

BUSINESS CARD ADS — \$15.00 FOR 3 MONTHS

WANTED

**RADIO — WIRELESS
Pro-1925
ELECTRICITY — TELEGRAPHY
Pro-1900**

Books, Magazines, Autographs, Catalogs Ephemera
One Item or Entire Collection

New Wireless Pioneers
6270 Clinton, Elma, NY 14059 USA
(716) 681-3186



(201) 794-9606

VINTAGE TV'S
& RADIOS

**HARRY
POSTER**

P O Box 1883 • South Hackensack, New Jersey 07606

ANTIQUÉ RADIO REPAIR

Repair - Restore - Buy & Sell

Schematic Diagrams \$2.00

DAMASKE ELECTRONICS

574-W16834 Janesville Road
Muskego, WI 53150
Phone: (414) 679-0838

VOGUE PICTURE RECORDS

Bought * Sold * Traded
Paying market prices

Michelle Manganaro
PO Box 535
Coopersburg, PA 18036
(215) 965-5538

50 years **CHUCKS** of service!

Any Tube Radio Repaired and
Guaranteed to work good.
\$26.00 plus large parts & UPS

CHUCKS
167 LYNN DRIVE — PO Box 598
NEW HAVEN, WV 25265 — PH (304) 882-2220

RADIO-TV TUBES

Dick Bergeron
Box 311
Fissex Center, Vt 05451
Tel 802-879-0611

FREE PRICE CATALOG

Over 1400 types, all new in original boxes

Are You Looking For Antique Radios, Parts,
Tubes, Schematics, Etc.?

For Free Flyer, a 2-Stamp LSASE is required to insure a
response to your request. Send to:

Olde Tyme Radio Company
2445 Lyttonsville Road, Silver Spring, MD 20910

Wish to contact us by phone?
Our number is (301) 585-8776.
Please call 10 am to 10 pm (Local Time)

Antique Radios

David & Nancy Snow
P.O. Box 6352
Jackson, MI 49204
(517) 750-4992



We Buy, Sell, Repair
ARBE - III Battery Eliminators



The Incomparable Capehart

Kenny Bunny

*Exotic Radios & Phonographs
Pasadena Antique Center*

480 SO. FAIR OAKS PASADENA, CA 91105 **RES. (213) 733-7733**
(818) 449-7706

VINTAGE MECHANICAL &
MUSICAL ANTIQUES

MEMORY MACHINES
KIRTLAUCK PROP.



5726 W. A. ABAMA
DALLAS, TEXAS 75098
PHONE 171 31522 5399

**SCHEMATICS 1920-1960
RADIO/TV/HAM/MISC.**

**FULL DESCRIPTION OF SET IN
FIRST LETTER PLEASE — \$3.50 EA.**

ALTON H. BOWMAN
RD2 (CHAPIN VLG.)
CANANDAIGUA, NY 14424

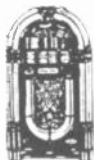

OLD

JUKE BOXES DEPOCA
SLOT MACHINES PINBALLS
VENDING MACHINES RADIOS

VIA DUCHESSA JOLANDA 13/A
10138 TORINO ITALY
TEL 011/39-11-7713048

PICTURE THIS SCENE:

BOB: What I miss on this island most Bing, is that old portable radio we used to have when we took the girls to the beach. Remember, it had a good tone.

BING: Wouldn't do you any good Bob, You can't buy batteries for those old radios any more.

BOB: I'd heard that, but I also heard that a company in St. Louis sells a converter that lets you operate those set's on ordinary batteries that are available just about anywhere.

BING: Sounds too good to be true. What else do you know about it?

BOB: Well I also heard that the converter costs less than a couple of those big battery packs would if they were available today and that the recommended batteries cost around five dollars and last for months.

BING: Say Bob, I'm impressed. We've got to get one of those. Wow!

***** * *****

Yes sir! You should have one too. For any battery set that calls for a 1.5 to 9 volt "A" battery and a 67 1/2, two 45's or a 90 volt "B" battery. Sets like the Zenith Transoceanics and other suitcase portables, so popular in the late 30's and the 40's and 50's. Also farm radios using similar batteries. The converter goes in the battery compartment along with 5 or 6 "D" cells, which are the only batteries required to operate the radio. Power to the converter and radio are controlled by the receiver switch but absolutely no radio modifications are required. The converter measures approximately 3 x 5 x 2 inches. It has plug connections and can be easily transferred from one radio to another. Suitable battery holders (not supplied) are recommended for installation.

For sets requiring a 1.5 volt "A" battery, order # CVA-1 \$79.95
For sets requiring a 6, 7.5 or 9 volt "A" battery, order # CVA-9 \$79.95

Installation kit: (consists of battery holders, connectors
and instructions) order # BK-1 \$9.95

ORDER FROM:

Include \$3.50 for UPS. =====	ANTIQUÉ ELECTRONICS SUP. 688 W. FIRST ST. TEMPE, ARIZONA, 85281	TESLA ELECTRONICS CO. 835 BRICKEN ST. LOUIS, MO 63122
----------------------------------	---	---

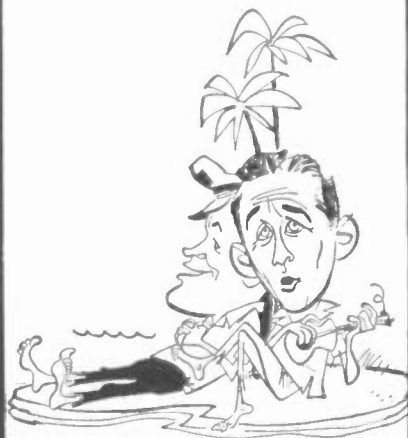

COLLECTOR BOOKS NOW AVAILABLE FROM ANTIQUE RADIO CLASSIFIED

☞ BOOKS MARKED LIKE THIS ARE THE MOST POPULAR AND ARE
ESPECIALLY RECOMMENDED FOR NEW COLLECTORS!

- The Auto Radio: A Romantic Genealogy**, Matteson. *Information, photos & ads from the early days of the automobile radio through the 1950's.* 316 pgs., hardcover.\$34.95
- Communications Receivers**, Moore. *Information on 700 receivers by 50 manufacturers produced from 1932 to 1981 are included in this 112-page book. 100+ radios are illustrated.*\$14.95
- Crosley Catalog** (reprint). *1923 catalog covering the early Harko through the XX models.* 32 pgs. \$4.50
- ☞ **Flick of the Switch**, McMahon. *The standard photo reference guide for collectors for radios from the 30's to the 50's. 1000+ photos of radios.* 263 pgs.\$11.95
- Golden Age of Radio in the Home**, Stokes. *Covers New Zealand radios.* 168 pgs., hardcover ...\$24.95
- Great Radio Personalities** (reprint). *Black & white portraits and info on all the favorites from the golden days of radio - Abbott & Costello, Baby Snooks, and more.* 128 pgs.\$11.95
- Los Angeles Radio Manufacturing**, Paul. *History of radio manufacturers in the Los Angeles area from 1922 to 1942.* 88 pgs.\$10.50
- Most Often Needed 1926-38 Diagrams** (reprint). *Circuit diagrams for 600 of the most common radios of the period.* 240 pgs.\$11.95
- Official Radio Service Manual** (reprint). *100's of pre-1930 circuits & notes.* 356 pgs.\$19.95
- Radio Collector's Guide**, McMahon. *Listing of 9,000+ radios made by some 1200 companies from 1921 to 1932. Gives manufacturer, year, model name and other info. No photos.* 264 pgs.\$11.95
- ☞ **Radio Collector's Directory/Price Guide**, Grinder/Fathauer. *An introduction to collecting plus a price guide. Over 8500 models are listed, many with current prices.* 321 pgs.\$15.95
- Radio Horn Speaker Encyclopedia**, Paul. *Listing of horn speakers for over 320 manufacturers for the 1920's. Expanded information on ten manufacturers.* 80 pgs. Over 145 photos.\$11.90
- Radio Enters the Home**, RCA (reprint). *1922. The Aeriola Jr. and RC era.* 128 pages.\$12.95
- Radio Equipment & Supplies**, Robertson-Cataract Electric Company (reprint). *1922 catalog of radios, accessories and other equipment. Includes RCA, Clapp-Eastham & others.* 168 pgs.\$13.95
- ☞ **Radios-The Golden Age**, Collins. *Full-color book on the colorful Catalin and bakelite radios from the late 1920's to the early 1940's.* 128 pgs.\$14.95
- ☞ **Radio Manufacturers of the 1920's, Vol. 1**, Douglas. *The first of three comprehensive volumes. Vol. 1 covers A-C Dayton thru Ferguson.* 225 pgs.\$19.95
- ☞ **Radio Manufacturers of the 1920's, Vol. 2**, Douglas. *The second of three comprehensive volumes. Vol. 2 covers Freed-Eisemann thru Priess* (Expected to be available in June 1989)
- Radio Craft - 50 Years of Radio** (reprint). *Reprint of Golden Jubilee issue of 1938.* 144 pgs.\$14.95
- S. Gernsback Radio Encyclopedia** (reprint). *1927 classic encyclopedia on radio.* 175 pgs.\$11.95
- Saga of the Vacuum Tube**, Tyne. *Standard reference to vacuum tubes prior to 1930. Several 100 photos.* 495 pgs.\$15.95
- 70 Years of Radio Tubes and Valves**, Stokes. *The story of the radio tube from the laboratory to the commercial market.* 256 pgs. Over 400 photos and illustrations\$19.95
- ☞ **Vintage Radio**, McMahon. *The standard photo reference guide for collectors for radios prior to 1930. Over 1000 pictures.* 263 pgs.\$11.95
- Westinghouse Catalog** (reprint). *Early 20's catalog featuring the RA-DA and other early Westinghouse apparatus.* 8 pgs.\$4.00
- White's Index to A. R. C. - 1984-1987.** *Index to Antique Radio Classified for 1984 thru 1987. 1000+ entries.* 20 pgs. (No shipping charge on this or following item if ordered without books.)\$4.00
- White's Index to A. R. C. - 1988.** *A copy of the Feb. 1988 issue which includes the 1988 index.* ...\$2.50

All books are softcover except those marked "hardcover".

Enclose \$1.50 shipping per order for orders under \$35. Shipping outside of U.S. is extra.
Send payment with order. Allow 2 to 4 weeks for shipping. Mass. residents please add 5% sales tax.

ANTIQUE RADIO CLASSIFIED
P.O. Box 2, Carlisle, MA 01741

(Apr 89)

REPRINT BOOKS ON EARLY RADIO - WIRELESS - TELEVISION TELEGRAPH - TELEPHONE

RADIO

- Archer, G.L., *Big Business and Radio*. The growth of radio from 1922 to 1938. 538 pgs.\$36.50
- Blake, G.C., *History of Radio Telegraphy and Telephony*. Early wireless schemes, developments and patents to 1928. 50-page bibliography. 449 pgs.\$35.50
- Codel, M., *Radio and Its Future*. 1930. A 1930's look into the future. A collection of articles including DeForest, Grunow, Kolster, Sarnoff, Maxim, Colpitts, Paley, Durstine and Codel. 375 pgs.\$28.00
- Dunlap, O.E., *Radio's 100 Men of Science*. 1944. Biographical narratives of pathfinders in electronics & television including Gilbert, Galvani, Faraday, Loomis, Hughes, Dolbear, Tesla, Hertz, Popoff, Nipkow, Branly, Jenkins, Conrad, Weagant, Kolster, DuMont, Olson. 330 pgs.\$25.00
- McNicol, D., *Radio's Conquest of Space*. 1946. A chronological treatment of the early days of radio, the scientists and their inventions. A few of the chapters: Spark Gaps & Oscillators, Wireless Spans the Atlantic, Regenerative Receivers, The Advent of Commercial Radio. 388 pgs.\$29.00
- Report of the Chief Signal Officer: 1919*. A record of the telegraph, telephone and radio in WWI.\$46.50
- Military Signal Communications*. A two-volume anthology of early documents covering the history of military communication, the Civil War to WWII. Includes visual signaling, telegraph, telephone and radio. 2 vols., 750 & 625 pgs. ...\$71.50
- Signaling and Communicating at Sea*. A two-volume anthology of over 50 articles. Semaphores, pigeons, flashing lights, flags, radio, teletype. 2 vols., 480 & 524 pgs. ...\$73.00

TELEVISION

- Abramson, A., *Electronic Motion Pictures: A History of the Television Camera*. Mechanical TV to Zworykin to 1940's. 228 pgs.\$24.50
- Dinsdale, A., *First Principles of Television*. 1932. Complete technological history of television before 1932. 299 pgs.\$25.50
- Dunlap, O.E., *The Outlook for Television*. 1944. Records the evolution of television from 1925 to 1932. Includes 22-page chronology of Radio/TV from 640 b.c. 310 pages.\$24.50
- Hess, G.N., *An Historical Study of the Du Mont Television Network*. 1960. A search for why the fourth television network failed.\$19.00

TELEGRAPH TELEPHONE

- Bright, C., *Submarine Telegraphs: Their History, Construction and Working*. 1898. An account by a chief engineer, of early cable attempts, failures & successes. 819 pgs.\$57.50
- Casson, H.N., *The History of the Telephone*. A survey published in 1910 of the first 35 years of the telephone industry.\$27.50
- Electric Telegraph: An Historical Anthology*. The rise and progress of the electric telegraph from the late 19th century to recent times. A collection of early writings. 625 pgs.\$4.00
- Eyewitness to Early American Telegraphy*. Reprints of reports and letters of Alfred Vail from the 1830's and 40's. An invaluable primary resource. 288 pgs.\$25.50
- Fahie, J.J., *A History of Electric Telegraphy to the Year 1837*. 1884. A definitive history of the earliest telegraph systems preceding Morse. 566 pgs.\$38.50
- Prescott, G.B., *Bells' s Electric Speaking Telephone*.\$38.50
- Reid, J., *The Telegraph in America*. 1879. A classic history of the telegraph, the principal firms & key persons to 1879. 868 pgs.\$63.00
- Smith, Willoughby, *The Rise and Extension of Submarine Telegraphy*. An engineer's and designer's autobiographical account of cable laying in the mid-1900s including the 1856-66 Great Eastern missions. 409 pgs.\$32.00

THE FAMOUS M.I.T. RADIATION LAB. SERIES

- #13 *Propagation of Short Radio Waves*, 746 pgs. \$29.95
- #15 *Crystal Rectifiers*, 457 pgs.\$19.95
- #17 *Components Handbook*, 640 pgs.\$29.95
- #18 *Vacuum Tube Amplifiers*, 761 pgs.\$29.95
- #19 *Waveforms*, 799 pgs.\$29.95
- #20 *Electronic Time Measurements*, 546 pgs.\$24.95
- #21 *Electronic Instruments*, 735 pgs.\$29.95
- #22 *Cathode Ray Tube Displays*, 764 pgs.\$29.95
- #23 *Threshold Signals*, 400 pgs.\$19.95
- #25 *Theory of Servomechanisms*, 383 pgs.\$19.95
- #27 *Computing Mechanisms & Linkages*, 371 pgs. \$19.95

The above are quality reprints. Send for free list of over 80 reprints of books on early radio, television, broadcasting and telegraph available from A.R.C.

Send payment with order. Mass. residents add 5% tax. Allow 4 to 6 weeks to receive books.

Shipping is free in U.S. Outside of U.S., please add 10% for shipping.

Send order with payment to: Antique Radio Classified, P.O. Box 2, Carlisle, MA 01741

EXTRAVAGANZA '89

Sponsored by the
Michigan Antique Radio Club

July 21 & 22, 1989

Dillon Inn
525 W. Canal Road
Lansing, Michigan 48917
(517) 627-8381



EVENTS

See Reverse Side For Times and More Details

- ★ Two-Day Open-Air Flea Market
- ★ Hospitality Area
- ★ 50/50 Raffle Both Days
- ★ Programs
- ★ Equipment Auction, Conducted by Steve Waldron
- ★ Donation Auction
- ★ Equipment Contest (Categories are:)

“RADIOS OF THE AGES”

- | | |
|----------------------|---------------------|
| 1. Pre-1920's Radios | 3. 1930-1939 Radios |
| 2. 1920-1929 Radios | 4. 1940-1949 Radios |

— Trophies & Ribbons For Winners —

* Please, no consoles (as space is limited)



For More Information, Contact:

Jim Clark
1292 Starboard
Okemos, Mi 48864
(517) 349-2249

**COME JOIN US AT OUR FOURTH ANNUAL
EXTRAVAGANZA EVENT**

EXTRAVAGANZA '89

PROGRAM SCHEDULE

Friday, July 21

8 am	- on	Registration
		\$10.00 ...MARC Member seller's fee
		15.00 ... Non-member seller's fee
		1.00 ... Non-seller's admission fee
8 am	- on	OPEN-AIR FLEA MARKET
8 am	- 10 pm	Hospitality Area (Motel Lobby)
Noon	- 1 pm	Women's Luncheon
1 pm	- 6 pm	Auction Check-in of Equipment
1:30 pm	- 2:30 pm	The Development of Stereo Radio, Oran Sauder
2:30 pm	- 3:30 pm	Primitive Amateur Radio Presentation & Demonstration, Bruce Tanner
6 pm	- 6:45 pm	Open Forum Club Meeting
7 pm		Friday's 50/50 Raffle Drawing
7 pm	- conclusion	Auction, Conducted by Steve Waldron <i>10% fee on all items sold.</i>



Saturday July 22

Dawn	- Noon	OPEN-AIR FLEA MARKET
8 am	- 10 am	Contest Check-in
8 am	- 3 pm	Hospitality Area (Motel Lobby)
9 am	- 10 am	Collecting German Radios, Eric Marx
10 am	- 11 am	The Historical Roots of Radio, Joe Turner
10 am	- 11 am	Contest Judging (Popular Vote)
Noon	- 1 pm	Luncheon, at which contest awards will be announced
1 pm	- 3 pm	Contest Room Viewing
2 pm		Saturday's 50/50 Raffle Drawing
2 pm	- conclusion	Donation Auction <i>An Auction of Those Items You Have Donated to the Club at the Meet</i>

Tear off and Return Lower Section

EXTRAVAGANZA '89 REGISTRATION FORM July 21 & 22, Lansing, Michigan

- () MARC members seller's registrations @ \$10 ea. _____
() Non-members seller's registrations @ \$15 ea. _____
() Non-seller's admission fees @ \$1 ea. _____
* () Saturday Luncheon Reservations @ \$6.⁵⁰ ea. _____

TOTAL ENCLOSED: _____

Name _____

Address _____

City/State/Zip _____

Make check payable to MARC.

Mail form and check to: Larry Anderson, 3453 Balsam NE, Grand Rapids, MI 49505

* You must make reservations for the Saturday luncheon by July 1st to be assured of a meal at the luncheon.

ARCA-89 – June 1-3

Antique Radio Club of America 1989 Convention

Ramada Inn – Mystic, Conn. – Plan to attend...

THURSDAY – June 1

- Flea Market Begins at Sunup
Seminars Alan Douglas: *Radio Manufacturers of the Twenties* – 11 am
Robert Merriam: *The Massie Wireless Telegraph System* – 1 pm
Contest Check-in, Viewing & Peoples' Choice Voting
Museum Tour.. Visit to N.E. Museum of Wireless and Steam (in R.I.). *1908 wireless station plus equipment from spark to WWII. Museum's 25th-Year.*
(2pm-6pm)

FRIDAY – June 2

- Flea Market Begins at Sunup
Contest Late Check-in, Judging & Viewing
Seminars Ray Moore: *Communications Receivers* – 10:30 am
Ralph Williams: *The Story of The Voice of the 20's Museum* – 1 pm
Richard Foster: *Restoration & Collecting Tips* – 2 pm
Meeting ARCA Membership Meeting – 3 pm
Banquet Evening Social Hour, Banquet & Awards – 6 pm
Auction Pre-Registration following Banquet – 9 pm

SATURDAY – June 3

- Flea Market Sunup until start of Auction
Auction Old Equipment Auction – 8:30 am
Museum Tour.. 90-minute ferry ride to Long Island to the Voice of the 20's Museum,
(noon-8pm) with picnic. *Museum contains 300 sets, 150 Atwater Kents: "breadboards - boxes - bathtubs - cathedrals - tombstones - consoles."*

Mystic, Conn., Area Highlights – Bring the Entire Family

A few of the possibilities for on-your-own or ARCA-89 tours:

- †Mystic Seaport: nation's largest (17 acres) maritime museum including period homes, shops and 19th-century tall ships
- †Marinelife Aquarium: dolphin/whale/sea-lion demonstration
- †Outlet Stores – †Shopping in the Town of Mystic
- Tour the USS Nautilus and WWII Subs. – U.S.C.G. Academy
- Historic Homes – Windjammer Cruises – Doll & Toy Museum
- † An ARCA 15-passenger van will loop hourly to these nearby attractions.

Plan to bring another collector to ARCA-89.

The 1989 Convention of the Antique Radio Club of America will be held at the Mystic, Conn., Ramada Inn (Exit 90 off of I-95) on June 1, 2, & 3, 1989. For a room reservation, phone the Ramada at (203) 536-4281 (or write the Ramada at P.O. Box 427, Mystic, CT 06355) and mention ARCA-89. To obtain more information on the convention, send 25¢ stamp to Bill & Jane Denk, 81 Steeplechase Road, Devon, PA 19333. ARCA members have received info. in the mail.

PLEASE CALL FOR MY LATEST OFFERS ON . . .

TV'S Pre World War II . . . paying OVER \$1000.
Even for kits!

- Old or Unusual . . . 1940's-1960's
- Color . . . early 9", 15", 16", 19", 21" ROUND CRT's (1950's)

RADIOS-CATALINS, chrome, unusual, World's Fair
—Mickey Mouse, Snow White . . . 1930's . . . paying \$1000.
—Spartan Mirror Radios . . . paying OVER \$800 (\$15,000 for console!)
—Novelty . . . tube and transistor types

WE ALSO BUY Stereo "3D" cameras, viewers, View Master,
oak and mahogany furniture, black and chrome Deco items,
1950's unusually shaped lamps, tables, furniture.



**HARRY
POSTER**

(201) 794-9606

P O Box 1883 • South Hackensack, NJ • 07606

Member: MAARC/ARCA/MARC/PARS/AWA/VRPS/IHRS/NFWA/NZVRS/NERC/GNYVWA/HRSA



Style

SIGHT • SOUND •

IF YOU COLLECT,
buy or sell Televisions . . .
SUBSCRIBE TODAY!

IF YOU COLLECT,
buy or sell CATALIN, novelty
or mirror radios . . .
SUBSCRIBE TODAY!



SIGHT SOUND STYLE is a 16-page quarterly magazine. Each issue features articles, pictures and prices of early Televisions! **PLUS CATALIN** and novelty radios are described, pictured and priced! Lots of Classified and Display ads offering TV's and great radios!

1 Year First Class . . . **\$14** 1 Year Overseas . . . via airmail . . . **\$34**

Annual price guide (Shirt-pocket Index and pricing-October) . . . **\$10**

CLASSIFIED ADS . . . **ONLY 15¢ PER WORD!**

SSS P.O. Box 2224

S. Hackensack, NJ 07606

CLASSIFIED ADVERTISING POLICY

ONE FREE 20-WORD AD for subscribers in each issue; additional words are 10¢ each. See details below. All classified ads must be received (not just postmarked!) by the ad deadline. Late ads are held for the following issue. Please enclose correct payment with all ads. Stamps or cash are OK for small amounts. (Canadian and other foreign advertisers, please see "Payment" on page two for methods.) "Free words" cannot be accumulated from month to month; "free words" must be "taken" when ad is submitted.

Please write each ad on a separate sheet of paper, especially when included with other A.R.C. correspondence. A 3" x 5" card is suggested if the ad is short. Ads may be sent in advance; again, write each ad on a separate piece of paper and indicate the month (or two months) you want the ad to run.

Please write legibly and use both capital and small letters. Do not use dashes between words. Some numbers and letters can look alike, for example 1, l and I (the number one, the capital i and the small L.) Write the following characters clearly (especially in model numbers): 1, l and I; 0, O, o, Q and D; r and n; 6, b and G; V, U, u, v and Y; A and R; 5, S and s; 2, Z and z. We try to correct spelling errors, so when using an uncommon word or manufacturer which looks similar to a common word or manufacturer, note it so that we do not "correct" it. Editor's comments are in [brackets].

Advertising is accepted only for items related to antique radios, communication, electricity, etc. All items must be described fairly; reproductions, reprints and not-original items must be identified as such. Advertisers agree to respond promptly to inquiries and orders, and to resolve problems promptly if the buyer is not satisfied.

Publisher reserves the right to edit ads without notification to the advertiser and to reject ads for any reason. Publisher is not responsible for errors due to illegibly written ads or for any other reason; if requested, the ad will be run in the next available issue at no charge for errors made by A.R.C. All ad rates and details are subject to change by the publisher. See page two for additional information.

CLASSIFIED AD DETAILS

Classified ads must have a standard heading such as **WANTED, FOR SALE, FOR TRADE, FOR SALE/TRADE, SERVICES, MESSAGE, HELP, etc.** This heading is the only bold or all-capitalized words allowed in the ad. Capitalize only manufacturer names, model names, etc. Wanted and For Sale ads are mixed together to encourage the reading of all ads, including the Wanted ads. This standard ad format makes scanning the ads easier.

Before writing your ad, please look over the ads in a recent issue of A.R.C., and try to write your ad in the same style.

To encourage varied content of the ads, **multiple insertions of the same classified ad are limited to two successive months.** (To run an ad continuously, use a boxed classified or display ad.)

Classified Ad Rates per Month

Subscribers:

First 20 words: **FREE***

10¢ per word for extra words over 20 plus

10¢ per word for a shaded ad (count all words including free words).

* Subscribers may take 20 free words on only one ad each month.

Non-Subscribers:

20¢ per word plus

10¢ per word for shaded ad.

Please do not forget to send in the extra 10¢ per word when your classified ad runs over the free 20 words; your payment will be appreciated, and it will help to keep A.R.C. healthy.

BOXED CLASSIFIED AD DETAILS

Deadline: 5th of the month!

Boxed classified ads can run unchanged for three months or more. No words are free. Ads may be shaded and may include bold and all-capitalized words freely. The ad need not begin with For Sale, etc. Boxed classified ads are placed with the display ads on the lower portion of the page.

Minimum run is 3 months, prepaid.

Boxed Classified Ad Rates per Month

Nonshaded ads:

12¢ per word for all words,* none free, plus

10¢ per word for each bold word plus

10¢ per word for each all-caps word.

Shaded Ads:

22¢ per word for all words* plus

10¢ per word for each all-caps word.

Note: All words in shaded ads are bold.

Non-Subscribers:

Add 15¢ per word to above costs.

*Three of the total words can be bold-all-caps at no extra charge.

PHOTO & DRAWING DETAILS

The deadline for ads with drawings or photos is the fifth of the month.

Drawings and photos are encouraged as the response to your ad is much larger and the reader knows better what you want or are selling. Send in your drawing or photograph and A.R.C. will reduce it or enlarge it as needed.

Photo and Drawing Rates per Month

\$5.00 per month for each photo or drawing

IMPORTANT — COUNTING WORDS — IMPORTANT

The **standard headings: WANTED, FOR SALE, etc.,** count as **one word** each time used in an ad.

Name, address and (one) **telephone number,** count as **6 words,** regardless of length. Ham call letters and business name can be included in the 6 words and do not count extra. (Note: "Jim, (111) 111-1111" also counts as 6 words.) So, please include complete name and address in your ads.

Each additional word, abbreviation, model number or number group, extra telephone numbers, etc. count as one word. Hyphenated words count as two words.



SECOND CLASS
POSTAGE PAID
at Carlisle, MA

A.R.C., P.O. Box 2, CARLISLE, MA 01741
RETURN POSTAGE GUARANTEED

TO:

POSTMASTER: Deliver Promptly

**CLASSIFIED AD
DEADLINE JUNE 10TH**