

ALL - WAVE RADIO

SEPTEMBER
1935

15
CENTS
U.S.A.

Vol. 1

No. 1

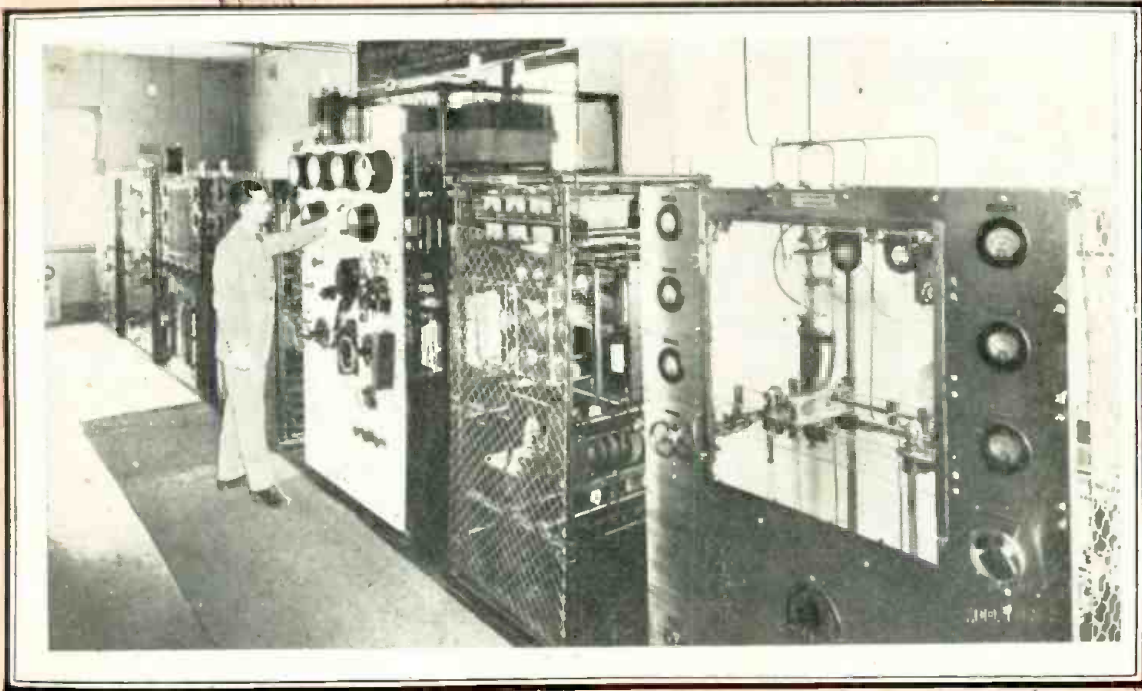

COMPLETE 10 - PAGE ALL - WAVE STATION LIST

"Channel Echoes" by ZEH BOUCK

"Globe Girding" by J. B. L. HINDS

Circuits by LOUIS MARTIN

Receiver by J. A. WORCESTER

Aerials by ARTHUR H. LYNCH

Comments by G. S. GRANGER

ULTRA SHORT AND SHORT WAVE • BROADCAST AND LONG WAVE



Communication and Broadcast Engineering

The monthly journal for engineers and executives in the fields of telephony, telegraphy, radio broadcasting and communication, aeronautical, police and marine radio, signalling, etc.

Recent Numbers of Communication and Broadcast Engineering have carried the following articles:

- N. B. C.'s Studio System.....by T. H. Phelan
- High Fidelity Remote Pickup Equipment.....by John P. Taylor
- Maintaining and Measuring the Frequency of Transmitters....by V. J. Andrew, Ph.D.
- Coupling the Broadcast Antenna to the Transmission Line.....by Paul Rosekrans
- An Efficient Remote Amplifier.....by J. C. Bailey
- Accounting System for Broadcast Engineers.....by R. C. Powell
- WOR's Directive Antenna.....by J. F. Morrison
- Design of Pads.....by L. W. Barnett
- Ultra High Frequency Police Radio.....by Paul F. Godley
- Concentric Transmission Line at KDYL.....by John M. Baldwin
- High Fidelity Broadcasting.....by John J. Long, Jr.
- Commercial Radio Trends.....by Haraden Pratt
- Continuous Aural Frequency Monitoring.....by Robert C. Moody
- Temporary Vertical Radiator Construction.....by George Brown

Departments in each number cover New Products and Equipment, Federal C. C. Activities and Reports, "Telecommunication," Maps of Communication and Broadcast Systems, etc.

Subscription Rate
\$3.00 Yearly
(Foreign and Canada \$4.00)

BRYAN DAVIS PUBLISHING CO., 19 East 47th St., New York, N. Y.

Enclosed find 25c. to cover mailing costs of one sample copy of "Communication and Broadcast Engineering."

Enclosed find (\$3.00 for 1 yr. / \$5.00 for 2 yrs.) subscription.

Name (Please Print)

Address

Town and State

Name of Company

Title or Occupation



J. E. Smith
President
National Radio
Institute

I WILL HELP YOU START A SPARE TIME OR FULL TIME RADIO SERVICE BUSINESS WITHOUT CAPITAL

**HERE ARE A FEW EXAMPLES
OF THE KIND OF MONEY
I TRAIN MY MEN TO MAKE**

Clears \$4500 in 18 Months

"Before taking your Radio Course I was making \$18 a week. I came here three years ago. In about 18 months I made about \$4500 in Radio. I cannot say too much for the wonderful help I have received from N. R. I."

Noel W. Ray,
619 Broad St.,
Gadsden, Alabama



Spare Time Work Pays \$18 a Week

"I only do spare time Radio work and average \$18 a week. People who in good times would buy a new Radio, now have the old one fixed."

Stephen J. Drapelaty,
407 Wunderlich Avenue,
Barberton, Ohio.



Now Owns Own Business

"If I had not taken your Course I would be digging ditches instead of running my own business. One week I made \$75 on repairing alone, and this doesn't count sales. If a fellow wants to get into Radio, N. R. I. is the starting point."

R. S. Lewis,
Modern Radio Service,
Pittsfield, Ill.



You Get PRACTICAL EXPERIENCE with Radio Equipment I Give You

My Course is not all theory. I'll show you how to use my special Radio equipment for conducting experiments and building circuits which illustrate important principles used in such well-known sets as Westinghouse, General Electric, Philco, R.C.A., Victor, Marconi, and others. You work out with your own hands many of the things you read in our lesson books. This 50-50 method of training makes learning at home easy, interesting, fascinating, intensely practical. You learn how sets work, why they work, how to make them work.

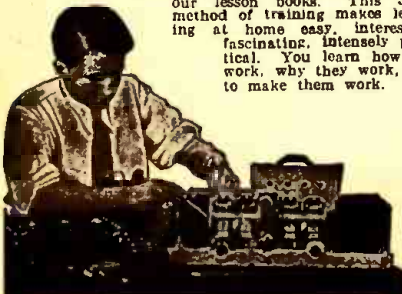

Free Book Tells How Mail Coupon!

The world-wide use of Radio sets for home entertainment has made many opportunities for you to have a spare time or full time Radio business of your own. The day you enroll I start sending you Extra Money Job Sheets which quickly show you how to do Radio repair jobs common in most every neighborhood. Many N. R. I. men make \$5, \$10, \$15 a week extra in spare time while learning. I show you how to install and service all types of receiving sets. I give you Radio equipment and instructions for conducting experiments, for building circuits and testing equipment, and for making tests that will give you broad, practical Radio experience. Clip the coupon below and get my free 64-page book, "Rich Rewards in Radio"—it gives you a full story of the success of N. R. I. students and graduates, and tells how to start a spare time or full time Radio business on money made in spare time while learning.

Many N. R. I. Men Make \$5, \$10, \$15 a Week Extra in Spare Time While Learning

Many of the seventeen million sets now in use are less than 50% efficient. I will show you how to cash in on this condition. I will show you the plans and ideas that have enabled many others to make \$5, \$10, \$15 a week in spare time while learning. Ford R. Leary, 1633 Davison Road, Flint, Mich., wrote: "My part-time earnings while taking the N. R. I. Course were \$651."

Get Ready Now for a Radio Business of Your Own and for Jobs Like These

Broadcasting stations use engineers, operators, station managers, and pay up to \$5,000 a year. Radio manufacturers use testers, inspectors, fo-

FREE LESSON

On Radio Set Servicing and Rebuilding

I'LL PROVE my Course is WHAT YOU NEED to master Radio. Send coupon for FREE lesson, "Direct Stage by Stage Elimination Method of Trouble Shooting." This interesting lesson shows many ways to correct every-day Radio troubles. Get acquainted with N.R.I. Training. See how well the lessons are written—how PRACTICAL they are. You'll quickly see why so many of my students have become Radio Experts and now earn two or three times their former pay. See for yourself. Get the sample lesson FREE.

MAIL COUPON NOW!

men, engineers, servicemen and buyers, and pay up to \$6,000 a year. Radio dealers and jobbers employ hundreds of servicemen, salesmen, managers, and pay up to \$5,000 a year. Radio operators on ships enjoy life, see the world, with board and lodging free, and get good pay besides. My book tells you of the opportunities in these fields, also in Aviation Radio, Television, Police Radio, Short Wave Radio, Automobile Radio and other new branches of this fast growing industry. Get it.

I Train You at Home in Your Spare Time

Hold your job until you're ready for another. Give me only part of your spare time. You do not need a high school or college education. Hundreds with only a common school education have won bigger pay through N.R.I. J. A. Vaughn jumped from \$35 to \$100 a week. J. E. McLaurine increased his earnings 100 per cent. The National Radio Institute is the Pioneer and World's Largest organization devoted exclusively to training men and young men by Home Study for good jobs in the Radio industry.

You Must Be Satisfied

I will give you an agreement to refund every penny of your money if you are not satisfied with my Lesson and Instruction Service when you complete my Training. And I'll not only give you thorough training in Radio principles, practical experience in building and servicing sets, but also Advanced Specialized Training in the type of Radio work you choose.

Get My Free Book of Facts

Mail the coupon for "Rich Rewards in Radio." It's free to any ambitious fellow over 15 years old. It tells you about Radio's spare time and full time opportunities; about my training; what others who have taken it are doing and making. Mail coupon now in an envelope, or paste it on, a 1c post card.

J. E. SMITH, Pres.
Dept. 5ES1
National Radio
Institute
Washington, D.C.

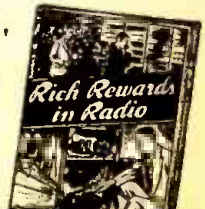

This Coupon is Good For One FREE COPY OF MY NEW BOOK

National Radio Institute,
J. E. SMITH, President,
Dept. 5ES1,
Washington, D. C.



Dear Mr. Smith: Without obligation, send me the Sample Lesson and your free book about spare time and full time Radio opportunities, and how I can train for them at home in spare time. (Please print plainly.)

Name Age.....
Address
City State... "39"

Find out about the World Famous Course that Pays for Itself

Presenting the

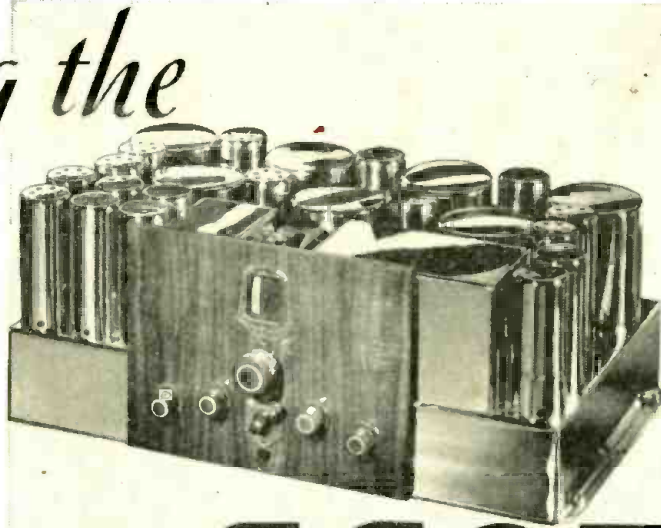

SCOTT *Imperial Hi-Fidelity* ● All-Wave

FULL RANGE
High Fidelity
25 TO 16,000 CYCLES

Triple A.V.C.

Surplus Power
35 WATTS STRICTLY CLASS "A"

Variable Selectivity

Complete details ready... Mail Coupon

The genius of Scott engineering now takes sound reproduction into thrilling new fields. The new SCOTT *Imperial HI-FIDELITY ALL-WAVE* reproduces every sound vibration up to 16,000 cycles . . . covers the human ear's full tonal range and more than doubles the best previous accomplishment of high-fidelity radio reproduction. With this uncanny ability every colorful overtone, every shade of sound, lives with breath-taking actuality for the first time.

At last you can take advantage of the first high-fidelity broadcasts from the new high-fidelity stations. Ordinary radios of today are incapable of bringing more than a fraction of the tonal beauty available—with a SCOTT *Imperial HI-FIDELITY ALL-WAVE*, you can enjoy this new type of radio program NOW! Again Scott offers a receiver years ahead of competition.

The SCOTT *Imperial HI-FIDELITY ALL-WAVE* achieves still another great scientific feat by combining Full Range High Fidelity with startling sensitivity and selectivity beyond that ever known before. It brings in station after station—on both broadcast and short wave bands—that you have never heard before. Only Scott gives you a radio that is a true musical instrument, and also a world-cruiser to take you on journeys-by-ear to the most distant points of earth.

More than a score of revolutionary new technical features characterize the SCOTT *Imperial HI-FIDELITY ALL-WAVE*. Among them are Triple Automatic Volume Control, that keeps every program constantly at predetermined volume . . . exclusive Scott-designed visual tuning . . . exclusive Scott between-station noise suppressor . . . etc.

To realize the full beauty of tone brought by the SCOTT *Imperial HI-FIDELITY ALL-WAVE*, new and wholly different consoles have been especially designed.

The SCOTT *Imperial HI-FIDELITY ALL-WAVE* is custom-built to most exacting laboratory standards in one of the world's finest radio laboratories. Its every part, excepting tubes, is warranted for five years of trouble-free service. Sold only direct from the Laboratories, for 30-day trial in your home, anywhere in the U. S. A.

Send today for complete details, definite proof of the amazing performance of the SCOTT *Imperial HI-FIDELITY ALL-WAVE*, and particulars of the 30-day trial offer.

E. H. SCOTT RADIO LABORATORIES, INC.
4450 Ravenswood Ave. Dept. 0000. Chicago, Ill.

Please send complete details of the new Scott Imperial Hi-Fidelity All-Wave and particulars of your 30-day trial offer.

Name.....
Address.....
City..... State.....

ALL-WAVE RADIO

VOL. 1

NO. 1

CONTENTS FOR SEPTEMBER, 1935

Cover Illustration

20 KW Short-Wave Transmitter of Station VK 2ME, installed at Radio Centre, Pennent Hills, New South Wales.

Features

Debunking Radio Circuits	by Louis Martin	Page 7
5-Meter Receiver	by J. A. Worcester, Jr.	10
Signals and Noise	by Arthur Lynch	26
New 22-Tube "Full Range" High Fidelity Receiver	by E. H. Scott	32
Answers to Some Frequent Questions Asked About Radio Reception	by Engineering Dept., Columbia Broadcasting	34

Departments

Dial Light		5
Globe Girdling	by J. B. L. Hinds	12
Channel Echoes	by Zeh Bouck	15
Star Short-Wave Broadcasters		16
All-Wave Station List		18
Short-Wave Station Addresses		21
U. S. Broadcast Station List		22
The Footloose Reporter	by G. C. B. Rowe	30
Radio Proving Post		36
Back Wash		40
Roses and Razzberries	by "Beat Note"	41
Queries		42
Pointers		43

Published Monthly by the

CLARENCE W. EMERSON
President

MANSON PUBLICATION CORP.

EDWIN W. LEDERMAN
Treasurer

200 FIFTH AVENUE
NEW YORK CITY

Subscriptions for the United States, \$1.50; in Canada, \$2.00 a Year.

SEPTEMBER, 1935

3

ALL WAVE RADIO

the *New* magazine of the Radio Field, is *New* in name, *New* in appearance, but very *Old* in experience.

The Editorial Staff, because of their intimate knowledge of Radio and close personal contact with this field since the early days of broadcasting, know its requirements and are pledged to the one axiom, performance, not promise.

On page 5, this issue, is our story. Ambitious, yes; but constructive in every detail.

Read it, digest our plans, see for yourself how radically we depart from present publishing procedure.

Then you be the judge. Are we on the right track? On your decision is based our future.

Be a charter reader. Subscribe today.

Our trial offer: The first eight issues for \$1.00

Don't delay—fill out the coupon.

ALL WAVE RADIO

200 FIFTH AVE. NEW YORK CITY

Gentlemen: Enclosed please find

\$..... in { CASH
M. O.
CHECK

Name

Street & No.

City State

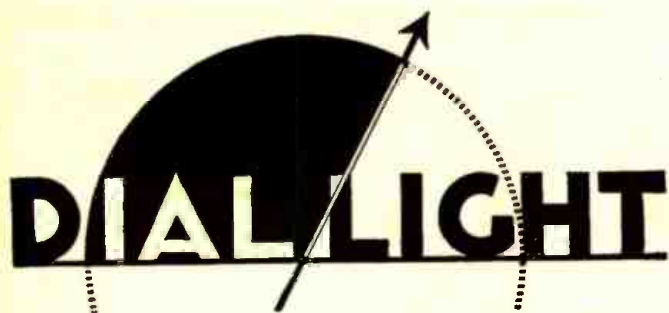

DIAL LIGHT

THIS IS A MAGAZINE for the radio listener and experimenter and no one else. If you like to build your own receivers, we can offer you the best there is in the way of design: if your impulse is to tinker, we can offer you no end of ideas: if your interest in radio rests entirely in the enjoyment of programs, the enchantment of distance reception and the thrill of the unexpected, we can offer you sound advice, accurate station data, seasoned news and a dramatic panorama of radio of our own making.

PUTTING OUT A REAL magazine for the radio fan is a job in itself. For some peculiar reason, it has not been attempted since the early days of radio broadcasting. There are a number of general radio publications available, but none whose pages are given over exclusively to the interests of the true radio fan.

We are of the opinion that radio history is being repeated—that the intense interest in the technical and dramatic phases of radio, so evident some twelve years ago, is being recaptured. The reason is obvious—from the ultra-high-frequency spectrum down to the low-frequency regions, the ether is crammed with appeal.

The time is ripe for a magazine devoted solely to the incidents, the drama, the technical phases and the criticism of the transmissions from one end of the wavelength scale to the other . . . in other words, a publication dealing with the non-commercial side of *all-wave radio*.

ALL RADIO FANS are not interested in quite the same things. You may devote the major part of your listening time to the short-wave broadcast bands, or you may find the amateur, police, aircraft and commercial phone bands of such absorbing interest that you are content to ignore the other classes of transmissions. On the other hand, you may not have been initiated into the realm of the short waves, with the result that your interest lies entirely in the broadcast band.

Some radio fans are technically minded and seem never to tire of building new receivers or redesigning old ones. You may be a fan of this cut, or you may have no interest in this phase of the hobby. In the latter case you wish to have knowl-

edge of the respective merits of manufactured receivers that you may exercise your own judgment in purchasing.

KNOWING THE DIFFICULTIES that might beset us in this venture, we evolved what we believe to be a new departure from the ordinary plan of editorial supervision. Rather than place the supervision in the hands of one man, we have created a board of editors and engineers to run the publication. These men, selected from the commercial field, serve on a consulting basis and are paid retainers for this work. Their activities are coordinated by the editorial director, a man who has had fifteen years experience as an editor of radio publications. Each member of the board was selected for his specialized knowledge in some phase of radio and each member is free to handle his work after his own dictates.

We are confident that this manner of supervision will serve to maintain a fresh viewpoint and obviate the possibility of the magazine falling into a rut, which is often the case when a publication is chained to the set moods and the limited scope of a single editor. We are equally as confident that, with a group of crack engineers on the board, we are in a position to offer our readers exclusive interpretations of the best there is to be had from commercial receiver design.

WE HAVE MADE IT a policy that all material to reach these pages must first be passed upon by the board. This procedure will provide an authenticity to signed and unsigned articles alike, not to be gained outside of the material prepared by an engineer of outstanding fame. Moreover, before the data on a receiver may be published, the receiver must pass three tests: First, the circuit must be straightforward; second, the receiver must at least meet set standards of sensitivity, selectivity and frequency response (the standards depending upon the class of reception the receiver is designed for) and, third, the receiver must pass tests that serve to assure its practicability in every-day use.

To such receivers are given a seal of approval. This seal is a protection to you against freak circuits that may look pretty on paper but have no merit; against cheap or poorly designed equipment; against incorrect applications of engineering features and against claims having no basis in fact.

MOST OF US have been in the game long enough to know that a magazine can always be improved upon. Should you have suggestions or criticisms we will be pleased to have them. You can assist us materially in making ALL-WAVE RADIO the best magazine in the field.

ATTENTION

SERVICE MEN

ENGINEERS

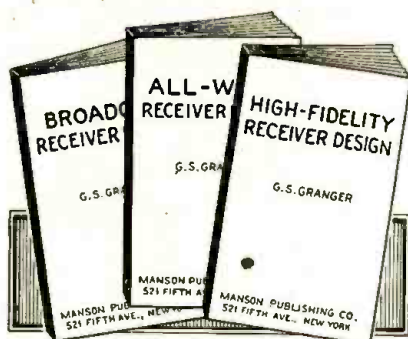

- Volume 1—Broadcast Receiver Design.
Volume 2—All Wave Receiver Design.
Volume 3—High Fidelity Receiver Design.
One hundred pages. Forty-three diagram illustrations.

Receiver Design has made tremendous advances in the last year and the Service Man and Engineer who has not kept abreast with such developments is as handicapped as a 1920 mechanic trying to "trouble shoot" a 1934 car.

Constant advancement in radio construction and theory has created a demand for up-to-the minute treatment of the subject.

To meet this condition we have published a series of booklets convenient in size, written for YOU by G. S. Granger, known to every Service Man and Engineer for his authoritative articles.

In addition to clear, concise explanations of all circuit functions, there are contained in these texts formulas and schematic diagrams essential in the calculation of circuit values, etc.

The knowledge essential to the success of every Service Man and Engineer is presented in these volumes in a complete and readily understandable form.

You cannot afford to be without these three volumes. They form an indispensable part of your kit.

Printing limited so order your copies today.

MANSON PUBLISHING COMPANY

200 Fifth Avenue

New York, N. Y.

Gentlemen:

- Send me postpaid volumes checked below, for which I enclose \$.....
- | | |
|---|--------|
| <input type="checkbox"/> Broadcast Receiver Design..... | 50c |
| <input type="checkbox"/> All Wave Receiver Design..... | 50c |
| <input type="checkbox"/> High-Fidelity Receiver Design..... | 50c |
| <input type="checkbox"/> Complete Set. Three volumes..... | \$1.00 |

Name

Address

NOW IN USE

IN

20 COUNTRIES

ALL-WAVE RADIO

FOR SEPTEMBER, 1935

Debunking Radio Circuits

By LOUIS MARTIN

REVOLUTIONARY IDEAS are rare, and revolutionary ideas that really work and can stand the test of time and use are almost nil. Every so often either through sheer accident or diligent research, a brilliant idea materializes, but such classic innovations are very few and very far between. But to judge from some editorial and, most glowing advertising claims, this condition does not exist in the radio business. Regeneration is rediscovered almost every day in the week; the virtues of the beat note in picking up and tuning in telephone stations have been expanded to such proportions that the lay reader has come to endow it with the same cosmic powers as befits the crystal gazer; noise-reducing antenna systems have been explained and expounded and exploded until the imagination does more noise-eliminating than the system*; the crystal detector has been used, discarded, and used again, each time with new authority and with breath-taking possibilities.

Nor is this all. Every new circuit or design presented to the readers of popular radio literature is disgustingly complete and modern: every last detail always has been worked out; every last crumb always has been raked and sifted and counted until there is nothing left of the signal but trash; tremendous volume with little or no signal input is always claimed; and every tube (especially the multi-grid tubes) is given five or six jobs to perform in order to be sure that no single grid or plate is laying down on the job while the others are busy pumping signals into the next chaotic stage.

This rather caustic description of certain present-day authors and their

receivers is not over-exaggerated to the extent that one might glean from the previous paragraphs. After all, their claims are not exactly lies, unless, of course, you define a lie as the exaggerated truth. With the kind consent of the EDITORIAL BOARD of this magazine, I would like to devote the following material to a systematic debunking of these revolutionary circuits.

ONE TUBERS

Single-tube short-wave receivers are almost always of the regenerative type. This type of circuit yields maximum gain per tube, and this maximum is the same regardless of how ingenious the



LOUIS MARTIN
Radio editor and engineer... a writer
of merit.

scheme used for controlling the regeneration. Whether the tube is a triode, tetrode or pentode, the maximum gain due to regeneration is the same, and moreover this gain is the same regardless of whether the tickler is connected in any of the grid or plate circuits and coupled to the control-grid circuit or whether feedback is accomplished through the grid-plate capacity, as in triodes. No amount of armchair coaxing can increase regenerative gain, although this classical circuit has been redrawn more different ways and garbed with more different pseudonyms than anything else in radio.

Fig. 1, at A, shows the true, recognizable circuit of the regenerative connection, and B of the same figure shows how the circuit may be redrawn and the parts changed about so as to justify its existence. The (1), (2), and (3) circuits show the tickler in the plate, screen and suppressor-grid of different tubes. If you should trace the connections of the "B" set, you will find them identical with the A schematics.

The point to be emphasized is that regardless of the grid or plate circuit in which the tickler is placed, the gain due to regeneration is the same; and if some bright manufacturer of regenerative receivers wants to make an improvement, he could place a *good high-ratio* tuning dial on the regeneration control. Remember, the theoretical maximum gain in a regenerative stage is infinite, and the practical limit of gain is determined almost solely by how close to the oscillation point you can bring the tube.

REFLEXING THE SINGLE TUBE

Not satisfied that the multi-grid tube is hitting on all five grids, certain cr-

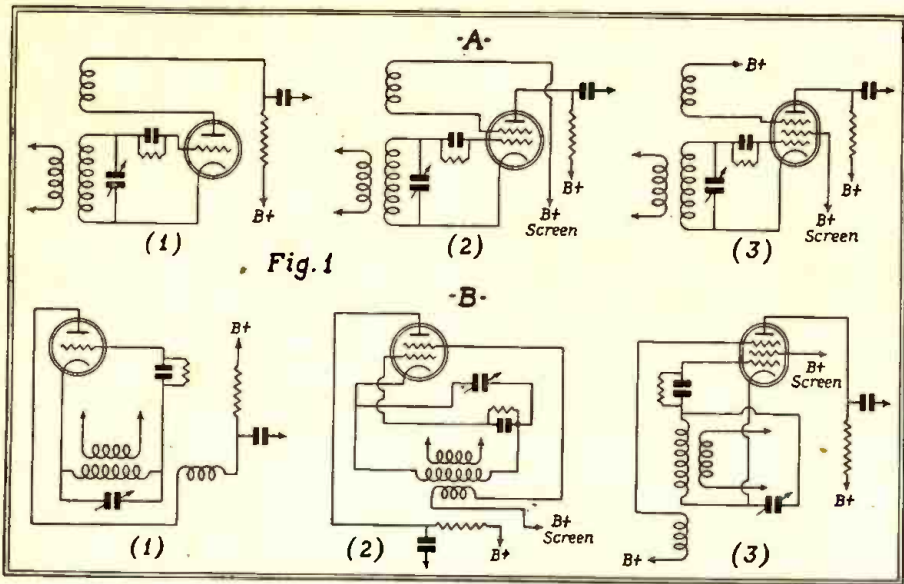

Circuits that are recognizable at (A) and the same, though not so recognizable, at (B).

circuit tinkerers use a single tube as a regenerative detector and then reflex the audio into the front-end of the tube again for additional confusion. The reflex circuit is perfectly good when properly designed and when the relative r-f and a-f voltages are carefully calculated so that you know the distortion that can arise and the limitations of the circuit. But the mere connection of an audio transformer from the plate back to the grid circuit and the addition of regeneration to compensate for the evils of design do not constitute good reflexing. It is perfectly permissible to use a non-regenerative r-f amplifier tube as an audio amplifier, but for the love of the signal, don't attempt to add regeneration!

EXCEPTION TO RULE

There is one exception to this statement. The 6F7 tube may be used as an audio amplifier and regenerative detector with good success; but the 6F7 is truly two separate tubes in a single envelope, and you can do with this one envelope—within limits—what ordinarily takes two tubes to accomplish. A simplified diagram, not suitable for constructional purpose, is shown in Fig. 2 to illustrate the mode of connection.

Now, some may argue that this circuit is not reflexed because the audio is not returned to the same tube elements. But the point is that the audio is returned to the same tube, and if you want to think of it in this manner, then it is reflexed. In any event, the 6F7 is about the only tube which can be reflexed in this manner and can use regeneration to advantage at the same time.

If regeneration is removed in order to stabilize a one-tube reflexed circuit, the maximum gain will be about the same as that obtained with regenera-

tion and no reflexing. It's six of one and half-dozen of the other.

MULTI-TUBE TRF CIRCUITS

When the circuit manipulator decides to use more than one tube in a home-constructed receiver, he usually wants to make sure that the signal is squeezed dry after each tube. This procedure is sound economics, but poor engineering. Stability is an important consideration when more than one model of a receiver is to be built, especially when hundreds of different people are going to invest money. It is far safer to obtain a little less gain per tube and increase the stability than to attempt to regenerate the detector, feed the audio into the second tube, remove it, then feed it back to the first tube again, and finally pull it out of the first tube and try and sneak it into the second tube through some idle grid.

Tubes are relatively cheap these days, and in fairness to constructors there should be a golden rule to the effect that a single tube intended for a single purpose should be used only for that purpose unless there is a darn good reason for doing otherwise.

STANDARD REGENERATIVE RECEIVERS

Standard versions of two-tube receivers are as follows: regenerative detector and one stage of audio; tuned r-f stage and tuned regenerative detector; and untuned r-f stage and tuned regenerative detector. During all the years of radio and the vacuum tube, these combinations have given sure-fire results without the necessity for resorting to prayer and soliciting the good graces of Lady Luck.

Three-tube receivers give very excellent results on short waves, and for the average listener are quite sufficient unless loudspeaker results are desired.

Standard combinations of such sets are as follows: tuned r-f stage, tuned regenerative detector, and one audio stage (the best combination in the opinion of the writer); untuned r-f stage, regenerative detector and one audio stage; regenerative detector and two audio stages (recommended for the reception of local stations on a loud-speaker). Any additional trick items give considerably more noise and not much more signal.

THE SUPERHETERODYNE

When not abused, the superheterodyne is without doubt the most efficient circuit in commercial use today. And it is because of its efficiency that many designers of short-wave receivers (for publication) completely disregard some of its finer qualities. The selectivity of a super resides to a large extent in the i-f amplifier; and so many early designers neglected to add a stage of tuned r-f ahead of the mixer to eliminate image interference. In just what they have put their faith the writer has been unable to determine, and when some aggressive engineers decided to raise the i-f to about 460 kc in order to reduce image interference, these self-same men kicked because they lost a little gain. We all know now that image interference elimination is more important than the slight loss in gain obtained with the 460 kc than with the 175 kc i-f.

One nationally-known manufacturer deliberately inserted a tuned r-f stage on the broadcast and one short-wave band of his receiver, and just as deliberately cut it out on the highest-frequency bands. At that same time, another nationally-known set manufacturer had one r-f stage ahead of the mixer on all but the highest-frequency band—and put two there!

The coil-switching business is another headache. Aside from shielding each coil separately, it is essential that at least one unused coil—the next lower-frequency coil—be short-circuited to prevent absorption and consequent dead spots. The switching arrangement requires another arm on the switch and several more wires, but it is worth

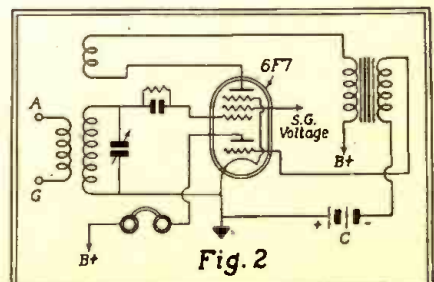

Using the 6F7 as a regenerative detector and reflexed audio amplifier.

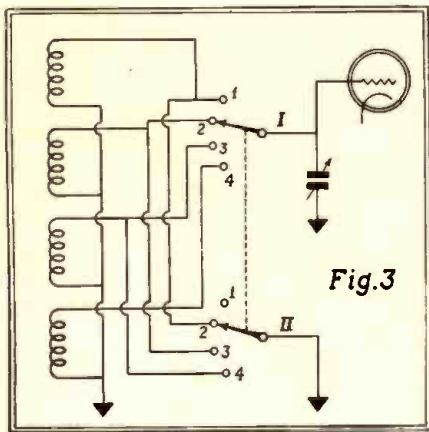

Typical switching arrangement used to short-circuit one unused coil in a receiver.

while at the end. A typical switching system is shown in Fig. 3.

AVC SYSTEMS

The purpose of an avc system in a broadcast receiver is to prevent the overloading of the audio amplifier on strong local stations. The purpose of the avc system in a short-wave receiver is to prevent, or, rather, minimize, fading. These two requirements require different types of design for their fulfillment. The broadcast-set avc system must be designed for strong signals and have a relatively large time constant; the short-wave receiver avc system must be capable of varying the sensitivity of the receiver quickly, so that any decrease in signal strength is immediately compensated for by increased sensitivity of the set.

Fig. 4 is a representative circuit of a typical avc system. The theory is that the rectified voltage across R_2 charges the "tank" condenser C through R . If the detector is linear, the voltage drop across C is proportional only to the carrier voltage, and it is this voltage across C that is applied to the grids of the tubes under control. If the signal strength should suddenly drop, the voltage across R_2 drops, and the voltage applied to the grids of the controlled tubes should also drop almost instantly. If R_1 , C_1 , C or R are made too large, then the condensers cannot discharge fast enough to lower the bias, and the signal keeps dropping in strength as it fades.

It is difficult to give values to these components unless the specifications for the receiver in which the system is to be used are available. But the point to be emphasized here is that there are definite values for all sets, and most designers have values that are too high for the high-frequency bands, although good for the broadcast band. In the opinion of the writer, the proper solution to this problem is a compro-

mise in an all-wave set, but little compromise is required in a strictly short-wave receiver.

BEAT OSCILLATORS

The one and only purpose of the beat oscillator is to provide an audible means of properly tuning-in a phone station, and this purpose is distinct from its purpose of enabling the reception of continuous-wave signals. The beat oscillator beats with the carrier and side bands of a station, and if the percentage modulation of the station is low, then the audio will disappear when the beat oscillator is turned off. The beat oscillator does not and cannot increase the sensitivity of a receiver as many would have us believe—it is a good station hunter and nothing else.

THE LINEAR DETECTOR

There has probably been more ballyhoo written about the second detector than any other single receiver function. To begin with, all detectors are linear if the signal strength and circuit proportions are correct. The diode is called a linear detector because it becomes linear with relatively small signal voltages, and is especially valuable with large signals, though it is

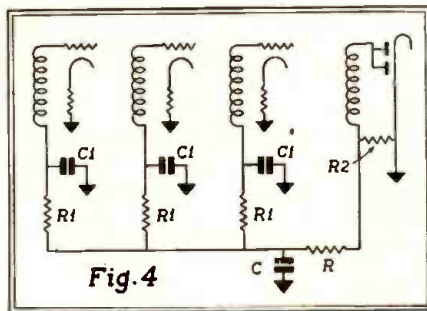

Typical avc system suitable for short-wave receivers.

insensitive when linear. This means that it is useless to use a diode detector with an insensitive receiver unless only local stations are desired.

The writer has seen more than one, two and three-tube receiver, designed to pick up everything on the air, using a diode detector. And the designers brag about it as a valuable feature! The diode detector is suitable only when large signal voltages are to be handled with small distortion and when a simple and economical avc system is to be used. For sensitivity, the good old-fashioned grid-leak and grid-condenser detector is yet to be improved upon, and for large signals, the diode is the best we have. And lest we forget, the good quality that can be obtained from a diode cannot compensate for the poor design in the audio system.

THE AUDIO SYSTEM

All of which brings us to the audio system. For one and two-tube receivers,

the type 30 tube or its 2.5 and 6.3 volt equivalents is as good as any. The mere fact that a new tube is announced does not mean that it is good anywhere in the circuit. The type 58 tube is one of the best r-f amplifiers, but it is hopelessly inadequate as a final output tube. The four- or five-tube short-wave receiver should use a pentode output tube because of the high power-sensitivity of pentodes. When there is plenty of audio gain then one or two triodes are fine.

THE ELECTRON-COUPLED OSCILLATOR

Fig. 5 is the circuit of the garden-variety of electron-coupled oscillator. If we forget about the plate and suppressor-grid in the tube, then we have a simple Hartley triode oscillator circuit with which we are familiar. The electron-coupled oscillator is not a peculiar oscillator circuit, it is a unique method of coupling the oscillator to the load, or output. The coupling to the load is not magnetic or electrostatic, but electronic; hence the name.

This circuit is stable simply because the load cannot react upon the tuned circuits through the tube capacity because the suppressor grid shields the plate from the oscillator elements. It is stable in this respect only, and is not any more stable than any other oscillator of the Hartley type. In fact, if the tube has no suppressor grid, then the plate-screen capacity should be neutralized by any of the popular neutrodyne or Rice systems so popular before the 1929 fiasco.

IN CONCLUSION

The writer does not wish to leave the impression that all designs are poor and that all articles ballyhoo everything. He merely wishes to point out some very common exaggerations of the truth and some things that some authors seem to forget in their haste to convince the reader. In general, there are more good designs than poor ones, but the trouble seems to be that some poor designs get more sales talk than the good ones.

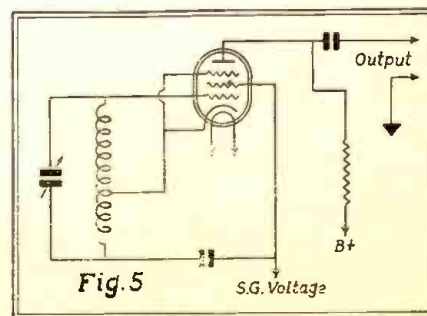

A typical Hartley oscillator circuit with an additional plate and suppressor grid makes an electron-coupled oscillator.

5-METER RECEIVER

By J. A. WORCESTER, Jr.

- A TWO-TUBE SET USING A CLOSED-END LINE INSTEAD OF A TUNING COIL. THE CIRCUIT IS THE OSCILLODYNE.

HERE IS A simple, smooth working, five-meter receiver that has a conservative range of 75 miles under average night-time receiving conditions. Consistent reception at this distance has been obtained on numerous occasions with nothing more elaborate than a short, indoor wire, about 10 feet long, as an antenna. Although during the period of testing no outstandingly good reception periods were noticed, it is felt that when such conditions obtain the effective range will be much greater than the above value; particularly if the receiver is situated in the path of a directive antenna array.

There is undeniably as much thrill in receiving a five-meter station located 75 or 100 miles away as there is in receiving Australia or some equally distant station on the regular short-wave bands. Consequently, if you are a bit fed up with reception on the regulation channels, here is a chance to get a new thrill by setting up reception records on the five-meter band and here is a receiver capable of holding its own with the best of them.

"CLOSED-END LINE"

The secret of this receiver's success lies in the tuning inductance, which really is not an inductance at all but

a long, closed-end line. It is a well-known fact that such a line, when less than a quarter wavelength long, will exhibit an inductive reactance and when such a line is substituted for the customary coil a marked improvement in results obtainable is immediately evident. This is perfectly reasonable since a coil at these ultra-high frequencies has too low a "Q" to result in an effective tuned circuit, while a line really comes into its own at these frequencies.

NO "PRUNING" NECESSARY

An inspection of the photograph of Fig. 3 will indicate that the line consists of parallel conductors separated by about one-eighth inch and wound around a plug-in coil form. Since the wires are connected at the top, the current in one wire at any point is equal in magnitude but flowing in the opposite direction from that in the other wire. Consequently the inductive fields cancel and no inductance is introduced by the use of a plug-in coil form. In will be noted that the total

amount of wire is very much greater than that employed when using the customary small self-supporting coil, and consequently proper operation in the five-meter band is easily obtained without the pruning and squeezing together of turns generally associated with the initial adjusting procedure of five-meter receivers.

THE CIRCUIT

The receiver employs the self-quenching type of super-regenerative circuit, as shown in Fig. 1. This form of super-regeneration was introduced by the writer about two years ago in the form of the Oscillodyne Receiver and since that time has been almost universally employed in ultra-short-wave receivers. The action of this circuit differs radically from that of the customary super-regenerative circuit in that all signals regardless of their initial amplitude build up to the same r-f amplitude; while in the latter circuit the final amplitude is directly proportional to the initial value of the signal. Hence, the self-quenching circuit provides maximum amplification automatically while the ordinary super-regenerative circuit requires circuit adjustment for each signal in order to obtain maximum results. The result is that the self-quenching circuit is more sensitive to weak signals and easier to tune than the typical hook-up.

COLPITTS OSCILLATOR USED

The oscillator circuit employs the Colpitts arrangement. The Colpitts arrangement is used instead of the conventional Colpitts circuit because of its greater stability.

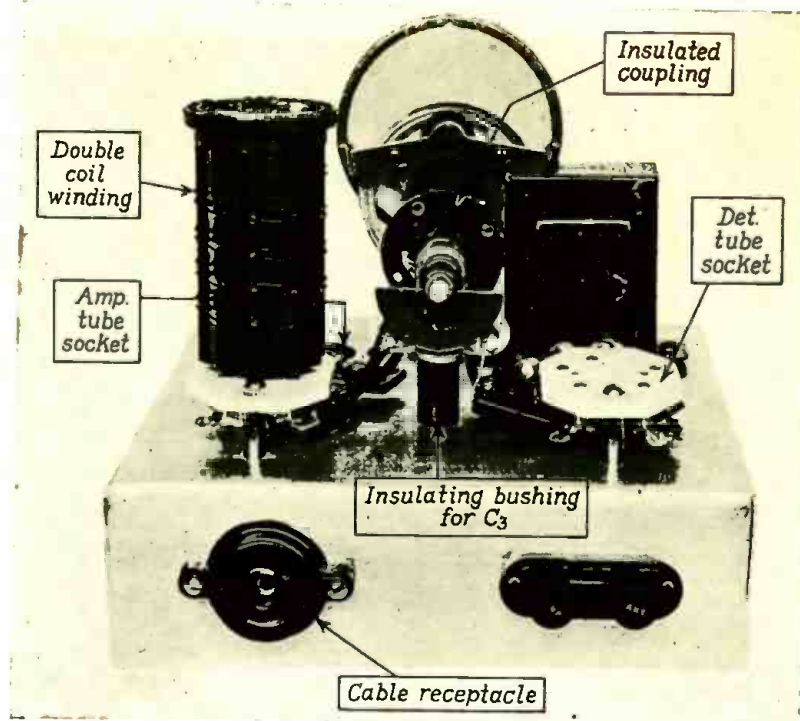
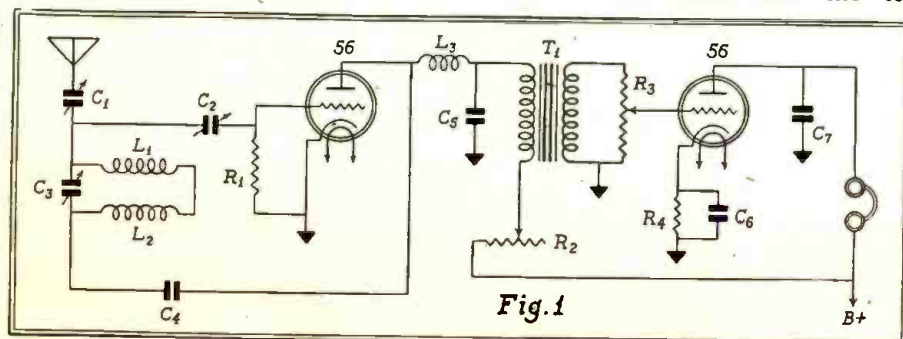

Fig. 3. Rear view of the completed receiver.



Complete circuit of the 5-Meter Receiver. See the Legend on the following page for parts specifications.

LEGEND

- C1, C2—Hammarlund Equalizers, 3-35 mmfd, EC-35.
 C3—Hammarlund 20-mmfd Variable Condenser, MC-20-S. (One stator plate removed as per text).
 C4—Cornell-Dubilier .0005-mfd Mica Condenser.
 C5—Cornell-Dubilier .005-mfd Mica or Paper Condenser.
 C6—Cornell-Dubilier .5-mfd Tubular By-Pass Condenser.
 C7—Cornell-Dubilier .001-mfd Mica Condenser.
 L1, L2—See text for details. Wound on 4-prong Hammarlund XP-53 Low-Loss Coil Form.
 L3—Hammarlund 2.3-mh R-F Choke.
 T1—A-F Transformer, 3 to 1 ratio.
 R1—I.R.C. Metallized Resistor, 250,000 ohms, ½ watt.
 R2—Electrad 50,000-ohm Volume Control.
 R3—Electrad 250,000-ohm Volume Control.
 R4—I.R.C. Metallized Resistor, 2000 ohms, ½ watt.
 Aluminum chassis (see Fig. 4).
 Hammarlund 4-prong Isolantite Socket.
 Hammarlund 5-prong Isolantite Socket.
 I.C.A. 5-prong Wafer Socket.
 Hammarlund Flexible Coupling.
 Bakelite or brass shaft, 4" x ¼".
 Crowe No. 123 Airplane-Type Dial.
 Eby Twin Binding Post.
 Eby Twin Speaker Jack.
 Alden 4-prong Connectorald Socket.
 Two RCA Type 56 Tubes.

plidity and smoother operation. As is customary when employing a self-quenching detector, transformer coupling is used in preference to other forms. A fairly large condenser is employed to by-pass the "interruption frequency" and for best results this value should not be decreased. The potentiometer, R2, is used to adjust the detector plate voltage to its best operating value; while R3 is employed as a volume control. This latter control is necessary as the hiss level in the output of the audio tube is too high for comfortable headphone reception when full gain is utilized. The gain is sufficient to operate a small dynamic or magnetic speaker on signals within at least a 35-mile range.

CONSTRUCTION

The chassis employed is constructed from 14 gauge sheet aluminum and measures 7 in. square by 2 in. deep. The proper location of the various parts can be determined from an inspection of the photographs of Figs. 2 and 3. It is imperative that this layout be rigidly adhered to; particularly as regards the placement of the detector circuit components. It will be noted that the isolantite sockets for the coil and detector tube are mounted above the chassis by means of bushings and that the variable tuning condenser, C3, is mounted between them. The adjustable grid condenser, C2, is mounted directly to the grid terminal of the tube socket; while the adjustable antenna coupling condenser, C1, is directly mounted to the proper terminal on the coil socket. The plate blocking condenser, C4, is

mounted directly by its pigtailed between the stator of the tuning condenser and the plate terminal of the tube socket, as indicated.

SPREADING THE BAND

In order to spread the 56 to 60 megacycle band over the major portion of the dial, one of the stator plates from the 20-mmfd. condenser is removed. This is easily accomplished by sawing the two small brass rods supporting the stator plates so that the rear half of the condenser can be removed. This condenser is

completely insulated from the chassis by employing an insulated bushing for support at the desired height as well as an insulated washer under the screw head. The hole through the chassis is sufficiently large for ample clearance. The shaft of the condenser is connected to the airplane dial on the front of the chassis by means of a flexible coupling and bakelite rod. This is clearly shown in Fig. 2.

The half-watt grid leak, R1, is mounted directly between the grid and cathode tube socket terminals and the choke, L3, is mounted directly under the tube socket and as close to it as feasible.

It should be emphasized again that the location of the various parts discussed should be rigidly adhered to if satisfactory results are to be obtained. The wiring of the audio circuit is entirely conventional and requires no detailed comment.

TUBES REQUIRED

The tubes employed in this receiver are the type 56, requiring a 2.5-volt heater supply and, in this case, 90 volts plate supply. Although 37's were not available for test, it is likely that this type will also work satisfactorily although its mutual conductance is not as high as the 56.

The "coil" is wound on a Hammarlund XP-53 form and this form should be employed if pruning is to be avoided. The winding consists of four double turns of parallel wires separated by one-eighth inch. The

(TURN TO PAGE 44)

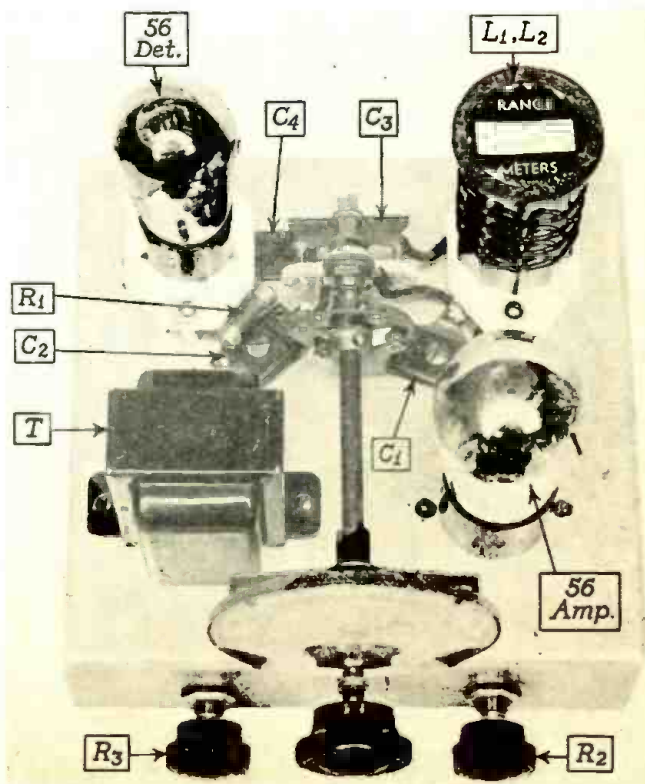

Fig. 2. Front view of receiver. The designations correspond to those given in the circuit of Fig. 1 and in the Legend.

GLOBE GIRDLING

CONDUCTED BY
J.B.L.HINDS

IT AFFORDS ME great pleasure to greet my old and new friends of radio and to express the wish for each of them that much pleasure and success will come to them in their efforts through the assistance of ALL-WAVE RADIO. Our utmost efforts will be expended to furnish that which you desire in the way of information regarding short-wave stations and reception. Your requests and suggestions will be of material help and will be much appreciated.

STATION LISTS

Your attention is invited to the lists of best short-wave stations or stations broadcasting programs, and telephone and experimental stations. The time given is Eastern Standard Time. The latter class of stations include many which broadcast music on test programs and special broadcasts. A great many phone stations are on voice only and test only on voice, but quite a few are sending verifications on reception reports received; others acknowledge but do not specifically verify. The address section contains many addresses of both classes of stations. These lists will be revised and enlarged upon from month to month. Any information regarding changes which should be made will be gratefully received.

INTERNATIONAL BROADCASTS

The day has passed when one must depend upon the broadcasting chains to relay to their homes the varied

programs of foreign cities from all corners of the earth. There was a time when one received quite a thrill from hearing such a program through the medium of the long waves, but since they have built receivers that will bring them in directly with equal clarity, the tide has turned and listeners are purchasing such sets and receiving more and more enjoyment from them as they progress in the art of tuning.

There is no doubt, however, that the international transmitting was the cause of the present ever-growing interest in short-wave receiving. American and foreign newspapers are devoting more and more space to short-wave matters and the short waves seem to be coming into their own. European and other countries have not been slow to recognize the value of their overseas broadcasts. Take for illustration the English, German, French, Italian, Dutch, Belgian and Japanese. Many of these broadcasts continued for a long time on an experimental basis and with no seemingly fixed time schedules. The rapid advancement in facilities and conditions of transmission and reception have made it possible for definite programs to be arranged and adhered to. There is considerable pleasure derived in listening to the varied programs emanating from these stations located many thousands of miles from your receiver, and more particularly when the programs can be heard without the

use of headphones and with reasonable strength and clarity. The British Broadcasting Corporation, through their wonderful Daventry transmitters, have done much to stimulate the present interest.

INCREASING ACTIVITY

There are now considerably more than 100 transmitters broadcasting regular programs from Africa, Austria, Australia, Argentina, Belgium, Bolivia, Brazil, China, Cuba, Canada, Costa Rica, Canary Islands, Colombia, Dominica, Denmark, England, Ecuador, France, Fiji Islands, Germany, Guatemala, Holland, Hungary, Italy, India, Java, Japan, Malaya States, Mexico, Nicaragua, Norway, Panama, Portugal, Peru, Singapore, Switzerland, Spain, U. S. S. R., Vatican, Venezuela and the United States, and I venture to say that those with the present-day receivers are intercepting regularly a majority of the programs from these transmitters when they are on the air.

While the writer has not a verification from China, Fiji Islands, Malaya States and Singapore, he has received verifications on the balance and like all ardent fans, hopes to gather in the rest. If you are a collector of verifications, there are many other countries to be added to the above list of stations other than regular broadcast stations.

Generally speaking reception for the past few months has been above the average. Many new stations have come on the air and we may look forward for continued improvement in facilities in the various countries and additions made to the number of ever-growing short-wave transmitters. While we cannot expect as good reception conditions in the coming few months, we know we can at all times receive certain countries well, due to seasonal conditions. As the seasons change, certain stations fade out but others come into hearing, which makes DXing all the more interesting.

Consistent tuning the year around brings results. I toy and tune daily over the various bands of the stations



J. B. L. HINDS...
a veteran of the dial,
operating one of the
receivers with which
he has girdled the
globe.

known to be on the air at stated times and keep a log of how they are received. I employ the loudspeaker entirely in operating my receivers. I never was very keen for using headphones and do not feel that I miss many signals, especially with a band-spread set.

ANTENNAS

I lay considerable stress upon experimentation in antennas as they bring in the signals, and believe everyone should do his utmost to find an antenna to suit his particular location and receiver. I have tried several systems and am still experimenting. I believe directional antennas assist some but not as much as some experts claim. What an antenna will do for one it will not do for another. So experiment until you find one to suit you.

Claim is made that this kind of a doublet antenna and that kind of a double-doublet will take all the auto ignition out of your receiver if it is erected in the proper direction. I would ask how this can be done if your building is surrounded by four streets of traffic?

In other words, I am not yet sold on any one antenna system to eliminate noise, or any filtering system to eliminate noises through the house line. The latter trouble to my mind is the source of more annoyance to the average operator than the former. Especially is this true to the operator of a receiver in a city apartment building and it would be interesting reading to hear how the many electrical interferences could be eliminated or controlled. And all operators know how much it exists but none talk about it. Is there no way to overcome it? Let us make this a live subject and arrive at a solution if there is one, for it is a vital question.

VERIFICATIONS

Among the many verifications received lately are: YNLF, Nicaragua; SUZ, Egypt; VUB, India; JVM, Japan; PRF5, Brazil; PLV, Java; HP5B, Panama; The Graf Zeppelin, VK3LR, Australia; LU5CZ, Argentina; ORG and ORK, Belgium; ZFB, Bermuda; TIEP, Costa Rica; HJ5-ABC, HJ2ABC and HJA7, Colombia; CO9GC, Cuba; FGW, Guatemala; HI4D, Dominica and HAS3, Hungary.

ITEMS OF INTEREST

A recent letter from CQN, Macao, China, calls attention to a change in time—3:00 to 5:00 A. M. (E. S. T.) on Mondays and Fridays on 49.8 meters. They advise that this is the only broadcast station in Macao and

OF ALL MAN'S hobbies, none can compare with the enchanting diversion of drawing from space transmissions from the remote corners of the earth. Young and old have found in this hobby a new world and thrills beyond expression. Aside from this, there are the lasting satisfactions of special attainment, the "chalking up" of new stations and the receipt by mail of station verifications from the far ends of the globe.

This great hobby of stalking down stations has become universal. The technique of the sport has been developed in much the same way as the technique of any other sport—through practice and experience. The art of tuning is not to be gained overnight.

To a handful of men goes the credit for making of this hobby a really worth-while pursuit. Much of this credit should go to Mr. J. B. L. Hinds. He is a veteran whose experience has made of him an authority on the subject of distance reception. He has lent council to many listeners, has been instrumental in furthering the art of the hobby and has reached his present high standing through sheer merit.

We consider ourselves fortunate in having obtained the services of Mr. Hinds. He is to conduct this Department of ALL-WAVE RADIO and we rest in the assurance that his informal articles regarding distance reception will prove both highly interesting and valuable to each and every one of our readers.

For the sake of those who are not as yet acquainted with Mr. Hinds through his many contributions to radio periodicals, we might add that he is Member No. 17 in that much-cherished fraternity of aces—"The Heard All Continents Club." He has an impressive array of over 200 verification cards and letters, and recently won a substantial prize in a contest sponsored by the International Short Wave Club. He also won fifth place in the recent Denton Trophy Contest.

Mr. Hinds will be pleased to assist readers of ALL-WAVE RADIO in their reception problems. You are invited to correspond with him regarding stations, reception conditions, tuning, etc., and he will be pleased to receive reception reports from other parts of the country for publication in this Department. All such letters should be addressed to Mr. J. B. L. Hinds, 85 St. Andrews Place, Yonkers, N. Y. If you wish a personal reply, be sure to enclose a stamped and addressed envelope with your letter. Letters with regard to technical subjects should be addressed to Queries Editor, ALL-WAVE RADIO, 200 Fifth Ave., New York, N. Y.

EDITORIAL DIRECTOR.

was installed October 9th, 1933, being installed especially for telephone communication with Hongkong, Canton and Manila, but at present only broadcasting. A scheme of their plant and photo of amplifier and rectifier were enclosed. It will be noted that they do not broadcast on Sunday, and I

guess you all know that they never have.

No doubt you often listen to the identification signal used by XEBT, Mexico City, at announcement periods and which sound like the old time rubber bulb auto horn, only higher pitched. The instrument used, which is a home-

One of the more than 200 verification cards and letters received by Mr. Hinds from stations in all parts of the world.

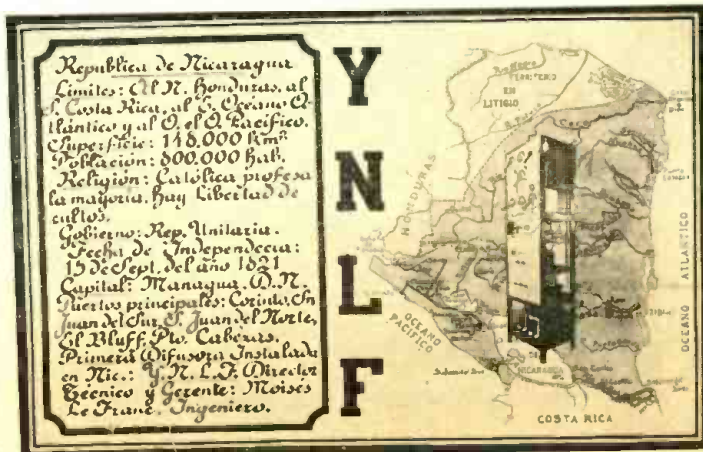

made affair, consists of two pieces of board with a spring fastened to one end, all covered with leather, with two holes in the top board. The announcer presses down on the top board and when it comes back to place by aid of the spring, the sound is emitted through the two holes. The siren call which you hear occasionally on this station is usually used once a day in connection with Missing Persons Bureau announcements.

HJ1ABE, Cartagena, Colombia advises that they have installed a new Collins transmitter and that their programs on 49.05 meters should come to us much better. They are now broadcasting with 180 watts power. It is hoped that they will realize their desire, but W2XE is in very close proximity.

CARACAS TRANSMITTER

A request for information from Radiodifusora Venezuela, YV3RC, Caracas, brings the following: YV3RC transmits daily on 6150 kc. and 1200 kc. from 11:00 A. M. to 2:00 P. M. and from 5:00 P. M. on to 10:30 P. M., Caracas time. Eastern time is one-half hour earlier. The transmitters are located about four and one-half miles from Caracas on the site called, "Las Barrancas." They use a half-wave doublet fed through a 280-foot, 500-ohm transmission line, and coupling to the antenna is made with a transformer. The studio is located in the center of Caracas and is coupled with the plant through a seven-mile line. Both transmitters use Class B modulation. The ground around Caracas is very sandy and the city is situated in a valley. To the north runs a ridge of mountains about 3300 feet above the level of Caracas. Excellent programs are broadcast from this station and much enjoyed here.

CT1AA, Lisbon, Portugal, who style themselves, *Radio Colonial*, have lately been testing on 50.17 meters early evenings and asking for reports. They

also announce they are testing on 25.4 meters between 2:00 and 3:00 P. M. It is assumed that they are coming on the air with a new line of transmitters, which seems to be the fashionable idea these days.

THE JAP STATIONS

The International Telephone Company of Japan, Ltd., which is designated in Japan as *Kokusai Denwa Kaisha, Ltd.*, and located in the Osaka Building in Tokio, is still attracting much attention, as they have for the past year. The programs from their Nazaki transmitters were first heard for quite a spell on JVM on 27.93 meters, with an occasional broadcast on JVN on 28.14 meters, or simultaneously on that wavelength with JVM. They then began coming over JVT on 44.44 meters but of late have been found on JZG on 47.39 meters with a similar program. The transmitters of these stations are putting out a fairly strong signal, but the carriers are all extremely shaky or wavering. The programs of these stations consist of dialogues, address songs and music peculiar to the country.

WAVERING SIGNALS

The steady wavering or "beat" in their carriers brings to my mind my continued reception sometime ago of F3ICD, Radio Saigon, known as the "Voice of France in Indo-China," which, of course, is not now on the air. Radio Saigon was then transmitting daily on approximately 49.10 meters and W8XAL, Cincinnati, on 49.18 meters. Some complained that these two stations interfered with each other. I conducted some correspondence with the Engineer of W8XAL at the time and received some interesting information on the subject of the "beat" in Saigon's carrier on account of its location and extreme distance from my receiver. Still, I have never been able to quite reconcile the data when making comparisons with other carriers in the Far

East which do not have such a decided "beat" or wavering to their carriers. I was told that the beat, or unsteadiness, which I mentioned as being on Saigon's carrier, was a natural phenomena on all long-distance, short-wave reception; that in ordinary broadcasting most of this signal travels near the surface of the earth and is called a ground wave and is picked up directly by the receiving antenna; in the case of short waves the ground wave does not go very far but the station radiates a strong wave which goes up into the sky, strikes the Heaviside layer, and is reflected back to earth, where it is picked up by the receiving antenna. In the case of reception of the Saigon station, I was undoubtedly receiving at least two separate signals coming from opposite directions around the earth. Since the distance that these signals travel is slightly different they do not reach the antenna simultaneously and at times the phase relationship of these two signals is such that they interfere with each other, rather than add. Since the Heaviside layer is constantly shifting, this interference varies, causing the unsteadiness mentioned.

While I am not a technician and would not pass comment, it is interesting information and I am passing it on to you as such.

NEW STATIONS BEING HEARD

C09GC—Santiago, Cuba; 48.79 meters, relaying the programs of long-wave station CMKB daily from 9:00 to 10:00 A. M., 11:30 A. M. to 1:30 P. M., and 3:00 to 4:30 P. M.

VE9AS—Fredericton, New Brunswick; 6425 kc., 46.695 meters, on the air with test programs between 6:00 and 8:00 P. M. Address; Short Wave Station VE9AS, c/o Electrical Engineering Dept., University of New Brunswick, Fredericton, N. B.

CSL—Emissora National Portuguese, Lisbon; 6150 kc., 48.78 meters, in early evening.

XECW—Del Caballero Santokan, Mexico, D. F.; 10 watts, 5980 kc., 50.17 meters. A fair signal for a 10 watter, if the code does not cover. Daily, 10:30 to 11:30 P. M. Address, Calle del Bajio, 120, Mexico, D. F.

HC2JSB—Guayaguil, Guayas Province, Ecuador, on 38.96 meters. On the air from 8:15 to 11:15 P. M.

HJ1ABJ—LaVoz de Santa Marta, Santa Marta, Colombia, on 5925 kc., 50.63 meters, in early evenings.

HJ4ABL—Ecos de Occidente, Manizales, Colombia, on about 49.18 meters. Some report the call letters HJ4ABN.

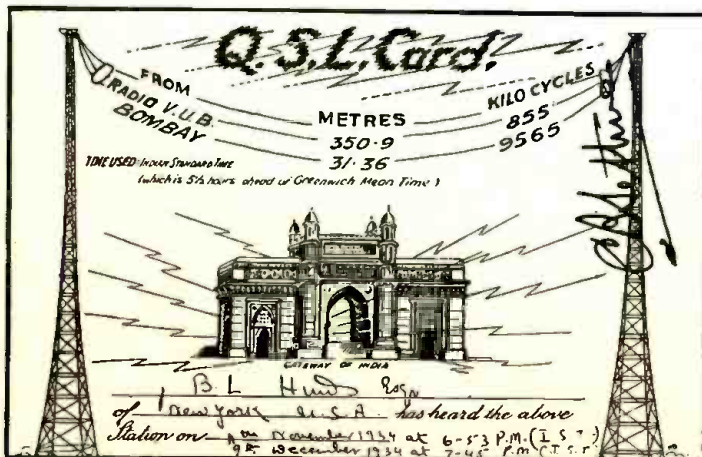

A "Veri" card from Radio VUB, Bombay, India, received by Mr. Hinds in 1934.

CHANNEL ECHOES

BY ZEH BOUCK

IN THE SPRING a young fan's fancy lightly turns to thoughts of Australia—and it is just about now that these stations begin coming in well again. VK2ME, VK3ME and VK3LR, around thirty-one meters, make merry with the ether in the wee hours. They can usually be heard as early as four A.M., and by the time the flowers that bloom in the spring tra-la have definitely put in appearance, these stations will hold up well unto breakfast.

SOME FOLKS LIKE to sit up all night, waiting for the Australians to come through. This however, is not our idea of the correct procedure. We prefer coming home just in time for 'em. The approved technique is to tune in the laughing kookaburra bird with one hand, while mixing the bicarb with the other.

MANY SHORT-WAVE enthusiasts are lured to the region of megacycles, with the idea that there they will find surcease from the plugging that so definitely mars many of our own sponsored programs on the long waves. True, on the British programs, this desired emancipation can be achieved—the Daventry stations having nothing to sell other than excellent entertainment with a British flavor that is delightful rather than otherwise. Quite the same cannot be said of the German stations. While we may not be asked to buy some brand of tooth-paste or mouth-wash, you'll have to swallow a lot of Nazi soft-soap.

AS FOR THE Latin Americans, from COH to HJ1ABB, they plaster it on more thickly than Captain Henry and a dozen Show Boats. A short tango of the type imported from New York cabarets will be followed by a lengthy talk describing the beatitudes of some particular undertaker. (The term is used ill-advisedly. Having been down in those parts, we appreciate that few undertakers can afford to be particular.) Follows then another abbreviated number on a couple of guitars introducing an elaborate speech extolling the virtues of a midwife. Next, La Cucaracha followed with intimate details concerning the strength of the very excellent pants made by one Senor Lopez.

BUT AT LEAST one thing can be said of South American stations—they advertise reasonably essential things.



ZEH BOUCK . . . first radio columnist in the world . . . a keen and just critic of radio . . . operator extraordinary on first plane flight around South America during which he flashed the first airplane SOS to result in two-way communication and the summoning of help. Salutem!

SPEAKING OF THE southern continent, PRF5 has been rolling up from Rio in excellent fashion during the past month or so, bringing along on its carrier memories of the Hotel Gloria and Copacabana. We have at times wondered if this was the station from which, a few years back, we, ourself, had the honor of broadcasting.

WE RECALL VIVIDLY that the studio and transmitter were then located on the top floor of a four-story building, dedicated during the day to the wholesale distribution of plumbing contrivances. This edifice was constructed in the form of a series of mezzanines or balconies, each one loaded with bathtubs, sinks and what have you. From the top mezzanine it was a sheer drop, from one lavatory to another, to the ground floor. We recall one member of our party, who had become an expert with a cuspidor in the Palace bar, demonstrating his marksmanship on a bath-tub four floors below.

WHILE PROBABLY twenty or thirty tubs and sinks were actually fitted with pipes, for demonstration purposes, the water had been turned off for the night. Our guide informed us that this was the custom, for the broadcasting artists had the habit of whiling away the time before and after their appearances by playing with the faucets. Whereupon several members of our party made the rounds, and surreptitiously

turned on every faucet in the place, in which condition we saw to it that they remained upon our departure.

WE WERE FLYING north from Rio the next morning anyway.

WE HAVE TWO grand opera programs now on the air—one sponsored by a tooth-paste manufacturer and the other by a packer of coffee. As our dissipations include neither product, we hold no particular brief for either sponsor. One broadcast is from the stage of the Metropolitan Opera House, on Saturday afternoons, and the other, a studio performance, in English, from eight to nine Sunday evenings.

THE FORMER IS by far the better and more enjoyable presentation—but not because the entire opera is broadcast. Rather despite this fact; for most grand operas become slow moving vehicles and heavy when shorn of the action and spectacular effects behind the footlights. For radio purposes, a one-hour condensation is ideal.

THE PALM GOES to the Metropolitan broadcasts because they are actually more beautifully done, and this we feel is partially due to the fact that they are presented in the original tongues. In translating foreign operas into English, and singing them in this language, nothing is gained and a good bit lost. Half the time, the words in the arias cannot be distinguished anyway—and this goes for Jaegel, Mario, Bori and most of the artists who have sung on the Sunday evening broadcasts. And when the words can be actually understood, the illusion of the opera is often disintegrated, because the idea of yelling at one another flowery declamations set to music is contrary to American psychology. (It should be unnecessary to state here that we are not arguing against light opera in English, or even the grand variety, when conceived and worded after the American tradition.)

THE THIRD, and to our mind the most serious objection to Anglicized presentations, is the probability that the artists, forced to concentrate on the articulation of unfamiliar words to familiar tunes, cannot give performances up to their standards as witness the unsatisfactory showing of Bori in *Manon*.

(TURN TO PAGE 44)

STAR SHORT-WAVE BROADCASTERS

TO READ IN KILOCYCLES, CHANGE DECIMAL TO COMMA. HOURS LISTED IN E. S. T.

AFRICA

Mc-Kc	Call	Location-Time
12.830	CNR	Rabat, Morocco Sun., 7:30-9 A.M.
8.050	CNR	Rabat, Morocco Sun., 2:30-5 P.M.

49-METER BAND

6.100	ZTJ	Johannesburg, S. Afr. 3:30 A.M.—4 P.M.
6.060	VQ7LO	Nairobi, Kenya Col. 11 A.M.—2 P.M.

ASIA, OCEANIA AND FAR EAST

13.070	VP1A	Suva, Fiji Islands 12:30-1:30 A.M. Daily except Sat. and Sun.
10.740	JVM	Nazaki, Japan 1:30-7:30 A.M. 7-11 P.M. (Irregular)

31-METER BAND

9.590	VK2ME	Sydney, Australia Sun. 12-2-4:30-8:30 9:30-11:30 A.M.
9.580	VK3LR	Melbourne, Australia 3-8 A.M., except Sun.
9.570	VUY- VUB	Bombay, India Wed., 11-12:30 P.M. Sat., 11-12:30 P.M.
9.510	VK3ME	Melbourne, Australia Wed., 5-6:30 A.M. Sat., 5-7 A.M.
7.880	JYR	Kemikawa-Cho, Japan 4 A.M.—8 A.M.
6.750	JVT	Nazaki, Japan 1:30-7:45 A.M.

49-METER BAND

6.130	ZGE	Kuala Lumpur, Malaya Sun., Tues., Fri., 6:40-8:40 A.M.
6.120	YDA	Bandoeng, Java 4 A.M.—11 A.M.
6.110	VUC	Calcutta, India Daily, 9:30 A.M.—12 Noon—Sat., 11:45 P.M. 3 A.M.
6.020	CQN	Maoa, China Mon., Fri., 3-5 A.M.
6.010	ZHI	Singapore, Malaya Mon., Wed., Thurs., 5:30-8:15 A.M.; Sat., 10:30 P.M.—1:15 A.M.
4.250	RV15	Khabarovsk, U.S.S.R. 1 A.M.—9 A.M.

CANADA

11.720	CJR X	Winnipeg, Manitoba 8-11 P.M., 11:30 P.M. —12 A.M.
--------	-------	---

49-METER BAND

6.150	CJRO	Winnipeg, Manitoba 8-11 P.M., 11:30 P.M. —12 A.M.
6.110	VE9HX	Halifax, N. S. 8:30-11:30 A.M.—5-10 P.M.
6.090	VE9GW	Bowmanville, Ont. Mon., Tues., Wed., 3 P.M.—12 A.M.; Thurs., Fri., 7 A.M.—12 Noon; Sat., Sun., 1-9 P.M.
6.090	VE9BJ	St. John's, N. B. 5-11 P.M.

Mc-Kc	Call	Location-Time
6.070	VE9CS	Vancouver, B. C. Daily, 6-7 P.M.; Sun., 1:45 P.M.—1 A.M.
6.000	VE9DN	Drummondville, Que. Sat., 11:30 P.M.—1:10 A.M.

CUBA, MEXICO, CENTRAL AMER- ICA AND WEST INDIES

13.420	TIEP	San Jose, Costa Rica Sun., 1-4 P.M.
11.880	TGW	Guatemala City, Guat. 8-11 P.M.
9.430	COH	Havana, Cuba 11-12 noon, 5-6 P.M.; 8-9 P.M.
6.800	HIH	S. Ped. de Macoris, R.D. 4-7 P.M.
6.710	TIEP	San Jose, Costa Rica 5-10 P.M.
6.710	YNLF	Managua, Nicaragua 6 P.M.—12 A.M.
6.530	HIL	Santo Domingo, R. D. Sat., 8-10 P.M.
6.480	HI4D	Santo Domingo, R. D. 11:55 A.M.—1:40 P.M., 4:40-7:40 P.M.
6.320	HIZ	Santo Domingo, R. D. Daily, 4:40-5:40 P.M.; Sat., 11 A.M.—12:40 P.M.
6.230	HI1A	Dominican Republic 12:10-1:40 P.M.; 7:40-9:40 P.M.

49-METER BAND

6.150	CO9GC	Santiago, Cuba 9-10 A.M., 11:30 A.M., 1:30 P.M., 3-4:30 P.M.
6.030	HP5B	Panama City, Panama 12 noon-1 P.M., 8-10:30 P.M.
6.010	COC	Havana, Cuba 9:30 A.M.—12:30 P.M., 4-6-8-10 P.M. Daily; Sat., 11:30 P.M.—1:30 A.M.
5.980	HIX	Santo Domingo, R. D. Tues., Fri., 8:10-10:10 P.M.; Sun., 8:40-10:40 A.M.—2:40-4:40 P.M.
5.970	XECW	Mexico City, Mexico 10-11:40 P.M.
5.960	XEBT	Mexico City, Mexico 6 P.M.—2 A.M.
5.940	TGX	Guatemala City, Guat. 11 A.M.—2:30 P.M., 6-10 P.M.
5.940	TGW	Guatemala City, Guat. 8-11 P.M.
5.820	TIGHP	San Jose, Costa Rica 8-11:30 P.M.

EUROPE

21.470	GSH	Daventry, England Irregularly
17.790	GSG	Daventry, England 6-7:30 A.M.

19-METER BAND

15.370	HAS	Budapest, Hungary Sun., 8-9 A.M.
15.280	DJQ	Berlin, Germany 12:30-2 A.M.
15.250	Pontoise, France	7-11 A.M.
15.220	PCJ	Huizen, Holland Sun., 8-11:30 A.M.
15.200	DJB	Berlin, Germany 3:45-7:15 A.M.

Mc-Kc	Call	Location-Time
15.130	GSF	Daventry, England 4:30-9 A.M.
15.110	HVJ	Vatican City, Rome 10:30-10:45 A.M.
12.400	CT1GO	Paredo, Portugal Tues., Thurs., Fri., 1- 2:15 P.M.; Sun., 10- 11:30 A.M.

25-METER BAND

12.230	CT1CT	Lisbon, Portugal Sun., 7-9 A.M.; Thurs., 4-6 P.M.
12.000	RNE	Moscow, U.S.S.R. Sat., 10-11 P.M.; Sun., 6-7 & 10-11 A.M.
11.900	Pontoise, France	11:15 A.M.—2:15 P.M., 3-6 P.M.
11.860	GSE	Daventry, England 6-10:45 A.M.
11.770	DJD	Berlin, Germany 12 Noon-4:30 P.M.
11.750	GSD	Daventry, England 3-5 A.M.; 12 Noon-4:30 P.M.
11.730	PHI	Huizen, Holland Mon., Thurs., Fri., Sat., Sun., 8:30-11 A.M.
11.710	Pontoise, France	7 P.M.—10 P.M., 11 P.M.—12 A.M.
10.330	ORK	Brussels, Belgium 2:45-4:15 P.M.

31-METER BAND

9.870	EAQ	Madrid, Spain 5:15-7 P.M.; Sat., 1-3 P.M. I. B. C.; Sun., Tues., Thurs., Sat., 7-7:30 P.M.
9.870	IRO	Rome, Italy 2:30-5 P.M. Daily. Mon., Wed., Fri., 7:45 -9:15 P.M.
9.690	CT1AA	Lisbon, Portugal Tues., Thurs., Sat., 4:30-7:30 P.M.
9.590	HBL	Geneva, Switzerland Sat., 5:30-6:15 P.M.
9.580	GSC	Daventry, England 6-8 P.M.
9.570	DJA	Berlin, Germany 8-11:30 A.M., 5:15-9:15 P.M.
9.550	LCL	Jeloy, Norway 5-8 A.M.
9.540	DJN	Berlin, Germany 3:45-11:30 A.M. 5:15-10:30 P.M.
9.510	GSB	Daventry, England 3:30-4:30 A.M., 9:15 A.M.—12 Noon, 1:45- 4:45 P.M.
8.020	IRS	Rome, Italy Mon., Wed., Fri., 2:30 -8 P.M. (Irregular).
7.800	HBP	Geneva, Switzerland Sat., 5:30-6:15 P.M.
7.120	HB9B	Basle, Switzerland Thurs., 4-4:30 P.M.
6.610	REN	Moscow, U.S.S.R. 1 P.M.—6 P.M.

49-METER BAND

6.200	CT1GO	Paredo, Portugal Daily, except Sat. & Mon., 7:20 P.M.—8:30 P.M.; Sun., 11:40 A.M. —1 P.M.
6.140	CSL	Lisbon, Portugal 3-7 P.M.

Mc-Kc	Call	Location-Time
6.150	LCL	Jeloy, Norway 11 A.M.—6 P.M.
6.090	IRA	Rome, Italy Mon., Wed., Fri., 6-7:30 P.M.
6.070	OER2	Vienna, Austria 9 A.M.—5:30 P.M.
6.060	OXY	Skamleback, Denmark 1—6 P.M.
6.050	GSA	Daventry, England 10:45 A.M.—12:45 P.M. 4:30—8 P.M.
6.020	DJC	Berlin, Germany 12 Noon—4:30 P.M., 5:30—10:30 P.M.
6.000	RV59	Moscow, U.S.S.R. 1 P.M.—6 P.M.
5.970	HVJ	Vatican City, Rome 2—2:15 P.M. Daily; Sun., 5—5:30 A.M.
5.400	HAT	Budapest, Hungary Sun., 8-9 P.M.

SOUTH AMERICA

10.350	LSX	Buenos Aires, Arg. 6:15—7:15 P.M. Daily; Wed., 10 P.M.
--------	-----	--

31-METER BAND

9.500	PRF5	Rio de Janeiro, Brazil 5:30-6:15 P.M.
8.190	PSK	Rio de Janeiro, Brazil 6-7:30 P.M. (Irreg.).
7.820	OA4AC	Lima, Peru 9—11:30 P.M.
7.400	HJ3ABD	Bogota, Columbia 7:30-11:30 P.M.
7.220	HKE	Bogota, Columbia Mon., 6-7 P.M.; Tues., Fri., 8-9:30 P.M.
7.140	HJ4ABB	Manizales, Columbia 4-7 P.M. (Irregular).
7.000	HJ5ABE	Cali, Columbia 7—10 P.M. (Irreg.).
6.670	HC2RL	Guayaquil, Ecuador Sun., 5:45-8 P.M.; Tues., 9:15-11:45 P.M.
6.620	El Prado	Riobamba, Ecuador Thurs., 9-11:30 P.M.
6.480	HJ5ABD	Cali, Columbia 7-10 P.M.
6.450	HJ1ABB	Barranquilla, Colum. 4:30-10 P.M.
6.370	YV4RC	Caracas, Venezuela 4:30-10:30 P.M.
6.230	OAX4B	Lima, Peru Wed., Sun., 7-9:30 P.M.

40-METER BAND

6.170	HJ2ABA	Tunja, Columbia 1-2 P.M., 7-10 P.M.
6.170	HJ3ABF	Bogota, Columbia 6-11 P.M.
6.150	YV3RC	Caracas, Venezuela 10:30 A.M.—1:30 P.M. 4:30—9:30 P.M.
6.120	HJ1ABE	Cartagena, Columbia Daily, 7-11 P.M.; Sun., 8-11 A.M.
6.110	YV2RC	Caracas, Venezuela 10:30 A.M.—1 P.M., 5:15—10 P.M.
6.100	HJ4ABL	Manizales, Columbia 6—7:30 P.M.
6.100	HJ1ABD	Cartagena, Columbia Daily, 7:30 - 9 P.M.; Sun., 11:30 A.M.—1 P.M.
6.080	CP5	La Paz, Bolivia 8—9 P.M.
6.070	HJN	Bogota, Columbia 6—11 P.M. (Irreg.).

Mc-Kc	Call	Location-Time
6.050	HJ3ABI	Bogota, Columbia 8—10 P.M.
6.040	HJ1ABG	Barranquilla, Colum. 6—10 P.M.
6.030	YV6RV	Valencia, Venezuela 5—7 P.M., 9-10 P.M.
5.970	HJ3ABH	Bogota, Columbia 12-1 P.M., 7-10 P.M.
5.950	HJ4ABE	Medellin, Columbia Mon., 7-11 P.M.; Tue., Thurs., Sat., 6:15— 8 P.M.; Wed., Fri., 7:30-10:30 P.M.
5.940	HJ1ABJ	Santa Marta, Colum. 7—11:30 P.M.
5.890	HJ2ABC	Cucuta, Columbia 11 A.M.—12, 6—9:30 P.M.
5.850	YV5RMOM	Maracaibo, Venezuela 5:15—9 P.M.
5.780	HCK	Quito, Ecuador 7:30—10:30 P.M.
5.780	OAX4D	Lima, Peru Wed., Sat., 7-10 P.M.
5.600	HJ5ABC	Cali, Columbia 8-10 P.M.
5.400	HJA7	Cucuta, Columbia Mon., 4-30-7:30 P.M.
4.600	HC2ET	Guayaquil, Ecuador Wed., Sat., 9-11 P.M.
4.110	HCJB	Quito, Ecuador 7:30-9:45 P.M., except Mon.

UNITED STATES

21.540	W8XK	Pittsburgh, Pa. 7 A.M.—2 P.M.
--------	------	----------------------------------

16-METER BAND

17.780	W3XAL	Bound Brook, N. J. Daily, 9-10 A.M.; Tues., Thurs., Fri., 3- 4 P.M.
--------	-------	--

Mc-Kc	Call	Location-Time
19-METER BAND		
15.340	W2XAD	Schenectady, N. Y. 2:30—3:30 P.M.
15.270	W2XE	Wayne, N. J. 11 A.M.—1 P.M.
15.210	W8XK	Pittsburgh, Pa. 7 A.M.—4 P.M.

25-METER BAND

11.870	W8XK	Pittsburgh, Pa. 4:30—10 P.M.
11.830	W2XE	Wayne, N. J. 3—5 P.M.

31-METER BAND

9.590	W3XAU	Philadelphia, Pa. 12 Noon—7:50 P.M.
9.570	W1XAZ	Boston, Mass. 7 A.M.—1 P.M.
9.530	W2XAF	Schenectady, N. Y. 6:30 P.M.—11 P.M.
6.430	W3XL	Bound Brook, N. J. Irregular

40-METER BAND

6.140	W8XK	Pittsburgh, Pa. 4:30 P.M.—2 A.M.
6.120	W2XE	Wayne, N. J. 6—11 P.M.
6.100	W3XAL	Bound Brook, N. J. Mon., Wed., Sat.; 5 P.M.—1 A.M.
6.100	W9XF	Chicago, Ill. Tues., Thurs., Fri., Sun., 4-9:30 P.M., 11 P.M.—2 A.M.
6.080	W9XAA	Chicago, Ill. Daily, Irregular; Sun., 11:30 A.M.—9 P.M.
6.060	W8XAL	Cincinnati, Ohio 6:30 A.M.—7 P.M., 10 P.M.—2 A.M.
6.040	W1XAL	Boston, Mass. Sun., 5-6:30 P.M.; Tues., Thurs., 7:30- 8:45 P.M.

"BRIDGE" By WEBSTER

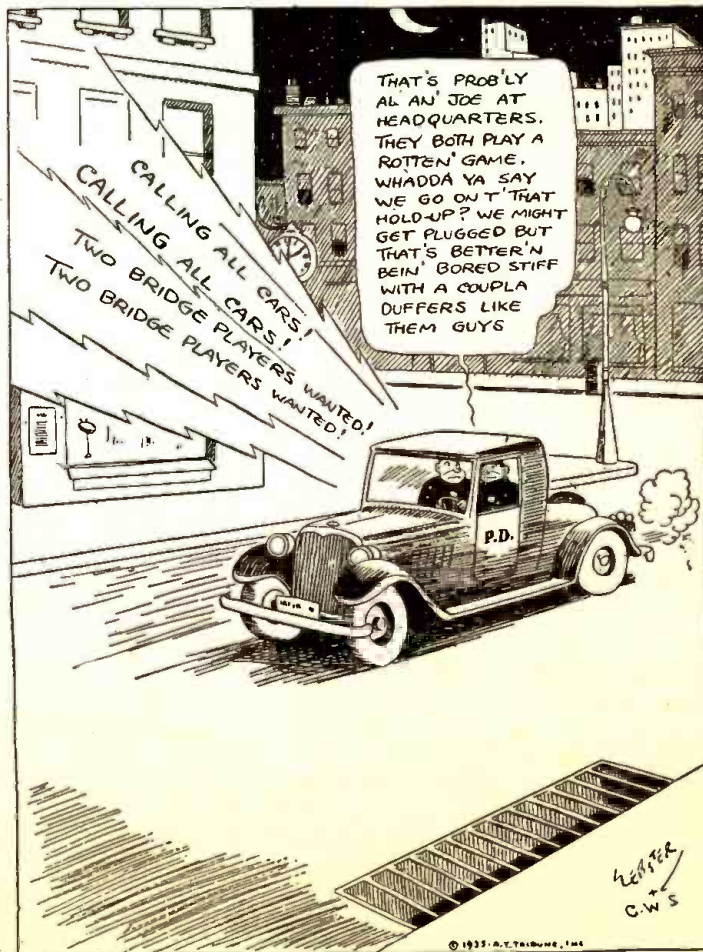

Courtesy of
N.Y. HERALD TRIBUNE

ALL-WAVE STATION LIST

STATIONS AND BANDS FROM 5 TO 2142 METERS, OR 60 MEGACYCLES TO 224 KILOCYCLES

5-METER AMATEUR BAND 60.000 to 56.000 Mc.

7-METER POLICE BAND 36.000 to 30.000 Mc.

10-METER AMATEUR BAND 30.000 to 28.000 Mc.

11-METER BROADCAST BAND

26.200 PLX Malabar, Java.

13-METER BROADCAST BAND

Mc-Kc	Call	Location-Time
21.550	XGBA	Shanghai, China P-O
21.540	VK3LR	Lyndhurst, Austral. P-O
21.540	W8XK	Pittsburgh, Pa. P-2, 3
21.500	NAA	Washington, D. C. P-O
21.490	FYA	Paris, France P-O
21.480	-----	Warsaw, Poland P-O
21.470	GSH	Daventry, Eng. P-2, 3
21.460	W1XAL	Boston, Mass. P-O
21.410	WKK	Lawrenceville, N. J. P-D
21.160	LSL	Buenos Aires, Arg. P-D
21.080	PSA	Rio de Janeiro, Br. P-D
21.030	LSN	Buenos Aires, Arg. P-D
20.850	EHY-EDM	Madrid, Spain P-2
20.380	GAA	Rugby, England P-2
20.040	OPL	Leopoldville, Belgian Congo P-2
20.020	DHO	Nauen, Germany P-2
19.810	WKN	Lawrenceville, N. J. P-D
19.690	CEC	Santiago, Chile P-D
19.600	LSF	Buenos Aires, Arg. P-2
19.520	IRW	Rome, Italy P-2
19.500	LSQ	Buenos Aires, Arg. P-3
19.350	PMA	Bandoeng, Java P-2
19.270	PPU	Rio de Janeiro, Br. P-D
19.250	DFA	Nauen, Germany P-D
18.890	ZSS	Klipkeuval, S. Afr. P-2
18.830	PLE	Bandoeng, Java P-2

16-METER BROADCAST BAND

Mc-Kc	Call	Location-Time
18.680	OCI	Lima, Peru P-3
18.620	GAU	Rugby, England P-2
18.470	KTO	Manila, P. I. P-O
18.460	HJY	Bogota, Columbia P-D
18.400	PCK	Kootwijk, Holland P-1
18.350	FZS	Saigon, Indo-China P-1
18.350	WLA	Lawrenceville, N. J. P-D
18.310	GAS	Rugby, England P-2
18.300	YVR	Maracay, Venezuela P-2
18.250	FTE	St. Assise, France P-2
18.200	GAW	Rugby, England P-2
18.180	CGA	Drummondville, Ont. P-D
18.180	PMC	Bandoeng, Java P-1
18.120	LSY	Buenos Aires, Arg. E-O
18.050	PCV	Kootwijk, Holland P-2
18.040	GAA	Rugby, England P-D
17.760	IAC	Piza, Italy P-1
17.760	DJE	Nauen, Germany E-20
17.750	HSP	Bangkok, Siam P-1
17.540	VWY	Poona, India P-1
17.520	DFB	Nauen, Germany P-2
17.270	DAF	Ocean Gate, N. J. P-OS
17.120	WOC	Norden-Land, Ger. P-OS
16.800	WLK	Lawrenceville, N. J. P-D
16.040	KKP	Kaukuku, Hawaii P-3

THE ALL-WAVE Station List is progressive by frequency. Frequencies are in megacycles (Mc), but may be translated into kilocycles (Kc) by merely changing the decimals to commas.

Wavelength markers are inserted at the points where the principal Broadcast, Amateur, Police, Aircraft, Foreign Broadcast and Weather bands are located in the frequency spectrum. The vertical rules indicate the stations operating in a given band. In the case of Police, Aircraft and Weather Report stations, the listings are alphabetically by call letter, for convenience in checking location.

The Commercial Phone and Experimental stations listed by frequency, are coded. "P" indicates a Phone station; "E" an Experimental station; "O" indicates that transmissions are irregular, and "D" indicates that the station operates daily. The numbers 1 to 5 indicate the time of day the stations operate. In other words, a day is broken up into five progressive units: 1 is early morning; 2, morning; 3, afternoon; 4, evening; 5, night. This is an easy code to follow, for it indicates to a nice degree not only the general time of day but also the general wavelength most commonly used for each of the five units of a day. Thus, 1 is early morning when wavelengths of 11, 13, 16 and 19 meters are commonly used; 2 is late morning when the 25-meter band comes into use; 3 is afternoon when the 31-meter band becomes active, etc. Thus, LSL Buenos Aires, Argentina, appears in the accompanying list at 7.900 megacycles (close to the 31-meter band), and is coded "P-3,5." This coding indicates it is a Phone station and operates in the afternoon and night (3,5). Note that the "3" practically establishes the wavelength of the station.

Mc-Kc	Call	Location-Time
15.880	FTK	St. Assise, France P-2
15.860	CEC	Santiago, Chile P-D
15.810	LSL	Buenos Aires, Arg. P-D

19-METER BROADCAST BAND

15.760	JYT	Kemikawa, Japan E-1
15.620	OCJ2	Lima, Peru P-D
15.610	JVF	Nazaki, Japan P-1
15.600	JVE	Nazaki, Japan P-1
15.410	KWO	Dixon, California P-3
15.350	KWU	Dixon, California P-3
15.250	RIM	Tashkent, U.S.S.R. P-1
15.070	WNC	Hialeah, Florida P-D
15.040	RKI	Moscow, U.S.S.R. E-2
14.980	KAY	Manila, P. I. P-1, 4
14.960	HJB	Bogota, Columbia P-D
14.690	PSF	Rio de Janeiro, Br. P-D
14.600	JVH	Nazaki, Japan P-1
14.590	WMN	Lawrenceville, N. J. P-D

Mc-Kc	Call	Location-Time
14.560	HBJ	Geneva, Switzerl. E-O
14.530	LSN	Buenos Aires, Arg. P-D
14.500	TIR-TIU	Cartago, Costa Rica P-D
14.500	YNA	Managua, Nicarag. P-D
14.500	HPF	Panama City, Pan. P-D
14.480	TGF	Guatemala City, Guatemala P-D
14.480	HRM	Tela, Honduras P-D
14.470	WMF	Lawrenceville, N. J. P-D
14.460	GBW	Rugby, England P-D

20-METER AMATEUR BAND 14.250 to 14.150 Mc.

13.900	WQP	Rocky Point, N. Y. E-2
13.830	SUZ	Cairo, Egypt P-D
13.650	HJY	Bogota, Columbia P-O
13.600	JYK	Kemikawa, Japan E-O
13.580	GBB	Rugby, England P-D
13.420	GCJ	Rugby, England P-1
13.390	WMA	Lawrenceville, N. J. P-D
13.350	YVQ	Maracay, Venezuela P-D
13.280	CGA3	Drummondville, Ontario, Can. P-DS
13.220	KPJ	Manila, P. I. P-1
13.180	DGG	Nauen, Germany P-2
12.840	WOO	Ocean Gate, N. J. P-OS
12.830	CNR	Rabat, Morocco P-1
12.830	HJA3	Barranquilla, Col. P-D
12.800	IAC	Piza, Italy P-2S
12.780	GBC	Rugby, England P-OS
12.400	DAF	Norden-Land, Ger. P-OS
12.300	PLM	Bandoeng, Java P-1
12.290	GBU	Rugby, England P-4
12.150	GBS	Rugby, England P-D
12.060	PDV	Kootwijk, Holland P-1

25-METER BROADCAST BAND

11.990	FZS	Saigon, Indo-China P-1
11.970	KKQ	Bolinas, California P-4
11.950	FTA	St. Assise, France P-2
11.710	KIO	Kaukuku, Hawaii P-4
11.660	PPQ	Rio de Janeiro, Br. E-4
11.500	XAM	Merida, Mexico P-3
11.000	PLP	Bandoeng, Java P-1
10.990	ZLT	Wellington, N. Z. P-1
10.970	OCI	Lima, Peru P-4
10.850	DFL	Nauen, Germany P-O
10.840	KWV	Dixon, California P-D
10.770	GBP	Rugby, England P-O
10.680	WNB	Lawrenceville, N. J. P-D
10.670	CEC	Santiago, Chile P-4
10.660	JVN	Nazaki, Japan E-1
10.610	WEA	Rocky Point, N. Y. E-O
10.550	WOK	Lawrenceville, N. J. P-D
10.520	VK2ME-VLK	Sydney, Australia P-1
10.420	XGW	Shanghai, China P-1
10.420	PDK	Kootwijk, Holland P-2
10.400	YBG	Medan, Sumatra P-2, 4
10.400	KEZ	Bolinas, California E-O
10.380	WCG	Rocky Point, N. Y. E-O
10.330	ZFD	Hamilton, Bermuda P-3
10.320	PPM	Rio de Janeiro, Br. P-4
10.290	DIQ	Zessen, Germany E-O
10.260	PMN	Bandoeng, Java P-1
10.220	PSH	Rio de Janeiro, Br. P-4
10.170	RIO	Bakou, U. S. S. R. P-2
10.140	OPM	Leopoldville, Belgian Congo P-D
10.070	EHY	Madrid, Spain P-3
10.050	SUV	Cairo, Egypt P-3, 4
10.050	ZFB	Hamilton, Bermuda P-DS

Mc-Kc	Call	Location-Time	
9.970	KAZ	Manila, P. I.	P-1
9.950	GCU	Rugby, England	P-4
9.930	HKB	Bogota, Colombia	P-5
9.900	LSN	Buenos Aires, Arg.	P-5
9.870	WON	Lawrenceville, N. J.	P-4
9.840	JYS	Kemikawa, Japan	P-1
9.830	IRM	Rome, Italy	P-3
9.800	GCW	Rugby, England	P-4
9.800	LSI	Buenos Aires, Arg.	E-4
9.760	VK2ME-VLK	Sydney, Australia	P-1
9.750	WOF	Lawrenceville, N. J.	P-4
9.710	GCA	Rugby, England	P-4

31-METER BROADCAST BAND

9.670	DGU	Nauen, Germany	P-D
9.480	PLW	Bandoeng, Java	P-1
9.470	WET	Rocky Point, N. Y.	E-O
9.420	PLV	Bandoeng, Java	P-1
9.330	CGA4	Drummondville, Ontario, Can.	P-D
9.280	GCB	Rugby, England	P-3
9.170	WNA	Lawrenceville, N. J.	P-4
9.140	YVR	Maracay, Venezuela	P-D
9.020	GCS	Rugby, England	P-4
9.010	KEJ	Bolinas, California	P-O
8.980	VWY	Poona, India	P-1
8.950	WEL	Rocky Point, N. Y.	E-4
8.770	PNI	Makassar, D. E. I.	P-1
8.680	GBC	Rugby, England	P-O
8.570	WOO	Ocean Gate, N. J.	P-O
8.470	DAF	Norden-Land, Ger.	P-O
8.380	IAC	Pisa, Italy	P-O
7.900	LSL	Buenos Aires, Arg.	P-3, 5
7.890	DFT	Nauen, Germany	P-3
7.860	SUX	Cairo, Egypt	P-3, 4
7.710	KEE	Bolinas, California	E-O
7.630	RIM	Moscow, U. S. S. R.	P-1
7.610	KWX	Dixon, California	P-5
7.560	KWY	Dixon, California	P-O
7.520	KKH	Kaukuku, Hawaii	P-4
7.500	RKI	Moscow, U. S. S. R.	P-1
7.390	ZLR	Wellington, N. Z.	P-1
7.370	KEQ	Kaukuku, Hawaii	P-5

40-METER AMATEUR BAND 7.300 to 7.000 Mc. Code

6.900	GDS	Rugby, England	P-5
6.750	WOA	Lawrenceville, N. J.	P-5
6.740	WEJ	Rocky Point, N. Y.	E-4
6.730	WQO	Rocky Point, N. Y.	E-O
6.670	YVQ	Maracay, Venezuela	P-5
6.650	IAC	Pisa, Italy	P-5
6.420	HJA3	Barranquilla, Col.	E-O
6.350	JZG	Nazaki, Japan	E-1

49-METER BROADCAST BAND (See "Star" Broadcast List)

6.080	ZHJ	Penang, S. S.	E-1
5.820	HJA2	Bogota, Columbia	P-4, 5
5.800	KZGF	Manila, P. I.	P-1
5.660	CFU	Rossland, Canada	E-O
5.150	PMY	Bandoeng, Java	P-2
5.080	WCN	Lawrenceville, N. J.	P-4
5.020	ZFA	Hamilton, Ber.	P-5S
4.980	GBC	Rugby, England	P-O
4.900	CGA8	Drummondville, Ontario, Can.	P-O
4.730	WOO	Ocean Gate, N. J.	P-O
4.510	VPN-ZFS	Nassau, Bahamas	P-3, 4
4.320	GDB	Rugby, England	P-4
4.320	G6RX	Rugby, England	E-4
4.310	WTDV-WTDW	Virgin Islands	E-3
4.100	WND	Hialeah, Florida	P-O

AIRCRAFT BAND 52 to 60; 87 to 97; 100 to 113; 126 to 129 Meters. (List Follows)

KEU	Burbank, Cal.
KFM	Sacramento, Cal.

KFO	Oakland, Cal.
KGE	Medford, Ore.
KGJW	Brownsville, Tex.
KGQZ	Santiago, Cal.
KGSB	Alameda, Cal.
KGSP	Denver, Colo.
KGSR	Pueblo, Colo.
KGT	Fresno, Cal.
KGTA	Winslow, Ariz.
KGTD	Wichita, Kans.
KGTE	Wichita, Kans.
KGTH	Salt Lake City, Utah.
KG TJ	Las Vegas, Nev.
KGTL	Kingman, Ariz.
KG TN	Las Vegas, Nev.
KG TQ	Springfield, Mo.
KG TR	Robertson, Mo.
KG TS	Omaha, Neb.
KG TV	Beaumont, Tex.
KG TX	Pocatello, Idaho
KG TY	Butte, Mont.
KG TZ	Spokane, Wash.
KG UA	El Paso, Tex.
KG UB	Houston, Tex.
KG UC	Fort Worth, Tex.
KG UD	San Antonio, Tex.
KG UE	Brownsville, Tex.
KG UF	Dallas, Tex.
KG UG	Big Spring, Tex.
KG UH	Waco, Tex.
KG UK	Shreveport, La.
KG UL	Ablene, Tex.
KG UM	Frijoles, Tex.
KG UN	Douglas, Ariz.
KG UP	Tucson, Ariz.
KG UQ	Phoenix, Ariz.
KG UR	Indio, Cal.
KG US	Burbank, Cal.
KG UT	Blythe, Cal.
KG UV	Robertson, Mo.
KG UZ	Ponca City, Okla.
KKO	Elko, Nev.
KMP	Omaha, Neb.
KMR	North Platte, Neb.
KNAS	Kansas City, Mo.
KNAT	Dallas, Tex.
KNAU	Tulsa, Okla.
KNAV	Oklahoma City, Okla.
KNWA	St. Paul, Minn.
KNWB	Fargo, N. Dak.
KNWC	Pembina, N. Dak.
KOE	Cheyenne, Wyo.
KQC	Rock Springs, Wyo.
KQD	Salt Lake City, Utah
KQK	Bakersfield, Cal.
KQM	Des Moines, Iowa
KQQ	Iowa City, Iowa
KQUU	Little Rock, Ark.
KRA	Boise, Idaho
KRD	Pasco, Wash.
KRF	Lincoln, Neb.
KSDB	Jackson, Miss.
KSI	Burbank, Cal.
KST	Kansas City, Mo.
KSX	Albuquerque, N. M.
KSY	Tulsa, Okla.
KUT	Redding, Cal.
KVO	Portland, Ore.
KZJ	Seattle, Wash.
WAEC	Pittsburgh, Pa.
WAED	Harrisburg, Pa.
WAEE	Camden, N. J.
WAEF	Newark, N. J.
WAEG	Cresson, Pa.
WAEH	Milwaukee, Wis.
WAEI	Detroit, Mich.
WAEJ	Springfield, Ill.
WAEK	Mobile, Ala.
WEEB	Baltimore, Md.
WEEC	Charleston, S. C.
WEEF	Spartanburg, S. C.
WEEG	Greensboro, N. C.

WEEH	McRae, Ga.
WEEJ	Jacksonville, Fla.
WEEM	Miami, Fla.
WEEN	Linden, N. J.
WEEO	Orlando, Fla.
WEER	Richmond, Va.
WHG	Columbus, Ohio
WHM	Indianapolis, Ind.
WKDL	Miami, Fla.
WMDV	San Juan, P. R.
WNAK	Cleveland, Ohio
WNAL	Brooksville, Pa.
WNAM	Bellefonte, Pa.
WNAO	Newark, N. J.
WNAT	Orlando, Twsp., Ill.
WNAU	Moline, Ill.
WQDQ	New Orleans, La.
WQPD	Atlanta, Ga.
WSDC	Newark, N. J.
WSDD	Boston, Mass.
WSDE	Birmingham, Ala.
WSDK	Memphis, Tenn.
WSDL	Duluth, Minn.
WSDR	Madison, Wis.
WSDS	Chicago, Ill.
WSDT	Nashville, Tenn.
WSID	Cincinnati, Ohio
WUCG	Chicago, Ill.

80-METER AMATEUR BAND 4.000 to 3.900 Mc.

120-METER POLICE BAND 2.500 to 2.380 Mc. (List Follows)

KGBZ	Little Rock, Ark.
KGHD	Seattle, Wash.
KGHE	Snoqualmie Pass, Wash.
KGHG	Las Vegas, Nev.
KGHJ	Long Beach, Cal.
KGHM	Reno, Nev.
KGHS	Spokane, Wash.
KGHX	Santa Ana, Cal.
KGOZ	Cedar Rapids, Iowa.
KGPA	Seattle, Wash.
KGPB	Minneapolis, Minn.
KGPE	Kansas City, Mo.
KGPF	Santa Fe, N. M.
KGPG	Vallejo, Cal.
KGPH	Oklahoma City, Okla.
KGPI	Omaha, Nebr.
KGPK	Sioux City, Iowa
KGPN	Davenport, Iowa
KGPO	Tulsa, Okla.
KGPP	Portland, Ore.
KG PQ	Honolulu, T. H.
KGPR	Minneapolis, Minn.
KGPS	Bakersfield, Cal.
KG PW	Salt Lake City, Utah
KG PX	Denver, Colo.
KG PZ	Wichita, Kan.
KGZA	Fresno, Cal.
KGZC	Topeka, Kan.
KGZD	San Diego, Cal.
KGZF	Chanute, Kan.
KGZG	Des Moines, Iowa
KGZH	Kla'th Falls, Ore.
KGZJ	Phoenix, Ariz.
KGZM	El Paso, Tex.
KGZN	Tacoma, Wash.
KGZO	Santa Barbara, Cal.
KGZP	Coffeyville, Kan.
KGZR	Salem, Ore.
KGZU	Lincoln, Nebr.
KGZV	Aberdeen, Wash.
KGZW	Lubbock, Tex.
KGZX	Albuquerque, N. M.
WCK	Belle Isle, Mich.
WMDZ	Indianapolis, Ind.
WMJ	Buffalo, N. Y.

120-METER POLICE BAND
(Continued)

WMO	Highland Park, Mich.
WPDA	Tulare, Cal.
WPDE	Louisville, Ky.
WPDF	Flint, Mich.
WPDG	Youngstown, Ohio
WPDH	Richmond, Ind.
WPDI	Columbus, Ohio
WPDK	Milwaukee, Wis.
WPDL	Lansing, Mich.
WPDM	Dayton, Ohio
WPDN	Auburn, N. Y.
WPDO	Akron, Ohio
WPDP	Philadelphia, Pa.
WPDR	Rochester, N. Y.
WPDS	St. Paul, Minn.
WPDT	Kokomo, Ind.
WPDV	Charlotte, N. C.
WPDW	Washington, D. C.
WPDX	Detroit, Mich.
WPDY	Atlanta, Ga.
WPDZ	Fort Wayne, Ind.
WPEA	Syracuse, N. Y.
WPEB	Grand Rapids, Mich.
WPEC	Memphis, Tenn.
WPEE	Brooklyn, N. Y.
WPEF	New York, N. Y.
WPEG	New York, N. Y.
WPEK	New Orleans, La.
WPEM	Woonsocket, R. I.
WPES	Saginaw, Mich.
WPEC	Muskegon, Mich.
WPEE	Reading, Pa.
WPEF	Jacksonville, Fla.
WPEG	Baltimore, Md.
WPEH	Columbus, Ga.
WPEI	Hammond, Ind.
WPEJ	Hackensack, N. J.
WPEK	Birmingham, Ala.
WPEL	Knoxville, Tenn.
WPEM	Clarksburg, W. Va.
WPEO	Swarthmore, Pa.
WPEP	Lakeland, Fla.
WPEQ	Portland, Me.
WPER	Pawtucket, R. I.
WPEU	Palm Beach, Fla.
WPEV	Miami, Fla.
WPEW	Bay City, Mich.
WPEX	Pt. Huron, Mich.
WPEY	Rockford, Ill.
WPEZ	Shreveport, La.
WPEA	Albany, N. Y.
WPEB	Portsmouth, Ohio
WPEC	Utica, N. Y.
WPEE	Cranston, R. I.
WPEF	Binghamton, N. Y.
WPEG	La Grange, Ga.
WPEH	South Bend, Ind.
WPEI	Huntington, N. Y.
WPEJ	Mineola, N. Y.
WPEK	Cleveland, Ohio
WPEL	Toledo, Ohio
WPEM	Grosse Pt., Mich.

100-METER AMATEUR BAND
2.000 to 1.800 Mc.

175-METER POLICE BAND
1.712 to 1.555 Mc.
(List Follows)

KGHK	Palo Alto, Cal.
KGHO	Des Moines, Iowa
KGHY	Whittier, Cal.
KGJX	Pasadena, Cal.
KGPC	St. Louis, Mo.
KGPD	San Francisco, Cal.
KGPI	Beaumont, Tex.
KGPL	Los Angeles, Cal.
KGPM	San Jose, Cal.
KGZE	San Antonio, Tex.
KGZI	Houston, Tex.
KGZL	Wichita Falls, Tex.

KGZQ	Waco, Tex.
KGZT	Santa Cruz, Cal.
KGZY	San Bernardino, Cal.
KSW	Berkeley, Cal.
KVP	Dallas, Tex.
WEY	Boston, Mass.
WKDT	Detroit, Mich.
WKDU	Cincinnati, Ohio
WMP	Framingham, Mass.
WPDB	Chicago, Ill.
WPDC	Chicago, Ill.
WPDD	Chicago, Ill.
WPDU	Pittsburgh, Pa.
WPED	Arlington, Mass.
WPEH	Somerville, Mass.
WPEI	Providence, R. I.
WPEL	Middleboro, Mass.
WPET	Lexington, Ky.
WPEW	Northampton, Mass.
WPF	Newton, Mass.
WPFN	Fairhaven, Mass.
WPGC	Schenectady, N. Y.
WPGF	Providence, R. I.
WPGG	Findlay, Ohio
WRDS	E. Lansing, Mich.

"BROADCAST" BAND
(See Separate Domestic List)

Mc-Kc	Location	Kw
1.149	Washford Cross, England	50
1.149	Brookmans Park, England	50
1.120	XENT; Nuevo Laredo, Mex.	150
1.104	Madona, Latvia	50
1.077	Bordeaux, France	20
1.059	IIBA; Bari, Italy	20
1.050	Falkirk, Scotland	50
1.031	Konigsberg, Germany	60
1.013	Slaithwaite, England	50
0.995	PX1, Amsterdam, Holland	25
0.977	G5WA; Cardiff-Bristol, Eng.	50
0.959	Paris, France	100
0.922	OKB; Brno, Czechoslovakia	32
0.913	Toulouse, France	60
0.904	Hamburg, Germany	100
0.890	XEW; Mexico, D. F.	50
0.877	G2LO; London, England	50
0.841	"Witzleben," Berlin, Ger.	100
0.832	RW39; Moscow, No. 4 U.S.S.R.	100
0.830	LR5; Florida, Argentina	30
0.814	IMI; Milan, Italy	50
0.804	G5SC; Falkirk, Scotland	50
0.785	Leipzig, Germany	120
0.767	G5GB; Daventry, England	25
0.740	Munich, Germany	100
0.731	Tallinn, Estonia	20
0.722	RW9; Kiev, U.S.S.R.	36
0.713	I1RO; Rome, No. 1, Italy	50
0.704	SBA; Stockholm, Sweden	55
0.677	Sottens, Switzerland	25
0.668	Slaithwaite, England	50
0.660	XGOA; Nanking, China	75
0.658	Cologne, Germany	100
0.638	Prague, No. 1, Czechoslovakia	120
0.629	Trondelag, Norway	20
0.620	Cairo, Egypt	20
0.619	KZRM; Manila, P. I.	50
0.609	Florence, Italy	20
0.592	Vienna, Austria	120
0.574	Stuttgart, Germany	100
0.565	Athlone, Irish Free State	60
0.556	Beromunster, Switzerland	100
0.546	HAL; Budapest, No. 1, Hung.	120

FOREIGN BROADCAST BAND
550 to 2000 Meters

Mc-Kc	Location	Kw
0.401	RCZ; Moscow, No. 3, U.S.S.R.	100
0.375	RW5; Sverdlovsk, U.S.S.R.	50
0.355	RW12; Rostov-on-Don, U.S.S.R.	20
0.280	RW7; Tiflis, U.S.S.R.	35
0.271	RW49; Moscow, No. 2, U.S.S.R.	100
0.260	LKO; Oslo, Norway	60

256.4	RW11; Tashkent, U.S.S.R.	25
0.245	RW53; Leningrad, U.S.S.R.	100
0.238	Kalundborg, Denmark	75
0.232	RW20; Kharkov, U.S.S.R.	20
0.230	Luxembourg	150
0.224	Warsaw, No. 1, Poland	120
217.5	RW76; Novosibirsk, U.S.S.R.	100
0.216	SBG; Motala, Sweden	30
0.208	RW10; Minsk, U.S.S.R.	35
0.200	Droitwich, England	150
0.191	Berlin, Germany	60
0.182	Paris, France	75
0.174	RW1; Moscow, No. 1, U.S.S.R.	500
0.166	Lahti, Finland	40
0.160	Kootwijk, Holland	50
0.160	Brazov, Roumania	20

WEATHER REPORT BAND
732 to 2142 Meters
(List Follows)

Call	Mc-Kc	Location
KCAA	296	Tulsa, Okla.
KCAC	284	Butte, Mont.
KCAD	359	Idaho Falls, Idaho
KCAE	308	Winslow, Ariz.
KCAF	296	Albuquerque, N. M.
KCAG	248	Amarillo, Texas
KCAH	350	Kingman, Ariz.
KCAJ	272	Little Rock, Ark.
KCAK	230	Shreveport, La.
KCAL	266	Yuma, Ariz.
KCAM	338	Tucson, Ariz.
KCAN	365	Fargo, N. Dak.
KCAO	314	El Paso, Texas
KCAP	326	Big Spring, Texas
KCAQ	266	Minneapolis, Minn.
KCAR	302	Pueblo, Colo.
KCAS	344	Spokane, Wash.
KCAT	320	Milford, Utah
KCAU	332	Houston, Texas
KCAV	254	Springfield, Mo.
KCAW	254	San Antonio, Texas
KCQ	290	St. Louis, Mo.
KCR	308	Boise, Idaho
KCS	260	Pasco, Wash.
KCT	284	Los Angeles, Cal.
KCU	344	Fresno, Cal.
KCV	332	Oakland, Cal.
KCX	266	Medford, Ore.
KCY	284	Portland, Ore.
KCZ	365	Seattle, Wash.
KDA	350	Chicago, Ill.
KDN	290	Rock Springs, Wyo.
KGD	338	Salt Lake City, Utah
KIS	272	Iowa City, Iowa
KJF	320	Omaha, Neb.
KKJ	365	Fort Worth, Tex.
KLK	254	Reno, Nev.
KOJ	314	Elko, Nev.
KRC	359	Kansas City, Mo.
KSG	326	Cheyenne, Wyo.
KVM	284	North Platte, Neb.
WEK	332	Wichita, Kans.
WFT	248	Spartanburg, S. C.
WHZ	266	Atlanta, Ga.
WNR	260	Richmond, Va.
WRW	320	Greensboro, N. C.
WSG	224	La Crosse, Wis.
WSX	266	Boston, Mass.
WWAB	266	Buffalo, N. Y.
WWAC	314	Nashville, Tenn.
WWAF	365	Miami, Fla.
WWAG	338	New Orleans, La.
WWAH	320	Albany, N. Y.
WWAP	254	Pittsburgh, Pa.
WWAQ	260	Jackson, Miss.
WWAR	320	Jackson, Mich.
WWAS	332	Cincinnati, Ohio
WWAT	224	Birmingham, Ala.
WWAU	326	Memphis, Tenn.
WWAV	344	Jacksonville, Fla.
WWAW	332	Charleston, S. C.
WWBC	254	Titusville, Fla.
WWBF	248	Mobile, Ala.
WWO	344	Cleveland, Ohio
WWQ	284	Bellefont, Pa.
WWU	338	New Brunswick, N. J.
WWX	272	Washington, D. C.

In Writing For Veries . . .

ADDRESSES OF PRINCIPAL SHORT-WAVE-STATIONS BY COUNTRY

AFRICA		CUBA, MEXICO, CENTRAL AMERICA AND WEST INDIES		Call	Address
Call	Address	Call	Address		
CNR	Director General des Postes, Rabat, Morocco.	CO9GC	Laboratorio Radio-Electrico, Grau y Caminero, Apartado 137, Santiago, Cuba.	G6RX	Rugby Radio, Hillmorton, Warwickshire, England.
OPL-OPM	Radio Leopoldville, Congo Belge, Africa.	COC	Post Office Box 98, Havana Cuba.	GSA-GSH, et al.	British Broadcasting Corporation, Broadcasting House, London, W.1., England.
SUV-SUX	Post Office Box 795, Cairo, Egypt.	COH	Estacion COH, Calle B No. 2 Vedado, Havana, Cuba.	HAS-HAT	Director Radio. Hungarian Post, Gyam St. 22, Budapest, Hungary.
VQ7LO	P. O. Box 777, Nairobi, Kenya Colony, Africa.	HI1A	Radiodifusora HI1A "La Voz del Yaque," Santiago de Los Caballeros, R. D.	HB9B	Radio Club, Box 1, Basle Switzerland.
ZTJ	Radio ZTJ, Johannesburg, South Africa.	HI4D	Radiodifusora HI4D, "La Voz de Quisqueya," Dominican Republic.	HBL-HBP, et al.	Information Section, League of Nations, Geneva, Switzerland.
ASIA, OCEANIA AND FAR EAST		HI4D	Radiodifusora HI4D, "La Voz de Quisqueya," Dominican Republic.	HVJ	Radio HVJ, Castine, Pio IV, Vatican City, Vatican, Italy.
Call	Address	HIH	Radio HIH, "La Voz del Higuamo" San Pedro de Macoris, R. D.	IAC	Coltano Radio, Piza, Italy.
CQN	Government Broadcasting Station CQN, Postmaster General, Post Office Bldg., Macao (Portugese), China.	HIL	Radio HIL, Apartado 623, Santo Domingo City, R. D.	IRM-IRV	Radio Radio, Via Calabria N. 46/48, Rome, Italy.
FZS	Postale Boite 238, Saigon, Indo-China.	HIX	Radio HIX, J. R. Saladin, Director of Radio Communication, Santo Domingo, R. D.	LCL	Ministere Du Commerce, Administrator des Telegraphes, Oslo, Norway.
HSP	Government Post & Telegraph, Bangkok, Siam.	HIZ	Radiodifusora HIZ, Calle Duarte No. 68, Santa Domingo, R. D.	OER2	Radio OER2, Vienna, Austria.
Java Stations	H. Van der Veen, Engineer, Java Wireless Stations, Bandoeng, Java.	HP5B	Radio HP5B, P. O. Box 910, Panama City, Panama.	ORK-ORG	Director of Communications, Bruxelles, Belgium.
JVM-JVT	International Wireless Telephone Company of Japan, Osaka Bldg., Kojimachiku, Tokio, Japan.	TGX	Radiodifusora TGX, Director M. A. Mejicano Novales, 11 Avenue N. 45, Guatemala City, Guatemala.	ONY	Stateradiofonien Heibersgade 7, Copenhagen, Denmark.
JYR	Radio JYR, Kemikawa-Chochiba, Ken, Japan.	TGW	Radiodifusora Nacional TGK, Republic de Guatemala.	PCJ-PHI	Phillips Radio, Huizen, Holland.
KAY et al.	Philippine Long Distance Telephone Co., Manila, P. I.	TIEP	"La Voz del Tropico," Apartado 257, Costa Rica.	Pontoise	Minister des Postes, 193 Rue de Grenelle, Paris, France.
RV15	Far East Radio Station RV-15, Khabarovsk, U.S.S.R.	TIGHP	Radiodifusora TIGHP, "Alma Tica," Apartado 775, San Jose, Costa Rica.	RNE-RFN RV59	Radio Centre. Solianka 12, Moscow, U.S.S.R.
VK2ME	Amalgamated Wireless Ltd., Wireless House, 47 York St., Sydney, N.S.W. Australia.	VPN	Station VPN, Nassau, Bahama Islands.	SOUTH AMERICA	
VK3LR	Australian Broadcasting Commission, Broadcast House, 264 Pitt St., Sydney, Australia.	WTDV	H. M. McKenzie, St. Thomas, Virgin Islands.	Call	Address
VK3ME	Amalgamated Wireless Ltd., P. O. Box 1272-L, Melbourne, Australia.	WTDW	S. I. Winde, Christiansted Virgin Islands.	CP5	Radio CP5, Casilla 637, La Paz, Bolivia.
VPIA	Amalgamated Wireless, Ltd., Suva, Fiji Islands.	XAM	Director General de Correos, Merida, Yucatan, Mexico.	El Prado	Apartado 98, Riobamba, Ecuador.
VUC	Indian State Broadcasting Service, 1 Garstin Place, Calcutta, India.	XDA-XDC	Secretaria de Comunicaciones, Mexico, D. F.	HC2ET	Radiodifusora del Telegrafo, Casilla 249, Guayaquil, Ecuador.
VUY-VUB	Indian State Broadcasting Service, Irwin House, Spratt Road, Ballard Estate, Bombay, India.	XEBT	El Buen Tono, S.A., Apartado 79-44, Mexico, D. F.	HC2RL	P. O. Box 759, Guayaquil, Ecuador.
XGW	Radio Administration, Sassoon House, Shanghai, China.	XECW	Radio XECW, Mexico, D. F.	HCJB	Casilla 691, Quito, Ecuador.
YBG	Radio Service, Serdangweg 2, Sumatra, Dutch East Indies.	YNLF	Radiodifusora YNLF, c/o Ing. Moises Le Franc Calle 15 de Set No. 206, Managua, Nicaragua.	HCK	Radiodifusora HCK, Quito, Ecuador.
YDA	H. Van der Veen, Engineer, Java Wireless Stations, Bandoeng, Java.	EUROPE		HJA7	Radio HJA7, Cucuta, Colombia.
ZGE	Radio ZGE, Kuala Lumpur, Malaya States.	Call	Address	HJ1ABB	Apartado 715, Barranquilla, Colombia.
ZHI	Radio Service Company, Broadcast House, 2 Orchard Road, Singapore, Malaya.	2RO	5 Via Montello, Rome, Italy.	HJ1ABD	Estacion HJ1ABD, Cartagena, Colombia.
ZLT-ZLW ZLR	Supt. Post & Telegraph, G.P.O., Wellington, New Zealand.	CSL	Radio CSL, Emissora National, Lisbon, Portugal.	HJ1ABE	Apartado 31, Cartagena, Colombia.
CANADA		CT1AA	Antonio Augusto de Aguir, 144, Lisbon, Portugal.	HJ1ABG	Apartado 816, Barranquilla, Colombia.
Call	Address	CT1CT	Oscar G. Lomelino, Rua Gomez Freire 79-2 D, Lisbon, Portugal.	HJ1ABJ	"La Voz de Santa Marta," Radio HJ1ABJ, Santa Marta, Colombia.
CGA-CJA, et al.	Marconi Station, Drummondville, Quebec, Canada.	CT1GO	Portugese Radio Club, Paredé, Portugal.	HJ2ABA	"La Voz Del Paiz," Tunja, Boyaca, Colombia.
CJRX-CJRO	Royal Alexander Hotel, Winnipeg, Manitoba, Canada.	DAF	Hauptfunkstelle Nordeich, Norden-Land, Germany.	HJ2ABC	Pompilio Sanchez, Cucuta, Colombia.
VE9LJ	Capitol Theatre, St. Johns, N.B. Canada.	DJA, et al.	German Short Wave Station, Broadcasting House, Berlin, Germany.	HJ3ABD	Colombia Broadcasting, Apartado 509, Bogota, Colombia.
VE9CS	743 Davie St., Vancouver, B. C., Canada.	Dutch Phones	Partstaat 29, S'Gravenhage, Holland.	HJ3ABF	Apartado 317, Bogota, Colombia.
VE9DN	Canadian Marconi Co., Box 1690, Montreal, Quebec, Can.	EAQ	P. O. Box 951, Madrid, Spain.	HJ3ABH	"La Voz de La Victor," Bogota, Colombia.
VE9GW	Rural Route No. 4, Bowmanville, Ontario, Canada.	EHY-EDM	Piy Margall 2, Madrid, Spain.	HJ3ABI	Apartado 513, Bogota Colombia.
VE9HX	Post Office Box 998, Halifax, N. S. Canada.	English Phones	Radio Section G.P.O., 89 Wood St., London E.C. 2, England.	HJ4AEB	Radio Manizales, Apartado 175, Manizales, Colombia.
		English Ships	Connaught House, 63, Aldwych, London W.C. 2, England.	HJ4ABE	Radiodifusora de Medellin, Medellin, Colombia.
		French Phones	166 Rue de Montmartre, Paris, France.	HJ4ABL	"Ecos de Occidente," Manizales, Colombia.
				HJ5ABC	"La Voz de Colombia," Radiodifusora, HJ5ABC, Cali, Colombia.

(TURN TO PAGE 25)

U. S. BROADCAST

ALPHABETICALLY BY CALL LETTERS, AND BY FREQUENCY

Call	Location	Kc	Watts	Call	Location	Kc	Watts	Call	Location	Kc	Watts
KABC	San Antonio, Texas	1420	100	KGDY	Huron, S. Dakota	1340	250	KOMO	Seattle, Wash.	920	1000
KABR	Aberdeen, S. Dak.	1420	100	KGEK	Yuma, Colo.	1200	100	KONO	San Antonio, Texas	1370	100
KADA	Ada, Okla.	1200	100	KGER	Long Beach, Calif.	1360	1000	KOOS	Marshfield, Ore.	1200	100
KALE	Portland, Ore.	1300	500	KGEZ	Kalispell, Mont.	1310	100	KORE	Eugene, Ore.	1420	100
KARK	Little Rock, Ark.	890	250	KGFF	Shawnee, Okla.	1420	100	KOTN	Pine Bluff, Ark.	1500	100
KASA	Elk City, Okla.	1210	100	KGFG	Oklahoma City, Okla.	1370	100	KOY	Phoenix, Ariz.	1390	500
KBPS	Portland, Ore.	1420	100	KGFI	Corpus Christi, Texas	1500	100	KPAC	Port Arthur, Texas	1260	500
KBTM	Paragould, Ark.	1200	100	KGFL	Los Angeles, Calif.	1200	100	KPCB	Seattle, Wash.	650	100
KCMC	Texarkana, Ark.	1420	100	KGFK	Moorhead, Minn.	1500	100	KPJM	Prescott, Ariz.	1500	100
KCRC	Enid, Okla.	1370	100	KGFL	Roswell, N. Mex.	1370	100	KPO	San Francisco, Calif.	680	50000
KCRJ	Jerome, Ariz.	1310	100	KGFW	Kearney, Nebr.	1310	100	KPOF	Denver, Colo.	880	500
KDB	Santa Barbara, Calif.	1500	100	KGFX	Pierre, S. Dak.	630	200	KPPC	Pasadena, Calif.	1210	50
KDFN	Casper, Wyo.	1440	500	KGGS	San Francisco, Calif.	1420	100	KPQ	Wenatchee, Wash.	1500	100
KDKA	Pittsburgh, Pa.	980	50000	KGGF	Coffeyville, Kansas	1010	1000	KPRC	Houston, Texas	920	1000
KDLR	Devils Lake, N. Dak.	1210	100	GGGM	Albuquerque, N. Mex.	1230	250	KQV	Pittsburgh, Pa.	1380	500
KDYL	Salt Lake City, Utah	1290	1000	KGHF	Pueblo, Colo.	1320	500	KQW	San Jose, Calif.	1010	500
KECA	Los Angeles, Calif.	1430	1000	KGHI	Little Rock, Ark.	1200	100	KRE	Berkeley, Calif.	1370	100
KELW	Burbank, Calif.	780	500	KGHL	Billings, Mont.	950	1000	KREG	Santa Ana, Calif.	1500	100
KERN	Bakersfield, Calif.	1370	100	KGIR	Butte, Mont.	1360	1000	KRGV	Weslaco, Texas	1260	500
KEX	Portland, Ore.	1180	5000	KGIW	Alamosa, Colo.	1420	100	KRKD	Los Angeles, Calif.	1120	500
KFAB	Lincoln, Nebr.	770	5000	KGIX	Las Vegas, Nev.	1420	100	KRKO	Everett, Wash.	1370	50
KFAC	Los Angeles, Calif.	1300	1000	KGKB	Tyler, Texas	1500	100	KRLC	Lewiston, Idaho*	1420	100
KFBB	Great Falls, Montana	1280	1000	KGKL	San Angelo, Texas	1370	100	KRLD	Dallas, Texas	1040	10000
KFBI	Abilene, Kansas	1050	5000	KGKO	Wichita Falls, Texas	570	250	KRMD	Shreveport, La.	1310	100
KFBK	Sacramento, Calif.	1310	100	KGKY	Scottsbluff, Nebraska	1500	100	KROW	Oakland, Calif.	930	1000
KFDM	Beaumont, Texas	560	500	KGMB	Honolulu, Hawaii	1320	250	KRSC	Seattle, Wash.	1120	100
KFDY	Brookings, South Dak.	780	1000	KGNF	North Platte, Nebr.	1430	1000	KSAC	Manhattan, Kan.	580	500
KFEL	Denver, Colo.	920	500	KGNO	Dodge City, Kansas	1340	250	KSCJ	Sioux City, Iowa	1330	1000
KFEQ	St. Joseph, Mo.	680	2500	KGO	San Francisco, Calif.	790	7500	KSD	St. Louis, Mo.	550	500
KFGQ	Boone, Iowa	1370	100	KGRS	Amarillo, Texas	1410	1000	KSEI	Pocatello, Idaho	890	250
KFH	Wichita, Kansas	1300	1000	KGU	Honolulu, Hawaii	750	2500	KSL	Salt Lake City, Utah	1130	50000
KFI	Los Angeles, Calif.	640	50000	KGVO	Missoula, Mont.	1200	100	KSLM	Salem, Ore.	1370	100
KFIO	Spokane, Wash.	1120	100	KGW	Portland, Ore.	620	1000	KSO	Des Moines, Iowa	1320	250
KFIZ	Font du Lac, Wis.	1420	100	KGX	Olympia, Wash.	1210	100	KSOO	Sioux Falls, S. Dakota	1110	2500
KFJB	Marshalltown, Iowa	1200	100	KHJ	Los Angeles, Calif.	900	1000	KSTP	St. Paul, Minn.	1460	10000
KFJI	Klamath Falls, Ore.	1210	100	KHQ	Spokane, Wash.	590	1000	KSUN	Lowell, Ariz.	1200	100
KFJM	Grand Forks, N. Dak.	1370	100	KICA	Clovis, N. Mex.	1370	100	KTAB	San Francisco, Calif.	560	1000
KFJR	Portland, Ore.	1300	500	KID	Idaho Falls, Idaho	1320	250	KTAR	Phoenix, Ariz.	620	500
KFJZ	Fort Worth, Texas	1370	100	KIDO	Boise, Idaho	1350	1000	KTAT	Fort Worth, Texas	1240	1000
KFKA	Greeley, Colo.	880	500	KIDW	Lamar, Colo.	1420	100	KTBS	Shreveport, La.	1450	1000
KFKU	Lawrence, Kansas	1220	1000	KIEM	Eureka, Calif.	1210	100	KTFI	Twin Falls, Idaho	1240	500
KFNF	Shenandoah, Iowa	890	500	KIEV	Glendale, Calif.	850	100	KTHS	Hot Springs National Park, Ark.	1040	10000
KFOR	Lincoln, Nebr.	1210	100	KIT	Yakima, Wash.	1310	100	KTM	Los Angeles, Calif.	780	500
KFOX	Long Beach, Calif.	1250	1000	KIUJ	Santa Fe, N. Mex.*	1310	100	KTRB	Modesto, Calif.	740	250
KFPL	Dublin, Texas	1310	100	KJBS	San Francisco, Calif.	1070	100	KTRH	Houston, Texas	1330	1000
KFPM	Greenville, Texas	1310	15	KJR	Seattle, Wash.	970	5000	KTSA	San Antonio, Texas	1290	1000
KFPW	Ft. Smith, Ark.	1210	100	KLCN	Blytheville, Ark.	1290	100	KTSM	El Paso, Texas	1310	100
KFPY	Spokane, Wash.	1340	1000	KLO	Ogden, Utah	1400	500	KTUL	Tulsa, Okla.	1400	250
KFQD	Anchorage, Alaska	780	250	KLPM	Minot, N. Dakota	1240	250	KTW	Seattle, Wash.	1220	1000
KFRD	San Francisco, Calif.	610	1000	KLRA	Little Rock, Ark.	1390	1000	KUJ	Walla Walla, Wash.	1370	100
KFRO	Longview, Texas	1370	100	KLS	Oakland, Calif.	1440	250	KUMA	Yuma, Ariz.	1420	100
KFRU	Columbia, Mo.	630	500	KLUF	Galveston, Texas	1370	100	KUOA	Fayetteville, Ark.	1260	1000
KFSD	San Diego, Calif.	600	1000	KLX	Oakland, Calif.	880	1000	KUSD	Vermillion, S. D.	890	500
KFSG	Los Angeles, Calif.	1120	500	KLZ	Denver, Colo.	560	1000	KVI	Tacoma, Wash.	570	1000
KFUO	Clayton, Mo.	550	500	KMA	Shenandoah, Iowa	930	1000	KVL	Seattle, Wash.	1370	100
KFVD	Los Angeles, Calif.	1000	250	KMAC	San Antonio, Texas	1370	100	KVOA	Tucson, Ariz.	1260	500
KFVS	Cape Girardeau, Mo.	1210	100	KMBC	Kansas City, Mo.	950	1000	KVOD	Denver, Colo.	920	500
KFWB	Hollywood, Calif.	950	1000	KMED	Medford, Ore.	1310	100	KVOO	Tulsa, Okla.	1140	25000
KFXD	Nampa, Idaho	1200	100	KMJ	Fresno, Calif.	580	500	KVOR	Col. Springs, Colo.	1270	1000
KFXJ	Grand Junction, Colo.	1200	100	KMLB	Monroe, La.	1200	100	KVOS	Bellingham, Wash.	1200	100
KFXM	San Bernardino, Calif.	1210	100	KMMJ	Clay Center, Nebr.	740	1000	KWCR	Cedar Rapids, Iowa	1430	250
KFXR	Oklahoma City, Okla.	1310	100	KMO	Tacoma, Wash.	1330	250	KWEA	Shreveport, La.	1210	100
KFYO	Lubbock, Texas	1310	100	KMOX	St. Louis, Mo.	1090	50000	KWFFV	Hilo, Waiakea, Hawaii*	1210	100
KFYR	Bismarck, N. Dakota	550	1000	KMPC	Beverly Hills, Calif.	710	500	KWG	Stockton, Calif.	1200	100
KGA	Spokane, Wash.	1470	5000	KMTR	Los Angeles, Calif.	570	1000	KWJJ	Portland, Ore.	1060	500
KGAR	Tucson, Ariz.	1370	100	KNOW	Austin, Texas	1500	100	KWK	St. Louis, Mo.	1350	1000
KGB	San Diego, Calif.	1330	1000	KNX	Los Angeles, Calif.	1050	50000	KWKC	Kansas City, Mo.	1370	100
KGBU	Ketchikan, Alaska	900	100	KOA	Denver, Colo.	830	50000	KWKH	Shreveport, La.	850	10000
KGBX	Springfield, Mo.	1310	500	KOAC	Corvallis, Ore.	550	1000	KWLC	Decorah, Iowa	1270	100
KGBZ	York, Nebr.	930	1000	KOB	Albuquerque, N. Mex.	1180	10000	KWSC	Pullman, Wash.	1220	1000
KGCA	Decorah, Iowa	1270	100	KOH	Reno, Nev.	1380	500	KWTN	Watertown, S. Dak.	1210	100
KGCU	Mandan, N. Dakota	1240	250	KOIL	Council Bluffs, Iowa	1260	1000	KWTO	Springfield, Mo.	560	1000
KGCX	Wolf Point, Montana	1310	100	KOIN	Portland, Ore.	940	1000	KWYO	Sheridan, Wyo.	1370	100
KGDE	Fergus Falls, Minn.	1200	100	KOL	Seattle, Wash.	1270	1000	KXA	Seattle, Wash.	760	250
KGDM	Stockton, Calif.	1100	250	KOMA	Oklahoma City, Okla.	1480	5000				

STATION LIST

ASTERISKS DENOTE CONSTRUCTION PERMITS HAVE BEEN GRANTED

Call	Location	Kc	Watts	Call	Location	Kc	Watts	Call	Location	Kc	Watts
KXL	Portland, Ore.	1420	1000	WCLO	Janesville, Wis.	1200	100	WHAZ	Troy, New York	1300	500
KXO	El Centro, Calif.	1500	100	WCLS	Joliet, Ill.	1310	100	WHB	Kansas City, Mo.	860	500
KXRO	Aberdeen, Wash.	1310	100	WCNW	Brooklyn, N. Y.	1500	100	WHBC	Canton, Ohio	1200	100
KXYZ	Houston, Texas	1440	500	WCOA	Pensacola, Fla.	1340	500	WHBD	Mt. Orab, Ohio	1370	100
KYA	San Francisco, Calif.	1230	1000	WCOC	Meridian, Miss.	880	500	WHBF	Rock Island, Ill.	1210	100
KYW	Philadelphia, Pa.	1020	10000	WCOL	Columbus, Ohio	1210	100	WHBI	Newark, N. J.	1250	1000
WAAB	Boston, Mass.	1410	500	WCRW	Chicago, Ill.	1210	100	WHBL	Sheboygan, Wis.	1410	500
WAAF	Chicago, Ill.	920	500	WCSC	Charleston, S. C.	1360	500	WHBQ	Memphis, Tenn.	1370	100
WAAT	Jersey City, N. J.	940	500	WCSH	Portland, Maine	940	1000	WHBU	Anderson, Ind.	1210	100
WAAW	Omaha, Nebr.	660	500	WDAE	Tampa, Fla.	1220	1000	WHBY	Green Bay, Wis.	1200	100
WABC	New York, N. Y.	860	50000	WDAF	Kansas City, Mo.	610	1000	WHDF	Calumet, Mich.	1370	100
WABI	Bangor, Maine	1200	100	WDAG	Amarillo, Texas	1410	1000	WHDH	Boston, Mass.	830	1000
WABY	Albany, N. Y.	1370	100	WDAH	El Paso, Texas	1310	100	WHDL	Olean, N. Y.	1420	100
WACO	Waco, Texas	1420	100	WDAY	Philadelphia, Pa.	1370	100	WHEB	Portsmouth, N. H.	740	250
WADC	Tallmadge, Ohio	1320	1000	WDAY	Fargo, N. Dakota	940	1000	WHEC	Rochester, N. Y.	1430	500
WAGF	Dothan, Ala.	1370	100	WDBJ	Roanoke, Va.	930	1000	WHEF	Kosciusko, Miss.	1500	100
WAGM	Presque Isle, Maine	1420	100	WDBO	Orlando, Fla.	580	250	WHFC	Cicero, Ill.	1420	100
WAIU	Columbus, Ohio	640	500	WDEL	Wilmington, Del.	1120	250	WHIO	Erie Pa.	1260	1000
WALA	Mobile, Ala.	1380	500	WDEV	Waterbury, Vt.	550	500	WHIS	Bluefield, W. Va.	1410	250
WALR	Zanesville, Ohio	1210	100	WDGJ	Minneapolis, Minn.	1180	1000	WHJB	Greensburg, Pa.	620	250
WAMC	Anniston, Ala.*	1420	100	WDNC	Durham, N. C.	1500	100	WHK	Cleveland, Ohio	1390	1000
WAML	Laurel, Miss.	1310	100	WDOD	Chattanooga, Tenn.	1280	1000	WHN	New York, N. Y.	1010	1000
WAPI	Birmingham, Ala.	1140	5000	WDRG	Hartford, Conn.	1330	1000	WHO	Des Moines, Iowa	1000	50000
WARD	Brooklyn, N. Y.	1400	500	WDSU	New Orleans, La.	1250	1000	WHOM	Jersey City, N. J.	1450	250
WASH	Grand Rapids, Mich.	1270	500	WDZ	Tuscola, Ill.	1070	100	WHP	Harrisburg, Pa.	1430	500
WATR	Waterbury, Conn.	1190	100	WEAF	New York, N. Y.	660	50000	WIBA	Madison, Wis.	1280	500
WAVE	Louisville, Ky.	940	1000	WEAN	Providence, R. I.	780	250	WIBG	Glenside, Pa.	970	100
WAWZ	Zarephath, N. J.	1350	250	WEBC	Superior, Wis.	1290	1000	WIBM	Jackson, Mich.	1370	100
WAZL	Hazleton, Pa.	1420	100	WEBQ	Harrisburg, Ill.	1210	100	WIBU	Poynette, Wis.	1210	100
WBAA	West Lafayette, Ind.	890	500	WEBR	Buffalo, N. Y.	1310	100	WIBW	Topeka, Kansas	580	1000
WBAL	Baltimore, Md.	1060	10000	WEDC	Chicago, Ill.	1210	100	WIBX	Utica, N. Y.	1200	100
WBAP	Fort Worth, Texas	800	50000	WEED	Rocky Mount, N. C.	1420	100	WICC	Bridgeport, Conn.	600	500
WBAX	Wilkes-Barre, Pa.	1210	100	WEEI	Boston, Mass.	590	1000	WIL	St. Louis, Mo.	1200	100
WBBC	Brooklyn, N. Y.	1400	500	WEEU	Reading, Pa.	830	1000	WILL	Urbana, Ill.	890	250
WBBL	Richmond, Va.	1210	100	WEHC	Charlottesville, Va.	1350	500	WILM	Wilmington, Del.	1420	100
WBBM	Chicago, Ill.	770	25000	WEHS	Cicero, Ill.	1420	100	WIND	Gary, Ind.	560	1000
WBBR	Brooklyn, N. Y.	1300	1000	WELL	Battle Creek, Mich.	1420	50	WINS	New York, N. Y.	1180	1000
WBBZ	Ponca City, Okla.	1200	100	WENR	Chicago, Ill.	870	50000	WIOD	Miami, Fla.	1300	1000
WBCM	Bay City, Mich.	1410	500	WESG	Elmira, N. Y.	1040	1000	WIP	Philadelphia, Pa.	610	500
WBEN	Buffalo, N. Y.	900	1000	WEVD	New York, N. Y.	1300	1000	WIS	Columbia, S. C.	1010	500
WBEO	Marquette, Mich.	1310	100	WEW	St. Louis, Mo.	760	1000	WISN	Milwaukee, Wis.	1120	250
WBHS	Huntsville, Ala.	1200	100	WEXL	Royal Oak, Mich.	1310	50	WJAC	Johnstown, Pa.	1310	100
WBIG	Greensboro, N. C.	1440	500	WFAA	Dallas, Texas	800	50000	WJAG	Norfolk, Nebr.	1060	1000
WBNO	New Orleans, La.	1200	100	WFAB	New York, N. Y.	1300	1000	WJAR	Providence, R. I.	890	250
WBNS	Columbus, Ohio	1430	500	WFAM	South Bend, Ind.	1200	100	WJAS	Pittsburgh, Pa.	1290	1000
WBNX	New York, N. Y.	1350	250	WFAS	White Plains, N. Y.	1210	100	WJAX	Jacksonville, Fla.	900	1000
WBOQ	(See WABC)			WFBC	Greenville, S. C.	1300	1000	WJAY	Cleveland, Ohio	610	500
WBOW	Terre Haute, Ind.	1310	100	WFBE	Cincinnati, Ohio	1200	100	WJBC	La Salle, Ill.	1200	100
WBRB	Red Bank, N. J.	1210	100	WFBG	Altoona, Pa.	1310	100	WJBK	Detroit, Mich.	1500	100
WBRC	Birmingham, Ala.	930	1000	WFBL	Syracuse, N. Y.	1360	1000	WJBL	Decatur, Ill.	1200	100
WBRE	Wilkes-Barre, Pa.	1310	100	WFBM	Indianapolis, Ind.	1230	1000	WJBO	Baton Rouge, La.*	1420	100
WBSO	Needham, Mass.	920	500	WFBR	Baltimore, Md.	1270	500	WJBW	New Orleans, La.	1200	100
WBT	Charlotte, N. C.	1080	50000	WFDF	Flint, Mich.	1310	100	WJBY	Gadsden, Ala.	1210	100
WBTM	Danville, Va.	1370	100	WFEA	Manchester, N. H.	1340	500	WJDX	Jackson, Miss.	1270	1000
WBZ	Boston, Mass.	990	50000	WFI	Philadelphia, Pa.	560	500	WJEJ	Hagerstown, Md.	1210	100
WBZA	Boston, Mass.	990	1000	WFLA	Clearwater, Fla.	620	250	WJIM	Lansing, Mich.	1210	100
WCAC	Storrs, Conn.	600	500	WGAL	Lancaster, Pa.	1500	100	WJJD	Chicago, Ill.	1130	20000
WCAD	Canton, N. Y.	1220	500	WGAR	Cleveland, Ohio	1450	500	WJMS	Ironwood, Mich.	1420	100
WCAE	Pittsburgh, Pa.	1220	1000	WGBB	Freeport, N. Y.	1210	100	WJR	Detroit, Mich.	750	10000
WCAL	Northfield, Minn.	1250	1000	WGBF	Evansville, Ind.	630	500	WJSV	Alexandria, Va.	1460	10000
WCAM	Camden, N. J.	1230	500	WGBI	Scranton, Pa.	880	250	WJTL	Oglethorpe Univ., Ga.	1370	100
WCAO	Baltimore, Md.	600	500	WGCM	Gulfport, Miss.	1210	100	WJW	Akron, Ohio	1210	100
WCAP	Asbury Park, N. J.	1280	500	WGES	Chicago, Ill.	1360	500	WJZ	New York, N. Y.	760	30000
WCAT	Rapid City, S. Dak.	1200	100	WGH	Newport News, Va.	1310	100	WKAQ	San Juan, Puerto Rico	1240	1000
WCAU	Philadelphia, Pa.	1170	50000	WGL	Ft. Wayne, Ind.	1370	100	WKAR	East Lansing, Mich.	1040	1000
WCAX	Burlington, Vt.	1200	100	WGN	Chicago, Ill.	720	50000	WKBB	East Dubuque, Ill.	1500	100
WCAY	Carthage, Ill.	1070	100	WGNY	Chester Twp., N. Y.	1210	100	WKBF	Indianapolis, Ind.	1400	500
WCBA	Allentown, Pa.	1440	250	WGPC	Albany, Ga.	1420	100	WKBH	La Crosse, Wis.	1380	1000
WCBD	Waukegan, Ill.	1080	5000	WGR	Buffalo, N. Y.	550	1000	WKBI	Cicero, Ill.	1420	100
WCBM	Baltimore, Md.	1370	100	WGST	Atlanta, Ga.	890	500	WKBN	Youngstown, Ohio	570	500
WCBS	Springfield, Ill.	1210	100	WGY	Schenectady, N. Y.	790	50000	WKBO	Harrisburg, Pa.	1200	100
WCCO	Minneapolis, Minn.	810	50000	WHA	Madison, Wis.	940	2500	WKBV	Richmond, Ind.	1500	100
WCFL	Chicago, Ill.	970	1500	WHAM	Rochester, N. Y.	1150	50000	WKBW	Buffalo, N. Y.	1480	5000
WCHS	Charleston, W. Va.	580	500	WHAS	Louisville, Ky.	820	50000	WKBY	Muskegon, Mich.	1500	100
WCKY	Covington, Ky.	1490	5000	WHAT	Philadelphia, Pa.	1310	100	WKEU	La Grange, Ga.	1500	100

Call	Location	Kc	Watts	Call	Location	Kc	Watts	Call	Location	Kc	Watts
WKJC	Lancaster, Pa.	1200	100	WNBR	Silverhaven, Pa.	1200	100	WRUF	Gainesville, Fla.	830	5000
WKOK	Sunbury, Pa.	1210	100	WNBO	Memphis, Tenn.	1430	500	WRVA	Richmond, Va.	1110	5000
WKRC	Cincinnati, Ohio	550	500	WNBX	Springfield, Vt.	1260	1000	WSAI	Cincinnati, Ohio	1330	1000
WKY	Oklahoma City, Okla.	900	1000	WNBZ	Saranac Lake, N. Y.	1290	50	WSAJ	Grove City, Pa.	1310	100
WKZO	Kalamazoo, Mich.	590	1000	WNEL	San Juan, P. R.*	1290	500	WSAN	Allentown, Pa.	1440	250
WLAC	Nashville, Tenn.	1470	5000	WNEW	Newark, N. J.	1250	1000	WSAR	Fall River, Mass.	1450	250
WLAP	Lexington, Ky.	1420	100	WNRA	Knoxville, Tenn.	1010	1000	WSAZ	Huntington, W. Va.	1190	1000
WLB	Minneapolis, Minn.	1250	1000	WNOX	Muscle Shoals, Ala.	1420	100	WSB	Atlanta, Ga.	740	50000
WLBC	Muncie, Ind.	1310	50	WNYC	New York, N. Y.	810	1000	WSBC	Chicago, Ill.	1210	100
WLBK	Kansas City, Kan.	1420	100	WOAI	San Antonio, Tex.	1190	50000	WSBT	South Bend, Ind.	1360	500
WLBL	Stevens Point, Wis.	900	2500	WOC	Carter Lake, Iowa	1420	100	WSFA	Montgomery, Ala.	1410	500
WLBZ	Bangor, Maine	620	500	WOCL	Jamestown, N. Y.	1210	50	WSGN	Birmingham, Ala.	1310	100
WLEU	Erie, Pa.	1420	100	WOI	Ames, Iowa	640	5000	WSIX	Springfield, Tenn.	1210	100
WLLH	Lowell, Mass.	1370	100	WOKO	Albany, N. Y.	1430	500	WSJS	Winston-Salem, N. C.	1310	100
WLIT	Philadelphia, Pa.	560	500	WOL	Washington, D. C.	1310	100	WSM	Nashville, Tenn.	650	50000
WLNH	Laconia, N. H.	1310	100	WOMT	Manitowoc, Wis.	1210	100	WSMB	New Orleans, La.	1320	500
WLS	Chicago, Ill.	870	50000	WOOD	Grand Rapids, Mich.	1270	500	WSMK	Dayton, Ohio	1380	200
WLTH	Brooklyn, N. Y.	1400	500	WOPI	Bristol, Tenn.	1500	100	WSOC	Charlotte, N. C.	1210	100
WLVA	Lynchburg, Va.	1200	100	WOR	Newark, N. J.	710	50000	WSPA	Spartanburg, S. C.	1420	100
WLW	Cincinnati, Ohio	700	50000	WORC	Worcester, Mass.	1280	500	WSPD	Toledo, Ohio	1340	1000
WLWL	New York, N. Y.	1100	5000	WORK	York, Pa.	1000	1000	WSUI	Iowa City, Iowa	880	500
WMAL	Washington, D. C.	630	250	WOS	Jefferson City, Mo.	630	500	WSUN	(See WFLA)		
WMAQ	Chicago, Ill.	670	5000	WOSU	Columbus, Ohio	570	750	WSVA	Staunton, Va.*	550	500
WMAS	Springfield, Mass.	1420	100	WOV	New York, N. Y.	1130	1000	WSVS	Buffalo, N. Y.	1370	50
WMAZ	Macon, Ga.	1180	500	WOW	Omaha, Nebr.	590	1000	WSYR	Rutland, Vt.	1500	100
WMBC	Detroit, Mich.	1420	100	WOWO	Ft. Wayne, Ind.	1160	10000	WSYB	Syracuse, N. Y.	570	250
WMBD	Peoria, Ill.	1440	500	WPAD	Paducah, Ky.	1420	100	WTAD	Quincy, Ill.	1440	500
WMBF	(See WIOD)			WPAX	Thomasville, Ga.	1210	100	WTAG	Worcester, Mass.	550	500
WMBG	Richmond, Va.	1210	100	WPEN	Philadelphia, Pa.	920	250	WTAM	Cleveland, Ohio	1070	50000
WMBH	Joplin, Mo.	1420	100	WPFB	Hattiesburg, Miss.	1370	100	WTAQ	Eau Claire, Wis.	1330	1000
WMBI	Chicago, Ill.	1080	5000	WPG	Atlantic City, N. J.	1100	5000	WTAR	Norfolk, Va.	780	500
WMBR	Auburn, N. Y.	1310	100	WPHR	Petersburg, Va.	1200	100	WTAW	College Station, Texas	1120	500
WMBQ	Brooklyn, N. Y.	1500	100	WPRO	Providence, R. I.	1210	100	WTAX	Springfield, Ill.	1210	100
WMBR	Jacksonville, Fla.	1370	100	WPTF	Raleigh, N. C.	680	1000	WTBO	Cumberland, Md.	800	250
WMC	Memphis, Tenn.	780	500	WQAM	Miami, Fla.	560	1000	WTCN	Minneapolis, Minn.	1250	1000
WMCA	New York, N. Y.	570	500	WQAN	Scranton, Pa.	880	250	WTEL	Philadelphia, Pa.	1310	100
WMEX	Chelsea, Mass.	1500	100	WQBC	Vicksburg, Miss.	1360	1000	WTFI	Athens, Ga.	1450	500
WMFD	Wilmington, N. C.*	1370	100	WQDM	St. Albans, Vt.	1370	100	WTIC	Hartford, Conn.	1060	50000
WMFE	New Britain, Conn.*	1380	250	WRAX	Williamsport, Pa.	1370	100	WTJS	Jackson, Tenn.	1310	100
WMFF	Plattsburg, N. Y.*	1310	100	WRAW	Reading, Pa.	1310	100	WTMJ	Milwaukee, Wis.	620	1000
WMFG	Hibbing, Minn.*	1210	100	WRAX	Philadelphia, Pa.	920	250	WTNJ	Trenton, N. J.	1280	500
WMFH	Boston, Mass.*	1120	500	WRBL	Columbus, Ga.	1200	100	WTOC	Savannah, Ga.	1260	1000
WMFI	New Haven, Conn.*	900	500	WRBX	Roanoke, Va.	1410	250	WTRC	Eikhart, Ind.	1310	50
WMFJ	Daytona Beach, Fla.*	1420	100	WRC	Washington, D. C.	950	500	WVFW	Brooklyn, N. Y.	1400	500
WMFK	Ponce, P. R.*	1420	100	WRDO	Augusta, Maine	1370	100	WVAE	Hammond, Ind.	1200	100
WMMN	Fairmont, W. Va.	890	250	WRDWA	Augusta, Ga.	1500	100	WVJ	Detroit, Mich.	920	1000
WMPC	Lapeer, Mich.	1200	100	WREC	Memphis, Tenn.	600	500	WWL	New Orleans, La.	850	10000
WMT	Waterloo, Iowa	600	500	WREN	Lawrence, Kansas	1220	1000	WWNC	Asheville, N. C.	570	1000
WNAC	Boston, Mass.	1230	1000	WRGA	Rome, Ga.	1500	100	WWPA	Clarion, Pa.*	850	250
WNAD	Norman, Okla.	1010	1000	WRJN	Racine, Wis.	1370	100	WWRL	Woodside, N. Y.	1500	100
WNAX	Yankton, S. Dak.	570	1000	WRK	Rockford, Ill.	1410	500	WWSW	Pittsburgh, Pa.	1500	100
WNBK	Binghamton, N. Y.	1500	100	WROL	Knoxville, Tenn.	1310	100	WVVA	Wheeling, W. Va.	1160	5000
WNBH	New Bedford, Mass.	1310	100	WRR	Dallas, Texas	1280	500	WXYZ	Detroit, Mich.	1240	1000

U. S. AND CANADIAN BROADCAST STATIONS BY FREQUENCY

540 KC	CJRM.	640 KC	KFI, WAIU, WOI.	770 KC	KFAB, WBBM.
550 KC	CFNB, KFUO, KFJR, KOAC, KSD, WDEV, WGR, WKRC, WWSVA*.	650 KC	KPCB, WSM.	780 KC	CHWK, KELW, KFDY, KFQD, KTM, WEAN, WMC, WTAR.
560 KC	KFDM, KLZ, KTAB, KWTO, WFI, WIND, WLIT, WQAM.	660 KC	WAAW, WEAJ.	790 KC	KGO, WGY.
570 KC	KGKO, KMTR, KVI, WKBN, WMCA, WNAX, WOSU, WSYR, WSYU, WWNC.	670 KC	WMAQ.	800 KC	WBAP, WFAA, WTBO.
580 KC	CHRC, CKCL, CKUA, KMJ, KSAC, WCHS, WDBO, WIBW, WTAG.	680 KC	KFEQ, KPO, WPTF.	810 KC	WCCO, WNYC.
590 KC	KHQ, WEEL, WKZO, WOW.	690 KC	CFRB, CJJ.	820 KC	WHAS.
600 KC	CFCF, CFCO, CJOR, KFSD, WCAC, WCAO, WICC, WMT, WREC.	700 KC	WLV.	830 KC	KOA, WEEU, WHDH, WRUF.
610 KC	KFRC, WDAF, WIP, WJAY.	710 KC	KMPC, WOR.	840 KC	CFQC, CRCT.
620 KC	KGW, KTAR, WFLA, WSUN, WHJB, WLBZ, WTMJ.	720 KC	WGN.	850 KC	KIEV, KWKH, WWL, WWPA*.
630 KC	CFCY, CJGX, CKOV, KFRU, KGFX, WGBF, WMAL, WOS.	730 KC	CFPL, CJCA, CKAC.	860 KC	WABC, WBOQ, WHB.
		740 KC	KMMJ, KTRB, WHEB, WSB.	870 KC	WENR, WLS.
		750 KC	KGU, WJR.	880 KC	CFJC, CRCO, KFKA, KLX, KPOF, WCOC, WGBI, WQAN, WSUI.
		760 KC	KXA, WEW, WJZ.		

890 KC CJIC, KARK, KFNF, KSEI, KUSD, WBAA, WGST, WILL, WJAR, WMMN.
 900 KC KGBU, KHJ, WBEN, WJAX, WKY, WLBL, WMFI.*
 910 KC CJAT, CRCM.
 920 KC KFEL, KOMO, KPRC, KVOD, WAAP, WBSO, WPEN, WRAX, WWJ.
 930 KC CFAC, CPCH, CFLC, CHNS, CKPC, CKPR, KGBZ, KMA, KROW, WBRC, WDBJ.
 940 KC KOIN, WAAT, WAVE, WCSH, WDAY, WHA.
 950 KC CRCS, KFWB, KGHL, KMBC, WRC.
 960 KC CKY.
 970 KC KJR, WCFL, WIBG.
 980 KC KDKA.
 990 KC WBZ, WBZA.
 1000 KC KFVD, WHO, WORK..
 1010 KC CHML, CHWC, CKCD, CKCK, CKCO, CKIC, CKWX, KGGF, KQW, WHN, WIS, WNAD, WNOX.
 1020 KC KYW.
 1030 KC CFCN, CKLW.
 1040 KC KRLD, KTHS, WESG, WKAR.
 1050 KC CRCK, KFBI, KNX.
 1060 KC KWJJ, WBAL, WJAG, WTIC.
 1070 KC KJBS, WCAZ, WDZ, WTAM.
 1080 KC WBT, WCBD, WMBI.
 1090 KC KMOX.
 1100 KC CRCV, KGDM, WLWL, WPG.
 1110 KC KSOO, WRVA.
 1120 KC CHLP, CHSJ, CKOC, KPFO, KFSG, KRKD, KRSC, WDEL, WISN, WMFH*, WTAW.
 1130 KC KSL, WJJD, WOV.
 1140 KC KVOO, WPAI.
 1150 KC WHAM.

1160 KC WOWO, WWVA.
 1170 KC WCAU.
 1180 KC KEX, KOB, WDG, WINS, WMAZ.
 1190 KC WATR, WOAI, WSAZ.
 1200 KC CHAB, KADA, KBTM, KFJB, KFXD, KFXJ, KGDE, KGEK, KGFI, KGGH, KGOV, KMLB, KOOS, KSUN, KVOO, KWG, WABI, WBBZ, WBHS, WBNO, WCAT, WCAX, WCLO, WFAM, WFBE, WHBC, WHBY, WIBX, WIL, WJBC, WJBL, WJBW, WKBO, WKJC, WLVA, WMPC, WNBO, WPHR, WRBL, WWAE.
 1210 KC CHNG, CKBI, CKCH, CKMC, KASA, KDLR, KFJI, KFOR, KFPW, KFVS, KFXM, KGY, KIEM, WPPC, KWEA, KWFW, KWTN, WALR, WBAX, WBBL, WBRB, WBS, WCOL, WCRW, WEBQ, WEDC, WFAS, WGBB, WGRM, WGNV, WHBF, WHBU, WIBU, WJBY, WJBJ, WJIM, WJW, WKFI, WKOK, WMBG, WMPG*, WOCL, WOMT, WPAX*, WPRO, WSB, WSIX, WSOC, WTAX.
 1220 KC KFKU, KTW, KWSC, WCAD, WCAE, WDAE, WREN.
 1230 KC CJOC, KGBX, KGGM, KYA, WFBM, WNAC.
 1240 KC CJCB, KGCU, KLPM, KTAT, KTFI, WKAQ, WXYZ.
 1250 KC KFOX, WCAL, WDSU, WHBI, WLB, WNEW, WTCN.
 1260 KC CFTP, KOIL, KPAC, KRGV, KUOA, KVOA, WHIO, WNBX, WTOC.
 1270 KC KGCA, KOL, KVOR, KWLC, WASH, WJDX, WOOD.
 1280 KC KFBB, WCAM, WCAP, WDOD, WIBA, WORC, WRR, WTNJ.
 1290 KC KDYL, KLCN, K TSA, WEBC, WJAS, WNBZ, WNEL.
 1300 KC KALE, KFAC, KFH, KFJR, WBBR, WEVD, WFAB, WFBC, WHAZ, WIOD, WMBF.
 1310 KC CHCK, CJKL, CJS, CKCV, KCRJ, KFBK, KFPL, KFPM, KFRR, KFYO, KGBX, KGCC, KGEZ, KGPW, KIT, KIUI*, KMED, KRMD, K TSM, KXRO, WAML, WBEO, WBOW, WBRE, WCLS, WDAH, WEBR, WEXL, WFBG, WFDL, WGH, WHAT, WJAC, WLBC, WLNH, WMBQ, WMFF*, WNBH, WOL, WRAW, WROL, WSAJ, WSGN, WSJS, WTEL, WTJS, WTRC.
 1320 KC KGHF, KGMB, KID, KSO, WADC, WSMB.

1330 KC KGB, KMO, KSCJ, KTRH, WDRC, WSAI, WTAQ.
 1340 KC KFPY, KGDY, KGNO, WCOA, WFEA, WSPD.
 1350 KC KIDL, KWK, WAWZ, WBNX, WEHC.
 1360 KC KGER, KGIR, WCSC, WFBL, WGES, WQBC, WSBT.
 1370 KC CKCW, KCRC, KERN, KFGJ, KFJM, KFJZ, KPRO*, KGAR, KGFG, KGFL, KGKL, KICA, KLUF, KMAC, KONO, KRE, KRKO, KSLM, KUJ, KVL, KWKC, KWYO, WABY, WAGF, WBTM, WCBM, WDAS, WGL, WHBD, WHBQ, WHDF, WIBM, WJTL, WLLH, WMBR, WMFD*, WPPB, WQDM, WRAC, WRDO, WRJN, WSVS.
 1380 KC KOH, KQV, WALA, WKBH, WMFE*, WSMK.
 1390 KC CJRC, KLRA, KOY, WHK.
 1400 KC KLO, KTUL, WARD, WBBC, WKBF, WLTH, WVFV.
 1410 KC CKFC, CKMO, KGRS, WAAB, WBCM, WDAG, WHBL, WHIS, WRBX, WROK, WSPA.
 1420 KC CKGB, CKNC, KABC, KABR*, KBPS, KCMC, KFIZ, KGFF, KGGC, KGIW, KGIX, KIDW, KORE, KRLC*, KUMA, KXL, WACO, WAGM, WAMC, WAZL, WEED, WEHS, WELL, WGPC, WHDL, WHFC, WILM, WJBO, WJMS, WKBI, WLAP, WLB, WLEU, WMAS, WMBC, WMBH, WMFJ*, WMFK*, WNRA, WOC, WPAD, WSPA.
 1430 KC KECA, KGNF, KWCR, WBNS, WHEC, WHP, WNBR, WOKO.
 1440 KC KDFN, KLS, KXYZ, WBIG, WCBA, WMBD, W SAN, WTAD.
 1450 KC CPCT, CKX, KTBS, WGAR, WHOM, WSAR, W TFI.
 1460 KC KSTP, WJSV.
 1470 KC KGA, WLAC.
 1480 KC KOMA, WKBW.
 1490 KC WCKY.
 1500 KC CHGS, KDB, KGFI, KGFK, KGKB, KGKY, KNOW, KOTN, KPJM, KPQ, KREG, KXO, WCNW, WDNC, WGAL, WHEF, WJBK, WKBB, WKBY, WKBZ, WKEU, WMBQ, WMEX, WNB, WOPI, WRDW, WRGA, WSYB, WWRL, WWSW.
 1510 KC CFRC, CKCR.

IN WRITING FOR VERIES

(Continued from Page 21)

HJ5ABD "La Voz del Valle," Cali, Colombia.
 HJ5ABE Radiodifusora HJ5ABE, Cali, Colombia.
 HJB Marconi Telegraph Co., Apartado 1591, Bogota, Colombia.
 HJN Ministerio de Correos y Telegraph, Bogota, Colombia.
 HJY All-America Cables, Inc., Bogota, Colombia.
 HKE Observatoria Nacional de San Bartolome, Bogota, Colombia.
 LSN-LSL, et al. Compania Internacional, 143 Defensa, Buenos Aires, Argentina.
 LSX Transradio Internacional, San Martin 329, Buenos Aires, Argentina.

OA4AC-OA4AD P. O. Box 853, Lima, Peru.
 OAX4B-OAX4D All-America Cables, Inc., Lima, Peru.
 PPU-PPQ, et al. Caixa Postal 500 Rio de Janeiro, Brazil.
 PRF5-PSK Comp. Radio Internacional Do Brazil, P. O. Box 709, Rio de Janeiro, Brazil.
 YV2RC Apartado Correos 2009, Caracas, Venezuela.
 YV3RC Radiodifusora Venezuela, YV3RC, Caracas, Venezuela.
 YV4RC Estacion S.A.R., Este 10 bis N. 71, Caracas, Venezuela.
 YV5RMO Box 214, Maracaibo, Venezuela.
 YV6RV "La Voz de Carabobo," Radio YV6RV, Valencia, Venezuela.
 YVQ-YVR Servicio Radiotelegraphico, Maracay, Venezuela.

UNITED STATES

Call	Address
Dixon Stations	140 Montgomery St., San Francisco, Cal.
W1XAL	70 Brookline Ave., Boston, Mass.
W1XAZ	Hotel Statler, Boston, Mass.
W2XAD-W2XAF	General Electric Co., Schenectady, N. Y.
W2XE	485 Madison Ave., New York, N. Y.
W3XAU	1622 Chestnut St., Philadelphia, Pa.
W3XL-W3XAL	30 Rockefeller Plaza, New York, N. Y.
W8XAL	Crosley Radio Corp., Cincinnati, Ohio.
W8XK	William Penn Hotel, Pittsburgh, Pa.
W9XAA	Navy Pier, Chicago, Ill.
W9XF	20 North Wacker Drive, Chicago, Ill.

SIGNALS and NOISE

ONE WITHOUT THE OTHER

A RECENT LETTER, from a listener in California, advises us that its writer was listening to two of the English stations, with volume and clarity comparable to regular local reception. One of the stations was in the 25-meter band and the other in the 31-meter band. The time was 7:30 A.M., in San Francisco, which would be 10:30 A.M., in New York.

We mention this letter because it indicates how it is generally possible to secure similar results, if the proper precautions are taken. It is our purpose to explode some of the theories which have been touted as facts by self-proclaimed radio "experts" and "engineers," who know so much that "isn't" that they have gone a long way toward discouraging the more discriminating listener, who, as a result, is missing much of the pleasure and instruction which the modern all-wave receiver can be made to provide.

"POOR RECEPTION"

Before getting into the whys and the wherefors, let us mention that our friend in California wrote us regarding the fine results he was getting, after he had written several rather warm letters. These letters gave details regarding the failure of his receiver to give him the satisfaction he expected from it, as a result of the advertising claims made by its manufacturer. Then, too, he was equally vehement in his comments upon the performance of the special antenna system, purchased from the present author's company, which displayed a similar inability to live up to the claims made for it. These points are presented with a view to pinning the present article right down to cold facts so as to avoid the customary hypothetical case, which offers

By

ARTHUR H. LYNCH

so much room for the imaginative author to expound theories as though they were facts.

FOREIGN RECEPTION ANYWHERE

Some years ago, an attempt was made to permit listeners in the U. S., Canada and Mexico to hear broadcasting from various stations in Europe. In order to provide programs which would be attractive to American listeners, Lloyd George, Senator Marconi and other important personages, were invited to speak from the English stations, while Owen D. Young, Henry Ford, General Harbord, David Sarnoff and many others of prominence, addressed remarks to European listeners from radio stations in all parts of this continent.

Europe broadcast to America for an hour each night, for an entire week. During the foreign transmissions, every station on the American continent ceased operations. During the transmissions from this side, which were of similar duration, the foreign stations were off the air, for the same reason. These tests were carried on in the regular broadcast band and they were quite successful. They were run in the same fashion, for three successive years and served to stimulate an interest in international broadcasting. With the introduction of short-wave broadcasting, they were no longer necessary and were abandoned.

When foreign reception was first

found possible on the short waves, it was more or less in the nature of a laboratory venture. In fact, it was looked upon by one group of engineers as being possible but practically worthless. These gentlemen, who, it is pleasant to relate, have made many valuable contributions to the art, had such strong convictions concerning the negative value of foreign reception on short waves, that they prepared and circulated a rather costly and comprehensive booklet which purported to explain just why long-distance, short-wave reception would never have any real entertainment value and that, while it was possible to hear some of the foreign stations with reasonable regularity, the value of the programs was nullified by the terrific background noise which accompanied them. The reputation of these gentlemen was very good and their past accomplishments had been such as to lend much weight to their findings, especially in view of the strength with which their statements were made. Fortunately, the radio engineering field is not entirely free from dissenters and many continued their investigations in spite of the fact that they were told they were wasting their time and that nothing of any importance could come of their work.

NOISE-FREE RECEPTION

Today, it is not at all uncommon for listeners in all parts of this country to bring in programs from various European centers, and from Japan, Australia and South Africa as well. And, we may say, not only bring them in, but do so with a freedom from the noise which accompanied the first attempts, which makes the foreign reception compare favorably with much of the local broadcasting. Certainly, in suitable locations, with suitable equipment and with reasonable precautions taken in connection with the installation, the actual program value from the standpoint of material, as well as faithfulness of reproduction, is certainly good enough to warrant the attention of the most discriminating listener or critic. Reception conditions are being improved all the time; they are very much better than a year ago, and will continue to improve.

Before we are misunderstood with regard to the "reception anywhere"

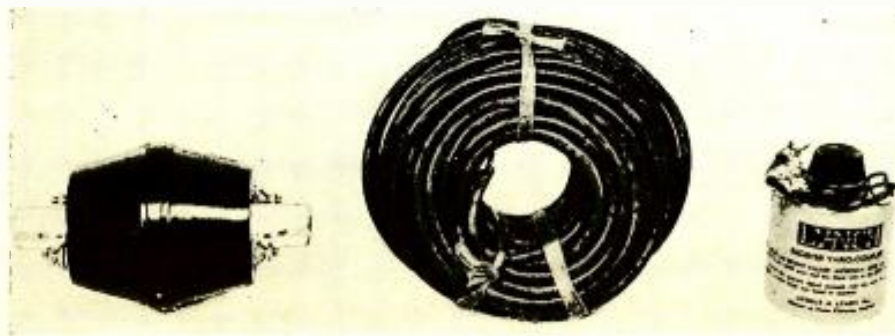

Fig. 5. The principal working units of an all-wave, noise-reducing antenna system: Antenna coupling transformer; heavy-duty, low-impedance transmission line; receiver coupling transformer with variable impedance adjuster.

title heading the previous paragraphs, may we explain that we mean the word as a description of any normal location. There are a few locations, where the local interference is so great that it is impossible to secure satisfactory foreign reception regardless of the precautions taken to avoid noise interference. On the other hand, it is pleasant to record that such locations are few and far between. Our contact with hundreds of thousands of listeners, in all parts of the world, leads us to believe that suitable foreign reception may be had in just about ninety-nine cases out of a hundred.

"MAKING" GOOD LOCATIONS

We are not suggesting that nearly all locations are good ones and the reception of foreign stations is just as simple as rolling off a log. It is no such thing. Some advertising has been a bit optimistic and certainly misleading in this respect.

This optimism is pardonable and should be understood by the present or the prospective short-wave listener. When radio receivers came to be operated from the electric light line instead of from batteries and when they were changed from multi-control to single dial control, they were also made much more sensitive. With this increase of sensitivity came simplicity of installation. Shorter and shorter aeri- als were needed and, in some instances, the more elaborate receivers were provided with self-contained antennas. These receivers performed remarkably well and since the quality of reproduction which they made possible was far superior to the phonograph, they found their way into homes of people who, up to that time, would not countenance a radio.

To avoid confusion of thought, it must be borne in mind that these receivers were designed for reception on the regular broadcast channels. That



ARTHUR H. LYNCH . . . King of Aerials; President of Arthur H. Lynch, Inc.; the author of the accompanying article. Mr. Lynch's pioneering work in the field of noise-reducing antenna systems has led to a general betterment of reception conditions. He initiated the first broadcast tests between the United States and Europe.

is, they were not designed for short-wave reception. Then the engineering departments of various manufacturers began to realize that something in the nature of fair results could be obtained from the short waves, if certain precautions were taken.

Receivers were designed and displayed to the sales departments and many of the executives took the new creations home with them for trial. Their enthusiasm at being able to hear the foreign stations overshadowed the fact that the programs were not entirely unalloyed with noise. In a great many cases it was possible to secure satisfactory foreign stations with little or no noise. As more and more companies got into the production of short-wave and all-wave receivers, it was but natural for them to exploit the merits of their particular products to compete with the claims made for similar receivers of competitive makes.

It was a sorry day for some of them when dealers and department stores, having sold the receivers on time or to charge accounts, found it increasingly difficult to collect because the receivers, while satisfactory on the broadcast band, were anything but a pleasure to hear when they were tuned to England, Germany or any of the other foreign stations, which they were supposed to bring in with ease.

SOLVING THE PROBLEM

It soon became evident to those engaged in this very interesting and potentially profitable field, that something had to be done if short-wave broadcasting was to amount to anything. It was suggested by some that a certain amount of improvement could be had if reasonable attention was given to the antenna system. The

constant increase in popularity of the short-wave and the all-wave receivers may well be credited to the vast improvement which the modern antenna makes possible and without which, foreign reception in many localities would be entirely unsatisfactory.

Nor must it be thought that a suitable antenna for satisfactory reception entails a knowledge of radio, a considerable expense, or a great expanse of open territory, free from the sources of waves which would interfere with the desired stations.

For the present owner of an all-wave receiver or the prospective purchaser of one, a knowledge of the fundamentals which are to be applied, in order to assure the best results are both worth while and interesting. Furthermore, they are not anything like as difficult to understand as many would have us believe. They are just the simple fundamentals which have been employed in the electrical and the telephone fields for many years. Their use involves no great difficulties, even though the practical applications of the fundamentals has caused the manufacturers no end of research to bring them to the efficiency and the simplicity of installation which they boast today.

The California friend, to whom we have referred, may well be considered as representative of thousands of others, in all parts of the world. It may aid us in getting a more complete understanding of the entire matter if we review his case. It is truly typical.

TYPICAL CASE

Attracted by the advertising of one of the all-wave receiver makers, he made a purchase. The receiver he

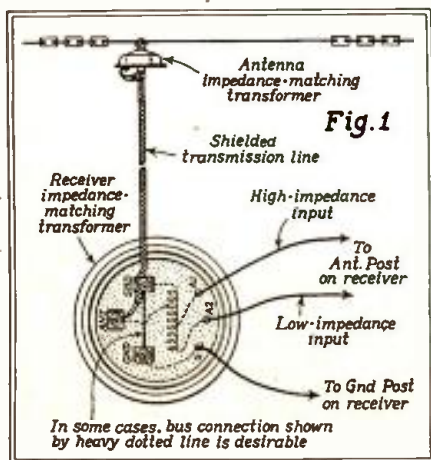

A noise-reducing aerial system expressly designed for broadcast reception.

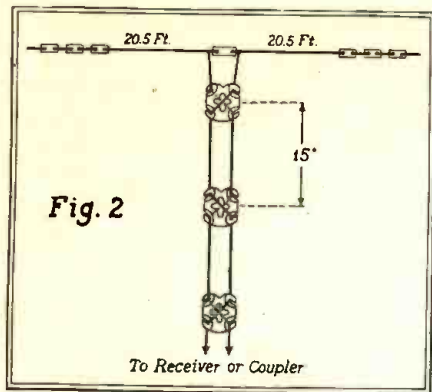

Fig. 2
 Doublet antenna, with widely spaced transposed transmission line . . . a system fast becoming obsolete.

purchased is a very good one. It is not a cheap one, nor is it one of those extremely expensive outfits which cause the heart to skip a beat when the price is mentioned. It is an excellent and very popular receiver—one with which we are very familiar and which we know to be capable of bringing in the foreign stations with excellent volume and clarity.

We were advised of the purchase and asked if we could recommend an antenna which would help the purchaser to secure the results which he was led to expect and which he was most emphatically not getting. Being familiar with the receiver and having most of the information regarding the location of local potential sources of noise supplied to us by our correspondent, we made what we thought were the necessary recommendations. A purchase was made. Our instructions were carried out to the letter. The results were anything but satisfactory. Our correspondent was disappointed and requested us to look further into the matter and make further suggestions.

In the meanwhile an identical receiver and the same type of antenna, were installed in our laboratory and the performance observed. It was discovered that a slight upsetting of the tuning was apparent on some of the short-wave bands, because of the failure of the antenna system to match the receiver perfectly. Two courses for remedying the trouble were open to us. Both were tried, with just about equal results. It was possible to readjust one of the "trimmer" condensers, with which all receivers are equipped, or a new type of transformer could be used to bring about the desired result in an entirely different fashion. Hesitating to suggest that our correspondent, who claimed to be without any knowledge of radio circuits, start making adjustments on his receiver, the latter course was decided upon, with the complete solution of the problem resulting.

Similar results may be secured in nearly every such instance. We do wish to emphasize, however, that there are certain locations which are just the "bad news," as far as radio reception is concerned, even though they are not very numerous. The only solution to the interference problem in such a location, is to move!

FUNDAMENTALS SIMPLE

In considering short-wave reception, we are often asked why there is more interference on the short waves than we find in the regular broadcast bands. The answer is relatively simple. Any electrical device which is attached to either the electric light circuit, the telephone line, or is operated from local power-supply sources, is a potential generator of electrical radio waves. If the operation of the device is accompanied by electrical sparking such as may be observed between the brushes and the commutator of the ordinary electric fan, this interference may be enough to cause untold trouble with the short-wave radio. Devices of this nature cause the emission of waves which are similar in many respects to the desired radio waves. Their wavelength is determined largely by the character of the circuit to which they are attached as well as by their own electrical characteristics. In most instances, these electrical constants are such as to create interference in the short-wave bands. Electric fans, vacuum cleaners and most other devices operated by small motors, cause interference in the 25- and 49-meter bands, while the average automobile ignition system causes most trouble in the vicinity of 17 meters. The interference caused by the operation of dial telephones is noticeable over the entire dial of the receiver, but more noticeably at the shorter wavelengths. These disturbing electrical impulses are picked up by or fed back into, the house wiring system with the result that the wires become radiators of the undesirable electrical disturbance. This is picked up by the radio-receiver system and comes out of the loudspeaker or headphones in the form of noise, which blights the desired program.

Fortunately, most of the interference caused by such devices is of rather limited intensity and the extent of the field it covers is comparatively small. Furthermore, most of it is considered to have electrical characteristics—polarization, to be specific—which are exactly the opposite to those of the desired radio wave.

Thus, we are brought to the realization that suitable reception should be possible if we are able to have an

antenna for picking up the desired radio wave, without picking up the local interfering waves. It is not too difficult to find such a location for the antenna.

THROUGH THE NOISE ZONE

We are then faced with the problem of bringing the desired wave to the receiver, through a zone in which we know that interference is to be encountered. In other words, we are faced with much the same problem met when it is desired to run a stream of water from a lake to a town without having the water polluted by other water mixing with it. It is common to incorporate this principle in our reservoirs and water-supply systems. In certain cases, the supply actually passes through other lakes, without coming in contact with them, because the supply is fed through pipes. Much the same sort of thing is found in connection with the pipe lines which connect oil-producing territories with refineries, sometimes several hundred miles distant.

This procedure has given rise to the term "transmission-line" which, in the electrical and radio fields, performs the same function as the pipe line.

Even before the introduction of short-wave reception for general use, the need for a transmission-line was found to exist for broadcast reception, over comparatively long distances, or where local interference was found to be excessive.

There is nothing particularly new about the principles necessary to employ to secure the desired result and simple, inexpensive devices were placed on the market which enabled the owners of good radio receivers to obtain reception with so much freedom from interference that it was possible for them to listen to distant stations with much the same degree of satisfaction previously enjoyed when listening to "locals."

BROADCAST AERIAL SYSTEM

This equipment has come into general use and is generally sold at the

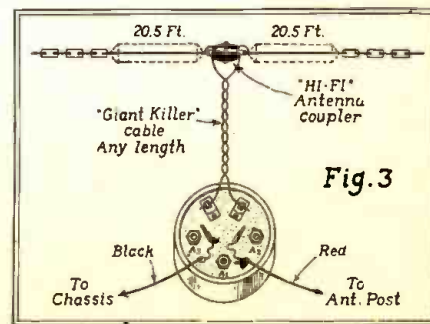
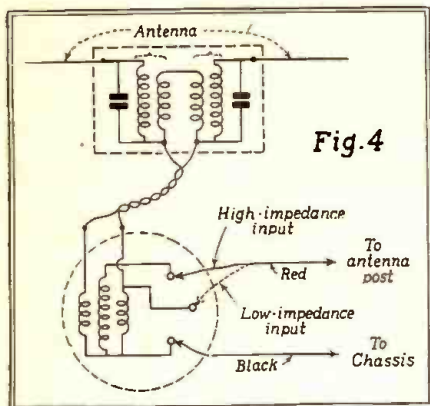

Fig. 3
 A modern, all-wave, noise-reducing antenna system, using a doublet antenna and closely-spaced transposed transmission line.



The fundamental circuit of the all-wave antenna system shown in Fig. 3, which has multiple resonance points.

same time as the receiver, except in those stores which cater to the "hard" buyer. Salesmen sometimes hesitate suggesting the additional expense of the antenna system for fear of losing the sale of the receiver or for fear of having the customer demand that the antenna be included with the receiver, without additional cost.

In its most popular and efficient form, such an antenna system is illustrated in Fig. 1. The fundamentals upon which its performance depends are apparent to the layman with even a meagre understanding of electrical principles, if the circuit is observed. No better system has yet been developed for the regular broadcast receiver or the new "high-fidelity" receivers which, incidentally, have high-fidelity characteristics *only in the regular broadcast band*. This important point is not generally understood.

SHORT-WAVE RECEPTION MORE DIFFICULT

While such an antenna and transmission-line are ideal for broadcast reception, the system shown in Fig. 1 is totally unfit for satisfactory reception on short waves. In order to have a suitable transfer of radio energy, from the antenna, through the transmission-line and to the receiver, it is necessary to have all of the circuits suitably in tune with each other. Otherwise serious losses, resulting in insufficient volume, will result.

The first attempt to develop a system which would permit the antenna to be tuned to the short-wave stations and then have the desired program carried over the transmission-line to the receiver, without picking up interference and without undue loss, was very effective and became quite popular, in spite of the fact that it was rather expensive and was both unsightly and somewhat difficult to install. It comprised a "doublet" antenna and a two-wire transposed transmission-line, with various forms of

transformers or other coupling devices between the lower end of the transmission-line and the receiver. A simple diagram of such an antenna and transmission line is shown in Fig. 2. This type is now almost obsolete.

"SINGLE-WAVE" CHARACTERISTICS

Unfortunately such an antenna is much more efficient on a single wavelength than on the other wavelengths we may desire to receive. Since most receivers are inherently more efficient on long waves than on short waves, it was found desirable to strike a compromise by designing the antenna to be most efficient on the shortest wavelength to be received and then trust that the decreasing efficiency of the antenna on the longer waves would be made up for by the increasing efficiency of the receiver itself. This compromise system was generally satisfactory on all of the short waves but it was woefully lacking as a collector of signals in the regular broadcast band.

An attempt to make the antenna more useful in the entire short-wave range was later brought about by the introduction of the "double-doublet" which, in effect, is two doublets, tuned to different wavelengths, suitably coupled together. While this type of system does help to give a more even response throughout the short-wave range, it provides no improvement worth consideration, in the broadcast band. It is costly and difficult to install because of the great space it requires.

This brought another compromise, by which the doublet and noise-reducing transmission-line were utilized in the short-wave range and the whole system converted into an ordinary antenna, with no noise reducing properties whatever, in the regular broadcast band. The change from the former to the latter was brought about by the manipulation of a switch attached to the transformer placed be-

tween the end of the transmission line and the receiver itself.

In passing, a word should be said about the unfortunate and misleading statements made by one of the radio commentators, under the auspices of a large and reputable radio company, concerning a so-called "short-wave" antenna, which was nothing more than a common antenna, made to smaller proportions than the ordinary broadcast antenna and possessed of no noise-reducing properties whatever. And it was still more unfortunate for the same commentator to expound the value of a noise-reducing antenna system sold by his company which, while incorporating noise-reducing principles in the broadcast band, was just an ordinary type of antenna on short waves. Current comments on a "new" system, now being offered for sale, suggests that the "latest system eliminates interference on all bands." There just isn't any such animal and, while a good antenna system, suitably designed and put up, can reduce interference on all bands, it can not be counted upon to eliminate such interference under all conditions. Furthermore, a good, all-wave, noise-reducing antenna system can be made to provide such a marked improvement over the ordinary type of antenna, in the vast majority of cases, that the use of superlatives and exaggerated claims is unfortunate and not at all necessary. There is no cure-all for radio interference.

MODERN ALL-WAVE SYSTEM

Recognizing the desirability of using the doublet type of antenna for the short waves, yet realizing its shortcomings in connection with broadcast reception, radio engineers began to seek some method of securing the desired result. Much of the credit for accomplishing this result must be given to Mr. J. G. Aceves, who, incidentally, is the man whose patent

(TURN TO PAGE 44)

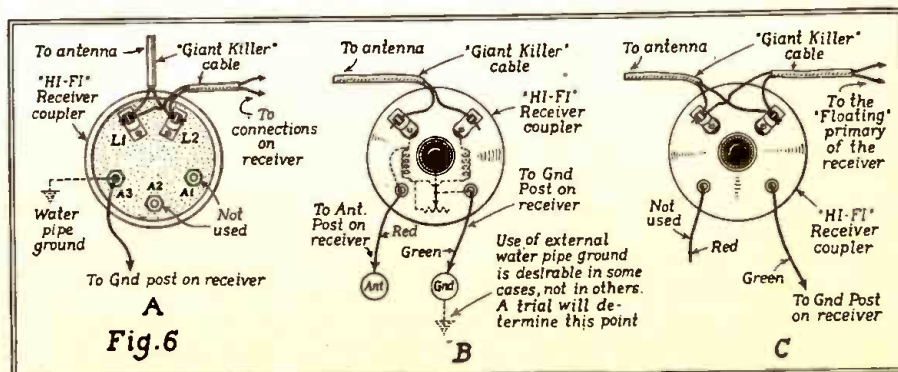

Improved results may be obtained in certain cases by replacing the type of receiver coupler shown at A, with the "variable impedance" type shown at B. When this latter type coupler is used with a receiver having a "floating" primary, the connections are made as shown at C.

The Footloose Reporter

RADIO

HEROES



The Gold Medal awarded George Rogers, of the *Morro Castle*, by the Veteran Wireless Operators Association

IF NOISY CONFUSION could be compared with the opening of a bottle of champagne in inexperience hands, then the opening of the elevator door on the Hotel Montclair roof-garden was indeed the popping of the cork with the resulting confusion—and good time. No doubt could linger for a second that the members of the Veteran Wireless Operators Association were glad to see one another. That fact was most apparent—with sound and plenty of it.

Bill McGonigle, erstwhile operator on the *S. S. Commewjne* and now the Association's secretary when he isn't keeping the stock of the A. T. & T. above par in his spare time, told us where to sit so we could see the doings. Bill is a diminutive, black-haired son of Erin, whose brain tires you out trying to keep up with it, but he always has time to be a good fellow. He left us precipitately to greet Dr. Kolster, whose decimeter that was developed many years ago, is still used in its prehistoric form. John V. L. Hogan of research renown came in and Henry Hughes and Arthur Lynch and Theodore Haubner and Ernest Cole of the *S. S. Mohawk* and and George Rogers of the *Morro Castle* and—here I was nudged violently.

"Isn't that Reilly coming through the door?"

"Where and what Reilly?"

"Hauptmann's counsel. Look . . . that fat man with glasses."

Not having visited Flemington during the trial, we could only identify the man by his pictures. This stout, sparsely haired individual with his tortoise-shelled spectacles certainly made us wonder if the well known barrister had ever been to sea in a shack. Many eyes followed him to the table near the center of the room and we heard several other *sotto voce* references to lawyers amid the general uproar and the dah-dit-dits coming over the public-address loudspeakers.

So many events were on the program that it was started long before the ice cream was brought in, but the one that interested us beyond all the others was the presentation of the Association's awards for meritorious radio work. George Clark, the president of the V. W. O. A., announced that Mayor Donahue of Bayonne, New Jersey, would make the presentation of the Association's gold medal to George Rogers, who lives in that town. Up to the table, covered with amplifiers and tangles of wires with telegraph keys shining through and a long stemmed microphone, walked the stout man who we had mistaken for Reilly. Rogers, a huge, shy man, walked ponderously to the table and stood with downcast eyes, while *Hizzoner* said the usual trite remarks that are always repeated on such occasions. Rogers turned from the microphone with the gold medal and the Testimonial Scroll in his hand to return to his table, when the Mayor recalled him and then presented him with a gold medal from the Board of Commissioners of the city of Bayonne, in recognition of Rogers' splendid work on the *Morro Castle*.

Like Mayor Donahue, we feel that the heroism Rogers displayed on board the *Morro Castle* is too well known a story to repeat here. Somehow or other, you generally expect to see a fat man

full of fun and the life of the party. Not so Rogers. He seemed like a man who having stood for a few eternal minutes at the brink of hell, can not realize that he was pulled back. His eyes have seen and his body endured a holocaust. The man can not pull a curtain over his thoughts.

Several other names were read . . . operators awarded the Testimonial Scroll for carrying on the traditions of radio men at sea. Two scrolls were awarded posthumously to Robertson of the British freighter *Usworth*, who remained at his key for four days while his ship wallowed helpless in a heavy sea with a broken rudder, and to McDonald, of the *Mohawk*, who went down with the ship when it collided with the *Talisman* off the New Jersey coast in January of this year.

McDonald's assistant, Ernest Cole, was awarded a Scroll. He was awakened out of a sound sleep by quick blasts of the ship's whistle and after partly dressing, he hurried to the radio shack. He acted as messenger between the bridge and the shack, telling McDonald that the *Mohawk* then was four miles off Sea Girt, New Jersey. Back and forth in the icy gale he climbed four or five times, with the list of the ship getting greater and greater. Between trips he helped McDonald with the emergency radio apparatus and then when he went to the bridge to report to the captain that more ships were coming to their aid, he found the bridge deserted. He rushed to the port end of the bridge and looked over . . . no one in sight. Then to the starboard side. Nobody. Had he and McDonald been left?

He rushed to the shack and reported to his chief and was ordered to go at once to his post at the lifeboats. There he found a group of men struggling to get the boat over the side. Everything was frozen. Gloves were practically useless . . . coats and

sweaters offered hardly any protection against the biting gale. Working against the weather's handicap, the men managed to swing the life-boat about and then literally had to force it down the side of the ship, the list was so great.

When it was finally launched, it seemed as though all their disheartening efforts were in vain, for the enormous waves tossed the life-boat back against the now sinking *Mohawk*. Men whose hands were numb pulled with the strength of desperation at the unwieldy oars, Cole doing his part at that back-breaking task. The frantic shouts, "For God's sake, pull away from the suction," spurred them on to even greater efforts, which were rewarded, for the *Mohawk* was slowly getting farther away.

For more than an hour Cole's life-boat was urged toward the *Limon* and *Algonquin*, that had come to the aid of the *Mohawk*. They came towards the *Algonquin's* stern and shouted for a rope, but before one could be cast off, they were half way to the ship's bow and then beyond it. They tried to reach the *Limon*, but could not work their way to the lee side. Cole noticed the *Algonquin* turning towards them and with a flash-light, luckily in the life-boat, dot-dashed the message, "Unable to buck sea." By remarkable seamanship on the part of the *Algonquin's* captain, a line was made fast to Cole's boat and one by one his fellow passengers went to safety on the *Algonquin's* deck.

This was "off the record" as far as the other diners were concerned, for I hunted up Cole and asked him for details, amid the constant code coming from the loudspeakers. He wound up his story with:

"As soon as I hit the deck I went to the *Algonquin's* shack to see if I could help out the boys there and when I couldn't, I went down to ask the doctor about my ears, which hurt. I found him busy, so I turned to and helped until he had a chance to examine my ears. They were frost-bitten, my left one pretty badly. . . Oh, it's all right now; it stopped peeling a couple of days ago."

I asked Cole if he had ever been on another ship that had sent out an SOS.

"Yes, I was on the *Sujameco* back in May, 1926 or 1927, when she went ashore at Coos Bay, Oregon. We were running in a bad fog. I raised the nearest radio compass station and asked for our position. I got the answer that we were inland with the ocean two miles away. The compass station man evidently forgot about the bay we were in, but that news, even

though wrong, told us we were near land. Within a short time, we felt the ship stop suddenly when we hit the shore."

"Was there anyone hurt or lost?", I inquired.

No, indeed," Cole laughed. "We all got ashore safely . . . we came over the side and down a ladder, whose bottom was on dry land. We sent out an SOS for help to get us afloat, but it seemed as though the more they hauled on the *Sujameco*, the deeper she went into the shore. It took them three months to get us off, but we had a swell time hunting and fishing, for it was all wild country around there."

Cole's story of the *Mohawk* disaster is typical of the way ships' operators place duty first and foremost. Even though he had passed through a harrowing experience in that open boat, before he went to see about his pain-ing ears, he went to the shack to see if he could be of assistance. Duty is surely spelt with capitals in the code of these men.

Our conversation with Cole was interrupted with calls to pipe down for it was time to exchange greetings with the San Francisco, Chicago and Boston chapters of the V. W. O. A., who were also having similar dinners and cruises. A loudspeaker in the middle of the room was connected into the telephone line and we heard the other diners telling how many were present at their parties. Although this was strictly a radio affair, yet the telephone was resorted to for this part of the program.

A radio message was received from the Byrd Antarctic expedition, of which two members of the V. W. O. A. have been doing their part in keeping

the expedition in touch with civilization. Peterson and Bailey's message said in part they were taking a look at the ice all about them and were thinking of the gang in New York with something to put ice into.

When other messages of greeting had been read to the diners—incidentally there was one from Marconi, an Honorary Member of the Association—the master of ceremonies announced that Theodore D. Haubner was going to give something away. The gray-haired man who walked towards that table of miscellaneous apparatus, was described as being the first operator to send an SOS, which occurred while he was on the S. S. *Arapahoe* well over a score of years ago. Mr. Haubner told how in those distant days every operator provided himself with a pair of phones, which were carried with him all over, even though phones were always a part of the ship's radio equipment.

Before embarking on his first assignment, Mr. Haubner bought a pair of Schmitt and Wilkes phones, which were taken all over the world. It was through those phones that he had received a reply to his historical SOS and he now presented the head-set to Mr. Clark, Director of the RCA Museum, and president of the V. W. O. A. This was the first memorial presented to the Association.

The rest of the party was radio operators' fun—dancing, horseplay and all that. They were a fine crowd of men and from their conversation one could not help but be impressed that though they razed their jobs between themselves, yet there is something that holds their jobs above all else.

This is most certainly tradition.

(TURN TO PAGE 46)

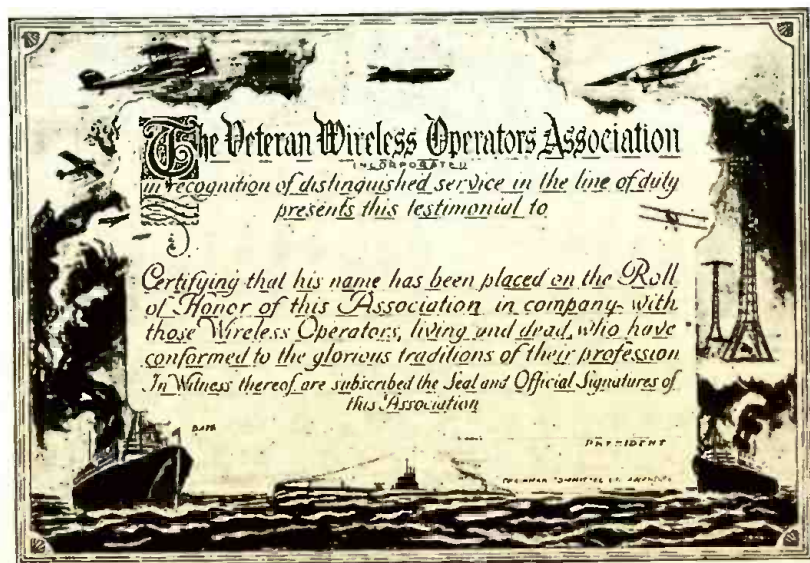

The Veteran Wireless Operators Association Testimonial Scroll.

NEW 22-TUBE "FULL-RANGE" HIGH-FIDELITY RECEIVER

A REMARKABLE NEW RECEIVER WITH FREQUENCY RANGE FLAT FROM 25 TO 16,000 CYCLES—AN UNDISTORTED OUTPUT OF 50 WATTS—SELECTIVITY CONTINUOUSLY VARIABLE—10 KC AT FIVE THOUSAND TIMES FIELD STRENGTH—DOUBLE AVC SYSTEM—COVERING ALL WAVELENGTHS FROM 13 TO 550 METERS.

By E. H. SCOTT

THE HEADING OF this article tells you it is a description of a 22-tube radio receiver, and I can imagine a number of readers asking themselves why we are using 22 tubes, when the average receiver only uses from 8 to 10. The answer to that question is that this new receiver incorporates some very outstanding developments in radio receiver design recently perfected in our research laboratories, and accomplishes results never before secured in a radio; results, I might say, which cannot be secured with less than 22 tubes. A careful analysis of the circuit would show that every single tube has a very definite function to perform, and that not one of them can be eliminated without decreasing the efficiency or performance of the receiver.

In a short magazine article, only a few of the outstanding features can be covered. One of the first things asked about any receiver is—What is the tone like? Before answering this question, perhaps, it would be well to give an idea of what constitutes good tone.

E. H. Scott Radio Laboratories.

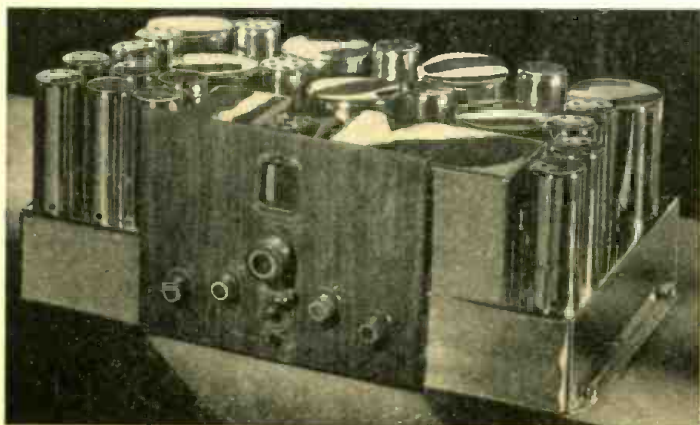

A view of the Scott Imperial Allwave chassis. The use of 22 tubes makes possible high power, high fidelity reception.

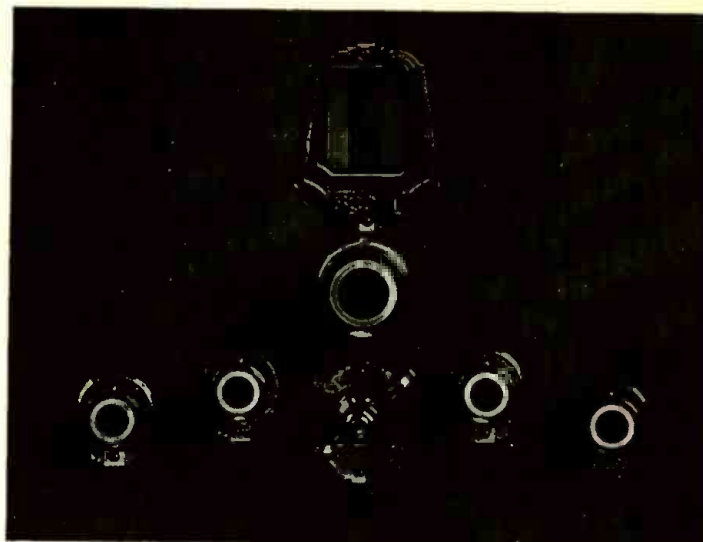

The panel of the Scott Imperial Allwave receiver. From left to right are: Volume Control; Bass Control; Two-Point Sensitivity Control; Variable Selectivity and Fidelity Control. Below: Wave-Change Switch Lever and Beat Frequency Oscillator Switch.

What is Good Tone?

If a radio receiver is to give complete and perfectly natural reproduction on all sounds and tones, it must have a frequency range which covers the entire audible tonal range of the human ear. Scientific laboratory tests show that this audible range, including the fundamental frequencies and their harmonics, to be from 25 to 16,000 cycles.

When you are listening to any musical instrument or a human voice, you do not hear simply a pure tone consisting of one single frequency, but you also hear a succession of weaker tones called harmonics or overtones of the fundamental frequency, and it is only by these harmonics that you are able to recognize one musical instrument from another. Some instruments are richer in harmonics or overtones than others. For example, the important overtones of the cello go up to 8,500 cycles, the bass clarinet goes up to 10,000 cycles, the violin and oboe up to 14,000 cycles and the flute to 15,000 cycles.

It can clearly be seen, therefore,

that if you are to secure natural and life-like fidelity of musical instruments or voice, the receiver must be capable of reproducing all frequencies, without appreciable attenuation, that the human ear can hear, and that is from as low as 25 to as high as 16,000 cycles.

The frequency response of the finest "High Fidelity" receivers so far introduced is 7,500 cycles. Obviously, this covers just half of the audible frequency range, and that part of the music which consists of the harmonics and overtones between 7,500 and 16,000 cycles is lost.

Frequency Range.

The new Scott Imperial Allwave incorporates a remarkable new continuously variable Fidelity-Selectivity Control. When this control is set for maximum Fidelity, the receiver has a practically flat response covering the whole frequency range from 25 to 16,000 cycles. The first time you listen to a program on this new receiver from a high-quality station, is an extremely interesting experience. The instruments in the orchestra come in so clearly and with such realism, that you have no difficulty in visualizing the harpist plucking each individual string; the scrape of the bow on the violin, with the highest notes coming through clear and strong above those of the other instruments. When the cymbals clash, you immediately visualize the two round brass plates striking. To hear a piano selection is an absolute revelation.

However, it is quite impossible, without an actual listening test in which a direct comparison can be made between what is now considered a high-class receiver, and this new full range

High-Fidelity instrument, to appreciate the tremendous difference there is in the reproduction when the frequencies above 5000 cycles are brought in. Visualize yourself in a dimly lighted room in which you can barely distinguish the various objects, then imagine turning a control, which gradually brings up the illumination in the room until everything is clear and distinct. Your reaction will be very much the same when you listen for a few minutes to a regular radio receiver, then for the next few minutes on the new Scott Imperial Allwave. First you hear music which you consider perfectly pleasing and satisfactory until you switch over to the Imperial, and then, and then only, do you know what you have been missing, and begin to realize that up to this time, you have only been hearing about half of the musical tones of the various instruments being broadcast.

Reserve Power.

The transmissions from broadcast stations are continually improving, but if you are to secure smooth, undistorted reproduction from all classes of programs, it is necessary that the power amplifier be capable of handling every loud passage or "peak" that comes in without overloading. Most of the time the audio level does not exceed 6 watts, but there are often dozens of passages in the course of a single program where "peaks" or loud passages may rise to as high as 30 or 40 watts, and it is necessary that we have a reserve power of about five times the normal audio level if we are to entirely eliminate distortion or raspiness on the loud passages or "peaks" in music and speech reproduction, and bring it in clear and distinctly at any degree of volume.

The very large undistorted output of the power amplifier incorporated in the Scott Imperial Allwave is attained through the use of an absolutely constant fixed bias; practically ideal plate voltage regulation having a very low resistance; the use of a total filtering capacity exceeding 100 mfd.; a first audio stage using a duplex diode triode type 6A6 tube; a second audio stage using two super triode type 76 tubes in push pull; and a third audio stage using 4 high mutual-conductance power amplifier triode type 2A3 tubes, operating as push-pull pure Class "A" tubes. This amplifier has an absolute undistorted output, with strict Class "A" operation up to 35 watts, and from 35 watts to its full 50 watts, the amplifier becomes Class "A" Prime.

Although the amplifier has such a very large undistorted output, it is

under perfect control at all times, and any degree of volume can be secured, from the faintest whisper to full volume. One feature that will be especially appreciated by the critical listener, is the fact that there is no detectable hum, even under the quietest listening conditions, and this in spite of the fact that its frequency range is considerably greater than even the most gifted human ear.

Degree of Selectivity.

The degree of selectivity possessed by a receiver naturally determines its ability to tune through powerful local stations and bring in weak distant signals. The selectivity of the Scott Imperial is variable so that any desired degree of selectivity can be secured. In the maximum selective position, the selectivity is 10 kc. or better at 5000 times field strength, which is more than sufficient to reach out and bring in weak distant stations which ordinarily would be blanketed by interference from powerful nearby stations on adjacent channels.

On the other hand, when listening to local stations, a high degree of selectivity is not necessary, or desirable, and under these circumstances, the selectivity can be broadened out, and the receiver will then reproduce every tone from the lowest fundamental to the highest harmonic, which the highest fidelity station on the air is capable of broadcasting.

Another very interesting feature of this new variable Fidelity-Selectivity Control, is that with it you secure maximum sensitivity when the receiver is in the *maximum selective position*, which makes it the ideal receiver for those who are particularly interested in DX reception from very distant foreign stations, as well as those who are interested primarily in tonal perfection.

It is not a very difficult matter to incorporate extreme sensitivity in a receiver, provided the word "usable" is not inserted before the word "sensitivity." But it is an extremely difficult matter to provide a high degree of usable sensitivity, that is, sensitivity free from noise.

In the Scott Imperial Allwave, special precautions have been taken in the form of very careful and complete shielding, with thorough filtration of r-f, i-f, oscillator and audio systems to prevent feed-back between one element of the system to another. This, in addition to the very advanced design and high degree of efficiency developed in the antenna coupler, the antenna tuner, r-f stage, and the four i-f stages, combined with an especially efficient double avc system, makes it easy to bring in, at good volume, numbers of foreign distant stations that would not ordinarily be heard.

Double AVC System.

There are few things in radio more annoying than to tune in a distant station and have the pleasure of your reception spoiled by the constant fading in and out of the signal. To attain the best possible reception of stations in all parts of the world, the new Scott Imperial Allwave incorporates, not merely the regular single type avc, but two distinct avc systems, each designed to provide the most efficient avc action and keep the signal practically constant at any desired volume level, irrespective of variations in signal strength.

In locations where electrical or local interference is bad, it is very desirable that some means be provided for limiting the sensitivity of the receiver so that this noise can be eliminated. The system incorporated in the Scott Imperial Allwave is another new development of our research laboratory, and is quite different to the usual Noise Suppression Systems, whose principal fault has been to destroy the effectiveness of the avc when the Noise Suppressor was in operation, and also to cause considerable distortion on mediumly weak signals. The Noise Suppressor incorporated in the Scott Imperial Allwave, however, does not impair the action of the avc in any way, nor does it affect the tone quality, or cause distortion on any station, either local or distant. It is continuously variable, enabling you to adjust your receiver to the point where

(TURN TO PAGE 46)

A view of the separate power amplifier of the Scott Imperial Allwave receiver.



ANSWERS TO SOME FREQUENT QUESTIONS ASKED ABOUT RADIO RECEPTION

By the Engineering Department of
COLUMBIA BROADCASTING SYSTEM

AT SOME TIME or other almost every member of the radio broadcast audience has experienced the annoying phenomenon of fading or "mushing" of a radio program to which he is listening. When this occurs to the programs from a broadcast station 100 or more miles away, most listeners accept the distortion as one of the natural results of broadcasting over long distances with our present facilities.

Under certain conditions, however, (and only at night) fading and "mushing" are experienced by listeners within 30 miles or so of the transmitter. When this occurs the listener is inclined to suspect the broadcast station of faulty operation. The responsibility, however, rests upon a mysterious electrical "cloud" in the stratosphere and beyond—known to scientists as the Kennelly-Heaviside Layer. To explain this we must first describe the different "waves" which carry the radio program from the broadcast station to the home.

The "Ground" Wave for Primary Transmission.

Radio waves in their journey from the transmitter to the receiver may travel over one, two or more paths simultaneously. There is, first of all, the so-called "ground" wave, which travels directly over the surface of the earth from the transmitter to the receiver. (See Fig. 1).

It is this wave that serves the primary listening area of a radio broadcast station. Its transmission is *unaffected* by any meteorological or seasonal conditions and is of the same intensity during both the day and the

night. The useful range of the ground wave depends upon the power of the transmitter, the frequency upon which it is operating, the nature of the intervening terrain, the conditions at, and the sensitivity of, the radio set in the home.

The "Sky Wave" for Long-Distance Transmission.

Because of many obstructions usually found in the path of this "ground" wave it becomes rapidly attenuated, or weakened, as it moves over the surface of the earth. *Long-distance* transmission, therefore, depends upon another type of radiation, the "sky" wave. The "sky" wave, upon leaving the transmitter, travels *upwards* with little attenuation until it reaches the Kennelly-Heaviside Layer, 70 or so miles above the earth. This layer, composed of free electrons, (infinitely small "particles" of electricity) acts as an electrical mirror. The "sky" waves are reflected by this mirror and are returned to the earth. (See Fig. 2).

The point at which the waves are returned to the earth is usually many miles from the transmitter. Because of the more or less unobstructed path the wave has followed, through the upper air, the strength of the received signal may, at times, reach very great intensities. The Kennelly-Heaviside Layer, however, does not have well defined, fixed surfaces. It is, on the contrary, very much in the nature of a tremendous cloud of free electrons which, like the visible, moisture laden clouds we see close to the earth, is continually moving, shifting, drifting and changing shape.

During the daytime, the nature of this cloud is such that it cannot reflect the waves in the broadcast frequency spectrum. For this reason, no fading effects on broadcast transmission manifest themselves during the daylight hours. Only direct "ground" waves from the broadcast station reach the listener and no fading or "mushing" disturbs the quality of the program.

At night, however, conditions of the upper atmosphere are favorable for

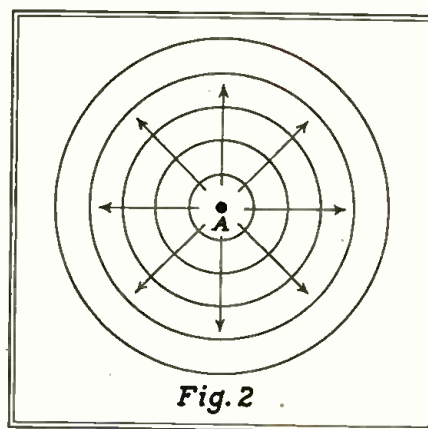

Fig. 2

A radio wave, like the ripples on water, travels out in all directions in ever-widening circles.

refraction of the radio waves of broadcast frequencies. But . . . because of continual movement of the Kennelly-Heaviside Layer, its virtues as a "mirror" are, to say the least, uneven. As a result, the "sky" wave itself, returning from its contact with this rolling surface, is subject to a great deal of variation or fading.

Fading.

At times, the ground wave and a sky wave arrive at the receiving point after having traveled over two paths of different lengths. The two waves do not, therefore, arrive at precisely the same instant and are said to be "out of phase." Under these conditions fading or "mushing", or any number of odd effects, may occur—to the irritation of the broadcast listener—and of the broadcast station engineering staff!

This phenomenon, which usually manifests itself at distances greater than 50 or more miles from the transmitter, and never in the daytime, is sometimes disagreeably evident to listeners relatively close to the transmitter. At night-time, during certain

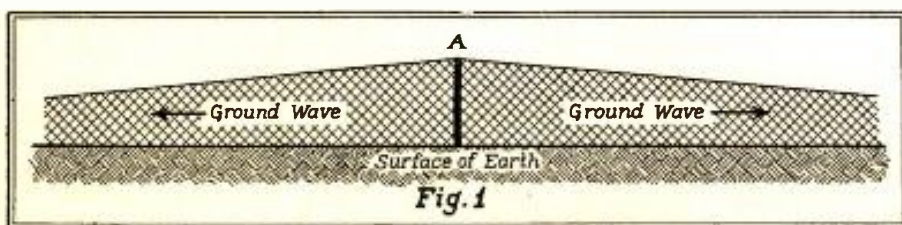

Fig. 1

Showing the manner in which a radio ground wave leaves a transmitter, A, follows the surface of the earth, and decreases in intensity with distance.

seasons of the year, and at particular times during the eleven-year sunspot cycle, these fading effects are unusually prominent. Under these conditions, listeners in a metropolitan area served by high-powered transmitters are apt to suspect the management of the broadcast station of faulty operation. The unfavorable results, however, are caused by the admixture of the "sky" and the "ground" waves at the receiving points, which may be many miles from the transmitter (usually located beyond the city limits).

All broadcast stations have certain areas wherein "mushing" of the signal occurs at night and these areas change with the seasons of the year and various other factors. Strenuous efforts are being made to overcome such effects which, of course, curtail the service area of a station to some degree. But it is not an easy matter to deal with invisible waves traveling through an invisible, inaccessible cloud of electrons, many miles above the earth!

Although matters of this nature are beyond the control of the broadcast listener, there are several vital factors which the listener should pay particular attention to if he desires the greatest enjoyment possible from his radio.

The Importance of the Home Antenna.

An item of paramount importance is the type of receiving antenna employed and its location. In thickly populated areas there is almost always a certain amount of man-made, electrical noise which, unless carefully guarded against, will mar, if not completely ruin, the reception of broadcast programs. In order to guard against this it is necessary to have a good antenna installed in a suitable place and in a workmanlike manner. It must be erected in a location that careful tests show to be free from electrical noise or at least where the noise is at a minimum. The lead-in from the antenna to the set must be a transmission line type* in order that the advantage of the noise-free antenna location be realized. If the lead-in is not of the shielded type it will, of its own accord, pick up electrical disturbances and bring them to the radio set.

After an antenna is installed it must be periodically inspected and serviced. An antenna which has been exposed to the destructive forces of the elements is always a potential source of trouble because of corroded connections, weatherbeaten insulations and defective lead-in strips and insulators. Too much stress cannot be laid upon the importance of this often neglected phase

*Read the article by Mr. Lynch in this issue.—Ed.

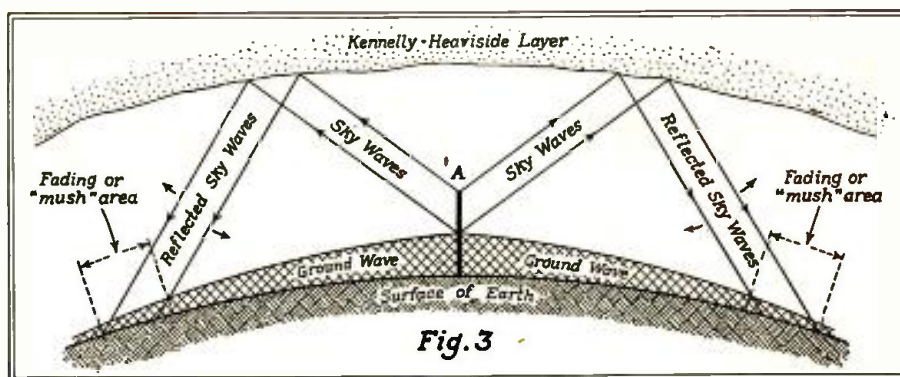

Fig. 3
Sky waves are reflected or refracted by the ionized layer in the upper atmosphere and, so, return to earth. Note the areas where they interfere with the weak ground waves.

of a radio installation.

As the use of the better grade of radio receivers which will reproduce the high audio frequencies increases, the listener will become more and more aware of the need of a good antenna installation. As the tone range of the receiver is extended into the high audio-frequency region the amount of electrical noise that is heard also increases. Obviously, the way to overcome this difficulty is to use an antenna which is efficient and provides the receiver with a strong, noise-free signal.

Modern Radio Transmission is EXACT.

One of the foremost achievements of the modern broadcast station is the excellent fidelity with which it transmits its programs. Ever since the event of radio broadcasting, unceasing efforts have been made to improve the faithfulness with which the radio station transmits its program material. Years ago a great deal of effort was made on the part of the broadcasters and the radio set manufacturers to obtain true reproduction of all the low tones. Today, reproduction of the low frequencies is an accepted accomplishment and, of late, a great deal of attention has been given to the

matter of obtaining faithful reproduction of the high audio frequencies.

In anticipation of a greater demand for the better grade of radio sets which will reproduce the high audio frequencies, the broadcasters have continued the development of their equipment. At the present time most of the large stations in this country have greatly improved the fidelity of their transmission by extending the frequency range of their transmissions to 8000 cycles or higher. Wide tone-range broadcasting of this kind results in more realistic reproduction of such musical instruments as the violin, clarinet, oboe, flute, piccolo, trumpet, tamborine and triangles. Sounds incidental to the performance being broadcast are reproduced with much greater fidelity and become more readily distinguishable by the listener.

Service Your Radio.

In order to take full advantage of these latest advances in the art of radio broadcasting the listener must provide himself with equipment which is capable of receiving and reproducing this wide band of audio frequencies. But it is not sufficient merely to obtain a good radio set—its installation must be made with the utmost care and it must be properly serviced at regular intervals.

A modern radio set is a very complicated mechanism. Just as in the case of the modern automobile, it requires proper servicing if it is to operate efficiently at all times. The average radio set is probably in use many more hours of the day than is the average car. The small amount of attention it sometimes receives is a tribute to the manufacturer, but it will eventually exact toll in imperfect reception and lessened enjoyment of programs. If the listener will periodically have a competent radio man service his receiver from antenna to loudspeaker he will immeasurably improve the performance of his radio set and thereby enhance his enjoyment of this modern miracle of entertainment.

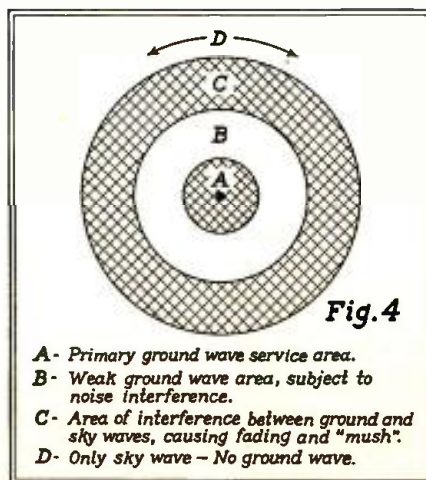

Fig. 4
A- Primary ground wave service area.
B- Weak ground wave area, subject to noise interference.
C- Area of interference between ground and sky waves, causing fading and "mush".
D- Only sky wave - No ground wave.

Ground waves die out but a short distance from the radio transmitter. Sky waves, on the other hand, travel great distances through space.

RADIO PROVING POST



ACRATONE MODEL 157

WE CAN RECOMMEND this receiver to anyone wishing a very fine all-wave set.

The dial deserves praise. It consists, essentially, of two dials in one. The first is used for rough tuning and has a ratio of about 5.5 to 1; the second is used for fine tuning and has a ratio of about 135 to 1. Tuning-in a short-wave station with this dial is just about as simple as tuning in a broadcast station on the standard band. The face of the dial is divided into two main sections, the first calibrated in megacycles for all except the broadcast band and the second is calibrated from 1 to 100, and is used only for the fine-tuning knob. The "rough" and "fine" knobs are mounted on concentric shafts.

CALIBRATION

The calibration of this receiver seems much better than average. Checks on 12, 7.5, 6, and 4 megacycles convinced us that the calibrations

could be relied upon to a comforting degree. There are no trick markings or crazy-shaped indicators to confuse the listener; everything is simple and reliable.

TUNING BROADCAST BANDS

The broadcast band was tackled first. Tuning is sharp, quality is exceptionally good, and the sensitivity more than adequate for the DX broadcast hunter. Nothing much can be

UNBIASED OPINIONS are always valuable, especially when they concern the radio business in general and radio receivers in particular. The man not engaged professionally in the radio field must secure his radio knowledge through sad experiences of friends or of himself, unless there is available some medium through which he may obtain unbiased enlightenment.

It is the purpose of this department to operate currently marketed radio receivers and to report on the operation of these receivers. These reports will be written from the viewpoint of the reader who wants to know something about the receiver without wallowing through detailed technical descriptions.

It is our aim to break each description into two sections: the first dealing with the operation of the receiver, and the second dealing with any unusual circuit arrangements which may be used. Complete diagrams will not be published, and are not available through this magazine. Furthermore, we cannot furnish comparative information on commercial receivers. Our Seal of Approval will answer for the receivers described in these pages.

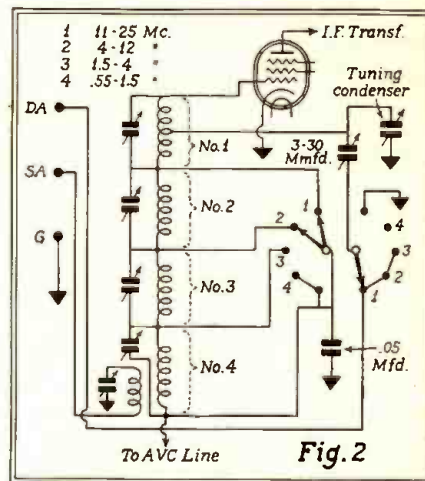

Antenna switching arrangement used in the Acratone Model 157.

said about the second, 1.5- to 5-mc band. There are so many stations here, including the harmonics of some poorly filtered broadcast stations, that an intelligent analysis of the performance of a receiver is impossible by listening in this band. Probably in a more isolated section of the country this band may have some value, but such is far from the case in a city.

The 4- to 12-mc band takes in the 25-, 31-, and 49-meter international broadcast stations, and most of the listening was done here. With the aid of the "second-hand," we tuned in fully fifteen different broadcast stations in one sweep of the dial. We got so used to this "second-hand" business that we found it difficult to go back to the "standard" s-w set after a few days. Just imagine, one rotation of the "second-hand" knob covers 1/135 of the dial, and since it is a simple matter to move this knob 1/100 of a rotation, it is possible to rotate the tuning condenser 1/3500 of its semi-circular swing! This is real mechanical band spread.

And the set brings them in too. The 100 as well as the 20,000-watt boys can be understood. You know, many receivers demodulate a signal when it is too weak, so that the carrier is audible, but the voice or music sounds like it had passed through a saw mill. The design of this receiver seems to be such that demodulation is nil on



Fig. 1. The Acratone Model 157 All-Wave Receiver.

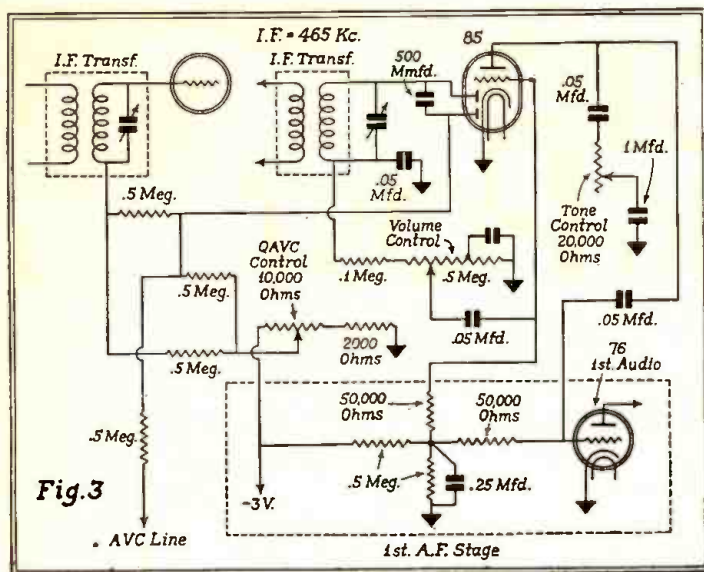

Second detector and avc system used in the Acra-tone Model 157 All-Wave Receiver.

weak stations, and they can be interpreted easily.

Little need be said about the 11- to 25 mc band. The usual stations were heard and some that could not be tuned in with a receiver using an "ordinary dial." Quality, of course, is excellent, and an entire lecture in French, from one of the French 19-meter stations, and lasting over half hour, was listened to and understood. That station took so long to announce that we were forced to move to another station before the sun set.

TECHNICAL FEATURES

This receiver has eight tubes used in the following* manner: a 78 as r-f amplifier; a 6A7 as first-detector and oscillator; two 78's as i-f amplifiers; an 85 as avc tube and second detector; a 76 as first audio amplifier; a 42 as output tube; and an 80 as a rectifier. Although the particular model proved (Fig. 1) has but four bands, there is available another model of this chassis having five bands, the fifth covering the long-wave European broadcast band.

The antenna circuit, shown in Fig. 2, is designed for use with any type of antenna, single wire or doublet; and part of the wave-band switch, also shown in the same figure, has provision for short-circuiting one unused section of the tapped coil.

When a single antenna is used, it is connected to posts DA and SA. On bands 1, 2, and 3, the DA post connects through the 3-30 mmfd. condenser to the tuning condenser; on band 4, the antenna connects to the special primary shown in the diagram. If a doublet is employed, the DA section is cut out on the broadcast band and the primary used.

Section 1 of the coil is for the No. 1 Band; Sections 1 and 2 for the No. 2

Band; Sections 1, 2 and 3 for the No. 3 Band, and Sections 1, 2, 3, and 4 for the No. 4 Band. The tuning condenser tunes only part of the coil on the No. 1 Band.

The plate of the r-f tube connects to a tuning system exactly the same as the coil section shown in Fig. 2, and the output is resistance-coupled to the grid of the 6A7 mixer tube. The right-hand section of the switch in the second coil arrangement is unused, since there is no antenna circuit to switch. The oscillator grid coil is also the same, but four separate plate coils are used, consecutively connected in series as the wave-band increases.



EMERSON MODELS 38, 42 and 49

THE LITTLE EMERSON (Fig. 4) is typical of the "skip band" receivers that are available. This particular set (all the model numbers listed above represent the same chassis) is an a-c, d-c affair designed to operate over two tuning ranges: the broadcast and limited police range from 545 to 1750 kc; and the most active short-wave broadcast bands, extending from 5.5 to 15.5 mc. This latter band includes the 19-, 25-, 31-, and 49-meter broadcast channels. Either band may be selected by means of a switch located at the back of the cabinet. (This receiver is now being produced with this switch on the front panel—a much needed improvement.)

About 180° of the circular dial is graduated for the broadcast band, and the remaining arc is reserved for the

The i-f amplifier is "standard," but the second detector and avc system may require some explanation. See Fig. 3. The signal from an i-f transformer feeds one diode of the 85 and the rectified voltage appears across the .1- and .5-megohm resistors, the latter being the volume control. Part of the signal is also coupled to the second diode through the 500-mmfd. condenser; this diode is biased through the qavc control a maximum amount of 3 volts, secured in the power supply circuit. When the signal on this second diode becomes greater than 3 volts, the second diode rectifies, and this rectified voltage appears across the .5-megohm resistor shown connected between the arm of the qavc control and the avc diode. By varying the qavc control, the avc diode bias may be decreased to .5 volt. The avc is applied to the controlled tubes (the r-f, mixer and two i-f stages) through half-megohm resistors.

The same minus 3 volts also biases the r-f, mixer, i-f, triode section of the 85 and the first audio tube through the star resistor arrangement shown within the dotted first-audio section.

IMAGE RESPONSE

Tests for image response failed—no image interference could be found. This condition is a healthy sign of good design, and must be considered by those interested in obtaining a receiver free from unwarranted interference.

short-wave band. By means of a dual lighting system, that part of the scale in use is illuminated while the other half remains in the dark. About the only adverse criticism with regard to the dial is the fact that the knob-to-condenser tuning ratio is but 3.5:1, too small for such a wide frequency band.*

The receiver was placed in operation and the switch turned to the broadcast position. Selectivity was good, quality better than average for a set of this size, and the sensitivity was sufficient to bring in many DX broadcast stations with good volume.

Before discussing the results obtained on the s-w band, one or two points about receiver reviews should be emphasized. In the first place, receivers vary in price and in the service

*This has been changed. Current models have the periphery type dial action. Tone control has also been added.—Ed.

FIRST TESTS

At 1 o'clock in the afternoon the receiver was warmed up and the knobs twirled to get the feel of the set. The dial is large and calibrated in megacycles, except for the broadcast band, which is calibrated in kilocycles. Wavelength markings do not appear at all. The dial is plainly marked, and is not confused by fancy script. The pointer traverses about 270° of arc and the knob to condenser ratio is 12:1.

The highest frequency-band is from 10 to 24 mc. This range includes the 14-, 19-, 25-, and the beginning of the 30-meter broadcast bands. Results were very good. The noise level was low with the tone control turned up to "brilliant," the avc system seemed to function quite well in maintaining steady signals, the quality (often forgotten in s-w sets) enabled clear understanding of speech, and a complete operetta from GSD on 11.75 mc was thoroughly enjoyed. This band was tuned carefully for image interference, but none could be found. Amateurs rolled in from all over the country on phone. We reluctantly turned the switch to the 4- to 10.5-mc band to see what happens on the crowded 49-meter band.

49-METER CHANNEL

Short-wave listeners know the chaos that prevails here. Commercial code and broadcast stations are to be found on every point of the dial. IRU, Italy, on about 9.83 mc and EAQ, Spain, testing on 9.86 mc, interfered with one another at times, but we attributed this interference to the fact that EAQ was testing on code with low-frequency ICW. In the late afternoon GSB, on 9.51 mc, came on the air, and was received like a local.

The set behaved exceptionally well. There were fully half a dozen stations pumping soup into the 49-meter channel and each and every one was received without interference from

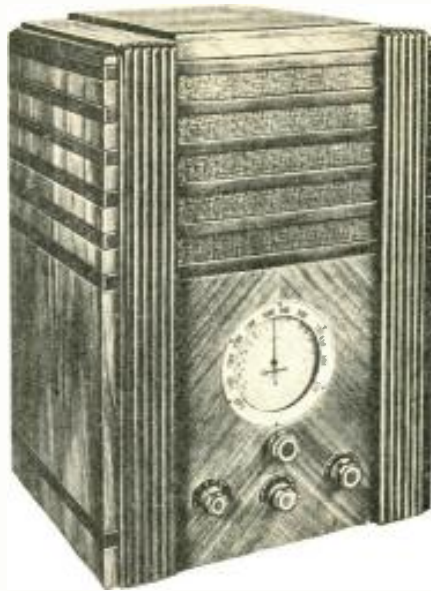

Fig. 6. The Lafayette Model 60 All-Wave Receiver.

the others. Here again, the tuning was smooth, the noise low, and the avc system maintained steady signals. The remaining part of the dial was swept carefully for image interference and dead spots, but none could be found.

The 4.2- to 1.5-mc band was turned on about 7 in the evening, but there were so many stations plying their trade that we gave up. It is unfortunate that a number of regular broadcast stations are located near one of the test positions and it seems that many of these stations try to kill several birds with one stone by radiating intense harmonics. One of these stations on 1400 kc was traced down, during a lecture on spaghetti, to 4.2 mc, the highest frequency in the band, the third harmonic being almost as loud as the second.

In conclusion, then, this receiver gave excellent service on the short-wave and broadcast bands. The results were not phenomenal, but they were darn good, and the stability of the signals and the low noise background indicates good engineering.

TECHNICAL POINTS

Either of the two models of this receiver has ten tubes used in the following manner: one 6D6 as an r-f amplifier; one 76 as an oscillator; one 6D6 as a mixer, or first detector; one 6D6 as an i-f amplifier (465 kc); one 76 with grid and plate strapped together as a diode detector and avc tube; one 75, with the two diode plates grounded, as an audio amplifier; one 42 as an audio driver stage; two 42's in the output stage, push pull; and one 5Z3 rectifier.

The circuit itself is perfectly standard with, perhaps, a few exceptions which will now be considered. Fig. 7 shows a detail of the r-f, mixer and oscillator coil secondaries. The ends of these coils indicated by the arrows connect to the grids of the respective tubes through the range switch. The coils are numbered from 1 to 4 inclusive, and these numbers refer to the wave-band covered: 1, from 550 to 1500 kc; 2, from 1.5 to 4.2 mc; 3, from 4 to 11 mc; and 4, from 10 to 24 mc.

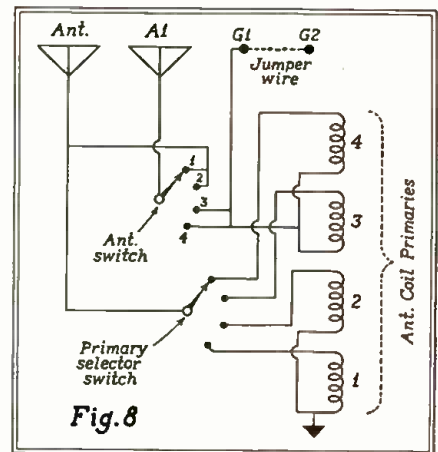

The antenna switching arrangement used in the Lafayette Model 60.

The first thing to note is that the avc is on the r-f tube on all bands and on the mixer tube on bands 1, 2 and 3 only. This means that the avc is not on the mixer on the No. 4 band, which accounts for the relatively high sensitivity of the set on this band. The avc is on the one i-f stage on all bands.

The second thing to note is that inductive trimming is used in the No. 4 band on the mixer and oscillator coils. This receiver is one of the few now being manufactured which employs this form of trimming. A good idea, since it is well known that capacitive variations can never completely compensate for inductive deviations.

The trimmer condensers, from one end of the coil to ground on the Nos.

(TURN TO PAGE 45)

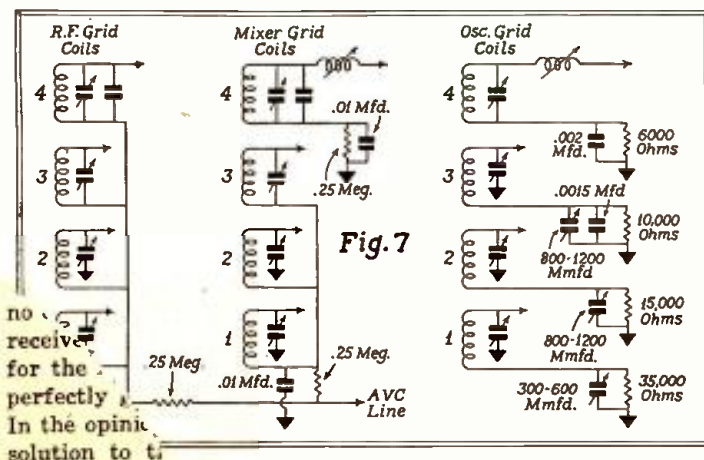

The r-f, mixer and oscillator circuits of the Lafayette Model 60 All-Wave Receiver.

BACKWASH

A PAGE GIVEN OVER TO THE EXPRESSIONS AND OPINIONS OF READERS

"BACKWASH"

To the Reader:

Instead of dispensing with this "Letters-From-Readers" department for the first issue, we are appropriating the space for our own use . . . we shall write letters to you. Thus we can discuss in an informal way, the sum and substance of ALL-WAVE RADIO. Should the idea prove appealing, suppose you reply to our letters on this page, giving your own impressions of the magazine. Does it fill the bill?

There is but one article in this issue dealing with the construction of a receiver. No doubt you would have been more satisfied had there been three or four such articles. We should have liked to have included a few more, but our manner of dealing with receiver designs does not permit us to release the data for publication until we are completely sure of our ground. It takes time to design a good receiver and more time still to put it through its paces. The radio engineering field is not so rich in new ideas that good receivers can be turned out in batches. We could, of course, resort to "armchair engineering" which is a very ineffectual—and unfair—way of going about the design of a receiver, but we much prefer to take our time, select only proven features and rest in the assurance that the receivers described in ALL-WAVE RADIO are really worth building.

We have a number of sets "in the works." Two or three should be ready for the next issue. These sets incorporate new ideas and when we say new ideas, we don't mean old stunts done over.

In the meantime, we trust that you will find the receiver described in this issue of sufficient interest to give it a trial. It is simple in detail, costs but little to construct, yet has good efficiency. The 5-meter band is highly interesting and well worth investigating. However, this band is in the early stages of development and is far from being as active as the higher wavelength bands. Consequently, before investing any money in a 5-meter receiver, it might be well to determine

if there is any 5-meter activity within a radius of, say, 50 miles or so of your home. If you reside some distance from a densely populated area, there is a possibility that you would hear nothing at all on this band. We issue this warning to those who are under the impression that 5-meter signals may be picked up anywhere. This warning will probably go unheeded with the result that many people "out of range" will build the set and pick up signals in spite of this!

ALL-WAVE STATION LIST

This issue contains a list of stations operating on wavelengths ranging from about 5 meters to 2000 meters. Certain commercial services are not included as they can be of no possible interest to the average fan.

The main list provides a pretty good picture of that part of all-wave radio offering entertainment of one sort or another. The one exception is the "Weather Band." The stations in this band offer a distinct service to farmers, autoists, etc., who find a foreknowledge of weather conditions of great value. The average receiver cannot tune to the "Weather Band" but some of the new receivers coming on the market have this band included. Consequently, we feel that a listing of the stations offering sectional weather reports is well worth while.

You will note that all "short-wave" station frequencies are given in megacycles but in such a manner that any frequency may be read in kilocycles by the simple means of changing the decimal point to a comma. Thus, 11.730 is, roughly, eleven and seventenths megacycles (11.7 mc) or, eleven thousand seven hundred and thirty kilocycles (11,730 kc). In other words, when reading in megacycles, the decimal is carried to three places—when reading in kilocycles, the decimal point is conveniently altered to a comma and the reading is constituted entirely of whole numbers. Thus, rapid "eye readings" may be made and compared with the calibrations on the dials of modern all-wave receivers irrespective of whether the dial readings are in kilocycles or megacycles.

The "readability" of the All-Wave Station List is further enhanced by the "spotting" of the active bands. Since most fans continue to think of these bands in terms of wavelength, the bands are referred to in this manner. Thus, prominent markers are placed in the continuous frequency listing to denote the locations of the active regions, such as the 49-meter broadcast band. Moreover, vertical rules are extended along the list so as to include all stations in a given band.

There are a number of other things with respect to the All-Wave Station List we should like to remark upon. For example, the short-wave broadcast stations and the short-wave commercial phone and experimental stations are listed separately. This simplifies both lists, eliminates the possibility of confusion and yet does not make it difficult to spot a station rapidly, since both the lists have the vertical rules with wavelength markers.

A marker is also inserted for the standard broadcast band, but here again the listings are separate for the sake of convenience. There are, as a matter of fact, two lists, one arranged alphabetically by call letters and the other by frequency. The listing by frequency is particularly handy for the person who wants to know what stations he can angle for in each channel.

The "Police" and "Aircraft" band listings are by call letters only as more often than not, the only information required is the location of a station giving a certain call. Knowing the actual frequency upon which one of these stations operates is of little, if any, value, since frequency reading in such narrow bands is next to impossible even with good band-spreading systems.

We believe the All-Wave Station List to be about as convenient as one can make it. You may differ with us on this point. If so, we should be pleased to have your views as to the manner in which the list should be prepared.

The All-Wave Station List is much too long to repeat each month. With

(TURN TO PAGE 48)



By "Beat Note"

A RED ROSE EACH to Marconi, Westinghouse (Co.), Amos and Andy, Armstrong, Big Ben, DeForest, Jack (Ya hear me?) Benny, the conductivity of God's atmosphere and the Kookaburra bird, for having made possible the existence of this magazine.

A NICE, BIG razzberry to the Hills of Nebraska which, though having provided a few lush lines for the play *Rain*, have consistently thwarted the efforts of two expectant experimenters to hear each other on 224 megacycles over a distance of ten miles.

THIS DEPARTMENT wishes to cast a flower in the direction of Alexander Woollcott who, while Rome burned and the Town cried, had the goodness of soul to make his appearance in the Ritz Bar so your commentator might broadcast the news that the Little Man is more of the rosy-cheeked cherub and less of the dissipated minstrel than many of his photographs would indicate.

When he barged out, this department was given the opportunity of appraising his physical and sartorial immaculateness, so different from our mind's picture of him.

Are there others who, through some queer psychological influence, had also pictured him as a flabby gourmand? If so, dispel such visions and the next time you hear him painting indelible scenes with his word brushes, rest in the knowledge that he is all lovely and pink.

TOO OFTEN WE find the night a hell of wakefulness. Sleep will not come and the passing hours add to our discomfort. With such earthly distractions menacing our well-being, it is but natural that we should offer up thanks for those sweet moments of slumber that seem to enrich the soul and rejuvenate the body.

Our mind turns to such an evening some months-past—an evening when Morpheus fluttered into the room whilst GSA gently massaged our ears with a Blattnerphone reproduction of a sermon by the Archbishop of Canterbury.

MUST WE CAST berries on the waters? What of these Central and South-American short-wave broadcasters who consistently (or inconsistently?) skip from one frequency to another like excited grasshoppers. Or have they ants in their pants?

WE HARDLY need introduce you to "Beat Note"—he seems able to introduce himself without assistance from us.

Needless to say, this fellow is hiding behind the cloak of a pen name. So be it. There are no objections, however, to remarking that he is an old timer in the radio game. He has been at it since 1910. More than likely he will kick in with phones on his head.

Which reminds us that all short-wave broadcasters might dispense with this folderol and decide where they want to hang out for good. Suppose WEAf were to decide some night to perch on top of WABC. What would the advertisers say? Or suppose Police Radio WPEG decided to flutter about in the vicinity of the Municipal Broadcaster, WNYC? What would *His Honor* say? Or suppose some Ham in the 20-meter phone band suddenly developed a yen for NAA's wavelength? What would the F.C.C. say?

Such things don't happen because the advertisers, His Honor and the F.C.C. would say *plenty*. But such things happen in the short-wave broadcast bands because no one seems to care what the *listeners* may say.

What are they broadcasting for, anyway?

HAVE WE GOT a handful of razzberries for these "professional type" Hams who use Bugs! Easily 95 per cent of them sound like V wheels gone completely berserk. For tittle-wittles and tweet-tweets, they take the cake. They've got a code all their own in which "s" is four dots, "h" is five dots, and a letter like "l" is whatever they make it. When it comes to "ch", either they leave it out or show a bit of originality by resorting to the four dashes used by the square heads.

If you fellows can't pound straight brass, who not use side-swipers?

WHEN A DAY has been unusually hard, we amble home, retire to our corner

of the household and twirl the dial into a commercial dotter. The steady stream of dots, or the monotonous repetition of the V wheel, brings us peace.

Thus we sit, absorbing ethereal pulses, when suddenly the mechanical robot awakens from its subconscious murmurings and hurls a call at London. Man is at the tape . . . things are ready to pop!

Then traffic—good old TFC—drumming the contacts, clean as a whistle, etching words into the ether. It's a thrill—it's poetry to the old timer.

In these intervals of wakefulness the station is mighty. The perfectly timed dots and dashes flash the brain. Thoughts are instantly laid down at the four corners of the earth. And then—in the midst of this supremacy the station falters as if shaken to the core. The tempo changes: the signals are blurred, drugged. It sounds as though a keen intelligence had suddenly been devitalized. What *has* happened? Man is at the key! Nuts!

A GREAT ART is waning. The brass pounders of yesteryear had fists that would charm a cobra. The boys of the north sent clean-cut stuff that could be read easily at top speed: many of the Navy men could sing you a lullaby with the "tropical swing"—a dreamy tempo with elongated dots and dashes.

When those men put fist to key they *sent*.

There's some of the old gang left, but the mechanical senders are ruining 'em. No practice any more. The old touch just isn't there. Soon it will sound as though they are sending with their feet.

Will the Hams keep the old art alive? We trust so. It's sunk commercially.

A ROSE TO W9ARK (20-meter phone band) for demonstrating the art of diplomacy . . . in functioning as a go-between for W6CNE and W2HFS, when these two stations were hurling messages for us, he referred to your commentator as a *gentleman*.

This has given us more poise and a renewed confidence in our importance.

We have been addressed as "Esquire" but all such letters came from people or concerns after our money. Never have we been called "gentleman."

Q U E R I E S

SHORT-WAVE CONVERTER

Q.—May a short-wave converter be used with any type of broadcast receiver? What results may be expected?

A.—A short-wave converter may be used with any type of broadcast receiver. Less undesirable response (frequency interference) will be had when the converter is used with a tuned radio-frequency receiver. When the converter is used with a superheterodyne, the combination is a "double superheterodyne" with so many frequencies involved that spurious interference is apt to be troublesome. This will depend a great deal on the design of the superheterodyne used. If the receiver has a stage of pre-amplification, the interference will be reduced.

The over-all sensitivity of such a combination is dependent upon the sensitivity of the converter and the broadcast receiver. It may be said that a poor converter used with a good broadcast receiver will not prove as sensitive a combination as a good converter used in conjunction with a receiver having only moderate sensitivity.

A really good converter—and there are only a few of them—used with a well-designed tuned radio-frequency receiver, is a combination hard to beat . . . yet a combination difficult to obtain.

B. F. OSCILLATOR

Q.—Can a beat-frequency oscillator be used with a tuned radio-frequency receiver?

A.—No. These oscillators or "signal beacons" can be used only with superheterodyne receivers as they operate at one frequency only.

REGENERATION CONTROL

Q.—Is condenser regeneration control superior to resistance regeneration control?

A.—Condenser control is smoother in most instances, but usually not so precise as the regulation of voltage by means of a potentiometer. The latter is to be preferred, principally because of its ease in handling, yet

THIS DEPARTMENT is intended primarily for our readers. All questions should be addressed to: Queries Editor, ALL-WAVE RADIO, 200 Fifth Ave., New York, N. Y. We reserve the privilege of publishing only such questions as are of general interest. If personal replies are requested, enclose a stamped and addressed envelope and 25 cents for each question. Phone interviews cannot be given.

condenser control can be improved by using a shunt vernier condenser for fine adjustments . . . much the same idea as band spreading.

HAM INTERFERENCE

Q.—An amateur with a phone transmitter interferes with my reception of broadcast stations. Can anything be done about this?

A.—If you will keep in mind that the amateur has a license which gives him the right to operate his station, and approach him with this understanding of the situation, he will more than likely go out of his way to clear up the trouble for you. He may be able to solve the problem at the transmitter, though the solution may call for the insertion of a wave trap in your own aerial. The trap should be tuned to the frequency of his transmitter.

If the amateur shows an unwillingness to cooperate with you—which is unlikely—report the matter to the Federal Communications Commission, Washington, D. C.

ADDING AVC

Q.—Can I add automatic volume control to my receiver?

A.—Forget it. The answer is yes, but the job is much too ticklish. You will save yourself a lot of grief if you purchase a receiver having this feature.

RECEIVER COILS

Q.—Is a receiver with plug-in coils superior to one having built-in coils and a wave-changing switch?

A.—Yes, everything else remaining

constant. Nevertheless, "built-in" coils, as you call them, are not to be sneezed at. They are very much better today than they were a year ago, as are the switches used with them. It is no longer possible to condemn them . . . one can condemn only the occasional improper application of the coils and switches to wave-changing systems.

FOREIGN B. C. RECEPTION

Q.—Can foreign stations, operating in the broadcast band, be received in the United States?

A.—Yes. Many such stations are received in this country. Stations in Australia, New Zealand, China and Japan are picked up regularly by radio fans on the West Coast and less regularly by fans on the East Coast. The best listening time lies between 1:00 A. M. and 6:00 A. M., when these stations are most active and our locals have shut down.

The European stations are most active at the time our own local stations are going full blast, but many of them continue transmissions into the early morning hours. Some of them are picked up as early as 6:00 P. M., E. S. T.—but here again, the chances of reception are best after midnight, when local transmissions have thinned out and left the air moderately clear.

A list of foreign stations that operate in the broadcast band is included in the All-Wave Station List, published in this issue. Run through the list until you spot the Broadcast Band marker. Note that these stations have powers of ≥ 0 kilowatts or more. Theoretically, these "big fellows" are the ones that should "break through," though practically, it is often the "little fellow" that is heard. Should you receive stations other than those listed, we would appreciate having your reports.

Note that the All-Wave Station List also includes foreign broadcasters operating on frequencies much lower than our own, namely: in the European broadcast band ranging from about 1000 to 2000 meters. Some American broadcast receivers—mainly those

(TURN TO PAGE 47)

POINTERS

ADDING YOUR OWN BAND SPREAD

There are many fine all-wave receivers in use not having the convenience of band spread. It is next to impossible to log short-wave stations on the dials of such sets, even though the dials may be equipped with high-ratio drives.

Band spread may be added to such receivers providing that the dial-drive mechanism is not subject to slippage and the tuning knob is not too close to the edge of the dial.

The accompanying illustration shows how the band-spreading or logging system may be added. A small, etched metal dial is mounted on the receiver panel directly over the shaft of the dial-drive knob. A narrow pointer is then attached to the dial knob either by forcing it into the set-screw hole or fastening it to the under surface of the knob with a thin application of

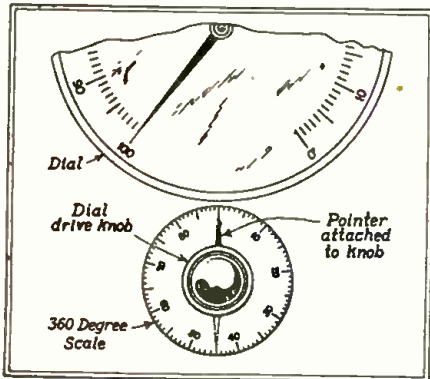

Simple means of adding band-spread to an all-wave tuning dial.

Duco cement. Or the knob may be replaced by one having a pointer.

The band-spread dial may be any of the various types of metal or celluloid dials on the market, but should preferably have a 360-degree scale. However, if an additional pointer is added to the dial-drive knob, as indicated by the dotted lines in the illustration, the scale may be 180 degrees.

It is obvious that with the addition of this supplementary scale, it is possible to log "between divisions" on the main tuning scale. Thus, the log of a station might be 11.0 on the main scale and 50 on the supplementary scale. Just so long as there is no dial-drive slippage, the station will always turn up at the same double-scale reading. Moreover, ade-

quate logging may be kept even though there may be dial-drive slippage, providing care is taken never to allow the knob to be turned beyond the point where the main scale pointer reads minimum or maximum.

GROUND WIRING

More potentially excellent short-wave receivers are actually poor in operation because of the manner in which the sets have been wired. No matter how good your present home-constructed set may be, it can be improved in the event that the "ground" or return connections are made to a number of points on the chassis, as in A of the accompanying illustration.

The point is that the chassis should not be used as a portion of any radio-frequency circuit. The ground or return connections should be made just as if the chassis were not there—the chassis should be grounded to the circuit, not the circuit to the chassis.

When return connections and ground connections are made to a number of points on the chassis, as in A, unwanted differences of potential are created which are apt to result in instability or oscillation. Furthermore, it is difficult to make good contacts to a chassis, unless the chassis is copper plated, with the result that high-resistance contacts are created that may lead to noisy reception.

It is preferable to bunch ground and return leads in the manner shown in B of the accompanying illustration. This eliminates noisy contacts and places all connections at the same r-f ground potential. If two stages are well separated, two terminal points may be used, as indicated, and these two points connected together with heavy copper wire. The chassis

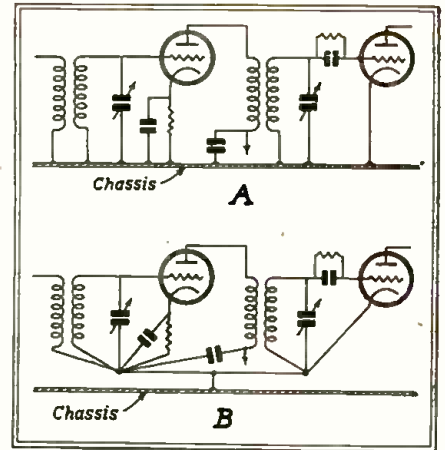

The wrong way (A) and the right way (B) of making ground and circuit-return connections to the chassis.

should then be grounded to the bus connection so formed.

ON WINDING COILS

Contrary to general belief, plug-in coils are not difficult to wind if one goes about the job in the proper way. Furthermore, it is not at all necessary to smear the windings with coil dope to keep the turns in place. This is, as a matter of fact, a poor way of doing things as the dope reduces the efficiency of the coils.

If the coil form hasn't the holes necessary for running the ends of the windings through to the inside of the form, take some string having about the same diameter as the wire to be used and wind trial coils to determine where the various holes should be located. Thus, if a secondary calls for 15 turns of wire, space wound, make just such a coil with string and mark the places on the form where the holes should be made.

(TURN TO PAGE 48)

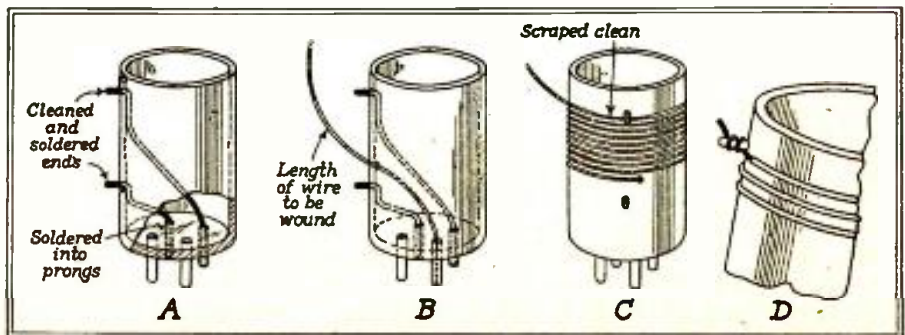

The four steps in winding tight coils which do not require coil dope to hold the turns in place.

RIDER'S MANUALS



When a receiver has its "in-nards" all out of kilter and the ailing part just can't be located—consult

RIDER'S MANUALS

and there you will find the answer. Save your time and money by using the Manuals that are recommended by

LEADING TUBE
MANUFACTURERS
LEADING INSTRUMENT
MANUFACTURERS
LEADING SET
MANUFACTURERS
LEADING SCHOOLS

You will find in Rider's Manuals more schematics . . . more i-f. peaks . . . more layouts . . . more alignment data . . . more real servicing information than in any other Manual.

RIDER'S MANUALS

Vol. I 1000 pages . . \$7.50
Vol. II 800 pages . . 6.50
Vol. III 1070 pages . . 7.50
Vol. IV 1060 pages . . 7.50
Vol. V 1200 pages . . 7.50
Servicing Superheterodynes 1.00

SPECIALIZED AUTO RADIO MANUALS

Vol. I 350 pages . . \$3.50
Vol. II 416 pages . . 3.50

JOHN F. RIDER,
Publisher
1440 Broadway,
New York City

CHANNEL ECHOES

(Continued from Page 15)

IT SEEMS TO US that a compromise could and should be achieved. Translate the spoken dialogue into reasonably natural English. (It will not be necessary to discard altogether the poetic flavoring.) Have these lines delivered by actors who speak English fluently. Such dialogue can usually be made sufficient to indicate action and to carry the plot. Surely, not more than an occasional explanation by such a commentator as Deems Taylor should be necessary—as is the case, even in the one-hundred percent English renditions. AND THEN PERMIT the arias to be sung by the artists in the tongues in which they have thrilled countless thousands from the stage!

WHEN ONE HEARS the comment that something or another is "just around the corner," you can't be quite sure these days whether the speaker is referring to television or prosperity. We can only hope that prosperity doesn't take so long in turning the corner.

IN MAKING THE transition from long to short waves, the average fan all too often jumps clean across the stations bordering on two-hundred meters, and goes in for megacycle tuning. Some excellent entertainment, not to mention fairly good DX, is available from American stations just above the upper police band.

SEVERAL FRENCH stations can be heard about three o'clock in the morning, as a rule, (something else to come home for) just below and above two-hundred meters.

AND THERE ARE the police broadcasters themselves which offer their own unique delights. One may lean back comfortably in his easy chair, and revel vicariously in the knowledge that some man, at three six La Salle Street, is beating his wife.

THE BEST WE ever ran across on the police bands was the broadcast to all cars that a fire engine—glorified in its red and brass trimmings—had been stolen. We understand that the firemen were not in it at the time.

SIGNALS AND NOISE

(Continued from Page 29)

covers the principles which have made the modern radio receiver possible: One of his patents covers most of the principles involved in making it possible to operate a receiver directly from the power line, instead of using batteries.

Without going into the technical de-

tails of the antenna system, which are rather involved, a general understanding of its physical properties and overall performance is well worth while. The details of the system, as shown in Fig. 3, have been developed to a nicety. The more technically inclined reader will find no trouble in understanding the principles upon which the system is based, by referring to the diagram in Fig. 4. A photo of the principal units comprising this system, is shown in Fig. 5.

Considering that the doublet, or the double-doublet is suitable for operating on the short waves, but is deficient in the regular broadcast band, it was desired to improve the efficiency in the broadcast band without sacrificing any of the noise-reducing properties of the antenna system, as a whole.

Suitable performance on the short waves had previously been brought about by replacing the transposition blocks and "open line" with a new type of transmission-line, which had a very low resistance on short waves and which matched the impedance of the doublet without any transformers or similar devices. Furthermore, suitable coupling units for insertion between the lower end of the new transmission-line and the receiver had also been developed.

By the use of the arrangement shown diagrammatically, in Fig. 6, the desired result was accomplished. With this new type of antenna coupler, the antenna functions satisfactorily on all waves and it does so without the need for doing any switching. Reception of the short-wave bands is of the order of magnitude indicated by our friend in California. What the coupler does is to adjust the impedance of the transmission-line to the input impedance of the receiver. Since all receivers do not have the same input impedance, the coupler is made variable.

5-METER RECEIVER

(Continued from Page 11)

length of the winding is 1¼ inch. In order to secure the turns in place, small drops of duco cement are applied along the ridges of the coil form.

A single wire more than 8 feet in length is generally satisfactory for an antenna. A non-resonant antenna is used so that fairly tight antenna coupling can be used without encountering dead spots. If you have the time and inclination, it may, of course, be advisable to experiment with more pretentious antenna systems.

OPERATION

To put the receiver in operation, the antenna coupling condenser, C1, may

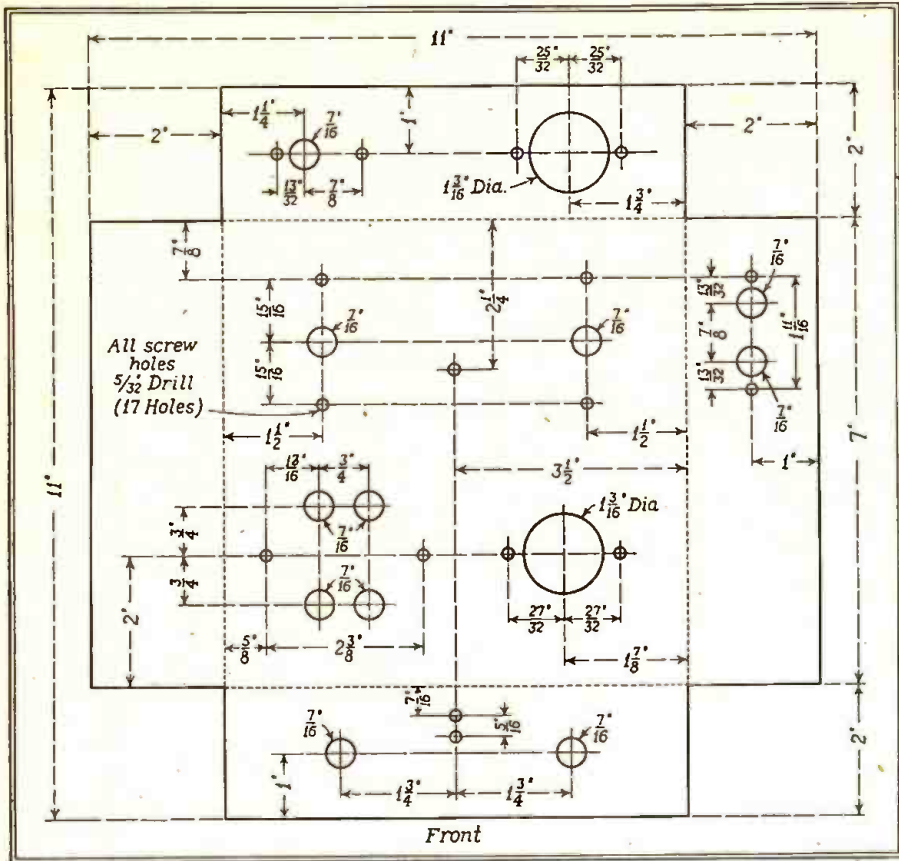

Fig. 4. Measurements and hole locations for the 5-Meter Receiver chassis. Use aluminum.

be adjusted initially so that the edge of the adjustable plate just touches the mica dielectric. The grid condenser, C2, should be adjusted until a loud hissing sound is heard throughout the tuning range. This condition will obtain with the plate nearly all-in. During these adjustments, R2 should be all-out and the volume control, R3, at maximum gain. R2 should then be backed down until it is just above the point where the hiss decreases abruptly. If R2 can be all-in with some hiss still remaining, the antenna coupling condenser should be increased slightly. R3 should now be backed down until the hiss level is at a satisfactory value for headphone reception. It should now be possible to tune in 5-meter stations providing any within range are on the air. Preferably a listening test should be made in the evening when activity is at its peak. The 5-meter band should occupy somewhat more than half the dial and it may be necessary, due to small alterations in individual layouts, to adjust the length of the coil winding slightly to get the band in the center of the dial.

RADIO PROVING POST

(Continued from Page 39)

1 and 2 coils, have values of 4 to 50 mmfd, and those directly across the

coil on the Nos. 3 and 4 bands have values of 3 to 40 mmfd. All other values are marked on the diagram. The tuning condensers for the three bands connect, of course, to the band switches.

The antenna circuit is equipped for either a single wire or doublet antenna, and the change from one to the other in the case of the doublet is made in the receiver through the switching arrangement shown in Fig. 8. With a single-wire aerial, the ground jumper is left attached and the aerial is connected to the ANT post of the set; the A1 post is left blank. The primary coil selector switch then selects the proper antenna primary, and the bottom ends of all the primaries are grounded, as shown. When a doublet antenna is used, the ground jumper is disconnected and the ground left on the G2 post; G1 is open. Now, with the antenna switch in the Nos. 1 and 2 position, the doublet wires are connected together to function as a T-type aerial, and the bottom ends of these primaries are grounded. In the 3 and 4 positions, line A1 connects to the bottom ends of coils 3 and 4, while the top ends connect to the ANT line, in turn. This arrangement results in more uniform sensitivity over the entire tuning range of the receiver.

Fig. 9 is an interesting detail draw-

Announcing
TRIPLET

VOLT - OHM - MILLIAMMETER

IN KIT FORM!

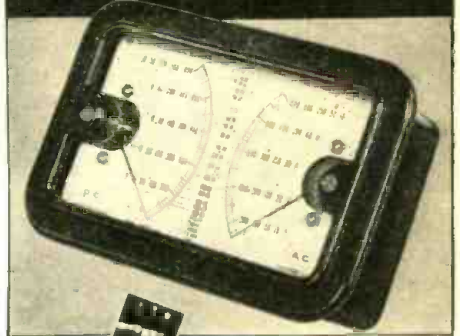

SERVICE men who want to build their own equipment, or who want to use instruments that can be made to fit special space and installation requirements, will be particularly interested in Triplett No. 1200 Volt - Ohm - Milliammeter. Now, it is available in kit form, and is designed for use with built-in job equipment.

Every necessary item is included in this kit—and all assembly details have been carefully worked out. All you need is soldering iron and a pair of pliers. The complete kit includes these units:

Triplett Twin Meter, net	\$10.33
Special Triplett Selector Switch, net	1.67
Shunt Board for 1-10-50-250 milliamperere readings: 1500 ohms and 1.5 megohms, net	2.33
Resistor board for 10-50-250-500-1000 DC volts and 50-250-500-1000 AC volts and current limiting resistors for 1500 ohms and 1.5 and 3 megohms, net	4.83
.5 MFD Condenser for output measurements, net	.33
Rheostat Assembly, consisting of .65-6000-9000 ohm resistors for ohmmeter zero adjustments, net	1.67
Set of blue prints and instructions, net	.67
Hook up wire, net	.33
No. 32 Triplett test leads, net	.50

SEE YOUR JOBBER

See this complete kit at your jobber's. Total price, complete kit, net to dealers... \$16.67

THE TRIPLET ELECTRICAL INSTRUMENT COMPANY

142 Main Street Bluffton, Ohio, U.S.A.

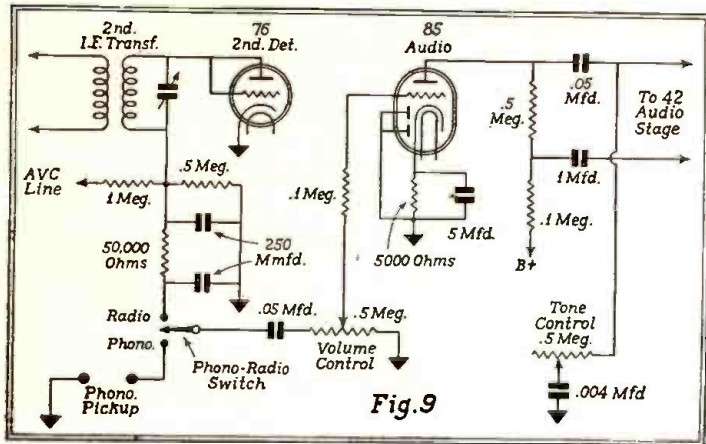

Fig. 9

Second detector and first a-f circuit of the Lafayette Receiver, showing the AVC and phono connections.

lowed this tradition of the sea. They stood by their keys, ignoring their own danger, thinking only of that which tradition called upon them to do. The latest neophyte to that grand fraternity, who have gone down into the silence of the sea, is the radio operator of the U. S. N. Dirigible *Macon*—Ernest M. Dailey, who stayed at his post sending direction signals to the rescue ships until just before the ship struck the water. He jumped from the ship into the water and was not seen again by his shipmates.

Another incident of the devotion to duty of seagoing operators.

22-TUBE FULL-RANGE HIGH-FIDELITY RECEIVER

(Continued from Page 33)

noise caused by local interference, etc., is eliminated, after which all stations tuned in will be heard without interference or noise. This allows the receiver to be operated at the maximum sensitivity possible in your particular location, to give the most satisfying reception.

Other Features.

In addition to the features mentioned, this new receiver has an improved Beat Frequency Oscillator for

ing of the second detector and first a-f circuits, showing the AVC, phono-graph, tone control and volume control circuits.

With the switch in the Radio position, rectification of the signal takes place in the first 76 across the .5-megohm resistor. The full audio is taken through a .05-mfd condenser to the grid of the 76 audio tube through a .1 meg resistor, designed to maintain a high input impedance to the 76 audio tube at low volume-control settings. With the switch in the Phono. position, the pickup is introduced in the grid circuit of the 76 audio tube and the radio output disconnected. The

tone control is available on both radio and phonograph.

RADIO HEROES

(Continued from Page 31)

The men who follow the sea from time long past have had their traditions and they live up to them and die for them. A captain is always the last to leave his ship or else he sinks with her. A radio operator "stands by" at his key until ordered otherwise by his captain. Down at the tip of New York City in Battery Park, past which thousands of ships sail each year, a stone monument bears the names of operators who have fol-

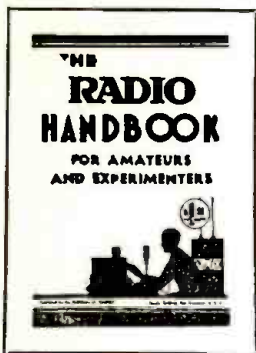

Now on the Press! A 300 Page Handbook by "Radio" Newer - Bigger - Better Only \$1.00 per Copy

HERE is the book you have waited for... a Handbook by "RADIO." New as tomorrow. Chock-full of the kind of information you don't find in other books. The work of a group of experienced amateur radio engineers who know what you want. Frank C. Jones, W. W. Smith, Jayenay Hawkins, Clayton F. Bane, I. A. Mitchell, D. B. McGown... are the men who were assigned the task of writing this modern handbook, one the novice and experienced radio man alike can understand. There are 64 pages of facts on receivers... from a one-tuber to a 12-tube crystal superheterodyne, with complete information on the engineering, design, construction and operation of each. You will find ANY high-frequency receiver of your choice described in this book. Each receiver is the best

in its field. Then there are 64 pages of new facts on CW transmission, showing how to design any kind of a transmitter from a one-tuber for beginners to a de luxe 1 KW high-efficiency transmitter. The many new methods of neutralizing, antenna coupling, low-C tube operation, etc., are all described in this great book. 64 pages devoted to Radiotelephony. Here, again, you find the information needed for building any kind of a phone set from the single-tuber for beginners, to the 1 KW job for the high-power man. New modulation systems... all the data on various types of new controlled-carrier systems... many pages of new microphone data... theory of radiotelephony, etc. Everything is explained, step by step. You cannot go wrong if you use this book as your guide to better

radio. And another 64 pages devoted to ultra-high frequency communication, showing everything of importance... many kinds of transceivers, new Jones superheterodynes, diathermy applications, etc. Last, but not least, the antenna chapter is alone worth the price of the book. It is COMPLETE! Tells how to tune all types of antennas for best results. Gives tables, charts, curves, etc. The chapters

on transformer design, audio systems, rectifier and filter design, monitors and frequency meters, laboratory equipment, transmitting and receiving tubes tell you what you want to know. Here is your new AUTHORITY. \$1.00 per copy.

Send the Coupon and \$1.00 NOW!

Be one of the first to get a copy of this great book.

Publishers of "RADIO"

Pacific Building, San Francisco, Calif.

Send _____ copies of THE "RADIO" HANDBOOK at \$1.00 per copy, postpaid. I enclose \$_____ in full payment.

Name _____

Street & No. _____

City _____ State _____

locating weak short-wave stations easily, using a special compensating circuit which gives a clear audible note on both weak and strong signals; an Attenuation Equalizer or Filter which effectively chops out the 10,000-cycle whistle from adjacent channels when using full frequency range, but which does not impair the frequency response either above or below this one frequency; a Self-Stabilized Oscillator with voltage regulation which keeps the plate voltage on the oscillator constant at all times to within $\frac{1}{4}$ of a volt, irrespective of the fluctuation in line voltage or signal strength, thus eliminating the peculiar twisting or distorting effect which often mars the reception of weak or distant stations on the short-wave bands; a Perfected Bass Control which enables the bass response to be adjusted at five separate cutoff points between 25 and 150 cycles so that when listening to a program from a high-grade broadcast station which is not overmodulating its carrier, and whose output is free from station hum, the deep bass tones of all instruments can be fully enjoyed. However, when tuned to a station which is overmodulating badly or whose carrier hum is objectionable, this control enables all audio frequencies below 150 cycles to be eliminated, so making it possible to obtain

the most pleasurable reception from the station.

All four wave bands are very accurately calibrated, and the receiver is custom built to order for those desiring something above the ordinary.

QUERIES

(Continued from Page 42)

manufactured for export—have this added band. If you own such a receiver, try for some of these fellows.

AIRCRAFT BANDS

Q.—I have listened to conversations on frequencies I presume to be the Aircraft Bands, but do not recall ever hearing the call letters of any of the stations. Is this customary and what are the Aircraft Bands?

A.—Most of the Aircraft Stations operate in groups and on a single frequency or wavelength, thus forming what might be termed a "national party line." However, they do not operate at all times on the same frequency. Each station or group of stations has a number of frequency assignments. Unlike, say, the Police Radio Stations, they do not "stay put," but alter frequency when expedient. There are, however, four distinct Aircraft Bands. These are grouped together in the All-Wave

Station List. The higher frequencies are used during daylight hours, the lower frequencies after dark. But, there are no hard and fast rules regarding their use since the "skip distance" effect of signals brings on many freak conditions.

"SHIP-TO-SHORE" PHONE

Q.—Why isn't it possible to hear "both ends" of a ship-to-shore radio-telephone conversation?

A.—In a few cases it is possible, when both the ship and the shore station operate on the same frequency. In most instances, however, the ship transmits on one frequency and the shore station on another frequency. Consequently, two receivers are necessary to pick up both ends of the conversation.

DETECTION AND AVC

Q.—Is it good practice to use a diode detector for both rectification and automatic volume control?

A.—Yes, providing you have no objections to a marked reduction in receiver sensitivity brought on by the avc control feature. The usual way of getting around this objection is through the use of delayed automatic volume control, in which case the avc does not "take hold" until the signal



FRANKLIN STUDIOS

offers a complete

Advertising Display
Service—Re-style and
Coordinate

your

Boxes, Cartons, Counter
Displays, Car Cards, etc.

FRANKLIN STUDIOS

135 W. 25th Street
New York City

DEPENDABLE CONDENSERS



Type EP9808
8-8 MFD
450 W.V.
525 M.S.V.
Size $4\frac{1}{2} \times 1\frac{1}{2}$
List Price \$1.60
Your Cost \$.96

LOOK to Page 7 for a
real buy on
Electrolytics

The new C-D catalog 128 features much more than just one good buy. Pages and pages with all the information you want about the most complete condenser line in the world!

ELECTROLYTICS—

A complete range of capacities at voltages from 25 to 500 volts D.C. at new low prices!

PAPER—

5 Pages devoted exclusively to the world's most complete paper condenser line.

MICA—

Built with that exclusive Dubilier patented construction, "the series connected stack." From 250 to 50,000 volts.

GET YOUR COPY OF
THIS HANDY CATALOG TODAY!

CORNELL-DUBILIER

C O R P O R A T I O N

4344 BRONX BOULEVARD • NEW YORK



Place Your Order Now For the October
Issue of All Wave Radio
New Circuits, New Lists and Tips You Need

voltage is comparatively large. In this case, the receiver is at maximum sensitivity for the reception of weak signals and has its sensitivity reduced *only* when a strong signal is tuned in.

Delayed automatic volume control calls for a negative bias on the paralleled diode plates of the detector tube. This bias is not conducive to good rectification under all circumstances and, in consequence, many receiver designers prefer to separate the two functions by using one diode plate for rectification and the other diode plate for delayed automatic volume control. Then, bias may be kept off the detector diode by returning it to the cathode of the tube, and placed on the d-avc diode by returning it to ground. In this case, the bias on the d-avc diode will be equal to the drop in voltage across the cathode resistor.

BACKWASH

(Continued from Page 40)

the exception of the short-wave broadcast stations, schedules, frequencies and calls are not changed very often. We intend publishing it once every four months. It is necessary to run the short-wave broadcast station list each month as changes are constantly being made in the schedules and operating frequencies.

POINTERS

(Continued from Page 43)

Go through the same procedure for the primary winding—and the tickler, if there is to be one.

Now the coil is "planned out" and we have sections of string of the proper length for each coil. Say there is just a primary and secondary winding—therefore, we have two sections of string, one a "primary" and one a "secondary," each of different diameter and length.

The next thing to do after drilling the holes in the coil form, is to cut off sections of wire for the primary and secondary coils, these sections to be about 7 inches longer than the string sections. After that is done, cut two lengths of heavy (aerial) wire to serve as leads from the coil-form prongs to the holes which are to serve the *upper* ends of the primary and secondary windings. These two heavy wires are soldered into the proper prongs and the upper ends carried through the coil-form holes so that about a half-inch of the wire is left sticking straight out in each case. This is shown in A of the accompanying illustration. These half-inch ends should be scraped clean and then

coated with solder.

Now we come to the winding of the coils. Let us say that we start with the secondary winding and that this is to be of fairly heavy wire, space wound. The first thing to do is to stick one end of the wire through the hole for the lower end of the coil and solder this end into the proper coil-form prong. This is shown in B of the illustration. The loose end of the wire (which, you will remember, is over-length) is fastened to a hook or some other strong anchorage so that the wire may be drawn taut.

The string now comes into play so that the coil may be space wound. The string may be held with the thumb at the start of the winding and then wound on to the form along with the wire so that the two are running parallel.

Now, holding the coil firmly in both hands, and at all times keeping the wire taut, start winding both the string and the wire onto the form by slowly working toward the wire anchorage. This is done by turning the coil form and slowly walking toward the anchorage, making sure to maintain a strong pull on the form so that the wire will be wound on very tight.

Keep winding in this manner until the end of the string has been reached, at which point there should be the correct number of space-wound turns of wire on the form. This should also bring the end of the secondary wire right up even with the heavy wire sticking out of the hole.

Now comes the real stunt . . . it's easy enough if you go about it the right way. Maintain your hold—and pull—on the coil form with the left hand—so that the turns cannot possibly lose any of their tightness—and with the right hand, take a knife and scrape clean that part of the coil wire in the general vicinity of the heavy terminal wire, as shown in C of the illustration. Then take a pair of pliers, grab both wires over the hole and give a good twist toward the right. This anchors the secondary wire to the terminal wire and is sufficient to hold the turns "as is" while you clip the secondary wire end loose from the hook. Then a few more good turns of this scraped wire around the terminal wire will complete the anchorage and at the same time increase the tightness of the secondary winding. This must be done with pliers, however. The result will be similar to the sketch in D of the illustration.

The next move is to solder the combined connection and anchorage and snip off the projecting ends of the wires to make a neat job.

This all sounds harder than it really is. If it is done correctly, it will be almost impossible to displace the turns on the coil-form. No coil dope is required and the turns will maintain their positions even with rough handling.

Primary and tickler windings are made in the same manner with the exception that no string is used, as such coils are not usually space wound.

PUBLICITY RELEASE

The 1935 Electrical and Radio Exposition, which will be held in Grand Central Palace, New York City, September 18 to 28 inclusive, under the sponsorship of the Electrical Association of New York, is expected to be the most comprehensive and complete display of the latest advances in the fields of domestic and industrial appliances and services, and radio, yet held. It is well described as a National Review of Electrical Progress, and is the largest exposition to be held anywhere in the country.

A feature that will be of great interest to the general public is the "Hall of Science," in which will be shown and demonstrated the many electrical and scientific achievements of which the average layman knows little, if anything, but which are in themselves of consuming interest.

Under the supervision of Dr. Orestes H. Caldwell, well-known writer and lecturer, and Editor of *Radio Today*, as Science Director in the "Hall of Science," there will be a group of scientific men of standing to show and demonstrate and explain such mystifying scientific discoveries as The Electric Eye, which does so many amazing jobs, the radio knife, which marks a new advance in modern surgery, the electric brain, which thinks like a man, the talking book for the blind, the ship's eye which enables it to pierce the fog, the electric tongue, how the scientist puts more vitamins in the milk we drink how electricity bakes bread without crust, the "electric frisker" for concealed weapons, the "lie detector," the electric guide for the blind, the electric valet for the helpless, the music of the electrons, the home radio printing press, transmitting pictures over the telephone wires, how the ultraviolet ray works, and the dance of the molecules, a special exhibit by the New York Museum of Science and Industry which will demonstrate how to hear your voice in telephone conversations, the fathometer, used in submarine signalling, the Barkhausen effect which allows the visitor to hear the reversal of magnetism, and many other interesting inventions in the field of electrical science.



DON'T TAKE OUR WORD FOR IT



But read what others have to say.

"The books should be of interest to engineers as well as Service men."

Communication and Broadcast Engineering.

"All these books avoid complex mathematics and will appeal to the amateur, service man, set builder and SWL as well as the advanced radio engineer."

Radio.

"This trio of informative pamphlets were intended to meet the demand for technical and semi-technical data on modern receiver design. In producing them Mr. Granger has performed his task well."

The New York Sun.

"May I congratulate you on having secured the services of such an excellent writer as Mr. G. S. Granger, who thoroughly understands the practical and technical details of his work."

**J. E. Smith, President
National Radio Institute.**

"The information contained in these books is not only presented in a very clear and concise manner, but I must say that the information completely covers the field of design in a modern and efficient manner."

**R. E. Moore
Denver School System.**

"... and might add in closing that the books are most up-to-date and highly informative."

**Rod Stanley
Montreal, Canada.**

"... these (Granger Books) will be quite valuable and we hope to list them in our next catalog."

**Radio Laboratories
Kansas City.**

"... delighted to read that Mr. Granger has decided to write three booklets on receiver design."

**N. J. McHugh & Co.,
Bruxelles, Belgium.**

These Books Have Already Been Sold in Twenty Countries !!

**ORDER
YOUR
COPY
TODAY**

**MANSON PUBLISHING COMPANY
200 Fifth Avenue, New York, N. Y.**

Gentlemen:

Send me postpaid volumes checked below, for which I enclose \$.....

- Broadcast Receiver Design \$.50
- All-Wave Receiver Design50
- High-Fidelity Receiver Design50
- Complete Set. Three Volumes 1.00

Name

Address

**Don't Let a Poor Aerial
Spoil Otherwise Excellent Reception**

**The BEST Costs No More!
Why Be Satisfied with Imitations?**

As a result of LYNCH pioneering in the Aerial Field, many hundreds of thousands of antennas have been sold. But LYNCH HI-FI Antennas still maintain their superiority—technically, mechanically and electrically.

There's a Reason!

Competitors have copied the fundamentals of noise-free aerials, but they cannot duplicate LYNCH PERFORMANCE.

LYNCH HI-FI Antennas are *Patented* and *Guaranteed*.

NOISE-REDUCING TWINS

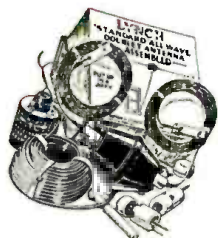

LYNCH HI-FI ASSEMBLED ANTENNA

All ready to hang. Saves 90% of installation time. Any novice can install it—quickly, easily, correctly. Makes every set perform better on ALL waves. Results are **\$6.75** List
amazing.

**The ONLY Two Companion Devices
For Reducing Noise on ALL Waves!**

LYNCH FILTERADIO

Cuts out objectionable noise from the light line, consumes no current. Makes interference from circuit breakers, motor generators, etc., practically negligible.

Easy to install; simple to adjust. One type **\$5.00** List
serves all purposes.

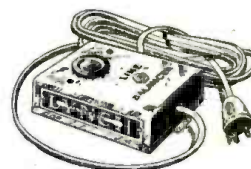

...A 40% discount is allowed to members of the I. S. W. C.
If local jobber or dealer cannot supply you, order direct.

ARTHUR H. LYNCH, Inc., 227 Fulton St., New York, N.Y.

PIONEER OF NOISE-REDUCING AERIALS