

ATWATER KENT

RADIO

PARTS LIST

The parts listed in this booklet are sold to Atwater Kent Radio Distributors for service purposes only. Parts not listed by number and name are not sold singly and come only as part of an assembly.

When ordering, be sure to give both the number and name of the part desired.

ATWATER KENT MANUFACTURING COMPANY

4700 WISSAHICKON AVENUE, PHILADELPHIA

Printed in U. S. A. Copyright Aug., 1928. by Atwater Kent Mfg. Co.

THE ATWATER KENT
RADIO WARRANTY

FOR THE
SEASON 1928-1929

We warrant each new piece of apparatus manufactured by us to be free from defect in material and workmanship. This warranty shall not apply to any apparatus which has been subjected to misuse, neglect or accident, nor shall it apply to complete sets not factory wired. Neither shall it apply to complete sets factory wired or units which have been repaired or altered outside of our factory. This warranty is in lieu of all other warranties, expressed or implied; and we do not authorize any representative or person to assume for us any other liability in connection with our equipment.

Our obligations under this warranty are limited to the furnishing at our factory of any part of said equipment which shall, within sixty days after delivery of the factory wired Radio Receiving Set or Unit to the original purchaser, be returned to us, transportation charges prepaid, and which examination shall disclose, in our judgment, to be defective.

This does not apply to complete sets or parts which have not been connected in accordance with the instructions furnished by us, or complete sets from which the serial number has been removed.

Labor charges incurred in the repair of defective radio material are allowed only on material returned to the jobber immediately after purchase, and which has not been altered, abused or incorrectly connected.

Warranty material is repaired or replaced by us. Credit is not issued.

SALES DEPARTMENT
SERVICE DIVISION

SERVICE PARTS LIST

for

MODEL 9, No. 4660

MODEL 10, No. 4700

MODEL 12, No. 4910



MODEL 12



MODEL 10

- | <i>Part No.</i> | <i>Part No.</i> |
|---|--|
| 1068 | 3907 |
| Staples, per 100..... | Mounting Screw for Tube Units, Switch and No. 1 Transformer..... |
| 3469 | 3911 |
| Binding Post Knurled Nut..... | Mounting Screw for Condenser and Amplifiers..... |
| 3482 | 3933 |
| Tube Contact Spring Nut for Tube Socket No. 4802, used on Model 10-4700 and Model 12-4910..... | Rubber Feet..... |
| 3614 | 4010 |
| Binding Post Locknut..... | Tube Contact Spring Screw for Tube Socket 4802..... |
| 3615 | 4085 |
| Tube Contact Spring Nut for 4500 and 4661 Tube Units; 4520 Detector Two Stage; 4940 Detector One Stage; 4925 Two Stage..... | Antenna and Ground Binding Post Screws..... |
| 3616 | 4098 |
| Tube Contact Spring Screw for 4500 and 4661 Tube Units, 4520 Detector Two Stage, 4940 Detector One Stage, 4925 Two Stage..... | Vernier Knob Complete..... |
| 3617 | 4177 |
| Tube Contact Spring (top)..... | Amplifier Condensite Cover Retaining Screw..... |
| 3618 | 4183 |
| Tube Contact Spring (bottom)..... | Battery Switch..... |
| 3623 | 4334 |
| Condenser Dial Retaining Screw..... | Antenna Name Plate..... |
| 3627 | 4335 |
| Rheostat Switch Pointer for 4520 Detector Two Stage and 4940 Detector One Stage..... | Ground Name Plate..... |
| 3638 | 4465 |
| Condensite Cover Retaining Screw used on 4520 Detector Two Stage, 4940 Detector One Stage, 4925 Two Stage..... | Grid Condenser used on 4940 Detector One Stage, 4520 Detector Two Stage..... |
| 3703 | 4477 |
| Tapped Transformer Switch Contact Blade..... | Condensite Cover only, for 4565 Variable Condenser..... |
| 3785 | 4497 |
| Condensite Knob for Tapped Transformer, Tube Units, Detector Two Stage and Detector One Stage..... | Rheostat Resistance Unit (10 ohms) for 4500 Tube Unit used on Model 10-4700 and Model 12-4910..... |
| 3841 | 4500 |
| Phone Post Retaining Nut..... | Tube Unit with 10 ohms Rheostat used on Model 10-4700 and Model 12-4910..... |
| 3849 | 4516 |
| Rheostat Resistance Unit (4 ohms) for 4520 Detector Two Stage, used on Model 9-No. 4660 and Model 10-No. 4700..... | Phone Post Thumb Screw..... |
| 3899 | 4520 |
| Rheostat Switch Pointer used on 4500 and 4661 Tube Units..... | Detector Two Stage Amplifier (4 ohms rheostat)..... |
| 3903 | 4527 |
| Tube Contact Spring for Tube Socket No. 4802 only..... | Cable Terminal..... |
| | 4529 |
| | Cable Eyelet..... |
| | 4900 |
| | Variable Condenser complete with Dial..... |
| | 4572 |
| | Variable Condenser—case only (Brown)..... |
| | 4591 |
| | Tapped Transformer Switch Shaft Spring..... |
| | 4596 |
| | Log Card..... |
| | 4623 |
| | Vernier Knob Screw..... |

Refer to numerical list for prices

Part No.

- 4631 Transformer End Cover complete with Angle Plate.....
- 4633 Tapped Transformer No. 1. Radio Frequency used on Model 9—4660, Model 10—4700, Model 12—4910.....
- 4636 Transformer No. 3, Radio Frequency used on Model 10—4700 and Model 12—4910.....
- 4651 Mounting Board 20½ in. x 10 in. for Model 9—4660.....
- 4661 Tube Unit with 20 ohms Resistance for Model 9—4660.....
- 4662 Rheostat Resistance Unit (20 ohms) for 4661 Tube Unit used on Model 9—4660 only.....
- 4663 Transformer No. 2, Radio Frequency (Model 9—4660 only).....
- 4664 Conductor Cable complete 12 Foot Model 9—4660; Model 10—4700; Model 12—4910.....
- 4691 Switch Knob Holding Spring for 4925 Two Stage used on Model 12—4910 only.....
- 4801 Mounting Board 29¼ in. x 10 in. Model 10—4700.....
- 4802 Tube Socket Model 10—4700, Model 12—4910.....
- 4814 Grid Leak used on 4940 Detector One Stage and 4520 Detector Two Stage.....

Part No.

- 4837 Condenser Dial, complete.....
- 4877 Tube Socket Mounting Screw.....
- 4879 Grid Resistance Unit for No. 2—4946 Radio Frequency Transformer used on Model 10—4700, Model 12—4910.....
- 4917 Mounting Board 34 in. x 10 in. for Model 12—4910.....
- 4921 Switch Knob complete for 4925 Two Stage Amplifier used on Model 12—4910 only.....
- 4925 Two Stage Amplifier used on Model 12—4910 only.....
- 4940 Detector and One Stage Amplifier used on Model 12—4910 only.....
- 4946 Transformer No. 2 Radio Frequency used on Model 10—4700, Model 12—4910.....
- 4953 Rheostat Resistance Unit (7 ohms) for 4940 Detector One Stage used on Model 12—4910 only.....
- 4960 Fixed Resistance Unit (5 ohms) for 4925 Two Stage Amplifier used on Model 12—4910 only.....
- 4977 Grid Resistance Unit for No. 1 Radio Frequency Transformer used on Model 9—4660, Model 10—4700, and Model 12—4910.....
- 8685 By-Pass Condenser.....
(Replaces 7646 By-Pass Condensers)

Refer to numerical list for prices

MODEL 20, No. 4640—MODEL 24 (DE LUXE) No. 4920

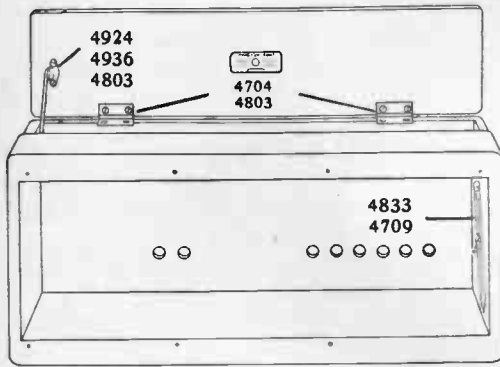

MODEL 19 CABINET No. 4986

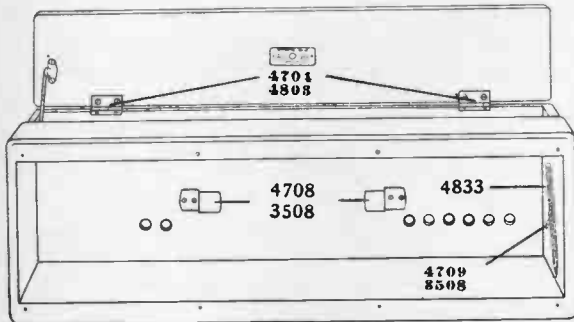

MODEL 20 CABINET No. 4680



4686

4685



7646 Obsolete
(superseded by 7893)



4903
4905



4742



113



3933

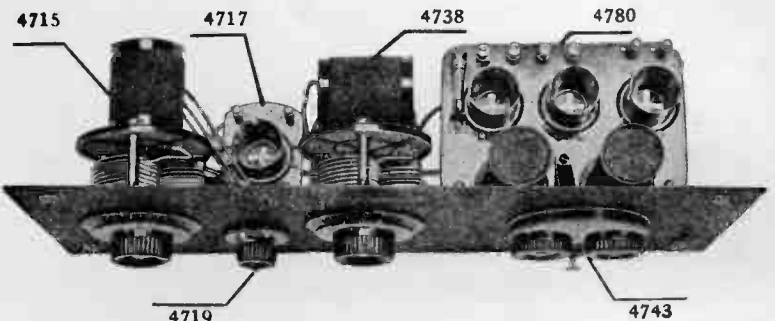

ASSEMBLY GROUPS, MODEL 19

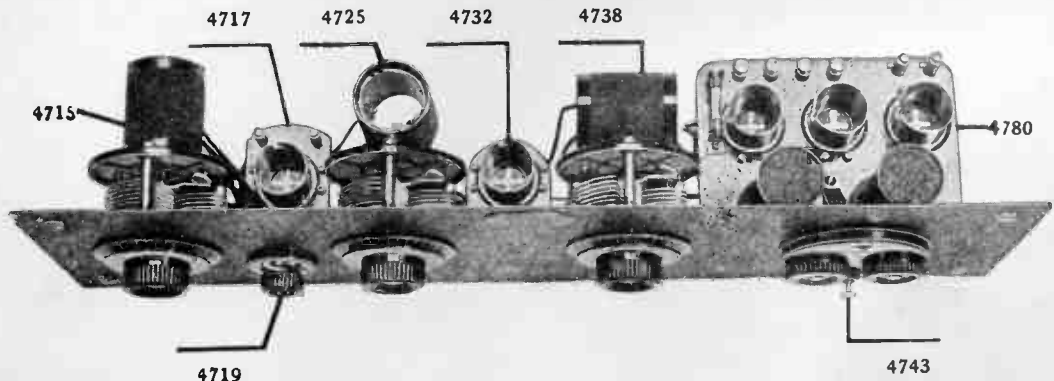

ASSEMBLY GROUPS, MODELS 20 AND 24 (DE LUXE)

Part No. CABINET PARTS

- 4680 Cabinet Complete for Model 20.....
- 4986 Cabinet Complete for Model 19.....
- 4702 Panel & Angle Base Assembly only for Models 20 or 24.....
- 4832 Panel & Angle Base Assembly only for Model 19.....
- 4710 Panel Screw (Nickel).....
- 4909 Panel Screw (Gold).....
- 4685 Ground & Antenna Nameplate.....
- 4686 Radio Speaker & Battery Conn. Name-plate
- 113 Fastening Pin (per 100)
- 4704 Lid Hinge.....
- 4768 Lid Hinge Holding Screw.....
- 4708 Log Card Clip
- 3508 Log Card Clip Holding Screw.....
- 4713 Dial Indicator.....
- 4924 Lid Support Hinge.....
- 4768 Lid Support Hinge Holding Screw.....
- 4936 Lid Support Hinge Holding Screw Washer...
- 4833 Lead Pencil
- 4709 Lead Pencil Clip
- 3508 Lead Pencil Clip Holding Screw.....
- 3933 Rubber Cabinet Supports.....
- 7893 By-Pass Condenser (under frame of set) replaces 7646.....
- 4742 By-Pass Condenser Holding Clip
- 4511 By-Pass Cond. (obsolete—replaced by 7893)
- 7852 Instruction Book.....
- 4903 6 Ft. Battery Cable.....
- 4905 10 Ft. Battery Cable.....
- 4803 Hinge Screw.....

Refer to numerical list for prices

No. 4715—#1 Variable Condenser and Tapped Transformer Assembly—Complete

Part No.	
4714	No. 1 Tapped Transformer.....
4010	Transformer Mounting Screw.....
4366	Transformer Mounting Screw Nut.....
4949	Grid Resistance Coil.....
4805	Rear Condensite Condenser Plate.....
4654	Front Condensite Condenser Plate.....
4836	Rear Condenser Plate Holding Screws.....
4655	No. 1 Variable Condenser.....
4819	Spacer Screw.....
4566	Spacer Screw Nut.....
4818	Spacing Sleeve.....
4577	Rotor Assembly.....
4557	Rotor Locknut.....
4588	Rotor Balance Weight Assembly.....
4562	Condenser Rotor Plate.....
4665	Var. Condenser Rotor Connector.....
4666	Var. Condenser Stator Connector.....
4459	Condenser Stator Plate.....
4820	Stator Spacer Screw.....
4150	Stator Spacer Screw Nut.....
4151	Shaft Adjusting Screw.....
4179	Shaft Adjusting Screw Locknut.....
4147	Tension Spring.....
4164	Tension Spring Adjusting Screw.....
4606	Tension Spring Holding Screw.....
4166	Tension Spring Adjusting Screw Locknut.....
4837	Dial for 1/4" Shaft.....
3623	Dial Set Screw.....

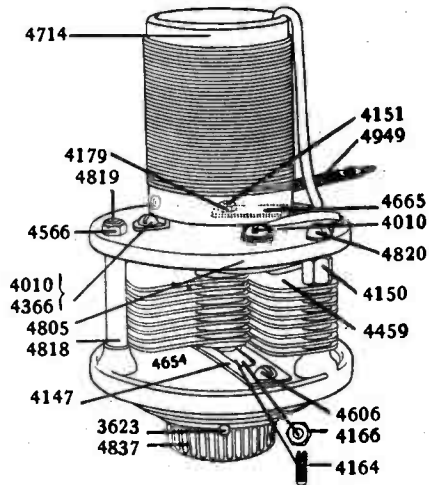

No. 4715.—No. 1 VARIABLE CONDENSER AND TAPPED TRANSFORMER ASSEMBLY

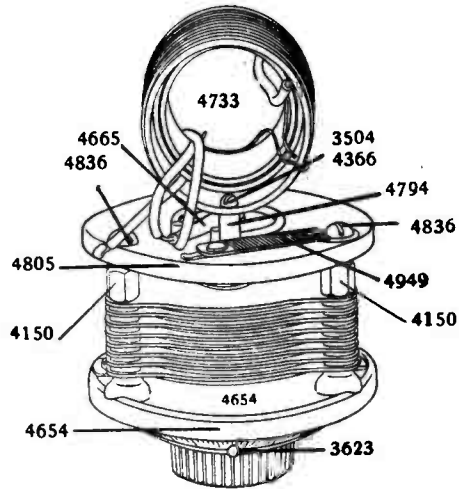

No. 4725.—No. 2 VARIABLE CONDENSER AND TRANSFORMER ASSEMBLY

No. 4725—#2 Variable Condenser and Transformer Assembly—Complete

(NOTE: All parts other than those listed are the same as Assembly No. 4715.)

Part No.	
4733	No. 2 Radio Frequency Transformer.....
4655	No. 2 Var. Condenser.....
3504	Transformer Mounting Screw.....
4794	Transformer Mounting Screw Spacer.....
4366	Transformer Mounting Screw Nut.....

No. 4738—#3 Variable Condenser and Transformer Assembly—Complete

(NOTE: All parts other than those listed are the same as Assembly No. 4715)

Part No.	
4733	No. 3 Radio Frequency Transformer.....
4655	No. 3 Var. Condenser.....
3504	Transformer Mounting Screw.....
4794	Transformer Mounting Screw Spacer.....
4366	Transformer Mounting Screw Nut.....

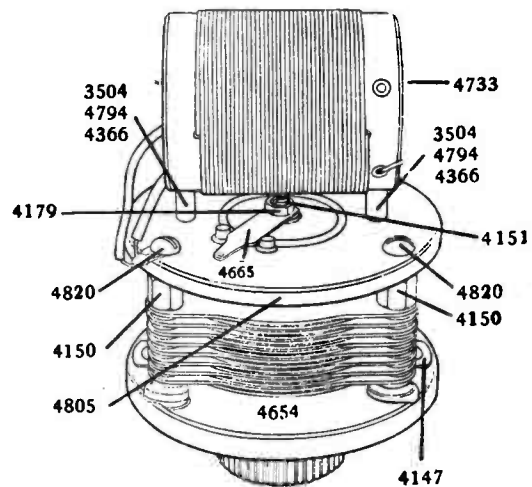

No. 4738.—No. 3 VARIABLE CONDENSER AND TRANSFORMER ASSEMBLY

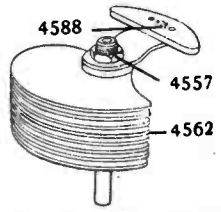
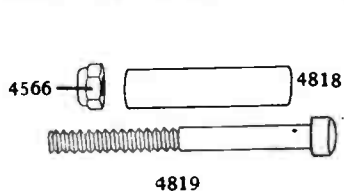

No. 4577.—ROTOR ASSEMBLY

Refer to numerical list for prices.

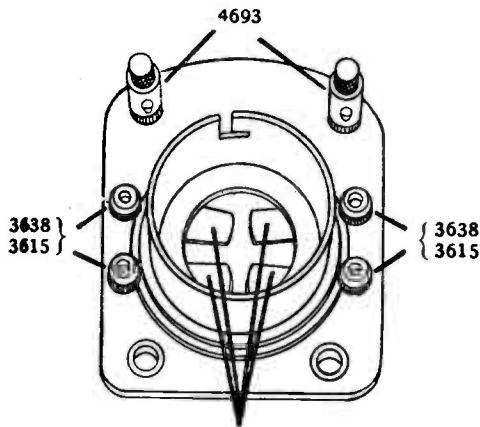

7644
1st R. F. SOCKET No. 4717

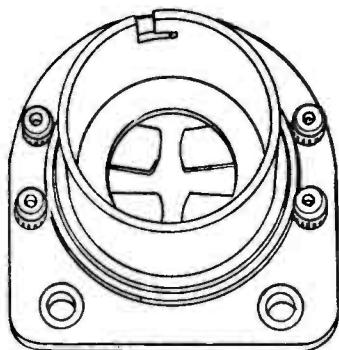

2nd R. F. SOCKET No. 4732

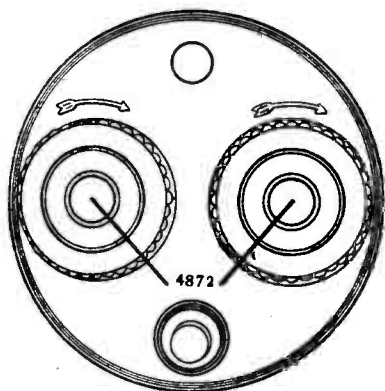

DOUBLE RHEOSTAT AND SWITCH
PANEL No. 4743

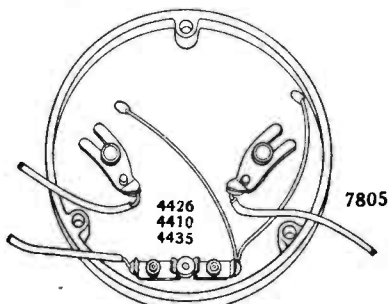

(Rear View)

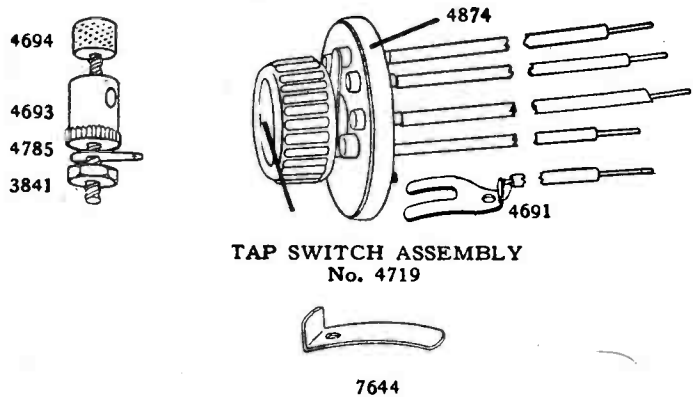

TAP SWITCH ASSEMBLY
No. 4719

7644

No. 4743—Double Rheostat and Switch Panel Assembly—Complete

Part No.

- 4872 Knob and Contact Spring.....
- 7805 Binding Spring and Lead Wire.....
- 4426 Switch Contact Spring.....
- 4410 Switch Contact Spring Holding Nut.....
- 4435 Switch Contact Spring Washer.....

For Model 24 (De Luxe)

- 7640 Double Rheostat and Switch Panel Assembly....
(This is the same as No. 4743 except for gold
plating on parts.)

No. 4717 —First Radio Frequency Socket— Complete

Part No.

- 7644 Single Contact Spring (Replaces Nos. 3617-3618) ..
- 3638 Contact Spring Holding Screw.....
- 3615 Contact Spring Holding Screw Nut.....
- 4795 Socket Mounting Screw.....
- 3841 Socket Mounting Screw Nut.....
- 4693 Ground or Antenna Post.....
- 4694 Ground or Antenna Post Thumb Screw.....
- 3841 Ground or Antenna Post Nut.....
- 4785 Ground or Antenna Post Soldering Clip.....

No. 4732—Second Radio Frequency Tube Socket—Complete

(NOTE: Parts No. 3617, 7644, 3618, 3638, 4795 and 3841 for
this socket are the same as 4717 socket.)

No. 4719—Tap Switch Assembly— Complete

Part No.

- 4691 Binding Spring and Lead.....
- 4873 Knob Assembly.....
- 4874 Base and Taps.....

For Model 24 (De Luxe)

Part No.

- 4914 Tap Switch Assembly Complete.....
- 7844 Knob Assembly.....
- 7845 Base with Taps.....

Refer to numerical list for prices.

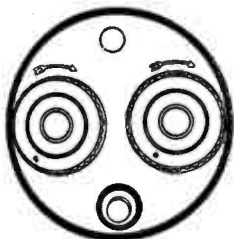

DOUBLE RHEOSTAT
No. 7840
(See Note)

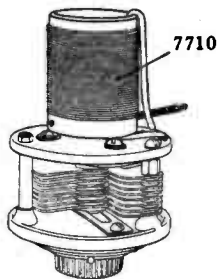

ASSEMBLY
No. 7618

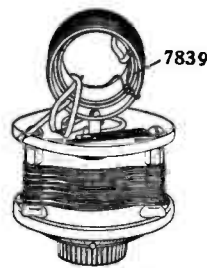

ASSEMBLY
No. 7810

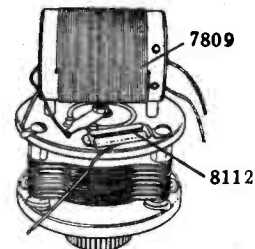

ASSEMBLY
No. 7812

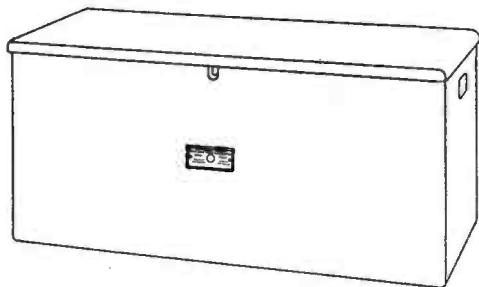

BATTERY CONTAINER
No. 7790

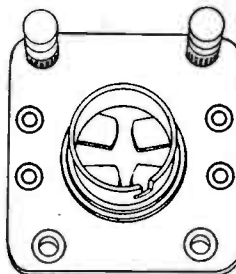

1st R. F. SOCKET
No. 7808

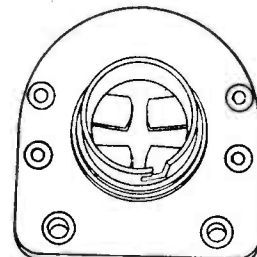

2nd R. F. SOCKET
No. 7811

CABINET PARTS

Part No. 7807 Cabinet complete.....

No. 7808—1st R. F. Tube Socket Assembly—Complete

No. 7811—2d R. F. Tube Socket Assembly—Complete

No. 7840—Double Rheostat and Switch Panel Assembly—Complete

Part No. 4690 Rheostat Resistance Unit

NOTE: The Double Rheostat No. 7840 differs from No. 7640 used on Models 20 and 20 Compact in that the Rheostat Resistance Unit controlling the R. F. tubes is 14 ohms and that of the Unit controlling the A. F. tubes, 8 ohms. On the No. 7640 Double Rheostat, both units are the same, having a resistance of 8 ohms.

No. 7650—Tap Switch Assembly—Complete

No. 7813—Detector and 2-Stage Amplifier—Complete

No. 7618—No. 1 Tapped Transformer and Condenser Assembly Complete

No. 7810—No. 2 Variable Condenser and Transformer Assembly—Complete

Part No. 7839 No. 2 R. F. Transformer

No. 7812—No. 3 Variable Condenser and Transformer Assembly—Complete

Part No. 7809 No. 3 R. F. Transformer

7855 Base with Socket Assembly with Tube Contact Springs.....

No. 7790—Battery Container

7815 Battery Cable.....

8241

4785

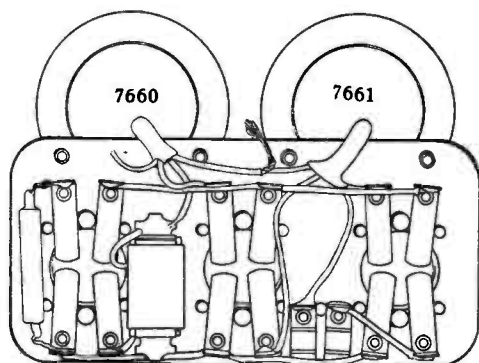

(Rear View) DETECTOR AND 2-STAGE AMPLIFIER ASSEMBLY
No. 7813

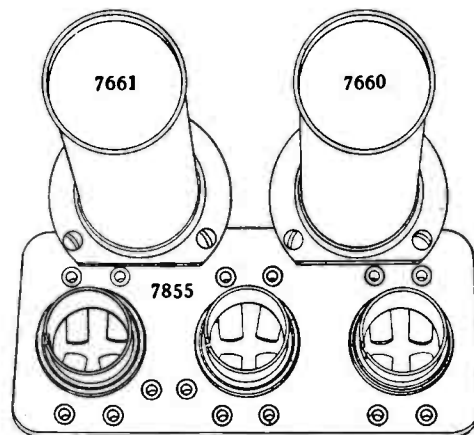

(Top)

Refer to numerical list for prices.

MODEL 20 COMPACT, No. 7960

NOTE: Many parts for the Model 20, No. 7960 Compact are the same as those used in the Model 20, No. 7570 Set listed on the foregoing pages. Therefore, only those which are any way different are given under the Model 20, No. 7960 Compact and parts not shown or listed below should be selected from the parts list for the Model 20, No. 7570 Set.

NOTE: Except for the few minor changes shown below, all assemblies are the same as those for the Model 20, No. 7570 Set. Only parts which differ are indicated. Complete assemblies have been given different numbers wherever any of the component parts are different.

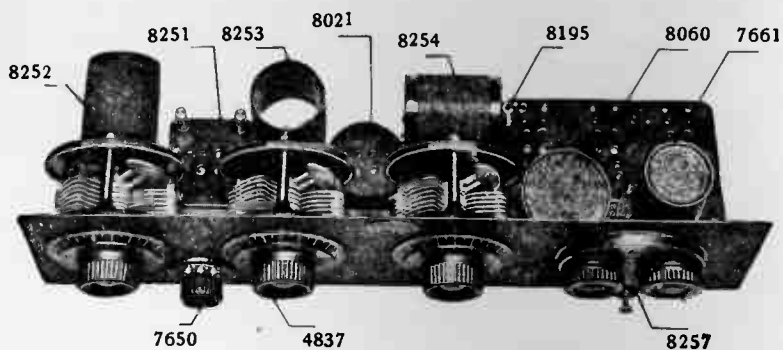

ASSEMBLY GROUPS, MODEL 20 COMPACT — 7960

No. 8262—No. 1 Tapped Transformer and Condenser Assembly—Complete

Part No.

8252 No. 1 Tapped Transformer

No. 8263—No. 2 Variable Condenser and Transformer Assembly—Complete

Part No.

8253 No. 2 R. F. Transformer

No. 8264—No. 3 Variable Condenser and Transformer Assembly—Complete

Part No.

8254 No. 3 R. F. Transformers

8112 Grid Condenser

No. 8251—1st R. F. Tube Socket Assembly—Complete

Part No.

7682 Socket Mounting Screw

7647 Ground and Antenna Post Assembly

3620 Ground and Antenna Post Screw

No. 8021—2d R. F. Tube Socket Assembly—Complete

No. 8257—Double Rheostat and Switch Panel Assembly

Part No.

4690 Rheostat Resistance Unit for R. F.

8310 Rheostat Resistance Unit for Detector

8190 Fixed Grid Resistance

8303 Fixed A. F. Rheostat Resistance

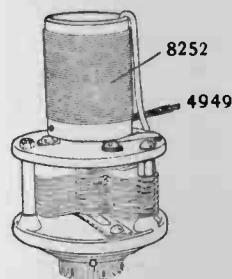

ASSEMBLY
8262

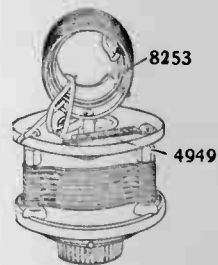

ASSEMBLY
8263

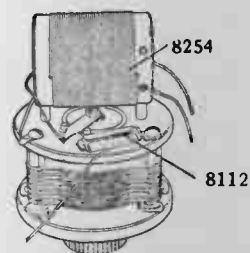

ASSEMBLY
8264

Refer to numerical list for prices.

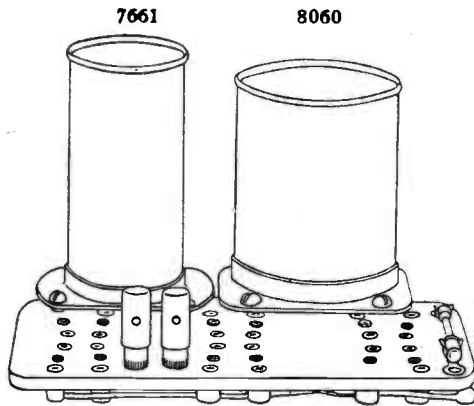

8330 DETECTOR 2-STAGE AMPLIFIER

NOTE: The double rheostat No. 8257 differs from No. 7640 on Model 20 Compact 7570, in that the 8257 rheostat resistance on the Detector tube is 16 ohms and the rheostat assembly has one (1) more lead, which is the resistance controlling the A. F. tubes. On the No. 7640 double rheostat both resistance units are the same, having a resistance of 8 ohms and have no fixed resistance for the A. F. tubes.

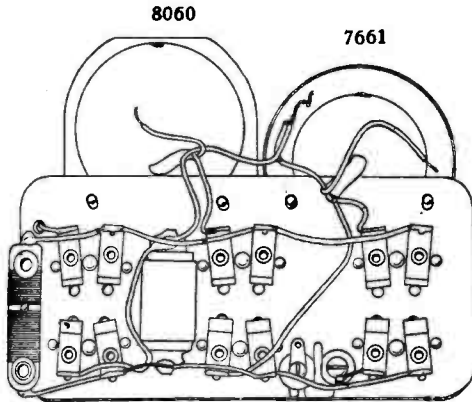

(Bottom)
8330 DETECTOR 2-STAGE AMPLIFIER

No. 8330—Detector and 2-Stage Amplifier Complete

Part No

- 8238 Base with Phone Posts and Contact Springs
- 8060 1st A. F. Transformer
- 7661 2nd A. F. Transformer
- 8241 Phone Condenser
- 8195 Grid Leak
- 7638 Phone Post Spring
- 7686 Insulation Sleeving per ft.....

All No. 1 A. F. Transformers carry the No. 8060. Specify whether round base, oval base or Transformer with dent on side is required.



4690 RHEOSTAT RESISTANCE UNIT R. F.



8190 FIXED (GRID) RESISTANCE



8310 DETECTOR RESISTANCE UNIT

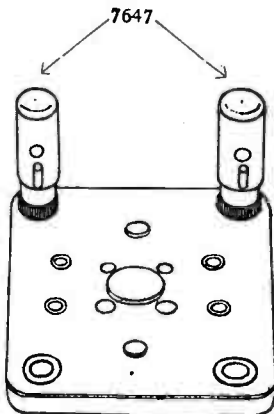

No. 1 R. F. SOCKET
No. 8251

8303 A. F. FIXED RESISTANCE

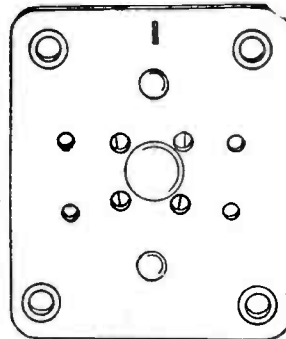

No. 2-3-4 R. F. SOCKET
No. 8021

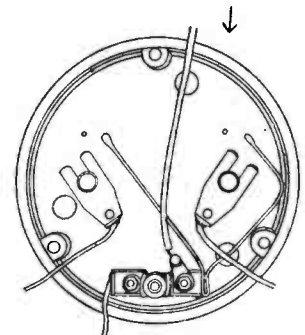

REAR VIEW
RHEOSTAT 8257

Refer to numerical list for prices.

MODEL 30, No. 8000 SET

NOTE: Many Parts for the Model 30, No. 8000 Set are the same as those used in the Model 20 Compact, No. 7960 Set. Therefore, only those which are in any way different are given under the Model 30 and parts not shown or listed should be selected from the parts list for the Model 20 Compact, No. 7960 Set.

NOTE: Except for a few minor changes shown in the foregoing, all assemblies are the same as those for Model 7960 20 Compact. Only parts which differ are indicated. Complete assemblies have been given different numbers wherever any of the component parts are different.

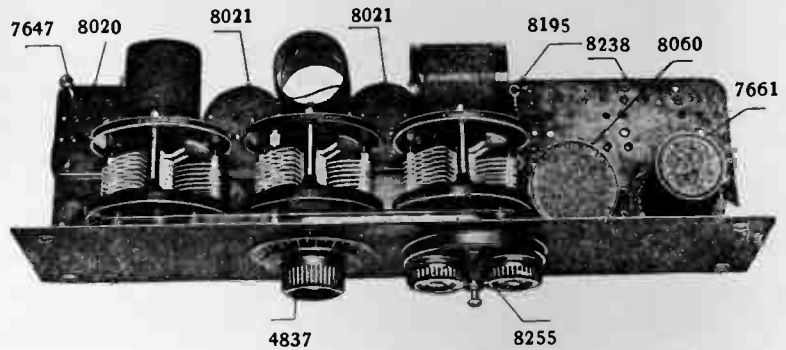

No. 8255—Double Rheostat Assembly

MODEL 30, No. 8000 SET

Part No.

- 4606 Rheostat Mt. Screw.....
- 4690 Rheostat Resistance Unit for R. F.....
- 8310 Rheostat Resistance Unit for Detector.....
- 8256 Fixed Resistance Unit for A. F.....
- 4872 Switch, Knob and Contact Spring.....
- 7805 Binding Spring Lead Wire.....
- 4426 Switch Contact Spring.....
- 4410 Switch Contact Spring Holding Nut.....
- 4435 Switch Contact Spring Washer.....

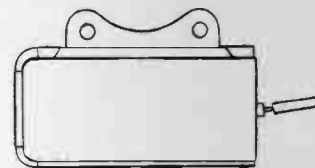

8685

BY-PASS CONDENSER

No. 8022—Det. 2-Stage Amplifier (After Serial No. 522000 Change to 8340)

Part No.

- 7682 Det. 2-Stage Mounting Screw.....
- 3841 Det. 2-Stage Mounting Nut.....
- 8238 Det. 2-Stage Base with Contact Springs and Phone post.....
- 8241 Phone Condenser.....
- 8195 Grid Leak.....
- 8215 Phone Binding Post.....
- 8131 Phone Binding Post Screw.....
- 8167 Vernier Knob (Complete) No Screw.....
- 7961 Vernier Knob Screw.....
- 8023 Main Panel and Angle Piece.....
- 8035 Cabinet.....
- 8112 Grid Condenser.....

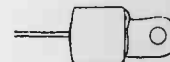

8062

CHOKE COIL

Part No.

- 8062 Choke Coil.....
- 8190 Fixed (Grid) Resistance.....
- 8685 By-Pass Condenser.....
- 8092 Grid Resistance.....
- 8021 No. 2 or No. 3 Tube Socket.....
- 8020 No. 1 Tube Socket.....
- 7647 Ant. and Grd. Binding Post.....
- 4795 Ant. and Grd. Binding Post Screw.....
- 7682 Socket Mounting Screw.....
- 7619 Tube Socket (Used Previous to Serial 517001).....
- 7630 No. 2 or No. 3 Tube Socket (Used Previous to Serial 517001).....
- 7965 Var. Con. Pulley Belt.....
(Both belts the same)
- 8185 Sub-panel Assem.....
- 9168 No. 1 and No. 3 Condenser Pulley.....
- 9169 No. 2 Condenser Pulley.....

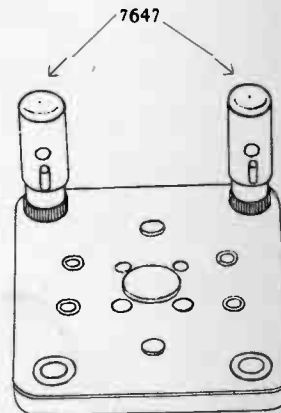

8020 No. 1 TUBE SOCKET



8092

GRID RESISTANCE

Refer to numerical list for prices.

MODEL 32, No. 8270 SET

NOTE: Many parts for the Model 32-8270 Set are the same as those used on the Model 30-8000, Model 35-8100 and Model 20 Compact 7960 Set. Therefore, only those which are in any way different are given under the Model 32-8270 and parts not shown or listed should be selected from the parts list for the Models 30-8000, 35-8100 and Model 20 Compact 7960.

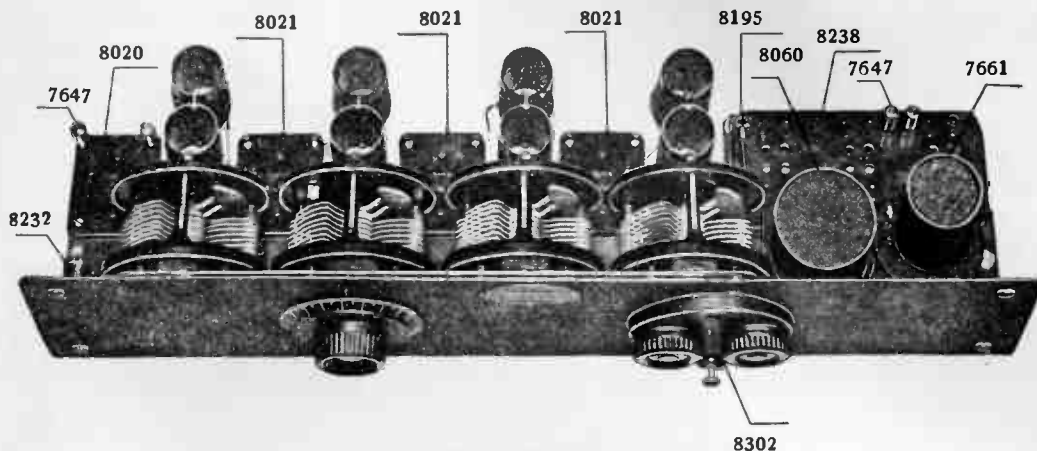

MODEL 32, No. 8270 SET

Part No.

- 8296 Sub-Panel Assembly
- 8146 Var. Condenser Pulley Belt (2 used) ..
- 8282 Var. Condenser Pulley Belt (Long) ...
- 9169 No. 2 Condenser Pulley
- 9168 No. 1 and No. 3 Condenser Pulley ...
- 9171 No. 4 Condenser Pulley



8284

GRID RESISTANCE



8308

RHEOSTAT RESISTANCE
UNIT FOR R. F.

Part No.

- 8020 No. 1 Tube Socket.....
- 7647 Ant. Grd. Binding Post.....
- 3620 Ant. Grd. Binding Post Screw.....
- 8021 No. 2, 3 or 4 Tube Socket

Part No.

- 8284 Grid Resistance.....
- 8275 Detector 2-Stage Amplifier.....
- 8241 Phone Condenser.....
- 8238 Det. 2-Stage Base with Contact Springs
and Phone Post.....
- 8195 Grid Leak.....
- 8112 Grid Condenser.....
- 7647 Phone Post.....
- 8131 Phone Post Screw.....
- 7682 Det. 2-Stage Mtg. Screw.....
- 3481 Det. 2-Stage Mtg. Nut.....
- 8281 Main Panel and Angle Piece.....
- 8250 Cabinet (Complete).....
- 8302 Double Rheostat Assembly.....
- 8308 R. F. Rheostat Resistance.....
- 8310 Rheostat Resistance for Det.....
- 8256 Fixed Resistance for A. F.....
- 4872 Switch Knob and Contact Spring.....
- 8002 Binding Spring and Lead Wire.....
- 4426 Switch Contact Spring.....
- 4410 Switch Contact Spring Holding Nut ..
- 4435 Switch Contact Spring Washer.....
- 4606 Rheostat Mounting Screw.....
- 8232 Choke Coil.....
- 3487 Choke Coil Retaining Screw.....
- 4366 Choke Coil Retaining Nut
- 4822 Choke Coil Retaining Lock Washer ..
- 8190 Fixed Grid Resistance

Refer to numerical list for prices.

MODEL 33, No. 8930, SET

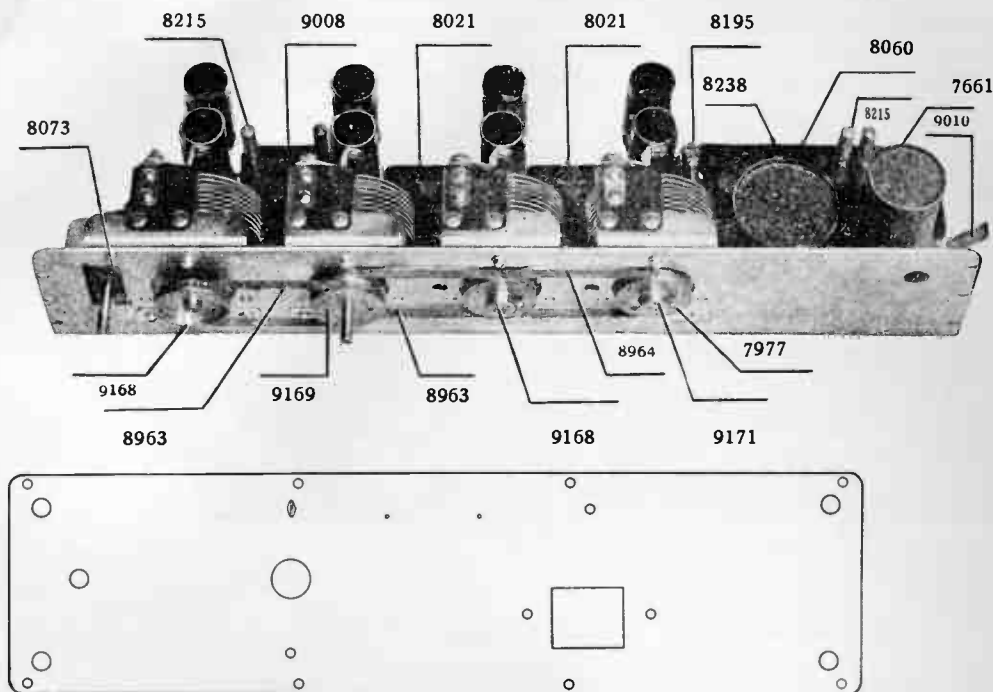

NOTE: Many parts for the Model 33, No. 8930, Set are the same as those used on the Model 32, 30 and 20 Compact Set. Therefore, only those parts which are different are listed under Model 33, No. 8930, and those not listed should be selected from the parts list for previous sets.

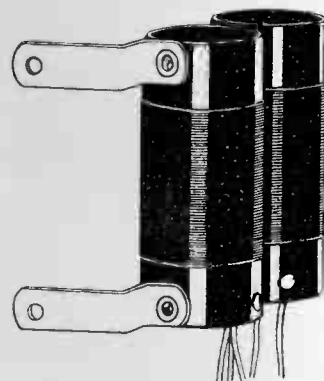

8988 FRONT PANEL



9022
ANT. ADJ
KNOB

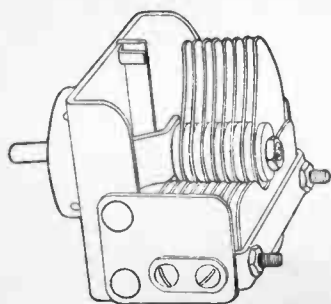

No. 9190—Variable Condenser Group

(These condensers are furnished in a group of four matched condensers only)

Part No.	
9168	No. 1 and No. 3 Condenser Pulley
9169	No. 2 Condenser Pulley
9171	No. 4 Condenser Pulley
8963	Condenser Pulley Belt (Short) (2 used) ..
8964	Condenser Pulley Belt (Long) ..
7977	Pulley Set Screw
8073	Var. Condenser Bearing Tension Spring.
8094	Var. Condenser Bearing Tension Spring.
8085	Var. Condenser Extension Washer

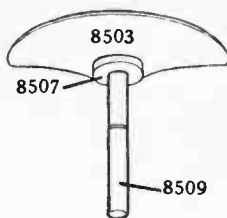

8513
ANT. ADJ.
CONDENSER

No. 9220—R. F. Transformer Group

(These transformers are furnished in a group of four matched transformers only)

Part No.	
8218	Mounting Nut

No. 8950—Double Rheostat Assembly

Part No.	
4690	R. F. Rheostat Resistance Unit
8310	Detector Rheostat Resistance Unit
8256	A. F. Fixed Resistance

No. 8340—Det. 2-Stage Amplifier

Part No.	
9008	No. 1 R. F. Tube Socket
8021	No. 2 and No. 3 Tube Sockets
8993	Cabinet
8988	Front Panel
9022	Antenna Adjustment Knob
9059	Front Panel (for No. 9050 Model 33-C Set)
9010	Battery Cable
9043	Battery Cable (5 ft. for No. 9050 Model 33-C Set)
8685	By-Pass Condenser
8996	Grid Resistance
8190	Fixed Detector Resistance
8513	Antenna Adjustment Condenser
8509	Antenna Adjustment Condenser Shaft ..
8503	Antenna Adjustment Condenser Rotor Plate
8507	Antenna Adjustment Condenser Washer ..
8187	Antenna Adjustment Condenser Screw ..

Refer to numerical list for prices.

MODEL 50, No. 8500 SET

parts for the
8930, Set are
used on the
120 Compact
only those
different are
133, No. 8930,
ted should be
parts list for

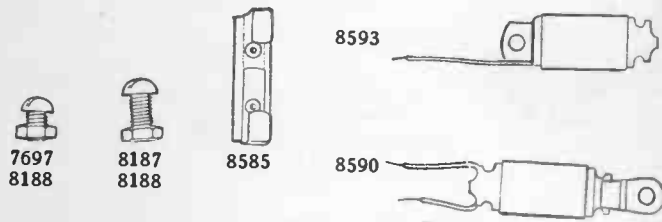
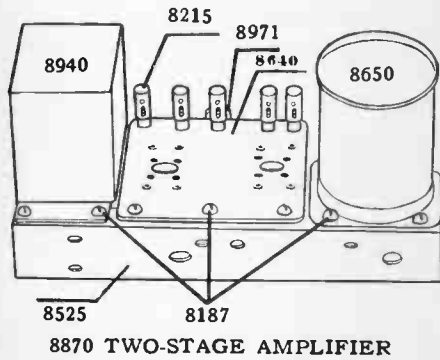
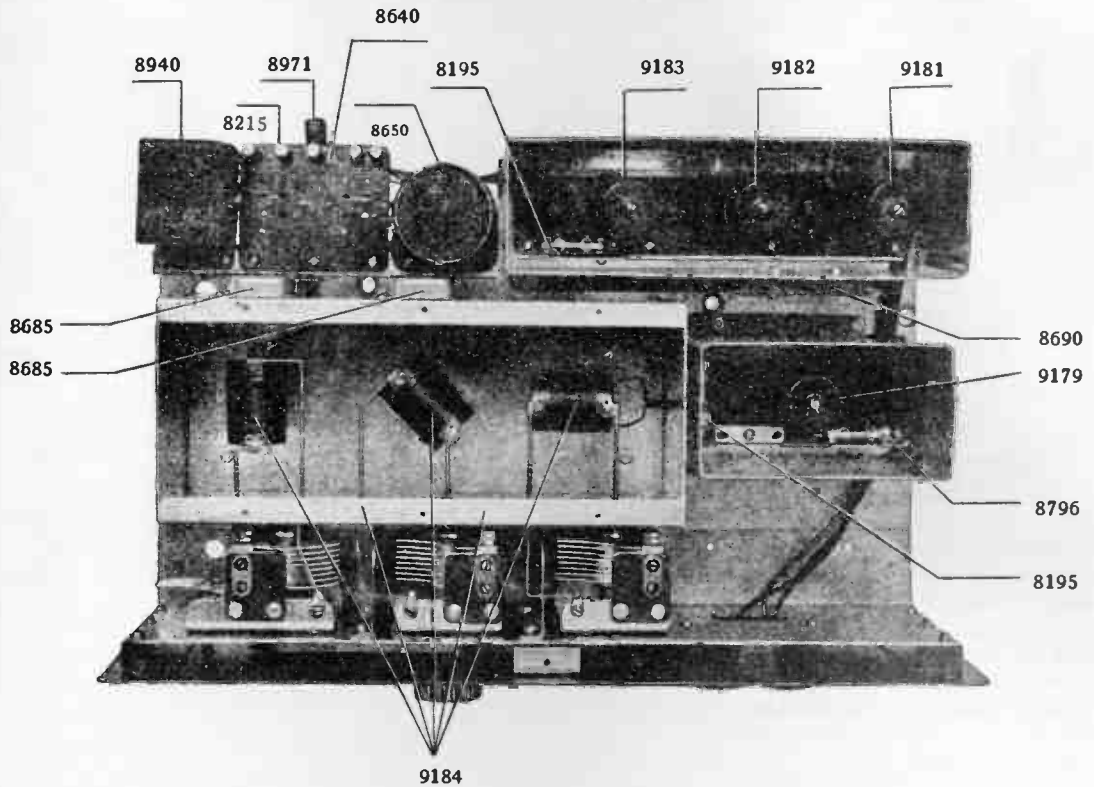

No. 8870—Two-Stage Amplifier

- Part No.
- 8650 No. 1 Audio Frequency Transformer
 - 8940 No. 2 Audio Frequency Transformer
 - 8640 Audio Frequency Base with Contact Springs and Binding Posts
 - 8971 Ground Spring
 - 8525 Mounting Bracket
 - 8215 Binding Post
 - 8131 Binding Post Screw
 - 8187 Mounting Screw (3/8" long)
 - 8188 Mounting Screw Nut
 - 8220 Mounting Screw Lock Washer (per hundred)
 - 8232 Choke Coil

No. 9184—R. F. Tuning Coil Assembly

- Part No.
- 8591 No. 2 Tuning Coil Fixed Condenser
 - 8601 No. 3 Tuning Coil Fixed Condenser
- (The above condensers are furnished only in pairs and must be installed in pairs as furnished)

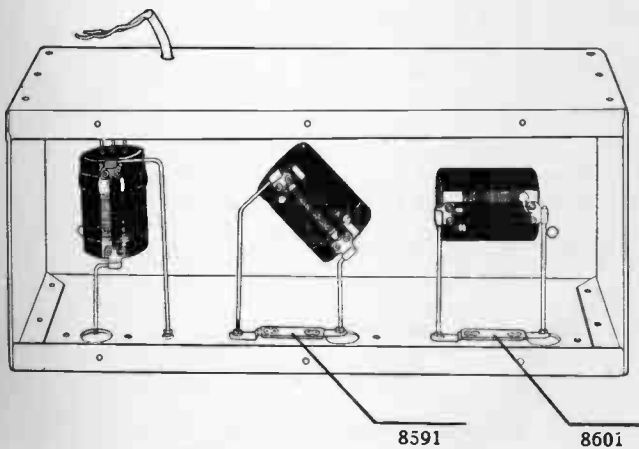

9184 R. F. TUNING COIL ASSEMBLY

Refer to numerical list for prices.

MODEL 50, No. 8500 SET

For parts not listed see pages covering Model 33 and earlier model sets

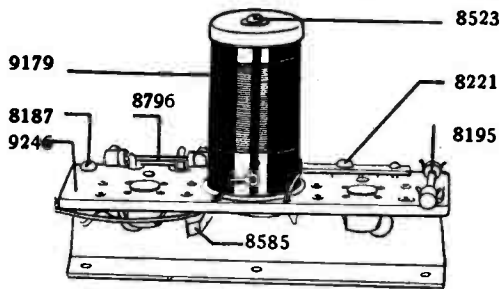

8535 No. 1 R. F. AMPLIFIER ASSEMBLY
(Rear View)

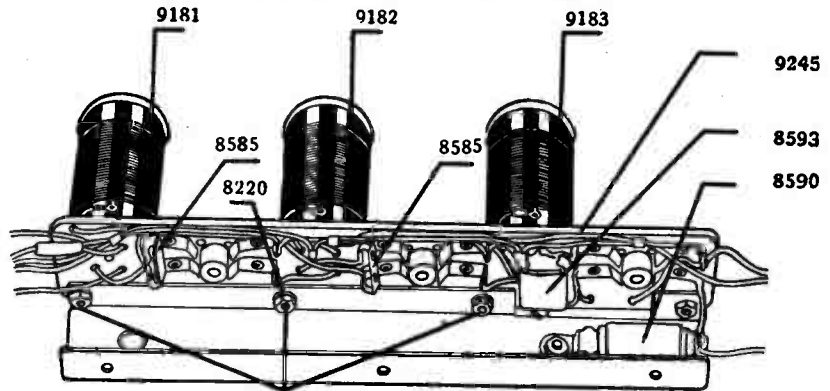

8187 8188
8540 No. 2 R. F. AMPLIFIER ASSEMBLY (Rear View)

No. 8535—#1 R. F. Amplifier Assembly

Part No.	
9179	No. 1 Radio Frequency Transformer
8523	Transformer Mounting Screw
8188	Transformer Mounting Screw Nut
8519	Transformer Cap
9246	No. 1 Radio Frequency Amplifier Base
8195	Grid Leak
8796	No. 1 Radio Frequency Resistance
8221	Adjustment Condenser Holding Screw
8585	Stabilizing Condenser

No. 8540—#2 R. F. Amplifier Assembly

Part No.	
9181	No. 2 Radio Frequency Transformer
9182	No. 3 Radio Frequency Transformer
9183	No. 4 Radio Frequency Transformer
8585	Stabilizing Condenser
8195	Grid Leak
9245	No. 2 Radio Frequency Base
8660	Choke Coil
8590	Phone Condenser
8593	Grid Condenser

No. 9010—Battery Cable No. 8530—Cabinet

Part No.	
8553	Metal Container
8559	Front Panel
9022	Antenna Adjustment Knob
8685	By-Pass Condenser
8690	By-Pass Condenser
8187	Mounting Screw (3/8" long)
7697	Mounting Screw (1/4" long)
3620	Mounting Screw (1/8" long)
8188	Mounting Screw Nut
8220	Mounting Screw Lock Washer
8509	Antenna Adjustment Condenser Shaft
8503	Antenna Adjustment Condenser Rotor Plate
8507	Antenna Adjustment Condenser Washer
8187	Antenna Adjustment Condenser Screw
8571	Container Screw
8714	Wood Holding Screw

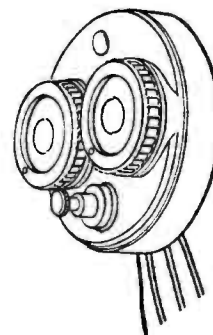

8555



8714



8660

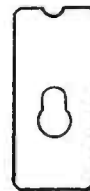

8073



8094

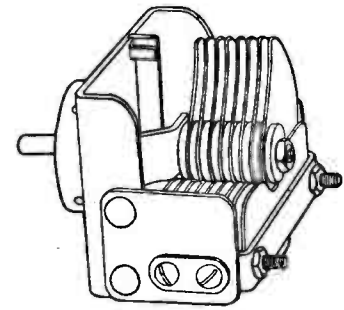

9210

No. 9210—Variable Condenser Group

(These condensers are furnished in a group of three matched condensers only)

Part No.	
8146	Condenser Pulley Belt (2 used)
9168	No. 1 and No. 3 Var. Condenser Pulley
9169	No. 2 Var. Condenser Pulley
8513	Antenna Adjustment Condenser
8073	Var. Condenser Bearing Tension Spring
8094	Var. Condenser Bearing Tension Spring
8085	Var. Condenser Extension Washer
7977	Pulley Set Screw

No. 8555—Double Rheostat Assembly

Part No.	
8599	R. F. Rheostat Resistance Unit
8310	Detector Rheostat Resistance Unit
627	A. F. Fixed Resistance

Refer to numerical list for prices.

B POWER UNIT, TYPE R, No. 8800

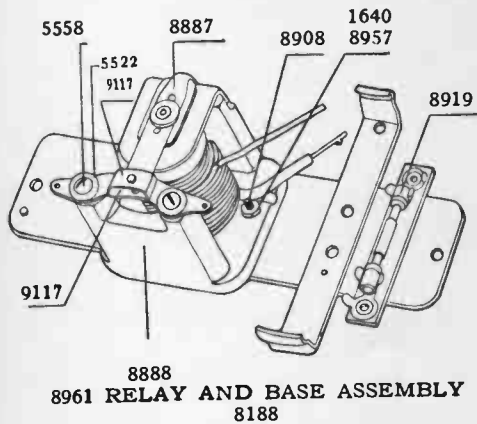
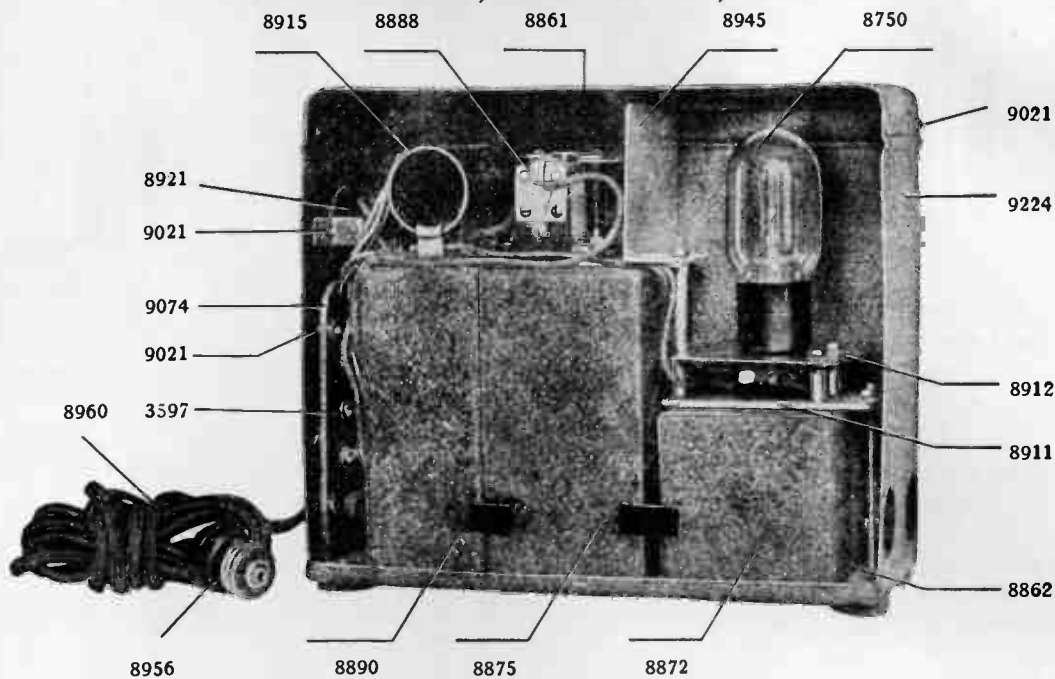

8888
8961 RELAY AND BASE ASSEMBLY
8188

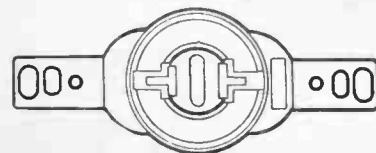
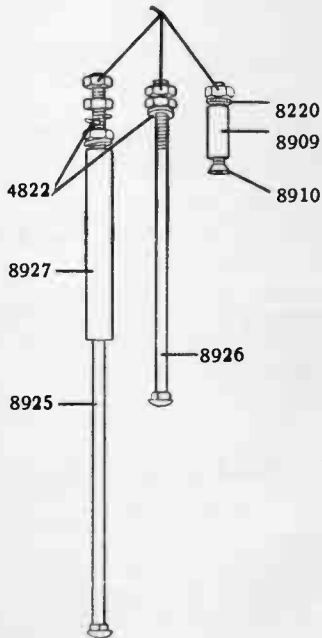

8921 RECEPTACLE

Part No.

1640	Relay Mounting Lockwasher
3470	Terminal Screw Washer
3597	Terminal Screw
4822	Lockwasher
5522	Fixed Contact Insulator Washer
5523	Fixed Contact Insulator Bushing
5558	Fixed Contact Holding Screws
8015	Name Plate Rivet
8021	Tube Socket
8188	Mounting Nut
8220	Socket Mounting Lockwasher
8750	Rectifying Tube
8861	Case Lid
8862	Base
8872	Transformer Assembly
8875	Condenser Assembly
8887	Armature Assembly
8888	Relay
8890	Choke Assembly
8908	Relay Mounting Screw
8909	Socket Mounting Bushing
8910	Socket Mounting Screw
8911	Short Holding Strap
8912	Fibre Shield
8915	Resistance Coil
8919	Detector Resistance
8920	Panel only (old style—3 amplifier taps)
8921	Trickle Charger Receptacle
8925	Long Bolt
8926	Short Bolt

Refer to numerical list for prices.

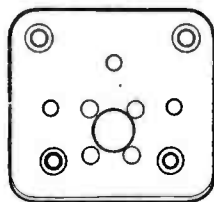

8021
TUBE SOCKET



9075
BATTERY LEAD

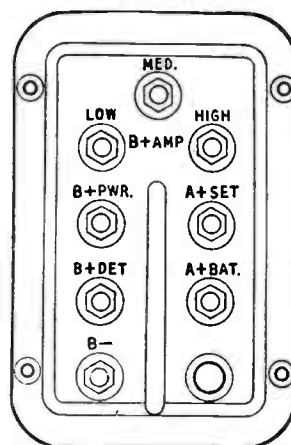

8920
PANEL ONLY (old style)

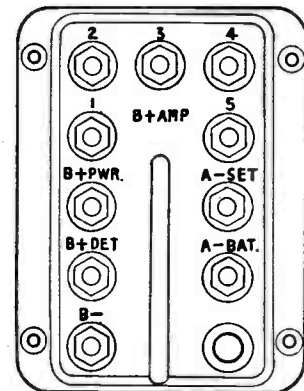

9074
PANEL ONLY

Part No.

- 8927 Bushing
- 8929 Panel with Terminals and Leads
- 8931 Terminal Nut
- 8932 Terminal Thumb Nut
- 8945 Aluminum Shield
- 8956 Attachment Plug
- 8957 Relay Mounting Nut
- 8958 Terminal Clip
- 8960 Double Conductor Cord with Plug.....
- 8961 Relay and Base Assembly
- 9021 Mounting Screw.....
- 9074 Panel only (5 amplifier taps).....
- 9075 Battery Lead.....
- 9088 Base Pad with Screw.....
- 9117 Fixed Contact and Holder.....
- 9224 Case with Trickle Charger Name Plate..

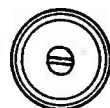

9088
BASE PAD



8932

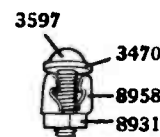

"B" POWER UNIT, TYPE S, No. 9000 (25 CYCLE)

NOTE : The parts used on the "B" Power Unit No. 9000 are the same as those listed under "B" Power Unit No. 8800, with the following exceptions :

Part No.

- 9150 Case Lid
- 9156 Transformer
- 9158 Socket Mounting Bushing.....
- 9162 Short Bolt Bushing
- 9163 Short Bolt
- 9226 Case with Trickle Charger Name Plate..

DETECTOR TUBE CAP

Used with all battery model sets excepting Model 35

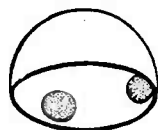

9123 DETECTOR TUBE CAP WITH ENVELOPE

Refer to numerical list for prices.

MODEL 36, No. 9390 RECEIVING SET

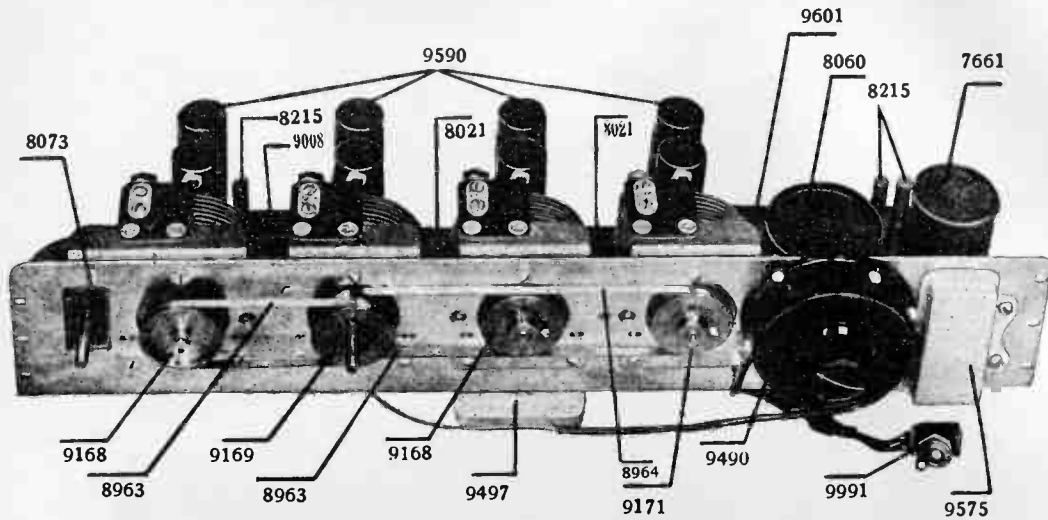

NOTE—Any parts not listed below are the same as those used on Model 33—No. 8930 set, and should be selected from previous parts lists.

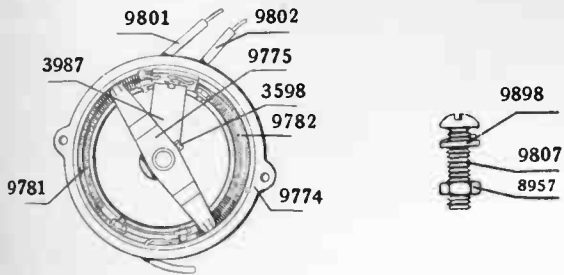

9490 VOLUME CONTROL UNIT (USED ON SETS ABOVE 2,610,000) (Rear View)

Part No.	NAME OF PART
9561	Volume Control Unit (used on sets below 2,610,000)
9807	Volume Control Mtg. Screw
9898	Volume Control Mtg. Lock Washer
8957	Volume Control Mtg. Nut
9774	Volume Control Housing
9771	Volume Control Knob
3987	Volume Control Knob Binding Spring
9775	Contact Spring and Screw
3598	Contact Spring Set Screw
9447	Resistance Mtg. Screw
9781	No. 1 Resistance
9782	No. 2 Resistance
9563	Volume Control Condenser Unit
9633	Volume Control Condenser Unit Spring
9614	Binding Spring and Lead

Part No.	NAME OF PART
9602	DETECTOR 2-STAGE AMPLIFIER
9601	Detector 2-Stage Base
9598	Phone Condenser
9597	Shunt Resistance

Part No.	NAME OF PART
9480	Cabinet
9495	Front Panel (used on sets below 2,610,000)
9929	Front Panel (used on sets above 2,610,000)
9619	Toggle Switch (used on sets below 2,610,000)
9991	Toggle Switch (used on sets above 2,610,000)
9575	Single Bypass Condenser
9497	Double Bypass Condenser
9588	Power Supply Cable and Panel (used on sets below 2,610,000)
9748	Power Supply Cable and Panel (used on sets above 2,610,000)
9591	Cable Connection Panel (used on sets below 2,610,000)
9747	Cable Connection Panel (used on sets above 2,610,000)
9586	Cable Clamp
9587	Cable Clamp Strap
9585	Socket Plug
9008	No. 1 Tube Socket
9590	R. F. Coil Group
8996	Grid Resistance
9653	Shipping Container

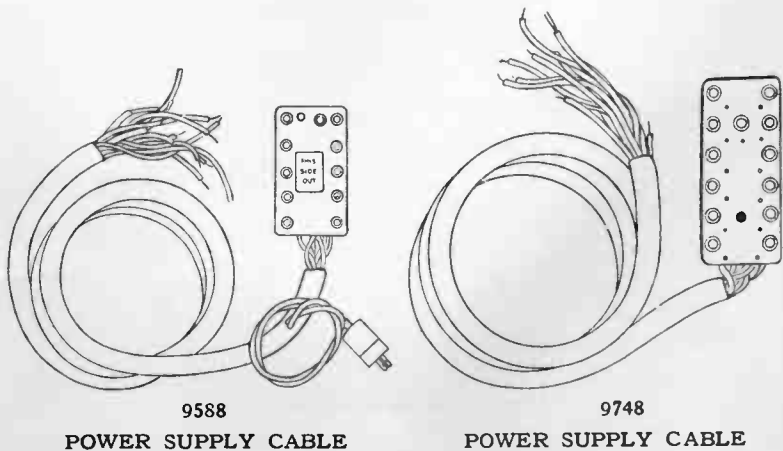

9588 POWER SUPPLY CABLE

9748 POWER SUPPLY CABLE

Refer to numerical list for prices.

MODEL Y, No. 9360 POWER SUPPLY

(Above serial No. 260,000)

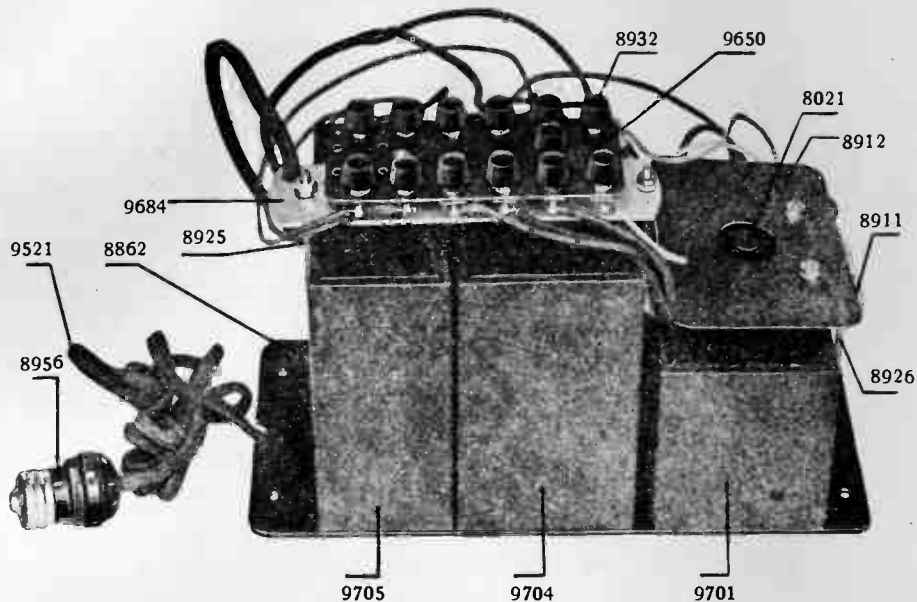

NOTE—Any parts not listed below are the same as those used on Model R, No. 8800, and Model S, No. 9000, Power Supply, and should be selected from previous parts lists.

Part No.	NAME OF PART	Part No.	NAME OF PART
9469	Case (used on units below 260,000).....	9684	Long Strap only (used on units above 260,000).....
9681	Case (used on units above 260,000).....	9486	Potentiometer.....
9499	Case Lid (used on units below 260,000)..	9554	Receptacle.....
9696	Case Lid with Name Plate (used on units above 260,000).....	9488	Long Strap Assembly (used on units below 260,000).....
8862	Base.....	9397	Rubber Insulating Bushing.....
9088	Base Pad and Screw.....	9515	Resistance Coil.....
9209	Base Screw.....	9521	Double Conductor Cord and Plug.....
9431	Panel Assembly (used on units below 260,000).....	8919	Detector Resistance.....
9693	Panel Assembly (used on units above 260,000).....	9424	A. F. Resistance.....
9689	Panel Screw.....	9434	Filament Resistance.....
9681	Mtg. Screw.....	9503	Transformer Assembly (used on units below 260,000).....
9688	Ground Screw.....	9701	Transformer Assembly (used on units above 260,000).....
9685	Mtg. Bushing.....	9505	Condenser Assembly (used on units below 260,000).....
9697	Socket Mtg. Screw.....	9704	Condenser Assembly (used on units above 260,000).....
		8890	Choke Assembly (used on units below 260,000).....
		9705	Choke Assembly (used on units above 260,000).....
		9511	Aux. Choke and Condenser Assembly..

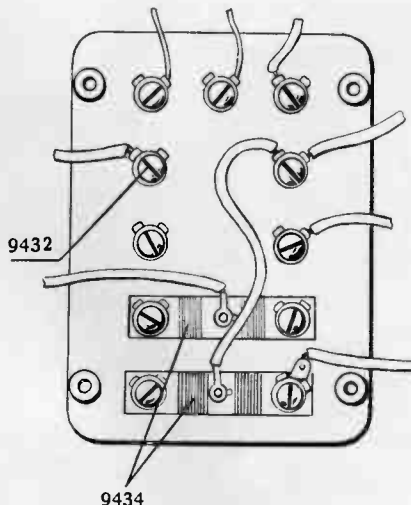

9431 PANEL ASSEMBLY

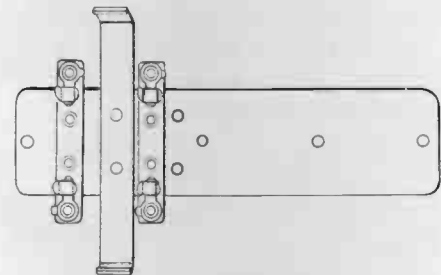

9488 LONG STRAP ASSEMBLY

Refer to numerical list for prices.

TYPE "Y" POWER SUPPLY, No. 9360

(Below serial No. 260,000)

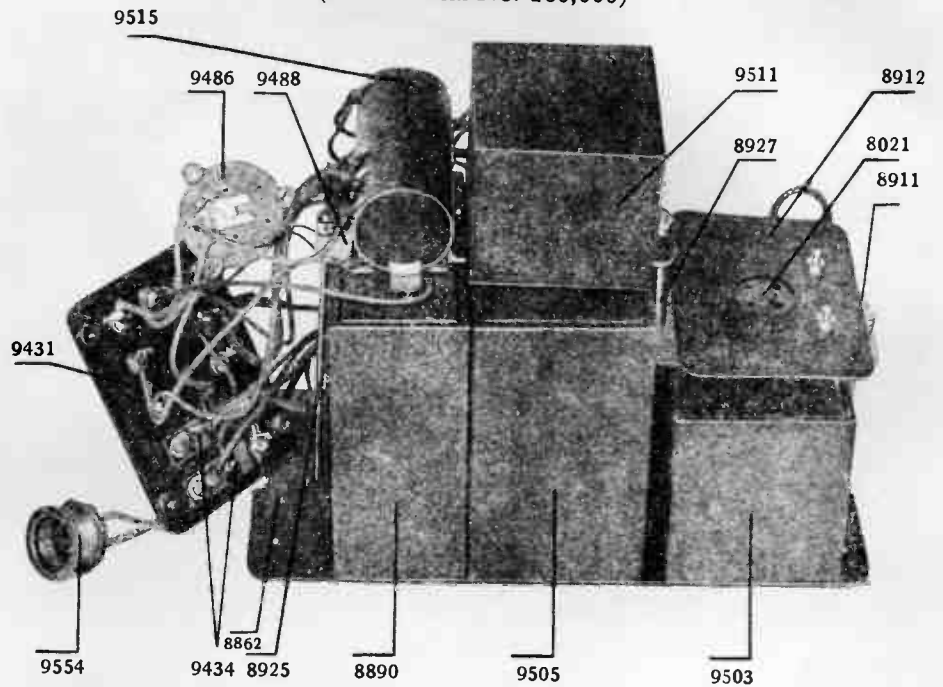

00, Power Supply.

units above

d on units

Plug

d on units

d on units

on units

on units

units below

units above

Assembly

MODEL 37, No. 9500 SET

(Below serial No. 1,265,000)

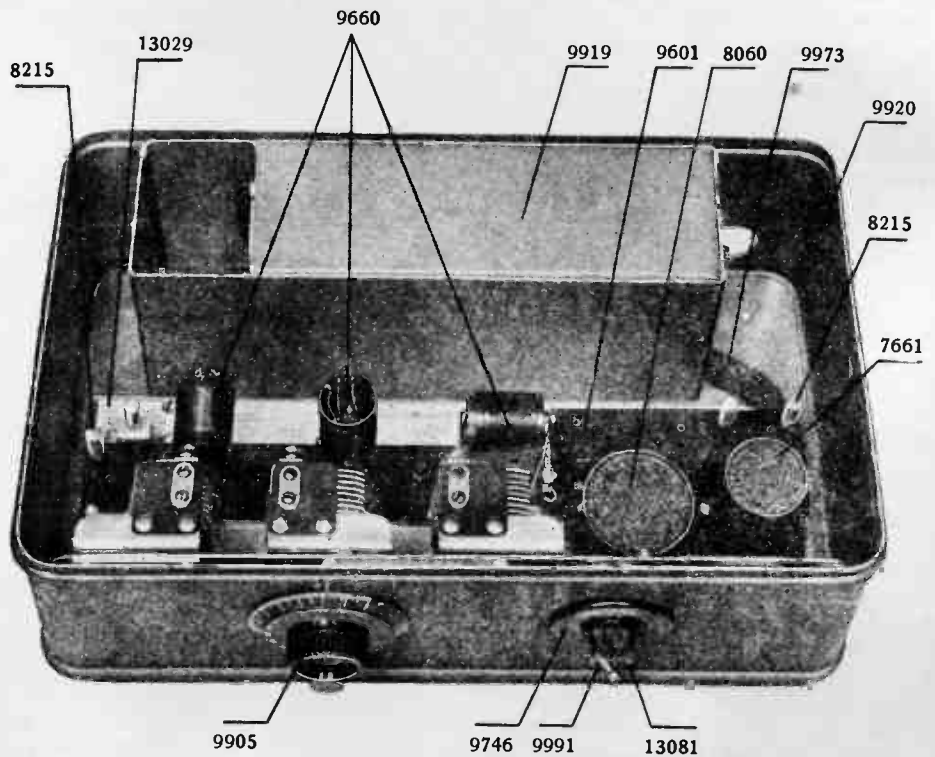

Refer to numerical list for prices.

August 1, 1928

MODEL 37, No. 9500 RECEIVING SET

(Above Serial No. 1,265,000)

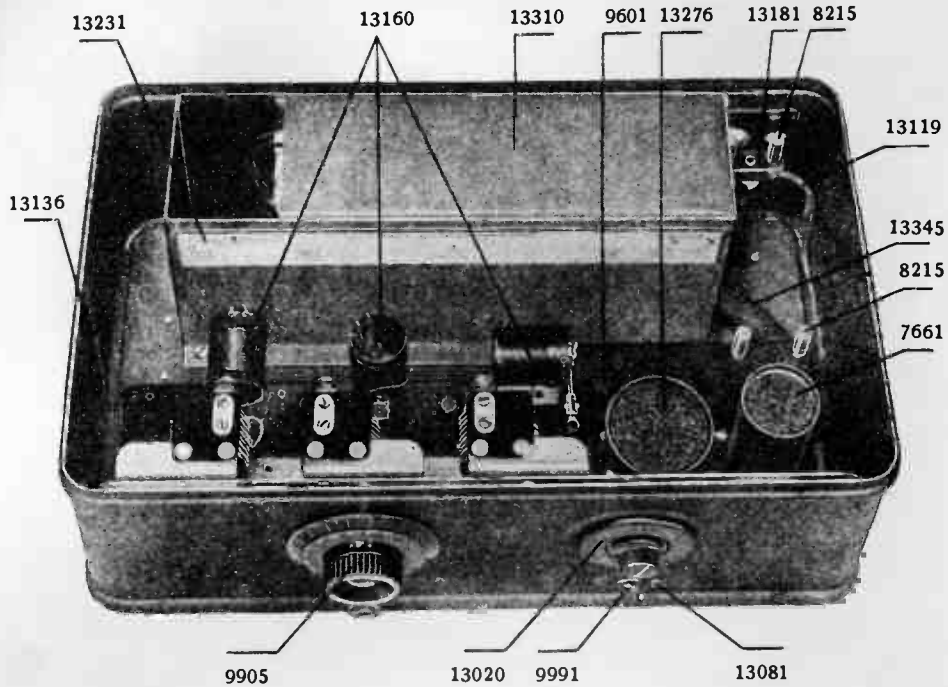

Part No.	NAME OF PART
9620	Cabinet Complete (used on sets below 1,265,000)
9710	Cabinet Complete (used on sets above 1,265,000)
9952	Cabinet Lid
9920	Cabinet Body (used on sets below 1,265,000)
13136	Cabinet Body (used on sets above 1,265,000)
9906	Dial Indicator
8236	Lid Nameplate (ship)
9905	Dial
9991	Toggle Switch
8208	Ant. and Ground Nameplate
8015	Ant. and Ground Nameplate Rivet
13081	"On" Button
8167	Vernier Knob—less Screw
9575	Single Bypass Condenser
9928	Double Bypass Condenser
9660	R. F. Amplifier (used on sets below 1,265,000)
13030	R. F. Amplifier (used on sets between 1,265,000 and 1,385,000)
13160	R. F. Amplifier (used on sets above 1,385,000)
8232	Choke Coil
8136	Short Belt
8146	Long Belt
9973	Power Supply Cable and Panel (used below 1,385,000)
13345	Power Supply Cable and Panel (used above 1,385,000)
9804	Cable Connection Panel (used on sets below 1,385,000)
13342	Cable Connection Panel (used on sets above 1,385,000)

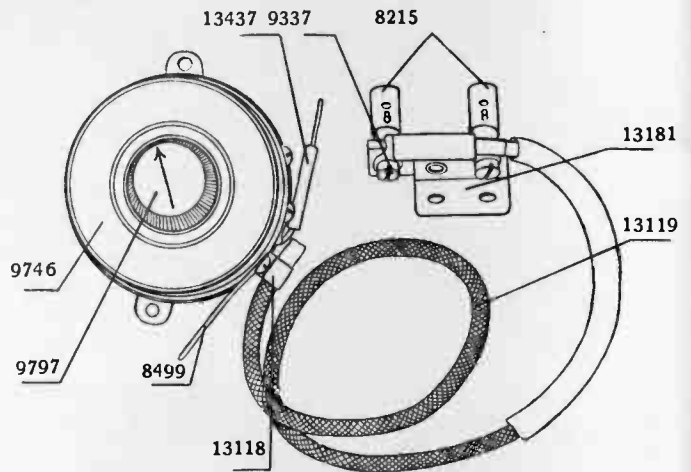

13020 VOLUME CONTROL (USED ON SETS ABOVE 1,265,000)

Part No.	NAME OF PART
9100	Var. Condenser Group (used on sets below 1,360,000)
13170	Var. Condenser Group (used on sets above 1,360,000)
13125	Extension Washer
8439	Grid Resistance
8112	Grid Condenser
9168	No. 1 and No. 3 Condenser Pulley
9169	Dial Condenser Pulley
9911	Shipping Container
9746	Volume Control Housing
9797	Volume Control Knob
13247	Knob Holding Spring
9785	Contact Spring and Screw
9788	Resistance Unit

Refer to numerical list for prices.

MODEL 37, No. 9500 SET (Continued)

Part No.	NAME OF PART
9801	Red Lead (used on sets below 1,265,000)
13437	Red Lead (used on sets above 1,265,000)
13436	Green Lead (used on sets below 1,265,000)
8499	Green Lead (used on sets above 1,265,000)
9807	Volume Control Mtg. Screw
9447	Resistance Mtg. Screw
9898	Resistance Mtg. Washer
8957	Resistance Mtg. Nut
13112	Cont. Spring Set Screw
4785	Solder Clip
13118	Ant. and Ground Cable Clip
13119	Ant. and Ground Cable
13181	Ant. and Ground Post Base and Bracket
13113	Ant. and Ground Cable and Post Assembly
8215	Ground Ant. and Phone Post
13363	Detector and 2-Stage Amp. (used above 1,385,000)
9601	Detector and 2-Stage Base
9598	Phone Condenser

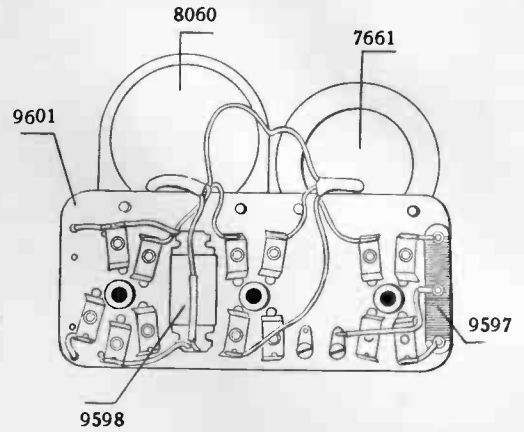

9602 DETECTOR AND 2-STAGE AMP. (USED BELOW 1,385,000) (Bottom View)

Part No.	NAME OF PART
9597	Shunt Resistance
8060	No. 1 A. F. Transformer (used on sets below 1,385,000)
13276	No. 1 A. F. Transformer (used on sets above 1,385,000)
7661	No. 2 A. F. Transformer
9337	Phone Post Screw
8195	Grid Leak
8221	Mounting Screw
8220	Mounting Lock Washer
8188	Mounting Nut

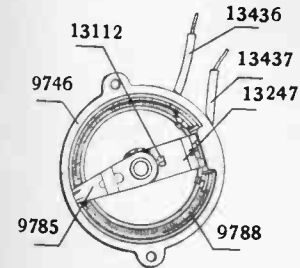

9510 VOLUME CONTROL (USED BELOW 1,265,000) (Rear View)

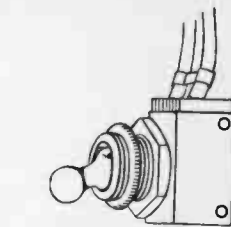

9991 TOGGLE SWITCH

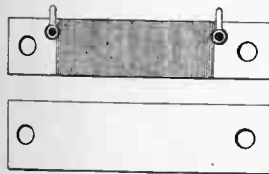

13369 RESISTANCE UNIT

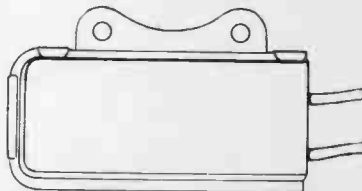

9575 SINGLE BY-PASS CONDENSER

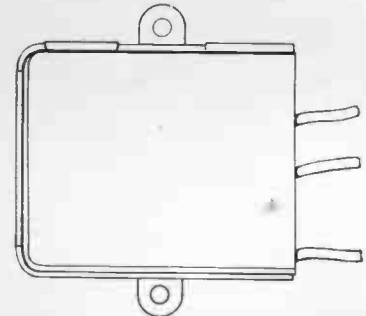

9928 DOUBLE BY-PASS CONDENSER

POWER SUPPLY

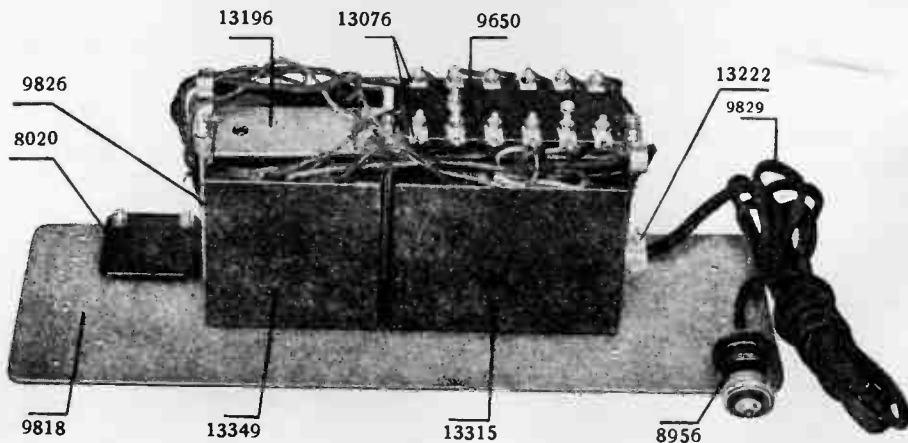

Refer to numerical list for prices.

POWER SUPPLY PARTS

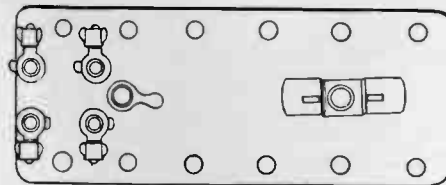
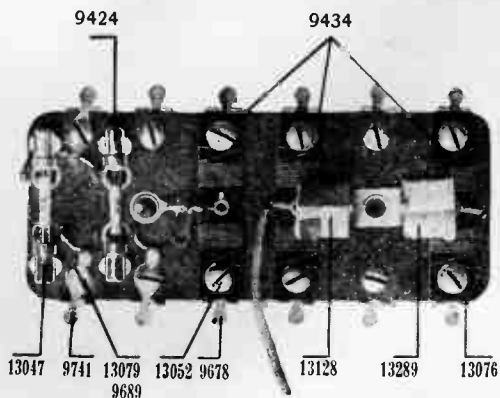

9650
PANEL AND HOLDERS



13047
DETECTOR RESISTANCE



9691-92 13128-13289
RESISTANCE

Part No.	NAME OF PART
9831	Panel and Strap Assembly (used on sets below 1,265,000)
13121	Panel and Strap Assembly (used on sets between 1,265,000 and 1,385,000)
13344	Panel and Strap Assembly (used on sets above 1,385,000)
13127	Panel Assembly—less Strap (used on sets below 1,385,000)
13346	Panel Assembly—less Strap (used on sets above 1,385,000)
9088	Base Pad and Screw
9818	Base
9688	Mtg. Screw
9821	Transformer (used on sets below 1,265,000)
13133	Transformer (used on sets between 1,265,000 and 1,385,000)
13349	Transformer (used on sets above 1,385,000)
9825	Choke and Condenser (used on sets below 1,385,000)
13315	Choke and Condenser (used on sets above 1,385,000)
13231	Tube Chart
9919	Power Unit Cover
13310	Power Unit Cover, with Tube Chart
13079	Panel Mtg. Screw
13196	Strap and Wire Holders (used after 1,265,000)
9764	Strap (used previous to 1,265,000)

Part No.	NAME OF PART
9650	Panel and Resistance Holders
9434	Filament Resistance
8919	Detector Resistance (used on sets below 1,385,000)
13047	Detector Resistance (used on sets above 1,385,000)
9424	A. F. Resistance
13052	Panel Screw
13249	Base Mtg. Screw
9685	Strap Bushing
9826	Mounting Bolt
9829	Double Conductor Cord and Plug
9691	Resistance 226 (used on sets below 1,265,000)
13128	Resistance 226 (used on sets above 1,265,000)
9692	Resistance 171 (used on sets below 1,385,000)
13289	Resistance 171 (used on sets above 1,385,000)

MODEL 37, No. 9700 CONSOLE SET

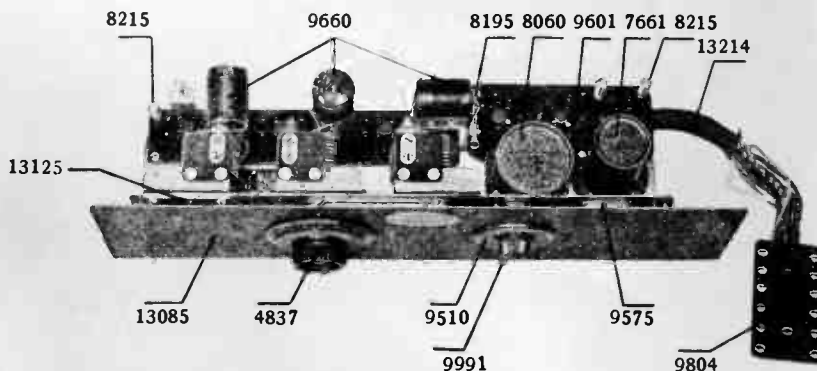

Refer to numerical list for prices

MODEL 37 SETS (Continued)

NOTE—All parts used on Model 37—No. 9700 Console Set, are the same as those used on Model 37—No. 9500, with the following exceptions:

Part No.	NAME OF PART	Part No.	NAME OF PART
13085	Main Panel and Brackets.....	13277	Double Conductor Cord and Plug.....
13082	Shipping Container (set).....	13029	Tube Chart.....
13214	Power Supply Cable and Panel.....	13218	Mounting Screw.....
13094	Power Unit Panel and Strap Assembly.....	13219	Mounting Screw.....
13005	Panel Assembly—less Strap.....	13063	Shipping Container (power unit).....

MODEL 37, No. 9740 25-CYCLE SET

NOTE—All parts used on Model 37—No. 9740, 25-cycle set, are the same as those used on Model 37—No. 9500, with the following exceptions:

Part No.	NAME OF PART	Part No.	NAME OF PART
13090	Cabinet Complete.....	13314	Power Unit Cover, with Tube Chart...
13226	Cabinet Body.....	13234	Transformer Assembly.....
13163	25-cycle Name Plate.....	13235	Choke and Condenser Assembly.....
8225	Grid Resistance.....	13161	Power Unit Base.....

MODEL 37, No. 9830 25-CYCLE CONSOLE SET

NOTE—All parts used on Model 37—No. 9830, 25-cycle Console Set, are the same as those used on Model 37—No. 9700, Console Set and Model 37—No. 9740, 25-cycle set, with the following exceptions:

Part No.	NAME OF PART
13385	Shipping Container (power unit).....

MODEL 38, No. 9400 RECEIVING SET

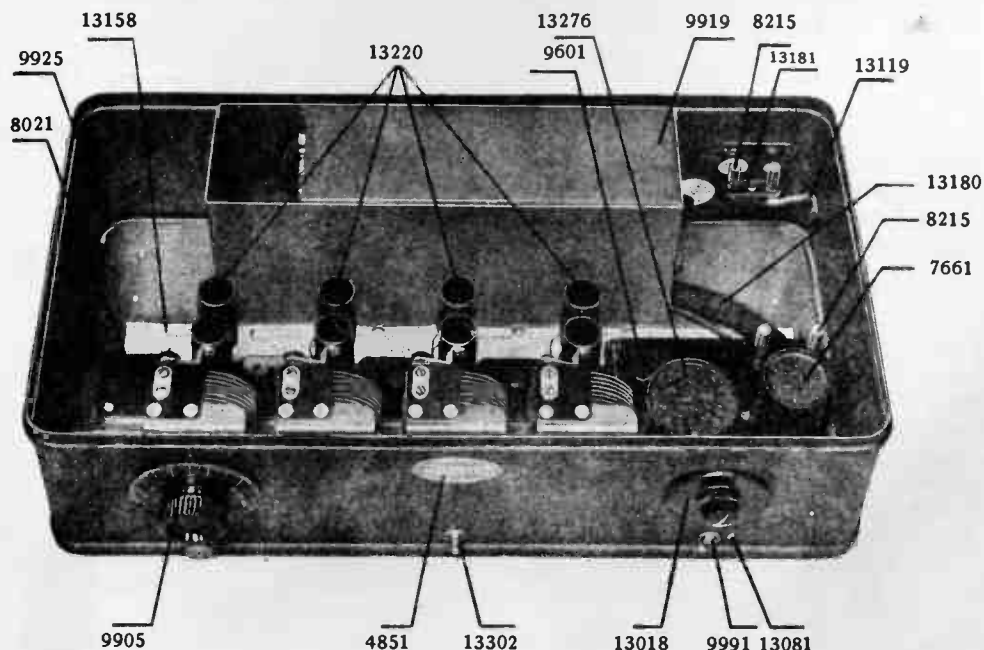

Refer to numerical list for prices.

MODEL 38, No. 9400 SET (Continued)

Part No.	NAME OF PART	Part No.	NAME OF PART
9560	Cabinet Complete	8195	Grid Leak
9209	Base Screw	9598	Phone Condenser
1271	Mtg. Lock Washer	13180	Power Supply Cable and Panel
9925	Cabinet Body	9804	Cable Connection Panel
13165	Cabinet Lid	8021	Tube Socket
9906	Dial Indicator	8220	Mtg. Lock Washer
8236	Lid Name Plate (ship)	8221	Mtg. Screw
4851	Front Name Plate	8188	Mtg. Nut
13081	"On" Button	13296	Resistance Unit
13302	Toggle Switch	13442	Shield
13018	Volume Control Unit	8232	Choke Coil
9807	Volume Control Mtg. Screw	7697	Choke Coil Mtg. Screw
9898	Mtg. Lock Washer	9575	Single Bypass Condenser
8957	Mtg. Nut	13105	Double Bypass Condenser
13139	Red Lead (used on sets below 1,752,000)	8996	Grid Resistance
13438	Red Lead (used on sets above 1,752,000)	9169	No. 1 Condenser Pulley
8499	Green Lead (used on sets below 1,752,000)	9168	Condenser Pulley
13298	Green Lead (used on sets above 1,752,000)	9171	Condenser Pulley
13112	Contact Spring Set Screw	13263	Condenser Pulley
9746	Volume Control Housing	8112	Grid Condenser
9797	Volume Control Knob	8085	Var. Condenser Extension Washer
9785	Contact Spring and Screw	8963	Belt
13247	Knob Holding Spring	8964	Belt
9788	Resistance Unit	13264	Belt (extra long)
9447	Resistance Unit Mtg. Screw	4666	Solder Clip
13118	Ant. and Ground Cable Clip	4649	Screw
13181	Ant. and Ground Post Base and Bracket	9905	Dial
8215	Ground Ant. and Phone Post	9991	Toggle Switch
9337	Binding Post Screw	9919	Power Unit Cover
4785	Solder Clip	13158	Tube Chart
13119	Ant. and Ground Cable only	13222	Bracket
13113	Ant. and Ground Cable Assembly	13249	Bracket Screw
9602	Detector and 2-Stage Amplifier (used on sets below 1,752,000)	9366	Mtg. Nut
13282	Detector and 2-Stage Amplifier (used on sets above 1,752,000)	8094	Var. Condenser Bearing Tension Spring
9601	Detector and 2-Stage Base	9262	Mtg. Lock Washer
8060	No. 1 A. F. Transformer (used on sets below 1,752,000)	13210	Var. Cond. Group (used on sets below 1,752,000)
13276	No. 1 A. F. Transformer (used on sets above 1,752,000)	13200	Var. Cond. Group (used on sets above 1,752,000)
7661	No. 2 A. F. Transformer	13220	R. F. Coil Group
		13141	Shipping Container

POWER SUPPLY PARTS

Part No.	NAME OF PART	Part No.	NAME OF PART
13173	Transformer Assembly	13079	Panel Screw
9825	Choke Condenser Assembly (used on sets below 1,752,000)	9687	Panel Screw
13315	Choke Condenser Assembly (used on sets above 1,752,000)	9650	Panel and Resistance Holders
9829	Double Conductor Cord and Plug	13076	Locking Clip
8956	Attachment Plug	13138	226 Resistance (used on sets below 1,752,000)
9678	Solder Clip	13303	226 Resistance (used on sets above 1,752,000)
9909	Power Unit Base	9692	171 Resistance (used on sets below 1,752,000)
9688	Mtg. Screw	13289	171 Resistance (used on sets above 1,752,000)
9685	Bushing	8919	Detector Resistance (used on sets below 1,752,000)
9826	Mounting Bolt	13047	Detector Resistance (used on sets above 1,752,000)
13004	Panel Assembly—less Strap (used on sets below 1,752,000)	9424	A. F. Resistance
13304	Panel Assembly—less Strap (used on sets above 1,752,000)	9741	Solder Clip
13117	Panel and Strap Assembly (used on sets below 1,752,000)	13052	Mounting Screw
13305	Panel and Strap Assembly (used on sets above 1,752,000)	9689	Mounting Screw
13196	Strap and Wire Holders	9434	Filament Resistance

Refer to numerical list for prices.

MODEL E SPEAKER, No. 8670

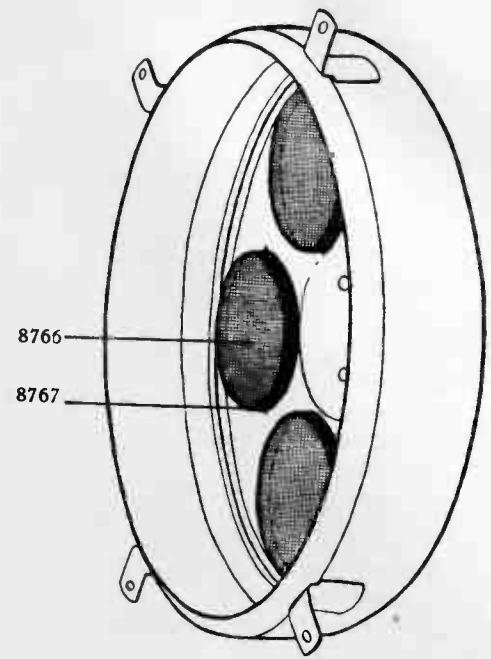
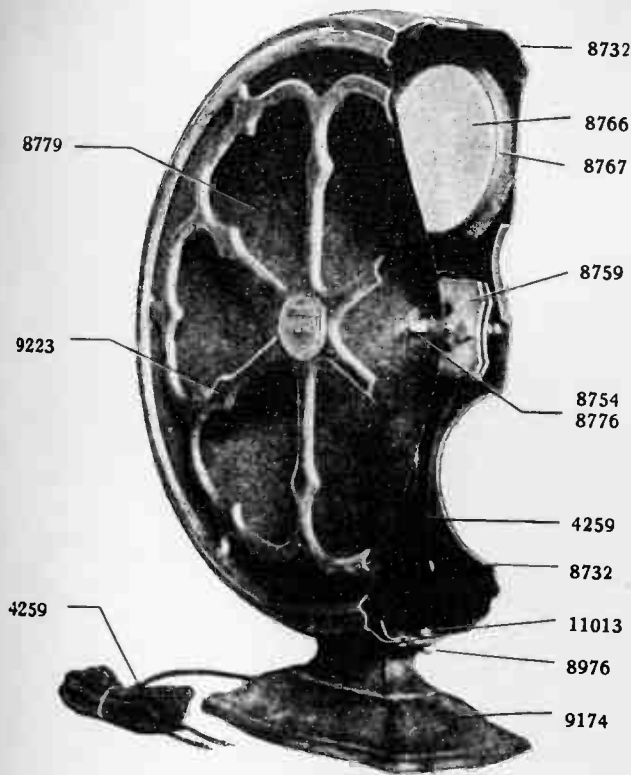

8966 FRAME (CONSOLE)

No. 8759—Sound Unit Complete

Part No.	
4259	9 ft. Cord
4834	Terminal Screw
8731	Base Washer
8732	Frame
8749	Rubber Damper
8752	Sound Unit Mounting Nut
8754	Diaphragm Spring Screw
8766	Cloth Screen
8767	Screen Retaining Ring
8768	Sound Unit Mounting Nut Washer
8776	Diaphragm Spring Nut
8779	Diaphragm
8852	Terminal Screw Nut
8966	Frame (Console)
8969	5 ft. Cord (Console)
8976	Base Screw
9174	Base
9205	Front Retaining Screw
9223	Grilled Front with Name Plate
9273	Base Gasket
11013	Base Nut
13301	Bag and Binder for Sound Unit



8752

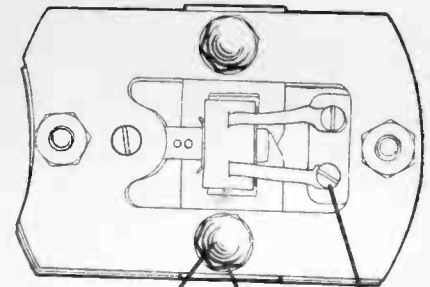

8759 SOUND UNIT

PHONOGRAPH ATTACHMENTS

The parts used on the various attachments are the same as those used on the Model M sound unit, with the following exceptions:

Part No.	
4338	Reproducer Housing (5-V)
4339	Reproducer Housing (6-C)
8477	Reproducer Housing (VE-O) (VE-E)
8587	Magnet Housing Assembly (VE-O)
8730	Gold Cord (9 ft.) (VE-O)

Refer to numerical list for prices.



9255 Diaphragm Screw and Nut Wrench
(Should an occasion arise necessitating the removal of the diaphragm, the dealer will find a pair of the above wrenches invaluable in removing and replacing the diaphragm spring screw and nut without damaging the gold-plated finish.)

August 1, 1928



MODEL
"R"

MODEL "R," No. 4800

<i>Part No.</i>	
4649	Bell Screw.....
4649	Reproducer Housing Screw.....
4806	Reproducer Housing.....
4838	Diaphragm.....
4849	Diaphragm Washer.....
4850	Diaphragm Adjusting Spring.....
4864	Horn (Gooseneck).....
4866	Diaphragm Gasket (Rubber).....
4889	6 ft. Cord.....
4896	Magnet Housing Assembly less Cord..
4897	Base Assembly.....
4933	Base Pad (Felt).....
7877	Base only.....
7878	Bell.....
7881	Sound Unit complete.....



MODEL
"H"

MODEL "H," No. 7700

<i>Part No.</i>	
4251	Diaphragm.....
4252	Diaphragm Gasket (Rubber).....
4254	Diaphragm Adjusting Spring.....
4649	Holding Screws (for Bell).....
4259	9 ft. Cord.....
4887	Reproducer Housing Screws.....
4934	Base Pad (Felt).....
7573	Diaphragm Washer.....
7693	Reproducer Housing.....
7701	Horn (Gooseneck).....
7717	Magnet Housing Assembly less Cord..
7718	Base Assembly.....
7719	Bell.....
7876	Base only.....
7883	Sound Unit complete.....

CONE
TYPE



MODEL
"K"

MODEL "K," No. 7750

<i>Part No.</i>	
4450	Sound Unit Nut.....
7727	Base Nut.....
7741	Diaphragm Pin.....
7745	Sound Unit Reed.....
7754	Base Pad (Felt).....
7755	Base Washer.....
7758	Double Conductor Cord 6 ft.....
7759	Base Screw.....
7781	Frame Including Name Plate.....
7782	Sound Unit Assembly.....
7873	Parchment Diaphragm complete.....
7879	Base.....

MODEL
"G"



MODEL "G," No. 8290

<i>Part No.</i>	
4251	Diaphragm.....
4252	Diaphragm Gasket (Rubber).....
4254	Diaphragm Adjusting Spring.....
4649	Holding Screws (for Bell).....
4259	9 ft. Cord.....
4887	Reproducer Housing Screws.....
4934	Base Pad (Felt).....
7573	Diaphragm Washer.....
8363	Reproducer Housing.....
8365	Horn (Gooseneck).....
7717	Magnet Housing Assembly less Cord..
8364	Base Assembly.....
8366	Bell.....
8362	Base only.....
7883	Sound Unit complete.....

Refer to numerical list for prices.

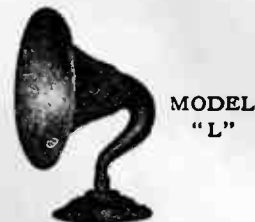

Part No. MODEL "M," No. 4460

- 4210 Bell.....
- 4211 Base Pad (Felt).....
- 4214 Base Screws.....
- 4215 Base Nut.....
- 4251 Diaphragm.....
- 4252 Diaphragm Gasket (Rubber).....
- 4254 Diaphragm Adjusting Spring.....
- 4259 Double Conductor Cord 9 feet.....
- 4261 Base Assembly.....
- 4266 Horn.....
- 4301 Diaphragm Washer (Steel).....
- 4439 Reproducer Housing.....
- 4452 Reproducer Housing Set Screw.....
- 4628 Sound Unit complete.....
- 4646 Magnet Housing Assembly and Cord..
- 7874 Base only.....

Part No. MODEL "L," No. 4645

- 4251 Diaphragm.....
- 4252 Diaphragm Gasket.....
- 4254 Diaphragm Adjusting Spring.....
- 4259 9 ft. Cord.....
- 4632 Reproducer Housing.....
- 4642 Horn (Gooseneck).....
- 4648 Bell.....
- 4649 Bell Holding Screw.....
- 4887 Reproducer Housing Screws.....
- 4934 Base Pad (Felt).....
- 7573 Diaphragm Washer (Steel).....
- 7717 Magnet Housing Assembly less Cord..
- 7580 Base Assembly.....
- 7876 Base only.....
- 7882 Sound Unit complete.....

MODEL E-2, No. 9790 SPEAKER

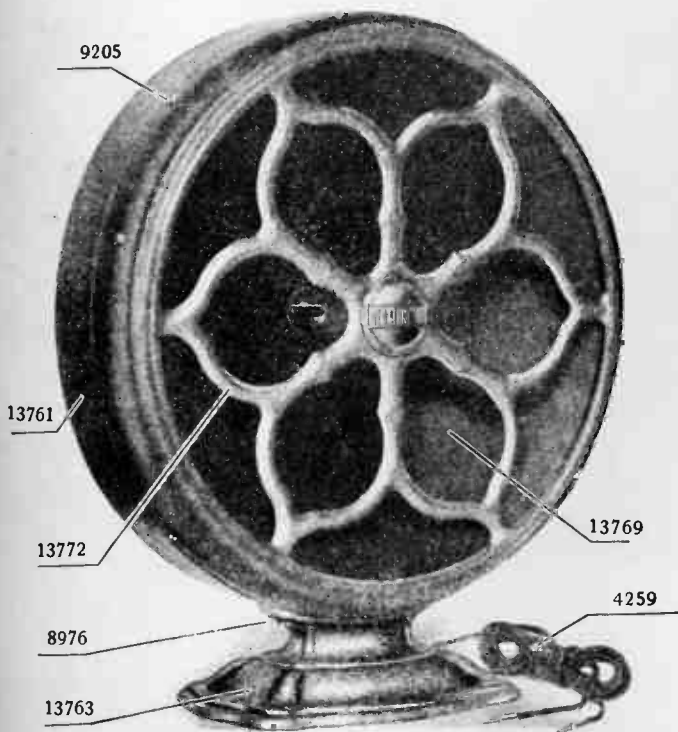

- Part No.*
- 13761 Frame.....
 - 13779 Base Gasket.....
 - 13763 Base.....
 - 13782 Sound Unit.....
 - 13764 Cloth Screen.....
 - 13603 Cloth Screen Retaining Ring.....
 - 13769 Diaphragm.....
 - 13772 Front Grill with Nameplate.....
 - 13587 Shipping Container.....

Note:—Many parts for Model E-2—No. 9790 Speaker are the same as those used on Model E No. 8670 Speaker. Therefore, only parts which differ are listed under Model E-2 and all other parts should be selected from previous lists.

Refer to numerical list for prices.

MODEL E-3, No. 9810 SPEAKER

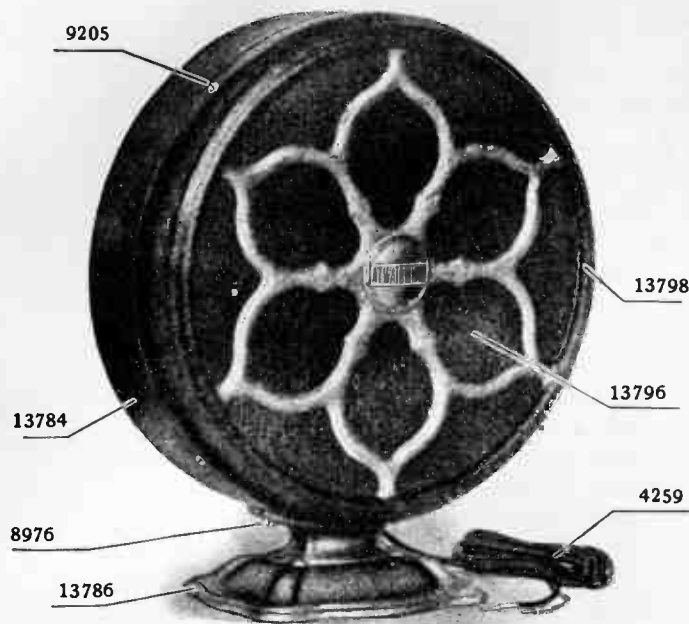

Part No.

- 13784 Frame
- 13807 Base Gasket
- 13786 Base
- 13788 Sound Unit
- 13789 Cloth Screen for Frame
- 13791 Screen Retaining Ring
- 13796 Diaphragm
- 13798 Front Grill with Screen and Name-plate

Note:—No Parts of this assembly are furnished separately.

- 13803 Shipping Container

Note:—Many parts for Model E-3, No. 9810, Speaker are the same as those used on Model E, No. 8670 Speaker. Therefore, only parts which differ are listed under Model E-3 and other parts should be selected from previous lists.

MODEL 40, No. 9800 SET

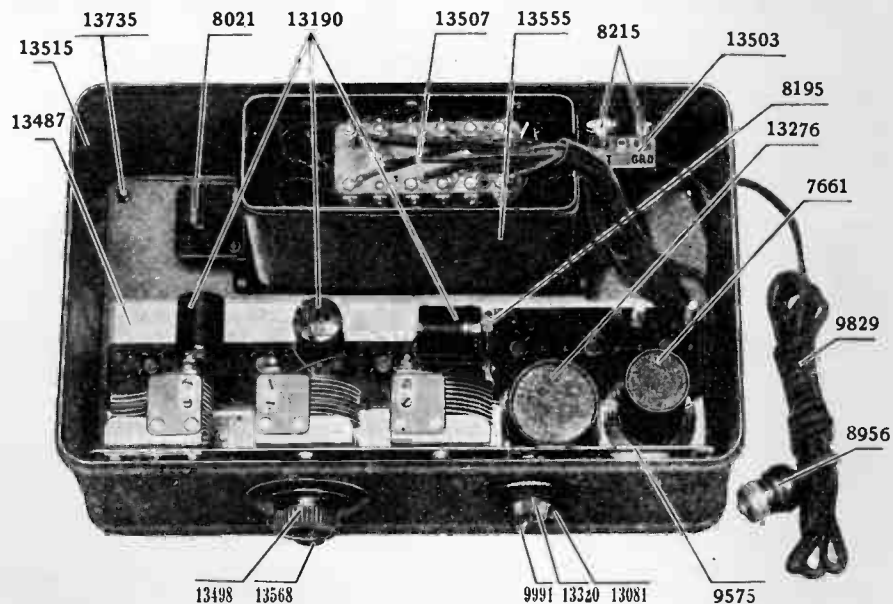

Refer to numerical list for prices.

MODEL 40, No. 9800 SET (Continued)

Note:—Many parts of Model 40, No. 9800, Set are the same as those used on Model 37, No. 9500 set. Therefore, only parts which differ in any way are listed under Model 40 and all other parts should be selected from previous parts lists.

13330 CABINET, COMPLETE

<i>Part No.</i>	
13515	Cabinet Body.....
13521	Cabinet Lid.....
13519	Lid Nameplate.....
13499	Cable Bracket.....
7697	Cable Bracket Screw.....
13516	Dial Indicator.....
1547	Vernier Stud Screw.....
13517	Cabinet Feet.....
13081	"On" Button.....
13487	Tube Chart.....

13507 POWER SUPPLY CABLE AND PANEL.....

<i>Part No.</i>	
13506	Cable Connection Panel.....
13509	Sleeve.....

POWER SUPPLY PARTS

<i>Part No.</i>	
13555	Transf. Cond. and Choke Assembly....
8021	Tube Socket.....
13535	Panel Assembly.....
13534	Panel and Resis. Holders.....
9434	Filament Resis.....
9424	A. F. Resis.....
13047	Det. Resis.....
13538	Bias Resistance.....
9829	Double Conductor Cord and Plug.....
8956	Attachment Plug.....
9991	Toggle Switch.....
13556	Power Supply Cover.....

13320 VOLUME CONTROL UNIT

<i>Part No.</i>	
13501	Housing.....
13502	Knob.....
13247	Knob Holding Spring.....
9785	Contact Spring and Screw.....
13604	Resistance Unit.....
13605	Lead (red).....
13606	Lead (green).....
13607	Lead (yellow).....
13504	Ant. and Grd. Cable and Bracket.....
13503	Ant. and Grd. Base.....
13569	Ant. and Grd. Post Screw.....
8215	Ant. and Grd. Post.....

13363 DETECTOR AND 2-STAGE AMPLIFIER.....

Note:—See Model 37, No. 9500, list for parts.

SET PARTS

<i>Part No.</i>	
13369	R. F. Plate Resistance.....
13170	Variable Condenser Group.....
13483	Short Belt.....
13484	Long Belt.....
13482	Ant. Cplg. Transformer.....
9575	Single Bypass Condenser.....
9928	Double Bypass Condenser.....
13496	Wiring Assembly.....
13498	Dial.....
13568	Vernier Knob—Less Screw.....

Refer to numerical list for prices.

MODEL 42, No. 9850 SET

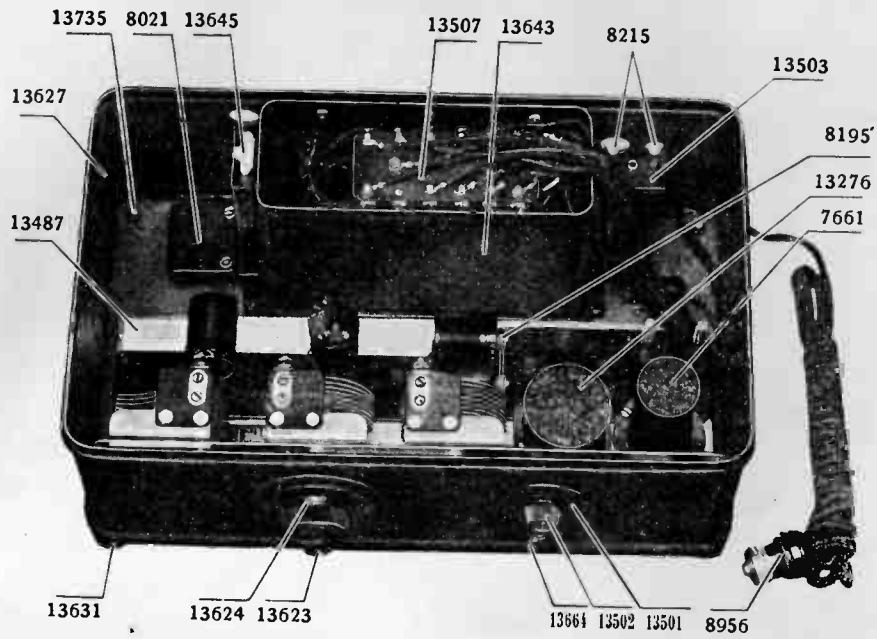

NOTE:—Many parts for Model 42—No. 9850 Set are the same as those used on Model 37—No. 9500 Set. Therefore, only parts which differ are listed under Model 42 and those not listed should be selected from previous lists.

13370 CABINET, COMPLETE

Part No.	NAME OF PART
13627	Cabinet Body.....
13516	Dial Indicator.....
13748	Vernier Stud.....
13628	Vernier Knob Screw.....
13631	Ball Feet.....
13632	Ball Feet Retaining Screw.....
13635	Lid, Complete.....
13634	Nameplate.....
8272	Nameplate Rivet.....
13081	"On" Button.....
9366	Base Nut.....
1271	Base Lockwasher.....
13487	Tube Chart.....
13735	Round Head Base Nut.....

13363 DETECTOR AND 2-STAGE AMPLIFIER

13190 R. F. AMPLIFIER

13507 POWER SUPPLY CABLE AND PANEL

Part No.	NAME OF PART
13506	Panel.....
13509	Sleeve.....

13320 VOLUME CONTROL UNIT

NOTE:—See Model 40—No. 9800 List for Parts.

SET PARTS

Part No.	NAME OF PART
13369	R. F. Plate Resistance.....
13483	Short Belt.....
13484	Long Belt.....
13482	Antenna Cplg. Transformer.....
13496	Wiring Assembly.....
13624	Dial.....
13623	Vernier Knob—less Screw.....
9274	Power Supply Side Mtg. Screw.....
13811	Power Supply Base Mtg. Screw.....
13499	Cable Bracket.....
13608	Shipping Container.....
13621	Literature Assembly.....

POWER SUPPLY PARTS

Part No.	NAME OF PART
13643	Transf. Cond. and Choke Assem.....
13645	Automatic Voltage Control.....
9274	Socket Mtg. Screw.....
13535	Panel Assembly.....
13534	Panel and Resis. Holders.....
13538	Bias Resistance.....
13664	Toggle Switch.....
13556	Cover.....

Refer to numerical list for prices.

MODEL 44, No. 9900 SET

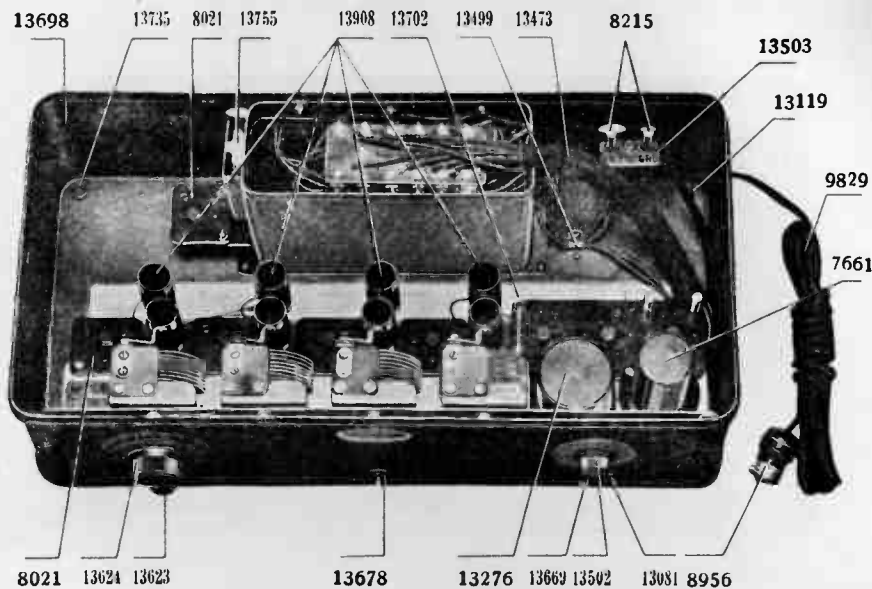

13410 CABINET COMPLETE

Part No.	
13516	Dial Indicator
13698	Cabinet Body
13628	Vernier Knob Screw
1547	Vernier Stud Screw
4822	Vernier Stud Lockwasher
13631	Ball Feet
13632	Ball Feet Retaining Screw
13735	Round Head Base Nut
9366	Hex. Base Nut
13701	Cabinet Lid
13634	Lid Name-plate
8272	Lid Name-plate Rivet
13702	Tube Chart

13363 DETECTOR AND 2-STAGE AMPLIFIER

Note:—See Model 37—No. 9500 list for parts.

13743 POWER SUPPLY CABLE AND PANEL

13742	Cable Sleeve
13506	Connection Panel

13390 VOLUME CONTROL UNIT

13501	Housing
13502	Knob
9785	Contact Arm
13112	Contact Arm Set Screw
13247	Knob Holding Spring
13604	Resistance Unit
13691	Lead (red)
13692	Lead (green)
13693	Lead (yellow)
13503	Antenna and Ground Base
13569	Antenna and Ground Post Screw
13123	Brown Insulation Sleeving
13504	Ant. and Grd. Cable and Base Assembly

SET PARTS

Part No.	
13908	R. F. Coil Group
13200	Variable Condenser Group
8021	Tube Socket
13383	R. F. Plate Resistance
13668	Antenna Cplg. Transformer
9575	Single Bypass Condenser
13105	Double Bypass Condenser
8439	No. 1 and No. 3 Grid Resistance
8225	No. 2 Grid Resistance
13675	Short Belt
13676	Long Belt
13677	Extra Long Belt
13688	Wiring Assembly
13678	3 Pole Toggle Switch
13499	Cable Bracket
13811	Cable Bracket Screw
13624	Dial
13623	Vernier Knob-less Screw
13609	Shipping Container
13492	Literature Assembly

POWER SUPPLY PARTS

13754	Transf. Cond and Choke Assembly
13755	Automatic Voltage Control
13758	Panel Assembly
13534	Panel and Resis. Holders
13756	Bias Resistance
13664	Toggle Switch
13556	Cover

Note:—Many parts for Model No. 44—No. 9900 Set are the same as those used on Model No. 38—No. 9400 Set. Therefore, only parts which differ are given under Model No. 44 and all others should be selected from previous lists.

Refer to numerical list for prices.

MODEL 52, No. 9930 SET

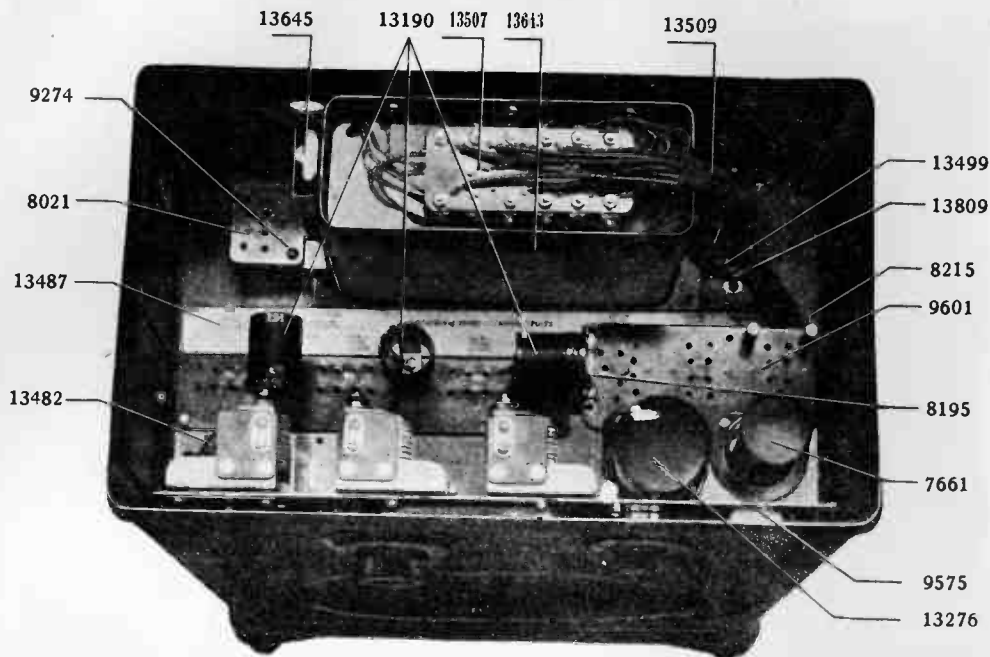

SET PARTS

Part No.

- 13499 Cable Bracket.....
- 7689 Cable Bracket Strap.....
- 13487 Tube Chart.....
- 13882 Antenna Name Plate.....
- 13989 Ground Clamp Assembly.....
- 13899 Ground Clamp only.....
- 13897 Ground Clamp Screw.....
- 13928 Washer.....
- 13926 Literature Assembly.....
- 13898 Shipping Container.....

NOTE:—Parts Not listed above are the same as those used on Model 42, No. 9850 Set, and should be selected from Previous Parts Lists

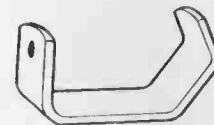

13899 GROUND CLAMP



13897 GROUND CLAMP SCREW

13530 VOLUME CONTROL UNIT

Part No.

- 9798 Lead (red).....
- 8499 Lead (green).....
- 13607 Lead (yellow).....
- 13943 Antenna Cable.....
- 13944 Ground Cable.....
- 13946 Terminal.....
- 13937 Wire Clamp.....

NOTE:—All other parts of 13530 Volume Control unit are the same as those used on No. 13320 Volume control unit for Models 40 and 42, and should be selected from previous lists.

13363 DETECTOR AND TWO-STAGE AMPLIFIER

13190 R. F. AMPLIFIER ASSEMBLY

13507 POWER SUPPLY CABLE

POWER SUPPLY PARTS

NOTE:—All power supply parts for Model 52, No. 9930 set are the same as those used on Model 42, No. 9850 set and should be selected from Previous Parts Lists.

Refer to numerical list for prices.

MODEL 52, No. 9930 SET (Cont'd)

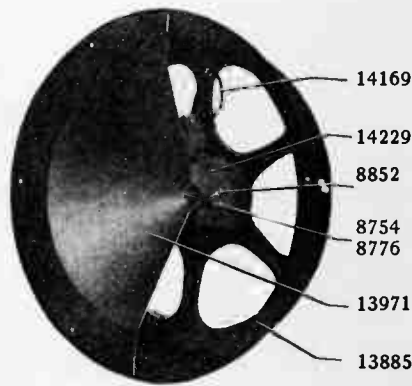
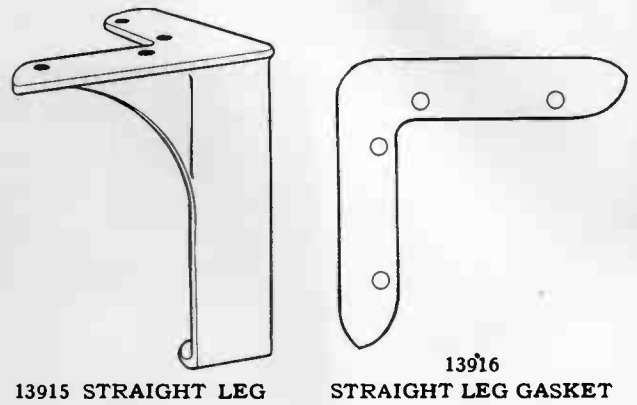
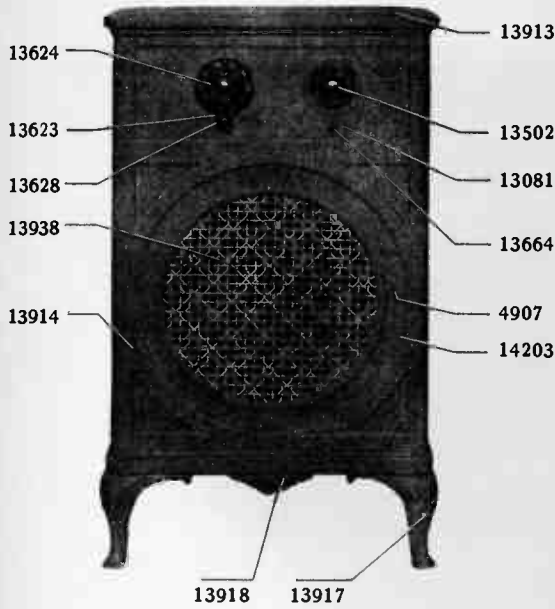

13600 FLANGE SPEAKER

Part No.	
13885	Frame.....
14229	Sound Unit.....
14225	Dust-proof Bag.....
14169	Phone Cord.....
14512	Mounting Nut.....
13929	Large Washer.....
13931	Small Washer.....
13932	Mounting Washer.....
8752	Sound Unit Mounting Nut.....
13971	Diaphragm.....
8754	Diaphragm Spring Screw.....
8776	Diaphragm Spring Nut.....

14203 CASE (less grilles and speaker)

Part No.	
13914	Body Assembly.....
13081	"ON" Button.....
13516	Dial Indicator.....
8236	Name Plate.....
8272	Name Plate Rivet.....
13748	Vernier Stud.....
13628	Vernier Knob Screw.....
13915	Straight Leg.....
13916	Straight Leg Gasket.....
8729	Leg Mounting Screw.....
9366	Leg Mounting Nut.....
13917	Curved Leg.....
13919	Curved Leg Gasket.....
13918	Ornament.....
13938	Front or Rear Grill.....
4907	Grill Screw.....
3597	Grill Screw.....
13934	Rear Grill Ring.....
13936	Cardboard Washer.....
8731	Steel Washer.....
13935	Front Grill Ring.....
13913	Case Lid.....

Refer to Numerical list for prices.

MODEL 41, No. 9910 SET (D. C.)

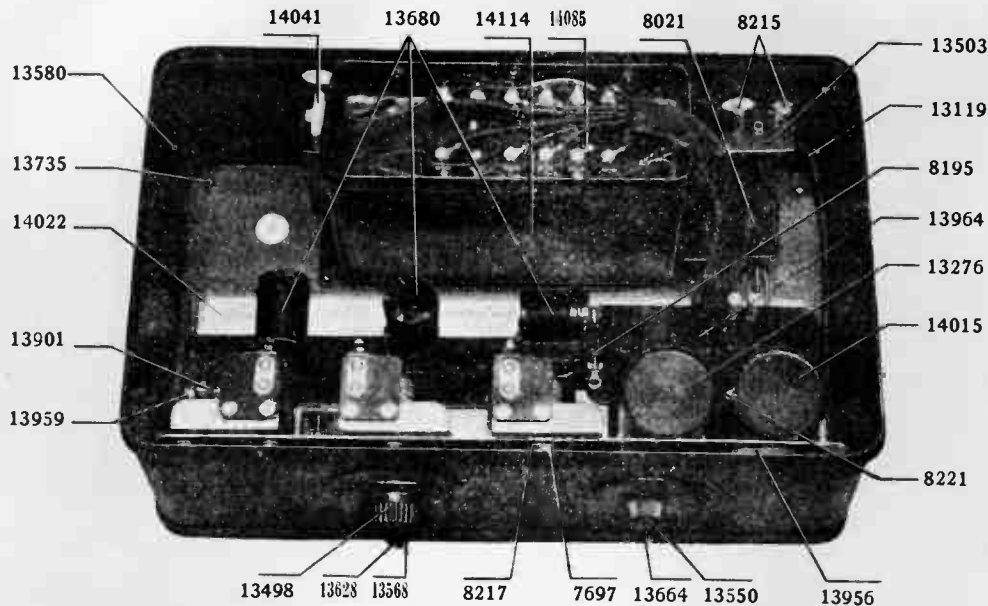

Part No. 13580 CABINET COMPLETE

- 13970 Cabinet Body
- 14022 Tube Chart
- 13905 "D. C." Name Plate
- 9206 Name Plate Rivet

Note:—Parts not listed above are the same as those used on No. 13330 cabinet for Model 40, No. 9800 set, and should be selected from previous lists.

Part No. SET PARTS

- 13961 No. 1 R. F. Bias Resistance
- 14039 Filament Shunt Resistance
- 13955 Double By-pass Condenser
- 7697 Mounting Screw
- 8220 Mounting Lockwasher
- 8221 Mounting Nut
- 13956 Single Bypass Condenser
- 13901 No. 1 R. F. Plate Resistance
- 13959 Resistance Base
- 9689 Resistance Base Mounting Screw
- 4822 Resistance Base Mounting Lockwasher
- 14008 Literature Assembly
- 14005 Instruction Book
- 14007 Shipping Container

Note:—Many parts for Model 41, No. 9910 D. C. set are the same as those used in Model 40, No. 9800 A. C. set and should be selected from previous lists.

14071 DETECTOR AND 2-STAGE AMPLIFIER

- Part No.
- 13964 Detector and 2-Stage Base
- 8215 Phone Post
- 9337 Phone Post Screw
- 9678 Solder Clip
- 8195 Grid Leak
- 14072 Phone Condenser
- 13276 No. 1 A. F. Transformer
- 14015 No. 2 A. F. Transformer

14085 POWER SUPPLY CABLE

- Part No.
- 13509 Cable Sleeve
- 14084 Cable Connection Panel

13680 RADIO FREQUENCY AMPLIFIER

13550 VOLUME CONTROL UNIT

- Part No.
 - 14024 Lead (red)
 - 14025 Lead (black)
 - 14026 Cable, Bracket and Post Assembly
- Note:—Parts not listed above will be found under No. 13320 Volume Control unit for Model 40, No. 9800 A. C. Set.

POWER SUPPLY PARTS

- Part No.
- 14114 Transformer, Condenser and Choke Assembly
- 8021 Tube Socket
- 9274 Tube Socket Mounting Screw
- 14041 Voltage Regulator
- 14042 No. 1 R. F. Choke
- 14471 No. 2 R. F. Choke
- 9829 Double Conductor Cord and Plug
- 8956 Attachment Plug
- 13664 Toggle Switch
- 13966 Panel Assembly
- 14138 Panel and Resistance Holders
- 9678 Solder Clip
- 9741 Solder Clip
- 9424 Detector Plate Resistance
- 13556 Lid

Refer to numerical list for prices.

MODEL 43, No. 9870 SET

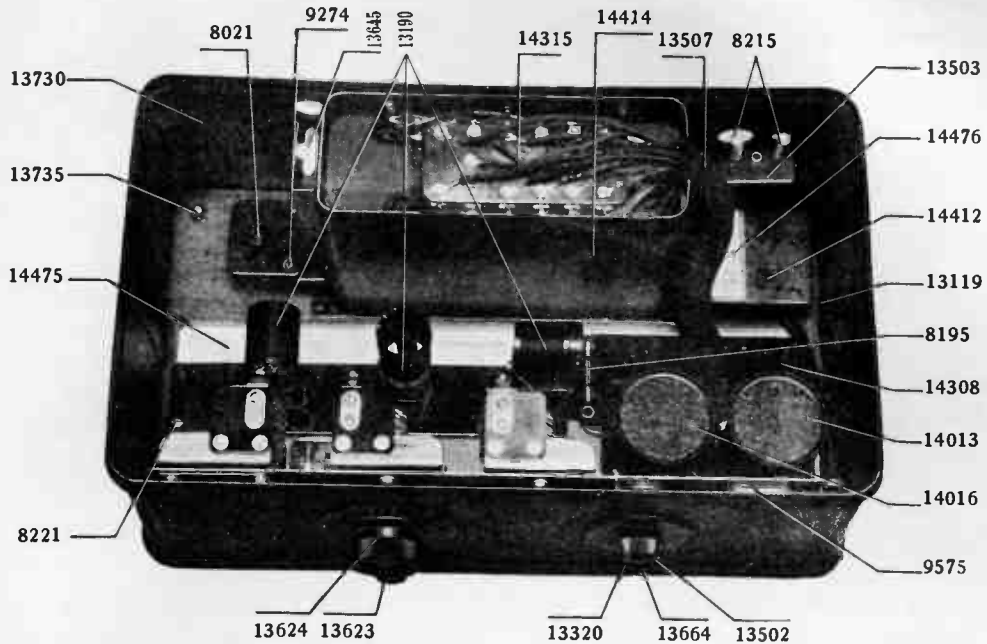

13730 CABINET COMPLETE

Part No.

14475 Tube Chart.....

NOTE:—All other parts for No. 13730 Cabinet will be found under No. 13370 Cabinet for Model 42, No. 9850 set.

SET PARTS

14516 Double By-pass Condenser.....

13170 Var. Cond. Group.....

14302 Instruction Book.....

13621 Literature Assembly.....

14299 Shipping Container.....

NOTE:—All other set parts should be selected from Model 42, No. 9850 set.

13190 R. F. AMPLIFIER.....

13320 VOLUME CONTROL.....

NOTE:—See Model 40—No. 9800 set for parts.

Part No.

14315 POWER SUPPLY CABLE & PANEL.....

13506 Cable Connection Panel.....

13507 Cable Sleeve.....

14314 DETECTOR AND 2-STAGE AMPLIFIER.....

14308 Detector and 2-Stage Base.....

14016 No. 1 A. F. Transformer.....

14013 No. 2 A. F. Transformer.....

NOTE:—All other parts are the same as used on 13363 Det. and 2-stage amplifier for Model 42, No. 9850 set.

POWER SUPPLY PARTS

14414 Transf., Cond. and Choke Assem.....

13645 Automatic Voltage Control.....

8021 Rectifying Tube Socket.....

14412 Speaker Plug Socket.....

9274 Mounting Screw.....

8220 Lockwasher.....

9829 Double Conductor Cord and Plug.....

8956 Attachment Plug.....

14421 Panel Assembly.....

13534 Panel and Resis. Holders.....

13502 Panel Screw.....

9689 Panel Screw.....

7697 Panel Screw.....

14427 Bias Resistance.....

13556 Lid.....

14476 Speaker Plug Card.....

9424 A. F. Resis.....

13047 Detector Resis.....

Refer to numerical list for prices.

MODEL 40F, No. 9960 SET, 25 CYCLES

NOTE:—All parts used in Model 40 F, No. 9960 set are the same as those used in Model 40, No. 9800 set with the following exceptions:—

Part No.

13590	Cabinet Complete.....
13991	Cabinet Body.....
14187	Literature Assembly.....

Part No.

14194	Shipping Container.....
14295	Transf., Cond. and Choke Assem.....
14262	Mounting Strap Assem.....
13728	Mounting Strap Only.....
13813	Power Supply Cover.....
13163	"25-cycle" Name Plate.....

MODEL 42F, No. 9970 SET, 25 CYCLES

NOTE:—All parts used in Model 42F—No. 9970 set are the same as those used in Model 42, No. 9850 set, with the following exceptions:—

Part No.

14187	Literature Assembly.....
14188	Shipping Container.....

Part No.

13660	Cabinet Complete.....
13996	Cabinet Body.....
13163	"25-cycle" Name Plate.....
14258	Transf. Cond. and Choke Assem.....
13728	Mounting Strap Only.....
13813	Power Supply Cover.....

MODEL 44F, No. 9980 SET, 25 CYCLES

NOTE:—All parts used in Model 44F—No. 9980 set are the same as those used in Model 44—No. 9900 set, with the following exceptions:—

Part No.

14187	Literature Assembly.....
14193	Shipping Container.....

Part No.

13670	Cabinet Complete.....
13997	Cabinet Body.....
13163	"25-cycle" Name Plate.....
14292	Transf., Cond. and Choke Assem.....
13728	Mounting Strap Only.....
13813	Power Supply Cover.....

MODEL E-3, FLANGE SPEAKER, No. 13500

Part No.

13848	Frame.....
13985	Sound Unit.....
8852	Terminal Nut.....
14225	Dust Proof Bag.....
4767	Speaker Cord.....

Part No.

13982	Sound Unit Nut.....
14508	Diaphragm.....
13852	Steel Ring.....
14393	Mounting Nut.....
14474	Shipping Container.....

MODEL E-3, LUG SPEAKER, No. 13650

Part No.

13886	Frame.....
13985	Sound Unit.....
14225	Dust Proof Bag.....
8852	Terminal Nut.....
4767	Speaker Cord.....

Part No.

13982	Sound Unit Nut.....
13796	Diaphragm.....
13798	Front Grill Complete.....
9205	Front Retaining Screw.....
13988	Shipping Container.....

Refer to numerical list for prices.

MODEL F, No. 9890 SPEAKER (ELECTRO-DYNAMIC)

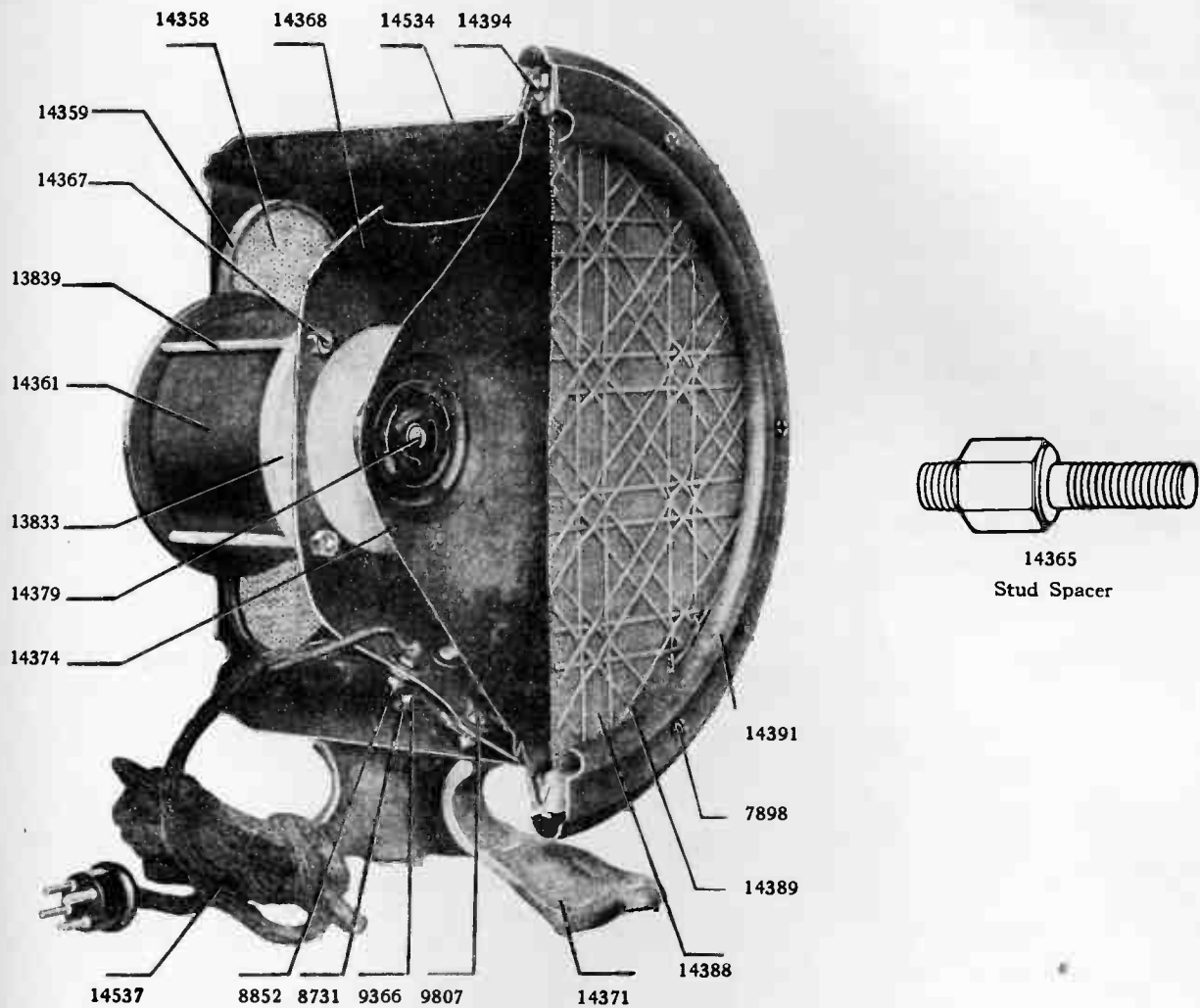

<i>Part No.</i>	
14534	Frame
14371	Base
8976	Base Screw
8731	Base Washer
9366	Base Nut
14358	Back Screen
14359	Retaining Ring
14368	Cone Housing
9807	Mtg. Screw
14396	Washer
9678	Solder Clip
8753	Solder Clip
8852	Mounting Nut
14361	Coil and Case Assembly
13833	Centering Plate
13839	Mounting Bolt
13928	Mounting Washer

<i>Part No.</i>	
14367	Mounting Nut
14537	Cable and Plug Assembly
14374	Diaphragm Assembly
14379	Center Screw
14381	Center Washer
14382	Steel Ring
14394	Flat Head Screw
14383	Cardboard Ring
14384	Cardboard Ring
14388	Front Screen and Ring
14389	Grill
14391	Front Cover
7898	Mtg. Screw
14392	Stud Spacer Nut (Acorn)
14492	Shipping Container
14622	Diaphragm Coil Centering Gauge (3 required)

Refer to numerical list for prices.

MODEL F-2, No. 14200 ELECTRO-DYNAMIC SPEAKER

Part No.

- 14768 Shipping Container.....
- 14365 Stud Spacer.....
- 14615 Screw.....
- 14497 Screw.....
- 15079 Speaker Plug.....

NOTE:—All other parts for model F-2 Speaker will be found under Model F, No. 9890 Speaker, on page 43.

MODEL F-2C, No. 14300 SPEAKER (ELECTRO-DYNAMIC)

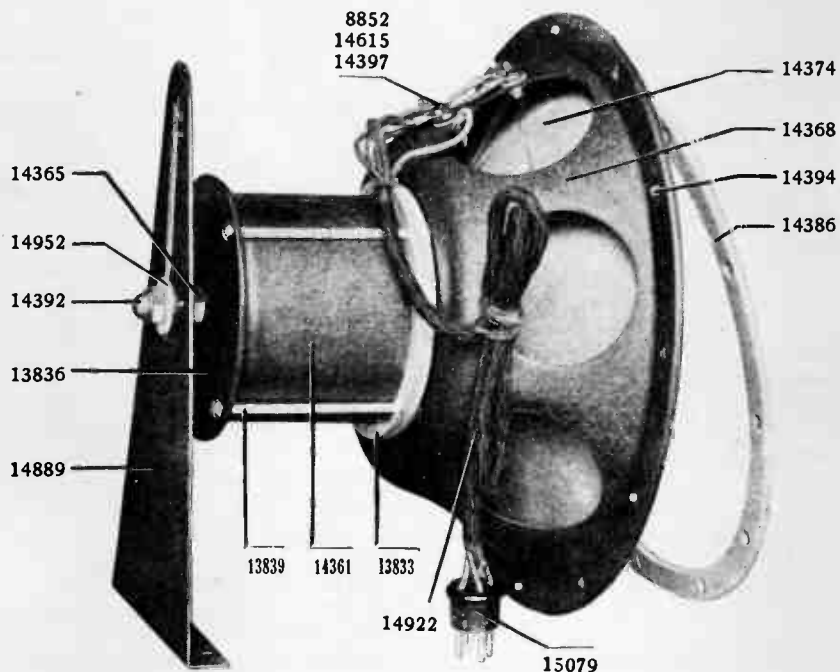

NOTE:—All parts not listed below will be found under Model F, No. 9890 Speaker, on page 43.

Part No.

- 14397 Insulation Bushing.....
- 14615 Screw.....
- 14365 Stud Spacer.....
- 13836 Back Plate.....
- 14922 Cable and Plug Assembly.....
- 14386 Cardboard Ring.....
- 14769 Shipping Container.....
- 14889 Mounting Bracket.....
- 14952 Washer.....
- 15079 Speaker Plug.....

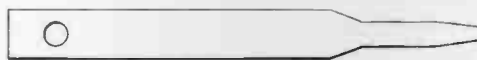

14622

DIAPHRAGM COIL CENTERING GAUGE

Refer to Numerical list for prices.

MODEL 46, No. 14100 SET (ELECTRO-DYNAMIC)

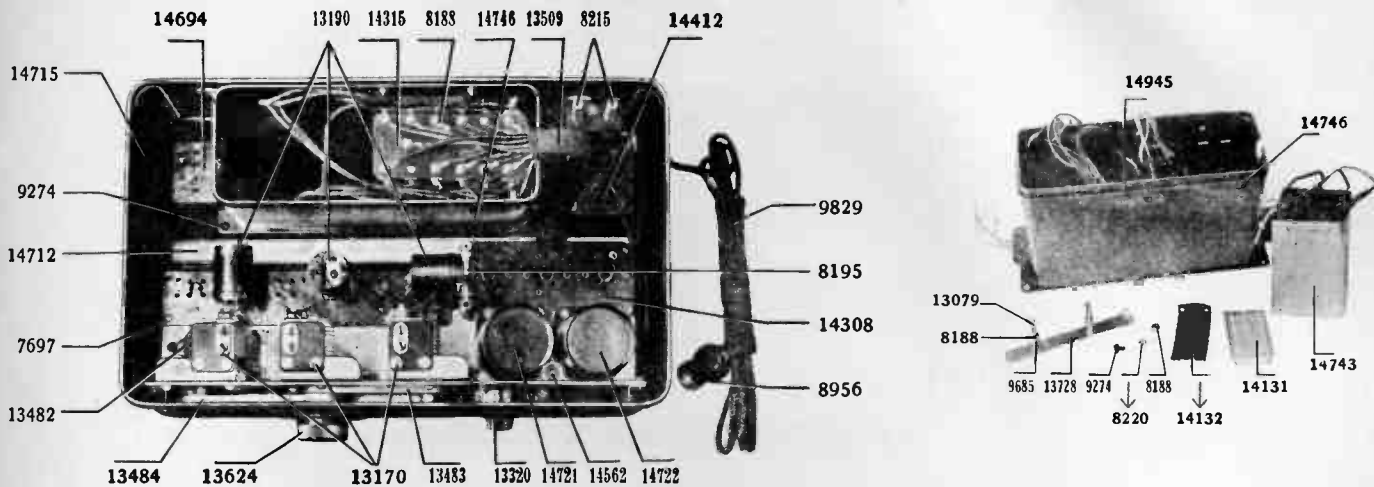

NOTE:—All parts not listed under Model 46, No. 14100 Set, will be found under Model 43, No. 9870 Set, on page 41.

SET PARTS

Part No.	
13369	R. F. Plate Resistance.....
14562	Detector and 2-Stage Amplifier Retain- ing Washer.....
14516	Double By-pass Condenser.....
13482	Antenna Coupling Transformer.....
13170	Variable Condenser Group.....
14767	Instruction Book.....
14709	Literature Assembly.....
13989	Ground Clamp Assembly.....
9123	Tube Cap.....
14766	Shipping Container.....
14861	Grid Condenser.....

13880 CABINET, COMPLETE.....

Part No.	
14715	Cabinet Body.....
13635	Lid, Complete.....
14712	Tube Chart.....

NOTE:—For other parts of 13880 Cabinet, refer to No. 13370 Cabinet on page 36.

13320 VOLUME CONTROL UNIT.....

Part No.	
14857	Contact Arm.....

NOTE:—For other parts of No. 13320 Vol. control unit see page 35.

14723 DETECTOR AND 2-STAGE AMPLIFIER

Part No.	
14308	Base and Springs.....
14721	No. 1 A. F. Transformer.....
14722	No. 2 A. F. Transformer.....
8195	Grid Leak.....
8221	Transformer Mounting Screw.....
9598	Phone Condenser.....

POWER SUPPLY PARTS

Part No.	
14746	Transformer, Condenser and Choke As- sembly.....
14743	Condenser Assembly.....
14945	Transformer and Choke Assembly.....
14131	Clamp Support.....
14132	Clamp.....
8188	Clamp Mounting Nut.....
14262	Mounting Strap Assembly.....
13728	Mounting Strap only.....
13079	Mounting Strap Screw.....
9685	Mounting Strap Bushing.....
14412	Speaker Plug Socket.....
14694	Rectifier Tube Socket.....
14738	Speaker Plug Chart.....
14494	Black with Green Tracer Lead.....
14495	Red with Green Tracer Lead.....
13407	White Lead.....
14432	Green with Yellow Tracer Lead.....
14569	Insulating Sleeve.....
9829	Double Conductor Cord and Plug.....
8956	Attachment Plug.....
13664	Toggle Switch.....
14736	Paper Insulating Tube.....
14587	Panel Assembly, Complete.....
14586	Panel Only.....
14427	Bias Resistance.....
14565	Detector Resistance.....
14575	A. F. Resistance.....
14753	Power Supply Cover.....

14315 POWER SUPPLY CABLE AND PANEL

Part No.	
13506	Cable Connection Panel.....
13509	Cable Sleeve.....

13190 R. F. AMPLIFIER.....

Refer to Numerical list for prices.

MODEL 45, No. 9880 SET

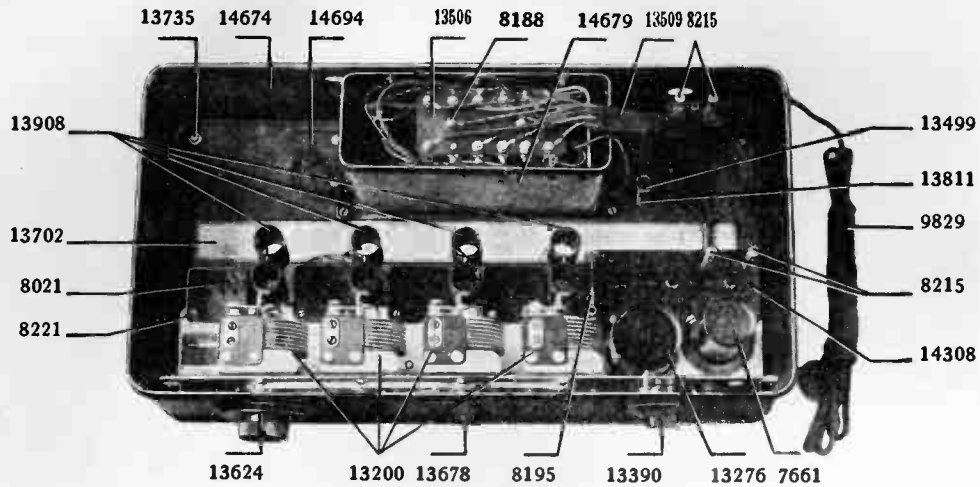

NOTE:—Any parts not listed under Model 45, No. 9880 Set, will be found under Model 44, No. 9900 Set, on page 37.

13810 CABINET, COMPLETE

<i>Part No.</i>	
14674	Cabinet Body.....
13701	Lid, Complete.....
13702	Tube Chart.....

13363 DETECTOR AND TWO-STAGE AMPLIFIER

NOTE:—See Model 37 set, No. 9500, on page 27, for parts of 13363 detector and 2-stage amplifier.

13743 POWER SUPPLY CABLE AND PANEL

13908 R. F. COIL GROUP

13390 VOLUME CONTROL UNIT

<i>Part No.</i>	
14857	Contact Arm, Complete.....
15115	Contact Arm Adjustment Gauge.....



15115

SET PARTS

<i>Part No.</i>	
14562	Detector 2-Stage Retaining Washer....
13492	Literature Assembly.....
14304	Shipping Container.....
13989	Ground Clamp.....

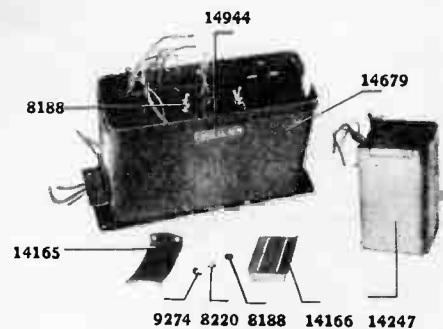

POWER SUPPLY PARTS

14679	Transformer, Condenser and Choke Assembly.....
14247	Condenser Assembly.....
14944	Transformer and Choke Assembly....
14165	Clamp.....
14166	Clamp Support.....
14694	Tube Socket.....

Refer to Numerical list for prices.

MODEL 47, No. 14500 SET

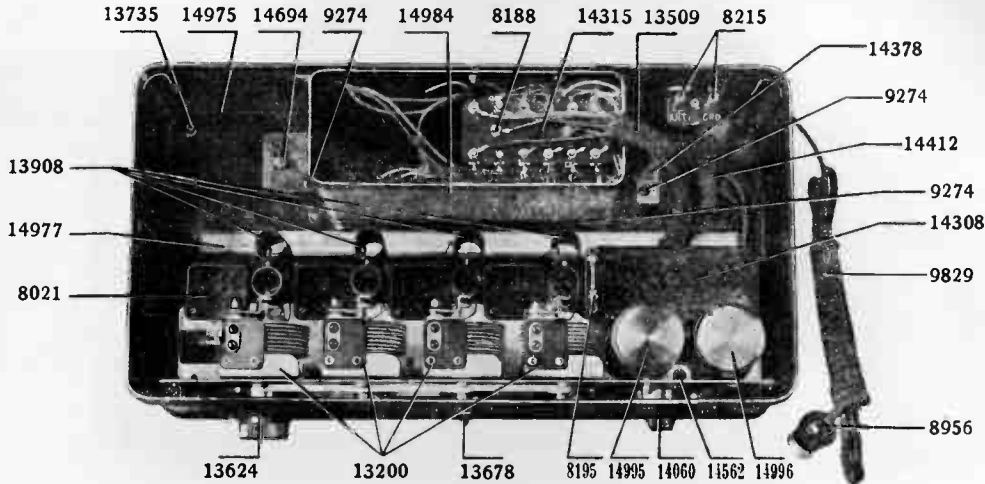

NOTE:—All parts not listed under Model 47, No. 14500 Set, will be found under Model 44, No. 9900 Set, on page 37.

14020 CABINET, COMPLETE.....

<i>Part No.</i>	
14975	Cabinet Body.....
13701	Cabinet Lid.....
14997	Tube Chart.....

14997 DETECTOR AND 2-STAGE AMPLIFIER

<i>Part No.</i>	
14562	Retaining Washer.....
14308	Detector and 2-Stage Base.....
14995	No. 1. A. F. Transformer.....
14996	No. 2 A. F. Transformer.....

NOTE:—All other parts for No. 14997 Det. 2-stage will be found on page 27.

SET PARTS

<i>Part No.</i>	
13908	R. F. Coil Group.....
13688	Wiring Assembly.....
13678	3-Pole Toggle Switch.....
15008	Literature Assembly.....
13989	Ground Clamp Assembly.....
15011	Shipping Container.....
13369	R. F. Plate Resistance.....
13668	Antenna Coupling Transformer.....
14999	Double By-pass Condenser.....
14074	Variable Condenser Group.....

POWER SUPPLY PARTS

<i>Part No.</i>	
9829	Double Conductor Cord and Plug.....
14262	Mounting Strap Assembly.....
13728	Strap Only.....
13079	Strap Screw.....
9685	Strap Bushing.....
14586	Panel Only.....
15063	Bias Resistance.....
14565	Detector Resistance.....
14575	A. F. Resistance.....
13813	Power Supply Cover.....
14587	Panel Assembly.....
14984	Transformer Condenser and Choke Assembly.....
14951	Transformer and Choke Assembly.....
14743	Condenser Assembly.....
14132	Clamp.....
14131	Clamp Support.....
14694	Tube Socket.....
14412	Speaker Plug Socket.....
14738	Speaker Plug Chart.....

14315 POWER SUPPLY CABLE AND PANEL

14060	VOLUME CONTROL UNIT.....
<i>Part No.</i>	
15039	Mounting Screw.....
14857	Contact Arm, Complete.....
14992	Antenna and Ground Base Assembly..

NOTE:—All other parts for No. 14060 Vol. control unit will be found on page 37.

Refer to Numerical list for prices.

MODEL 53, No. 13100 SET (ELECTRO-DYNAMIC)

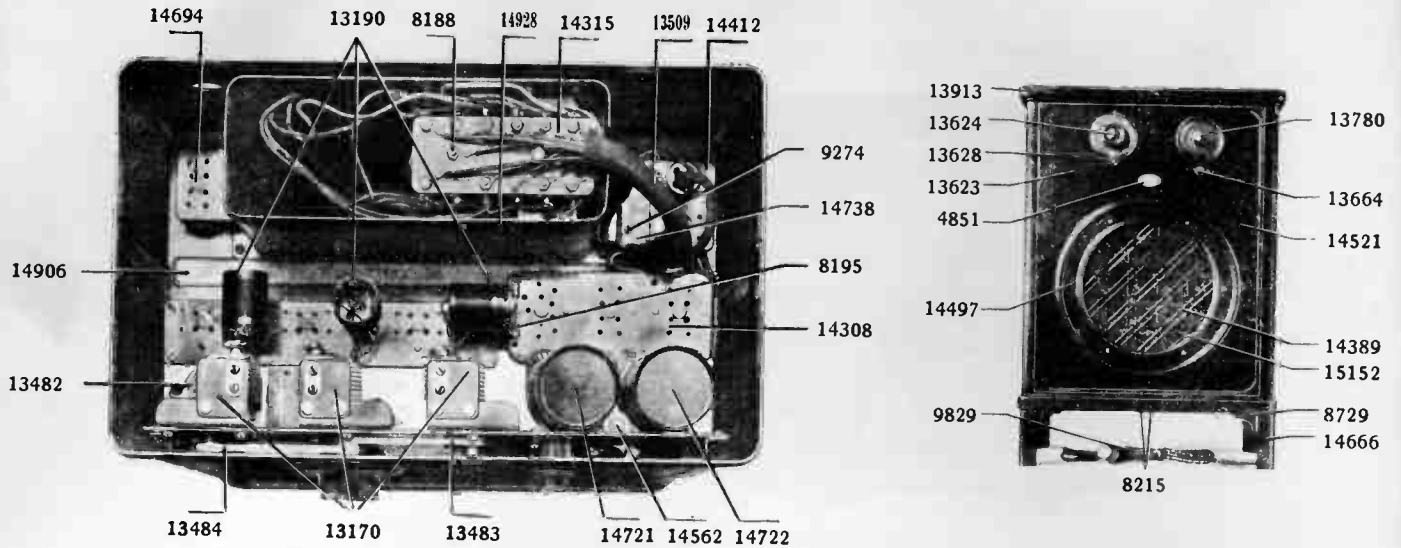

NOTE:—All other parts not listed below will be found under Model 46, No. 14100 set, on page 45.

SET PARTS

Part No.	
13989	Ground Clamp Assembly.....
14911	Literature Assembly.....
14912	Shipping Container.....
14477	Wooden Top Brace.....
14478	Wooden Bottom Brace.....

13190 R. F. AMPLIFIER

13780 VOLUME CONTROL UNIT

Part No.	
14857	Contact Arm, Complete.....
13607	Yellow Lead.....
14644	Red Lead.....
14507	Green Lead.....
14642	Antenna Cable.....
14643	Ground Cable.....
13946	Terminal.....
13395	Terminal.....
13937	Wire Clamp.....
8215	Binding Post.....
14636	Binding Post Base.....
14646	Antenna and Ground Cable Assembly..
14647	Antenna and Ground Assembly, Comp.

14723 DETECTOR AND 2-STAGE AMPLIFIER

NOTE:—See Model 46, No. 14100 Set, on page 45.

14315 POWER SUPPLY CABLE AND PANEL

14915 CONSOLE (less grilles and speaker)

Part No.	
14521	Body Assembly.....
14916	Mounting Strap Screw.....
14528	Mounting Strap.....
14666	Leg.....
14853	Leg Gasket.....
8729	Leg Screw.....
13913	Lid.....
15152	Front Screen.....
14386	Front Screen Ring.....
14389	Front Grill.....
14384	Front Grill Ring.....
14497	Grill Screw.....
14532	Grill Nut.....
14895	Lockwasher.....
14942	Grill Nut.....
14906	Tube Chart.....

13990 ELECTRO-DYNAMIC SPEAKER

NOTE:—See Model F, No. 9890 speaker on page 43 for parts.

POWER SUPPLY PARTS

Part No.	
14928	Transformer, Condenser and Choke Assembly.....
14926	Condenser Assembly.....
14949	Transformer and Choke Assembly.....
14262	Mounting Strap Assembly.....
13728	Strap Only.....
13079	Strap Screw.....
9685	Strap Bushing.....

NOTE:—All parts not listed above will be found under Model 46, No. 14100 Set, on page 45.

Refer to Numerical list for prices.

MODEL 56, No. 13900 SET

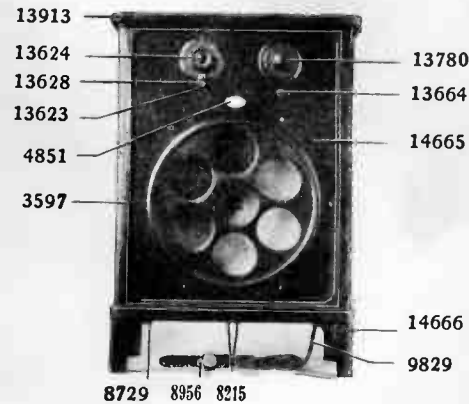
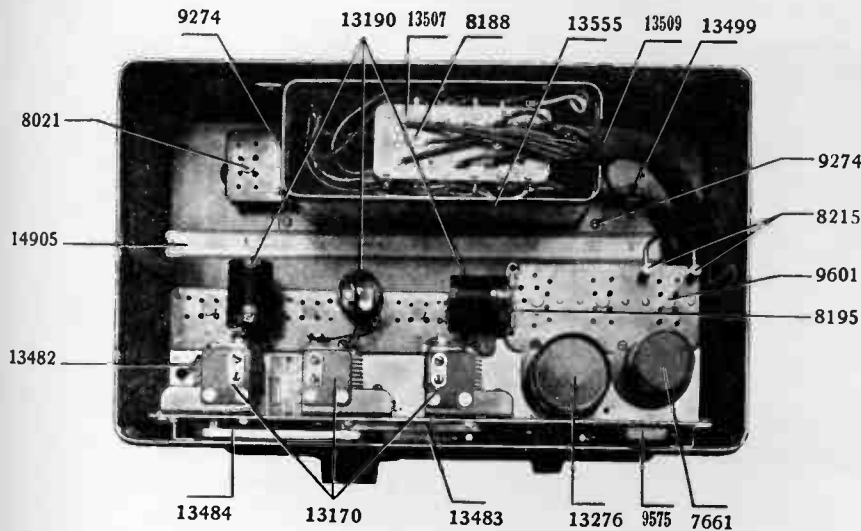

NOTE:—All other parts for Model 56, No. 13900 Set, will be found under Model 40, No. 9800 Set, on page 35.

SET PARTS

- Part No.*
- 14905 Tube Chart.....
 - 14658 Literature Assembly.....
 - 14477 Wooden Top Brace.....
 - 14478 Wooden Bottom Brace.....
 - 13989 Ground Clamp Assembly.....
 - 14659 Shipping Container.....

13780 VOLUME CONTROL UNIT.....

- Part No.*
- 14857 Contact Arm, Complete.....
 - 13607 Yellow Lead.....
 - 14644 Red Lead.....
 - 14507 Green Lead.....
 - 14642 Antenna Cable.....
 - 14643 Ground Cable.....
 - 13946 Terminal.....
 - 13395 Terminal.....
 - 13937 Wire Clamp.....
 - 8215 Binding Post.....
 - 14636 Binding Post Base.....
 - 14646 Antenna and Ground Cable Assembly..
 - 14647 Antenna and Ground Assembly, Comp.

13363 DETECTOR AND 2-STAGE AMPLIFIER

NOTE:—See Model 37, No. 9500 Set, on page 27.

14667 CONSOLE (less Speaker).....

- Part No.*
- 14665 Body Assembly.....
 - 14666 Straight Leg.....
 - 14853 Straight Leg Gasket.....

NOTE:—All parts not listed above will be found under Model 52, No. 9930 Set, on page 39.

13190 R. F. AMPLIFIER.....

13600 FLANGE SPEAKER.....

NOTE:—See Model 52, No. 9930 Set, on page 39.

13507 POWER SUPPLY CABLE AND PANEL.....

POWER SUPPLY PARTS

NOTE:—See Model 40, No. 9800 Set, on page 35.

February 1, 1929

Refer to Numerical list for prices.

MODEL 57, No. 14000 SET

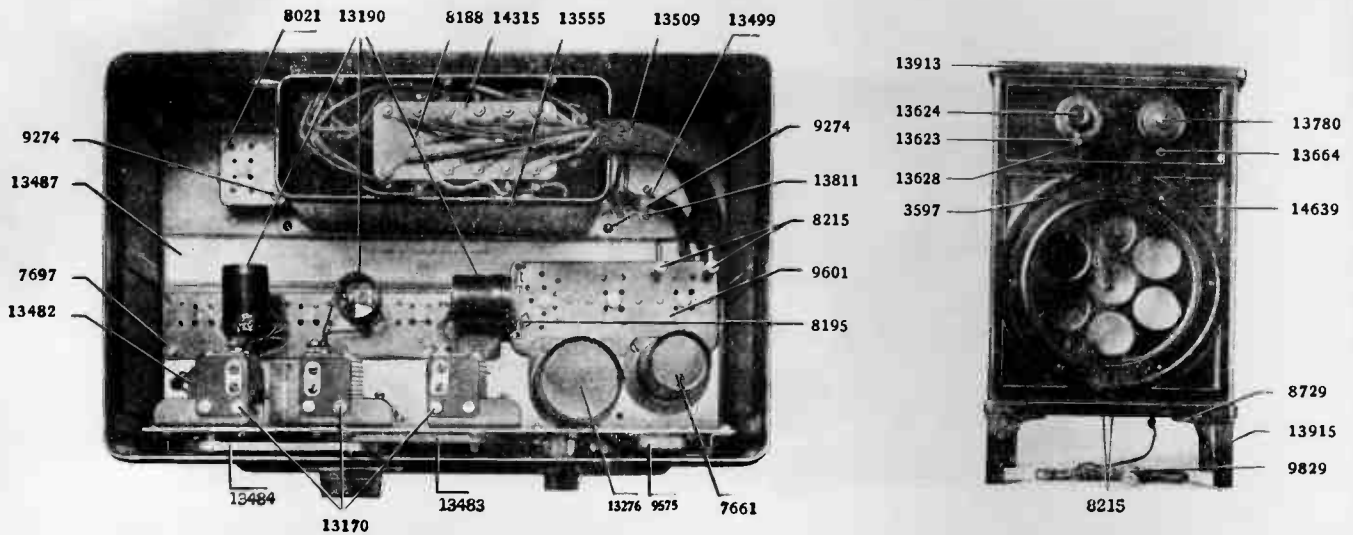

NOTE:—All other parts for Model 57, No. 14000 Set, will be found under Model 40, No. 9800 Set, on page 35.

SET PARTS

Part No.

- 13487 Tube Chart.....
- 14655 Literature Assembly.....
- 14652 Shipping Container.....
- 13989 Ground Clamp Assembly.....
- 14477 Wooden Top Brace.....
- 14478 Wooden Bottom Brace.....

13780 VOLUME CONTROL UNIT

Part No.

- 14857 Contact Arm, Complete.....
- 13607 Yellow Lead.....
- 14644 Red Lead.....
- 14507 Green Lead.....
- 14642 Antenna Cable.....
- 14643 Ground Cable.....
- 13946 Terminal.....
- 13395 Terminal.....
- 13937 Wire Clamp.....
- 8215 Binding Post.....
- 14636 Binding Post Base.....
- 14646 Antenna and Ground Cable Assembly
- 14647 Antenna and Ground Assembly, Comp.

13363 DETECTOR AND TWO-STAGE AMPLIFIER

NOTE:—See Model 37, No. 9500 Set, on page 27.

14641 CONSOLE (less Speaker).....

Part No.

- 13519 Nameplate.....
- 14639 Cabinet Body only.....

NOTE:—All parts not listed above will be found under Model 52, No. 9930 Set, on page 39.

13600 FLANGE SPEAKER.....

NOTE:—See Model 52, No. 9930 Set, on page 39

14315 POWER SUPPLY CABLE AND PANEL

13190 R. F. AMPLIFIER.....

POWER SUPPLY PARTS

NOTE:—See Model 40, No. 9800 Set, on page 35.

Refer to Numerical list for prices.

MODEL 55, No. 14900 SCREEN-GRID SET

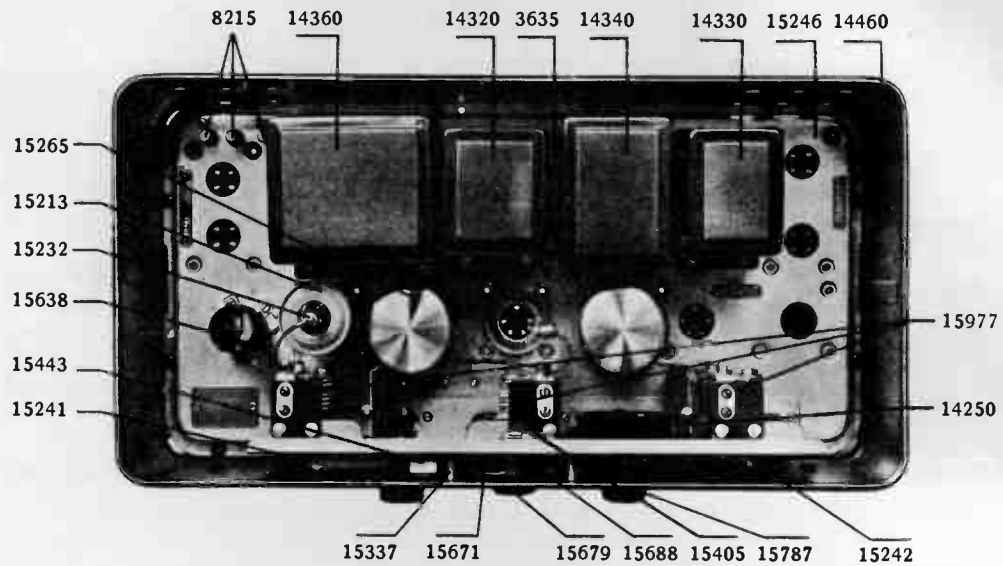

14460 CABINET ASSEMBLY, COMPLETE

<i>Part No.</i>	
15692	Body Assembly.....
13701	Lid.....

FINAL BASE ASSEMBLY

<i>Part No.</i>	
15638	R. F. Coil Group.....
15265	R. F. Coil Shield.....
15213	Tube Shield.....
14360	Power Trans. Unit.....
14340	Condenser Unit.....
14320	Filter Choke Unit.....
14330	In and Output Unit.....
15327	Condenser Unit Container.....
15833	Condenser Unit Spring.....
15834	Condenser Unit Spacer.....
15332	Condenser Unit Lid.....
15329	Trans. Unit Lid.....
15331	Choke Unit Lid.....
15333	In and Output Unit Lid.....
15415	Bottom Plate, Complete.....

MAIN PANEL ASSEMBLY

<i>Part No.</i>	
15228	Panel Only.....
15337	Panel Spacer Bushing.....
15279	Panel Spacer Screw.....
15776	Dial Adj. Support.....
15237	Angle Shield.....
15369	Top Shield.....
15232	Grid Cap.....

LAMP SOCKET ASSEMBLY

<i>Part No.</i>	
15405	Socket Assembly.....
15404	Lamp.....
15747	Resistance Lead.....
15643	Mounting Lockwasher.....

VARIABLE CONDENSER ASSEMBLY

<i>Part No.</i>	
15977	Condenser Group.....
15686	No. 2 Pulley.....
15688	Dial Gear.....
15671	Dial Vision Plate.....
15648	Dial Mounting Screw.....
15241	Short Belt.....
15242	Long Belt.....

15386 DISTANCE SWITCH ASSEMBLY...

<i>Part No.</i>	
15383	Base.....
15381	Shaft.....
15374	Contact Blade.....
14788	Mounting Screw.....
15742	Lead (Yellow).....
15446	Lead (Blue).....
15447	Lead (Red-White Tracer).....

Refer to numerical list for prices.

MODEL 55, No. 14900 SCREEN-GRID SET (Cont'd)

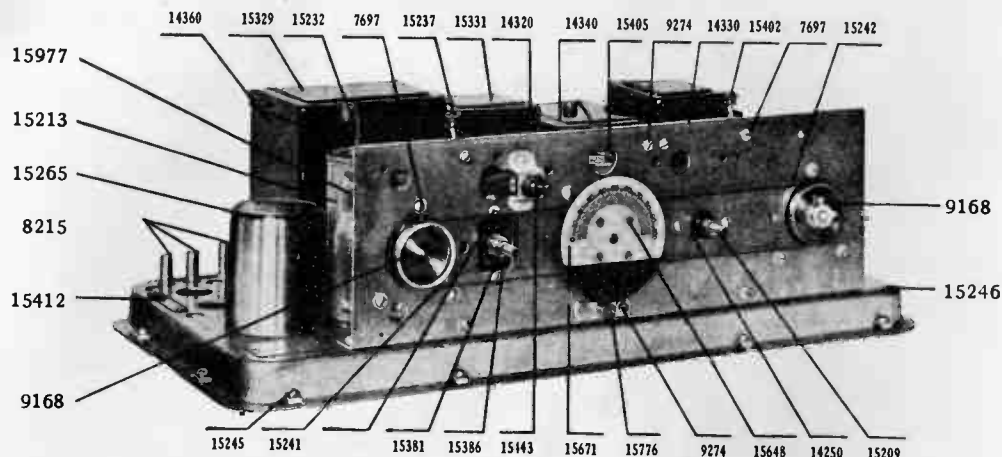

SUB-BASE ASSEMBLY

Part No.

15246	Base Plate Only
15639	Base Plate, Sockets, Nameplates
15245	Base Nut, Round Head
15252	Rect. and Speaker Plug Socket
15254	R. F. Socket
15256	Det. and 1st. A. F. Socket
15258	2nd A. F. Socket
15214	Tube Shield Base
15261	Four Resis. Base
15586	Two Resis. Base
15283	Ant. Post Screw
15587	Ant. and Grd. Plate
15408	R. F. Tube Plate
15409	Det. Tube Plate
15411	Power Tube Plate
15412	Rect. and Speaker Plug Plate

15278	Output Group Leads
15491	Resistance Group Leads
15479	Filament Group Leads
15739	Wire Clamp
15262	R. F. By-pass
15263	Det. By-pass
15792	Phone Condenser
15271	R. F. Choke
15272	1st A. F. Cathode Series Resis.
15274	R. F. Fil. Shunt and Bias Resis.
15904	R. F. Grid Bias
15547	2nd A. F. Fil. Shunt Resis.
15544	2nd A. F. Bias Resis., No. 2, Yellow
15545	2nd A. F. Bias Resis., No. 1, Maroon
15592	1st A. F. and Filter Resis., Black
15285	1st A. F. Plate Resis., Gray
15286	Bleeder Resis., Purple
15287	Det. Cathode Resis., Blue

Below Serial No. 3380001 Table Model and No. 4140001 Panel Model

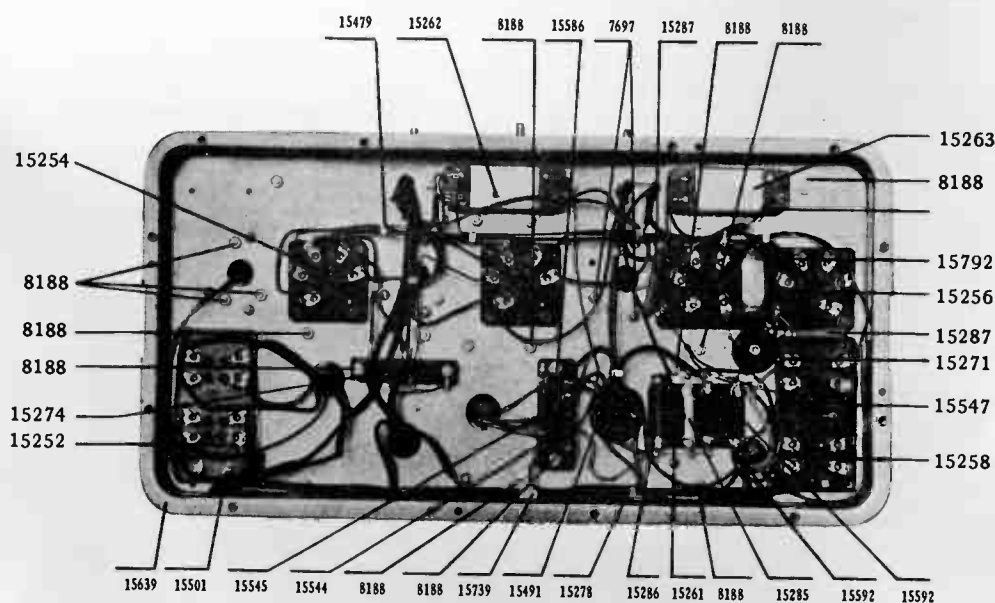

Refer to numerical list for prices.

MODEL 55, No. 14900 SCREEN-GRID SET (Cont'd)

Above Serial No. 3380001 Table Model and No. 4140001 Panel Model

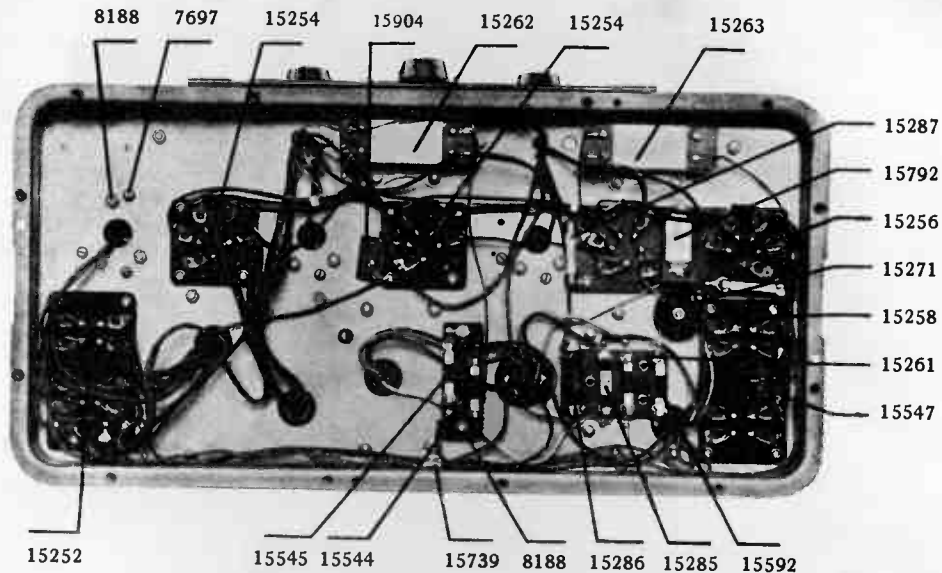

15501 DOUBLE CONDUCTOR CORD AND PLUG

Part No.

15499 Cord Only

8956 Plug Only

VOL. CONT. AND DIS. SWITCH KNOB

Part No.

15787 Knob

15562 Knob Set-Screw

15443 TOGGLE SWITCH ASSEMBLY

Part No.

13664 Toggle Switch

15373 Bracket

14250 VOLUME CONTROL UNIT

Part No.

15211 Housing

15209 Shaft

15297 Resistance

15564 Lead (White)

15565 Lead (Red)

15566 Lead (Red-Black Tracer)

15679 DIAL KNOB ASSEMBLY

Part No.

15678 Dial Knob Only

15681 Rubber

15682 Dial Screw

15591 Literature Assembly

15588 Instruction Book

15689 Shipping Container

MODEL 55-C, No. 14800 SCREEN-GRID SET

NOTE:—All parts not listed below will be found under Model 55, No. 14900 Set, on pages 51 and 52.

Part No.

15676 Front Panel, Complete

15675 Front Panel Only

15705 Front Panel Brace

15766 Front Panel Brace Screw

15765 Front Panel Brace Lockwasher

15656 Bottom Plate

14470 Power Transformer Unit

15688 Shipping Container

Refer to numerical list for prices.

MODEL F-3, No. 14190 POWER SPEAKER

NOTE:—All parts not listed below will be found under Model F, No. 9890 Speaker, on page 43.

Part No.

15135	Cone Housing Assembly.....
15041	Insulating Card Screw.....
15085	Insulating Card Solder Clip.....
15142	Diaphragm Assembly.....
15133	Diaphragm Centering Washer.....
15134	Diaphragm Insulating Washer.....
15138	Case and Coil Assembly.....
15631	Field Coil Only.....
15118	Back Plate.....
15139	Centering Plate Assembly.....
15131	Case and Coil Mounting Bolt.....
15627	Case and Coil Mounting Washer.....
15227	Cable and Plug Assembly.....

MODEL F-4, No. 14380 POWER SPEAKER

NOTE:—All parts not listed below will be found under Model F, No. 9890 Speaker, on page 43.

Part No.

13843	Frame.....
14368	Cone Housing Assembly.....
15595	Case and Coil Assembly, Complete.....
15635	Field Coil Only.....
15559	Front Spacer Ring.....
15708	Back Plate.....
15193	Case and Coil Mounting Bolt.....
15561	Case and Coil Mounting Washer.....
15226	Cable and Plug Assembly.....
15113	Cable Connecting Card.....
14212	Plug Only.....
15579	Shipping Container.....

MODEL F-4C, No. 14410 POWER SPEAKER

NOTE:—All parts not listed below are same as Model F-4, No. 14380 Speaker (above).

Part No.

15611	Cone Housing Assembly.....
15612	Case and Coil Assembly, Complete.....
15572	Back Stud.....
15227	Cable and Plug Assembly.....
15578	Shipping Container.....

Refer to numerical list for prices.

MODEL 55-F, No. 15600 SCREEN-GRID SET (25 CYCLE)

Note:—All parts not listed below are same as Model 55, No. 14900 Set on pages 51, 52, 53.

Part No.

14730 Cabinet Assembly, Complete.....
14720 Condenser Unit.....
14740 Power Trans. Unit.....
16065 Power Trans. Unit Lid.....
16055 A. F. Grid Bias Resis (2 used).....
16056 Fil. Shunt Resis.....

Part No.

15881 2nd Audio Tube Plate.....
15997 Speaker Plug and Rect. Tube Plate....
16067 Literature Assembly.....
16066 Instruction Book.....
16068 Shipping Container.....

MODEL 55-F-C, No. 15700 SCREEN-GRID SET (25 CYCLE)

Note:—All parts not listed below are same as Model 55-F, No. 15600 Set, above.

Part No.

15676 Front Panel Assembly.....
14750 Power Trans. Unit.....
16069 Shipping Container.....

MODEL F-6, No. 14480 POWER SPEAKER

Note:—All parts not listed below will be found under Model F-4, No. 14380 Speaker, on Page 54.

Part No.

15869 Case and Coil Assembly.....
15854 Field Coil Only.....
15142 Diaphragm Assembly.....
15805 Shipping Container.....

MODEL F-6-C, No. 14490 POWER SPEAKER

Note:—All parts not listed below will be found under Model F-4, No. 14380 Speaker, on Page 54.

Part No.

15874 Cone Housing Assembly.....
15855 Case and Coil Assembly.....
15572 Back Stud.....
15227 Cable and Plug Assembly.....
15806 Shipping Container.....

MODEL F-7, No. 14510 POWER SPEAKER

Note:—All parts not listed below will be found under Model F-4, No. 14380 Speaker, on Page 54.

Part No.

15872 Case and Coil Assembly.....
15863 Field Coil Only.....
15807 Shipping Container.....

MODEL F-7-C, No. 14520 POWER SPEAKER

Note:—All parts not listed below will be found under Model F-4, No. 14380 Speaker, on Page 54.

Part No.

15875 Cone Housing Assembly.....
15864 Case and Coil Assembly.....
15863 Field Coil Only.....
15227 Cable and Plug Assembly.....
15808 Shipping Container.....

Refer to numerical list for prices.

MODEL F-2-A No. 14760 POWER SPEAKER

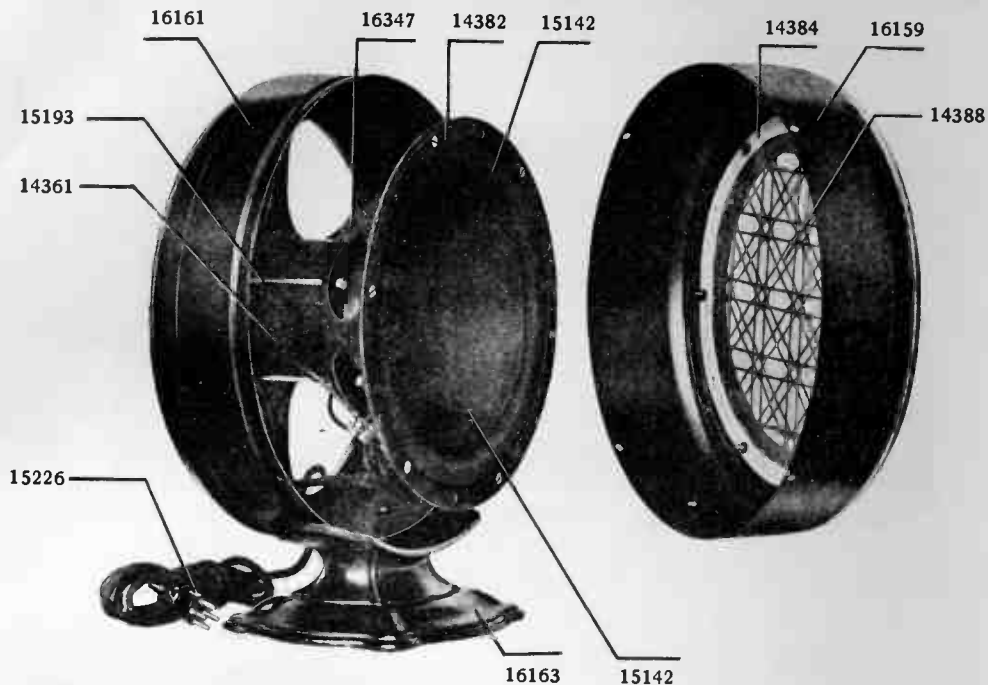

Note:—All parts not listed below will be found under Model F, No. 9890 Speaker, on Page 43.

Part No.

16159	Front Frame.....
16161	Back Frame.....
16448	Frame Screw.....
16163	Base.....
16347	Cone Housing Assembly.....
16215	Shipping Container.....
15142	Diaphragm Assembly.....

MODEL F-4-A, No. 14770 POWER SPEAKER

Note:—All parts not listed below are same as Model F-2-A, No. 14760 Speaker (above).

Part No.

16348	Cone Housing Assembly.....
16131	Shipping Container.....

MODEL F-6-A, No. 14780 POWER SPEAKER

Note:—All parts not listed below are same as Model F-6, No. 14480 Speaker, on page 55.

Part No.

16159	Front Frame.....
16161	Back Frame.....
16163	Base Assembly.....
16349	Cone Housing Assembly.....
16216	Shipping Container.....

MODEL F-7-A, No. 14790 POWER SPEAKER

Note:—All parts not listed below are same as Model F-7, No. 14510 Speaker on Page 55.

Part No.

16159	Front Frame.....
16161	Back Frame.....
16351	Cone Housing Assembly.....
16163	Base Assembly.....
16217	Shipping Container.....

Refer to numerical list for prices.

MODEL 60, No. 15000 SCREEN-GRID SET

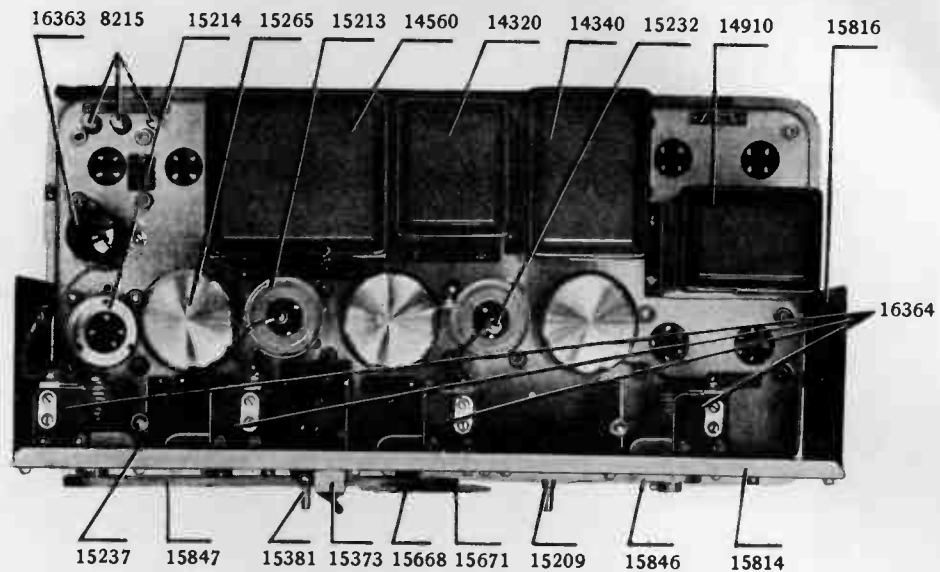

Note:—All parts not listed below will be found under Model 55, No. 14900 Set, on Pages 51, 52, 53.

14620 CABINET ASSEMBLY, COMPLETE

Part No.

- 15692 Body Assembly.....
- 13701 Lid.....
- 16236 Escutcheon.....

- 14250 VOLUME CONTROL UNIT.....
(Used in sets below serial No. 3,100,001)

Note:—See Page 51.

FINAL BASE ASSEMBLY

Part No.

- 16363 R. F. Coil Group.....
(Used in sets below serial No. 3,100,001)
- 16984 R. F. Coil Group.....
(Used in sets above serial No. 3,100,001)
- 15842 R. F. Coil Shield (1 used).....
- 15265 R. F. Coil Shield (3 used).....
- 14560 Power Trans. Unit.....
- 15876 Top Shield Support.....
- 14910 Input and Output Trans. Unit.....

- 15170 DUAL VOLUME CONTROL UNIT.....
(Used in sets above serial No. 3,100,001)

Part No.

- 16576 Volume Control Cover.....

MAIN PANEL ASSEMBLY

Part No.

- 15814 Main Panel Only.....
- 15826 Angle Shield (1 used).....
- 15237 Angle Shield (2 used).....
- 15816 R. H. End Shield.....
- 15817 L. H. End Shield.....
- 15823 Top Shield.....

15443 TOGGLE SWITCH ASSEMBLY

Note:—See Page 53.

15405 LAMP SOCKET ASSEMBLY

Note:—See Page 51.

15501 DOUBLE CONDUCTOR CORD AND PLUG

Note:—See Page 53.

VARIABLE CONDENSER ASSEMBLY

Part No.

- 16364 Condenser Group.....
- 15845 Short Belt.....
- 15846 Long Belt.....
- 15847 Extra Long Belt.....

SET PARTS

Part No.

- 15591 Literature Assembly.....
- 15588 Instruction Book.....
- 15852 Shipping Container.....

Refer to numerical list for prices.

MODEL 60, No. 15000 SCREEN-GRID SET (Cont'd)

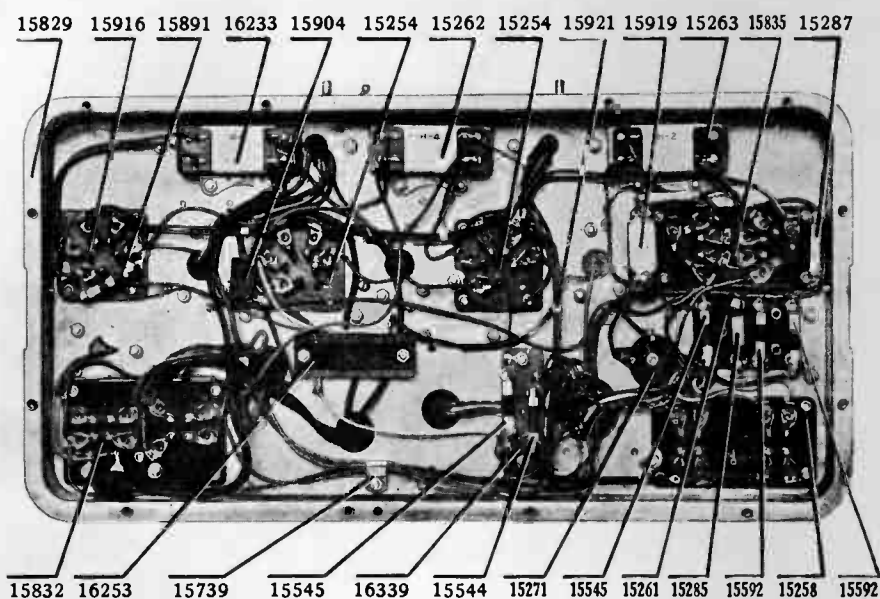

SUB-BASE ASSEMBLY

Part No.

16339	Two Resis. Base
15829	Base Plate Only
16362	Base Plate, Sockets, Nameplates
15832	Rect. and Speaker Plug Socket
15916	R. F. Socket (1 used)
15254	R. F. Socket (2 used)
15891	Screen-Grid Resis. No. 2 (black and red)
16295	Bleeder Resis.
16253	1st R. F. Bias Resis.
15835	Det.-1st Audio Socket
15804	Det.-1st Audio Nameplate
15803	Rect. and Speaker Plug Nameplate
15984	2nd Audio Nameplate
16233	No. 1 Bypass Condenser
15262	No. 2 Bypass Condenser
15263	No. 3 Bypass Condenser
15904	R. F. Grid Bias Resis.
15919	Phone Condenser
15271	R. F. Choke (1 used)

Part No.

16659	R. F. Choke (3 used)
	(Above Serial No. 3,100,001)
16724	Resistor, white (1 used in later models)
16725	Resistor, black and yellow (1 used in later models)

15386 DISTANCE SWITCH ASSEMBLY (Used in sets below serial No. 3,100,001)

Note:—See Page 51.

16871 DISTANCE SWITCH ASSEMBLY (Used in sets above serial No. 3,100,001)

Part No.

15383	Base Assembly
15381	Shaft
15374	Blade
16788	Distance Switch Condenser
	(Black Rubber Covered Lead)

MODEL 60-C, No. 15100 SCREEN-GRID SET

Note:—All parts for Model 60-C, No. 15100 Set are same as Model 60, No. 15000 Set with the following exceptions.

Part No.

16241	Front Panel Assembly
16236	Escutcheon
15946	Shipping Container

Note:—Where Serial No. 3,100,001 is referred to in Model 60 Set, Serial No. 5,500,001 should be used when ordering parts for Model 60-C Set.

Refer to numerical list for prices.

MODEL 61, No. 15300 SCREEN-GRID SET (D. C.)

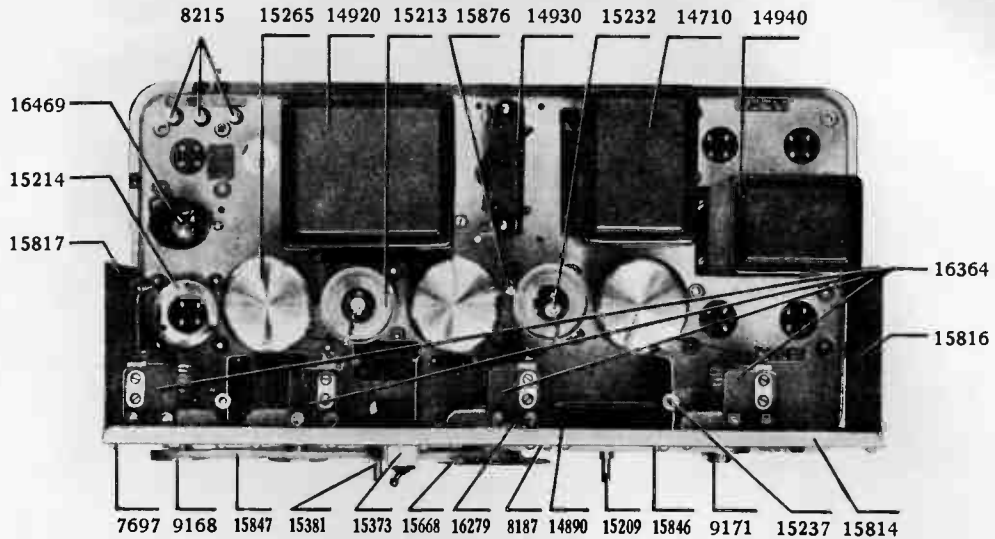

Note:—All parts not listed below will be found under Model 55, No. 14900 Set, on pages 51, 52, 53.

14950 CABINET ASSEMBLY, COMPLETE

<i>Part No.</i>	
15692	Body Assembly
13701	Lid.
16238	Escutcheon

14890 VOLUME CONTROL UNIT

<i>Part No.</i>	
14857	Contact Arm
15211	Housing
15209	Shaft
15297	Resistance

FINAL BASE ASSEMBLY

<i>Part No.</i>	
16469	R. F. Coil Group
15842	R. F. Coil Shield (1 used)
15265	R. F. Coil Shield (3 used)
14920	Power Choke Unit
14710	Condenser Unit
14940	Audio Unit

LAMP SOCKET ASSEMBLY

<i>Part No.</i>	
16279	Socket Assembly Only
16099	Lamp

SET PARTS

<i>Part No.</i>	
16305	Literature Assembly
16246	Instruction Book
16071	Shipping Container
15679	Dial Knob Assembly
15787	Vol. Cont. and Dis. Switch Knob

16358 TOGGLE SWITCH ASSEMBLY

<i>Part No.</i>	
13664	Toggle Switch Only
15373	Bracket

14930 FILAMENT RESISTANCE ASSEMBLY

<i>Part No.</i>	
16432	Fil. Series Resis. No. 2
16433	Fil. Series Resis. No. 1
16434	A. F. Fil. Shunt Resis.

16364 VARIABLE CONDENSER ASSEMBLY

Note:—See Page 57.

15386 DISTANCE SWITCH ASSEMBLY

Note:—See Page 51.

Refer to numerical list for prices.

MODEL 61, No. 15300 SCREEN-GRID SET (D. C.) (Cont'd)

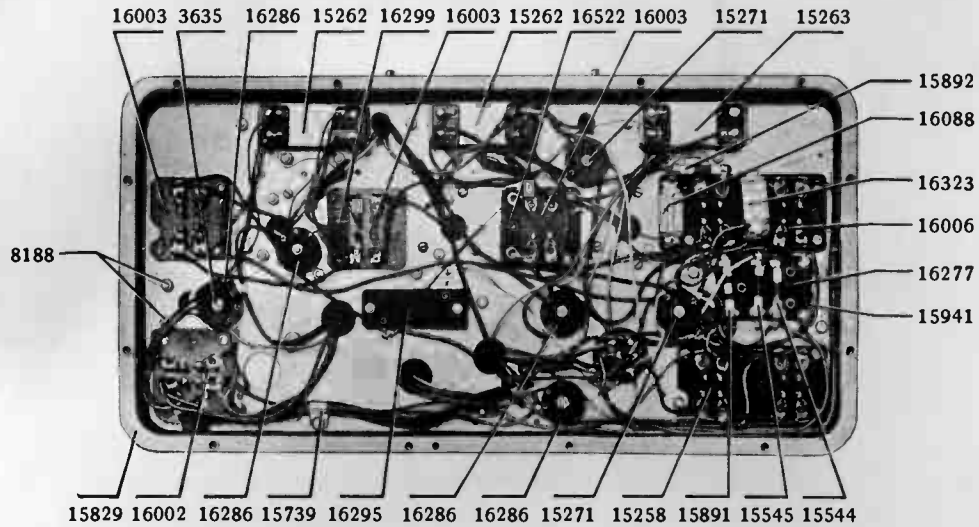

SUB-BASE ASSEMBLY

Part No.

- 15829 Base Plate Only.....
- 16468 Base Plate, Sockets, Nameplates.....
- 15882 Speaker Plug Plate.....
- 15878 R. F. Tube Plate.....
- 15879 Det.-1st Audio Tube Plate.....
- 15881 2nd Audio Tube Plate.....
- 16002 Speaker Plug Socket.....
- 15258 2nd Audio Socket.....
- 16277 Four Resistance Base Assembly.....
- 15271 R. F. Choke (2 used).....

Part No.

- 16286 R. F. Choke (4 used).....
- 16295 Bleeder Resis.....
- 16522 3rd R. F. Fil. Shunt Resis.....
- 16323 Double Phone Condenser.....
- 16088 Grid Condenser.....
- 16322 Bias Resis. Green Covered (2 used)....
- 15891 Screen-grid Resis. No. 2 (red and black)
- 15941 Det. Plate Resis. (purple and yellow)..
- 15892 Grid Leak (green).....
- 16299 2nd R. F. Grid Bias Resis.....

MODEL 61-C, No. 15400 SCREEN-GRID SET (D. C.)

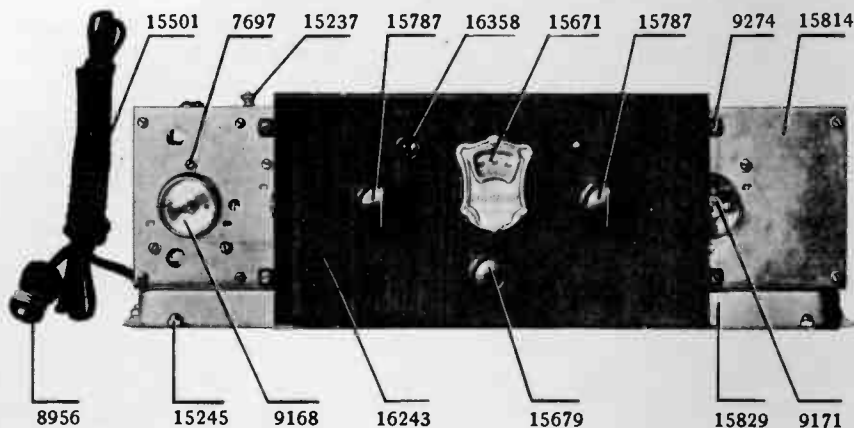

Note:—All parts not listed below are same as Model 61, No. 15300 Set, on Page 59, with the following exceptions.

Part No.

- 16243 Front Panel Assembly.....
- 16238 Escutcheon.....
- 16072 Shipping Container.....

Refer to numerical list for prices.

MODEL 67, No. 15500 SCREEN-GRID SET (BATTERY)

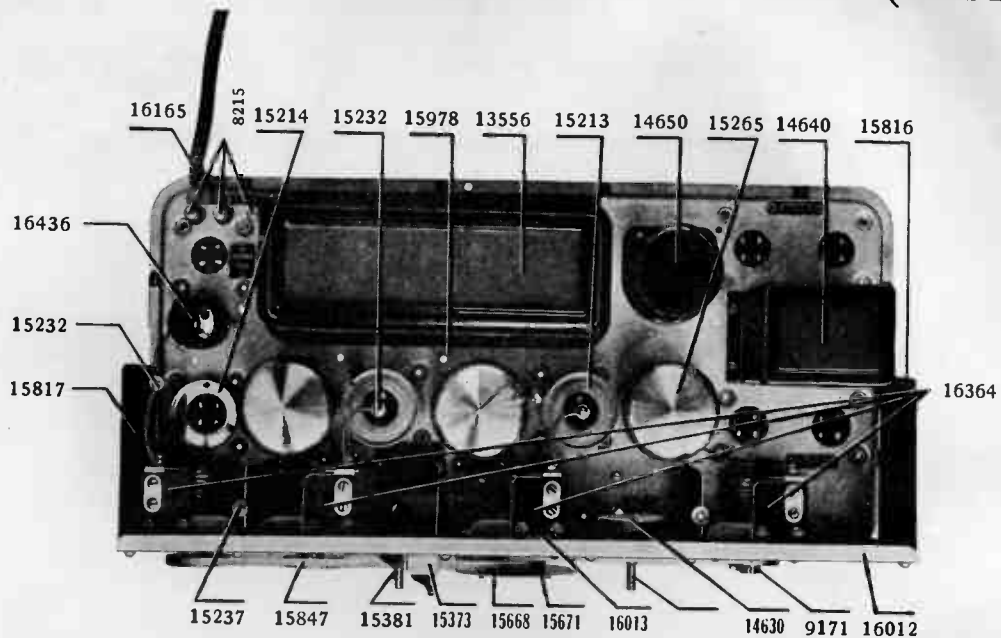

Note:—All parts not listed below will be found under Model 55, No. 14900 Set, on Pages 51, 52, 53.

14660 CABINET ASSEMBLY, COMPLETE

Part No.	
15692	Body Assembly.....
13701	Lid.....
16237	Escutcheon.....

VARIABLE CONDENSER ASSEMBLY

Part No.	
16364	Condenser Group.....
15845	Short Belt.....
15846	Long Belt.....
15847	Extra Long Belt.....

FINAL BASE ASSEMBLY

Part No.	
16436	R. F. Coil Group.....
15842	R. F. Coil Shield (1 used).....
15265	R. F. Coil Shield (3 used).....
15978	"C" Battery Container.....
13556	"C" Battery Container Lid.....
14640	No. 1 and No. 2 A. F. Trans. Assembly.....
14650	Output Trans. Unit.....
15876	Top Shield Support.....
16165	Battery Cable.....

LAMP SOCKET ASSEMBLY

Part No.	
16013	Socket Assembly.....
16099	Lamp.....

16045 TOGGLE SWITCH ASSEMBLY

Part No.	
16283	Toggle Switch Only.....
15373	Bracket.....
16037	Insulation Sleeving.....

MAIN PANEL ASSEMBLY

Part No.	
16012	Panel Only.....
15826	Angle Shield (1 used).....
15237	Angle Shield (2 used).....
15823	Top Shield.....
15876	Top Shield Support.....

SET PARTS

Part No.	
16101	Literature Assembly.....
16058	Instruction Book.....
16032	Shipping Container.....

15386 DISTANCE SWITCH ASSEMBLY

Note:—See Page 51.

14630 VOL. CONT. UNIT, COMPLETE

Refer to numerical list for prices.

MODEL 67, No. 15500 SCREEN-GRID SET (BATTERY) (Cont'd.)

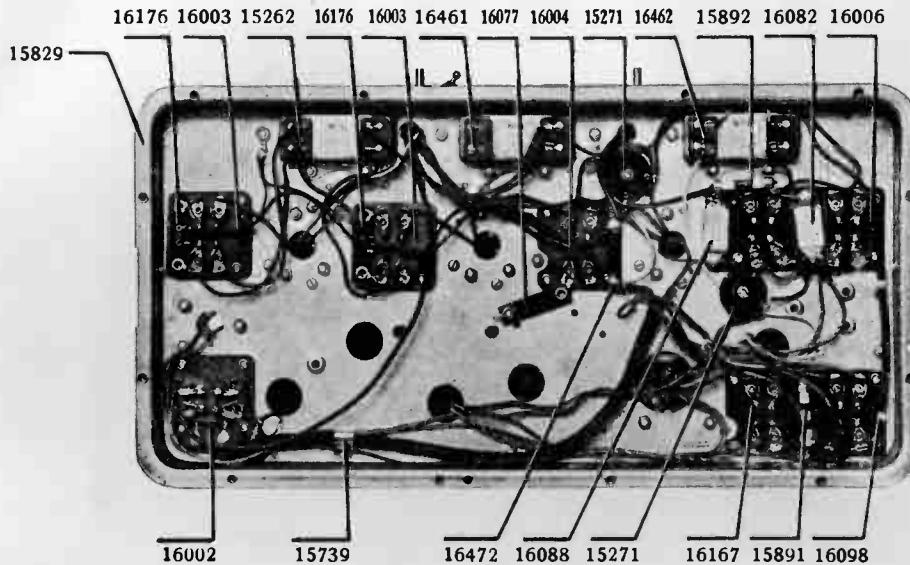

SUB-BASE ASSEMBLY

<i>Part No.</i>		<i>Part No.</i>	
15829	Base Plate Only	16077	3rd R. F. Fil. Resis.
16435	Base Plate, Sockets, Nameplates	16472	3rd R. F. Screen Resis. (purple and red) ..
15878	R. F. Tube Plate	15892	Grid Leak (green)
15879	Det.-1st Audio Tube Plate	15891	Det. Plate Resis. (red and black)
15881	2nd Audio Tube Plate	16081	Det. A. F. Fil. Resis. (yellow tubing) ..
15877	Speaker Plug Plate	16082	Double Phone Condenser
16002	Speaker Plug Socket	16088	Grid Condenser
16003	R. F. Socket (2 used)	16098	Group Leads
16004	R. F. Socket (1 used)	15739	Wire Clamp
16167	2nd Audio Socket	15262	R. F. By-pass Condenser
16006	Det.-1st Audio Socket	16461	Bypass Condenser
15945	Model Nameplate	16462	Bypass Condenser
16176	1st and 2nd R. F. Fil. Resis. (2 used) ..		

MODEL 67-C, No. 15200 SCREEN-GRID SET (BATTERY)

Note:—All parts for Model 67-C, No. 15200 Set are same as Model 67, No. 15500 Set, with the following exceptions.

<i>Part No.</i>	
16243	Front Panel Assembly
16033	Shipping Container

Refer to numerical list for prices.

MODEL 66, No. 15800 SCREEN-GRID SET (CONSOLE)

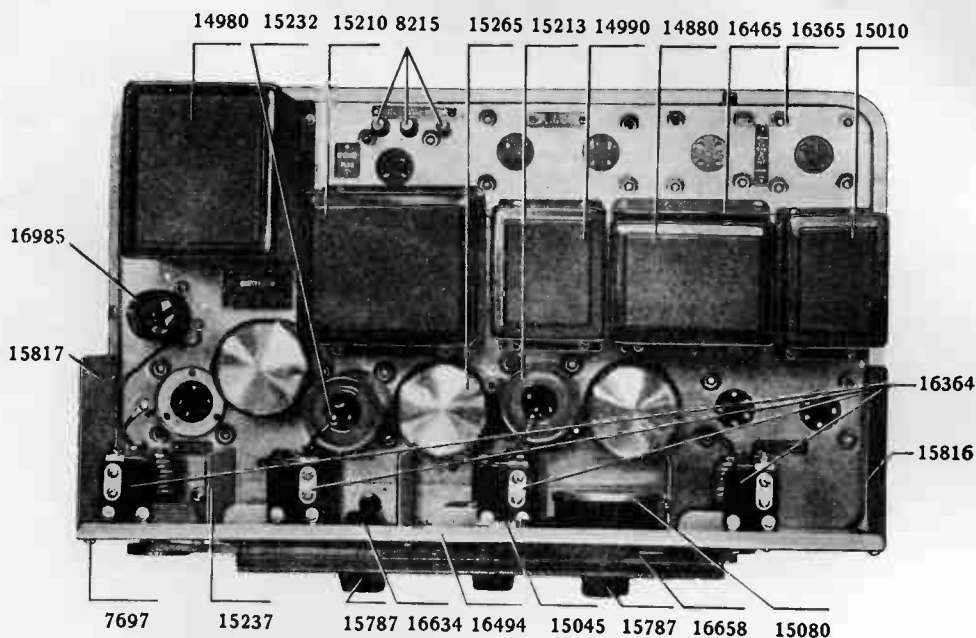

Note:—All parts not listed below will be found under Model 55, No. 14900 Set, on Pages 51, 52, 53.

FINAL BASE ASSEMBLY

Part No.

16985	R. F. Coil Group.....
15265	R. F. Coil Shield (3 used).....
15842	R. F. Coil Shield (1 used).....
14980	Power Trans. Unit.....
15210	Filament Trans. Unit.....
14990	Filter Choke Unit.....
14880	Condenser Unit.....
15010	Input and Output Unit.....
16396	Condenser Unit Cover.....
16465	Condenser Unit Shield.....

15080 VOLUME CONTROL UNIT.....
Used in early sets.

Part No.

15170 VOLUME CONTROL UNIT.....
Used in later sets.

Note:—See Page 57.

MAIN PANEL ASSEMBLY

Part No.

16494	Main Panel Only.....
15237	Angle Shield (2 used).....
15826	Angle Shield (1 used).....
15816	R. H. End Shield.....
15817	L. H. End Shield.....
15823	Top Shield.....

16634 TOGGLE SWITCH ASSEMBLY.....

16658 FRONT PANEL ASSEMBLY,
COMPLETE.....

Part No.

16632	Front Panel Only.....
16239	Escutcheon.....

Refer to numerical list for prices.

MODEL 66, No. 15800 SCREEN-GRID SET (CONSOLE) (Cont'd)

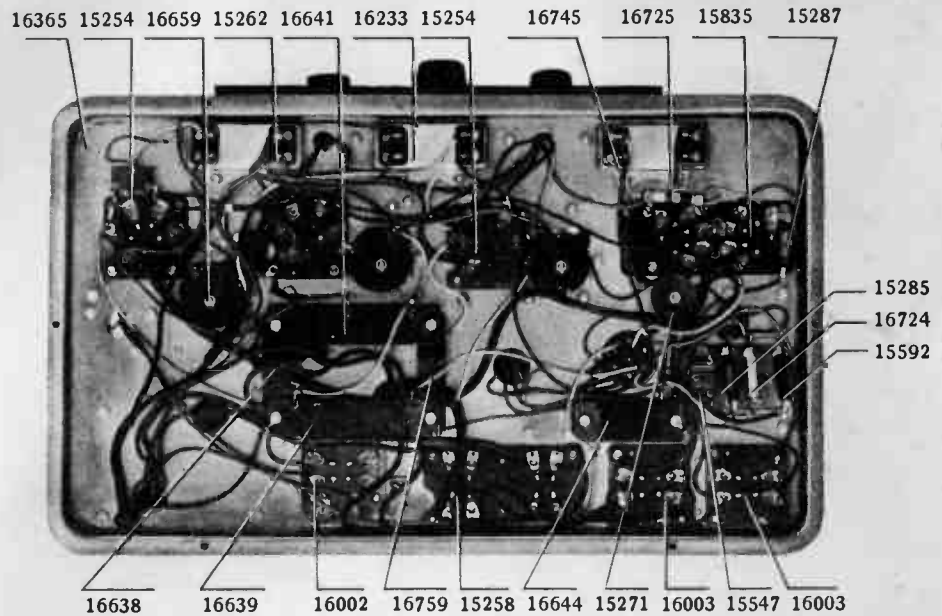

SUB-BASE ASSEMBLY

Part No.

- 16365 Base Plate Only.....
- 16986 Base Plate, Sockets, Nameplates.....
- 15254 R. F. Socket.....
- 15835 Det.-1st Audio Socket.....
- 16003 2nd Audio Socket.....
- 15258 Rectifier Socket.....
- 16002 Speaker Plug Socket.....
- 16724 Detector Filter Resis. (white).....
- 16725 Detector Bias Resis. (black and yellow).....
- 15287 1st A. F. Grid Leak (blue).....
- 15592 Detector Coupling Resis. (black).....
- 15262 No. 1 R. F. By-pass Condenser.....
- 16233 No. 2 R. F. By-pass Condenser.....
- 16745 Detector By-pass Condenser.....

16364 VARIABLE CONDENSER GROUP..

Note:—See page 57.

15501 DOUBLE CONDUCTOR CORD AND
PLUG.....

Note:—See page 53.

Part No.

- 15285 1st A. F. Filter Resis. (gray).....
- 15547 2nd A. F. Fil. Shunt Resis.....
- 15547 R. F. Det. 1st A. F. Fil. Shunt Resis.....
- 16641 Bleeder Resis. No. 1.....
- 16759 Bleeder Resis. No. 2.....
- 16638 1st R. F. Bias Resis.....
- 16639 R. F. Resis.....
- 16768 R. F. Bias Resis.....
- 16643 1st A. F. Bias Resis.....
- 16644 2nd A. F. Grid Filter Resis.....

15405 LAMP SOCKET ASSEMBLY.....

Note:—See page 51.

SET PARTS

Part No.

- 16687 Literature Assembly.....
- 16523 Instruction Book.....
- 16456 Shipping Container.....

Refer to numerical list for prices.