

\*\*\*\*\*3-DIGIT 857  
J750970 D08 9203 5894 999

TOM MILLER  
ASST CE  
KTZR  
2033 S AUGUSTA PL  
TUCSON AZ 85710

# Radio World

**Fundamentals  
of AC:**  
A 10-Part Course  
Beginning This  
Issue, p. 18

Vol 16, No 23

Radio's Best Read Newspaper

December 9, 1992

## Promotions Generate Revenue

by Bruce Ingram

**CHICAGO** Twenty years ago, a bumper sticker was just a bumper sticker—a low cost mini-billboard and nothing else.

Now it is a different story. Radio station bumper stickers and most other promotional items are expected to pay their own way and perhaps even turn a profit.

In an era of ever tightening advertising budgets, when radio stations are often tuned out by agencies, radio promotion efforts have become increasingly important to the station's bottom line.

### No money for fun stuff

Annette Hauck, an account executive for Pensacola, Fla.-based 'Mo Money Associates, says she has noticed a gradual slowdown over the past few years in radio station buys of logo-emblazoned giveaways such as umbrellas, sunglasses, t-shirts, balloons, arm garters, disposable shavers, cigarette lighters, towels and dozens of other purely promotional items in the company's 132-page catalogue.

"That's their fun stuff," she said. "It's the first thing to go when times get tough."

But the opposite is true for promotional items with revenue generating potential. Bumper stickers, for example, have increased in value to radio stations since someone had the bright idea of printing coupons on the peel-off backing of the decals.

Hauck recalled with admiration one customer who managed to print 10 coupons on the back of one 3x11-inch sticker. "That was particularly ambitious," she said. "He probably made money on the deal."

In addition to bumper stickers, Hauck said radio stations have been getting considerable mileage out of other 'Mo Money products such as half-sized credit cards designed to be worn on key chains. One side is stamped with the logo of the station and the other becomes a long-term coupon for a car wash or some other local advertiser offering discounts for cardholders.

### Involve the retailer

Some stations go even further on the promotion side with the key cards, she observed, by stamping serial numbers on them and using them to give away hourly prizes to listeners.

Hauck said she has even seen coffee mugs used in a similar way, one side advertising the station and another touting a local bakery or coffee shop chain, allowing customers to bring in their mugs for special deals.

In her opinion, very few stations make money on these deals, but they do profit in terms of getting their logo into circulation in the market-

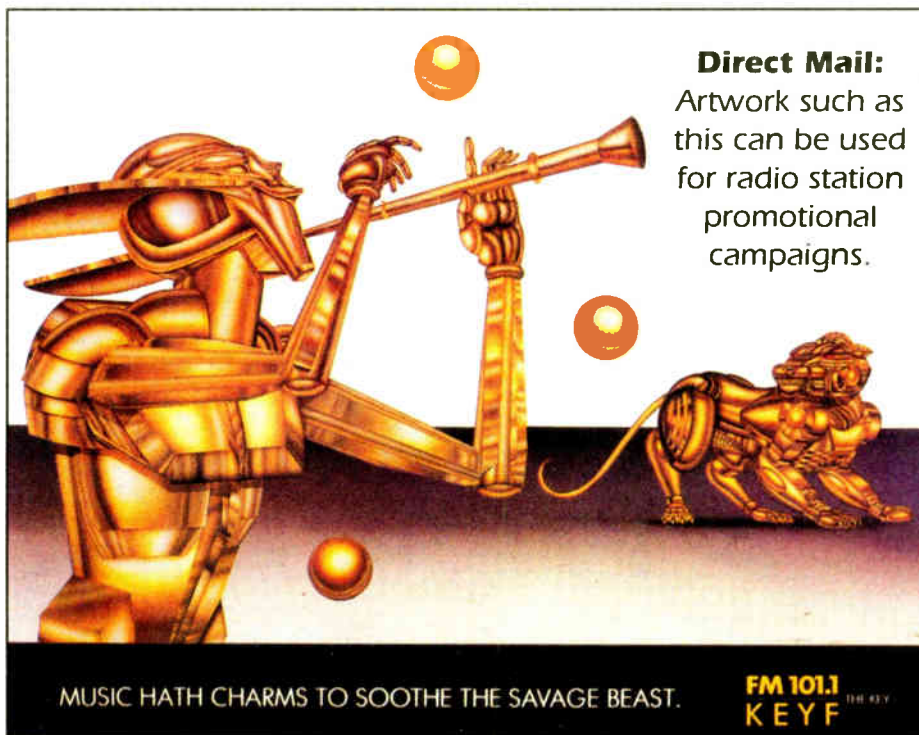

**Direct Mail:**  
Artwork such as this can be used for radio station promotional campaigns.

place for little or no cost. "I think these techniques are basically a way for stations to break even on their promotions," she said. "They're happy just to get help paying for these things."

Rick Lawrence, president of Broken Arrow, Okla.-based Communication Graphics, disagrees with Hauck. Communication Graphics has specialized

in the design and production of radio decals for more than 20 years. "When you take a critical piece of promotion and tie it to a way to generate revenue, you really have a win/win situation."

### Not the same old sticker

Some stations have made "significant profits" using bumper stickers as pro-



Have You Heard What's So Great About WNWV...

Artwork courtesy of Broadcast Direct

motional/advertising media he said, though it's often difficult to isolate actual profit figures because the coupons are generally offered as part of a client's overall advertising package.

In such a case, the decal becomes something extra for station advertisers, encouraging them to buy additional air time or to favor radio over other media such as newspapers.

"Couponing works very well for radio because stations can target a very specific audience," Lawrence said. "When you run a coupon in a newspaper, you are really shooting at a pretty broad demographic."

continued on page 29 ▶



## Meet A New World Leader.

Introduced a year ago, the Audio-metrics CD 10 has become the market leader in the US- the world's toughest radio market. It's the only broadcast-ready CD player with cartridge auto-lock, programmable EOM indicator and instant music start.

So, take the lead and put this outstanding performer to work for you.

USA Phone: 1-800-622-0022  
Fax: 317-966-0623  
Canada Phone: 1-800-268-6817  
Fax: 416-764-0729

**HARRIS  
ALLIED**

## Future of SBE Show Negotiated

by John Gatski

**WASHINGTON** With continued low attendance at the Society of Broadcast Engineers (SBE) national conventions, could the 1993 Miami gathering be the organization's last national show?

SBE officials reportedly are trying to work out an agreement with the NAB that would give the SBE control of the technical sessions at the NAB spring show. Under the terms of the agreement, the SBE national convention could be eliminated.

If such an agreement is reached, the SBE, in conjunction with its chapters, likely would continue to hold regional shows, such as the successful Seattle and St. Louis events.

NAB Science and Technology Engineer Andy Butler confirmed that the SBE's coordination of the technical sessions and

continued on page 10 ▶

Circle (96) On Reader Service Card

World Radio History



# NEWSWATCH

## SBE Elects New Officers

**SAN JOSE, Calif.** Newly elected Society of Broadcast Engineers (SBE officers for 1992-1993 are: President (second term), Richard Farquhar, Television Systems, Canal Winchester, Ohio; Vice President, Charles Kelly, Broadcast Electronics, Quincy, Ill.; Secretary, Marvin C. Born, WBNS stations, Columbus, Ohio; and Treasurer (second term), Robert Goza, KMOV, St. Louis.

Six board of directors seats were filled, each for two-year terms. Those elected were: Phil Aaland, KCET, Hollywood, Calif.; David Carr, KHOU-TV, Houston;

Dane Eriksen, Hammett and Edison, San Francisco; Ed Miller, WEW-TV, Cleveland; Robert Reymont, Nationwide Communications, Mesa, Ariz.; Martin "Sandy" Sandberg, Current Technology, Richardson, Texas.

The other six seats were not up for elections, with all current holders continuing their terms.

## Swanson Receives SBE Honorary Membership

**SAN JOSE, Calif.** Hilmer Swanson, a well known AM technology innovator, has been selected as a Society of Broadcast

Engineers (SBE) honorary member. The award was made at the recent SBE convention in San Jose.

Swanson, who is senior staff scientist for Harris-Allied's broadcast division, joined the company in 1965. He has pioneered such innovations as pulse-duration modulation, progressive amplitude modulation and polyphase modulation. In 1986, Swanson was awarded a patent for digital amplitude modulation used in Harris' DX transmitter line.

Former ABC Broadcast Operations & Engineering President Julius Barnathan also received an honorary SBE membership.

Other award winners honored at the SBE convention included Engineer of the Year, Terry Baum, Criterion Broadcast Services, Milwaukee; Fellow of SBE, Paul Lentz,

Sylvania, Ohio; SBE Educator of the Year, Jerry Whitaker; and SBE Technology Award, George Yazell, Lakeland, Fla.

## NAB Files Against Satellite CD Radio

**WASHINGTON** The NAB has filed a petition to deny Satellite CD Radio's proposed satellite digital audio radio service application, which was cleared for filing by the FCC in October.

Satellite CD Radio plans to construct, launch and operate a digital audio radio service consisting of two geostationary satellites with complementary terrestrial repeaters in urban areas. The system would provide high rate digital audio, among other services, to subscribers.

The NAB said the FCC action is premature, given the status of digital audio broadcasting in the U.S.

The FCC decision to move on the Satellite CD Radio filing comes "despite the absence of any policy determinations as to the shape, structure or goals of DAB (digital audio broadcasting)," according to the NAB's petition to deny.

## New EBS Technology Demos Scheduled at FCC

**WASHINGTON** The FCC has scheduled demonstrations of new Emergency Broadcast System (EBS) alerting technology. ▶

# A Little Bit of MAGIC...



## Revealed!

**THE R-10 IS BASED ON A SIMPLE PREMISE:** Low cost does not have to be synonymous with low quality (as is so often experienced). When you've got Audioarts' experience and expertise, value engineering becomes a task of carefully defining the features required and manufacturing in an efficient manner, utilizing the best of computer and machine technology.

**THE RESULTS ARE SELF-EVIDENT:** the R-10 is a fully modular console, with the componentry you'd expect to see in a much larger design. *No other console in its price range can even come close!*

The R-10 has gold audio switches, gold edgcard connectors, conductive plastic faders, conductive plastic monitor pots, fully burned-in socket-mounted ICs, industry standard machine control switches and, of course, documentation and instructions that make installation really simple.

With the R-10 you can take advantage of Audioarts' reputation and experience, and be assured that quality and performance will be yours.

**AUDIOARTS ENGINEERING**

6720 V.I.P. Parkway, Syracuse, NY. (tel 315-455-7740/fax 315-454-8104)

# Index

## FEATURES

<b>Radio Station Honored as 'Point of Light'</b> by Dee McVicker	<b>13</b>
<b>Refurbish an Old Console For Fun and Practicality</b> by Jim Somich	<b>14</b>
<b>Marconi Prepares to Cross the Atlantic</b> by George Riggins	<b>15</b>
<b>Assessing the Value of Directional AMs</b> by W.C. Alexander	<b>16</b>
<b>Basic Properties of Alternating Current</b> by Ed Montgomery	<b>18</b>
<b>Suggested Review for Self-Inspection</b> Harold Hallikainen	<b>22</b>
<b>Pro Audio Editing on a Budget</b> by Bruce Bartlett with Jenny Bartlett	<b>23</b>
<b>High-Tech Gadgetry Demands Sharper Skills</b> by Barry Mishkind	<b>24</b>
<b>Radio Today Is Same as It Never Was</b> by John "O" Shepler	<b>24</b>

## RUNNING RADIO

<b>Proper Staffing a Must for Switching to Satellite</b> by Karl Baehr and Harry Nelson	<b>29</b>
<b>Design Room Noise Out of Your Studio</b> By Edwin Bukont	<b>31</b>
<b>Vying for CHR's Lost Audience</b> by Charles Taylor	<b>32</b>
<b>Country Music Evolved with Medium</b> by James Wold	<b>38</b>
<b>Help Clients to Help Your Bottom Line</b> by John Cummuta	<b>39</b>



# Final Vote on RBDS Standard Shows Nearly Complete Support

by John Gatski

**WASHINGTON** The National Radio Systems Committee (NRSC) has approved a U.S. Radio Broadcast Data Systems (RBDS) standard, based on final ballot comments that were due back on Nov. 9.

According to John Marino, the NAB's director of technical regulatory affairs, no major negative comments were received on the final NRSC ballots. "Essentially, it was overwhelmingly

approved," he said.

The final ballots sent back by NRSC members contained no technical objections, but Marino said there are some editorial changes to be made to the standard text. The official announcement of the standard's approval will be made at the Winter Consumer Electronics Show (WCES) in January as part of the industry-wide promotion of RDS.

Also at WCES, most major receiver manufacturers will take part in a joint display and demonstration of RBDS receivers. About five Las Vegas radio stations will be broadcasting RBDS signals, and RBDS encoder manufacturers will provide set-up and support.

The RBDS standard was adopted within a short time period (its U.S. debut demonstration was made in 1989). It is based on the European-developed RDS technology, allowing station tuning by format, receiver text display, automatic emergency alerting, and automatic switching between transmitters or translators.

The first NRSC ballots on the RBDS standard that were returned Sept. 30 contained only a few objections to the proposed standard, mostly centered around the program type (PTY) continued on page 10 ▶

## RBDS: Program Type Codes

PROGRAM TYPE	8 CHARACTER DISPLAY
0. No Program Type Code	****
1. News	NEWS
2. Information	INFORM
3. Sports	SPORTS
4. Talk	TALK
5. Rock	ROCK
6. Classic Rock	CLS_ROCK
7. Adult Hits	ADLT_HIT
8. Soft Rock	SOFT_RCK
9. Top 40	TOP_40
10. Country	COUNTRY
11. Oldies	OLDIES
12. Soft	SOFT
13. Nostalgia	NOSTALGIA
14. Jazz	JAZZ
15. Classical	CLASSICL
16. R&B	R_&B
17. Soft R&B	SOFT_R&B
18. Language	LANGUAGE
19. Religious Music	REL_MUSC
20. Religious Talk	REL_TALK
21. Personality	PERSNLTY
22. Public	PUBLIC
23-29. Spares	
30. Emergency Test	TEST
31. Emergency	ALERT!

Note 1: It is anticipated that the codes listed above will cover most existing formats and will be capable of handling the future evolution of new formats.

Note 2: \_ refers to a space in 8 character display

# NEWSWATCH

▶ continued from previous page  
gies on Dec. 11, at the FCC in Washington.

In a recent rulemaking procedure, the FCC embarked on a plan to replace the current two-tone EBS alerting systems with a system that incorporates elements of the RDS, WRSAME and the current two-tone system.

## NAB Wants SBAC Expanded

**WASHINGTON** The NAB has asked for increased broadcaster representation on the FCC's Small Business Advisory Council (SBAC), which has been allotted only two broadcaster slots.

In a letter to FCC Chairman Al Sikes, NAB President/CEO Eddie Fritts said the SBAC's "limited representation of broadcasters...will work against the goal of providing the Commission with thorough guidance on expanded mass media involvement of minority and small businesses."

In a recent ownership ruling, the Commission said it wants to encourage more participation by minorities and small business in broadcasting.

## President Signs DAT Bill

**WASHINGTON** As expected, President Bush has signed the Audio Home Recording Bill, the so-called "DAT Bill."

The legislation requires copy-limiting circuitry in all consumer digital recording machines, including DAT, MD, DCC, recordable CDs and any new technologies. It also requires the manufacturers to pay royalties on blank recording media and each recording machine.

Critics believe the copy-limiting function requirement will hinder semi-professionals and professionals, such as radio stations, that use consumer recorders.

## New FCC Forms Available

**WASHINGTON** Broadcasters can now use the revised FCC Form 301 (application for construction permit for commercial broadcast station, August 1992 edition.)

Since many applicants may be far along in completing the old forms, the Commission will continue accepting applications on the old forms, supplemented by exhibits containing the additional information with regard to the national and local radio multiple ownership rules.

The new form eliminates the need to file supplemental information. To obtain the revised forms, contact the FCC: 202-632-FORM, or write FCC Form Distribution Center, 2803 52nd Avenue, Hyattsville, MD 20781.



## Features:

- 56/64 Kb/s Switchable
- Built-in Power Supply
- Portable or Rack Mount
- Complies with CCITT G.722
- 7.5 KHz Full Duplex Audio
- Ideal for Studio-to-Studio Links

**COMREX DIGITAL CODECS** provide wideband, two-way audio to put listeners right at the scene for sports, news, weather and more. The Comrex Codec allows broadcasters to take advantage of the new digital telephone services which are fast becoming an excellent low-cost alternative to satellite links or dedicated lines.

Our codecs can be used with switched 56 Kb/s and 64 Kb/s (ISDN) services as well as dedicated digital lines. The versatility and intelligence built into the Codec assure compatibility with virtually any digital telephone network, so all you have to do is plug it in and turn it on.

Call or fax us for complete information plus our useful notes on "How to Order and Use Digital Phone Service."



Comrex Corporation  
65 Nonset Path, Acton, MA 01720  
800-237-1776 508-263-1800  
Fax 508-635-0401

Comrex (UK) Ltd.  
75 The Grove, Ealing  
London W5 5LL, UK  
081-579-9143 Fax 081-840-0018



**-Proven Technology**  
**-Proven money makers**

Facilities world-wide have adopted the **DCR1000 Digital Cart Machine** by Fidelipac, with over 500 units in use. The **DCR1000** reduces maintenance costs, media expense and delivers spectacular on-air audio. Can you afford to wait any longer?

Order now and get 100 digital diskettes FREE!



The Davis Communications Group, Inc.

Call for details:  
Eastern & Central  
800/525-1037  
Mountain & Pacific  
800/523-1037



## Who's running the ship?

**U**nattended operation is one way to keep your station profitable, but you still have to mind the store.

The acclaimed Burk Technology ARC-16 Remote Control System is the first step. You can control transmitter and studio from any phone.

But wait. There's more!



**I**ntroducing AutoPilot™ from Burk Technology.

AutoPilot is break-through computer software that makes automatic operation of your studio/transmitter facility a dream come true.

- Automatic power changes
- Automatic pattern changes
- Automatic site changes
- Automatic power trim
- Automatic fault recovery
- Automatic logging

Now your imagination is the only limit.

The new FCC fine schedule is imposing. Why risk a big penalty when AutoPilot can help you stay within the rules?

Call us at 508-433-8877  
or toll free at  
**1-800 255-8090**  
for more information  
and a FREE DEMO.

**BURK**  
TECHNOLOGY

Circle (18) On Reader Service Card

# All the News That Fits, I Print

by Alex Zavistovich

**WASHINGTON** Well, I have lots of ground to cover in this issue, so let's not waste any time.

The radio broadcast data system (RBDS) standard is basically a done deal. Ballots came back to the National Radio Systems Committee (NRSC) agreeing to the format identifiers proposed in the standard, which will be introduced at the Winter Consumer Electronics Show (WCES) in January. The WCES will be a springboard for the technology in general, as a host of receiver manufacturers will display RBDS-equipped tuners receiving the 57 kHz subcarrier data stream from several Las Vegas FMs.

It will be interesting to find out what AM broadcasters think about the new tuners. At least one major player in the car audio market says its RBDS tuner plans will not include the ID Logic B chip that was part of the compromise struck by the NAB to move the RBDS standard forward.

Not only that, but locker-room talk among many other car audio makers seems to be that few if any of the RBDS tuners to be sold in the U.S. will have an ID Logic B provision. Why not? Well, besides the fact that the technology is still on the drawing board, many car stereo makers are of the opinion that few customers will go to the effort of updating the chips in their receivers when AM stations change format. (Remember, ID Logic is a receiver-based technology, not a transmission technology, like RBDS.) It will also drive up the price of the tuners.

That's the thing about a voluntary standard: No one has to comply with it.

★ ★ ★

Word on the street is that attorney Toni Cook will be nominated as a new

FCC Commissioner, most likely replacing Sherrie Marshall, whose term has expired. Cook, communications advisor to Sen. Ernest Hollings (D-S.C.), is the stepdaughter of Vernon Jordan, who heads President-elect Bill Clinton's transition team. The topic of Cook's nomination was raised at a meeting of the South Carolina Broadcasters Association in mid-November.



Cook's name has been tossed around as a likely FCC candidate for weeks now, but this is the strongest indication I've heard that she's the top contender. If it pans out that way, her selection is a politically smart move. Not only is she an extremely competent professional with the appropriate background, she's also a black woman. The political correctness of her nomination is inescapable.

★ ★ ★

When I was in junior high school, the chic contraband recording to own was George Carlin's "Class Clown." The live concert album included the now-infamous "Seven Dirty Words," which became the FCC's yardstick of obscenity in radio. I won't list them here, but as English words go, they're some of the heavyweights. As Carlin used to smirk, they will "curve your spine, infect your mind, and keep the Allies from winning the war."

Over the years, the FCC's stand on indecency has changed, and new phras-

es have entered the discussion, including "safe harbor" and "patently offensive by community standards" (whatever that means). The Commission lately has found itself battling group owners like Evergreen and Infinity over the subject matter aired by personalities such as Steve and Garry and Howard Stern.

How the FCC can presume, from its D.C. headquarters, to identify community standards in diverse and geographically distant cities is beyond me. Let's face it: A handful of letters sent to the FCC in opposition to so-called "obscene" programming would actually represent a *minority* opinion, considering that a station's come can be in the hundreds of thousands during morning drive, when many of the "transgressions" occur. Of course, no one will write to the FCC saying, "Hey, Howard Stern is pretty funny. I have no problem with him." It's the negative letters that form the FCC's opinion of "community standards."

Anyway, I'd like to see what kind of feedback the FCC gets on the Nov. 18 "Seinfeld" show aired on NBC. The episode focused on a bet as to which of the cast members could go the longest without indulging in the habit known for causing poor eyesight and hairy palms—a favorite topic among shock jocks.

Is there a double standard here? I think it's safe to say there is a greater chance that children—a *lot* of children—will be watching a top-rated prime time network television show than will be tuning in to a local DJ. Not even Howard Stern has that kind of reach...yet. (Sorry, Howard.)

Will the FCC receive letters of protest on the Seinfeld show? If it does, will punitive action be taken against NBC? If there is no punitive action, how will the FCC reconcile that with the fines imposed on radio broadcasters? I'm sure Evergreen and Infinity will be watching closely.

★ ★ ★

The text of the FCC's plan for DARS, or digital audio radio services (DAB, that is) was released in early November. Among the statements contained in the text was the Commission's commitment to "continuing our work with the broadcast industry to ensure that broadcasters are able to promptly implement terrestrial DARS." The FCC is supportive of continued development of in-band, on-channel digital audio broadcasting, among other means of delivery.

What was the Commission's source of in-band information? None other than a *Pilot Tone* installment titled, "DAB Surprise à la Acorn" (RW, August 19, 1992). Thanks for the footnote, Commissioners.

Finally, this issue marks the first of a 10-part instructional course from RW contributor Ed Montgomery on Fundamentals of AC. Like his other series, continuing education credits are available for successfully completing the course. See Ed's column for more information.

That's it for now. Tune in next time,

*Alex*

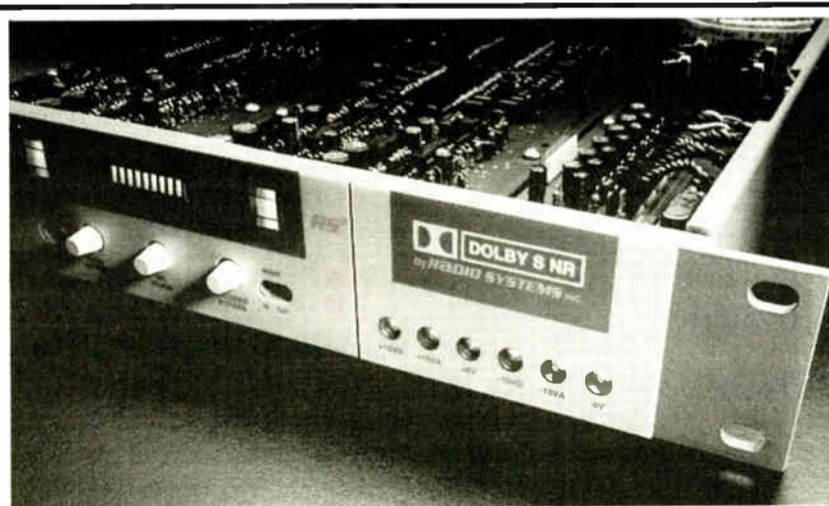

## Is it digital or is it Dolby S?

Get up to 24 db of noise reduction on your audio carts, phone lines, RPU, or any analog program feed.

RS<sup>2</sup> is a simple-to-use, economical, encode-decode, multiband noise reduction system featuring Dolby S and built-in phase correction for stereo sources.

Up to three stereo encode or decode cards can be packaged in a single 19" rack unit frame.

Also available in phase correction version only.

**RADIO SYSTEMS INC.**  
800/523-2133 or FAX 609/467-3044

Circle (151) On Reader Service Card

World Radio History



# READERS FORUM

If you have comments for Radio World, call us at 800-336-3045 or send a letter to Readers Forum (Radio World, Box 1214, Falls Church, VA 22041 or MCI Mailbox #302-7776). All letters received become the property of Radio World, to be used at our discretion and as space permits.

## Treasure the past

Dear RW,

I was pleased to read Barry Mishkind's "The Forgotten Empire" in the Oct. 7, 1992 issue of RW. The history of radio is receiving increasing attention among popular writers and scholars, but it is unfortunately true that good collections of broadcasting artifacts are few and far between.

Even the Smithsonian Institution is forced to refuse many donations because it has long since run out of space. University archives are rarely in a position to accept, much less preserve, artifacts. This is partly because archives are chronically underfunded, but also because many broadcasting artifacts are bulky, or otherwise difficult to manage.

My own research in the history of magnetic recording recently led me to inquire as to a collection of historical artifacts from radio station WGST, donated to the University of Georgia in the mid 1980s. According to those responsible for it, this collection never saw the light of day after the university received it. The collection has now simply been disposed of!

Nonetheless, I would implore readers who have artifacts to make them available to the public and to scholars, because these artifacts contribute to our understanding of radio history. But by all means, before letting them out of your grasp, try to obtain some kind of promise that these items will be preserved, or at least not destroyed.

David Morton, Graduate Student  
Georgia Institute of Technology  
Atlanta, Ga.

## AMAX overlooked

Dear RW,

It's disconcerting that Audio magazine, a major voice among audio performance enthusiasts, utterly neglects the acronym AMAX and/or mention of the superior AM tuner/receiver standards AMAX implies in Audios' 1992 "Annual Equipment Directory."

Even more appalling: of the 80 models of component radio tuners listed in this direct-

ory, only three are listed as AM-stereo compatible. One of these is the Denon TU-680NAB, which I take from John Gatski's RW piece ("State-of-the-Art NAB Tuner Gets a Listen"; Oct. 7, 1992) to be in fact the AMAX model—but you'd never know it from the directory. Like the other AM-FM tuners (and 185 integrated receivers, none of which offers AM stereo), no AM performance specifications are given.

The Denon TU-680NAB is priced in the directory at \$650—ironically, the cheapest of the three AM stereo-capable tuner models; the others are \$799.95 and a pretentious \$2,500!

I pointed out in a book I wrote long ago (Modern Radio Broadcasting, TAB Books, 1969) that AM's fidelity limitations lay in the receivers. AM transmission facilities were not (and are not) inherently limited. The Western Electric Doherty-based 1 kW AM made in the '40s easily met FCC FM specifications with regard to frequency response, distortion and noise, and many conventional AM transmitters of the '50s could also (short of stereo, of course—but most FMs still were mono then).

But when a consumer audio industry leader ignores AMAX, and when only three models among 80 tuners and 185 receivers offer AM stereo in 1992, it's deplorably clear that AM radio faces a monumental struggle for its very survival, let alone recovery.

Having grown up with AM, I hate to watch it decay. When the clear-channel powerhouses ultimately become silent, perhaps someone will offer a Requiem for this deceased friend.

Robert H. Coddington  
Richmond, Va.

## Tape concerns

Dear RW,

I have some concerns as to the best type of cassette tape for long term storage. A number of customers have brought in reel-to-reel tapes of their weddings, graduations, etc. They would like a cassette dub both to listen to, and perhaps pass on to their children.

I've told them the obvious techniques for tape storage: even temperature, low humidity, no dust, and I've always used top grade metal tape. But I wonder about the long term stability (oxidation or binder separation) of pure metal tape versus ferric oxide or chrome. Would any reader care to comment on the best media formulation so that 30 years from now they've got something to listen to?

Mike Sokol  
JMS Productions  
Hagerstown, Md.

## Deregulation fallout

Dear RW,

The person who wrote the "absentee owner nightmare" letter in the Oct. 7, 1992 issue indicated that he was a broadcaster who has tried to follow FCC rules throughout his 49 years in the business and felt that most stations across the land also tried to be in compliance. The person also wrote about a series of violations he discovered while checking out a small town station for a friend.

Well, guess what folks: The station described in that letter is not an isolated case.

## Treasure Or Terror?

A new trend can lead to either a treasure trove or a Pandora's box. Nowhere is this more true than in the trend of applying digital technology to broadcasting. How this development will finally be applied towards the sound of radio in the future

depends on the wisdom of those working now.

Not so long ago, the term "digital" was understood only by the practitioners of the black art of computer software programming and hardware design. They alone understood the potential offered by the manipulation of ones and zeroes.

With the introduction of cost-effective mass-produced microprocessors, the field of digital signal processing (DSP) expanded into sound—first in the professional audio and musical instrument arenas, then providing the bridge to broadcasting in the form of digital audio workstations. Now digital technology touches every aspect of the audio chain, from processing and editing to transmission and reception of broadcast signals.

DSP has become so accessible that easily affordable consumer audio components allow spectral manipulation previously unavailable at any price. Even a child now can decide whether he or she wants to listen to a favorite song with the ambience of an intimate club setting or a massive concert hall.

The flexibility allowed by digital signal processing also has expanded the science/philosophy of psychoacoustics in broadcasting. Proponents maintain that large portions of the audio signal can be discarded as irrelevant to the ears, yielding a CD-quality listening experience that requires less computer memory to store and less bandwidth to pass.

Detractors of this compression theory argue that the ill effects of such manipulation, while not readily apparent at first listen, definitely will be detected down the line. Audio undergoing repeated cycles of compression, processing and recompression will show degradation in quality due to these "cascading" operations, they say.

What does this mean for broadcasters? Certainly, the abundant applications of DSP offer radio sonic riches. Engineers and programmers, jointly responsible for a station's sound "signature," have a wide range of choices, from the purity of an original CD to minute tailoring of almost every aspect of the waveform.

Still, one must remember that signal manipulation no longer lies solely with the radio station. As DSP becomes increasingly available in receivers, everyone has a hand in the process (or the processing). While it is the broadcasters' right to make their station sound the way they like, now, more than ever, final control of the station's sound is passing to the consumer.

—RW

I was hired to be chief engineer for an individual who owned two FMs, an AM with another FM about to go on the air and an FM yet to be constructed. All small town stations.

Once employed, I found that two of the stations were classic examples of neglect. Transmitters were filthy inside and one FM transmitter had frozen grid and plate tuning capacitors on the driver. That's right—no way to tune the driver.

At the new FM site which was about to go on the air, I found that an old portable type building was used to house the transmitter. The building had holes in one wall which let rain pour into the building. Once the new FM went on the air, the owner had me build a simple automation system to program a CD player. Then, the owner instructed the manager to turn on the automation at night and go home—leaving the station to operate totally unattended without any EBS control.

Want to really save some bucks? Try what this owner has been getting away with. Originate over 60 percent of the programming at one station to feed your other stations. Then, stick an FM tuner at your other stations and rebroadcast from the tuners. Never mind that your farthest station FM tuner only gets a few microvolts of signal and you can't do better than 40 dB signal to noise with all the tuner filters on. Pass a proof, why bother?

I am no longer employed there. Think it's just another isolated case? While looking around for work I found another small market operator 60 miles away who turns on an automation system and walks away, letting the station run unattended without any EBS control.

I believe what we are starting to see is fallout from deregulation, especially in smaller markets. Some of this is actually a public hazard. For example, the individual who employed me operated his new FM

unattended at night and was unable to send an EBS alert that a tornado was headed for the station's city of license. This in spite of the fact that the primary EBS station (which was not being monitored because nobody was at the station) sent an alert warning about the tornado.

Fortunately, the tornado did not touch down. The owner defended his actions by stating that local EBS is not required—never mind that he was violating EBS rules every night that he ran unattended.

I agree with the other letter. "If the owners don't care any more than this about a radio station operating legally, then they should be inspected and fined."

The practice of the FCC to simply send letters rather than investigate a reported problem may indicate deregulation has approached "no regulation."

Radio will lose credibility if the public does not get vital information such as severe weather warnings where in some cases, seconds are critical. We have an EBS system that works when manned and activated. And, with a well maintained transmission facility, we have a dependable information system for the public.

I think the real question to ask about all this is whether radio is broadcasting to serve the public interest or to serve somebody's pocket book. It is possible to operate a radio station in the public interest and still make money. But, if you can get away with it, you can run a radio station into the ground and make more money.

If radio is operated without regard for the public interest, the public will no longer be interested in radio. Let's face it folks, direct broadcast satellite and digital audio on cable will lack only one thing: local public interest, which a local radio station can provide. Once radio loses public interest credibility, small or large market, it will be difficult to get it back.

No name provided  
Charles City, Iowa

# Radio World

Vol 16, No 23

December 9, 1992

Editor.....Alex Zavistovich  
Managing Editor.....Lucia Cobo  
International Editor.....Alan Carter  
Associate Editor.....Charles Taylor  
News Editor.....John Gatski  
Contributors.....Frank Beacham/N.Y.  
Bruce Ingram, Pamela Watkins, Nancy Reist  
Technical Editor.....John Bisset  
Technical Advisor.....Tom McGinley



Radio World (ISSN 0274-8541) is published semimonthly by Industrial Marketing Advisory Services, Inc., 5827 Columbia Pike, Suite 310, Falls Church, VA 22041. Phone: 703-998-7600, Fax: 703-998-2966. Second-class postage rates are paid at Falls Church VA 22046 and additional mailing offices. POSTMASTER: Send 3579 forms and address changes to Radio World, P.O. Box 1214, Falls Church VA 22041. Copyright 1992 by Industrial Marketing Advisory Services, Inc. All rights reserved.

**Next Issue of  
Radio World  
December 23, 1992**





## Introducing Our Newest Line Of Broadcast Equipment.

Harris Allied brings to the broadcast industry yet another first—the Audiometrics Model 386 33 broadcast computer.

This computer's beauty is more than skin deep. It has an FCC Class B rating, internal shielding, and includes RFI and EMI filtering. It comes complete with a 386 33 Mhz motherboard, a 120 Mb IDE hard drive with 64K cache with a MTBF of 150,000

hours, 5.25" and 3.5" floppy drive, 2 Mb RAM expandable to 16 Mb, a 14" .28 pitch SVGA monitor, Microsoft DOS version 5.0 with manuals, optional rack mount and much, much more.

The Audiometrics 386 33 is the first computer designed and built with the broadcast environment in mind to handle the many specific tasks that you do, with endurance and

simplicity as priorities, not afterthoughts.

From hardware to software... from editors to voice mail— we can preconfigure a variety of broadcast oriented options into your system.

Nobody knows broadcast like Harris Allied. Nobody knows technology like Harris Allied. Who else could bring you the best computer

technology at a price that's right for today's broadcast professional— just \$1895 complete!

Call on the audio leader— Harris Allied, for the products you need at the prices you want.

8:00 a.m. to 8:00 p.m. EST  
 1-800-622-0022  
 Fax 317-966-0623  
 Canada 1-800-268-6817  
 Toronto 416-731-3697

 **HARRIS  
 ALLIED**



# New Motorola DSP Chip Helps Car Audio Sound

by Frank Beacham

**AUSTIN, Texas** Motorola, Inc. has introduced a new low-cost 24-bit digital signal processor (DSP) to provide digital audio and ambience effects for automotive and consumer electronics.

The new Symphony DSP56004 microprocessor, designed for high volume, cost sensitive markets, will bring the benefits of digital audio processing to cars and homes, providing CD-quality sound and effects that until now were only available in professional audiophile equipment, according to Bryant Wilder, Motorola's DSP operations manager.

In environments such as car compartments, the 56004 can compensate for the vehicle's acoustic limitations such as reflective surfaces, compartment size and number of passengers. The chip can also perform noise cancellation and dynamic volume control to maintain the audio level regardless of car speed or road and wind noise.

Digital signal processing also can enhance the listening experience by creating spatial impressions based on acoustics and surroundings. For example, it can achieve this by mimicking the reverberations and echoes of such environments as jazz clubs, concert halls or stadiums.

## What once was pro

The 56004 produces acoustic special effects using synthetic reverberations obtained by delaying and digitally filtering certain signals, according to Motorola. Previously, only a subset of these reverberation effects were possible using expensive analog circuitry, which, because of cost and integration factors,

was practical only in professional audio equipment.

"It's quite a science—and becoming an art—to craft an audio algorithm to a car's environment," said Mike Collins, marketing manager for Motorola's DSP products. "Auto radio manufacturers can

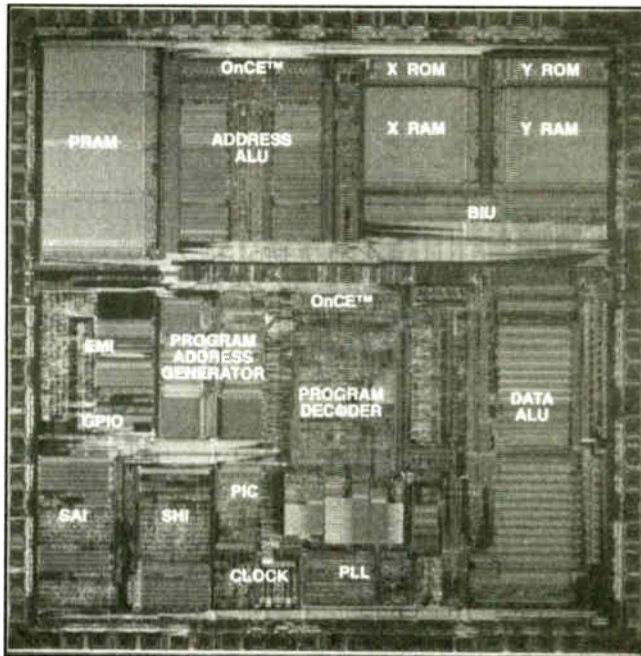

The Motorola Symphony DSP56004 microprocessor designed for automotive applications.

now compensate for the characteristics of an individual model of car."

Collins said he expects manufacturers to create adaptive algorithms that can make real-time adjustments according to driving conditions at any given moment.

"You could have a series of microphones in the car to continuously monitor the sound output and adjust the system to

changing conditions," Collins said.

"Say you are driving down the road at 60 miles per hour. Road noise is very high. The radio automatically cranks up the volume to compensate. When you hit the exit ramp and slow down to 30 and it becomes quieter, the volume is lowered."

## Sophisticated functions

The chip can also be programmed to distinguish types of noise, such as the cyclic sound of a tire hitting pavement. "There are noise cancelling algorithms that would create equal but opposite noise," said Collins.

Though the new chip does not improve the RF section of an automobile receiver, it can improve quality of sound, he said.

"Once it's down to the baseband or the IF frequency, we can improve the separation between channels and the image rejection of other channels that may bleed in," Collins said. "We can extract more information out of noise using digital techniques."

Home audio devices, such as digital speakers, digital amplifiers and television receivers, also can benefit from the new chip.

Motorola said Dolby Laboratories in San Francisco is working to implement its Dolby Surround Pro Logic algorithm for the 56004 chip, which could allow easy integration of cinema sound capabilities into next generation television receivers.

The new Motorola DSP is not to be confused with more limited DSP devices now found in some models of portable CD players and home audio receivers, Collins said.

"Just because a product says DSP

means little. That's a general term, like saying car. There are many models of cars and that is the same with DSP. The CD players with DSP are hardwired. There's no instruction set. All they do is take the digital information off the disc and convert it to analog. Symphony is a genuine breakthrough."

The Symphony microprocessor, developed around the Motorola DSP 56000 core architecture, is now available for \$36.80 in quantities of a thousand. Auto electronics manufacturers such as Becker (Karlsbad, Germany), Blaupunkt (Hildesheim, Germany), Ford (Dearborn, Mich.), Nokia (Salo, Finland) and Volkswagen (Wolsburg, Germany) have endorsed the chip and are evaluating it for use in their products.



## NEW AM RULES

### AMSTUDY

**DAYTIME ALLOCATION STUDY**

- Both Dataworld and FCC Databases Studied
- Utilizes NEW (Corrected) Groundwave Curves
- NEW Adjacent Channel Protection Ratios Employed

### AMNIGHT

**NIGHTTIME INTERFERENCE STUDY**

- Utilizes NEW FCC Skywave Propagation with Greatly Improved Accuracy
- Calculates Extent of Nighttime Interference Received (Detailed Individual Night Limit)
- Provides Allowable Vertical Radiation to All Pertinent Stations (AM Night Permissible Radiation)
- Includes All Co-Channel and First Adjacent Records

### GWAVE

**GROUNDWAVE (Daytime) COVERAGE CONTOUR STUDY**

- Utilizes NEW (Corrected) Groundwave Curves
- Allows Input of Measured Soil Conductivity Data
- Counts Population Within Coverage Area Using 1980, 1986 and 1990 Census Data

### SKYWAVE

**SKYWAVE (Night) COVERAGE CONTOUR STUDY**

- All AM Nighttime Coverage Contours Have Changed Size and Shape
- Utilizes NEW FCC AM Skywave Propagation Model
- Counts Population Within Contours Using 1980, 1986 and 1990 Census Data

## dataworld®

P.O. Box 30730, Bethesda, Maryland 20824

FAX (301) 656-5341

(301) 652-8822      (800) 368-5754

# MIX'N MATCH

## System 10,000 Modular Amplifiers

Over 40 interchangeable Microphone, Line and Audio DA Modules for you to mix 'n match to your requirements.

- Transformer or Active Balanced Outputs • VCA Option Available • Backup, Alarmed Power Supplies • RF Protected
- Clean & Quiet Performance • Attractive & Safe Design
- Cool Operation

**AUDIO TECHNOLOGIES, INC.**  
328 W. Maple Ave., Horsham, PA 19044, USA  
(215) 443-0330 • FAX (215) 443-0394



Call, fax or write for free detailed brochure

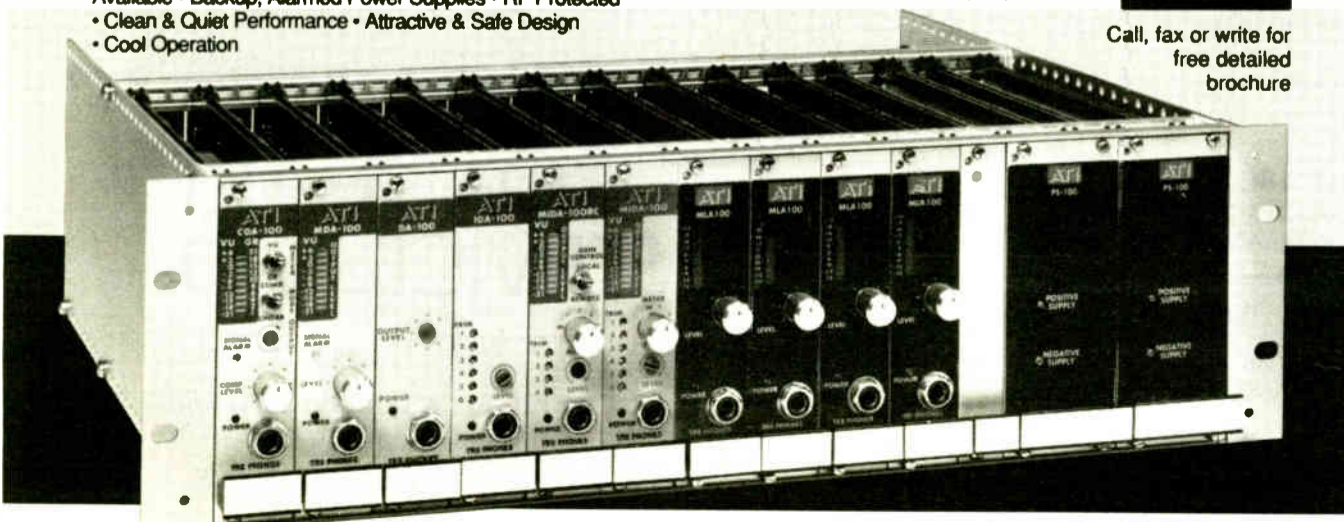

Grade (47) On Reader Service Card

World Radio History

Circle (63) On Reader Service Card



# Broadcast Interests Guide

## Digital Compression Tests

by Dee McVicker

**GENEVA, Switzerland** A task group known as TG-10/2 could pioneer the digital compression frontier for AM and FM broadcasters who continue to face limited STL spectrum, large audio libraries and little consensus among equipment manufacturers on how to compress the digital bandwidth.

Task group TG-10/2 of the International Radio Consultative Committee (CCIR) recently took on the challenge of bit reduction algorithms by conducting a series of listening tests intended to address the major concerns of this technology, including the "cascading" of coded material.

CCIR became involved to ensure that the compression algorithms ultimately used meet the needs of broadcasters. U.S. interests were instrumental in pushing for conclusive testing.

Concern about the effects of cascading audio through several generations of digital compression has increased as broadcasters continue to add digital equipment to their audio chains.

The speculation is that various masking techniques used in new generation coding schemes—many of which operate in the frequency domain and exploit

acoustical perception—will be incompatible and will result in audible distortion.

### Listening tests

In an attempt to answer this concern and others, the CCIR task group began conducting listening tests in February with the mandate to recommend standards for several radio applications.

Major compression algorithm proponents were invited to participate. The algorithms included ASPEC, Dolby AC-2, Aware System, SB-ADPCM from Switzerland, a Japanese system, and ISO Layer II and III (MUSICAM).

The TG-10/2 task group, which is made up of engineers from the United Kingdom's BBC, Canada's CBC and other nations including Australia and France, completed preliminary listening tests of three of the four applications in May, and converged in Paris, France, in June to discuss the results.

Discussions were extended to a follow-up meeting in Geneva, Switzerland, during the first week in October. As of this writing, CCIR had not officially announced the results of the subjective tests, which encompassed general audio quality, stereophonic imaging and the

continued on next page ►

## 'Pioneer' Plans Delayed

by John Gatski

**WASHINGTON** The FCC will not approve any "pioneer's preference" for satellite or terrestrial digital radio services until it has gathered more information for its pending Notice of Proposed Rulemaking (NPRM) and Further Notice of Inquiry (FNOI) on DAB—or, as the Commission now calls it, digital audio radio service (DARS).

In a footnote contained in the recently released text of Gen. Docket 90-357, "Amendment of the Commission's Rules with Regard to the Establishment and Regulation of New Digital Audio Radio Services," the FCC said "we find

there is a good cause to delay the tentative award of a pioneer's preference until later in this proceeding."

The delay in processing any pioneer's preference applies to satellite DARS as well as terrestrial proposals, according to the text.

The FCC concluded that most of the digital radio system proponents still regard their work as "proprietary," but "as the technology becomes more fully developed and service proposals become specific, we will be better able to address a pioneer's preference request."

The FCC approved the pioneer's preference process in 1991 to facilitate innovative broadcasting technologies. It allows a station to ask for permission to implement a technology without going through bur-

densome competing applications. The applicant had to petition for rulemaking asking for a spectrum allocation for a new service or ask for a rule amendment to permit use of a new technology in an existing service.

Strother Communications and Satellite CD Radio applied for the pioneer's preference in 1991. Both are still before the FCC.

In July, Satellite CD Radio withdrew another application to the FCC

**The delay in processing any pioneer's preference applies to satellite DARS as well as terrestrial proposals.**

for permission to conduct some provisional experimental satellite work. That application is unrelated to pioneer's preference or the company's main application for a digital audio satellite service that recently was accepted by the FCC for filing. The NAB applauds the FCC's decision to delay approving pioneer's preferences—especially for satellite digital radio, which is considered potential competition for existing broadcasters.

"That (the FCC's pioneer's preference delay) is a positive step," NAB Deputy General Counsel Barry Umansky said.

Umansky said the pioneer's preference rewards creativity and innovation, but does not take into account the impact on other services or the public.

## The ENCO DAD486x

### DIGITAL AUDIO DISTRIBUTION SYSTEM

\*Special  
Introductory  
Price  
**\$4500**

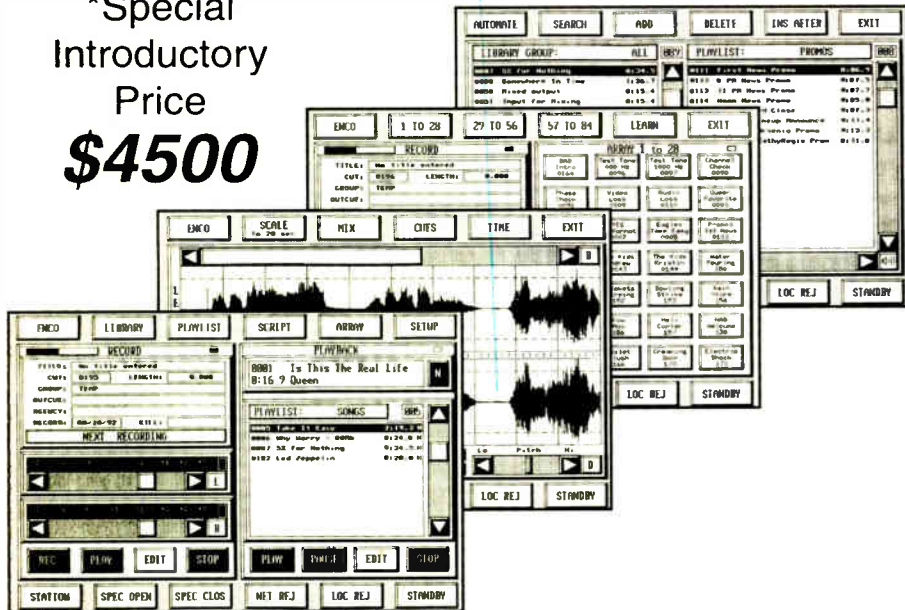

### Professional Software for Digital Audio Broadcasting

- Full Bandwidth Stereo Audio Record/Playback
- Intuitive Graphic Audio Editing
- Instant Play "Array" & "Hot" Buttons
- Multiple Playlist Creation & Editing
- Data Compression Options

### Operates on Any Common PC/AT 486 System

- Choose Your Own Hardware Source & Options
- Network Multiple Workstations with LAN

## ENCO Systems, Inc.

1866 Craighsire Drive • St. Louis, Missouri 63146-4006 USA  
Telephone: 800-ENCO-SYS (USA) • 314-453-0060 • Fax: 314-453-0061

\*Includes S/W and D.S.P. PC adapter

**CALL OR FAX FOR SPECS and TURNKEY OPTIONS**

## Coast to Coast

### The Preferred Source

The very best broadcast equipment and service at the very best prices.

► **Equipment Lease Specialists** ◀

## BROADCAST SERVICES CO.

The Davis Communications Group, Inc.

**Eastern & Central**  
VOICE 800/525-1037  
FAX 919/934-1537

**Mountain & Pacific**  
VOICE 800/523-1037  
FAX 805/266-1695



# Broadcasting Guides Listening Test

► continued from previous page

multigenerational effects of tandem coding of each algorithm.

Final recommendation is pending an effort to have Dolby and ISO (MUSICAM) produce a collaborative algorithm. I'm not sure if that's going to happen or not," CCIR member Greg Urbiel said. Urbiel also is CBS Radio's Midwest director of technical operations, whose participation in digital compression standards-making includes listening tests conducted in 1990 by ISO, the International Standards Organization.

## A standard process

The ISO tests have resulted in a draft document by the standards-setting body that, pending the outcome of a six-month review, could result in a three-part standard. The three compatible layers to the proposed standard are referred to as ISO Layer I, ISO Layer II and ISO Layer III—all MUSICAM derivatives.

Final recommendations of the CCIR listening tests have not been announced. However, according to CCIR TG-10/2 member Louis Thibault of the Communications Research Center in Ottawa, Canada, results favored ISO Layer II for two of the applications and ISO Layer III for one of the three applications tested by TG-10/2.

ISO Layer II was favored in listening tests of the DAB emission application and what the group calls the contribution and distribution application, or those functions in radio having to do with moving audio between studios and final transmission points.

Both applications called for a 48 kHz sampling rate and 20 kHz bandwidth, with an emission data rate of 192 kilobits per second (kbps) per composite two-channel, a contribution data rate of 180 kbps per independent channel and a distribution data rate of 120 kbps per independent channel.

The contribution/distribution application also called for a configuration of five tandem codings of each participating system in the contribution mode and three tandem codings in the distribution mode.

## Different codecs

ISO Layer III, an algorithm design resulting from the collaboration between MUSICAM and ASPEC, was favored in listening tests of what the group calls the commentary, news and current affairs application—or feeding actualities from the field to the station studio.

This application called for low data rates of 60 kbps per independent channel, with each participating system configured in three tandem codings and allowed to operate within a 15 kHz bandwidth at a 32 kHz sampling rate.

A fourth application in the CCIR tests, studio archiving of audio libraries, has not yet been tested by the group and will be limited to only those systems using primarily time-domain bit rate reduction techniques.

Although not appropriate for applications requiring the real-time operation of frequency-domain coding, time-domain systems such as the Dolby ADM and the G.722 were deemed highly useful by the group for archiving audio.

These loss-less systems are not based on psychoacoustic techniques, Urbiel

said. "When the audio is brought back out of the hard drive, it is reconstructed in its exact original fashion."

TG-10/2 plans to conduct tests of the archiving application in the coming months based on storage capacity, and systems will "be judged on the merits of who's got the best algorithm for storage," according to Urbiel.

## More tests expected

Further listening tests, however, are expected to take place for emission, contribution/distribution and commentary applications. Following TG-10/2 recommendations for each application, expect-

ed by the end of the year, the group anticipates another series of tests by winter 1993.

"Obviously whatever is being recommended will have to pass muster with the idea of starting out contribution/distribution, being put through emission, and with all those tandems, it still has to sound good," Urbiel said.

The upcoming tests, he added, are expected to approximate the typical radio network environment, and could entail testing differing systems in tandem.

"The tests anticipated for next winter will include the recommended algorithms of five contribution codecs in cas-

cade, plus three distribution in cascade plus one emission codec in cascade," Thibault said. "There will probably be another configuration which will include one commentary link codec attached to this chain."

The issue of mixing various compression schemes in tandem is one that needs further investigation, Thibault added. His organization recently conducted informal tests of the cascading effects of ISO Layer II in series with ASPEC with no conclusive results.

"If you connect in tandem codecs very different from each other, you can have interaction from these, so that the overall result will not be set by the lowest quality of codec, but something worse. A safe statement is that this is something that should be discouraged," Thibault said.

## Who said a workhorse can't be a thoroughbred?



The Sony PCM-7010 DAT Recorder

It wasn't Sony. Because the PCM-7010 was built from the ground up as a professional DAT recorder that can handle everything from music recording and on-air radio and television broadcasting to audio-for-video production and corporate multimedia systems.

The PCM-7010 features high-speed search, variable-speed playback, punch-in/out with cross-

fade and confidence monitoring. And, with its advanced options, you can record, playback and display SMPTE time code and store digital audio in memory for instant-start playback. If you want a workhorse DAT recorder that can do it all, today and tomorrow, you want the Sony PCM-7010. For more information, call the Sony Professional Audio Group at 1-800-635-SONY, ext. 7010.

**SONY**



# SBE Convention Talks

► continued from page 1  
elimination of the national SBE show are among the "options" being discussed.

"That would be something that they (SBE) could definitely do within the scope of what we have been discussing," Butler said. "However, that is their decision."

## Discrete negotiations

SBE President Richard Farquhar declined to comment on details of the negotiations with the NAB. He noted, however, that the NAB has not made an official proposal to combine with SBE at the spring show. When asked whether the SBE had made its own official proposal to NAB, Farquhar said, "No."

Farquhar did confirm that the SBE will hold its "SBE Day" at the 1993 NAB spring convention, as it did quite successfully in 1992, and is committed to carrying out the Sept. 29-Oct. 2, 1993 national SBE convention in Miami. The Miami show will be a joint show with the Radio-Television News Directors Association (RTNDA).

Although Farquhar said the SBE has a commitment to hold two more national conventions jointly with RTNDA—Los Angeles in 1994 and Cincinnati in 1995—he declined to comment on whether a new deal with NAB would supersede those commitments.

The recent San Jose show has reinforced many SBE members' lack of faith

in the national conventions. The official registration at San Jose was roughly 250, and the SBE listed the total four day attendance at 1,005, including all exhibitors and their guests.

Resolving difficulties with the national convention would be seen as a positive step for the SBE board of directors, which did not have a good year in 1992.

Besides the dismal turnout of the San Jose show, several major chapters nationwide were in open rebellion last spring, calling for a dues strike and hinting at secession.

Chapters claimed that the national leaders were not making good decisions on behalf of the membership, including site selection for the national conventions, an unpublicized dues increase, and what they perceived as a general unresponsiveness of the board of directors.

## The board's performance

Since the NAB spring show, communication with the chapters by the board of directors has improved, but individual chapter members said the board still has more to accomplish (such as stabilizing the national show situation) to alleviate their concerns.

The national SBE convention grew out of a regional midwest show, but the SBE decided to move it about the country to try and give more members a chance to go to a show at least every few years.

That decision, however, has not been

particularly effective—especially for shows scheduled in the west or the deep south. The 1988 Denver show was considered a failure because of low attendance; the 1991 show in Houston, although posting acceptable attendance figures, also was criticized because it lost money. The midwest shows (St. Louis, Kansas City) have garnered the most praise—because, according to some observers, they were located in the center of the country.

Several SBE members that were interviewed by *RW* said they would welcome an SBE/NAB collaboration. "I think it would be wonderful," said John Schneider, past president of the Seattle chapter. "It would give the SBE a structure to hold its functions where attendance is guaranteed."

Schneider said the NAB show always has a large number of SBE members in attendance because station managers consider it among the most important trade shows for broadcasters. "The NAB show attracts more SBE members than the national SBE show," Schneider said.

Ron Simpson, chairman of the Philadelphia chapter, said his members would support the SBE holding its national show with the NAB. "We would be ecstatic," Simpson said.

Chip Fetrow, a member of the Washington, D.C. chapter, said the SBE's involvement with NAB would be more beneficial than its relationship with RTNDA.

"I suspect that (an agreement with NAB) will be warmly received," Fetrow said.

There are drawbacks to collaborating with the NAB on a national show, according to other SBE members. These disadvantages include a lack of identity for the SBE at the NAB show, and elimination of SBE's philosophy of moving the show around to different regions of the country.

Supporters of NAB involvement, however, said the SBE can maintain its identity by supporting regional conventions, such as the one held in Seattle, which reported 2,300 attendees at its 1992 show.

# RBDS Mark Passes NRSC

► continued from page 3

codes used to designate formats.

One of RBDS's most promising features is the selection of stations by format. A station broadcasting the 57 kHz data stream is assigned a code for the type of format it transmits. When the user pushes a particular format button on the receiver, it will scan the other stations that are on the format.

There had been some concern by broadcasters on the initial ballots that some of the 22 format codes were too general because some stations broadcast format variations that do not fit the general categories. For example, there is one country RBDS format code, but some stations broadcast variations, such as "classic country," "country gold," or "bluegrass" that are not secure RBDS formats.

Supporters of the RBDS standard said that adding too many formats would make the receiver too complicated for consumers. The general categories, RBDS standard supporters argue, would get listeners "in the ballpark," and they could then choose which of the stations play music that suits their taste.

Most of the format objections expressed in the first ballot, however, were not voiced on the final ballot, according to Marino.

Since RBDS currently is not effective for AM, the new standard includes a provision that requires receivers to contain ID Logic B, a technology that allows AM stations to be selected by format. But instead of being activated by a broadcaster's signal, formats are accessed from the receiver's internal computer that is programmed with all U.S. stations' format information.

Although the standard will be known as RBDS the receiver logos will read RDS, according to Marino.

## Digital automation for PDs

You love getting a call at 3AM on a Saturday because your part-timer forgot how to work the automation system. Right?

An if YOU can't remember the answer, call tech support. They'll get back to you a week from Thursday.

Or, have that part-timer call the company that pioneered 24-hour factory-trained digital automation support.

Get the call, or make the call. It's your call.

You don't need another headache.

You need a Desk Jockey.

the  
**Desk Jockey™**  
Digital automation that makes sense



**BROADCASTERS  
GENERAL STORE**  
2480 S.E. 52nd St., Ocala, FL 34480  
(904) 622-9058



## It thinks it's a cart machine.

Only RS-DAT features end-of-message signals, large lighted buttons, standard broadcast remote control, balanced audio ins and outs, automatic cue-up and satellite recording ability.

These features make the RS-6700 perfect for automation, network capture, on-air playback and production applications.

If you want to use DAT for broadcast, contact the pro DAT experts for more information on the RS-6700.

**RADIO SYSTEMS INC.**

800/523-2133 or FAX 609/467-3044



# Local Radio Stations Can Access Cable Audio Services

by Frank Beacham

**NEW YORK** Digital Cable Radio (DCR) and Digital Music Express (DMX), the competing CD-quality cable audio music services, have opened the doors to radio stations who wish to provide digital station feeds to local cable subscribers.

Each of the services provides multiple channels of narrowly-formatted music programming to subscribers via local cable TV systems. A special digital-to-analog tuner, provided with the service, is directly connected to the user's home stereo system and is operated via remote control.

The delivery technology of each system is capable of delivering far more programming than is currently offered. Additional audio channels can easily be added locally to either DCR or DMX, officials of each company said. The only technical requirement for a station desiring to place its signal on one of the networks is to deliver a digital audio feed to the cable system's head-end.

Radio stations wanting to join either service must negotiate with the local cable systems and not directly with DCR or DMX, both of whom wholesale their programming and technology to individual cable system owners.

## Through the cable company

"The broadcaster should call the cable company and say, 'Here's our

programming on its Bergen County, N.J. system and programming from The Greek Voice on its system in Clearwater, Fla.

"We have shipped in excess of 30 pieces of local origination equipment," Del Beccaro said. "In addition to radio programming, some cable operators are putting on simulcast audio from video channels, like local pay-per-view programming."

## A matter of time

Oliver said he is not aware of any cable company adding radio stations to DMX's

**Radio stations wanting to join either service must negotiate with the local cable systems.**

programming yet, but noted, "it's purely and simply a question of timing."

He said DMX is still involved in an aggressive rollout and "the cable guys are concentrated on marketing the core DMX service and haven't thought so much yet about added features."

Neither executive sees radio broadcasting as competition for his service, and both said certain local station feeds could be complementary to their music "narrowcasting."

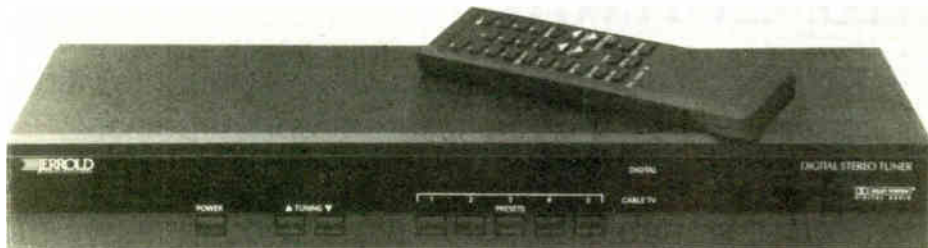

With a cable system's permission, a local radio station can be received on a cable audio service tuner, such as Digital Cable Radio's (shown here).

format. We think it would a terrific thing for you to package along with DMX," DMX President Tom Oliver said. "The head of programming or marketing of the cable system would then respond."

So far, few stations have added their signals to either DCR or DMX. "The radio industry has not gotten off the dime and recognized they ought to be doing this," DCR President David J. Del Beccaro said. "I think the reason is that not many stations have been aggressive about working out deals."

Del Beccaro said that about a half-dozen stations are carried with DCR music programming throughout the country, but declined to name them. He said he could not provide a list of the stations due to cable company confidentiality requirements.

## Several stations

Del Becarro did give an example of a cable system that provided programming from other sources on DCR equipment. He said Vision Cable carries the BBC 1 and Japan Radio pro-

"We are delivering a huge number of different formats of music that are very closely attuned to a consumer's mood of music listening," Oliver said. "Our subscriber simply has to touch a button and he's got the music of his choice. This is not competitive with radio or the record business."

"We view radio as a wonderful local phenomenon," Oliver said. "Radio offers broad appeal formats and often has very popular local disc jockeys."

So why should a radio station seek out a spot on a digital cable audio service? "Because a station benefits by a digital signal being brought to the home in a state-of-the-art manner," Del Beccaro said. "Radio is now perceived by many consumers as yesterday's technology. We think radio would be a complement, not a competitor, to our service."

For more information contact DMX, in care of International Cablecasting Technologies, 11400 West Olympic Blvd, Suite. 100, Los Angeles, CA 90064, 310-444-1744; and DCR at 2200 Byberry Road, Hatboro, PA 19040, 215-957-8290.

# ROHN®

## One Source For Complete "Turn-Key" Broadcast Tower System

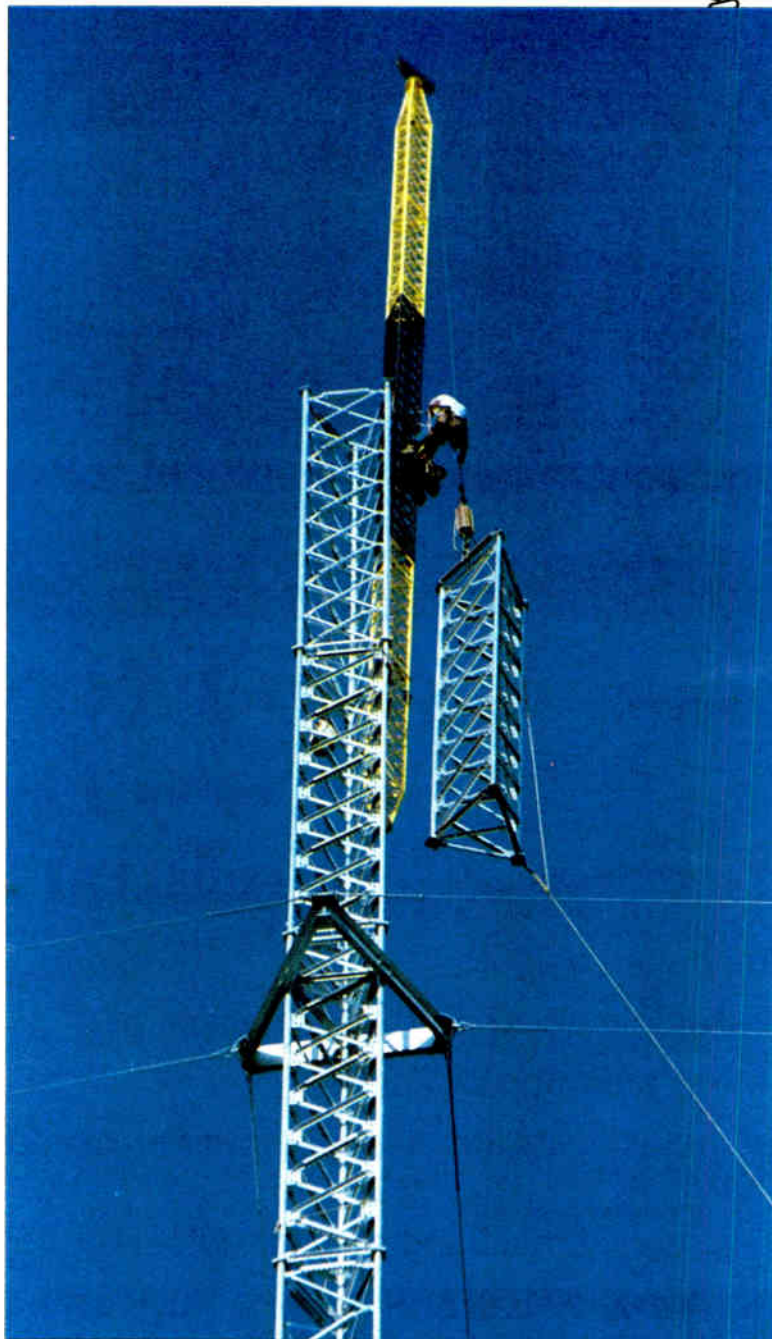

Beginning with a DIRECT CALL, ROHN can guide your project to completion. And we won't stop there. When we install your system you can get our 20 Year Warranty, the best warranty in the industry.

Call Mike Fleissner now for broadcast tower help or information on our towers and equipment shelters.

## 1-800-225-ROHN

Serving the communications industry for 45 years

**ROHN®**

P.O. Box 2000  
Peoria, Illinois 61656  
FAX: (309) 697-5612



Copyright ROHN 1992

Circle (170) On Reader Service Card





Starting  
under \$3,100

# Cost-Effective Quality

## The New Dynamax MX Series

### Modular Audio Console

- True modular design
- Ultra-reliable motherboard construction
- VCA mixer and monitor control
- Active balanced line inputs, transformer isolated mic inputs
- Active balanced main and monitor outputs
- Full monitoring/cueing facilities with VCA level control and active source selection
- Built-in cue amp with speaker and amplified stereo 8-ohm headphone output
- Remote start logic
- Count-up event timer
- Two input expansion switches standard
- Two inputs per module, mic/line or line/line - line inputs may be mono or stereo, consumer or professional format
- Four assignable outputs - two stereo plus two mono
- Available in 6, 8, 10 or 12 channel models
- Rotary or linear faders
- Separate audio and logic power supplies
- Sturdy, all-steel construction
- Durable Lexan overlay control surfaces
- All inputs/output connection via compact, captive screw barrier strips - no soldering, crimping or spade connectors necessary
- Excellent RF immunity

Call any Fidelipac Dealer for more information about the quality, features and unbelievably low prices of the new modular Dynamax MX Series Console.



Fidelipac Corporation □ P.O. Box 808 □ Moorestown, NJ 08057 U.S.A. □ TEL 609-235-3900 □ FAX 609-235-7779

Circle (136) On Reader Service Card  
World Radio History



## OFFBEAT RADIO

# Radio Station Honored as 'Point of Light'

by Dee McVicker

**NEW ORLEANS** Non-commercial WRBH(FM) ended its first decade of operation as the 257th Point of Light, a coveted award bestowed by President Bush and a fitting distinction for a station whose primary goal is serving its audience.

With great ceremony, the non-profit station became one of the do-good organizations to receive one of the President's 1000 Points of Light honors, distinguishing it as the nation's first FM reading service for the visually impaired.

It was an event even WRBH supporters couldn't have envisioned. For WRBH General Manager Tim Green, and the station's many volunteers, the recognition capped a long, arduous struggle to keep the 54 kW station on the air.

## No funds, no time

Prior to the call from the White House, Green had embarked on a local media blitz in hopes of replenishing WRBH's



WRBH's Tim Green

depleted operating funds and staving off insolvency. Green quit his job with a local commercial radio station to manage WRBH, which was running on less than two weeks' operating cash. To say the least, Green was nervous about the future of the station.

Barely eight years on the air and having taken root after a decade-long petition to the FCC, WRBH had not yet won the support of the New Orleans community. Indeed, said Green, "People didn't even know about it unless they stumbled onto it on the left hand of the dial."

As a non-profit station affiliated with neither a university nor social agency, WRBH needed community support to sustain its operation. Without it, the vision set forth by WRBH's founder, Dr. Robert T. McClean, a Ph.D. from Loyola University and an advocate for the blind, was in serious jeopardy of vanishing into thin air.

If Green didn't do something, and fast, the station would go dark and its 24-hour reading service of newspapers, books, and other printed material would no longer exist for the blind.

## Kick out the jams

As a local jazz musician and radio veteran, Green arrived at the only possible solution: have a concert. After placing a few phone calls, he formed a new band and booked it for a performance at a prestigious club in glitzy New Orleans.

As Green had expected, the booking took the local press by storm, being noted as much for where it was as to who was performing: Every performer in the band was blind. "The media was so interested in this that we had been invited to all the television stations; I brought the musicians in with me to put on the air (and) all the local papers wrote about us," said Green.

The idea spun off a series of promotional campaigns that helped bring the station back into solvency—all of which had far-reaching implications for WRBH.

Apparently, White House scouts had also picked up on the WRBH story in their search for individuals or organizations worthy of recognition in the President's 1000 Points of Light program. The program got its name from a popular Randy Travis song and took flight in President Bush's 1988 election campaign.

"One day I got a phone call from the White House," recalled Green. "(They said) that Bush was naming us the 257th Point of Light. I eventually got to meet (President Bush) and talk with him." In a ceremony at Disney World, WRBH was commemorated along with other organizations the President had recognized as important philanthropists.

The event was a turning point for the station. Local and national attention had come together "to make this thing work," related Green, who has watched WRBH grow from a fledgling station to a vital concern with support from several key businesses and over 550 contributing members.

## Movin' on up

Recently, WRBH moved from its leased studios in an 1,100 square foot apartment to its newly acquired renovated Victorian mansion. Five studios with the latest in wares now await the 200 volunteers—some blind—who arrive to read over a hundred different magazines each month.

Now one of only two stations in the United States to offer this kind of service on the FM dial, WRBH reading fare includes *People*, *The New Yorker*, *The Wall Street Journal*, and novels as well as local publications. Poetry readings and short story readings are also aired, often on remote.

"We read to the blind all the mainstream publications that sighted people read, so the blind will be as up to date as their sighted peers," said Green. Surprisingly, because of the breadth of reading material aired, most of WRBH's listeners are sighted—an estimated 90 percent.

The station, however, remains firmly focused on the blind. Along with its expansion into the new facility, with some \$500,000 in equipment alone, WRBH is able to provide workshops so the newly blind can become literate in Braille. A computer adapted for blind operators, as well as meeting rooms for advocacy groups, has also been added to the list of services in what Green describes as a "communications center for the blind."

Very soon, Green also hopes to complete a \$100,000, 24-track studio for drama productions. Always thinking of new ways to bring in money for the station's cause, Green plans to rent the studio to major drama production houses and radio stations. One project has

already been put through the studio, and at least one other major drama production is in the planning stage.

In an even more ambitious goal, Green envisions "Repeater stations throughout the state with one studio in each one of those repeaters so they can read their local papers, and the rest of the broadcast will be fed directly from this site."

Taking time out from implementing his vision for WRBH, Green again met with President Bush in August. "He was quite personable and aware of what we were doing here," reported Green.

Obviously impressed with WRBH's hard-won success, President Bush acknowledged the anniversary of this once almost dark station by sending a personalized letter to its some 200 volunteers, who celebrated 10 years of WRBH reading service to the blind on September 12.

□□□

Dee McVicker has been covering the broadcast beat for four years as a regular contributor to *RW* and as a freelance writer specializing in industry newsletters, manuals and brochures. She can be reached at 602-543-7363.

## THE RUGGEDNESS OF OUR CD PLAYERS ISN'T A RETROFIT.

From the get-go, we designed our Industrial Strength CD players to stand up to the kind of heavy-duty use that typical consumer CD players can't handle.

That's why every TASCAM CD player is rack-mountable. And why both the CD-301 and CD-401 feature balanced XLR and unbalanced RCA outputs for added flexibility.

The economy-minded CD-301 (\$549,\* including hardwired remote) offers the high reliability required for heavy-use applications, plus precision playback capability. The CD-301 also features a single-play function to automatically stop playback at the end of a song, allowing DJs to concentrate on voice-overs or to make a clean start for the next track. And a link function to permit hookup of multiple CD-301s for automatic back-and-forth sequential play.

The high-performance CD-401 (\$849\*) incorporates TASCAM's award-winning ZD circuit to eliminate low level distortion and ensure sound quality that meets the most demanding standards.

The CD-401's fader-start feature allows play to start automatically on fade-in and stop at the completion of a fade-out. The CD-401 is available with optional hardwired or wireless remote.

For more information, call or write TASCAM, the company whose Industrial Strength product line also includes cassette decks and mixers.



## TASCAM



© 1992 TEAC America, Inc., 7733 Telegraph Road, Montebello, CA 90640. 213/726-0303. \*Suggested retail price.

Circle (99) On Reader Service Card



ARE YOU IN CONTROL  
OF YOUR RF?

## Get TranStat™

The complete transmitter control and monitoring system. TranStat™ provides for control of RF system functions, daily monitoring and meter readings and annual statistical information for budgeting. TranStat™ also provides programmable functions that allow you to customize its operation to your specific installation.



To get complete control of your RF system  
contact Continental first.



Continental Electronics Corporation

P.O. BOX 270879 DALLAS, TEXAS 75227-0879  
214-381-7161 TELEX: 73-398 FAX: 214-381-4949

Circle (105) On Reader Service Card

### BOTTOMLINE BROADCASTER

# Refurbish an Old Console For Fun and Practicality

by Jim Somich

**BROADVIEW, Ohio** Rebuilding outdated audio consoles is not only an extremely cost effective way to improve the performance of your station, it is also a lot of fun.

Over the past several months, I have outlined the basic circuit topologies required to rebuild any old board, regardless of vintage. The basic building blocks are: mic preamps, balanced-to-unbalanced interfaces, line amplifiers, power supplies, and monitor amplifiers.

There are more reasons to rebuild a console than just to save money, however. Often you will want special features on your board that are not readily available in a stock console. You don't have to build a board from scratch; it is much easier to start with an old shell and refurbish it.

This month, we will tackle the mechanical challenges of refurbishing an audio console, and conclude next time with the electronics reconstruction.

#### Initial inspection

Depending on the condition of the console you are rebuilding, you might have to strip it down to the bare bones. This is especially true of old tube-type boards that have been in daily service for decades or stored away in damp garages or basements. If you are rebuilding a more recent console in good condition, you can skip this column and start on electronic rebuilding in the next installment.

A complete mechanical rebuilding will include: stripping all wiring; removing all components—faders, switches, meters, etc. (and individually cleaning each); disassembly of cabinetry; rust and paint removal; repainting, and mechanical reassembly.

All wiring will have to be replaced in most older boards. If the insulation is brittle, if many modifications have been made and the board is a rat's nest, or if there has been a fire or flood, you will have no choice but to build a new wiring harness.

Go to work with wire cutters and systematically remove all of the old wiring. Strip all removable components from the cabinet and remove the wire ends from all the terminals.

All components removed from the board should be cleaned as required. In stubborn cases, you might have to soak the entire component in solvent to clean off years of grime and tobacco tar. Components in better condition might just require lubrication and light cleaning. All switches and faders should be cleaned and lubricated. Parts that are beyond repair will have to be replaced.

#### Cabinetry

Disassemble the cabinetry if it is to be refinished. Remove the front panel and any other removable panels. All paint should be removed before attempting refinishing. I like to use a process called Gentle Stripping. This is a dry paint removal system where the cabinet is blasted with plastic pellets. It is available nationwide.

While this stripping will remove even old, stubborn paint, it will usually leave

rust spots behind that must be sanded off manually. If you choose to use paint remover and elbow grease...good luck! You've got your work cut out.

After paint removal, you have a chance to fill in any extraneous holes that might have been drilled in the panels over the years. You can use plastic body filler sold in auto supply stores.

In most cases this is a two-component system that must be mixed right before use. Work fast because it sets up quickly. Large openings should be backed with thin metal to support the filler. After the filler has dried, sand it down flush with the metal surface.

Unless you have access to professional facilities, do not attempt to paint the cab-

**Adding special features that are not readily available is only one of the many reasons to rebuild a console.**

inet yourself. You will only achieve mediocre results and spend a lot of money using cans of spray paint from the hardware store.

What you will need is something that is baked on for years of wear and tear. The best process I have found is called electro-coating. An electrical charge is placed on the items to be painted and the paint is given an opposite charge. As the paint exits from a low-velocity spray gun, it is attracted to the cabinet.

When an epoxy-based paint is used the results are factory-fresh and will wear for years. Check the Yellow Pages for electro-coaters.

After painting, you can add any designs or lettering to the panel with dry-transfer letters. After you are finished, you can spray the surface with a light coat of clear lacquer for protection.

#### Mechanical assembly

After you have the cabinet painted, added lettering and designations, and have reassembled it, install all of the components you had previously removed such as faders, switches, meters etc. These should be clean and work smoothly. The bad parts should be discarded and replaced.

If there were any wooden parts, such as end panels, they should be sanded down and refinished also. Armrests often have to be stuffed and recovered. This can be handled by most furniture upholstery shops.

Next month we will discuss electronic rebuilding. This includes the design of new circuit modules, their fabrication and installation. If you cannot save the original wiring harness, it will be necessary to fabricate one from scratch.

□ □ □

Jim Somich is president of Somich Engineering and chief engineer of WOIO(TV) in Cleveland. He can be reached at 216-526-4561.



# Marconi Prepares to Cross the Atlantic

by George Riggins

**LONG BEACH, Calif.** In previous installments, I have described the events leading up to the commercial demonstration of wireless telegraphy by Guglielmo Marconi in England.

We pick up the story again after Marconi established Marconi's Wireless Telegraph Co. Ltd. in England and after the Italian Navy adopted Marconi's communication system for its fleet.

In 1900 there were 14 submerged telephone cables crossing the Atlantic. These cables represented an investment of up to \$2,500 per mile in cost (in 1900 dollars). In addition, there were maintenance vessels and crews necessary to keep the cables in proper repair. The imbedded costs were estimated to have been between \$4.5 million and \$9 million—quite a sum of money for the turn of the century.

## Distant shores

Looking into the future, Marconi decided to pursue quietly his conquest of the Atlantic. The eastern terminus was set for Poldhu on the Cornwall Coast in the southwest region of England. This construction was started in October of 1900. The transmitter was designed to be 100 times more powerful than previous installations.

The station was to be designed and installed by Professor Fleming, who later became famous for perfecting the "Fleming Valve." The first air checks from the new transmitter were conducted in January of 1901 between Poldhu and the Isle of Wight.

At this point geography became a factor in choosing the terminus on the North American continent. St. John's in Newfoundland was selected because the distance was the shortest to the Cornwall Coast.

Marconi, B.S. Kemp and P.W. Paget left Liverpool on Nov. 26, 1901, aboard the ocean liner Sardinian with the equipment thought necessary for the receiving tests. Balloons and captive kites were to be used for holding the aerials aloft rather than trying to build towers on short notice.

The party landed at St. John's in early December. Signal Hill was chosen as the receiver site due to its topographical characteristics. The hill can best be described as being on a lofty eminence overlooking the port and forming a natural bulwark, protecting it from the fury of the Atlantic winds.

The site encompassed approximately two acres on top of a small plateau. There were other buildings on the plateau including the Cabot Memorial Tower and an old military barracks, at the time being used as a hospital.

## Lift-off

The equipment was placed in the lobby of the barracks on Dec. 9. The following day the first balloon was inflated with about 1,000 cubic feet of hydrogen and attached to 600 feet of wire—about 10 pounds of weight. The wind tore the balloon loose and carried it out to sea. Back to the kites. The kites could be flown to about 400 feet above the ground with the weight of the wire.

Before leaving England, a pre-arranged

time schedule and signal were agreed upon. Poldhu only needed to be notified as to when the receiving equipment was in readiness. The first listening watch was set for Dec. 12, 1901.

The receiving equipment consisted of the latest coherer and a telephone ear piece. Marconi was of the opinion that the human ear was more sensitive than the apparatus for recording the signal on paper tape as was done for most incoming messages.

So began the wait.

## Preserving history

Barry Mishkind, our *Eclectic Engineer*, made some comments about the disappearing history in the broadcast portion of our entertainment industry (*RW*, Oct. 7, 1992). To add to Barry's comments I will mention a minor blip in the overall scenario.

Several years ago, Larry Cervon made an interesting presentation to a Broadcast Electronics distributor luncheon. The presentation included 10 or 12 excerpts from the many taped interviews Larry accumulated over the many years he was associated with manufacture and sale of broadcast equipment. Several of the people interviewed are no longer with us, and most of the others are now out of active rolls in the industry.

I asked Larry for permission to use two or three comments from the excerpts. The response almost blew the speaker cones from my ears. Not in volume but in the emphatic "no." It is my supposition that Larry is writing a book. It is too bad that a few snippets of information cannot be shared with the rest of the industry. Hurry up and get your book in print, Larry.

On a brighter note, several weeks ago I had a conversation with Steve Tunwall, chief engineer of KMA(AM) in Shenandoah, Iowa. In the course of the

conversation, I asked if any copies of the book written on the 50th anniversary of KMA going on the air were still available. Tunwall sent me a copy of the book, and although as of this writing I have not finished the book, it appears to be well documented with a very impressive list of present and former employees and artists.



Bob Nicholas, who grew up in the St. Louis area, leafed through the book with comments about various programs he remembers hearing in the late 1920s and early 1930s. Bob mentioned that at one time KMA and KFNF were owned by competing nursery companies. Both stations had good signals in the St. Louis area.

One other station that caught Bob's attention was KOIL of Council Bluffs, Iowa. KOIL was owned by the Mona Motor Oil Company at the time and originated many of the programs carried by a small network in the Midwest.

Over the past three or four years, I have received a few small booklets and flyers done on anniversary dates by stations. There must be more of such items in the files of many stations. How about keeping the eyes open and sending a copy to either Barry Mishkind or me so the past can be shared with others interested in history?

On another subject, Dale Gamble of Candler, N.C., responded to my comments about not being able to receive a good signal from WBT(AM) Charlotte, N.C., while listening in a motel room in

Columbia, S.C., last June.

Dale sent me a small version of the WBT coverage map. As best as I can enlarge the map, it appears that Columbia is at about the five millivolt per meter (5 mV/m) ground wave and a little east of the line for the 5 mV/m 50 percent skywave signal contour. If my geography is correct, the skywave and the groundwave would probably do a lot of phase cancelling in the area, thereby leaving very little signal for a small AM/FM receiver to recover.

□ □ □

George Riggins has experience in radio and electronics dating back to the 1930s. He also is a licensed ham radio operator and has had his own broadcast sales and service company, Riggins Electronic Sales, for more than 20 years. He can be reached at 310-598-7007.

## WHEN YOU WANT MORE THAN JUST AN ANTENNA

JAMPRO has been providing the broadcasting industry with state-of-the-art antennas for over 35 years, longer than any other US antenna manufacturer. With over 3000 antenna systems delivered, at JAMPRO you don't just buy an antenna, you invest in experience.

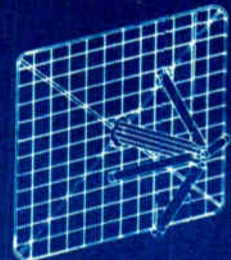

JAHDCP  
Arrowhead  
Screen Dipole

## THE LEADERS IN ANTENNA TECHNOLOGY

- Complete line of FM & TV broadcast antennas
- RF components, Filters & Combiners
- Modern 7000 ft FULL SCALE test range
- Directional antennas and pattern studies.

Call or fax us your needs today.

(916) 383-1177  
Fax (916) 383-1182



6340 Sky Creek Drive  
Sacramento, CA 95828

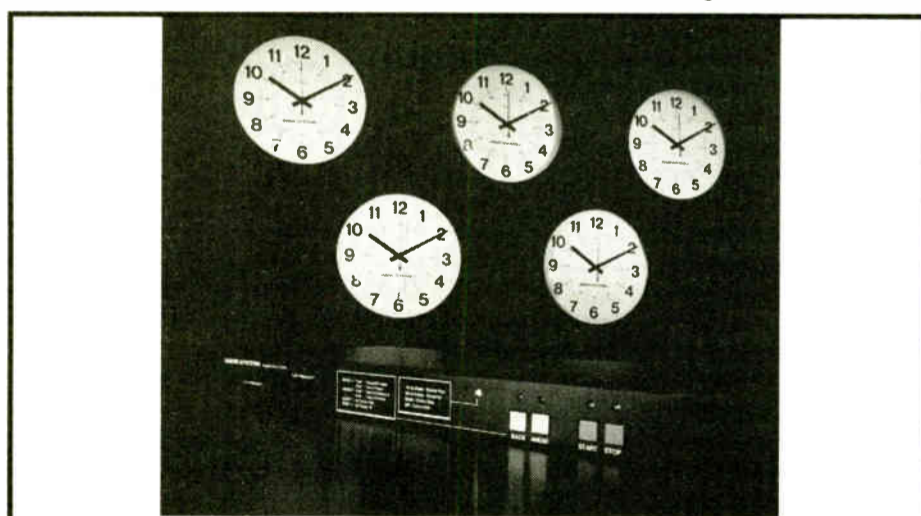

## Impulse Buy.

Up to 50 of our big, bright, economical analog clocks can be connected to the Radio Systems impulse clock driver for super accurate on-second timing throughout your facility.

- Low cost system • One second advance and hold
- Daylight Savings advance • External sync reference capable
- Internal crystal or line sync reference (TCXO time-base optional)
- Battery back up standard • New digital read-out available!

**RADIO SYSTEMS INC.**

800/523-2133 or FAX 609/467-3044

Circle (75) On Reader Service Card  
World Radio History

Circle (129) On Reader Service Card



## FEED LINE

# Assessing the Value of Directional AMs

by W.C. Alexander

**DALLAS, Texas** With radio station prices being what they are and the economy being in its current condition, a lot of stations are available at very good prices. Those owners who were conservative in the 1980s now have cash available, and the marketplace is ripe for these folks to move on some real bargains.

But what is really a bargain? This is the question that these owners are asking their engineers and programming experts. The engineers are busy dashing about looking over facilities while their programming counterparts are spending their time checking out the various markets to see how they could program a station there and secure an audience share.

In the last few columns, I talked about examining facilities first on paper, then in an on-site inspection. These topics were discussed broadly, and I received several inquiries from readers. This time, I'll cover some specific areas that seem to be of particular interest.

## Phasing equipment

Although I offered some general guidelines for evaluating AM directional arrays, there are some others that I can offer here. We'll start with the phasing equipment.

One of the first things I do when I look at a directional facility is to determine

what type of design is used in the phasor. There are three basic types commonly seen in the field: tank, shunt (Ohm's Law), and T-network.

The tank-type power divider, shown in

the position of the tap, the power to the tower can be somewhat varied.

Tank-type power dividers are usually quite stable once adjusted properly, but adjusting them can be a nightmare. The other advan-

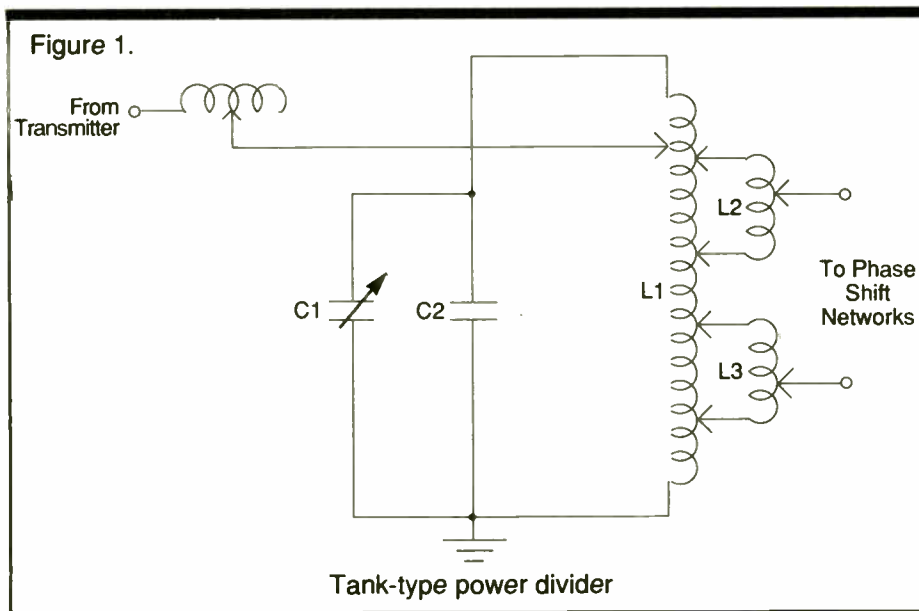

Figure 1, consists of a parallel resonant circuit using "jeep" coils positioned across turns of the tank inductor. Where these jeep coils are positioned determines both the phase angle and the power of the RF sent to each of the towers in the system. The "jeep" coils (L2 and L3) are usually roller inductors, and by varying

tage is a low parts count. Bandwidth is usually poor, however, due to the excessive stored energy in the tank circuit.

Very popular in years gone by, you are apt to see a tank-type divider in any directional array constructed before 1970. The tell-tale mark of a tank-type divider is a "resonator" control, which is nothing more than a variable capacitor across the tank coil.

Sometimes an RF ammeter or milliammeter is installed in the phasor between the bottom of the tank circuit and ground. The circuit is adjusted by tuning

the operating parameters on the antenna monitor and examine the operating log. Are the parameters stable?

Finally, look at the common point resistance and reactance. If they are other than 50 ohmsj0, count on modifying the system at some point in the future. If they are 50 ohmsj0, look carefully at the feed circuit of the power divider. This may be difficult to maintain if there is no input T-network. You might factor in the price of a new phasing system if any of these tests turn up trouble.

## Shunt-type

The shunt-type power divider, shown in Figure 2, is the preferred design of recent years. The main advantage is the degree and range of adjustment available. The disadvantage is the component count (and thus cost), which can be quite high.

Naturally, with more components, it follows that overall stability will be lower, but this can often be compensated for with environmental controls. Maintenance demands will certainly be higher.

This is probably the simplest design around, as it works on the principle of Ohm's Law. Tapped coils (usually roller inductors) connected between the common point bus and ground divide the power and send it to each tower. Adjust the roller tap closer to the common point bus and more power is fed to that tower; adjust it closer to ground and less power is fed.

Due to mutual coupling, there is some effect on phase shift in the power divider controls, but a well built phasor will keep this to a livable minimum. All the phase shift circuits are usually T-networks downstream of the power divider.

If you find this type of phasing equipment in place, look at all the things mentioned above, and then take a good look at the condition of the roller inductors. If the coils are heavily oxidized and/or pitted from arcing,

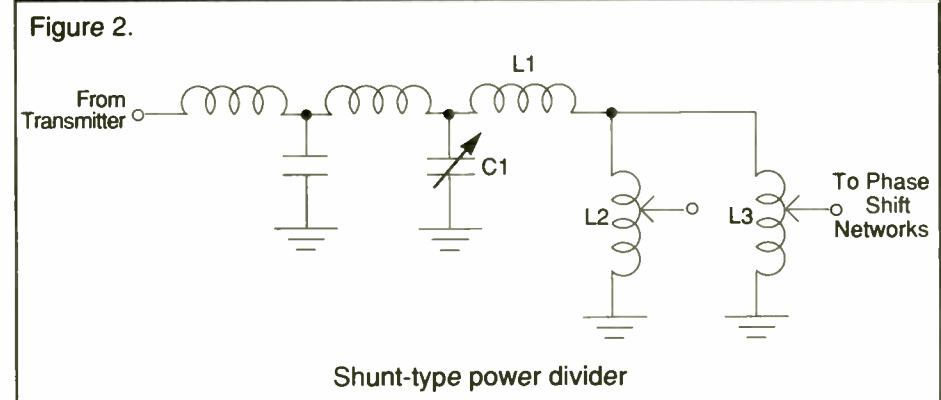

this control for minimum current. The trouble is, the common point impedance is pretty drastically affected by this adjustment, and readjustment of the feedpoint tap on the tank coil and the reactance-cancelling coil in the input circuit (L4) may be necessary after such an adjustment.

Moving the feedpoint tap can upset the whole apple cart, though, so it is not uncommon to find where a matching T-network has been more-or-less recently added ahead of the whole works to provide the ability to easily adjust the common point resistance and reactance. Since the common point resistance of tank-type power dividers is often nowhere near 50 ohms, a transmitter change will often make the addition of such a network (and the modification of the station license) necessary.

If you find a tank-type power divider in place at the station you are looking at, first listen to the station. How is the audio bandwidth? If it sounds narrow on a good quality, wideband receiver, the trouble could be the power divider. Next, look at

this spells *trouble*. Count on replacing these components. Turns counters become important when controls are used quite a bit, so look to be sure that all the counters work.

## T-network type

Occasionally, I run across a T-network type power divider. This unusual circuit uses the input impedance of a T-network to control both power division and phase. The advantage of this type of circuit is low parts count and (usually) stability. The disadvantage is difficulty of adjustment and interaction of controls. As a rule, the shunt arm of each T-network will affect power division more than phase, and vice versa with the input arm.

While this type of phasing equipment design is somewhat rare, it is not necessarily a bad thing. An experienced engineer who knows the way the system operates and the way the controls interact can easily keep it adjusted. Bandwidth may be better than with the shunt-type circuit.

Again, look for all the usual things plus

continued on page 18 ►

# TRADE UP TO A CCA

## FM BROADCAST TRANSMITTER



### Available Models:

2.5 KW	12 KW
4 KW	20 KW
5 KW	25 KW
8 KW	27.5 KW
10 KW	35 KW

# CCA

## CCA TRANSMITTERS

P.O. Box 426 • Fairburn, Georgia 30213 • USA  
1-404-964-3530 • FAX: 1-404-964-2222



# Rackmountable Technics CD Players

## SLPG100PKG



*Cues to music / Peak program search*

**Only \$149.95**

## SLPG300PKG



*Cues to music / Peak program search*

*Headphone jack / Keypad select*

*Wireless remote*

**Only \$169.95**

## *Need We Say More?*

*Order yours today! By calling 800-426-8434 or  
FAX 800-231-7055*

# **BSW**

**BROADCAST SUPPLY WEST**

America's Full-Time Broadcast Supplier

*\*Due to tremendous response on these packages we advise you to order early to ensure availability.*

Circle (28) On Reader Service Card



# Basic Properties of Alternating Current

*Editor's note: This is the first in a 10-part series called Fundamentals of AC. Northern Virginia Community College will offer 1.2 CEUs (Continuing Education Units) to registered students who successfully complete the course and an examination mailed at its conclusion.*

To register, fill out the form provided on page 20 and send it to the Community Education Office, Annandale Campus, 8333 Little River Turnpike, Annandale, Va. 22003. Or contact the college directly by writing to the above address, or by phoning 703-323-3168 or 703-323-3528. The fee for the course is \$30.

by Ed Montgomery

## Part I of X

**ANNANDALE, Va.** Whenever electrons flow through a conductor, a magnetic field is produced around the electron flow. This magnetic field exists at a right angle to the flow of electrons; it is directly proportional in strength to the amount of electrons flowing.

When direct current circuits are studied, the magnetic field plays a minimal role, increasing to a steady strength until the current flow is cut off. At this point the magnetic field collapses down to the conductor.

When pulsating direct current, or alternating current, is used, the magnetic field is constantly changing, permitting the transfer of information from one conduc-

tor to another. This is known as "transformer action" and is a very important part of alternating current circuitry.

A magnet has invisible lines of force or flux extending from one pole to the other. There are several terms used to identify

up magnetic tape records for specific recording characteristics.

The total number of magnetic lines present is termed magnetic flux. Flux density describes the number of magnetic lines in a specific area perpendicular to the direction of the flux. One magnetic line per square centimeter is known as a Gauss. This unit is often used to describe the build up of magnetic fields

Figure 2.

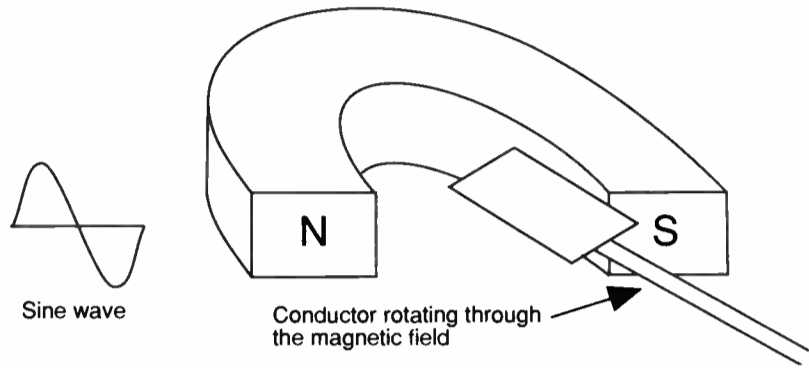
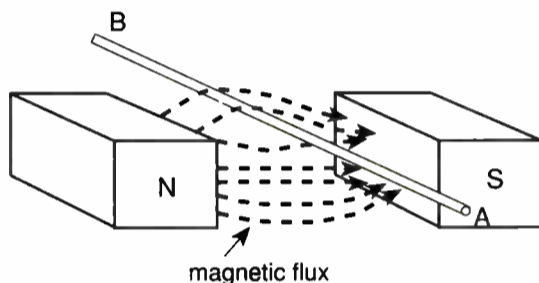

Figure 1.



specific properties of these lines of force. One magnetic field line is known as a Maxwell. One Weber is equal to  $10^8$  lines.

Since a Weber is a rather large unit, microWebers and nanoWebers are often used to identify this property. NanoWebers per meter is a term used when setting

on cathode-ray-tubes and record heads. Periodically they must be degaussed.

If a conductor passes through magnetic flux, it will temporarily sever the magnetic lines of force and create the effect of a rotating magnetic field around it. This will cause electrons to flow. Electricity is produced through electromagnetic induction.

In Figure 1, when the conductor moves downward between the poles, a counterclockwise magnetic field will be produced.   
continued on page 20 ►

## Directional AM Values

► continued from page 16  
the condition of roller inductors.

Another very important thing to look for at a directional AM site is the type and condition of the transmission lines. You are apt to see open, three- (or more) wire transmission lines supported on T-poles in very old systems, rigid 1 5/8-inch or 3 1/8-inch four-bolt square-flange coaxial line at facilities built in the 1950s and 1960s, and foam/air "Helix" type or EIA-flanged rigid coaxial lines in later systems. Coaxial lines may be above ground on supports or buried.

Open, three-wire elevated transmission line is hard to beat for cost, serviceability and loss, but it has a high characteristic impedance that varies with temperature, humidity, and air density, and it is difficult to maintain a match. Another disadvantage is RF radiation, where E- and H-fields under the lines may exceed ANSI guidelines.

Coaxial lines that are mounted above ground are certainly easier to inspect and

work on than buried lines, but they are more prone to have phase-shift drift with temperature. The old four-bolt square flange lines may not be 50 ohms, and parts will probably have to be home-made for any repairs.

Buried air or foam lines are usually stable and reliable, but if water gets in and you have to dig them up, again, you have trouble.

While we're talking about transmission lines, it wouldn't hurt to touch on voltage standing wave ratio (VSWR). In the days before the advent of the OIB (Operating Impedance Bridge), array designers and builders didn't worry about standing waves too much. In fact, it was just about impossible to do anything about such problems.

Still, in many systems, some effort was made by "line balancing." This is often evidenced by the installation of an RF ammeter at each end of each line. The terminating T-network was adjusted for roughly the same current on each end of the line.

# NEW!

## From Sine Systems: The DAI-1 Dial-Up Audio Interface

Used with other equipment you can have:

- **EBS Compliance In Walk-A-Way Operations** (at last)
- **A Remote Soundbite-Recorder** (great for radio newsrooms)
- **Remote Broadcasts** (no one at the station & no tones on the air)

For more information about our innovative product, call (615) 228-3500

**SINE SYSTEMS**

## Fishing For A Phone Number?

Catch it in the  
**1992 Radio World Directory Issue**

— The Industry Source for Manufacturer, Supplier, NAB and FCC Phone Listings, as well as Product Information, Company Profiles, Buyers Guide Reprints, RW's 1991 Editorial Index, Reference Material, and More...



**NOW AVAILABLE!!**

To order, send \$14.95 to:  
Radio World, P.O. Box 1214  
Falls Church, VA 22041

Theoretically, when the currents in and out of the line are the same, the VSWR on the line is low (unless the line is a half-wave or multiple in length). This was a pretty rough means of matching a line, but it was just about all they had in those days. I have heard of a three-ammeter net method used as well, but don't know of anyone who has done it.

In an on-site inspection, you will probably not carry an OIB with you to check the match on the lines. Still, you can often tell by looking whether any effort was made to match them.

Before I say anything else, let me say that at AM frequencies, VSWR has little effect on line loss (assuming the line is a good quality, low loss line to start with). That prefaces my next statement, which is that eliminating standing waves on AM lines will seldom improve the efficiency or root mean squared (RMS) of an array. Matched lines often will, however, result in more stability and possibly fewer components in the system. They will many times have a much more profound effect on bandwidth than anything else.

If the lines aren't matched right now and the bandwidth is OK, it may be better not to mess with the line matching (if it ain't broke, don't fix it). If the bandwidth is poor, matching the lines may make the situation better or worse. Either way, in that situation, it may be well to go ahead and get an OIB and match them, then work on the bandwidth at the input T-network or elsewhere.

Next month, we will continue along this vein and talk about bandwidth, sampling systems, filters, diplexing, and ground systems.

□ □ □

Cris Alexander is director of engineering for Crawford Broadcasting. He can be reached at Box 561307, Dallas, Texas 75356.



**You Don't  
Need Just  
Digital Audio,**

**You Need  
Digital Audio  
For Radio.**

**Finally.** Digital audio recording and playback that operates like it was meant to be in a radio station. DigiCenter™ from ITC. Designed by people who have been putting audio equipment in your studios for over 20 years.

**Built for radio.** Active balanced and differential I/O, selectable impedance and levels, CD quality audio performance, features compatible with the rest of your studio equipment. Desktop or rack mountable versions, plus remote workstations.

You decide what operating features you need: Digital Cart Machine; Live Assist; Satellite Automation; Program Automation. And DigiCenter™ is expandable. You'll be able to meet your station's needs next year, and for years to come.

We designed DigiCenter's™ DSP-1 Digital Signal Processing board to our demanding specifications. Same with the Audio Mixer Board, Analog I/O, and the mechanical interfaces. There's nothing "off-the-shelf" about DigiCenter™ because there's nothing "off-the-shelf" about your sound.

**Tested?** We've had a DigiCenter™ test system operating for over a year, 24 hours a day, in a commercial radio station, *making money*. We do not expect you to deal with "well it worked OK in the lab."

**Service?** DigiCenter™ has an integral modem and self-diagnostic software (standard), that can communicate with a host diagnostic system right here in our plant, 24 hours a day. And, you can communicate, toll-free, with our experienced, dedicated Technical Service staff.

**Price?** There are a lot of "apples vs. oranges" comparisons going on right now. Look at DigiCenter's™ specifications, and what's "standard" versus "optional". Feature for feature, we believe DigiCenter™ offers you the best performance value.

We're not the first ones on the block with "digital"; far from it, but professional audio takes a little longer. Any consumer can buy "digital audio", you need digital audio for *radio!*



For more information call ITC toll-free at: (800) 447-0414  
Outside the U.S.: (309) 828-1381  
FAX: (309) 828-1386

**International Tapetronics Corporation**  
P.O. Box 241  
Bloomington, IL 61702

DigiCenter™ is a trademark of International Tapetronics Corporation.

Circle (117) On Reader Service Card **World Radio History**





# Basic Properties of AC

► continued from page 18

duced in the conductor and electrons will flow from points A to B. If the conductor moves upward between the poles, a clockwise field will be produced, causing electrons to flow from points B to A.

## Perpendicular motion

To produce a flow of electrons, either the magnetic field or the conductors must be in motion. If neither moves, no flux lines will be broken, resulting in no current flow. To produce the maximum amount of current, the conductor must be perpendicular to the magnetic lines. This principle can be demonstrated quite easily

with a radio receiver.

The antenna in the receiver is intercepting a radio signal consisting of magnetic lines of force. As you rotate the receiver in a horizontal plane, you will notice that the radio signal will come in strong, fade away, and then come in strong again. Usually, the strongest signal occurs when the receiver's antenna is perpendicular to the radio signal.

The weakest signal occurs when the antenna is parallel to the radio signal. Radio signals are measured with a calibrated receiver known as a field-intensity meter. It contains a meter that is one meter in length. Electromagnetic waves

intercept the antenna and produce a small amount of electrical energy.

Radio transmission is a very inefficient way of sending information. One doesn't have to travel very far from the transmitter site to discover that the

constant speed as illustrated in Figure 2. The result will be electron current produced in the form of a sine wave.

Current will increase, decrease to zero, and then increase in the opposite direction, and then return to zero. This wave-



## Digital Storage Space

Five and one-half minutes of audio with a 5 kHz bandwidth and no moving parts. It's Henry Engineering's latest, cost-effective product — the DigiCord.

This DigiCord is perfect for network news delay, weather, EBS, request line playback and any on-air source that doesn't exceed five and one-half minutes.

Up to 16 random-length messages may be recorded. Playback is random-accessible. Messages can be played back in any order. A user selectable "repeat" mode

permits automatic looping. DigiCord easily records from a mic, tape deck or studio line. Balanced line-level audio in and out. It's digital which means no maintenance and no moving parts to wear out.

For complete details on the DigiCord, call on Harris Allied. We'll tell all, including how the DigiCord is now available with 8 kHz bandwidth at no extra charge.

**8:00 a.m. to 8:00 p.m. EST**  
**1-800-622-0022**  
**Fax 317-966-0623**  
**Canada 1-800-268-6817**



Figure 3.

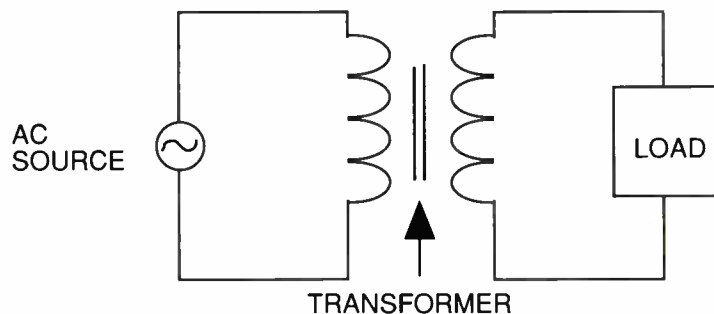

Schematic diagram of an iron core transformer with an AC source and load

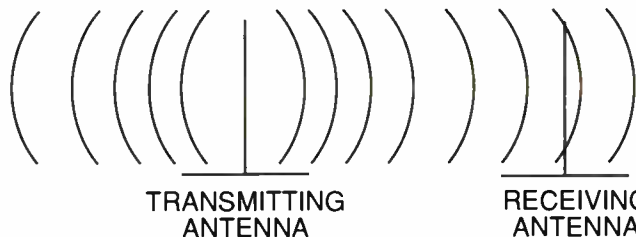

Electro-magnetic waves transmitted through free space

radiated energy is down in the millior microvolt range.

Since the motion of the magnetic field is necessary to produce an electron flow, and since the magnetic fields are within a finite space, it is necessary to pass the conductor constantly through the magnetic field in alternate directions to produce a continuous current flow.

## How AC is born

The current in the conductor will change directions every time the conductor changes directions. The electron or current flow will change or alternate producing "alternating current" or "AC."

Often AC is produced by rotating the conductor through a magnetic field at a

form of current generation will continue as long as the conductor continues to rotate within the magnetic field.

Many factors determine the amount of voltage induced in the conductor, creating the current flow: the strength of the magnetic field, the length of the conductor passing through the field (usually hundreds of feet of wire coiled up), and the speed at which the conductor passes through the field.

Generating alternating current is quite simple. It requires only the movement of a conductor through magnetic flux. The process requires no chemical reaction producing positive and negative charges.

Since the current is constantly changing

continued on page 22 ►

## REGISTRATION FORM

Community Education Office  
 Northern Virginia Community College Soc. Sec. No. \_\_\_\_\_  
 Annandale Campus Day Phone ( ) \_\_\_\_\_  
 8333 Little River Turnpike Evening Phone ( ) \_\_\_\_\_  
 Annandale, VA 22003

NAME \_\_\_\_\_ (Last) (First) (M.I.)

ADDRESS \_\_\_\_\_ (Street) (Apt. #)

(City) (State) (ZIP)

FOR STATISTICAL PURPOSES ONLY:

BIRTH DATE: \_\_\_\_\_ SEX: Male \_\_\_\_\_ Female \_\_\_\_\_

RACE: White \_\_\_ Black \_\_\_ American Indian \_\_\_ Alaskan Native \_\_\_ Asian or Pacific Islander \_\_\_ Hispanic \_\_\_ Other \_\_\_\_\_

(See Course Sample in Bold Below)

	course prefix	Course Number	Section No. and Campus	Course Title	CEU	Course Dates	Day	Time	Fee
1	ELEC	911	01N	<b>Fund of AC</b>	1.2	12/92		<b>RW Newspaper</b>	<b>\$30</b>
2									
3									
4									

METHOD OF PAYMENT: CASH \_\_\_ CHECK \_\_\_ MONEY ORDER \_\_\_ VISA \_\_\_ MASTERCARD \_\_\_

Credit Card No.: \_\_\_\_\_

Expiration Date: Month \_\_\_\_\_ Year \_\_\_\_\_

Signature: \_\_\_\_\_

OFFICE USE: SA91 \_\_\_\_\_ RU97 \_\_\_\_\_ RU98 \_\_\_\_\_ RECEIPT # \_\_\_\_\_ DATE \_\_\_\_\_





**I**ntroducing ADX, the first digital production system designed for the real world of broadcasting. A world where time is of the essence, change is the rule, last-minute is routine, and creativity is the competitive edge!

ADX is a fully integrated system which combines the creative flexibility of digital recording and editing with the speed and intuitiveness of a fully automated production mixer. Instead of simply storing audio elements and their edit decisions, ADX also recalls and recreates the mixing and processing talent of the producer.

Just imagine having the ability to precisely replay complex multitrack production work the way you mixed and equalized it yesterday, last week or last month! Think of the creative time saved when a change or update is requested in an otherwise perfect mix.

Plus, the ADX is unencumbered by the architectural limitations of first-generation workstations and is designed to grow and expand with your needs. Even the basic system has more standard features than anything before.

And like all PR&E products, ADX is a powerful tool optimized for the fast and furious demands of broadcasting and backed by world-famous PR&E support. Call today for information on ADX, the next generation of digital.

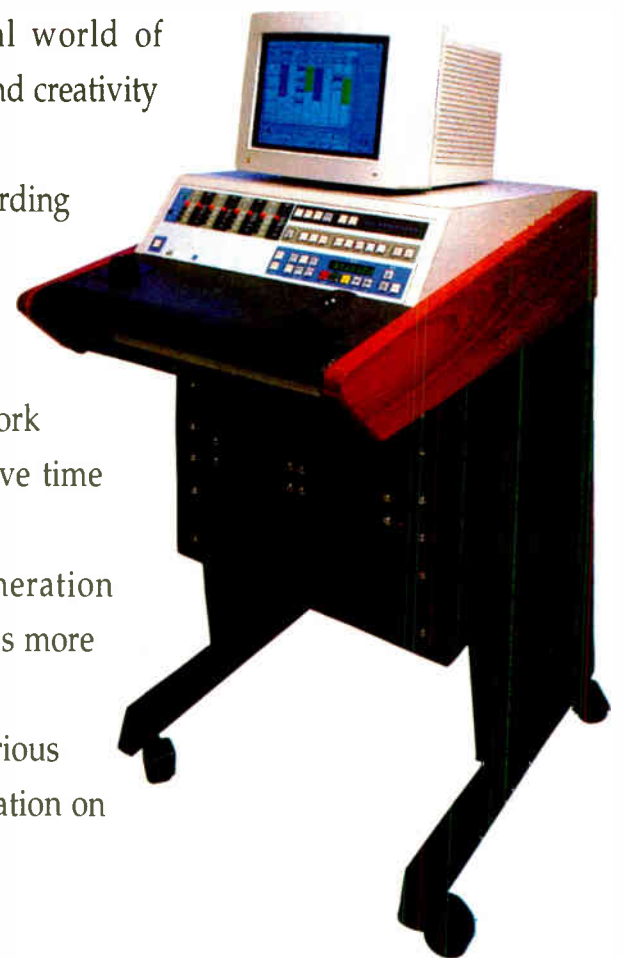

Pacific Recorders & Engineering Corporation, 2070 Las Palmas Drive Carlsbad, CA 92009  
Tel: 619-438-3911 Fax: 619-438-9277 GSA Contract: GS-03F-2057A

**DESIGNS THAT MAKE THE DIFFERENCE**

Circle (115) On Reader Service Card  
World Radio History



## INSIGHT ON RULES

# Suggested Review for Self-Inspection

by Harold Hallikainen

**SAN LUIS OBISPO, Calif.** I've received some more neat stuff in the mail. First off, we have the proposed FCC FM Self Inspection Report. This 35-page form is similar to the AM form we've been discussing for a while. I can send you a copy of the FCC FM Self Inspection Report if you send \$3.50 for copying and postage to the address at the bottom of this column. Checks should be payable to H&F and marked "FCC FM SI."

I also recently received a copy of "The Big Book" from Wind River Broadcast

Center (phone: 303-669-3442). Wind River has done an excellent job of organizing the technical requirements of a radio station. The book includes printed dividers for each section.

## Volumes of info

The dividers for volume 1 include a table of contents for that section. Sections include Announcements, Antenna and Tower Data, Calendar, Designated Chief Operator, EBS, Equipment Performance Measurements, FCC, Licenses, Technical Logs, Power Pattern Change Data, Preventive Maintenance, Public Inspection

File, Remote Control, Extension Metering, ATS and Transmitter Operation, Phone Numbers, Transmitter Data, Trouble Checklist, and Forms Masters.

Volume 2 of the publication includes FCC Rules for parts 0 through 19 and 70 through 79, plus a technical directory.

Volume 3 of "The Big Book" organizes a station's Public Inspection File. Dividers are provided for each type of document to be in the file. The divider has printed instructions describing the FCC requirement, the file retention period, and spaces to fill in an "inventory" of the documents in that section.

Continuing our review of the proposed AM self inspection form, the form asks if the required station inspections are being made by the chief operator. FCC Rule 73.1870(c)(1) makes the chief operator responsible for inspections of the station's transmission system, required monitors, meters and control systems. The chief operator may delegate the duties, but not the responsibility.

## Do inspections right

The chief operator is to maintain sufficient supervisory oversight to ensure the inspections are being completed properly. No inspection schedule is specified by the FCC. When I started in radio, a transmitter site inspection was required five days a week. Later, this requirement was dropped to once a week.

At this point, the frequency of inspection is up to the station licensee. It will probably be determined based on equipment stability and reliability. Further, having extensive monitoring capability at the control point allows most of the typical transmitter site inspections that are still required. The self inspection form asks for the date of the last inspection.

Rule 73.1870(c)(3) requires the chief operator (or designee) to review the station logs at least weekly to ensure compliance with the rules and station's license. I have suggested that the reviews be done exactly weekly, perhaps Monday morning.

A weekly "Log Review" form can be prepared and used as a checklist in doing the review. In addition, this would be a good time to check all the control point equipment and log monitor readings. Possible log review items for a non-directional AM include: operator on duty whenever station is on air; all operator licenses posted; antenna current within limits; carrier on/off times as authorized; power change times as authorized; EBS receiver checked daily; EBS test received 8:30 a.m. to sunset (log

continued on page 30 ▶

## Digital Audio Breakthrough!

Improve your station's sound by eliminating tape carts. Make your move to the top quality (and convenience) of Media Touch digital audio.

### No hiss, flutter, or phase problems

Listeners will love your superb sonics, and tight, smooth segues with true overlap. With Media Touch's digital audio, you *won't* hear the distortion, compression, aliasing, or grunge of certain other hard disc systems. Audio quality *doesn't*

get any better than Media Touch's uncompressed digital, CDI-C, MUSICAM or Dolby AC-2!

### Music on Hard Disk!

Previously, jocks wanted the convenience of all their songs on carts. Now, jocks prefer their music on instant-access digital disk! Play any song (by title, artist, length, album, disk or sound code) as fast as fingers can reach out and touch. And it's *amazingly affordable* to put spots and songs on hard disk. Media Touch plays commercials, music, liners on-the-air and records in production on *one* multi-tasking drive!



WCCO's uncluttered, paper-free Media Touch Minneapolis studio is shown above. Logs, timing, commercial outcues and live copy show on our screen.

Media Touch is today's system of choice for Bloomberg, Paxson, Sconnix, Liggitt, and other duopoly/LMA pioneers from New York City to Guam.



Dolby AC-2 and the double-D Dolby logo are trademarks of Dolby Laboratories Licensing Corp., used under license. Media Touch and MUSICAM are trademarks.

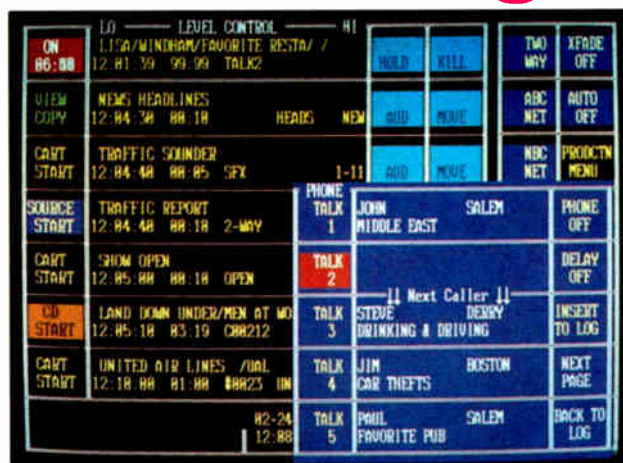

Media Touch puts all your music, commercials and copy at your fingertips. Media Touch's touch-sensitive computer screen (or smart faders and button box) simplifies selection, sequencing, and starting your songs and spots. You get perfect merges from commercial logs and music playlist software.

Media Touch's hard disk recorder is the industry's best sounding, thanks to our quality breakthrough with uncompressed, MUSICAM or Dolby AC-2 digital audio.

### Or, 4 Brands of CD Juke Boxes

For those who prefer their music from compact discs instead of hard disk, Media Touch also controls every kind of juke box.

### Make Duopoly/LMAs More Profitable

For larger digital audio systems serving several stations, Media Touch pioneered (and perfected) Novell Local Area Networks for several stations. We also automatically record (and play) unattended and run satellite formats.

### Paper-free, Clutter-free Studio

Media Touch combines music playlists, countdown clocks, commercial logs, live copy, ending cues, tags, weather, promos, and even sports scores on *one* simple screen. Every song, spot, sounder, source and function is at your fingertips. Media Touch has been *delivering* features for years other systems only *hope* to get next year!

Media Touch is amazingly affordable! Call for our free video showing this fantastic system!

## Media Touch Music Corp.

A Dave Scott Company

4125 Keller Springs, Suite 122, Dallas, Texas 75244

(800) 330-3004 or (214) 221-3100

FAX: (214) 931-0707

## Basic AC Properties

▶ continued from page 20

ing in AC, the magnetic field surrounding the conductor is also constantly changing. This changing field can transfer energy from one wire to another, with magnetic flux being the only connection between the two. This is the principle on which transformers operate. It is known as "transformer action." Transformers not only transfer power, but they also have the capability to increase or decrease voltage in a circuit.

This same principle of energy transfer is what makes wireless communication possible. The transmitting antenna is one part of what could be considered a transformer, and the receiving antenna is the other part. This is illustrated in Figure 3. The only linkage between the two is the magnetic flux created at the transmitter.

□ □ □

Ed Montgomery is a communications teacher at Thomas Jefferson High School for Science and Technology. He has taught broadcast engineering at Northern Virginia Community College and worked as a broadcast engineer for several radio stations. He can be reached at 703-750-5090.



## LINE OUT

# Pro Audio Editing on a Budget

by Bruce Bartlett  
with Jenny Bartlett

**ELKHART, Ind.** Our recent articles on two-track digital audio workstations (DAWs) sparked a lot of interest. Many broadcasters want to know more about hard-disk workstations so they can produce CD-quality spots and promos.

Both two-track and multitrack systems are available. Two-track models cost less, but they only do editing, not production. If you want to record, overdub and mix several tracks of audio, you need a multitrack system. It will allow you to record music, voice, and sound effects to hard disk, assign them to various tracks, and mix them to stereo.

When you choose a hard drive for this system, allow at least five megabytes (5MB) of disk space per track-minute of material you record onto disk. For example, suppose you made a series of two-track stereo recordings that totalled 10 minutes. They would consume 100MB (5x2x10=100). That's for the soundfiles alone, not including space for edit buffers and regular programs.

## The MicroSound DAW

Multitrack DAWs are becoming affordable even for small radio stations. For example, Micro Technology Unlimited makes the MicroSound DAW, a 38-track unit which sells for \$3,690 excluding the

computer and hard drive. A complete workstation, including a 486-33 computer and 600MB drive, costs around \$8,300.

MicroSound works on any IBM-compatible computer (286 and up) with 640K of memory, 10 MHz to 33 MHz, running Windows 3.0 or 3.1. If you want to overdub, record and playback at the same time, you need at least a 386-25.

floor is claimed to be -110 dB.

It's a three-part system, including a circuit card you plug into a slot in your computer, an external I/O box with connectors, and software.

Here's how it works. First, record program material onto your hard disk. You can record up to 20 soundfiles. Each soundfile is a separate recording of, say, a music bed,

sound within the soundfiles. They might be sound effects, sections of music, or a few seconds of dialogue. Using a mouse, you specify the start and stop points of each segment. Over 3,000 segments can be defined.

When you edit the sound segments, you can zoom-in down to the waveform level for precise editing. Edits can be undone. You can extend or shorten segment lengths by clicking and dragging the start or end point.

## Virtual tracks

After defining the segments, you're ready to place them in up to 38 "virtual" tracks. (A virtual track is a section of disk memory that simulates a tape track). Click and drag each segment to the desired track. The segments appear on-screen as rectangles on a time scale made of gridlines. See Figure 1.

You can also adjust the timing of segments after recording them. Using your mouse, slide the segments left or right—earlier or later in time. Or type in the desired SMPTE start time for each segment. In this way, you can make all the cues start at the right points.

You can time-shift segments within each track. As an example, suppose you've recorded a door-slam sound effect. If it comes in too soon, just slide it later in time with your mouse.

You can put a segment in more than one track. Or put a segment in several places in a single track. For example, put a horn beep at various cue times in a track.

Using the computer, you can set the volume level of each track, and of each segment. You can add fades to duck music

continued on page 25 ►

Figure 1. Screen display of MicroSound workstation

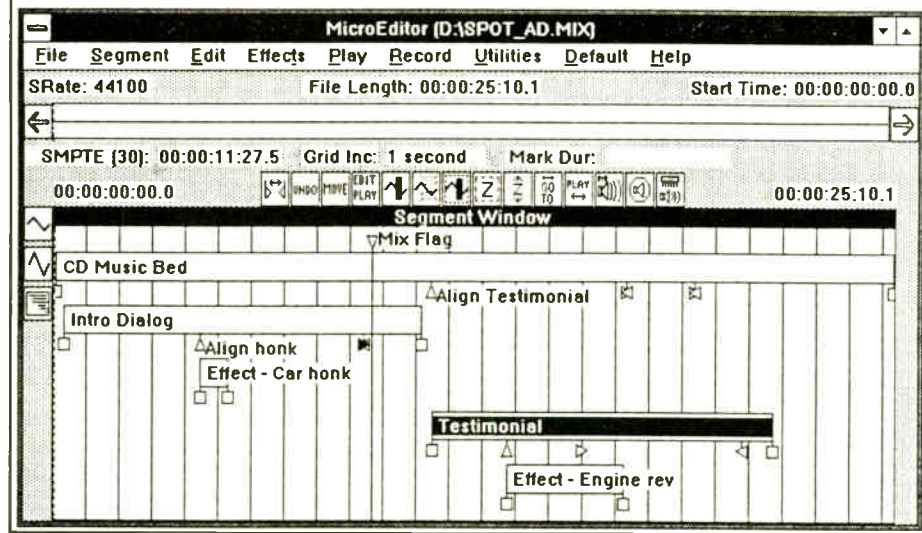

The sound quality is up to CD standards, thanks to the 16/18 bit A/D converter running at up to 48 kHz. Fifteen sampling rates are available. The noise

narration, or several sound effects. Alternatively, record multiple sounds into one file, pausing between each recording.

Next, you define segments or portions of

# More Power To You.

## SERVICE AND SUPPORT

When the Empire State Building's newest tenants needed top quality high power transmission line, they turned to the company that's been on the job at the Empire Broadcast Center for over two decades—MYAT. We delivered TV Channel 41's 8<sup>3</sup>/<sub>16</sub>" 75Ω line and Channel 25's 9<sup>3</sup>/<sub>16</sub>" 50Ω waveguide adapters on time, in spec and within budget. Our computer-aided design, manufacturing and testing capabilities can do the same for you.

## MAXIMUM VELOCITY AND MINIMUM ATTENUATION

That's what MYAT rigid line and RF components deliver. We manufacture them using pure highest quality copper or aluminum and thoroughly test each one before shipping. Princeton University's Plasma Physics Laboratory evaluated MYAT performance, and chose our components for their research reactor.

## RELIABILITY AND LONGEVITY

They're important to you—and to us. So we use non-galling silver plated beryllium copper contact springs, brass elbow reinforcements and virgin Teflon inner supports—MYAT line sections and components are warranted for a full year. That's why you'll find the bright blue MYAT logo in transmitters and systems by Harris, Acrodyne, QEI, Micro Communications and Broadcast Electronics. And at thousands of broadcast stations worldwide. Whether you're planning a new tower, upgrading an older installation, or coping with an emergency, MYAT power is as close as your phone. Put it to work in your RF transmission system. Contact your RF distributor, or phone us at (201) 767-5380.



CALL FOR OUR NEW CATALOG.  
RIGID LINE: RADIO'S EFFICIENT CHOICE.

**MYAT, INC.**

Manufacturers of RF transmission equipment since 1951.  
**40 Years of Experience, 40 Years of Excellence.**

380 Chestnut Street • P.O. Box 425 • Norwood, NJ 07648 • Tel (201) 767-5380 • Fax (201) 767-4147

Circle (143) On Reader Service Card



## ECCLECTIC ENGINEER

# High Tech Gadgetry Demands Sharper Skills

by Barry Mishkind

**TUCSON, Ariz.** For many engineers, it seems the trip to the transmitter site can get pretty boring. The equipment and Rules changes in the industry make it a very different chore than in "the old days."

What a change it is from those days. Perhaps you remember when the transmitter readings needed logging every half hour, plus or minus two minutes. Frequently, tubes or parts would fail and need immediate attention. The common solution in the larger markets was to have the transmitter site manned all day.

These transmitter engineers would take the required readings each half hour and make the various routine adjustments to the loading and tuning. Other duties might include cutting the grass or waxing the transmitter.

## Chores are fewer today

Today's modern transmitters often will run for days or weeks without any external attention. Thanks to such advances as solid state power amplifiers and automatic power adjust circuits, operation can be kept very close to nominal with virtually no drift. Modulation is also highly predictable once the audio processor has been set up.

For some engineers, the high point of the trip to the site is checking around the transmitter building for signs of intruders (man or animal) or weather damage.

Does this mean there is less need today for engineers and their maintenance runs to the transmitter site?

No. State of the art requires more highly trained technicians. Many signals of impending equipment failure are very subtle. Still, the engineer must be able to recognize such signs before they reach the stage where air time is lost.

This is not always easy. Today's engineers are busy, operating more and more stations per capita than ever before. When engineers met not so long ago, a common question was: "How many engineers are on staff at your station?"

Now, the question is: "For how many stations do you engineer?" There's not much time these days to wax the transmitter.

At the same time, the loosening of regulations regarding the logs that must be kept and the quality of studio staff provide less and less qualitative data for the engineer. We've all seen transmitter logs worth less than the paper used to create them.

Some stations have met this challenge with computers to log and report on transmitter parameters. Taking the readings accurately at regular intervals, and storing them on paper or the hard drive, gives the engineer the ability to note even small variations or trends.

However, most stations don't have this luxury. They lean more heavily on the handwritten logs generated by the transmitter inspection trips. Indeed, all stations need to give periodic attention to the quality of documentation available.

## Sufficient documentation

Clearly, the better and more complete the logs, the more easily a station can handle an FCC inspection. Yet, the sta-

tion itself benefits from careful documentation.

To gain this benefit, all the readings available on the transmitter ought to be regularly logged. Even if it seems like a boring series of similar numbers, the day will come when a failing part will stand out like a sore thumb, given away by an excessive current or voltage reading. On the other hand, if the maintenance log is simply a series of checkmarks indicating "normal operation," it'll be much harder to catch any telltale patterns.

For instance, a resistor that changes in value under load or heat can create all sorts of problems. One example might be where the filament voltage on a tube rises. If not caught promptly, the tube life might be greatly reduced.

One of the most common gripes of engineers who take over a station or even assist during an emergency is the lack of information on when repairs were made, what was done, and why.

This is critical because problems may reoccur. Knowing which parts to watch and how to replace them quickly will reduce downtime. Another benefit is in knowing which parts you need to have in stock to deal with most problems.

Exactly what kind of maintenance record you should develop depends on your station's needs. Typical areas of concern include the transmitter-antenna match, filament and power line voltage stability, STL receive strength, remote control calibration, and building temperature. You may have others. The important thing is to develop a feel for the normal readings. Then any unwanted changes will grab your attention quickly.

For your own peace of mind and that of others to come, cultivate the habit of writing everything down. The more the better. You never can have enough in your maintenance logs!

## For the book shelf

Tab Books has just released Volume 4 of The Encyclopedia of Electronic Circuits by Rudolf Graf. It contains about a thousand circuits and ideas. Featured among 104 categories are alarm and security, audio, test, and even computer-related circuits. There's bound to be something in there to take care of that nagging project.

For those of you curious about how the FCC is testing these days, the newly released 3rd edition of the General RadioTelephone Operator's License Study Guide by Thomas LeBlanc (Tab Books, 1992) should prove interesting.

While the general class license itself is no longer valid for broadcast, this study guide is more than just a review of radar and marine topics. Stressing concepts over memorization, the material covered is important to all engineers.

□□□

Barry Mishkind, aka RW's "Eclectic Engineer," hides out in Tucson, AZ. He can be reached at 2033 S. Augusta Place (85710). Electronic addresses: BMISHKIND on MCI Mail, Internet or CompuServe users can send to "barry@coyote.datalog.com."

R E V O X

PR99

REVOX

Designed specifically for broadcast professionals, the ReVox PR99 delivers the highest quality audio, outstanding performance and reliability, year after year. Precision engineered with advanced audio electronics, the PR99 offers an impressive list of operating features such as: • balanced and floating inputs and outputs • a solid die-cast aluminum transport chassis and head block • a true Autolocator with Zero Locate and Address Locate functions • rack mounts standard • full "solid state" transport control with motion sensing • easily accessible modular electronics • varispeed control • the service and support of the only company backed by over 40 years of engineering excellence. Providing outstanding flexibility in live on-air broadcasts, remotes or commercial production tasks, the industry proven PR99 is the top choice among professionals. Call today for more information.

**REVOX®**

1425 ELM HILL PIKE - NASHVILLE, TN 37210  
TELEPHONE 615-254-5651 TELEFAX 615-256-7619  
IN CANADA 416-510-1347

© ReVox is a registered trademark of STUDER  
REVOX AG, Regensdorf, Switzerland.

Circle (182) On Reader Service Card



## O-TIPS

# Radio Today Is Same as It Never Was

by John "Q" Shepler

**ROCKFORD, III.** This August represented a personal landmark. Twenty-five years ago, I joined the world of professional broadcasting as a nervous high school student hoping to be good enough to work part-time. A lot has changed during those years and a lot hasn't.

In this month's column, I'd like to share with you a few observations and experiences from the past, and perhaps an enlightened view on where things may be headed.

## Humble beginnings

In 1967, the state of the art for most stations was still vacuum tubes, reel tape, and vinyl records. The small-town station I started with didn't have the best and latest, but I didn't know that or even care. It was *professional* radio and that was exciting.

We had one cart machine for spots on AM. It was a mono ATC, carved from a solid block of aluminum. The FM station came on at 4 p.m., went off at 10 p.m., and had the only solid state gear in the place—a five-channel Sparta console with built-in turntables.

## Micro Sound Workstation

► continued from page 23

under dialogue. Effects and panning can be simulated.

Once you've assembled your virtual tracks and set their levels, mix them by playing them all at once. The computer will take several seconds or minutes to calculate the mix before it will play. Record the stereo mix onto your two-track recorder. You can back up your soundfiles, edits and mixes to DAT, load them in later and re-do them.

Suppose you need to synchronize a singer with a music track. You can play the music soundfile while recording the singer's soundfile—even on the same disk drive. The MicroSound also can sync to SMPTE or MIDI.

For on-air work, the MicroSound can emulate a broadcast cart machine. To make it do this, set up a cue list of the sound events in sequence—a station break, a program intro, a record, and so on. While viewing the cue list, tap a computer key to play each event at the proper time, or let it run automatically.

MicroSound has many options: time compression/expansion, noise reduction, unbalanced or balanced connectors, AES/EBU or SPDIF digital inputs and outputs, parametric EQ, filtering, and sample-rate conversion.

The manual and on-line help are excellent, as is the company's tech support. For more information, contact Micro Technology Unlimited at 156 Wind Chime Court, Raleigh, N.C. 27619; or phone 919-870-0344.

□□□

Bruce Bartlett is a microphone engineer and technical writer for Crown International, and the author of *Stereo Microphone Techniques*, published by Focal Press. Jenny Bartlett is a technical writer. Bruce can be reached at 219-294-8388.

The few produced commercials were wound onto Magnecorder decks for playback. Most announcements were read live.

Both AM transmitters were homemade. The main 5 kW transmitter was a disaster and was soon replaced with a new Gates BC5H. The 1 kW aux was the original station transmitter built just after World War II. It was a fine piece of work and looked like a manufactured product in its black crinkle finish. Those 833A tubes still put out a respectable signal today.

Within five years, the state of the art was clearly solid state. A competing FM

station came on the air in stereo—including the cart machines and production studio. Except for the transmitter, it was fully solid state.

Sudden competition from a station with all-new gear is the one thing certain to drive perpetually cost-sensitive broadcasters to upgrade their technology. And they did.

Financial pressures are nothing new. I didn't know it at the time, but my original employer had recently reduced staff by eliminating the job of board operator in favor of combination announcers/operators.

He had also installed a remote control to eliminate the transmitter engineer, although the first telephone regulation tempered this move.

## The way we were

The decline of AM is like a trip through a looking glass—everything's reversed. In the late 1960s and early 1970s, for example, AM was king and FM was the financial loser. It was common to simulcast AM on FM. Now it's the other way around.

In 1992, FM sounds like AM used to. It has the big audiences, intense processing, larger staffs and larger budgets. AM has been ratcheted down another notch. First television took over as the premier broadcast medium. Now FM has taken

continued on page 30 ►

## Custom Sound



## CRL's Signature Series

### Unbelievable Sound

CRL's newest FM processing system allows you to produce a sound that is as unique and personal as your own "signature." Engineered using the latest digitally controlled analog techniques, CRL's Signature Series gives you quality sound that can outperform the "harsh" or "edged" sound that has been found to be typical of the new Digital Processing technology.

### Customized Processing

The system consists of the Audio Signature FM processor and the Modulation Signature FM limiter/stereo generator. Processing presets, special bass enhancement and our digitally synthesized stereo generator help customize your processing to meet your station's needs. Add our optional Real Time Event Sequencer to gain "dayparting" capabilities and to store up to 200 events and up to 26 Audio Signature processing presets, or control the system direct via IBM PC or through a modem.

### Competitive Price

The Signature Series offers an affordable way for you to tailor your station's sound. Call or Fax CRL or your regional representative TODAY, and let CRL's Signature Series put you in absolute control of your Custom Sound.

just another one of the benefits of our experience.



Experience  
Reliability  
Performance

## CRL SYSTEMS

2522 West Geneva Drive Tempe, Arizona 85282  
800/535-7648 602/438-0888 Fax 602/438-8227

Circle (193) On Reader Service Card



# DIGILINK

*...a revolution in radio studio technology .....*

## **THE DIGITAL AUDIO ADVANTAGE...**

Introduced in April of last year, Digilink is a digital audio workstation that saves your station money. There is no more routine maintenance, it has a 15 year average life, *and* you have total automation capability for nights... weekends... or whenever you need it. It comes complete in a 5 1/4" high, rack mounted cabinet that converts ordinary analog audio to CD quality digital audio which is stored on a computer hard drive. It does this just like you would store a business letter on your home computer. Digilink can then call up and play any digital audio file in milliseconds off its internal hard drive. Basically, you can think of Digilink as a huge multideck cart machine or "rotary cart player" where you can line up and play thousands of carts our audio cuts sequentially. A single Digilink can therefore replace all of your cart machines in production, On Air, or in automation.

## **Digilink is a perfect cart or reel machine replacement...**

Digilink is the perfect replacement for magnetic tape based cart or reel machines. With Digilink, you can replace your cart machines with CD quality digital audio that requires no calibration, no maintenance, and the media has a 15 year average life. You can replace your reel to reel machines, razor blades, and tape with fast, nondestructive, CD quality, on screen waveform editing. You can cue virtually instantaneously. Digilink even costs less than comparable analog cart or reel machines. Digilink is the perfect audio record and play system for professional radio broadcast applications.

## **Digilink performs ALL types of automation...**

With Digilink you can operate fully live or mix various automation types into your daily programming. You can store all of your audio on hard disk at an incredible price or you can use hard disk for only commercial material recording. Digilink has an internal audio switcher with machine logic control. Digilink therefore supports satellite automation, reel and DAT tape automation, CD automation, and full hard disk automation all out of one compact box. Because Digilink is a computer, you can print out a log of what you have scheduled to play *or* print out a log of what really did play. With Digilink, you can be live on the air with full CD quality audio or program the system and walk away forever. Digilink even interfaces with all major traffic and billing systems through a Digilink import-export routine.

## **Digilink is engineered and manufactured by Arrakis...**

Digilink is not simply a hardware package assembled from parts built by *other* computer manufacturers and run under our software. Arrakis is the *only* manufacturer to build nearly all parts of the digital system in-house. We build our own *Arrakis* DSP board, SCSI board, I-O board, switcher board, cabinet, and cabling. Because Arrakis builds the system and doesn't simply mark up someone else's hardware, Arrakis can offer you Digilink with broadcast features and performance unmatched by anyone *and* at a truly remarkable price !!!

2619 Midpoint Drive, Fort Collins, CO. 80525



..... at an incredible price. !!!!!

**SALE \$7,995**

under

for a COMPLETE 6 hour stereo system

whether you lease for under \$300 a month or buy, with Digilink you can literally make money by ...

- reducing maintenance,
- reducing staff demands,
- improving On Air sound,
- improving Production, and improving all areas of your station performance !!!



## FEATURES

- Simultaneous record- play !!!
- Uncompressed CD quality audio or mix 2:1 or 4:1 compression
- Use keyboard, mouse, trackball, or even a touchscreen
- Digital Waveform Editing
- Mix mono and stereo files
  
- Live Cart Machine replacement
- Reel to Reel machine replacement
- Satellite Automation
- Tape Based Automation
- CD Automation
- Hard Disk Based Automation
- Traffic and Billing Interface
- supports digital networks

## SPECIFICATIONS

all tests performed at 1:1 compression

### Digital Signal Processing System (DSP)

Sampling System- 16 bit linear PCM, 2 channels  
Sampling Rates- 44.1,32,22kHz, fixed filter on routing switcher  
Compression- 0,2,4...adaptive differential PCM

### Controller -

Floppy Disk- 3 1/2" 1.44M capacity, System Hard Disk- 40MB  
Printer Support- IBM compatible, parallel port

### Audio Performance- Digital Record playback

THD- .008%, Dynamic Range >85dB,  
Freq Response- (+)(-).5dB 10Hz-15kHz

### Physical Specifications

Dimensions- 19" Rack mounted- 19"W x 5 1/4" (3RU)H x 16"D  
Weight- 60lb's , Power- 110/220VAC, 50/60Hz, 100W

### Audio Performance- Routing Switcher

THD- .005% typ, S/N < 100dB below +4dBm  
Dynamic Range- >120dB,  
Freq. Response- (+)(-).1dB 20Hz-20kHz

by **ARRAKIS SYSTEMS inc.**

Voice (303) 224-2248, FAX (303) 493-1076



# Good News for Radio Stations

## Increase Business Coverage . . . Without Spending a Dime

No matter what your format, we have news for you! And it's news your listeners want to hear. News about the economy in a form they understand. How do we know? We asked them. In a national survey more than 60% of the respondents told us they are paying more attention to business news now than they were six months ago. We also learned that a majority of them use the stock market as an indication of the health of the economy.

**Where are they turning for this information?**  
More than a quarter of the respondents cited radio as a viable source of business and economic news ... making stock market information a key way to reach listeners, particularly the much sought after high SES listener.

So who can give you the most complete stock market information available to radio stations? We can. We're the Nasdaq Stock Market, the second largest market in America. For years, we have been providing television stations with daily customized market reports. Now Nasdaq has developed a variety of services that provide radio stations with this same type of information.

**Best of all, all of our services are free!**  
Just call 1-800-777-NASD, and let Nasdaq develop a custom market report to fit your needs. It's a unique way to add to the service you provide without spending a dime.

THE NASDAQ STOCK MARKET  
**NASDAQ**<sup>SM</sup>  
The Stock Market for the Next 100 Years



## Use Promotion to Generate Revenue

► continued from page 1

To that end, Lawrence says bumper stickers have undergone a radical evolution in recent years, hoping to appeal to core listeners instead of driving for new cume.

"Design has become very important today," he explained. "Instead of the old two-color stickers with station and frequency, the product has become much more interesting and artistic." As a result, core listeners are proud to identify themselves with the station.

This in turn, has resulted in a new source of revenue tied to bumper sticker promotions. Lawrence says record companies are beginning to tie in with radio stations on decals featuring cover art from new releases likely to appeal to the station's core audience, with coupons on the back driving retail sales of the recording.

This can be a double win for the radio station, Lawrence added, because in addition to generating revenue, a bumper sticker with a nice graphic from a group like U2 could be very appealing to listeners.

For whatever reason, Lawrence says bumper stickers are clearly considered

essential by radio stations today. Major stations in Los Angeles typically place orders of two or three million units now, he pointed out, up from 25,000 or so in

**Promotions doing double duty as self-liquidating advertisements can help radio stations secure a larger share of revenue.**

the early 1970s—and orders of 50,000 pieces are currently common even from stations in markets outside of the top 100.

### Direct mail tactics

Direct mail is another promotional technique that has been transformed from an expense to a revenue generator in recent years with companies such as San Diego, Calif.-based Radio Mail. Radio Mail encourages stations to sell packages of radio time and mailed-coupons to clients. Mailed, that is, in envelopes emblazoned

with the radio station's logo.

According to Radio Mail's Vice President/Director of Sales and Marketing Greg Spraul, stations can either give the service away to clients that buy longer flights of airtime, sell it at a low price with increased spot ad rates or sell it independently at a rate that undercuts local direct mail companies.

"Basically, you're letting the advertiser pay for your promotion," Spraul said. "Stations can use the mailing to insert a newsletter or a program schedule or anything they want in addition to the coupons."

Taking this idea a step further, all of these promotions doing double duty as self-liquidating advertisements can also help radio stations secure a larger share of the available advertising revenue in their markets.

Courtney Thompson, president and CEO of Broadcast Direct Marketing in Coral Gables, Fla., says most radio stations simply wait hat in hand for whatever business advertising agencies dole out to them.

Instead, he favors a more aggressive approach to sales, using promotional items as value-added incentives.

A station with a strong core audience of men 25-44, for instance, is in good position to approach directly the brand manager or district sales manager of a company targeting the demographic with a marketing plan that

emphasizes promotions.

That strategy, Thompson says, allows stations to make an end run around ever-tightening corporate advertising budgets and increase revenues by tapping promotion and special events budgets.

"Ad budgets have grown two to six per-



Bumper stickers can add revenue to a station's bottom line.



### UPLINK

## Proper Staffing a Must For Switching to Satellite

by Karl Baehr and Harry Nelson

**ALBUQUERQUE, N.M.** This month we will take a look at developing a working "hierarchy" for a satellite radio station. No matter what the market size, a basic personnel infrastructure can prepare you for whatever demands your growth will make on you.

By structuring your station's staffing around individual growth and performance, you are keeping costs in line and streamlining the staff to be compatible with your affiliation to the network you use.

The suggestions made this month may help you identify a basic nucleus for your station. The fact remains you do not need a large staff to effectively operate a satellite radio station—especially if you are utilizing the cost effective technology available today to lessen your workload. One appropriately trained employee can keep a satellite station humming right along beautifully.

### What's important

Two important points here: (1) Qualify your people before you hire them, especially concerning their "new" satellite environment; and (2) Maximize your people after you hire them.

It is better to have six good people with depth on staff than 12 "specialists" running around your station. Let's look closely at the first point, qualifying personnel.

The interview techniques you use to hire prospective employees are critical

continued on page 36 ►

## TXL-110, TXL-210

Transmission Limiters

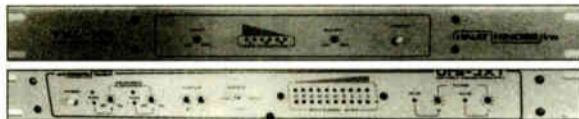

**ENVIRONMENTALLY SAFE... NO EAR POLLUTION...**  
Just CLEAR, BIG DIMENSION SOUND.

Today's digital audio imposes a new requirement on broadcast transmission systems, particularly audio processors.

The TXL series Transmission Limiters are designed to preserve your program resource and deliver it intact to the transmission system, without the familiar processing residue that cost rating points.

The TXL series limiters are also safe to your FINANCIAL ENVIRONMENT... (No slick, multicolor full page ads to pay for).

**HINAT HINDES inc**

CALL TODAY...For more on the

42 ELAINE ST., THOMPSON, CT 06277  
203-935-9066 / 9242 FAX 203-935-9919

cent a year on average, recently, while special event and promotions funds have grown at 10 or 20 percent or more per year," he said.

"Those budgets offer radio stations an alternative kind of selling, instead of standing in line at the agency radio window, hoping they will be treated favorably."



**DO YOU KNOW YOUR MARKET? YOUR COMPETITION DOES!**

**DATAWORLD MAPS CAN**

- Depict your coverage!
- Market orient your sales people!
- Target your ethnic/demographic markets!
- Identify marginal signal areas!
- Plot any special requirements!

### MAP OPTIONS

- SHADOWING (TERRAIN SHIELDING)
- CONTOUR COVERAGE
- POPULATION DENSITY
- ZIP CODE BOUNDARIES
- RECEIVED SIGNAL LEVEL
- SPECIAL REQUIREMENTS

**dataworld**  
A Service of DW, INC.

(301) 652-8822

(800) 368-5754



QEI QEI QEI QEI QEI QEI QEI QEI QEI QEI

## WHY QEI?

### 24 Hours.



Our 24 hour service hotline number is 609-728-2020.

Call us toll free at 800-334-9154 for all the facts on QEI

"New Reliables" FM transmitters from 1kw to 30 kw.

### Power Up.



With our FMQ 3.5/5/10 kW or 20/30 kW FM transmitters, you can upgrade power in the field.

Call us toll free at 800-334-9154 for all the facts on QEI "New Reliables" FM transmitters from 1kw to 30 kw.

### No Extras.



We never charge you extra for single phase power. Not on our FMQ 10000 or our FMQ 20000B—not even on our 30 kW FMQ 30000B.

Call us toll free at 800-334-9154 for all the facts on QEI "New Reliables" FM transmitters from 1kw to 30 kw.

### Less is More.

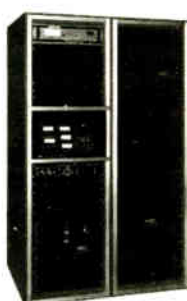

All of QEI's FM transmitters have no plate blockers or sliding contacts.

Call us toll free at 800-334-9154 for all the facts on QEI "New Reliables" FM transmitters from 1kw to 30 kw.

### Free.



Our FREE spares kits include every solid state component of the transmitter, exciter and remote control.

Call us toll free at 800-334-9154 for all the facts on QEI "New Reliables" FM transmitters from 1kw to 30 kw.

### The Longest.



Our PA tube warranty is the longest in the business — 15,000 hours.

Call us toll free at 800-334-9154 for all the facts on QEI "New Reliables" FM transmitters from 1kw to 30 kw.

### Single Phase 30 kW.



Our new FMQ 30000B is the only 30 kW transmitter available with a single phase power supply.

Call us toll free at 800-334-9154 for all the facts on QEI "New Reliables" FM transmitters from 1kw to 30 kw.

### Built-in Backup.



QEI's constant 50 Ohm interstage impedance lets you bypass the IPA or PA in the unlikely event of a problem.

Call us toll free at 800-334-9154 for all the facts on QEI "New Reliables" FM transmitters from 1kw to 30 kw.

QEI CORPORATION  
ONE AIRPORT DRIVE • P.O. BOX D • WILLIAMSTOWN, N.J. 08094  
TEL (800) 334-9154 • (609) 728-2020 • FAX (609) 629-1751

**Q**UALITY • **E**NGINEERING • **I**NNOVATION

Circle (163) On Reader Service Card

## Suggested Log for Review

► continued from page 22

data and time); tower lights checked daily (failures logged), and FAA notified of top light or beacon failures.

### Good form

A control point monitor check might include: modulation monitor peak flash lamp OK; modulation monitor carrier level OK; modulation OK; EBS receiver OK. In addition, various parameters might be logged, including: TRL receive level, TRL discriminator voltage; remote control data error rate; STL transmitter AFC voltage; STL transmitter forward and reflected power; AM carrier frequency deviation; stereo pilot frequency deviation.

The form would include a space for comments, the chief operator signature, and the date. The data listed above is from the suggested form in the NAB Guide For Broadcast Station Chief Operators (available from NAB at 800-368-5644). Directional AM stations and FM stations could prepare similar inspection "checklists" to ensure the weekly chief operator log review is complete.

The FCC AM Self Inspection Report asks for log pages showing the chief operator reviews for the past two months.

The report goes on to ask if problems detected by the chief operator are logged

and reported to the station licensee. This requirement is spelled out in Rule 73.1870(c)(3).

Next time we'll continue our discussion of the FCC Self Inspection Report. I should also have received documentation on a \$32,750 fine issued to a directional AM for various problems. Some station licensees appear to be ignoring the technical aspects of station operation. Further, it appears that some contract engineers are merely "putting out fires" instead of making the licensee aware of rule violations.

As a broadcast technical specialist, a contract engineer should be selling his or her knowledge of the FCC technical requirements as well as keeping the station on the air and sounding good. Recall also that the chief operator of a directional AM station is required to be an *employee* of the station, not a contract engineer (see 73.1870(b)(1)).

□ □ □

*Harold Hallikainen is president of Hallikainen and Friends, a manufacturer of transmitter control and telemetry Systems. He can be reached at H&F, 141 Suburban Rd., San Luis Obispo, CA 93401; phone: 805-541-0200. He can also be reached on Internet at ap621@cleveland.freenet.edu or through CompuServe at >Internet: ap621@cleveland.freenet.edu.*

## Radio Is Same as It Never Was

► continued from page 25

over as the premier radio medium.

Will AM survive? Sure it will. FM will survive too. The problem with radio is trying to keep things as they were. The radio of the 1930s and 1940s is gone forever. No more studio orchestras. No more enormous facilities. With very few exceptions, no more board operators, producers, directors, writers, announcers, and hoards of assistants. Television took that away.

The radio of the 1960s, 1970s, and 1980s is gone too. It's just hard to let go. I don't miss the radio of the 1930s because I wasn't around then. I will miss the radio I've known, with its 'round-the-clock live air personalities, news staffs, call-in personal requests and a chief engineer at every station.

Where are we headed now? Not more of the same; just more of the same direction. That direction is more competition, which lowers margins, driving businesses to first cut costs and then find totally different ways to operate.

### The way we will be

You can see the new modes of operation maturing today. Every station has a satellite dish. Originally, these simply took the place of telco lines. More and more, they now deliver programming services. With full FM stereo quality, the idea of network programming is taking radio in the same direction as television.

Look for the networking trend to continue. It's just too easy to pot up the bird and walk away. Technically, it's easier and more fool-proof than the taped automation systems, and you still get to insert local spots, news and weather whenever you like.

There's also a body of evidence to support that the local listeners don't care if the announcers are 2,000 miles away. In fact they often aren't listening close enough to know. Those who do know may very well prefer the professional

glitz of national productions.

More sophisticated stations may go with multiple program services and a digital switcher to select from the array of programs available. What goes on the air will be determined primarily by what the sales staff can sell and also what the audience responds to.

Where does that leave the local staff? Unfortunately, the trend toward fewer air personalities and equipment operators is likely to continue. The same is true of engineering.

### A digital road

The station chief engineer of the future is likely to be the chief and only engineer for a regional group, or else work as an independent contractor.

Digital solid state equipment is already making this practical. The computerization of everything in the station from transmitter to audio storage will increase equipment reliability, but demand different technical skills.

The early CEs had expertise in RF. In the last 10 to 20 years, the key skill has been audio. The skill for the future will be computers.

So what's really different in 25 years? Only that radio is becoming more homogeneous. Future owners may be more like franchise operators, offering consistency and low costs with the same sound coast to coast. That's likely to be the only way to keep so many channels occupied and profitable.

I guess the only sad note is that fewer nervous high school students, like myself, will ever get that chance to bungle their way into an exciting career in live radio.

□ □ □

*John Shepler is an engineering manager, writer, and longtime RW columnist. He can be reached at 5653 Weymouth Drive, Rockford, IL 61111.*



# Design Room Noise Out of Your Studio

by Edwin Bukont

## Part VI of VII

**GREENBELT, Md.** In any audio system, the final product contains only two components—the desired signal, and the undesired noise. Throughout the construction project, as we design, choose and build, we strive to maintain or improve upon the ratio of signal to noise.

This article, the sixth in the series on studio construction, will focus on the reduction of room or ambient noises. Ambient noises come from three sources: vibration, leakage and air movement, which involves both vibration and leakage. While there are practical and budgetary limitations to noise control, some control is within the reach of almost everyone's budget.

### Sound transmission class

Noise control should be addressed in the planning stage as you are determining square footage needs and cost per square foot. Proper wall construction will impact your usable space and will cost more than the typical wall divider.

A useful term to know, when explaining your needs to the architect and general contractor, is "sound transmission class" or STC. The good contractor or architect will probably ask you "what STC do you want your walls and doors to be?"

STC is a measure of how a boundary attenuates the passage of sound and across what range of frequencies does it provide that attenuation. The higher the number, the greater the attenuation and the broader the range of affected frequencies.

This STC is calculated according to a standard which is weighted to account for normal hearing sensitivity and the known properties of construction materials and practices. For most purposes, STC-45 should be maintained on all boundaries and penetrations (doors, windows, conduits). But in your hit music station with the 150 W monitor amps, you will need an STC of at least 55, preferably 63.

Go easy on the amount of window and door penetration. Even the best installed window or door will reduce the STC by 10-15. By themselves, few doors or windows have an STC of better than 40. You may find it is cheaper to build a sound lock entrance to the studio area, and use commonly available solid core doors, than it is to purchase an "acoustic door" with a higher STC.

If properly placed and installed, a door rated at STC-40 with weatherstripping, or preferably, magnetic gasket, around the frame and a drop of wiping seal along the bottom edge, is usually sufficient. Avoid placing the door where it will be easily coupled into the microphone.

An excellent coverage of the entire noise control topic is provided in "Handbook for Sound Engineers—The New Audio Cyclopaedia" by Howard Sams & Company. Electronic supply houses often stock this title.

### Walls

Before exploring standard methods of quality wall construction, here are some inexpensive methods of improving upon the STC of standard grade walls. Space studs at the traditional 16-inch On-Center (OC), rather than the current trend of 24-inch OC. Fill any empty spaces with a fire

code-approved insulating material such as fiberglass batting.

This should be done in the general wall areas, and around door or window frames. Have your contractor apply a generous layer of vinyl caulking or other sealant along the floor area on which the walls will stand.

Wall materials such as sheetrock and finish materials should extend as close as possible to the edges, but without touching adjoining walls. Leave a gap just wide enough for the tip of the caulking gun and run a generous bead of caulk around all edges. Use caulking or gasket seals around

outlet and switch covers.

Where possible, walls should extend beyond the ceiling, preferably to the next deck above. Again, use caulking across the top of the header and seal around the edges. Seal around conduit and plumbing penetrations, even those above the ceiling. Seal around door and window frames as well.

In any type of wall, if you are putting a window through the wall, explain to your carpenter that you do not want the finish trim and frame on either side of the wall to touch the inner casing. The gap between casing and frame should be sealed with a heavy rubber gasket.

The outer frames should be *screwed to the wall, not the window casing* as is commonly done.

Extending the wall beyond the ceiling is necessary for three reasons. First, it reduces the introduction of outside noise and vibration to your studio. Second, it reduces sound from the studio that might be annoying to other tenants or other studios in your facility.

Third, it creates a sealed room for your heating, ventilation and cooling (HVAC) and wiring needs. This is especially necessary if your building has a common air

continued on page 35 ▶

## TOTALLY TRANSPARENT TRANSMISSION PROTECTION.



## TRANSMISSION LIMITER 4000

### Pure Sound.

Protecting transmission systems from peak overload without audible artifacts—while stringently preserving natural sound quality—is the primary objective of many of the world's finest broadcast operations. That is why so many facilities around the world are choosing the Orban Transmission Limiter 4000. The 4000 provides the peak control they need, without audibly adding, subtracting or interfering with their signal in any way.

### Don't Take Our Word for It.

The 4000 provides transparent limiting with any source. Blind tests confirm that the sound of the Orban Transmission Limiter 4000 is virtually indistinguishable from the original source when driven as much as 15dB into limiting—even to trained listeners. Try it for yourself and hear what your facility can deliver when it is protected, not just restricted.

### Sophisticated, Easy to Use.

Orban engineers took years to develop the complex algorithms which permit the 4000 to protect inaudibly. Yet, they kept the front panel of the 4000 clean, clear and businesslike. The precision LED displays indicate any action of the compressor or HF limiter circuitry. The only adjustments are for INPUT level and OUTPUT level. The built-in tone generator and test mode permit rapid system setup and alignment.

### Orban Signature Quality.

The Transmission Limiter 4000 is one of a family of reliable, quality Orban products designed for demanding broadcast applications. Call your local Orban dealer

for a hands-on demonstration of the Orban Transmission Limiter 4000—another breakthrough product from the leaders in broadcast audio processing.

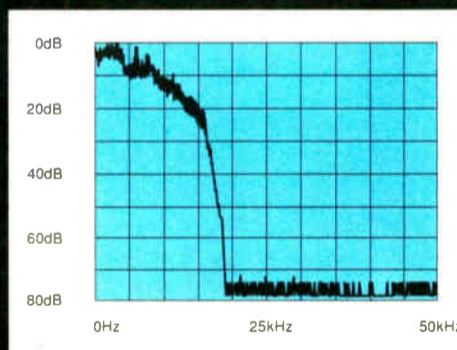

Power spectral density at the 4000's output using "maximum peak hold" measurement. (5kHz/div. horizontal; 10dB/div. vertical)

**orban**

a division of AKG Acoustics, Inc.  
1525 Alvarado Street, San Leandro, CA 94577 USA  
Tel: (1) 510/351-3500 Fax: (1) 510/351-0500

© 1992 AKG Acoustics, Inc. Orban is a registered trademark of AKG Acoustics, Inc.  
AKG is a registered trademark of Akustische u. Kino-Geräte Ges.m.b.H., Austria.



## USAirplay

# Vying for CHR's Lost Audience

by Charles Taylor

**WASHINGTON, D.C.** Transition was the signature of American radio in 1992. Popular music moved further from the mainstream and deeper onto the street. Rap and rhythm ruled, as urban became not only the sound but the fashion of the nation's youth.

The two biggest radio hits of the year were both from urban groups: the drab "End of the Road" from Boys II Men and "Jump" by newcomer kiddie duo Kriss Kross. "Road" set a new record with a whopping 13 weeks at No. 1 on

the Billboard Hot 100.

But while "Yo!" became the catch phrase at top 40 radio, adults 25-54 responded. "No!," retreating for something more conventional and less "wordy." Adult contemporary stations—and a number of struggling top 40 stations—responded with the Mix/Hot AC sound, which avoided the sleepy tone of traditional AC, but promised no rock and no rap.

### Springtime sprint

WRQX(FM) here in Washington was among the stations to drop top 40, becoming Mix 107.3. Between the spring and winter ratings period alone, the station sprinted from No. 8 to No. 5

### Popular music moved from the mainstream onto the street.

in this competitive market, according to Arbitron surveys. In its waning top 40 days, the station failed even to rank top 10.

Contemporary Hit Radio became so divided, in fact, that by year-end, chart bible Billboard split its airplay charts



Jon Secada

into two sectors: Mainstream and Rhythm/Crossover. The latter camp accommodates artists like Bobby Brown, Arrested Development and House of Pain; the former features artists such as Patty Smyth, Bryan Adams and Annie Lennox. The two also share artists, including En Vogue, Cathy Dennis and Color Me Badd, all fortunate enough to play to the center line.

Country radio, meanwhile, cashed in on top 40's lack of identity, flourishing like never before in history. The format surged to become the third most popular (behind AC and news/talk), and helped sell more albums than mainstream or urban/dance acts. The lavishly

continued on page 35 ►

### The Hit List

As 1992 fades to black, here are my picks for the year's best on U.S. radio.

**1.** "Just Another Day," Jon Secada—Windows cranked, coupe romping down the highway and the radio loud enough to crack the wind. Secada defined the summer airwaves with this sweeping, anthemic song that previewed a solid debut disc. Move over Phil Collins; adult radio has a new star. With hair, even.

**2.** "If You Asked Me To," Celine Dion—In her native Canada, Dion is known as Queen Celine. And how. The formulaic songs her "knowledgeable" American producers arranged are ignited despite themselves by a voice that converts the simplest melody into a musical phenomenon. The premiere female vocalist of the year.

**3.** "Bohemian Rhapsody," Queen—It was like being a kid again when radio re-embraced this song for a new generation, carried along on the shoulders of the movie "Wayne's World." It also demonstrated that well-crafted music can be timeless.

**4.** "Damn I Wish I Was Your Lover," Sophie B. Hawkins—If she never has another hit, this lady can sleep easily at night. Guttural, passionate, a brilliant and inspired performance.

**5.** "Funky Divas," En Vogue—The diversity of this foursome's repertoire is striking. This year brought us the hard-edged panic of "Free Your Mind," the R&B snap of "My Lovin'" and the sexy hiss of "Giving Him Something He Can Feel." Top Group Effort of the Year.

**6.** "Why," Annie Lennox—Lennox added elegance to her repertoire with the solo, "Diva." Following the breakup of Eurythmics, a matured Lennox chose a path that maintained potent vocals, only gentler. Among the finest musical hours of 1992.

**7.** "It Won't Be Long," Alison Moyet—A treasure with (sadly) only limited success, Moyet exhibits the most powerful voice in popular music today. Her popularity is centered at modern rock radio, supported this year by a killer acoustic road tour. "Hoodoo," Moyet's third disc, is rock solid, and this selection from it is a gem.

**8.** "The One," Elton John—His career has been marked by misses along with the continuous string of hits, but this disc supported a number of memorable moments, accompanied by a confident, comfortable spirit. "The Last Song," a cut about an AIDS-stricken man's reconciliation with his father, is probably John's best work since 1982's "Empty Garden."

**9.** "Finally," CeCe Peniston—Every year warrants a dance diva. She sang, we danced; good enough.

**10.** "Hormonally Yours," Shakespear's Sister—"Stay," comparable in intensity to "Nothing Compares 2U," is only a bite of the feast to be found on this collection. Something to accommodate every mood is offered. Buy this album, OK? Now.

## Call Later.

Our extended hours make it easier to call on the service, selection and support of Harris Allied, the nation's largest supplier of broadcast equipment.

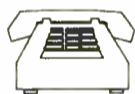

### Eastern

8:00 am - 8:00 pm



### Central

7:00 am - 7:00 pm

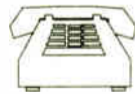

### Mountain

6:00 am - 6:00 pm



### Pacific

5:00 am - 5:00 pm

800-622-0022

**HARRIS ALLIED**



**BELAR**  
STEREO MONITOR

You can measure...

with the best monitor and the most accurate test set.

The FMM-2/FMS-2 series monitors provide an even greater degree of precision measurement than ever before... You can measure S/N below 90 dB, You can measure crosstalk below 85 dB, You can measure separations of better than 70 dB, You can measure frequency response to better than 0.25 dB, You can measure distortions to lower than 0.01%, and much more... Our uncluttered panels and autoranging voltmeters make these measurements a dream.



**BELAR**  
ELECTRONICS LABORATORY, INC.  
LANCASTER AVENUE AT DORSET, DEVON, PENNSYLVANIA 19333

(215)687-5550

Call or write for more information on Belar AM, FM, Stereo, SCA and TV monitors.



# Very Affordable.

# Very Reliable.



---

## AIRMASTER 90

---

 **AUDITRONICS**

*The Sound of Perfection*

3750 Old Getwell Road, Memphis, TN 38118  
901-362-1350, FAX: 901-365-8629

Circle (127) On Reader Service Card  
World Radio History





# Air Worthy.

Here's the compact disc player that requires no technical or programming modifications.

Intuitive in operation, you and the entire staff will benefit from the many sophisticated yet simple-to-operate features of the SL-P1300 Compact Disc Player.

The SL-P1300's disc compartment is built for full-time use. You can spot a pro by

how easily he or she changes discs. The SL-P1300 doesn't get in the way. Simply press a key to open the disc compartment lid, insert the disc, then push the lid manually to close. Since the disc is visible in the compartment, you can confirm operation at a glance. With auto cue, the SL-P1300 will position the pickup at the start of the first note of each track, ready to begin play

instantly at your command. This is a real work-saver for radio stations and DJs.

With search dial and frame cueing, the SL-P1300 is just as much at home in your production room. Two-speed search dial cueing and the exclusive rocker control provide mixing precision unmatched by any other machine.

The SL-P1300 incorporates

8-times oversampling and four digital-to-analog converters (2 per channel) as well as 18-bit technology to provide superb sound quality.

Call on a Harris Allied professional for complete details on the Technics SL-P1300.

8:00 a.m. to 8:00 p.m. EST  
 1-800-622-0022  
 Fax 317-966-0623  
 Canada 1-800-268-6817  
 Toronto 416-731-3697



© 1993 Harris Allied

Grade (73) On Reader Service Card

World Radio History



# Design Ambient Noise Out of Your Studio

► continued from page 31

system. In wall construction, use screws rather than nails wherever possible. Fill the screw holes with carpenter's glue or caulking. This creates a tighter and longer lasting seal than nails when materials are joined.

## Keeping costs down

Except for window design, the above should cause a minor, if any, increase in construction costs because nails, screws, weather-stripping and caulking are usually purchased in bulk. Significant improvement in STC can be achieved at a moderate cost by doubling the sheetrock layers on each

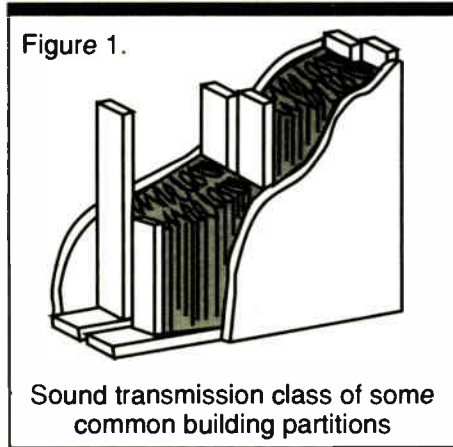

wall that faces into a studio.

These layers must be screwed together, not nailed! Use at least half-inch sheetrock for each layer. Note that this puts quite a stress upon the wall so 16-inch OC walls are necessary. True acoustic control requires, however, that surfaces be "de-coupled" so that vibration cannot continue from one structure to another.

An expensive, but very effective method

## Vying for CHR's Lost Audience

► continued from page 32

hyped Garth Brooks finished the year with five albums among the top 40, while newcomer Billy Ray Cyrus pulled the longest-running No. 1 debut album in the rock era.

## Urban obsessed

Country music failed to instigate much action on the urban-obsessed mainstream airwaves, however. Cyrus' top 10 "Achy Breaky Heart" was more a novelty than a trend. For the most part, top 40 and Hot AC stations turned up their noses at music marketed primarily to country radio.

Many in the industry pinpoint modern rock as the next rage. Top 40 hits by Shakespear's Sister, Toad the Wet Sprocket, Soup Dragons and Red Hot Chili Peppers provided proof of its potential. No doubt, music is more innovative on alternative radio than any other format.

Certainly, some format needs to take over. As rap continues to increase in popularity, its merit consistently nose-dives. How long can the follow-the-dots caliber of much of radio's rap continue? Like many trends, its originality has been muddled by a glut of contrived babble, bidding to cash in on the craze of the day.

I, for one, look forward to tomorrow.

of de-coupling walls is to build two walls, with staggered studs and so constructed to create a room-within-a-room. Beware of door, window and conduit penetrations that can seriously compromise the wall if handled improperly.

Using the techniques described above, you build two walls that do not touch and have no coupling path. The space between studs is filled with insulation. The walls are separated by the thickness of a piece of sheetrock placed between them. The sheetrock floats in place and is held by the fiberglass batting.

Note that the studs of one wall are offset from the studs of the other by 50 percent of the OC spacing. The outer wall should maintain an unbroken boundary. The inner wall should form a closure with no connection to the outside (see Fig. 1). Wall finishes will vary with personal taste, budgets and local building codes.

One troublesome error that often occurs is ordering too little material or trying to treat only half of each wall so that the room sounds "live." That might be tolerable with only one mic open in a very large room. But in a small studio, or with more than one mic open, your talent will sound thin and hollow due to the effects of comb filtering wherein direct and reverberant sounds arrive at the mic at different times.

If you really want to sound "live," use one of the many fine digital or analog reverb units available everywhere. Insert the unit in the mic chain or the entire air chain. Some consoles, such as Wheatstone's A-500, provide a handy "speech" bus wherein the reverb unit may be easily inserted.

## Wall coverings

Plan on fully treating all wall surfaces with some form of acoustic material. Armstrong, USG and other companies make a fine line of attractive, low pile wall coverings and accessories, such as matching ceiling tiles that are suitable for radio studios. Your general contractor or property manager is a good source of information on these products. This reduces installation time and avoids use of various glues that will eventually peel off.

In some instances, the STC of a panel material may be sufficient for you to substitute panels for the second layer of sheetrock. If you prefer the more typical high pile coverings such as Illbruck's Sonex, beware of imitation products that do not pass fire codes.

Gather information on flame test ratings from all companies. I generally find that the low pile materials provide the most attractive facility and the best balance between absorptive and reflective characteristics. If the covering is affixed to the wall with adhesive, I caution you to apply these coverings as early as possible because the adhesives usually emit noxious fumes that may take several weeks to dissipate before talent can work in a studio for extended period of time.

Remember to allow for the thickness of wall coverings when placing and mounting electrical fixtures. Explain the desired result to the electrician ahead of time to avoid unhappiness later. These coverings may also affect door, window and related casing construction—read, "cost"!

One caveat—with the coming implementation of the Americans with Disabilities Act (ADA), be sure that your doors, frames and any step-up areas can accommodate those persons. If you install ramps into your

studios, be sure that door sweeps and seals will still work properly where they abut the end of a ramp.

Throughout the station, viewing windows, door hardware and electrical controls such as light switches, light dimmers and fire or

panic alarm actuators should be low enough to allow for those in wheelchairs. Our next article will examine acoustic ceiling, floor and furniture construction.

□ □ □

Edwin Bukont is the CE at WPGC-AM-FM Morningside, Md. (Washington). He can be reached there at 301-441-3505, ext. 8213; address: 6301 Ivy Lane, Suite 801, Greenbelt, MD 20770.

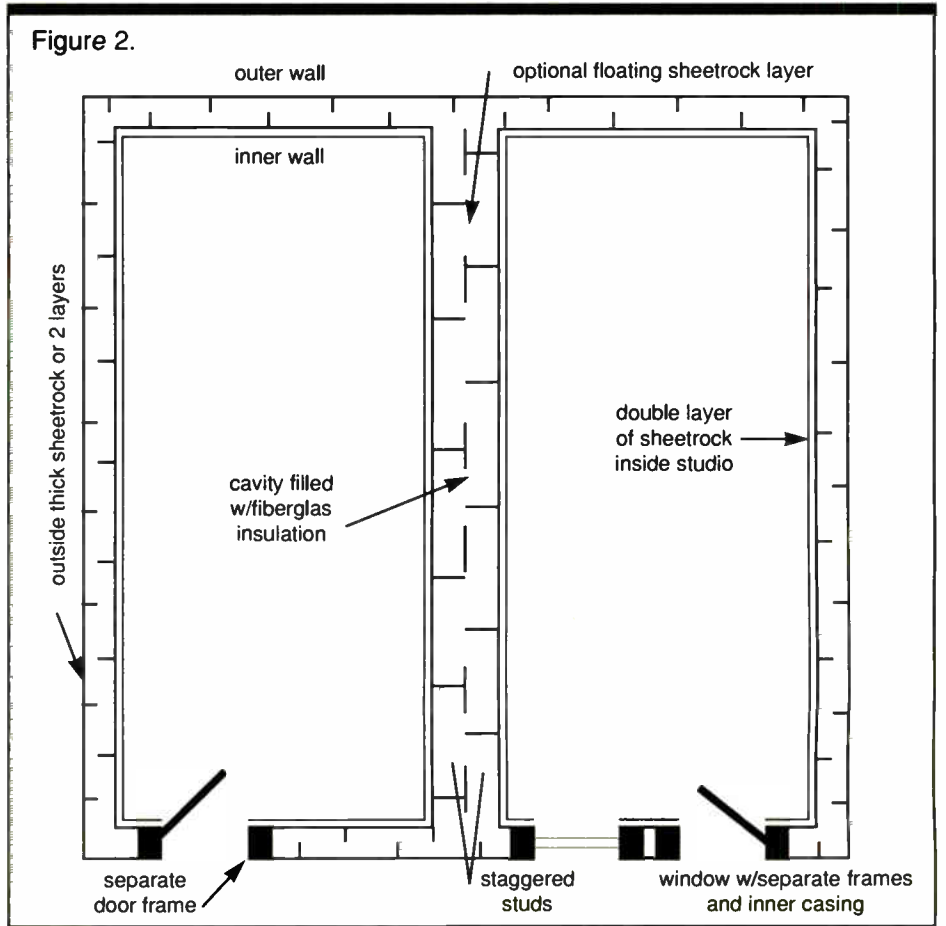

**RADIOMAIL**  
**START IMMEDIATELY!**  
 No Budget Necessary!  
 You Can Add  
**\$472,000**  
 Gross Profit This Year With...  
**RADIOMAIL**  
 • Increase Your Sales  
 • Improve Your Cash Flow  
 • Promote Your Station  
 • Increase Your Listenership  
 Contact Greg Spraul  
 (619) 597-0263 FAX (619) 597-0992

Circle (45) On Reader Service Card



# Who's running the ship?

**U**nattended operation is one way to keep your station profitable, but you still have to mind the store.

The acclaimed Burk Technology ARC-16 Remote Control System is the first step. You can control transmitter and studio from any phone.

But wait. There's more!



**I**ntroducing AutoPilot™ from Burk Technology.

AutoPilot is break-through computer software that makes automatic operation of your studio/transmitter facility a dream come true.

- Automatic power changes
- Automatic pattern changes
- Automatic site changes
- Automatic power trim
- Automatic fault recovery
- Automatic logging

Now your imagination is the only limit.

The new FCC fine schedule is imposing. Why risk a big penalty when AutoPilot can help you stay within the rules?

Call us at 508-433-8877  
or toll free at  
1-800 255-8090  
for more information  
and a FREE DEMO.

# BURK

TECHNOLOGY

Circle (15) On Reader Service Card

# Satellite Affiliates Need Proper Staffing

► continued from page 29

in light of the smaller personnel demands of a satellite radio station. Each person on your team must be chosen with the clear goal of maximum compatibility.

The world of satellite radio is very different in manner to the world of local live broadcasts. There are fewer employees, most or all programming originates from a distant source, and required skills are different. We will look at these dynamics of proper placement and provide sample questions to clarify your approach to interviews.

Fewer employees means less intense "activity" in-house. Each employee must be the self-motivated type that doesn't require all the action surrounding a station with 20-40 fellow workers. So, in your interview, look for individuals capable of working well on their own, without a great deal of interaction. Sample question: "Do you enjoy working on projects by yourself and seeing them to fruition?"

## Networkers and promoters

Because the programming source is sometimes thousands of miles away and developed by individuals you may not recognize if you were to pass them on the street, you must hire folks who can deal with the vague monolith called "The Network." Sample questions: "How would you rate your communications skills? Are you aware of what (network) is doing with this current format?"

From the beginning it is best to have a staff that can effectively keep an ear on what your programming source is up to and communicate those impressions to network or local management. Above all, get them involved in this programming and don't just leave it up to "the experts" at the network level.

Finally, one special skill that is needed at a satellite station is that you hire strong promoters. Each person must be

able to contribute positioning statements, promotional concepts and develop an active skill in enlivening your presence in the market.

Too often satellite stations do not require their staff to participate in the overall promotion of the station. At a satellite station it is imperative that every individual participate in functions that the community can view as aggressive and viable.

Sample questions: "Have you partici-

**It is better to have six good people with depth on staff than 12 "specialists" running around your station.**

pated in, or better still, originated station promotions in your career? How important to you is developing a presence on the street in our community?"

## Staff of all trades

In conclusion, let's look at these items: critical positions, collections and interns at the satellite station.

**General Manager/General Sales Manager.** In most market situations it is recommended that this position be defined as one, not two positions. This cuts overhead, yes, but more importantly, at smaller stations particularly, it is easier to maintain a clear direction. Goals are coordinated by one person and maintained by the same person.

**Operations Manager.** This person will spend his or her days at the station and must function at a higher level than a program director. He will in fact combine programming and management skills, much as the combined position(s) of general manager and sales manager mentioned above. The operations manager should have on-air and production skills with the aptitude for handling several departmental projects at once.

**Office Manager.** Traffic, computer

literacy, collections, generating programming logs and billing should all be part of this person's daily performance. He or she must be able to positively affect morale within the station as well as present a competent face to the community.

We suggest you have a separate receptionist for overflow clerical work and to assist your account executives. Too often stations require the office manager to "man" the phones. Any station's

first line of contact with advertisers and the public is your receptionist; it shouldn't be a busy office manager.

**Account Executives.** One for every 30 active accounts. Some satellite stations we have consulted have loaded their sales executives up with a hundred or more accounts. It's impossible to serve that many clients, especially if collection is part of the salesperson's duties (which is not recommended).

If the collections duties are too burdensome on your office manager, engage an outside collection agency. There are several national firms that have good performance ratios and a businesslike approach to collections. Interview your collection agent as you would any other employee. In representing your station, he or she is like an employee.

## Talent pool

**Part Time.** Internship programs with local universities, school district extracurricular activities, etc., are a great way to get people who want to work at your radio station. They can add to your morale as well. They have an interest in developing in the industry as opposed to some lateral move or paycheck. This is a great proving ground for your future employee pool as well.

**Engineer.** It is recommended you have a local engineer on a fee basis, not salary. Regular maintenance should be performed on all aspects of the broadcast chain, which lessens the chances for costly, large scale repairs.

**Morning Show.** Finally, we'd like to present the option of a local morning show host. In satellite stations this individual can play a pivotal role in generating income as well as developing local programming that scores rating points.

Whichever route you take, however, remember that a strong morning personality can add to your "in-house" enthusiasm, execution of station promotions and remote broadcast revenue generation, as well.

□ □ □

Karl Baehr is president of KBE Broadcasting By Design, a consultancy offering a variety of services to satellite affiliates. Baehr is a former programmer and air personality. Harry Nelson is president of Harry Nelson & Associates, a satellite consultancy and an Operations Manager at Satellite Music Network for nearly a decade, programmer and former air personality of the year. Harry Nelson can be reached at 800-67-RADIO and Karl Baehr can be reached at 505-828-0488.

Clipping creates **LOUDNESS**  
Composite clipping is the **LOUDEST**

The trick is to keep distortion low. . .  
Introducing



**SE-1 LOW DISTORTION  
COMPOSITE PROCESSOR**

Distortion-canceling circuitry allows more clipping (loudness) with less distortion.

Simple Installation & Setup

Only \$395.00 Complete!

The SE-1 allows you to increase your loudness up to 6 db over using no composite clipping. Distortion is negligible up to 3 db of clipping with a gentle rise at 6 db.

There is no finer composite processor on the market today.

. . . Loudness WITH Quality

**SE SOMICH ENGINEERING**  
**800-334-3925**

Processing Tools for Competitive Broadcasters

Circle (188) On Reader Service Card

"Doing things for  
successful FM translators"



**FM TECHNOLOGY  
ASSOCIATES, INC.**

Talk with Howard  
Enstrom, veteran  
broadcast consultant  
who, in the 70s  
switched to FM  
translators as a  
specialty.



**FMTA services: Feasibility studies,  
frequency searches, system design-  
engineering, FCC applications. Pub-  
lisher of The SIGNAL SOURCE, bi-  
monthly newsletter all about FM  
translators. BEST EQUIPMENT  
PRICES.**

**FM TECHNOLOGY  
ASSOCIATES, INC.**

30925 Vista Vista  
Mount Dora, FL 32757  
(904) 383-3682 FAX (904) 383-4077

Circle (20) On Reader Service Card



# DIGITAL AUDIO FOR THE LIVE BROADCASTER FROM SMARTS BROADCAST SYSTEMS

By John Schad  
President - SMARTS Broadcast  
Systems

Hard drive digital audio has swept through the radio industry in the past couple of years. Starting first with satellite automation systems, companies soon began expanding into control of conventional open reel systems and compact disks.

In the rush to build new and better automation equipment, the live broadcaster, who represents the greatest majority of station in the country, was the last to be considered.

Now, SMARTS Broadcast Systems has developed the first totally integrated system for live broadcasting, combining accounting, traffic, billing, and a myriad of digital audio functions into a single, cohesive system.

Each element in the system works independently, so that a system can change and grow with station needs. But seen as a whole, the system brings a

level of organization and sophistication to a live operation that is often lacking at all levels of broadcasting.

Here's how the system works. Work stations are set up at key points within the radio station. The traffic department, the copy desk, the newsroom, the production room, and of course, the AM and FM control rooms, anywhere access to the system is needed.

SMARTCASTER digital audio units are installed in production, control room and newsroom facilities. Network nodes are installed in standard computers at other locations.

An inexpensive SMARTKIT can be installed in the office computer. The copy and traffic director can use this system normally, but also audition and delete spots, change stop dates, write copy and send it to the production rooms, and generally administrate the entire station from that on location. We are vesting system control, including traffic and spot inventory control, where

it belongs in the traffic department.

The station now has a smooth flow of electronic "paperwork" without the paper. The incoming traffic order is entered into the machine. The copy desk is now aware that copy must be written. Once written the copy is lined up in the production room — and production knows what has to be produced. Once produced, the digital audio, all part of the same system, is transferred to the control room for play on the air. Traffic knows when spots become outdated, and can audition, change stop dates, or delete all from the traffic desk. Each entry triggers the next to create a check and balance system throughout the entire operation. This greatly reduces the problems of outdated copy, copy not available, copy not produced, or the wrong copy getting on the air.

Only SMARTS Broadcast Systems has the software — both billing and traffic and digital audio, and the expertise to make such a complex yet reli-

able system work.

You also can implement the system a little at a time, purchasing modules as your needs grow.

The modularization makes each system individual and unique, tailored to the precise needs of every station, yet supportable because each module is standardized. The system functions the way you want it to function, and grows as you need it to grow.

SMARTS Broadcast Systems has continuously broadened its line of products and services to provide something for every broadcaster from the large to the tiny market. We specialize in working with you to make your station operation more efficient through digital audio, digital automation, and computerization. We're also available 24 hours a day, 7 days a week when you need help. Give us a call at the toll free number below so we can find ways to bring more dollars to your bottom line.



**SMARTS BROADCAST SYSTEMS**  
BOX 263, EMMETSBURG, IA 50536  
**(800) 747-6278**  
(712) 852-4047 FAX (712) 852-3061



# Country Music Evolved with Medium

by James Wold

**MINNEAPOLIS** I believe country music has the most interesting history of any musical format on the radio today. It has been heard on the air for nearly as long as the medium has existed.

Country music first made it on the air on a few high-powered radio stations. The format evolved from the early roots of country to the varied styles of presentation and subgenres in existence today.

Many southern radio stations had begun programming country music by the early 1920s. It was only natural for listeners to request local music when radio stations began appearing in the South. What we now call country music was heard pretty early on radio stations in that part of the country.

## Folk singers on WSB Atlanta

In what most historians agree was the first performance of a country artist on radio, late in 1922 Fiddlin' John Carson was featured on WSB Atlanta. WSB, owned by the Atlanta Journal, first signed on the air on March 16, 1922.

A few months after sign-on, the station was featuring the music of several folk performers, including the Reverend Andrew Jenkins; a blind gospel singer, Clayton McMichen; Ted and Boss Hawkins; and Bob White, a blues-ragtime cornetist and jazz group leader. WSB's manager, Lambkin Kay, put Carson on the air because Carson's

recordings were well known.

Much of the country music that was heard on radio in the 1920s was broadcast on "barn dances." These were usually regularly scheduled programs filled with fiddle and banjo solos, square dance music, rural comedy and country music.

## Barn dancing

Most radio stations airing country music used local hillbilly performers. More often than not, performers were paid little or nothing, but were allowed to promote their area appearances. For the broadcaster, the presentation of the music and the performers was an adjunct to selling airtime to sponsors interested in getting the attention of users of farm implements, stock feed, and fertilizer.

WBAP Fort Worth, Texas produced the first radio barn dance on Jan. 4, 1923, a year and a half before the WLS National Barn Dance in Chicago and three years before the famed WSM Grand Ole Opry in Nashville.

In those early unregulated days of American broadcasting, WBAP programs, featuring such groups as the Peacock Fiddle Band from Cleburne, Texas, could be heard by listeners in New York, Canada, Hawaii, and Haiti. Country music barn dances began appearing on radio stations located primarily in the South and Midwest.

Although stations WSB and WBAP had programmed barn dance shows as early

as 1922, WLS in Chicago produced the first show to achieve longevity and national recognition.

WLS was owned by the Sears Roebuck Co. from its beginning until Sept. 1928, when it was purchased by the Prairie Farmer newspaper. From the very first it aimed many of its broadcasting features at rural and small-town listeners in the Midwest, because Sears Roebuck was trying to persuade rural Americans to use its mail order catalogue to provide for their clothing, appliance, farm equipment and utensil needs.

A group of country-style fiddlers performed on the first program of what was to become the popular National Barn Dance, and the music was so well received that hundreds of requests for various fiddle tunes arrived within the next week. The WLS Barn Dance (as it was first called) was broadcast solely on WLS until the early 1930s, when it was picked up by the National Broadcasting Company (NBC) and was aired coast to coast as the National Barn Dance under the sponsorship of Alka Seltzer.

Throughout its long history (it did not really come to an end until 1968, after having been broadcast on WGN in Chicago for about seven years), the National Barn Dance had a broader musical perspective than most country shows.

## The Grand Ole Opry

The National Life and Accident Insurance Company owned and operated WSM in Nashville, Tenn. The Grand Ole Opry began as a means to sell life insurance to rural southerners. Transmitted throughout the southland via WSM's 50 kW signal, this broadcast became the premiere country music show. During the late '30s, the 30 minutes of the Opry was aired by NBC.

The early program clocks of WLS, WSM, and hundreds of other radio stations, in every region, were filled with 15-minute segments of hillbilly bands and singers.

The 1930s was a decade of expanding radio coverage of country music.

Pioneer country music disc jockeys such as Randy Blake at WJJD Chicago, Rosalie Allen at WOY New York, Eddie Hill at WSM Nashville, Lee Moore at WWVA Wheeling, W.Va., and Squeakin' Deacon Moore at KYLA Pasadena, Calif., all garnered national reputations. According to Billboard, by 1949 at least 650 radio stations used live country talent.

By the mid 1950s, the number of country radio shows began to decline. Live country radio programs, with the exception of the "Grand Ole Opry," had all but vanished. The top 40 format came into wide use and dealt a severe blow to country music as radio stations made moves to satisfy the demands of youth.

As a result, country radio began dying off quickly. Block programmed radio stations gradually eliminated their country music blocks. There were exceptions: KFOX Long Beach, for years Southern California's only country outlet, was staffed with strong personalities. The station maintained a highly personalized presentation until the late 1960s.

## A format is born

Country radio did not begin using a format presentation until the early 1960s. Executives who advocated format country radio included Harold Krelstein of Plough Broadcasting. Early consultants included ex-country DJs Joe Allison and Chris Lane. One of the first country-formatted stations was KAYO, Seattle, Wash.

KBBQ Los Angeles, described its "Sizzlin' Sixty" playlist as "the best of the modern country music by top name performers, many from the pop field...augmented by a supplementary list of more of the best country sounds." WZIP Cincinnati; WTCR Ashland, Ky.; WSLR Akron, Ohio; WCJW Cleveland and KSON, San Diego, all reported to the Country Music Association (CMA) their preference for modern country—as did KRAM Las Vegas, WROL

continued on next page ▶

## Have You Ever Needed Your Computer In Two Places at One Time?



**PC-Companion Plus** is the answer you've been looking for.

- ✓ **Easier Information Distribution**  
Now, you can have remote access to your wires and other important data.
- ✓ **Better Physical Security**  
Locate your computer in a secure area and still have round the clock access to your information.
- ✓ **User Friendly**  
No complicated software to install. Just plug it in and go.

Distribute your important information without a costly and complicated network. Instead, experience the advantages of having a second keyboard, monitor and mouse up to 250 feet away from your computer. No software to set up means installation is quick and easy. Whether you're in the office or the booth, your computer is still close at hand.

Options include: Audio channel, remote serial printer line, PS/2 or serial mouse.

Note: PC-Companion Plus is not a multi-tasking device. Both users may view the display, but only one should type.

**Cybox Corporation**  
2800-H Bob Wallace Ave  
Huntsville, AL 35805 U.S.A.  
(205) 534-0011  
Fax (205) 534-0010

Made in USA

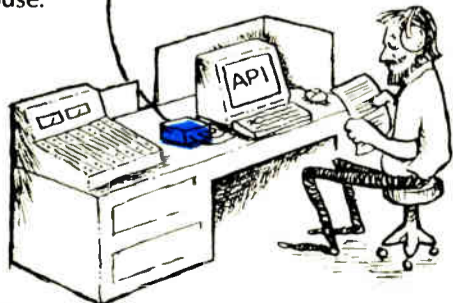

Circle (183) On Reader Service Card



## What can you say about a DA?

Radio Systems distribution amplifiers are really no big deal.

Sure, the specifications *are* excellent and they *are* easy to install, thanks to rear panel barrier strips.

And, they *are* flexible with independent front panel level adjusts for each channel, balanced bridging inputs, and low impedance outputs.

OK, 1,800 *are* in service, most for over five years, so they *are* reliable.

Not to mention that they're inexpensive, and available in eight channel, stereo or mono models.

Come to think of it, there *is* a lot to say for a Radio Systems DA.

**RADIO SYSTEMS INC.**  
800/523-2133 or FAX 609/467-3044

Circle (70) On Reader Service Card



**MARKETING & MANAGEMENT**

# Help Clients to Help Your Bottom Line

by John Cummuta

**ALGONQUIN, III.** The United States Post Office is suffering tremendous losses these days, mainly because it has not yet figured out what business it is really in. It hasn't figured out which customers really butter its bread, and so it has not adequately served the real revenue-producing clients.

The result? These clients are going elsewhere for service, and that money is no longer flowing to the Post Office.

## Country Format Grew with Radio

▶ continued from previous page  
Knoxville, and WVOJ Jacksonville, Fla.

As country radio stations celebrated Country Music Month a year ago, Billboard reported "Country Music Riding High" in headlines on its front page.

As recently as Sept. 1, 1992, Billboard headlines read: "Country Widens Lead Over Top 40." In the three years since the Billboard Arbitron national format ratings were initiated, top 40 has sunk from its high point of 15.9 percent of total listenership in the spring of 1989 to an all-time low of 10.50 percent last spring.

In the same time period, country radio jumped from 9.4 percent of the total radio audience to 12.7 percent, its highest ever share, reported the accompanying article in Billboard.

The Country Music Association reports that there were 521 fulltime country music radio stations in America in 1971; 1534 in 1980; and 2,203 in 1992. Turn your radio on a country music station and you might still hear Ferlin Husky singing, "Country Music Is Here to Stay." I agree with him.

□ □ □

James T. Wold is a free-lance writer based in Minnesota. He is author of Minnesota Microphones, published by Northstar Press. Wold can be reached at 1106 South Seventh St., Minneapolis, MN 55415.

As radio station operators, you are in the same position as the Post Office, and if as commercial broadcasters you do not clearly identify what business you are in and who your primary customers are, you could find yourself in the same dinosaur graveyard as thousands of postal workers.

### Advertisers come first

Every time the question of postage rates comes up for reconsideration (every several years), the Postal Rate Commission soaks third-class commercial mailers, so it can limit the amount it has to raise first-class postage rates for the average citizen. The reality is that third-class postage accounts for a much more significant portion of the Post Office's income.

However, these business-blind bureaucrats continue to bleed the goose laying the golden eggs so they can look good to the more numerous general public.

So, what has happened? Third class mail volume has declined seriously over the past couple years. It started when we got that nice little raise from 25 cents to 29 cents on a first class stamp, while third class mailers saw their rates jump over 30 percent!

Now the Post Office is crying over its huge budget short-falls, and is reducing staff like a neutron bomb. But the fault is its own. To succeed in business, you must identify what your primary business is, who the customer for that business is, and what that customer most needs from you. Then concentrate on giving it to him.

General managers and sales managers will probably agree with what I will say here, but good luck trying to get the program director on board. A commercial radio station's primary customer base is its advertisers, not its listeners. And business success will only come from concentrating on and serving the needs of those advertising customers, in every way possible.

But, you might say, we are already kissing up to our advertisers big time. We give them bonuses and special off-rate-

card deals, along with tickets to the big game and a free remote.

So what? You are giving them what you already have to give. But that's not necessarily what they want or need.

### A faulty premise

Let me suggest that most commercial radio stations operate from the outdated premise that their only job is to deliver pairs of ears to the customer. In other words, the station concentrates on building audience, so that the advertisers' commercials hit more eardrums than

they would airing on the station across town. Such station's management believes that, if it has delivered another rating point, it has done its job.

That is the same attitude the Post Office has. It believes that if it stuffs advertising mail into all the mail boxes it has done its job for the people paying billions of dollars in postage.

Here's the problem with that attitude, and why I call it outdated. It's too easy for a competitor to come along and offer slightly better service, or a new

continued on page 40 ▶

"Country... with a happy kick!"

*Super Gospel Country*  
RADIO NETWORK, Inc.

An innovative new idea for radio targeting the 25+ audience with Contemporary Gospel that's Country

**HOT!! NEW!!**

**CHRISTIAN COUNTRY FORMAT**

24 Hour digital stereo live via satellite from Nashville, Tennessee. Quality high tech professional radio programming with award winning air personalities.

For Air Check & Affiliate information, call:  
**1-800-877-1950**

Also available - free weekly syndicated "Primetime Playlist" Show

SUBSCRIPTION/READER SERVICE FORM		
<b>Radio World</b>		
<b>FREE Subscription/Renewal Card</b>		
I would like to receive or continue receiving <b>Radio World</b> FREE each month. <input type="checkbox"/> Yes <input type="checkbox"/> No		
Signature _____	Date _____	
Please print and include all information:		
Name _____	Title _____	
Company/Station _____		
Address _____		
City _____	State _____ ZIP _____	
Business Telephone ( ) _____		
Please circle only one entry for each category:		
<b>I. Type of firm</b>		
D. Combination AM/FM station	F. Recording Studio	
A. Commercial AM station	G. TV station/teleprod facility	
B. Commercial FM station	H. Consultant/ind engineer	
C. Educational FM station	I. Mfg, distributor or dealer	
E. Network/group owner	J. Other _____	
<b>II. Job Function</b>		
A. Ownership	G. Sales manager	
B. General management	E. News operations	
C. Engineering	F. Other (specify) _____	
D. Programming/production		
<b>III. Purchasing Authority</b>		
1. Recommend	2. Specify	3. Approve
<b>Reader Service</b>		
Dec. 9, 1992 Issue Use Until March 9, 1993		
Please first fill out contact information at left. Then check each advertisement for corresponding number and circle below. NOTE: Circle no more than 15 numbers, otherwise cards will not be processed.		
001	023 045 067 089 111 133 155 177	
002	024 046 068 090 112 134 156 178	
003	025 047 069 091 113 135 157 179	
004	026 048 070 092 114 136 158 180	
005	027 049 071 093 115 137 159 181	
006	028 050 072 084 116 138 160 182	
007	029 051 073 095 117 139 161 183	
008	030 052 074 096 118 140 162 184	
009	031 053 075 097 119 141 163 185	
010	032 054 076 098 120 142 164 186	
011	033 055 077 099 121 143 165 187	
012	034 056 078 100 122 144 166 188	
013	035 057 079 101 123 145 167 189	
014	036 058 080 102 124 146 168 190	
015	037 059 081 103 125 147 169 191	
016	038 060 082 104 126 148 170 192	
017	039 061 083 105 127 149 171 193	
018	040 062 084 106 128 150 172 194	
019	041 063 085 107 129 151 173 195	
020	042 064 086 108 130 152 174 196	
021	043 065 087 109 131 153 175 197	
022	044 066 088 110 132 154 176 198	
Copy & Mail to: Radio World, PO Box 1214, Falls Church, VA 22041		



# Help Clients to Help You

► continued from page 39

added option, or faster delivery or some other new wrinkle that makes his service look better. Hence the Post Office is now faced with UPS, Federal Express, and in many communities what is called "Alternative Delivery Services." These services will deliver advertising mail directly to every house in a target area.

Because of the Post Office's non-customer-centered business attitude, they have lost tons of business. And because they continue to see themselves as nothing more than a toll-road along which advertisers pay to drive their mail into the nation's mail boxes, they will continue to be subject to growing competition.

Doesn't that sound a bit familiar? Don't

you know of commercial radio stations who, when it comes to advertisers, see themselves as nothing more than a pipeline through which advertisers can funnel their messages to all those ears out there?

Instead of selling real marketing services to their advertisers, they sell *time*. It's up the advertiser (or its agency) to figure out what to do with that time so it will positively execute the advertiser's overall marketing strategy.

## Marketing service

My advice to you as a radio station operator is not to follow the same path as the Post Office. First of all, you don't have a legal monopoly, so you *can* go out of business, whereas the Post Office

can just hit the taxpayers to make up its losses.

Reinvent the way you look at your business, in terms of what you provide to your advertising customer. Instead of seeing yourself as simply a medium the advertiser can use or not use, see yourself as a marketing services company that offers a variety of ways for your advertisers to reach their target market, hear back from their target market and maintain a dialogue with their target market. Instead of selling availabilities, get on your client's side of the desk and use your station's capabilities to help him or her increase his business.

To do that effectively will take a fresh perspective on what services your station can offer an advertiser, and it will take a better understanding of marketing by your sales force.

Imagine your sales people going out to prospects and clients as *marketing con-*

*sultants* rather than radio sales people. Imagine them helping (for no charge) each client create or refine his business's marketing strategy, and then offering a menu of marketing services your station can provide to help the business execute that strategy.

Imagine that menu including air time, direct mail, even newspaper advertising—all coordinated by your station to present a cohesive and impactful message to the target market. Then imagine the dismay of your radio competitors who are just out there selling pieces of time.

Next month we'll start to examine how to do this.

□ □ □

*John Cummuta is an independent Marketing and Management consultant, and the author of the Sales Machine database marketing course. He can be reached at 708-658-9107.*

## Products & Services Showcase

For more information on the products shown below, circle the appropriate Reader Service No.(s) on the enclosed Subscription/Reader Service card or contact the advertiser directly.

**Improve Your Voice!**  
Clear the cobwebs out of your mic signal path with the new **Benchmark MP-3 Mic Preamp**

- 1 dB noise figure
- THD = 0.005% (2 kHz at A=40 dB)
- Variable gain +26 to +65 dB
- Balanced output
- +48 V Phantom power input
- Jack mount anywhere!

**\$95**



*Benchmark*  
...the measure of excellence™

Contact your pro audio dealer or call  
**BENCHMARK MEDIA SYSTEMS, INC.**  
800/262-4675 315/437-6300 FAX 315/437-8119  
READER SERVICE NO. 109

**PORTABLE OFF SITE  
EBS MONITOR \$350<sup>00</sup>**  
Tuneable AM/FM Receiver and  
FCC Certified Decoder Model C.D.

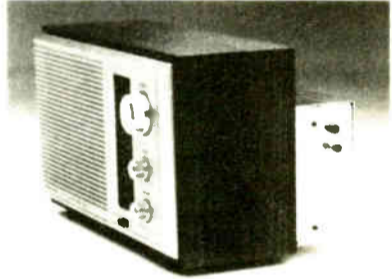

Ideal for use during hours of unattended operation at the studio and transmitter site. With modern remote control equipment the alert message can be put on the air with a telephone.

Decoder in a minibox (price \$250<sup>00</sup>) is available for use with receiver of your choice, or the decoder can be driven by phone line audio.

**Gorman Redlich Mfg. Co.**  
257 W. Union St.  
Athens, Ohio 45701  
FAX 614-592-3898 Phone 614-593-3150  
READER SERVICE NO. 13

**ECONCO**  
**REBUILT POWER TUBES**



Approximately One Half  
the Cost of New  
3,000 Hour Unconditional Guarantee  
Call for Our Price List

Econco 1318 Commerce Ave. Woodland, CA 95695  
Phone: 916-662-7553 Fax: 916-666-7760 Telex: 176756  
Toll Free: 800-532-6626 From Canada: 800-848-8841  
READER SERVICE NO. 154

**Shively**

A good FM antenna is crucial to quality broadcasting. An antenna that is merely adequate will compromise the performance of even the best studio equipment and transmitter.

Shively regularly includes standard features that other companies either provide only as options or simply do not offer.

At Shively, we design and build antennas of uncompromising technical quality and performance. And, we build them to last.

call or write for more information

**Shively Labs**  
A Division of Howell Laboratories, Inc.  
19 Harrison Road, Bridgton, ME 04009  
207-647-3327 FAX 207-647-8273  
READER SERVICE NO. 112

**WireReady™**  
Offering a real choice for today's radio news

**STOP WASTING PAPER**

**SAVE TIME & MONEY**

**COMPUTERIZE YOUR NEWS**

- Print just what you need
- Split-Screen editing
- Easy-to-Install
- Simple-to-Use

Manages: AP, UPI, Reuters, ABC, CBS, NBC, NOAA, CNN, and many others.  
Hundreds of Users: AM/FM music, AM news/talk, State Networks, U.S. Gov't agencies.

**WireReady Newswire Systems Inc.** 31-H Union Ave., Sudbury MA 01776 USA  
(508) 443-8181 (800) 833-4459 FAX (508) 443-5988  
READER SERVICE NO. 91





**GO WITH THE WINNERS.**

**DYNAMAX DCR1000 SERIES  
DIGITAL CARTRIDGE RECORDER**

*"We redubbed our entire  
thousand-cart music library to  
Dynamax 13MB Floppy Disks.  
The conversion to DCR1000  
digital machines was painless.  
Our PD and Jocks are ecstatic."*

*Russ Mundschenk  
Chief Engineer  
EZ-101 FM  
#1 AC Station  
Philadelphia, PA*



**DYNAMAX™**  
BROADCAST PRODUCTS BY FIDELIPAC™

**Fidelipac Corporation**  
□ P.O. Box 808  
□ Moorestown, NJ 08057  
□ USA  
□ 609-235-3900  
□ FAX: 609-235-7779



# Products & Services Showcase

For more information on the products shown below, circle the appropriate Reader Service No. (s) on the enclosed Subscription/Reader Service card or contact the advertiser directly.

Uh-Oh... We Should Have Called **CORTANA**



**STATI-CAT** for Affordable Lightning Prevention.

Let Us Design a System for You

Stati-Cat provides a continuous, low-resistance discharge path for the static electric charge on tall structures. Dissipation points are 1/8", type 304 stainless steel rods ground to needle sharpness. They won't bend, not even from ice and severe weather.



Write to us today for a **FREE** brochure!  
P.O. Box 2548, Farmington, N.M. 87499  
Call (505) 325-5336 FAX (505) 326-2337

READER SERVICE NO. 118

**Disc Trak™ Digital Cart Machine**  
Superior Audio quality matching CD, DAT, and other digital sources.

- ▶ 112 seconds of stereo audio on a single disk.
- ▶ Instantaneous cueing, up to 5 start/stops can be entered.
- ▶ LCD display provides spot name and timing information.
- ▶ Available in record/playback only.
- ▶ CD quality on 50¢ media.
- ▶ Immediate Delivery



**BE BROADCAST ELECTRONICS INC**

4100 N. 24th ST., P.O. BOX 3606, QUINCY, IL 62305-3606 U.S.A.  
PHONE (217) 224-9600, TELEX: 250142, FAX (217) 224-9607

READER SERVICE NO. 59

**SEND YOUR AUDIO ACROSS THE STREET OR AROUND THE WORLD**

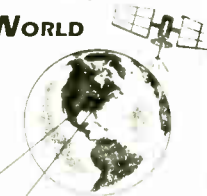

When you think digital audio, think *California Digital*. We provide satellite/digital technology to make many options available at low cost.

**DIGITAL AUDIO**

California Digital offers expertise in:  
Digital satellites  
Fiber Optics  
Training  
System design  
Fiber optic brokering  
Equipment sales, leasing & financing  
Switch 56 & ISDN program distribution  
Satellite time brokering (space segment brokering)

Call for details on cost effective solutions

**CALIFORNIA DIGITAL AUDIO**  
530 New Los Angeles Avenue  
Suite 114-96  
Moorpark CA 93021 USA

**805-523-2310 Fax: 805-523-0480**

READER SERVICE NO. 186

**GET LUCKY!**



- Hottest new promotional item for live remotes
- A Las Vegas style one-armed bandit which distributes coupons instead of money
- A smashing success at NAB '92

Promote Your Remote

CALL REEL BONUS AT:  
**619-779-9427**

READER SERVICE NO. 100

**Affordable CD Music Libraries!**

Halland CD libraries are *in stock!* Our Oldies, Gold, and AC/CHR libraries offer the *best* selection at the *best* price!

"Rock 'N' Roll Graffiti"... *Oldies*, 1229 hits on 50 CDs  
"The Seventies"... *Gold* for AC/CHR, 545 hits on 30 CDs  
"The Eighties Plus"... *New AC/CHR*, 768 hits on 44 CDs

Give us a call...see why over 500 stations worldwide rely on Halland for CD quality that's *affordable!*



Halland Broadcast Services, Inc.  
1289 E. Alostia Ave. Glendora, CA 91740 818-963-6300 FAX 818-963-2070

READER SERVICE NO. 34

Buy Into the Industry's  
**#1 Buyer's Guide**  
Place Your Products & Services  
Showcase ad in the  
**1993 Radio World Directory**  
*Advertising space closes December 11.*  
Call your Radio World Representative or  
**1-800-336-3045**  
*For More Information*  
**Don't Miss Out!!!**

If you haven't tried this pre-amp, you don't know how good your microphones can sound.



If you read ads for microphone pre-amps you'll find they all, regardless of price, promise the same things: low distortion, low noise, and great noise rejection.

**PROMISES... PROMISES**

Sontec promises you something better. Install our MPA-1 pre-amp. If it's not cleaner and more transparent than what you're now using, just return it for credit. Now that is a promise!

**Sontec Electronics**  
Audio Drive, Goldbond VA 24094 USA  
703-626-7256 FAX: 703-626-7257

READER SERVICE NO. 78  
World Radio History

**Tired Of Replacing Expensive Headphones?**

Designed to provide vivid sound reproduction when used with today's digital sources, these stereophones feature high-performance 40 mm drivers. The maximized power handling capability ensures full, accurate reproduction of the wide dynamic range found in digital program material.

The soft leatherette earpads and adjustable headband provide for hours of comfortable listening while the closed-back design of the earpieces allows for privacy and prevents unwanted outside sounds from interfering with your listening enjoyment. The 3.0 m (9.8 ft.) cable is terminated in a 3.5 mm mini plug, ideal for portable systems, and a 1/4" plug adapter is included for home use.



**Only \$29<sup>95</sup>**

2342 S. Division Avenue  
Grand Rapids, Michigan 49507  
**1-800-999-9281**

200 Fareway Drive - Suite 2  
Smithfield, North Carolina 27577  
**1-800-369-7623**



**AUDIO BROADCAST GROUP**

READER SERVICE NO. 22



# STATION SERVICES

News and Services for Business, Programming and Sales

## Jay Leno on Unistar

**LOS ANGELES** Unistar Radio Networks acquired the exclusive radio distribution rights to "Last Night on Tonight with Jay Leno," from NBC Enterprises. The weekday morning show features the best of Jay Leno's monologue from the previous evening's "The Tonight Show with Jay Leno."

The one-minute vignette is edited from the monologue and distributed via satellite for broadcast in morning drive. Friday night's monologue is fed on Mondays.

For information contact Renee Casis at Unistar at 212-373-4977; or circle Reader Service 83.

## Katz Radio Group Launches Sports Division, Enters Arena of Sports Syndication

**NEW YORK** The Katz Radio Group created a division dedicated exclusively to sports sales. Stu Heifetz, former vice president of Katz Radio Sports Sales, will oversee the new KRG Sports Sales, including account executives in New York, Chicago and Los Angeles.

In a release, the company said the new division's objectives include solidifying a pre-emptive position for KRG Sports sales activities and maximizing revenue opportunities for KRG-represented sports franchises.

In a separate announcement, Katz revealed it has entered into a joint venture with Major League Baseball Productions. Under the agreement, a new radio program, "This Date in Baseball History," will be available to stations on a market-exclusive basis through Katz

Radio Group Syndication.

The 90-second program features baseball actualities presented by veteran sportscaster Mel Allen.

For information contact Katz at 212-424-6000; or circle Reader Service 165.

## Vegas-Style Slot Machine Available for Promotions

**PALM DESERT, Calif.** Multi-Media Advertising is distributing Reel Bonus, a Las Vegas style, one-armed bandit look-alike promotional machine that distributes custom coupons instead of money.

The machine is designed to increase traffic at radio station remotes and to provide a vehicle for the distribution of promotional items, prizes and advertiser coupons.

For information contact Rick Banik at 619-779-9427; or circle Reader Service 113.

## Political Program Presents Both Sides

**WASHINGTON** The Independent Broadcasters Network recently debuted "Battleline," a two-hour Monday-Friday program originating from Washington.

The program features Barry Lynn, a First Amendment attorney formerly with the American Civil Liberties Union; Peter Flaherty, chairman of the Conservative Campaign Fund and former chairman of Citizens for Reagan; and on an alternating basis with Flaherty, Dr. Robert Grant, president of the American Freedom Coalition and chairman of the 350,000 member Cristian Voice.

"Battleline" guests include journalists,

activists and politicians. Calls also are accepted from listeners.

For information contact Robyn Williams at 813-573-4402; or circle Reader Service 44.

## Forbes Magazine Available to Radio

**NEW YORK** The "No Guts, No Story" editorial product of Forbes magazine is now available to radio stations in 10 original short-form radio commentary programs weekly. Under an exclusive arrangement with Forbes Inc., John T. Brady & Associates will make the 90-second programs available to stations via satellite on a barter basis.

Programming materials in "The Forbes Report" include regular commentary from Malcolm S. Forbes Jr., president and editor-in-chief of Forbes.

For information contact Linda Lovisa at 212-688-2424; or circle Reader Service 147.

## Motor Sports Radio Available on Barter Basis

**JOHNSON CITY, N.Y.** Sportcom Associates is now offering its Motor Sports Radio programming to radio sta-

tions on a barter basis for the 1993 racing season.

Programs available from Sportcom include "Race-Talk," a twice weekly preview and review of the news and events in major league auto racing and "Radio Road Test," a weekly program of driving impressions.

For information contact Paul Kaminski at 800-462-5677; or circle Reader Service 87.

## Sports Byline USA Targets Males 18-49

**SAN FRANCISCO** Station operators looking for late-night programming designed to appeal to young men can turn to "Sports Byline USA." The program is hosted by Ron Barr and originates at KSFO(AM) San Francisco.

Sports Byline USA airs Monday-Friday, 10:06 p.m.-1 a.m. ET. The program invites listener call-ins (via a toll-free number) and Barr conducts interviews with sports celebrities and industry executives, along with breaking sports news and final scores.

For information contact Ron Barr at 415-434-8300; or circle Reader Service 190.

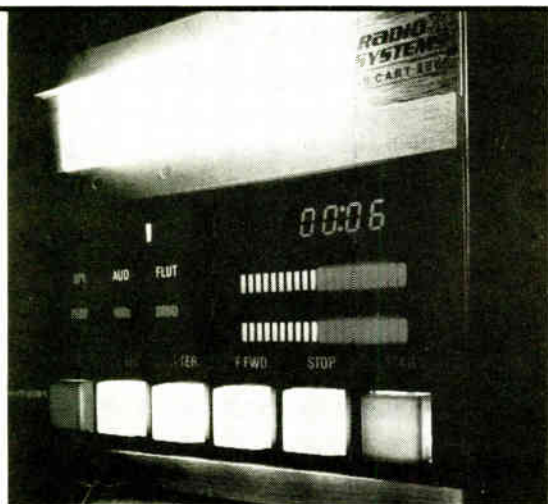

## Alive and well.

Some companies would like you to believe that the cart is dead. But today, with an installed U.S. base of more than 100,000 machines, carts are in active use at more than 98% of all U.S. broadcast facilities.

So, if you depend on carts everyday, we just wanted you to know that we're a manufacturer who still believes in the format, and make the finest cart machines available.

The RS-2000 cart machine. It will make your carts sound like digital until the day it makes sense to go digital.

**RADIO SYSTEMS INC.**  
800/523-2133 or FAX 609/467-3044

Circle (120) On Reader Service Card

# TRUE BLUE FOR THE MORNING ZOO.

**Drive time is your busiest time, so make sure your spots, liners and music are on the cart more stations count on.**

P.O. Box 3100 • Winchester, VA 22601  
Tel: (800) 522-CART or (703) 667-8125  
Fax: (703) 667-6379

Circle (43) On Reader Service Card



# Broadcast Equipment Exchange

"Broadcast Equipment Exchange" accepts no responsibility for the condition of the equipment listed or for the specifics of transactions made between buyers and sellers.

## AMPLIFIERS

### Want To Sell

Marantz 8: (2) McIntosh MC240; ARC D76A, \$1150 ea; (3) MC40, (2) A116, \$550 ea; Krell Altair w/outboard PS, \$2750; (2) Krell KST100, \$2000 ea; Quicksilver MX190, \$1750; Nak PA7, \$1150; Stax DA80, \$950; Levinson ML1, \$1550; NRG PA1, \$4500/BO/trade. R Katz, Allegro Sound, 15015 Ventura Blvd, Sherman Oaks CA 91403. 813-377-5264.

Marti PMG-20H (2) prog/line amps, \$75 ea. T Devine, WVLC, 300 W Vine St, Lexington KY 40507. 606-253-5900.

Dynaco ST120, not working. R Robinson, TNA Rcdg, 10 George St, Wallingford CT 06492. 203-269-4465.

Audionics (20) dist amp in (2) 10-input mainframes w/Audionics ext pwr sply, \$1000+s/h; Symetrix SX204 headphone amp, \$120. B Lord, Lord Bldg, 133-3 SE 208th St, Kent WA 98042. 206-631-2374.

APT Holman preamp, \$200; Gates Solid statesman limiter, \$100. P Wells, KJOY, 625 Broadway #1200, San Diego CA 92101. 619-238-1037.

LPB DA1-16 dist amp, new. J Gelo, 813-642-6899.

Dynaco Stereo 70, gd cond, new out-put tubes, \$125. D Heinen, KRSE, 2120 Riverside Rd, Yakima WA 98901. 509-248-1390.

Marantz 18 high voltage, discrete rcvr, 40 W chnl, mint cond, \$350. J McLane, Oddeo, 115 W Gutierrez, Santa Barbara CA 93101. 805-963-3941.

Dynaco ST120, not working. R Robinson, TNA Rcdg, 10 George St, Wallingford CT 06492. 203-269-4465.

Shintron 220 audio dist amp, 1x6 w/manual, new, \$30. D Bailey, Rock Shoppe Prods, 3422 Beech St, Rowlett TX 75088. 214-475-9796.

Marantz 8-B, exc cond, \$995; Mdl 9s, BO. 305-866-6048.

UREI 1122 phono, stereo preamp. T Devine, WVLC, 300 W Vine St, Lexington KY 40507. 606-253-5900.

Dynaco stereo 80, solid state, exc cond, \$85. J Newman, 401-847-0455.

RCA, Altec, Dynaco tube amps, sell of trade. Tracy Eaves, 615-821-6099 (evenings before 10PM EST).

New 250 W solid state amp, \$1800. Call for details. Bill Hoffman, 518-583-9490.

### Want To Buy

Denon POA8000, 6600; Sansui B2301, C2301, BA5000; Fisher SA(K) 1000; Nak PA5/2; B&W MPA810; Peplows; ARC M360, D150, D79, D75, D76; Crown Macro Ref; Marantz 1-10; McIntosh; JBL Harstfield, Paragon, Cascade. R Katz, Allegro Sound, 15015 Ventura Blvd, Sherman Oaks CA 91403. 813-377-5264.

## ANTENNAS & TOWERS

### Want To Sell

Rigid line, 3-1/8", up to 800' avail, on tower, exc cond, pressurized, seller will remove from tower. M Kobylika, WJET, 1535 Ash St, Erie PA 16503. 814-455-0240.

Kintronics AM 50 ohm, 5 kW dummy load w/RF ammeter & change over relay, exc cond, \$500. D Igou, Bldg Engrg, 8435 Twisted Oaks, Garden Ridge TX 78266. 210-651-9049.

Cont G5CPM-2E 2-bay FM tuned to 102.3, gd cond, avail immed, BO. P Bossert, KSPK, 516 Main St, Walsenburg CO 81089. 719-738-3636.

Electro Imp DPTC-25KFM air-cooled dummy load, 115 V req, 3 1/8" input, BO. R Miller, KUAU, 490 Ulumalu Rd, Haiku HI 96708. 808-572-5534.

Large collection of AM RF tuning parts. T McGinley, WPGC, POB 10239, Washington DC 20018. 301-441-3332.

Scala CL-FM yagi xlator, gd cond. S Cichorsky, Paso Bldg, POB 2031, Paso Robles CA 93447. 805-239-3916.

Potomac AMM-19D 6-twr digital ant/monitor, \$2500. M Turner, WYIC, 7641 Camberwood Dr, Indianapolis IN 46268. 317-872-3004.

Harris ERI FML3-E 3-bay on 95.9 MHz; 320', 1 5/8" HCC158-50J coax; AEL FM-25KG, SN 218, 96487 hrs, gd cond; RCA BTA-15E exciter, 98.9 MHz. 501-862-9696.

HJ5-50A 480' helix w/conns, type N, 4'; 150' RSL5-1, 4'; (4) L47PN plated, new, \$150 ea; 1 5/8" snaps, 206706-4, \$3 ea; 879 EIA conn, \$150. 817-566-5036.

Cablewave CFM LP-3 3-bay circ polar FM on 92.1 MHz. 318-728-5852.

ERI G4CPL-3 3-bay CP tuned to 98.3 MHz, end fed, 1 5/8", \$3000+s/h/BO. W Kalka, KNOT, 116 S Alto, Prescott AZ 86303. 602-778-2983.

Andrew 1062 3 1/8" elbow, \$200; 1861 reducer w/bullet, \$50; 7/8" to F part #33682, \$25; 78AGM 3 1/8" end kit, \$70. J Cunningham, KEOR, R12 Box 113B, Stonewall OK 74871. 405-265-4496.

Capacitors MC-1-1000 vacuum, \$150; Aerovox 1970S.001 @ 20 kV mica, \$120. L Caldwell, KRLW, Hwy 412 E, Walnut Ridge AR 72476. 501-935-0438.

UTC 120 180' guyed, beacon, side light tuning unit, lighting chokes, diode unit, 0-5 amps, electric eye, you dismantled, \$3500/BO+s/h. J LoPresti, WGSF, 111 Avalon Dr, Warner Robins GA 31093. 912-929-4904.

Shively 6-bay, 3 yrs old on 98.9 MHz, avail 12/92. K Stone, 512-332-9191.

Cablewave 1 5/8", 270' w/ant conn attached ground strap, twr clamps attached, rolled up & boxed, \$6/foot. W Schlaugat, WPRE, Box 90, Prairie du Chien WI 53821. 608-326-2411.

HJ5-50A 480' Helix w/conns, type N; 150' RSL5-1; (4) L47PN plated, new, \$150 ea; 1 5/8" snaps 206706-4, \$3 ea; 1-879 EIA conn, \$150. 817-566-5036.

USED TOWERS BOUGHT AND SOLD. Call 1-800-643-6988.

### Want To Buy

Reducer to go from 3 1/8 to 7/8 to PL259 line. R Miller, KUAU, 490 Ulumalu Rd, Haiku HI 96708. 808-572-5534.

150'-198' self-supporting tower; trade 198' guy twr w/new cables & insulators for 150'-198' twr. E Prendergast, KAOK, PO Drwr S, Lake Charles LA 70602. 318-474-0645

51.5 ohm coax switch similar to RCA MI-561562-C/Dielectric 12724110. J Landry, WHDH, 7 Bulfinch Pl, Boston MA 02114.

ERI/Cablewave 6-bay circ polar FM, rated at 10 kW, input on 92.3 MHz; 3/6-bay circ polar FM on 99.5 MHz. 318-728-5852.

Need used channel 2 TV antenna, high gain 15 kW input, maximum directional capability a plus. Write to: Feizal Sikaffy, Box 140815, Coral Gables FL 33134.

## AUDIO PRODUCTION

### Want To Sell

Telos 10 10-line phone syst, \$1200+s/h; Valley People 400 mic processor, \$250+s/h. B Lord, Lord Bldg, 13313 SE 208th St, Kent WA 98042. 206-631-2374.

UREI 1178 stereo peak, exc cond, \$650. J Somich, Somich Prods, 1208 Stoney Run Terr, Cleveland OH 44147. 216-526-0967.

Studio Sound S305 vintage passive filter sets, matched pr, consec #, rack-mount, rare, \$175 ea/trade. R Katz, Allegro Sound, 15015 Ventura Blvd, Sherman Oaks CA 91403. 813-377-5264.

Symetrix 528 voice proc, like new, parametric EQ, phantom pwr, de-esser, \$400/BO. S St John, St John Prods, 3620 Connecticut Ave, Kenner LA 70065. 504-464-8881.

## CASSETTES • CARTS • REELS

### J & I AUDIO/VIDEO

A wholesaler in the Radio and Television market.

Now running SPECIALS on audio and video:

BASF CASSETTES-AMPEX R-Rs  
AUDIOPAK, FIDELIPAK & ITC CARTS

For more information  
call Kris Elliot at

1-800-942-1711  
or write to: J&I Audio/Video

20899 Kelvin Pl.  
Woodland Hills, CA 91367

Circle (71) On Reader Service Card

Symetrix 528 voice proc, para EQ, phantom pwr, de-esser, \$300. S St John, St John Prods, 3620 Connecticut Ave, Kenner LA 70065. 504-464-8881.

Symetrix T1-101 telephone hybrid, exc cond, \$320; SWA UA 1.0, (2) UAD.5, UPS-3, L+R/L-R matrix w/rack mount case, \$250; Orban 621 A/R para EQ, \$100. M Persons, WYRQ, 402 Buffalo Hills Ln, Brainerd MN 56401. 218-829-1326.

UREI 532 single-chnl graphic EQ, \$150. T Devine, WVLC, 300 W Vine St, Lexington KY 40507. 606-253-5900.

UREI 527A (2), gd shape, \$325 pair. M Reichard, 219-482-9288.

Tapco 2200 10-band graphic EQ, XLR & 1/4", in & out stereo, \$75; Orban 526A deesser, XLR in, 1/4" line out, \$115; Yamaha PM430 8-chnl, XLR in & out, 2-band EQ, pan pots, effects in & out, carry case, \$250. A Mitchell, 703-768-6186.

Roland SPH323 phaser, \$75; Rockmann sustainer & stereo chorus/delay, \$350/both. W Gunn, 619-320-0728.

Prophet 600 synthesizer, \$450; Spectro Acoustics rack mount 200 W amp, \$150; Crown VFX2 electronic crossover, \$125. W Gunn, 619-320-0728.

TT (Bantam) ADC patchbays, 144 pts, 1 rack sp, \$129; Tannoy HPB385A 15" coaxial monitor pair in cabinet, \$1750; Altec 436A tube compressors, Daven attn, both \$700. W Gunn, 619-320-0728.

SKL H/L/O variable filter (pair), \$200. W Gunn, 619-320-0728.

AKG 414 P48 like new, \$675; Dynaco 410, 400 W amp, \$400; dbx 1BX expander, \$135. W Gunn, 619-320-0728.

MCI JH110A 2-trk in stand w/sound & vision remote/locator, \$1200; Orban 674A parabolic stereo EQ, \$600; Foxtex 3070 comp/limiter, \$150; Foxtex 3180 reverb, \$50. W Gunn, 619-320-0728.

### Want To Buy

Crown EQ2; dbx 10/20, 20/20, 14/10; Yamaha REV5, REV7; Burwen TNE7000. R Katz, Allegro Sound, 15015 Ventura Blvd, Sherman Oaks CA 91403. 813-377-5264.

## WANTED DEAD OR ALIVE! PULTEC EQ'S

Fairchild & Teletronix Limiters; Neumann. Telefunken. AKG, RCA, & Schoeps microphones. Tube McIntosh or Marantz amps & pre-amps. Sontec, ITI, & Lang EQs. Neve or API equipment. Boxes of old tubes; Urei, Orban. United Audio, DBX, & other outboard gear. Ampex ATR102s or 104s. Parts for MCI JH110/114 recorders. Altec 604s/crossovers/Tannoy speakers. JBL 2231; Altec 288h drivers; Misc. equipment of all types.

### Please Call:

Dan Alexander Audio  
5935 Market St.  
Oakland, CA 94608  
1-(415) 644-2363  
FAX: 1-415-652-4022

Fairchild 600 conec or 602 Conex high freq limiters. J Gangwer, 942 32nd St, Richmond CA 94804. 415-644-2363.

## AUTOMATION EQUIP

### Want To Sell

SMC MSP-12 200-event programmer, DAS-12 audio switcher, (3) cart mchs, (3) Carousels, kybd, mon, wiring, pwr units, manuals, exc cond, \$8000. M Jarvis, KORC, POB 1419, Waldport OR 97394. 503-563-5100.

BE Control 16 customer panel, kybd, pwr sply, batt pack, audio control, nds work, \$1000. L Smith, WCSS, 6 Genesee Ln, Amsterdam NY 12010. 518-843-2500.

AR-1000 audio control, AR-1000 prog, (4) Scully R-Rs, (6) SMC 250RS Carousels, SMC 790 cart encoder/decoder & (4) ITC cart mchs. B Wolf, WREO, POB 738, Ashtabula OH 44004. 216-993-2126.

Conex CG-25R 25 Hz gener, \$210; CS-25B 25 Hz sensor w/(3) DS25 dual sensors & PS-3 pwr sply, \$536. J Blodgett, WGTF, 308 Westgate Pkwy, Dothan AL 36303. 205-794-4770.

Harris 9000, working when removed w/Micropolis 1055-2 floppy disk drives not working, (2) 42-tray IGM Go-Carts, 1 working, TEC 70X mon & keyboard w/misc parts, \$5000/BO. J Huffman, 503-298-5116.

Schafer 901 w/2 ITC RP cart mchs, (4) RS 250 SMC Carousels, (1) RS 350 Carousel, \$4000/will separate. S Southern, WCIR, Box 1037, Beaver WV 25813. 304-252-6452.



## Broadcast Equipment Repair

- Backed by 90 day warranty
- Highly trained, professional staff
- Fully equipped with up-to-date test equipment
- Emergency service available

Call: 217-222-8200, ext. 3160  
from 8AM to 5PM CST weekdays  
or ext. 3500 other times

Conex GC-25 25 Hz gener, \$50. T Devine, WVLC, 300 W Vine St, Lexington KY 40507. 606-253-5900.

BE Econo/Sat 16 w/custom rack, (3) SMC/Otari ARS1000 reels, (2) IGM Go-Cart 24s, stereo, 2000-event brain, rem ctrl pwr, sat int panels, mon spkr, extra printer, exc cond w/books, \$12K. T Barna, BRC, 403 New Forge Rd, Ancram NY 12502. 518-851-3408.

Otari ARS-1000 PB, new. J Phillips, WZOM, 408 Clinton, Defiance OH 43512.

SMC RP-1000 prog w/DS-20 switcher, pwr sply, dig clock, working cond, \$500+s/h; (3) SMC 252RS Carousels, \$200/all+s/h. B Elliott, WFRX, 915 E 4th St, Charlotte NC 28204. 704-338-9970.

BE Control 16 (2) brains w/manuals, sat cards, spare source cards & parts w/o tape decks, \$2500 ea/BO. B Mounjoy, WETB, POB 1162, Eliz TN 37644. 615-543-5849.

Schafer 903 E (5) ITC 750 stereo R-Rs w/(5) ITC Prem line mono PBs, (4) 48-cart audio files, 3-day memory, exc cond, \$5000. J Curtis, KFRO, POB 4299, Longview TX 75606. 903-663-3700.

Harris System 90 from retired syst. L Caldwell, KRLW, Hwy 412 E, Walnut Ridge AR 72476. 501-886-6666.

Harris 9000 w/Tel 70 terminal/CRT & Extel AH-11R printer w/10 cases of paper, BO; (2) 48-tray stereo IGM Instacarts, gd cond, \$5000 ea; (2) 42-slot stereo Go-Carts, gd cond, \$1000 ea; (4) ITC 750, gd cond, \$200 ea, free rack w/all 4; MEI Digsound/Satmaster, \$1500. D Greer, WDZZ, 1830 Genesee Trws, Flint MI 48502. 313-238-7300.

SMC MSP-12 w/DAS-12 audio switcher, (3) IGM 250 mono Carousels, (3) PB carts, keyboard, mon, manual, cables, wiring & pwr splys, racks, \$8750. 503-563-5100.

Schafer 7000 w/new pwr sply, all/part. 907-586-6037.

Cetec Schafer 7000 level 1 memory w/ext memory, 4 racks, (4) ITC 750 R-Rs, (2) audio file lts, terminal & printer, works fine, \$3500. G Kaufman, 319-243-1390.

## Value & Economy for Tough Economic Times

- ☆ Rebuilt & New equipment at 'bottom line' prices
- ☆ Replacement electronics & update kits for ITC, Harris, Autogram & other brands
- ☆ Full rebuild & repair service for ITC, BE and other popular cart & reel equipment.
- ☆ Tacsam and Otari factory authorized service center
- ☆ Tape heads, transformers, RF & other engineering supplies

### THE SMART CHOICE!



1305-F Seminole Trail  
Charlottesville, VA. 22901  
(804) 974-6466

Mastercard & Visa Welcome

Circle (39) On Reader Service Card

## ITC REPAIR — REFURBISHMENT

Direct Factory Cartidge Machine Repair Service  
Upgrades or Refurbishment  
All Work Warranted

Call The ITC Technical Service Department  
Toll-Free at



(800) 447-0414  
(309) 828-1381



International Tapetronics Corporation  
2425 South Main Street  
Bloomington, IL 61704





**AUTOMATION . . . WTS**

IGM Go Cart 48-tray, BO. 907-586-6037.

**BUSINESS OPPORTUNITIES**

**Want To Sell**

Music format libraries (2) superior, ready for partnership/sale w/rcdg equip, potential unlt'd. J Gelo, 813-642-6899.

**CAMERAS (VIDEO)**

**Want To Sell**

Canon VC-40A color, stereo mic, title gener, Quasar VHS 3-sp'd tape deck, 4 hd HiFi, \$750/BO. J Diamond, Joe Diamond Co, Box 102C, Chubbic Rd RD#1, Canonsburg PA 15317. 412-746-3455.

**YOUR AD COULD BE HERE!**  
Call Simone Today!  
**1-800-336-3045**

**Want To Buy**

RCA TK-45 control cable & manual; RCA TK 86 t2 VDC pwr sply. G Kirby, Gray Fox Video, 13613 US 36, Marysville OH 43040. 614-261-8871.

**CART MACHINES**

**Want To Sell**

ITC Delta I (2), new, stereo PB, \$2500 both. Jim, Henry Bdc'tg, 1950 S Sunwest Ln, San Bernardino CA 92412. 714-384-9750.

Fidelipac/Dynamax CTR-10 stereo plyr, like new, \$850. D Igou, Bdc'tg Engrg, 8435 Twisted Oaks, Garden Ridge TX 78266. 210-651-9049.

**ITC R/P Mono Premium Series.** BE R/P mono 3000 Series . . . \$395/ea, good operating condition. Warranties & Rebuilds available. Mark at 619-598-3311.

BE 900-5303-001 triple stack, \$1995+s/h; (6) Fidelipac Dynamax CTR112, \$1450 ea. B Lord, Lord Bdc'tg, 13313 SE 208th St, Kent WA 98042. 206-631-2374.

ITC SP & RP delay (3) mono spd, exc cond, \$600 ea; ITC RP w/delay function, mono, \$1000; Fidelipac 300 audio carts, .40-7.00 lengths, reload pancakes & winder, \$300 all/part out. S Southern, WCIR, Box 1037, Beaver WV 25813 304-252-6452.

ITC R/P stereo, triple cue, gd cond, \$1000/BO. M Aldridge, Remote Sound Engrg, POB 616, Collewah TN 37363. 615-396-2893.

ITC Delta stereo play only, single, very gd cond, \$1200. J Slavov, WHGR, POB 546, Jackson MI 49204. 517-740-1165.

Collins mono, rec/PB, tube w/custom case, fair-gd cond, \$85; BE 3200 mono, PB, parts, gd motor, \$50; Beau cart, mono, PB, 1 fair cond, other parts, \$100 both. T Barna, BRC, 403 New Forge Rd, Ancram NY 12502. 518-851-3408.

ITC 3D (2) 1 stereo, 1 mono. J Phillips, WZOM, 408 Clinton, Defiance OH 43512.

Harris/Gates AHS-3A-4A auto switcher, audio, \$500; (3) Criterion PB units, 1 counter top, 2 rack mounted in custom cases w/spare parts & manuals, \$150 ea. B McKitrick, McKay Enterprises, 331 Mulberry St, Catasauqua PA 18032. 215-264-5295.

Gates mono R/P, 2 piece deck mount; BE 2000PS stereo PB, w/aux tone sensing; Pioneer 1050 2-trk, stereo, 10 & 7. 214-563-1071.

Tapecaster 700 RP delay unit, gd cond, \$100; (3) Harris Criterion III, gd cond, BO. B Brinitzer, WDNC, 1000 Park Forty, Durham NC 27713. 919-361-1429.

ITC 99B/RPSE stereo R/P w/ELSA, little use, mint cond w/manual, \$2495/BO. B Mountjoy, WETB, POB 1162, Eliz TN 37644. 615-543-5849.

BE 5300C tripledeck, stereo, PB, mint less than 50 hrs, BO. R Kaufman, Pams Prods, POB 462247, Garland TX 75046. 214-271-7625, after 3PM CDT.

ITC RP mono record, rack mount, \$475/BO. Mark 916-573-1452.

**Want To Buy**

Audio & tone det cards for UMC single-play, rec cards for stereo R/P. 904-678-8943.

Mono R/P, any mdl, working/not, up to \$50. E Lightman, WEDL, 550 Merchant St, Ambridge PA 15003. 412-266-2802.

**CASSETTE & REEL-TO-REEL RECORDERS**

**Want To Sell**

Studer A807-2/4-VUK 2-trk analog

**EXPERT REVOK REPAIRS**  
Fast Turnarounds—Competitive Rates  
Rebuilt A77s, \$900  
Capstan shaft resurfacing, \$35.  
**JM TECHNICAL ARTS**  
30 Music Sq. W. #5  
Nashville, TN 37203 (615) 244-6892

mastering w/rare 4th hd for 1/4-trk PB, \$6950/BO; HS77 MK IV full-trk mono, 10 hrs use, \$875/BO/trade; port case for A77 w/mono spkrs & pwr amps, exc cond, \$375. R Katz, Allegro Sound, 15015 Ventura Blvd, Sherman Oaks CA 91403. 813-377-5264.

Revox PR-99 MKII 1/2-trk stereo, play w/25 Hz sensor, \$1100 ea. D Peluso, KJUL, 2880 E Flamingo Rd Ste E, Las Vegas NV 89121. 702-732-2200.

3M 56 (2) 2-trk 7 1/2-15 ips console mdls w/new Saki hds, great cond, \$400 ea. T Breneman, Breneman Radio Svcs, 23117 Collins St, Woodland Hills CA 91367. 818-999-5270.

**Tascam DA-50 Pro DAT R/P w/remote & manual, recently overhauled, BO. Steve, 703-998-7729.**

Sony/MCI JH110C 2-trk in roll around metal cab; Technics RS1500 2-trk, excel cond. J Gelo, J & H Music Prog., 813-642-6899.

Otari MX5050QXHD 8-trk in custom cons, demo, \$3500/BO; 8-trk in Ruslang cons, new, \$4000/BO; 4-trk in custom cons, new, \$2500/BO; MKII 2-trk in custom cons, \$2500/BO. J Diamond, Blue Diamond, Box 102C Chubbic Rd Rd 1, Canonsburg PA 15317. 412-746-3455.

Ampex AG 440-B full-trk factory cons, \$350; AG-600-B, stereo, 3 3/4 & 7 1/2, \$100; 600, full-trk, port case, exc, \$125. D Lundy, Lundy Rcdg, POB 408, Heidrick KY 40949. 606-546-6650.

**Ampex, ITC, Scully Reel-to-Reel Tape Recorder Spare Parts, Accessories, Motor Remanufacturing.**

**VIF INTERNATIONAL**  
PO Box 1555  
Mtn View CA  
94042  
Direct order line (800) 848-4428  
in area code 408  
dial 739-9740  
Telex 62922869 ESL UD  
FAX: 1-408-739-0809

Tascam 32 2-trk, great cond w/orig pkg & manual, \$700+s/h. G Parmelee, Music Svcs Unltd, RR 1 Box 1020, Brandon VT 05733. 802-247-5528.

Sony CCP-100 cass duplicator, 30 ips 1x1, exc cond w/operator & svc manuals, monaural, direct drive, ferrite hds, \$300. E Cole, WRGF, POB 3509, Lakeland FL 33802. 813-682-2235.

Logger, slow spd, Dictaphone 1000 system. J Phillips, WZOM, 408 Clinton, Defiance OH 43512.

ITC 750 stereo, exc cond, \$350; Magnecontrol PT 6-6A, orig factory cases, BO. D Lundy, Lundy Rcdg, POB 408, Heidrick KY 40949. 606-546-6650.

MCI 110B motors, boards, head stacks & parts. M Shea, Precision, POB 723, NY NY 10276. 212-989-2684.

MCI JH-110BX 2-trk stereo w/rem in orig rollaround, 4-trk cab, \$1500; ITC SP mono cart plyr, \$350; UMC 11 series mono cart plyr, \$250. P Wells, KJQY, 625 Broadway #1200, San Diego CA 92101. 619-238-1037.

ITC 850 R/P stereo in roll around cab, \$1500. S Southern, WCIR, Box 1037, Beaver WV 25613. 304-252-6452.

Scully 280 motors, cards, parts; 8-trk 1" R/P combo hd & erase hd to match for Scully 100; Inovonics Trentol units; Tascam T-2640 duplicators, 8:1 spd, 3 slaves. R Robinson, TNA Rcdg, 10 George St, Wallingford CT 06492. 203-269-4465.

Telefunken M15A 2-trk, 7 1/2 & 15 ips in console w/outboard meters. R Rhodes, R Rhodes Music, POB 1550, NY NY 10101. 212-245-5045.

Tascam 48 1/2", 8-trk, min/sec counter, mint cond, \$2950. Wayne Gunn, 619-320-0728.

Pioneer RT-1020L, 3-hd, 3-motor, stereo w/o manual, \$125+s/h. D Morris, WKUN, 702 E Spring St, Monroe GA 30655. 404-267-6558.

Scully 284B-8 1" 8-trk 3 3/4-30 ips w/V576 var spd mod, manuals, perf cond, \$3000; MCI JH110A 1/2", 9 yrs old, 7 1/2, 15, 30 ips, gd cond, hds gd cond, analog meters, manuals, \$2500 incl's s/h. Tom, 415-969-3030.

Ampex 350 (2), mono w/Inovonics elects, solid state rackmount, \$350 ea; Ampex AG-350, mono w/solid state rackmount, \$500. A Baker, Bdc'tg Prods, 804 E 38th St, Indianapolis IN 46205. 317-925-7371.

Tascam 34-4 4-trk R/P perf w/M30 4-trk cons, like new, \$1600. J Hayes, 702-731-5250.

Inovonics 375 (2) solid state elects for Ampex 351, \$150 ea. S Kirsch, Silver Lake Audio, 2590 Hillside Ct, Baldwin NY 11510. 516-623-6114.

Otari 4050 stereo cass duplication, high spd, great cond, \$3500. T Calandra, BCMK Studios, 2355 Delaware Ave, Buffalo NY 14216. 716-877-2265.

ITC 770 (2), 1 R/P, \$300; 1 play w/25 Hz sensor, \$175; Otari ARS-1000, new hds, \$450, all in gd cond, you pay s/h. B Elliott, WFRX, 915 E 4th St, Charlotte NC 28204. 704-338-9970.

Ampex AG440 (2) 1/4" full-trk, R/P in Ruslang roll around cons, 1 \$500, 1 \$750; 1/4" 1/2-trk PB only, 2 pcs in metal roll around cons, \$400; AG440 1/2 or 1/4" 2/4-trk hds, 2 sets of elects, \$900. 617-630-0007.

Technics RS-1500/RS1506 rem ctrl unit, BO. J Newberry, Golden Ntwk, 1450 Chapin Ave, Burlingame CA 94010. 415-348-4836.

Scully/Westrex VP131 3II AH stereo hd, in svc, \$25K. F Virtue, Virtue Studios, 8809-11 Rising Sun Ave, Philadelphia PA 19115. 215-763-2825.

Scully 280 parts; Inovonics Trentol units, constant tension upgrade kit; Tascam T-2640 duplicators, 8:1 spd, 3 slaves, cass to cass expandable. R Robinson, TNA Rcdg, 10 George St, Wallingford CT 06492. 203-269-4465.

Wollensak 3 3/4 & 7 1/2 ips, gd shape, \$50; Wollensak R/P, \$15; (2) Ampex for parts, \$25 ea; (75) 3" hds, \$25; (8) 10" metal hds, \$7; (884) 3" hds, \$500; (107) 7" hds, \$50, will separate. Steve, Dynes Comms, 957 Natl Rd, Wheeling WV 26003. 304-243-0744.

Technic RSM-65 (2), new, \$350 ea/BO; Sony TC-228 8-trk cart, new, \$200/BO; Sony TC-777-4, mint cond, \$350/BO. J Diamond, Blue Diamond, Box 102C Chubbic Rd Rd 1, Canonsburg PA 15317. 412-746-3455.

Otari 5050B-11s (2) in perf shape, \$1425 ea; full-trk, \$1295, in svc. K Thomas, Rebel Prods, 5555 Radio Ln, Jacksonville FL 32205. 904-388-7711.

MCI JH-110 (2) 2-trk 1/4" in roll around cabinets, \$2000. C Durso, KPBS, 5164 College Ave, San Diego CA 92182. 619-594-8100.

Ampex 350 rem ctrl box, \$20. D Bailey, Rock Shoppe Prods, 3422 Beech St, Rowlett TX 75088. 214-475-9796.

Scully 284-B8-trk, vari spd, \$5000; Technics RS 85M, \$75; ECho Plate H2, \$500. H Sewil, Oakridge Music, 2001 Elton, Ft Worth TX 76117.

Otari MX-5050BIIQ 4-chnl, 4-trk, 1/4", 7 1/2-15 ips in roll-around, exc cond, \$2195/BO. B Mountjoy, WETB, POB 1162, Eliz TN 37644. 615-543-5849.

Otari MX-5050, mint cond, \$2150. D Sainte-Johnn, KFRC, 500 Washington St, San Fran CA 94111. 415-986-6100.

**CLEAN PATCH BAYS NO DOWN TIME**



**VERTIGO BURNISHERS AND INJECTORS RESTORE ORIGINAL PERFORMANCE TO YOUR PATCH BAYS**  
\$34.95 Ea. Please write for additional information and order form today.  
**VERTIGO RECORDING SERVICES**  
12115 Magnolia Blvd. #116 818-907-5161  
North Hollywood, CA 91607 fax 818-784-3763

Otari MX5050 (2) 1/4" 2-trk, 4-hd, 7 1/2-15 ips, 10 1/2" reels, XLR in & out w/rem & rack mounts, low hrs, \$525 ea; Tascam 22-4 1/4", 4-trk, 3-hd, 7 1/2-15 ips w/rem, low hrs, \$500; Audiotronics 162-S-2 sync, \$100. A Mitchell, 703-768-6186.

Tascam 22-2, gd cond. Shawn, Sunrise Broad, POB 2307, Newburgh NY 12530. 914-561-2131.

Otari 5050B, 4-chnl, 1/4" tape, (2) road cases, clean, 12 yrs old, \$750; Sony TCM-5000 EV, 3-head mono, port, built-in condenser mic, voice-operated, start

w/dig delay, mixes 2 mics, line in, pre-end alarm, hard case & book, mint cond, \$285. 718-347-2940.

Marantz PMD 221 (2), 2-sp'd, port, \$125 ea; (16) Scotch-Ampex 10 1/2" reels, 1/4", used once, \$5 ea/\$60 all. A Mitchell, 703-768-6186.

Tascam 40-4 w/dbx & flight case, \$950; Tascam 48 8 trk, excel for sync, \$2950. W Gunn. 619-320-0728.

**Want To Buy**

Miniature, open reel, small cart; colored plastic reels; Tandberg 11/P whole/parts. J Morinelli, 215-789-5472.

Nagra 3S/4S w/NAB hds; Sony TC880/8750; Revox B215. R Katz, Allegro Sound, 15015 Ventura Blvd, Sherman Oaks CA 91403. 813-377-5264.

Otari MK III-8 hd bridge w/o hds. R Robinson, TNA Rcdg, 10 George St, Wallingford CT 06492. 203-269-4465.

Otari MK III 8-hd bridge w/o hds. R Robinson, TNA Rcdg, 10 George St, Wallingford CT 06492. 203-269-4465.

MCI/Sony capstan & reel motors, any cond., rec'dg heads, most mtgs, machines, new, used. Relapped then sold. Amp Services, 224 Datura St No 614, W Palm Beach FL 33401. 800-826-0601, in FL 305-659-4805.

Ampex ATR100 taperecorders for parts. Circuit cards, heads, motors, machine parts, or electronic parts. Call 818-907-5161.

Scully '100' recorders, record/play amplifiers, 8, 16, 24 track heads. Sequoia Electronics, 1131 Virginia Ave, Campbell CA 95008. 408-866-8434.

**CD's**

**Want To Sell**

Denon DN-950FA plyr, used 6 mos, \$730+s/h. B Lord, Lord Bdc'tg, 13313 SE 208th St, Kent WA 98042. 206-631-2374.

**EMPLOYMENT**

To place ads in this section, use the ActionGram form. To respond to box numbers write Radio World, PO Box 1214, Falls Church, VA 22041. Attn: \_\_\_\_\_

**POSITIONS WANTED**

**Station oper, announcing & perf student,** age 63, desires Fresno CA area, perf talk, news, C&W, easy, let's talk. A Bulick, POB 416, Yuma AZ 85366. 602-342-0306.

**Laurie Kendrick gives great headlines,** Houston bdc't vet will do talk or be news/sidekick at any major mkt station. 713-460-1307.

**Freelance engr w/heavy duty exper** for any job, anywhere w/great refs, audio, RF, automation, xmtrs, ants/construction, domestic/intl. 813-849-3477.

**Quick flx prog, sales, mktg & engr expert,** freelance for struggling stations anywhere. 813-849-3477.

**DJ/Intern, any format, seeks pos,** will give 110% to PD/boss, any shift/location. Marc, 718-998-0676.

**Exper in all aspects of radio prod,** produced & aired own show w/collection of late 60s/70s music. Ed, POB 154118, Irving TX 75015-4118. 214-986-7006.

**Current Sports Dir at upstate NY AM** w/7 yrs radio exper is ready to move & help your station grow. 518-523-2153.

**10 yr male radio vet exper** in most formats seeks air/PD/air pos, perf mid-west, will relocate, familiar w/dig DJ. 219-271-8457.

**Radio vet, mornings/middays/afternoons,** voices, award winning spots seeks TN/FL/AK offers, computer proficient. James, 927 Freeman, Sherman TX 75090.

**Operations/Engineering Director,** 25 year results oriented pro seeks solid company that appreciates excellence. Write to: Radio World, POB 1214, Falls Church VA 22041. Attn: Box #12-09-01RW.

**DJ w/1 yr AOR exper on air,** relocated to Phoenix from Chicago, Shock Jock influenced, desire to succeed. Don, 625 W 1st #157, Tempe AZ 85281. 602-921-7037.

**1 yr 2 wks exper on air & 1 mo prog dir exper,** anywhere in US. Gary, 814-266-1173.

**10-yr pro seeks C&W station anywhere** for lasting relationship, w/copywriting. T Brehmer, 319-326-0255.

**Quick flx prog, sales, mktg & engr expert,** freelance for struggling stations anywhere. 813-849-3477.

**HELP WANTED**

**Tulsa AM/FM**

Seeking engineering assistant. Formal basic electronics training and three years broadcast engineering required. Should have knowledge of directional antenna systems, transmitters, studio and remote equipment, and new construction. Immediate opening. No phone calls please. Resume to Wayne Smith, CE, KRMG/KWEN (K95FM), 7136 S. Yale #500, Tulsa OK 74136. Competitive salary and benefits. NewCity is an Equal Opportunity Employer.

**ABOUT OUR EMPLOYMENT SECTION**

**HELP WANTED:** Any company or station can run "Help Wanted" ads for \$1.50/word or buy a display box for \$55/column inch. Payment must accompany insert, use your MasterCard or VISA; there will be no invoicing. Blind box numbers will be provided at an extra charge of \$10. Responses will be forwarded to listee, unopened, upon receipt. Call 800-336-3045 for details.

**POSITIONS WANTED:** Any individual can run a "Position Wanted" ad, FREE of charge (25 words max), and it will appear in the following 2 issues of Radio World. Contact information will be provided, but if a blind box number is required, there is a \$10 fee which must be paid with the listing (there will be no invoicing). Responses will be forwarded to the listee, unopened.

**Mail to: BROADCAST EQUIPMENT EXCHANGE**  
PO Box 1214, Falls Church, VA 22041  
Attn: Simone Mullins

**SOUND YOUR BEST ON THE AIR!**

**CART MACHINE SERVICES:**  
**CART MOTORS REBUILT** to quiet flutter-free perfection-shafts resurfaced  
Single \$110.00 Triple \$130.00

**CART HEADS RELAPPED** guaranteed to perform like new  
Same day turnaround  
Replacement heads and motors available

**REEL TO REEL SERVICES:**  
**HEADS RELAPPED** and precise digital/optical  
**ASSEMBLY ALIGNMENTS** performed for maximum response & head life  
**CAPISTAN & REEL MOTORS REBUILT** for MCI, OTARI and more.

For peak performance from your recording equipment, call The Audio Magnetic Professionals.

**AMP SERVICES**

224 Datura Street, Suite 614, West Palm Beach, FL 33401  
Call 1-800-826-0601 for "Same Day Service" in Florida (407) 659-4805  
Authorized Parts Dealers for: MCI • OTARI • TEAC/TASCAM

Circle (123) On Reader Service Card



Want To Buy

Technics SLP-770777/999/similar, will pay near-new price, gd cond, maybe 2. M Friend, WTJU, Box 711 Newcomb Hall, Charlottesville VA 22904. 804-924-0885.

COMPUTERS

Want To Sell

Xerox Diablo daisywheel printer w/cheap software. P Wells, KJQY, 625 Broadway #1200, San Diego CA 92101. 619-238-1037.

NEC P6 24-pin dot matrix printer w/8 int fonts, \$150. P Cibley, Cibley Music, 138 E 38th St, NY NY 10016. 212-986-2219.

Micro Pro Wordstar, never used, \$40/BO. Steve, Dynes Comms, 957 Natl Rd, Wheeling WV 26003. 304-243-0744.

Hitachi 1503S CD ROM plyr, works well w/software, \$250; HP Scan Jet reads printed text, new, \$450. 718-347-2940.

CONSOLES

Want To Sell

Audiolabs Quantum QS-22 12-chnl, very gd cond, XLR conns, slide pots, rem starts \$2000+s/h. P Robillard, WYLD, 2228 Gravier St, New Orleans LA 70119. 504-834-7745.

Gately 16x8 w/EQ on every chnl, 4 effects buss, quad mon, Canon conns for line & mic inputs & Canon conns for outputs in custom cons, \$1500. A Baker, Bdct Prods, 804 E 38th St, Indianapolis IN 46205. 317-925-7371.

British Helios classic 24/16/24, circa 1970s, updates/mods w/doc discrete mic preamps, 9 sep PS w/wood rack cab, mahogany desk, \$9500/BO/trade; Snake 16 phantom-powered inputs w/ext PS, 250' Beiden 19-pr cable/mil conns/ss strain reliefs, 10' Neumann XLR snake mates w/box or Beiden snake, top qual, exc cond, \$750/BO/trade. R Katz, Allegro Sound, 15015 Ventura Blvd, Sherman Oaks CA 91403. 813-377-5264.

SPOTMASTER BROADCAST ELECTRONICS

PARTS AND ACCESSORIES

SEQUOIA ELECTRONICS

1131 Virginia Ave. Campbell, CA 95008 (408) 866-8434

SMC 8-chnl, solid state, great cond, \$200+s/h. F Smith, 615-624-7126.

JBL 4311 pr spkrs, \$750/BO; JBL Decade 36 spkrs, \$500/BO. J Diamond, Joe Diamond Co, Box 102C, Chubbic Rd RD#1, Canonsburg PA 15317. 412-746-3455.

RCA 15AD dual-chnl, nice cond, \$500. R Elm, WWJC, 1120 E McCuen St, Duluth MN 55808. 218-626-2738.

Gates M6407 4-chnl prod, mono, gd cond w/manual, \$100. E Lightman, WEDL, 550 Merchant St, Ambridge PA 15003. 412-266-2802.

RCA OP-6/OP-7 tube mixers & expanders, 4x1, gd cond, \$250 ea. 805-963-3941.

Harris Medalist 8, 8-chnl stereo board, stereo & mono outputs, 24 stereo chnl inputs, \$1800/BO. J Curtis, KFRO, POB 4299, Longview TX 75606. 903-663-3700.

Sparta/Cetec 3410 10-chnl stereo, gd cond, \$1250. M Persons, WYRQ, 402 Buffalo Hills Ln, Brainerd MN 56401. 218-829-1326.

MCI JH618 8-mic line & 8 stereo line cards, non-VCA, up to 18 direct outs, patchbay, VU, BC opt, papers & conns, low hrs, \$8000. T Perkins, 301-420-4692.

Harris Deluxe 80 8-chnl mono, gd cond, \$700+s/h; BE Spolmaster 8 mono, great cond, \$750+s/h. B Brinitzer, WDNC, 1000 Park Forty, Durham NC 27713. 919-361-1429.

McMartin B802 stereo w/spare ladder attenuators & misc parts, works good, \$1000+s/h. P Wahl, WWIB, 5558 Hallie Rd, Chippewagnus WI 54729. 715-723-1037.

Russco Studio Master 505, mono; McMartin EBS record set. 214-563-1071.

Gates Yard Board, painted white, \$300; Bogen CSM remote mixer, \$125. W Gunn. 619-320-0728.

Want To Buy

Gates stereo Yard complete & repairable. B Elliott, WFRX, 915 E 4th St, Charlotte NC 28204. 704-338-9970.

Cetec Series 10 info, will pay copy costs. L Smith, Smith Studios, 15 Ravenhill Rd, Winnipeg Manitoba Canada R2K 3K4.

RCA/GE/Gates pref, 40s/50s mdl, gd cosmetic cond, min external visible mods. R Wells, KSRO, 627 College Ave, Santa Rosa CA 95404. 707-545-3313.

DISCO & SOUND EQUIPMENT

Want To Sell

EV T-350, (2) 1040A & N-3 horn spkrs & 3-way xover ntwk in walnut cab, w/o woofers, new cond, \$250 all. S Lawson, KAK Prods, 920 Hyland Dr, Santa Rosa CA 95404. 707-528-4055.

Ivle 10A freq analyzer, BO; 20A pink noise gener, BO; 6 1/2' custom equip rack; goose necks; mic cables; Soundworkshop 262 stereo reverb, \$500/BO; ART DR1 dig reverb, new, \$750/BO; ART O1A dig reverb, new, \$750/BO; (2) ADA 2.561 dig delays, new, \$500 ea/BO; Loft 450 delay line flangers, new, \$500 ea/BO; (2) Nexus 96 point patch bays, 1/4" in front, RCA in back, new, \$300 ea/BO; Switchcraft 48-pt patch bay, balanced, used, \$100/BO; (2) AB Syst 205A stereo pwr amps, 200 W, new, \$500/BO; AB Syst 301 spkr switcher, new, \$250/BO. J Diamond, Blue Diamond, Box 102C Chubbic Rd RD 1, Canonsburg PA 15317. 412-746-3455.

Symetrix SE-400 para EQ, new, \$450/BO; (2) phase shifters, new, \$250 ea/BO; (2) SG-200 stereo noise gates, new, \$300 ea/BO; A-200 stereo headphone amp, 20 W per chnl, new, \$200/BO. J Diamond, Blue Diamond, Box 102C Chubbic Rd RD 1, Canonsburg PA 15317. 412-746-3455.

dbx 208 8-chnl noise reduc, new, \$2000/BO; 154 & 155 4-chnl noise reduc units in same rack, mint cond, \$600/both/BO; 150 2-chnl noise reduc, new, \$300/BO. J Diamond, Blue Diamond, Box 102C Chubbic Rd RD 1, Canonsburg PA 15317. 412-746-3455.

EMT 140-T plate reverb, \$450; RCA 220 V heavy duty bulk erase, \$1500; Telex 6120 master reel cons, stereo, new cond, \$1750. 617-630-0007.

Ashly SC-66 para EQ, great cond w/manual, \$300. D Bailey, Rock Shoppe Prods, 3422 Beech St, Rowlett TX 75088. 214-475-9796.

JVC 4-DD-5 CD-4 quadraphonic disc demod, new, \$75/BO. D Pulwers, 703-751-9346.

Duntech Sovereigns mdl 2001, light oak, fine cond, \$6000+s/h. 305-866-6048.

EV Sentry 100 (2) studio mon spkrs, \$115 ea. A Mitchell, 703-768-6186.

Klipsch Lascales horns in road cases, will handle 300 W per chnl, excel cond, BO. R Kaufman, Pams Prods, POB 462247, Garland TX 75046. 214-271-7625, after 3PM CDT.

Dolby 301 A-type stereo, discrete, \$500. W Gunn. 619-320-0728.

Want To Buy

FINANCIAL SERVICES

Want To Sell

EQUIPMENT Financing, Lease Purchase Option. Need equipment for your radio, television or cable operation? New or Used. No down payment. Carpenter & Associates, Voice 504-764-6610 Fax 504-764-7170.

FINANCING ON ALL RADIO EQUIPMENT IMMEDIATE. Easy to qualify, Fixed-rate, long-term leases, Any new or used equipment & computers, 100% financing, no down payment, No financials required under \$50,000, References available. Call Mark Wilson (800) 275-0185. EXCHANGE NATIONAL FUNDING. Use Our Experience For Your Business.

LIMITERS

Want To Sell

Gentner/Texas Audio Prisms, very gd cond, 3 yrs old, \$1000 ea. J Salov, WHGR, POB 546, Jackson MI 49204. 517-740-1165.

Dorough DAP 310, \$400. E Horton, KWOG, 255 N Russell, Douglas WY 82633. 307-358-3656.

Orban 8000A, gd cond, in svc. A Stevenson, WHZT, 313 N Mattis Ave #205, Champaign IL 61821. 217-355-1059.

UREI 1178 dual peak, used 6 mos, \$500+s/h. B Lord, Lord Bdctg, 13313 SE 208th St, Kent WA 98042. 206-631-2374.

We buy Optimod 8000A's and 8100A's 414-482-2638

Pac Rec AM Multilimiter, gd cond, \$300; Inovonics 250 5-band proc, gd cond w/FM limiter cards, \$1800. R Dietterich, WORD, 7 Pkwy Ctr #625, Pittsburgh PA 15220. 412-937-1500.

Orban 8100 Optimod, exc cond, \$3500. J Salov, WHGR, POB 546, Jackson MI 49204. 517-740-1165.

Mod Sci Stereomaxx FM audio separation enhancer, 1 yr old, \$1000. A Keddie, WTPI, 3135 N Meridian, Indianapolis IN 46208. 317-925-1079.

Optimod 8100A1, exc cond, \$3400; UREI LA-4 compressor, exc cond, \$350. B Watson, KSAK, 3352 Honeybrook Way, Ontario CA 91762. 909-947-8440.

CBS Audimax 4450A; FM Volumax 4110; Audimax tube ALC, all gd cond, BO. P Wahl, WWIB, 5558 Hallie Rd, Chippewagnus WI 54729. 715-723-1037.

Electrodyne CA700 (2), \$400 ea. R Rhodes, R Rhodes Music, POB 1550, NY NY 10101. 212-245-5045.

BE AGC. 214-563-1071.

Want To Buy

CBS Audiomax & Volumax, AM mono. D Gagnon, WTBC, 20 Jackson Hghts, Essex Jct VT 05452. 802-878-8293.

Collins 26U-1/Gates 39-B. T Smith, RF Concepts, 13034 Elmington Dr, Cypress TX 77429. 713-260-5842.

Shure M-62 level-loc. J Arthur, DVS Comms, Rd 1, Belfast NY 14711. 716-365-8870.

MICROPHONES

Want To Sell

Neumann M56, exc cond, \$750; EV-642 shotgun, exc cond, \$295; (2) Sony C-35P w/pwr splys, \$595 both. F Virtue, Virtue Studios, 8809-11 Rising Sun Ave, Philadelphia PA 19115. 215-763-2825.

RCA 44 jr ball mount, BO. J Phillips, KWOG, 408 Clinton, Defiance OH 43512.

Shure SM-5B studio, very gd cond w/holders, \$150 ea. J Salov, WHGR, POB 546, Jackson MI 49204. 517-740-1165.

Peerless MB 520 (2) w/pwr sply, \$500/BO; (3) AKG D2000E, \$125 ea; (4) Sony ECM-33FP, \$200 ea; (6) Sony ECM-22, \$150 ea/BO; (2) Sony C-22, \$150 ea/BO; (6) Sony ECM-21, \$100 ea/BO; Fostex M55RP, \$250 ea/BO. J Diamond, Joe Diamond Co, Box 102C, Chubbic Rd RD#1, Canonsburg PA 15317. 412-746-3455.

Telefunken/Schoeps CM61 tube mic, very rare, uses std 6AU6 plug-in tube, orig PS, new cable, mint cond, \$2475; CR-176 large diaphragm tube mic, new, \$1250. R Katz, Allegro Sound, 15015 Ventura Blvd, Sherman Oaks CA 91403. 813-377-5264.

Senn 4032 (2), used 6 mos, \$254 ea+s/h. B Lord, Lord Bdctg, 13313 SE 208th St, Kent WA 98042. 206-631-2374.

EV RE-20 w/Luxo boom, mint cond, \$335. 404-267-6558.

RCA 77-DX, nice cond w/monogrammed RCA canvas bag, \$550. 718-347-2940.

Sennheiser 405 cardioid w/cleaned capsules, no AC sply, \$500; AKG C568EB 10" condenser shotgun, 9-52 VDS phantom powering w/box, foam windscreen, mint cond, \$300. J Newman, 401-847-0455.

AKG 451 EB condenser w/rolloff & cardioid capsule, \$125; Crown GLM very small, nds ext pwr, used twice, \$135. A Mitchell, 703-768-6186.

Telefunken M-250, U-67, 221-A; Neumann U-67, KM-56, UM-57; RCA KV3A-10,0001, 44-BX, 77-DX, BK-4, BK-5, 74-B, varicustics; Altec M-20, M-11, M-30 tube type mics. Trade or sale. Tracy Eaves, 615-821-6099 (evenings before 10PM EST).

Telefunken M921 dual (2-way, not front/back) nickel capsules, cardioid only, classic tube mic; Neumann KM84 pair, mint, \$1100. W Gunn. 619-320-0728.

EV 676 supercardioid mics 3/\$200; EV RE10 mic, \$125. W Gunn, 619-320-0728.

Telefunken tube mic pre amps V-76, U-73 limiter's; RCA BA-21As, BA-1As; Altec tube mic-pres. Tracy Eaves, 615-821-6099 (evenings before 10PM EST).

Desk mics (hiZ), EV-Shure mic stands, also baby booms (3); tubes, new (32) RCA, GE, Sylvania; Sams tube sub books #8 & #6; RCA tube manual; Sony head demagnetizer (new); jack femal connectors; EV 502 transformer primary/secondary. Mr. Oliver, 212-874-7660/0274. Call afternoons till 10PM.

Want To Buy

RCA 770X working, gd cond, maybe more. B Berry, Karavan Bdctg, 13 Montgomery Pl, Conroe TX 77394. 409-321-2920.

AKG C24. R Katz, Allegro Sound, 15015 Ventura Blvd, Sherman Oaks CA 91403. 813-377-5264.

Sennheiser 405/6 access. R Rhodes, R Rhodes Music, POB 1550, NY NY 10101. 212-245-5045.

Turner U9S dynamic. S Sparkman, WSGS, Box 7898, Hazard KY 41701. 606-436-5580.

RCA 77DXs/44BXs ribbon, chrome/TV grey, gd cond, BO. R Kaufman, Pams Prods, POB 462247, Garland TX 75046. 214-271-7625, after 3PM CDT.

MISCELLANEOUS

Want To Sell

Grinan Fixture, 240-slot Lazy Susan rack, table-top, wood w/yellow formica covering, exc cond, \$200. S Southern, WCIR, Box 1037, Beaver WV 25813. 304-252-6452.

PHONE: 703-998-7600 FAX: 703-998-2966



Call Simone Mullins, Classified Ad Manager, to reserve space in the next issue. Use your credit card to pay, we now accept VISA and MASTERCARD.

Radio World 5827 Columbia Pike, Ste 310 Falls Church, VA 22041

Select from these categories for best ad positioning:

- Acoustics, Amplifiers, Antennas & Towers & Cables, Audio Production (Other), Automation Equip., Brokers, Cameras (Video), Cart Machines, Cassette & R-R Recorders, CATV-MATV Equip., CD's, CD Players, Computers, Consoles, Disco-Pro Sound Equip., Financial Services, Limiters, Microphones, Miscellaneous, Monitors, Movie Production Equip., Receivers & Transceivers, Remote & Microwave Equip., Satellite, Software, Stations, Stereo Generators, Switchers (Video), Tapes, Carts & Reels, Tax Deductible Equip, Test Equipment, Transmitters/Exciters, Tubes, Turntables, TV Film Equip., Video Production Equip., Video Tape Recorders, Positions Wanted, Help Wanted

Display Rates for Classified Advertising Effective January 1, 1991

Table with 4 columns: Line length (1-9 col inch, 10-19 col inch, Distributor Directory, Professional Card, Classified Line Ad, Blind Box Ad) and 4 rows: 1x, 3x, 6x, 12x rates.

To compute ad costs: Multiply the number of ad inches (columns x inches) by the desired rate schedule for your per unit cost. Example: a 3" ad at the 1x rate is \$165, at the 3x rate \$159, at the 6x rate \$150, at the 12x rate \$147, etc.

ACTION-GRAM

Equipment Listings

Radio World's Broadcast Equipment Exchange provides a FREE listing service for all broadcast and pro-sound end users. Simply send your listings to us, following the example below. Please indicate in which category you would like your listing to appear. Mail your listings to the address below. Thank you.

Please print and include all information: Contact Name, Title, Company/Station, Address, City/State, Zip Code, Country. I would like to receive or continue receiving Radio World FREE each month. Signature, Date. Please Circle only one entry for each category: I. Type of Firm, II. Job Function.

WTS WTB Category: Make: Model: Brief Description:

\*Closing for listings is the first and third Fridays for the next month's issue. All listings are run for 2 issues unless pressed for space or otherwise notified by listee.

Broadcast Equipment Exchange

Phone: 703-998-7600 PO Box 1214, Falls Church, VA USA 22041 FAX: 703-998-2966



**MISCELLANEOUS . . . WTS**

Rec sleeves, 45 rpm, various; Radio Shack Pwr Plug w/plug in adap & manual, \$25; Radio Shack cable converter, \$20; (8) different old mic tech manuals, \$40/BO; album mailers, \$1 ea/BO; (31) 25-pin conns, \$1 ea; (7) 13-pin conns, \$1 ea; (6) hot mix radio shows on CD, BO; Ronnie Spector on Apple lable 45s, mint cond, \$3 ea; patch bay, \$65/BO; (34) American Top 40 w/Casey Kasem shows, 1984-1985, \$5 ea; (8) Rick Dees shows, \$20 ea. Steve, Dynes Comms, 957 Natl Rd, Wheeling WV 26003. 304-243-0744.

Optimers (3), new 2" readouts, counts to 9:59 & resets, momentary closure resets unit to 0:00, \$57.50 ppd; Audio Dig TC-2 dig delay unit, new w/o manual, \$950 ppd UPS; audio & RF tech manuals for Sparta Elec Corp equip; (3) Sparta TPA 7-1 25 W audio mods, \$45 ea/3 for \$100; (8) Nortronics CH3-R sensor tape hds, \$10 ea/8 for \$50. D Peluso, KJUL, 2880 E Flamingo Rd Ste E, Las Vegas NV 89121. 702-732-2200.

Audio Input xformers Ampex 15095 (4), plug in octal 8-pin, 150/600 ohm input, 15K out, \$18 ea; (9) 4580116-20, plug in octal 8-pin, 600 ohm input, 15K out, \$18 ea; (2) Triad A-10-J, 600 ohm input/60K output, \$36 pair; (2) UTC A-20 pri 50/125/200/333/600 ohm in, sec 50/125/200/333/600 ohm out, \$40 pair. S Lawson, KAK Prods, 920 Hyland Dr, Santa Rosa CA 95404. 707-528-4055.

**Rotron Blowers for Eloom, CCA, CSI, McMartin, Harris, rebuilt & new.**  
Goodrich Enterprises Inc.  
11435 Manderson St., Omaha, NE 68164  
402 493 1886 FAX 402 493 6821

WE 1890 xformers, \$35/pair; UTC LS-141 hybrid xformer, new, \$50; UTC LS-33 20 W line to line xformers, \$100/pair; Cinema Engrg 64266 xformers, \$30/pair. R Robinson, TNA Rcdg, 10 George St, Wallingford CT 06492. 203-269-4465.

Executone K18027 phone syst w/2 CPU's, 20 phones, nds work w/intercom, conf, music on hold, spare parts &

prints, BO. L Smith, WKYG, 1715 ST marys Ave, Parkersburg WV 26102. 304-485-4565 x117.

WE 1890 xformers, \$35 pair; UTC LS-141 hybrid xformer, new, \$50; UTC LS-33 20 W line to line xformers, \$100 pair; Cinema Engrg 64266 xformers, \$30 pair. R Robinson, TNA Rcdg, 10 George St, Wallingford CT 06492. 203-269-4465.

Dayton W3056 5000 W gener w/220 & 110 AC output voltage. 214-563-1071.

Airchecks of favorite AM as rcvd on qual equip at this location. J Douglas, 402 Shirley Rd, Seaford VA 23696.

Cannon Faxphone 15 combo fax & phone, thermal replaced w/plain paper, all modes, memory, \$275. J Schloss, KICD, 2600 N Hiway Blvd, Spencer IA 51301. 712-262-1240.

Optima desktop rack cabinets, 7" & 10 1/2", \$65 ea. D Heinen, KRSE, 2120 Riverside Rd, Yakima WA 98901. 509-248-1390.

Audio Line (3) 1/4", 48-pt patchbays, new, \$50 ea. D Heinen, KRSE, 2120 Riverside Rd, Yakima WA 98901. 509-248-1390.

Vacuum capacitors, variety; 200 W wirewound resistors. R Elm, WWJC, 1120 E McCuen St, Duluth MN 55808. 218-626-2738.

Heathkit VTVM, \$10; McCurdy switch mod, \$5; (44) ADC patchbay jacks, unbal w/normal, \$1.25 ea. D Bailey, Rock Shoppe Prods, 3422 Beech St, Rowlett TX 75088. 214-475-9796.

**Want To Buy**

RCA on-air light; WE clock; DAT of '60s Bucannan & Ceilas Pal-O-Mine 45 rpm single; NAB SuperRadio. Klay, 801-272-1814.

Billboard magazines 1955-1965, any/all issues. B Berry, Karavan Bdcg, 13 Montgomery Ave, Conroe TX 77384. 409-321-2920.

UTC LS-10X, 12X, LS-18 xformers; WE 120A schematic; Hycor 4201 passive EQ. R Robinson, TNA Rcdg, 10 George St, Wallingford CT 06492. 203-269-4465.

UTC LS-10X, 12X, LS-18 xformers; West Electroacoustic schematic for mic #120A; Hycor 4201 passive EQ. R Robinson, TNA Rcdg, 10 George St, Wallingford CT 06492. 203-269-4465.

**SPACE AVAILABLE**  
Call Simone Mullins  
at 1-800-336-3045

Someone to start 4-chnl quadraphonic rcdg & sound reprod club. D Pulwers, 703-751-9346.

Mod xformer for RCA 10U2/BC-10P. G Arroyo, WONQ, 1033 Semoran Blvd, Casselberry FL 32707. 407-830-0800.

CCA 2500R dummy load. 214-563-1071.

Jazz record collections, 10" LP/12" LP be-bop, swing, dixie, highest prices paid. B Rose, Program Recdgs, 228 East 10th, NYNY 10003. 212-674-3060. Radio transformers by Chicago, UTC, Triad, Peerless, Freed, Sola, send list. J Gangwer, 942 32nd St, Richmond CA 94804. 415-644-2363.

**MONITORS**

**Want To Sell**

Belar SCA-1 SCA on 67 kHz, \$400. R Dietterich, WORD, 7 Pkwy Cr #825, Pittsburgh PA 15220. 412-937-1500.

TFT 724A stereo; FM 763, new parts, \$2500 both+s/h. 614-775-2600.

**Want To Buy**

Belar AMM-1/AMM-2, working, mono OK, BO. R Miller, KUAU, #90 Ulumala Rd, Haiku HI 96708. 808-572-5534.

## SERVICES

**ROHN.**  
**Broadcast Towers**  
**Furnished & Installed**  
Guyed or Self-Supporting  
Solid or Tubular  
20 Year  
Warranty!  
Call Mike Fleissner  
toll free  
**1-800-225-ROHN**

**CUSTOM SOFTWARE**

- PC DOS BASED
- NOVELL NETWORK
- DIGITAL AUDIO
- DEVICE CONTROL

**PROJECTS PERFORMED WORLDWIDE**

**Mediacomp**

VOICE : (519) 893-6639 FAX : (519) 893-8390

SPECIALIZING IN ERECTION,  
REPAIRING, PAINTING  
AND MAINTENANCE  
RADIO, TWO-WAY, TV, TOWERS  
AND FLAG POLES

**A STEEPLEJACK CO.**  
PAINTING AND STEEPLEJACK  
CONTRACTORS

FULLY INSURED FOR YOUR PROTECTION

DON HIGHLEY 3722 ROMA  
713-462-6105 HOUSTON, TEXAS 77060

**AM FM TV**

Addresses, Mailing lists,  
Data Discs, Mailings to P.D.'s  
& General Managers. For  
details, call **The Radio Mall**

**1-800-759-4561!**

**Communications**  
**Data Services, Inc.**

Richard P. & Richard L. Bisy, Principals

Real World Propagation™ Studies  
Online/Remote Access Services  
3 Arc Second Terrain Data  
1990 Population Data  
FCC & FAA Databases

For more information call  
(703) 534-0034 • (800) 441-0034

**When cost and quality count!**

**NORTH STAR TOWER**

Tower Construction & Maintenance

Canton, NY  
315-386-4832  
FAX: 315-378-0851

**REMOTE EQUIPMENT RENTALS**

**COMREX and GENTNER**  
1, 2 & 3-Line Extender Systems  
**MARTI and TFT**  
450, 455 & 161 MHz RPU Systems  
**SWITCHED-56 SYSTEMS**  
Call or FAX Dwight Weller  
**WELLER AUDIO-VISUAL ENGINEERING**  
Phone: 410-252-8351 FAX: 252-4261

**BROADCAST DESIGN & CONSTRUCTION, INC.**

- Facility Relocation
- R.F. Systems
- Soundproof/Acoustical
- Custom Cabinetry

24 HOUR EMERGENCY SERVICE  
**(313) 465-3226**

**TENCO TOWER**

Lic. No. 357096

Installation & Maintenance of  
Broadcast & Communications  
Towers & Antennas

Donald J. Tenny

(916) 362-6846  
(916) 638-8833  
9723 Folsom Blvd. Suite A Sacramento, CA, U.S.A. 95827 FAX: (916) 638-8858

**Tower Sales & Erection**

Turnkey Site Development  
Installation & Maintenance  
AM/FM Broadcast, TV,  
Microwave Systems,  
Antennas & Towers

**TOWER COMM**  
Communications Specialists

Ben Wall  
President  
Gen. Contractor #25891

6017 Triangle Dr.  
Raleigh, NC 27611  
(919) 781-3499  
Fax (919) 781-6454

## CONSULTANTS

**Congratulations! You've found THE CARD!**

**Radio Systems Engineering**  
"For all your Engineering Needs"

AM - FM - TV - Translators - LPTV  
FCC Applications - Design - Installation

Call, fax, or write **today!**  
**(800) 551-1667**  
fax: (702) 898-8731  
4289 Roanridge - Las Vegas, NV 89120

**T.Z. Sawyer**  
**Technical Consultants**  
**1-800-255-AMDA**

AM Directional Antenna Proofs  
AM-FM-TV-LPTV  
FCC Applications & Exhibits  
Station Inspections

6204 Highland Drive  
Chevy Chase, MD 20815-6610  
Telefax 301-913-5799

**PC - SOFTWARE**

AM FM TV Search Programs  
Contour Mapping-STL Paths  
RF HAZ-1990 POP Count  
FAA Tower-Draw Tower

**Doug Vernier**  
Broadcast Consultant  
1600 Picturesque Dr  
Cedar Falls, IA 50613

**800-743-DOUG**

North America RF & Audio  
**Mirkwood Engineering Services**

Broadcast and Telecommunications  
Consultants

Multidiscipline Engineering and Planning Firm  
including • Application & Allocation Services  
• Project, Engineering & Construction Management • Site Acquisition  
• Rural & Remote Site Installations  
• Field Service • Studio Design & Installation

50 Park Ave. Claremont, NH 03743  
(603) 542-6784

**Consulting Communications Engineers**

- FCC Data Bases
- FCC Applications and Field Engineering
- Frequency Searches and Coordination
- AM-FM-CATV-ITFS-LPTV

**OWL ENGINEERING, INC.**

1306 W. County Road. F,  
St. Paul, MN 55112  
(612) 631-1338 "Member AFCE"

**MULLANEY ENGINEERING, INC.**  
Consulting Engineers

- Design & Optimization of AM Directional Arrays
- Analysis for New Allocation, Site Relocation, And Upgrades AM FM TV LPTV Wireless Cable (MDS/MMDS/ITFS/OFS)
- Environmental Radiation Analysis
- Field Work
- Expert Testimony

9049 Shady Grove Court  
Gaitersburg, MD 20877  
Phone: (301) 921-0115  
Fax: (301) 590-9757

**Moffet, Larson & Johnson, Inc.**  
Consulting Telecommunications Engineers

Two Skyline Place  
5203 Leesburg Pike # 800  
Falls Church VA 22041  
703-824-5660  
800-523-3117  
Member AFCE

**W. LEE SIMMONS & ASSOC., INC.**

BROADCAST TELECOMMUNICATIONS CONSULTANTS

1036 William Hilton Pkwy  
Ste 200F  
Hilton Head Is., SC 29928  
1-800-277-5417  
803-785-4445  
FAX: 803-842-3371

**Shaffer & Associates, Inc.**  
Consulting Engineers

- FCC Applications
- Propagation Studies
- AM, FM, TV, LPTV, MMDS
- Radiation Field Measurements
- Tower Construction/Maintenance

3050 Post Oak Blvd., Suite 1700  
Houston, Texas 77056  
(713) 621-4499 (713) 621-5751 Fax

**EVANS ASSOCIATES**  
Consulting Communications Engineers

FCC Applications, Design & Field Engineering  
Broadcast Engineering Software

216 N. Green Bay Rd.  
Thiensville, WI 53092  
**(414) 242-6000**  
Member AFCE

Without Advertising  
a Terrible Thing Happens.

**... NOTHING**

Contact Radio World Newspaper for availabilities  
P.O. Box 1214 Falls Church VA 22041

**1-800-336-3045**





MONITORS . . . WTB

Any older McMartin mod monitors. C Goodrich, 11435 Manderson, Omaha NE 68164. 402-493-1886.

MOVIE PROD EQUIP

Want To Sell

Maganasync Moviola 3000 16mm edge trk rec w/inching knobs, 3 PB units, 16mm edge trk w/inching knobs, AB&H proj & counter w/large display & small unit w/display that run from master sync motor; (2) control panels, main & mini, \$19K all. A Baker, Bdct Prods America, 804 E 38th St, Indianapolis IN 46205. 317-925-7371.

RECEIVERS & TRANSCEIVERS

Want To Sell

SCA decoder, high quality micro-miniature 67/92 kHz, prewired & ready to install, \$15. D Jackway, Background Music Eng. 5742 Fairoak, Springfield MO 65810. 417-881-8401.

AM STEREO RECEIVERS Portable, Home/Studio, Auto RADCO GROUP 708-513-1386

Sony SRF-A1 AM, port, new, \$89, w/AC adapter, \$99. C Fox, WOLF, 4853 Manor Hill, Syracuse NY 13215. 315-468-0908.

Lafayette LT-725 AM/FM/SCA, 67 kHz stereo tuner, just tweaked, \$125/BO. D Pulwers, 703-751-9346.

SCA RECEIVERS—ALL TYPES

Reading Service / Ethnic / Data Professional, Portable, Table DAYTON INDUSTRIAL CORP. (Manufacturer) 4411 Bee Ridge Rd. #319 Sarasota, FL 34233 Tel: 813 378 5425 FAX: 3394

GE MPI 2 W, 2-chnl, UHF handheld mobile radio w/belt clip, exc cond, \$200. J Newman, 401-847-0455.

Sony XR-A 37R 12 V, auto, 22 W/chnl, new, \$275. 718-347-2940.

Scott Radio Labs, Navy Shortwave rcvr, rack mount, old, works, BO. D Heinen, KRSE, 2120 Riversiders Rd, Yakima WA 98901. 509-248-1390.

Want To Buy

Regency ACT-R-106 scanner, gd cond w/ or w/o crystals. G Edwards, 704-488-9301.

REMOTE & MICROWAVE EQUIP

Want To Sell

TFT 7610-R & C (2) dig telemetry ctrl w/manuals, \$1200. R Driver, WAIM, 2203 Old Williams Tom Rd, Anderson SC 29621. 803-226-1511.

Marti STL 10 (2) exc cond w/combiners, 951.375/625, \$3500. J Salov, WHGR, POB 546, Jackson MI 49204. 517-740-1165.

COMREX RENTALS 1, 2 and 3-Line Extenders Switched 56 Systems Call Steve Kirsch for details Silver Lake Audio (516) 623-6114 FAX: 377-4423

Moseley PCL 303 composite STL on 949 MHz, working, \$1900; Micro Controls RCR9/RCT9, 9 chnl, cleaned & checked, 110 kHz control, audio telemetry, \$900; Moseley tube-type SCA gener on 67 kHz, \$125. E Horton, KWOG, 255 N Russell, Douglas WY 82633. 307-358-3656.

Moseley TRC 15-AW w/Hallikainen dig readout option, gd cond w/manuals, \$750. K Stokes, 504-383-8695.

TFT 7610, nds repair, \$400; Moseley TRL-1 telemetry return on 450 MHz, \$600; RCA/Moseley TRC-1 rem xmtr,

side only nds minor repair, \$100. R Dietterich, WORD, 7 Pkwy Ctr #625, Pittsburgh PA 15220. 412-937-1500.

Studer dual line telephone hybrid, \$500; variable coils removed from 5 kW operation. R Dietterich, WORD, 7 Pkwy Ctr #625, Pittsburgh PA 15220. 412-937-1500.

Marti RMC-15 16-chnl, 3 pieces w/manual, exc cond, \$500. D Igou, Bdct Engrg, 8435 Twisted Oaks, Garden Ridge TX 78266. 210-651-9049.

RENTALS RENTALS RENTALS COMREX 3-line extender Frank Grundstein 215-668-6434 Audio/Video Consultants 215-642-0978

Marti telemetry equip. 214-563-1071.

Comrex LXR single-line rcvr, exc cond, little use, BO. B Clain, 413-783-4626.

Moseley TRC-15 STL rem ctrl & cntrl term & telemetry rcvr, \$750. G Wise, WEKU, 102 Perkins Bldg, Richmond KY 40475. 606-622-1672.

Moseley TRC-15 (2), 1 Hallikainen interface, radio send/recv, \$1000, 1 radio send/SCA return, \$500, both w/manuals. M Martindale, KVON, 1124 Foster Rd, Napa CA 94558. 707-252-1440.

Moseley TRC-15AW 16-chnl, gd cond, SCA option, \$750. B Brinizer, WDNC, 1000 Park Forty, Durham NC 27713. 919-361-1429.

Marti RPT-40 161.64, 161.67, fact tuned, \$450; Scala Parafactor PR-450, 942.5 MHz, 2 dipoles only, not complete dish, BO. 210-774-1320.

Want To Buy

STL-type xmtrs & rcvrs, pref solid state, mono/stereo. M Heller, WTRW, 1414 16th St, Two Rivers WI 54241. 414-794-1800.

Gentner VRC 2000. M Hopper, WHBQ, 483 S Highland St, Memphis TN 38111. 901-458-3255.

Marti CR-10 UHF 450-460 MHz. H Thompson, WWIC, 815 W Willow St, Scottsboro AL 35768. 205-259-1050.

Telfax 31 VGC, new side panels, meter & loop sw, works good, clean, \$375/BO. J Schloss, KICD, 2600 N Hiway Blvd, Spencer IA 51301. 712-262-1240.

15-30 W solid state such as Marti RPT402-R-30, 160-170 MHz or 455 MHz. B Rathman, KRVM, 200 N Monroe St, Eugene OR 97402. 503-687-3370.

Marti CR-10 on VHF band. P Bassert, KSPK, 516 Main St Walsenburg CO 81089. 719-738-3636.

Gentner VRC2000/comparable. Mark, WHBQ, 483 S Highland St, Memphis TN 38111. 901-458-8255.

SATELLITE EQUIP

Want To Sell

Zephyrus 300 w/304 mainframe, 391 rcvr, 321 demod, card tuned to .33 MHz, new, excel cond, \$850. M Vanhooser, 214-827-5759.

Fairchild Dart 384 dig rcvr w/cards for Unistar news & Indiana U sports, BO. C Cage, WERK, 8510 S State Rd 3, Muncie IN 47302. 317-289-9375.

Adcom 7550 rcvr for SMN/Unistar formats; Satcue 400 switcher, \$3500. J Salov, WHGR, POB 546, Jackson MI 49204. 517-740-1165.

Wegener 1816, \$1000. B Coleman, KPNC, Box 2509, Ponca City OK 74601. 405-765-2485.

SCPC rcvr w/Sat Sys Corp 50 Hz to 7.5 kHz audio bandwidth, 50 kHz noise bandwidth, 100 kHz min carrier spacing, 3.7 to 4.2 GHz input freq, \$1050. 503-563-5100.

Wegener 1816 ku-band freq agile rcvr w/2.8m dish, LNB, \$1000. P Wahl, WWIB, 5558 Hallie Rd, Chippewagunus WI 54729. 715-723-1037.

Wegener 1615 demod, 15 kHz, 6.30 MHz, exc cond, \$200. D Morris, WKUN, 702 E Spring St, Monroe GA 30655. 404-267-6558.

Wegener 1601-50 rcvr w/boards for SMN real country, avail 1/1/93, \$1000. L Caldwell, KRLW, Hwy 412 E, Walnut Ridge AR 72476. 501-886-6666.

NEED CASH?

We buy: Fairchild DART 384 Scientific Atlanta 7300/7325 Unistar AM Only/FMT 41 Oldies AC-II/CNN Microdyne 1100 Series SSCP

We sell quality Reconditioned units with a 30 Day Guarantee

New Avcom & Microphase SSCP Satellite Systems (719) 634-6319 (Fax) 635-8151

SCPC SATELLITE AUDIO RECEIVE EQUIPMENT. New and used, many brands, complete units, downconverters, commercial LNB's. All in excellent condition, good prices, perfect for low cost SCPC uses. SASE for list. Universal Electronics, Inc. 4545 Groves Road #13, Columbus OH 43232. 1-800-241-8171.

Want To Buy

Fairchild Dart 384 dig sat rcvr & downconverter. M Heller, WTRW, 1414 16th St, Two Rivers WI 54241. 414-794-1800.

SEDAT card for Fairchild DART rcvr. R Wells, KSRO, 627 College Ave, Santa Rosa CA 95404. 707-545-3313.

SOFTWARE & DATABASES

Want To Sell

FMStudy 3.0—New Version! FCC allocation program for IBM and compatibles. Full EGA and mouse support, \$59.95 (\$1.50 s&h). Database available. Call or write—order, demo or upgrade info. BEAM Software, 3N460 Coulter Lane, St. Charles, IL 60175 708-584-1668

POWERFUL PC SOFTWARE

COUNTPOP 1990 US Census Find coverage area population INTERCHK (FCC's FMOVER) Uses graphics to display Service & Interference contours over US map QCHANNEL & FCC FM database FM channel search program SEARCHFM & FCC FM database Deluxe graphics over Map, Mouse & zoom CONTOUR (w/NGDC interface) Flexible FCC contour generating program PLOTPATH—STL program Graphic design of STL systems PLOTCOMM for HP plotters Professional contour plotting program SEARCHAM — SEARCHTV AM, FM & TV databases & more (Send for full software list & descriptions)

DOUG VERNIER Broadcast Consultant 1600 Picturesque Dr., Cedar Falls, IA 50613 Phone: 319-266-8402 Order Line: 800-743-DOUG

STATIONS

Want To Sell

Complete Class C FM setup. 10 years old. Includes all the equipment from the transmitter site to the studio. Great deal! Call Joe for details at 512-288-2011.

50 kW AM in Capital City, clear chnl, mid/low dial pos, unltd time non dir, days dir, nights, sale/lease. 501-470-1525.

RETIRING!!! MUST SELL Ohio full time AM, Small amount down or discount for cash. POB 69, Bellefontaine, OH 43311

FM CP 25 kW, Susanville CA, \$25K; CP 25 kW, Laramie WY, \$30K. 608-831-8708.

AM/FM/combo, FT in CA/OR/AZ/WA/NV/UT, others considered if price is right. D Crepps, 805-294-9442.

Want To Buy

Exper & energetic radio bdct pro seeks AM/FM to buy who down & owner financing. E Smith, POB 1341, Florence MS 39073.

Want to buy your station at your price. Write to: Box 206, Warwick NY 10990.

STEREO GENERATORS

Want To Sell

RCA BTS 101 (2), \$100 ea. R Dietterich, WORD, 7 Pkwy Ctr #625, Pittsburgh PA 15220. 412-937-1500.

Rood/Marcom 203 stereo gen/test set, \$300/BO; Moseley CSG-2 185 kHz sub-carrier gener, \$100. P Wells, KJQY, 625 Broadway #1200, San Diego CA 92101. 619-238-1037.

Moseley, \$450. E Horton, KWOG, 255 N Russell, Douglas WY 82633. 307-358-3656.

TFT EBS10, great cond, tuned to 94.7 MHz, \$350. B Brinizer, WDNC, 1000 Park Forty, Durham NC 27713. 919-361-1429.

TAPES/CARTS & REELS

Want To Sell

MARATHON PRODUCTS COMPANY Audio Cartridge Rebuilding Division

Rebuilding/reloading, like new, all brands, any length up to & including 3.5 minutes, \$1.75 ea. FOB out plant, 48 hrs delivery. New NAB Marathon cartridges prices on request. 35 Years professional experience! Lifetime member AES R.D. MYERS Sr. Manufacturers of Audio Devices, Continuous Tape Mag.

69 Sandersdale Rd. Charlton, MA 01507 1-508-248-3157 or 1-508-853-0988

Circle (55) On Reader Service Card

7" on 1/4" (15) reels of classic DJs, AOR, \$75/BO. D Pulwers, 703-751-9346.

Carts, (200), various lengths & brand names, great shape, \$1 ea; UMC cart replacement motor, \$100. Steve, Dynes Comms, 957 Natl Rd, Wheeling WV 26003. 304-243-0744.

Ampex 456 Grand Master carton w/10 hubs, new, \$100; (3) Scotch 10 1/2" metal, new, \$10 ea; (2) Fidelipac 300 type-C, new, 10 1/2", \$10 ea; (2) VIF NAB adapters, unused, \$30 pair. M Saady, 1st City Rec, 14160 84 Rd #3E, Briarwood NY 11435. 718-846-2062.

A&D Cartridge Rebuilding Service

We clean, load & pack. Serviced within 10 work days! Work guaranteed! 3706 Vold Ct., Eau Claire, WI 54701 (715) 835-7347

Scotchcart II's (650), various lengths w/C&W & AC, \$2.50 ea+s/h. B Lord, Lord Bdctg, 13313 SE 208th St, Kent WA 98042. 206-311-2374.

Audiopak AA-2 new, (20) 70 sec; (15) 40 sec, used once, \$100 all. Kent, WASI, 347 W Berry St #600, Ft Wayne IN 46802. 219-423-3676.



Circle (5) On Reader Service Card

AOR radio (15) on 7" reels, classic DJs from 1969-1983, \$75. D Pulwers, 703-751-9346.

Capital xcription library. BO. D Brennan, Brennan Prods, 3596 Lorna Ridge Dr, Birmingham AL 35216. 205-823-0088.

5" hubs in white boxes, (90), large NAB & small centers, BO. C Scherer, 216-696-0123.

C&W & southern gospel (350) albums, 1955-1985, \$1.25 ea/\$300 all. D Morris, WKUN, 702 E Spring St, Monroe GA 30655. 404-267-6558.

100+ 78 rpm R&B records, gd/exc cond, \$5 ea+s/h. K Rogers, RPS, POB 3887, Greenville SC 29608. 803-859-7930.

ITC/Scotch (2000), various lengths, \$0.75 ea. B Brinizer, WDNC, 1000 Park Forty, Durham NC 27713. 919-361-1429.

Want To Buy

Cash for Orr radio, Irish band A/V tapes & boxes, 3, 5, 7 & 10" reels; Orrtronic Car Mate; Aeromate tape plyrs. H Norman, 205-825-0390.

Disc recs, needles, blanks, rec xcriptions. B Davies, Virgo Prods, 5548 Elmer Ave, N Hollywood CA 91601. 818-761-9831.

Beautiful music tapes for collector, pref unannounced w/25 Hz tones. 800-248-9879.

50¢-\$100 per rec for 45 rpm recs & LPs from 50s & 60s. nice cond. B Berry, Karavan Bdctg, 13 Montgomery Pl, Conroe TX 77384. 409-321-2920.

CHAP 120 CD music library. J Leon, Leon Rcdg Studio, POB 51, Jackson Hghts NY 11372. 718-383-7212.

TAX DEDUCT EQUIPMENT

Want To Sell

Any bdct equip will be appreciated for new AM school going on air soon, esp need 500 W xmtr, air mon & STL. E Smith, 601-845-2265.

Educ audio prod studio seeks working equip donations, will pay s/h, rcpt given. M Tupper, Univ S Fla, 4202 E Fowler Ave CIS 1040, Tampa FL 33620. 813-974-2591.

Small college carrier-current station w/o budget & failing cart machs, nd cart mach. Doug, WQBR, 129 Quirk Bldg, Ypsilanti MI 48197. 313-487-2228.

Theatre/music hall seeks donation of vintage mic like RCA 77DX/44BX/equiv. B Coffman, Old Town Music Hall, 140 Richmond St, El Segundo CA 90245. 310-322-2592.

Eng student desiring donation of old bdct equip (anything) in repairable cond, will pay all shipping charges, EE student at Purdue. C Gill, POB 371, Indianapolis IN 46206. 317-923-2800.

TRANSCOM CORP.

Serving the Broadcast Industry Since 1978

Fine Used AM & FM Transmitters and Also New Equipment

For the best deals on Celwave products, Andrew cable and Shively antennas.

Table listing various transmitters: 1 kW FM 1960 Gates FM1C, 2.5 kW AM 1982 CCA 2500D, 1 kW FM 1978 Collins 831C2, 2.5 kW AM 1976 McMartin BA2.5K, 2.5 kW FM 1978 CCA 2500R, 5 kW AM 1979 Harris MW5A, 3 kW FM 1975 CCA 3000D, 5 kW AM 1968 Harris BC5H, 3 kW FM 1974 Harris FM3H, 5 kW AM 1972 CCA AM5000D, 3.5 kW FM 1979 Syntronics SI-F-3, 5 kW AM 1977 RCA BTA 5L, 5 kW FM 1989 Harris HT5, 10 kW AM 1988 Nautel Ampfet 10, 15 kW FM 1975 AEL 15KG, 50 kW AM 1977 CCA AM50,000D, 25 kW FM 1988 TTC 25,000

1077 Rydal Road #101 Rydal PA 19046

800-441-8454 • 215-884-0888 • FAX No. 215-884-0738

Circle (179) On Reader Service Card



**TAX DEDUCTIBLE . . . WTS**

Monte Vista Christian School, would appreciate any donations of used radio equipment along with used TV broadcast equipment. T Quinn, 408-475-0423.

**TEST EQUIPMENT**

**Want To Sell**

Philips PM6507 curve tracer, \$1475/BO/trade. R Katz, Allegro Sound, 15015 Ventura Blvd, Sherman Oaks CA 91403. 813-377-5264.

General Radio 1606-A RF bridge, BO; 1211B 0.5-50 MHz oscillator w/pwr sply, BO. D Kanago, Kayway Radio, 918 E 10th, Spencer IA 51301. 712-262-6499.

Tek FG507/TM515 function gen w/roadcase, \$800; Tek DC508a/TM503 1.8 GHz freq counter, \$375; Sounder phase check set, BO; HP 400FL AC voltmeter, BO; Pulse Dynamics pulse gener, \$50. P Wells, KJQY, 625 Broadway #1200, San Diego CA 92101. 619-238-1037.

Fidellpac 390 wow & flutter meter, very gd cond, \$300. P Wahl, WWIB, 5558 Hallie Rd, Chippewagun WI 54729. 715-723-1037.

**RADIO RESOURCES**

1201 S. Sharp Street  
Baltimore, MD 21230

- New and quality pre-owned broadcast equipment for sale
- Test and remote equipment available to rent for a day or a month
- Call and ask us how to turn your excess equipment into **\$\$\$CASH\$\$\$**

Call Steve, Chuck or Scott

**1-800-54-RADIO**  
**1-800-547-2346**

9 AM-6PM E.S.T.

Circle (3) On Reader Service Card

Patch bays (4) ADC single inputs (24) rack mount; Dynakit pre-amp PAS 2; manuals for Ampex recorders 601, 351, 350 also for Gotham PBF 150 W amp & Neuman lathe 131 disc cutter. Mr. Oliver, 212-874-7660/0274. Call afternoons till 10PM.

**Want To Buy**

Boonton/any 0-450 MHz gener, AM & FM, will repair. J Cunningham, KEOR, Rt2 Box 113B, Stonewall OK 74871. 405-265-4496.

GR 1602B admittance meter access, reasonable. C Scott, WKYU, Western KY Univ, Bowling Green KY 42101. 502-745-3834.

**TRANSMITTERS**

**Want To Sell**

Exciters: McMartin B-910 tuned and calibrated to your frequency, guaranteed; Mono, stereo, SCA. Goodrich Ent. Inc. 11435 Manderson St., Omaha NE 68164. 402-493-1886 FAX: 402-493-6821

**CAPACITORS OVERNIGHT**

- Power Supply computer grade: up to 450 VDC
  - Transmitting-MICA Sangamo, Comell-Dubilier
  - Oil Filled Non-PCB Oval, Rectangular
- 1-800-323-0460**  
FAX 1-802-425-3664  
Kellner Electronics, Inc. Charlotte, VT 05445

**Circle (9) On Reader Service Card**

Phillips/PYE 1233/51/02, new/unused 10 kW FM, 88 to 108 MHz range. Unit ready to ship complete w/aerial filters & air ducting, manuals & circuits, \$16,000 US dollars FOB. Ray Anderson, East Anglian Productions, Studio Hoese, 21-23 Walton Rd, Frinton-On-Sea, Essex CO13 0AA, United Kingdom. (44) 0255 676252 or fax (44) 0255 850528.

NEC FBN 9200E 25 kW FM, 1984, uses single 4CX15000A w/new tube & 25 kW air-cooled Electro Imp DPTC-25KFM dummy, BO. R Miller, KUAU, 490 Ulumalu Rd, Haiku HI 96708. 808-572-5534.

Collins 830-D 1 kW FM w/exciter & manuals, \$2900. Bob, 603-448-0500.

**FM TRANSMITTERS**

250 watt 1979 Wilkenson 250E  
1.5 kW 1966 Bauer 607A  
2.5 kW 1975 Collins 881-D2

PMA MARKETING, INC.  
"Transmitting Savings to You"  
414-482-2638 FAX 414-483-1980

Harris TE-3 FM exciter, overhauled, exc cond, composite & SCA inputs on 99.3 MHz, \$650; Gates BC-250GY AM 250 W xmt, \$1500, add \$150 for chnl below 1300 kHz; ITC 1 kW FM w/o exciter, BO. E Horton, KWOG, 255 N Russell, Douglas WY 82633. 307-358-3656.

Gates HFL-3000 single-phase plate/xformer for HFL-3000 linear amp, 208/240 AC primary, 5400V at 1.2A/1200V at 0.25A, \$250. G Mendenhall, 217-228-0822.

LPB AM-60P 60 W on 1430, exc cond w/manual, \$1100. R Driver, WAIM, 2203 Old Williams Tom Rd, Anderson SC 29621. 803-226-1511.

TTC AM-10000 10 kW AM tuned to 1140 kHz, 6 yrs old, in use, solid state audio driver & exciter, \$25K; CCA 1 kW AM, tuned to 1190 kHz, \$3000; Sparta 701 1 kW AM, tuned to 1190 kHz, \$3000. G Arroyo, WONQ, 1033 Semoran Blvd, Orlando FL 32707. 407-830-0800.

Collins 830-D 1 kW, FM w/exciter & manuals, \$2900. R Vinikoor, WNTK, RR1 Box 249, New London NH 03257. 803-526-9464.

Gates 250-T 250 W tuned to 1570, gd cond, \$2000/BO+s/h; Collins 20-C 1000 W tuned to 1570, gd cond, \$2000/BO+s/h. J LoPresti, WGSR, 111 Avalon Dr, Warner Robins GA 31093. 912-929-4904.

TDD-5 25 W AM tuned to 530 kHz, \$500. 615-624-7126.

CCA 1000 AM, 1 kW tuned to 1190 kHz, on air, \$3000; Sparta 701 1 kW AM tuned to 1190 kHz, on air, \$3000; TTC AM-10000, 10 kW tuned to 1140 kHz, on air, \$25K. G Arroyo, WONQ, 1033 Semoran Blvd, Casselberry FL 32707. 407-830-0800.

Harris/Gates FM5-C FM 5000 W w/TE-3 exciter on 103.1 MHz, clean, rbit, \$6000; C-M Mdl 50, 50 W AM, adjusts to any pwr up to 50 W, \$500+s/h. J Cunningham, KEOR, Rt2 Box 113B, Stonewall OK 74871. 405-265-4496.

Rockwell/Collins 310Z-2 FM exciter w/stereo gener & composite STL input cards, used few hrs, mint cond, \$1800. B Watson, KSAK, 3352 Honebrook Way #7, Ontario CA 91762. 714-947-8440.

Used & New Transmission Line, many sizes & lengths, many like new. 412-733-1994.

**Want To Buy**

10 kW FM, single phase, pref Harris/one been replaced by upgrade, no problems, freq on 92.3. R Muselman, 816-359-2261.

**WE BUY**  
**MOSELEY PCL-303 & 606's**  
**414-482-2638**

FM 2 or 2 1/2 kW, pref Collins/Harris. R Vinikoor, WNTK, RR1 Box 249, New London NH 03257. 603-526-9464.

Harris 20 kW, W Wilson, WKTY, 1005 SW 10th Ave, Topeka KS 66604. 913-357-8888.

Harris/Cont FM 10 kW w/ w/o exciter. C Scott, EME Comms, Rt 3 Box 485-C, Moultrie GA 31768. 912-890-2506.

3 kW FM, gd cond w/o exciter for back-up, 105.9 MHz, single phase. K Sleeman, KQPM, 110 W Standley, Ukiah CA 95982. 707-763-0191.

2 kW FM, gd cond, pref East coast, \$3000+ depending on make & mdl. B Vinikoor, 603-448-0500.

**DISTRIBUTOR DIRECTORY**

The following distributors serving the broadcast industry would be glad to help you with any of your requirements.



SYSTEMS WITH RELIABILITY

**FM-Antennas**

Outstanding performance and quality you can be sure of. All antennas are completely tested on SWR's test range. Custom directional patterns are available.

Contact **JIMMIE JOYNT**  
**214-377-4623**

**CORNELL-DUBILIER MICA CAPACITORS**

FROM STOCK

**JENNINGS VACUUM CAPACITORS**

FROM STOCK

**JENNINGS VACUUM RELAYS**

**SURCOM ASSOCIATES**

2215 Faraday Ave., Suite A  
Carlsbad, California 92008  
(619) 438-4420

**This Space Available**

Call Simone for details

1-800-336-3045

**FM BROADCASTERS!!**

We can meet all your FM transmitter needs!!

**SOLID STATE**



Amplifiers and transmitters are available at the popular levels of 25, 100, 300, 500, 1000, 1500, 2000, 2500, 3000, 4000 and 4500 watts. All units are broadbanded and designed for local and remote operation.

**ZERO BIAS GROUNDED GRID TRANSMITTERS**

**SINGLE TUBE—MEDIUM POWER**

Offered at 1.5, 3.5, 5.5, 7.5 and 12KW. These transmitters include a broadbanded solid state IPA, which can be used as emergency transmitters and a single zero biased grounded grid triode in their PA.

**TWO TUBE—HIGH POWER**

These transmitters utilize two grounded grid triodes and are available at standard outputs of 15, 22, 25, 30, 40 and 50KW.

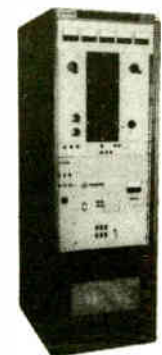

"The Transmitter People"

**Energy-Onix**

752 Warren Street, Hudson, New York 12534  
(518) 828-1690 FAX (518) 828-8476

A Wise Enterprise

Circle (140) On Reader Service Card

**PETER DAHL CO.**

Save \$\$

Heavy Duty Replacement Transformers DC Filter chokes and capacitors for AM & FM transmitters manufactured by: AEL, CCA, CSI, COLLINS, CONTEL, CONTINENTAL, BAUER, GATES, GE, HARRIS, ITA, McMARTIN, RAYTHEON, RCA, SINGER, SINTRONIX, WILKINSON. Many other models also available.



FAST Delivery and FREE Technical Support.

5869 WAYCROSS AVENUE EL PASO, TEXAS 79924  
(915) 751-2300 TELEX: 76-3861 PWDCC  
FAX: (915) 751-0768

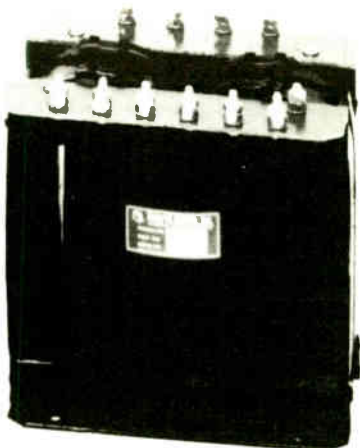

Circle (173) On Reader Service Card



**TRANSMITTERS . . . WTB**

1-5 kW, newer w/remote, loadable to 500 W, 950 kHz. K Riggs, KTBR, 829 SE Cass, Roseburg OR 97470. 503-672-4427.

**USED TV TRANSMITTERS,**  
antennas, cable, rigid line, etc. one watt to 110 kW. Best FM Line BUY — SELL

**BROADCASTING SYSTEMS**  
602-582-6550  
FAX: 602-582-8229  
Kenneth Casey

5 kW AM on 1410 kHz, pref 1970s/newer, no PCBs, \$12-\$15K. R Egan, WIZM, 432 Cass St, La Crosse WI 54601. 608-785-7914.

FM 2/2.5 kW, pref Collins/Harris. Bob, 603-448-0500.

Collins 30K/30V, driving distance from Houston pref. T Smith, RF Concepts, 13034 Elmington Dr, Cypress TX 77429. 713-260-5842.

RCA 1R plate xformer & choke, 3750-0-3750 at 1 amp. R Wells, KSRO, 627 College Ave, Santa Rosa CA 95404. 707-545-3313.

Tunable FM exciter & ant, 10-50 W. A Anello, Anello Tech Svcs, 1915 W Waters Ave #1, Tampa FL 33604. 813-933-6009.

McMartin AM/FM xmtr, any model, exciter or stereo modules. Goodrich Ent., 11435 Manderson, Omaha NE 68164. 402-493-1886.

**TUBES**

Want To Sell

**ECONCO**  
Quality Rebuilt Tubes

Approximately 1/2 the Cost of New

Call for Our Price List  
**800-532-6626**  
**916-662-7553**

**FAX 916-666-7760**

Circle (11) On Reader Service Card

**FACTORY NEW TUBES**  
Sales Under Cost Because Overstock

**4CX1000A \$220.00**  
**4CX1500B \$270.00**

Other types: Please Call, Will Beat Anybody's Price Subject to Prior Sales Whichever Come First

**CALL 1-800-783-2555**  
**JoLida Tube Factory**  
Annapolis Junction, MD

Penta prem output tubes, KT88, \$35; KT99B, \$55; EL34HD, \$15; 12AX7B, 6072M/PR. R Katz, Allegro Sound, 15015 Ventura Blvd, Sherman Oaks CA 91403. 813-377-5264.

**For the Best Prices**  
& 24 Hr service on transmitting tubes call 402 493 1886 day or night. FAX 402 493 6821. TELEX 940103 WU PUB TLX BSN

**REBUILT ELECTRON TUBES**

Partial List: 6623, 23791, TH150, 6425F, 5604, 6696, 6697, 5681, 5682, 5671, 7804, 3CX10,000H3, 3CX20,000H3, 4CX5000A, 4CX35,000C

**Vacuum Tube Industries, Inc.**

**1-800-528-5014**  
**508-584-4500 X75**

4CX3000A, used, OK; (3) 3CX2500F3, BO. T Devine, WVVK, 300 W Vine St, Lexington KY 40507. 606-253-5900.

4-1000A, 8877, 4CX250B, 4CX1500B, 4CX3000A & more. We carry large inventory all major brands, Eimac, Amperex, RCA, etc. Call Stew 1-800-842-1489.

Audio generator, TE22 (Lafayette), Sencore transiator tester (portable); Cannon plugs, male & female 3 prong (new); new & used cable w/Cannons or without. Mr. Oliver, 212-874-7660/0274. Call afternoons till 10PM.

Want To Buy

**ELECTRON TUBES**  
**Vacuum Tube Industries, Inc.**

**1-800-528-5014**  
**508-584-4500 X75**

**WANTED: TUBES**

I pay cash or trade for all types of transmitting or special purpose tubes.

Mike Forman  
1472 MacArthur Blvd. Oakland CA 94602  
**(510) 530-8840**

6072, 5651, 5691, 5692, 6005, 6084, 6386, 7308, 6AQ5, 6BL7, 6DN7, 6EJ8, 6EM7, 6GK5, 6HU8, 6JK6, 6XK8, ECC808, ELL80, 300B, 2A3, 13CW4, VF14, AC701. R Katz, Allegro Sound, 15015 Ventura Blvd, Sherman Oaks CA 91403. 813-377-5264.

**TUBE REBUILDING**

**FREELAND PRODUCTS**

Since 1940  
**SAVE ABOUT 50%**  
**—We buy dud tubes—**

**800-624-7626**  
**504-893-1243**  
**FAX 504-892-7323**

RCA 8021. A Weiner, WHVW, 507 Violet Ave, Hyde Park NY 12538. 914-423-6638.

**TURNTABLES**

Want To Sell

Carrera 33/45 rpms, new w/new Stanton cart, \$90; tone arm w/hd shell, \$25; Harris EQ preamp, \$45; (3) Audio Technica ATP-N2, new, \$45; RCA tone arm, \$40/BO. Steve, Dynes Comms, 957 Natl Rd, Wheeling WV 26003. 304-243-0744.

Technics SP10MKII-1 (2) w/stand & tone arm, \$775 ea+s/h; (2) RTS stereo phono preamps, \$220 ea+s/h. B Lord, Lord Bdcg, 13313 SE 208th St, Kent WA 98042. 206-631-2374.

Technics SP-10 (2) w/mounts & ATI 10" tone arms, exc cond, \$150 ea. B Brintzer, WDNC, 1000 Park Forty, Durham NC 27713. 919-361-1429.

Harris-Gates CB-77, (2), new, \$350 ea; (2) Micro Trak 303 stereo, new, \$150 ea; (2) Shure M-2323 stereo, new, \$125 ea. V Mlyneis, WCPN, 8211 Essen Ave, Parma OH 44129. 216-884-3705.

Micro Trak 303 tone arm, new, \$60. T Devine, WVVK, 300 W Vine St, Lexington KY 40507.

Russco Super Pro 12" 3-spd tables, Shure tone arms, pre amps, Stanton carts, new felt pads, gd cond, \$250 ea/BO+s/h. J LoPresti, WGSR, 111 Avalon Dr, Warner Robins GA 31093. 912-929-4904.

Gray antique 16" tone arm w/Shure cart, \$50. A Mitchell, 703-768-6186.

**VIDEO PROD EQUIP**

Want To Sell

Pana S-VHS edit suite w/camcorder, switcher, editing VCRs, monitors, dig effects + more, \$6500. B Kidd, Airwaves One, 510 W 2nd, Rayville LA 71269. 318-728-4574.

Radio Shack video proc, \$175. Steve, Dynes Comms, 957 Natl Rd, Wheeling WV 26003. 304-243-0744.

Convergence 103 editor, A/B roll, \$1500; AVS 6000 dig stds conv, \$6000; For-A 410 TBC, \$1200. C Denke, Amer Prev Svcs, 2247 15th W, Seattle WA 98119. 206-282-1776.

Shintron 366 spec effec gener & EIA RS-170 sync gener w/manual, \$150. G Kirby, Gray Fox Video, 13613 US 36, Marysville OH 43040. 614-261-8871.

**THIS MONTH'S CROSSWORD PUZZLE**

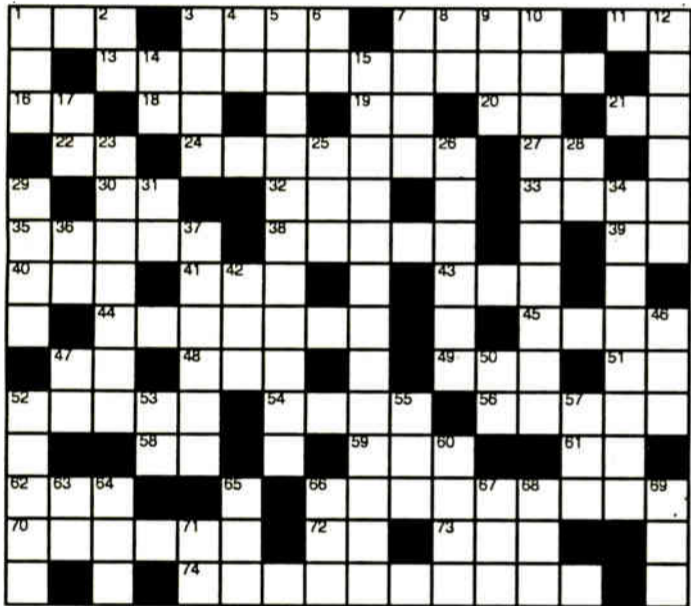

by Steve Walker

Answers in next issue of RW

**ACROSS**

1. 'til you drop...
3. Drug cops or FCC guys
7. Ross Perot: "I'm all \_\_\_\_"
11. Postscript
13. "For a good time, call \_\_\_\_"
16. PC
18. "The world leader in radio broadcast technology"
19. America
20. North Star
21. 12th Greek letter
22. Talking horse
24. Tubes
27. Old North State
30. Antenna radiation
32. Three (prefix)
33. Wherever I hang my hat ...
35. Writer Clemens
38. Oak nut
39. Logical operator
40. Crow sound
41. Inclusive
43. Familiar possessive, French.
44. "Clearly Digital"
45. Workroom
47. Boss engineer
48. Didn't make it to the hospital
49. Mail-order engineering school
51. About
52. Blood vessel to heart
54. Head current
56. Cooling substance
58. Smartness test
59. Alfred E. Neuman magazine
61. First initials of popular mail order catalog
62. Youngster
66. Dynamax
70. Leaving; book of Bible
72. House current
73. Make changes to
74. Whirlwind Active Press Box

**DOWN**

1. PR&E Consoles
2. Measure of alkalinity or acidity
3. Worry
4. Where you go when you hurt
5. \_\_\_\_ Audio \_\_\_\_ (Card D)
6. Third Reich special police; abbr.
7. Otherwise
8. George Wallace state
9. Lip, edge
10. "One Take. One Choice."
12. disk & dat
14. Away; outside of (prefix)
15. AD-302 ITC Delta upgrade board
17. Musical note, alternate spelling
23. "Do it right...Do it \_\_\_\_"
25. Cetacean
26. MPA-1 mic preamp
28. Prefix meaning "in association with"
29. Remove copper on circuit board
31. One of Jack's giant's favorite words
34. C-Quam company
36. Bing Crosby's home state
37. "Increase affiliate services...without spending a dime."
42. Lion symbol
46. Writing instrument
47. See 28 down
50. In the event that
52. SX-20 digital audio card for PC
53. American defense contractor
55. Unhappy
57. Recorded "Fanfare for the Common Man"
60. To show someone how to use something, abbr.
63. Beast of burden
64. The piper's son
65. Turntable manufacturer
66. Religious law, Roman
67. Not high
68. Disk drive interface type
69. Crystal Clear Digital Audio
71. Direction overhead

# ADVERTISER INDEX

This listing is provided for the convenience of our readers. Radio World assumes no liability for inaccuracy.

Page No.	Advertiser	Reader Service No.	Page No.	Advertiser	Reader Service No.
45	AMP Services	123	29	Hinat-Hindes	102
7	ATI	47	19	ITC	117
26,27	Arrakis	21	44	J&I	71
42	Audio Broadcast Group	22	15	Jampro	129
43	Audiopak	43	49	Kelner	9
33	Auditronics	127	48	Marathon	55
17	BSW	28	22	Media Touch Music Company	50
32	Belar	77	23	Myat	143
40	Benchmark Media Systems	109	28	NASDAO	157
42	Broadcast Electronics	59	31	Orban Associates	57
3	Broadcast Services	185	21	Pacific Recorders	115
8	Broadcast Services	132	49	Peter Dahl	173
10	Broadcasters General Store	93	30	OEI	163
4	Burk Technology	18	35	Radio Mail	45
16	Burk Technology	15	4	Radio Systems	151
25	CCA Electronics	52	10	Radio Systems	60
42	CRL	193	15	Radio Systems	75
3	California Digital	186	38	Radio Systems	70
14	Comrex	79	43	Radio Systems	120
42	Continental Electronics	105	42	Reel Bonus	100
38	Cortana	118	11	Rohn Towers	170
7	Cybex	183	37	SMARTS Broadcast Systems	138
29	Dataworld	63	40	Shively Labs	112
40	Dataworld	41	18	Sine Systems	197
50	Econco	154	36	Somich Engineering	188
8	Econco	11	42	Sontec	78
49	Enco	89	9	Sony	156
36	Energy Onix	140	24	Studer Revox	182
12	FM Technology	20	39	Super Gospel Country Radio Net	23
41	Fidelipac	136	48	Tapeworld	5
40	Fidelipac	158	13	Tascam	99
40	Gerstman Software	91	48	Transcom	179
40	Gorman Redlich	13	2	Wheatstone	111
44	Hall Electronics	39	51	Wheatstone	134
42	Halland Broadcast Services	34	52	Wheatstone	88
1	Harris-Allied Broadcast Equipment	96			
6	Harris-Allied Broadcast Equipment	32,160			
20	Harris-Allied Broadcast Equipment	26,152			
34	Harris-Allied Broadcast Equipment	73			
32	Harris-Allied Broadcast Equipment	-			

Position	Name	Position	Name
Publisher	Stevan B. Dana	Ad Coordinator	Regan Deatherage
Associate Publisher	Carmel King	Ad Coordination Manager	Simone Mullins
Marketing Consultant	Al Leon	Circulation Director	Tiana Hickman
Production Director	Kim Lowe	Circulation Manager	Rebecca Seaborg
Production Manager	Julianne Stone	Accounts Receivable	Steve Berto
Production	Lisa Lyons, Lisa Mamo		

**Advertising Sales Representatives**

U.S. East: Skip Tash ..... 703-998-7600 Fax: 703-998-2966  
 U.S. West: Dale Tucker ..... 916-721-3410 Fax: 916-729-0810  
 International: Stevan B. Dana ..... +1-703-998-7600 Fax: +1-998-2966  
 Europe: Dario Calabrese ..... +39-2-753-0274 Fax: +39-2-753-2697  
 Japan: Eiji Yoshikawa ..... +81-3-3327-2688 Fax: +81-3-3327-3010

Free subscriptions are available upon request to professional broadcasting and audiovisual equipment users. For address changes, send current and new address to RW a month in advance at P.O. Box 1214, Falls Church, VA 22041. Unsolicited manuscripts are welcomed for review; send to the attention of the appropriate editor.



# Just RIGHT!

**4-TRACK PRODUCTION** doesn't have to be complicated. The **MR-40** has just the features most stations are looking for: 4-track bus assign for your tape recorder; program assign so you can transfer direct to your 2-track—or go right on-air! It has machine Start/Stops just below the fader like an on-air console, but also includes a 3-band equalizer section so you can have the tone control that a normal radio console couldn't provide. It even has a stereo send bus that follows stereo channel balance controls—ever so important for today's stereo effects devices.

Mono modules have both mic and line inputs: mic for recording and line for track playbacks. Subgroup channels provide fader control for

record levels and also have a second track playback path for really quick sessions. And of course the MR-40 has an on-air type monitor section, complete with control room, headphone and studio outputs plus all the necessary muting and tally functions you'd want. It even has a built-in cue speaker and power amplifier.

Small format doesn't mean we've cut corners either: all audio switches are gold contact, assign buttons are LED illuminated, all ICs are double burned-in and all circuits are double-tested—we don't take any chances with reliability! The **MR-40** is a perfect blend of excellence in engineering and sensible size. It's just right for 4-track. So contact Audioarts.



## MR-40 Audio Mixing Console



**AUDIOARTS® ENGINEERING**

6720 V.I.P. Parkway, Syracuse, NY, 13211 (tel 315-455-7740/fax 315-454-8104)

Circle (134) On Reader Service Card  
World Radio History



# Wheatstone's Finest

We've taken all that we know, all that you've asked for, and the very best of today's technology and components to bring you our finest radio console: the A-6000.

The A-6000 has all the features you could need (or even MIGHT need) but with a family of over 125 input module combinations, you're free to choose the features you DO need: like a built-in routing switcher with individual alpha channel displays, so you can configure your console to suit changing program requirements; Wheatstone's exclusive Bus-Minus™ system, the ultimate tool for news and sports events; four mix-minus busses, bringing real power to talk formats; logic controlled program and mix-minus buses, giving you complex function from simple switch commands; a full array of stereo and mono send controls for studio or effect

mixes; and of course, an equalizer option for your production suite. You can even add features later; you can relocate any module anywhere in the mainframe at any time, preventing obsolescence as format needs change.

And while Wheatstone is well known for superior technical performance, the A-6000 surpasses even our own previous consoles in virtually every measurement category.

The A-6000 has the appearance, features and power to excite the most demanding program and production staff; its engineering, performance and thoughtful design will help your technical staff achieve excellence. So contact Wheatstone, the people with knowledge, experience and a commitment to excellence.



Wheatstone Corporation

A-6000

67207 I.P. Parkway, Syracuse, NY 13211 (tel 315-455-7740/fax 315-454-8164)

Circle (88) On Reader Service Card

WorldRadioHistory