0000770 000 070 48 11 19
BARRY HUNTER
LSE
LSE
2003 HOUCC 111 12
TUCCH AC 007 10

Radio World®

Vol 14, No 8

Radio's Best Read Newspaper

April 25, 1990

FCC Acts To Rejuvenate AM

by Charles Taylor

Washington DC The FCC has taken a major step toward revitalizing the AM band with a massive notice of proposed rulemaking on technical criteria for the existing and expanded AM bands.

In addition, the Commission has adopted changes to its skywave and groundwave calculations and decided to allow, among other measures to alleviate congestion, AM stations to negotiate interference.

The actions came down at a highly anticipated FCC meeting 12 April. They followed an 5 April freeze of all applications for new AMs or major changes to existing stations, pending action taken on issues within MM docket 87-267, which will redefine all rules affecting AM.

The 12 April actions, according to

Mass Media Bureau Chief Roy Stewart, "represent an attempt for a comprehensive strategy for rejuvenation of AM radio service."

"AM has become unattractive to the American public," added Bill Hassinger, assistant chief for engineering. "This is demonstrated by its ratings."

The notice of proposed rulemaking for 87-267, first set parameters for the expanded AM band, which will add between 250 and 300 new stations nationwide among 10 channels, from 1605 to 1705.

The Commission determined that channels should be awarded to stations creating the most congestion and interference in the existing band. The suggestion went against consistent requests by a number of groups, including minorities, women, daytimers and noncom-



The FCC's freeze, enacted days before the NAB convention, drew mixed reactions from the broadcast industry.

mercial stations, who had requested allocation preference.

"We should not be ashamed of opting for quality," commented Commissioner Andrew Barrett, adding that the move did not reflect the FCC's general tenor.

"You will find that this commission is in support of minorities, women and non-commercial stations."

Added Commissioner Sherrie Marshall, "We realize this will disappoint (continued on page 3)

TV Marti Launched

by John Gatski

Miami FL Cuba's attempts to dissuade the US from broadcasting TV Marti did not stop the United States Information Agency from proceeding with scheduled tests of the new television service in March.

With the onset of the tests, south Florida radio and TV stations are worried that the television service will cause Cuba to retaliate against them.

TV Marti's \$7.5 million test broadcast of western information and entertainment to Havana began 27 March, according to the USIA's Voice of America.

Cuba jammed the first series of TV Marti signals just minutes after they went on the air by transmission of a counter video signal of 50-100 horizontal lines, VOA officials said.

Three days prior to TV Marti going on the air, Florida AMs got an earful of what they could continue to expect if TV Marti beamed its programming to Cuba.

Castro speaks at high power

5 A 24 March policy speech by Fidel Castro was broadcast on six AM frequencies from high power Cuban transmitters, interfering with several US AMs, according to the stations. The frequencies included 620 kHz, 670 kHz, 1040 kHz, 1100 kHz, 1160 kHz and 1380 kHz.

Stations on those frequencies and adjacent channels confirmed the Cuban signals were very strong and caused intermittent interference.

The interference is not new. Castro's speeches are often transmitted on five or

six Cuban frequencies and directed toward the US, according to the FCC. A similar speech was broadcast 7 March.

Other Cuban broadcasts also interfere with US signals. One such interfering (continued on page 7)

FCC Raids Philly FMs

by John Gatski

Philadelphia PA As a result of a complaint, stemming in part from recent

confusion over modulation monitoring, the FCC sent its measurement truck to the City of Brotherly Love recently and has notified several stations they face consequences for overmodulating.

The FCC will take "enforcement action" against six Philadelphia FM stations for overmodulation, based on measurements taken 12-16 March by an FCC inspector, according to the Commission's Field Operations Bureau enforcement division.

"There were six stations found overmodulating (in Philadelphia). Enforcement action will be taken against all six," FOB Engineer Bob Weller said.

Through four Philadelphia engineers who did not want to be identified, Radio World learned the FCC notified WEGX, WSNI, WMGK, WXTU and WIOQ they had been measured and found to be overmodulating. The sixth station could not be determined.

The measurements were taken by the FCC's Engineering and Measurement unit, Laurel, MD. The Philadelphia visit was not a routine monitoring but based on a confidential "complaint," Weller said.

The FCC's action against the stations could range from an advisory notice to a fine up to \$3000, Weller said.

The FCC emphasized that the Philadelphia visit was not a first strike in a Commission offensive against overmodulation, but part of FOB's normal duties to investigate cases of overmodulation. (continued on page 8)

SPOIL YOUR LISTENERS.... Not Your Audio
Pure Sonic Integrity—99.997% Distortion Free



FX 50 Exciter

No matter what your format is... no matter which processing you run; your entire system is no better than your exciter. So why limit the potential of your signal? Join the hundreds of broadcasters that have already realized what a difference the FX 50 can make. Call BE now at 217-224-9600.



BE® BROADCAST ELECTRONICS INC.
4100 N. 24th ST., P.O. BOX 3606, QUINCY, IL 62305, (217) 224-9600, TELEX: 250142, FAX: (217) 224-9607

Circle 50 On Reader Service Card

World Radio History

Tower Ice Specs Stir Controversy

by Alan Carter

Washington DC A controversy is quietly developing within an Electronic Industries Association subcommittee over including mandatory icing standards in antenna tower designs.

The current standard does not include any minimum thickness of radial ice specification.

But when attempts were made recently in an EIA/TIA subcommittee to make icing requirements mandatory, the efforts were thwarted in a way

some consider questionable. Much of the opposition focused on additional costs to towers with the icing stipulations.

Reversing positions

At an 18 May 1989 meeting, the subcommittee voted to make ice load considerations mandatory for all towers, according to minutes obtained by **Radio World**. A recommendation to exclude towers under 300' was rejected.

However, the subcommittee reversed itself on 5 October

1989, the minutes indicated. When a motion to revert to the existing standard, but include an icing map, failed, the subcommittee said the existing standard was reinstated. There will be no ice map or county listing of ice, but the standard will contain a discussion of ice in the appendix.

The issue is slated for further discussion before a draft of the standard is distributed for a vote.

Some members contacted declined to discuss the procedures of the subcommittee,

claiming it is a private group operating under EIA legal guidelines. Others, however, were willing and noted their concerns about icing standards.

"What goes on in a committee meeting stays there as far as I'm concerned," said Chairman Charles Werner of Rockwell International, who was absent 5 October. "No one has called me about it."

Werner said there is no concrete data or research to support uniform icing standards. "It's not a simple issue," he said.

He maintained it is the responsibility of design engineers to recommend to a particular buyer what icing considerations should be included.

Norm Kouba of Tower Tech, who chaired the 5 October meeting, also declined to discuss the action of the subcommittee.

But Kouba supported Werner's position that a designer has to make considerations for ice. "There is not enough evidence that can clearly define how much ice you can get in a region," Kouba said. "It's all local and very subjective."

He, continued, however "Down the line, we will end up with this (a mandatory icing standard). It takes a while ..."

Calls for ice standard

Among subcommittee members contacted who supported making ice standards mandatory is Don Marshall, VP engineering, LeBlanc & Royale Telcom of Oakville, Ontario, Canada. He also is chairman of a committee in the Canadian Standards Association that is comparable to the EIA subcommittee.

"It (icing) should be addressed," Marshall said. "I can appreciate where they are coming from because some of their product line could be jeopardized (from price increases)."

Excluding towers under 300' would be a compromise, Marshall said.

Marshall, as well as others supporting icing requirements, recalled towers which fell during ice storms in the past year.

He also said he had heard the criticism that the subcommittee only represents the interest of manufacturers. "You become a voting member by paying your dues to belong," he said.

But Marshall conceded that "Definitely that committee is weighted in one direction." He said, "It would help to broaden the scope of the committee. There is nobody representing the broadcasters."

Consultant Tom Silliman, president of Electronic Research
(continued on page 10)

We Re-invented the Wheel AND IT'S SQUARE!

Naturally, with all of Wheatstone's experience at building and interfacing consoles, it was inevitable that we would take on the design and manufacture of suitable furniture for our audio installations. First we listened to engineers and their requests, then we went to work. The result is a significant improvement over previous designs.

Consider the advantages of double-sided equipment cabinets with fully interchangeable door panels, with each side able to accommodate 19 inches of rackmount equipment. Consider the convenience of hinged twin drop-down punchblock panels for easy installation and maintenance. Consider the advantage of hard chrome plated steel mounting rails that eliminate the stripping problems associated with lesser aluminum designs. Simply consider the strength we've achieved with full inch and a half thick side panels and hybrid inch and a half thick countertops.

We have re-invented cabinet technology. We've wedded the latest precision NC metal componentry to hybrid plywood high density, high resin pressure-laminated substrates. Our construction and bonding techniques have been optimized to eliminate stress related laminate problems. We've handled wire management: there are generous pathways between each enclosure, as well as an integral channel punchblock housing under the console counter to keep everything neat, concealed and away from unauthorized hands. And, since cabinet faces can accept either equipment or door panels, systems can easily be configured to fit virtually any room. Doors can even be placed on cabinets intended for future electronics installation.

This cabinetry is very clever, unbelievably strong, and (of course) square—precisely. It has that Wheatstone major market look. So contact Wheatstone for furniture, consoles, or prewires.



Wheatstone Corporation

6720 V.I.P. Parkway, Syracuse, NY 13211

TEL 315-455-7740 FAX 315-454-8104

INDEX

EUREKA's Tradeoffs by Steve Crowley	13
KNIX Saddles Up for a Move by Dee McVicker	16
Learning to Speak With Your Computer by Ed Montgomery	17
Reducing the Risk Of Lightning Strikes by Thomas Vernon	18
Going Cordless with the IRS 690 by Ty Ford	24
Paycheck Nightmare by Al Peterson	27
Putting BBSs to Work for You by Barry Mishkind	28

FCC Proposal Would Help AM

(continued from page 1)

some groups, but this makes it equal across the board."

By moving those stations creating the most interference, the FCC said that not only would it help clean up the existing band, but it would offer immediate establishment of service in the expanded band. During this transition, the expanded band would not be open to new applicants, it added.

For both the expanded band and the existing AM band, the FCC presented numerous proposals, intending to clean up and add potency to AM's ailing condition. The suggestions will be presented en masse in the near future for comment.

Stereo and simulcasting

An effort to boost the acceptance of AM stereo among stations is included in the NPRM, though the Commission is seeking comments as to how best to approach the stereo issue.

Hassinger said that the Commission would not open up the question of selecting an AM stereo standard. For the expanded band, the NPRM will ask whether stereo should be a requirement for a new allocation or whether existing AM stereo stations should be given a preference.

Considerations for stations on the existing band include whether the FCC should require all AM stations to imple-

ment stereo by a specific date allow incentives in granting licenses or upgrades for AMs that would convert to stereo.

Another recommendation moved to banish or give incentives toward abolishing the simulcast of FM programming over AM.

"Simulcasting has become a sign of weakness," said FCC Chairman Al Sikes. "It was pursued by AM stations when FM was in its infancy and now it has become symptomatic of AM's weakness."

Commissioner Marshall questioned the validity of banishing simulcasting and asked that language be carefully constructed in the NPRM to treat the elimination of simulcasting as an incentive.

At a press conference after the meeting, Stewart said the issue revolves around whether duplication of programming denotes a marginally stable station. "We'll have to pay attention to comments when they come in."

A wealth of improvements

Other issues that the Commission considered include abolishment of the RSS to define protection ratios in favor of a single protection method; increasing adjacent channel protection from 0 dB to 16 dB; allowing common ownership of two AMs in a single market if it will reduce interference; and boosting Class 3 stations to 50 kW if protection criteria are met.

In addition to the extensive NPRM on 87-267, the Commission also adopted three Report and Orders to help AM. The three changes adopted by the Commission included, first, new policies to reduce interference between AMs, as outlined in MM docket 89-46. Most significant, the FCC reversed its policy looking down upon private negotiations to diminish congestion among AMs.

To encourage broadcasters to use the method, the agency also proposed within its review of 87-267 to issue tax certificates to licensees receiving payment from other licensees either to reduce service area or to surrender licenses.

The Commission ruled with 89-46 to discontinue its policy to hold open a radio frequency for a period of one year after a station goes dark for applicants wishing to replace the deleted facility.

"In most instances, this policy has led to the perpetuation of AM stations' causing or receiving objectionable interference," the FCC said. It added that the present policy of maintaining these deleted AM facilities was a disincentive for bringing the stations into compliance with current AM assignments.

Also, the FCC ruled to set forth guidelines regarding a service floor to be used

when analyzing AM modification proposals. Its case-by-case decisions will hinge on the amount of AM interference that would be eliminated, compared to the number of AM and FM stations remaining available to areas that will lose service, the Commission said.

Skywave and groundwave

The second Report and Order replaced existing AM skywave propagation curves with a new propagation model, as contained in MM docket 88-508. The new model, the FCC said, will enable both the agency and broadcast consulting engineers to know more accurately the inter-signal relations produced by AM stations.

The final action replaced current methods for calculating groundwave field strength, outlined in MM docket 88-510. The new curves are a computer-generated mathematical calculation of predicted groundwave field strengths at all distances, which the Commission said will more accurately reflect groundwave signal coverage and aid in predicting when objectionable interference occurs.

The Commission said it will defer implementation of the changes outlined by its three rule makings until the issues within 87-267 are resolved.

Your Direct Connection.

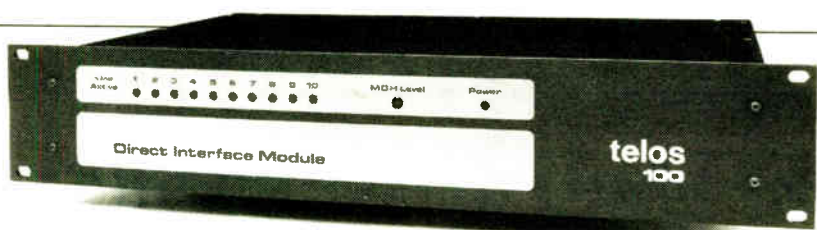

Switching among multiple phone lines for call-ins no longer means using a 1A2 key system or your own homemade switch. Now, the Telos 100 Direct Interface allows you to connect up to ten lines to your Telos digital hybrids and control panels. The Direct Interface features music-on-hold, and a full-featured Mitel® desk set is an option for call screening.

Complete systems, consisting of the Direct Interface, a multi-line switch panel, and a famous Telos digital hybrid, start at as little as \$3475. Telos already has a reputation for the best sounding, easiest to use talk show systems. Now, they're quicker than ever to install! Isn't it time you experienced the pleasure of great phones?

Bradley
BROADCAST
8101 CESSNA AVENUE • GAITHERSBURG, MARYLAND 20879
TOLL FREE: 800-732-7665 • MD & DC: 301-948-0650 • FAX: 301-330-7198

Where Service and Engineering Make the Difference

Circle 75 On Reader Service Card

DURA TRAK 90™ Forget it.

Install a Dura Trak™ 90 cart machine, then forget about it: BE engineers made these new decks the simplest, most reliable and best-performing machines in their class.

- Clean audio performance with accurate cart guidance system, Phase Lok V head block and rugged direct drive motor.

- Designed to eliminate on-air mistakes with Cart-not-cued and Cart-previously-played lockouts, automatic muting and auxiliary start pulse.

- Fast Forward and three tone cue sensing standard.

- Engineered for durability with 1/2" aluminum deck plate, gold-to-gold contacts, solid cast front panel.

Simplicity, reliability, quality, affordability—Dura Trak 90 has them all. So you really will be able to forget about it. Just remember to contact your Broadcast Electronics distributor or call Bob Arnold at (217) 224-9600.

* 115 VAC, 60 Hz, F.O.B. Quincy, IL. Exclusive of sales or use tax.

BE BROADCAST ELECTRONICS INC

4100 North 24th Street • P.O. Box 3606 • Quincy, IL 62305
Tel: (217) 224-9600 • Fax: (217) 224-9607 • Tlx: 250142

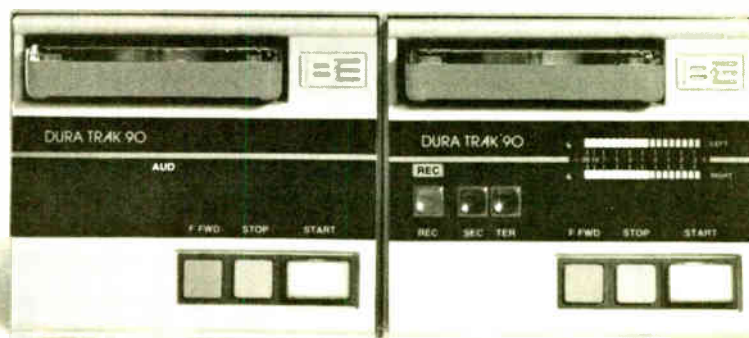

DURA TRAK 90 STEREO PLAYBACK: \$1795* / STEREO RECORD/PLAYBACK: \$2695*

Circle 17 On Reader Service Card

After the Freeze: AM's Rebirth

by Judith Gross

Falls Church VA As I tap this out on the trusty word processor I'm literally sitting on the edge of the chair, waiting for word about the FCC's massive rulemaking on AM.

Since I won't have had a chance to digest the details by the time this gets to you, all I'll say for now is that, yes, it's massive, and yes, it will be controversial.

You say AM needs first adjacent interference action? Well, like the commercial for that certain brand of spaghetti sauce says, it's in there.

How about expanded band? It's in there.

OK, what about, at long last, AM stereo? Yep, it's in there too. And in a way that should solve the problem without causing World War III.

So, take a deep breath, read the news accounts, talk to your colleagues and the experts, too. I'll fill you in with more elaborate thoughts next time and hope you'll let me hear from you as well.

Word that something BIG was coming hit just as a good portion of the industry left for the NAB show in Atlanta. It's always something, huh? We knew it was going to get interesting when we heard about the AM freeze.

Some consultants were forced to rush home after barely arriving in Peachtree town, so they could finish up those last few applications before the 5 April deadline for the freeze. Ya missed a good show. But we'll fill you in on that, too, in the 9 May NAB wrap-up issue.

☆☆☆

Well, there it was, in all its white marbled glory: the US Supreme Court. All nine justices were gathered to hear arguments in two cases involving the FCC: *Astroline vs. Shurberg* and *Metro vs. FCC*. And JG's *Earwaves* was there for the play-by-play.

A very eloquent attorney named

Gregory Guillot argued for Metro and Harry Cole, of Bechtel & Cole, who will be starting his *Cole's Law* column with RW shortly, argued for Shurberg.



Both cases involve minority preference, in sort of odd applications. The Shurberg case dealt with a distress sale, wherein a group with a member of a minority at the helm got the station.

However, during the argument, it came out that the one minority shareholder had 70% owner equity for a contribution of \$210, while those with smaller owner equity had come up with a grand total of \$24 million. Mighty strange arithmetic.

Anyway, the High Court is a stuffy place, with everybody (JG included) in a dark suit and the justices looking very somber from an enormous and imposing bench.

The basic argument in both cases, from the non-FCC attorneys, was that giving broadcast license preference to a member of a minority is not necessarily a surefire way to guarantee the "program diversity" on which the Commission's minority preference policy is based.

Justice Scalia was the most vocal. He pointed out the danger of trying to associate certain behaviors with particular minorities. Would a black owner always program urban music? An Hispanic always salsa? And would such predictions be just another form of racial stereotyping and discrimination?

Interesting issues for broadcasters to

think about. The esteemed Brethren are expected to hand down decisions in June.

☆☆☆

Here's some top secret info leaked to me in the corridors of the Atlanta convention center. Denon is working on a recordable CD.

It's still a prototype, mind you, since the company needs to get feedback from

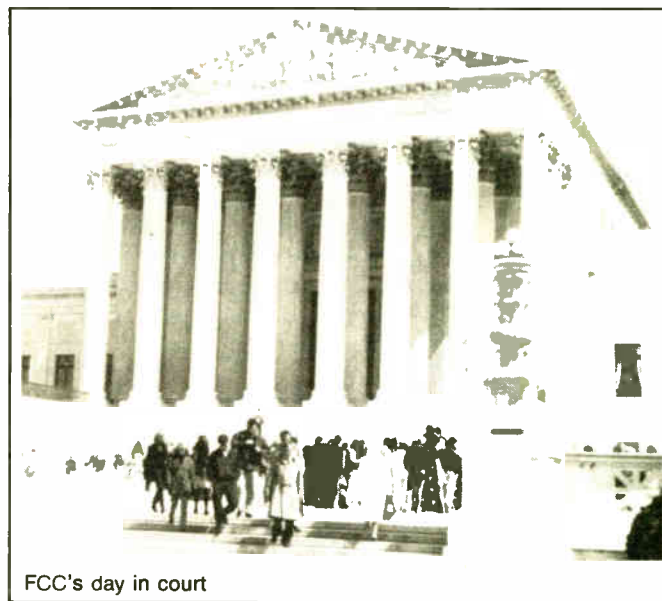

FCC's day in court

potential users and has a few problems to iron out. One concerns the indexing of cuts, which apparently must be done when the CD is "pressed." How does this reconcile with the flexibility to record, oh say, spots of several different lengths and types as needed?

Well, I suggested that some sort of generic indexing, with predetermined lengths could be employed and the Denon folks are looking into that one. Next problem is how to bypass an obsolete cut.

I have no doubt the Denon engineers will ace that one before long too, and it will be just a matter of time before we see a recordable CD on the market.

And on the subject of the laser discs,

Phil Wells of Giant Step Enterprises in beautiful San Diego (where I hear it's always sunny, even when it rains) sent along an article from the *San Diego Union* detailing the benefits of—are you ready for this—coloring your compact disc with a green felt pen.

Supposedly, the golden ears say, the Big Green Clean, as it's called, makes the recording clearer and more resonant,

especially on the high end. Those who employ the method line the edges with the green ink and they say no other color will do (sorry, all you magenta, turquoise and char-*treuse* lovers).

Then there's the plastic ring method with special rings being marketed by Monster Cable. These are supposed to cut down on the flutter that can cause vibrations in the playback.

And if you're really a fanatic, you can use a special substance called Finyl being marketed by a San Diego lawyer. It's supposed to cut down on the "glare" when the laser is reading the information.

Companies manufacturing CDs were reported to have called these home remedies "a bad joke." But lots of audiophiles swear by them, green ink and all.

And me? Well, the whole concept of CDs is so new to me that I'm still having trouble removing them from the plastic cases. Easy does it now . . .

Heard a juicy tidbit? Spill your guts to Earwaves by faxing JG at 703-998-2966, writing to PO Box 1214, Falls Church VA 22041, or calling 703-998-7600. Who knows, you could win a coveted RW mug.

WMMS Goes All Out for On-Air Reliability

Brian Emery, Chief Engineer of WMMS, knows how important it is to stay on the air in a competitive market like Cleveland.

That's why Brian trusts his two FM transmitters (and his reputation) to his Burk TC-8 Remote Control System.

Many people think of our little 8-channel system as ideal for limited budgets. And it is, too. The TC-8 is still just \$2,495.

But the TC-8 packs a surprising amount of value into that tiny price. Especially when being on the air all the time counts.



TC-8 Remote Control System

WMMS, always technically progressive, was one of the first stations to choose a TC-8 back in 1985.

Later, they added a new FM transmitter. What to use for remote control? The Burk TC-8, of course.

Brian's formula is simple: If it's not reliable, it costs you money. He also has another motivation to stay on the air. His corporate headquarters are on the same floor.

Burk Technology builds remote control equipment you can depend on. Our systems are backed by a two year warranty and our same day repair service. Call us for a copy of our latest product catalog.

Burk Technology, Inc.
7 Lomar Drive
Pepperell, MA 01463
(508) 433-8877

BURK
TECHNOLOGY

Call TOLL FREE
1-800 255-8090

READERS FORUM

If you have comments for *Radio World*, call us at 800-336-3045 or send a letter to Readers' Forum (Radio World, Box 1214, Falls Church VA 22041 or MCI Mailbox #302-7776). All letters received become the property of Radio World, to be used at our discretion and as space permits.

Credit where due

Dear RW:

I want to thank **Radio World** and Dee McVicker for their excellent coverage of our recent project at WRCQ, Fayetteville, NC. However, there is one mistake that needs to be corrected.

In the article, Dee refers to Broadcast Supply. All the equipment for the studios was purchased from Broadcast Services Company, Four Oaks, NC.

Given the short time line of the project, Neil Davis' and Cindy Edwards' help was essential.

Once again thank you.

Jerry E. Brown
Broadcast Support Group, Inc.
Chapel Hill, NC

Helpful info

Dear RW:

I always look forward to reading each new copy of **Radio World**. Your staff and contributors keep us in the industry updated on a variety of issues affecting broadcasters.

From FCC actions to equipment reviews, **RW** fills the bill. Also, the Reader Service Card makes it easy to get desired information with one mailing.

I appreciate the *1990 Annual* and in

particular the subject index. I recently needed to compile a report on RF radiation. The *Annual* gave me several detailed articles for reference.

I'm certainly glad I saved those back issues.

Ed Hobgood, CE
WJSU-FM, Jackson State University
Jackson, MS

A boost for NFR

Dear RW:

On 22 March, WQYK received special Temporary Experimental Authorization from the FCC to conduct over-the-air tests of frequency modulation through our AM transmitters (Noise-Free Radio, or NFR) for a period of six months. Frequency modulation will be superimposed on our normal AM carrier.

This testing is a direct result of the work of George Yazell, a retired PE from Lakeland, FL. In a cooperative arrangement between George and myself, we have designed and constructed the transmission and receiving equipment.

At this point the NAB has shown no signs of approval for our work but continues to insist that NRSC-2 is the solution to our AM woes.

Does NRSC-2 address the problem of impulse noise (static)? No. Does the NAB actually believe that the average civilian cannot hear the difference between FM and NRSC-AM?

C'mon guys, let's try something that will directly address the basic problems of AM radio.

Frank Berry, Dir., Technical Operations
WQYK AM/FM
St. Petersburg/Tampa, FL

Non-ionizing radiation

Dear RW:

Thought your readers might be interested in some field experiences with non-ionizing radiation compliance.

Broadcasters must now comply with new standards in regards to human exposure to non-ionizing radiation. The new standard is plainly laid out in material from the NAB and FCC.

The old standard was something like "anything less than what burns through the tower guy's gloves." Many of the practices of days gone by are just not accepted and could cost someone a license.

I have had two recent unpleasant experiences with non-ionizing radiation compliance. The first was simply by chance. I was on the way to work at one station and had to pass by the transmitter site of another. Dropping by the transmitter shack to pick up some goodies, I noticed a strange vehicle loaded with hardware. You guessed it! It was climbing gear. No one had notified me and the tower man seemed to have little knowledge of NIR.

Fortunately I was in the right place at the right time. We reduced power as needed and met the standard. The tower man now has a copy of the FCC guidelines and strict instructions to call even if he's only working on the two-way stuff

Recent controversy and confusion about the FCC's modulation regulations have created problems for FM broadcasters.

A near decade of deregulation, plus new developments in measurement technology have combined to place stations in what many engineers are calling a "Catch 22" situation.

On the one hand, the Commission, through its Office of Science and Technology, got out of the business of type-accepting modulation monitors.

At the same time, however, the FCC's enforcement bureau and field inspectors have continued to approach the entire modulation question as if there had never been any shift in policy or change in the technology.

While field offices do make known the basic measurement technique used for monitoring modulation, there are still unanswered questions.

How does the Commission deal with short peaks of overmodulation, and is there a "fudge factor"—much like that which is generally thought to exist when patrol cars use radar to identify speeding cars—allowing for short instances which exceed the limits?

Caught In An FCC Catch 22

These questions have left stations at a loss to determine how to comply with the modulation regulations and manufacturers of monitoring equipment grappling with the thorny question of how liberally they may interpret the rules.

It's understandable that stations in aggressively competitive markets would seek the maximum allowable

modulation. But the entire industry is concerned about providing the best possible quality in a world of CDs and DAT and worried about the tendency of receiver manufacturers to narrow the IF bandwidth to keep consumers from complaining about interference.

Some engineers have even suggested eliminating the "speeding ticket" approach to modulation entirely and moving toward monitoring the occupied bandwidth instead.

Whatever the solution may be, the new Sikes Commission should take a look at modulation rules in terms of definition and enforcement. The FCC needs to develop an approach that will consider recent technological advances and provide for interference protection.

A clarification—much like that concerning dial-up remote monitoring—or if necessary a petition for rulemaking on modulation would go a long way towards helping stations maintain quality and competitiveness while preventing interference.

And it should be undertaken before the next widespread modulation enforcement "raid" in a particular market or city.

—RW

below our antenna. Another broadcaster on the tower seemed not to be concerned about powering down or turning off to comply.

The next incident presented another problem, not with compliance but convenience. We had been in touch with all co-located broadcasters about non-ionizing radiation compliance on our towers but were surprised when one fellow broadcaster called and wanted to turn off our gear with only minutes notice.

We had been very clear to everyone about our need to comply but had done a poor job of making clear the idea that commercial stations just don't turn off because the tower guy finds it a convenient time to work. Fortunately no real harm was done but it was ratings time and I wonder who gets to explain to

management why a remote planned for two months has to be canceled to work on the tower.

Many tower crews don't take the problem seriously. They've climbed hot towers for years. Now someone has to explain to them why they can't work at what may be the best time for them. I can't say I'd want to climb a thousand foot stick in the dark either.

It may be some time before this all gets sorted out. I've already had misunderstandings with other broadcasters. For some stations going off for work at the wrong time could cost more than the tower work itself. Figure that into your next budget.

Jerry A. Miller, CE
KDCK/KGNO
Dodge City, KS

Radio World
Vol 14, No 8 April 25, 1990

Editor, Judith Gross
Associate Editor, Alex Zavistovich
News Editor, Alan Carter
Reporters, Charles Taylor, John Gatski
Benn Kobb, Frank Beacham/L.A.
Editorial Assistant, Marissa Friedman
Technical Advisor, Tom McGinley

Production Director, Kim Lowe
Jeanne Pearson, James Gillgam,
Bill Spencer

Publisher, Stevan B. Dana
Associate Publishers, Arthur Constantine
Carmel King

Ad Coordination Manager, Simone Leaser
Circulation Manager, Tiana Hickman
Accounts Receivable, Caroline Freeland

Advertising Sales Representatives:
East Coast, Art Constantine
800-336-3045, Fax: 703-998-2966
Midwest, Mike Dahle
914-762-3572, Fax: 914-762-3107
West Coast, Pat Macsata
415-786-2198, Fax: 415-786-2754

Radio World (ISSN: 0274-8541) is published semimonthly (except February, which has 3 issues) by Industrial Marketing Advisory Services, Inc., 5827 Columbo Pike, Suite 310, Falls Church, VA 22041. Phone: 703-998-7600, Fax: 703-998-2966. Second-class postage rates is paid at Falls Church VA 22041 and additional mailing offices. POSTMASTER: Send 3579 forms and address changes to Radio World, P.O. Box 1214, Falls Church VA 22041. Copyright 1990 by Industrial Marketing Advisory Services, Inc. All rights reserved. Free subscriptions are available upon request to professional broadcasting and audiovisual equipment users. For address changes, send current and new address to RW a month in advance of the above address. Unsolicited manuscripts are welcomed for review; send to the attention of the appropriate editor.

Next Issue
Radio World
May 9, 1990

Send Radio World your

TECH TIPS

Have a favorite maintenance technique, quick fix or creative solution to an equipment problem? Don't give it away. Send it to **Radio World** and earn

\$25
for each tip published.

Keep it simple and include name, address and phone. FAX it to 703-998-2966 or mail it to: P.O. Box 1214, Falls Church, VA 22041.

**GET IT
RIGHT**
GET IT FROM **ALLIED**



Forget everything you've heard.

That's what you'll do when you hear the new Telemix 2000 on-air phone system. Gentner's digital hybrid technology delivers the cleanest, clearest sound that ever came out of a telephone line. The optional Frequency Extender actually gives you a broader range of audio than the telephone line holds. It gets rid of that tinny "telephone sound" by augmenting the low end for full, natural voice quality.

Telemix 2000 not only gives you clearer sound, but more control. You can record calls on-air or off-air, talk to callers on or off the air, conference calls together, even put extended-frequency remote signals

on the air. Hands-free, one-button operation means you'll never have to take off the headphones or leave the mic.

Telemix 2000 is easy to work with right from the start. It comes fully assembled, tested and ready to install. Gentner even has custom control panels to match most consoles or studio furniture at no extra cost.

Make your phones work harder—and your work easier. Our new white paper, "Getting the most out of your phone system with today's technology," will show you how. Call your Allied representative today for your copy—before you forget.

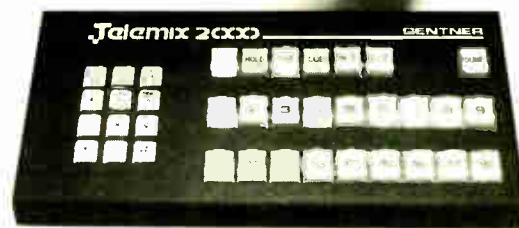

NEW

**HARRIS
ALLIED**
BROADCAST EQUIPMENT

800-622-0022

CANADA 800-268-6817

STUDIO EQUIPMENT • HARRIS RF PRODUCTS • SATELLITE GEAR • TRADE-INS • TURNKEY SYSTEMS

© 1990 HARRIS/ALLIED

Circle 7 On Reader Service Card
World Radio History

State Licensing Study Released

by Charles Taylor

Washington DC A long-awaited government report outlining incidents of state involvement in the licensing of broadcast engineers and technicians has been released, ending the issue's near-dormancy for more than a year.

The 22-page report, released 19 March, draws few conclusions, focusing instead on professional organizations' reactions and specific disputes between practicing technicians and the six states that have brought action against their use of the term "engineer."

Unfair control?

Ordered in January 1989 by Rep. Matthew Rinaldo (R-NJ) and Rep. Edward Markey (D-MA), the study is intended to help lawmakers assess whether states possess unfair control of technicians ability to practice their trade and whether

legislation may be needed to block state influence over engineers.

No real action has evolved since the controversy began two and a half years ago. When legislation halting state intervention was called for by the National Association of Radio Telecommunications Engineers (NARTE), the congressmen ordered examination by the Government Accounting Office (GAO).

Regarding the state incidents—reported in New Jersey, Michigan, New Mexico, Texas, Washington and Colorado—the GAO said that complaints generally were triggered by the use of the terms "engineer" or "engineering," typically found in trade magazine and telephone directory advertisements.

"In some of the cases we identified," GAO said, "the individuals cited have challenged the state board's assertion of jurisdiction over them. States have responded to these challenges in differ-

ent ways, ranging from simply dropping the matter to proposing changes to their statute."

The report then quoted NARTE's claim that such inconsistency has created "a regulatory crisis for telecommunications engineers and technicians."

Three issues to resolve

The GAO noted three primary elements of the issue that need resolution: whether "telecommunications engineering" constitutes the "practice of engineering" as defined by state engineering statutes; whether individuals can offer engineering services or call themselves "engineers" to the public without being state-licensed; and an agreed-upon definition of what constitutes telecommunications engineering.

It also noted that GAO found "no consensus among various groups within the telecommunications industry concerning

the impact these issues have on them."

NARTE, GAO explained, is a proponent of legislation to preempt state jurisdiction over engineers. The Society of Broadcast Engineers does not support NARTE's specific proposal but is concerned about state licensing and recently proposed that the FCC preempt state licensing of technicians that work exclusively at FCC-regulated facilities.

Other organizations expressed concern over individuals who claim to be telecommunications engineers without professional registration. According to the report, the National Society of Professional Engineers "does not consider the title 'engineer' to be a generic title available for use by those who do not engage in the practice of engineering."

For copies of the GAO report, call the agency at 202-275-6241.

TV Marti Goes On the Air in Cuba

(continued from page 1)

broadcast, Radio Moscow, was taken off in early March when the Soviet Union terminated rebroadcasts of the radio programming.

Whatever programming it chooses, Cuba has the capacity to crank as much as 300 kW from its AM transmitters, based on FCC estimates.

Unofficial reports estimated the transmitter capacity could be as high as 1 million W, several Florida CEs said.

Helping distressed AMs

About 11 Florida stations, subject to heavy interference from Cuba, are authorized by the FCC to transmit with increased power day/and or night, with a different antenna configuration or on an alternate frequency, all dependent on the protection contours.

The policy was enacted in the early 1980s to help stations overcome Cuban

broadcast interference that increased in strength when the US's Radio Marti went on the air, according to the FCC AM Section spokesman Henry Straube.

Even with the increased power of these stations, many stations worry about Cuba's threats of retaliation for TV Marti.

WSUN serves St. Petersburg on 620 kHz and has authorization to increase its licensed 5 kW limit to 10 kW to overcome Cuban interference.

"We keep up with it now," WSUN Promotions/Assistant Engineer Zoltan Koppany said. "But we are expecting them (Cuba radio) to fire it up within the next few weeks."

Coral Gables' WVCG-1080 kHz is specially authorized to transmit 20 kW instead of its licensed 10 kW at night because of interference from a Cuban station.

WVCG CE John Sitone said the station

needs as much as 50 kW at night with the threat of increased Cuban retaliation.

"The thing is that Castro does not want TV Marti," Sitone said.

Signal option

WRFM-830 kHz in Hialeah has FCC permission to broadcast its daytime signal from 880 kHz during interference, but the station has not employed that option yet, GM Adib Eden Jr. said.

He said interference on 830 kHz is more prevalent at night, but the FCC would not authorize the same frequency move as its daytime signal because of WCBS's clear channel status on 880 kHz.

The feeling among Florida stations is that interference will only get worse, Eden said.

"All broadcasters are concerned that he (Castro) will retaliate," Eden said. "His transmitters range from 500 kW to a million watts."



Multiple Amplifier Arrays

Have them your way!

Four or eight channels for YOU to easily configure as Microphone, Line Buffer, Distribution and Level Matching Amplifiers. Form sum and difference networks, Interface phone lines, Drive headphones, Make a

simple Mixer or Press Box... just by changing jumpers. Gains to 82dB, Low noise balanced inputs. Clean +24dBm active or transformer balanced outputs.

Configurable circuitry... to fit your needs.

Call or write for free detailed brochure.

AUDIO TECHNOLOGIES, INC.
328 W. Maple Ave., Horsham, PA 19044
(215) 443-0330 • FAX (215) 443-0394



FROM \$349

Air Cooled
Dummy Loads
now in power
ratings of
5kW, 10kW,
15kW, 25kW,
35kW, 50kW,
and 75kW
with low VSWR
that is stable
under power
with a
frequency range
of 60hz to
240Mhz.
QUIET
COMPACT
PORTABLE



**ALTRONIC
RESEARCH
INC.**

For (OMEGALINE) RF
Coaxial Load Resistors

WATER AND AIR COOLED
MODELS FROM 5 to 200KW

CALL TOLL FREE
1-800-482-LOAD

P.O. Box 249
Yellville, AR 72687
(501)449-4093

FCC Cites Philly FMs

(continued from page 1)

Although the FCC would not reveal the specific complaint that prompted the FCC inspection, its involvement may, in part, stem from concern by modulation monitor company, Belar, which is located in nearby Devon, PA.

Belar President Arno Meyer said he voiced concern to the Commission's Office of Engineering and Technology (OET) last fall about confusion surrounding modulation rules and a national tendency toward overmodulation.

"We did complain that there is an overmodulation problem throughout the United States," Meyer said. "But we did not complain about any one station.

"We were told six months ago (the Commission would look into overmodulation problems) and they finally got around to it," Meyer said.

Discrete spectrum photos

To show the Commission an example of overmodulation, Belar recently sent photographs of occupied bandwidth spectrums of three unidentified Philadelphia stations Meyer had measured. He changed the carrier frequencies in the photos to avoid identifying the stations.

The photographs "could have precipitated this (FCC) visit," Meyer acknowledged.

Based on FCC 73.1570 rules, a station cannot modulate more than 100% (75

kHz deviation) if it has no subcarriers and 110% (82.5 kHz deviation) if it has as many as two subcarriers.

Although modulation monitors have not been type-accepted by the FCC since 1983, the old rules specified monitor accuracy within 5%.

Of the stations he measured, Meyer said one had 103% modulation, which is within the rules because of the margin of error. Another station measured 108%, which is legal because the station used subcarriers.

The third was modulating about 120%, clearly illegal, based on the rules, Meyer said.

A knock at the door

WSNI CE Mike Guidotti confirmed that his station was monitored and visited by the FCC.

"They nailed us for overmodulation of 3%," Guidotti said.

CEs at other stations that reportedly were monitored would not comment about the FCC action.

Also, neither Weller nor FCC Engineering and Measurement Engineer Jim Higgins, who made the surprise inspections, would comment about what modulation readings were recorded at WSNI or the other stations.

Some unofficial reports said there may have been a station found to be modulating as high as 120%, but the FCC would neither confirm nor deny those reports.

Modulation Measurements

by John Gatski

Washington DC Engineers! Do you know how FCC inspectors measure a particular station's modulation when they make their mobile visits to your town?

As demonstrated by its recent monitoring of Philadelphia stations, FCC Engineering and Measurement Unit inspectors employ a uniform system to make sure the same criteria applies to all stations that are monitored, Field Operations Bureau Engineer Bob Weller said.

Inside the FCC van, the unit's composite modulation equipment includes a signal generator, a high quality receiver, RF spectrum analyzer and oscilloscope.

Weller said the Commission's measurement technique is very accurate and clearly indicates what are legal and illegal modulation levels.

"Essentially, a calibrated 75 kHz deviated (i.e., 100% modulation) FM signal is generated and fed into a high-quality receiver," Weller explained. "The receiver discriminator output is observed on an oscilloscope and adjusted so that the calibration signal fills a portion of the

oscilloscope display."

According to Weller, "The calibration signal is then removed and a real station signal is observed. Comparison of the real station's display with the calibrated signal's display using the oscilloscope's graticule or using its internal digital measurement features gives the modulation level of the station."

Modulation measurement accuracy depends on the accuracy of the calibrated 75 kHz deviated signal. During measurements of stations, FCC inspectors generate the 75 kHz deviated signal with a 31,188 Hz modulating frequency, which is accurate within $\pm 0.032\%$

Accuracy also depends on the receiver's flat frequency response to at least 100 kHz, the FM antenna's flat response on the frequency being measured and a monitoring location free of multipath, according to the FCC.

Monitoring directly from the transmitter's sampling loop can compensate for multipath, FCC Engineer Jim Higgins said.

For information about the FCC's modulation procedures, contact Bob Weller at 202-632-7593.

Higgins noted that measurements were made off-air and through a direct connection to transmitter sampling loops, which avoids multipath complication.

Privately, one engineer said there is a "mild" loudness war in Philadelphia, but "nothing compared to New York City."

A new look at the rules

Meyer said he had asked the FCC to come up with a modulation "directive" last year, based on the confusion about the Commission rules and the 1983 deregulation that led to elimination of modulation monitor standards.

One example of the controversy surrounding modulation stems from Modulation Science's introduction of the Mod-Minder last year.

Although the FCC no longer approves modulation monitors, the company said

the device meets pre-1983 type acceptance rules, but allows up to 4 dB more modulation because it measures modulation by ignoring shorter peaks.

Belar and other traditional modulation monitor companies interpret the FCC rules differently, claiming that monitors must consider the short peaks to accurately gauge modulation.

However, based on information **Radio World** obtained, only one of the five known of the six stations reportedly notified about overmodulation in Philadelphia was using a Modulation Sciences' ModMinder. The other four stations were using other modulation monitors.

Based on the varying interpretations, Meyer believes the FCC needs to clarify its rules. "Does the Commission have a rule on overmodulation? If not, tell us. We will modify our monitors accordingly," Meyer said.

For more information, contact Bob Weller at the FCC, 202-632-7593, Jim Higgins at the FCC, 301-725-3474, or Arno Meyer at Belar, 215-687-5550.

Audio/Video Systems Engineers

Walt Disney Imagineering is the creative energy behind the Walt Disney Theme Parks. If you have the talent, the experience, and the drive to turn imagination into reality, we need you.

With lots of exciting new projects ready to leap off the drawing board, our future looks bright and prosperous. In fact, the

incredible growth at WDI has created great new opportunities for **Audio/Video Systems Engineers** who have at least 5 years of experience in the field. This represents a highly attractive alternative to the broadcast industry, and it's a great chance to work closely with Attractions Designers in finding ways to best utilize the audio/video state-of-the-art technology.

Walt Disney Imagineering offers an outstanding benefits package and a creatively charged work environment. After all, what would you expect from the Company who is in the business of making people smile? For immediate consideration, please send your resume to: **Walt Disney Imagineering, 800 Sonora Avenue, Glendale, CA 91221-5020, Attn: Human Resources, Dept. NAB-RW.** Equal Opportunity Employer.



©Disney

WALT DISNEY Imagineering ©

CLASS A FM BROADCASTERS

UPGRADE TO 6 KW

New **SEPARATION TABLES** indicate most separations increased but some actually **decreased**.

The following studies will be of assistance to you in filing with the FCC.

- CHANNEL ALLOCATIONS
- SERVICE CONTOURS
- TERRAIN ELEVATION RETRIEVAL
- POPULATION COUNTING
- AREA-TO-LOCATE (ALS)

Call our Sales Department to place your order or for more information.

dataworld®
A Service of DW, Inc.

Fax (301) 656-5341
(301) 652-8822 (800) 368-5754

QEI QEI QEI QEI QEI

WHY QEI?

The Longest.

Our PA tube warranty is the longest in the business — **15,000 hours.**

Call us toll free at 800-334-9154 for all the facts on QEI "New Reliables" FM transmitters from 3.5 kw to 30 kw.

QEI CORPORATION
ONE AIRPORT DRIVE • P.O. BOX D
WILLIAMSTOWN, N.J. 08094
TEL (609) 728-2020 • FAX (609) 629-1751

QUALITY • ENGINEERING • INNOVATION

GO WITH THE WINNERS.

DYNAMAX CTR100 SERIES

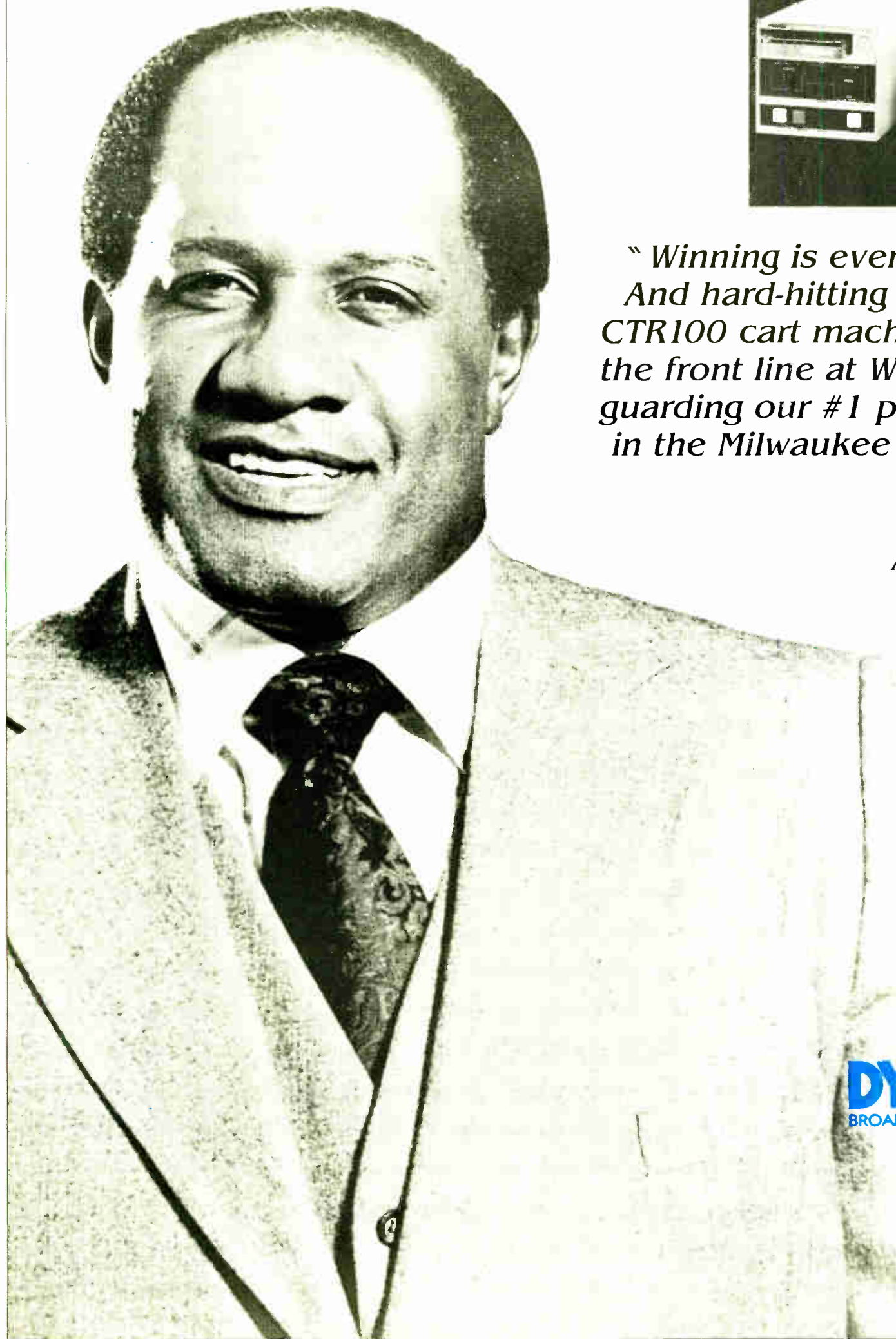

*"Winning is everything.
And hard-hitting DYNAMAX
CTR100 cart machines are on
the front line at WLUM-FM
guarding our #1 position
in the Milwaukee market."*

*Willie Davis
President
All Pro Broadcasting*

DYNAMAX
BROADCAST PRODUCTS BY FIDELIPAC[®]

Fidelipac Corporation
 P.O. Box 808
 Moorestown, NJ 08057
 U.S.A.
 609-235-3900
 TELEX: 710-897-0254
 FAX: 609-235-7779

Circle 35 On Reader Service Card

World Radio History

FM Travelers' Service Offered

by Charles Taylor

Charlotte NC When Charlotte investor Eric Silverman elected to try his hand at the business of broadcasting, buying an available FM, AM or TV station decidedly wasn't enough.

"I thought radio and television themselves were very competitive. I've always been interested in them. But I wanted to try to create something different," he said.

Two years, 103 pages of engineering deliberation and many dollars later, Silverman appears to have done just that.

The founder of MHS Holdings here has proposed the nation's first 24-hour com-

mercial FM travelers' service, designed to broadcast from five transmitting sites along a 25-mile X-shaped stretch of Interstates 77 and 85 in Charlotte.

FCC seems intrigued

So far, he said, the FCC seems intrigued. The application, which was filed last December, points out that the service would be experimental, giving the Commission the right to grant the privilege on a temporary basis. No nod has been given yet, but those involved are hopeful with the service's possibilities.

"The thing that struck Mr. Silverman is that people who are traveling in their

cars aren't listening to AM. They're listening to FM," said Silverman's engineer, John Lundin, VP with Washington's du Treil, Lundin and Rackley. "It might be an approach to take to see if you can get better quality audio and better information to the public."

Just how the experimental service intends to reach its highly segmented audience is somewhat of an engineering curiosity.

The operation will consist of a five "cell" system transmitting coverage in a cloverleaf pattern along the two interstates. Each of the transmitter cells will operate at 92.7 MHz with a maximum directional effective radiated power of 84 W, utilizing vertical polarization only.

An antenna height of 53' is proposed for each of the four cells, which surround the fifth central cell—with a 200' antenna—located closest to the intersection of the highways. Each of the four will feed the signal from a 10 W FM transmitter—in mono—to a pair of vertically stacked, vertically polarized Scala CL-FM log periodic antennas.

From the central site, four 10 W transmitters will feed a pair of horizontally stacked, vertically polarized antennas. Each pair of antennas will be oriented to-

ward the other cells.

One of the few uncertainties of the operation is potential interference that might result as a result of the carrier synchronization. Might one transmitter create interference over another?

Solving problems

According to Lustin, techniques exist if a problem should arise. First, power could be reduced from the rated 10 W output. Orientation of the antenna system could be changed to reduce effective radiated power toward the problem area. The beamwidth of the transmitters at the four outward cells can be reduced with loss in maximum gain by stacking the antennas horizontally, as they are at the central cell.

This, Lustin said, would narrow the horizontal plane pattern and subsequently reduce coverage of the roads feeding the interstates.

As far as programming, Silverman intends a variety, however, specifics have not yet been solidified. "People on that segment of the highway at midnight will not be the same who were there at 11 AM or 3 in the afternoon, so I don't see the need for total live broadcasting," he said. "Part of it will be in an evolutionary stage."

According to papers filed with the FCC, the service would provide basic traveler information, including the location of emergency services; the location and description of routine services such as lodging, food and gas; and availability of miscellaneous goods and services such as clothing, drug stores, camping equipment, packaged food, souvenirs, post offices, banks, laundry and religious services.

The service's advertising would be limited to the narrow spectrum of businesses travelers would frequent in travel, which Silverman said poses no threat to other radio stations in the Charlotte market.

"We'd be creating new radio dollars, not affecting the present radio dollar. We're going for a whole different segment of the market. I don't think other stations in the market see me as a threat or a problem," he said.

For information, contact Marc Silverman at 704-362-0400.

GET IT RIGHT
GET IT FROM ALLIED

THE SOURCE
with resources, design
expertise and unparalleled
worldwide capabilities



HARRIS ALLIED SYSTEMS

Harris Broadcast Division is one of the largest and most respected manufacturers of transmitters, antennas and related RF products worldwide. Allied Broadcast Equipment represents the largest selection of audio and studio equipment in the world—over 5000 products from more than 250 manufacturers. Together, we offer total program management with engineering and design expertise that ranges from facility layout and site preparation to furniture design, from equipment specification to final verification of performance.

When you work with Harris Allied Systems, you work with people who know broadcasting and communications from conception and design through final sign-on and documentation. So you can be most confident that your pro-

ject will have a functional, ergonomic layout like the ones pictured here. You can be sure that all of your equipment will meet the highest standards of form, function and reliability. You can then concentrate on the other important aspects of managing your facility.

From transmitter building (pre-fabricated or constructed on-site), to transmitter installations, towers, antenna systems and even terrestrial microwave links, the experts at Harris Allied Systems will ensure total systems integration and performance.

HARRIS ALLIED SYSTEMS

217-222-8290

P. O. BOX 4290 • QUINCY, IL 62305-4290

©HARRIS/ALLIED 1990

Icing Specs

(continued from page 2)

Inc., said he is concerned that mandatory icing is not included, citing icing as the "primary" reason towers fall.

Consultant Bob Cornforth of Cornforth Associates also supported mandatory icing standards.

"I think the industry and consultants need to give broadcasters the best advice they can," Cornforth said. "It's a little hard to say what people's motives are. I see some are concerned about the cost and competing on a cost basis. As a consultant, I'm mainly concerned about quality."

fm TRANSMITTERS
FROM CONTINENTAL

- COMPACT AND EFFICIENT
- SOLID-STATE DRIVER
- EXCLUSIVE SOFT START™
- AUTOMATIC POWER CONTROL
- TOTALLY SELF CONTAINED
- TRANSTAT™ READY

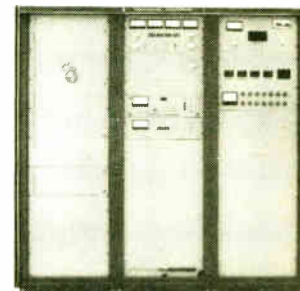

varian 
continental electronics division



P.O. Box 270879 Dallas, Texas 75227 • (214) 381-7161 FAX: (214) 381-4949

2061

C270



\$3,995

2-TRACK

With Center Track
Time Code \$5,995

C274



\$4,995

4-TRACK

C278



\$5,995

8-TRACK

REVOX OPEN REEL RECORDERS. HIGHER QUALITY. LOWER PRICES.

THE C270 SERIES This exciting new line of recorders provides you with all the traditional Studer Revox benefits—mechanical precision, electronic sophistication, supreme sound quality and superior support—adding up to state-of-the-art analog recording technology. The C270 is available in 2, 4 and 8-track versions with or without remote/autolocator.

BEST BUY Compare the “street” price and performance of any C270 Series machine with the competition, and you’ll find there is no competition. The die-cast deck plate and head block, the precision mechanics and a host of powerful features tell you any C270 Series machine will last as long as you need a reel-to-reel in this emerging era of digital workstations. And in the digital future, you’ll need analog recorders that will sound good—for a long time. That’s why your last reel-to-reel should be a Studer Revox.

TIME CODE . . . OR NOT The C270 2-track version offers optional center track time code for effortless synchronization to picture or sound. The C274 4-track and C278 8-track are both equally adaptable to production or post. The optional remote/autolocator stores 18 start/stop addresses and provides full transport and channel remote control to fit into any professional studio environment.

LOGGING TOO For station logging applications, special super low speed versions of the C274 and C278 are available with built-in time/date code generator and reader with search capabilities, providing up to 25 hours of continuous audio on one reel of tape.

Call your Studer Revox Professional Products Dealer—or Studer Revox direct—to discuss all the details. Or simply call **800-366-4900** to receive our C270 series color booklet.



C270 Remote/Autolocator

STUDER REVOX

Studer Revox America, Inc. • 1425 Elm Hill Pike • Nashville, TN 37210 • (615) 254-5651
New York (212) 255-4462 • Los Angeles (818) 780-4234
Studer Revox Canada Ltd., Toronto (416) 423-2831
Circle 65 On Reader Service Card

© 1990 Studer Revox America, Inc.

World Radio History

How the newest AM transmitters earned one of the oldest names in radio.

Introducing the Gates Line of 1, 2.5 & 5 kW Solid State AM Transmitters.

Gates. It's more than a name — it's a tradition of quality and value. To earn that name, these affordable new transmitters had to meet the highest industry standards in five key areas:

Value

- Overall efficiency of up to 72% cuts power costs.
- Multimeter plus PA voltage, PA current, and forward/reflected power meters standard.
- Output tuning included as standard.
- Remote inputs compatible with both TTL and relay-type remote systems.

Durability

- No tube failures, time-consuming adjustments or replacement costs.
- Modular construction with easily accessible socketed MOSFETs.
- "Chimney design" air handling keeps transmitter clean and dust-free.
- 100% solid state "soft-failure" power amplifiers.

Simplicity

- Six independently adjustable power levels accommodate virtually all PSA/PSSA requirements.

GATES



- Color Stat™ front panel with signal flow block diagram and red Fault LEDs shows transmitter status at a glance.
- Rugged, dependable discrete logic controller.

Reliability

- Automatic overload power cutback keeps the transmitter

on the air at the highest safe power level.

- Bandpass output network has proven its lightning survival capabilities in the field.
- Automatic instant AC restart.
- Battery backed-up controller memory.

Performance

- Patented Polyphase Pulse Duration Modulation technology.
- Unsurpassed reach with 130% positive peak capability.
- Minimal distortion, overshoot and ringing for crisp, "ear grabbing" sound.

Original circa-1946 Gates transmitters are still on the air to remind us that value, durability, simplicity, reliability, and performance are as important right now as they ever were. So if you want an affordable solid state transmitter with all the "old-fashioned" advantages, call Harris today for more information on the newest AM transmit-

ters — and how they earned the proudest name in radio.



Harris Broadcast Division
Marketing Department
P.O. Box 4290, Quincy, IL USA 62305-4290
Tel (217) 222-8200 Ext. 3408
Fax (217) 222-7041

© 1990 Harris Corporation

Circle 37 On Reader Service Card

World Radio History

EUREKA's Tradeoffs

by Steve Crowley

Washington DC Last month we saw how the EUREKA 147 digital audio broadcasting (DAB) system uses psychoacoustics to reduce the digital audio data rate by a factor of six. Now we'll see how the transmission scheme helps the data divide and conquer multipath interference.

The EUREKA system takes into account the variation of multipath with time and frequency. Variation with time

CONSULTANTS CORNER

can occur when the receiver is in motion and moving through interference pockets.

Frequency variation is less intuitive. Multipath interference occurs when signals on paths of varying length arrive at the receiver out of phase. That phase relationship is a function of wavelength, which corresponds to frequency. A different frequency will change the phase relationship and thus change the likelihood of interference at any point.

Multiple carriers

The EUREKA system overcomes multipath interference by distributing the data over many carrier frequencies. Each carrier is phase modulated, with phase representing a digital symbol. Two phases could represent the binary symbols "one" and "zero," for example. More likely, a four or eight phase scheme will be used for greater bandwidth efficiency.

This system can transmit 16 stereo programs in 4 MHz of bandwidth. The 4 MHz channel might contain 256 carriers spaced every 15,625 Hz, with 16 carriers for each of the 16 programs. The data for the first program would occupy the first, 17th, 33rd and so on up to the 241st carrier. If transmission was from 300 to 304 MHz, the corresponding carrier frequencies would be 300.00, 300.25, 300.50 . . . 303.75 MHz. The second program would occupy carriers 2, 18, 34, etc.

With the data divided over so many

frequencies, the data rate per frequency is low—so low that each symbol lasts longer than the spread of propagation delays. Furthermore, the receiver doesn't sample between symbols (that period of uncertainty when phase transitions arrive from multiple reflections). These features prevent interference between one symbol and those before or after it.

Not safe from itself

Even though symbols are protected from each other, a symbol isn't protected from itself. Multipath signals can still arrive out of phase and wipe out a frequency. When this happens on one of the 16 frequencies carrying a program, 15 are left. Using error correction, the receiver predicts the missing data.

Part of the error correction scheme is analogous to that used for compact discs. The audio data bits are interleaved in time. Extra bits containing error control information are added to the data stream.

This transmission process is called COFDM: Coded Orthogonal Frequency Division Multiplexing. "Coded" refers to the error correction process.

"Orthogonal" ultimately means that information can be extracted separately from each carrier without interference from adjacent carriers; it allows for modulation and demodulation using digital signal processing. "Frequency Division Multiplexing" refers to the distribution of data over many frequencies.

COFDM provides a "coding gain" that allows the receiver to respond to total power even with destructive multipath; this gain enables the system to use less power than FM, which responds to total power only in a multipath-free environment.

All this multiplexing and error correction takes a lot of digital processing power. Transmitters and receivers will largely be computing devices.

All receiver processing functions are being developed on integrated circuits. A major simplification in receiver design is possible with COFDM; the receiver processes only the carriers containing the desired program. It isn't necessary

(continued on page 15)

What Do BSW and JBL Speakers Have In Common?



Both offer great performance, smooth response and maximum value for the dollar.

The 4400 series monitor speakers from JBL are proven performers. They capture the full dynamic range, extended frequencies, and precise character of your sound as no other monitors can. There are 4 models available to match every monitoring application and all of them are extremely efficient, giving you the maximum amount of sound for your money. For even better performance, purchase your JBL monitors from BSW, the high performance supplier. BSW is at your service with qualified personnel available to provide the model you need at a great price, with the best delivery and after sale support in the industry. Go with a winning combination, JBL and BSW.

BSW

BROADCAST SUPPLY WEST

America's Full-Time Broadcast Supplier

1-800-426-8434

ORDERS • INFORMATION • SPECIFICATIONS
BSW • 7012 27th Street W • Tacoma, WA 98466 • FAX 206-565-8114

QEI QEI QEI QEI QEI

WHY QEI?

Power Up.



With our FMQ 3.5/5/10 kW or 20/30 kW FM transmitters, you can upgrade power in the field.

Call us toll free at 800-334-9154 for all the facts on QEI "New Reliables" FM transmitters from 1kw to 30 kw.

QEI CORPORATION
ONE AIRPORT DRIVE • P.O. BOX D
WILLIAMSTOWN, N.J. 08094

TEL (609) 728-2020 • FAX (609) 629-1751

QUALITY • ENGINEERING • INNOVATION

Circle 14 On Reader Service Card

QEI QEI QEI QEI QEI

WHY QEI?

24 Hours.



Our 24 hour service hotline number is 609-728-2020.

Call us toll free at 800-334-9154 for all the facts on QEI "New Reliables" FM transmitters from 1kw to 30 kw.

QEI CORPORATION
ONE AIRPORT DRIVE • P.O. BOX D
WILLIAMSTOWN, N.J. 08094

TEL (609) 728-2020 • FAX (609) 629-1751

QUALITY • ENGINEERING • INNOVATION

Circle 61 On Reader Service Card

Circle 18 On Reader Service Card

Design Your Own Audio Processing— introducing the CRL *Audio Signature*



The CRL Audio Signature is a unique way to think of audio processing. Combine a powerful four band compressor to an advanced microprocessor system: the result is a unit that thinks the way you do about processing. The Audio Signature includes:

- EXTENDED RANGE LINEARIZED COMPRESSORS
- USER DEFINABLE PROCESSING PARAMETERS
- COMPLETE FOUR PROGRAM MEMORY
- COMPLETE REMOTE CONTROL VIA RS-232 CONNECTOR
- REMOTE TERMINAL DISKETTE INCLUDED
- FOUR BAND REAL TIME ANALYZER DISPLAY
- EIGHT POSITION LED MULTIMETER
- UNIVERSAL AC-DC POWER SUPPLY (50 - 270 volts)

The Audio Signature lets you define the processing parameters that you want. Select the band split points—tailor the wide-band and multi-band density for your format. Boost or cut each band as you like. Once you have created the sound that you want, store your design in one of four memory positions. Remote control—you bet! Your PC and modem can control the Audio Signature from anywhere. Call or write CRL today — learn how you can design your own audio processing.

**THE
PROFESSIONAL'S
CHOICE**



Circuit Research Labs, Inc.

2522 West Geneva Drive

Tempe, Arizona 85282-3192 U.S.A.

(800) 535-7648 (602) 438-0888 FAX 438-8227

EUREKA: A Primer For the DAB System

(continued from page 13)

to decode the entire 4 MHz signal.

Those are the concepts. Details aren't pinned down because development is ongoing. There are myriad tradeoffs. For example, better error correction methods require more data and greater bandwidth.

There's no great rush to finalize. Ideally, system performance will be optimized to the propagation characteristics of allocated spectrum, of which there's none. It works best in the VHF and UHF bands and the European consortium developing the system is seeking frequencies for both satellite and terrestrial use.

Could spectrum be found in this country for a terrestrial system? How much would be needed? With interference criteria among the many specifications up in the air, we don't know. So, let's speculate.

No hurry

If every AM and FM station in and around a major market had this system, at least 20 MHz of spectrum would be necessary. When that much is required, unused television channels come to mind. But the unused channels aren't in the largest markets. Besides, until the additional spectrum requirements of HDTV are known, unused channels aren't available.

Radio astronomy . . . no. Land mobile . . . no; they're trying to get the TV channels, too, and may try to take whatever is found for DAB. Aeronautical, maritime, radio location . . . all no.

The hams. They did lose 220-222 MHz to land mobile last year due to inactivity. (The fundamental allocations precept: Use It or Lose It.) 20 MHz? No.

How about Uncle Sam?

That's about it . . . except for federal government frequencies. A bill pending in Congress would require the government to turn over at least 200 MHz of its spectrum for non-government use.

At the same time, a lot of people in this town are calling for cuts in the military due to receding superpower tensions. Could part of the military's 225-400 MHz band be closed down like an obsolete army base?

And while all that's going on, the Na-

tional Telecommunications and Information Administration (NTIA), the agency principally responsible for telecommunications policy, is conducting a review of use and management of the spectrum.

NTIA is also looking at allocation sharing. This would allow government and non-government users to share the same band on an equal basis. Since EUREKA spectra consists of hundreds of closely-spaced carriers, each having random phase and low power, it looks like wide-band noise; it's relatively benign to other communications systems.

The developers even hint at sharing spectrum with existing television stations. An exclusive allocation may not be necessary for DAB.

Implications are uncertain

Who gets DAB? It's not necessarily today's broadcasters. Once spectrum is allocated, how will assignments be determined? The last thing today's stations need is local over-the-air digital audio as a competitor.

Still, broadcasters face increasing digital competition. Consumer electronics get better and cheaper. Digital audio transmission by cable television systems is on the rise. The EUREKA system was originally designed for satellite audio transmission; it could still end up there.

Perhaps broadcasters could have an assignment preference. Since there will initially be few receivers, broadcasters could simulcast analog and digital signals. In the long term, digital and analog broadcasting may be complementary, especially if digital receiver prices don't reach analog levels.

If existing stations get DAB, however, what happens to the station marketplace? With the EUREKA system, all stations in an area can have equal quality digital signals. As digital receivers grow in number, the combined analog and digital signal quality of a 250 W AM station would approach that of a Class C FM facility.

The ultimate in AM improvement.



Steve Crowley is a registered professional engineer with the consulting firm of du Treil, Lundin & Rackley, Inc., 1019 19th Street, NW, Third Floor, Washington, DC 20036. He can be reached at 202-223-6700, or by FAX at 202-466-2042.

WE'VE MADE DEAD AIR A DEAD ISSUE.

There are worse things in radio than dead air. But not many.

And if your CD players aren't built to resist tracking errors, you could find yourself listening to some very embarrassing silence.

Not with the new CD-701 from Tascam. Its unique disc clamping system is a technological triumph that virtually eliminates disc vibration. So you never hear the awful hush that means a tracking error has occurred.

What you do hear is the finest sounding CD unit you can buy, with the same proprietary "ZD Circuitry" praised by two of Japan's top audio magazines* for eliminating low-level digital distortion.

Then there's the optional RC-701 Remote Control with Auto Cue so you can cue to the music instead of the track (for even less dead air). Or you can add the Ram Buffer for true, instantaneous startup.

And with four times oversampling and 16-bit D/A converters in an extra-rugged chassis, the CD-701 is superbly designed for the broadcast environment.

Can a CD player really deliver this kind of performance, track after track, disc after disc? Only if it's a Tascam.

Contact us or visit your Tascam dealer for more information about the CD-701. And take the sounds of silence off your playlist.

TASCAM



©1989 TEAC America, Inc., 7733 Telegraph Road, Montebello, CA 90640, 213/726-0303
*Radio Technology Component Grand Prix '88, CD Division, Stereo Sound Component of the Year (1988) & Best Buy (1988)

EBS EQUIPMENT

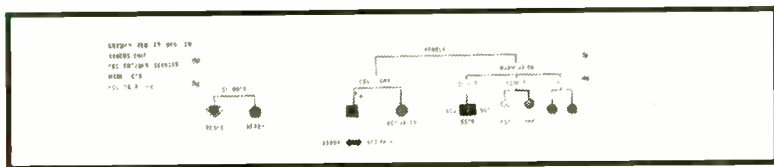

	Price
Model CEB Encoder-Decoder	\$540
Model CE Encoder Only	\$375
Model CE With Stereo Option	\$405
Model CD Decoder Only (REQUIRED FOR LPTV)	\$320
Receiver can be supplied to drive Decoder	\$100

- Encoder FCC Type Accepted • Decoder FCC Certified •
- Exceeds FCC Specifications •

All interconnections to the EBS equipment are made through a barrier terminal block. No special connectors necessary. In stock—available for immediate delivery.

GORMAN REDLICH MFG. CO

257 W. Union St. • Athens OH 45701 • 614-593-3150

Circle 64 On Reader Service Card

World Radio History

Circle 31 On Reader Service Card

KNIX Saddles Up for a Move

by Dee McVicker

Phoenix AZ KNIX-FM's guitar-picking music has been heard on the hot, dusty trails of Phoenix longer than most can remember. But, as any cowboy

FACILITIES SHOWCASE

will tell you, KNIX is not just about country music.

It is about bolo ties, oversized belt buckles and pickup trucks. And it is

about Arizona, which KNIX fits like a comfortable pair of cowboy boots.

Relocating KNIX-FM and its sister station, KCW-AM was as much an undertaking as, well, moving the Grand Ole Opry.

A project of grand scale or not, the move was necessary. The old facility in Tempe, AZ, had been expanded to accommodate AM and FM growth several times over the past couple of years.

Now, with a new satellite

country music service scheduled to air in the fall of 1989, the only place to go



The news editor's workstation at KNIX can be cued from the FM air studio next door. PHOTO BY JILL JACKSON

was out.

Luckily, the stations didn't have to go far. In a stretch of land behind the old facility, Buck Owens Stations structured a two-story, 25,000 square foot building for its blossoming staff of over a hundred. The planning alone took two and a half years.

Myriad details

Elliott Klein of Klein Broadcast Engineering, spearheaded most of the planning.

"Planning was very, very detailed," said Klein. "We wanted to build one of the best studios in the nation, and I think we have."

Director of Engineering Bob Van Buhler agrees. A KNIX/KCW newcomer who had started his tenure with the stations just as the new facility was getting underway, Van Buhler teamed up with Klein to execute the plan.

The result was a new building that included three on-air studios, two two-track production studios, an eight-track production studio and an expansive news center.

The plaster was barely dry in the new facility when Van Buhler began one of the most important projects for the group: introducing the new country and western service on Satellite Music Network.

The satellite feed for Buck Owens' country and western music service is up-linked on Ku band to Chicago and then re-uplinked on C band to affiliate stations. Today, some 17 stations downlink the traditional country and western format, including KCW-AM.

Quality reference

Instead of running direct lines between the network studio and the AM studio Klein said, "we decided to operate the AM just like an affiliate would in Minot, ND or Seattle, WA." This, he said, gives the group a reliable reference for quality control.

Manned by board operators around the clock from a Pacific Recorders & Engineering RadioMixer console, the AM on-air studio provides KCW with local commercial inserts and live assist when needed.

Several studio doors down, KCW's program feed is originated from a stand-up PR&E BMX-25 Series III console in

(continued on page 19)

Best Sellers.



Across the country and around the world, more broadcasters count on Audiopak tape carts than any others. That's because Audiopak carts are designed and manufactured for consistency, durability and exceptional audio performance — cart after cart after cart.

Whether you use carts as a "backup," for spots only or as your principal audio format, Audiopak has the right cart for you. The industry standard A-2 with 605 tape offers "workhorse" performance and outstanding longevity. With its revolutionary "neutral-design" casing and high-performance 613 tape, the AA-3 is perfect for stereo recording and playback. The AA-4's advanced 614 tape delivers sound that's so crisp and clean even professionals can't tell the difference between AA-4s and digital sources in blind listening tests.

Longevity, consistency, performance — whatever your needs, there's one way to be sure your carts will always meet them. Just do what thousands of broadcasters world-wide do. Insist on genuine Audiopak broadcast tape cartridges.



audiopak inc.
P.O. Box 3100
Winchester, VA 22601
USA
Tel. (703) 667-8125
Fax: (703) 667-6379



WHY QEI?

Single Phase 30 kW.



Our new FMQ 30000B is the only 30 kW transmitter available with a single phase power supply.

Call us toll free at 800-334-9154 for

all the facts on QEI "New Reliables" FM transmitters from 1kw to 30 kw.

QEI CORPORATION
ONE AIRPORT DRIVE • P.O. BOX D
WILLIAMSTOWN, N.J. 08094

TEL (609) 728-2020 • FAX (609) 629-1751

QUALITY • ENGINEERING • INNOVATION

Learning to Speak With Your Computer

This is the eighth in a 12-part series called An Introduction to Digital Electronics. Northern Virginia Community College will offer 1.3 CEUs (continuing education units) to registered students who successfully complete the course and an examination mailed at its conclusion.

Successful completion of the course and the final exam will also earn 1.3 professional credits toward recertification under the maintenance of certification provisions of the SBE Certification Program. To register, contact the Director of Continuing Education, Annandale Campus, 8333 Little River Turnpike, Annandale, VA 22003, or call 703-323-3159. The fee for the course is \$20.

by Ed Montgomery

Part VIII of XII

Annadale VA Since the beginning of the 1980s computers have become an aid to almost all walks of life.

Originally large machines, development of microprocessor technology has

display, light emitting diodes or a magnetic disk.

The input information must be converted to a series of digital pulses for

As electronics technology has advanced, the power of the personal computer has expanded.

the logic circuits of the computer. Several codes are available for this conversion such as ASCII, BCD and Hexadecimal.

These codes change the high-level language (BASIC, PASCAL, etc.) into the digital signals with which the computer must work.

Clocks and triggers

Registers are areas where information is temporarily stored. Control is the area where all areas of the computer are synchronized together. Often called the clock, this circuitry provides the "trigger" or pulse chain that allows mathematical functions to occur.

Arithmetic logic circuitry contains all of the logic gates previously discussed. All calculations in binary form take place here.

The accumulator is a special purpose register that contains the latest information from

Figure 1.

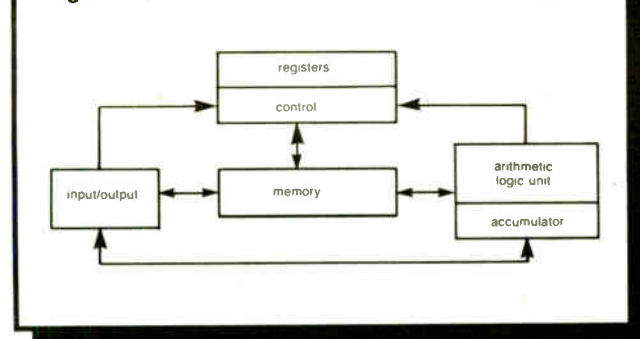

reduced their size and expanded their memories to the point that a desktop system can do more than what much larger machines could do just a few years ago. (Figure 1 is an illustration of the basic components of a computer.)

Input devices for the computer include keyboards, magnetic disk, tapes or a modem connected to a telephone line. Output can be via printer, video

the arithmetic logic circuitry.

Memory is the location where information is stored for future use. This can be from numerous sources: magnetic tapes and disks or RAM and ROM chips (Random Access Memory/Read Only Memory).

All of the work within the computer is performed in machine language.

(continued on page 20)

WHEN IT'S TIME TO WORK, WE PLAY.

ON AIR

Few things can make you look worse than equipment that doesn't work on cue. What you need is a CD deck that's at home in the studio, not at home in the home.

Tascam's CD-401 and CD-501 were especially designed for the broadcast environment. Their extra-rugged chassis design insures consistent, reliable performance even through demanding non-stop use.

Disc after disc, day after day, year after year.

Of course, they include all the features you'd expect. Independent D/A converters for the left and right channels, balanced +4 outputs and sub code out for system automation. Plus a 3-beam laser pick-up that provides perfect alignment and instantaneous error correction.

Don't let a consumer deck turn your programming into the original amateur hour. Contact us or visit your Tascam dealer for more information about the CD-401 & CD-501. No matter how hard you play them, they're guaranteed to work.

TASCAM®



© 1989 TEAC America, Inc., 7733 Telegraph Road, Montebello, CA 90640, 213/726-0303.

QEI QEI QEI QEI QEI

WHY QEI?

Less is More.



All of QEI's FM transmitters have no plate blockers or sliding contacts.

Call us toll free at 800-334-9154 for all the facts on QEI "New Reliables" FM transmitters from 1kw to 30 kw.

QEI CORPORATION
ONE AIRPORT DRIVE • P.O. BOX D
WILLIAMSTOWN, N.J. 08094

TEL (609) 728-2020 • FAX (609) 629-1751

QUALITY • ENGINEERING • INNOVATION

Oh-Oh! Call CORTANA

STATI-GAT The Affordable Lightning Prevention System

- Charge dissipation with 1/8", type 304, sharpened stainless steel rods
- Won't bend from ice/severe weather
- Provide a continuous low-resistance discharge path for static electricity

Cortana Corporation

Write for a Free Brochure.

P.O. Box 2548, Farmington, N. M. 87499
Call (505) 325-5336

Reducing the Risk Of Lightning Strikes

by Thomas Vernon

Harrisburg PA Signs of spring are cropping up all over central Pennsylvania: flowers coming up, the Susquehanna overflowing its banks and potholes in the roads.

And with spring at hand, can the lightning season be far behind? This month *Station Sketches* looks at some things you can do to make your plant more immune to bolts from the blue.

Lightning can enter the transmitter building via one of three methods: direct hits to the tower or transmitter building, via power or phone lines and indirectly via strikes to nearby structures.

Start at the top

The first place to examine at the site is the tower. Grab a pair of binoculars and check the rods on top. They should project well above the beacon in order to protect it.

Severe hits may vaporize these rods. Continuous flexing by the wind may loosen bolts securing them. They should be checked for tightness whenever the tower is inspected.

Also use binoculars to inspect the guy wires and their associated insulators. Considerable currents can be induced into

these wires during a direct hit to the tower.

Currents of such magnitude will easily jump the insulators, frequently leaving them with carbonized paths, cracked, broken or in severe cases, nonexistent.

Broken insulators should be repaired as soon as possible, as shorted sections of guy wire can cause reradiation problems and ultimately degrade your coverage pattern.

STATION SKETCHES

The anchoring point for each group of guy wires should be grounded to the nearest radial by a heavy copper strap.

At the base

Now let's move down to the base. On grounded towers, there should be at least four 10' galvanized steel rods driven into the earth and securely bonded to the tower.

The objective here is to get as much metal as possible in contact with the water table. This may be difficult in areas with sandy soil and good drainage.

Incidentally, if you have questions about

soil conductivity or what constitutes a good ground in your area, check with the local power company. They probably have more experience and more information than anyone else.

Protection for insulated towers is a bit more complicated. Start with the ball or horn gap. It should be clear of debris and cleaned periodically with crocus cloth so that bare metal is exposed.

Left unattended, repeated arcs across the ball gap can cause carbon buildup and rust—i.e., a high resistance path. Gaps should be set just slightly beyond the flashover point for 125% modulation during humid weather.

If you have one of the newer noise generators with pulsed noise, you can check the gap without worry of damage or overloads.

Energy from approaching storms can also be a hazard to your system. A static drain choke, connected between the feedline and station ground will eliminate problems with static buildup on the tower.

Such chokes are available from the larger equipment manufacturers for about \$150.

Continuing on the way into the build-

ing, you can create a high impedance path to the tuning unit by forming one or two 12" loops in the feed line from the tower.

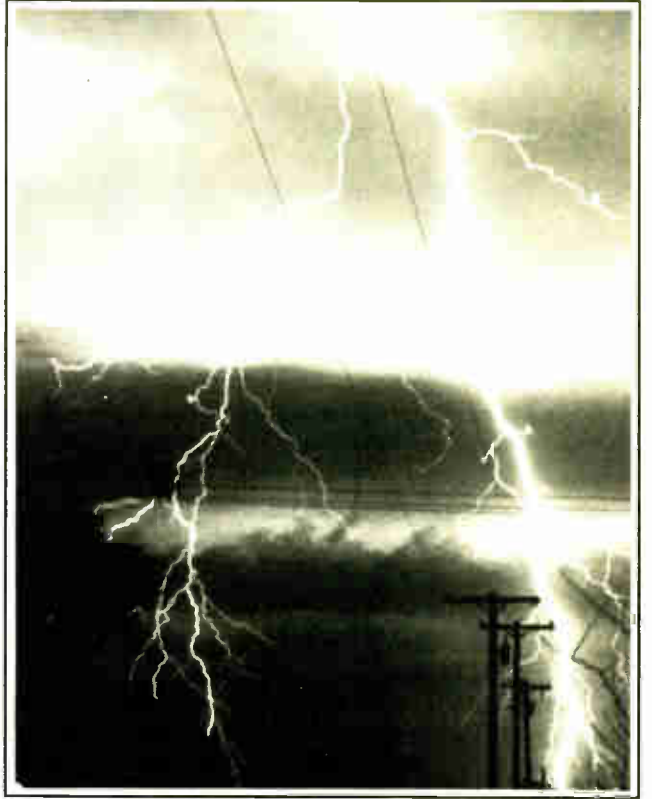

Before you attempt to bend the feedline, fill it with sand to prevent flattening of the tubing as the loop is being formed.

Cables for tower lighting should follow the loop in the feedline on their way from the doghouse to the tower. In this

(continued on page 23)



KNIX Finds New Arizona Home

(continued from page 16)
the network studio.

Two Studer A-807 playback recorders are also available in the studio, one of which has been rigged by Van Buhler to automatically record when the operator's mic is on.

Especially useful for pre-recording programs of callers ringing in on the service's toll-free line, the recorder is triggered from the mic channel on the BMX board.

To trigger affiliate stations for jingles and local commercials, sub-audible 25 Hz and 35 Hz tones are sent from the studio through the satellite path and converted to relay closures by the Wegener Panda II system.

A 50 Hz high pass filter in the studio's CRL SGC800 processor allows the insertion of these sub-audible tones, which are coded according to left, right and left-and-right channels.

Air studio layout

The air studio for KNIX-FM, which airs a more contemporary country format and has the advantage of compact disc for at least 80% of its source, was equally well planned.

Inset into PR&E maple wood cabinetry, which is used throughout the facility, is a stand-up BMX-26 Series III console and four Studer A-727 compact disc players.

ITC Delta cart decks as well as Studer A-807 playback recorders were placed into side cabinetry and two announcer turrets were positioned at the front of the console.

One of the turrets includes studio monitoring controls and a digital clock and timer for W. Steven Martin, a morning personality on the FM. "He almost has his own console," pointed out Van Buhler.

A large news center is at the hub of the group's radio complex, with two edit stations, a news editor's workstation and a news/air studio.

Both edit stations are equipped with PR&E NewsMixers, ITC Delta cart decks and Revox PR-99 recorders.

Dominating the studio is the editor's workstation, which is controlled by a BMX-18 Series III console and supported with a Revox PR-99 recorder and a Studer A-721 cassette recorder.

The news/air studio, which overlooks the two edit stations through a large window, was the last studio completed in the facility and is equipped with ITC Delta cart machines and an Autogram console brought over from the old facility.

The two two-track production studios, which are booked back-to-back on most afternoons by the stations' production people, are identically equipped with BMX-22 Series III consoles, Studer A-812 recorders, Technics turntables and

Studer A-727 compact disc players.

The "crown jewel," as Van Buhler calls the eight-track production studio, has the same basic gear as the two-tracks, but with considerably more production power. The most noticeable indication of this is the Studer A-820 eight-track recorder.

"This is probably the only A-820 in the state," said Van Buhler, who commented that the large eight-track deck is no more difficult to use than a two-track.

Total compatibility

One of the major reasons the group purchased the A-820 is its compatibility with the recording industry. According to Klein, "It uses one-inch tape with standard recording studio eight-track head configuration, so anything we produce in there is totally compatible with any recording studio in the country."

All work on the Studer A-820 is done from a remote unit situated within arm's reach from the studio's PR&E ABX-34 console.

Pitch-shifting problem solver

Also within arm's reach from console control is an Eventide H3000B Ultra-Harmonizer and a Yamaha SPX900. Used for reverberation and other special effects, the Eventide also solves a problem that arrived with the new network service.

Network and local AM commercials that overrun or fall short of the network's time for commercial breaks are fed through the Ultra-Harmonizer to be fitted into the 60-second or 30-second time allotment, depending on the commercial break.

Explained Van Buhler, "The (Ultra-Harmonizer's) microprocessor changes the pitch of the audio so that when you're slowing the speed down, where the pitch of the audio would normally go down, it upshifts the pitch of the audio going through at the same time."

The equipment aside, one of the most impressive features of Phoenix's Grand Ole Opry is the hallway that leads into all seven studios.

"We originally were going to do a very functional rectangular design," said Van Buhler. "And someone said, 'Hey, let's have something that sweeps.'"

The hall that "sweeps" visitors and personnel into the studios is curved in a half-circle, making it inviting to drop in on all the activity going on inside.

Visitors who stay awhile are sure to find far more than guitar-picking country music. Namely, bolo ties, oversized belt buckles and, yes, even pickup trucks.

■ ■ ■

Dee McVicker is a free-lance writer and regular contributor to RW. To inquire about her writing service, call 602-899-8916.

NOW YOU DON'T HAVE TO GO TO PIECES TO GET SOPHISTICATED 8-TRACK PRODUCTION.

Up to now, to achieve 8-track recording you needed a room full of equipment, four arms, and more wires than the phone company.

Enter the Tascam 688 midi-studio. A completely integrated 8-track production system with all the capabilities of a recorder, mixer and synchronizer.

And at \$3295,* it costs less than buying components individually.

There are twenty inputs for you to work. Plus, an Automatic Mixer Routing system that simplifies multi-track mixing.

By recording onto standard audio cassettes, the 688 offers convenience at a cost savings. And you won't believe how good it sounds. With sonic capabilities that go head-to-head with any 8-track reel-to-reel.

So get down to your local Tascam dealer and hear the new 688 for yourself. You'll see we've got it all together.

TASCAM®

© 1989 TEAC America Inc., 7733 Telegraph Road, Montebello, CA 90640, 213/726-0303.
*Manufacturers suggested retail price.

The Language of Bits and Bytes

(continued from page 17)

Known as low-level language, it is in a binary form. An assembly language is also used to replace all of the 0s and 1s when programming.

Tower of Babel

These languages differ for each microprocessor and often within the same one made in different years. A programmer's reference guide is necessary to understand the device's functions.

High-level language contains terms oriented towards the user. Conversion from high to low-level is performed by an interpreter or compiler.

BASIC is one of the popular languages used in personal computers. The system—which stands for Beginner's All-Purpose Symbolic Instruction Code—was developed at Dartmouth College.

Numerous variations of this language have been developed and most but not all are transportable from one computer

Figure 3. Delta's RCS-1V

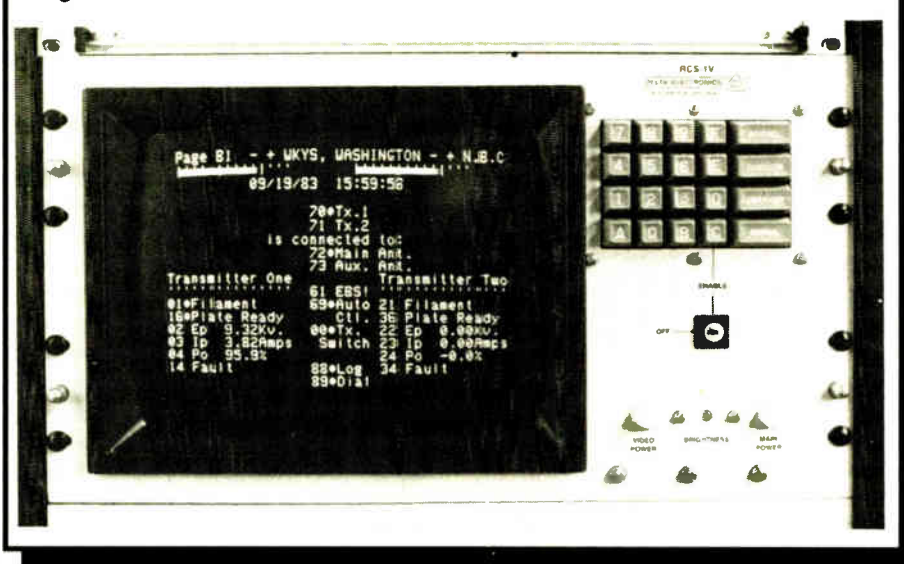

to another. A family of computer programs that supervises the operation of other programs is known as the operating sys-

tem. The applications programs are responsible for input/output management.

Programmed disks

Operating systems' programs are often included on disks programmed with the software an individual desires to use. They have the ability to record data and retrieve it for use at a future date.

mation. Often they are programmed for a specific purpose by manufacturers for their clients. (Figure 2 is an illustration of a formatted disk.)

Expanded power

As electronics technology has advanced, the power of the personal computer has expanded.

Original machines had 48,000 or fewer bytes of memory with which to work, much of that being used by the operating system. Over the years, however, this has been greatly expanded with many newer machines containing millions of bytes of memory.

This technology is often used in offices for word processing, inventory management and record keeping. Personal computer technology can be used in numerous areas of monitoring and control such as environmental management of buildings and security.

An example of where this technology has been used in broadcasting is the Delta RSC-1V. The device employs computer technology to monitor and control transmitter parameters with a minimum amount of human interaction with equipment.

Figure 3 illustrates the system. The local unit is located with the transmitter. It contains a central processing unit

Figure 2.

36 sectors are formed to store information

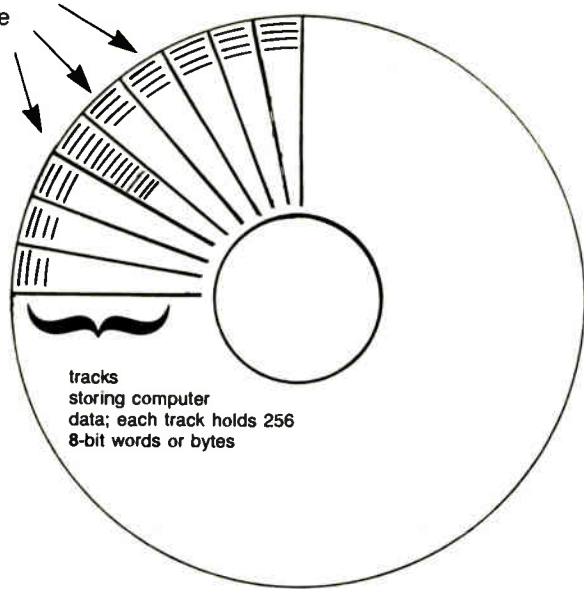
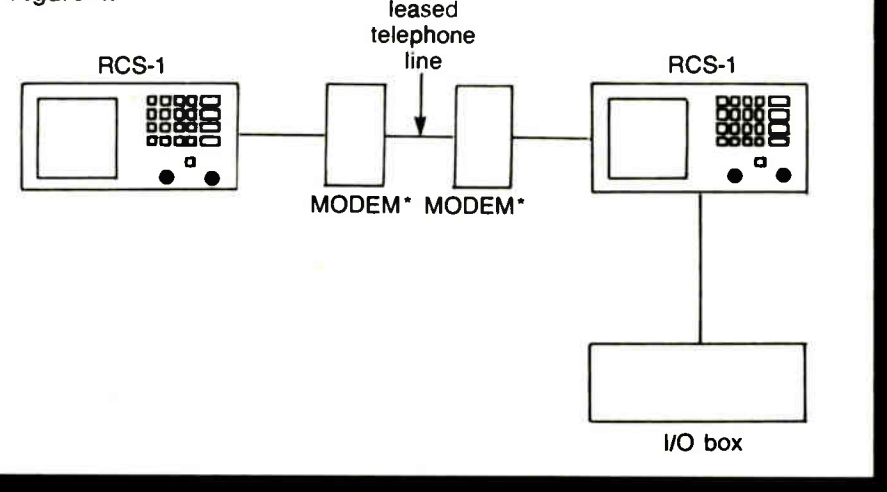

Figure 4.



If one wished to store information on a blank disk, then the disk must be "formatted" to hold the information. Formatting divides the disk into sectors where "tracks" are made to store data.

The dividing of sectors and assignment of tracks can vary from manufacturer to manufacturer. Some personal computers also come with a "hard disk" built in.

This disk is made of an aluminum substrate with a thin coat of magnetic material applied on one or both sides. Hard disks contain many more tracks of infor-

that monitors all operations of the transmitter.

The CPU takes actual data and compares it to the measurements necessary to operate the equipment within licensed tolerances. All data is constantly displayed on a cathode-ray tube screen or on a printer.

Modulation displays and vital transmitter readings are constantly displayed, as illustrated in Figure 3. The remote unit is located at the control point permitting monitoring and adjustment.

The system sends serial data between the remote and local units using full duplex data over an unconditioned leased telephone line or microwave link.

The RCS-1V monitors up to 87 conditions and, using a voice synthesizer, may be interrogated from any touch-tone telephone. (Figure 4 is an illustration of how the RCS-1V can be set up.)

■ ■ ■

Ed Montgomery currently is an electronics teacher at Thomas A. Edison High School in Fairfax County. He has taught broadcast engineering at Northern Virginia Community College and worked as broadcast engineer for several radio stations.

Live! . . . in concert! ALL the Time

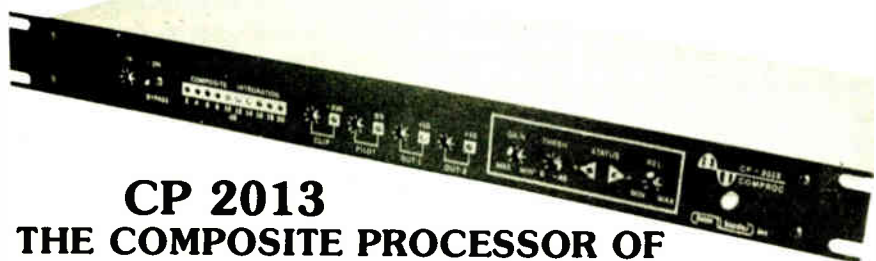

CP 2013 THE COMPOSITE PROCESSOR OF THE FUTURE HERE TODAY

- ★ Low second harmonic clipper — flat to 420KHz!
- ★ Separation exceeding 60 dB
- ★ Ultra smooth, fast acting AGC, builds stereo image without the grunge!
- ★ 1½ dB louder than any other composite clipper
- ★ Multiple outputs plus remote control

AVOID THE RUSH — CALL NOW

hnat hinders inc

42 Elaine Street • R.R. 1 • Thompson, Connecticut 06277 • (203) 935-9086 • (203) 935-9242

BEXT Inc.



HIGH PERFORMANCE AT AFFORDABLE PRICES

- New front panel programmable composite STL's
- New directly programmable FM composite receivers
- New options for synchronous boosters and translators
- New FM exciters, transmitters, amplifiers: 2W to 30kW
- Same old price, quality, service and reliability

BEXT INC. 619-239-8462
739 Fifth Ave. San Diego CA 92101
TLX 229882 FAX 619-239-8474

BUILT TO SURVIVE THE MORNING ZOO

Don't let its stylish chassis fool you: Micromax[®] is engineered from the inside out to handle everything your crew can throw at it. The way DJs in a hurry sometimes "slam-start" carts, for example. Ordinary cart machines can't always keep up with that kind of treatment. But Micromax's belt drive flywheel/capstan and DC servo pinch roller motor roll with the punches—they deliver smooth, wow-free starts in as little as 60 milliseconds.

PR&E engineers designed Micromax to the same high standards of dependability and efficiency as a Pacific Records console. In fact, it actually runs so efficiently that cooling vents are unnecessary. Cooler components are longer-lived components—and this is the coolest cart machine made.

It's loaded with standard features, too: Replay Inhibit, three cue tones, cue erase, auto fast re-cue and many more. Including Pacific Records'

Maxtrax[®] tape heads* with matched electronics for outstanding audio quality.

On performance, features and reliability, Micromax will go head-to-head with any cart machine you can name (except, of course, our own Tomcat[®]). Yet its manufacturer-direct price will make extremely efficient use of your equipment budget. So if things sometimes get a little wild in your studio, your next step should be clear. Call PR&E for more detailed information on the cart machine that's engineered to hang tough and stay cool—Micromax.



**PACIFIC RECORDERS
& ENGINEERING CORPORATION**

2070 Las Palmas Drive • Carlsbad, California 92009
Tel: 619-438-3911 • Fax: 619-438-9277



Harris Technology in Action

“We’re burning up every other AM in the market with our new DX10.”

WSEA AM serves the Delmarva region and South Jersey from Georgetown, Delaware. They recently acquired a 10 kW day/1 kW night directional authorization, a Harris DX 10 digitally modulated solid state AM transmitter—and a new Corporate Chief Engineer, Terry Dalton. “By the time WSEA’s owner Great Scott Broadcasting hired me,” Terry recalls, “they had already decided on the Harris. I could understand that, since the fifteen year old Gates at WSEA still passes its proof of performance tests. But I needed to be sold on the new Harris transmitter. I’d heard about the DX series’ all-solid-state design and its digital modulation, but I didn’t expect them to make much difference.”

Terry ran his DX 10 into a dummy load at full power continuously for six weeks before putting it on the air. “I was ready to jump on the slightest malfunction,” he admits, “but I couldn’t find anything. That kind of stability and reliability was one thing that turned my head around.

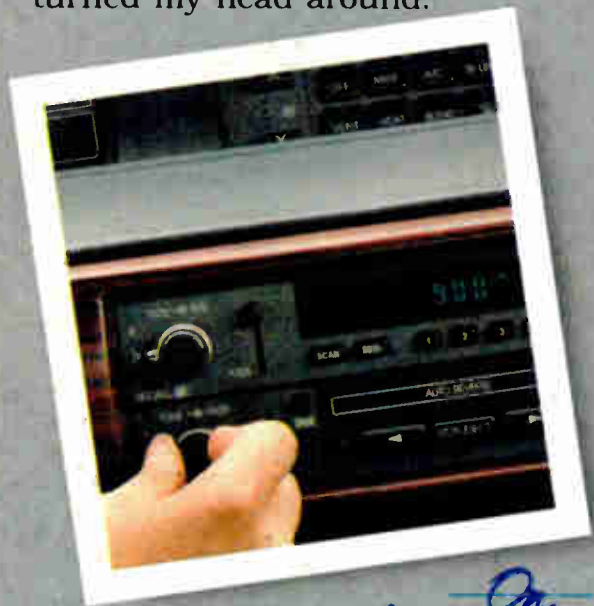

On the road...
OR AT HOME, DX PERFORMANCE IS AUDIBLY SUPERIOR.

The other was performance—in A/B comparisons we ran with the old Gates, the two signals were like day and night. We had NRSC-2 pre-emphasis on both and an Optimod 9000 with the high end cranked all the way up on the Gates—but the Harris DX

Optimod is a registered trademark of Orban, Inc.



Chief Engineer Terry Dalton

AND “THE BLOWTORCH” WSEA’S NEW HARRIS DX 10 DIGITALLY MODULATED AM TRANSMITTER.

was still cleaner and brighter. The low end from the DX 10 was tight and punchy, with none of the old transmitter’s boominess.”

When WSEA finally put their new DX 10 on the air, they did it with no announcements at all. “That very first day,” Terry reports, “we got calls from people picking us up in places where they never could before. Others commented on how much better we were sounding, even on car radios. We were still running 1 kW under our old non-directional authorization. But we were burning up every other AM in the market, including some that put out an audibly overmodulated signal. Our sales department immediately named this new DX 10 ‘The Blowtorch.’”

Terry verified the DX 10’s increased coverage personally on a drive to New Jersey. “I used to lose WSEA around Cape May,” he says. “This last time, the signal stayed clear all the way to Atlantic City—a 35 mile increase in range without any more power.

Measurements showed me why we’re getting out so much further now. The asymmetrics are incredible: I’m running 98/9% negative peaks and 119% positive, with absolutely no distortion or splatter.

In tests, I’ve taken the positive peaks even higher, and it stays clean. Digital modulation and solid state circuitry make a real difference.”

“I was ready to find things wrong with the DX 10,” Terry admits, “But its performance and reliability have me 100% sold. As far as I’m concerned, any new Great Scott Broadcasting AM stations will have Harris DX transmitters.”

We’re glad the DX 10 won Terry Dalton over. It shows that DX transmitters are doing everything we expected of them. After all, real innovations should make a difference in the real world.

If you’d like more information on DX series AM transmitters from 10 to 50 kW*, call (217) 222-8200, Ext. 3408. If outside the continental US, fax your request to (217) 224-2764. And for studio equipment to take full advantage of DX transmitter performance, call Allied Broadcast Equipment at (800) 622-0022.

* Ask us about applications to 500 kW.



HARRIS BROADCAST DIVISION
MARKETING DEPARTMENT
P.O. BOX 4290 • QUINCY, IL USA 62035-4290

Circle 12 On Reader Service Card

© 1989 Harris Corporation

World Radio History

How to Cut Your Lightning Risks

(continued from page 18)

way, they also offer a high impedance path to lightning.

Be sure to secure lighting cables with black cable ties only. White cable ties will rapidly deteriorate when exposed to the ultraviolet rays of the sun.

Contrary to popular belief, connecting the ground side of the lightning gap to the radial system does not really provide adequate protection.

Again, this is because radials do not reach down to the water table. A popular scheme is to drive four 10' rods, one on each side of the tower pier. These rods should be Cadwelded or silver soldered to the ground straps that run under the tower base.

Additional 10' rods should be installed at 20' intervals around the transmitter building. These should be bonded to the building ground system.

Cadwelding

About the only effective method to connect dissimilar metals outdoors is via Cadwelding. In this process, powdered copper oxide and aluminum compound are placed in a mold around the connection.

The mixture is then ignited and the result is molten copper, which makes a permanent bond. In fact, Cadwelding is becoming the preferred method of making copper-to-copper connections outdoors. It's less expensive than silver soldering and makes a better bond.

The transmitter building should be surrounded by a 3" copper strap. Ground rods may be connected to the strap with #6 bare copper wire. It's important to keep all connections as short as possible and to avoid sharp bends.

Severe bends can increase the overall inductance. Our goal is to have the lowest possible inductance and thus maximize the efficiency of the ground system in shunting fast rise-time surges to ground.

Side mounted FM antennas should be grounded to the tower—as should the transmission line—at regular intervals. Typically, the manufacturer of the cable sells grounding kits for each type of transmission line.

A sudden change in the VSWR during summer months is a good indication of lightning damage and such changes should be investigated by a transmission line/antenna inspection.

Related structures

In most areas (Florida excluded) the above measures will adequately protect the tower from direct strikes. Now it's time to consider buildings, auxiliary equipment and other nearby structures.

Here we must concern ourselves with sideflash. This occurs when a strike jumps from one structure (the tower) to another object close by.

Roofs of nearby buildings may require conventional lightning rods mounted on the highest point. Such rods are connected together and grounded via special cable.

Extreme caution must be exercised in the installation of lightning rods. A system with poor connections will not be able to dissipate the lightning it attracts. This would create an extreme hazard to the occupants and equipment

in the building.

Don't forget other small antennas on or near the building, such as ENG, STL or microwave dishes. Typically, in-line coaxial lightning arrestors are employed for protection. Small support towers for such antennas must also be connected to the ground system.

Power lines deserve special attention. These should be protected with surge arrestors and line chokes. Surge arrestors are located close to the service entrance and go between each leg of the AC line and ground.

Some surges and noises can escape the best protectors. For these problems, line chokes are quite effective. Commercial units can be expensive, but you can make your own with insulated bus bar wire and ferrite materials.

Audio and control lines

In a similar manner, audio and control lines entering the building should be protected. If you're using phone lines, carbon blocks are usually provided by telco, but you may want to supplement these with gas tubes or MOVs.

Chokes should be installed downstream from the surge eliminators to filter out any high frequency transients that are left.

By following the procedures outlined here, you should be well on your way to having a more peaceful summer, with fewer traumatic calls coming from your pager.

■ ■ ■

Tom Vernon, a regular RW columnist, divides his time among broadcast consulting, computers and instructional technology. He can be reached at 717-367-1151.

SPECTRUM™
S Y S T E M S



Your station, like most, is racing into the digital domain. Just think about your growing CD library. Wouldn't it be marvelous if your audio processing chain could be fully digital, too?

With the new Spectrum System, that option is yours, today.

Spectrum System includes the Digital Prizm, a four-band pre-processor that allows you to shape your signal with digital accuracy, for maximum apparent loudness right to the fringe.

Then there's our all new FM limiter/stereo generator, the Digital Lazer. The Lazer gives you incredible stereo separation and keeps your signal at optimum modulation. Plus, with 8 separate pre-sets, you can infinitely fine tune your sound, A/B the results and return precisely to where you started. All at the touch of a button with absolute repeatability.

Get your personal demonstration today. Just give your authorized Spectrum System dealer a call.

GENTNER

Gentner Electronics Corporation 1825 Research Way Salt Lake City, UT 84119 (801) 975-7200 Fax: (801) 977-0087

"Call me, I'm interested." Circle 91 **World Radio History**

"Send me literature." Circle 70.

Going Cordless with the IRS 690

by Ty Ford

Baltimore MD Being able to confirm the existence of intelligent life has always been one of life's little pleasures for me.

This month's *Producer's File* spotlights the beyerdynamic IRS 690 infrared headphone system as a fine example of intelligent life as applied to devices manufactured for our industry.

In addition to being intrinsically "sexy," the IRS 690 is FM modulated, full bandwidth, (20 Hz-20 kHz) and light

(about 9.5 ounces).

It should be noted that the IRS 690 headphone also favors the bass frequencies more than the AKG 240. If you normally turn up the bass or loudness controls on your headphone amp, you'll probably be able to run them flat when using the IRS 690.

The headphone system has an adjustable headband, padded semi-open earpieces and is as comfortable to wear as my time-tested AKG 240.

If you're concerned about service, be-

yerdynamic General Manager Paul Murphy quotes a 24-hour turnaround time for 97% of all repairs. The remaining two or three percent are due to out-of-warranty work or if written quotes are requested.

Features

A switch on the side of the left ear-cup turns the IRS 690 on and off. A switch on the side of the right ear cup allows you to monitor in stereo, or either the right or left channel in both phones.

Being able to select either right or left channel increases the versatility of the IRS 690. For example, during overdub recording you could have two different headphone mixes going simultaneously.

A thumb-wheel at the bottom of the right earpiece lets you adjust the IRS 690's volume all the way up to 114 dB. For someone who really likes loud phones, like me, the volume was more than sufficient.

PRODUCER'S FILE

Because the headphone is of semi-open design, it is not as resistant to feedback as a closed design headphone. If you're using a downward expander or gate on your mic processing, you won't have a problem with feedback anyway.

Wiring-in the IRS 690 is simple. The transmitter comes with a six-foot cable that



Orban's Industry standard automatic level control units excel for one simple reason: They offer extraordinarily transparent control action on a wide variety of program material. Whether being used for multi-track recording or on stereo mixes, Orban compressor/limiters can be counted on to maintain transparency and dynamic integrity while efficiently controlling levels and peaks, with few audible artifacts.

464A Co-Operator™ (Gated Leveler/Compressor/HF Limiter/Peak Clipper):

A four-stage, system approach to level control. Features quick set-up with straightforward front panel controls. Two channels in one rack space. Your "assistant operator" for a wide range of production chores. Astonishingly transparent and easy-to-use.

422A/424A Gated Compressor/Limiter/De-Essers: A full featured, "hands-on" production tool. Designed to allow maximum control of individual parameters such as compression ratio, and attack and release times. Contains an effective de-esser. Ideal for voice processing. Widely recognized for its smoothness. 422A mono/424A dual-channel/stereo.

412A/414A Compressor/Limiters: Orban's inexpensive compressor/limiters. Utilize the same basic circuitry as the 424A, but do not include the de-esser, nor the gating. A THRESHOLD control makes them ideal for sound reinforcement. Very effective for basic, cost-effective level control. 412A mono/414A dual-channel/stereo.

787A Programmable Mic Processor:

Combines a compressor having adjustable release time with 3-band parametric EQ, de-esser, and noise and compressor gates in a fully programmable package. Designed for voice talent processing, the unit can be used to store 99 commonly-used instrumental and vocal settings for instantaneous recall. MIDI, RS-232, and remote control interface options.

Optional Security Covers: Attractive, acrylic security covers are available to fit standard 19" rack-mount products—from one to four rack spaces, in opaque white, clear, and transparent blue.

orban

LISTEN TO THE DIFFERENCE.

Orban a division of AKG Acoustics, Inc.

645 Bryant St., San Francisco, CA 94107 (415) 957-1067 Telex: 17-1480 FAX: (415) 957-1070

Circle 73 On Reader Service Card

World Radio History



is terminated by a 1/4" TRS plug, which plugs into any stereo headphone jack.

A stereo adapter for "walkman" style mini jacks is also included. The transmitter will operate with input levels ranging from 35 mV to 2 V.

Below 35 mV an automatic mute circuit cuts off the transmitter. Signals over 2 V cause the transmitter to overmodulate, which results in distortion in the cans and a nasty headache.

Per the instructions, the best results were obtained by increasing the gain to the transmitter until the power lamp began to flicker slightly with modulation.

Modulating at this level gave me all the gain I needed. Note that as you reduce the modulation to the transmitting unit, the volume in the phones also decreases.

Range and use area

In my conversation with beyerdynamic's Mike Solomon, I learned that the size of the IRS 690's coverage area was dependent on a number of factors.

Environments with lots of hard reflective surfaces work the best. Larger spaces or those with many absorptive surfaces reduce the coverage of the unit.

Placing the transmitter in my living room, as close to the front of my house as possible, I was able to receive a good

(continued on page 26)

If Your Only Excuse For Not Buying An ITC Cart Machine Has Been Money, You Just Ran Out Of Excuses.

Introducing
the Series 1 cart
machine from
ITC. As the world's
leading cart
machine manufac-
turer, we under-
stand how to make

a superior cart machine. And the new
Series 1 cart machine is superior.

Equally as important, we realize
each station has a different need and
a different budget. That's why we
designed the new Series 1 with all the

features you need at a
realistic price.

Pound the
buttons. Flip
the switches,
jam a cart in

and yank it out a few

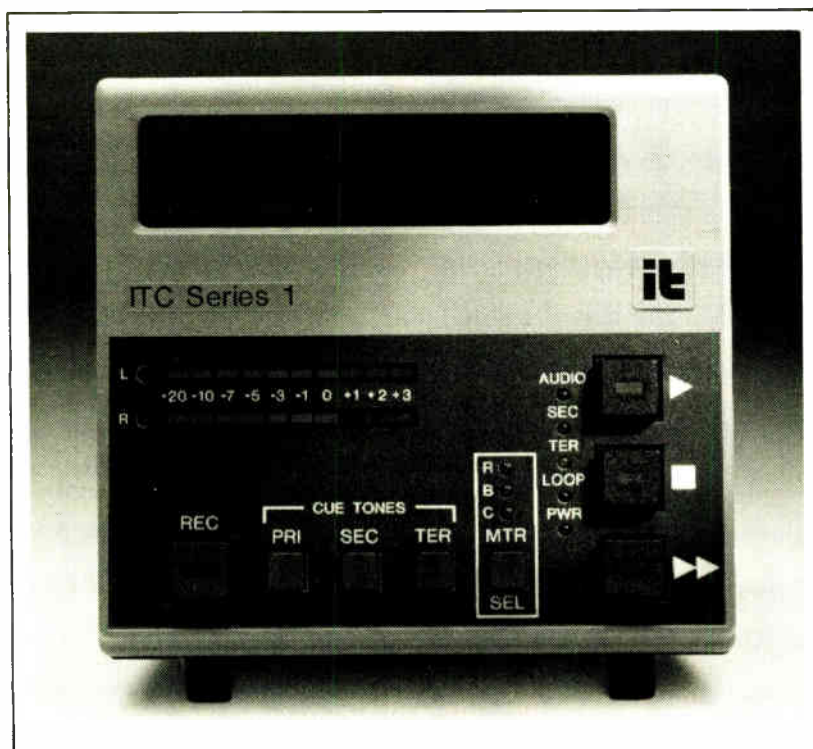

hundred thousand
times. We've built
the new Series 1
to take anything
you can dish out,
24 hours a day,
365 days a year.

So before you

mortgage your program director
or settle for something of less value
than ITC, check out the new Series 1
today.

You won't need an excuse to
buy one.

For more information and the
names of the Series 1 dealers nearest
you, call ITC toll free at 800-447-0414
or call collect at 309-828-1381 from
Alaska and Illinois. Outside the USA,
contact your local
ITC distributor.



International Tapetronics Corporation... The World Leader in Cartridge Machines

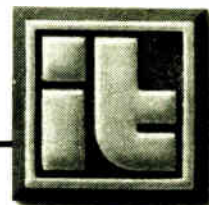

Infrared Headset Gets the Nod

(continued from page 24)

stereo signal at the rear of the house, a distance of 28 feet.

When I opened the front window and shot the transmitter out over the lawn I was amazed to find that the lack of reflectivity reduced the range to about six feet. At that distance you had to be within a narrow 20° arc in front of the transmitter.

In the studio, which is a combination of reflective and absorptive surfaces, reception was much better. In some cases I could get a good signal even if I was behind the transmitter.

With the transmitter sitting atop one of my equipment racks, which is placed

against a wall in my studio, I was able to achieve good coverage over a 160° arc.

Beyerdynamic recommends placing the transmitter at a height at which it can get a clear shot to the receive element, which is encased in a small plastic bubble on top of the headband.

Charging considerations

According to the manual, charging time from a "flat state" is approximately 14 hours. Periodic recharges require that you connect the headphones to the transmitter via a small pigtail that plugs into the headphone.

The "wall-wart" power supply that

comes with the basic unit has two plugs, usually one for the transmitter and one for recharging the headphone.

Since you probably won't be charging the headphone and operating the transmitter at the same time, you could use the plugs to charge two headphones at the same time.

Beyerdynamic also has optional chargers, capable of charging two pairs of headphones, for \$49.

If you forget to recharge the IRS 690 you're out of luck. The batteries are not user replaceable. If the advantages of cordless operation really appeal to you, consider having a couple of pairs of headphones charged up on standby.

Beyerdynamic is currently looking into fast charge NiCad batteries, but to date they haven't found them at the right price.

How long?

The manual states that, with a complete charge, the headset will operate for about four hours. I found that the early warning LED began blinking after 4.5 hours, even though the audio had not begun to degrade.

Twenty minutes later, with the warning light still blinking, the level of the phones had dropped noticeably and there was quite a bit of distortion.

I was operating the phones at less than full volume, but above average. My guess is that running the phones at lower levels would lengthen the time be-

tween charges.

Rocky LaPadula, who's part of the morning team at WGRX here in Baltimore, has been using another manufacturer's infrared phones for about a year.

He's learned to simply turn them off when he's not using them. This conservation technique gives him a week's worth of use on fresh batteries.

Aside from being somewhat nervous about remembering to keep the phones charged, the only other thing I don't like about the IRS 690 is the rush of white noise in the headphones when the transmitter mutes.

This happens when the transmitter is not modulated for more than 45 seconds. If you're planning to use these cans on the air you'll probably never be bothered by it.

During very quiet passages and during voice only recording, a low level hiss similar to that generated by an FM station can be heard.

The IRS 690 system with a power supply/charger, transmitter and headphone lists for \$399 list. For multiple monitoring applications, you can get additional receiver/headsets separately at \$299.

For those difficult to reach parts of your studio complex, you can get a "slave" transmitter for an additional \$149 that can redirect the signal at up to a 70° angle.

If you have any questions call Mike Solomon or Paul Murphy at beyerdynamic: 516-935-8000.

Ty Ford is an independent audio consultant and regular contributor to RW. He is currently writing an advanced production book for Focal Press. Reach him by phone at 301-889-6201 or by MCI mail #347-6635.

GET IT RIGHT
GET IT FROM ALLIED

Did You Get The News?

Is your station ready for the season? Whether it's news, music, baseball or reports—throw a 'DART' from Harris Allied at your competition.

THE FAIRCHILD DART 384

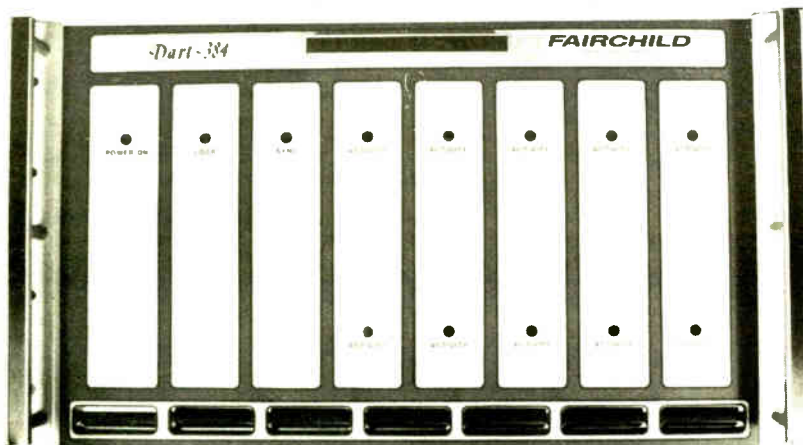

THE BEST RECEIVER ON EARTH

- Requires only 10½" of rack space
- Stable crystal-controlled downconverter
- Remote program channel selection
- Remote transponder selection
- Selection of up to 4 transponders

Recommended for reception of ABC, CBS, Dow Jones, Mutual, NBC, Transtar, United Stations and Westwood One.

Call The Experts

HARRIS ALLIED
SATELLITE EQUIPMENT

317-962-8596

3712 NATIONAL RD. WEST • P.O. BOX 1487 • RICHMOND, IN 47375

©HARRIS/ALLIED 1990

MAKE THE MOST OF YOUR NIGHTS.

AM daytime broadcasters: Do you have a low power overnight authorization? Do you need an inexpensive backup for your main transmitter? Either way, a low power transmitter from LPB is your high performance solution.

- FCC Part 73 Type Approved
- Cost effective—low electric power consumption
- Compatible with all AM Stereo systems
- Compact design mounts on the wall
- Hundreds in service across the country
- Satisfaction guaranteed
- One year warranty
- Ten day delivery

Find out how easy it is to own, install and operate an LPB low power AM transmitter—and how low your overnight electric bill can be. Call John Tiedeck today at 215-644-1123.

LPB 28 Bacton Hill Road • Frazer, PA 19355
Tel (215) 644-1123 • Fax (215) 644-8851



AM-100-P
25 TO 100 WATTS
\$3995

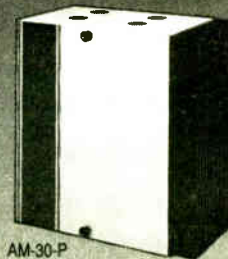

AM-30-P
2 TO 30 WATTS
\$995

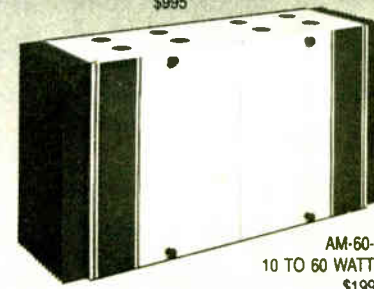

AM-60-P
10 TO 60 WATTS
\$1995

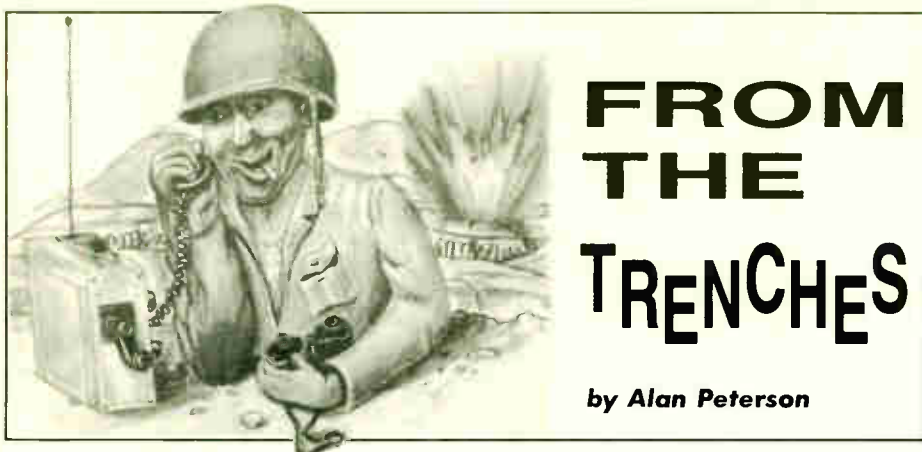

Paycheck Nightmare

Dear JG:

I'm writing from a brand new trench—starting on 19 March, I became the new afternoon personality for WLAD, Danbury, CT.

I'm shoulder-to-shoulder with CE Tom Osenkowsky; a fellow RW writer and sharp engineer. Can't wait to describe to you what his shop looks like.

To my former co-workers at WSBS in Great Barrington, MA ... you guys are great and I'm gonna miss all of you. Thanks for seeing me through a real tough time in my life and giving me a shot on a fantastic station. Hang in there.

Strange to think only a year ago I got my walkin' papers in Syracuse and now I'm only 55 miles from Noo Yawk City. Boggles the mind, it does ...

Anyway, let me tell you a little about a subject we all love, but never seem to have a lot of: Money. Shekels, zlotys, clams, filthy lucre, call it what you will.

It's what we want.

Sure, those occasional "perks" are kinda nice. "Here Al, we had a Bert Kaempfert album left over ... want it?"

Not to mention the annual turkeys, Easter hams (we used to get "Easter Hamm's" beer at one place) or tickets to the station-sponsored demolition derby. Let's face it. The happiest five words in any broadcaster's vocabulary are "Pay to the order of".

Of course, we've all heard about some operations where payroll could be one or two days late, or where the personnel all get paid in cash. It happens. Some of us have worked those places.

Bakersfield, CA's talented Chuck McKay tells me of a place he worked at near the Canadian border. When payday rolled around, all the jocks got their checks and then it was Jesse Owens-time to the bank!

The unfortunate jock who came in last

found zero money left and couldn't cash his check—the station's financial status was that close to the edge.

Now, it is well known that actors and disc jockeys are notoriously bad money handlers ... myself included. But what happens when it's the money itself that handles itself badly?

You'll love this. Payday rolled around at my part-time job in Springfield, MA. Everybody got a check but yours truly. OK, no problem. I'll just leave a note to the PD.

Next pay period I get a check, but the one from last period is still AWOL. Now I'm a little peeved. Another note, another check. But not the one I'm waiting for!

Here it is six weeks after the pay period and I'm still waiting for a %*\$&*! check.

The station was never negligent. My check was put into one of those slant-

Shekels, zlotys, clams, filthy lucre, call it what you will. It's what we want.

mount, stuck-to-the-wall mail slot thingies and fell into the inky depths of the contraption.

It was missing for six weeks deep inside and had to be extracted by disassembling the miserable thing (thanks again, Bill). See, it was issued on time,

but "fell between the cracks."

Wait, it's not over yet. The check had to be banked so I was going to make the deposit Monday ... whoops, no good: President's Day.

OK, so I'll make it Tuesday ... darn it, that's my interview in Connecticut and I won't be anywhere near the bank. Ah, Wednesday! Perfect!

Wednesday I get home to grab my check and head out to the bank. I knew I left it in my red shirt pocket ... the very same red shirt that was now hanging out to dry on the line after a tumble in the washing machine!

My wife Susan ran a load of permanent press clothing and my check—my pay from six weeks ago—was now a paper mache oyster the size of a bottle of correcting fluid!

If it weren't for Hope in the WHYN payroll office issuing me another check I probably would've shredded every shirt on the line (doesn't the name "Hope" sound very reassuring in a payroll office?).

Even then, Hope wasn't in that Wednesday and I had to wait until Friday for some kind of action. Still it was worth it.

ABBA's song from the '70s summed it up real well for me: "Money, Money, Money ... Must be fun-ny ..."

Having said it before, I wouldn't be doing this for a living if it wasn't fun. Or funny. And as long as I keep seeing those little zeroes on my stubs each week, you'll know where to find me. Clean shirts and all.

—Al

Al Peterson, WLAD's most recently added air personality, can be contacted c/o Radio World.

The engineers who know RF best already know us very well.



If you're looking for superior rigid coaxial transmission line and RF components, your transmitter or tower might be a good place to start. Take a look around—you'll probably find the bright blue Myat logo. TV and radio RF engineers at Harris, Acrodyne, QEI, Micro Communications, and Broadcast Electronics all routinely specify our products. And so do the antenna experts at Jampro and the engineers for the Navy's top airborne radar system.

All of these manufacturers demand long life and superior efficiency. They expect the highest quality materials, the toughest construction techniques, plus the most effective expansion compensation designs. And, like you, they have budgets and schedules to meet. All of them demand Myat, because they know Myat delivers.

Next time you need rigid transmission line or RF components, call your favorite RF equipment distributor or phone us direct at (201) 767-5380. For quality, durability, value and service, Myat is the name to know.

MYAT, INC. • 380 CHESTNUT ST. • P.O. BOX 425 • NORWOOD, NJ 07648
TELEPHONE: (201) 767-5380 • FAX: (201) 767-4147



Putting BBSs to Work for You

by Barry Mishkind

Tucson AZ Several issues back, we discussed an advancement in technology that makes an on-line instruction manual a possibility.

This concept has real appeal to the broadcast engineer, especially those that operate as contract engineers, often being called out to deal with an emergency situation.

Sure, you have probably been there: It's late at night, the transmitter is open in front of you and the diagram and wiring schematic do not match the transmitter at which you are glaring.

Even more distressing is the facility without documentation. Sometimes it left with a previous engineer. Other times, the owner lost it or gave it to the kids as a coloring book!

(One story that curls what little hair I have left concerns a station in a country south of here. Seems the transmitter manual was found in its original sealed envelope, 30 years after installation!)

"Curses!" (and worse), I've shouted into the air numerous times. Even with the wonderfully competent technical service available from several transmitter manufacturers, it is easier if there is

some hard copy in front of you.

What a time saver it would be to dial up the manufacturer on a computer and find the information and/or schematics of that malfunctioning piece of equipment. (That's especially true if the equipment is older and there is no hint of where the original documentation went.)

Unfortunately such a service is not yet available. While many manufacturers do have their manuals in computer files, these files are not accessible to us.

On the other hand, there are a number of electronic BBSs (bulletin board services) out there that can make your life a little easier in some respects.

Of course, there are a lot of services that are not essential to your life. And even if they were, if you are like me, you may shudder at the magnitude of phone bills using all those services could generate.

So what good is a BBS? Let's take a look.

Going on line with a BBS

Logging on to a BBS is not that hard. Most of them are using carrier recognition programs, so you don't have to worry about what baud rate to run or whether to set up for 8N1 or 7E1, etc.

There will be a log-on routine, prompting you for your name and— if you are

a registered user—your password.

First time callers to a particular BBS will be asked for some information and usually have limited access initially. Rules are explained and subscription fees, if any, are stated.

ECLECTIC ENGINEER

If you are somewhat hesitant about how to access the information, relax. Help screens and menus are almost always available, although commands do vary from system to system.

I usually make it a practice to capture the information to my disk so I can read it at leisure after hanging up or print out the commands for reminders.

I'd also suggest making a file folder for each service you call. That way you have the command structure handy and can be more time efficient, which keeps your phone costs down.

Having logged on, you will likely check out the message section, to see if there are any messages you need to read. Or, you can mosey on over to the files section and download a utility or text file.

The standard for file transfer now is the "ZIP" format, which compresses the files for faster transmission. If you check a local BBS where you live, you should be able to find PKZ102.EXE, which will uncompress the files you download.

Hitting the hot spots

Next it's time to check out the current hot topics. On a recent evening, there was a discussion going on one BBS relating to FM modulation and new monitoring techniques.

Another thread dealt with what was needed to upgrade some STLs to meet the new standards. Even though the FCC has recently stayed the deadline for conversion, many engineers have questions about their systems and what they will have to do in the future to stay legal.

Over on CompuServe's BPFORUM, among other topics, I noticed a discussion about cartridge recording levels and dealing with the production department.

Another series of messages was related to remote broadcasts and telephone line extenders. If you had questions about how your station could benefit from this technology, several users were ready to offer advice, suggestions and experiences.

Dialing into the Allied/Radio World BBS you might have connected to a discussion about how to deal with a motor problem on a popular cartridge machine.

Several engineers added their thoughts in trying to help someone cure a problem. That is probably the best example of how we can use a BBS to help one another.

And, if you happened to have this odd intermittent in your station, by checking in you would have found a possible solution.

Manufacturers participate

Quite often, manufacturers themselves log in onto a BBS and offer factory advice and assistance.

CRL, the processor manufacturer, has its own BBS. Its value can be demonstrated by a quick example. Suppose you have a problem or question at 2:30 AM.

Obviously, no one is at home up at CRL.

But, if you upload your query before zonking out, CRL would then have your letter first thing in the morning. Then, without wasting time on the phone, they would have your information, can pass it to the right person and get back to you with the answers.

It's also a great answer to the telephone tag game—the one where you call and the person you need is at lunch. When he calls you, you are on your way to the transmitter.

Leaving a message on the BBS ensures its reception. Your response is available when you have time to handle it.

Minimizing the costs

Of course, the matter of phone bills still can make you wince, if you spend much time on-line. Some folks use a timer to remind them to get off promptly.

Another idea that seems useful to those that do a lot of BBS-ing, is PC-PERSUIT. This is a service that allows you to benefit from the reduced load on the data networks at night.

Quite often, manufacturers themselves log onto a BBS and offer factory advice and assistance.

For a fee of about \$30, PC-PERSUIT will often allow you up to 30 hours of connect time to most major cities by dialing a local number.

Compared to even the special "deals" offered by long distance companies, typically \$8 to \$10 per hour, you can see the savings that can be had if you are going to be connected very often.

Perhaps you and the programming department could share an account allowing the DJs to get jokes and promotional ideas while you check out the latest FCC actions, SBE news or send some E-Mail to a friend.

The list is coming

Watch this column for the upcoming listing of BBSs of interest to the broadcast community. To help you know what's out there, we will periodically print an updated list of them.

If you know of a BBS that should be included on this list, let me know. Conversely, if you know of any problems or defunct BBSs, we'd appreciate that info, too.

By the way, in dialing into some of these BBSs I discovered a file listed as COVPRED. This is not the same COVPRED I discussed in the 21 February issue of RW. However if you want a copy of the COVPRED I discussed then, it's still available if you send me a disk and \$4.50 to cover postage and handling.

Please send information, suggestions or comments to me at 2033 S. Augusta Place, Tucson, AZ, 85710. Or, send it to my MCI Mail number: 325-9883. Your input will make a difference. Thanks.

Barry Mishkind, aka RW's "Eclectic Engineer," is a consultant and contract engineer in Tucson. He can be reached at 602-296-3797.

BALANCE YOUR BUDGET

McCurdy's affordable alternative to pricy audio distribution systems is the ADA-700.

Compact and self-contained, this 1 Rack Unit high (1 3/4") stereo component, with individually adjustable outputs, offers exceptional performance characteristics.

The ADA-700 can be configured as a stereo input with 8 stereo outputs, or as a single bridged monaural input with 16 individual outputs.

Other features include

a continuously variable -6 to +28 dB gain adjustment, isolated outputs and a quiet toroidal power transformer.

ONLY \$460

McCurdy

McCurdy Radio Industries

108 Carnforth Road, Toronto, Ontario Canada M4A 2L4 Tel: (416) 751-6262
 Telex: 06-963533 Telefax: (416) 751-6455
 1051 Clinton St., Buffalo, New York 14206
 Tel: (212) 772-0719

40
YEARS OF EXCELLENCE

BUYERS GUIDE

AM Transmitters & Exciters

WCHB Commends Harris Gates

by Michael Bradford, Engineer
E.H. Munn, Jr. & Associates, Inc.

Coldwater MI Our client, WCHB, Inkster, MI, had a problem. The station had been operating on 1440 kHz with a 12-tower directional array from a site near Inkster.

However, WCHB also held a CP for 1200 kHz for a new facility to be located near Taylor, MI. The CP had been granted on condition that WCHB dispose of its 1440 operation, which was concluded in mid-February. Now the interesting work began.

USER REPORT

Tom King and the crew at Kintronics in Bristol, TN were called to assemble a filter that would pass the "new" 1200 kHz signal and "block" the 1440 kHz signal, to allow use of a common tower for initial test measurements to comply with the terms of the CP.

Don Baad, our newest staff engineer, and I arrived at WCHB and installed the new filter unit in one of the closest "dog

houses" in the twelve tower array. We ran a length of RG-8U into the studio/transmitter building and adjusted the filter to provide a 50 ohm j0 load for the still-to-be-bought transmitter.

Calling on Harris

On 15 February—a Thursday morning—a call was made to Jim Marwood, the Michigan Harris rep in Columbus, OH. Jim was given the chance to impress everyone once again with the quick Harris service this firm has relied upon for years.

Why? It had become necessary to tune, pack, ship and deliver the new transmitter in a matter of days—and over a weekend, to boot! Jim called the folks in Quincy and a brand new Gates I (that's right . . . they're called "Gates" once again!) transmitter was on its way to the transmitter/studio site in Michigan.

On Monday morning, 19 February, my wife Linda and I arrived at the WCHB building around 8:30 and set about installing the main wiring for the Gates I. The junction box was nearby; the overhead cable was installed in about an hour.

As promised, the truck with the new

transmitter arrived around 10 AM. With the help of Terry the station manager, Willie, Ron and some other strong backs, the whole transmitter—power transformer and all—was off-loaded and skidded into place in the transmitter room.

In about an hour, the initial AC wiring, ground strap and audio cables were installed. The RG-8U cable required a type N connector, which was somewhere in the bottom of my tool box. The installation instructions were simple and clear.

Preset power

As the temporary operation on 1200 kHz required several power settings, the Gates I and its six preset power levels was ideal.

other transmitters.

Power adjustments are on the front panel, with a fine tuning screwdriver for each. The metering permits easy viewing of each of the stages in the transmitter. The LED tally lights and block diagram on the front panel are a great troubleshooting help.

Operation is cool and quiet in the uncluttered cabinet. Staff can easily see what is happening at a glance, with minor up or down power adjustments made by simply pushing a button.

Fast turnaround

From the time of delivery to the first on-air sound was just four hours! This is amazing for a new transmitter installation and clearly shows how easy an installation can be with some forethought, planning and delivery on time.

The Gates I and its higher power sisters are now ready for delivery from Harris Corporation in Quincy, IL. I found the installation quick, and the transmitter has been on line and operating without a "burp" since mid-February.

♦ ♦ ♦

Editor's note: Michael Bradford has been a staff engineer with E.H. Munn, Jr. & Associates for just over five years. Prior to that he was director of engineering for Patten Broadcasting. He began his broadcasting career some 27 years ago and has held a valid FCC license since 1964.

For more information on the Gates I AM transmitter, contact Ron Frillman at Harris: 217-222-8200, or circle Reader Service 49.

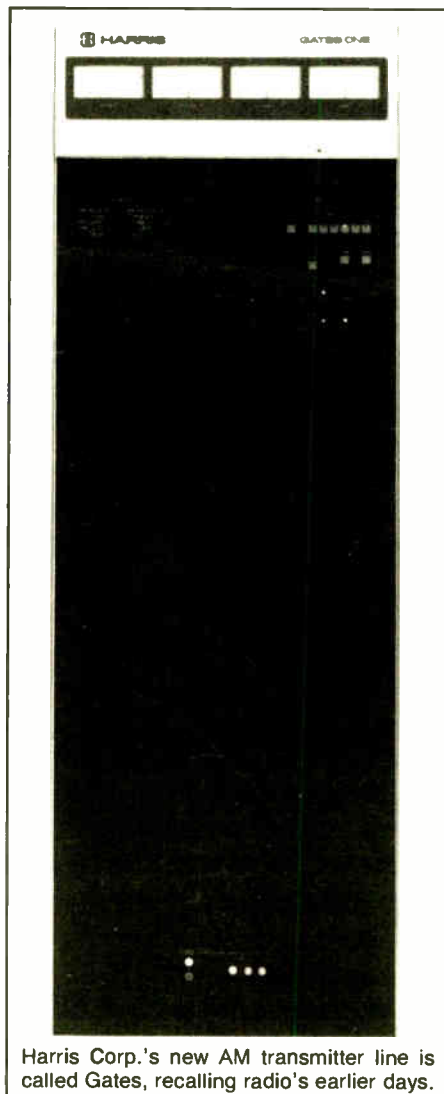

Harris Corp.'s new AM transmitter line is called Gates, recalling radio's earlier days.

The audio and remote control interface connections are right up front in the box, with large knockouts already in place for cable entry. With the power adjustments also right on the front panel, it took only moments to fire her up and set the initial power and modulation levels.

The Gates I front panels swing open to permit access to the various monitor adjustments for each of the six power levels. This is a nice touch; no longer do you need external pads for the various modulation levels for the various power levels as is required in some



- AUTOMATIC**
- SWITCH TO SECONDARY OR TERTIARY STEREO INPUTS ON PRIMARY LOSS OF CHANNEL
 - SWITCH TO SECONDARY OR TERTIARY STEREO INPUTS ON PRIMARY LOSS OF AUDIO
 - LOSS OF CHANNEL CORRECTION
 - AUDIO POLARITY CORRECTION
 - User programmed sequence and time delays
 - On-line audio monitoring and stereo audio switching
 - Microprocessor based
 - Audio error alarms and level matching

AND MORE... CALL OR WRITE FOR COMPLETE DETAILS

TITUS TECHNOLOGICAL LABORATORIES

77 Kreiger Lane, Glastonbury, CT 06033
(203) 633-5472

BUYERS GUIDE INDEX

Harris Gates I Transmitter by Michael Bradford, E. H. Munn, Jr. & Associates	29
Continental 314F Transmitter by Joe Kerby, Kerby Communications	30
Omnitronix OMNI-1000 Transmitter by Ron Simpson, WPAZ	32
Delta ASE-1 AM Stereo Exciter by John L. Cole, WBTM	36
Energy-Onix Transmitter by Jim Emmel, WWAX	38
MTS System 3000 EBS Monitor by Skip White, WQXR	39

Also, a Technology Update from CCA and a Special Report from Burden Associates.

Continental 314F Shines at KTUC

by Joe Kerby, President
Kerby Communications

Tucson AZ In the fall of 1989—September, to be exact—KTUC in Tucson, AZ purchased the new Continental 1 kW 314F solid state transmitter.

A string of signal and equipment-related problems brought KTUC to Continental. First, the station is located at 1400 AM—an extremely noisy location on the dial.

KTUC also had an old Gates transmitter that was on its last leg, with an RCA as a standby. The station's signal just wasn't loud enough. What's more, as a Class 4 station with poor

tower location, KTUC had been having a hard time covering some parts of Tucson.

Peter Palagonia, former chief engineer at KTUC, had made the decision to purchase the 314F at NAB '89.

USER REPORT

Peter said, "They looked a little nervous when I tested it at 200% modulation." But you can leave it to a Continental to hold up through almost anything!

Overnight results

The day before it arrived, an electrician had come to the station to run electricity for the transmitter. Peter and I excitedly prepared for the installation.

We began to hook up the 314F on the evening it was delivered, and worked right through until dawn.

In general, the installation went very well. We ran into a small glitch with the interlock, but with the fine 24-hour service Continental has, we worked it out in a matter of minutes.

What transpired the next day was something of a miracle. KTUC became the loudest AM station in Tucson overnight. In its 25 years on the air, the station never sounded better.

The 314F has several features that I feel make it superior to any other transmitter. Here are just a few.

The output of the 314F is unique in that the output of the solid state RF modules can be switched off by "clamping" the TTL RF drive signals.

The signals are then fanned out to each RF module, which has its own clamp. If the output transistor gate and drain voltages should ever be simultaneously high, demanding too much current, the module is automatically "clamped" and we get an RF module fault indication. This ability to clamp

or efficiency with the 314F transmitter.

This came in very handy when we had some work done on the tower during morning drive. We were able to lower the power to 20% for the tower workers' safety, without losing quality and efficiency.

I remember the GM asking me, "When are we going on low power?" I said, "We have been for the last two hours."

High marks

The 314F is virtually maintenance-free; it requires little else than your normal monthly inspections and a good cleaning every three months. The transmitter's reliability will cut down on those dreadful 3 AM trips to the transmitter site!

The transmitter's reliability will cut down on those dreadful 3 AM trips to the transmitter site!

allows for an excellent range in the output power without greatly reducing the modulation range.

No loss of quality

Audio performance remains good at all power levels and efficiency. So when you find it necessary to lower power or if you lose an RF amp module, you won't have to sacrifice audio quality

I've tried and tested the 314F and have received superb results. I give it an A+ rating in my book. If you're looking to improve your station's current sound, I would highly recommend the 314F.

If you are just putting a station on air, the 314F would be the way to go. I think you, too, will find the 314F to be reliable, compact, loud, efficient, and the best transmitter you've ever had working for you!

For 1 kW stations that want big sound, the 314F is also the way to go. In fact, no matter how you slice it, the 1 kW 314F is another fine product from the Continental line!

...

Editor's note: Joe Kerby is a principal in Kerby Communications. He can be reached at 602-290-1892.

For more information on the 314F 1 kW AM transmitter, contact Walt Rice at Continental: 214-381-7161, or circle Reader Service 82.



Puts your signal in it's place!

If you need a quality antenna, you need: **JAMPRO ANTENNAS, INC.** The really experienced one for over 30 years.

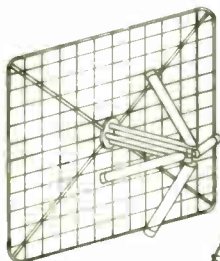

JAHD CP
Arrowhead
Screen Dipole

JSDP CP Spiral
Broadband Antenna

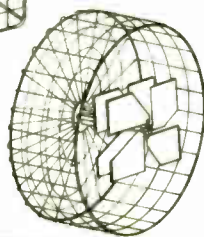

JBBP FM Antenna
Balanced Excitation

JAMPRO is the world leader in custom-designed, directional, CP antennas.

- With over 1600 of our penetrators delivered, more stations have penetrated their market.
 - Our custom-made directional antennas are operating world wide.
 - Full-scale antenna measurements on **JAMPRO's** all-year, all-weather test range.
 - We custom-make tower structures to duplicate your's, for optimum results.
 - Ask about **JAMPRO's** low-power educational packages.
- Give us your requirements and see how fast we produce.

JAMPRO Antennas, Inc.

6939 Power Inn Road
Sacramento, CA 95828
(916) 383-1177 • Telex: 377321
FAX (916) 383-1182

Circle 20 On Reader Service Card

Make the Right Switch...

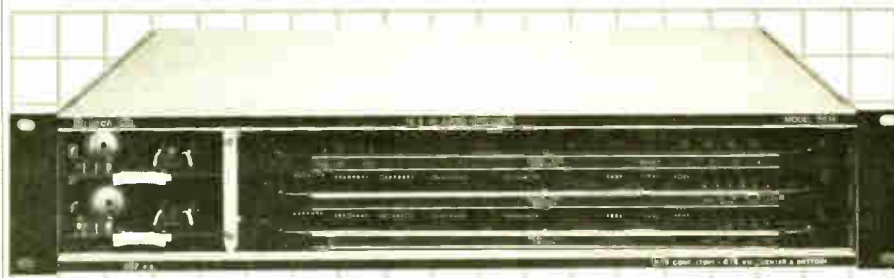

With The Compact (2 RU) Audio Only
Routing Switcher from di-tech

MODEL 5616 STANDARD FEATURES

- 16 x 16 Stereo
- 16 x 32 Mono
- Plug-in P.C. Cards
- Serial Coax for External Control Panels
- Output Level +24 dBu @ 150 Ohm
- RS232 / RS422 Computer Control
- All I.C.'s are Socketed for easy maintenance

ALL FOR A
COMPACT PRICE
\$5250

di-tech

48 Jefryn Boulevard, Oeer Park, N.Y. 11729
Tel: (516) 667-6300 • Fax: (516) 595-1012

Circle 5 On Reader Service Card

THE PORTABLES
SESCOM'S ANSWERS
TO YOUR LITTLE
AUDIO PROBLEMS...



57 DIFFERENT BOXES
FOR COMMON AUDIO
INTERFACING
SMALL SIZE 4 1/2" W X 4 1/2" D
X 1 1/2" H
COMMON AC POWER SUPPLY OR
BATTERY OPERATION
CAN BE DAISY-CHAINED
FOR MULTI-FUNCTIONS
RACKMOUNT AVAILABLE
AFFORDABLE, EASY TO USE

SEND FOR FREE CATALOG

SESCOM INC.

2100 WARD DR.
HENDERSON NV 89015 U.S.A.
702-565-3400, 800-634-3457, FAX 702-565-4828

Circle 41 On Reader Service Card

Pointers for NRSC Compliance

by John Bisset, Sales Mgr
Delta Electronics, Inc.

Alexandria VA By the end of June, those of us responsible for AM stations will have a new occupied bandwidth curve to which these stations must conform—the National Radio Systems Committee (NRSC) RF emission standard, adopted by the FCC.

GUEST OVERVIEW

Among other changes, the 25 dB down frequency moves from +15 kHz to +10.2 kHz. The changes which each station must implement are indicated in Figure 1. All stations must meet this new curve on 30 June 1990, whether or not an NRSC-I box is employed.

The FCC provides for "presumptive compliance" for AM stations that have installed an NRSC-I box by the 30 June date.

This means that the station will be presumed to meet the new emission curve, simply by virtue of the fact that the NRSC-I box was installed.

Catch 22

An important concept to grasp is that although the FCC has waived routine measurements that demonstrate compli-

ance, the station must still comply with the new emission limitation.

This places the engineer in one of those "Catch 22" situations—you're not required to make measurements, but you must comply.

How do you know if you comply unless you measure? It has been demonstrated to the FCC that simply installing an NRSC-I box does not guarantee compliance.

Post-NRSC clipping (use of transmitter "safety clippers" for example) and high values of incidental phase modulation (IPM) can contribute to a station operating contrary to the new emissions curve.

The rules do not force stations to buy spectrum analyzers or Splatter Monitors to monitor compliance. However, the prudent engineer may want to rent or borrow such an instrument so there are no surprises.

Output only as good as input

Most of the newer transmitters and exciters described in this issue will meet the new limitations with flying colors. However, remember, their output is only as good as the audio provided at the input.

The advent of AM stereo has caused transmitter manufacturers to pay much closer attention to the phenomenon of IPM.

Such modulation conditions can be easily reduced using either an AM stereo modulation monitor or a Splatter Monitor

set to the "Q" measurement mode. For newer transmitters, if adjustment is required at all, it usually involves simple tuning and neutralization adjustment.

Making older main or auxiliary transmitters conform to the new standard may take a little work, but the result will be worth the time. Most of the adjust-

ment any rumors that stations will be required to buy new transmitters in order to comply with this new bandwidth curve.

Conversion choices

Conversion does not necessarily mean a completely new audio chain, although many stations are taking this opportu-

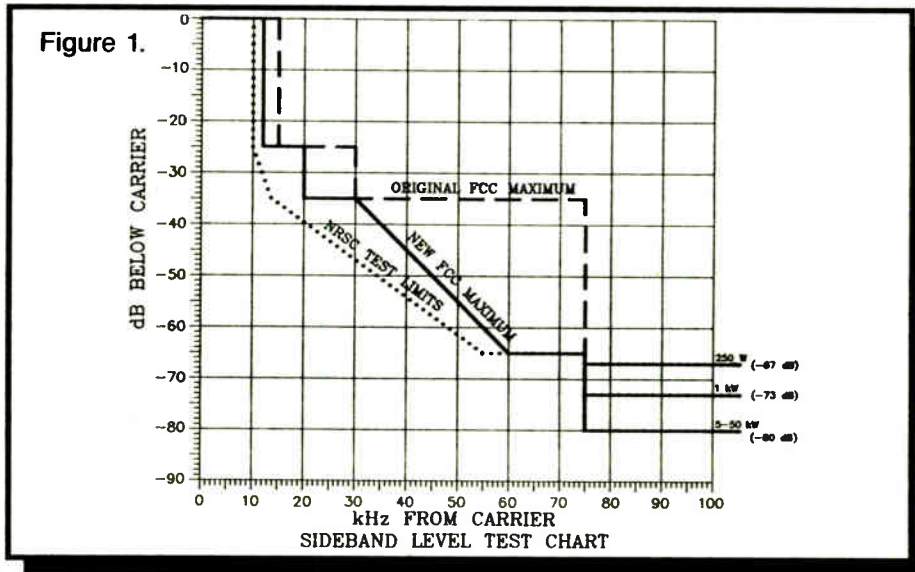

ments and modifications parallel the work done in preparing a station for AM stereo.

The fact that AM stereo has been successfully installed on "home-brew" type transmitters in other countries should dis-

nity to examine such possibilities.

Several manufacturers offer retrofit kits to upgrade existing processors. If you are satisfied with your present processing, best check with the manufacturer or rep
(continued on page 34)

Heart Monitor.

No matter how you look at it, the heartbeat of your TV station depends on a healthy transmission line. If a problem develops, how would you ever know until it's too late?

Now there's a way to check your line thoroughly and accurately before a simple problem becomes a major malfunction. It's the PRH-1 High Power Pulse Reflectometer from Delta Electronics.

The rugged PRH-1 puts out a low current, 5,000 volt variable pulse that overcomes the obstacles of long transmission lines, with no risk of damage. What you end up with is a series of echoes from the pulse displayed on your oscilloscope screen which represent your transmission line. The shape of the echoes determines the nature of any problem.

The PRH-1 operates like a champ in high RF fields, withstanding interference without any visible degradation of

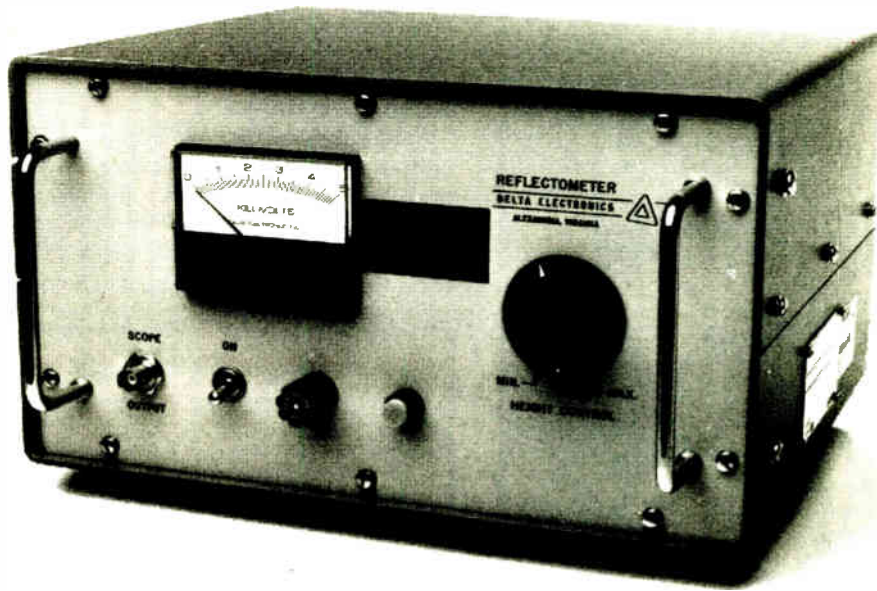

pulse echoes. This makes the PRH-1 ideally suited for crowded antenna farms and community antennas, unlike traditional time domain reflectometers. Its ability to measure AM and FM lines as well make the PRH-1 a sound investment.

What you don't know about your transmission line can hurt you. Considering the consequences you'll suffer being knocked off the air, shouldn't you consider buying the PRH-1 as your top priority?

To see actual PRH-1 test results, call or write today. Delta Electronics, Inc., 5730 General Washington Drive, P.O. Box 11268, Alexandria, VA 22312. Telephone: (703) 354-3350, FAX: (703) 354-0216, Telex: 90-1963.

The Above Standard
Industry Standard.

DELTA ELECTRONICS



©1989 Delta Electronics, Inc.

WPAZ Applauds Omnitronix

by Ron Simpson, CE
WPAZ-AM

Pottstown PA When the decision was made to install a new 1000 W AM transmitter at WPAZ, three main criteria had to be met: the transmitter had to be solid state, it had to be reliable and it had to be inexpensive.

The features that attracted us to the OMNI-1000 from Omnitronix were its high efficiency, the redundancy of critical circuitry, ruggedness, modularity and no requirements for patching. We were replacing a 1200 pound 1000 W transmit-

ter that dwarfed the 22" wide, 58" high, 325 pound OMNI-1000.

We inspected the OMNI-1000 at Omnitronix's Ft. Washington facilities and were quite impressed with the transmitter's clean lines and low distortion

USER REPORT

and noise characteristics. The audio frequency response was flat to well beyond 10 kHz and distortion below 2% across the band. Noise was -58 dB below 100% modulation; harmonics, -84 dB.

Delivery and installation

Because ours was the first OMNI-1000 manufactured, Omnitronix provided us with two engineers to help with installation and checkout.

Installing the OMNI-1000 was by far simpler and quicker than any other transmitter installation I've ever undertaken. The transmitter is made up of four self-contained 19" chassis that slide into a standard 19" cabinet.

The transmitter was received mounted in its cabinet. Packing material was removed and all printed circuit cards were installed. The 240 volt line was measured and the appropriate primary tap on the isolation transformer was connected.

Next, the antenna cable and ground strap were installed. The six interconnection cables were plugged in and we were ready to go.

Turning on the juice

Initial power-up was accomplished with the main circuit breaker on the power supply front panel. On both the power supply front panel and the control unit front panel, LEDs indicated that correct voltages were obtained. The con-

trol unit's front panel also indicated the frequency synthesizer was locked and all systems were "go" for applying high voltage.

At this point the high voltage switch on the control unit was depressed and the 300 volts DC current was applied to the power amplifier modules.

Each power amplifier module contains four diagnostic LEDs. At a glance the status of each module's low voltage, high voltage, temperature and output power can be determined. This is a great feature for routine maintenance.

The power amplifier modules unplug easily and no patch is required for a damaged or missing module.

On the control unit there is a multimeter for measuring all important transmitter voltages and an ammeter in the high voltage line. Additionally, there is a power meter to measure forward or reflected power.

Checking it out

During initial testing there were no glitches or failures. The audio was connected and the levels set. Our transmitter was purchased without the optional plug-in audio processor and modulation monitor PCBs. However, we already have our own modulation monitor and processor so this did not present a problem.

We installed the OMNI-1000 prototype in July of 1989. Since then we've gone off the air once due to lightning, which took out the reflected directional coupler's detector diode. This was the only problem we had and the directional coupler was subsequently re-designed with better protection.

In January of 1990 we installed the first production OMNI-1000. This unit has five preset switch-selectable power outputs, allowing the operators to switch to the 500 W pre-sunrise power and the three post sunset powers.

The temperature difference in the combination transmitter room/shop is significant. You can finally tell that there is indeed air coming from the central air system.

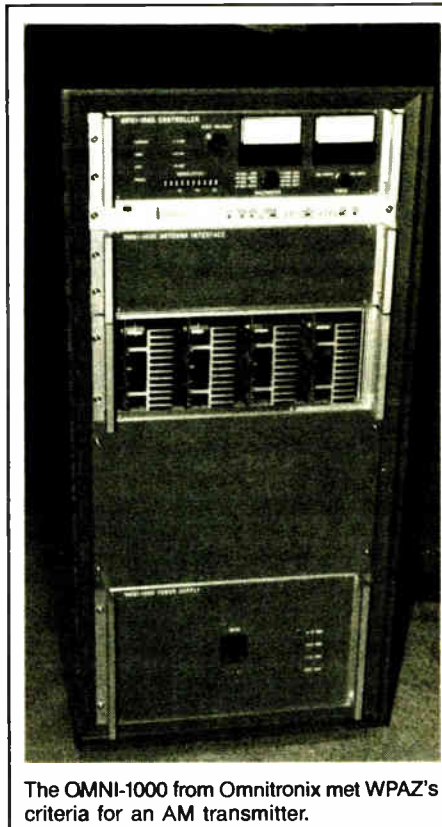

The OMNI-1000 from Omnitronix met WPAZ's criteria for an AM transmitter.

We have been very pleased and impressed with the support Omnitronix has given us. It is great to see a new company making an attempt to enter the market with refreshing ideas. We are looking forward to a long relationship with them.

■ ■ ■

Editor's note: Ron Simpson can be reached at 215-493-4252.

For information on the OMNI-1000, contact David Solt at Omnitronix: 215-540-0654, or circle Reader Service 24.

Where's that phone number?

Find it fast in the new 1990 Radio World Annual

Your Source For . . .

Manufacturer, Supplier, NAB and FCC Phone Listings

As Well As . . .

Product Information, Company Profiles, Buyers Guide Reprints, RW's 1989 Editorial Index, Reference Material, and More . . .



Don't have one?
Get it Fast!
Send \$14.95 for each Annual to:

RW 1990 Annual
P.O. Box 1214
Falls Church, VA 22041

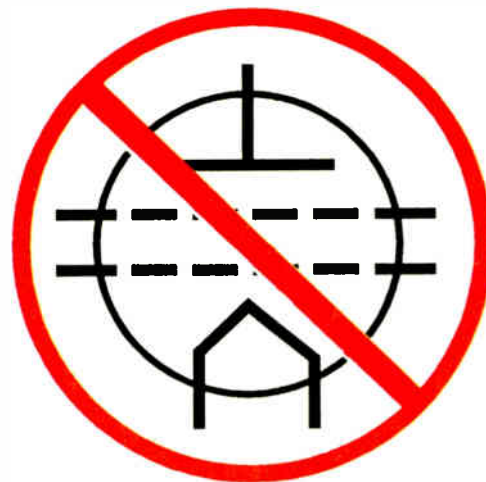
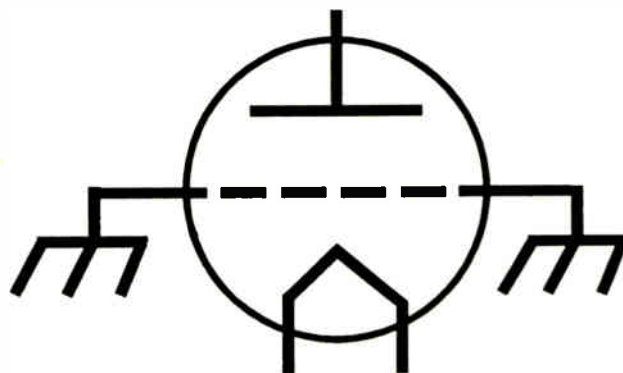

CCA ELECTRONICS, INC.

360 Bohannon Road/P.O. Box 426
Fairburn, Georgia 30213
Phone:(404) 964-3530 Fax:(404) 964-2222

RADIO PRODUCTION 1990.

Total creative control,
starting at less than \$6,500*.

Interface easily to analog
and to all major digital formats.

Fast learning curve to
high creative output.
Difficult editing tasks
made quick and easy.

Time expansion and
compression—without
pitch change

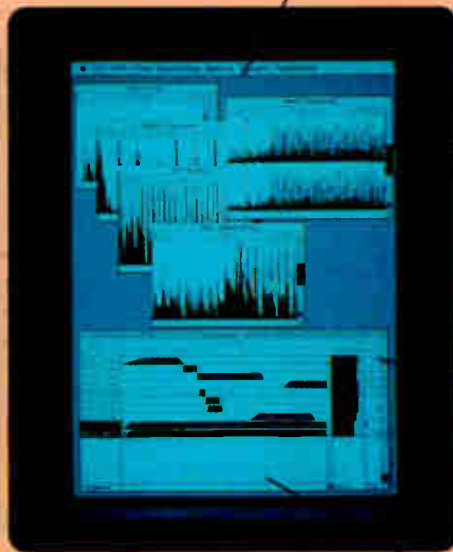
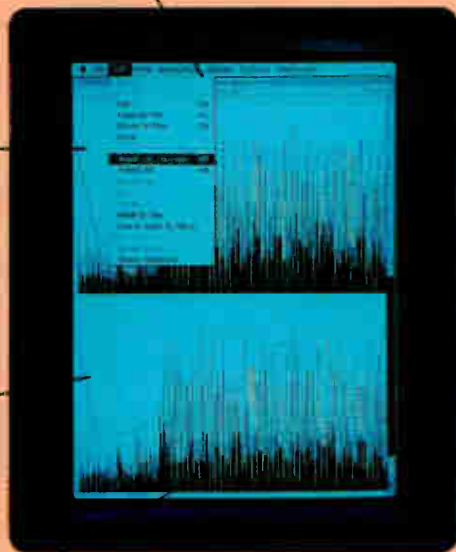

"Duck" a background
track beneath a voice-
over. Fade-out/fade-in,
with complete accuracy.

Storage capacity from 10
minutes to 6 hours of
stereo digital audio.

Superlative audio quality.
Multiple mixes and
multiple generations—
without degradation.

Easily expandable and
upgradable—now
and in the future.

STUDER DYAXIS. DIGITAL AUDIO HARD DISK FOR RADIO. YOUR LOW COST WAY TO BEAT UP ON THE COMPETITION.

Ratings wars—the push to get
advertisers—the crunch on operating
costs... You always need to move faster
and be better than the competition.

The station offering quick turn-
around and the ability to produce more
complex, sophisticated and creative
spots, jingles, promos and programs is
likely to be the winner. With Dyaxis,
you can *be* that winner. Your adver-
tisers love you. Your listeners love
you. And your competition hates you.

The Studer Dyaxis is the most

powerful and cost effective hard disk
digital recording/editing system
available, starting under \$6,500*—*proof*
that digital audio for radio doesn't have
to be expensive.

No ad can tell you all that Dyaxis
will mean to production at your station.
So call us at **800-366-4900** for our
12-page Dyaxis color brochure and
read about your exciting future in
digital audio editing with Dyaxis.

Now, *see* what you *hear*. On Dyaxis.
From Studer, a name you can trust.

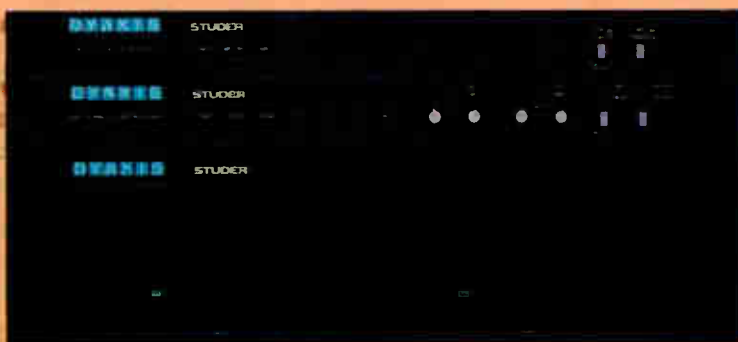

*Price not including Apple Macintosh computer.

STUDER REVOX

Studer Revox America, Inc.
1425 Elm Hill Pike • Nashville, TN 37210 • (615) 254-5651
New York (212) 255-4462 • Los Angeles (818) 780-4234
Studer Revox Canada Ltd., Toronto (416) 423-2831

NOW AVAILABLE
MacMix™ version 2.3
and
Excellerator/DSP Card

Circle 30 On Reader Service Card

World Radio History

CCA F Series Updates Shortwave

by John Binsfeld, Director of Sales
CCA

Fairburn GA The newly developed CCA F series shortwave transmitters were specifically designed to lead medium power plate modulated AM into the 21st century.

TECHNOLOGY UPDATE

This proven technology has gained the respect of shortwave broadcasters worldwide. The F series transmitters are available in power levels from 1 to 50 kW in either single or multiple frequency configurations.

Some of the design features include: solid state low level RF and AF stages, solid state control logic, automatic power control and VSWR protection.

Withstands climatic variation

The AM10000F-HF single frequency model is self contained in two 38"x34" cabinets. High quality modulation iron assures reliability in harsh tropical environments as well as high altitude applications.

A total of three beam power tetrodes are employed in the conventional single-ended Class C PA stage and Class B

push-pull modulators. Modulator bias is provided and regulated by the solid state modulator driver stages.

Conservatively rated, quality components were selected to withstand continuous high modulation levels with 125% positive peaks.

The low Q "PI-L" output matching network delivers the high frequency sideband response demanded by shortwave broadcasters. Sideband symmetry and low ICPM reduce the distortion effects of selective fading common to skywave signals.

NIST contract

CCA was awarded contracts to deliver three of the AM10000F-HF transmitters to the National Institute of Standards

Sideband symmetry and low ICPM reduce the distortion effects of selective fading . . .

and Technology (at the time, the National Bureau of Standards) at Boulder, CO. These new CCA transmitters will be the source of the WWV time and frequency standard transmissions at 5 MHz, 10 MHz, and 15 MHz from now until well into the next century.

The F series AM transmitters will also be

available in medium wave standard broadcast (540-1600 kHz) versions at 25 kW and 50 kW.

These models will replace the AM25000D and AM50000D transmitters. CCA, committed to the simplicity and reliability of this established technology, believes these new transmitters will maintain the company's position as a major supplier to "powerhouse" AM broadcasters worldwide.

Editor's note: For additional information on the AM10000F HF transmitter, contact John Binsfeld at CCA: 404-964-3530, or circle Reader Service 47.

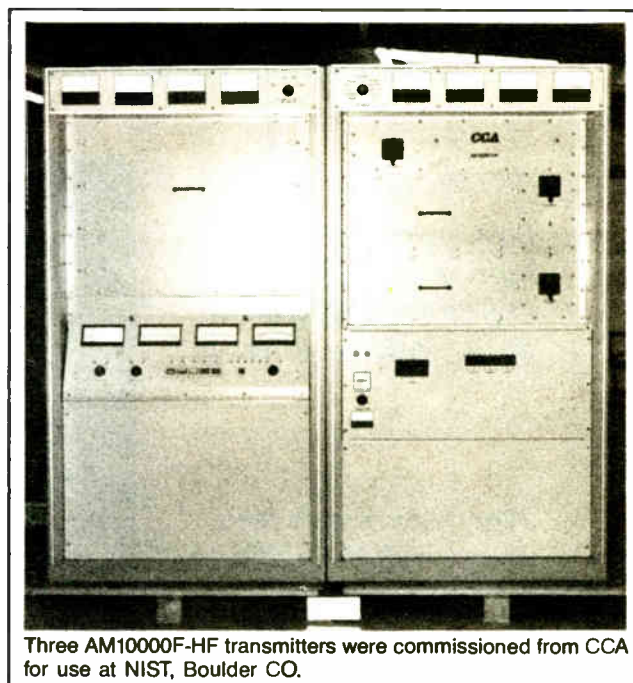

Three AM10000F-HF transmitters were commissioned from CCA for use at NIST, Boulder CO.

Complying with NRSC-2

(continued from page 31)

about what is available for your specific model.

If an upgrade kit is unavailable, or for that matter, if there is no compliance support, manufacturers also offer several add-on systems. When considering this approach, be sure the equipment will meet the necessary requirements.

A filter that meets the new FCC curve but has severe overshoot or ringing will only compromise your overall sound. The overshoot problem alone will seriously effect your modulation level and is worth considering.

Radio Design Labs has expanded its "stick-on" series to include both an NRSC preemphasis and brick wall filter modules. Both modules were introduced at the NAB. Their small size and low cost offer the engineer yet another method of achieving compliance.

Making measurements

A number of contract and consulting engineers now own the equipment to make occupied bandwidth measurements. In addition, Delta can provide the names of companies that rent AM Splatter Monitors.

For stations that opt not to purchase and install an NRSC filter by 30 June 1990, the FCC will require measurements to be made.

Again, we have that Catch 22 situation. The station must comply with the

new bandwidth limitation, and must make measurements to prove compliance; but without installing an NRSC-1 processor, compliance will be difficult.

If the measurements show the station is operating outside the limits, then the station will be in violation of the new rule.

Uncle will be watching

Several engineers in charge at FCC field offices have openly admitted that travel funds have been reinstated for their offices.

The imposition of a new more restrictive occupied bandwidth rule—coupled with funding for field inspections—makes it even more important that our houses be in order technically.

Remember, the deferral of measurement requirement is not a blank check to operate in an illegal or out-of-tolerance manner. If an interference complaint is received, the station will need to demonstrate compliance through Splatter Monitor or spectrum analyzer measurements.

To assist engineers in evaluating their spectrum, Delta Electronics has prepared a packet that includes several applications bulletins and forms that can be used to document spectral compliance.

The packet is available at no charge by calling Delta at 1-800-8-DELTA-8. For a more in-depth discussion of the new spectrum rules, see Harold Hallikainen's article on page 53 of the Radio World Annual.

Broadcast Telephone has never sounded better.

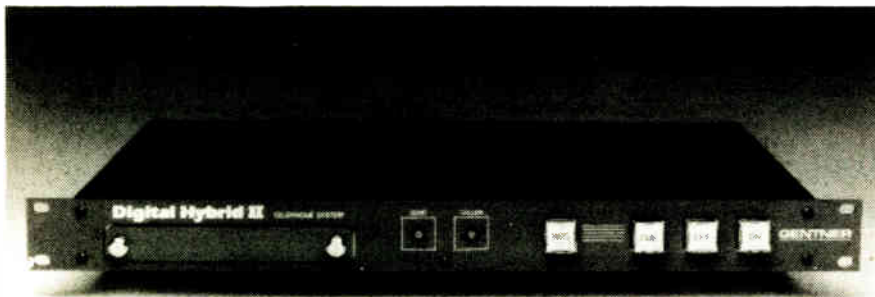

GENTNER

Using DSP Technology, 16 bit processing and 2 times oversampling, the Gentner Digital Hybrid II means quality and consistency for your on-air calls.

Your Northeast salesperson has all the details!



NORTHEAST BROADCAST LAB, INC.

Serving The Broadcast Industry Since 1961

Main Office
P.O. Box 1179
S. Glens Falls, NY 12803
Tel: 518-793-2181
Fax: 518-793-7423

Mid-Atlantic
P.O. Box 565
Southampton, PA 18966
Tel: 215-322-2227
Fax: 215-953-0523

New England
P.O. Box 406
Auburn, NH 03032
Tel: 603-483-1002
Fax: 603-483-2352

Southwest
P.O. Box 867717
Plano, TX 75086
Tel: 214-612-2053
Fax: 214-612-2145

NRSC-2 Dilemma? No Problem.

We deliver the simple, effective, and inexpensive solution to your compliance with the mandatory NRSC specification.

Easily installed in only minutes, our product utilizes digital techniques for full asymmetrical peak control, self-regulating pre-emphasis and no-overshoot lowpass filtering. It works with any existing processing, or can even stand alone as the only processor you really need!

NOVONICS MODEL 222 - \$590

Inovonics Inc.

CALL 1-800-733-0552
FAX: (408) 458-0554



LIMITED
TIME
ONLY

SPECIAL INTRODUCTORY OFFER



AUDIOMAX MODEL 4000

10 sec - 100 sec	\$2.95 ea.
140 sec - 4.5 min	\$3.45 ea.
5.0 min - 10.5 min	\$3.95 ea.

**SATISFACTION
GUARANTEED**

**CALL FIDELIPAC
FOR A FREE SAMPLE
AND A LIST OF
STOCKING DISTRIBUTORS**

New from Fidelipac, the AUDIOMAX 4000 Broadcast Audio Cartridge, developed specifically for premium quality stereo use. AUDIOMAX 4000 is completely bias and phase compatible with Type AA-4 cartridges, yet provides improved performance and reliability.

- Extended High Frequency Response
- Improved Headroom
- Longer Wear Tape Formulation
- Reduced Oxide Shedding
- Lower Tape Surface Abrasion
- Tougher Plastic Shell
- Tighter Tolerance Construction
- Satisfaction Guaranteed



FIDELIPAC®
BROADCAST TAPE PRODUCTS

Fidelipac Corporation
P.O. Box 808 • Moorestown, NJ 08057 • U.S.A.
609-235-3900 TELEX: 710-897-0254
FAX: 609-235-7779

Fidelipac Corp. reserves the right to limit quantities, and to withdraw this offer at any time without prior notice.

WBTM Excited by Delta ASE-1

by John L. Cole, DE
WBTM-AM

Danville VA Delta Electronics seems to emphasize products for the AM broadcast industry. This emphasis was

USER REPORT

an important factor in WBTM's selection of the Delta ASE-1 exciter.

When WBTM went shopping for a C-

QUAM AM stereo exciter in 1984, there weren't many field-proven installations to document the success of the Delta product.

Still, we felt confident enough in Delta Electronics to buy the ASE-1 exciter and ASM-1 monitor "hot off the press." Time has proven our confidence in Delta's exciter/modulation monitor to have been well placed.

Modular design

One of the things that technical personnel will appreciate is the modular design of the ASE-1.

Each major circuit function is grouped

together on its own PC board to facilitate servicing and provide for cost effective updating as the state of the art advances.

Something Delta calls Zero Insertion Force Sockets for the PC boards and an extender board that puts the card up in the air where you can get to it, make the engineer's life a lot easier.

If you've ever had to grab a board with vice grips and prop your feet against the

performance of any C-QUAM system. With the Delta ASE-1 exciter two sets of delay and EQ adjustments are standard and remotely selectable.

This allows the user to set the adjustments for best performance on the main transmitter and antenna and then switch in the other set of delay and EQ for best performance with the night pattern antenna or another transmitter.

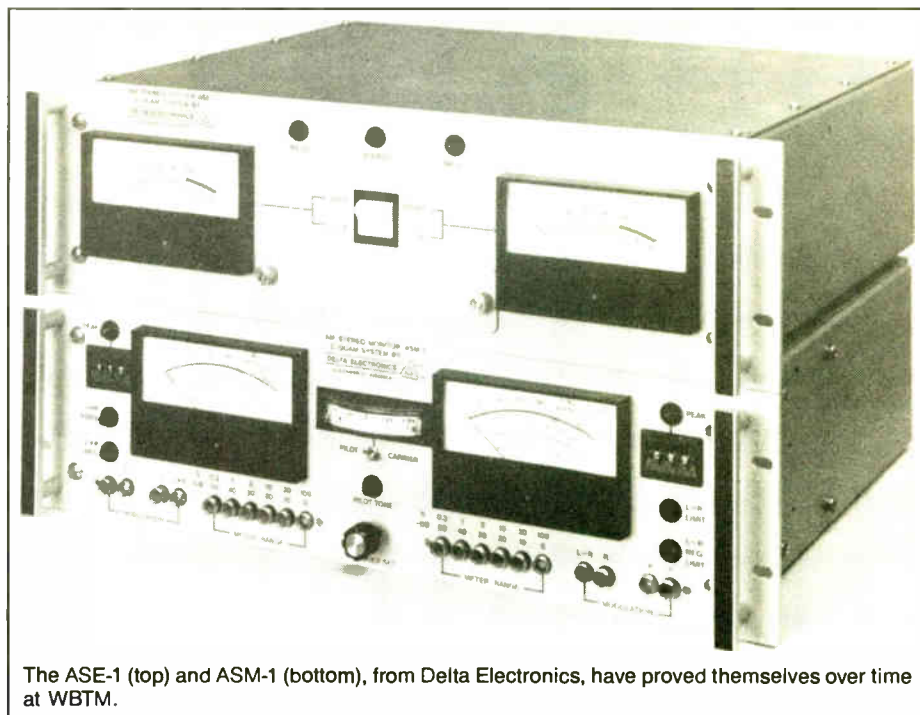

The ASE-1 (top) and ASM-1 (bottom), from Delta Electronics, have proved themselves over time at WBTM.

side of the rack to pull it out of the socket, you'll love Delta's ZIF devices.

Delta has taken some of the fear out of interfacing the exciter to the transmitter by providing two TTL level outputs and two variable level RF outputs. This allows you to mix and match new and old, main and alternate or main and auxiliary transmitters—and have outputs to drive them all.

Precise adjustment of delay and equalization is essential for optimum

Adjustments are easily made through clearly labeled access holes on the top and rear of the exciter chassis.

Optimal closed loop performance

In our case, no degradation in stereo performance is introduced by the directional antenna, so I have the "night" delay and EQ controls set up for best closed loop performance with the exciter's built-in sample transmitter.

When this signal is fed into the ASM-1 modulation monitor, I have a quick and easy check of system performance.

An important feature of the exciter is the blend circuit. This circuit limits L-R excursions during periods of heavy single channel modulation.

To allow an excessively high angle of L-R information would result in very noticeable distortion on receivers. Some audio processors provide for this L-R protection and some do not. With the blend circuit in the exciter properly adjusted, you'll not have to worry about this problem.

Setup and routine monitoring of the system are aided by dual analog meters on both the exciter and monitor. Left, right, L+R and L-R levels can be monitored at a glance.

Separation measurements are easily made with the ASM-1 modulation monitor.

Improved manual

Delta's technical manual is substantially improved over earlier versions. It provides concise procedures for setup and testing of the system and an expanded troubleshooting section.

Delta also manufactures the CQS-3 C-QUAM standards generator, a handy device that provides calibrated standard C-QUAM signals to verify modulation

(continued on page 42)

GET IT RIGHT
GET IT FROM ALLIED

Q Do You Know These Guys?



A If Not, You Should.

These gentlemen are veteran, experienced broadcast personnel who are the "heart" of Harris Allied Equipment Exchange. Their experience is unparalleled. They BUY, SELL and TRADE used broadcast equipment and have been since the late 1960s.

We need to BUY used equipment to replace our inventory. Business is good and so our shelves are a bit bare. Have you checked under your benches...in the cabinets...in that store-room...up in the attic, etc.? What are you waiting for? Take a look around and let us know what you have and we'll try to make a deal with you.

We accept TRADE-INS on buys of new equipment and we SELL USED and NEW broadcast equipment (demos and scratch & dents). We also selectively BUY used radio equipment of various vintages.

Call on us any business working day. (That's Jim on your left and Chuck to your right.) They've been around for a long time and they know the business. You're guaranteed the best knowledgeable broadcast assistance the industry has to offer and you'll get the fairest price for your used equipment.

HARRIS ALLIED
EQUIPMENT EXCHANGE

FAX 317-966-6321

317-962-1471

635 SOUTH E ST. • P.O. BOX 1487 • RICHMOND, IN 47374

©HARRIS/ALLIED 1990

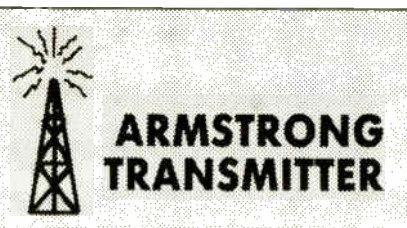

FINEST REBUILT TRANSMITTERS

We're the leading re-manufacturer of transmitters worldwide.

Transmitters are available:

- Tuned & Tested on YOUR Frequency
- Guaranteed and Installed
- Completely Re-manufactured
- Expedited Service available

Trade-Ins gladly accepted - WE DELIVER!
See your choice in transmitters WORKING in our huge new showroom BEFORE you take it home!

**NO ONE ELSE OFFERS YOU THIS!
SEE & TEST IT ALL YOU WANT!**



ARMSTRONG TRANSMITTER CORP.
5046 Smoral Road (315) 488-1269
Syracuse, NY FAX (315) 488-1365



All seven Bonneville stations are now "UnProcessed."

KBIG in Los Angeles. New York's WNSR. KOIT in San Francisco. In Seattle, KSEA. WTMX in Chicago. Kansas City's KMBR. KZPS in Dallas. Every one of the seven Bonneville FMs is now broadcasting a louder, cleaner signal, *legally*. With "The UnProcessor," the advanced microprocessor-based ModMinder™ from Modulation Sciences.

What's even more remarkable is that the Bonneville stations are doing all this without any additional processing. Because ModMinder isn't a processor—it's a more accurate, more correct device for measuring modulation. In fact, "The UnProcessor" made such an impression on Jim Stagnitto, WNSR's Director Engineering, that he called it "the

most important product for broadcasters brought out in 1989" in a *Radio World* article published in the issue of August 23rd.

Jim Stagnitto's not alone in his opinion, either. Modulation Sciences has already shipped over 100 ModMinders to stations in all formats, in cities all across the country. So if you don't have one yet, the odds are your competition does.

Still wondering how well "The UnProcessor" works? Someone in your area already knows. Fortunately it's not hard to find out exactly how much louder and cleaner you can sound with ModMinder. Just call Modulation Sciences toll free at (800) 826-2603.



modulation sciences, inc.

115 Myrtle Avenue • Brooklyn, NY 11201 • Tel 718-625-7333 • Toll Free 800-826-2603 • Fax 718-260-8286

Energy-Onix: A CE's Time Saver

by Jim Emmel, PD/OM
WWAX-AM

Olyphant PA As you read this article, you may wonder why it was written by the PD/OM and not by the CE. The fact is that, since we installed our new Energy-Onix transmitter, the airstaff is more involved with the unit than our CE.

After limping along with a "vintage" transmitter ever since we signed on the air better than two years ago, WWAX, an AM daytimer in Olyphant, PA, was in dire need of a new unit. The old box provided a clear, rich sound whenever it was on the air—but that was the uncertainty of it all.

We never knew when it was going to go down, nor did we know when or if we could correct the problem. Transmitter failures had become a way of life. Frequently, some breaker had been tripped that meant a "reset" from the comfort of the studios was out of the question.

Emergency trips to the transmitter site could (and often were) required several times in a single broadcast day. The temperament of our aging transmitter was just one of many factors necessitating the search for new, state-of-the-art equipment.

Engineering considerations

The engineering staff had four major considerations in selecting our replacement transmitter.

The new unit had to be capable of producing the 1600 W just recently

granted by the FCC. Our present box was putting out 400 W—our originally licensed power—and although it was a 1 kW transmitter, we hesitated to push it to the maximum.

Only single-phase power was available at our site. Upgrading to a 5 kW transmitter meant the installation or derivation of three-phase power, a drastically expensive project for our terrain. The local power company balked at any mention of this. Thus, a 2.5 kW transmitter capable of single-phase operation could not be secured easily either new or used.

USER REPORT

Our replacement transmitter would have to be field upgradeable, as our engineering consultants planned to re-measure our signal's contours and submit for an additional power allocation. What would happen if we were granted an excess of 2.5 kW and management would have to be convinced that yet another more powerful transmitter were required?

The new unit had to fit physically into our somewhat cramped transmitter building and financially within the budgetary constraints of a growing AM daytimer.

Bernie Wise, president of Energy-

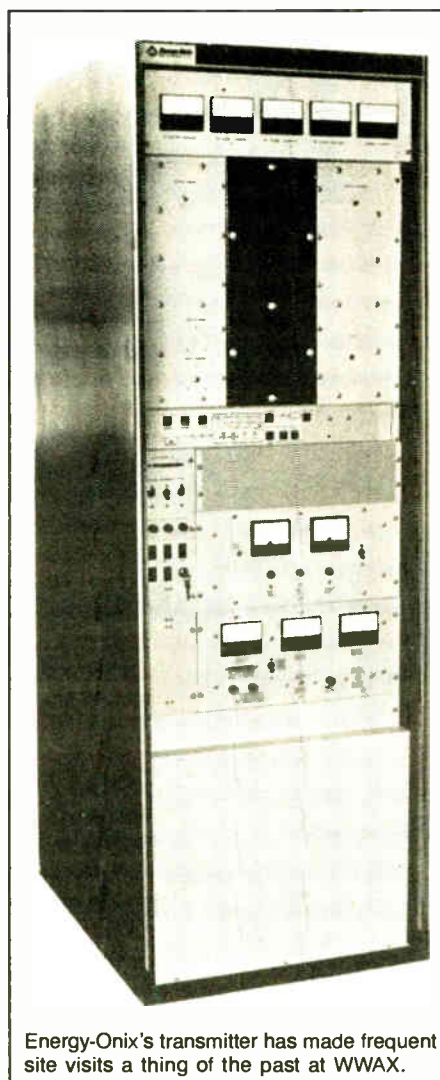

Energy-Onix's transmitter has made frequent site visits a thing of the past at WWAX.

Onix, headquartered in Hudson, NY, solved all our problems and eased our fears with his AM prototype.

An Energy-Onix first

While Bernie had been engineering transmitters for ages and of late had been building his own FM and high-powered AM transmitters, the transmitter WWAX needed would be truly a first for the firm. Moreover, Bernie was dedicated to giving his new product an abundance of personal attention.

Now to convince the CE, Walter

Rounds, who seemed rather skeptical until he too grilled Wise. After a lengthy conversation between the two, Walter concluded that going with Energy-Onix was a sound decision.

In mid-summer 1989, WWAX management gave Energy-Onix approval. In late autumn the new transmitter was delivered and readily installed by a crew that included one of the transmitter's designers.

Up and running

Hours after their arrival, we were fully functional. Our "Just Classic Hits" format never sounded better: the fidelity was superb. For some time with the old transmitter we had to push the high end of our processor, but with the Energy-Onix model, this was no longer necessary nor desired.

A sudden spurt of excessive modulation would have knocked down the modulators on our old relic. The new transmitter, however, maintained the surge and alerted the operator that the problem needed correcting. We delighted in this as we do not use composite clipping nor do we engage in loudness wars.

Every year during the winter months we suffer some type of tower or unipole damages due to severe ice build-up; this might have ordinarily resulted in a transmitter outage. The past winter marked yet another occurrence as our unipole collapsed.

And yet, the Energy-Onix transmitter stood its ground. Engineering quickly adapted the transmitter to accept the situation until permanent repairs could be made at the tower.

We count on our Energy-Onix transmitter to keep working for us atop our mountainous transmitter site and we have faith in its reliability and soundness of construction.

Now our CE can spend some time in the studios doing the maintenance work he had to squeeze in before, because his presence isn't constantly required at the transmitter shack anymore. We can all relax—we've got an Energy-Onix!

Editor's note: For more information, contact Bernie Wise at Energy-Onix: 518-828-1690, or circle Reader Service 33.

With the whole world turning to Stereo . . .



Why in the world broadcast in AM Mono?

Modernize with C-QUAM® AM Stereo!

Face it. We live in a stereo world. And you join a family of winners when you choose C-QUAM AM Stereo. You'll find . . .

- Nearly 800 C-QUAM AM stations around the globe
- More than 20 Million C-QUAM decoder IC's shipped to receiver manufacturers
- 4 countries to date with a C-QUAM AM Stereo standard

For details on the Motorola C-QUAM AM Stereo system, call Steve Kravitz collect at 708/576-0554. Fax 708/576-5479.



MOTOROLA
C-QUAM® SETTING THE INDUSTRY STANDARD

C-QUAM IS A REGISTERED TRADEMARK OF MOTOROLA, INC.

Companies . . . The National Supervisory Network is now listed with Harris/Allied Broadcast Equipment. The National Supervisory Network is the first operations service company to be listed with Allied.

The Davis Communications Group, Inc. has relocated. The new mailing address is Rt. 3, Box 45E, Four Oaks, NC 27524. The phone number is 800-525-1037.

Three broadcast engineers have joined to form the Lahm, Suffa & Cavell consulting firm, located in Fairfax, VA. Karl Lahm, William Suffa and Garrison Cavell will



provide technical and strategic advice to station owners and operators. Lahm, Suffa & Cavell is located at

9653 Lee Highway, Suite 25, Fairfax, VA. The telephone number is 703-591-0110.

People . . . Sony Communications Company has named Courtney Spencer vice president of its Professional Audio Division.

Gentner Electronics Corporation (NASDAQ:GTNR) has appointed Hugh Heinsohn as director of marketing. Heinsohn's responsibilities include managing the company's Sales, Distribution, Marketing Coordination and Customer Support departments.

Marti Electronics has appointed Dan Rau to the position of director of sales and marketing.

Harris Corporation has named Jeff Baker as its radio sales representative for the Northeastern United States. Mr. Baker is replacing recently retired Bob Hallenbeck.

JBL Professional welcomes Lance Korthals as its vice president of market development. Lance is responsible for directing the growth of new professional markets and companies.

System 3000 Solves EBS Woes

by Skip White, CE
WQXR

Jacksonville NC It was a dark and stormy night. The National Weather Service was predicting severe thunderstorms and the chance of tornados.

The old EBS receiver came to life to warn the control room operator that the storms were approaching rapidly. The DJ pressed the switch to put the EBS announcement on the air but there was only silence.

One of those severe thunderstorms had knocked the CPCS-1 station off the air! The emergency information that could save lives and property was no longer available. What now?

USER REPORT

Think about it. What could your station do under those conditions? If you wait for the CPCS-1 to come back on, the information could be too little or too late—or both.

Even if the news wire sends the information it might still be too late. Can your listeners afford to be uninformed?

Affordable problem solvers

There was no simple solution to many of the problems surrounding the Emergency Broadcast System until recently. A

The capability of having all three receivers active simultaneously puts the System 3000 in a class of its own.

new family of EBS systems has been introduced by Multi-Technical Services Company.

Dubbed the System 3000 and the System 1000, these EBS systems are practical and cost effective problem solvers. I've had my System 3000 for about four months now, and I want to tell you all about it.

The important thing to remember is that the System 3000 is a *system*. The receivers, decoders and encoder are all designed to work with each other.

Good-looking and easy to use

The System 3000 eliminates the usual hodgepodge of interfacing a Brand X receiver with a Brand Y decoder and a Brand Z encoder; it combines all the essential ingredients into one compact package. It even tests itself and will tell you when something is wrong.

The System 3000 looks good. The front panel is a friendly charcoal grey color, which blends very well with the other equipment in your rack. It needs just 3 1/2" of rack space.

There are six push buttons and six LED indicators. On the rear apron are a 25-pin DB-25 style connector, three UHF coaxial jacks and a power connector.

The DB-25 makes installation quick and easy. Mine was installed and oper-

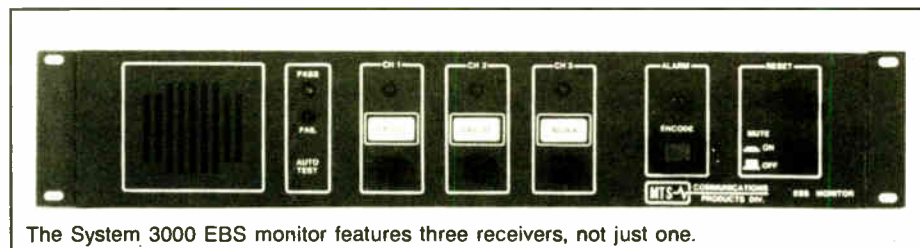

The System 3000 EBS monitor features three receivers, not just one.

ating in less than fifteen minutes, thanks to the DB-25 terminal block option.

What makes the System 3000 unique? First, it has three receivers instead of just

one. Multi-Technical Services offers receiver modules for the standard AM and FM broadcast bands and one for picking up NOAA weather radio broadcasts.

Wide coverage stations can monitor the CPCS-1 of an adjacent region and provide even more complete emergency information. The decoders sense the presence of either the EBS two-tone alert signal or the NOAA single tone alert signal.

The capability of having all three receivers active simultaneously puts the System 3000 in a class of its own.

The System 3000 is controlled by a proprietary microprocessor system. An on-board computer system constantly scans

(continued on page 40)



INTRODUCING:



NAUTEL AMPFET ND25/50, 25 KW & 50 KW

SECOND GENERATION ALL SOLID STATE AM TRANSMITTERS

- Solid state design utilizing digital circuit techniques results in superior audio performance and high efficiency
- Specifically designed for NRSC Standards compatibility and AM Stereo operation in support of improved AM radio
- Parallel modular configuration provides true active reserve without need for operator intervention
- On air serviceability features allow module removal without interruption in broadcasting
- Built-in duplicate exciter sections offer complete backup of critical low level control circuitry

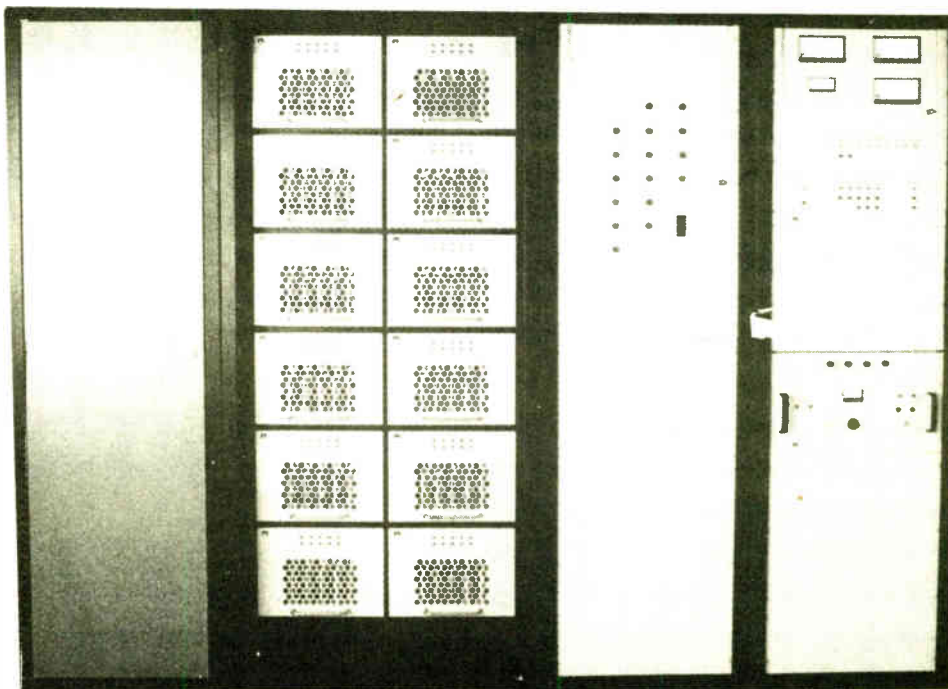

ALL SOLID STATE AMPFET ND SERIES AM MEDIUM WAVE TRANSMITTERS

POWER RANGE UP TO 100 KW

Phone:(902)823-2233 Canada-Fax:(902)823-3183-Tlx:019-22552



NAUTEL
(Nautical Electronic Laboratories Limited)
RR#1, Tantallon, Halifax County
Nova Scotia, Canada B0J 3J0

Nautel Maine Inc.
201 Target Industrial Circle
Bangor, Maine
04401 U.S.A.



Examining Options For Low Power AM

by Richard Burden, President
Burden Associates

Canoga Park CA One area of broadcasting which makes particular use of the AM receiver is low power AM radio. Applications fall under Part 15 and Part 90 of the Commission's rules.

Perhaps the best known low power AM radio application is that of the campus radio station, authorized under Part 15. This application employs carrier current technique, the process by which the RF signal is superimposed upon an

to enter the power line while preventing the low frequency 60 Hz from backing into the transmitter.

This network also makes the match between transmitter and load. The equivalent circuit of the power line is represented by a low resistance (usually in the order of 1 to 50 ohms) in series with an inductance.

Variable transformer

This interface device, therefore, contains a variable transformer to match the resistive element of the load and a variable capacitor to null out the inductive element.

Connection to the power line is at the 220 or 110 volt secondary of the incoming power transformer. The RF signal then follows the route of the electrical wiring throughout the building.

The signal emitted does not radiate as an antenna. Instead, it yields a strong induction field in the vicinity of the conductor with a rapidly diminishing field that varies as the inverse cube of the distance.

This physical principle allows for a strong signal to be received in the close proximity of the conducting cable.

The rapid attenuation of this same signal keeps the signal confined to the area of interest. (LPB has a publication on this subject, titled "Tech Note 1A."

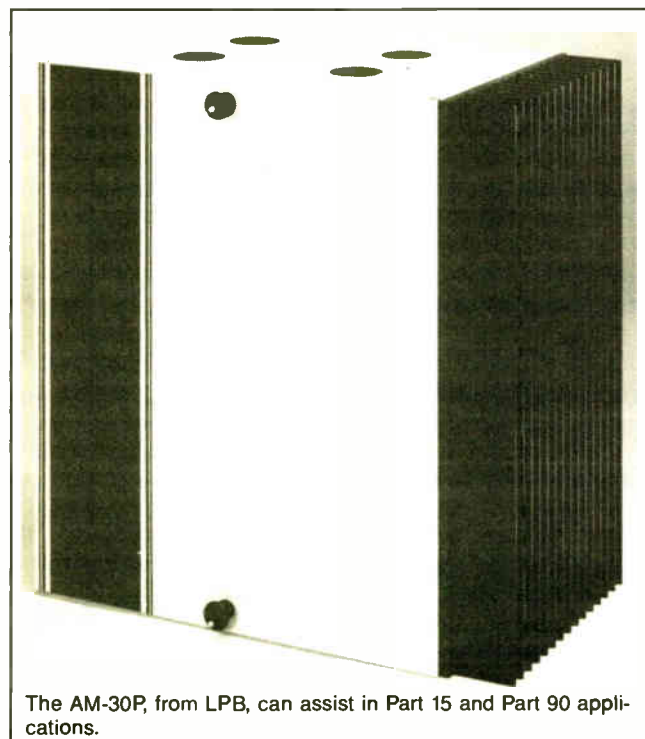

The AM-30P, from LPB, can assist in Part 15 and Part 90 applications.

existing power line.

The output of the transmitter is interfaced with the power line through a high pass network. This allows the RF energy

Bi-directional RPU for \$250 with The Cellular Production Unit™

by The Davis Communications Group

By connecting our \$250.00 Cellular Production Unit™ to your cellular telephone, you get a fully bi-directional RPU system capable of interfacing with any audio gear you own, including frequency extenders. The CPU™ features a separate output for return



audio, and provides you with instant mobile remote capability from any cellular service location, without FCC licensing or RF problems.

- Sports Events
- Live News Coverage
- On-Site Promotions
- Boom Boxes
- Roving Interviews
- TV IFB/CUE

BROADCAST SERVICES CO.

CPU and Cellular Production Unit are trademarks of The Davis Communications Group.

Neal Davis, Four Oaks, NC, 919 934-6869 • Keith Arnett, Front Royal, VA, 703 635-1413
FAX 919 934-1537

It can be obtained by writing the company at 28 Bacton Hill Rd., Frazer, PA 19355.)

Drive-ins and leaky cables

Another common carrier current technique is used at numerous drive-in theaters. Here the RF signal is superimposed upon the existing field loud-speaker wiring and the sound from the picture is received on the standard AM automobile receiver.

SPECIAL REPORT

Although originally intended to circumvent speaker theft, this technique has been widely accepted as an improve-

ment in audio for the theatre patron.

A variation of the carrier current technique is "leaky cable technology." Here, the technique is employed as the vehicle for routing an RF induction signal.

Leaky cable is terminated in its characteristic impedance. At AM broadcast frequencies, it intentionally leaks a linear induction field along its length.

There has been much misconception on the subject of the radiated field. Some argue that this constitutes an antenna. Actually, its representation is that of a transmission line terminated in its characteristic impedance and is more properly defined as a "Terminated Transmission Line."

It is the dummy load, or termination, that is the actual antenna member in this system. The resultant field, linear along

(continued on next page)

A New Wrinkle in EBS

(continued from page 39)

up to three stations and listens for an alert tone.

In between stations, the computer conducts a full test of the receivers, decoder and encoder and lights the front panel auto test "pass" indicator. If any portion of the system fails the built in test procedure, the "fail" lamp is activated.

Multi-Technical also makes an AM receiver module. The receivers are sensi-

the System 3000. All the indicators and control functions of the front panel are available at the rear panel connector jack.

Since the interface circuitry is built into the EBS system, you need only connect it to your remote control equipment. It really is that simple!

My System 3000 has been in operation since mid August of 1989. It has performed flawlessly since it was installed.

The engineers who designed the System 3000 have extensive experience in

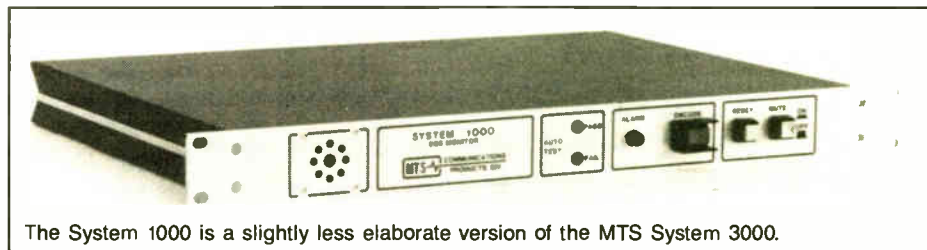

The System 1000 is a slightly less elaborate version of the MTS System 3000.

tive and stable, both important for EBS monitor duty. They are also factory tuned and do not require adjustment.

Attractive for automated stations

The System 3000 can be configured for fully automatic operation, with the ability to take over programming during an emergency broadcast and then relinquish control when the broadcast concludes. This feature is especially attractive for automated stations.

Remote control operation is easy with

the design and production of military specification electronic equipment, so the System 3000 should prove to be a reliable and cost effective investment for any station.

Single receiver version

The comments in this article are directed mainly toward the System 3000, but apply to Multi-Technical's System 1000 as well.

The 1000 is a single receiver version of the EBS system and offers the same operational features and benefits of the System 3000. The System 1000 is smaller, requiring just 1 3/4" of rack space.

Do I like it? You bet I do! This is what an EBS System ought to be. It is well designed and well built, and the built-in reliability makes the System 3000 easy to maintain.

You just plug it in and it works. Your DJs will like the easy operation, and you will like the superb performance of the System 1000/3000 series. I wish all broadcast equipment was built like this!

(Author's note: With apologies to Snoopy, that "dark and stormy night" was real. Hurricane Hugo made landfall nearly two hundred miles south of Jacksonville, North Carolina. Thanks to the System 3000, our station was never out of touch with the emergency information our listeners needed.)

Editor's note: Skip White is CE for WQXR, Jacksonville, NC. He can be reached at 919-455-0330.

For more information on the System 3000, contact Lyn Williams at MTS: 919-553-2995, or circle Reader Service 89.

QEI QEI QEI QEI QEI

WHY QEI?

Free.



Our FREE spare kits include every solid state component of the transmitter, exciter and remote control.

Call us toll free at 800-334-9154 for all the facts on QEI "New Reliables" FM transmitters from 1kw to 30 kw.

QEI CORPORATION
ONE AIRPORT DRIVE • P.O. BOX D
WILLIAMSTOWN, N.J. 08094
TEL (609) 728-2020 • FAX (609) 629-1751

QUALITY • ENGINEERING • INNOVATION

Putting Low Power into Practice

(continued from previous page)

its length, yields a propagation characteristic which attenuates as the inverse cube of the lateral distance from the conductor.

Wide range of supporters

Measured data supports the physics of this approach. Leaky cable has found favor in those applications where a linear field was required over longer distances.

Users of this technology include the Los Angeles Lakers and Los Angeles Kings at the Forum. The sports teams employ this method to receive game broadcasts inside the arena. Santa An-

effective use of induction principles and standard AM broadcast receivers.

Longer lengths of induction cable can be found on the approach roads to such attractions as Walt Disney, Epcot Center and the Grand Ole Opry. These attractions make use of induction techniques to provide information to incoming motorists. As commercial establishments, they operate under Part 15 of the rules.

Part 90—travelers' information

In the late '60s, Cliff Moore, GM of the Los Angeles Department of Airports, used leaky cable technology to solve a

licensed service limited to local government use, for the expressed purpose of providing information to the traveler.

Authorization includes both leaky coax

area of interest.

Conversations with receiver manufacturers would seem to indicate that the public has abandoned interest in AM radio. But the continuing effort on behalf of AM improvement is helping AM to compete in today's world.

The multifaceted uses of low power AM radio only add to the value and ver-

Others who use leaky coax techniques for language translation and aid to the hearing impaired attest to this simple but effective use of induction principles and standard AM broadcast receivers.

ita Racetrack uses the technique to enhance the enjoyment of racing.

Other uses have served the church community. The Crystal Cathedral in Garden Grove, CA utilizes leaky cable routed through the parking area to provide reception of services held in the sanctuary to those choosing to remain in their vehicles.

Others who use leaky coax techniques for language translation and aid to the hearing impaired attest to this simple but

congestion problem at LAX, which has the distinction of being the busiest vehicular traffic airport in the world.

Moore felt the congestion at LAX could be relieved if motorists were provided with traffic, parking and airline location information as they entered the airport area. This was the beginning of what is now known as the Traveler's Information Service.

The Commission issued rulemaking on the TIS service in 1977. This is a

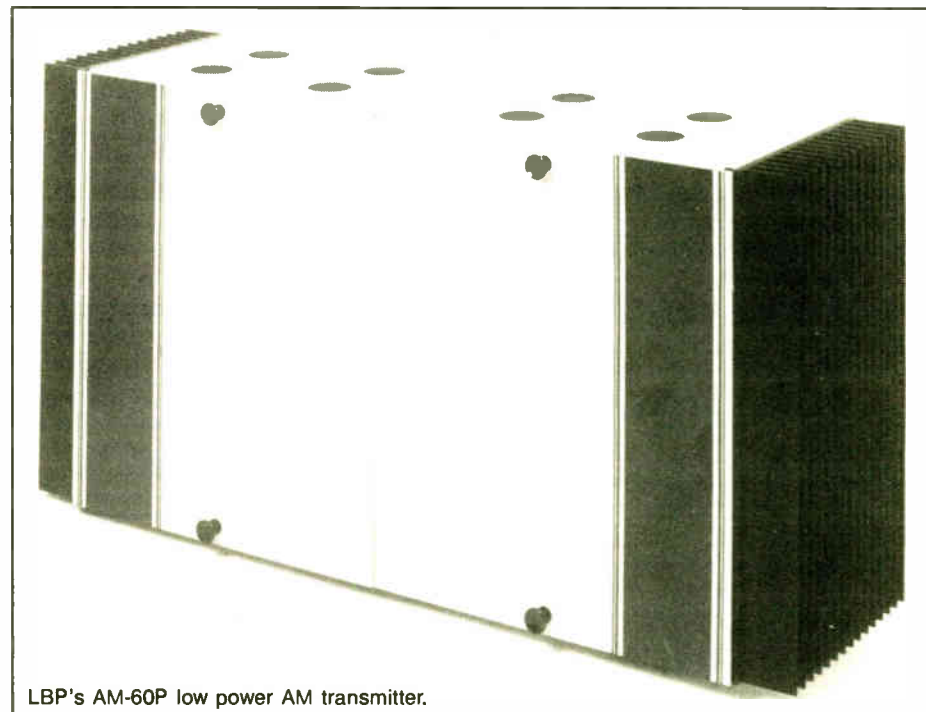

LBP's AM-60P low power AM transmitter.

technology and short vertical antennas. Power limitations for this service are a maximum of 50 W into a leaky cable or 10 W into an antenna system.

The maximum field at 1.5 km from the site of an antenna system is not to exceed 2.0 mV/m regardless of power, which limits coverage to the specific

satiluty of the AM broadcast spectrum.

■ ■ ■

Editor's note: Richard Burden is president of Burden Associates, a broadcast engineering service.

For information on low power transmitters, contact John Tiedeck at LPB : 215-644-1123, or circle Reader Service 19.

COMPLETE YOUR DEFINITION OF "CLASS A," CALL CONTINENTAL ELECTRONICS

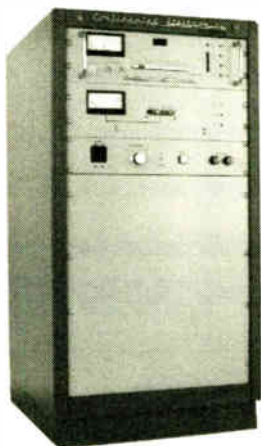

500/1000W

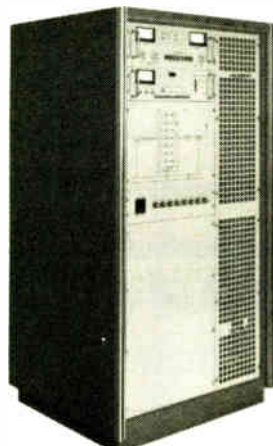

3.8 kW

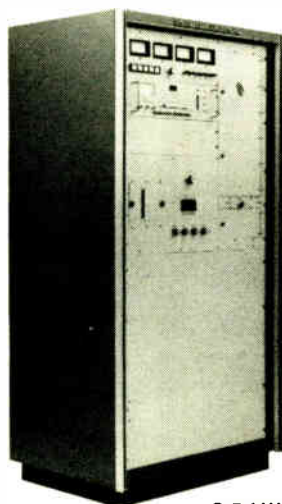

2.5 kW

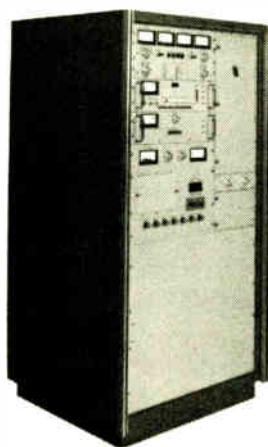

5 kW

Continental Electronics is here to assist you with your new definition of "Class A." You can increase power, increase revenue base, and expand your listening audience by upgrading your transmitting facility.

Continental has engineered four transmitters to meet your needs. The 500/1000 Watt transmitter is single phase and is only 42 inches tall. This transmitter and the 3.8 kW are totally solid-state and designed for high efficiency and reliability.

The 2.5 kW and the 5 kW transmitters are single tube transmitters. All Continental FM transmitters include an internal harmonic filter and the Ultimate 802A Exciter.

For service after the sale, call the Continental 24-hour tech line. At Continental, service is an attitude, not a department.

So, call your Continental Sales Manager to get the complete definition of "Class A."

varian 

continental electronics division

P.O. Box 270879 Dallas, Texas 75227

Telephone: 214-381-7161 Fax: 214-381-4949 Telex: 73398



CONSULTANTS

WBTM Praises ASE-1

(continued from page 36)

monitor calibration and assist in system evaluation.

According to Delta, other AM stereo manufacturers use the CQS-3 to tune up their systems.

With over 200 C-QUAM systems in the field, Delta has learned a lot about the "real world" operating environment. This understanding is evident when you talk to the company's service personnel.

ration was on a CD of oldies.

The GM listened and said, "Yeah, it sounds great, but switch to the air monitor and we'll see how it really sounds to the listeners." When the announcer told him that it *was* the on-air signal, he was very pleasantly surprised.

If your station is considering AM stereo, you owe it to yourself to investigate the Delta ASE-1/ASM-1 system. Delta also provides management with sales

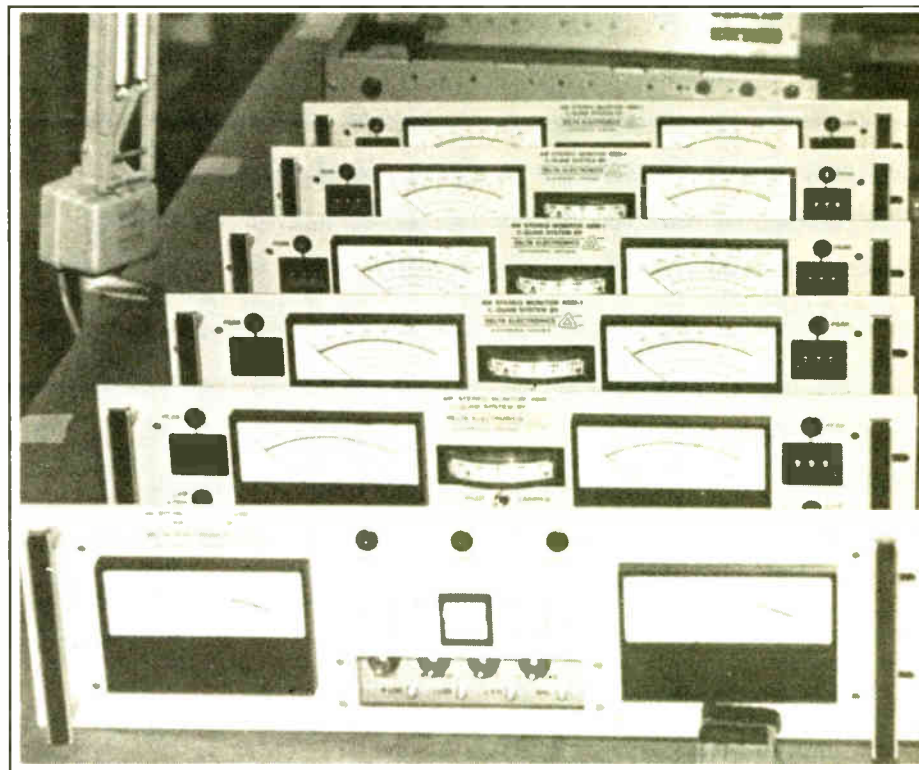

Delta's ASM-1 stereo monitor goes hand-in-hand with the company's ASE-1 exciter.

They offer real nuts and bolts help if you have a problem. They are also sensitive to the pressures under which engineers in the field sometimes must work.

Bottom line: great sound

All of this sounds good, but how does the thing sound? Let me tell you it sounds great. Recently, our company president and GM was in the control room and the announcer on duty pointed out to him how good the sepa-

and promotional advice to assist with the conversion to AM stereo.

Delta's continued improvements in the exciter and solid basic C-QUAM design have made this product a winner.

Editor's note: John Cole, director of engineering at WBTM-AM and WAKG-FM, can be reached at 804-793-4411.

For information on the ASE-1/ASM-1 system, contact John Bisset at Delta Electronics: 703-354-3350, or circle Reader Service 10.

ADVERTISER INDEX

This listing is provided solely for the convenience of our readers. Radio World assumes no liability for inaccuracy.

Page No.	Advertiser	Reader Service No.	Page No.	Advertiser	Reader Service No.	Page No.	Advertiser	Reader Service No.
6	Allied/Gentner	7	17	Cortana	9	34	Northeast Broadcast	71
10	Allied/Harris	29	14	CRL	98	24	Orban	73
26	Allied/Fairchild	56	8	Dataworld	16	21	Pacific Recorders & Engineering	32
36	Allied Broadcast	54	31	Delta Electronics	67	8	QEI	80
7	Altronic Research	62	30	Di-Tech	5	13	QEI	14
36	Armstrong Transmitter	11	35	Fidelipac	15	13	QEI	61
7	ATI	40	23	Gentner	70 & 91	16	QEI	28
16	Audiopak	45	15	Gorman Redlich	64	17	QEI	6
20	Bext	58	12	Harris	37	40	QEI	8
3	Bradley Broadcast Electronics	75	22	Harris	12	30	Sescom	41
1	Broadcast Electronics	50	20	Hnat Hindes	68	11	Studer Revox	65
3	Broadcast Electronics	17	34	Inovonics	3	33	Studer Revox	30
40	Broadcast Services	60	25	ITC	51	15	Tascam	31
13	BSW	18	30	Jampro	20	17	Tascam	99
4	Burk Technology	85	26	LPB	87	18-19	Tascam	52
32	CCA	27	28	McCurdy	48	29	Titus Technology	36
10	Continental Electronics	25	37	Modulation Sciences	78	8	Walt Disney Imagineering	
41	Continental Electronics	21	38	Motorola AM	81	2	Wheatstone	22
			27	Myat	26	43	Wheatstone	13
			39	Nautel	94	44	Wheatstone	42

Advertising Sales Representatives:

East Coast, Art Constantine: 800-336-3045 Fax: 703-998-2966
 Midwest, Mike Dahle: 914-762-3572 Fax: 914-762-3107
 West Coast, Pat Macsata: 415-786-2198 Fax: 415-786-2754

new station construction field service AM directionals

RON KROB
broadcast technical consultant

4910 Four Star Court
Fort Collins, CO 80524 303 484 2704

EVANS ASSOCIATES
Consulting Communications Engineers

FCC Applications, Design & Field Engineering
Broadcast Engineering Software

216 N. Green Bay Rd.
Thiensville, WI 53092
(414) 242-6000
Member AFCCE

W. LEE SIMMONS & ASSOC., INC.
BROADCAST TELECOMMUNICATIONS CONSULTANTS

1036 William Hilton Pkwy Ste 200F
Hilton Head Is., SC 29928
(803) 785-4445

Consulting Communications Engineers

- FCC Data Bases
- FCC Applications and Field Engineering
- Frequency Searches and Coordination
- AM-FM-CATV-ITFS-LPTV

OWL ENGINEERING, INC.

1306 W. County Road. F,
St. Paul, MN 55112
(612)631-1338 "Member AFCCE"

SOFTWARE
FM CHANNEL SEARCH

FM Database pool
MSDOS
EGA Graphics-Color
Broadcast Technical Consulting

Doug Vernier
Broadcast Consultant
1600 Picturesque Drive
Cedar Falls, IA 50613
319-266-7435

Moffet, Larson & Johnson, Inc.
Consulting Telecommunications Engineers

Two Skyline Place
5203 Leesburg Pike # 800
Falls Church VA 22041
703-824-5660
800-523-3117
Member AFCCE

FCC's Engineering
AM, FM and TV Data Bases for your PC
Call today to request a free sample.
Communications Data Services

6105 E Arlington Blvd
Falls Church VA 22044
(703) 534-0034

DOMINATE YOUR MARKET!

Full Service Consulting
Sales & Marketing
Programming
Engineering

Bill Elliott, Consultant
48 Imperial Avenue
Pittsfield, MA 01201
413-442-1283

Lahm, Saffa & Cavell, Inc.
Consulting Engineers

- Interference Resolution
- Coverage Improvement
- RF Hazard Studies
- Custom Software
- AM Antenna Improvement
- Former Chief Engineers
- Suburban Washington Based

9653 Lee Highway, Suite #25
Fairfax, Virginia 22031
Phone 703-591-0110
Fax 703-591-0115

DISPLAY YOUR CONSULTANT'S CARD HERE AND BE SEEN BY OVER 21,000 READERS
Call Simone Leiser at 800-336-3045

SERVICES

RADIO SYSTEMS ENGINEERING

FCC Applications • Design
• Installation • Field Service

Experienced & Affordable

4289 Roanridge
Las Vegas, Nevada 89120

24 Hr: (702) 454-2085

HARMON'S TOWER SERVICE, INC.

Maintenance, Painting,
Antenna & Equipment
Installation,
Winch Services

435 B Broadway
Columbus, GA. 31901
(404) 327-1074

THIS SPACE AVAILABLE

Call
1-800-336-3045

DOWNEAST ENGINEERING
147 Durham Rd., Freeport, ME 04032
(207) 865-9002

Electronic Repairs & Services
Equipment Piled Up In Need of Repairs?
(Qualified Service Technicians)
New & Used Equipment (Call for Price) New Studio Designs

BROADCAST SPECIALISTS
WILLIAM H. YANIK
(Manager, Sales and Service)

TOWER SERVICES
Light Replacement
Routine Maintenance
Ground Systems
Painting
20 years Experience

John Nix
PO Box 13244 Salem, OR 97309
503-581-4056
1-800-321-4056

MIRKWOOD ENGINEERING

Rural & Remote Site
Field Engineering

50 Park Ave.
Claremont, NH 03743
603/542-6784

PARAMOUNT COMMUNICATION SYSTEMS

INSTALLATION AND SERVICE OF BROADCAST ANTENNA SYSTEMS/TOWER MAINTENANCE & ERECTION

WESTMONT, NJ (609) 869-0222

THIS SPACE AVAILABLE

Call
1-800-336-3045

Contact Radio World Newspaper for availabilities.
P.O. Box 1214 • Falls Church VA • 22041

WE SURPRISED OURSELVES!

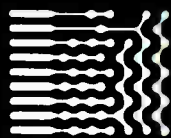

AUDIOARTS® A-50 RADIO CONSOLE!

We wanted to know if it really was possible to build a high quality low-cost radio console. We found the answer to be quite exciting! We've come out with the A-50 console and even given it its own trade name: AUDIOARTS. This console comes complete with machine control functions; individually programmable channel logic; program, audition and telephone outputs; control room and studio monitors; as well as headphone and cue power amplifiers. It's also designed so you can expand or add accessory modules as your needs grow.

The A-50 is cost effective through clever engineering and the latest advances in electronic assembly procedures. It was developed by the same design team that creates our other high end equipment. Its performance is light years beyond the competition.

Imagine the benefit that our major market experience can bring to your station. Take advantage of Wheatstone's expertise and reputation. Call us today for immediate action!

 Wheatstone Corporation

6720 V.I.P. Parkway Syracuse, NY 13211 (TEL 315-455-7740 FAX 315-454-8104)

Circle 13 On Reader Service Card

World Radio History



"Many of the headaches associated with building a new studio were eliminated with the WHEATSTONE pre-wire package. Set up and wiring of WAZU was a breeze. The furniture is solid and good looking, quick and easy to assemble—many hours were saved. Our jocks love the easy straight-forward layout of the new A-500 air console... and, after a quick and easy production room installation, little time was needed teaching the staff how to use the new multi-track studio; operators familiar with an on-air console adapt themselves easily to the SP-6 stereo console and the easy ways to insert special effects and audio processing—operation is so simple!"

John Soller, chief engineer at WAZU

Radio is Starting to Experience a Shortage: *Technical Experts*

Let our experts supply your prewired studio, consoles, studio furniture and audio system engineering. We'll help with your design, then build, wire, test and document your whole studio furniture installation—all at our factory. This takes a *major* load off your technical people and ensures project completion on time.

When Osborn Communications decided to upgrade member station WAZU in Dayton, Ohio, they chose WHEATSTONE for the job. With 12 rooms of Wheatstone consoles already installed, the Osborn people are well qualified to vouch for our commitment to client satisfaction.

Draw on our experience and reputation. Get a great looking studio with cutting edge performance. Contact WHEATSTONE—the experts!

 Wheatstone® Corporation

6720 V.I.P. Parkway, Syracuse, NY 13211 (TEL 315-455-7740 / FAX 315-454-8104)

Circle 42 On Reader Service Card

World Radio History