

*****3-DIGIT 857
J668776 D08 8704 8761 779
BARRY MISHKIND
CE
KXEW
2033 AUGUSTA PL.
TUCSON AZ 85710

Radio World

Vol 13, No 3

Radio's Best Read Newspaper

February 8, 1989

AM Rule Changes Endorsed

by Charles Taylor

Washington DC A majority of broadcasters generally support four separate FCC proposed rule makings aimed at improving AM technical criteria.

One consistent concern of many of the organizations filing comments in December, however, was that splitting the proposals into four dockets could lead to AM improvement in a piece-by-piece fashion rather than collectively and might actually increase interference.

Proposed in October, the four dockets

intend to facilitate enhancement of nighttime operations for Class II and Class III daytime stations; to improve methods for calculating skywave and groundwave field strength, and to review methods of calculating nighttime protection.

Many of the commenters dealt with the four issues in one filing, including the NAB, which called the package "critical to establishing a sound technical basis for the AM broadcast industry."

CBS also pledged support for any effort intending to improve AM, claiming that "the current level of interference is

a primary reason for the shift of listeners to FM and reinforces the public's perception of AM as an inferior, second-class service."

Docket 88-508

Docket 88-508 proposed to adopt a 25% exclusion method that includes adjacent channel skywave interference in the RSS calculation.

But because adoption of the proposals may result in new co-channel interference in the interior service areas of Class I stations, the NAB said the Commission

should adopt an implementational proposal to insure that co-channel interference won't increase as a result of the 25% limit.

Clear Channel Broadcasting Service noted that in adopting the new method, the Commission should utilize the time of six hours after sunset as the reference hour.

In Docket 88-509, the Commission proposed that Class II-S and Class III-S stations be allowed to establish nighttime operations at levels below the 250 W minimum power.

Capital Cities/ABC advised the FCC to proceed cautiously, saying that no net gain would result if increased service from secondary nighttime stations caused interference to primary stations.

Also, Capital Cities opposed the proposal to define requests for separate
(continued on page 17)

Progress Report From VOA False

by Charles Taylor

Washington DC Reports from Voice of America (VOA) officials that the first phase of its broadcast studio renovation here was completed in December were incorrect and misleading, according to a number of staff technicians.

Information in a 29 November VOA press release claimed the nine studios that constitute phase I were being "inaugurated" following months of delays and alleged cost overruns. The document indicated that phase I would be finished by year end.

In a follow-up conversation with VOA's office of public affairs, however, an official said the information was erroneous.

In turn, contractors have not begun phase II's 10-studio renovation since phase I facilities are not up and running. Estimates in December claimed that both phases would be complete by mid-1989, already six months later than the completion date specified in the May 1987 contract.

VOA said the value of the total renovation contract is on target at \$6.6 million, although a report by the Office of Inspector General of the USIA, VOA's parent agency has placed the figure at \$8 million (see RW 1 July, 1988).

No estimate for completion

VOA Deputy Director Robert Barry hesitated to estimate when the phase I studios would be ready for training and on-air use. Bob Peterson, a member of VOA's audio and studio engineering division and the authorized representative of the contracting officer, however, said he hoped the work would be complete by 20 January.

The modernization of the broadcast studios, part of a comprehensive moder-

nization effort launched by VOA in 1983, has been plagued by delays for two years. Problems included the obligatory removal of discovered asbestos and PCBs, a legal tangle with
(continued on page 11)

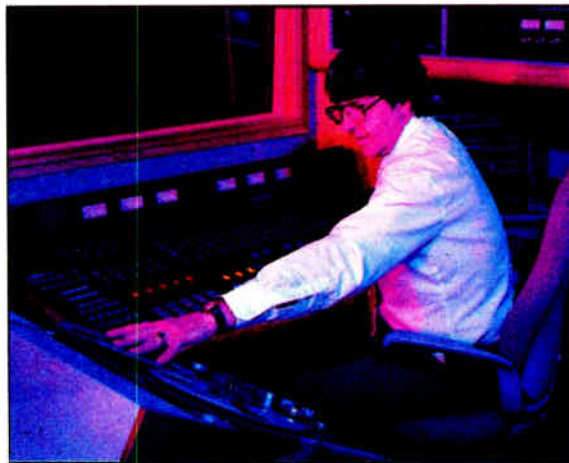

One of VOA's newly renovated studios. But are they really ready?

Fidelipac Accessories

- Taple Top and hand held bulk tape erasers
- ON AIR and RECORDING studio warning lamps
- Cartridge storage racks for wall, table and floor mounting
- Cartridge test tapes and precision alignment gauges
- Splicing tape, blocks and kits
- Back-lubricated cartridge tape, on 7-inch and 10-inch hubs

Contact Fidelipac
or your Authorized Fidelipac Distributor



FIDELIPAC®
BROADCAST TAPE PRODUCTS

Fidelipac Corporation □ P.O. Box 808, Moorestown, NJ 08057 □ U.S.A.
609-235-3900 □ TELEX 710-897-0254 □ FAX 609-235-7779

RIAA Opposes Recordable Compact Discs

by John Gatski

Washington DC The technology for recordable audio compact discs (CD-R) continues to improve, prompting opponents to rally against the recordable disc as they have digital audio tape (DAT) for the past two years.

Taiyo Yuden, a Japanese audio tape manufacturer, made the first public demonstration of recordable (one-time-only) audio CDs in London on 8 December. The demonstration included playback only of the recorded CDs and the company claimed they can be played on any CD player.

Taiyo Yuden does not plan to manufacture a recorder, only the discs, according to a company press release. The discs will sell for \$9 each.

The company said recordable audio CDs could be marketed within a year, but it does not plan to sell any until the copyright dispute, which has embroiled DAT, is settled.

Some electronics companies, such as the Tandy Corp., are working on CDs that can be recorded over and over. CD-R technology can be used for computer and graphics software, such as CD-ROM.

"The recordable (audio) CD poses even a greater threat than DAT," said Hilary Rosen, government relations and public affairs VP for the Recording Industry Association of America (RIAA) in
(continued on page 17)

NEWS BRIEFS

Pirate Station Told To Ship Out

Long Beach NY US District Judge John McNaught ruled that the right of free speech does not include the right to broadcast without a license, according to the FCC, and forbade broadcasting from a pirate station aboard the freighter Sarah in Long Beach, NY.

The station's attorney, Jeremiah Gutman, who was out of the

country following the ruling, had cited first amendment rights as the primary justification for legal broadcast from unoccupied spectrum.

The station originally went on the air for four evenings in the summer of 1987, but was ordered off by the FCC. Three men connected with the operation were arrested, though charges later were dropped.

In this ruling, Judge McNaught

held that three organizers of the illegal station had violated both federal and international law and therefore are permanently enjoined from operating the station.

Call To Stop Jamming

Vienna AUSTRIA Secretary of State George Shultz, in one of his last speeches as secretary of state, called on the Soviet Union to dismantle the jamming equipment that it has used in the past to block western radio broadcasts.

Shultz was speaking at a meeting of the 35-nation Conference

on Security and Cooperation in Europe (CSCE).

SST Decision Expected

Colony MO Structural Systems Technology (SST), charged with three alleged safety violations regarding the collapse of an antenna tower here last June, has contested the allegations with the Occupational Safety and Health Administration (OSHA), according to OSHA.

The company faces possible fines of \$16,920 for three violations regarding the disaster, which left three tower workers dead and KRXL-FM and KTVO-

TV without a tower.

Normally, a decision is reached on an appeal in such cases within three to six months, according to Denver Holt, St. Louis area director of OSHA, which filed the charges after an investigation.

SST President Cabot Goudy would not comment.

RF and Boosters

Washington DC The FCC has added FM booster stations to the list of facilities requiring analysis for environmental radiofrequency (RF) radiation.

FM boosters had been categorically excluded from the radiation rules, primarily because of their low power 10 W limitations. However, since the stations now can operate at much higher frequency, up to 20 kW, the FCC concluded that it was necessary to analyze them to be sure the RF protection guidelines will not be exceeded.

FM translators still subject to the 1 W to 10 W limitations, will continue to be categorically excluded.

Hazeltine Suspended

Washington DC The Pentagon has suspended Hazeltine Corp. from government work following charges of fraud in military contracts, according to a statement.

The suspension is the result of a two-year Justice Department investigation of abuses in military contracting. Fourteen defense contractors and consultants, including the Continental Electronics division of Varian Associates, are under suspicion in the investigation.

Hazeltine Research, which owns exclusive rights to the AM stereo radio technology for Leonard Kahn's ISB stereo system, is affiliated with Hazeltine Corp.

The company pleaded guilty to conspiracy charges and agreed to pay nearly \$2 million in criminal fines, civil penalties and court costs, according to a statement. Joseph Colarusso and Charles Furciniti, executives of the company, also pleaded guilty to conspiracy to defraud the government and to commit wire fraud, it said.



INDEX

Getting Started Multitracking	18
by Bruce Bartlett	
Radio On A Methane Gas Site	21
by Dee McVicker	
Digital Technology Comes of Age	23
by John Shepler	
Keeping a Non-Technical FCC File	24
by Harold Hallikainen	
DAT Breaks Timecode Barrier	26
by Mel Lambert	
Uncovering Radio's Call Sign Histories	27
by George Riggins	
The Sliding Scale of Licensing	28
by Jeffrey Baker	

Wheatstone Corporation

6720 V.I.P. Parkway, Syracuse, N.Y. 13211 (315-455-7740)

Towers Brought Down in SC, MD

by John Gatski

Columbia SC It was a bit ironic that on 28 December a mis-aimed garbage truck was responsible for turning WCEZ FM's 375' tower into a crumpled heap of metal trash.

But as it turned out, radio towers can be at the mercy of man or the elements.

In Bethesda, MD, on the same day, extreme winds from a thunderstorm brought down one of WGMS-AM's towers, knocking the station off the air.

Not a good day

According to WCEZ CE Andy Moore, the station's tower was knocked down after a Capitol Waste Systems garbage truck driver turned his truck too sharply, hitting the supporting structure. The tower was located adjacent to a commercial building that houses an interior decorating store.

"The driver snagged the bottom guy-lines and pulled the tower down," Moore said. "It destroyed most of the transmission line and the three-bay ERI antenna."

Moore said WCEZ was back on the air on 30 December after a contractor erected the station's old two-bay Shively antenna on the tower of a local TV station. The signal is being transmitted in mono to the tower via phone lines.

Tower and antenna damage was estimated at \$60,000, Moore said. Capitol Waste Systems has agreed to pay for ei-

ther rebuilding the antenna at the site or relocation costs at another site.

Either way, Moore added, a new antenna and tower will be operational by March 15.

Building slightly damaged

The tower collapse also damaged an antenna owned by a local paging company, which was able to get it repaired, according to Moore. The building which houses the interior decorating store was not extensively damaged.

WCEZ is a full-power Class A beautiful music station. Its sister station is news format WVOC-AM. Both stations broadcast from the same studio, but the AM

less at 60% to 70%.

WGMS-AM in Maryland also had its tower troubles that day when an unexpected thunderstorm unleashed 80 mph wind gusts on the area, toppling one tower of its four-tower directional antenna system.

Losing signal

The four-tower directional configuration, located a few miles northwest of Washington, DC, normally transmits the classical music station's 5000 W daytime signal (1000 nighttime) southeast toward the city, according to CE H.L. Leyh.

With the loss of one tower, Leyh explained, the station had to switch to a

. . . car listeners are receiving a signal up to 90% of full strength, but the signal to home listeners is considerably less . . .

transmitter/antenna site is located near the studio while the FM transmitter was located about 10 miles away.

The temporary antenna arrangement provides minimal coverage with reduced antenna gain and listeners have noticed a difference, Moore noted.

He said car listeners are receiving a signal up to 90% of full strength, but the signal to home listeners is considerably

considerably weaker 1000 W daytime (250 W nighttime) omnidirectional signal from one of the three remaining towers.

"There's no doubt, it reduced the signal quite a bit," Leyh said.

WGMS plans to have a new tower

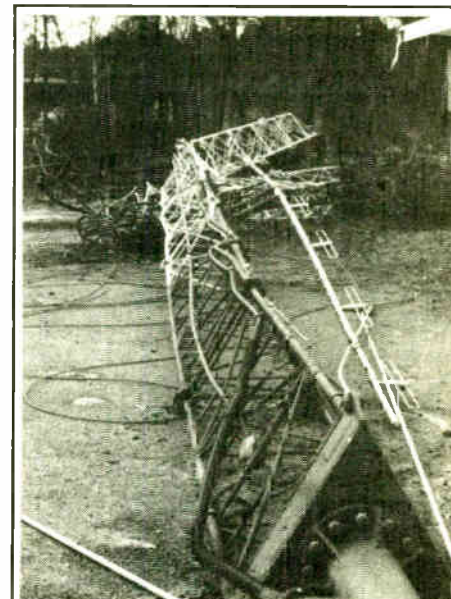

The twisted wreckage of WCEZ's antenna tower lies where it fell in Columbia, SC.

erected within a few weeks at a cost of \$50,000 to \$70,000, he added.

The consolation for WGMS listeners is its FM simulcast. The FM signal originates from an antenna located on the campus of American University in Washington, DC, which was not affected by the wind gusts.

For more information, contact Andy Moore at 803-772-5600 or H.L. Leyh at 301-468-1800.



Pardon Us If We Brag

We can't help it. Sennheiser's MKE 4032 is an ideal mic. This condenser has the rich, full sound of models costing two or three times as much. Powered by an internal battery or phantom power, the 4032 has a built-in blast filter and shock mounting. When a great mic comes along, we just have to show off.

Call Toll Free 800-732-7665



**BRADLEY
BROADCAST
SALES**

Where Service and Engineering Make the Difference

8101 Cessna Avenue • Gaithersburg, Maryland 20879-4177
MD & DC: 301-948-0650 • FAX: 301-330-7198

So Many Ways Better Broadcast Electronics' FM-3.5A 3500 Watt FM Transmitter

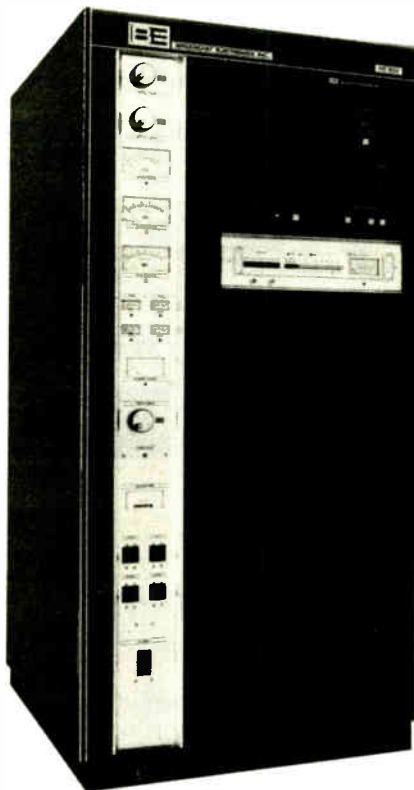

- First with a 4CX3500A one tube design.
- Patented folded half-wave cavity eliminates plate blocking capacitor and sliding contacts.
- Our own solid state broadband IPA in slide out drawer.
- Industry standard FX-30 exciter.
- Emergency 250 watt patching.
- First with automatic power control that maintains constant output power with proportional VSWR foldback protection.
- Ten individual meters.
- Optional microprocessor video display system (MVDS) with diagnostics.

The Model FM-3.5A single tube FM transmitter is the first choice for optimum Class A service. Over seventy on the air in the United States, Canada and overseas.

BE BROADCAST
ELECTRONICS INC.

4100 N. 24th ST., P.O. BOX 3606, QUINCY, IL 62305-3606, (217) 224-9600, TELEX 250142

It's Not the Final Bell For Finial

by Judith Gross

Falls Church VA It came as a real surprise to Winter Consumer Electronics Show visitors who came to see the **Finial Laser Turntable** unveiled.

At the **Finial news conference**, instead of announcing product availability, the company told a hushed crowd that it had **scratched plans** to manufacture and market the turntable due to production costs.

I saw and heard the laser turntable in action at the AES in L.A. last November and it sounded good.

But when it came time to produce the optics-intensive machine, pragmatic concerns apparently took over and mass production **wasn't possible**, according to Jacques Robinson, Chairman of Finial's parent company **Carillon Technology**—or CTI (they also own dbx).

It's a shame for consumers, stations and music production companies which have accumulated **vast vinyl libraries** and had hoped to be able to use the laser turntable to **preserve the originals** and/or reproduce the music pressed onto them without the hiss, pops and clicks the usual wear and tear produces.

But wait . . . **all is not lost**. I talked to **Jacques Robinson** (who was about to take off for his wedding and honeymoon, by the way) and he says that while **Carillon has no plans** to continue with the laser turntable, he hopes to be able to interest another company in **licensing the technology** from CTI.

"We would have had to price it in the **\$10,000 range**," Robinson said. OK, that's high, but not out of the question, judging from the **burning interest** I've heard every time the thing gets mentioned.

But Robinson said **consumer volume**



would have been necessary to keep the costs down, and at 10 big ones that **wasn't too likely**.

One problem, he says, was in the **precision electronics** required, you know, placement of parts, tolerances and so on. In prototype form that's no big deal, but on an **assembly line** with relatively unskilled labor, well . . . not exactly cost effective.

Another **snag** was in the electronics which decode the **optical information**. In quantity the cost is much lower than if only a small number of parts are ordered.

So what now? Well, CTI hopes to either **license the technology** or enter into some kind of **joint venture** with a manufacturer who thinks it could have a go at making the laser turntable **profitable**.

What comes immediately to mind is either a **large consumer firm**, oh say a

Sony or Panasonic, or a small **broadcast equipment manufacturer** who would add broadcast specs.

The thing is, broadcast companies are used to dealing with a **smaller, specialized market** and might be able to adapt the laser turntable successfully.

Robinson says some companies have already contacted CTI about it, so we may not have **heard the last** of the laser turntable yet. "We're optimistic," Robinson says. If you know any interested par-

first phase was complete.

What they **didn't say** was that the studios aren't quite up and running. I guess complete means they **look OK** . . .

It was **just a coincidence**, and not an editorial comment, that when the FCC's MMB chief **Lex Felker** was defending the Commission's recent approach to setting technical standards during an SBE presentation that the **lights suddenly went dim**.

They turned up brightly again when

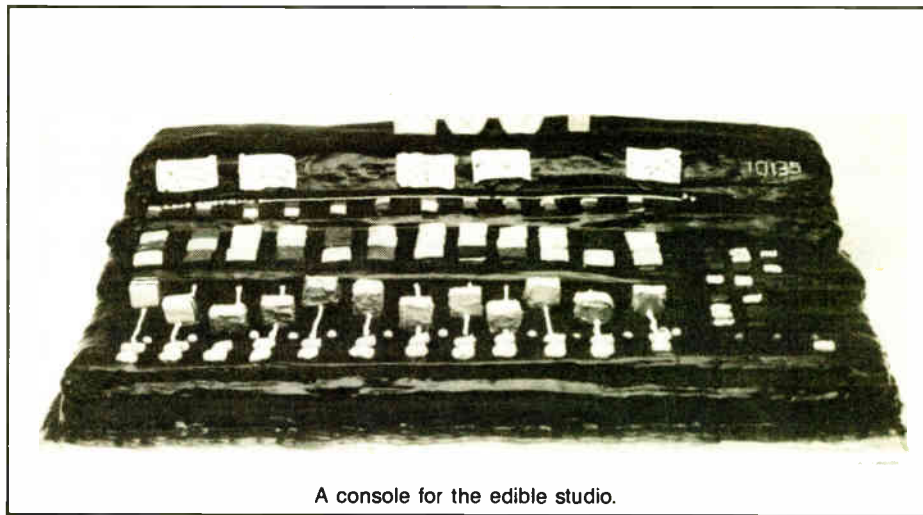

A console for the edible studio.

ties, call Jerry Werner at Finial's number: 408-720-9800.

☆☆☆

Maybe you were **also intrigued** by that delicious looking console in the form of a cake in the **Radio Systems** ad. I mean, faders, even a digital clock!

The **chocoholic** in me was aroused, so I asked Radio Systems president **Dan Braverman** about it, and could I get a piece?

Remember, this was the company that featured Philadelphia pretzels at the NAB show (anybody notice a **food trend** here?).

Anyway, **the cake**, which was about a foot high, two feet long and 18 inches deep and weighed about 30 pounds **smothered in chocolate frosting**, was provided by Dan's older brother David, who runs **LeBus**, a gourmet cafeteria at the University of Pennsylvania.

Gosh, that's a **far cry** from the dorm mess hall where I went to school. Anyway it took **eight hours** to bake, was a chocolate pound layer cake and was used to celebrate the shipping of the **first RS console** by Radio Systems back in May.

Dan had the foresight to put a **"100" candle** on it and use it as an ad when the 100th console was sold (can't help but wonder if there are photos with "500" or "1000" lying in wait), and the **yummy console cake** was gone not long after that, with a lot of overstuffed but contented employees staying away from the scale.

But gee, Dan, you didn't save me a piece.

☆☆☆

Is it just me, or is there something not right about **government officials lying** about the progress of a project costing the taxpayers millions?

We're talking, yes, again, about the **VOA modernization project**, which is not only reportedly **over budget** by about a million and a half but also **behind schedule**. VOA officials said the

the **ABES' Wally Johnson** maintained that the public interest was not being served by current Commission policies. Hmmm . . .

CompuSonics, the audio-on-floppy-disk folks have done what many in the industry think they should have done from the start. They have **quit manufacturing** and have become an engineering and licensing firm instead.

The company has licensed **Digital Trends Inc.** of Concord CA to manufacture its line in the US, and the English firm **Ferrograph, Ltd.** has extended a previous option with the company to include the hard and floppy disk machines in its line as well . . .

Another company that a lot of folks have asked about is **Straight Wire Audio**. Bill Sacks surfaced again at Christmastime on the DC "mall" with reindeer, looking a lot like the jolly old elf himself with a long getting-whiter-every-day beard and a jolly paunch to match.

But unfortunately, the **company is in bankruptcy**, sans assets. Sacks says he **feels bad** about the way things went but he enjoyed his time with SWA and met a lot of wonderful friends.

He has plans to press on with some of his more **successful designs**, in conjunction with another manufacturer. If SWA owes you money, you can contact the **company's attorney**, Carol Hoshel at 301-986-1300 . . .

Are you an **old mic buff**? Jim Stagnitto, of the Big Apple's **WSNR** must be. He wants to know where he can get an **RCA 44-BX repaired**. Jim also is looking to find an **RCA 77-DX**. Call him at 212-752-3322.

And I just had to say something about **BRN**, the **Business Radio Network**, and the way the company promotes itself. Under its logo are the words "Bringing new listeners to AM radio." Thought you'd appreciate that.

Heard something interesting? Spill your guts to Earwaves. Write PO Box 1214, Falls Church VA 22041, or call me at 703-998-7600. Best tidbit of the month wins a coveted Radio World mug.

RF Specialties of Washington, Inc.

11721 15th Ave. N.E.
Seattle, Washington 98125
(206) 363-7730
John Schneider

RF Specialties of California

3463 State St. #229
Santa Barbara, CA 93105
(805) 682-9429 Sam Lane

RF Specialties of Texas

P.O. Box 8316
Amarillo, Texas 79114
(806) 372-4518
Don Jones & Tim Hawks

RF Specialties of Florida

P.O. Box 397
Niceville, Florida 32578
(904) 678-8943 Bill Turney

RF Specialties of Pennsylvania, Inc.

121 Conneaut Drive
Pittsburgh, Penn 15239
(412) 733-1994 Tom Monahan

Each Office is Independently Owned and Operated

TFT's Top of the Line Composite STL System

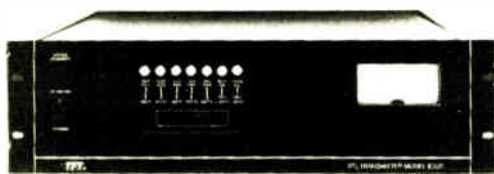

8300 STL System Features:

- Better than 75dB signal-to-noise ratio, 50dB stereo separation.
- Diagnostic Monitoring Capabilities.
- Interface to optional Automatic Changeover Units.
- IF Repeater available for difficult paths.
- Modular construction for low maintenance costs and ease of field service.
- Patented VCO Modulation for spurious-free output.
- Switchable receiver IF bandwidth.
- Two year limited warranty



RF Specialties Group

READERS FORUM

If you have comments for *Radio World*, call us at 800-336-3045 or send a letter to Readers' Forum (Radio World, Box 1214, Falls Church VA 22041 or MCI Mailbox #302-7776). All letters received become the property of Radio World, to be used at our discretion and as space permits.

Engineers always

Dear RW:

In the 1 December 1988 issue you make the suggestion that we call ourselves Broadcast Technicians. Why have you given up on us?

Could it be that there is a magazine called *Broadcast Engineering*? We also have *BM/E* and we have had the Society of Broadcast Engineers around for a long time.

We are broadcast engineers!! Yes, I am also a technician and a operator, but most of all, I am a broadcast engineer.

To be sure, I do not call myself an "engineer" or a professional engineer. The SPE wants everything to do with the word engineer.

I think that this is where we have the disagreement. They can have the word engineer, by itself, the "professional engineer" phrase, but not "broadcast engineer."

In the 15 December RW, Don Markley tries to make points for "his side." He, and others, do not want us to go out and advertise ourselves as engineers. Fine, but we all are broadcast engineers, and, yes, that great caveat, "consultant."

In my career, when anyone approaches me to put a station on the air, it is my duty to steer them to a qualified person or company to get the FCC license, but I handle the "engineering."

Everyday in this business, we are involved with engineering. Many times, it is at the component level, but daily, it is system engineering that we are into.

No, I do not design 12-tower AM DAs, but I do system engineering daily. What should we call the Mark Durenburgers and John Sheplers? They are broadcast

engineers if anyone is.

By the way, why should the SPE have a lock on state licensing? Maybe the state SBE chapters should work with their respective legislators, and require any "person" working on any broadcast equipment to be licensed by that state under the SBE.

If the SPE thinks they have a lock on the word "engineer" then the SBE has a lock on the word "broadcast."

Solution? Let the SPE get the other disciplines licensed, regulated and taxed, and leave the term "broadcast engineer" alone. It's ours. Period.

And if any industry magazine should be behind the keeping of our term "broadcast engineer," it should be **Radio World**.

Radio World Technician? Naw.

Tom Bosscher, Assistant CE
WCUZ
Grand Rapids, MI

Licensing fray off-base

Dear RW:

It amazes me that RW continues to publish such misleading and totally inaccurate articles regarding Professional Engineer registration.

Don Markley presented the facts in an excellent manner (RW *Readers' Forum*, 15 December) yet RW chooses to continue to foster the impression that the NSPE "threatens the livelihood of thousands of broadcast technicians." Nothing could be further from the truth!

Your ill-informed rhetoric only serves to frighten many innocent readers such as Messrs. Konopka and Jurich. (RW *Readers' Forum*, 15 December and 1 January).

Don't worry, Steve and Ed! The NSPE is *not at all interested* in forcing you (nor the other tens of thousands of operating or maintenance technicians) to become licensed.

I checked the facts with Mr. Schwartz of NSPE. The NSPE is interested in two areas:

First, that people who advertise themselves as *consulting engineers* are indeed qualified to perform such work. (This does *not* refer to "Contract Chiefs.")

Second, that the title "Engineer" is used only by properly qualified or licensed professionals.

The former issue involves only the very small percentage of broadcast personnel engaged in consulting work. The latter is purely a matter of semantics and threatens no one's job!

by Trenton Williams



The swearing in of a new President and the resulting change in administrations mark an excellent opportunity to reexamine issues facing broadcasters.

Even if the current Commissioners all stay in place, President Bush still has two open Commissioner slots to fill. It is a chance for him to make his mark and influence communications policy quickly.

Since the Reagan-Fowler/Patrick years were marked by extensive deregulation, the industry will be eager to see if the trend continues.

The new FCC would do well to explore the effect of past moves in this direction and ask how much further it can and should go.

On the technical side, it has become critical for the Commission to look honestly at how many more stations the existing spectrum can accommodate.

New Era Begins

The trade-off between allowing stations to proliferate and prosper and the need to protect the public's right to interference-free listening has to be looked at more closely.

It's the old question of the marketplace versus the public interest and it has an impact on virtually every technical rule making being contemplated—from translators to increased power for Class A FMs.

One other key area for the new Commission to examine will be that of station trafficking.

Speculative financial deals involving radio stations are still going strong and the impact on the health of the stations as well as on service to listeners needs to be carefully considered.

It's going to be an active four years for the new administration where communications policy issues are concerned. The AM band will grow and the broadcast industry will play increasingly important roles in all of our lives.

Now is a time to reconsider these issues in a forum with open discussion so that the resulting policy decisions are made in the best interests of all.

—RW

In the case of consultant Mr. Scoville (RW 15 December) the author failed to point out that Mr. Scoville *could* become registered in 39 states based on *experience* instead of a degree! He just happens to wish to practice in one of the 11 states which do not have this provision.

The fact is that these issues are nothing new. Most of the laws regarding the practice of engineering have been on the books for many years.

The NSPE has never been and is not now interested in licensing any station operating, maintenance or technical personnel nor is it interested in "swelling its coffers" with membership of same.

C'mon RW show a little class! Do your homework and drop the silly cartoons. Stop poking at windmills and get back to writing serious business of broadcasting.

Al Grossniklaus, PE
CET, Member NSPE, Member SBE
CE WOWK-TV
Charleston/Huntington, WV

Miffed at Mishkind

Dear RW:

Barry Mishkind's 15 December article, *Is It Really Good Enough?* simply is not. I must ask what is its relevance of noting

that "So far, the 'Sri Lankan' technical writer hasn't had time (to finish the missing manual section)?"

The stereotype that Barry reinforces is not one of "Sri Lankans" as inherently incompetent.

It is one of broadcast engineers as a crass, narrow-minded (if not bigoted) group. As the saying goes, "Include me out."

Mike Starling, CE
KPBS-FM
San Diego, CA

Editor's reply: Neither RW nor Barry intended to defame any national or ethnic group and we regret the way the apparently tongue-in-cheek comments looked in print.

New frontier?

Dear RW:

New look is great! *JG's Earwaves* continues as my favorite.

I put on a standalone FM in 1960 when everyone thought you were crazy. As far as I'm concerned AM is now the new frontier.

True, let's hear less about it, but action speaks louder than words.

Jim Hodges
Sacramento, CA

Radio World

Vol 13, No 3 February 8, 1989

Publisher: Stevan S. Dana
Assoc. Publisher: Arthur Constantine
Editor: Judith Gross
Buyers Guide: Richard Farrell
News Dept.: Alan Carter, Editor
Charles Taylor
John Gatski
West Coast: Frank Beocham
Circulation Mgr.: Marion Alsup
Ad Coordinator: Simone Leaser
Production Editor: Alex Zavistovich
Art/Production: Gina Rosario, Mgr.
Ginger Bamford
Jeanne Pearson

Radio World (ISSN: 0274-8541) is published semimonthly by Industrial Marketing Advisory Services, Inc., 5827 Columbia Pike, Suite 310, Falls Church, VA 22041. Phone: 703-998-7600, Fax: 703-998-2966. Application to mail at second-class postage rates is pending at Falls Church VA 22041 and additional mailing offices. POSTMASTER: Send 3579 forms and address changes to Radio World P.O. Box 1214, Falls Church VA 22041. Copyright 1989 by Industrial Marketing Advisory Services, Inc. All rights reserved.

Free subscriptions are available to professional broadcasting and audiovisual equipment users. For address changes, send current and new address to RW a month in advance at the above address. Unsolicited manuscripts are welcomed for review; send to the attention of the appropriate editor.

Why cart your CDs? Use the Denon CD Cart Player instead.



Nothing sounds better on the air than a CD played directly off the disc. But what about the delicate loading, handling, and maintenance hassles of ordinary CD players? And with constant handling the discs inevitably get dirty — that can cause on-air skips and glitches. Suddenly the extra sound quality isn't worth it. So you spend hours dubbing your CDs to tape carts.

Now you can get the best of both worlds. With Denon's DN-950F CD Cart Player, playing a CD is as easy as popping in a cart. From its rugged computer-type disk drive to the 3-pin XLR outputs, the DN-950F is built for heavy-duty broadcast use. And it has broadcast-ready remote control, quick cue and review and end-of-message functions. It's even designed so a side-by-side pair fits in a standard 19" rack. No wonder thousands of these machines are at work in studios around the world.



The Denon DN-950F

The DN-950F uses Denon's easy-to-load CD Cartridge. The cartridge keeps expensive CDs in mint condition, because the DJ never touches the disc itself. And it plays as easily as any other cart. With the Denon-950F CD Cart Player, you get the competitive edge of direct-to-air CD sound, without giving up the convenience you're used to. And without the hassles of conventional CD players. So why waste time and lose audio quality by putting your CDs on tape carts?

Put them into Denon CD Carts instead. Your Allied representative will show how easy it is — call today.

DENON

ONLY FROM

ALLIED
Broadcast Equipment

— A HARRIS COMPANY

ATLANTA, GA CHICAGO, IL DALLAS, TX
LOS ANGELES, CA RICHMOND, IN

1-800-622-0022

CANADA 416-731-3697

SBE to Modify 1989 Show

by Judith Gross

Washington DC Responding to complaints from exhibitors, the Society of Broadcast Engineers has already decided on several important changes to its national fall convention.

The SBE Board of Directors, meeting here in January, heard results of a survey of the 177 exhibitors who attended last September's convention. A total of 112 exhibitors responded to the survey, which was done by the Society's exhibitor advisory committee.

The survey results generally supported the informal opinions expressed by exhibiting companies during the show, namely, that there were not enough attendees, although the survey showed high praise for the "quality" of those who did attend.

While the news was not all good, SBE past president and spokesman Richard Rudman said the Board acted quickly to correct those things which exhibitors criticized.

Survey respondents used a weighted system to "grade" the SBE convention on several facets. The quantity of attendees got the lowest score, Rudman said, while the quality of the facilities got the best score.

"People were delighted with that, it seems," explained Rudman, "and they were also quite happy with the services of exhibition contractor Eddie Barker."

After reviewing the survey results, Rudman said the Board decided to implement several measures to attract more attendees to the exhibit floor.

To help avoid conflicts with other fall conventions, the SBE has set the schedule of its meet for the first Thursday in October through 1994.

While Rudman said that there was not enough survey data concerning the location of the convention, "there is an overall feeling that we should not go too far west with the show," he maintained.

"Denver (the site of last year's show) may be too far west. Our next show is in Kansas City and subsequent shows in St. Louis, Houston and Minneapolis will get us back on track," he added.

There were also complaints about the Sunday exhibit hours and Rudman says these have been eliminated. And unlike the '88 show, the SBE will offer free beverage tickets for its opening reception on the exhibit floor.

"We will also no longer have any overlap between sessions and exhibit time," Rudman explained. He said that if the SBE shares exhibit space with another organization's convention, as it did this past show, it will encourage the other group to do likewise.

There will also be a number of

"fun" items added to the show to keep interest from attendees high, Rudman said. Since it will be the SBE's 25th anniversary, there will be a party built around a jazz theme. "We'll try to do as much as possible to make it a 25 year celebration," he added.

Each convention registrant will also get a "shop coat" which will be stocked with food that can be eaten while browsing through the exhibits. Rudman said the

idea is to give attendees reasons to stay as long as possible on the exhibit floor.

Rudman said that the SBE Board acted so quickly on the survey complaints because it wants to insure continued support from the companies exhibiting their wares.

"In the survey, 72% said there are too many shows and they're cutting back. From our point of view we have to find out what we can do to insure that those

who are cutting back don't cut us," Rudman explained.

He also said that the SBE is willing to sit and talk with anyone from the industry about ways to address the problem of too many conventions in the latter part of the year.

In addition to tackling changes to its convention, the SBE Board discussed a number of other ongoing projects. One is a satellite uplink seminar to be held jointly with the NAB. The first session of the seminar is slated for March, here.

The SBE also plans to begin certifying graduates from the

Armed Forces Radio and TV training program, in part to help encourage more recruitment of minorities in the industry.

The Society has also announced the formation of a committee to encourage minority recruitment.

One other important item addressed by the Board was the current controversy over state licensing of engineers. Rudman said the Society is developing a position paper on this which will address the situation "for all our members, including contract station engineers."

Rigid Coaxial Transmission Lines Deliver Low Losses...High Gains.



Cablewave Systems delivers everything you need and expect from Rigid Coaxial Transmission Line performance...superior quality, plus optimum mechanical and electrical specifications.

To achieve this, Cablewave Systems fabricates high conductivity, hard-drawn copper tubing with precision machined, pin-type Teflon dielectric insulators. Standard 50 ohm transmission line is offered in sizes from $7/8$ " thru $9\frac{3}{16}$ "; 75 ohm in $6\frac{1}{8}$ " and $9\frac{3}{16}$ ". All utilize EIA bolt type flanges and inner connectors compatible with EIA

standards, MIL specs and international IEC recommendations. Aluminum outer conductor 50 and 75 ohm transmission lines are available on special order.

To complement our full line of Rigid Coaxial Transmission Lines and accessories, Cablewave Systems also manufactures a complete line of semi-flexible air and foam dielectric coaxial cables and connectors.

For a copy of our 48 page Rigid Coaxial Transmission Line catalog and information on other broadcast and RF communication products, contact Cablewave Systems.

Cablewave Systems

DIVISION OF RADIO FREQUENCY SYSTEMS, INC.
60 Dodge Ave., North Haven, CT 06473 • (203) 239-3311



IN 1989...

\$5995 STILL BUYS A CONSOLE THAT DOES ALL THIS...



OPERATIONAL FEATURES

- Three output busses
- Mix-minus
- Remote control, pulse/holding for A/B inputs
- Assignable DA outputs •
- Remote channel on/off control
- Total cart machine logic interface •
- Turntable synchronizer interface •
- Adjustable peak LED indicators
- Full metering
- Four auxiliary inputs
- "Headphone follow monitor" logic
- Talkback circuitry internal
- Programmable muting busses
- Timer on all models
- Clock on 18-channel console
- External tally-lamp control •
- Available Option

TECHNICAL FEATURES

- .02% distortion (20 to 20KHz)
- -88dB noise THD (+4dB out / 0dBv input)
- Excellent overload headroom
- Penny & Giles faders
- Quick disconnect input connectors
- I.C. socketing throughout
- Fully connectorized sub-assemblies and switches
- Plastic overlay captioning
- Total DC/VCA control
- Metal wrap-around case
- Microphone/ consumer/ line level on any input
- Insert patch points on every channel
- 2 year parts and service warranty

MODELS & PRICING

		List	Direct
RS-6	6 Channel	\$ 6995.	\$3995.
RS-12	12 Channel	9995.	5995.
RS-18	18 Channel	12,995.	7995.



RADIO SYSTEMS INC.

5113 WEST CHESTER PIKE ■ EDMONT, PA 19028
215/356-4700 ■ FAX 215/356-6744

800/523-2133
(IN PA 800/423-2133)

Class A Hike Debate Rages On

by John Gatski

Washington DC Supporters of a blanket power increase for Class A's proposed by the New Jersey Class A FM Broadcasters Association have stuck to their guns in the latest round of filings before the FCC.

Most Class A stations maintained their support for an across-the-board power increase from 3 kW to 6 kW, according to reply comments filed for a 22 December deadline.

On the other side, groups such as the NAB and the Association for Broadcast Engineering Standards (ABES) continued to back a power increase on a case-by-case basis and increased mileage separations.

The FCC's proposed rule making under Docket MM 88-375, which noted several options, would grant a 3000 W power increase for all Class A's except those currently short-spaced. The second option would require an increase in spacings between Class A's and other classes, in order to implement the increase and then only on an application-by-application basis.

Different views

According to the NAB, a case-by-case review would minimize interference to other classes of FM stations and not de-emphasize the FCC's technical standards for FM, which would be the result of a blanket increase.

The NAB also backs a case-by-case power increase proposal that would allow qualified Class A's to boost power as much as 25 kW, and they would be known as Class C3s.

Under the NAB-supported proposals, short-spaced stations receiving a power boost would be required to use a directional antenna, relocate their transmitters or reduce antenna height in order to minimize interference in short-space areas.

Although the NAB is "sympathetic to the concerns and desires of 'boxed-in' FM stations," who want to improve their coverage, the association noted that an automatic power increase would "severely disserve the public interest on the FM band as a whole."

Catering to Class Bs and Cs

New Jersey Class A broadcasters and other opponents of the NAB proposal are convinced the NAB wants to minimize the number of Class A's eligible for a power increase because the association is catering to the higher-powered Class B and C FMs.

Jarad Broadcasting Company President Ronald J. Marey said in comments that the NAB proposals are not fair to all Class A stations. Jarad owns WDRE

(92.7) in Westbury, NY.

"Under the NAB's proposals, nearly 1300 of the nation's 2093 Class A stations could increase power to 6 kW. But what about the other 743 stations?" he asked.

Marey said that a case-by-case review for Class A power boosts would "mean enormous delays" for stations seeking relief and cause unnecessary strain on the FCC's resources.

Interference guarded

Marey argued that a blanket increase will not, as the NAB contends, dimin-

ish the importance of technical standards for radio.

"If they read the New Jersey proposal, they will see that (New Jersey broadcasters) have spared no expense to ensure the public of interference-free FM reception . . ." he said.

He also chastised NAB for its "irresponsible" suggestion that Class A's should have to relocate their towers—an often impossible and expensive undertaking in urban areas.

"It demonstrates their lack of research and knowledge into problems plaguing

many Class A's in Zone 1 (northeast)," Marey said.

In reply comments from New York's Premier Broadcasting Group Inc., the owner of WKLL, Albany, and WUTQ, Utica both NY, the group warned that "literally hundreds of stations which need relief the most would be paralyzed in terms of their ability to improve service if the blanket increases were denied them."

FCC officials have indicated that action could be taken on the power increase this spring. The docket is MM 88-375.

Be prepared.

For the
first real
improvement
in AM sound
in more than
a decade.

The future offers real promise for AM radio. NRSC AM radios are almost here, factory-installed in new cars. Soon, home stereos and portable sets will also be NRSC-equipped.

NRSC (National Radio Systems Committee) has created a voluntary national transmission standard that makes wideband high-fidelity AM radios practical. As broadcasters adopt the NRSC standard, receiver manufacturers can extend and flatten their frequency response without risk of increasing the audibility of interference.

Is your station prepared?

The 9100B NRSC-standard OPTIMOD-AM® is the first choice of AM stations concerned about improving their sound to compete with FM. OPTIMOD-AM sounds great on both the new NRSC receivers *and* on the millions of narrow-band receivers already in the field that will be in use for years to come.

When replacing older-style processors with OPTIMOD-AM, stations experience a significant increase in coverage area. And when replacing any processor, stations experience a dramatic improvement in sound quality, on both *voice* and *music*, with no sacrifice of loudness.

Superior sound is an important part of an overall strategy to increase ratings and profits. With OPTIMOD-AM, your announcers' voices will have presence and impact, while still sounding very clean. Music will have real bass, with punch and warmth, not boom. The highs will seem to open up. And loudness and tonal balance will be consistent from source to source.

OPTIMOD-AM can be configured to operate optimally in mono, C-QUAM® stereo, or Kahn stereo. Mono units can be field-upgraded later to stereo by simply plugging in additional cards.

Be prepared. Call your Orban Broadcast Products Dealer for more information on OPTIMOD-AM 9100B, or call us direct.



SCA RECEIVERS



\$79.95 7 QTY

ERKO TECHNOLOGIES

7616 Burlington Omaha NE 68127
402-331-2632

Circle 19 on Reader Service Card

orban

Orban Associates Inc.

645 Bryant Street, San Francisco, CA 94107 USA

Telex 17-1480 FAX (415) 957-1070

Telephone (415) 957-1067 or (800) 227-4498

® OPTIMOD-AM is a registered trademark of Orban Associates Inc.
® C-QUAM is a registered trademark of Motorola, Inc

Circle 11 on Reader Service Card



Designed. Then priced.

Not vice-versa.

Other manufacturers set price goals, then commit their designers to create products to fit the price. Worse still, their prices must leave room for dealer profits.

Your station works as well as your consoles let it. How do you know whether your consoles have been built to a price, or designed to perform? If they're from Pacific Recorders, you have the assurance that a very real difference in priorities is at work.

The difference:

Our design engineers are in the happy position of being encouraged to choose materials, components, techniques and approaches as they see fit. Their objective is products with uniquely superior attributes: Maximum headroom. Minimum noise and distortion. Total RF immunity. Tough, reliable housings. Massive power supplies. Friendly control panels.

When they're finished, we price it.

And since we don't build in a dealer mark-up, our customers always receive the best price on their equipment. Our published end-user price would be others' "confidential dealer cost". The "negotiation discount" you'd properly expect from their dealers, we invest in superior components.

So the next time you have the chance to order new consoles, maybe you'd be better off to look beyond the price tag and see the value of our approach. Excellence first. All else second.

Please send me a brochure on:

- Air consoles
- Production consoles
- Cart machines
- Dolby SR® for cart
- Everything PR&E offers

NAME _____

STATION _____

ADDRESS _____

Return this coupon to:

Pacific Recorders & Engineering Corporation
 2070 Las Palmas Drive
 Carlsbad, CA 92009
 (619) 438-3911



PACIFIC RECORDERS & ENGINEERING CORPORATION
 The number one *choice* for more #1 stations

RW

VOA Misleading on Renovation

(continued from page 1)

sub-contractor Multiphase Consulting over the PCBs, and numerous delays in the delivery of custom equipment.

VOA officials blamed this most recent setback on a number of problems.

Peterson said the delays were caused by lags in the testing of studio equipment. He cited problems such as checking screw covers and reaffixing carpet that had peeled off studio walls.

The public affairs spokesperson said that 300 items were listed "not right" on the project's "punch list," which is much like a list of problems made following a new home walk-through.

"My understanding is that it's everything from the slant on the glass to whatever. It's a mess," the spokesperson said.

Blamed on debugging

Barry blamed the delays on "Debugging. As they go through and test the equipment, they have found that some of the stuff produced by some of the subcontractors has bugs in it that have to be taken out."

Specific problems that technicians cited included extensive mistakes in wiring and a prototype IFB/studio-to-control room talkback system.

One staff technician told *Radio World* that 700 pairs of audio cable and control cable were wired incorrectly.

"I did hear that there were some reversals of wiring," Barry confirmed. "It was brought up at the last progress meeting as something that had come up and been corrected."

The talkback intercom system was destined for trouble, according to Gary Marco, president of the National Federation of Federal Employee's Local 1418, VOA's technician's union.

"Here, they're putting a prototype system into an operational environment. They can't help but have problems with it," he said.

Barry confirmed that there were problems with the system, adding that they too had been corrected.

Fundamental cause of delays

As to the fundamental cause of numerous delays, some place blame on general contractor Grunley-Walsh and various subcontractors as not being

qualified to master the technicalities involved in building broadcast studios.

"Initially, the award was made to a contractor based strictly on price and not technical background," said Leo Darrigo, a former employee with VOA's special projects group. "The project was low-balled all the way.

"The problems have been a direct result of that. The subcontractor has failed to comply with some of the requirements that he needed to meet. Some of the delays encountered and some of the overruns were a result of his inability to meet the schedules," he said.

Added another VOA technician, "This whole modernization project has been a boondoggle. It's been thrown together.

It irritates me that these people are flushing money down the toilet and getting away with it."

But Barry commented, "You expect a certain number of things in a project like this. We are not particularly happy with the progress here. We've made that clear to the contractor and I believe the contractor himself is not terribly happy with the performance of some of his subcontractors."

Officials at Grunley-Walsh could not be reached for a response.

Numerous causes for setbacks

The NFFE's Marco with said he believed the long-lived dilemmas surrounding the renovation cannot be attributed

to a single source.

"I think it's design, installation, maybe some things with the delivery, but at every step of the process there has been a problem that's slowed the process down to where we're 21 months into this thing and they still haven't got a studio up," he said.

The VOA staff engineer said he has heard that at least one of the studios was to have been ready by the end of January.

"They're supposed to start using it for training and then put it on line and open up the rest of them," he said.

Once the nine studios are in use, Barry said renovation on the remaining 10 studios in phase I will ensue.

"As far as we're concerned, the contract is for the renovation of all of the studios and we intend to proceed," he said.

For more information, contact VOA public affairs at 202-485-8238.

NAB Finalizes Convention Plans

by John Gatski

Washington DC The NAB is putting the finishing touches on preparations for the 1989 edition of its annual convention and engineering conference scheduled 28 April-2 May in Las Vegas.

NAB Staff Engineer Stan Salek said the engineering conference schedule was nearly filled and the few open radio and supplementary sessions (radio and TV) have a 21 February scheduling deadline.

The NAB also announced that William Connolly, Sony Advanced Systems president, will receive the 1989 NAB Engineering Achievement Award for his contribution to broadcast technology in TV and radio over the years.

The award will be featured at the engineering conference luncheon. The luncheon speaker will be Leonard Feldman, the audio equipment editor/reviewer for *Audio* magazine.

New topics featured

According to the preliminary schedule, the engineering conference will feature

five radio sessions, nine TV sessions and eight supplemental sessions.

The radio schedule will include sessions on digital audio, FM improvement, radio engineering, AM systems engineering and radio production.

The supplemental schedule lists sessions on professional development, EBS forum, computers, preparing for an FCC inspection, broadcast automation/satellite systems, and safety and environmental concerns.

Salek said the professional development session is new and will concern such subjects as on-the-job stress and organizational aspects of radio and TV stations.

He also noted that many of the sessions will highlight not only new technology, but subjects such as FM improvement, that have mainstream applicability to broadcasting.

Space-wise, the NAB spring show upped its convention square footage to accommodate the long list of companies who want to exhibit their latest audio and video equipment, according to NAB Exhibits and Associate Membership

Director Rick Dobson.

"We're going to go over 400,000 square feet of exhibit space for the first time," Dobson said. "Last year, we had about 383,000 square feet."

Of the 400,000 square feet, about 330,000 square feet will come from the Las Vegas Convention Center while 70,000 square feet have been reserved at the Las Vegas Hilton, he noted.

An estimated 13,000 square feet of the extra capacity will come from use of the convention center's rotunda, Dobson said.

"That's another 20 or so exhibitors that we can accommodate," he added.

Although there is more square footage planned for the convention this year, demand for space is still more than can be accommodated at this time, Dobson said.

Some companies on waiting list

"We're still restricted by physical limitations," he said. "We have 100 companies on the waiting list."

Although there is an exhibit waiting (continued on page 12)

Morning zoo-in-a-box.



Java The Hun vocal shifter—one of 70+ Broadcast Ultra-Harmonizer™ digital effects designed to let you dial up pre-programmed insanity. It's easy to afford the broadcast-engineered H3000B's power and flexibility; ask your Eventide distributor.

RADIO'S MOST COLORFUL BLACK BOX

EVENTIDE INC.
ONE ALSAN WAY
LITTLE FERRY, NJ 07643
TEL: 201-641-1200 • TWX: 710-991-8715 • FAX: 201-641-1640

Eventide
the next step

Your Problem Solvers
from **ATI**



- Mike
- Line
- Phono
- Mixing
- Matching
- Metering
- Monitoring
- Processing
- Distribution
- Rack Mounting

AUDIO TECHNOLOGIES, INC.
328 W. Maple Ave., Horsham, PA 19044 • (215) 443-0330 • FAX (215) 443-0394



FCC Filings Continue Support for NRSC-1

by Charles Taylor

Washington DC Broadcasters continue to argue against the adoption of a National Radio Systems Committee (NRSC) transmission standard before an audio standard is in place—something the FCC seems determined to do.

In reply comments due 22 December, those filing on the proposed rule making contained in Docket MM 88-376 also contested the Commission's unrelated suggestion to allow AM stations to increase power in order to strengthen primary signal areas.

Too much at once

CBS reaffirmed its support for NRSC-1, but stressed that it is unrealistic and unfair to order simultaneous NRSC-2 compliance.

"Although many stations are already in compliance with NRSC-1 and the transmitting equipment alterations necessary to bring the remaining AM stations into compliance could be made quickly and cheaply, compliance with NRSC-2 will be more complex and expensive, in some cases requiring replacement of transmitting equipment," the network said.

Implementation of NRSC-2 would be reasonable, CBS said, after a two-year delay for NRSC-1 implementation.

The NAB also gave a nod to requiring AM stations to install equipment that complies with the NRSC-1 audio stan-

dard by the target date of 1 January 1990.

"NAB urges the Commission to require AM stations to install equipment that complies with the NRSC-1 audio standard by the earliest practicable date," the NAB said. "Additionally, NAB continues to suggest a reexamination of the NRSC-2 emission limitation at a later date, after additional NRSC-1 implementation information has been studied."

Questions cited

Delta Electronics, manufacturer of the Splatter Monitor, which enables AMs to measure compliance with NRSC-2, repeated its warning against a suggestion in the proposed rule making that the FCC could assume stations were in compliance with NRSC-2 if they adopt NRSC-1.

"Stations are free to cascade in the audio chain a myriad of audio processing devices which can readily exaggerate or defeat the effect of a fixed preemphasis network."

The Commission also sought comment in the proposed rule making on allowing certain AM stations to increase their power, providing that other stations do not experience increased interference within their primary signal contour.

The action, which would eliminate restrictions in Section 73.37 of the FCC's rules, would enable stations to accept greater interference in the expanded service area while providing better service to their existing communities, the Commis-

sion said.

"This would, however, increase interference to co-channel stations' signals beyond their primary contour," said the National Telecommunications and Information Administration (NTIA), which recommended in reply comments that the FCC not pursue that facet of the proposal.

No more interference

Capital Cities/ABC stressed that for the FCC to accept more interference on the AM band would detract from efforts by radio manufacturers to rid the band of interference through narrow band receivers, which reject undesired first and second adjacent channel signals.

Enhanced service "could be true only if there were a federal standard obliging radio manufacturers to accept fringe area interference in order to produce a higher quality received signal in a much smaller high-signal area," Capital Cities said.

"Only then will the public begin coming back to AM in significant numbers."

The NAB added that any proposal that allows additional interference to be endured by the listening public can in no way be considered an improvement to the AM band.

CBS also disputed the proposal, saying that "it is undisputed that, when a station increases power, all other co-channel and first adjacent channel stations will receive increased interference."

CBS said the Commission's view that the increase in power would lead to a stronger primary coverage area signal are speculative. The network wrote that it knew of no evidence "to support the view that stations that decide to accept interference will be able to increase power to a level necessary to penetrate buildings and overcome noise."

For more information on Docket 88-376, contact Hank VanDuersen at the FCC, 202-632-9660.

NAB Gets Show Rolling

(continued from page 11)

list, Dobson is confident many of them will receive space. Last year, he pointed out, about 70 companies were able to get space by the time the convention started.

Companies are given exhibit priority based on the number of years they have exhibited and the amount of space they reserved each of those years. The company gets 10 points for each year they exhibited and one point for each 100 square feet of exhibit space.

Although there has been a merger-mania among some companies in the industry, Dobson said a merger will not

give a priority point advantage to firms that have bought out smaller ones.

Instead of adding the point totals of both companies together, the NAB only will count the points of the company that had the highest number of points on any given year they both exhibited.

Dobson said the Harris-Allied merger, for example, will not end up as a single block of exhibit space, but that each company will exhibit separately because of their different product lines.

For more information, contact Rick Dobson at 202-429-5335 or Stan Salek at 202-429-5339.

ITC Cartridge Machines



Now available from
Broadcast Services Co.

We offer the finest sales support and customer service in the industry. Personal service is the foundation of our success.

Find out for yourself. Call Broadcast Services for complete information on the entire line of products from ITC/3M.

Neal Davis or Gary Liebisch
Four Oaks, NC. (919) 934-6869.
FAX (919) 934-1537. TLX 575082.

Keith Arnett
Front Royal, VA. (703) 635-1413.
FAX (703) 635-9762. EZ LINK 62046263.

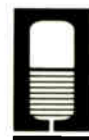

BROADCAST SERVICES CO.

A Company of The Davis Communications Group, Inc.

Authorized distributor
International Tapetronics Corporation/3M

FMX Receivers Debut at CES

by Alan Carter

Las Vegas NV Listeners soon may be able to hear what FMX stereo is all about.

Two receiver manufacturers at the Winter Consumer Electronics Show here in January displayed car radios capable of receiving the FMX stereo extension system and representatives of four others said they were seriously considering offering the option.

JVC has FMX on its top-of-the-line KS-RX5500 car receiver slated for delivery in April, according to Thomas Caronia, national sales and marketing manager for the car audio division. Retail price is \$549.

Alpine also showed its 1390 FMX stereo tuner, a \$200-option for its 5953 controller that costs \$250. Retail price of the Alpine package including FMX is approximately \$1000—with a \$600 CD changer, according to Tony Hick of the company's technical service department.

More to come

Other manufacturers seriously looking over FMX include Blaupunkt, Denon, Proton, and Sansui.

Broadcast Technology Partners (BTP), whose President Emil Torick and consultant Tom Keller are co-creators of FMX, used the CES to continue a full-court public relations campaign to educate retailers and manufacturers on FMX.



JVC's KS-RX5500 high-end tuner, with FMX.

"We're shifting gears," said BTP engineering VP Tom Rucktenwald. "What we're trying to do is talk to retailers and buyers to raise awareness."

From a hotel suite, BTP demonstrated the FMX system designed to allow listeners in the fringes of an FM's coverage area to receive a clean FM stereo signal without the noise that normally accompanies distant stereo signals.

Get FMX here

Both Alpine and JVC representatives said buyers were interested in their FMX

receivers. But Alpine's Hicks said, "They don't know about it."

While Blaupunkt does not have a unit planned with FMX "right now," the company had a simulated demonstration.

Visitors to the Blaupunkt suite had a "positive" reaction, said electronic design engineer Alex Popovic. "They sit down in front of the demonstration, and they are amazed," he said.

The Winter CES was the second showing by Sansui of an FMX prototype, according to Marketing Research and Development Director Fumio Ito. The company first showed an FMX car receiver at the Summer CES last year in Chicago.

Sansui is "still evaluating," Ito said, and the company may offer product at the end of 1989 or in 1990. Sansui is waiting for more stations to broadcast in FMX, a number already at 100, mostly in major markets.

Additionally, there is a "98 percent chance" that Denon will offer an FMX product this year, said Marketing Director Ken Furst.

Talk radio

Furst said FMX is a strong marketing tool for FM stations as they promote better coverage.

"Being a good sounding station is a

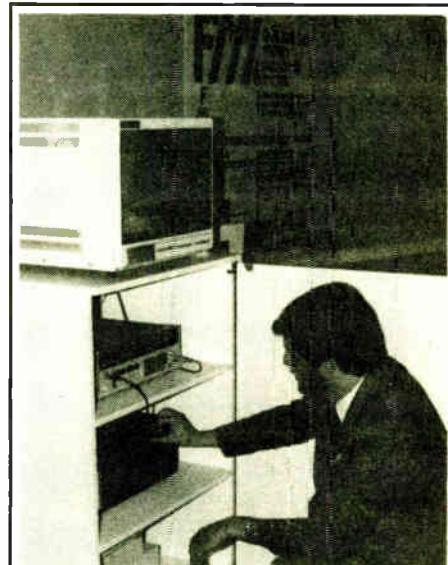

Blaupunkt Electronic Design Engineer Alex Popovic demonstrates the FMX system.

good marketing device," Furst said. "It's something else (stations) can talk about."

Proton Product Development Manager Larry Waterman said the company has not committed to FMX. But he added, "I could see where it could be an enjoyable relationship."

Waterman said Proton has a product under development that could accommodate FMX. The company has test equipment from BTP. "We are looking at it seriously."

For information on FMX, contact Broadcast Technology Partners at 203-622-2804.

NRSC Radios Slated for Unveiling in 1990

by Alan Carter

Las Vegas NV It will not be until 1990, but Delco has said it will offer an AM stereo car radio with NRSC deemphasis.

This was good news for broadcasters at the Winter Consumer Electronics Show here in January who have been working for four years to implement the NRSC transmission standard to improve AM.

A Denon representative also said the company has a design "in the works" for NRSC.

But other radio manufacturer representatives from Ford and Pioneer, for example, were not forthcoming.

Where's the product?

Broadcasters were not aware of any manufacturers with NRSC radios or prototypes on the exhibit floor.

In a meeting of the National Radio Systems Committee (NRSC) during CES, members noted their commitment to educating manufacturers on NRSC.

NAB Science and Technology VP Michael Rau said efforts on NRSC now has to go from the technical to the marketing arena.

The EIA's George Hanover said broadcasters have to formalize reasons why manufacturers should design receivers with NRSC and manufacturing executives in the US need to sell their Far East counterparts on the importance of the new technology.

FCC proposal

The lack of NRSC radios was not the only frustration with which the NRSC dealt at CES.

During the NRSC meeting, members noted their concern over an FCC pro-

posed rule making that favors implementation of an RF emission standard, NRSC-2, rather than an audio standard, NRSC-1, now used voluntarily by radio stations.

NRSC-1 would establish a 75 μ sec preemphasis and a 10 kHz stopband.



(From left) Eb Tingley, Michael Rau and Charles Morgan address attendees of the NRSC meeting at Las Vegas' CES.

NRSC-2 addresses the signal from the transmitter out and has a station's signal parallel to the audio standard to 10 kHz.

A decision on the NRSC rule making is expected in late spring.

Rau noted his disappointment that the National Telecommunication and Information Administration (NTIA), a telecommunication's advisory agency within the Commerce Department, filed a comment with the Commission supporting the move toward NRSC-2.

"I think we will just have to wait and see how the Commission comes out on this," Rau said.

Differences of opinion

The FCC proposal includes a provision where stations might be assumed to be in compliance with NRSC-2 if they implement NRSC-1, a point contested by some commenters. (See separate story, this issue.)

NRSC Chairman Charles Morgan of Susquehanna Broadcasting said the FCC wants to govern emissions from a station, not processing within a facility.

(continued on page 15)

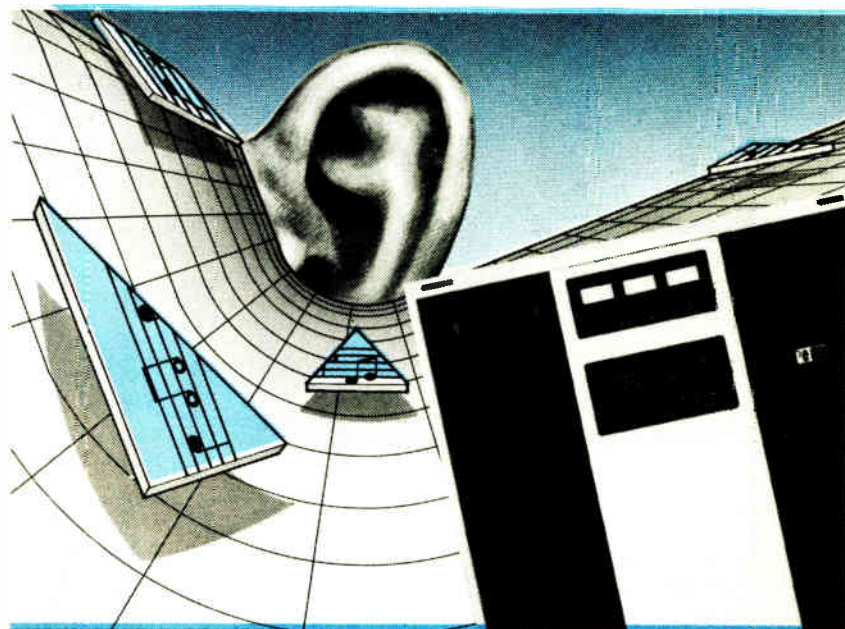

Ears Ahead!

*Harris' new DX-10 Digital Solid State
10 kW Transmitter delivers AM sound equal to FM*

Your listeners will love the vastly improved sound. New listeners will tune in. Competitors will wonder what you're using. And you will be amazed at the reduction in power costs. All because you installed the first and only solid state digital AM transmitter which operates at typical overall efficiency of 86%. The Harris DX-10.

Superb audio performance? You bet — no measurable tilt, ringing or overshoot. Signal clarity? Definitely—

low THD and IMD. Plus, the DX-10 is an operator's dream, with Harris' ColorStat™ signal flow diagnostic diagram and other exclusive extras to keep you on the air.

Install the DX-10. Be "ears ahead" immediately and be years ahead because you've gone digital. Call now for the DX-10 brochure, 1-800-4-HARRIS, Ext. 3005. Or write: Harris Radio Sales, P.O. Box 4290, Quincy, IL 62305-4290.



CES Session Explores Radio Improvements

by Alan Carter

Las Vegas NV A proposed certification mark to identify improved AM radios. The expanded AM band. FMX stereo extension. Radios with new design elements.

These were some of the topics panelists addressed in a session on "Improved Broadcasting: Tomorrow's Radio" at the Winter Consumer Electronics Show here in January.

NAB Science and Technology VP Michael Rau proposed that the NAB and

the Electronic Industries Association form a joint committee to develop a certification mark that manufacturers would put on new AM radios to identify them as containing improved technology.

The mark could identify such elements as NRSC, AM stereo and the expanded AM band.

"We have trouble communicating these concepts to consumers," Rau said. The label—some suggestions which include AQ, AMX and AMQ—would be a marketing handle, he explained.

Rau contended that the technical foun-



(From left) Donald Palmquist, John Crawford, Alex Felker, Ross Miyamoto, Michael Rau and Mike Townsen discuss improvements to radio at a CES panel session.

dations of AM broadcasting are changing and this somehow must be communicated to consumers in a way they can identify.

Delco's John Crawford said the competition for AM and FM broadcasting is increasing and consumers must perceive a value in programming or delivery.

Beginning in 1990, Delco will offer AM stereo radios that are wideband and have the NRSC standard. Designs also will accommodate the expanded (to 1705 kHz) AM band.

Ross Miyamoto of Sony Auto Sound Group said CDs with digital audio are a challenge for radio.

But he noted Sony included the expanded band on all its radios introduced at CES and is evaluating NRSC.

The FMX stereo extension system is another technological development Sony is studying, Miyamoto said. (See separate story, this issue.)

But Miyamoto said the drawback to FMX is that it does not improve reception in the main coverage area, only the fringe (for which it was designed).

A convenience feature from Sony included on its radio/CD combination is a "tuner timer" which can be programmed to override a CD to tune in the radio at a set time.

Mike Townsend from Pioneer noted that AM selling features are taken for granted. Pioneer introduced seven units with the expanded band, he said.

Townsend also called the proposed certification mark a good idea.

But he struck a nerve with some broadcasters with the suggestions that AM radio needs to offer more variety in programming.

Broadcasters argued that AM offered a variety of formats but that radios aren't designed for quality AM reception.

FCC Mass Media Bureau Chief Alex Felker intervened and said no one side is at fault. "I think there is enough blame to go around," he commented.

Felker noted the FCC is considering various rule changes that address AM, including technical criteria and the expanded band.

"As you can see, early 1989 is going to be an active year in radio broadcasting," Felker said.

RS DAT



RS-1000 \$2995.

DAT THAT WORKS!

From Radio Systems & Sony

The RS-1000 sounds like DAT and works like a cart machine!

Do DAT right! Do it with hardware built for broadcast. Contact RADIO SYSTEMS, INC. for complete details.

NOW AVAILABLE!
44.1 kHz Record Sampling
for direct digital dubs.

RADIO SYSTEMS INC.

5113 West Chester Pike ■ Edgemont, PA 19028 ■ 215/356-4700
800/523-2133 ■ (in PA 800/423-2133) FAX 215/356-6744

The only DAT machine that offers:

- Full Remote Control
- RS-232 Serial Interface
- Automation Interface
- End-of-Message Signals
- Large Broadcast Controls
- Auto Cue to Cut
- Auto Rewind
- No Cut Play-Through
- Plus Dozens of Additional Broadcast Features.

Summon a windstorm
with one finger:
Press below.



Windstorm—one of 70+ Broadcast Ultra-Harmonizer™ digital audio effects designed to give you fresh ideas, without letting you go stale trying to make them happen. Put the "special effects department" in a box™ to work for you.

RADIO'S MOST COLORFUL BLACK BOX

EVENTIDE INC.
ONE ALSAN WAY
LITTLE FERRY, NJ 07643

Eventide
the next step

TEL: 201-641-1200 • TWX: 710-991-8715 • FAX: 201-641-1640

DAT Players Set for US Consumer Sales

by Alan Carter

Las Vegas NV Copyright issues settled or not, Digital Audio Tape (DAT) players are about to go on sale to consumers in the US.

That according to DAT/USA International, a Trenton, NJ-based distributor, which used the Winter Consumer Electronics Show here in January to publicize what may be the first up-front effort to offer DAT players to retailers.

Among the brands that DAT/USA said it will import—bypassing the traditional dealer channel—are Akai, Alpine, Clarion, JVC, Kenwood, Nakamichi, Panasonic, Sharp, Sony, Tascam, Technics, Victor and Yamaha.

DAT/USA Managing Director Nat Gurien said his company does not believe the Recording Industry Association of America (RIAA) can stop the sale of DAT players in the US. RIAA opposes the sales due to possible copyright violations.

Moving ahead

Gurien also cited a Supreme Court ruling last year that upheld grey market importation by unauthorized dealers.

DAT/USA said it obtains product from US and overseas sources.

The players are 120 V, although not UL approved. But Gurien said the consumer machines are based on professional models that meet UL standards. Instructions are translated into English, and necessary cables for system hook-up are

included.

DAT/USA offers a warranty program through American Warranty Co., with options for a manufacturer's warranty or a premium certified plan.

A watchful eye

Hilary Rosen, RIAA government relations and public affairs VP, said her organization is monitoring the DAT/USA announcement, but no decisions have been reached on possible suits.

Rosen said if RIAA filed suit against every group that said it was going to sell DAT players, the organization would stay in court all the time.

"We really are going to wait and see how their actions measure up," Rosen said.

Rosen said RIAA is not against selling DAT players, but concerned about protection of copyright. "What we simply want to do is to find a way to protect our copyright and grow with technology."

The RIAA is concerned that consumers would use DAT players to make digital recordings of CDs. A proposed copycode developed by CBS has not proved neither inaudible nor effective enough during tests by the National Bureau of Standards.

The RIAA had previously pledged to sue any company which markets DAT players in the US.

For information from DAT/USA, contact Nat Gurien at 609-888-3633. Contact the RIAA at 202-775-0101.

NRSC Radios Due in 1990

(continued from page 13)

Broadcasters were concerned about how they will measure the RF emission standard, which requires an expensive spectrum analyzer or the more economical Splatter Monitor built by Delta Electronics.

A second concern is that there is not enough data on testing compliance with the standard and that NRSC-2 may not be a finalized standard, but may need revisions.

Delta representative John Bisset said Delta would be willing to loan its product for tests and evaluations.

The next NRSC meetings include an FM subgroup meeting 15 February at NAB headquarters in Washington, DC, and a full NRSC meeting 27 April prior to the NAB spring convention in Las Vegas.

For information on the NRSC, contact NAB staff engineer Stan Salek at 202-429-5391.

Affordable Lightning Protection



Charge dissipation with 1/8", type 304, stainless steel rods ground to needle sharpness. They won't bend from ice and severe weather. They provide a continuous low-resistance discharge path for the static electric charge on tall structures.



Let us design your system at no cost or obligation!

Stati-Cat • Stati-Kitty • Crow's Nest

The Folded Unipole:

The Ultimate Antenna for AM Broadcast!

- Broad bandwidth
- Grounded antenna
- Eliminates isocouplers
- Practical for AM-FM site consolidation
- Effective as a detuning skirt
- Fully FCC acceptable
- Custom kit; easy to assemble



Write for free brochures.

Also available from Cortana: Ground Radial Wire Detectors



P.O. Box 2548
Farmington, NM 87499
(505) 325-5336

Mastercard/Visa

Circle 74 On Reader Service Card

Best Of Both Worlds

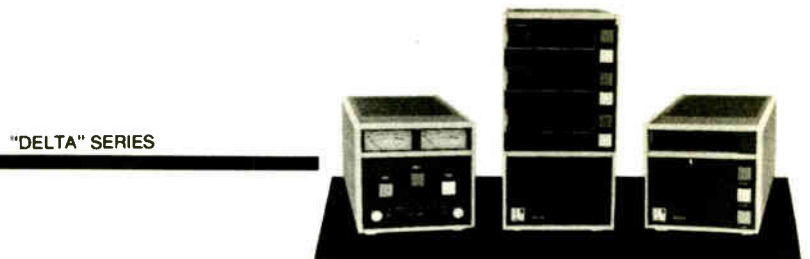

"DELTA" SERIES



"99B" SERIES

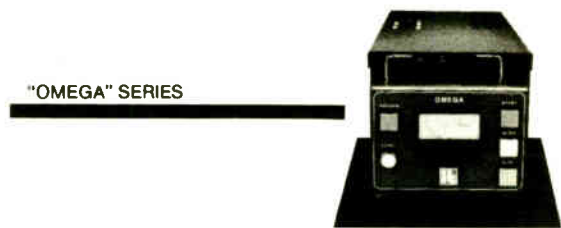

"OMEGA" SERIES

ITC And BSW

For years, you've depended on the quality and durability of ITC Cartridge Machines. You have also depended on the fast delivery and accessibility from BSW. Now you can have the best of both worlds. BSW, America's full-time broadcast supplier, is now an authorized ITC cartridge machine dealer. Choose from the economy OMEGA series, performance packed DELTA series, or the premium 99 series machines.

BSW and ITC offer a winning combination for cartridge machines and accessories. Call us today for complete specifications and pricing.

BSW

BROADCAST SUPPLY WEST

America's Full-Time Broadcast Supplier

1-800-426-8434

ORDERS • INFORMATION • SPECIFICATIONS
BSW • 7012 27th Street W • Tacoma, WA 98466 • FAX 206-565-8114

BATTERIES NOT INCLUDED*

But, almost everything else is. * The new Revox Series 270 is loaded with professional features you will not find on comparable machines at this price point. Many 270 standard features are available only as options on many other machines. Pro transport functions, pro audio quality, pro construction . . . That's value!



- Dolby HX Pro® Headroom Extension
- Seamless and gapless punch-in, punch-out
- Integral scrape-flutter filter in head assembly
- Constant tape tension on both spooling motors
- One-hand cueing under full servo control
- Fully modular audio electronics
- Front access to all audio electronics
- Built-in variable speed
- Selectable library rewind and record inhibit
- Optical End-of-Tape Sensor
- 1-year parts and labor warranty

*We're only kidding . . . back up batteries are a part of the real time clock in case of loss of AC power.

ATLANTA, GA

CHICAGO, IL

DALLAS, TX

LOS ANGELES, CA

1-800-622-0022

RICHMOND, IN

ALLIED
Broadcast Equipment

Filings Favor AM Rule Changes

(continued from page 1)

nighttime operations as minor change applications, and advised that no applications for separate nighttime operations should be approved before the Commission adopts the calculation improvements proposed in 88-508 and 88-511.

Greater Media Inc. generally supported Docket 88-509, but said that permitting voluntary power reductions by licensees unrestricted by operating schedule or city coverage requirements would be unwise.

Such a move would "foster the development of inferior technical facilities, which are part of the problem attending AM service today," the company wrote.

Greater Media also said that stations proposing power reductions below class minimums should be reclassified as Class II-S or Class III-S.

The NAB fully supported the docket, claiming it would allow many stations with nearly unusable nighttime service to better serve their communities.

Docket 88-510

In Docket 88-510, the Commission suggested replacement of existing AM broadcast skywave propagation curves with a recently developed propagation model that it said gives a better understanding of field strength in AM.

CBS and the NAB supported the action, with the latter adding that the Commission should consider the use of a safety factor to increase industry confidence in the FCC's new skywave propagation model.

Docket 88-511 concerns modifying FCC rules that relate to the calculation of nighttime RSS skywave interference levels to the protected groundwave contours of Class II and Class III AMs and the skywave service contours of Class I clear channel stations.

The Commission also proposed including first adjacent channel skywave signals and co-channel skywave signals in such calculations.

While CBS fully supported the meas-

ure, Capital Cities/ABC, Cox Enterprises and Clear Channel opposed the inclusion of co-channel and weighted adjacent channel interference in one numerical limitation.

Said Capital Cities, "A station that receives most of its interference to one sideband would, under the (proposal), receive an unrealistically high interference limitation. This overly high number would allow an excessive amount of new interference co-channel and on the other first adjacent channel."

It suggested instead that three separate night limits be calculated for each station: co-channel, lower sideband and upper sideband.

The Hearst Corporation supported the 25% exclusion principle protection, but suggested that the area be defined as the actual interference-free skywave service contour or the 0.5 mV/m contour, whichever is of greater field strength value.

Hearst also advised the FCC to postpone consideration of adjacent channel skywave interference to secondary serv-

ice and instead initiate a separate proceeding to determine the appropriate weighting factor to be used; and to implement the proposals in consideration with the change in skywave field strength determination methods proposed in 88-508.

Greater Media said it cautiously supported the methodology underlying the proposal, however, "any improvements in service created by this change would be offset by the negative impact on the AM band."

The company added that the RSS exclusion should be applied to the new 1605 kHz to 1705 kHz expanded AM band.

Foreign contributions

Cox wrote that the problem of foreign contributions to the nighttime limits of domestic stations should be addressed by grandfathering existing co-channel interference from foreign stations and excluding the contribution of these stations from RSS determinations.

Also, the company said, a more reliable data base for determining the contribution to a station's RSS limit from foreign allocations should be developed; and the cooperation of US treaty partners to put in place international standards to improve the quality of AM service should be sought.

The NAB, in its support of the document, said "it is most important to cure the admitted defects in the groundwave curves themselves, and less important to correct inaccuracies in the Commission's M3 map."

As with Docket 88-508, the NAB suggested the use of a safety factor to insure the absence of interference to the protected contours of existing stations.

For more information on the proposals, contact the following: Diane Hofbauer at 202-254-3394 for Class II-S and Class III-S; Wilson LaFollette at 202-632-5414 for calculating AM nighttime protection; and Larry Olson at 202-632-6955 for groundwave and skywave calculations.

Recordable CDs Face RIAA Opposition

(continued from page 1)

Washington.

RIAA and the International Federation of Phonogram and Videogram Producers (IFPI) have issued statements opposing use of audio CD-R without copyright protection for recording artists.

As with DAT, opponents of the technology argue that CD-R recorders' capability to make exact copies of recorded music is an infringement of the recording artists' copyrights.

Rosen said the recordable CD poses more of a problem for the recording artists than DAT because CD is now the accepted format of the recording industry.

For the first time, recordings equal to the quality of the original could be mass copied in the most popular format, she warned.

"The recordable CD will be a gift to each potential pirate. It would allow them to make perfect digital sound recordings with no loss in audio quality," IFPI Press and Information Director Mark Kingston said from London.

Rosen said RIAA is prepared to take whatever action is necessary to stop recordable audio CDs and equipment from being marketed without copyright protection for the recording artists.

"We will pursue our interests as vigorously as we have DAT," she said.

Besides the copyright controversy, Rosen noted that the CD-R equipment costs, like DAT, may hinder its marketability.

Costs have been estimated to be well in excess of \$1000 for the continuously recordable CD units. Taiyo Yuden did not have a cost estimate for a record-once

CD recorder because of its software-only involvement but predicted they could eventually be lowered to almost the same price as a conventional CD player.

The price would have to decrease significantly for the average consumer to buy a recorder, Rosen said.

She cited DAT machines, which until the recent winter CES have been sold mostly on the "grey market" because of the copyright controversy, as an example of CD-R's possible future.

Currently "grey market" DAT machines, which are sold directly by manufacturers, sell in the \$1500-\$2500 range, but many do not have warranties, Rosen said.

For more information, contact Hilary Rosen 202-775-0101, Mark Kingston at 44-143 43521 or Taiyo Yuden at 03-833 3981 in Tokyo.

The Most Versatile Distribution Amplifier Ever Made. ANY of 8 Inputs to ANY of 28 Outputs.

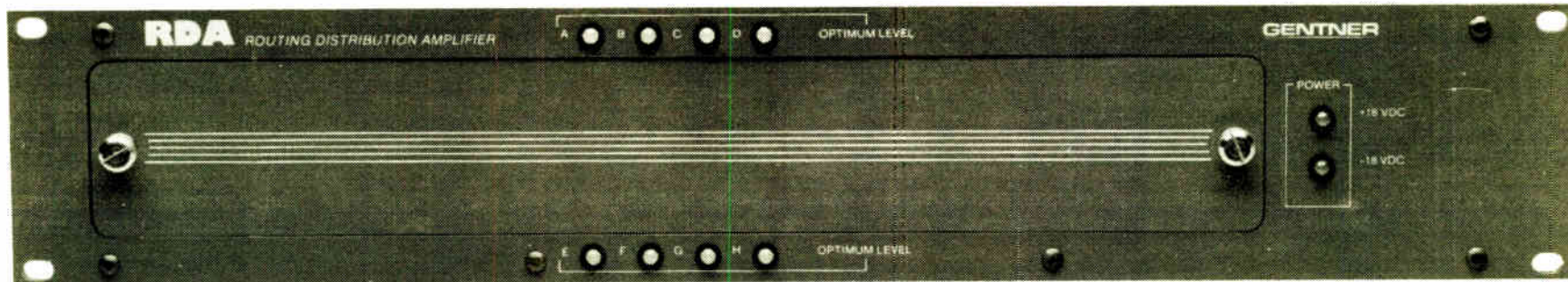

Gentner's Routing DA also features uncompromised audio quality. Product is available now. Call your Gentner distributor or Gentner Electronics for details.

GENTNER
ELECTRONICS
CORPORATION

1825 Research Way • Salt Lake City, Utah 84119

Telephone: (801) 975-7200

Facsimile: (801) 977-0087

Getting Started Multitracking

by Bruce Bartlett

Elkhart IN Many radio stations record their own spots with an in-house production studio. It can be equipped with modern semi-pro multitrack recording equipment, which is small, inexpensive, easy to operate and of broadcast quality.

We'll assume that your station already has quality microphones, mic stands, headphones, a 2-track recorder and a monitoring system.

You can assemble a professional-quality 8-track open-reel studio for under \$4000 or a 4-track cassette studio for about \$1700.

The integrated cassette studio

A cassette recorder/mixer combines a full-function mixer with a built-in high-quality 4-track cassette recorder. It can record up to four tracks at a time, say for stereo music, narration and sound effects. Current units offer surprisingly good quality.

The cost of a typical 4-track combined system will probably run about \$1700—\$1300 for the 4-track recorder/mixer and an extra \$400 for effects.

Some popular models are the Fostex 260, Tascam 246 and Audio-Technica AT-RMX64.

Figure 1 is a block diagram showing the signal flow through a typical mixer from input to output. Four to six mic/line inputs are common.

A trim control pad or input attenuator reduces the level of a microphone signal before it reaches the preamp. This prevents input-overload distortion.

LED overload indicators flash when distortion occurs in the mic preamp. They warn you to switch in the input pad or adjust the trim control so that distortion stops.

EQ is available in three degrees of sophistication: bass and treble controls, multiple-frequency and sweepable frequency.

Channel-assign switches let you send the signal of each instrument to the

desired tape track. There are pan pots for the stereo image placement and outputs or buses which feed the tape tracks.

A four-bus mixer provides four independent output channels; each chan-

Synchronous recording is used during overdubbing to keep pre-recorded tracks synchronized with new parts being added.

Previously recorded tracks are played

You can assemble a professional-quality 8-track open-reel studio for under \$4000 or a 4-track cassette studio for about \$1700.

nel carries a signal which may contain the sounds from one or more sources. The four channels feed a 4-track cassette recorder.

A direct output follows each input fader and is used for recording one instrument or voice per track, because the signal is cleaner at the direct output than at the bus output.

An auxiliary bus or effects bus is a channel in the mixer for sending a signal to and from an external signal processor, such as reverb or delay.

Some mixers have more than one such bus, allowing for a variety of special effects.

The monitor mixer is a submixer built into the larger mixer which controls the balance of the instruments heard over the studio monitor speakers or headphones. It also generates a cue mix.

Note that the auxiliary sends in the mixer can serve double duty as controls for a monitor mix or cue mix. Ping-ponging allows you to mix several pre-recorded tracks with your mixer and record the result on an empty track.

Then the original tracks are erased, freeing them up for more recording.

Cassette-deck

One of the techniques you can achieve with the cassette deck is overdubbing—recording a new track in sync with old tracks—which is a standard feature on multitrack recorders.

This way, music, sound effects and narration can be recorded one at a time until all the parts are on tape.

Figure 1. Signal flow through a typical mixer. For clarity, only one input channel and two output channels are shown.

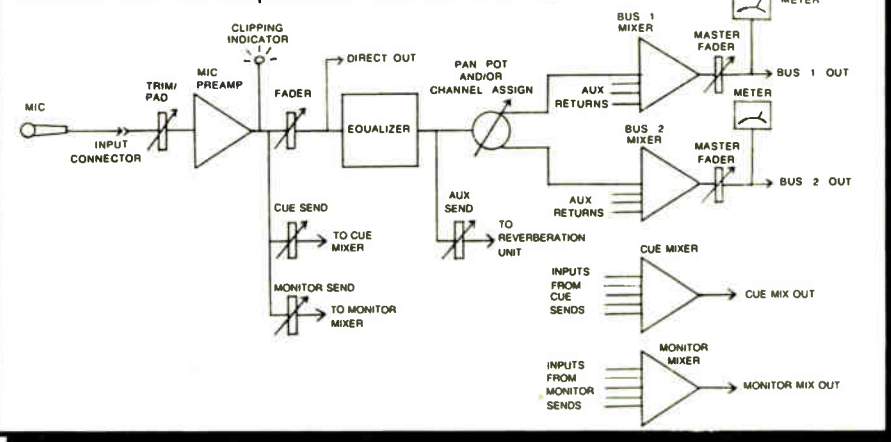

back from the record head, rather than the playback head. This keeps the timing of the old and new musical parts in sync. All multitrack recorders feature synchronous recording.

With Punch In/Out you can fix a mistake on a track without doing the whole track over. You insert corrected parts into a previously recorded track.

For noise reduction, Dolby and dbx systems are commonly used.

Tape-speed options include standard cassette speed of 1 7/8 ips as well as 3 3/4 ips for better high-frequency response and headroom, less noise and less flutter. Some recorders offer selectable tape speeds.

Pitch control varies the speed of the cassette recorder and lets you adjust the pitch of previously recorded tracks to be added.

As a slightly more elaborate alternative,

you might want to consider a separate 8-track recorder and mixer. This setup has more flexibility and higher sound quality than the 4-track cassette-recorder mixer, but costs more.

For example, a 6-in, 4-out mixer might run about \$1300 and an 8-track open-reel recorder about \$1900 with another \$800 for effects.

Some popular models are the Tascam M-308 and Fostex 450; two good 8-track recorders are the Tascam 38 and Fostex Model 80.

While an 8-track unit for semi-pro use can be bought for less than \$2000 includ-

ing built-in noise reduction, a 16-track recorder with built-in noise reduction costs less than \$6000. The sound quality is good enough to make master recordings.

Although an 8-output mixer is commonly used with an 8-track recorder, a lower-cost alternative is a 4-output mixer. It can be used by recording only four tracks at a time or by using the direct-out jacks in the mixer.

The Tascam 38 combines an 8-track open-reel recorder and a mixer, while the Akai MG1214 combines a 12-track large cassette recorder and a mixer.

Finally, don't let the term "semi-pro" scare you—excellent quality is becoming even more available at low prices.

■ ■ ■

Bruce Bartlett is a microphone project engineer and technical writer with Crown International. He can be reached at 219-294-8000.

SNEAK PREVIEW

- Bill Higgs on creative belt-tightening for Bottom Line Broadcasters
- Contract Engineering looks at the care and feeding of STLs
- Ty Ford gets back to the basics of equalization in Producer's File
- News on a Toledo station with an all-DAT format
- Digital workstation and automation equipment in the Buyer's Guide
- JG's Earwaves and much, much, more!

In the next edition of **RW**.
Look for it February 22nd.

AUDIO PROCESSING... hnaturally

A-MAZE (ā-māze)

HIGH DEFINITION IMPROVEMENT
For any existing processing chain plus... separation enhancement.

MIC-MAZE

HIGH DEFINITION MIC PROCESSING
Plus... program gain riding: STL, AM and SCA processing.

TRI-MAZE

FM STEREO, NRSC AM, OR TV
THE ULTIMATE IN FLEXIBILITY AND PERFORMANCE.

hnat hinders inc

42 Elaine Street • R.R. 1 • Thompson, Connecticut 06277 • (203) 935-9066 • (203) 935-9242

Not for amateur radio.

You're no amateur at this game, so why play around with amateur CD players in the studio? You've tried consumer models in the past, just to see if they'll work long enough to make sense. We can understand that. But in the long run, they *don't* make sense. And you know it. Even modified or beefed up versions have given you headaches. . . wrong levels, hifi connectors, too many buttons or the wrong ones. Not to mention skips, mutes and breakdowns. Why take chances playing around with an amateur deck in a pro application? Leave that home player at home where it belongs. Check out the Studer A727 and A730—pro players for radio pros.

A727 ▶ Thousands of A727's prove their reliability in radio stations all over the world—*everyday*. The A727 provides full 16-bit resolution with 4x's oversampling—plus powerful error correction circuits to protect against on-air problems from damaged or dirty discs.

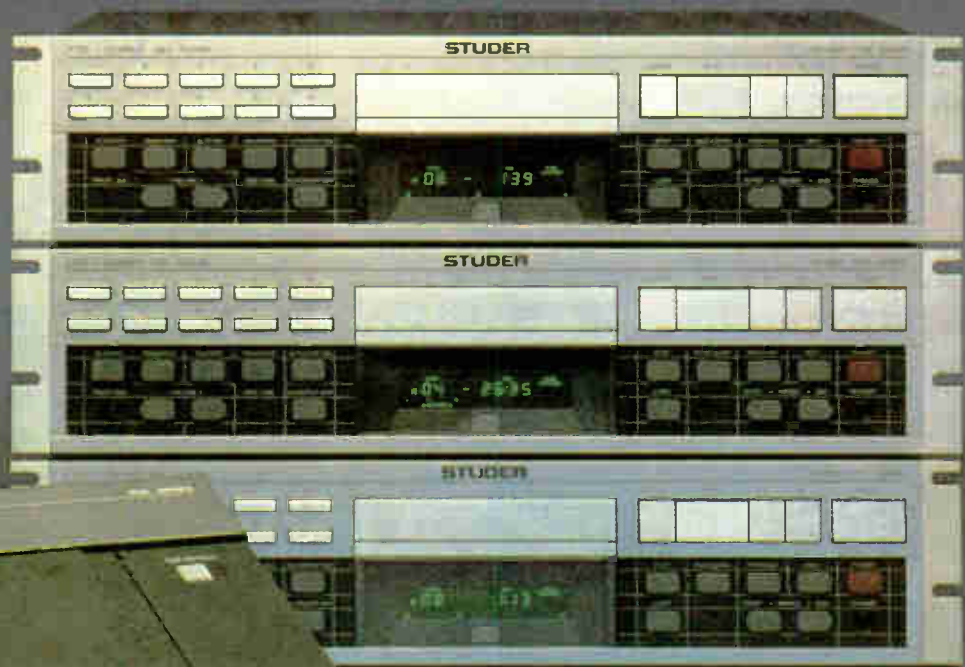

Designed for fast, creative production play, the **A730** is the newest addition to the Studer line of Pro CD players. This machine can recognize 100 discs and store up to 3 start cue points per disc. Its die-cast aluminum transport is built for professional use.

FEATURE	A727	A730	"Brand X" Player	FEATURE	A727	A730	"Brand X" Player
Fader Start	▼	▼		Disc Recognition		100 discs	
Parallel Remote w/Tallies	▼	▼		Varispeed Built-in		▼	
Start & End Review	▼	▼		End of Modulation Sense		▼	
End of Track Alarm	▼	▼		Monitor Speaker		▼	
RS422 Serial Control	▼	▼		Separate PGM & Monitor Outputs		▼	
System Clock in/out	▼	▼		Remote Monitor Speaker Mute		▼	
Digital Output	▼	▼		Audio Channel Reset		▼	
Die-cast CD Drive	▼	▼		Rack Mounts Standard	▼		
Cue Memories		3		Flush Mounting		▼	

Go ahead. Make the comparison.

Before those amateur machines break again, call your Studer Revox Full-Line Dealer, or contact us directly.

STUDER REVOX

Studer Revox America, Inc. ▶ 1425 Elm Hill Pike ▶ Nashville, TN 37210 ▶ (615) 254-5651
 Los Angeles, (818) 780-4234. New York (212) 255-4462. Chicago (312) 526-1660. Dallas/Ft. Worth (817) 861-1861.
 In Canada, Toronto (416) 423-2831.

We Have Standards, You Know.

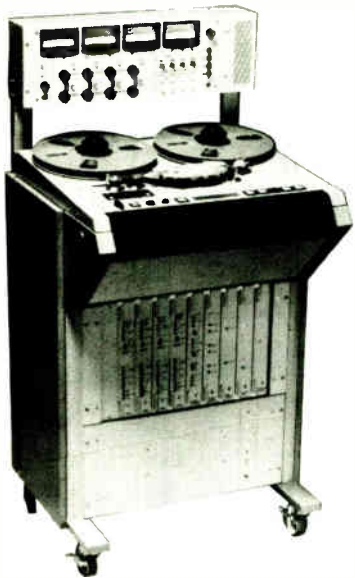

Otari MTR-10
& Denon DN950F

2-track **\$9456**

lease the package for \$213/month

4-track **\$13,239**

lease the package for \$298/month

Denon's DN950F CD Cart Player® is the standard at hundreds of radio stations in the U.S. and around the world. Now, here's your opportunity to move up to Denon AND get that other piece of pro gear you've been needing.

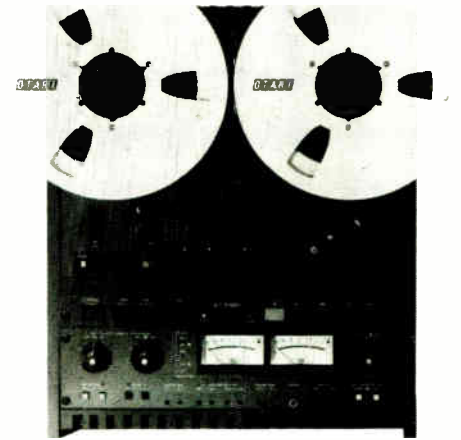

Otari MX5050B
& Denon DN950F

\$3695

lease the package for \$84/month

DENON CD CART PLAYER™

COMPACT
disc
DIGITAL AUDIO

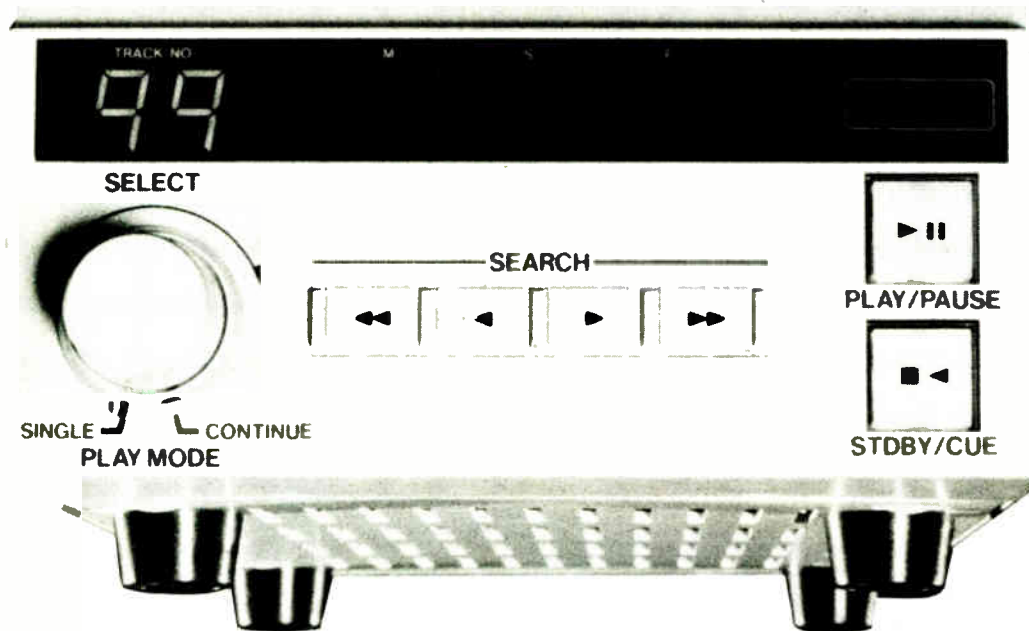
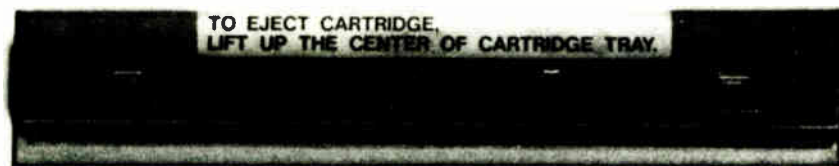

Denon DN950 CD Cart Player **\$1349**

lease 4 machines for \$122/month

CONSERVE CASH FLOW
GET THE
EQUIPMENT YOU NEED

LEASE IT!



Eventide H3000B
& Denon DN950F

\$3769

lease the package for \$85/month



Tascam 122 MKII
& Denon DN950F

\$1950

Leasing is subject to change, sales tax and credit approval.

ATLANTA, GA
LOS ANGELES, CA

CHICAGO, IL
800-622-0022

DALLAS, TX
RICHMOND, IN

ALLIED
Broadcast Equipment

— A HARRIS COMPANY

Radio On A Methane Gas Site

by Dee McVicker

Los Angeles CA While KRLA-AM pumps out oldies to the tune of 50 kW daytime and 20 kW nighttime power, the ground beneath the station's antenna site is pumping out enough methane to fuel, well, perhaps a radio station.

Methane aside, CE Dave Ping feels that this scarcely populated area in Irwindale, CA, was a choice site for KRLA's directional array.

Finding the right land, and enough of it, to erect a DA system in the Los Angeles area is extremely difficult. Ping says that Greater Media is very fortunate that KRLA's previous owners found it.

"Part of the condition of the transfer of license to us was that we would make the pattern work on a new site" recalls Ping, who found the existing pattern far from workable.

The old AM site was surrounded by some 90 power transmission towers that were distorting the direction of patterns.

"The nighttime pattern just would not work," says Ping. Until they moved to a new site, KRLA had a little chance of reacquiring the nighttime license that it

OFFBEAT RADIO

lost some 20 years ago.

Erecting towers and building a transmitter housing unit atop a percolating waste dump seemed the only option for nighttime broadcast.

The new site, further north of the population than the previous one, not only cleared KRLA from the power transmission lines that had distorted the pattern, it also made a deep null at 60° azimuth finally possible. "That was the null that couldn't be pulled in deep enough on the old site," according to Ping.

Ping, along with Greater Media's DE Milford Smith, set to work building an antenna site on a landfill that would continue to decompose waste and turn it into methane gas for at least another ten years.

"We had many consultants on the job," says Ping, "environmental consultants, a soil consultant, a corrosion consultant."

Most everyone agreed that one of the first concerns was the inevitable ground settling as garbage decomposed and turned into methane gas.

Says Ping, "No one really knows (how far the ground will settle), including the best consultant. In 10 years, the ground in spots might settle as much as 10". The solution, they decided, was 18" wide steel I-beams, or piles, to rest the antenna towers on.

Original surveys indicated that garbage was 120' deep throughout most of the site. That proved to be a conservative estimate.

Nine anodes scattered throughout the

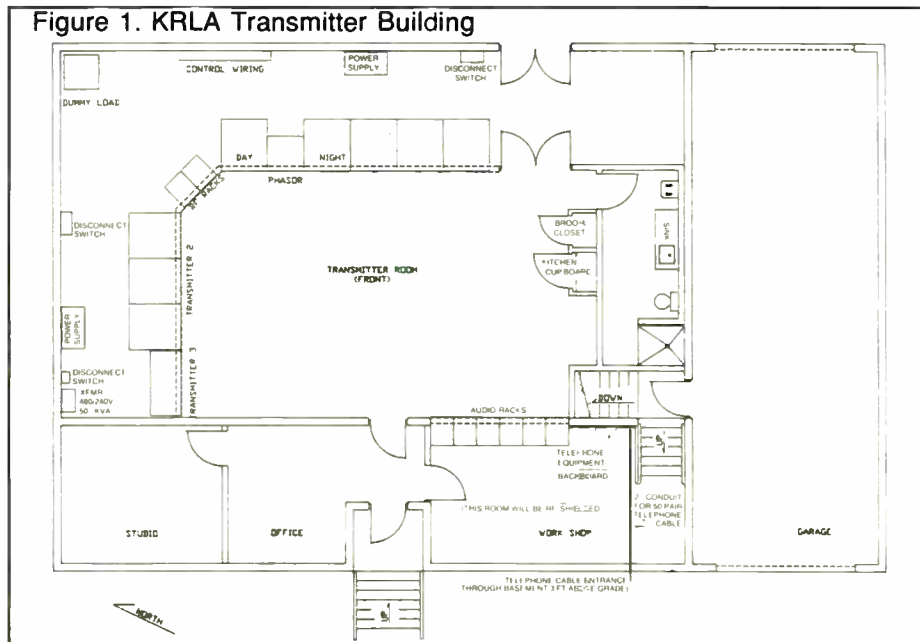

As piles were driven into the ground in 60' sections, it became evident that natural soil was farther down in more places than expected. Even at 200', Ping and his crew were finding little drive resistance.

Finally, at 200'—double their original estimate—they struck ground that was firm enough to support the weight of the

site receive the positive terminal and are positioned so that the current flowing onto the face of each pile is approximately equal.

To monitor the system, Ping planted a copper sulfate reference cell near one of the piles. Via remote control he can check for relevant voltage changes that would affect the operation of the system.

Since the station's ground system is attached to the top of the pile cap, Ping is assured that his ground system will also survive corrosion.

He is convinced, however, that as the ground settles, settling the copper ground radials along with it, it will become necessary to replace the ground system and/or to bring in fill dirt.

"But," Ping adds, "we don't want to put too much ground dirt on the ground system because it has to be close to the surface to keep the efficiency up." Ping suspects that a new ground system will be needed in 10 years.

Before Ping began building the two-story transmitter housing, he first excavated the site for normal soil. It was important, he felt, that at least the transmitter building was on natural soil to elimi-

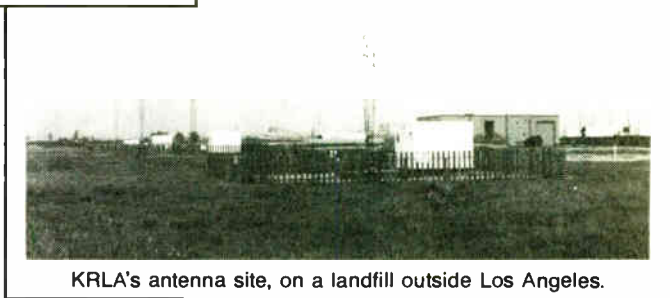

KRLA's antenna site, on a landfill outside Los Angeles.

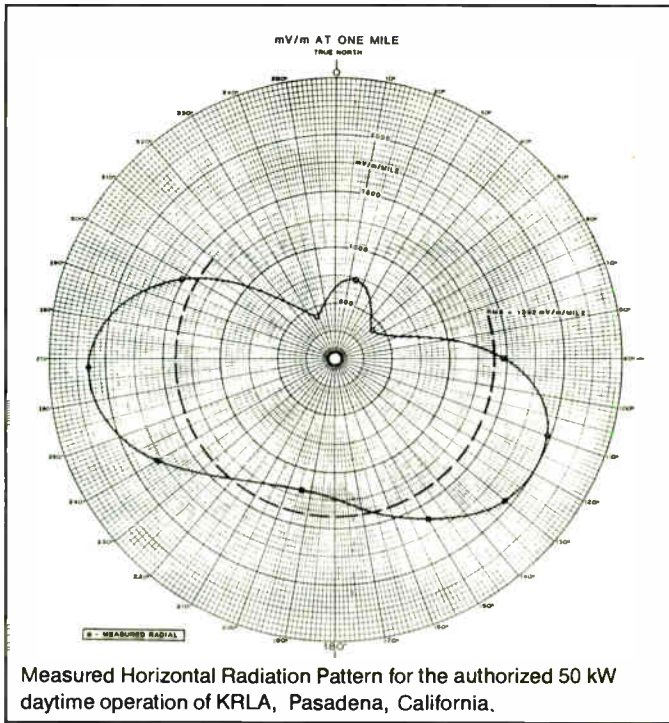

Measured Horizontal Radiation Pattern for the authorized 50 kW daytime operation of KRLA, Pasadena, California.

antenna towers.

Once the I-beams—33 in all—had been driven into the ground to support the weight of five 330' towers, they were joined together at the base of the towers and encased in concrete to form what Ping calls the pile cap.

Cantilevering off of the pile is a concrete encasement that supports the antenna-tuning buildings—the dog houses. This ensured that settlement below the surface would not cause problems to the tower or its utility housing above the surface.

While Ping realized the importance of firm antenna support in a methane quicksand, he was also aware that within a relatively short time these I-beams could give way to the site's natural electrolysis, or corrosion process.

To keep the steel from corroding, he installed a cathode protection system.

The active system is a simple reversal of the electrolysis process, where the steel I-beams react as cathodes by receiving the negative terminal of a DC power supply.

Nine anodes scattered throughout the

nate cracking in the building's foundation as the ground settled.

Once Ping found this small speck of land, he took precautions to maintain the soil's natural state. "One of the problems with a landfill area," he says, "is that the methane gas is under pressure as it percolates down in the garbage. And it will migrate laterally in the ground and get in the natural soil."

To eliminate methane from seeping into the natural ground soil and ultimately the transmitter building, a 1/8" rubber barrier was encased around the foundation.

To further protect any chance of methane breaking the barrier, Ping relieved methane pressure with an "exhaust system" placed underneath the methane barrier. This connects to a vent pipe above the building to pass pressurized methane gas.

Although Ping is relatively certain that this ground ventilation system will all

but eliminate gas from finding its way through the barrier and into the building, he isn't about to take any chances.

In the event the gas does break the barrier and arrive at the doorstep of the transmitter building, it will be met with a highly pressurized ventilation system inside.

This positive pressure pushing out from the building not only makes methane penetration unlikely, it also clears the building of dirt and dust.

The air ventilation system that Ping chose pumps out 4000 CFM and is equivalent to those found in hospital systems.

(continued on page 25)

Introducing radio's most colorful black box.

Shimmerish Swept Reverb program—one of 70+ Eventide Broadcast Ultra-Harmonizer™ digital audio effects you can use "right out of the box." Just turn the H3000B on, and it'll turn your listeners on.

RADIO'S MOST COLORFUL BLACK BOX
 EVENTIDE INC
 ONE ALSAN WAY
 LITTLE FERRY, NJ 07643
 TEL 201-641-1200 • TWX 710-991-8715 • FAX 201-641-1640

Eventide
 the next step

PERMISSIBLE AM DAYTIME RADIATION STUDIES

- Improve Existing AM Station Coverage
- Analyze Proposed New Station Sites
- Full-band Frequency Searches Relieves Menial Work & Excessive Labor Costs
- 72 Radials Studied (Each 5° of Azimuth)
- Soil Conductivities From Figure M3, Region II Database or Measured Data
- Current Domestic Rules & International Agreements Applied
- Available In-house or Remote Access

Call For Sample Run

dataworld®
 A Service of DW, Inc.
 P.O. Box 30730
 Bethesda, Maryland 20814
 (301) 652-8822 (800) 368-5754

Get
the
carts
you can
count on...

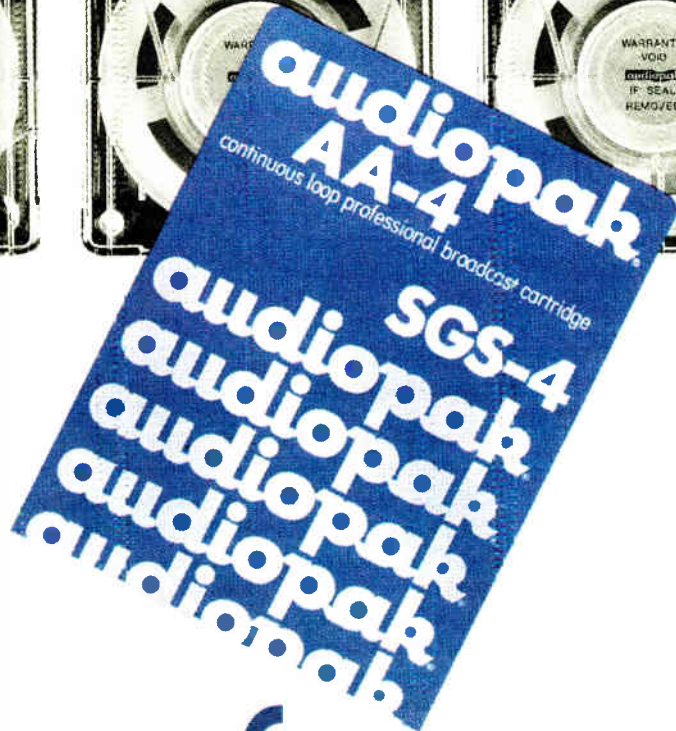

from a
source
you can
count on!

Demanding broadcasters around the world count on Audiopak broadcast cartridges for consistent response, dependable quality and outstanding reliability. High-performance tape formulations, superior coating processes and rugged, "no-maintenance" casing designs have made Audiopak the international standard. Why settle for other broadcast cartridges? Getting "workhorse" A-2s, "stereo" AA-3s or "digital-ready" AA-4s is as easy as picking up your phone.

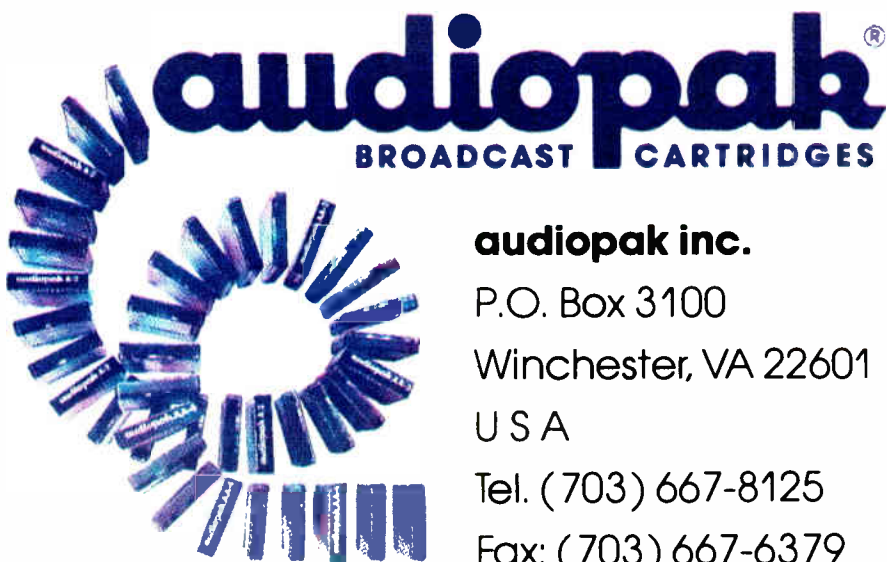

audiopak inc.

P.O. Box 3100
Winchester, VA 22601
U S A

Tel. (703) 667-8125
Fax: (703) 667-6379

We have the full Audiopak line of broadcast cartridges in stock for immediate delivery at competitive prices.

ALLIED
Broadcast Equipment

— A HARRIS COMPANY

ATLANTA, GA CHICAGO, IL DALLAS, TX
LOS ANGELES, CA RICHMOND, IN

1-800-622-0022

CANADA 416-731-3697

Digital Technology Comes of Age

by John "Q" Shepler

Rockford IL There's a new kid on the block. His game is quality and his name is digital. Today, he offers an improvement in audio but eventually he'll completely change the nature of radio broadcasting.

Digital techniques have been gradually infiltrating the broadcast plant for the last 30 years. The first automation systems were digital beasts. The tapes whirred back and forth and cartridges rode up and down on elevators.

Some systems even pressed jukebox mechanisms into service to replace DJs. But they all had one thing in common: their brains were digital. Oh, we're talking clunky relays spitting sparks, not quiet little microprocessor chips, but it was digital just the same.

Digital control has advanced steadily, paced by developments in the computer industry. Most stations now have computer systems to help with traffic, billing and music rotation.

Some even have computers in the office that talk to the program automation systems in order to schedule and log commercials. The brain power for automatic control of a radio station is already here. But the software to make it happen is coming at a much slower rate.

Beyond control

Digital control is only half of the equation. The other half is digital audio. In the last few years, digital has become part of almost every station.

A few weeks ago I stopped by a station to sort out a problem with the studio telephones. As I stood in the back of the air studio watching the personality

run his show, something dawned on me. Never once did this man touch a turntable.

The tables were there, all right, and nice new Panasonic quartz ones at that. They sat quiet and dark, out of sight and out of reach of the man at the board.

Instead, he worked the stack of CD players directly off his right shoulder. Not professional units like the turntables, mind you, these were consumer players, probably picked up from a sponsor or discount store. They sounded terrific.

I believe that radio is in a transition from the best of what was to something newer and better. The pace of this transi-

Q-TIPS

tion is picking up speed and may leave us all peeking into the studio and wondering what happened.

Those quartz turntables I just mentioned had many engineers and program directors drooling at the thought of owning a pair even five years ago.

Now, they go unused. There is little incentive for additional turntable improvements. The CD has nearly relegated them to the status of dinosaurs.

Analog tape

Now think about your other equipment. Cart machines and tape recorder technology was born in the fifties and has been getting better ever since. When will it, too, be superseded by something much better and totally incompatible?

Digital Audio Tape is the obvious replacement for analog recording. It offers many of the same advantages as CD.

Frequency response is flat

across the audio band. Distortion, hum and noise are reduced to levels that standard test instruments consider insignificant. Wow and flutter, the bane of any tape deck more than a few weeks out of the shipping carton, are immeasurable.

DAT and its competitors, based on VCRs coupled to PCM adaptors, do indeed raise the level of audio expectations. However, these advances are probably more evolutionary than revolutionary.

Take a close look at a DAT recorder. Is it really that much more than a souped-up cassette recorder? The fidelity improvement and ability to dub without generation loss are unquestionable.

However, you still have a roll of tape that rubs against a metal head and eventually wears it down. You still have the potential for tape jams in a fairly complicated mechanism. It still takes a fairly long time to locate and cue up a given piece of material—hardly what you could call random access.

How about editing? Pretty much like a cassette machine. It's less friendly than a big reel-to-reel where you can rock the reels and feel your way into a razor blade edit point.

Station integration

It could well be that once DAT gets past the legal bickering and into mass production, it will become as entrenched as the CD and will establish the standard for the next 20 years. What does this mean for radio?

There are few changes needed to incorporate this technology. You can mix the new audio equipment with the old and think nothing of it. However, the internals of the gear

have changed radically and that is what provides the potential for a revolution.

The revolutionary idea is the one that has DAT locked up in the courts, as far as consumer gear is concerned. If all of your equipment is standardized on a 44.1 kHz, 16 bit format, the obvious thing to do is to let one digital processor talk to another in its native language.

Forget all that analog interfacing. Keep the signal chain digital until you have to drive headphones or loudspeakers or modulate a transmitter. Con-

nect the CD to the DAT recorder with a digital link and you lose nothing in the dubs.

The big challenge will be to adapt the rest of the studio equipment for a digital processing chain. Control boards will multiply and divide bit patterns, not voltages.

The difference may seem subtle, but once you replace scratchy pots, analog switch ICs, hot transistor drivers and miles of shielded twisted pairs with digital ports and processors the control board becomes more like a computer than a public address mixer.

The challenge for broadcast equipment designers will be to (continued on page 30)

OUR FM MONITOR DESERVES A SECOND GLANCE.

BUT IT DOESN'T NEED IT.

Engineers look twice when they first see our 691 Stereo and SCA Monitor. But when they start to use it, they find the 691's meters are easily tracked in a single glance. Like everything else about the 691, its measurement displays are very well thought out.

A color-coded system ties together the associated displays, switches, and jacks for a particular function or test. Select your test by pushing a color-coded button and simply read the results on all of the indicators. It's as easy as it sounds.

Other benefits of the 691 include over 40 proof-of-performance and signal quality measurements. Add a scope and use the 691 as a spectrum analyzer... or get a vector display of L/R phasing. Perform a Bessel-Null calibration in minutes. Measure clipped composite accurately and quickly.

The 691 can now be optionally ordered to measure two SCAs. There are many other features... write or call for complete information.



QEI CORPORATION
One Airport Drive □ Box D
Williamstown, NJ 08094
Phone 609-728-2020
Toll Free 800-334-9154

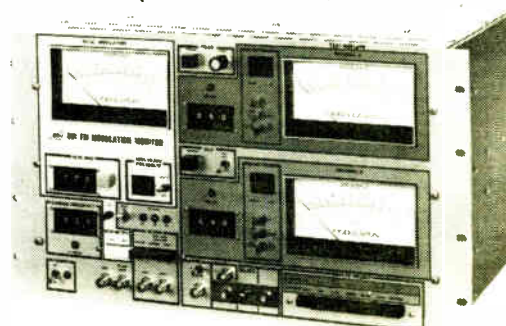

Subscription/Reader Service Form

February 8, 1989 Issue Use until May 8, 1989

FREE Subscription/Renewal Form

I would like to receive or continue receiving **Radio World** FREE each month. YES NO

Signature _____ Date _____

Please print and include all information:

Name _____ Title _____

Company/Station _____

Address _____

City _____ State _____ ZIP _____

Business Telephone () _____

Please circle only one entry for each category:

I. Type of Firm

D. Combination AM/FM station F. Recording studio
A. Commercial AM station G. TV station/teleprod facility
B. Commercial FM station H. Consultant/ind engineer
C. Educational FM station I. Mfg, distributor or dealer
E. Network/group owner J. Other _____

II. Job Function

A. Ownership D. Programming/production
B. General management E. News operations
C. Engineering F. Other (specify) _____

III. Purchasing Authority

1. Recommend 2. Specify 3. Approve

Reader Service

Please first fill out contact information at left. Then check each advertisement for corresponding number and circle below. NOTE: Circle no more than 15 numbers, otherwise card will not be processed.

001	021	041	061	081
002	022	042	062	082
003	023	043	063	083
004	024	044	064	084
005	025	045	065	085
006	026	046	066	086
007	027	047	067	087
008	028	048	068	088
009	029	049	069	089
010	030	050	070	090
011	031	051	071	091
012	032	052	072	092
013	033	053	073	093
014	034	054	074	094
015	035	055	075	095
016	036	056	076	096
017	037	057	077	097
018	038	058	078	098
019	039	059	079	099
020	040	060	080	100

Circle 73 on Reader Service Card

Circle 50 on Reader Service Card

Keeping a Non-Technical FCC File

by Harold Hallikainen

San Luis Obispo CA Last month we managed to stay indoors out of the winter cold by going over the technical paperwork the FCC requires us to keep and will likely ask to see in an inspection.

This month, let's avoid the cold by reviewing the non-technical paperwork required by the Commission. During an inspection, the FCC may check this file to insure it is complete.

This non-technical file is to be located at the main studio if the studio is in the community of license or if the studio is located outside the community of license pursuant to an authorization granted under 73.1125(a) prior to 16 July 1987.

Alternatively, the file can be located at any accessible place (such as a public registry for documents or an attorney's office) in the community of license.

The file is supposed to be available for public inspection during regular business hours [73.3526(d)].

Although the file is not technical in nature, it is often the chief operator who is most familiar with FCC requirements, so we'll review the required contents of this file.

FCC applications

A copy of every application filed after 13 May 1965 requiring local public notice is to be retained in the public file for seven years or until the next renewal, whichever is longer.

In addition, related correspondence between the FCC and the applicant, FCC decisions, citizen agreements and statements regarding petitions to deny (name and address of petitioner, etc.) [73.352a)(1)].

INSIGHT ON RULES

Also applications requesting an extension on a CP for a new station, consent to involuntary assignment or transfer or voluntary changes in ownership or control (FCC form 316) and related documents must be retained for the same period [73.3526(a)(2)].

The engineering section (and related material) of these applications need not be in the file.

If the engineering section shows service contours, copies of the maps showing contour information are to be in the file.

In addition, all ownership reports filed after 13 May 1965, along with related exhibits, letters and documents must be retained in the public inspection file for seven years or until the next renewal, whichever is longer [73.3526(a)(3)b].

Other necessities

Rules 73.3526(a)(4) and 73.1948(d) require a complete record of all requests (and the disposition of such requests) for broadcast time made by candidates for

public office or on their behalf.

These records are to be retained in the public inspection file for two years.

A copy of each employment report filed with the FCC and all related documentation that is open to public inspection at the FCC offices must be placed in the public file for seven years or until the next renewal, whichever is later [73.3526(a)(5)].

The booklet *The Public and Broadcasting—A Procedure Manual* explains the broadcast licensing proce-

if the station licensee feels the letter should be excluded from public inspection due to the nature of its content (defamatory, obscene, etc.).

Every three months, each commercial radio station is to place a list of programs that provided the station's most significant treatment of community issues during the preceding three months into the public inspection file.

The list must also include a description of the issues treated and the programming that provided this treatment [73.3526(a)(9)]. These lists are to be maintained for seven years.

Finally, according to Rule 73.3526(a)(10) certification of compliance with the

Although the file is not technical in nature, it is often the chief operator who is most familiar with FCC requirements . . .

dures (including applications, petitions to deny, etc.) to the public reviewing your public file.

A copy of this booklet is also required to be in the public inspection file [73.3526(a)(6)].

The public

A public file would be misnamed without some participation from the public it is seeking to serve.

Rules 73.3526(a)(7) and 73.1202 require letters from the public received by commercial radio and TV stations regarding operation of the station to be kept in the public inspection file for three years.

There is an exception if the writer requests the letter not be made public or

public notice requirements of 73.3588(h) (renewal pre- and post-filing announcements) should be placed in the public file for the same duration as the associated application.

We've listed the major paperwork that should be available to an FCC inspector and available to the public. An FCC inspector will generally check your public inspection file to insure it is complete.

I'll look forward to your comments and suggestions for areas of future discussion.

■ ■ ■

Harold Hallikainen is president of Hallikainen & Friends, a broadcast equipment design, manufacture, sales and installation firm. He can be reached at 805-541-0200.

Eliminate gain riding problems with the flick of a switch.

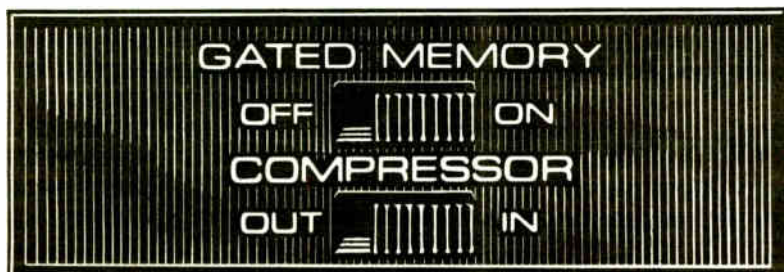

The new FP51 gated compressor/mixer rides gain automatically.

Once you set the compression level, the FP51 adjusts automatically to changing signal levels in critical remote-to-studio feeds to maximize signal output. As a result, your broadcast is quieter, smoother, better balanced and more natural sounding.

Eliminates background noise problems and "pumping": A gated memory "remembers" the compression level during pauses. This eliminates disruptive background noise build-up and the annoying "pumping" effect common to many compressors.

In addition to better sound, the FP51's automatic operation eliminates the need for constant readjustment by the audio engineer thereby freeing him to attend to other problems.

Loaded with features you've come to expect from Shure. The FP51 features switchable mic/line inputs and outputs, headphone jacks, tone oscillator, headphone cuing and low noise, distortion and RF susceptibility. It supplies phantom power and is AC or battery operable. And it's built with Shure's legendary emphasis on ruggedness and reliability. Shure Brothers Inc., 222 Hartrey Avenue, Evanston, IL 60202-3696. (312) 866-2553. Call for G.S.A. pricing.



SHURE
Breaking Sound Barriers for over 60 years

Circle 24 on Reader Service Card

CRL SPOTLIGHT

Upgrading Your FM Processing?



The CRL FMIG audio processing system is the perfect answer for those of you with a small budget, but a large budget need for FM processing. With the FMIG you get the market's cleanest limiter the SMP-850, followed by the SG-800A digitally synthesized stereo generator. The SMP-850 features a powerful input compressor, followed by our exclusive variable transfer function pre-emphasis limiter. Image widening stereo sound field enhance circuitry is standard equipment. The SG-800A's digital pulse amplitude modulator produces a flawless baseband stereo signal. Find out what the FMIG can do for you. We have a two week trial program available. Call or write us for details.



CRL Systems
2522 West Geneva Drive
Tempe, Arizona 85282 U.S.A.
(800) 535-7648 (602) 438-0888
TELEX: 350464

Circle 35 on Reader Service Card

Building a Tower on a Landfill

(continued from page 21)

After making the transmitter foundation literally gas-proof, Ping next started to work on interfacing the elements outside with those inside.

He still had to get all the necessary coaxial cable from the methane trenches into the transmitter building in order to get down to the business of radio.

Room to breathe

The methane, he knew, would begin propagating through the transmission lines as the sand in the ground lost force as a natural conduit. The transmission lines would provide more "breathing room" for the gas and bring it up against the building.

Ping solved this problem with what he calls "breather pits." Before cable and electrical lines entered the transmitter building, they were first introduced through a small entryway.

Here, the methane is defused by the building's ventilation system. What methane does remain after this blast of positive pressure is then quickly eliminated when the cables and electrical lines feed into gas-tight seals leading to the building.

This breather pit also provided an area to snake the cable into "S" bends, so that as the ground settled it wouldn't pull the cables out and rupture the floor of the building.

Ping also found this method very useful in bringing cable into the dog houses and used a similar method with the ground radials and the copper ground straps.

Water and waste

After Ping solved the problems of introducing radio to methane, he then had to deal with the environment itself. First there was the question of ground covering.

"We were going to put in an irrigation system so we could grow a ground cover," recalls Ping. "We found out that an irrigation system would not be a good idea."

Adding water to a waste disposal site, Ping discovered, was much like adding gasoline to a fire. The more water, the more the waste percolates and the more methane it produces.

Instead, KRLA will be hydroseeding

with a plant that requires very little irrigation. The plant they'll use is one that is used often by the fire department to re-seed an area where there has been a brush fire.

The next environmental issue on Ping's list, and perhaps the most important, is what to do with all the methane. To date, this challenge has been partially met with a methane collection system.



The KRLA transmitter building

"It's made up of 30 gas wells that are scattered around over the property," reports Ping. "Each of these gas wells are interconnected with PVC pipe that's supported above ground. It all goes back to

one point, which is a big blower that will pull the gas out of the ground."

The valves are still closed on this collection system that will ultimately package methane for disposal. But the jury is still out on what to do with the gas once they contain it.

"If it's of high enough quality and if there's enough," speculates Ping, "we will install a generating facility to actually run the transmitter site from the gas we're pulling off the ground."

And that's really making lemonade from a natural site "lemon."

Dee McVicker is a free-lance writer with a long record in equipment sales. Comments on articles and inquiries about her writing service can be taken at 602-899-8916.

STATUS



SYMBOLS

When your transmitter's down you're out of business. That's why you need the VRC-2000 Remote Control to let you know what's happening with your transmitter 24 hours a day. And, once you know the status of your system, the VRC-2000 lets you make adjustments quickly and efficiently at the touch of a button.

With the data interface, status reports are displayed on-screen and adjustments can be initiated directly from your PC. When you're away from the plant, status reports can be called up by phone using your personal access code. Once your ID code is recognized, a synthesized voice relays transmitter status. Adjustments may be made immediately via your Touch-Tone™ phone, or maintenance personnel may be dispatched to the transmitter site.

With options like the 2400 bps stand-alone modem, temperature

probe, computer printer and automatic dialer, the VRC-2000 becomes an extremely powerful monitoring and control system. Conditions at the remote site

are continuously monitored and reports are logged and printed on command. Corrective action can be initiated based on monitor conditions. In the event of an emergency, the VRC-2000 dials a series of numbers until a human operator is reached.

Whether you're broadcasting AM, FM or Television, your transmitter is a critical link. The VRC-2000 is designed to provide vital 'round-the-clock status even when man-hours are limited. Extensive diagnostics and complete remote control keep you up and running and on schedule. Check out your local Gentner dealer and find out how the VRC-2000 can help you maintain the Status Quo.



VRC-2000 REMOTE CONTROL

GENTNER REMOTE CONTROL

1825 Research Way • Salt Lake City, UT 84119 • (801) 975-7200 • FAX (801) 977-0087
Gentner Electronics Corporation is publicly traded over the counter. ©1989 - Gentner Electronics Corporation

The effects are all digital. The grins are only natural.

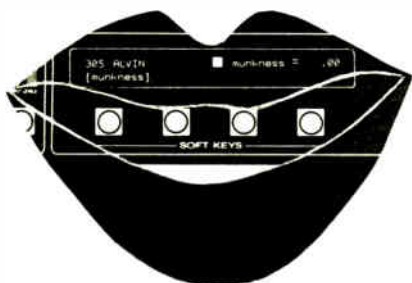

Alvin vocal shift program—one of 70+ Eventide Broadcast Ultra-Harmonizer® digital audio effects designed to stretch your imagination (and your smile). And when you have fun, so do your listeners.

RADIO'S MOST COLORFUL BLACK BOX
EVENTIDE INC.
ONE ALSAN WAY
LITTLE FERRY, NJ 07643
TEL: 201-641-1200 • TWX: 710-991-8715 • FAX: 201-641-1640

Eventide
the next step

Circle 12 on Reader Service Card

World Radio History Circle 18 on Reader Service Card

DAT Breaks Timecode Barrier

by Mel Lambert

Studio City CA As I mentioned in my last column, digital audio is rapidly invading practically every aspect of radio broadcasting, from portable DAT recorders (perhaps the ultimate "digital Nagra") to in-house random-access systems capable of holding a modest play list, commercial selections and station IDs.

Yet, despite the outstanding sonic advantages DAT offers for both field recordings and studio sessions, until very recently the format suffered from one, undeniable disadvantage: it lacked a reliable, robust technique for recording timecode.

Not essential

Several of the handful of Japanese and American firms currently offering DAT recorders were rather too quick off the mark to tell us that timecode might (not) be an essential feature for radio applications.

Why stock a station with hardware that was destined to be replaced in half a year with a MkII version which surprise, surprise, offered timecode capability.

Let's fess up: the dollar volume of hardware for the radio market is much, much smaller than that of our video-based brethren.

The "you-don't-need-timecode" story line, many chief engineers would argue, was simply intended to provide some breathing space while, behind the

scenes, the necessary hardware was developed.

Well, it would seem that those of us who took the plunge and bought early versions of DAT players without timecode will not be disappointed by news from the AES Convention, held in Los Angeles during early November.

Sure, there are many radio tasks for which timecode, at first sight anyway, makes little sense.

DIGITAL DOMAIN

Do we really need it for field interviews that will be transferred to analog for editing and replay to air or in the production studio preparing, for example, station promos from music library tracks with live voice-overs?

But, there again, think how these tasks might be handled more easily in one or two years' time.

Some potential solutions

As digital random-access editing systems become more cost effective, why shouldn't the source recording be spun off into such a system with a timecode track that identifies the time of day (to the nearest video frame) at which the recording was made?

Or what about indexing every cue on a tape to within a fraction of a millisecond, and using those labels in conjunction with a microprocessor-based remote controller?

To date, three potential timecode formats have been proposed for digital audio tape. The first format involved recording conventional 80-bit SMPTE/EBU timecode onto an analog track running the length of the DAT.

However, because of the tape's narrow track width and snail's-pace writing speed (0.32 inches per second; 1/6th that of compact cassette) dropouts can easily upset the timecode data.

Being a longitudinal track, the timecode information also cannot be read in either stop, pause or fast-wind modes.

Fostex Corporation, which also unveiled the D-20 Pro-DAT deck at the AES Los Angeles Convention, has developed a timecode format that involves converting incoming timecode data from a house-sync editing system or free-running timecode generator.

Then, using proprietary data-packing techniques, the deck records the digital timecode data into the User Subcode area of the DAT tape, in the same location as that currently used for PNOs (Program Numbers, Start/Stop IDs and time-stamp information).

Recording timecode information within the auxiliary subcode data area of the helical-scan DAT track offers several advantages over using analog linear tracks.

Like vertical-interval timecode (VITC), with suitable hardware the subcode data can be read in pause and stop mode, in addition to high-speed wind.

Behind the concept

The new Fostex D-20 Digital Master Recorder includes an elegant 4-head DAT transport design, to allow off-tape/confidence monitoring (essentially "read-after-write") and gap-free punch-in/outs.

It also enables the re-recording of timecode data during the manipulation of Start ID and PNO data, which also are recorded within the subcode area.

Recall that, being digital, this data is

encoded into a multiplexed form prior to magnetic recording onto tape.

Unlike analog technology, it is impossible to selectively re-record specific chunks of data without replaying the entire subcode block, replacing the new data and then re-recording the updated information.

So, for timecode-capable DAT recording, the designer needs to provide a 4-head, read-before-write transport design.

A new idea

The third, and latest, timecode proposal comes from NHK, the Japanese state broadcasting organization, working in close cooperation with Japanese manufacturing giants Matsushita Electric Industries and Sony Corporation.

Rather than encoding standard SMPTE- or EBU-format timecode information within the subcode data area, the joint NHK/Matsushita/Sony proposal involves a sophisticated technique that "translates" the hours, minutes, seconds and video frames of an input timecode stream into a "universal" DAT Timing Reference.

This is expressed in terms of DAT frames to within a resolution of 20.8 microseconds (at a sampling frequency of 48 kHz; at 44.1 kHz, the resolution is slightly lower).

(It is worth recalling that an NTSC-format, 30-fps video frame has a duration of 33.3 milliseconds; even synchronization systems with resolutions based on reasonable fractions of an NTSC video frame can seldom achieve a practical resolution accuracy in the studio of anything greater than 1-2 milliseconds.)

In addition, the proposed NHK/Matsushita/Sony format involves the recording of additional data bits within the subcode area that identify the (source) of timecode used to produce the DAT Timing Reference and also any User Bits

(continued on page 30)

Introducing the Newest Specialist!

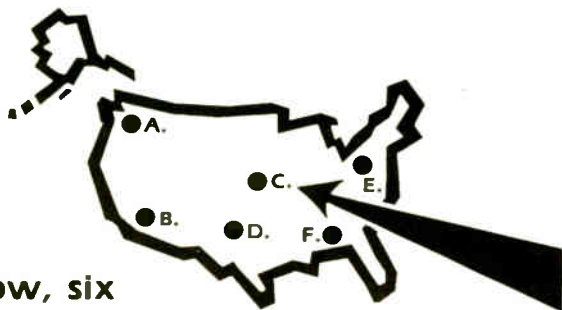

Now, six offices provide coast-to-coast coverage. For all your RF needs, call the RF Specialties office nearest you.



CHRIS KREGAR —
RF SPECIALTIES
OF MISSOURI

**RF Specialties®
Group**

SYSTEMS DESIGN
COMPETITIVE PRICING

A. RF Specialties of Washington, Inc.
11721 15th Avenue NE
Seattle, WA 98125
Phone (206) 363-7730
FAX (206) 362-5560
John Schneider

B. RF Specialties of California
3463 State Street, Suite 229
Santa Barbara, CA 93105
Phone (805) 682-9429
FAX (805) 682-4396
Sam Lane

C. RF Specialties of Missouri
RR #2, Box 152H
Kearney, MO 64060
Phone (816) 635-5959
FAX (816) 635-4508
Chris Kregar

D. RF Specialties of Texas
P.O. Box 7630
Amarillo, TX 79114
Phone (806) 372-4518
FAX (806) 372-1833
Don Jones & Tim Hawks

E. RF Specialties of Pennsylvania, Inc.
121 Conneaut Drive
Pittsburgh, PA 15239
Phone (412) 733-1994
FAX (412) 327-9336
Tom Monahan

F. RF Specialties of Florida
P.O. Box 397
Niceville, FL 32578
Phone (904) 678-8943
FAX (904) 729-2744
Bill Turney

—EACH OFFICE IS INDIVIDUALLY OWNED AND OPERATED—

Circle 13 on Reader Service Card



Old Faithful

We still make them like they used to

Today's X-701 stereo and mono cart machines still use the overdesigned hysteresis synchronous motor, 1 kg flywheel, and rugged all-steel case that have made Tapecaster® the budget-priced reliability leader for nearly 25 years. Features include:

• NAB eq at 7 1/2 IPS • Playtime to 31 minutes • Line voltage 115 VAC, 60Hz, 50W standard; 220 VAC optional, 50 Hz optional

For complete information call or write.
TAPECASTER®
a division of

auditronics, inc.

3750 Old Getwell Road • Memphis, TN 38118
901-362-1350 • Telex: 533356 • FAX: 901-365-8629

We'll
rebuild your
Tapecaster,
no matter
how old.

Circle 37 on Reader Service Card

Uncovering Radio's Call Sign Histories

by George Riggins

Long Beach CA Call signs. There are some very interesting stories as to why and how some of them came to be used.

There are ego trips for owners, first letters from slogans, and who knows what else.

One interesting set of call signs sent me by RW writer Barry Mishkind concerns three stations sharing the same frequency—1590—with each with an interesting name (i.e., KDAY/KOWL/KWED).

There must be many other sets with something in common. Taking the time to weed through the list should bring out some interesting combinations on the frequency.

A quick glance indicates that in addition to KWED we have KMON-FM and KSUN. Wonder how KTUE and KFRI got overlooked.

We have KMEN/KMAN and KSUE, but no WAVE or KAVE. Yes, there are many interesting calls but few that are complete words properly spelled unless we take the prefix away.

What Barry is pointing out is the rarity of two such calls (KDAY/KOWL) sharing the same frequency in fairly

close proximity, Los Angeles and South Lake Tahoe.

Station history

Several callers had stories of interesting pasts for stations. I'm sure that many readers would like to hear more about the background of some of the older stations.

I find it difficult to capture the ambience of a station over the telephone line

in a short conversation; however, I have received three noteworthy items.

One is a book written by Charles Ingersoll of Aitkin,

MN about the development of radio in Minnesota from 1912 through 1838.

Charlie, as he signs his name, has put together a comprehensive history of radio in Minnesota including the many changes of call sign, frequency and names and dates of people involved from the technical side.

First license

One envelope I received had a copy of the original *provisional license for a land radio station*. The information was sent by Ron Stephens, CE for KLZ/KAZY Denver.

The number on the license is 316 and is dated, 24 August, 1922. It was granted

to Reynolds Radio Company, Inc. for a term of three months.

The call issued is the same one being used today, KLZ, and was for 500 W input restricted to "8:00 to 9:30 PM Sunday, Tuesday and Friday and in accordance with weather and market schedule."

Other provisions of the license were: "Limited commercial, broadcasting entertainment and like matter, also market and weather reports.

"One commercial second class operator or higher required. This station is licensed for the specific service shown on the wave lengths indicated, no other service permitted. The hours of operation specified below may be changed or a division of time may be required, whenever in the opinion of the Secretary of Commerce, such action is necessary."

Radiotelegraphic system employed was "composite VT telephone." By the way, the station was granted two frequencies, 360 meters and 485 meters.

The 360 frequency was to be used for entertainment and like matter; the 485 meters was to be used for market and weather reports.

Dr. Radio

Included in the envelope was a media folder giving a short history of KLZ. It appears to begin in 1912 in Colorado Springs when Dr. Reynolds was granted an experimental license to operate 9ZAF for three months.

Dr. Reynolds was on the air again in 1919 as amateur station 9WH. After moving his dental practice to Denver, he was licensed again as 9ZAF.

The present call was granted in 1922. The frequency was changed to 560 kC in 1928 where it still remains with 5 kW, full time.

The other booklet was from WBT, Charlotte, NC. I was told that WBT was one of the early experimental licenses dating to 1912.

The first commercial license was granted in 1922. Another experimental license for the station was in 1920 with the call of 4XD. The present WBT was granted April 10, 1922 with 100 W. The broadcast hours were 10-11:45 AM and 7:30-9:45 PM.

Some of the early alumna of the station were Hal Kemp, John Scott Trotter and Kay Kyser. A couple that are reported to have applied for positions at the station are David Brinkley and Andy Griffith.

WBBR, now in Travellers Rest, SC is reported to have been among the earliest of the noncommercial religious stations in the USA.

The station was started in 1928 on Staten Island, NY and in addition to being noncommercial was the originating station for the "White" network.

Depending on what comes in, we can probably do at least one or two more articles on the old, the amusing and the sometimes laughable past. Send any historical data c/o **Radio World**.

■ ■ ■

George Riggins has experience in radio and electronics dating back to the 1930s. He is also a licensed ham operator and has had his own broadcast sales and service company, Riggins Electronic Sales, for over 20 years. He can be reached at 213-598-7007.

Splatter matters.

Splatter is a form of radio interference that can drive listeners away from AM radio. It creates distortion in your signal, wastes transmitter power on undesired sidebands and interferes with other stations. Even with an NRSC audio filter, misadjustment of the transmitter or audio processing equipment can still produce an RF spectrum that can exceed NRSC or FCC limitations.

That's why routine monitoring of your station's RF spectrum is a must. But it doesn't mean you'll have to bust your budget on a spectrum analyzer. It just means you need the rugged SM-1 AM Splatter Monitor from Delta Electronics.

For just \$2,150 you can now accurately measure your transmitter's spectral output, monitor transmitter IPM levels and make adjustments to improve clarity. An external audio input helps identify splatter sources.

The Splatter Monitor's unique offset feature tunes spectral segments for closer examination 10 kHz to

100 kHz away from the carrier. Unlike a spectrum analyzer, you can listen to the front panel speaker or your own headphones as you measure splatter levels on the front panel meter. The Splatter Monitor also has an alarm output to drive your remote control.

In this day and age where splatter matters, monitoring it doesn't have to cost you a fortune.

To find out more about the new Delta Splatter Monitor, call (703) 354-3350, or write Delta Electronics, Inc., 5730 General Washington Drive, P.O. Box 11268, Alexandria, VA 22312.

The Above Standard
Industry Standard.

DELTA ELECTRONICS



© 1988 Delta Electronics, Inc.

ALLIED

THE Automation Company

No matter what your automation requirement might be, the professionals at Allied Broadcast Systems have the answers. Allied has the unique distinction of representing the *leading* automation manufacturers and the ability to engineer a system to meet almost any programming need. What's more, we offer on-site installation supervision and training, if desired.

In addition, we have the facilities to custom build systems using any mixture of source machines and interfaces to utilize your existing compatible-source equipment.

Those stations wishing to upgrade outmoded controllers can now turn to Allied Broadcast Systems. We'll be happy to give you a quotation for upgrading your present system to a state-of-the-art programming tool.

If you're thinking of expanding, check our pricing for additional source machines and required interfaces.

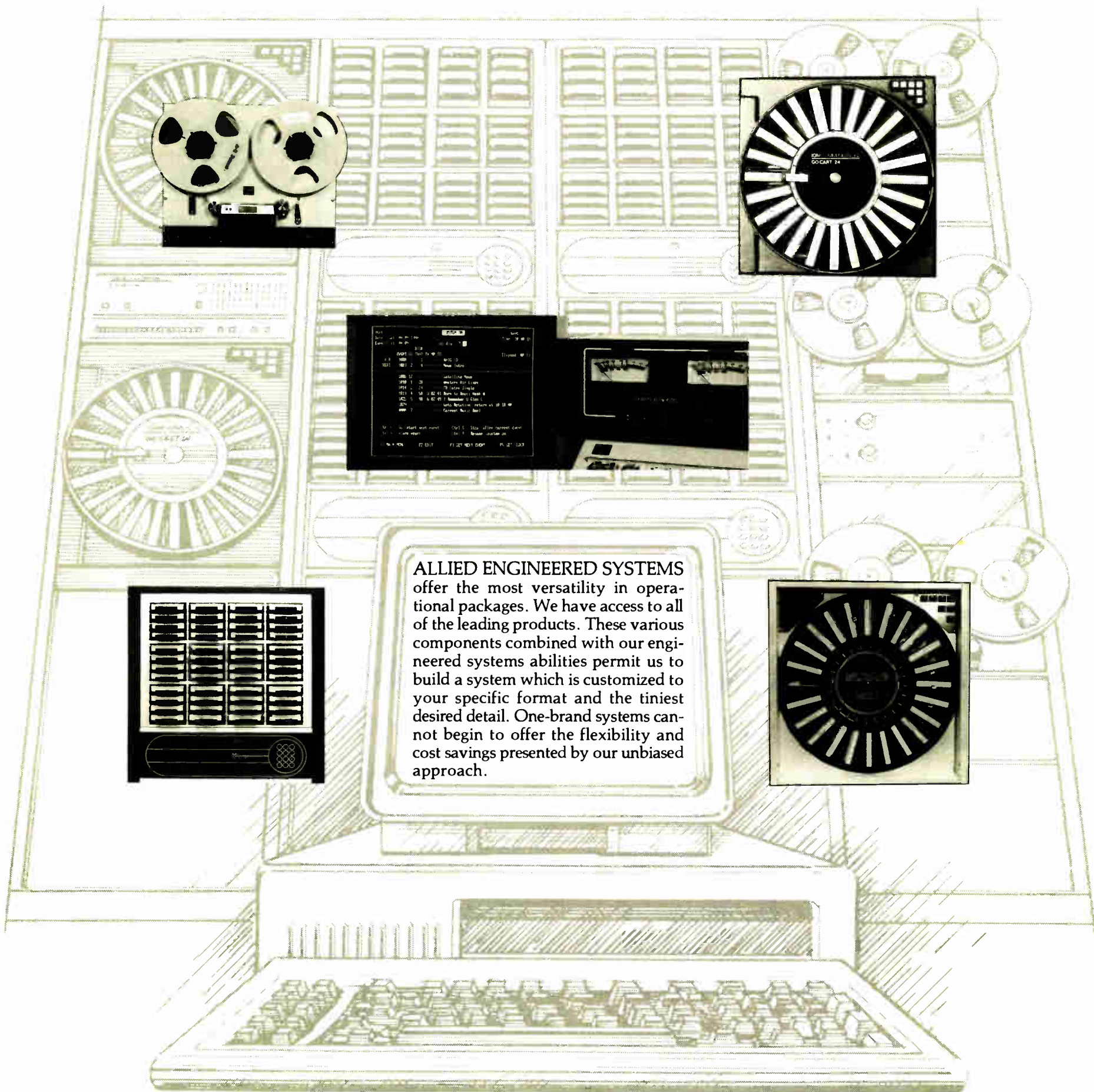

ALLIED ENGINEERED SYSTEMS offer the most versatility in operational packages. We have access to all of the leading products. These various components combined with our engineered systems abilities permit us to build a system which is customized to your specific format and the tiniest desired detail. One-brand systems cannot begin to offer the flexibility and cost savings presented by our unbiased approach.

IGM is a registered trademark of IGM Communications

We Are The Broadcast Automation Professionals!!

ALLIED

Broadcast Systems

— A HARRIS COMPANY

P.O. BOX 4551 • BRYAN, TX 77805

World Radio History

Call us with your problem

409-846-8244

We have an automatic solution

The Sliding Scale of Licensing

by Jeffrey Baker

Fairport NY If Abraham Lincoln were alive today, chances are he would never have become a lawyer and thus probably never become President. You see, Mr. Lincoln never went to law school.

So the story goes, Lincoln studied hard by the light of his fireplace for many long years, and then sat for the examination of the Illinois Bar.

Funny thing, in some states today, he would not be allowed to even sit for the exam. And neither would many candidates for the title of Professional Engineer be allowed to take that test.

How professions are regulated

These days, the professional licensing laws in most states specify a minimum educational standing to sign up for professional licensing examinations.

And in some cases, not only are a specific number of years needed, but an "approved" curriculum as well. And then there is the experience requirement.

Who makes these requirements? State legislators do. But, since most legislators are lawyers and lack first hand knowledge of other fields, they take the advice of those currently practicing in those areas of expertise.

These same "experts" are later appointed to a state board to oversee the specific licensing requirements.

So, people who have been in the discipline for some time and may have a vested interest in limiting the competition, get to decide who in the future will be permitted to legally enter that field.

Why is that a problem? Well, it seems that entrance requirements keep getting tougher and tougher. After all, one must be familiar with the rapidly expanding knowledge in the field, and that means steadily increasing requirements for study and supervised experience.

One need only look in back issues of IEEE's *The Institute* to see the debate over a four vs. five year engineering curriculum.

The irony is, that in some cases, members of state boards or professional organizations who make newer, tougher requirements have themselves been grandfathered around even the earlier, lesser provisions.

Lack of fairness

Years ago, when I was considering the choice of a career, I investigated the requirements for licensing as a professional (there's that word again) psychol-

... my instructors were allowed into private practice because they had been "grandfathered."

ogist in New York state.

I found that to put out one's shingle with that title on it, one had to pass a state licensing examination.

But before you could sit for the exam, you had to have a doctoral level degree in psychology and a minimum period of post doctoral experience.

That was surprising since I had had, as instructors, several practicing psychologists who held only a Master's degree.

Also, I had seen many job announcements for state facilities with the title "psychologist" which required only a Master's.

Selective requirements

It seems that the state can confer that title on persons having a lower level of education for practice in state run facilities. But in private practice, a higher standard is required.

Anyone trying to understand why should read the famous "channeling" document written by General Hershey when he was in charge of the military draft.

And in case you you hadn't guessed, my instructors were allowed into private practice because they had been

"grandfathered."

And then, not only was there a requirement for a degree, it had to be in a program approved by the American Psychological Association in either clinical or counseling psychology. No other specialties were permitted and no unapproved programs.

Guess what. Of the 20-odd clinical programs in New York at the time, only two were approved.

And, of the counseling programs none were acceptable. That means that only about forty people a year could be admitted to the private practice of professional psychology in the state.

Licensing of engineers

Why is this of interest to a broadcast engineer? Because remembering this experience and considering the current excitement about the professional licensing issue, I decided to look into requirements for becoming licensed as a PE in New York.

The requisites are similar, if not as lengthy. There is an education requirement—a bachelor's degree or higher in accordance with the approval of the Education Commissioner.

That approval has been delegated, so that generally a program must be accredited by the Accreditation Board for Engineering and Technology, sponsored by the major engineering associations.

In addition, four years of work experience satisfactory to the board is needed (generally after earning the degree), with advanced education substitutable for part of that experience.

This makes it impossible for anyone, even with the right educational credentials, to go directly into private practice, except as a member of a large firm with senior licensed members.

It is possible to bypass the education requirement through experience. However, such experience must be approved by the board. Twelve years is required for someone with no college level schooling.

Then of course, comes the examina-

tion, which includes in the basic part, general physical and engineering principles.

Taking the test

As I understand it, knowledge of basic structural principles is required of all engineers, regardless of specialty, along with such topics as engineering economy and professional regulations.

Oh yes, you also must be 21 years of age and a US citizen or lawful immigrant, be of good moral character (department's judgement) and pay \$190 for the exam and initial license (three year).

Specific requirements may be waived at the board's discretion, except for education, age, character and citizenship, for "persons of recognized standing in the

(continued on page 30)

THE CART YOU CAN COUNT ON...



Brett Huggins, C.E.
KROZ, Tyler, TX

"We've been using AA-4s for about a year and a half, and they're working out real well. I use them hard and heavy on both music and commercials, and I've had very few problems. They last a long time."

If you'd like to feel this good about your carts, call (800) 522-CART for more information.

CART AFTER CART.

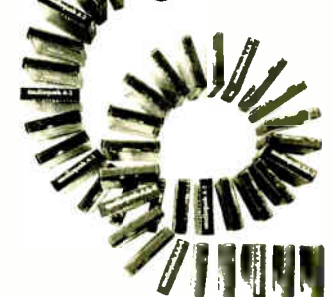

audiopak

audiopak inc. • 1680 Tyson Drive
PO Box 3100 • Winchester, VA 22601
Tel (800) 522-CART or
(703) 667-8125 • Fax (703) 667-6379
TLX (310) 476-1180

Vanguard Series™

Broadcast Audio Consoles



Performance, Value and Reliability through Innovative Technology

- Raised, tactile feel, lighted membrane switch panel-digitally scanned
- 12 stereo inputs plus optional expander
- VCA controls, rotary and linear
- Analog and fluorescent meters
- Modular, plug in electronics
- Easy punch block installation
- Effective RF protection

BC8DS
8 Mixer
Dual Stereo

only \$3,195

AUDIO TECHNOLOGIES INCORPORATED



328 Maple Avenue, Horsham, PA 19044 • (215) 443-0330

Digital: The Future of Radio

(continued from page 23)

create a set of controls that let the operator extract all of the flexibility that can be designed into a digital system, without becoming so complex that on-air mistakes become inevitable.

Communication is key

Where will all of this flexibility come from? Software!

Once again, consider the latest home computers. Many of them have only one or two circuit boards. Yet, you can spend months figuring out how to run spreadsheets, draw schematics, layout printed circuit boards, desktop publish a set of transmitter instructions or exchange programs on a bulletin board.

But the PC is just the start. Once the satellite receiver, CD players, DAT recorders, audio processors, control boards and even transmitters are talking the same language, you will be surrounded by a network of audio/control computers.

I expect the next 10 years or so to be a mixed marriage of analog and digital. Just as some stations are reluctant to give up their not-yet-30-year depreciated tube and transistor audio equipment, few cash-pinched operators are going to chuck working Ampex decks just for DAT.

They'll buy one of this and two of that as the advancements come, and keep the old stuff too. You may wind up with one computerized production studio and another next door that still needs the pots cleaned and the heads aligned weekly.

Digital effects

These are still transitional improvements. The really neat stuff is the ability to electronically record and edit the audio in its digital form.

You can change your voice, mix in a million sound effects, add room presence or take it away. You can record a show in bits and pieces, have all the pieces cataloged on a screen, then change the ones you don't like and string them all together to make a show.

You never once need to backcue a disc or splice a tape. When you make the changes electronically, you make them in seconds, not hours.

Audio processing is going to become a lot like word processing. To stay in the game, we must become fluent in this digital language, because we are the ones

who will make that major transition from what was to what will be.

On a separate note, many thanks to Eric Nichols of KJNP, North Pole, AK, who called to point out that my 1 January column on HV troubleshooting works great for transmitters with triodes but is not the best practice for tetrodes.

If your transmitter has tetrode tubes, be sure to disconnect both the screen and HV supplies when verifying that the rectifiers are good. An alternative is to remove the tube. You don't want to overstress a good tube by powering only the screen and not the plate.

■ ■ ■

John Shepler is an engineering manager, broadcast consultant, writer and regular RW columnist. He can be reached at 815-654-0145.

The Ins and Outs of State Licensing

(continued from page 29)

engineering profession who have practiced lawfully for more than 15 years."

That last, of course, is the grandfathering provision. It should now be impossible to meet, since licensing has been required long enough that anyone who is not now licensed, and who has been holding out to the public as an engineer, could not have been practicing lawfully.

Although not required by law, regulations necessitate the recommendations of already licensed PEs. This is easy if you work for a large firm with licensed senior partners.

If not, you could always join a local engineering society. There you can hobnob with the old boys (not many women there, I'm afraid) and hope you don't get called out for a station emergency during an important backslapping session.

What may happen

In my admittedly cynical look at institutionalized professionalism, I have tried to point out that if professional licensing laws are held to apply to the practice of broadcast engineering, their requirements would not be easy to meet.

Few broadcast engineers who are not recent graduates of approved programs could pass the general engineering portion of the licensing exam.

That general requirement is not likely to be waived, if, as is the case in other engineering specialties, the specialty examining board is merely subsidiary to a general engineering board controlled by currently licensed PEs.

Even if the broadcast profession is held to be a technical specialty separate from engineering and allowed to have its own board control the entire examination process, it is possible that old timers will hold up a higher standard for newcomers than they maintain for themselves.

This would serve to severely limit the number of entrants to the field at a time when it appears they are most needed.

But probably the main concern is that in the frenzy to counteract what is seen as a threat to the existence of broadcast engineering as a distinct occupation,

there is a rush to consult professionals in the field of law to file hasty writs and briefs.

I think it is important that we think about and discuss the issue carefully to be sure that the action finally taken is consistent with what we really want to accomplish.

It's a pity that Mr. Lincoln isn't here. He would surely know what to do.

■ ■ ■

Jeffrey Baker is with Heritage Media Inc. and principal of Technical/Design Services, a contract engineering service. He can be reached at 716-227-9510.

Adding Timecode to DAT

(continued from page 26)

that might be flagged as part of the incoming timecode bitstream.

Future implications

All of which means that a second-generation DAT recorder/player should be capable of accepting any of the current timecode standards—including 30/29.97 fps SMPTE, 25 fps EBU and 24 fps film rates—and converting it into time-of-day DAT-based timing references to a resolution of ± 20 microseconds, tagging the data with a source label.

During playback, a similarly outfitted DAT machine anywhere in the world would be capable of reconstructing suitable time base of SMPTE/EBU/film timecode for synchronization to video/film or of following an external source of code during audio-to-audio interlock.

In reality, the NHK/Matsushita/Sony proposal presented to the AES Standard

Committee at the Society's convention in November comprises a discussion document for the various international standards and professional associations to study and comment.

However, it can be assumed that hardware necessary to print and play back the new format is currently under development by at least two leading Japanese manufacturers.

I predict that prototype and maybe pre-production units of various timecode-capable DAT decks, in addition to the Fostex D-20 Pro-DAT machine, will put in an appearance at next NAB Convention in Las Vegas, at the end of April.

■ ■ ■

Mel Lambert has been intimately involved with the audio production and broadcast industries on both sides of the Atlantic for the past decade. He is currently president of Media & Marketing, a consultancy service for the professional audio industry.

ADVERTISER INDEX

Reader Service No.	Advertiser	Page No.	Reader Service No.	Advertiser	Page No.
52	3M	29	12	Eventide	25
20	ATI	29	33	Fidelipac	1
34	ATI	11	99	Full Compass	32
9	Audiopak	29	4	Gentner	17
37	Audiotronics	18	18	Gentner	25
22	Bradley	3	31	Harris	13
17	Broadcast Electronics	3	23	Hnat Hindes	18
26	Broadcast Electronics	31	71	Modulation Sciences	39
12	Broadcast Services	12	11	Orban	9
3	Broadcast Supply West	15		PR&E	10
35	CRL	24	50	QEI	23
59	CableWave	7	38	RF Specialties	4
74	Cortana	15	13	RF Specialties	26
30	Dataworld	21	10	Radio Systems	8
36	Delta	27	16	Radio Systems	14
19	Erko	9	24	Shure	24
8	Eventide	11	34	Studer Revox	19
47	Eventide	14	41	Wheatstone	2
49	Eventide	21	77	Wheatstone	40
			73	Western International	

Advertising Sales Representatives:

East Coast, Art Constantine: **800-336-3045**
 Midwest, Simone Leaser: **800-336-3045**
 West Coast, Pat Macsata: **415-786-2198**

Fax: **703-998-2966**
 Fax: **703-998-2966**
 Fax: **415-786-2754**

Great Sounds From Great Cartridges from ARISTOCART

*Superb in Quality
Supreme in Economy*



The NEW SLOPED Aristocart Audio NAB Cartridge AA 2006 and our NAB Standard A Aristocart Cartridge



SPACE SAVER UNITS Aristocart's compact racks are simple, lightweight, rugged and ready to wall mount.

Model AW-20, holds 20 cartridges ▶
 Model CD-40, holds 40 discs ▶

Place your order today or Call, Write or Telex for descriptive literature



Western International Communications Ltd.
 17 - 825 McBride Boulevard, New Westminster, B.C. V3L 5B5
 TELEPHONE (604) 526-3214 TELEX: 04-34639

DESIGNED FOR RADIO BY PEOPLE WHO KNOW RADIO...



MIX TRAK 90TM

ON-AIR CONSOLE

Unlike other consoles that try to be all things for all applications, the new Mix Trak 90 modular console from Broadcast Electronics is strictly designed for on-air use!

Mix Trak 90 features include:

- **Split Program Buss**
- **Three Telephone Mix-Minus Busses**
- **Balanced Patch Points Throughout**
- **On-card Voltage Regulation**
- **Transformerless Inputs and Outputs**

Another Mix Trak 90 value feature is the optional Source Sequencer. The Source Sequencer permits your on-air talent to automatically execute an entire series of events (such as a multi-spot commercial

break) with the touch of a single switch. When the Source Sequencer is at work, your DJ's are free to concentrate on what they do best: communicate!

The Mix Trak 90 offers full VCA gain control, Penny & Giles precision faders, independent Audition and Program metering, silent Hall Effect switching, automatic monitor dimming for easier cueing and a wide range of accessory modules.

*For more information about the new console designed with your special needs in mind contact your Broadcast Electronics Representative or call Bob Arnold at **217-224-9600**.*

BE[®] **BROADCAST ELECTRONICS INC.**

4100 N. 24th ST., PO. BOX 3606, QUINCY, IL 62305, (217) 224-9600, TELEX: 250142, FAX: (217) 224-9607

Circle 26 On Reader Service Card

World Radio History

Broadcast Equipment Exchange®

"Broadcast Equipment Exchange" accepts no responsibility for the condition of the equipment listed or for the specifics of transactions made between buyers and sellers.

AMPLIFIERS

Want to Sell

KLH 35 stereo amp & tuner, less speakers, \$25. P Russell, Bowdoin College, AV Services Sills Hall, Brunswick ME 04011. 207-725-3066.

Crown DC300AII amp, very few hrs, excel cond, BO. B Harris, 2950 S Birch St, Denver CO 80222. 303-757-3683.

Peavey CS-400, vgc w/crossover module, \$350. G Ingram, KIXC, POB 29, Quanaah TX 79252. 817-663-6363.

BGW 75, gd cond, \$200/BO. P Wolf, WCOO, 106 New Market Rd, Immokalee FL 33934. 813-574-5548.

Stanton 310B stereo phono preamp, like new, \$190; Radio Systems dist amp, 8 stereo out, 16 mono out, like new, \$300. D Clarke, 3682 N Sierra Way, San Bernardino CA 92405. 714-882-8103.

Crown IC150 stereo preamp, rack mtng, rugged, gd cond, \$100; Phase Linear 400, 200 plus 200, stereo, excel, \$325. B Laughlin, 816-361-0548.

Crown D-75 power amp, great cond, barely used, rack mountable XLR & 1/4 connectors, banana plugouts, 1 RU high, great monitor amp, \$350. W Feinberg, Totaltape Publ, 9417 Princess Palm, Tampa FL 33619. 813-621-6200.

Crest 1001 power amp, 1 RU high, 100 wchan, excel cond, XLR & 1/4 input connections, banana plug & 1/4" out connections. W Feinberg, Totaltape Publ, 9417 Princess Palm, Tampa FL 33619. 813-621-6200.

Ramko SMA-1000E monitor amp, \$75; Stanton phono 310, \$150 ea. Clark B, WFAS, Secor Rd, Hartsdale NY 10530. 914-693-2400.

Spotmaster DA amps, \$75 ea. B Roberts, ARP Studios, POB 325, Mt Pleasant SC 29465. 803-928-3663.

Want to Buy

Altec-Lansing 1569-A 800 ohm audio xfrms, need pair #15095. A Bobidosh, Bobidosh AV, 1197 High Ave Ste 7, Oshkosh WI 54901.

EICO HF89, HF85 stereo amps; HH Scott 299D amps; GE AI-320 amps; CCA/QRIT ultimate turntable pre-amps, any cond. K Smith, RR 3 Box 483A, Gorham ME 04038. 207-929-6129.

RCA amps monitor or booster. B Davies, Virgo Prod, 5548 Elmer Ave, N Hollywood CA 91601. 818-761-9831.

ANTENNAS & TOWERS

Want to Sell

Gates ERI FMC-4A 4 bay CP FM at 88.5, gd cond, \$2000. J Sims, KLJC, 15800 Calvary Rd, Kansas City MO 64147. 816-331-8700.

Reconditioned

American 50-B Two Drum Hoists. Specially set up for tower erection... \$8500 each, FOB: Suffolk, VA. We buy, sell and lease erection equipment.

Call Southern Tower Service Co., Inc. 804-539-8365.

Mark P21A72F-2 2.1 GHz antenna w/radome, almost new, BO; Andrew GP8F-890 8" diameter STL antenna, almost new, BO. K Schipper, KQKS, 9191 Sheridan Blvd, Westminster CO 80030. 303-427-7700.

Phelps Dodge CFM LP-2 tuned to 1039 MHz, 2 bay, \$1000. D Nixon, WOCA, POB 1850, Ocean City MD 21842. 301-641-0001.

Phelps Dodge CFM LP-3 tuned to 92.1 MHz, \$800. S McCloskey, WBHH, POB B, Beaufort SC 29903. 803-524-9210.

RCA TFU-24DM UHF TV antenna on chnl 41, prefer to donate to non-profit organization. C Haynes, POB 31235, Jackson MS 39206. 601-948-1515.

S-A 8005, 4.6 m sat antenna, \$2500; broadcast quality receivers, S-A 414, \$1975. Megastar, 702-386-2844.

Self supporting 180' tower, \$3500. G Gunter, KMAB, 650 N Bolton, Jacksonville TX 75766. 214-586-2162.

Shively 4-bay FM antenna w/radomes tuned to 103.1, 2 yrs old, \$3500/BO. P Martin, 414-482-2638.

Dielectric DCRH2 2 bay on 98.3, 7 yrs old, \$1100; Altronix 5715 15 kW dummy load, water cooled, 1-5/8" flange, \$450. JA Bowab, WDLT, 2402 Wolf Ridge, Mobile AL 36618. 205-344-3698.

ERI FM-L, gd cond, w/hardware & mounts on 98.3, \$4000/BO; Andrew 78" air line, 565', gd cond, on reel, w/connectors, \$1000. P Wolf, WCOO, 106 New Market Rd, Immokalee FL 33934. 813-574-5548.

ERI 1-3 bay antenna on 92.1, gd cond, hardware, brackets, \$2000/BO; Shively 6 bay on 88.7, 1 yr old, P Wolf, WCOO, 106 New Market Rd, Immokalee FL 33934. 813-574-5548.

Guyed Utility type tower, 200', 3 sided, tubular legs, galvanized, 18" face, painted, on the ground. H Greenberg, KMAS, POB 760, Shelton WA 98584. 206-426-1030.

LNR 210' Starpoint on ground, galv & painted, BO. J Schloss, KICD, 2600 Hiway Blvd, Spencer IA 51301. 712-262-1240.

RCA BFC-7B 7 bay antenna, vgc, tuned to 95.5 MHz. J Boxler, WKYC, 109 Plaza Dr, Johnstown PA 15905. 814-255-4186.

Vector 2 conductor lighting choke, new cond, \$125. J Almon, WYOR, POB 2085, Brentwood TN 37027. 615-794-9859.

AM antenna tuning unit, all new components, ready to use, gd to 5 kW, \$300 plus you ship. J Cunningham, KEOR, Rt 2 Box 113B, Stonewall OK 74871. 405-265-4496.

Cablewave FCC 78 50J 155' of 7/8" heliax, 2 pieces of 75' ea, BO. M Black, WEOS, Hobart & William Smith College, Geneva NY 14456. 315-789-8970.

Celwave power divider 1, 3-1/8 input port by 8, 1" output ports (2), never used & capped, \$2500 pls shpg. B Roberts, ARP Studios, POB 325, Mt Pleasant SC 29465. 803-928-3663.

Celwave 2-bay tuned to 103.1, used less than 4 yrs, w/heaters, \$1000. D Mance, WTOJ, 199 Wealtha Ave, Watertown NY 13601. 315-782-1240.

ERI 2 bay, tuned to 103.9, 3.5 yrs old, taken out of svcs 11/88, BO. R Eller, KBUS, 2775 NE Loop 286, Paris TX. 214-785-1068.

ERI LPC-11 FM antenna, 106.7 MHz 11 bay low power w/radomes, max output 50 kW, max input 95 kW, BO. J DeGroot, WKPK, POB 190, Gaylord MI 49735. 517-732-2474.

Jampro 2 bay 103.9 w/heaters, \$700. Clark B, WFAS, Secor Rd, Hartsdale NY 10530. 914-693-2400.

Phelps Dodge 2-bay (2), avail now, \$1000 ea. D Brown, KMCD, 57-1/2 Count St, Fairfield IA 52556. 515-472-4191.

Phelps-Dodge 12 bay, 300', Utility tower w/ice-ers (tuned to 101.1; 250' 3-1/8" flex line avail approx 3/1/89; Harris SX-1A, fire damaged, repairable or many usable parts; also SX-1A spare parts kit; RCA BTA-500R AM xmtr for parts. John or Mike, KMZU, 102 N Mason, Carrollton MO 64633. 816-542-0404.

Shively 1413-1, 4-1/8" x 20" rigid coax line, 520' (26) sections, \$250/section, gd cond. J Pollet, WRNO, 4539 I-10 Serv Rd, Metairie LA 70006. 504-889-2424.

Want to Buy

ERI CP G5C PM Series, 4-6 bays, MCD power 96.7 MHz. J DeGroot, WKPK, POB 190, Gaylord MI 49735. 517-732-2474.

Scala FM HDCA-5 or equiv antenna, tuned near mid-band, closer to 100.3 the better, buy or trade. B Harris, KMJL, 5350 S Roslyn #210, Englewood CO 80111. 303-741-5654.

360' tower to support 3/4 bay FM antenna & 3/4 LPTV chnl 6 antennas. D Jordan, WDTM, POB 3417, Jackson TN 38303. 901-668-1153.

5 Bay FM antenna at 91.5 MHz & 5 bay antenna at 88.3 MHz for educ FM. K Hill, WHCB, POB 2061, Bristol TN 37621. 615-878-6279.

Phelps Dodge/Celwave CP1000-4 radome needed for FM antenna. M Black, WEOS, Hobart & William Smith College, Geneva NY 14456. 315-789-8970.

AUDIO PRODUCTION

Want to Sell

Allison Kepex 500 w/LX100 power supply, \$150/BO. K Smith, RR 3 Box 483A Carl Rd, Gorham ME 04038. 207-929-6129.

Burwen DNF-1201A dynamic NR, \$200; Altec 1650 1/3 octave mono EQ, \$150. B Laughlin, 816-361-0548.

Howe Phase Chaser, \$700. R Rogers, KPOF, 3455 W 83rd Ave, Westminster CO 80030. 303-428-0910.

KLH Burwen TNE-7000A transient noise eliminator, 35" rack mount, EC, \$295. S Hofmann, Cameron Univ Theatre, 2800 W Gore, Lawton OK 73505. 405-561-2428.

Mod Sciences composite clipper, like new, \$350; late model 8000A Optimod, \$2000 firm. John 315-488-1269.

Orban 245F stereo synthesizers (2), brand new, unused, current model, \$250 ea. Steve, 303-499-5533 alt 6PM MST.

Orban 516EC 3 ch de-esser, vgc, \$395; Orban 106C 4-spring reverb, \$145; Allison RM-160 rack w/2 Kepex, 2 Gain Brain, \$495 pkg. R Miller, Filmmaker Inc, 606 W Broad, Bethlehem PA 18018. 215-691-0900.

Sescom SM-1A, SM-3 deluxe direct boxes, two passive, one active, BO. D Johnson, KAWL, POB 544, York NE 68467. 402-362-4433.

ATI compact disc patcher, brand new, \$120; ATI Talk Maker, like new, \$120. D Clarke, 3682 N Sierra Way, San Bernardino CA 92405. 714-882-8103.

ATI 575 osc, BO. P Cibley, Cibley Music, 138 E 38th, NY NY 10016. 212-986-2219.

CBS Audimax 440 mono, pair Volumax 410, working when removed from service, \$300. H Kneller, WKII, 3151 Cooper Ste 56, Punta Gorda FL 33950. 813-639-1112.

Harris (Audionics) M-90 stereo/audition/mono mixing console, \$3000; Harris/ITC 3 deck cart player, mono, \$600; ITC RP cart recorder, mono, \$400; MCI/Sony JH-110B R-R, \$3000; Gentner SP-4 telephone interface, \$375; in custom formica covered cabinet, sold separately or as package for \$6000. J McNally, KXBS, 9400 N Broadway, Oklahoma City OK 73113. 405-478-4499.

Moseley DCS-2 dig ctrl sys; (2) FSM-1 fail safe units; Mdl Piu-1 parameter hogging unit for TV or radio, sold as one system, \$2500; CBS Lab FM automatic peak ctrlr, studio & xmtr units, \$500. J Brown, Brown Comm, 314 Hwy 78 West, Jasper AL 35501. 205-221-6635.

ATI 575 osc, BO. P Cibley, Cibley Music, 138 E 38th, NY NY 10016. 212-986-2219.

CBS Audimax 440 mono, pair Volumax 410, working when removed from service, \$300. H Kneller, WKII, 3151 Cooper Ste 56, Punta Gorda FL 33950. 813-639-1112.

Harris (Audionics) M-90 stereo/audition/mono mixing console, \$3000; Harris/ITC 3 deck cart player, mono, \$600; ITC RP cart recorder, mono, \$400; MCI/Sony JH-110B R-R, \$3000; Gentner SP-4 telephone interface, \$375; in custom formica covered cabinet, sold separately or as package for \$6000. J McNally, KXBS, 9400 N Broadway, Oklahoma City OK 73113. 405-478-4499.

Moseley DCS-2 dig ctrl sys; (2) FSM-1 fail safe units; Mdl Piu-1 parameter hogging unit for TV or radio, sold as one system, \$2500; CBS Lab FM automatic peak ctrlr, studio & xmtr units, \$500. J Brown, Brown Comm, 314 Hwy 78 West, Jasper AL 35501. 205-221-6635.

ATI 575 osc, BO. P Cibley, Cibley Music, 138 E 38th, NY NY 10016. 212-986-2219.

CBS Audimax 440 mono, pair Volumax 410, working when removed from service, \$300. H Kneller, WKII, 3151 Cooper Ste 56, Punta Gorda FL 33950. 813-639-1112.

Harris (Audionics) M-90 stereo/audition/mono mixing console, \$3000; Harris/ITC 3 deck cart player, mono, \$600; ITC RP cart recorder, mono, \$400; MCI/Sony JH-110B R-R, \$3000; Gentner SP-4 telephone interface, \$375; in custom formica covered cabinet, sold separately or as package for \$6000. J McNally, KXBS, 9400 N Broadway, Oklahoma City OK 73113. 405-478-4499.

Moseley DCS-2 dig ctrl sys; (2) FSM-1 fail safe units; Mdl Piu-1 parameter hogging unit for TV or radio, sold as one system, \$2500; CBS Lab FM automatic peak ctrlr, studio & xmtr units, \$500. J Brown, Brown Comm, 314 Hwy 78 West, Jasper AL 35501. 205-221-6635.

ATI 575 osc, BO. P Cibley, Cibley Music, 138 E 38th, NY NY 10016. 212-986-2219.

CBS Audimax 440 mono, pair Volumax 410, working when removed from service, \$300. H Kneller, WKII, 3151 Cooper Ste 56, Punta Gorda FL 33950. 813-639-1112.

Harris (Audionics) M-90 stereo/audition/mono mixing console, \$3000; Harris/ITC 3 deck cart player, mono, \$600; ITC RP cart recorder, mono, \$400; MCI/Sony JH-110B R-R, \$3000; Gentner SP-4 telephone interface, \$375; in custom formica covered cabinet, sold separately or as package for \$6000. J McNally, KXBS, 9400 N Broadway, Oklahoma City OK 73113. 405-478-4499.

Allison Research Kepex 500 w/LX-100 power supply, \$150/BO. K Smith, RR 3 Box 483A, Gorham ME 04038. 207-929-6129.

Ampex 350 elec, fair to gd cond, 4 chnl, \$150/all; Remote trailer, 16' w/Quad-8 console, AC dist & isolation transformer, 24 trk, ready, \$7600/BO; Ursa Major Space Station digital reverb delay processor, vgc, \$300/BO. B Petruzzi, Rouse Street Prod, 804 Old Hickory Blvd E, Madison TN 37115. 615-868-8516.

Comrex PLX low freq extenders (9), sell as group or individually, hardly used, great cond, \$1000 ea; Comrex LX-PC power supply units for Comrex PLX (5), \$25 ea; Comrex LXT low freq extenders w/mounted voice couplers (5), \$400 ea; Comrex TLX rack mnt low freq extender, \$1000. R Meadows, Southeastern Sports Prod, 3216 Cranleigh Dr, Tallahassee FL 32308. 904-893-7808.

Eventide H969 Harmonizer, \$2250. G Spaniola, Seller Snd Std, 5014 Peelskill, Sterling Heights MI 48310.

KYBE 504 magnetic tape tester, cleaner, \$1200. M Murphy, 11621 Valle Vista Rd, Lakeside CA 92040. 619-561-2726.

Orban 245F stereo synthesizer, excel cond, \$100. D Alexander, WOMX, 4986 Gateway Dr, Akron OH 44326. 216-384-1897.

Rane ME-15 stereo graphic EQ, 2/3 octave, absolutely mint, \$250. M Osborne, WJQ, POB 9494, Ellsworth ME 04805. 207-667-7573.

Shure M68 mic mixer, 6 chnl, \$75. M Skinner, Color County Bdctg, 341 S Bluff St, St George UT 84770. 801-673-1450.

Shure M63 audio master EQ, companion to M67 remote broadcast mixer, fair cond, \$50. D Sites, 5809-K Cambridge Dr, Springfield VA 22152.

Teac 4 chnl mixing board, vgc, \$175. W Dougherty Jr, WLD Recdg, Music Valley Rt 1, Mill Spring MO 63952. 314-998-2377.

Texar Prisma (2) w/manual, \$2500. S Karwan, KCMJ, 619-320-6818.

Want to Buy

WANTED: PULTEC EQ'S

We will pay \$1,000 for almost any Pultec program EQ models EQP1/EQP1A/EQP1A3. Also wanted: EQH2/EQH3/MEQ5/MAVE/MB1/ITI & SONTEC EQ's/ any tube or ribbon mics and limiting amps.

Call or write to:

Dan Alexander Audio
2944 San Pablo Ave
Berkeley, CA 94702
(415) 644-2363
FAX: 415-644-1848

Want to Buy

Booklet for Fairchild 658 reverb. ETS Recor, POB 932, Honolulu HI 96808. 808-847-4300.

Orban 8000A and 8100 stereo processors wanted. Cash paid. Please call for quote.

Jon Hall
Hall Electronics
PO Box 7732
Charlottesville, VA 22906
804-977-1100

Phase Chaser. D Brown, KMCD, 57-1/2 Count St, Fairfield IA 52556. 515-472-4191.

AUTOMATION EQUIP.

Want to Sell

Cetec 7000GLS, (4) ITC 770 R-R, (2) Schafer 24 tray Carousel, 48-tray Instacart, Hazeltine controller w/clock, vgc, in use, \$13,500. T Hite, WAUC, Box 908, Wauchula FL 33873. 813-773-5008.

Harris 90 Brain & cart Carousel, \$800/BO. L Wilkins, Montgomery Ed Radio, 381 Mendel Pkwy, Mtgy AL 36117. 205-271-8900.

IGM 48 BPM, mono Instacart, just out of service, \$4000; IGM 740 System, 12 chnl, DEC computer, just out of service, excel for parts, \$300/BO. W Nystrom, KRDU, 597 N Alta, Dinuba CA 93618. 209-591-1130.

SMC 250 random select Carousels (2); (6) Schafer equip racks; (3) Scully 270 R-R PB units. D Jackson, WPRN, POB 566, Butler AL 36904. 205-459-3222.

SMC TS-25 dual 25 Hz tone detectors w/spare cards, \$300 ea; SMC 250 Carousel, completely refurbished, working well when removed, will sell as pkg or separately, \$1200 ea. D Purcell, Payne Prescott Bdctg, Box 151, Prescott AZ 86302. 602-445-6880.

Gates SC-48 programmer (parts); (2) Gates motor driven faders; Gates time pulse gen. R McDaniel, KJRG, 209 Meridian, Newton KS 67114. 316-283-5150.

IGM Basic III automation system w/logging, w/(4) IGM GoKart 24 Carousels, (5) Revox PR-99 PB decks, Audicord network delay cart recorder, (3) Audicord mono cart decks, complete & presently in use, BO; also (2) Otari ARS-1000 PB decks, \$700 ea/BO. C Gustafson, WKZO, 590 W Maple, Kalamazoo MI 49008. 616-345-2101.

SMC DPI, (2) Revox decks, (2) Otari decks, (9) Carousels, (3) single play time announce, switcher, brain, sell all or by piece. B Hicks, KBAT, 3306 Andrews Hwy, Midland TX 79705. 915-697-7300.

SMC ESPI fully equipped, (4) Carousels, Instacart 24 tray, (4) R-R Revox, (2) dual cart players, delay recorder for network, excel cond. R Monroe, KRXT, Kilgore St, Kilgore TX. 214-984-2001.

Broadcast Products & SMC AR-2000B automation system, controller, (6) Carousels, power supply & tape reader, w/clock & racks, working, \$3500. J McDonald, Wind River Group, Box 481, Broomfield CO 80020. 303-669-3442.

IGM Go-Cart 24, 3 yrs old, 300 hrs, like new, all manuals & hardware, \$1000; Sono-Mag 24 tray Carousel, rebuilt 1985, less than 300 hrs use, vgc, \$700. M Crouch, WCHE, 119 W Market St, W Chester PA 19382. 215-692-3131.

Kohler automatic transfer switch, solid state, 70 A single phase. J Lackness, KRIA, 512-828-3737.

SMC Mini-Pro System programmer, 350RS Carousels, (2) RSC-100 Carousel programmers & (2) racks, excel cond, perfect for satellite. J Bassett, 8787 San Pedro Way, Elk Grove CA 95624. 916-686-6613.

Sono-Mag MSP1 automation control head, 2000 event random access, \$3000; Sono-Mag 450 (2) bi-directional mono Carousels, \$1800 ea. W Hanlon, WKFD, 19 Updyke Ave, N Kingstown RI 02852. 401-295-8808.

Want to Buy

Satellite automation system & Carousels & Instacarts. B Romeijn, KJNO, 3161 Channel Dr Ste 2, Juneau AK 99801. 907-586-3630.

CAMERAS (VIDEO)

Want to Sell

CEI 280 complete functional color camera, w/camera head w/replacement cards, CCU w/replacement cards, lens (10-1 zoom; 12), spare yokes, remote control panel, 100' camera cable, range extender for lens, zoom & focus controls; spare view finder, power supply, lens, sell or trade for character gen suitable for television use. S Chism, Moody Bible Institute, 820 N LaSalle, Chicago IL 60610. 312-329-4068.

Fujinon A14X9B 14x1 zoom, removed from Sharp XC-800, excel 2/3" tubes, \$1000 or trade. W Ellis, KQZK, MPO Box 21, Springfield MO 65801. 417-865-2100.

Ikegami 730-A & 730-AP video cameras, gd cond, \$6,000 & \$7,000 respectively. D Gerisch, WMTV, 615 Forward Dr, Madison WI 53711. 608-274-1515.

Ikegami 730AP studio plumbicon cameras (3) w/CCU, 15 m cable, 5" viewfinder, finder info CG, Canon 15:1 lens, lens rear controls, extender, manual, case, as new, BO over \$10,000 ea; (2) Sachler 14 head, ped/pod & dolly, \$1,250 ea; Ike 730 ENG pkg: 1.5" finder, 2 charger, 2 batt, AC PS, VTR cable, rain cover, \$1395; (2) Ike 25 m camera/CCU cable, \$35

CAMERAS . . . WTS

JVC KY200 w/full studio pkg, incl viewfinder, remote zoom & focus controls, com choke control unit, 100' camera cable & more, \$2700. R Peterson, Pacific Comm, 1801 E 4th Ave, Olympia WA 98506. 206-754-7081.

Norelco PC70, (11) need some work, \$1750/all. Technichrome, 702-386-2844.

Panasonic WJ4600B special FX gen/switcher, \$1095. G Gunter, KMAB, 650 N Bolton, Jacksonville TX 75766. 214-586-2162.

Panasonic HV3500 color camera, \$995; Sony HVC200, \$250; Sony HVC220, \$300. W Carnes, KIIRT, POB 8234, Jacksonville TX 75766. 214-586-2162.

Philips 3 tube plumbicon camera w/10-100 Schneider zoom lens; also Sony VO 3800 portable VCR, excel, \$3250/BO; Ikegami HL 79D camera, \$13,500/BO. Steve, Box 10673, Denver CO 80210. 303-399-6444.

Hitachi-Shibaden FP-1500 U w/control unit, needs work but works, w/schematics, \$500. N Metzger, 312-989-1101.

Want to Buy

Panasonic PK 957958. G Pfeiffer, WNJU, Ste 11033, One World Trade Ctr, NY NY 10048. 212-775-1706.

RCA TK31, TK41 w/remote CCU/PG/cables. J Panza, PAVS, Box 9847, Kansas City MO 64134. 816-966-1587.

Rear lens controls for Fuji 14:1, 16:1 lens, both focus & zoom, Canon 12:1 also. H Larson, Matrix Mobile TV, POB 536, San Luis Obispo CA 93406. 805-544-5657.

CART MACHINES

Want to Sell

ATC mono R/P; Gates Criteria, mono PB only, clean. M Phelps, WLTT, 20300 Civic Ctr Dr, Southfield MI 48076. 313-354-9300.

Audi-Cord Moducart model 100 R/P; (2) A series PB, all in gd shape, \$100 ea. W Nystrom, KRDU, 597 N Alta, Dinuba CA 93618. 209-591-1130.

BE 3200 & 3100 R/P stereo units, ultra-mint cond, original heads, w/manuals, BO. R Kaufman, Pams Prods, POB 462247, Garland TX 75046. 214-271-7625.

Hall Electronics

Quality Used Equipment
30 Day Guarantee!

ITC WP Stereo, F, WD, 3, tones	\$795.00
Harris Criterion 90 Stereo, tones	\$95.00
BE-303C 3 Deck Stereo	895.00
Tapecaster X-700 RP Mono	445.00
Tapecaster X-700 P Mono	245.00

We Buy Used Equipment
Send for Free Flyer

P.O. Box 7732
Charlottesville, VA 22906
PHONE: (804) 977-1100

ITC R/P stereo in rack mount case or desk top, Q-tones, manual, \$1100. S Cilurzo, Infotideo, POB 879, Cardiff CA 92007. 619-268-3000.

Sparta Matic mono R-P, record amp bad, fair cond w/manual, BO; Sparta 4515 Century Series (3), one needs motor, fair cond w/manuals, BO; Tapecaster 700-P (2), one needs motor, fair cond, BO. B Stuart, KSUE, 3015 Johnstonville, Susanville CA 96130. 916-257-2121. Tapecaster 700 RP w/extra motor, \$375; Atus

AM 500 8 chnl console, \$175, brand new. J Klauk, 118 Bay St, Glens Falls NY 12801. 518-792-9290.

Tapecaster 700P mono play only cart machines (2), gd cond, \$200 ea. C Zalenski, Eds Comm Svcs, 9 River Terr, Johnson City NY 13790. 607-798-7111.

Tapecaster 700-P, \$50; Spotmaster 505-B (2), \$50. D Gerisch, WMTV, 615 Forward Dr, Madison WI 53711. 608-274-1515.

ATC/Gates Criterion I modules, power supplies, PGM amps, 1 kHz cue, \$25 ea. H Kneller, WKII, 3151 Cooper Ste 56, Punta Gorda FL 33950. 813-639-1112.

BE 3200P mono PB, very low hrs, used in limited prod environment, \$500. R Hardy, Richardy Prod, 3239 S 90th E Ave, Tulsa OK 74145. 918-627-2937.

BE 2100 stereo R/P, mint cond, \$2000. D Clarke, 3682 N Sierra Way, San Bernardino CA 92405. 714-882-8103.

Collins 642A (2), vgc, w/manuals, \$100 ea; Tapecaster, gd cond, \$250. J Schloss, KICD, 2600 Hiway Blvd, Spencer IA 51301. 712-262-1240.

Gates Criterion mono PB & Tapecaster 600RP, mono RP, gd cond, both working, \$225/both. M Meyer, WWCK, 3217 Lapeer, Flint MI 48503. 313-744-1570.

ITC 3 pack w/tones & ITC splice finder, excel cond. J Kiefer, 904-787-6404.

ITC 3D mono cart deck (2), 1 w/record amp, 3-tone; Nidec 3D motor gd/used; Spotmaster 505B mono cart PB. M Sequin, WVMT, POB 6200, Colchester VT 05446. 802-655-1620.

ITC PDQ Series, (4) mono. C Mandel, KAMP, Box 1018, El Centro CA 92244. 619-352-2277.

UMC Beaucart R/P w/motorized head azimuth-stereo w/spare heads, \$1600. E Kain, WNOE, 529 Bienville, New Orleans LA 70130. 504-529-1212.

Audi-Cord twin transfer R/P mono, BO. R Meadows, Southeastern Sports Prod, 3216 Granleigh Dr, Tallahassee FL 32308. 904-893-7808.

Gates Criterion 80 R/P, new heads & motor, mono, perf cond, \$600; Gates Criterion 80 rec amp, stereo, gd, \$300. P Morton, WRQL, POB 57, Rupert VT 05768. 802-394-7858.

ITC 3-D, (2) ITC 3-D triple deck, mono, \$1500 ea; (2) ITC WRA record amps, \$550 ea, mono, all gd cond w/manuals & in service. D Doelitzsch, WDDD, One Broadcast Center, Marion IL 62959. 618-997-8123.

ITC SP w/rack mount, \$800; ITC RP w/delay & all tones, \$1400; Gates Criteria, \$300 ea; Gates Criterion rec amps, \$200 ea. Clark B, WFAS, Secor Rd, Hartsdale NY 10530. 914-693-2400.

RCA RT-7, BA-7, several players & record amps & one 4 place cabinet for above, repairable cond, BO. R Meyers, Benchmark Comm Corp, 4700 SW 75 Ave, Miami FL 33155. 305-264-5963.

Want to Buy

Rack mount adapter for Gates Criterion 33C triple deck; also audio card & 8 kHz cue tone detector & stereo audio cards for Gates Criterion. F Morton, KEYB, POB 1077, Altus OK 73522. 405-482-1555.

Any stereo R/P unit under \$175. M Meyer, WWCU, 3217 Kapeer, Flint MI 48503. 313-744-1570.

BE motor for mdl 1070. H Kneller, WKII, 3151 Cooper Ste 56, Punta Gorda FL 33950. 813-639-1112.

Hall Electronics

Has moved and expanded!

Call us for the best values on
**WARRANTED Rebuilt, off price, and
new broadcast Equipment!**

We BUY equipment too!
Please call for quote.

Drop us a line or phone for our latest flyer.

804-977-1100
9:30AM-6:00PM EST

1712 Allied St.
Charlottesville, VA 22901

ITC cart machines, cash paid, working or not. M Brown, Radio Bdct Tech Cons, 3740 SW Comus St, Portland OR 97219. 503-245-4889.

ITC Cart Machines wanted.
Condition no matter. Parts
and other brand machines
seriously considered.
Cash paid.

Jon Hall
Hall Electronics
PO Box 7732
Charlottesville, VA 22906
804-977-1100

ITC Premium SP (mono) or Delta SP (mono) in gd working cond, also mono record amp for ITC Premium 3D wall tones. D Voss, KADR, POB 123, Farmersburg IA 52047. 319-536-2227.

Trade (2) Ampex AG440's in fair shape for cart machine. B Simmons, KTSB, POB D, Austin TX 78713. 512-471-5106.

SMC Carousel 350, need 3 random select machines for educ FM. K Hill, WHCB, POB 2061, Bristol TN 37621. 615-878-6279.

Stereo R/P cart machines (2). S Glick, Davis/Glick Prod, 11846 Ventura Blvd Ste 306, Studio City CA 91604.

**CASSETTES &
REEL-TO-REEL
RECORDERS**

Want to Sell

Ampex AG-440B, 1" 8 trk, multitrack, test tape, manual, gd cond, BO. R Kaufman, Pams Prods, POB 462247, Garland TX 75046. 214-271-7625.

Otari ARS1000DC stereo reproducer, vgc, \$975 including shipping. J Shephard, Globe Prod, POB 20465, Roanoke VA 24018. 703-344-3283.

Revox A77, runs good, BO; Teac 32-2B, good shape except for switch problem, \$100/Best Offer; Ampex ATR-700, excellent shape except for one PB switch, \$500. W Nystrom, KRDU, 597 N Alta, Dinuba CA 93618. 209-591-1130.

HARRIS

**NEW AND USED
EQUIPMENT
CART MACHINES**

Cart Mach. TDS-1R Mono Twin Deck P/B 3-tone Audiocord Corp. 2, \$1,200. Cart Mach. Mono Rec/Play 3-tone S21 Audiocord Corp 1, 1,200. Cart Mach. Stereo Rec/Play 3-tone S26 Audiocord Corp 1, \$1,250. Cart Mach. Stereo Playback only ITC Corp. SP0003. Units have been tested and are ready to go. \$750. Cart Mach. Single Play Stereo SP-0004 ITC 1, \$1,000. Record/Play RP-0003 Cart Mach. 115v 60hz Mono Triple Cue ITC 1, \$1,750. Eraser/Splice Locator ESL-V for NAB-AA size Cartridge ITC-3M 1, \$520. Stereo Cart Rec/Play ITC RP 0004 1, \$1,750. Cart Mach. PB CTR112 Stereo Playback, A size only 115v, 50/60hz, NAB EQ, 7.5 IPS, 3X high speed cue strappable 3.75/15 IPS Desk mnt Fidelipac 1, \$1,500. Go-Cart MDL 7826-2 used 78 Cartridge Stereo 60hz IGM #9575-1278-20 1, \$2,500. Go-Cart Stereo 60hz used 42 Cartridge, IGM Model 4226 1, \$2,500. Used ITC R/P RP003 Cart Stereo 1, \$1,500. Cart Mach ITC (Mono/Delta 4/1 Matched Pair) New Units 2, \$2,487

MISCELLANEOUS

Used BGW 75W Power Amps 2, \$200 ea. Used JBL4401 Speakers 6, \$150 ea. New Headset Telex TLXPH75 28, \$25 ea. New Headset Telex Dual TLXPH2 13, \$35 ea. New Cabinet 2 Bay 19in rack, table model MT77300000 Microtrack 13, \$200 ea. New Table Sports IV Remote Microtrack MT1944002 2, \$200 ea.

HARRIS BROADCAST DIVISION
P.O.B. 4290 Quincy, IL 62305
P. 217/222-8200
J. DeLay Ext 3103

Roberts 192, works, needs help, \$35; Wollensak 1500, needs work, \$25. D Stebbins, KZZN, Box 192, Littlefield TX 79339. 806-385-4474.

Scully 280B, 1/2" 4 trk, \$500. V Friedberg, Synesthetics, 58 Walker St, NY NY 10013. 212-431-4112.

**SCULLY
TAPE RECORDERS
—PARTS—
and Service**

**SEQUOIA
ELECTRONICS**

209 Lester Lane
Los Gatos, CA 95032
(408)356-3232

Studer A80/A810/B67; Technics SP10 MK II TT; Audiotronics 342-17224-11 consoles; Aphex Compeller & exciter, call for details & price. K Harrison, WRAL, Box 10100, Raleigh NC 27605. 919-890-6101.

Tandberg TCD320 cassette deck, immaculate, mic inputs, headphone inputs, one touch recrdg RCA inputs & outputs, \$350. W Feinberg, Totaltape Publ, 9417 Princess Palm, Tampa FL 33619. 813-621-6200.

Teac EM-1542 reel motor, for Tascam 30 series tape decks (32, 34, 38), brand new, \$50. J Roper, Imperial Snd Stds, RR 31 Box 405, Terre Haute IN 47803. 812-877-2663.

Teac X-10R 1/2 trk (2), dual capstan drive, \$175 ea. K Bagdasar, KCMN, POB 17444, Colorado Springs CO 80935. 719-636-5266.

Ampex AG600 (2) work (2) for parts & box of spare parts, all for \$500. J Heck, Gallup Bdctg, 401 E Coal, Gallup NM 87301. 505-863-4444.

Ampex 351 (2) R/P elect, tube type, cosmetically vgc, \$250/both; Ampex R/P elect, dual chan, tube type, \$175. R McDaniel, KJRG, 209 Meridian, Newton KS 67114. 316-283-5150.

Ampex 351 miniature tube R/P elect, excel cond, \$150. J Martin Newman, Box 7703, Atlanta GA 30357. 404-876-8623.

Magnecord 1028, gd cond, \$150. J Schloss, KICD, 2600 Hiway Blvd, Spencer IA 51301. 712-262-1240.

MCI JH110-B 4-1k, great cond, w/rem ctrl, 4 mem set, etc, \$4500. E Kain, WNOE, 529 Bienville, New Orleans LA 70130. 504-529-1212.

Otari MX5050 MkII 2 trk, mint cond, \$2700. D Clarke, 3682 N Sierra Way, San Bernardino CA 92405. 714-882-8103.

**STUDER
REVOX**

**FACTORY AUTHORIZED
SERVICE CENTER**

"SUPERLATIVE SERVICE"

Swiss trained in servicing A77, B77, A700, PR99, A67, B67, A810, A807, B710, A710 & C270. Fast 48-72 hour service w/90 day warranty. Huge parts inventory. VISA/MC. New & used machines available.

STUDIO-SONICS CORP.
1165 Tower Road
Schauamburg, IL 60173
(312) 843-7400

Otari ARS1000DC w/25 tone detect. BO. T Storck, KTRF, Thief River Falls MN. 800-426-1003.

Pioneer RAU-11/TAU-11, 3 motor, 3 head, 2 trk, 2 chnl R-R, wisep TAU-11 record amp, synchronized monitor jack, rem ctrl jack & prov for 4 trk heads, \$495 + shpg. C Pringle, Trinty Enterprise Co. POB 831, Webster City IA 50595. 515-296-9911.

Scully 270 reproducers (6), 2 trk stereo, various states of assembly, for parts or could make 1 or 2 complete units, \$100 ea/\$500 for all/BO plus ship. J Mathis, WKKG, POB 709, Columbus IN 47201. 812-372-4448.

Scully 4 trk 1/2" 15-30 ips converts to 2 trk 1/4", 1st 2 trks have xfmrless mods; Scully 2 trk 15-75 ips, 2 trk; Scully deck w/PS, mono heads, no elect. R Robinson, 203-269-4465.

Tascam 122, gd cond, very low hrs, used in lld prod environ, \$250. R Hardy, Richardy Prod, 3239 S 90th E Ave, Tulsa OK 74145. 918-627-2937.

Teac 80-8 w/rack mt, DX8 NR, PB64 patchbay, YTT1184 align tape, vgc, \$1700. B Busetti, Lizard Studios, 1124 W 2nd St, Florence CO 81226. 719-784-3540.

Teac A-3440 4 trk, like new cond; Teac 2A mixer, 6 chnl w/MB-20 meters, like new cond; Teac RX-9 dbx unit, like new cond, \$1650/all. J Bengner, JB Ent, POB 133, Ansted WV 25812. 304-658-5534 (8-10AM).

Ampex 300 (5), most w/ head stacks, tube elec, 3 in console. BO. F Cole, KOLA, 5005 LaMart Dr Ste 100, Riverside CA 92507. 714-664-9992.

Ampex 1100 16 trk, modified, needs work, \$6000; Scully 280, \$300; Inovonics replacement elec for Ampex or Scully 380, \$300 (2), mdl 275, \$250 (4), like new w/manuals. N Metzger, 312-989-1101.

Ampex 300 3 decks & 2 elec, unmounted, repairable cond, BO. R Meyers, Benchmark Comm Corp, 4700 SW 75 Ave, Miami FL 33155. 305-264-5963.

Ampex 351 w/inovonics amps, \$800 ea; Scully 280B w/amp in own rack, \$500. Clark B, WFAS, Secor Rd, Hartsdale NY 10530. 914-693-2400.

Ampex AG-440 1/2" 4 trk, vgc, \$700. S Vandenberg, Hugh Morris Prod, POB 232, Jenison MI 49429. 616-895-3105.

MCI JH-110B, like new w/original head, mono, \$2500. S Moseley, KOJY, 597 N Alta, Dinuba CA 93618. 209-591-1130.

Sony DTC-1000ES DAT recorder, perf cond w/English manual, used little, \$1695. F Forest, Musical Starstreams, POB 44, Mill Valley CA 94942. 415-383-7827.

Tascam EM-1542, reel motor for Tascam Series 30 decks (32, 34, 38), brand new or swap for Sony TC-850 head block, \$90. J Roper, Imperial Snd Stds, RR31 Box 405, Terre Haute IN 47803. 812-877-2663.

**CLEAN PATCH BAYS
NO DOWN TIME**



**VERTIGO BURNISHERS AND INJECTORS
RESTORE ORIGINAL PERFORMANCE
TO YOUR PATCH BAYS**

\$29.95 Ea - Please write for additional information and order form today
VERTIGO RECORDING SERVICES
12115 Magnolia Blvd. #116
North Hollywood, CA 91607 818-907-5161

Teac 3340-S 4 trk, 7.5-15 ips w/6 reels, new Ampex 456 Grand Mstr on 1.5" reels w/boxes, vgc, \$800; Ampex 600 1/2 trk in case, vgc, bal mic & line inputs, \$400. P Salyers, WOSU, 2400 Orlentangy River Rd, Columbus OH 43210. 614-292-9678.

Teac DX-8 dbx unit for Tascam 80-8 trk, \$125. B Roberts, ARP Studios, POB 325, Mt Pleasant SC 29655. 803-928-3663.

Teac gd shape & VU meters, \$130. W Dougherty Jr, WLD Recdg, Music Valley Rt 1, Mill Spring MO 63952. 314-998-2377 aft 7PM.

Uher 4000 Report L, vgc, w/pwr sply & svc man, \$550 + shpg. T Vernon, Assn for the Blind, 1800 N 2nd St, Harrisburg PA 17102. 717-238-2531.

Uher 4000 Report S, gd cond, w/svc man, \$350 + shpg. T Vernon, Assn for the Blind, 1800 N 2nd St, Harrisburg PA 17102. 717-238-2531.

Want to Buy

Ampex 1/2" gate 300/351 series; Ampex 300 console Dog House. ETS Record, POB 932, Honolulu HI 96808. 808-847-4300.

Rack mount kit & cage for Revox A-77. N Ofsonka, POB 374, Springfield VA 22150. 703-643-2775.

Otari MX5050's, working or not, cash paid. M Brown, Radio Bdct Tech Cons, 3740 SW Comus St, Portland OR 97219. 503-245-4889.

Tascam RC-71 remote controls (2). R Rouse, KZMQ, Country Club Rd, California MO 65018. 314-796-3139.

Otari and Revox tape machines wanted.
Please call for quote.
Cash paid.

Jon Hall
Hall Electronics
PO Box 7732
Charlottesville, VA 22906
804-977-1100

Brush wire recorder wanted, any cond, Mdl BK-303 or other model. 215-694-0521.

Ampex and Scully Spare Parts, Accessories, Motor Remanufacturing.

VIF INTERNATIONAL
PO Box 1555
Mtn. View
CA 94042

Direct order line
(800) 848-4428
in CA Dial (408) 739-9740
Telex 62922869 ESL UD

MCI/Sony capstan & reel motors, any cond, recdg heads, most mfgs, machines, new, used, relapped then sold. Amp Services, 224 Datura St No 614, W Palm Beach FL 33401. 800-826-0601, in FL 305-659-4805.

CATV-MATV EQUIP

Want to Sell

Catel stereo FM modulator for cable system, tuned to 94.1, \$1000/BO. J Corcoran, KWWW, POB 638, Wenatchee WA 98807. 509-662-7135.

CONSOLES

Want to Sell

Attec 1592A 5 chnl mic mixer, \$100. D Sis, St John's Univ, Collegeville MN 56321. 612-363-3378.

Audiotronics 110 prod console, EQ on all 8 mic/line inputs, 5534 ICs, cue/sole, CR and studio monitoring, 4/2 assigns, multi-track mon, reverb return, studio TB,

"World Class" Tapes & Duplicating

Agfa BASF 3M

- Digital Audio Tape (D.A.T.) In Stock
- Analog Tape, Audio Accessories
- Phone In Order, Ship Same Day
- Great Quality — Great Price
- On-Shell Printing

Call us at
(800) 365-0669
for prices on tapes & duplicating

World Class Tapes

Audio Tape Distributors & Duplicators

670 Airport Blvd., Suite 1
P.O. Box 7611
Ann Arbor, Michigan 48107
(313) 662-0669 (within Michigan)

CONSOLES . . . WTS

DOD R855 mike mixer, 4 chnl w/effects buss, 1 RU high, perf for talk shows or submixer for instruments, \$250. W Feinberg, Totaltape Publ, 9417 Princess Palm, Tampa FL 33619. 813-621-6200.

Fostex 3060 meter bridge for Fostex 350 8 chnl mixer, \$50. J Roper, Imperial Snd Stds, RR 31 Box 405, Terre Haute IN 47803. 812-877-2663.

Gates M-5236A only, works, \$100. B Howard, KOFO, Box 16, Ottawa KS 66047. 913-242-1220.

Harris Micromack, BO. B VanProoyen, WWJQ, 5658 143rd, Holland MI 49423. 616-243-2026.

Harris M-5133B Gateway 8 chnl mono tube type, met specs when removed, BO. D Johnson, KAWL, POB 544, York NE 68467. 402-362-4433.

RCA BC-18AD dual chan, monaural, gd cond, \$500 plus shpg or trade. W Ellis, KOZK, MPO Box 21, Springfield MO 65801. 417-865-2100.

RCA mono 8 input, 2 ch, very clean; GE mono, 11 input 2 ch, very clean. M Phelps, WLTT, 20300 Civic Ctr Dr, Southfield MI 48076. 313-354-9300.

Arrakis 100-RS gd cond, spare cards, \$400/BO; Consolidated 450' 4 cord w/shield, new, heavy shield, \$20; Belden 8412 mike cable, 400', new, \$20. P Wolf, WCOO, 106 New Market Rd, Immokalee FL 33934. 813-574-5548.

Hall Electronics

Quality Used Equipment
30 Day Guarantee!

UREI Mod I 10 pot Stereo \$1595.00
Cetec 200C 5 pot Dual Mono 495.00
McMartin B-501 5 pot Mono 495.00
McMartin Accu 5 5 pot Mono 295.00
Shure M-67 Mic Mixer 175.00

We Buy Used Equipment
Send for Free Flyer
P.O. Box 7732
Charlottesville, VA 22906
PHONE: (804) 977-1100

Gates MO377B remote mixer, tube type, 3 chnl, cosmetically vgc, \$325. R McDaniel, KJRG, 209 Meridian, Newton KS 67114. 316-283-5150.

Gates Dualux II, gd cond, w/manual, \$900. J Schloss, KICD, 2600 Hiway B vd, Spencer IA 51301. 712-262-1240.

Micro-Trak Sport III portable remote console, 4 inputs, 2 mic, 1 spotter, 1 aux, \$295. E Kain, WNOE, 529 Bienville, New Orleans LA 70003. 504-529-1212.

Ramko DC 5MS, electrically excel, visually poor, \$500. P Morton, WRQL, POB 57, Rupert VT 05768. 802-394-7858.

Ramko DC-8M not in use, compi except couple boards, \$500. J Almon, WYOR, POB 2085, Brentwood TN 37027. 615-794-9859.

GE BC1A power supply, gd cond, needs minor work, \$30 plus shpg. G Heidenfeldt, 2880 W Lake Rd, Wilson NY 14172. 716-751-6167.

Echoplex #2, 4x6 w/steel plate, 1 in 2 out, gd, \$600 or swap for 122BIII Tascam cassette rec; Fisner home made stereo (3) springs in parallel, gd, \$250; Scully 284B 1" 8 trk in cons, \$5000. HL Sewell, Oakridge Music Std, 2001 Eton Rd, Haltom City TX 76117. 817-838-8001.

AVR HAS MOVED

With 3000 sq. ft. of showroom and comprehensive in-house service, now truly The Widest Selection of Used Gear.

PCM 601 DAT In Stock
Tape Recorders, Consoles, FX, Microphones, Processors—
All Major Brands Available

WE BUY AND TRADE
TURN YOUR USED EQUIPMENT INTO CASH
All Used Equip. warrantied and calib. to factory specs.

CALL FOR PRICES ON NEW GEAR
Tel: (617) 924-0660

Ramsa WR 8118 compact 18 input by 2 master output, almost new, hardly used, \$2000. B Ranes, DIR, 32 E 57th, NY NY 10022. 212-371-6850.

RCA BC-308S, 8 input stereo board w/spare cards, gd cond, w/manuals, \$2000. Aldon Video, 424 Commerce Ln, Berlin NJ 08009. 609-768-2439.

Studio Master 16x8x2 w/Anvil case, vgc, \$1600. B Buseti, Lizard Studios, 1124 W 2nd St, Florence CO 81226. 719-784-3540.

Tascam M-308 mixer, 8 in 4 out, like new, \$1600. D Clarke, 3682 N Sierra Way, San Bernardino CA 92405. 714-882-8103.

Peavy MC-16 16 chnl stereo mixer, \$2500/BO. M Skinner, Color County Bdcgt, 341 S Bluff St, St George UT 84770. 801-673-1450.

Ramko DC-8M dual mono console, fair cond, replaced w/stereo 11/88, w/manual, \$300/BO. D Brown, KRED, 5640 Broadway, Eureka CA 95501. 707-443-1621.

RCA BC-7A stereo dual channel console, \$1500. R Pfeil, KPDR, POB 469, Wheeler TX 79096. 806-826-5737.

Sun modified 16 in, 16 tape in, 16 mic in, 16 out, 4 groups 4 main outs, 5 sends, 5 returns, cue, talk back w/patch bay, unbalance, 22 meters, 6 remote controls for tape, \$5000. N Metzger, 312-989-1101.

Want to Buy

Gates Stereo Yard; Gates Studioette M-5381A. B Bartoli, New World Bdcgt, POB 5607, Montecito CA 93108. 916-926-3273.

Collins 212T1 or 212T2 rack mount console in reasonable cond. S Brown, WLTE, 1111 3rd Ave S, Minneapolis MN 55404. 612-339-1029.

Record cutting head, like Heco, want amps (2), \$500. HL Sewell, Oakridge Music Std, 2001 Eton Rd, Haltom City TX 76117. 817-838-8001.

Shure M-67 or M26T 4 chan mic mixer. D Brown, KRED, 5640 Broadway, Eureka CA 95501. 707-443-1621.

Stevenson Interface mdls 104 & 300 modules in working cond. A Allegra, Calvary Baptist Church, 1380 Valley Forge Rd, Lansdale PA 19446. 215-368-4444.

DISCO & SOUND EQUIPMENT

Want to Sell

AKG R-25 remote control for AKG BX-25 reverb, \$50. J Roper, Imperial Snd Stds, RR 31 Box 405, Terre Haute IN 47803. 812-877-2663.

Altec Voice of the Theater speaker, 511B horn, 608-8A driver, 15" bass w/cabinet, BO. D Sis, St John's Univ, Collegeville MN 56321. 612-363-3378.

Auraton 5C, near field mixing monitors, 1 blown, \$50/pr. B Laughlin, 816-381-0548.

E-V S-1202 8 ohm, 300 W, 2 way high efficiency constant directivity stage system, almost new, great cond, \$500; Wireworks LB-15-50, MT-15-4, MT-15-8, MBT-15-1, 15 input stage box w/50', 4' fan out cable, 8' fan out cable, mic splitter. B Ranes, DIR, 32 E 57th, NY NY 10022. 212-371-6850.

JBL 4311-B monitor speakers, excel cond, \$500. J Martin Newman, Box 7703, Atlanta GA 30357. 404-876-8623.

Linnrdum w/MIDI retrofit & extra chips, \$600. P Cibley, Cibley Music, 138 E 38th, NY NY 10016. 212-986-2219.

Peavey 311B (2), excel cond, \$525/pr. G Ingram, KIXC, POB 29, Quanah TX 79252. 817-663-6363.

Soundworkshop 242C stereo spring reverb unit, 19" rack mount, peak LEDs, excel cond, carton & manuals, \$100. R Cannata, Cantrax Recorders, 2119 Fidler Ave, Long Beach CA 90815. 213-498-6492.

dbx 157 Pro 4 chnl simultaneous play-record, rack-mountable, (2) 8 chnl, \$500/4 chnl. H Fenster, Universal Rehearsal-Recording, 17 W 20th St, NY NY 10011. 212-929-3277.

JBL 4412 has minor marks on cabinets, sound perfect, \$600. D Alexander, WQMX, 4988 Gateway Dr, Akron OH 44326. 216-384-1897.

Want to Buy

KLH TNE 7000A transient noise filter; Burwin Research DNF-1100A dynamic noise filter; Burwin Research DNF 1201A dynamic noise filter. R Nelson, LGH Recording Std, Box 1, Flaxton ND 58737. 701-596-3565.

LIMITERS

Want to Sell

Burwin Research DNF-1201A dynamic noise filter useful for reducing tape hiss, \$175 plus shpg. L Dupree, Cenla Bdcgt, 1115 Texas Ave, Alexandria LA 71301. 318-445-1234.

Marti CLA-40A (2), gd cond w/manuals, BO. B Stuart, KSUE, 3015 Johnstonville, Susanville CA 96130. 916-257-2121.

Orban Optimod 8000A stereo gen, recently factory aligned & proofed, \$1925. D Kelly, KWPN, Box 84, W Point NE 68788. 402-372-5423.

Orban Optimod 9000A (2), both in operation & in excel cond, \$1900 ea or both for \$3600. J Kimel, WWSR, St Albans VT 05478. 602-524-2133.

Gates Sta-Level, BO plus shpg; Gates Yard console, mono, worked when removed, BO plus shpg. M Rockwell, WNBI, Box 309, Park Falls WI 54552. 715-762-3221.

Harris MSP90, excel cond. J Kiefer, 904-787-6404.

Harris Solid Statesman, black faced, gd cond, (2) AGC, (2) limiters, \$500/all. P Wolf, WCOO, 106 New Market Rd, Immokalee FL 33934. 813-574-5548.

Orban 111B dual spring reverb; CRL APP-400; CRL SEP-400A. M Sequin, WVMT, POB 620, Colchester VT 05446. 602-655-1620.

Orban 424A comp/limiter/de-esser, stereo, new, w/manuals, \$575; Orban 418A, new w/manuals, \$450. S Lawson, KAK Prod, 928 Hyland Dr, Santa Rosa CA 95404. 707-528-4055.

CBS 410 & 499 Volumax, \$75 ea; Gates FM top level, \$50 plus shpg. B Roberts, ARP Studios, POB 325, Mt Pleasant SC 29465. 603-928-3663.

CRL FM-4 System SPP-800, SEP-800, SMP-800 & SG-800 w/manuals & original perf measurements, \$4000. K George, WUSY, POB 8799, Chattanooga TN. 615-892-3333. Fax: 615-899-7224.

CRL PMC-300A mono, peak mod limiter, mint cond, \$550. P Mueller, WPSO, 8406 Little Rd, New Port Richie FL 37654. 813-848-8161.

Thomson CSF Labs Volumax 4440A, vgc, \$400 plus shpg. T Vernon, Assn for the Blind, 1800 N 2nd St, Harrisburg PA 17102. 717-238-2531.

Thomson-CSF 4450-A Audimax, never used, \$1295; Thomson-CSF 4500 presence EQ, never used, \$595; CBS Labs 400 Volumax, good buy, \$100. HM Dyer Electronics, 2982 Wixom Rd, Milford MI 48042. 313-685-2560.

Want to Buy

Gates Sta-Level M5167, manual wanted, copy OK; Collins 26U-1 manual wanted, copy OK. T O'Laughlin, WERN, Rt 1 Box 41, Barnered WI 53507. 608-924-2001.

MICROPHONES

Want to Sell

E-V 644 shotgun mic w/cable, vgc, \$75 ea or 3/\$195. S Hofmann, Cameron Univ Theatre, 2800 W Gore, Lawton OK 73505. 405-581-2428.

Audio-Technica ATM-63 cardioid, solid brass bodies, mint, \$100; EV RE-20, as new, \$250. J Martin Newman, Box 7703, Atlanta GA 30357. 404-876-8623.

E-V RE-15 (3) & RCA 77DX (needs ribbon), gd cond. H Kneller, WKII, 3151 Cooper Ste 56, Punta Gorda FL 33950. 813-639-1112.

Luxo mic stand, black, brand new, \$20; EV RE20, great mic, rarely used, mint cond, \$225. D Clarke, 3682 N Sierra Way, San Bernardino CA 92405. 714-882-8103.

Sennheiser MD211U, gd cond, \$175. P Wolf, WCOO, 106 New Market Rd, Immokalee FL 33934. 813-574-5548.

Beyer M-380 excel for recording bass, mint cond, \$125; AKG floor mic stands & booms, excel cond, \$25/set. M Osborne, WKSQ, POB 9494, Ellsworth ME 04605. 207-667-7573.

RCA 44BK w/out ribbon, \$100. P Morton, WRQL, POB 57, Rupert VT 05768. 602-394-7858.

Sennheiser MD421 studio mic, like new, used less than 30 days, \$200. R Meadows, Southeastern Sports Prod, 3216 Granleigh Dr, Tallahassee FL 32308. 904-893-7808.

Shure 545 Unidyne III dual impedance, \$75/BO; EV 636 dynamic omni-directional Hi 2 Lo 2, \$50. M Skinner, Color County Bdcgt, 341 S Bluff St, St George UT 84770. 801-673-1450.

Shure SM-68, like new w/wind-screens & cable, \$160/pr. W Dougherty Jr, WLD Recdg, Music Valley Rt 1, Mill Spring MO 63952. 314-998-2377 aft 7PM.

Shure SM57 (2), \$80; AKG C-951-E (2), \$200; Sennheiser 421 (2), \$100. N Metzger, 312-989-1101.

Want to Buy

Atlas DS-10 desk mic holder. ETS Record, Box 932, Honolulu HI 96808. 808-847-4300.

AKG D202, D200, or D222; EV RE20, PL20, or RE15. B Goldes, Balaika Orch of Detroit, 1937 Byrd, Dearborn MI 48124. 313-271-3261.

Altec M-20, M11, 21B, 21D mic capsules, etc. D Bisbee, 685 S Roys Ave, Columbus OH 43204. 614-279-6163.

RCA 30-A lapel ribbon; RCA SK-39 aerodynamic; RCA BK-6A dynamic; RCA BK-10 uniaxial. J Steele, Philocom, 160 W 77th St, NY NY 10024. 212-496-6054.

RCA or WE 77 or 44 or 639, etc, working or not. B Davies, Virgo Prod, 5548 Elmer Ave, N Hollywood CA 91601. 818-761-9831.

MISCELLANEOUS

Want to Sell

Boxer WS2107F fans (2), \$25 ea. W Feinberg, Totaltape Publ, 9417 Princess Palm, Tampa FL 33619. 813-621-6200.

Custom studio furniture, several pieces, never used. M Phelps, WLTT, 20300 Civic Ctr Dr, Southfield MI 48076. 313-354-9300.

Tab Books & others, call for list/prices. D Fong, Fong Prod, POB 886, Franklin Pk IL 60131. 312-671-4615.

Cannon, chassis-mount, 5-pin female XLR connectors, \$1 ea. J Martin Newman, Box 7703, Atlanta GA 30357. 404-876-8623

MUST SELL

Dynakit 60 W Amps & Preamps Pam. Ampex Mixers MX35 & xformers; Ampex remotes for 350-351 recorders; Patch Bays (4) single inputs & cords; Altec Mixers 1567 & xformers; Lafayette Audio Generator & Heath Oscilloscope; Rekokut Turntable CVS12 variable speed 25-100RPM; Fisher 400CX pre-amp, Ampex 620 Spkr-amp.

Mr. Oliver:
212-874-7660-0274 (PMs)

Jerrold PBF-5 chan 5 pass band filter for receive antenna systems, \$50. R Hardy, Richardy Prod, 3239 S 90th E Ave, Tulsa OK 74145. 918-627-2937.

Rotary dial 5 line telephones, beige, w/intercorn buzzer & hold, shielded multi port connectors, \$15 ea. M Rockwell, WNBI, Box 309, Park Falls WI 54552. 715-762-3221.

Superior Electric voltage stabilizer, 2.5 KVA, mdl EMT41028, \$350; General Signal isolation transformers, 120/120, 3 KVA, \$100 ea. Aldon Video, 424 Commerce Ln, Berlin NJ 08009. 609-768-2439.

Operator/service manuals for Ampex AG 600, 602, 602-2, 350 & 300 recorder/reproducers, all in excel cond, each \$25. J Newman, Box 7703, Atlanta GA 30357. 404-876-8623.

Acoustical wall covering, looks like Sonex, 800 sq ft, \$800. N Metzger, 312-989-1101.

Blay teletype ribbons, new unopened, over 150 for older teletype machines, BO. M Black, WEOS, Hobart & William Smith College, Geneva NY 14456. 315-789-8970.

Comtel CBC-3000 computer telemarketing systems, \$250; TI Omni 800 terminal printer w/complete maintenance manual, \$300 plus shpg. B Roberts, ARP Studios, POB 325, Mt Pleasant SC 29465. 803-928-3663.

Elgin PC-20721 station line coupler, telco auto answer w/external relay contacts (5), \$75/BO. A Garren, KWLJ, 931 SW King, Portland OR 97205. 503-228-4393.

Eventide Delay BD 931 6.4 sec, \$800; GE dist & noise analyzer, \$100; Heathkit oscilloscope 10-4560, \$200; Ingrid recorder conn ERC-19645-4, \$60. Clark B, WFAS, Secor Rd, Hartsdale NY 10530. 914-693-2400.

Hobart 1.5 kW 3 phase Wye aux power generator, skid mount, weather proof cabinet, repairable cond, BO. R Meyers, Benchmark Comm Corp, 4700 SW 75 Ave, Miami FL 33155. 305-264-5963.

JBL D16R2405 16 ohm replacement diaphragm for JBL 2405 tweeter in unopened box, new, \$50; AKG R-25, brand new remote control unit for AKG BX-25 reverb (or swap for Revox A77 remote control), \$50. J Roper, Imperial Snd Stds, RR31 Box 405, Terre Haute IN 47803. 812-877-2663.

Metal equip rack, 7' tall, no sides, \$100; Atlas-Sound mic stands (7), \$20-30; cust made outboard equip cons in table top area, call for description. N Metzger, 312-989-1101.

HARRIS

NEW AND USED EQUIPMENT CONSOLES

Used LPB Inc Mono Sch Console 1. \$1,200. Used Harris Medalist 8ch Stereo 1. \$4,000. Used Tascam 16ch Mixing Board 1. \$3,000. Used Harris Mono Sch Console 1. \$1,000. Used Harris Gateway 80 Mono 1. \$1,700. Demo Yamaha 16ch Stereo Yamaha M916 1. \$3,000.

REEL TO REEL TAPE MACHINES

Used ITC R-R Playback 750 Series 1. \$750. Used ITC R-R Rec/Play 7532T Stereo 1. \$750. New ITC R-R Rec/Play 770 Series 2. \$1,400. New Strider Rec/Playback B 67-1VUM 1. \$1,500. Used Teac X7-Mk2 R-R Tape 1. \$350.

MOD MONITORS

Belar Rt Amp R1A1 2. \$200 ea. Belar FMM-2 Mod Mon Used 1. \$1,000. Belar FMS-2 Mod Mon Used 1. \$1,100.

AUDIO PROCESSORS

Circuit Research Labs Processor Audio Stereo FM 2 sys 1 SPP-803 and 1 SMP-800 1. \$2,000. Harris MSP-90 Stereo AGC Amp 50hz. These will work fine on 60hz power 4. \$1,000. Harris MSP-90 Stereo FM Limiter 50hz. These units will work fine on 60hz power 5. \$1,500. Mosley 910GB Audio Processor Demo Unit 1. \$4,000.

SATELLITE

Harris 6550 SCPC Audio Receiver \$2600 ea. SCPC Audio Demo \$500 ea. Harris 6532 Receiver. Harris 6522 Receiver.

HARRIS BROADCAST DIVISION
P.O. Box 4290 Quincy, IL 62305
P. 217/222-8200
J. DeLay Ext. 3103

RON RADIO COMMUNICATIONS

P.O. Box 201 Brightwaters, NY 11718
"Professional Broadcast Engineers Serving the Industry"

ENERGY-ONIX FM TRANSMITTERS (100w to 60 KW)

MK 7.5 (7500 Watt) Ideal for the Class A Power Increase

FMX IS HERE !!! 100 Stations Now on the Air
Inovonics 705 Digital Stereo Generator with FMX \$1,695
Hnat Hindes Audio Processing
TRI-MAZE \$ 1,700 Mono \$3,295 Stereo
FM or AM NRSC Versions NOW Shipping
Z H - 1 (Zero Hysterisis Clipper) \$ 399
SX - 87 Telephone Hybrid \$ 465

SPECIAL OF THE MONTH (Prices good thru 02/28/89)

Micro Control Inc.. Composite STL List \$5,995
Electron Processing 10KHz Whistle filter \$199
Inovonics Model 222-00 NRSC AM Processor (Add to any Existing Processor) \$499
DANGER HIGH VOLTAGE Signs (14 X 20) \$15 each
Cart Labels \$16

Newsroom workstations w/R-R, cart, switcher, phone coupler, in rack, call for details; Omega phone system 30 plus phones w/KSU touch-tone, gd cond, BO. Clark B, WFAS, Secor Rd, Hartsdale NY 10530. 914-693-2400.

Phasing equipment, 1970 Gates phasor & (4) ATU shelves set up for 1170 kHz, 5 kW DA-1, parts list/price info avail. K Buckelew, WOBM, 360 Clayton Rd, Howell NJ 07731. 201-364-4400.

Radio Shack 4/P portable mod 4, 2 drives built-in modem, tons of software, \$250; Radio Shack DMP-120 dot matrix printer, R/S serial & parallel ports; 8 slot S-100 computer frame, 64K memory card, Cromemco 4FDC, frame has p/s no drives; Radio Shack Model 100 24K RAM great shape, AC P/S printer & modem cables manuals, \$250. S Sonnenblick, Media System Assoc, 8400 NW 5th St, Pembroke Pines FL 33024. 305-891-3588.

RCA MI-9472-A matching inductor, BO. T O'Laughlin, WERN, Rt 1 Box 41, Bamerseld WI 53507. 608-924-2001.

Want to Buy

KMUD-FM seeks suppliers for NTIA-funded project. Studio, production, test equipment. To receive complete list for bids, write Box 135, Redway CA 95560, or call 707-923-2413.

Old trade mag from RCA & WE, 1930-50. N Allebaugh, WICE, 100 John, Cumberland RI 02864. 401-725-9000.

EBS Unit w/FM receiver needed by educ FM. K Hill, WHCB, POB 2061, Bristol TN 37621. 615-878-6279.

NBC Network tone decoder, for NBC Talknet. T Hughes, KJDU, 1160 Marsh, San Luis Obispo CA 93401. 805-541-3031.

Realistic MTX-100 (2) marine transceiver & antennas. P Robillard, Robillard Comm, 1803 N 1st East St, Haynesville LA 71038. 318-624-0105.

Transcription records, 16", RCA Thesaurus Library. B Davies, Virgo Prod, 5548 Elmer Ave, N Hollywood CA 91601. 818-761-9831.

Vu-Data PS940A CRT for Vu-Data scope mdl PS940A or used scope of same model. F Anderson, 3801 Fifth Ave S, Great Falls MI 59405. 406-452-2810.

MONITORS

Want to Sell

Nati Electrolab AM RF amp, gd cond, \$200; Sansui TU-577 AMX digital, gd cond, \$25. P Wolf, WCOO, 106 New Market Rd, Immokalee FL 33934. 813-574-5548.

Ikegami	TM20-8RH	\$2750
Conrac	6122/RS19	3150
	6122/Y19	3150
	6142/Y19	3495
	CYB17/RS	2650
	HA19	1325
Tektronix	HE19	1325
	HE19	1450
	HE19/PALC	1450
	650A	1395
	655-1	1750
	655A1	3150
	656A1	3150
	658	1395
	Other Video Test Equipment Available! Call Duane Harvey at 800-527-4642 or in Texas. 214-348-8800.	

QEI stereo mod monitor, \$1500; TFT 753 AM mod monitor, \$850; Leader LDM170 dist analyzer LAG125 low dist osc. R Duncan, POB 426, Fairburn GA 30213. 404-964-3764.

EV Sentry 100A, studio monitors, new, \$250/pr. R Cobb, POB 5332, Sun City Center FL 33570. 813-634-1940.

McMartin TBM-44500A mainstereo mod monitor, gd, \$900; McMartin EBS-1 EBS gen, \$100. P Morton, WRQL, POB 57, Rupert VT 05768. 602-394-7858.

TFT 730A SCA monitor, excel cond, BO. T Hughes, KJDU, 1160 Marsh, San Luis Obispo CA 93401. 805-541-3031.

Want to Buy

Any FM mod monitor. M Benson, 9872 Esquon, Durham GA 95998. 916-893-5531.

MOVIE PRODUCTION EQUIPMENT

Want to Sell

Kodak Pageant high intensity 16mm arc movie projector, w/power supply, near mint cond, \$1200. G Ormrod, GFO Prod, 432 E X St, Tumwater WA 98501. 206-352-8028.

RECEIVERS & TRANSCEIVERS

Want to Sell

TFT EBS rcvr system, 760-01, 03, & 04 units, new, \$700. Aldon Video, 424 Commerce Ln, Berlin NJ 08009. 609-768-2439.

WE'VE DONE THE HARD PART

Our new program computes TV & FM Field Strength for you. It uses the FCC algorithm to determine distance to contour, field strength at distance, and bearings between coordinate pairs. It runs on any IBM-PC compatible and incorporates FCC Docket 88-56 rules. **Only \$95.00**

**Jeremy Lansman
Spectrum Resources
POB 240-467
Anchorage AK 99524
(907) 345-2630**

GE MasterPro UHF 2-way repeater, TX: 450.250, RX 455.3125, \$2000. S Sheldon, WSJM, 580 E Napier Ave, Benton Harbor MI 49022. 616-925-1111.

ICOM IC-H16 keyboard programmable commercial VHF handheld transceiver w/CM-8 NiCad, CM-16U charger, flex antenna & programming/service manuals in box, excel physical & elec cond, \$500, or trade for Collins S-line TX/RX, KWM-2A or LPB solid state carrier current xmt system. D Sites, 5809-K Cambridge Dr, Springfield VA 22152.

Motorola Base & mobile for 160 MHz, \$200. P Morton, WRQL, POB 57, Rupert VT 05768. 802-394-7858.

Radio Shack STD2100, 120 Wchannell receiver, \$175. R Cobb, POB 5332, Sun City Center FL 33570. 813-634-1940.

Wagner 1624 demod w/power supply & rack mount, \$200. B Roberts, ARP Studios, POB 325, Mt Pleasant SC 29465. 803-928-3663.

Want to Buy

KLH 21 FM table radio from '60s; also old German table radios. M Olsonka, POB 374, Springfield VA 22150. 703-643-2775.

REMOTE & MICROWAVE EQUIP.

Want to Sell

Fairchild/Comtech Dart, complete digital satellite audio receiving system, FOB Dallas, \$5000. H Beavers, KFJZ, 2214 E 4th, Ft Worth TX 76101. 214-522-9898.

**** BAX ****

FOR SALE OR RENT

C.N. ROOD 5KHz Bandwidth Extension System turns Phone Lines into Music Lines

Exclusive No. Am. Reps

MARCOM
408-438-4273

Moseley PCL-303/C composite STL rcvr, 951.5 MHz, \$850/BO; TFT 7700 composite STL xmt, 2 yrs old, \$1900; Mod Sciences CDL-2500 compos line drvr & rcvr, excel cond, \$800; Moseley SCM-1 subcarrier gen, perf cond, \$400. I Epstein, KJAZ, 1131 Harbor Bay Pkwy, Alameda CA 94501. 415-769-4800.

PBR-15 remote control, \$1000; TCR15 remote w/subaudible subcarrier, \$1500. John 315-488-1269.

Pulse Dynamics 288 2 chnl remote bcd w/dial & two Telex headsets, \$125. P Russell, Bowdoin College, Sills Hall, Brunswick ME 04011. 207-725-3066.

ADDS VPT-A2 new keyboard & CRT for use w/Moseley MRC 1600 remote control, \$795. E Kain, WNOE, 529 Bienville, New Orleans LA 70130. 504-529-1212.

Century Video ABC Talkradio decoders (3), \$500 ea. G Jacques, KSUN, 714 N 3rd, Phoenix AZ 85004. 602-252-0030.

Comrex single line PLX H transmit & RLX receive unit, \$1490 for system. G Wachter, KFYI, 631 N 1st Ave, Phoenix AZ 85003. 602-258-6161.

Comrex 2 line freq ext system, \$6500. P Canlone, WINE, Federal Rd, Brookfield CT 06804. 203-775-1212.

Marti 30/150 RPU rcvr, 161.73 w/LA-20 & LA-20E modules, also 10 dB preamp; Microdyne 1100 PCDR (5) SCPC rcvr; Harris 6550 satellite rcvr chassis w/power supply. M Sequin, WYMT, POB 6200, Colchester VT 05446. 802-655-1620.

Marti stereo STL system, xmtrs mdl STL-10, rcvrs mdl R-10, 948.375 MHz & 948.625 MHz; also (2) Scala Parafactor STL antennas, all units approx 2 yrs old, \$5000. C Hastings, WCSL, POB 370, Cherryville NC 28021. 704-435-3297.

Micro-Controls DLC/DLT-9 9 chan digital remote control unit, 4 phone lines, \$850. G Brown, WSWG, POB 1786, Washington NC 27889. 919-946-1016.

Moseley DRS-1 20 chnl expandable digital remote control system w/extra spare parts & boards, \$1350. G Wachter, KFYI, 631 N 1st Ave, Phoenix AZ 85003. 602-258-6161.

S-A DAT-32 w/crystals for 3, 15, 18 & 23, no audio cards, \$7000; Marti RMC2AX dial up remote control converted to wire line, not working, 25 chnl w/book, \$200. J Heck, Gallup Bldg, 401 E Coal, Gallup NM 87301. 505-863-4444.

TFT 704E remote meter & peak flasher for TFT mod monitor, \$100. E Kain, WNOE, 529 Bienville, New Orleans LA 70130. 504-529-1212.

WE 111-C repeat coils, excel cond, \$50 ea. J Martin Newman, Box 7703, Atlanta GA 30357. 404-876-8623.

WE KS-20159, L3 hardwire studio-to-xmt EQ units, \$50 ea. J Martin Newman, Box 7703, Atlanta GA 30357. 404-876-8623.

Fairchild 360 down-converter, brand new, BO over \$700. M Crouch, WCHE, 119 W Market St, W Chester PA 19382. 215-692-3131.

Moseley PCL-101 discrete STLs (2), recent vintage, gd cond, \$2000 ea or \$3000/pr. P Morton, WRQL, POB 57, Rupert VT 05768. 802-394-7858.

Satellite reception sys for Transtar Format 41, w/Wegener 1601 mainframe & pwr supply, 1610-01 7.44, 1610 7.04 demods, 1608-23 RF, 1689-04 IF downconverters, 2046-07 comm & control mod, (2) 1644-02 relay interfaces, Colorado Magnetics NS200B audio cart switcher & all instruc manuals, used for just over 1 yr. BO. J Hansen, KDMG, 100 Court Ave Ste 103, Des Moines IA 50309. 515-282-1033.

Teac PD400BL remote compact disc player, like new, \$125. R Cobb, POB 5332, Sun City Center FL 33570. 813-634-1940.

Do you have a Class A FM Construction Permit and \$100,000?

GOOD !!

We can build your station COMPLETE for \$100,000. We can make this exceptional offer because we do everything, including erecting a new 300 foot tower with all accessories.

OUR PACKAGE INCLUDES:

- * Modular transmitter/studio/office building delivered and completely installed at your site
- * Tower, antenna, and transmission line installed
- * Complete transmitter and monitoring system
- * Stereo control room complete down to clock on the wall
- * Complete production room
- * Fully furnished reception area, manager's office and work, refreshment areas

If the high costs of construction have delayed launching your Class A, WAIT NO LONGER !

Call Today: Fred at (817) 697-2462 or Don at (512) 448-2420

PARITY RADIO CORPORATION OF TEXAS

Call us about your Class C2 or Directional AM construction, too!

DISTRIBUTOR DIRECTORY

The following distributors serving the broadcast industry would be glad to help you with any of your requirements.

<p>SPENCER BROADCAST</p> <p><i>The Radio Station Specialists</i></p> <p>Chuck Spencer Phoenix, AZ 602-242-2211</p>	<p>THE SOURCE</p> <p>CALL US FOR ALL YOUR EQUIPMENT NEEDS</p> <p>Toll free: 800-223-8202 In Florida: 305-651-5752</p> <p>ELECTREX COMPANY</p>	<p>Kidd COMMUNICATIONS</p> <p>CALL US FOR... Audi-Cord Cart Machines & Audiopac Carts • Bogner TV Antennas • Cablewave Transmission Line • CRL Audio Processing • Eventide Digital Effects • Gentner Patch Bays • Jampro FM & TV Antennas • JBL Speakers • M/A Comm Video STL's • Mark Antennas • Orban Optimod's • Scala Antennas • Soundoller Equipment Racks • Studer-Revox Tape Recorders/Disc Players • Technics Turntables/Disc Players • TTC FM/TV Translators/Transmitters</p> <p>CALL US TODAY! KIDD COMMUNICATIONS 4096 Bridge Street • Suite 4 Fair Oaks CA 95628 916-961-KIDD(5433)</p>	<p>We have the knowledge and ability to provide you the best suited broadcast for your project... always at competitive prices!</p>
<p>SANGAMO-ACUSHNET MICA CAPACITORS</p> <p>PLASTIC CORP.—NON-PCB OIL FILLED CAPACITORS</p> <p>RF-ANTENNA AMMETERS</p> <p>RCA-RAYTHEON-AEL TRANSMITTER PARTS</p> <p>TRANSFORMERS & CHOKES 250 WATT THRU 50 KW</p> <p>COMMERCIAL RADIO COMPANY BOX 43, CAVENDISH VT 05142 802-226-7582</p>	<p>STAR SYSTEMS</p> <p>Audio Solutions</p> <p>Otari, 3M, Tascam ATR, Nakamichi Pro, Yamaha, Orban, Valley People, Studer/Revox, Fidelipac And much much more!</p> <p>Call for a current quote (603) 894-6565 326D S. Brdwy Salem, NH 03079</p>	<p>CORNELL-DUBILIER MICA CAPACITORS</p> <p>FROM STOCK</p> <p>JENNINGS VACUUM CAPACITORS</p> <p>FROM STOCK</p> <p>JENNINGS VACUUM RELAYS</p> <p>SURCOM ASSOCIATES, INC. 2215 Faraday Ave., Suite A Carlsbad, California 92008 (619) 438-4420</p>	<p>FCC's Engineering FM and TV Data Bases for your P.C.</p> <p>Call today to request a free sample.</p> <p>Data for Small Systems Suite #236 2020 Pennsylvania Ave, NW Washington, DC 20006 (703) 276-9442</p>
<p> American Media Services Authorized Distributor for Scotch Blank Cart II Broadcast Tape Cartridge & Scotch Open Reel Tape</p> <p>NAT'L: (800) 345-1953 TEXAS: (800) 521-1953 LOCAL: (817) 535-1953 FAX: (817) 536-1953</p>		<p>Call for Availabilities: 800-336-3045</p>	

REMOTE . . . WTB

Want to Buy

Marti STL 8, must be in gd working cond; also need hybrid combiner to combine two STL xmtrs. D Willey, Life Bldg, POB 96, John Day OR 97845. 503-575-1840.
S-A 7325 DPU 7.5 kHz Pgm Unit for the 7325 digital processing unit. G Urbiel, WWWJWJ, 16550 W Nine Mile Rd, Southfield MI 48086. 313-423-3366.

Comrex LX-T or Gentner single line encoder. M Black, WEOS, Hobart & William Smith College, Geneva NY 14456. 315-789-8970.
Fairchild Oart 384, 75 kHz or 15 kHz audio chnl cards. T Hughes, KJDJ, 1160 Marsh, San Luis Obispo CA 93401. 805-541-3031.
Receiver to pick up ABC entertainment news. D Jordan, WDTM, POB 3417, Jackson TN 38303. 901-668-1153.
STL for video service. AACT Inc, 156 Lazelle Rd, Wontington OH 43085. 614-846-9234.

Telephone lines only. J Foust, WXEE, Box 1340, Welch WV 24801. 304-436-4191.

STATIONS

Want to Sell

Looking for AM, FM or CP in east for right price/terms. H Kozlowski, 703-631-0197.

FM CP's WANTED

Clients seek CP's any size market. Small, medium, large. Will consider FM upgrades, too!

Media Market Brokers

Don Nahey
1-404-323-8081

CDL VSP-860 switcher, 20 inputs, 2ME, BKGD, 24 patterns, joystick, cable, Cox Chromakeyer, \$3500/BO. Steve, Box 10673, Denver CO 80210. 303-399-6444.

Panasonic AS-6100, 10 input, effects bank, DSK, w/AS-1000 sync gen & AS-2000 chroma keyer, \$1200. Aldon Video, 424 Commerce Ln, Berlin NJ 08009. 609-768-2439.

TAPES, CARTS REELS)

Want to Sell

Aristocarts (1200), various lengths w/50's, 60's & 70's music classics, carts are vintage 78-80 & dbx encoded, \$1.50 ea or \$1500 for the lot (preferred). T Minnard, KOFY, 415-442-1800.

Audiopak carts, (1000 plus), various lengths, AA-3's, some AA-2's & 4's, all in gd working order, BO. B Files, WKPE, 508-255-3220.

Capitol HOLN (60) pancake 3600' hubs of HOLN A-3 cart recording tape, sold in any quantity, \$15/hub or BO. J Emmel, WWAX, POB 750, Olyphant PA 18447. 717-489-0005.

Country Gold Library, 1300 titles on Capitol A2 carts, \$2500; A/C Gold Library, 800 titles on Fidelipac carts, \$1500. P Martin, 414-482-2638.

Sony P6-120MP 8mm video cassette, 120 min in Sp, never opened, 240 min in Lp, \$8/BO. D Fong, Fong Prod, POB 886, Franklin Pk IL 60131. 312-671-4615.

Aristocarts, approx 1000 w/AC format music, for programming or refurbishing. M Forrester, KYGL, 500 L St Ste 200, Anchorage AK 99501. 907-272-5945.

Carts (2000-2500), various lengths & makes, make offer. D Hartman, KLF, 992 Inland Cir Dr, San Bernardino CA 92408. 714-885-6555.

A&D Cartridge Rebuilding Service

We clean, load & pack. Serviced within 10 work days! Work guaranteed!
3380 Bakely Ave., Eau Claire, WI 54701
(715) 835-7347

Complete 50-60 & 70-80 music library on cart, most in stereo. C Mandel, KAMP, Box 1018, El Centro CA 92244. 619-352-2277.

Fidelipac Mastercart II carts (500), gd cond, w/stereo music, \$1 ea/BO. P Wolf, WCOO, 106 New Market Rd, Immokalee FL 33934. 813-574-5548.

Fidelipac Master Cart, approx 500 carts, various lengths, excel cond, \$3.25 ea. P Tinkle, WCMT, POB 318, Martine TN 38237. 901-587-9526.

Marathon carts (300+), 40s, 70s, 100s, etc, \$250 for lot, plus shpg. C Osgood, WBNC, POB 2008, Conway NH 03818. 603-447-5988.

Capitol HOLN (60) pancake 3600' hubs of HOLN A-3 cart recording tape, sold in any quantity, \$15/hub or BO. J Emmel, WWAX, POB 750, Olyphant PA 18447. 717-489-0005.

Records, 45s & 33s, mint cond, covering big band, swing, jazz, R&B, rock, blues, country, large collection, from 1920s to present. S Lawson, KAK Prod, 928 Hyland Dr, Santa Rosa CA 95404. 707-528-4055.

A-2 or AA-3 carts, sell or trade for other equip needs. JB Salazar, POB 3246, Laredo TX 79041. 512-722-6832.

Ampex & 3M used 2" & 1" tapes on 13" & 10.5" reels, \$20 ea; 3M bdct quality video tape, \$10 ea. N Metzger, 312-989-1101.

Fidelipac Master carts, (1000), 3.5 minutes, \$60 ea, add \$3 per 100 carts. D Peluso, KFM Radio, Las Vegas. 702-732-7753.

Fidelipac CTR124. J Lackness, KRJA. 512-828-3737.

IGM Good Music Series, 30 14" reels 7.5 ips 2T stereo, gd music, \$30/reel delivered. F Anderson, 3801 Fifth Ave S, Great Falls MI 59405. 406-452-2810.

NAB reels, 10.5" metal 1/4", all in gd cond, 1-10, \$1.50 ea, 11-100, \$1.25 ea, 100+, \$1 ea. Falk Recd Svcs, 7914 Fegenbush Ln, Louisville KY 40228. 502-239-1010.

Several hundred 3/4" U-matic cassettes used w/new boxes, ready for new tape reload, BO. R Meyers, Benchmark Comm Corp, 4700 SW 75 Ave, Miami FL 33155. 305-264-5963.

Want to Buy

Audio Devices tape boxes, 1950's, 10 & 7" in gd cond. ETS Record, Box 932, Honolulu HI 96808. 808-847-4300.

AAA carts, large selection needed. D Brown, KMCD, 57-1/2 Count St, Fairfield IA 52556. 515-472-4191.

TAX DEDUCTIBLE EQUIPMENT

Non profit educ station start up seeks donation exciter (FM), cart machine, etc, will pay freight. S Dorsey, Radio Techwood, 711 Techwood Dr, Atlanta GA 20332. 404-676-1207.

Christian Boarding School, (9-12) w/sat rovr seeks VCRs/VTRs & related equip for record, edit & download to 1/2" VHS or edu pgming. J Mann, Campion Academy SW, 42nd & Academy Dr, Loveland CO 80537. 303-667-5592.

Church & Christian school desire sound reinforcement & audio/visual/video prod equip in working cond, tax deduct donations preferred. A Allegra, Calvary Baptist Church, 1380 Valley Forge Rd, Lansdale PA 19446. 215-368-4444.

College station needs donations of R-R, cart machines & other equip. M Black, WEOS, Hobart & William Smith College, Geneva NY 14456. 315-789-8970.

Donation of equip to church, 3/4 editing recorders, PB units, audio & video. JB Salazar, ICS, POB 3246, Laredo TX 78044. 512-722-6832.

Eng student desiring donation of old bdct equip (anything) in repairable cond, will pay ship chgs, EE student at Purdue. C Gill, POB 371, Indianapolis IN 46206. 317-923-2800.

CONSULTANTS

R.L. HOOVER

Consulting Telecommunications Engineer

11704 Seven Locks Road
Potomac MD 20854
301-983-0054

Member AFCEE

R.J. GRANDMAISON, P.E.

CONSULTING ENGINEER

Applications and Rulemakings
11213 Split Rail Lane
Fairfax Station, VA 22039
(703) 764-0513
Member AFCEE

R. Sequerra Associates Ltd.

RF & audio instrument & product design uniquely for broadcasting

718-225-4159

SPECIALIZING IN ERECTION, REPAIRING, PAINTING AND MAINTENANCE MICROWAVE, RADIO, TWO-WAY, A.M. SYS., TV TOWERS

TEXAS STEEPLEJACK CO.

PAINTING AND STEEPLEJACK CONTRACTORS

FULLY INSURED FOR YOUR PROTECTION

MARIO RODRIGUEZ 5650 TIMBERCREEK PL. DR. HOUSTON, TEXAS 77084

(713)855-1262

RF and Audio

Coast to Coast

STEVE VANNI ASSOCIATES, INC.

BROADCAST TECHNICAL CONSULTANTS

Project Management Facility Planning
Equipment Installations

P.O. Box 422
Auburn, NH 03032

(603) 483-5365

FM Study Program

FM Searches Within The Budget Of Anyone Who Owns An IBM-PC L.R.C.
602/293-2374

EVANS ASSOCIATES

Consulting Communications Engineers

FCC Applications, Design & Field Engineering
Broadcast Engineering Software
216 N. Green Bay Rd.
Thiensville, WI 53092

(414) 242-6000

Member AFCEE

W. LEE SIMMONS & ASSOC., INC.

BROADCAST TELECOMMUNICATIONS CONSULTANTS

5 Gracefield Road
Hilton Head Is., SC 29928
(803) 785-4445

Moffet, Larson & Johnson, Inc.

Consulting Telecommunications Engineers
Two Skyline Place
5203 Leesburg Pike #800
Falls Church VA 22041
703-824-5660
800-523-3117
Member AFCEE

MIRKWOOD ENGINEERING

Rural & Remote Site Field Engineering

50 Park Ave.
Claremont, NH 03743
603/542-6784

NETCOM (201) 837-8424

Network Communications Consultants
State of the Art Engineering for Audio & Video
James Tronolone
931 Teaneck Road
Suite A-1
Teaneck, NJ 07666

SOFTWARE FM CHANNEL SEARCH

FM Database pool
MSDOS
EGA Graphics-Color
Broadcast Technical Consulting
Doug Vernier
Broadcast Consultant
1600 Picturesque Drive
Cedar Falls, IA 50613
319-266-7435

R.L. Kennedy & Associates

Telecommunications Engineering Consultant
Radio-TV-ITFS-Microwave

P.O. Box 141
Waynesville, NC 28786
(704) 648-3283

SPECIALIZING IN ERECTION, REPAIRING, PAINTING AND MAINTENANCE RADIO, TWO-WAY, TV TOWERS AND FLAG POLES

A STEEPLEJACK CO.

PAINTING AND STEEPLEJACK CONTRACTORS
FULLY INSURED FOR YOUR PROTECTION

DON HIGHLEY 3722 ROMA HOUSTON, TEXAS 77080
482-6105

MAGRILL ENGINEERING

(904) 591-3005

APPLICATIONS—CONSTRUCTION
UTILITY PROBLEMS SOLVED
FAIRFIELD, FLORIDA

Patton Circuit Systems

FCC Applications
Studio/Transmitter Installations
AM Directional Antennas
AM Antenna Broadbanding
General Field Engineering
Equipment Rebuilding/Calibration
AM Stereo
Nationwide & Overseas
Mike Patton (504) 292-4189
Baton Rouge LA

SPENCER BROADCAST

The Radio Station Specialists

Chuck Spencer
Phoenix, AZ
602-242-2211

EMPLOYMENT

To place ads in this section, use the ActionGram form. To respond to box numbers, write Radio World, PO Box 1214, Falls Church, VA 22041, Attn:

POSITIONS WANTED

27 yr old w/hands on exp seeks opportunity for more experience in AM, FM eng, have FCC general phone, SBE certified & NARTE. Mark, 304-525-3981.

CE, NBN, CE NJ state radio station, CE HBO MDS, seeks FT/PT employment, contracted work also welcome. M Rakoff, 114-41 Queens Blvd Ste 148, Forest Hills NY 11375. 718-591-0002.

DJ looking for work in LA, exper, Vietnam vet, any job in radio. R Nabor, 2342 Harwood St, LA CA 90031. 213-223-2799.

Exper GM seeking work in FL/SE area, ambitious, willing to relocate, team-player. Write: GM, POB 1401, Eilers FL 34680.

20 yr veteran career broadcaster, 12 yrs small market general management exp seeking growth opportunity, resume & qualifications upon request. Write: RW, POB 1214, Falls Church VA 220041. Attn: 2-2-89RW.

20 yr veteran chief seeks small market, wizard w/satellite, automation, processing & can make old equip sing, can pull air shift, will relocate. 802-394-7858.

Attention owners & GM's. Cut costs down to the bone w/me as OM/PD. My CHR format will make you number one. FM's only. Fox Hunter. 619-322-8855.

Exp tech at DA-3 8 tower AM-FM station seeks employment in heartland. J Scherer, Rt 1, Bell City MO 63735. 314-733-4398.

CE w/20 yrs exper in radio seeking position, familiar w/DA's, installation of transmitters & studios, people person, F White, POB 1825, Marathon FL 33050.

Electronic tech, ham radio, FCC lic/satellite TV installer for down link, needs position w/radio or TV station in NYC. M Saint-Cyr, 527 Maple St, Brooklyn NY 11225. 718-604-1617.

Exp CE seeks new opportunities, hands-on exper in all phases of FM & AM directional, FCC general & SBE Sr certification. 804-276-4597.

Radio eng position wanted by 26 yr old w/exp & schooling, neat, professional habits, contract work considered, prefer Wisconsin. Chuck, 715-423-6763.

HELP WANTED

The new V103, WVAZ is seeking a maintenance engineer with a proven proficiency in the repair & maintenance of bdct equipment. In particular, the person will be able to diagnose & repair, to the component level, xmtrs & related RF & microwave equipment, broadcast consoles, both the mechanical & electronic areas of tape cartridge machines, R-R tape decks, turntables, CD players & other types of equipment. In addition, the engineer will have knowledge in the construction of studios, design & fabrication of audio switching or other related electronic circuits. This is a union position. Send complete history to Sid Schneider, Operations Manager, WVAZ Radio, 408 South Oak Park Ave, Oak Park IL 60302. No phone calls. An EOE.

Contact
Radio World
PO Box 1214, Falls Church VA 22041
for availabilities. Phone 800-336-3045

TAX . . .
 Full Gospel Business Men's Fellowship is seeking tax deduct donations of all types of new or used audio & video equip for LPTV station. D Susong, 1939 Hill Trail Dr, Morristown TN 37814. 615-587-3915.

SCA subcarrier receivers, any cond, for non-profit radio reading service. T Vernon, Assn for the Blind, 1800 N 2nd St, Harrisburg PA 17102. 717-238-2531.

Harris 994-7023-001 stereo gain set, new cond, \$700/BO; B&W 410 dist analyzer, new cond, \$400/BO. S Daltch, Box 8091, Greenville NC 27835. 919-355-6543.

Tek 491 spectrum analyzer, \$1500; Tek492 spectrum analyzer, clean, repairable, \$7800; General Avionix USM-117C solid state portable scope, excel cond, w/plug-in, book, probes, \$125. M Murphy, 11621 Valle Vista Rd, Lakeside CA 92040. 619-561-2726.

TEST EQUIPMENT

Want to Sell
 B&K 1260 NTSC video pattern/sync gen, 1 yrs old, mint cond, \$1200. B Hoover, Box 39, Valier PA 15780. 814-938-7237.

Dukane 99A600 audio spectrum analyzer, BO. D Sis, St John's Univ, Collegeville MN 56321. 612-363-3378.

Want to Buy
 GR 1606A RF impedance bridge. J Glass, Northern IL Univ, De Kalb IL 60115. 815-784-2179.

GR 1606A or 1606B RF impedance bridge, must be in gd working cond w/manual & adapters to standard coaxial cable connectors. E Wilk, 312-237-2283.

Potomac AT-51 audio test set, audio analyzer & audio gen, perf cond, \$2500. S Citurzo, Infovideo, POB 879, Cardiff CA 92007. 619-268-3000.

TRANSMITTERS
Want to Sell
 AM xmtrs: GE 50 kW, Collins 21-E 5 kW, Gates BC-5E, Raytheon, RCA BTA-5T 1 kW, Gates BC-1J, BC-1G, BC-1F, RCA BTA-1R & many others, warranted. Jerry 315-488-1269.

Tek IL30 spectrum analyzer plug-in, \$700. B Dickerson, WEAG, POB 520, Stanke FL 32091. 904-964-5001.

BEST Inc.

High performance at affordable prices.
 10, 20, 30 and 80 W exciters.
 100, 250, 500, 1000 W solid state amplifiers.
 All front panel programmable, broadband.
 1000, 2000, 3000, and 5000 W tube amplifiers.
 2 and 20 W STLs.
 24 Hr. technical support on call.

HP 206CD, audio osc, as new, w/manual, \$100. J Martin Newman, Box 7703, Atlanta GA 30357. 404-876-8623.

Bext, Inc.
 739 Fifth Avenue.
 San Diego, CA 92101
 619-239-8462
 Telex 229882LJMUR

RCA WX2D field strength meter w/book, \$500. J Heck, Gallup Bdcg, 401 E Coal, Gallup NM 87301. 505-863-4444.

STOP WASTING YOUR TIME CALL BERNARD GELMAN ASSOCIATES FOR ALL YOUR EQUIPMENT NEEDS NEW OR USED (813) 646-4101

Tek 523A vector & 1480R wfm test equip, \$1500 ea. Steve, Box 10673, Denver CO 80210. 303-399-6444.

Bauer 610 FM 5 kW, uses McMartin B-910 exciter & 4CX5000A final, tuned to 103.1, \$5000/BO. P Martin, 414-482-2638.

Telemet 4504A1, synchronous detector, gd cond, \$300; Telemet 4501, TV demodulator, presently chnl 2, gd cond, \$300; Telemet 3705 envelope measurement set, gd cond, \$200. Aidon Video, 424 Commerce Ln, Berlin NJ 08009. 609-768-2439.

CSI T-25-F1 25 kW FM, tuned to 95.1 MHz, 1985 model, new final, relay panel & spare parts, gd cond, BO. J Clark, WRKU, 4531 Belmont Ave, Youngstown OH 44505. 216-759-0579.

Yaesu YC-355D freq counter, \$100. E Kain, WNOE, 529 Bienville, New Orleans LA 70130. 504-529-1212.

Harris TE3 exciter, w/SCA, stereo & (2) matched parts, output xistors for RF amp, \$700. W Clark, RRR2 Box 151, Pittsfield IL 62363. 217-285-6234.

Coaxial Dynamics 81001-A power meter, new, w/ext input, 1-5/8 flange, elements from 100 W to 5 kW, never used, \$500; London Instruments deviation meter, calib mod monitors, check STL & Marti deviation, etc, tunes to 1 GHz, \$800; HP 330D, fair, \$50; Digimax D-1200 freq ctr, \$250. P Morton, WRQL, POB 57, Rupert VT 05768. 802-394-7858.

Marti RPT40 transmitter, BO. T Storck, KTRF, Thief River Falls MN. 800-426-1003.

GR 1606B RF bridge w/accessories, manual & carrying case, \$1500/firm. ST Carter II, Cartronics, POB 3177, Indialantic FL 32903. 407-727-3015.

Parts for RCA BTF20E1, sold as package, \$5000/BO. J Schloss, KICD, 2600 Hiway Blvd, Spencer IA 51301. 712-262-1240.

RCA WX-2C (Potomac FIM-120-E) AM field intensity meter, excel physical & elec cond w/manual, \$400 or trade for Revox A-77 or Sparta 5-mixer stereo remote console w/power supply. D Sites, 5809-K Cambridge Dr, Springfield VA 22152.

BTF-1E, 1 kW FM RCA xmtr; BTE-10C FM RCA exciter; RCA BFA-4-A, 4 bay antenna; RCA BTS-1A, stereo subcarrier gen; Collins 26U-2 FM stereo limiter, \$5000 all. P Knies, WBDC, POB 330, Huntingburg IN 47542. 812-683-4144.

GR 1606B RF bridge w/accessories, manual & carrying case, \$1500/firm. ST Carter II, Cartronics, POB 3177, Indialantic FL 32903. 407-727-3015.

CCA FM 10000, refurbished before purchase 1.5 yrs ago, never used since purchase, now less exciter, \$7500. J Nicholson, Central Coast Bdcg, POB 666, Lincoln City OR 97367. 503-996-6800.

Dielectric 620-0675 3 dB hybrid combiners/splitter, has 4, 3-1/8" flanged ports, never used in perf cond, \$1800 pls shpg; 3 port RF patch bay 3-1/8" flanged, \$150 pls shpg. B Roberts, ARP Studios, POB 325, Mt Pleasant SC 29465. 803-928-3663.

FM xmtrs: GE 3 kW, Harris 5H, 5G, 5B 5 kW, 10 kW, Collins 830, CCA 10,000DDS, RCA BTF10-D, 20-25 kW CCA 25000DDS, Harris FM 20K, 1 kW, Collins 1000D, Gates FM-1B, FM-1-C & others. Jerry 315-488-1269.

Gates FM-1B xmtrs (2), 1 hardly used, other so-so, w/brand new THE-1 exciter, or w/TE-1 exciter, stereo gen & SCA gen, many spare parts, new & spare tubes, sell all or part, call; also Collins 250 W, AM for standby, \$400. P Morton, WRQL, POB 57, Rupert VT 05768. 802-394-7858.

QEI 695 3.5 kW FM xmtr, 3.5 yrs old, taken out of srvs 11/88, BO. R Eller, KBUS, 2775 NE Loop 286, Paris TX. 214-785-1068.

RCA BTA 5F 5 kW AM excel cond, electronically & physically, in storage ready for immed shipment, wall floor layouts, manuals, all tubes necessary for operation, \$10,000 plus loading & shpg. G Heidenfeldt, 2880 W Lake Rd, Wilson NJ 14172. 716-751-6187.

3.5-5 kW FM to operate on 93.9 MHz, prefer grounded grid final. D Jordan, WDTM, POB 3417, Jackson TN 38303. 901-668-1153.

FM xmtr, 20 kW, gd cond, w/manual, CCA, Harris, Continental or Collins. A Chambers, WAWZ, Box 37, Weston Canal Rd, Zarephath NJ 08890. 201-469-0991.

FM xmtr, 100-200 W & exciter & any related xmission equip. R Madura, Christian Comm Ctr, 1942 Grand Ave, Wausau WI 54401.

Gates BFE-10C for a Gates BFE-10C FM xmtr. S Zurbrick, KOSA, 1211 N Whitaker, Odessa TX 79760. 915-337-8301.

Harris or other late mdl AM xmtr, 1 kW, must be less than 10 yrs old, gd shape. P Salois, KPCR, POB 1, Bowling Green MO 63334. 314-324-2283.

UHF band, 100 W, 1 kW, 10 kW. AACT Inc, 156 Lazelle Rd, Wontington OH 43085. 614-846-9234.

EF86 tubes (10-12), for Gates console, new or used. S Budd, WRPS, 34 Goddard, Rockland MA 02370. 617-871-0724.

ARMSTRONG TRANSMITTER CO.
 Syracuse, NY
 Phone: (315) 488-1269
 Re-Manufacturers of Radio Transmitters

Used & Rebuilt Units in Stock—All AM/FM Power Levels
 • Reasonable Rates—90 Day Warranty
 • PCB Replacement, Re-Tuning & Installation Available
 • Trade-Ins Accepted
 Visit Our Showroom See Before You Buy

Elcom Bauer 690 exciter, tuned to 91.7, \$500. M Rigney, WMCN, 1600 Grand, St Paul MN 55105. 612-696-6082.

Gates 10 W xmtr; Gates Yard, mono, 8 ch board, BO. B Yates, St Josephs College, Windham ME 04062. 207-892-6766.

Gates/Harris BC-5E, 5 kW AM & BC-1F, 1 kW AM, excel cond, many spare parts, remote controllable, tested monthly since 5/85, \$10,000/BO. T Laffan, WDEV, 9 Stone St, Waterbury VT 05676. 802-244-7321.

Gates BC250G4, new tubes & plate transformer, \$1500. R Ness, WCSJ, POB 270, Morris IL 60450. 815-942-0022.

RCA TTU-12 UHF TV xmtr, 12 kW, no exciter, prefer to donate to non-profit organization. C Haynes, POB 31235, Jackson MS 39206. 601-948-1515.

TMC 6PT 4016 40 kW SSB xmtr, \$6500. M Murphy, 11621 Valle Vista, Lakeside CA 92040. 619-561-2726.

Transmitters, 1 kW AM, 5 kW AM, 5 kW FM, 25 kW FM replaced w/new ones. John 315-488-1269.

ARMSTRONG TRANSMITTER CO.
 Syracuse, NY
 Phone: (315) 488-1269
 Re-Manufacturers of Radio Transmitters

• Used & Rebuilt Units in Stock—All AM/FM Power Levels
 • Reasonable Rates—90 Day Warranty
 • PCB Replacement, Re-Tuning & Installation Available
 • Trade-Ins Accepted
 Visit Our Showroom See Before You Buy

Gates 10 W xmtr; Gates Yard, mono, 8 ch board, BO. B Yates, St Josephs College, Windham ME 04062. 207-892-6766.

Gates/Harris BC-5E, 5 kW AM & BC-1F, 1 kW AM, excel cond, many spare parts, remote controllable, tested monthly since 5/85, \$10,000/BO. T Laffan, WDEV, 9 Stone St, Waterbury VT 05676. 802-244-7321.

Gates BC250G4, new tubes & plate transformer, \$1500. R Ness, WCSJ, POB 270, Morris IL 60450. 815-942-0022.

RCA TTU-12 UHF TV xmtr, 12 kW, no exciter, prefer to donate to non-profit organization. C Haynes, POB 31235, Jackson MS 39206. 601-948-1515.

TMC 6PT 4016 40 kW SSB xmtr, \$6500. M Murphy, 11621 Valle Vista, Lakeside CA 92040. 619-561-2726.

Transmitters, 1 kW AM, 5 kW AM, 5 kW FM, 25 kW FM replaced w/new ones. John 315-488-1269.

STOP WASTING YOUR TIME CALL BERNARD GELMAN ASSOCIATES FOR ALL YOUR EQUIPMENT NEEDS NEW OR USED (813) 646-4101

Continental 315F 5 kW AM, some spares, all docs, excel cond, clean & ready to ship, 1410 kHz, BO. R Sullivan, WPOP, 345 E Cedar, Newington CT 06111. 203-666-1411.

Gates BC1F, excel cond, now in service, \$2500. C Ratliffe, WADE, 1 Radro St, Wadesboro NC 28170. 704-694-2175.

Harris XTS-1 & XTM-1 AM stereo exciter & AM stereo mod monitor, \$3500. E Kain, WNOE, 529 Bienville, New Orleans LA 70130. 504-529-1212.

Harris TE3 exciter, w/SCA, stereo & (2) matched parts, output xistors for RF amp, \$700. W Clark, RRR2 Box 151, Pittsfield IL 62363. 217-285-6234.

Marti RPT40 transmitter, BO. T Storck, KTRF, Thief River Falls MN. 800-426-1003.

Parts for RCA BTF20E1, sold as package, \$5000/BO. J Schloss, KICD, 2600 Hiway Blvd, Spencer IA 51301. 712-262-1240.

BTF-1E, 1 kW FM RCA xmtr; BTE-10C FM RCA exciter; RCA BFA-4-A, 4 bay antenna; RCA BTS-1A, stereo subcarrier gen; Collins 26U-2 FM stereo limiter, \$5000 all. P Knies, WBDC, POB 330, Huntingburg IN 47542. 812-683-4144.

CCA FM 10000, refurbished before purchase 1.5 yrs ago, never used since purchase, now less exciter, \$7500. J Nicholson, Central Coast Bdcg, POB 666, Lincoln City OR 97367. 503-996-6800.

Dielectric 620-0675 3 dB hybrid combiners/splitter, has 4, 3-1/8" flanged ports, never used in perf cond, \$1800 pls shpg; 3 port RF patch bay 3-1/8" flanged, \$150 pls shpg. B Roberts, ARP Studios, POB 325, Mt Pleasant SC 29465. 803-928-3663.

FM xmtrs: GE 3 kW, Harris 5H, 5G, 5B 5 kW, 10 kW, Collins 830, CCA 10,000DDS, RCA BTF10-D, 20-25 kW CCA 25000DDS, Harris FM 20K, 1 kW, Collins 1000D, Gates FM-1B, FM-1-C & others. Jerry 315-488-1269.

Gates FM-1B xmtrs (2), 1 hardly used, other so-so, w/brand new THE-1 exciter, or w/TE-1 exciter, stereo gen & SCA gen, many spare parts, new & spare tubes, sell all or part, call; also Collins 250 W, AM for standby, \$400. P Morton, WRQL, POB 57, Rupert VT 05768. 802-394-7858.

QEI 695 3.5 kW FM xmtr, 3.5 yrs old, taken out of srvs 11/88, BO. R Eller, KBUS, 2775 NE Loop 286, Paris TX. 214-785-1068.

RCA BTA 5F 5 kW AM excel cond, electronically & physically, in storage ready for immed shipment, wall floor layouts, manuals, all tubes necessary for operation, \$10,000 plus loading & shpg. G Heidenfeldt, 2880 W Lake Rd, Wilson NJ 14172. 716-751-6187.

RCA mod transformer for BTA 5F xmtr, new, in original crate, \$600 pls shpg. G Heidenfeldt, 2880 W Lake Rd, Wilson NJ 14172. 716-751-6187.

RCA 100X AM xmtr for parts, transformers, chokes, capacitors, some vacuum, relays, breaker switches, meters, large supply of 200 W wirewound resistors & misc. R Elm, WWJC, 1120 E McCuen St, Duluth MN 55808. 218-626-2738.

RCA BTA 50 F 50 kW AM, excel operating cond, recently removed from service, in storage for immed shipment, w/all tubes, schematics, floor plans, many extras, electrostatic air filter, solid state rectifiers, magnaphone lightening protection, etc, \$18,000 pls loading & shpg. G Heidenfeldt, 2880 W Lake Rd, Wilson NJ 14172. 716-751-6187.

Tepeco/Bob Jones J317-M 10 W FM transla-tor, used 1 month, new cond, \$1500. F Shields, Shields Comm, POB 351, Hunt TX 78024. 512-895-1230.

Want to Buy
 AEL AM5KD oscillator card 4A14 & Sanken audio amp plug-in module. R Jenkins, WAVL, POB 277, Apollo PA 15613. 412-468-4020.

AM 10 kW, gd cond; 3 or 4 tower phasor w/tuning unit. T Gray, WSM, POB 900, Graham NC 27253. 919-227-4254.

3 kW FM, FM mod monitor & FM stereo monitor. R Hughes, 205-456-1362.

Exciter, any cond & freq, need now. M Benson, 9872 Esquon, Durham CA 95938. 916-893-5531.

FM 10 kW in gd shape, operate at 97.3 MHz, prefer Harris, Continental or other that is still factory supported. B Cole, KSHR, 1270 W 13th, Coquille OR 97423. 503-396-2141.

FM exciter. J Panza, PAVS, Box 9847, Kansas City MO 64134. 816-966-1587.

Late model 20-25-30 kW FM, must be perf operating cond. D Dovich, 314-721-1247.

Tube type, older mdl exciter, low price range w/FM stereo gen if possible. S Dorsey, Radio Techwood, 711 Techwood Dr, Atlanta GA 20332. 404-676-1207.

Used xmtr, working or not, will remove. M Miller, Miller Tech, Box 3437, Chico CA 95927. 916-893-8737.

3.5-5 kW FM to operate on 93.9 MHz, prefer grounded grid final. D Jordan, WDTM, POB 3417, Jackson TN 38303. 901-668-1153.

FM xmtr, 20 kW, gd cond, w/manual, CCA, Harris, Continental or Collins. A Chambers, WAWZ, Box 37, Weston Canal Rd, Zarephath NJ 08890. 201-469-0991.

FM xmtr, 100-200 W & exciter & any related xmission equip. R Madura, Christian Comm Ctr, 1942 Grand Ave, Wausau WI 54401.

Gates BFE-10C for a Gates BFE-10C FM xmtr. S Zurbrick, KOSA, 1211 N Whitaker, Odessa TX 79760. 915-337-8301.

Harris or other late mdl AM xmtr, 1 kW, must be less than 10 yrs old, gd shape. P Salois, KPCR, POB 1, Bowling Green MO 63334. 314-324-2283.

UHF band, 100 W, 1 kW, 10 kW. AACT Inc, 156 Lazelle Rd, Wontington OH 43085. 614-846-9234.

TUBES
Want to Sell
 Machlett 6166A/7007, new (3), excellent condition, \$2200 each. M Murphy, 11621 Valle Vista, Lakeside CA 92040. 619-561-2726.

833A, \$100; 813, \$40; 845, \$770; 6146B, \$12; 807, \$5.95, new production 6 month/2000 hr warranty, Stanton 500 AL stylus-generic \$3.95, original \$7.95; 500 cartridge E or AL needle, \$12.95; Shure M-44C cartridge, \$21; generic stylus, \$3.95; original \$11.95 MTS EC cartridge, \$9.95, we ship prepay/COD/Amex. Triode Elect, Chicago IL 60618. 312-871-7459. Fax: 312-871-7938.

REBUILT ELECTRON TUBES
 Partial List: 6623, 23791, TH150, 6425F, 5604, 6696, 6697, 5681, 5682, 5671, 7804, 3CX10, 000H3, 3CX20, 000H3, 4CS5000A, 4CX35, 000C
Vacuum Tube Industries, Inc.
 1-800-528-5014

EIMAC 4CX-15000 (2), near new cond, \$800 ea. L Peters, 2211 Rolling Hills, Lancaster TX 75146. 214-223-3786.

Tubes, 4-250A, some new, some good used, some unknown. John or Mike, KMZU, 102 North Mason, Carrollton MO 64633. 816-542-0404.

Want to Buy
ELECTRON TUBES
 Partial List: 6623, 23791, TH150, 6425F, 5604, 6696, 6697, 5681, 5682, 5671, 7804, 3CX10, 000H3, 3CX20, 000H3, 4CS5000A, 4CX35, 000C
Vacuum Tube Industries, Inc.
 1-800-528-5014

IMAC 4CX-15000 (2), near new cond, \$800 ea. L Peters, 2211 Rolling Hills, Lancaster TX 75146. 214-223-3786.

Tubes, 4-250A, some new, some good used, some unknown. John or Mike, KMZU, 102 North Mason, Carrollton MO 64633. 816-542-0404.

Want to Buy
ELECTRON TUBES
 Partial List: 6623, 23791, TH150, 6425F, 5604, 6696, 6697, 5681, 5682, 5671, 7804, 3CX10, 000H3, 3CX20, 000H3, 4CS5000A, 4CX35, 000C
Vacuum Tube Industries, Inc.
 1-800-528-5014

IMAC 4CX-15000 (2), near new cond, \$800 ea. L Peters, 2211 Rolling Hills, Lancaster TX 75146. 214-223-3786.

Tubes, 4-250A, some new, some good used, some unknown. John or Mike, KMZU, 102 North Mason, Carrollton MO 64633. 816-542-0404.

Want to Buy
ELECTRON TUBES
 Partial List: 6623, 23791, TH150, 6425F, 5604, 6696, 6697, 5681, 5682, 5671, 7804, 3CX10, 000H3, 3CX20, 000H3, 4CS5000A, 4CX35, 000C
Vacuum Tube Industries, Inc.
 1-800-528-5014

IMAC 4CX-15000 (2), near new cond, \$800 ea. L Peters, 2211 Rolling Hills, Lancaster TX 75146. 214-223-3786.

Tubes, 4-250A, some new, some good used, some unknown. John or Mike, KMZU, 102 North Mason, Carrollton MO 64633. 816-542-0404.

Want to Buy
ELECTRON TUBES
 Partial List: 6623, 23791, TH150, 6425F, 5604, 6696, 6697, 5681, 5682, 5671, 7804, 3CX10, 000H3, 3CX20, 000H3, 4CS5000A, 4CX35, 000C
Vacuum Tube Industries, Inc.
 1-800-528-5014

IMAC 4CX-15000 (2), near new cond, \$800 ea. L Peters, 2211 Rolling Hills, Lancaster TX 75146. 214-223-3786.

Tubes, 4-250A, some new, some good used, some unknown. John or Mike, KMZU, 102 North Mason, Carrollton MO 64633. 816-542-0404.

We buy electron tubes.
 Contact us if you any for sale.
PATH
 507 Superior Ave.
 Newport Beach CA 92663
 714-722-6733

Gray 303 12" tone arms (2) in gd cond, no junk. M Rockwell, WNB, Box 309, Park Falls WI 54552. 715-762-3221.
 Gray 212 12" tonearm or equiv. J Schloss, KICD, 2600 Hiway Blvd, Spencer IA 51301. 712-262-1240.
 Shure Rek-O-Kut 16" tonearm. J Panza, PAVS, Box 9847, Kansas City MO 64134. 816-966-1587.
 CCA/QRK Ultimate TT preamps, stereo/mo-no, any cond. K Smith, RR 3 Box 483A, Gorham ME 04038. 207-929-6129.

Quantel DPE-5000 Plus 2 chnl DVE w/rotation & perspective, 3 sets control panels & switch over, \$10,000. D Thranhardt, 1491 Silver Lake Dr, Norcross GA 30093. 404-381-7632.

Vital VIX114A/4 three M/E production switcher with 24", rotary and spin wipes, auto transitions, three CKs one enc CK edgers in all keyers, \$7000. D Thranhardt, 1491 Silver Lake Drive, Norcross GA 30093. 404-381-7632.

Want to Buy

IVC 9000, one or two machines; standards conversion unit, must be in good working condition. H Henson, Henson Prod, 3796 Bethania Station Road, Winston Salem NC 27106. 919-924-8717.

VIDEO TAPE RECORDERS

Want to Sell

Hitachi HR-200 1" VTR, operational now, but needs repairs, w/TC-200 TBC in excel cond, \$3500 plus shpg. A Denke, American Motion Pictures, 206-789-1011.

JVC CR6600U 3/4" VCR w/RM70U remote ctrl, \$1295; Harris 690 frame sync TBC w/9 bit processing, corrects 1", 3/4" & 1/2", \$3295. D Brennan, Kustom Video, 3596 Lorna Ridge Dr, Birmingham AL 35216. 205-823-0088.

JVC CP5200, \$175. J Krepol, RNDL, 6147 Walker St, Phila PA 19135. 215-624-1050.

WORLDWIDE DIGITAL CONVERSION
 ALL FORMATS BROADCAST QUALITY
 Pal Multi-dupe/Hi-Band

TK VIDEO 12300 Coppola Drive
 Potomac, MD 20854 301-762-2786

JVC CR-4900U portable 3/4" U-matic VTR w/2 batt, charger/PS, case, excel cond, \$1850; Leader portable color monitor/waveform scope uses NP-1 batt, vgc, \$995. R Miller, Fil-maker Inc, 606 W Broad, Bethlehem PA 18018. 215-691-0900.

Panasonic NV 9400 portable 3/4" VCR, gd cond, \$995. W Carnes, KIIIT, POB 8234, Jacksonville TX 75766. 214-586-2162.

JVC editing system, CR-850, 6650, RM-86, excel cond, 250 hrs, manual, BO. R Hielt, WHSV, Rt 33 West, Harrisonburg VA 22801. 703-433-9191.

Sony VP2000, \$200; VO2600, \$250; VO2610, \$275; VO2630, \$350; VO2800, \$375; VO2860, \$500; VO2860A, \$600. J Krepol, RNDL, 6147 Walker St, Phila PA 19135. 215-624-1050.

TCR-100 2" video cart machine, gd cond, \$2500/BO. D Gerisch, WMTV, 615 Forward Dr, Madison WI 53711. 608-274-1515.

JVC CR8500LU 3/4" editing system, (2) VCR machines with 850 controller, very good, \$3750/Best Offer; Ampex VR1200 2" quad VTR, \$3500. Steve, Box 10673, Denver CO 80210. 303-399-6444.

Ampex VPR-5800 1" VTR, needs some work, \$200. N Metzger, 312-989-1101.

Sony VO-4800 portable 3/4" VCR, vgc with AC and two batteries, \$1250; JVC KY-2700 3 band matched saticon tube color camera with 12:1 servo zoom, AC, battery and hard case, vgc, \$2600; Anton Bauer Super D-14F 4 NiCad 14.4 V batteries, belt and charger/case, excellent condition, \$900. S Vanderberg, Hugh Morris Productions, PO Box 232, Jenison MI 49429. 616-895-3105.

Want to Buy

1" deck in good condition, under \$7000. C Weisshahan, 249 West 29th St, New York NY 10001. 212-563-6612.

TV FILM EQUIP

Want to Sell

B&H 614 EVMS 16mm telecine projector w/pedestal magnetic & optical sound, w/manuals, excel cond, \$1250; Telemation TM 203, full size multiplexer, w/manuals, gd cond, \$425. G Ormrod, GFO Prod, 432 E X St, Tum-water WA 98501. 206-352-8028.

RCA TK-27 camera only, \$500 plus shpg or trade. W Ellis, KOZK, MPO Box 21, Springfield MO 65801. 417-865-2100.

RCA TK27 film chain w/TP66 16mm-35mm simplex & slide projector; Buhl biplexer w/Elmo 16mm-8mm & super 8 w/sound, \$2500; Vital 114-10X video switcher 1ME, RG chromakeyer & audio follow & DSX, \$5,000/BO. T Judge, Tag Comm, 74 Weaver Rd, W Millford NJ 07480. 201-208-0180.

Eimo 16mm CLTC 24-fps projector for transferring films to video, synchronous motor, 5-bladed shutter, easy channel loading system, optical or magnetic sound, 12.5mm lens, perfect cond, \$750; Sony VCR-4 Uniplexer, \$120; will sell separately or \$800 for both. W Watrous, Watrous Prod, 745 S Orange Ave, Sarasota FL 34236. 813-366-3316.

Want to Buy

35mm telecine projector needed. W Carnes, K11RT, POB 823A, Jacksonville TX 75766. 214-586-2162.

Dumont TV camera chain, also need (2) Houston/Fearless TV tripods. A Weiner, Britton Rd, Montecillo ME 04760. 207-538-9538.

Kodak VP-1 Super 8 film-video player. D Dewese, WJYM, 8761 Fremont Pike, Perrysburg OH 43551. 419-874-7956.

VIDEO PROD EQUIP

Want to Sell

3M DP100 proc amp, \$500; Ampex 1085 proc amp, \$250; Ampex VR1200 2" quad parts. J Krepol, RNDL, 6147 Walker St, Phila PA 19135. 215-624-1050.

Conrac monitors (2), color 17" w/external sync & underscan 1 YCA 1 YCB, whole or parts; RCA tripod dolly & panhead for bdc studio, 250 lbs, \$550. R Falkenstein, Tri God Ministries, 3447 Arbor St, Phila PA 19134. 215-739-6599.

JVC RM 86U edit controller, new, \$900; For-A 440A TBC w/VEC-440, 8 mos old, \$6200; Prime Image Plus TBC, 8 mos old, \$2500. J Jones, RBY Recording, 920 N Main, Southbury CT 06488. 203-264-3666.

Knox K-128/K-32 char gen w/acc, gd cond, \$450. M Murphy, 11621 Valle Vista, Lakeside CA 92040. 619-561-2726.

Laird 7000 char gen w/extra fonts, \$1500. JVC 1900 3 tube camera studio & ENG config, mint cond, low hrs, w/extras, \$2000. J Jones, RBY Recording, 920 N Main, Southbury CT 06488. 203-264-3666.

Sony VO-2860A (2), \$650 ea; Sony VO-4800 (2), \$1200 ea; Precision Echo video compression unit, \$2500; RCA TR-600 2" VTRs (2), \$2500 ea; Sony BVE-500-A editor, \$400; CVS-520 digital TBC, \$1000; Microtime Image Plus, signal processor, \$1500. D Gerisch, WMTV, 615 Forward Dr, Madison WI 53711. 608-274-1515.

JVC CP-5500U, CR8200U, Cezar edit ctr, 34" edit system, \$3000; JVC CR-4700U 34" portable deck w/JVC TGP470 time code gen, \$3000. C Weisshahan, 249 W 29th St, NY NY 10001. 212-563-6612.

Quanta Q7, character gen, \$900; Tek 1470, sync gen, \$1000; Conrac DZB-15, high res, B/W mon, \$200; RCA TG-6 sync gen, \$200; EECO MTG, time code gen, new, \$600. Aldon Video, 424 Commerce Ln, Berlin NJ 08009. 609-768-2439.

Quanta Select 7 character gen, disc drive, 7 fonts, 250 pages, \$2850/BO; 3M D5000 character gen, 100 pages, 8 fonts, 512 colors, \$2850. Steve, Box 10673, Denver CO 80210. 303-399-6444.

ITE P-6 pedestals w/H-2 cam heads, new cond, counterbalance pedestals w/cam heads, \$6000 for both. D Thranhardt, 1491 Silver Lake Dr, Norcross GA 30093. 404-381-7632.

Panasonic AG-A600 remote controllers (5) w/search dial, new, \$10 ea; Panasonic NV C80 extension cables (7), \$5 ea; Comprehensive Video E8P, E8P-50 50' EIAJ 8 pin to EIAJ 8 pin video cables (3), \$5 ea. P Russell, Bowdoin College, AV Services Sills Hall, Brunswick ME 04011. 207-725-3066.

ACTIONGERRAM

Equipment Listings

Radio World's Broadcast Equipment Exchange provides a FREE listing service for all broadcast and pro-sound end users. Simply send your listings to us, following the example below. Please indicate in which category you would like your listing to appear. Mail your listings to the address below. Thank you.

Contact Name: _____
 Title _____
 Company/Station _____
 Address: _____
 City, State, Zip: _____
 Phone Number: _____

I would like to receive or continue receiving Radio World FREE each month. YES NO
 Signature _____ Date _____

Please print and include all information:

Please circle only one entry for each category:

I. Type of Firm

- D. Combination AM/FM station
- A. Commercial AM station
- B. Commercial FM station
- C. Educational FM station
- E. Network/group owner
- F. Recording studio
- G. TV station/teleprod facility
- H. Consultant/ind engineer
- I. Mfg, distributor or dealer
- J. Other _____

II. Job Function

- A. Ownership
- B. General management
- C. Engineering
- D. Programming/production
- E. News operations
- F. Other (specify) _____

Brokers, dealers, manufacturers and other organizations who are not legitimate end users can participate in the Broadcast Equipment Exchange on a **paid basis. Listings are available on an \$25/25 word basis. Call 1-800-336-3045 for details and complete display rates.

WTS: WTB: Category: _____

Make: _____

Model #: _____

Brief Description: _____

Price: _____

WTS: WTB: Category: _____

Make: _____

Model #: _____

Brief Description: _____

Price: _____

WTS: WTB: Category: _____

Make: _____

Model #: _____

Brief Description: _____

Price: _____

WTS: WTB: Category: _____

Make: _____

Model #: _____

Brief Description: _____

Price: _____

Broadcast Equipment Exchange
PO Box 1214
Falls Church, VA 22041

Any of these problems sound familiar? Get to know Modulation Sciences' composite baseband solutions.

Solutions

Problems

- Transmitter noise, heat, RF field interference and physical location make the transmitter room a poor place to locate the stereo generator and audio processing. Necessary and critical adjustments are inconvenient at best; nearly impossible at worst!
- Lossy, expensive, hard-to-install 950 MHz semi-rigid coax is often impractical to run from the studio to the STL antenna on the roof.
- Fire codes won't let you run PVC jacketed coax through the ceiling, except in very expensive metal conduits.
- Long composite runs at the transmitter or studio pick up ground loop hum.
- You need to drive multiple exciters without composite level changes and switching or relay hassles.
- The station has two stereo generators and two transmitters. You want a simple way to matrix-switch them without requiring complex backloading.
- It's a pain to use your spectrum analyzer and other test gear to make composite measurements because of the hassles of interrupting the air feed to connect them.
- The PD, the CE and the GM all want to monitor and measure the station's quality. But buying three modulation monitors is out of the question.
- Keeping tabs on the competition's signal quality is important, but it's inconvenient and expensive to do.
- Lots of boxes use composite baseband—the STL, stereo and SCA generators and more. You need an easy, economical way to test their performance, and directly measure composite baseband signals.
- The station has an old modulation monitor gathering dust. You don't trust the readings, but can't it still be useful?

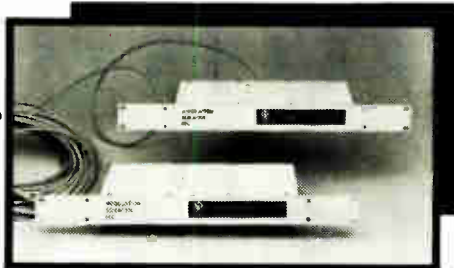

Modulation Sciences' CLD-2501/2 Composite Driver/Receiver

- ✓ Lets you put your stereo generators and audio processing where they belong—at the studio.
- ✓ Supports up to 3000 ft. (or two miles, on special order) of flexible, inexpensive, twinax cable – standard or PTFE-jacketed for plenum runs.
- ✓ Fully balanced against hum and noise pickup.
- ✓ 100 dB of immunity to ground-loop related noise and hum.
- ✓ Exceptional stereo separation and SNR performance.
- ✓ One driver can supply two independent receivers (each up to 3000 feet away in different directions) with composite stereo baseband audio and all SCA's.
- ✓ Works with 78 ohm twinax (Belden 9463) twinax for indoor service and 150 ohm twinax (Belden 9182) for outside or direct burial.



Modulation Sciences' CLD-2504 Composite Distribution Amplifier

- ✓ Makes distribution of composite baseband signals as easy as distributing audio.
- ✓ 1 composite input, 4 composite outputs.
- ✓ Unity gain with > 50 dB isolation between outputs.
- ✓ High impedance 50Ω input, low impedance outputs.
- ✓ BNC connectors on input and all outputs.
- ✓ Basic performance specs similar to Composite Line Driver.



Modulation Sciences' FM ModMinder™

- ✓ Provides all essential measurement functions of a high-quality modulation monitor when fed by any composite baseband audio source.
- ✓ Works with any wideband source of demodulated FM—even consumer tuners or stereo receivers.
- ✓ Displays total modulation percentage, overmodulation peaks, stereo & SCA subcarrier status, subcarrier injection level, allowable increase in modulation—all for about half the cost of a modulation monitor.
- ✓ If you have an old modulation monitor—even one that reads unreliably—that oldie's demodulator section can drive ModMinder. You get unbeatable accuracy at a \$3000 savings over the cost of a new modulation monitor.
- ✓ Plug-in cards adapt ModMinder to measure SCA subcarriers on non-standard frequencies.

Whether you have these audio distribution or measurement problems, or some unique puzzles of your own, Modulation Sciences has the convenient, cost-effective composite tools to help you solve them. Any further questions? Of course—so call 800-826-2603 Toll-Free for complete information and specifications on Modulation Sciences' Composite Problem Solvers.

modulation sciences, inc.

115 Myrtle Avenue • Brooklyn, New York 11201 • Tel. 718-625-7333 • Toll Free 800-826-2603



A SUCCESS STORY

THE OBJECTIVE was no small task: design a radio console that would become the new standard.

THE METHOD involved listening to veteran broadcast engineers and installers. After all, they're the people who have seen and experienced all the ideas that came before. From this research we learned of the problems that had to be solved and the features that broadcasters required. We then added ten years of console building experience and innovation, and created the A-500a console.

THE RESULT: An unsurpassed console that exceeds prior broadcast standards. Its module/mainframe interface borrows from the computer industry, utilizing all-gold contact insulation displacement technology. The logic system is based on programming the module slot, allowing full module interchangeability. It also provides for separate programming of the module's "B" input selection, thus avoiding embarrassing false starts and mutes. Full console-to-machine control is supported without extensive use of interface boxes and cables. Three audio busses are provided to enhance talkshows and remote functions. There are separate processing loops for the speech and music paths, as well as individual channel insert points. A complete line of microphone and line inputs, remote selectors, and machine control modules is offered in virtually any combination, configuration or mainframe size you desire. The A-500a also features a full family of studio turret and turret components to ease facility design.

THE PERFORMANCE: Needless to say, it's a new age for audio, and the A-500a is a step ahead. While specifications don't say it all, ruler flat frequency response, .003% distortion, crisp square wave response and a noise spec that's unheard of deserve merit. Couple such performance, reliability and innovation together, and a new broadcast standard is set.

THE SUCCESS: WHEATSTONE broadcast consoles are installed in major markets all over the country, from frontline independents to national networks. They are in use right now at some of the world's largest institutions.

THE POSSIBILITIES: The possibilities are up to you.



Wheatstone Corporation

6720 V.I.P. Parkway, Syracuse, N.Y. 13211 315-455-7740

Circle 77 On Reader Service Card

World Radio History