

Radio Guide

www.radio-guide.com

Digital Issue Now On-Line

January-February 2019 – Vol. 27, No. 1

Nautel – 50 Years of Worry-Free Transmission



Thank you
for **50 years**
from all of us
at **Nautel**

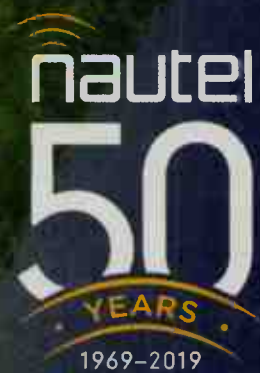

4351

*****AUTO**ALL FOR ADC 913
K.M. RICHARDS 556 PB
K.M. RICHARDS PROGRAMMING SVC.
PO BOX 7427
VAN NUYS CA 91409-7427

PRGRT STD
U.S. POSTAGE
PAID
PERMIT NO. 410
BEAVER DAM WI

AARON 650

FM REBROADCAST RECEIVER



For Challenging Reception Scenarios.

NEW! SportsCaster Simplifies Remotes!

For Radio or Video...it's the "missing link" that ties everything together.



SPORTSCASTER is an integrated system with everything in one place!
Used with Henry's Sports Pods, SportsCaster provides these functions...

- Talent mic audio mixing
- Talent headphone audio distribution
- Intercom between all announcers
- Talkback/Intercom facility for Producer
- Intercom between Producer and Talent
- Producer headphone audio mixing
- Field Reporter & Camera Ops headphone mixing
- Field Reporter Headphone output
- Intercom between Producer and Field reporter
- Party-line Intercom between Producer/Talent/Field reporter
- Camera Operators Headphones Output
- Talkback from Producer to Camera Operators
- Inputs for crowd mic, PA announcer, etc.
- Cue bus to audition auxiliary sources
- Main Program output to air or streaming

SportsCaster is the "missing link" that integrates all your audio and eliminates a carload of extra gear!

Call any Henry Engineering dealer, or visit www.henryeng.com. Tel: 562-493-3589



MID-MARKET STATION? HERE'S YOUR PERFECT CONSOLE.

Configurable from anywhere
World class AoIP network
Infinitely expandable
Dead simple to operate
Built to last - makes that drum beating bunny look like a short-timer
Priced to fit even the tightest budget
Made in the USA by the most trusted name in broadcast - Wheatstone

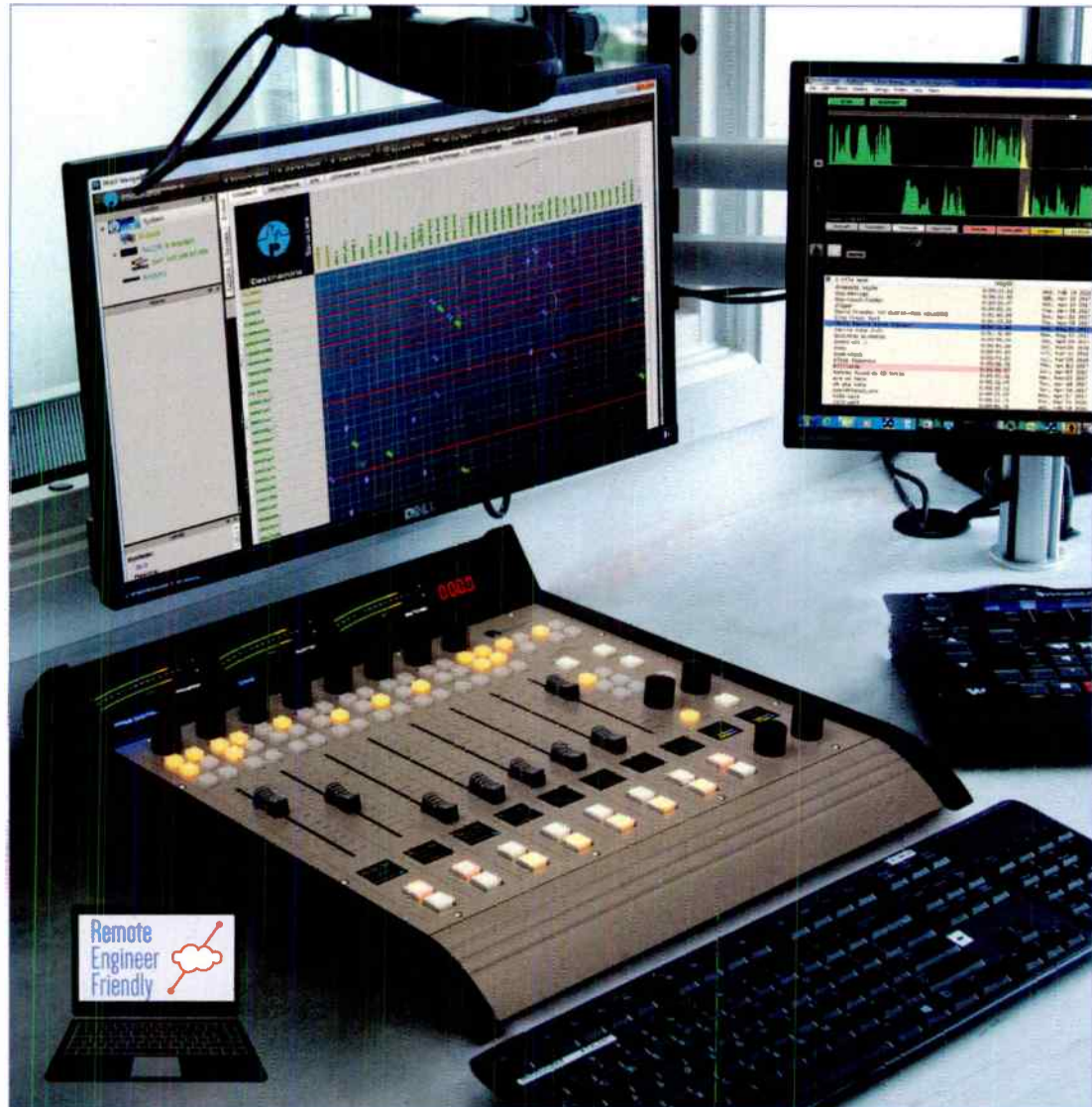

The DMX AoIP console defines power, simplicity, longevity, and value. Delivered ready to go, you just plug it in and are ready to broadcast. Included software lets your engineer access your system from anywhere at any time to handle your configuration needs. Expansion is just as easy. 8- or 16-channels. DMX grows as you grow.

DMX

8-Channel AoIP Networked DMX Console with Mix Engine I/O unit and Software **only \$4,999**

pre.com/



Bulletproof • Futureproof • Intuitive • USA-Made • Cost Effective

Designed and built in the USA by **Wheatstone** 252-638-7000 • sales@pre.com

World Radio History

Radio Guide

Contents

January-February 2019

In This Issue

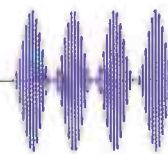

Critical Content for Radio

Cover Story	6
<i>Nautel Offers Heartfelt Thanks to Industry for 50 Years</i>	
Studio Site	8
<i>Blatant Latency</i>	
Maintenance Guide	10
<i>Transmitter SCR Power Control</i>	
FCC Focus	12
<i>FCC Enforcement: Issues/Programs List Requirements</i>	
User Report	14
<i>PCS Electronics Exciter Board Review</i>	
Transmitter Site	16
<i>My Transmission Line Can Hear!</i>	
Links & Lines	18
<i>Enhancing a Remote-Control System</i>	
Outside the Box	20
<i>The Clock</i>	
Radio History	26
<i>The Secret Radio Station</i>	
IT Guide	30
<i>Installing Linux for the Newbie</i>	
Remote Radio	34
<i>Remote Options Abounding</i>	

Small Market Guide	38
<i>The Curse of the Estranged dB</i>	
Engineering Perspective	42
<i>Identifying Important Things</i>	
Service Guide	44 & 45
<i>Radio Equipment, Products, and Services</i>	
Radio Classifieds	45
<i>Buy and Sell Used Equipment On-Line – FREE of CHARGE</i>	
Gear Guide	46
<i>New Product Releases, Reports, and Information</i>	
Final Stage	47
<i>Convention, and Event Register – Advertiser Information</i>	

Radio Guide

Volume 27 – Issue 1

Radio Guide Website: www.radio-guide.com
 Classified Ads: www.radio-classifieds.com

PO Box 20975, Sedona, AZ 86341
 Phone: 928-284-3700 • Fax: 866-728-5764
 Ray Topp (publisher & editor) – radio@rconnect.com

Radio Guide, ISSN 1061-7027, is published bi-monthly, six times a year, by Media Magazines Inc., PO Box 20975, Sedona, AZ 86341. Radio Guide is copyright 2019, Media Magazines Inc., and may not be copied, reproduced, or stored in any format, without the written permission of the publisher.

Cover Story – by Elaine Jones (page 6)

Nautel – Heartfelt Thanks to Industry for 50 Years: “The focus on customer support has led to rapid advancements in transmitter technology over the years. “I can look at many of our transmitters and see features that remind me of meetings and conversations I have had with Nautel engineers and sales people,” said Cris Alexander, DOE at Crawford Broadcast.”

Studio Site – by George Zahn (page 8)

Blatant Latency: “In this article, we’ll look at latency and see how it can create issues when a digital source has to convert audio back to analog. Similar issues can happen when encoding analog audio or sound into digital.”

FCC Focus – by Gregg Skall (page 12)

FCC Enforcement: Issues/Programs List “Perhaps foremost among these requirements is the quarterly Issues/Programs List. Indeed, the FCC Enforcement Bureau appears to have selected this requirement as its first major audit and enforcement action enabled by the on-line public file.”

Small Market Guide – by Roger Paskvan (page 38)

The Curse of the Estranged dB: “There is a non-scientific way to solve decibel log problems in seconds without using charts, tables or calculators. There is no need to involve algebra – just some addition and multiplication of simple numbers. He looked at me and said, “Okay, I’m listening.” First, some background ...”

Gear Guide – Equipment for Radio (page 46)

Acoustics First: “According to their website, Acoustics First now offers 37 products, most of which are designed to affect the sound in your space, be it a regular studio sized or an auditorium.”

Radio-Classifieds.com

- Buy or Sell Your Used Equipment
- Place as Many Ads as You Like
- **FREE!** – There’s Never Any Charge



Radio-Classifieds.com Latest 20 ads

Antennas [0]	Codecs & Au/P [0]	Internet & Stream [0]	STL, RPU, TSL [0]
Audio Amplifiers [0]	Computers & IT [0]	Microphones [0]	Satellite Gear [0]
Audio Delay [0]	Consoles & Mixers [0]	Monitors & Revers [0]	Speakers & Phones [0]
Audio Editing [0]	Directional Gear [0]	Phone & Hybrids [0]	Timers & Clocks [0]
Audio Processing [0]	CAS Gear [0]	RDS, REDS, SCA [0]	Tools & Test Gear [0]
Audio Routing [0]	Exciters & Gens [0]	Recorder & Player [0]	Towers & Coax [0]
Audio Storage [0]	Furniture & Racks [0]	Remote Control [0]	Transmitters [0]
Automation [0]	Grounding & Surge [0]	RF & HV Equip. [0]	MISC OTHER [0]

Powered by Media Magazines Inc. - Publisher of *Radio Guide Magazine* | www.radio-guide.com

- **End Users** – Buy or Sell Used Equipment – No Limit!
- **Manufacturers** – Sell Your Demos and Overstock
- **Enter and Edit Your Own Ads** – Photos Included

SHURE



BECAUSE THE WORLD IS YOUR STUDIO.

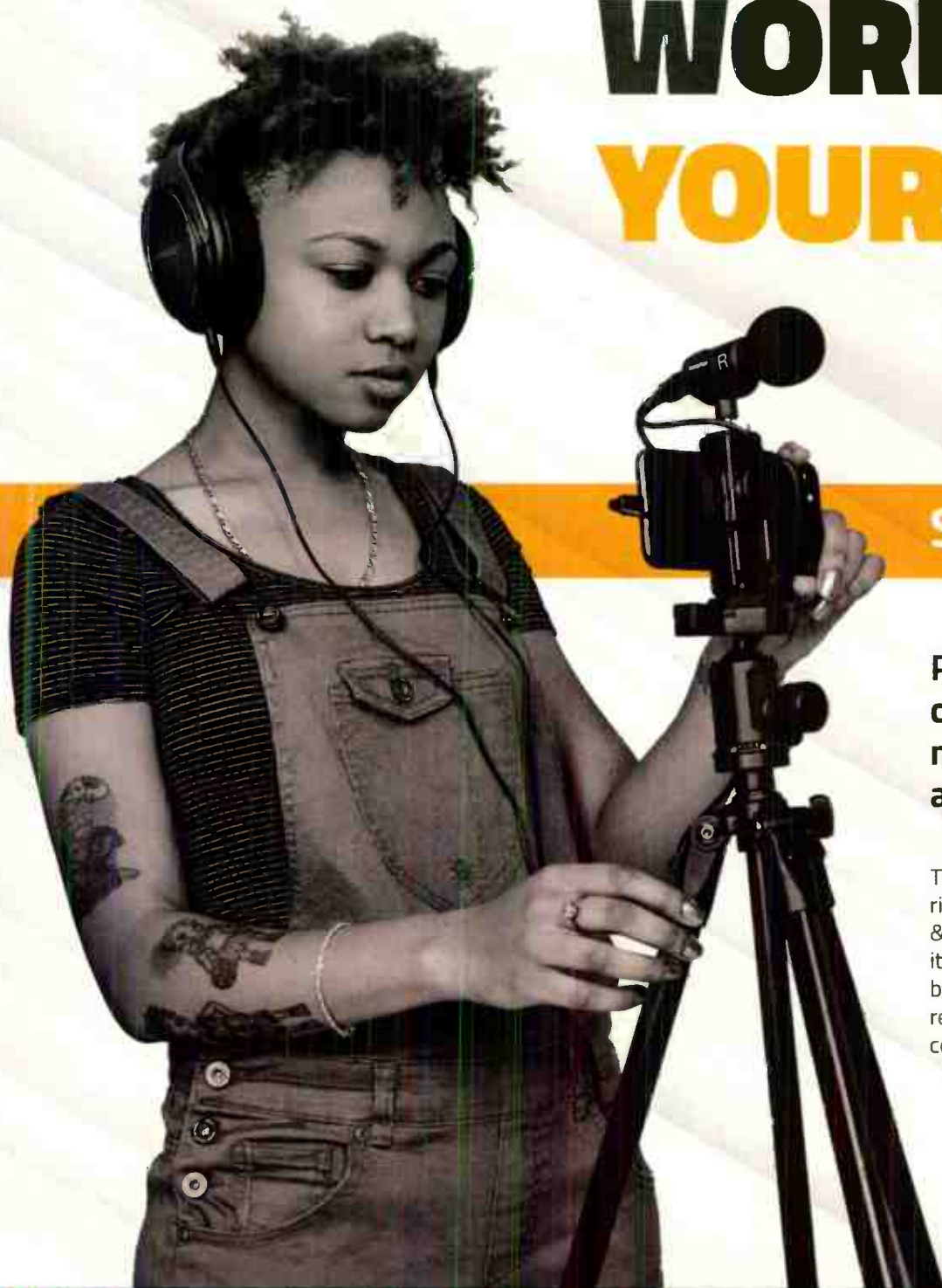

Shure MV88+ Video Kit

Premium digital stereo condenser microphone for mobile high fidelity video and audio recording.

ONLY
\$249

The MV88+ Video Kit is your mobile professional recording rig. Package includes Manfrotto PIXI Tripod, phone clamp & shoe mount mic clip, USB C & lightning cables, making it ready for audio and/or video capture right out of the box. The free ShurePlus MOTIV audio & video Apps enable recording control, and the ability to save and share your content in multiple formats.

Learn more at proaudio.com

or call (800) 433-2105

PROAUDIO.com
smart sound solutions

Cover Story

Nautel Offers Heartfelt Thanks to Industry for 50 Years

by Elaine Jones

In 1969, an entrepreneur and engineer named Dennis Covill won a contract to supply the first-ever solid-state navigational beacons to the Canadian government. Nautel, then known as Nautical Electronic Laboratories, sprang to life in the tiny fishing village of Hackett's Cove, Nova Scotia.

Fast forward 50 years: Covill's dream of creating a visionary, leading company in the field of RF transmission has resulted in a company with ISO-certified manufacturing plants in both Canada and the USA, and more than 16,000 transmitters deployed to date in over 177 countries.

Key to the company's success is a two-fold focus, the first being continuous innovation in the field of RF transmission and the second an unwavering commitment to customer support. Since the company's inception, support has never been discontinued on any product – a rarity these days.

Nautel President and CEO Kevin Rodgers is also a departure from the norm. Rather than moving to his position via the standard sales or engineering channels typical of technology companies, Rodgers spent 29 years at the helm of Customer Support, stepping into the top position at Nautel in 2014. The highly popular Nautel User Group – or NUG, held at the NAB show – was Rodgers' brain child.

The focus on customer support has led to rapid advancements in transmitter technology over the years. "I can look at many of our transmitters and see features that remind me of meetings and conversations I have had with Nautel engineers and sales people," said Cris Alexander, Director of Engineering at Crawford Broadcast. "In those conversations, they heard what I told them I wanted and that found its way into production transmitters."

Laying the Groundwork for Radio Transmission

Although Nautel's first products were navigational beacons, the company's true roots were in the designs of modular, solid-state hybrid RF amplifiers. Earning numerous patents, these amplifiers formed the basis of all Nautel transmitter designs and laid the groundwork for the company's entry into the broadcast industry in the early 1970s. The Radio industry saw its first solid-state Nautel transmitter in 1974 with a 2 kW AM. This was followed by higher power AM units throughout the 1980s, and the industry's first 10 kW solid-state FM transmitter in 1993.

Many of Nautel's early transmitters are still in use today, in both primary and auxiliary roles. "We are just now retiring a 1983 model AMPFET 10, which still works, from its auxiliary role and replacing it with a 2000 vintage ND unit," said Crawford's Alexander.

the adoption of numerous "smart" technologies suggested by customers as well as Nautel engineers.

To assist with a growing customer base, Nautel established parts warehouses in Memphis, Tennessee, the U.K., India, U.A.E, Philippines and Australia to ensure rapid parts delivery anywhere in the world. Indeed, Nautel's customer base has become very broad during the past 50 years, ranging from small 100W LPFM stations to the largest MW station in Europe – 2 MW – and everything in between.

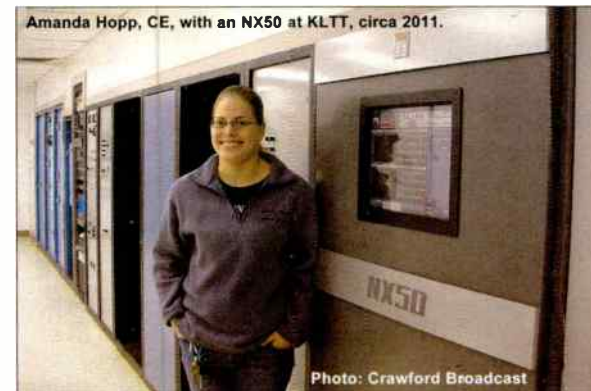

As one of the key players involved in "pushing the envelope" in HD Radio™ and DRM, Nautel partnered with iBiquity/Xperi and the DRM Consortium to bring about a number of advancements in digital radio transmission. These advancements led to the largest digital radio deployment in the world, covering the entire country of India and more than a billion potential listeners, with 33 high power Nautel transmitters at the core of the project.

Nautel Today and Tomorrow

As radio broadcasting has become more sophisticated, with increased interest in digital modes, Nautel has focused on ways to better make digital broadcasting "work" – creating more efficient modes of operation and methods of improving digital transmission itself for improved coverage and less interference. One technology now being adopted by the industry is Nautel's patented HD PowerBoost™ technology, which allows higher efficiency digital transmission and reduces the extreme peaks of digital signals for increased transmitter power and less stress on feedlines and antennas.

Another fascinating technology, with active Nautel involvement, is the concept of all-digital broadcast operation for both FM and AM. While this technology is still in the experimental phase, it is showing great promise. Testing with Nautel's HD Multiplex has shown the ability to provide up to 15 audio streams and data services within 600 kHz of FM bandwidth (or 9 streams in 400 kHz). On the AM side, audio quality can equal that of FM stereo. All-digital operation can not only increase coverage area, but enhance programming possibilities.

What's Coming in the Next 50 Years?

"It's hard to predict where the future will take our industry and Nautel," said Rodgers. "Changes are coming rapidly and we intend to be at the forefront of those changes. Advanced digital transmission technologies, cloud content delivery, and hybrid combinations of radio and the Internet are examples of technologies that will keep things interesting for years to come. And as usual, we will continue to listen to our customers, who will bring us some of the best ideas for keeping radio transmission worry-free. It's been a great 50 years, and we couldn't have done it without them. THANK YOU!"

Elaine Jones operates a technology marketing and PR firm based in Tucson, Arizona, and is Nautel's publicist.

5 DECADES OF GROWTH AND INNOVATION

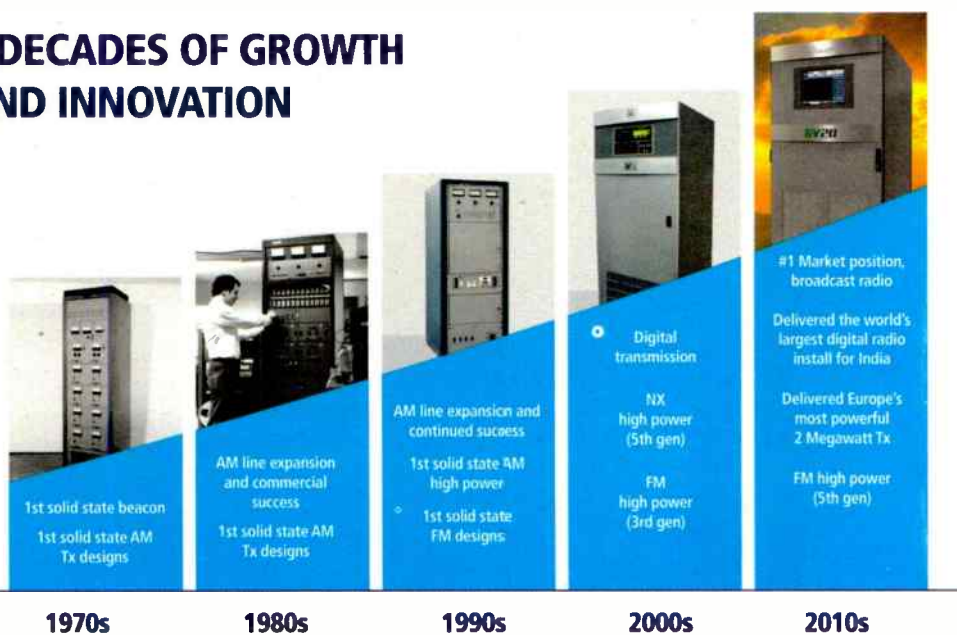

"Anyone who knows me knows I have always had a passion for customer support," said Rodgers, "and that passion is the foundation of the culture at Nautel. Customers are the life blood of our company and bring us superb ideas for product enhancements as well as new designs. When we started the NUG, we envisioned a venue for our customers to discuss products, not only with all of us at Nautel, but with each other, increasing tribal knowledge throughout the broadcast community. Little did we know that our annual meeting would become one of the 'can't miss' events at the annual NAB show, with hundreds in attendance. It's both humbling and exciting."

As the company grew, the need for expanded facilities resulted in not only a larger Nova Scotia operation, but a full manufacturing operation in Bangor, Maine which manufactures a wide range of AM and FM products.

The Breakout – Mid 2000's to Now

An even more rapid phase of expansion began in the mid-2000s with an increased focus on R&D. Establishing one of the largest engineering teams in the transmitter industry, Nautel completely revamped its AM and FM lines. This phase of expansion also saw the creation of the Advanced User Interface (AUI), which has since been deployed in more than 8,000 transmitters worldwide and

Celebrating 50 YEARS

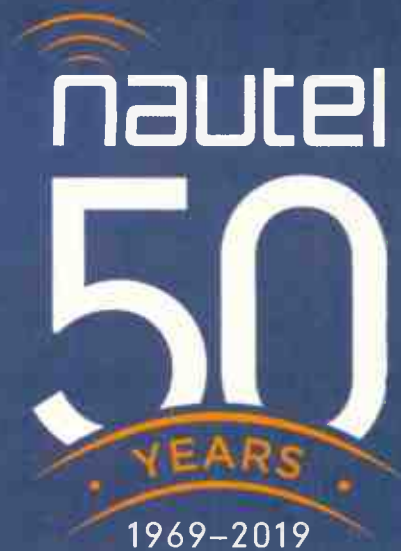

EXTRA 50 months
of warranty **FREE!**

That's over **8 years** of
transmission peace of mind
on any GV Series transmitter
ordered in the next 50 days*



Call your Nautel Rep today – **877-628-8350**

Worry-Free
Transmission

Because
Radio
Matters

- * Orders must be placed by end of NAB show 2019
- Offer cannot be combined with other promotions
- World wide

Blatant Latency

Is Digital Audio Slowing You Down?

by George Zahn

Many broadcasters have partially or fully entered the digital age, utilizing digital devices in places throughout the studio chain. Once the microphone transduces sound waves into digital audio, most everything in some studios stays binary through the studio/broadcast system until it leaves the listener's speakers.

For many of us, though, we are still using primarily analog audio consoles and microphones. For some, taking digital audio from, let's say, a computer or digital playback device into an analog chain can create some problems. In this article, we'll look at latency and see how it can create issues when a digital source has to convert audio back to analog. Similar issues can happen when encoding analog audio or sound into digital.

First of all, what is latency? Latency is the slight delay it takes a device to analyze and sample incoming sound (from a microphone) or analog audio. Similar to the early digital recorders (PCM encoders for early VCRs, DAT, etc.), a processor literally samples – taking “snapshots” of the amplitude and frequency of incoming analog audio upwards of 44,100 times every second. It then assigns a specific binary code to that 1/44,100th of a second, so it can be stored. Even the fastest processors can have a slight delay when encoding thousands of samples each second. A similar delay results when converting digital samples back to analog audio for playback.

The Pause That Doesn't Refresh

This latency is usually not as annoying as the delay that we experience with satellite delivered audio/video for interviews, in which you get awkward pauses as signal is literally shot from an uplink to a satellite and back to a receiver (approximately 70,000 miles for a satellite in geosynchronous orbit, for the trivia buffs out there). For video interviews, we see the field reporter shaking his or her head, waiting to respond while the audio travels to them. Then we wait again as their response returns. That double satellite hop can add about a one second gap to a satellite interaction, but that delay is simply from the distance traveled.

Latency in studio and broadcast digital audio is a bit less intrusive. Radio stations that broadcast both in digital and analog for over-the-air signals will often electronically delay their standard or analog signal to match the latency of the digital delay for listeners switching from a digital to analog reception.

Studio and public address digital latency can still add a few milliseconds, which can create monitoring issues. In fact, I'll relate a PA issue in which a local indoor venue was using a digital microphone (a Blue Yeti) with a USB

output. The microphone was being used in a live setting in which the Yeti was being fed into an analog mixer and amplification system. Let's think this through: The Yeti takes a few milliseconds to react to the announcer's voice and encode the voice digitally – then the digital audio has to be restored to analog for the amplifier, adding a few more milliseconds.

When the announcer was speaking in this large room indoor setting, the “slapback” of their voice, as they heard it through the PA system, was tantamount to the announcing delay you'd hear in an arena. A digital microphone, in this case one connected to an analog PA system, may not be the best choice, in my opinion. It definitely threw the announcer off her game until getting acclimated to the delay. When you hear yourself “reflected” back a few milliseconds later, the natural reaction is to slow down your speech to match what you're hearing, creating a vicious cycle. The same can happen if you're monitoring a digital microphone on headphones in a studio.

The Truth “Hertz”

When using the analog audio output jack of a laptop, PC, smart phone, or tablet from a headphone jack, there are more pitfalls that can happen. In this case, not so much latency, but rather frequency response. Most computers have a very basic soundcard that takes any digital audio inside the computer or storage device and converts it back to audio for listening on headphones or connecting the headphone jack to a mixer or amplifier for playback.

Upgraded computer soundcards will generally have a much higher quality and flat frequency response – more on that in a moment – and many computer users seem to feel that the lower end of the frequency spectrum, really solid bass, can be lacking from an OEM sound card. There's nothing to say that a basic soundcard will guarantee you crisp high frequencies either.

Remember, when comparing any audio device, that frequency response only means something if there is a decibel variation factored into the specification. As I've pointed out in other articles, be it a microphone, an amplifier, speakers, or a soundcard, it's easy to find a frequency response for a device listed simply as something like 20 Hz - 20,000 Hz. That really tells us very little about the fidelity of the device.

The key to understanding frequency response is knowing the variation in decibels within the frequency range. For instance 20 Hz - 20,000 Hz, plus or minus 1 decibel, speaks “volumes” because that device will faithfully reproduce the full human hearing frequency range with almost no “coloration” of the sound. What goes into the device is reproduced with a 2 decibel range (plus or minus 1 dB) from bass to treble.

A frequency response that only enumerates the frequency range, tells us nothing about the fidelity of the device. The bass could be exaggerated by any number of decibels while the device might be terribly deficient on treble or midrange, or vice versa. If you plan to use a computer soundcard for precise audio output, knowing the frequency response is very important.

USB Is a PDQ Fix

If you plan to use a computer for playing back audio, you can have an internal soundcard upgrade installed, but you can also use a USB audio interface, which is simply an external soundcard. Many audio interfaces will offer, at a minimum, RCA jacks for line output from the computer, plus digital audio output – and many will have a better frequency response. Most current USB audio interfaces are a minimum of USB 2.0. Fire wire interfaces are also available. An outboard audio interface can be used in addition to, or in place of, the motherboard-based or standard soundcard by configuring audio settings.

Input on many audio interfaces is also a plus – many audio interfaces have digital input and analog audio line level inputs rather than just the very basic microphone input on a standard soundcard. If you're recording into your computer from an outside source, you will definitely get a much better quality audio input than trying to attenuate line level audio into a basic soundcard mic jack.

If you're shopping, you can find high capacity, high fidelity cards in the \$500-\$3,000 range, usable for multiple studios and multi-track record encoding. But if you're just wanting to improve the fidelity coming from a laptop in a studio or on a remote, there are audio interfaces that can be had for \$50 and under. Don't expect as many “bells and whistles” on the less expensive cards or interfaces, but you don't have to scrimp on lower latency or good frequency response either.

So if you're comparing audio interfaces, be sure to check the frequency response and latency. We've covered frequency response already, and you can look for indications such as “low latency” when comparing. Latency is generally measured in milliseconds, although there are fewer indications of latency as a hard number than frequency response.

Other factors in any audio device are signal-to-noise ratio (ideally you want at least 80 or 90 dB of audio before 1 dB of noise (-80 to 1) and harmonic distortion, but many will be in that range. Types of digital audio connections, for example: S/PDIF, TosLink, or Optical audio, can affect your choice as well. For input and output, sampling rate is important and can often be selected within the device (32 kHz for bare bones broadcast audio quality, 44.1 kHz for CD quality or the slightly higher 48 kHz – the old PCM standard).

For example, for use with a laptop that I occasionally use for on-air or PA playback, I'm experimenting currently with a \$30 U-Control UCA 222 Behringer interface I recently bought. So far, it seems to be living up to its claims of 10 Hz - 20,000 Hz, plus or minus 1 dB, audio output with very low latency. When I start audio from the computer, the audio is instantaneous, on my first uses so far. I'm hearing better bass response as well, over the use of the headphone jack on the built-in soundcard that came with the computer.

Share Your Sampling!

Understanding latency is important as we encounter more hybrid audio systems and studio uses. A little research and networking with other radio professionals can go a long way to avoiding long audio conversion delays and make our audio much better. If you have some interesting audio interface stories, please feel free to share them so we can all learn!

George Zahn is a Peabody Award winning radio producer and Station Manager for WMKV-FM at Maple Knoll Communities in Springdale, Ohio. He is a regular contributor to Radio Guide and welcomes your feedback. Share your stories with others by sending ideas and comments to: gzahn@mkcommunities.org



Blue Yeti
USB Mic

BIG LEAGUE

Sports Coverage

Requires the Best Equipment



Don't compromise your next remote:

- Record and play coach and player interviews during the broadcast
- Create playlists for sponsor announcements
- Record the entire live broadcast simultaneously for your podcast after the game.
- Touchscreen audio routing & 6 IP interface options



Remote Audio Codec



<https://youtu.be/WLWYEJ6-9GY>

Tieline 
The Codec Company

317-845-8000 | sales@tieline.com | tieline.com

World Radio History

Maintenance Guide

Transmitter SCR Power Control

by Wiely Boswell

When you are on the floor with a 1/2-inch ratchet, and 1-1/8" socket, you would think you were not working on a transmitter.

My job was replacing an SCR in a Nautel FM-8 solid state transmitter. SCRs are common in electronic circuits, and I will look at its application in a vintage Continental tube based transmitter as well.

First, let's look at the SCR and its applications. An SCR is basically a diode that can behave as a switch. It will have some of the same characteristics as a diode, such as peak inverse Volts and forward current rating. It is also referred to as a thyristor, which is derived from thyatron, a gas filled tube device that behaves like the SCR. Hydrogen filled thyatrons are known by our counterparts that work on TV transmitters.



Figure 1

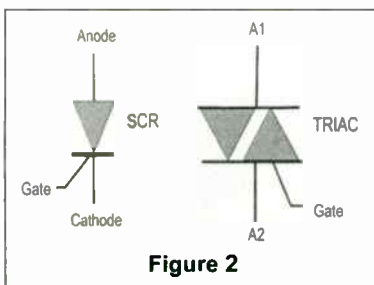

Figure 2

Figure 1 shows a Hydrogen filled Thyatron. This one is rated at 40 kV @ 1,500 Amps.

The SCR is the solid state equivalent, used as a crowbar on DC power supplies or in voltage sensitive electronic circuits. In these cases, the SCR is used as an electronic switch which shorts out power circuits to protect equipment. SCR crowbars are built into some Astron power supplies and HP has some supplies with a variable voltage trigger point. Once an SCR conducts, the current must be removed to reset to an open state. Figure 2.

SCRs turn on during a rising AC waveform as a way to control power delivered to a load. An SCR will only conduct during one polarity of an AC sine wave. A Triac is essentially two parallel SCRs connected in reverse. It can turn on during both the positive and negative portions, at a variable phase angle of the AC waveform. It is the prevalent circuit design of 120 VAC light dimmers. The sharp turn on transient can result in significant line noise which is mostly addressed by a filter choke. It could be referred to as pulse controlled regulation.

An SCR turning on during a sine wave, to control output power, is close to a switching regulator but is different. Switching power supplies are based on PWM (pulse width modulation) at a much higher frequency. The pulse amplitude remains constant but the "on" time duration changes as needed, to maintain the correct voltage at the output. Feedback is required from the output to the PWM control. One thing they have in common is a turning on in saturation, or all the way off, lowering wasted power to heat in the semiconductor drivers.

Figure 3 shows the input power schematic of a Nautel single phase FM-8 transmitter. A grounded center tapped secondary delivers 61 VAC from each leg to ground. Each leg feeds a power SCR rated 235 Amps at 400 PIV (Figure 4). Note both the B+ for the PAs and B+ for the IPA come from the same secondary winding. The AC supply is fused before the SCRs for the IPA circuit but not for the PAs. So the big clue, when the transmitter was down, was the main breaker

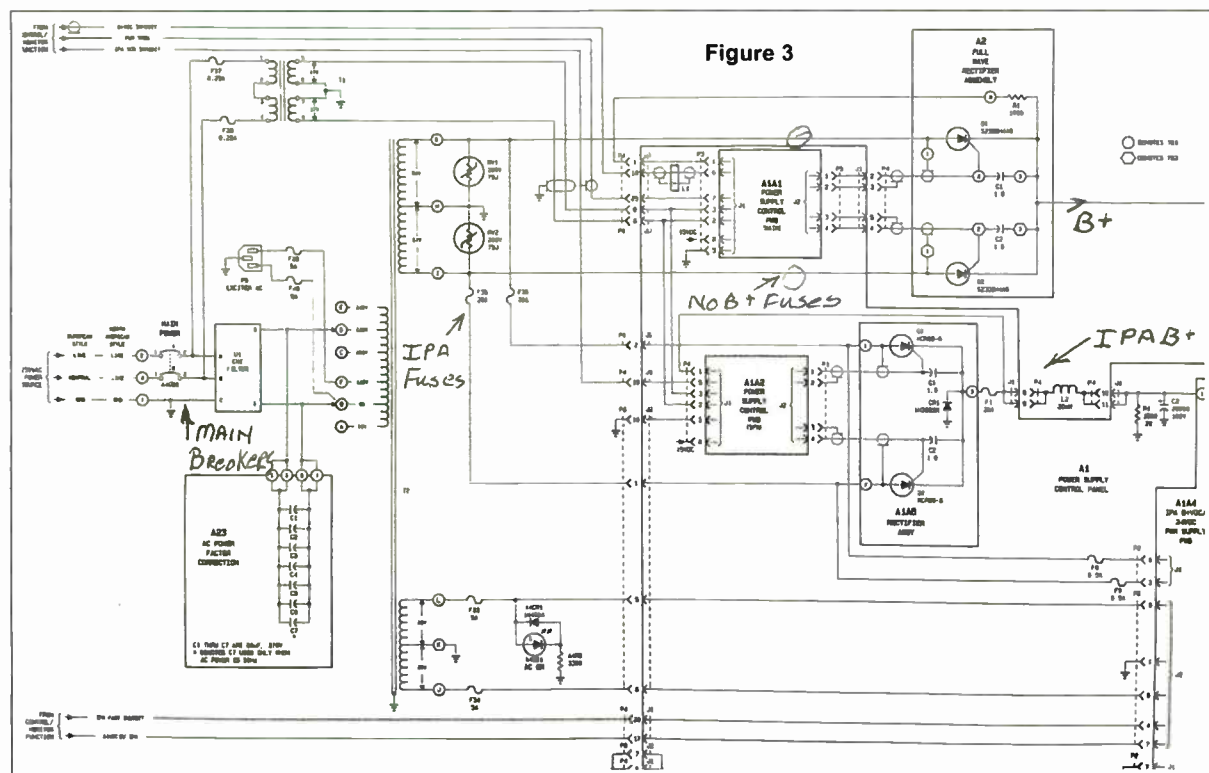

Figure 3

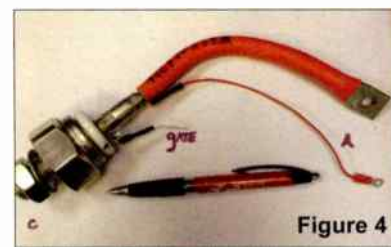

Figure 4

had tripped. Other than a shorted primary, a shorted SCR is the primary fault possible. I unhooked each anode lead and tested each one like a diode. The gate normally does not need to be grounded as you test it. Sure enough one had a dead short. So I went in with a ratchet and socket. It is a very tight space and that's where the "mechanic" practice helps getting it out.

Figure 5 shows the construction of the single phase heat sink (a 3 phase would have 3 SCRs). Figure 6 shows the SCR heat sink location in transmitter.

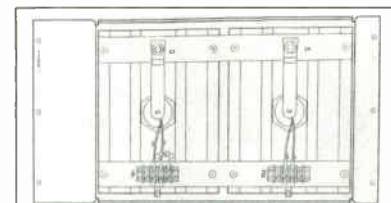

Figure 5

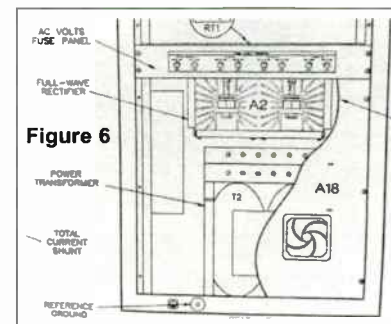
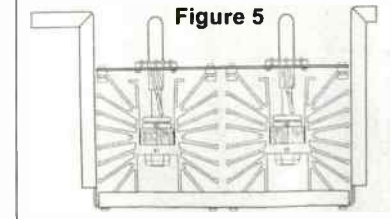

Figure 6

The SCRs rectify the 61 VAC and the regulator board controls the SCRs' gate regulating the B+. All PAs are powered by this B+, and the higher the B+, the higher the power output. It maxes out at about 50 VDC which is highest most FET PAs will allow. The B+ filter has a total of 0.6 Farads, requiring a discharge circuit (see Figure 7).

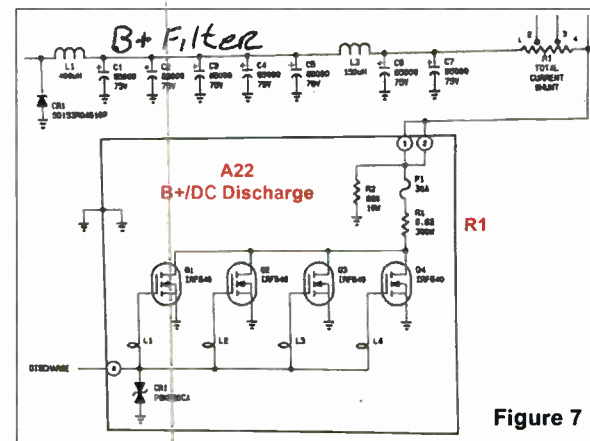

Figure 7

As the transmitter is turned off, four FETs in parallel will switch R1 across the B+ to quickly discharge it.

Not all B+ transmitter regulation operates the same - for example, the Q20 has an unregulated main B+ with common control of regulator modules. There is one regulator module per PA.

The Continental tube transmitter has SCR control that allows a slow start of the HV supply cabinet. It makes a smooth buzz as it brings up the input to the plate transformer, raising the HV plate voltage. The control board that controls this start up needs recapping occasionally. It is a very good spare part to have on the shelf.

However, sometimes you do need a serious socket set to work on a transmitter!

Wiely Boswell is Chief Engineer of Faith Broadcasting, Montgomery, AL; CBRE, CBNE, and SBE 118 Chairman. He may be contacted at: Wiely@faithradio.org

Touch control made simple.



We've combined the latest in multi-touch technology with a suite of familiar controls in our new Helix line to give your operators everything they need for on-air or production. Whether you're looking for a scalable console for the studio or a comprehensive virtual console that can be used anywhere, Logitek's Helix can accommodate your requirements. Helix is powered by the JetStream AoIP platform, which brings you space-saving high-density I/O along with buckets of mix-minus and onboard processing.

HELIX Radio and HELIX Studio - only from Logitek.

Logitek

radio.helixconsole.com



Curious about JetLink, a new way to send and receive broadcast-quality audio between two computers? Try our free version here:

get.jetlink.co

JETLINK

FCC Enforcement: Issues/Programs List Requirements

by Gregg P. Skall – Womble Bond Dickinson (US) LLP

Nearly a year ago the FCC required all broadcasters, radio and television, to maintain their public file on-line. As of March 1, 2018, all stations, including noncommercial educational, regardless of market size or number of full-time employees, were required to maintain their public file on-line on the Commission's servers. This has made the previously difficult to review station public file immediately available to anyone throughout the community, the country and the world, and most particularly, at the FCC Enforcement Bureau. The Commission takes initial responsibility for placing most of the application and authorization documents in the file itself, transferring them from other FCC on-line filing databases. However, some requirements, primarily dealing with documents that were to be initiated by a broadcaster, are still entirely the responsibility of the broadcaster.

Issues/Programs List: Perhaps foremost among these requirements is the quarterly Issues/Programs List. Indeed, the FCC Enforcement Bureau appears to have selected this requirement as its first major audit and enforcement action enabled by the on-line public file. Last December, the Bureau started sending inquiries to some broadcasters, noting that not all required public inspection file materials had been uploaded to the FCC's on-line system and specifically referencing issues with the quarterly Issues/Programs Lists. This is particularly troublesome, given that the FCC's on-line public file provides not only the Enforcement Bureau, but any person seeking to examine a station's public file, with the ability quickly to find documents through RSS links and keyword search capability. This has made review and oversight by the Enforcement Bureau, local residents, and public interest groups much easier. The Enforcement Bureau, the FCC's primary unit responsible for enforcing the Communications Act and FCC rules has the mission to investigate and respond quickly to compliance failures. Thus, the Issues/Programs List is fair game for enforcement and relatively easy picking.

FCC staff knows that many broadcasters have come to think of this requirement as perfunctory. Veteran broadcasters will remember a more stringent time when they were required to ascertain community issues by interviewing community leaders, identifying local community issues of public importance, and developing and airing programs responsive to the needs identified through those interviews. That requirement was later revised into the current Issues/Programs List on the presumption that local broadcasters were themselves knowledgeable about local issues.

The Current Requirement: On a quarterly basis – January 10, April 10, July 10 and October 10 – all broadcast licensees are required to compile and upload to their on-line public file, an Issues/Programs List, together with all public file materials for the license renewal period. It is important that this be done religiously and that each station keeps a careful record. Each licensee must make a certification at renewal time that it has complied with this requirement on its renewal application and we are about to start a new renewal cycle in October of this year. The on-line public file includes a specific file dedicated to issues/programs lists that should be used for placement of the lists. For transparency purposes, while not required, it is helpful to break down issues/programs lists by year and quarter for ease of review by third parties and for internal accounting purposes to ensure that all years and quarters have been included in the file.

List Requirement: The Issues/Programs List must reflect "programs that have provided the station's most significant treatment of community issues" during the preceding three months. Although the Commission has ruled that the list is to contain all of the most significant programs the licensee has aired to address the listed issues, it has not defined the term "most significant programs." However, if a program is not reported as significant, the licensee probably will not receive credit for it. Therefore, broadcasters should compile a comprehensive and accurate issues and programs list. The list should detail some of the community issues the station addressed during the preceding quarter and programming that gave the most significant treatment to those issues. While interviews of community leaders are no longer required, each list must include the licensee's best evaluation of the issues identified as important to the community of license and surrounding area – with a brief narrative explaining why those issues were chosen, a narrative description of the programming that addressed the issue, the program's title, duration, and time and date of the airing.

Unfortunately, many broadcasters have fallen into a pattern of simply listing a few issues that their programs cover without careful thought as to how they relate to the community and how those programs actually provide a treatment of the issue important to the community.

In these days of targeted demographics, stiff competition and severe industry consolidation, it is sometimes difficult to remember that all Commission licensees have a responsibility to provide issue-responsive programming. The Commission is on record stating that the gravamen of its public interest standards is responsive performance, and that the key question is whether the licensee took steps to meet that obligation. Therefore, it is more important to place emphasis on quality rather than quantity of the issues and programs selected. The function of the issues and programs lists is to give the public sufficient information about each station's issue responsive programming to determine whether the station has fulfilled its programming obligation.

What is an Issue? Broadcasters have wide latitude in determining what an issue is for purposes of the Issues/Programs list. The term "issue" has been sweepingly defined by the Commission as "[a] point of discussion, debate, or dispute, [a] matter of wide public concern." In choosing issues to focus on, actual programming of other licensees in the community may be taken into account. For example, if your program format is not attractive to senior citizens and another station in the market programs for that audience and addresses issues of concern to them, each station in the market need not program towards those issues. Though the Commission has done away with its formal ascertainment requirements, it is still advisable to meet with community leaders and members of the public to determine the issues they believe are of importance to the community. Should the station's license renewal be challenged, management's efforts at community ascertainment will be one of the key factors to determine whether the licensee deserves "renewal expectancy."

No minimum number of issues must be identified. The FCC has stated, however, that a licensee whose list includes at least five issues will likely be able to demonstrate compliance with their issue responsive programming obligation. The Commission has also recognized and taken into account the large variety of programming decisions and options, noting that a licensee might, for example, choose to concen-

trate on fewer than five issues and cover them in considerable depth over the quarter. Other licensees, it said, may cover more than ten issues due to the format and program length assigned to issue responsive programming. Even considering this statement, it is best that at least five issues be given significant programming treatment, and that those issues and programs are noted and described in the quarterly list.

A review of the FCC decisions on renewal applications and the fines that have been issued for failure to properly maintain and document the quarterly Issues/Programs Lists, reveals a surprising number of broadcasters are either entirely unaware of the Issues/Programs List requirement or have allowed the exigencies of other business needs to supersede the effort required for total compliance.

Is Local Production Required? Some broadcasters, very much aware of the requirement, have the mistaken impression that all programming on the list must be locally produced. That is not required. What is required is that the list includes a brief narrative describing what issues were given significant treatment in the programming that provided this treatment. The burden is on the broadcaster to demonstrate that it has aired programming relevant to the public issues of importance it has identified.

Contrary to popular belief, nothing in the rules or FCC orders requires that the programming be locally produced. The Commission's concern is only in the result and not the process, and the Commission has specifically said it is not concerned with how an applicant or broadcaster becomes aware of community issues, so long as such issues are identified and adequately responsive programming is offered or proposed.

In fact, the station may use *any* programming, wherever acquired, so long as a program addresses the local issue it has ascertained. For example, the issue may be domestic abuse. The station could air a radio health journal program addressing the issue of domestic abuse, how communities can deal with the issues, and where abused spouses can go for counseling and shelter. That program would provide important information to the community responsive to the community issue. The Commission's goal is that issues of importance to the community be discovered by the broadcaster and addressed in programming so that, "...informed public opinion, necessary to the functioning of a democracy, will be possible." When it adopted the Issues/Programs List requirement and discontinued formal ascertainment, the Commission gave great latitude to broadcasters on programming, saying the "...bedrock obligation contemplated by 'public interest' will be fulfilled with the least government intrusion and the most licensee flexibility." This flexibility allows broadcasters to address issues by virtually any means and can include, for example, public affairs, public service announcements, editorials, free speech messages, community bulletin boards, and religious programming.

The standard for license renewal, therefore, is guided by a retrospective showing for the prior license term that the licensee addressed community issues with programming of *whatever type or origin* that, "...in its discretion and guided by the wants of its listenership, [the licensee] determined were appropriate to those issues."

As a last point, it bears emphasis that stations subject to a local marketing or time brokerage agreement are nonetheless required still to conduct their issues assessment and assure that programs responsive to them are broadcast. This is a non-delegable licensee duty. Of course, the time broker can be the party that actually delivers the programming over the station, and appropriate provision for this compliance should be made a part of every local marketing or time brokerage agreement.

This column is provided for general information purposes only and should not be relied upon as legal advice pertaining to any specific factual situation. Legal decisions should be made only after proper consultation with a legal professional of your choosing.

Gregg Skall is a partner of the law firm Womble Bond Dickinson (US) LLP. He frequently lectures on FCC rules and regulations, represents several state broadcaster associations and individual broadcasters and other parties before the Federal Communications Commission in their commercial business dealings.

THERE'S A NEW MEMBER TO THE AARON FAMILY



INTRODUCING THE — AARON 655 —

REBROADCAST / TRANSLATOR RECEIVER

FM / **HD** Radio

The **AARON 655** is the first of its kind — combining an FM/HD Radio Receiver with an Audio Processor, Dynamic RDS Encoder, and IP-Streaming. With premium features and unparalleled performance, the AARON 655 excels in the most challenging reception conditions.

FEATURES

- Uncompromising DSP-based (SDR) receiver
- Program Sources: HD 1-8, FM, IP-streaming, Analog/AES Line Inputs
- RDS Encoder: Converts HD Pad Data, IP-Stream Meta Data or IP Telnet Data
- Audio Processor: Powerful 3-band, 10 factory resets, Dayparting
- No Dead Air: Assignable failover audio backup
- Dynamic Web Interface for remote control & monitoring
- Alarms & Notifications via email, SMS messages, SNMP support



www.inovonicsbroadcast.com | sales@inovonicsbroadcast.com | tel: 831-458-0552

PCS Electronics Exciter Board Review

by Bob Reite, CBT

I have developed an 1,800 Watt analog FM Transmitter to use as a “loaner” when one of my clients, who has “all their eggs in one basket,” is off the air due to a transmitter failure that is not readily repairable. To speed up the design process, I looked for ready made exciter boards. PCS Electronics has several choices (pcs-electronics.com). I first purchased the model MAXPRO2015+. Importing this from Slovenia was not as much hassle as I thought it would be, but I did have to acknowledge that it might generate “harmful interference.” After discovering that the MAXPRO2015+ did not meet my needed specification for spurious radiation, I ordered and tested the MAXPRO8015+.

Features Common to Both Models

On the bottom there is a 3/8 x 3/8 by 2-1/2 inch aluminum bar which is the heat sink for the output device and 7809 three-terminal regulator. This bar is not adequate by itself – it must be screwed to the case for adequate heat dissipation. The bar is at ground potential however, so no insulators are needed, just a very thin layer of heat sink compound to get the best thermal transfer. Five other mounting holes are provided on the board itself and the manufacturer recommends that these be screwed to grounded standoffs the same height as the heat sink bar for best stability. However, during testing, I found that it made no difference if these were grounded or left floating.

Both boards require 12 to 15 VDC input at 2.5 A maximum. Both have unbalanced audio input, which can be configured for 50 or 75 microsecond de-emphasis, or no de-emphasis for use as a composite input.

Output power is adjustable from 0-15 Watts. Both models include a lowpass filter so, in theory, they could be used as translator transmitter or similar low power use, but I suspect that most users of these boards will be driving an amplifier pallet.

The boards have several handy features for use as a driver. First, binary coded jumpers can be set to limit power to any level between 1 and 14 Watts – handy to protect a power amplifier from accidental overdrive. Second, there are external inputs for Forward and Reflected power samples. If nothing is connected to the external sample inputs, the display (if used) will read the exciter forward and reflected power. An SWR limit can be set to protect the output device. Once a voltage sample is detected on the external forward power input, the display board automatically switches to display of the amplifier forward and reflected power.

However, the typical directional coupler that comes on the common low pass filter boards does not have enough output to drive the display to the correct reading. I had to build a DC amplifier with an op-amp and provide a calibration control. However, the SWR limit will also act on high SWR on the amplifier output by shutting down the drive, thus protecting the amplifier.

One deficiency noted on both units, while using the 2x16 display, is the power level readout. The display only shows two significant digits for power levels 1.0 kW and above. The decimal point takes the place of the third significant digit, so this would not be legal instrumentation for levels above 999 Watts. I have not tested the

optional 4x16 display to see if it gives at least three significant figures at 1 kW and higher.

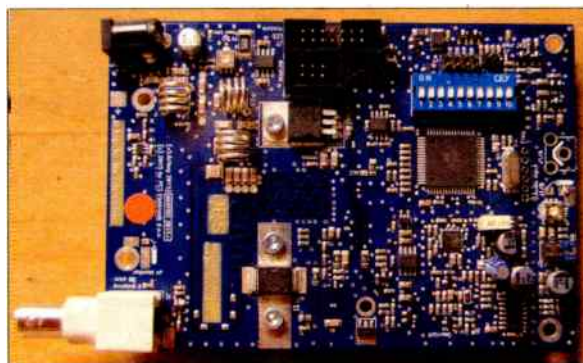

The MAXPRO2015+

The MAXPRO2015+

The display and control board is optional on the MAXPRO2015+ It has DIP switches for setting the frequency, and fine power control can be done with the trimpot, but that’s not at all convenient.

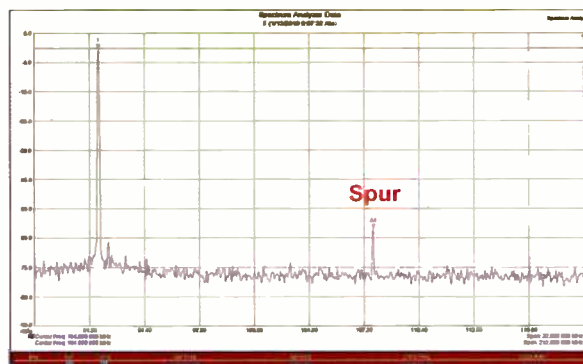

MaxPro 2015 Spectrum

I ordered this version originally as it was the lowest cost option and the website claimed, at the time, that all spurs and harmonics were better than 80 dB below carrier. This proved *not* to be the case. A call to the factory confirmed that spurs are only guaranteed to be down 65 dB on this model (the website has since been corrected). The board by itself would still be legal under U.S. rules, as at 15 Watts, emissions removed more than 600 kHz from the carrier only have to be down 55 dB. If used with an amplifier (assuming that the amplifier generated no spurs of its own), one could go to 158 Watts TPO and be just legal.

However, where the spur is can be a big problem! It is exactly 16 MHz above the carrier. No matter where the carrier is set, a -62 dB spur as measured on my sample will be found 16 MHz above it. If the transmitter is operated above 92 MHz, the spur winds up in the aircraft band.

The MAXPRO2018+

The MAXPRO2018+ is slightly larger than the MAXPRO2015, but the three most notable differences are the lack of a DIP switch assembly, an additional connector for “plug and play” operation of a transmitter controller made by PCS Electronics, and a shield can over the board near the 16 MHz crystal. I suspect the latter was necessary to get rid of the 16 MHz spur and indeed the spur on this

board is down 87.9 dB, well within the advertised 80 dB. The display and control board is mandatory on the MAXPRO2018+. This model is sold with the option of a 2x16 or 4x16 LCD display and control board.

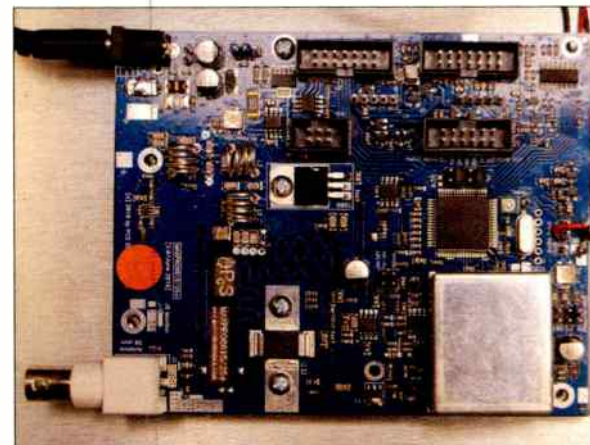

MAXPRO2018+



MaxPro 2018 Spectrum

Bottom Line

Needless to say, I cannot recommend the model MAXPRO2015+ board for anything other than testing power amplifiers into a dummy load, as the spur shows up in one of the worst possible places. On the other hand the MAXPRO8015+ board is a capable performer. It’s possible to build an FCC legal transmitter up to any legal power limit using the MAXPRO8015+ exciter board, as long as another provision is made for indicating output power for transmitters operating at 1 kW and above.

Finally, one question I get asked a lot: “Building your own transmitter for broadcast use, can’t be legal, can it?” The answer: “It depends.” For LPFM stations, no, unless you become a manufacturer. Transmitters used in the LPFM service must be certified for compliance by an independent testing agency in addition to all the other hoops you have to go through as described in 47 CFR Part 2, Subpart J of the FCC Rules. Transmitters used for full power FM stations may now get by with a Supplier’s Declaration of Conformity in which the manufacturer determines that the transmitter complies with the applicable technical standards. The compliance information statement, which includes the make and model of the product and contact information for the responsible party, may be included in the operating manual or a separate sheet. No marking is required on the transmitter itself, although it is permitted to mark it with the stylized FCC logo. Needless to say, the builder must have the necessary equipment to make the required measurements and keep careful records in case they are called upon to prove that the device meets the emission standards.

Bob Reite operates his contract engineering firm, Telecentral Electronics, Inc. servicing radio stations in Pennsylvania and New York state and may be contacted at br@telcen.com



Balancing Gadgets

Precision unbalanced to balanced audio converters. Exclusive input stage breaks ground loops. Starting at \$149 (SRP). Groundbreaking.



Failsafe Gadget

Monitors your programming for interruptions. If silence is sensed, backup is automatically engaged. Adjustable threshold and delay. \$229 (SRP). Sleep better.



Distribution Gadget

Drives up to eight destinations from a single mono or stereo source. Exclusive input circuitry breaks ground loops, even with unbalanced sources. \$249 (SRP). Hear there.



Talkshow Gadget

Turns a little live mixer into a radio mixer. Adds essential broadcast features like mic control, speaker muting, on-air signaling and monitor volume. Only \$229 (SRP). Make radio.

Cough. Drop.



Studio guests are only human. And humans cough. They cough and clear their throats and sniff and snort. Not the most pleasant experience for your listeners. If you tell your guests to turn their heads and cough, they might misunderstand. Besides, it really doesn't help that much.

Cure this with the Guest Gizmo. It has a cough drop (ahem) button built right in. Your guest feels the need to make disgusting noise and pushes the button until the urge has passed. You'll want one at every guest microphone position. The cough button is a necessary tool.

Speaking of necessities, every guest needs headphones. Which is why the Guest Gizmo provides a stereo headphone amplifier with volume control. Your guest can adjust headphone levels to personal taste (that human thing again). And the Guest Gizmo amp has the power to drive just about anything, even those big cans so beloved in radio.

You know those cool new mic arms with the built-in LED tallies? They're all the rage. Problem is lighting them up. Guest Gizmo to the rescue again. Hook up your mic arm to the logic port and the button changes from cough to on/off/cough and drives the red light whenever the mic is hot. Cool?

We're not done. The best part is how it mounts in your studio furniture. It drops into a 2 3/4 inch grommet hole. That's right. A quick trip to the hardware store for a hole saw, and you're ready for business. No router required. And at only \$179 (SRP), you can afford a gizmo for every guest.

No guests? No problem. Angry Audio has all kinds of gadgets and gizmos for tackling all kinds of tasks. So let's get at it. Those problems aren't going to solve themselves.



AngryAudio.com

Transmitter Site

My Transmission Line Can Hear!

by Gary Minker

I got a call the other day from an old Bibb Overalls wearing customer of mine, with a nice little Country Music station that blows a paltry 100 kW into the Ether. This is a nice old guy who does know a thing or three about tractors, generators, farming – and now to his amazement, transmission line.

The call was typical from him. Me: “Gary.” Him: “Hey, How y’all?” Me: “What’s new?” Him: “I seen somethin’ I never knowed.” And this is where things went South.

He said, “I learnt a new thing. I was out to the transmitter the other day, when a powerful big rain come up from the North and there was lightning. Man, there was lightning ever-where but the transmitter was a runnin’ good and I wasn’t worried about nothin’ till then it happened.”

Me: “OK, What happened?” Him: “I saw a big old bolt of lightning and things was fine, and then a few seconds later the boom come up on me and when the boom come up, the transmitter musta got scared cuz it shut off. My line can hear!”

That was pretty funny. This is not the first time that I have heard that joke, but my friend *wasn't* joking, and he wasn't too sure if it was the line or the transmitter. He said that the big box was humming along just fine and when the big boom hit the site, the box dropped to its knees and did not come back up.

I told him that I know this trick and he probably has a problem with one of the 21 sections of rigid line, or some of the multitude of joints or bullets, and that the vibration just rattled a bad joint and down goes the transmitter. He, of course, being a down to earth farming kind of guy, said that I could not be right and this is where the bet for real money comes in.

The Bet

I told him that I was pretty sure that I knew what to do and, that if he was willing, I would bring in a tower crew and prove to him that I was right. If I was wrong, I would pay for the crew, dinner and all my expenses. If I was right, he would pay for all that, more, and the parts to fix the problem. This bet was more than he could walk away from, so we agreed to come back in two days and start at Midnight.

The Proof

We all met at the tower site on the appointed day, Krispy Kreme's in hand, and I went over the game plan with the climbers. Go up the tower to the top-most joint under the antler. Take the line loose, put an EIA-to-Type “N” on the line along with a dummy – and bring your 1 pound rubber mallet.

I warmed up the Vector Network Analyzer and performed a characterization on the line, along with a live over Memorex trace that showed all 20 or so line sections, the joints and the insulators. Clearly the joints were all over the road for Return Loss and I knew that I had this fish shot in the barrel before it swam, but we started the diagnostic anyway since there was a dinner to be won. OK, I called up on the radio. Wham the first joint with the mallet, with a reasonable and repeatable amount of force. No changes. OK, one down, 20 something joints to go. Down to the next joint. Wham ... no change. Next joint ... Wham. The joint jumped 15 dB in Return Loss in Time (frequency) Domain. The colorful display of the red over the violet was all too clear to see. We repeated

this banging all the way down the line and revealed seven Krispy Kreme flaky joints. Dinner was delicious.

Cause and Effect

Transmission line, in the best of conditions, is not a forever kind of thing. While there are a great many Wave Guide, Coaxial, and Elliptical lines that have never given trouble, and are 30 to 50 years old, many rigid lines just do not give the trouble-free length of service that one would hope for. Line Sweeping is a tool in the bag that can often locate discontinuities in the system, that are about to be problematic.

Joint-based, rigid slip-bullet line, thermal cycles and shaves microscopic slivers of metal on a twice or more daily basis. At some point, with the micro-arcing from this slippage, fire can be inspirational, to quote Richard Pryor.

As the joint degrades, any sudden vibration can trigger a larger-than-before arc, at a connection which could set off an irreversible burn that only goes out after all the Teflon and brass have melted in to a puddle or dripped down the inside of the line. The soot is tough to clean and all the molten beads of metal need to be found or the problem can happen again and again.

Line Sweeping

It is important to Love your Line Sweeper. With so many people claiming to be a “certified” Line Sweeper because they have an “Anritsu Card” that only proves that they know what buttons to push on only a certain model of test apparatus, let alone competently interpret what the squiggly lines mean, you have to develop a relationship of trust with the person that you call Line Sweeper. Different types of line, have a different signature.

Various types of line exhibit well known signatures. Standard EIA type line has a positive going distinct bullet joint that also has the signature of a dent or other discontinuity. **Figure 1** shows the effect of repeated strikes with the rubber mallet. A similar result can be seen in **Figure 2**, of the close in view of SWR branded line. The unique cup and cap joint yields a better Return Loss than does the standard EIA type flange joint, but when the joint fails, the same positive going result will be displayed as in the red over memory violet trace. Metal type coaxial products like Heliax or Heliflex are virtually discontinuity free except for the numerous small dents, kinks and ground kit applications of **Figure 3**.

Gary Minker owns Radio Works R.F. Consulting
Email him at: gary@RadioWorksRFConsulting.com or call 561.969-9245 Find Gary on the web at www.RadioWorksRFConsulting.com

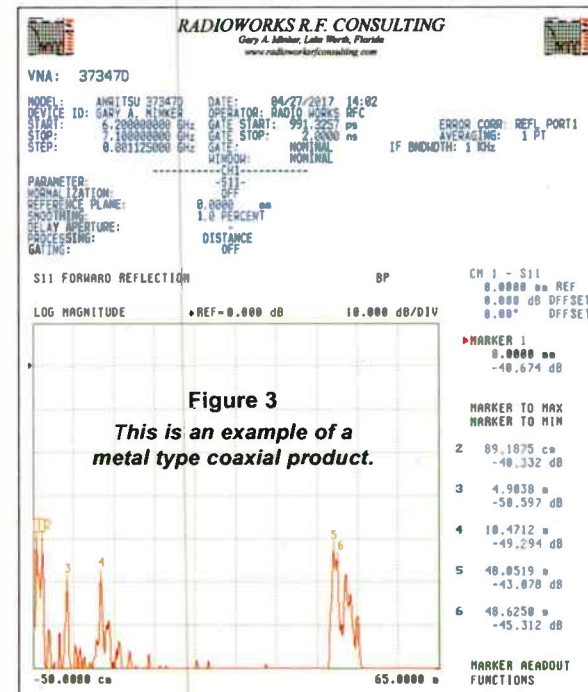
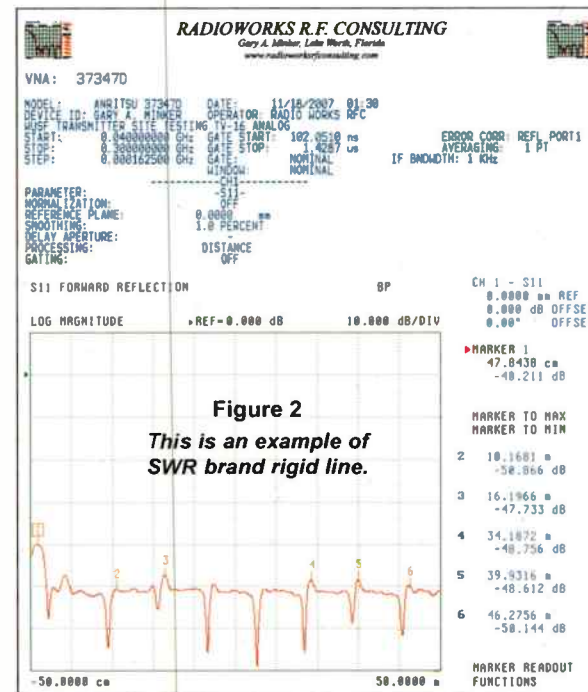
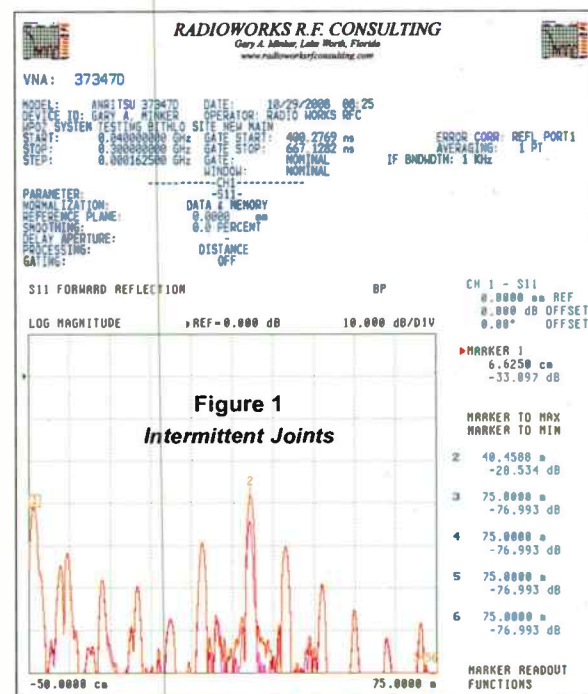



Look below the surface

Appearances can be deceiving. Axia® iQx looks like a traditional console, but it's actually a surface and mix engine rolled into one. We dove deep with AES67, giving you access to every source, anywhere on the network. iQx is affordable, allowing you to maximize existing network resources without paying for I/O you don't need! With nearly limitless connections, we can't even fathom the possibilities.



TelosAlliance.com/iQx

Available in the US from BGS.cc

SHAPING THE FUTURE OF AUDIO

THE TELOS ALLIANCE®

telosalliance.com | inquiry@telosalliance.com | +1.216.241.7225

World Radio History

The Clock

by Sam Wallington

One time I arrived early for a meeting (maybe I should clarify: I often arrive early for meetings!) and while waiting for others to arrive, I became irritated by the battery operated analog clock because it was a few minutes off. I took it off the wall, reset the time, and rehung it, thinking nothing of it.

Unfortunately, I did not quite get it on the hook. After several people arrived, it fell off the wall, crashing to the floor. The others in the room made a big fuss about it, especially because the minute hand had come dislodged. Based on the opinions of those in the room, it seemed the clock was irrevocably broken, and when they found out it was my fault, they blamed me for breaking it.

I picked up the clock, and, as the meeting started, I quietly sat down, disassembled the clock using my multi-tool, re-attached the minute hand, reset the time, and rehung it – carefully this time. The whole repair took perhaps two minutes.

The reaction of the others was astonishment: “You fixed it!” They were amazed that the clock functioned again, and I was surprised they were amazed!

A couple weeks later I realized why their reaction had seemed strange to me: The repair was so simple! I know they meant well, and were honest in their amazement, but I began to wonder how many in our society have reached

the point at which a simple repair is considered somehow great. At the time, my daughter was eight years old, and she could have easily fixed the clock. Here was a room with generally competent adults who were shocked it could be repaired at all – let alone in a couple minutes with a tool I carried on my belt.

What about my ability to fix a transmitter? Or my motorcycle or truck? On the scale of amazement surrounding my simple clock repair, it would be miracle territory for me to put a transmitter back on the air or replace a timing chain!

Maybe you have seen the animated Dilbert cartoon entitled “The Knack” (search YouTube if you need). That video is a reasonably accurate description of my childhood. For some strange reason, my parents felt comfortable with me using a screwdriver at 18 months, and I proceeded to take apart and re-assemble all sorts of things, starting with the kitchen cabinets and progressing to music boxes and other toys. Apparently, it freaked out my grandmother (understandably)! She had to be told that it was OK.

When I was nine, my 19-year-old brother bought (and repaired) a go-cart for me as a Christmas gift. Best Christmas ever! Some months later, my mom discovered me on the back porch with the motor disassembled (I just

wanted to see how it worked). She told me later that she said to herself, “Well, so much for the go-cart!” But an hour or two later, she heard the motor start up and I drove it off to play. (Don’t tell anyone ... I did have a couple parts left over, but since the engine worked fine until I sold it 10 or 15 years later, I guess they weren’t very important!)

The first time I failed to return something I had disassembled to a functional form, was as a young teenager when I disassembled a spring-based kitchen timer. My mistake was taking it apart while it was fully wound up. After I removed the screw that held the spring in place, I learned a valuable lesson about springs under tension, as I tried to gather all the little gears that had been launched all over my less-than-pristine bedroom. That one cost some allowance money to buy mom a new timer!

You may have a similar background, or work with someone who does. Chatting with some of my IT friends a few weeks ago, many of their early adventures were around computers, such as an Apple IIe, Commodore 64, or other early computers. Most of them wrote their first software at a young age because they grew bored with the built-in games. Alternately, they went deeply into gaming, moving from player to superplayer, and eventually to computer hardware and/or software experts to make the gaming better.

After my experience with the clock’s minute hand, I wondered if our culture’s obsession with safety has contributed to the problem. I took apart my childhood music boxes, but now music boxes require something like the jaws of life to get them open, and the act of looking inside destroys part or all of them. I realize that a music box contains all sorts of choking hazards, and I

(Continued on Page 22)

It's Time to Get Into the Mix



ProMix 4

The ProMix 4 is a compact full-featured monaural audio mixing console perfect for almost any broadcast studio, while excelling in remote broadcast and podcasting applications. It features three combination microphone/line inputs and a dedicated fourth input that may be switched between a balanced line input and the built-in USB audio interface. Other



features include: switch selectable program limiter, XLR program output, monitor output with muting and volume control, mix minus output for connection to an external telephone hybrid, on-air light relay output, and three 1/4" stereo headphone outputs with individual controls for volume, mix, and pan, allowing custom headphone mixes.

Broadcast Tools is a Veteran Owned Business
Designed, Assembled and Supported in WA State, USA.
www.broadcasttools.com

BROADCAST[®]
t o o l s
PROBLEM SOLVED

Abracadabra!



And just like *that!* It goes from AM to FM to HD/DAB/DRM to Streaming to Stereo Generator.
The only audio processor that adapts to your needs.

TelosAlliance.com/VOLT

SHAPING THE FUTURE OF AUDIO

THE TELOS ALLIANCE®

telosalliance.com | inquiry@telosalliance.com | +1.216.241.7225

World Radio History

The Clock

– Continued from Page 20 –

agree that they should be safer than when I was three, but, other than Legos, how do kids get hands-on education about how things work?

In *Surely You're Joking, Mr. Feynman*, Richard Feynman describes how he fixed radios as a kid by thinking, logically working his way through the problem in his mind, then taking action. He viewed problems as puzzles to be solved, and just kept playing with them until he figured them out. Obviously, his practice of playing with problems paid off as he went on to solve huge puzzles in physics and quantum physics.

Today's broadcast equipment is becoming more and more modularized and now it is often more economical to replace something rather than repair it. Early in my broadcast career, I repaired studio equipment, but now it makes little sense to repair any but the most expensive bits of gear. That is a little sad to me, because those who are newer to broadcasting may have never tuned a transmitter, and therefore may not have gained that innate sense of how resonance works. Replacing modules may not give a fundamental understanding of the principles of troubleshooting.

When I attend SBE meetings, I love that no one in the room is bothered by technology. Even gray-haired attendees (like me!) have recent model phones and know how to use them to their fullest, because they have played

with the features – and probably complained about how they would have designed some of them better. Often, they are Ham radio operators who regularly play with their amateur transmitter systems to improve and optimize them. At those meetings, you might hear stories about repairing the station's old remote vehicle or about how someone MacGyvered the air conditioner at the transmitter site to keep things running until a more permanent repair was possible.

My purpose is not to bemoan the changes in broadcast technology. An IP-enabled solid-state transmitter is so much more reliable and easier to deal with than earlier models. Instead, I want to focus on some good news. Even though many in our culture have less understanding of technology, the knowledge still exists and picking it up is still like how I learned: Taking time to play.

Play, and the learning that comes from it, does not happen unless there is freedom. First, there must be freedom to fail. Trying to fix anything under the threat of "success or else" would have stopped me from starting. Instead, I reasoned that the thing was already broken, but if I tried, I might be able to fix it – and even if I didn't succeed, I would at least learn something.

Second, playing requires freedom of time. Fixing a transmitter when the Program Director is calling every three minutes is ... well, a challenge! There needs to be enough time in the schedule to play, at least sometimes. Simply put, an overworked person cannot play properly because they're exhausted – perhaps something some in the radio industry have forgotten.

Finally, play needs to be free of fear. I have been surprised when people are afraid to try to fix something because they might make it worse, or because they might get in trouble. They, in turn, were surprised that I was

willing to try, even though I had never done that thing before. The difference is fear.

Ultimately, if we do not play, we will no longer be improving – a principle which applies in any field. A person needs a lot of time to play before they become proficient, and they need to continue to play with things that interest them to continue to improve and grow. If necessity is the mother of invention, play is the fuel. Innovation happens when people play – and broadcasting needs innovation!

The 2:00 a.m. broken transmitter does not feel like play. But if we can step back a bit, we might be able to turn off the part of our brain that is just mad about the lost sleep and consciously turn on the play circuits. Then the transmitter problem becomes a puzzle, we become engaged and able to think, and we try things until we figure it out. The play place (not the one at McDonalds) helps create efficient problem solvers.

The same idea applies with non-technical problems. Not getting along with the boss? Turn it into a puzzle and play with it a bit. Someone making your life difficult? Ratings falling off? Wish you could take a vacation? Need to clean up a big mess? If you can let yourself play, you'll come up with more possible solutions (and have more fun) than if you just complain about the situation.

Perhaps our culture is moving away from the ability to repair things, or maybe I just ended up in a meeting with people who were afraid to play in that area. In any case, we all get to choose (and help others choose) to grow by remembering how to play.

Sam Wallington is VP of Engineering for Educational Media Foundation, and has 34 years of experience in broadcast engineering. He can be reached at swallington@kloveair1.com

ALTRONIC RESEARCH INC.

Performance By Design

RF DUMMY LOADS for ALL YOUR APPLICATIONS

- AIR-COOLED
- HD
- HDTV
- WATER-COOLED



ALTRONIC RESEARCH INC.

P.O. Box 249 Yellville, Arkansas 72687 870-449-4093 Fax: 870-449-6000

E-mail: info@altronic.com Web Site: <http://www.altronic.com>



Sicon-8 Internet & Voice Remote Control

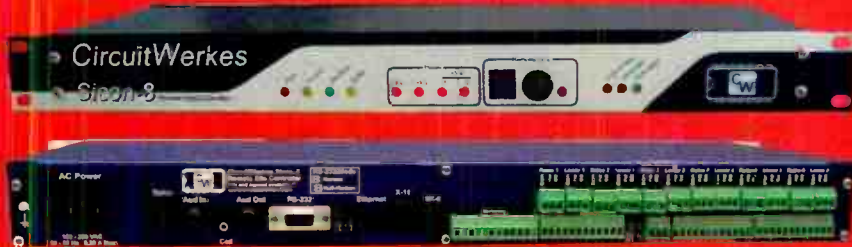

The CircuitWerkes Sicon-8 Remote Monitor & Control

- ▶ Uses Dial-up Internet Web server or free Sicontroller Software!
- ▶ 8 channels of metering, status and control (expandable to 32) and up to 5 alarms per channel.
- ▶ No accessories necessary to control your site right out of the box.
- ▶ Auto-ranging, auto-calibrating meters make setup a snap.
- ▶ Includes: Function scheduler, auto-logging & alarm reporting.

Internal Web Server

Free Sicontroller Software

The Sicon-8 lets you control your site via Internet with its internal Web server, via telephone, auto-answering cell phone or with our free software. Setup is a breeze using the Sicontroller software that also includes scripting, e-mail alerts, multi-site management, virtual metering & much more!

Web-Based Remote Controls w/Streaming Audio Option

Introducing the SiteSentry4 (4 channel remote control), SiteSentry2 (2 channel remote control) & WAM-2 audio monitor

- ▶ Web enabled remote controls with 6 relay outputs & 2 status inputs on all units.
- ▶ All units detect Stereo or Dual Mono Silence (independantly adjustable channels).
- ▶ User-programmed relays (DPDT) close automatically or via Web control
- ▶ All products include onboard temperature sensor
- ▶ Internal logging with onboard e-mailing.
- ▶ Supports DDNS services and Netbios names
- ▶ Upgradable firmware. Keep your product current with downloadable updates!
- ▶ Streaming audio option encodes Ogg-Vorbis & decodes mp3 or Ogg-Vorbis.



Remote Broadcasting Solutions

Discover more online at www.circuitwerkes.com



MicTel Mic/Line to Telephone Interface

- ▶ Outputs & Inputs for telephone handset, cellular phone or balanced line level at up to +10dBm.
- ▶ Operates up to 36+ hours on two 9V alkaline batteries.
- ▶ High quality, user-switchable, internal limiter prevents clipping.
- ▶ External power input with silent auto-switching battery backup.
- ▶ Individual gain controls for send, receive & headphones levels.

Unattended Dial-Up Broadcasts with the DR-10

- ▶ The DR-10 is a Dial-Up remote control with balanced, telephone audio input & output that can control many automation systems or your audio console for unattended remote broadcasts.
- ▶ Our Silencer™ option removes control tones from the audio path.
- ▶ Use the DPDT relays to insert the phone audio directly into the program path when necessary, especially for emergencies.



TelTap Pocket-Sized Manual Telephone Coupler

- ▶ Can be used as a phone tap or a passive manual telephone coupler.
- ▶ Send or receive telephone audio.
- ▶ Compact size & low cost makes the TelTap a great addition to your remote kit for main or backup capabilities.

Lots More CircuitWerkes Problem Solvers

- ▶ Transcom-16 - Move up to 16 contact closures from room to room over an audio cable
- ▶ DT-232 - Turns DTMF sequences into user-programmed serial outputs & action steps.
- ▶ FSK Encoders, decoders, transceivers and contact-to-FSK encoders/decoders.
- ▶ SUB-03 Subaudible tone decoder and SEN-6 Subaudible encoder.
- ▶ HC-3 telephone autocoupler and AC-12 rack of autocouplers
- ▶ DTMF-16 and DS-8 DTMF tone decoders.

Find Full product info & downloadable manuals online at www.circuitwerkes.com. 352-335-6555

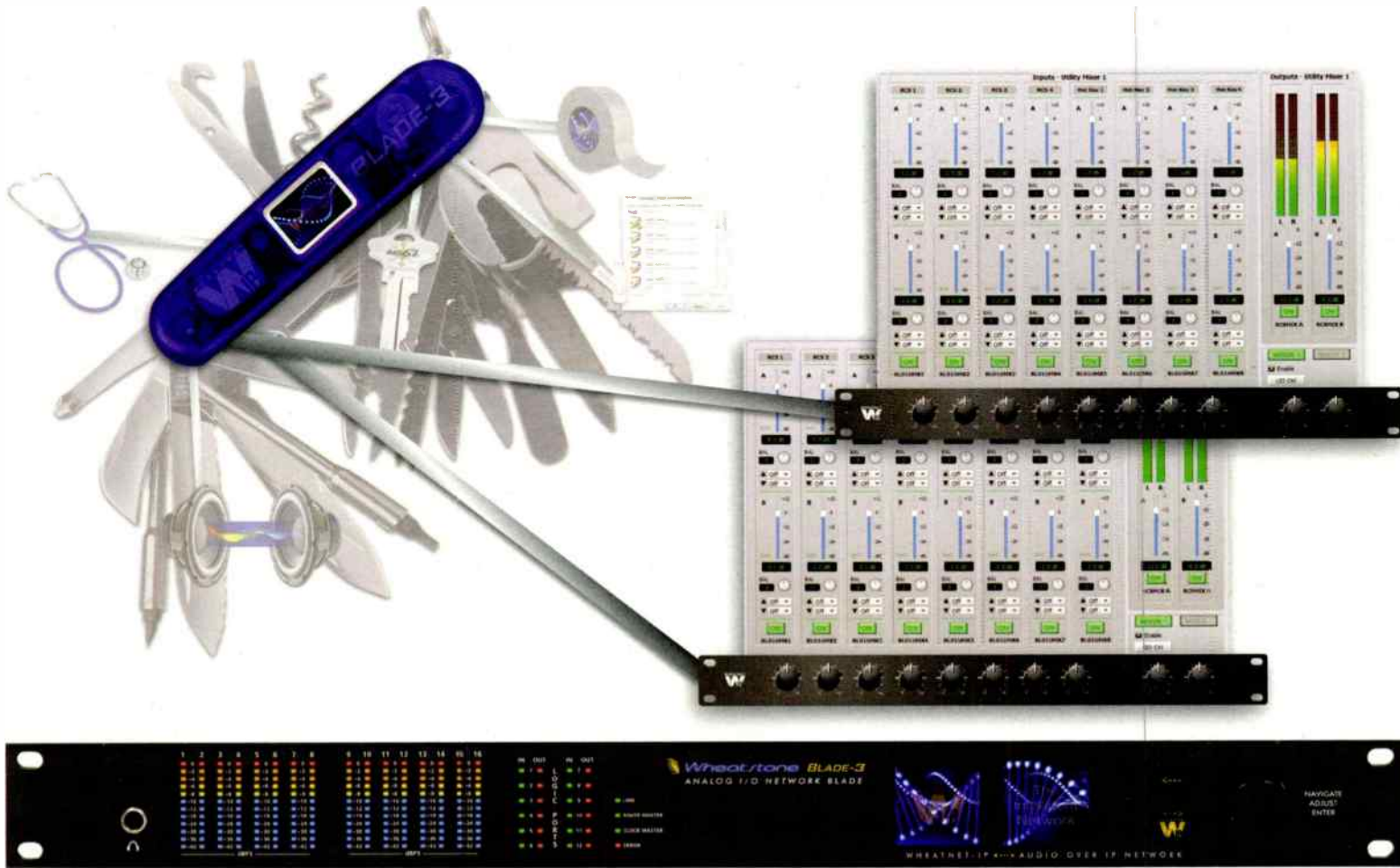

FUNCTION 3:
**ON-BOARD
 BOARDS**
**TWO VIRTUAL UTILITY
 MIXERS IN EVERY BLADE-3**

There are TWO 8 x 2 virtual mixers built into the BLADE. Why? So you can combine multiple inputs and deliver lovely mixed stereo audio. Of course, you can configure those mixers any way you like. Once you start thinking about it, you'll amaze yourself. Imagine building a network with these.

BLADE-3, the backbone of the WheatNet-IP Intelligent Network, is the Swiss army knife of AoIP audio interfaces. BLADES can literally do anything in the mic-to-transmitter chain. It's why it's called a "radio station in a box".

There are **DOZENS** of functions inside every BLADE - enough to run an entire radio studio.

Learn more: wheatstone.com/bl3-mixers-rg

Designed and built in the USA

1: Gigabit Connectivity • 2: Virtually All Audio Formats • 3: Two 8x2 Utility Mixers • 4: Audio & Control Routing Matrix • 5: Source & Destination Control • 6: Silence Detection • 7: Built-in Audio Clip Player • 8: Front Panel Logic Indicators
 9: 12 Universal GPIO Ports 10: 128 Software Logic Ports • 11: L10/SL10 Logging • 12: Stereo Audio Processor • 13: Associated Connections • 14: Aliases • 15: AES67 • 16: 44.1, 48K, External Sync or AES67 Operation • 17: Clock/Sync Indicators
 18: On-board Intelligent OS • 19: 44.1K or 48K Sampling Rates • 20: Auto Mono Summing • 21: Signal Splitting • 22: Gain Control on Every Input & Output • 23: Balance Control • 24: Flexible Signal Configuration • 25: Studio Bypass
 26: Front Panel Input and Output Metering • 27: Front Panel Headphone Jack and Source Selection • 28: Salvos/Macros • 29: Automation Control Interface (ACI) • 30: ScreenBuilder Compatible • 31: SNIWP • 32: L10 Test • 33: Backup Function
 34: Alarm Notification • 35: NTP • 36: Front Panel Locking • 37: Crosspoint Save • 38: Debugging Functions • 39: No Cooling Fans • 40: Sound Card Replacement • 41: Self Healing (and more...)



**THE FUTURE
CAN BRING
ANYTHING**
**LXE IS
READY FOR
EVERYTHING**



Virtually every button, knob, and display on the LXE is programmable using ConsoleBuilder. And you can design dynamic custom touchscreen interfaces to augment LXE's extensive screen set with ScreenBuilder.™
Need more input faders? Enable up to four layers to multiply the number (up to 32) in the same footprint.

Whether it's 2020, 2040, or 2080, your LXE will adapt to your needs.

Your Forever Console: wheatstone.com/lxe-forever-rg



Designed and built in the USA

IT'S ALL IN WHEATNET-IP



THE INTELLIGENT NETWORK

Radio History

The Secret Radio Station

by Steve Callahan

At one point or another in my career, I've worked at or have visited every radio station in the State of Rhode Island. Admittedly, Rhode Island is a small state but it has quite a few radio facilities. One puzzling question started me on a very interesting search for some lost radio history.

I was talking with an old-timer in Providence recently who, when he learned of my radio experience in the Ocean State, asked me, "Whatever happened to the secret government radio station in Scituate, Rhode Island?" Frankly, I was stunned and surprised because I didn't know of any secret government radio station in Rhode Island or anywhere else. But that doesn't mean that they couldn't have existed – I just didn't know of any.

I turned to the trusty Internet to see if there was any record of a secret government radio facility in Scituate, RI. Amazingly, there was quite a bit of information and I was more than interested in each and every word I found.

Scituate, Rhode Island is located in the center of the state, about twenty miles west of the capital city of Providence. Its one unique feature is 735 foot Chopmist Hill, which is one of the highest points in the state.

Back in 1940, with World War II on the horizon, The Federal Communications Commission surveyed locations around the country that would be suitable for secret radio listening posts. The FCC wanted to pick up radio transmis-

sions from German spies in this country along with other signals from other countries in the war zone.



Thomas B. Cave, the FCC's agent from the Boston office, was assigned to find a location for a listening post in Rhode Island. Initially he selected a site in Greenville, RI but later ruled it out for another site – the 138 acre Suddard farm on Darby Road in Scituate on Chopmist Hill.

The FCC proceeded to rent the farm from the Suddard family and then started to erect a series of telephone poles, with 80,000 feet of wire, 11 antennas and many advanced

radio receivers. Narragansett Electric was contracted to place the antenna support telephone poles, which were set extra deep so as not to show above the tree line. Several times pole setting crews from Narragansett Electric had to return to the site to move telephone poles as little as two feet from their original placement. The pole crews were never told what the telephone poles were being used for.

Barbed wire fences, guard towers and warning signs were installed at the site, saying that portions of the access road would be restricted during "military emergencies."

Amazingly, many local folks in Scituate during the war, despite the fact that it was a relatively small town, didn't know exactly what was happening up on Chopmist Hill.

It was a well-guarded secret until the FCC permitted a reporter to visit the site in March of 1945.

The site also included rotatable direction-finding antennas. These two antennas would be used, with other listening posts, to triangulate and locate distress transmissions from locations around the world. It turns out, that the Chopmist Hill station was far more sensitive and was able to receive signals from farther away than any of the other secret listening posts. A test was performed with a radio transmitter and a wire antenna which was draped out a window at the Pentagon in Washington, DC.



Abandoned 1960's vintage communication tower on site of former secret listening post.

(Continued on Page 28)

 <p>Studio Items Inc</p>   <p>Mic Booms On-Air Lights Speaker Mounts www.studioitems.com</p>	<p>TORPEY TIME <i>(The Good Time People)</i></p>   <p>Clocks Up/Down Timers www.ram68.com</p>	<p>Dixon Systems</p>   <p>News Mixers Line Matchers www.ram68.com</p>	 <p>RAM Systems</p>   <p>Broadcast Furniture Sound Absorption Panels www.ram68.com</p>
---	---	---	---

MAKE YOUR AM GREAT

...with ORBAN's
Flagship AM Processor!



Get yours from **SCMS** for
\$7391.



Call to schedule a

FREE DEMO

CONTACT **SCMS** for **ORBAN** products

1-800-438-6040 | www.scmsinc.com

Broadcast Equipment Solutions | 19 reps across the U.S. and Latin America



The Secret Radio Station

– Continued from Page 26 –

A signal was sent, simulating a German spy, and Chopmist Hill responded in just seven minutes – not only with the content of the message but its exact point of origin.

In early 1942, an operator at Chopmist Hill was amazed when he picked up messages between two men who were speaking German. Intelligence experts for the Navy Command Base, in nearby Newport, RI confirmed that the Chopmist operator had indeed picked up and listened to the German High Command in North Africa radioing orders to its tank commanders there. Even German tank-to-tank radio communication was monitored at Chopmist. That valuable information was relayed to the British forces in North Africa and that enabled the British 8th Army at El Alamein to be forewarned of German Field Marshall's Ervin Rommel's impending attack.

Another time that the Chopmist Hill proved its importance was when the steamer Queen Mary, then acting as a troop transport, was headed from Brazil to Australia with 14,000 Allied troops on board. German spies in Brazil had learned of the Queen Mary's route and reported the ship's progress to the German submarine fleet. Chopmist Hill station was the only listening post able to pull in the signals from the German spy network so that the big ship was able to change course and evade the U-boats.

There were many occasions when Chopmist Hill station was able to locate downed military aircraft. On

one occasion it guided a lost plane over the coast of Florida to safety with actress Kay Francis on board. Another time Chopmist located a downed military aircraft with 22 people on board over Labrador and the crew and wounded passengers were rescued.

As World War II drew to a close, so did the clandestine operations at Chopmist Hill. The station was disassembled and deactivated and another military secret was consigned to history books. However, just when you thought little Scituate, R.I. had its one and only brush with greatness, another plan, even more amazing, was being contemplated.

This was the time of the formation of the new United Nations, and a site for the new UN headquarters was being sought close to Boston or New York City. The criteria for the new UN headquarters was to be close to air and rail transportation, to require a minimum number of people to be displaced and to have enough space to locate a new airport. Scituate R.I. met all of those criteria.

Dr. Stoyan Gavrilovic of Yugoslavia headed a UN delegation to visit various sites and the delegation hiked up Chopmist Hill on January 23, 1946. They said the site

met all of the technical points and was one of the top sites in the United States for the site of the permanent headquarters of the United Nations. However, John D. Rockefeller Jr. donated \$8.5 million dollars to buy a 16 acre site on the East River which is where the UN now stands.

It's still not known why Chopmist Hill was so good at receiving the distant signals. Speculation ranged from atmospheric ducting to underground geological formations, but all of them were discounted. Thomas B. Cave admitted, just before his death in 1983, that the advanced, super-secret radio equipment housed at Chopmist Hill during the war was why it worked so well and saved so many lives.

Reportedly, there were other secret wartime listening posts at Fort Ward, Washington, Winter Harbor, Maine, Amagansett, NY, Cheltenham, Maryland and Jupiter, Florida.

Why not take a few minutes to conduct your own investigation to see if there was a "secret radio station" in your backyard?

Bibliography:

- Providence Journal Magazine: Dec. 6, 1981.
- Providence Journal: 11/23/45, 4/21/83, 1/24/46, 2/11/46, 2/21/51.
- Barbara Sarkesian: *Chopmist Hill and the United Nations*, at quahog.org
- Paul Eno: *How RI Almost Became the Center of the World*, Yankee Magazine January 1986.
- Tom Kneitel: *CB's Secret Wartime Mission, The Day They Heard Nazi Panzers on 11 Meters Radio*, February 1978
- Alan Rydberg: *The World War 2 Listening Post at Chopmist Hill in Scituate*, at smallstatebighistory.com
- Sieve Callahan, CBRE, AMD, is the owner of WVBF, Middleboro, Mass. Email at: wvhf1530@yahoo.com*



More than JUST a SIGN



**CUSTOM
COLOR
FONT
LOGO
LETTERING
DESIGN**

WWW.TITUSLABS.COM



Welcome to
Broadcast 3.0
ruby – Radio never looked so good.



Join us @
NAB
#N2503



DOWNLOAD
ruby BROCHURE
bit.ly/2k.T80bi

Feast your eyes on the new ruby mixing console.

Intuitive. Uncluttered. Powerful, yet so refined. Streamlined from every angle. Optimized controls: everything you need, nothing you don't. Only 5 cm (2") tall, from the bottom of its exquisitely cast side frames to the tops of its carefully chosen rotary selectors.

But great design goes beyond mere good looks. Which is why ruby is expertly crafted for both speed and accuracy — controls perfectly placed to fall naturally to hand. Premium-grade displays, faders and switches. Standards-based AES67 networking. Powerful features like AutoMix smart mixing and instant one-button switching between live and production modes. Up to 96 channels of DSP and 1,920 routing crosspoints*. The cherry on top? A customizable, context-sensitive touchscreen GUI that puts virtual control of mixer functions, playout software, studio devices, even Web feeds, social media and video, right at your operator's fingertips.

No other console is this smart. Slim, trim, and sharp as the cutting edge. Engineered and built without compromise by German craftsmen.

Sprechen Sie deutsch?

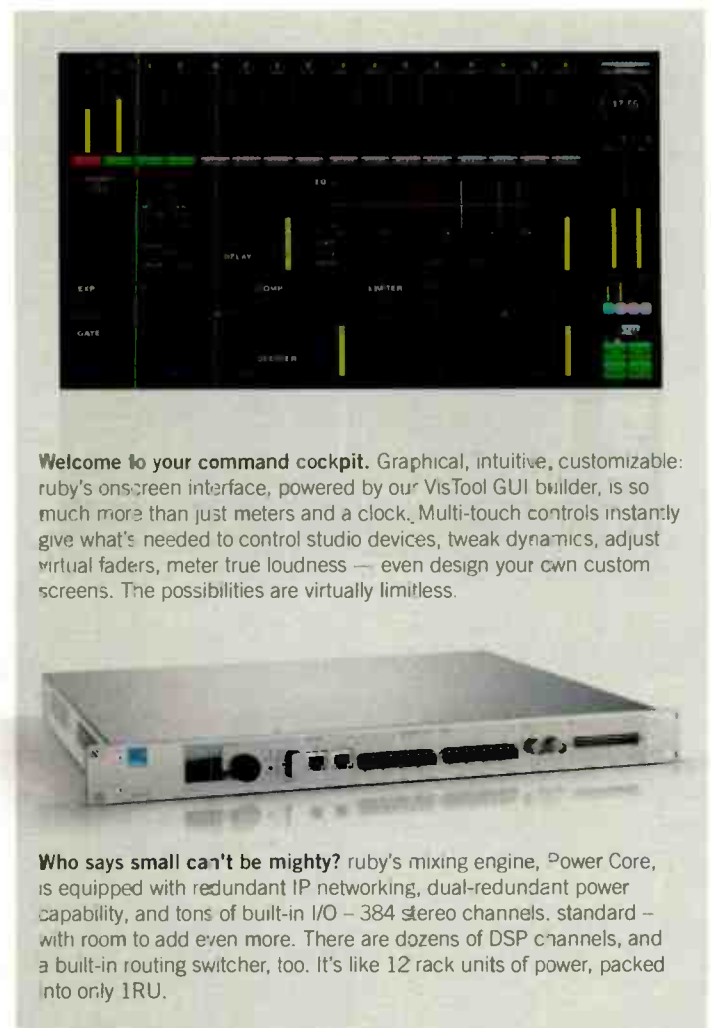

Welcome to your command cockpit. Graphical, intuitive, customizable: ruby's on-screen interface, powered by our VisTool GUI builder, is so much more than just meters and a clock. Multi-touch controls instantly give what's needed to control studio devices, tweak dynamics, adjust virtual faders, meter true loudness — even design your own custom screens. The possibilities are virtually limitless.



Who says small can't be mighty? ruby's mixing engine, Power Core, is equipped with redundant IP networking, dual-redundant power capability, and tons of built-in I/O — 384 stereo channels, standard — with room to add even more. There are dozens of DSP channels, and a built-in routing switcher, too. It's like 12 rack units of power, packed into only 1RU.

www.lawo.com

World Radio History

Installing Linux for the Newbie

Getting Around the Windows Obsolescence Situation – Part Five

by Tommy Gray – CPBE, CBNE

Your First Linux Computer!

Well, the holidays are past us for another year and we are all making our New Year's resolutions. I have had several inquiries from readers, asking if I would go through a step-by-step install of Linux Mint Cinnamon, that I use, for folks who might not be as "computer savvy" as others. Please keep in mind that, when I started this series several months ago, it was to address the computer obsolescence problems created by the never ending Windows updates and new Windows operating systems, and to provide an alternative. As you know, the change was literally forced on us. We had perfectly working Windows 7 and Windows XP computers that had been serving us well for years, and we were perfectly happy to keep using them. However, Microsoft™ was not happy with that because they could not sell you a new operating system, which also, in many cases, required a totally new computer to run it on. These mandatory changes have cost most of us a ton of bucks to implement, not to mention the sidelining of many a great computer that we are familiar with and are happy with – and trading a great computer for a mediocre Windows 10 computer.

So what do we do? Do we box them up and put them in storage or donate them to a charity, or something like that? Or do we find a way to keep using them and salvage our investment. In most cases, the answer should be that

we find a way to keep them and still use them. In past times, to migrate to a new operating system meant a steep learning curve in order to even be able to get it installed and working. These days, however, that is not the case. It is perfectly within the realm of the everyday user to be able to install Linux on an old Windows computer and have it work right out of the box. In times past, we had to edit scripts, and do all kinds of stuff that required being a computer junkie for the most part, but today installing Linux is something that anyone, who can perform normal computer operations, can accomplish. Recently, I have upgraded for a friend, several old Dell™ laptop computers he picked up at a salvage sale, along with a few from the Internet he got – not a one for more than \$50.

These particular machines are commercial grade Dell™ machines with Intel Core 2 Duo processors and 4 GB of RAM. They had 80-100 GB hard drives, which we upgraded to 500 GB for about \$25 each. The total investment he has in these machines is under \$100 each, and they are ready to go. I will outline for you the process I used to convert these machines to great running Linux Mint Cinnamon computers.

Getting Started

The first thing to do is to make a USB flash drive "boot drive." You will need a drive that has at least 4 GB free

space and nothing on it that you want to keep, as it will overwrite everything on the disk, and anything you have on it will be lost. The reason for the extra space will become apparent as we go along. The computers I upgraded, all had DVD drives, but would also boot to flash drive, so that was the option I chose. You can create a DVD boot disk but the flash drive is preferable, as it is the easiest – that is what I will talk about in this article. To make a boot disk you have several options. Regardless of which method you use, you need to first get the latest version of Linux Mint Cinnamon from www.linuxmint.com

Get the .iso file for your hardware, either 32 bit or 64 bit, depending on what your machine is. I would suggest creating a folder on your desktop and dropping the .iso file in it. You should have at least about 2.5 GB free space available on your drive for storage. At the time of this writing, the latest version of Cinnamon is version 19.1 which is a 2 GB .iso file.



The latest version (19.1) of Cinnamon is a 2 GB file.

(Continued on Page 32)

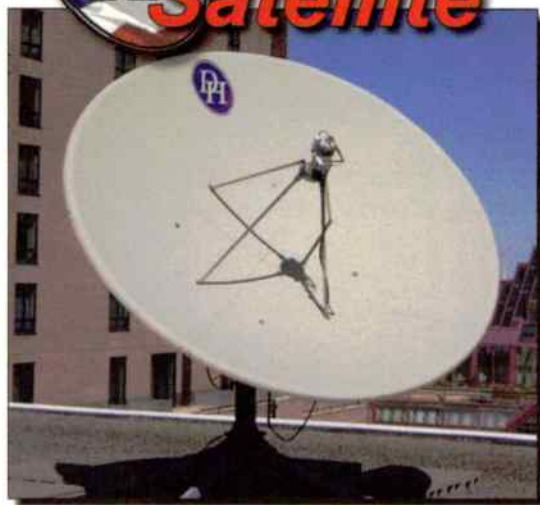

**DH 1-piece Antenna Sizes Available
From .6m to 5.0m**

DH Sectional Antennas Available:
1.8m ~ 2.4m ~ 2.7m ~ 3.0m
3.7m ~ 4.2m ~ 4.5m ~ 5.0m

Mount Options:

Fixed Az-El, Polar Tracking, Horizon to Horizon Tracking
Fixed & Dual-Powered Gibraltar Az-El
Dual-Powered Gemini Az-El

For More Information: dhsat@mhtc.net

DH Is The Industry Standard!

For over 35 years, our 1-piece antenna has outperformed the rest! The 4-piece, 3.7m has the same accuracy because we use 8 computer generated templates and attach them to the back prior to cutting the antenna. This allows for ...

**Superior Quality Quick Delivery
Easier Installs Cheaper Shipping
Fits Into Service Elevators For Roof Installs**

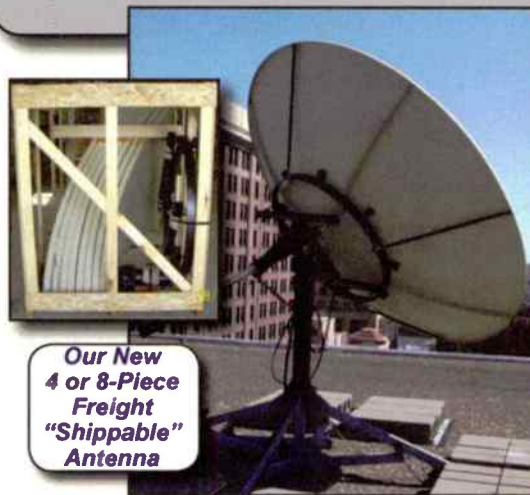

**Our New
4 or 8-Piece
Freight
"Shippable"
Antenna**



DHSatellite.com ~ 800-627-9443



SMARTS
Broadcast Systems

(800) 747-6278

www.smartsbroadcast.com
sales@smartsbroadcast.com

Skylla



Skylla's Smart Features:

Smart Special Events like ballgames, national and local.

Smart Satellite support, complete with incoming RBDS data, announcers, clocks, break-tracking, and automatic break fill.

Smart Automatic Downloads of audio from the Internet.

Smart Automatic Unattended Recording by time, closure, or both.

Smart Voice Tracking allowing people to voice track at the same time to the same log, both at the station and remotely. Also allows voice tracking to future yet-to-be-merged playlists.

Smart Design. For uptime and reliability: Linux. For data safety: RAID and machine-to-machine backups of audio and data.

SkyllaPad



Simplify local sports broadcasts.

With features found only on SkyllaPad, broadcasting remote sporting events has never been easier.

You supply audio, SkyllaPad supplies control. With the touch of a button on a Smartphone, tablet, or laptop, you're on the air and in charge of your remote.

SecGen

Traffic & billing software designed for you.



SecGen, the second generation of our original Smarts program, lets you define the setup by matching the program to your station's formats and breaks. Combined with the ability for single user, multi user, and remote user, SecGen can be customized to fit your needs.



SMARTS
Broadcast Systems

– Continued from Page 30 –

Choose the “Download” menu item, find what you need, then download it into a folder on your desktop. Now you have two options from here.

Option 1: First, if you have access to a Linux machine with a recent version of Linux on it, this is by far the easiest. Find your .iso file in your file manager as shown below, then right click on it.

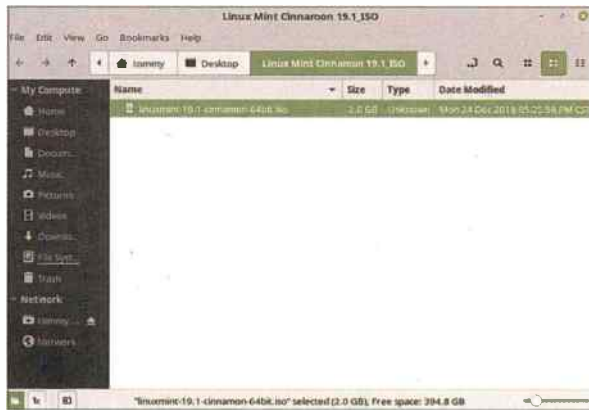

From the right click menu that pops up, select the option to “Make bootable USB stick.” Then select your USB stick from the available drives, and let it create.

Option 2: Create the bootable stick from Windows. This is not nearly as easy as Linux (another reason I like Linux). You will need to download a program to allow you to create a bootable flash drive. There are a great many out there. One program I have used successfully is called “Unetbootin.” Keep in mind I am *not* recommend-

ing any program, just giving you one option. Everyone will have something they prefer. If you are not sure, just do an Internet search for “creating a bootable flash drive” and you will find numerous options. Once you have “Unetbootin” running on your Windows computer, choose the option to create a “Diskimage.” Select the .iso file type. Choose “Downloaded .iso file,” then select your USB drive and let it create the bootable stick.

Where Do We Go From Here?

Once you have a working bootable USB stick, you can do a couple of things. The first, and preferred thing to do, is to actually run Linux from the flash drive and see if it will run on your computer. To do this, make sure that your computer is set to boot from the flash drive. This is in some cases automatic, and will boot from it, if it is in the machine. Other computers will require you to go into the setup utility at boot time and choose the boot order that puts the USB drive first in the list. Some of the machines I converted had no options in the BIOS to choose boot order and automatically booted from the flash whenever it was in the machine. Others of the same type had a boot order selection option in the BIOS. You will find what yours has, when you boot into the setup option at boot time.

Now boot the computer with the bootable drive inserted and give it some time to do its thing. Keep in mind that booting from the flash drive is not going to be as fast as booting from the hard drive. Eventually you will see a desktop for Linux Mint Cinnamon and you will immediately see that it looks just about like any Windows computer you have ever used. It has icons, a taskbar, background, etc.

From here you can actually run the computer, and see what it can do, by choosing programs from the menu

(Linux icon in the lower left corner of the screen). You can run all the programs there and see how it will run, remembering that once it is installed on your computer, it is going to run faster. Play around with your Linux Mint Cinnamon computer and see what it can do. Now this is just a tiny version of its capability but it will allow you to run it without doing anything to your computer. You can create files, do all kinds of things, and basically run your new Linux computer. Keep this in mind – you are running on your flash drive and when you reboot your computer, anything you do will be gone as it was only in memory for the most part. Notice on your home screen there is an icon that allows you to “install Linux Mint Cinnamon” on your computer. If at any time you want to go ahead and do the install, you simply click the icon and follow the on-screen instructions. You can either wipe Windows out and run just Linux, or you can do an “Alongside” install, where you will have an option at boot time to run either Windows or Linux – your choice. I will go into a complete install in the next issue. Enjoy!

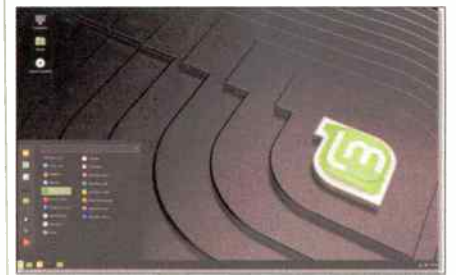

Linux Mint Cinnamon Desktop

Tommy Gray is a semi-retired veteran broadcast engineer currently staying busy doing engineering in the gulf south, through “Broadcast Engineering & Technology LLC”, a Louisiana based Consulting and Contract Engineering Firm, serving the US. www.BEandT.com



fuhgeddaboutit!

Admit it; you’d love to forget all about your FM antenna. You’d be perfectly happy if it were to spend decades out of sight, out of mind, and out of your budget. You just want it to work; day in, and day out.

We understand.

Shively designs antenna systems to work flawlessly. Year after year. At any site. Under any conditions. For any power level. Happily, in the background.

FM First.

This was Ed Shively’s vision in 1963, when he founded the company; and over 50 years later, we’re still doing our best to be absolutely forgettable.

Shively Labs®

A Division of Howell Laboratories, Inc. Bridgton, Maine 04009 USA

Call Toll-Free: (888) SHIVELY
Or visit us on the Web at: www.shively.com

- An Employee-Owned Company since 1995 -

ARRAKIS SYSTEMS INC.
MUSIC & ENTERTAINMENT

ALWAYS THE LEADER

For more than 35 years, Arrakis Systems has led the way with ground breaking innovations in cost effective, reliable Radio consoles... including USB, Bluetooth, world standard DANTE IP connectivity for ALL consoles and 'New for 2018' the DARC series AoIP consoles.



ARC-8
only \$849

ARC-10
from \$1,699

ARC-15
from \$3,799

MARC-15
from \$5,499

D.A.R.C.

Dante AoIP Radio Console uses the world standard DANTE IP protocol with more than 300 manufacturers and 1,000 compatible products. From only \$2,300.

operate from
anywhere that you
have wideband internet !!!

www.arrakis-systems.com

970-461-0730

World Radio History

Remote Radio

Remote Options Abounding

by Jim Turville

Since retiring from Corporate Engineering duties 4-1/2 years ago, I've settled into a slower pace and got a better handle on my health situation. I'm not implying that my work was killing me, as my doctor satirically asked me, but the manner in which I was handling my job was not conducive to good health. Getting away from the day-to-day management has given me a new outlook and a new lease on life. In that recent time, a long-time buddy and I bought a few unbuilt FM Construction Permits and have begun playing small-town radio. It has been rewarding, as well as challenging at times – putting a new station on the air and operating it on a tight budget in mostly rural communities.

I've been asked, on several occasions lately, about how we do live remote broadcasts at our little radio stations. I always quickly preface any response with a reminder that we are small town stations (my cities of license are less than 2,000 population each) and that most or all of my live talent are volunteer or amateur at the best. I also remind them that I'm an Engineer and some of my tactics are a bit out of the ordinary use of common things. But I felt that this would be a great forum for sharing some of the techniques that we use and maybe inspire some other broadcasters to try them out.

The first realization that I have had in these smaller markets is that the FCC's Connect American initiatives

have been mostly successful. That program has been going since late 2011, and involves the Federal subsidization of existing and new telco and Internet service providers to incentivize the expansion of high-speed Internet to underserved areas. Conveniently, that means all of my facilities – a single studio hub and several tower locations – are pretty much all covered in the expanded service areas with quality Internet service. Specifically, my studio location has amazingly rock solid broadband connection, which allows us to efficiently operate the five signals we are now programming there. The two closest ones are fed by terrestrial STL gear, but the other three are IP fed, with a reliability that makes the station fiscally stable. It also means that when we are out doing a live event – occasionally a live remote for a sponsor, but most often community events or high school sporting broadcasts – we can usually trust that reliable Internet will be available. We are fortunate that both of the cellular providers in the area – Verizon and AT&T – have a great 4G network as well. For a \$10 monthly charge, I have the hot spot option on my AT&T Android phone which can give me a 40 MB or better connection to my laptop; that lets me do live streaming of an event back to the station, or uploading files from the remote site as needed for “live” breaks.

With the connectivity in place, all I needed was a way to get that audio in and out of the necessary devices to get

it on the air. That required some research and experimentation, but I've created some functional and affordable solutions in which you might be interested.

At the studio, I have different ways to get outside connections on the air, or at least into production. First is an analog telephone interface. Mine is a JK Audio Broadcast Host (but several boxes do the same thing just as well), which is fed by a toggle switch for line selection. One position is an old-fashioned analog POTS line from my local wireline provider. The second position is the Line connection from a Magic Jack. I will address its advantages, but know that they probably apply to whatever VoIP service you have available as well. I also have a second Magic Jack number with which I use the “soft phone” app on a PC in the Studio. This lets me route mix-minus from the console to the sound card input on the PC, and the line out of the PC back to the board. Next, I have a Google Hangouts app on a PC in the studio, again with mix-minus to the input and PC playback to a pot on the board. And finally, I have a TRRS “Y” breakout cable, wired to be able to send mix-minus into and take L/R audio out back to a pot on the board. If all else fails, that can be plugged into a cellphone or tablet for the source and interface in the studio.

This combination gives me a ton of flexibility with whatever my remote site has available. For example, if we are doing a live school sporting event and the location has good 4G coverage, my talent may connect by Google Hangouts. That service, like many other live chat services, will give the best voice quality available. If the venue has no 4G service, but has 3G connectivity, then a Magic Jack call from a laptop might be the next best connection – as from one MJ to another bypasses the local Telco Central Office and eliminates the 3 kHz cut off of audio fidelity.

(Continued on Page 36)

DEVA[®]

BROADCAST

Available in stock from
Broadcast Depot, Call: 800-313-7592
www.devabroadcast.com

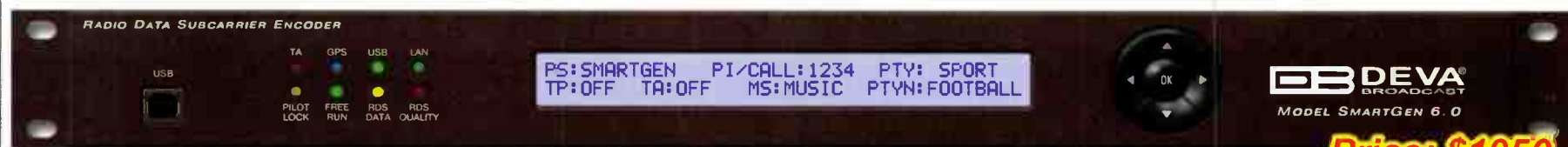

Modulation Monitors • Rebroadcast Receivers • RBDS Encoders • Broadcast Tools

Open the door to *your* possibilities!



ON THE AIR

Powerful, state-of-the-art automation with the flexibility to grow with you...

- The power of OPX in one stand-alone computer
- Easy to learn
- The power to handle the largest audio libraries
- Satellite and live programming
- Additional stations
- Remote voicetracking
- Remote control

OPXONE



Call (888) 274-8721

(888) BSI-USA-1

or email us at sales@bsiusa.com

Remote Radio

– Continued from Page 34 –

As a last option, having only cell service to make a phone call can connect to my Broadcast Host via the analog POTS line. This pretty much assures that “something” can connect from just about “any” location and we can be on the air. Obviously, we try to go with the best quality first, but it’s not ever been where we simply could not make a connection for a remote.

The remote end is also a challenge, as most of my “talent” is volunteer, or certainly not broadcast trained or technically savvy for the most part. This means we have to make it as simple and fail-proof as possible, while maintaining good connectivity and audio quality. I remember going to a remote with a huge bag of microphones, headphones, mixers and miles of cords and cables – but that requires time and technical expertise to set up, and you have sure created a lot of ways for something to go wrong at the same time. I’ve also found out the hard way that modern small-town athletic venues just do not allow space for that kind of a setup any longer.



Figure 1

My crew has, on many occasions, been relegated to broadcasting from the video deck, or even a corner of the stands amidst the crowd. As an aside, we found that doing this on the same side as your team is always advised!

But equipping your broadcast crew with nothing but a cell phone is space wise and avoids technical chaos in setting up for a broadcast. Between Blackberry, Android and iPhone models, there are only three ways to interface the user into the device. First is the old-fashioned and reliable TRRS 1/8” headset plug. Newer Android models have moved to a USB-C connector and the newer iPhones have moved to a Lightning jack. For either of these, a simple adaptor is available to connect back to the TRRS plug. **Figure 1** is my solo remote setup, used mainly for basketball or baseball where we have only one announcer. That is a “Gaming” headset, which comes with the TRRS connection, and has excellent voice band frequency response.

When circumstances require two remote announcers, there is a simple TRRS splitter cable that lets one connect two headsets to one jack.

Then, when a live “man on the street” situation is needed, the variation becomes a TRRS breakout cable to a hand-held microphone and pair of headsets. This is done with inexpensive gear so it can be tossed if damaged – the entire setup in **Figure 2** has a total cost of only \$30.

Finally, I also have a more “broadcast version” of the same equipment which adds to the flexibility. The Saramonic Smart Rigg II in **Figure 3** has an XLR for a broadcast



Figure 2

microphone, and jack for headset and connects to the phone. The newer version of this unit also is available with an iPhone-compatible lighting plug directly installed. This unit requires a 9V battery, so it’s something that has an extra layer of fail potential when sent out on remote. But the quality is amazing, whether you broadcast live or just record.



Figure 3

As for the recording, these interfaces also work great for a quasi-live event. Send your guy out with a mic and his phone, have them open the Voice Recording app, and just record the break and text or email it to the station. This lets me maintain full control over the audio, having the chance to review and edit before airing.

There are some wonderful Blue Tooth and other connection interfaces out there; but if you need something to give you a comparable remote connection without the price point of those items, purposing readily available items in a more unusual manner may be something that will work for you as well.

Jim “Turbo” Turvaille is semi-retired from 40 years in full-time Radio Engineering and lives in Rural Wheeler County Texas in a “tiny house” where he maintains a small clientele of stations under his Turbo Technical Services (www.jimturbo.net) operation providing FCC application preparation and field work.

Kintronic



Labs

Solutions for ALL FM Installations



FM Combiners

Model FMC-1.5 Isocoupler
for low-loss isolation
solution



Full line of Isocoils
for co-locating 1
or more FM
Translators on
AM tower



Introducing Two New Products



LAB4.50 Automatic Dehydrator
with 165,000 hour MTBF



DL-25K-FM
FM Dummy Load
25kW
VSWR: 1.15:1

ADDRESS: P.O. Box 845, Bristol, TN 37621

PHONE: 1-423-878-3141

EMAIL: ktl@kintronic.com

From analog FM to best-in-class HD Radio on your schedule and budget



Flexiva FMXi 4g

Transition to superior digital with exceptional ease and affordability

Flexiva™ Gen4 Exgine HD Radio Solution

- High-efficiency transmitters with industry-leading performance and compliance
- Industry's most advanced quality and diagnostics with robust Flexiva excitors
- New Flexiva **FMXi 4g** combines import/export functions into a single embedded device, including dynamic time/level/phase correction
- End-to-end management for multichannel program transport and delivery

NEW



Connecting What's Next
www.gatesair.com/flexiva

Since 1922, GatesAir has remained the industry's most trusted supplier for the over-the-air TV and radio networks worldwide. World-class engineering and industry-leading innovation marry outstanding performance with the industry's highest reliability and operational efficiency. Our impeccable sales and service bring it all together for our valued customers.



Small Market Guide

The Curse of the Estranged dB

by Roger Paskvan

The other day, I was working on a project with another engineer at a small market radio station. He was trying to decide if the extra money was worth it between a 44 dB LNB and a 50 dB LNB. The difference was \$100. We began talking about dBs and how much difference 3 dB can make on a dish. He finally just said, I don't want to have to crank out that big log formula every time I need to know the dB gain. I quickly realized that logarithms were very frustrating to him. I mentioned that there was an easy workaround for logs that utilizes just three simple numbers. This is the conversation that followed:

There is a non-scientific way to solve decibel log problems in seconds without using charts, tables or calculators. There is no need to involve algebra, just some addition and multiplication of simple numbers. He looked at me and said, "Okay, I'm listening." First, some background.

The word Decibel dates to the late 1800's of Alexander Graham Bell and his research on the famous telephone. Alexander had a lot to do with measurements of audio and signal intensities in his work, so he invented a term called the "Bel." (one L intentionally missing). The problem with the Bel was its numerical size. It was a huge unit, probably derived from the large signals needed in those days to operate the crude telephone equipment. With the modernization and efficiency of components, the same telephone

services are now achieved with much lower signal levels. In honor of its inventor, the logical thing to do was to keep the unit of measure and apply the metric system to the Bel. So, the Bel was divided by 10 and prefixed with the word deci (meaning 1/10 in metric). This became the root of the word, decibel, later termed dB. We now had a common way of expressing gain or loss in the form of a ratio between power, voltage or current. The B is only capitalized since it refers to Alexander's last name.

Loss

?

$$dB = 10 \log_{10} \frac{P2}{P1}$$

Gain

dB's

Webster defines decibel as a unit used in electrical engineering and acoustics to express the ratio between two values with the same dimensions. The quantities compared

may be two power levels, two voltages, two sound pressure levels, and so on. Since the quantities in the ratio always have the common same dimension units, the dimensions cancel out; the decibel itself is dimensionless. But, dB measurements must be made between identical impedances to be accurate. For example, the two power measurements must be on a 50 Ohm line or 600 ohm line, etc. for the numbers to work.

Decibels can be used to express gain or loss between any number of antennas, amplifiers or two measurements. They can be utilized to show the input/output differences between two amplifiers or two antennas thus providing meaningful gain figures, etc. This article will deal with power measurement.

So now that I've defined some basics, let's look at a method of finding dB's without doing those painful logarithmic calculations.

To begin understanding this method, you need to memorize three key numbers and their associated dB figures with a multiplier. **10 dB = 10X**, **6 dB = 4X**, and **3 dB = 2X**.

The key number is telling you what to do with the power value when its related dB figure is used.

For **10 dB**, the key number is **10**. This means that for an increase, or a +10 dB change, our power level would be multiplied by 10. For a decrease, or a -10 dB change, we would divide by 10.

For **6 dB**, the key number is **4**. This means that for an increase, or a +6 dB change, our power level would be multiplied by 4. For a decrease, or a -6 dB change, we would divide by 4.

For **3 dB**, the key number is **2**. This means that for an increase, or a +3 dB change, our power level would be multiplied by 2. For a decrease, or a -3 dB change, we would divide by 2.

(Continued on Page 40)

Why Not Switch to



Complete FM / TV Product Line

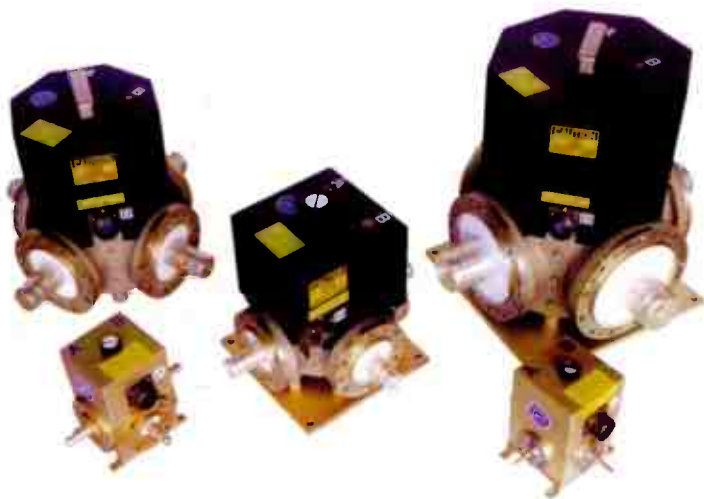

Coax switches available in Type-N and 7/16 DIN and 7/8" through 6-1/8"

- Antennas
- Splitters
- Notch Filters
- Harmonic Filters
- Power combiners
- Channel combiners
- N +1 Switching Matrix

Control panels available.

A subsidiary of **MEGA** RF Solutions

www.megaind.com

Toll Free: 800-545-0608 | www.mcibroadcast.com

Coaxial Dynamics

A CDI INDUSTRIES, INC. COMPANY
SPECIALISTS IN RF TEST EQUIPMENT & COMPONENTS

COAXIAL DYNAMICS has been a leading manufacturer of precision equipment for the measurement and termination of RF Power since 1969. Our equipment is used by engineers in a wide variety of applications throughout the world.

Our products include:

- Directional Wattmeters for both Analog & Digital applications from 1 W to 100 kW and from 2 MHz to 2.3 GHz.
- Wattchman RF Monitor/Alarm Systems.
- Line Sections & Plug-In Elements.
- RF Loads - Dry, Oil, Water, and Air designs up to 200 kW.
- Low Pass Filters & Power Sensors.

6800 Lake Abram Drive, Middleburg Hts., Ohio 44130, USA
440-243-1100 • Toll Free: 1-800-COAXIAL • Fax: 440-243-1101
E-Mail: sales@coaxial.com • Web Site: www.coaxial.com

- **Broadcast Equipment** •
Wattchman - High Power Wattmeters - Elements
- **Line Sections & Meters** •
- **Termination Loads** •
Dry - Oil - Water - Air



got all these features in your DA?

The **NEW**
Radio Systems ADA-2X8SS

2 STUDIO Stereo INPUTS to eight **isolated OUTPUTS**

with **Front Panel VU METERS**, **Headphone AMP** and **sets**

plus **Silence SENSE** with **EMERGENCY Switch-Over**, **Remote Control**

and full **Studio Hub + Connectivity**.

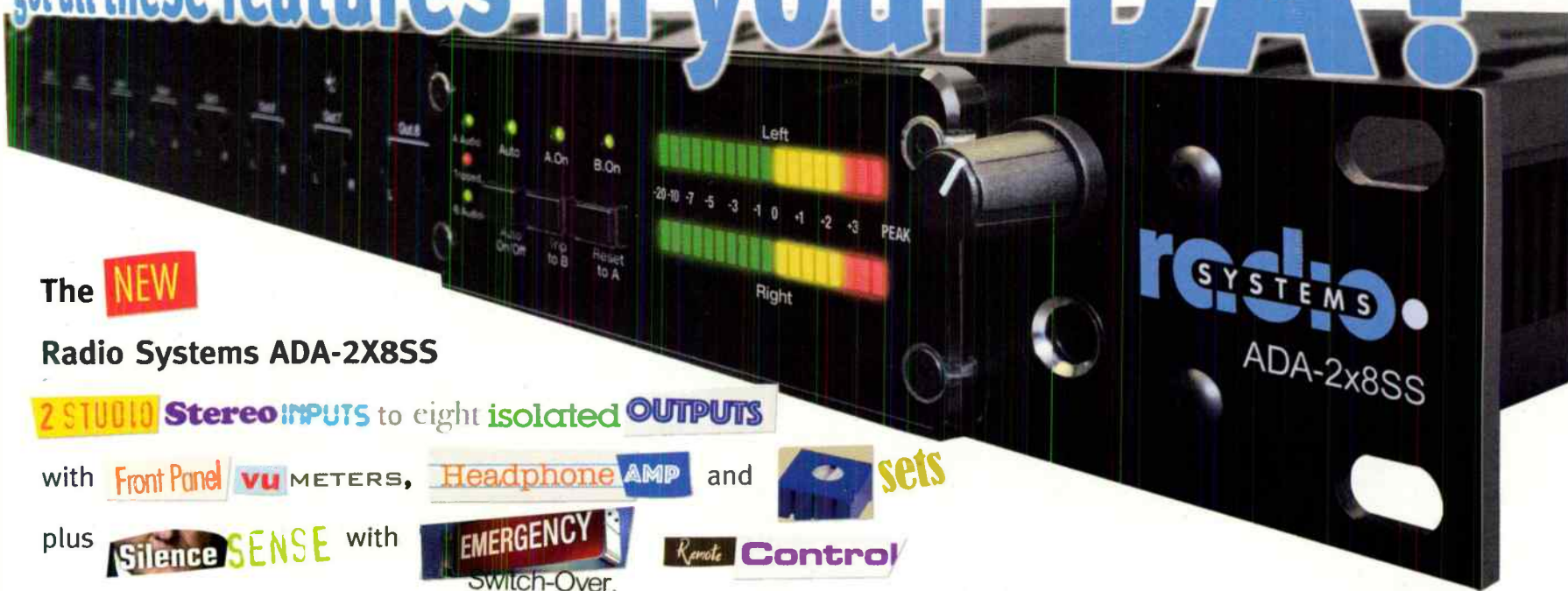

radio SYSTEMS

601 Heron Drive • Logan Township, NJ 08085 • (856) 467-8000 phone • (856) 467-3044 fax • www.radiosystems.com

– Continued from Page 38 –

While it is quite easy to visualize 3 dB as doubling the power, larger numbers follow the same logic but it may not seem that way. It is more difficult to realize that an LNB with 57 dB of gain will have doubled the power of a 54 dB gain LNB. Anyway, you cut it, 3 dB is double your input power. Remember, the power is doubled for every 3 dB gain and halved for every 3 dB loss. In this example, we had to double the power 18 times to get to 54 dB's and then double once more to get to 57 dB. Remember, if you increase a 50,000 Watt FM station to 100,000 W that is still only a 3 dB gain, even though the numbers are large.

By way of another example, a dish antenna with a 30 dB gain delivers one-tenth (1/10) the signal power of a larger dish having a 40 dB gain. The signal power at the focal point is multiplied by 10 for every +10 dB of gain and divided by 10 for every -10 dB of signal loss. In this example, the dish antenna signal power was multiplied by 10, four times, to get to a gain of 40 dB, then it was divided by 10 (-10 dB) to get down to 30 dB.

A CATV splitter loses 6 dB per port. What does this mean? With 6 dB gain or loss, the multiplier/divider is four. This means that for a given signal power at the input, each output port will have a 6 dB loss because of splitting the signal. Since 6 dB is four times and this is a loss situation, the input power is divided by four at each port. Referring to signal power, if the CATV signal input is 10 milliwatts, each port would measure 2.5 mW.

So, let's go through some worked examples of combining the key numbers, 3, 6 a 10 to figure dB's in your head and throw away the calculator.

Problem 1: An amplifier boasts a gain of 13 dB. If you put 4 Watts into this amplifier, what will be the power output? First, increase the level by 10 dB of the 13 dB (to 40 Watts) then increase it by the remaining 3 dB, which is 2x (double the 40 W). The answer becomes 80 Watts.

Problem 2: An antenna has a gain of 7 dB. If we feed it with 4 Watts, what will be the radiated power? First increase the level by 10 dB (40 W), then subtract 3 dB by dividing by 2. Answer is 20 Watts ERP.

Problem 3: If you feed 10 Watts drive into an amplifier and you measure 25 Watts output, how many dB gain is that? In your mind, run through combinations of dB equivalents. Find permutations that make 25 Watts. The combination that worked was add 10 dB (10x) then subtract 6 dB (divide by 4) and the answer is 4 dB. (10 dB - 6 dB)

Problem 4: You replace a broadcast amplifier with a new 9 dB unit. If you feed in 1 kW, what will be your output? Use 6 dB and 3 dB to make this work. (6 dB + 3 dB = 9 dB) Six dB is 4x and then add 3 dB which is 2x. Answer is 8000 Watts. (1000 x 4 = 4000 then times 2 = 8000 W)

Problem 5: This is wild, a LNB for a satellite dish claims 43 dB gain. How many times is the input signal from space multiplied? First, use 10 dB and 3 dB to figure this problem. Make the initial calculation 40 dB then add 3 dB to get your answer. 40 dB is 10 db + 10 dB + 10 dB + 10 dB. Since its key number is 10, we multiply 10 x 10 x 10 x 10 = 10,000, then you add 3 dB by multiplying the 10,000 x 2 = 20,000 times is you answer. That is a lot of gain in any device. (43 dB is a gain of 20,000 times)

So getting back to our original conversation at the beginning of this article, my friend wanted to know if it was worth spending the extra money for a 50 dB LNB vs

a 44 dB LNB. The answer is \$100 more buys you another 6 dB gain which is four times as much signal power. In English that means: 44 dB has a gain just over 25,000 times (similar to problem 5) where a 50 dB LNB has a gain of 100,000 times. (Basically, \$100 bucks buys 25,000 x 4)

As you can see **3, 6 and 10 dB** are fixed given ratios of power. By combining these three numbers in any number of combinations, most dB problems can be resolved without logs or a calculator. Keep in mind that for positive dB gain you multiply the ratios. For negative gain (loss) you divide the ratios.

If a numerical reference is used in place of one of the ratios, then the Decibel becomes a measure of reference against some standard which is called 0 dB. (Similar to par in a golf game)

For electronic calculations of power, the 0 dB references are: 0 dBm = 1 milliwatt (0.001 Watts) and 0 dBw = 1 Watt.

This means that all gains or losses are above or below the given reference. In this context, 20 dBm is 100 mw (10 x 10 or 1 mw x 10 x 10) and 50 dBm would be 100 watts. (10 x 10, five times) To make sense of this measurement, the reference must always be given. Everything utilizes the reference (0 dB) as one of the ratios. So your answers are numbers above or below that reference.

dB measurements can also be used for voltages, sound pressure and current measurement but that is a topic for a future article. Hope the New Year brings you a new way of thinking about the age-old dB.

Roger Paskvan is a Professor of Mass Communications at Bemidji State University, Bemidji, MN. You may contact him at: rpaskvan@bemidjistate.edu

Quality FM & TV Antenna Systems



SLANT-V
DIRECTIONAL



FM PANEL



POWER-TILLER



POWER-TILLER
WITH RADOME

PSI is dedicated to designing and manufacturing the highest quality product. Working diligently with station engineers, consultants and outside vendors ensures that each project is completed to the customer's satisfaction.

Wide range of antenna models are available at all power levels, directional and non-directional, multi-station and more.

Additional products include..

- Transmission Line
- Combiners
- Filters
- Turnkey Systems



Propagation Systems, Inc.

Phone: (814) 472 - 5540 Fax: (814) 472 - 5676
 Email: sales@psibroadcast.com www.psibroadcast.com

streaming **FAN** engagement 5G sound ATSC 3.0

Workflow COLLABORATION

Asset MANAGEMENT monetization

UNEXPECTED solutions VIEWER EXPERIENCE

LIVE LOCAL GLOBAL A.I. BUILDING AUDIENCES

every Story starts here.

NABSHOW
Where Content Comes to Life

APRIL 6-11, 2019 | LAS VEGAS

Register Today: NABShow.com

Free* Exhibits Pass with Code MP01

No one knows Media, Entertainment and Technology like us.

Industry convergence is powering the stories the world consumes. This is where you need to be. Surrounded by new gear, impressive tech and big thinking. NAB Show® is the real deal. And where deals are done.

Join our global community finding inspiration, discovering solutions, building audiences and growing profits. Together, we advance the art, science and business of storytelling.

your story will never be the same. ▶

*Offer expires March 24, 2019. Starting March 25, a \$50 fee will be applied.

Identifying Important Things

by George Nicholas

"I've got so much work, I don't know where to begin," Murph the Engineer moaned to his manager. "I know what needs to be done, but I can't seem to engage today."

Mark, the GM, replied, "One of the reasons I hired you, Murph, is your ability to juggle three or four high priority projects successfully. That's what makes you a better Engineer." Murph looked a little dazed at first, then realized Mark was probably right. "You may be on to something. I seem to have a lot of work, yet my calendar seems pretty empty." Mark gave the obligatory wink and "finger shooter" gesture and strolled down the hall.

Priority Paralysis

Clearly, Murph suffers from a disease I like to call "Priority Paralysis" – that defeated feeling one gets when faced with a desk full of papers, a person standing in the office and the phone ringing simultaneously! The good news is: there is a cure. However, it may take time, and it will take change.

Murph sat at his desk and started a list of everything he needed to do. After reviewing his list, it became clear there were a lot of tasks that really were not important, or less important than others. For example, he was two weeks behind on reviewing the logs, yet "sweep out the doghouse" was one of the first things on the list.

Murph's priorities were contaminated with *minutiae*, the fine points of everything unimportant. This is not to say details are not important – it is how they affect the process that matters. Many times priorities are not black and white, but

various tones of gray. Hint: Setting the first priority is always the most difficult, so do not start there. Start lower, and work your way up.

Meanwhile, never be too quick to blame yourself! Some problems in priority ranking may be the result of your organization. John Maxwell, in "Leadership 101," suggests three common problems in most organizations:

- **Abuse:** Too few employees are doing too much.
- **Disuse:** Too many employees are doing too little.
- **Misuse:** Too many employees are doing the wrong things.

Sound familiar? While you may not be able to change your organization single-handedly, you can recognize these problems and make adjustments.

Qualitative Analysis

What is *really* important, and what is not? Answering that question requires perspective. Perspective requires experience; and experience allows judgment. Here is a way to get to the heart of the issue: What if you had only one day left to do your job?

That sounds dramatic, but it is an excellent thought-starter. Suppose you are leaving for vacation in a week (which some studies suggest is your most productive week of the year), or you may be leaving for another position and want the engineering department to be in good shape for your successor. Or, worse, it may be your last day of good health.

For example, Craig Hospital in Colorado specializes in spinal cord injuries. A spinal cord injury is about as serious an injury as one can sustain and remain alive. They have done research on the effect of spinal cord injuries and how it relates to quality of life decisions of their patients.

Based on a British study that spanned several years, 195 men with back injuries were asked to consider 15 categories that contribute to quality of life, including health and personal safety; material comforts; relationships with family; relationship with spouse; raising children; having close friends; helping others; work; learning; understanding oneself; ex-

pressing oneself; socializing with others; entertainment, such as reading or listening to music; participating in active recreation, and participating in local government.

What is Important

Interestingly, both injured and non-injured men ranked health and personal safety first. But from that point on, the results were much different. The injured men cited relationships with family and spouse as second and third, followed by understanding yourself, followed by learning.

The non-injured men listed relationship with spouse as second, followed by work and material comforts; having and raising children was fifth. This correlates with experiences I have seen in others; usually a life or career threatening issue makes someone re-evaluate what really is important.

You might be asking yourself, "That's all fine and good; how does it affect me?" The point is that when determining what is truly important, you must look beyond the immediate tasks and try to imagine the "big picture," even taking yourself out of the picture.

To apply the principle, let us start with a list of categories (in no particular order) for you to consider, followed by a suggestion as to importance.

- FCC Compliance – Important.
- Being on the air – Important.
- Modulating at 100% – Not as important.
- Being competitively loud – Important.
- Being loudest in the market – Not as important.
- Helping the boss fix his/her computer at home – Important.
- Going to the bar with "the gang" after work – Not as important.

You get the picture. The importance of any matter is relative to the other issues at hand.

Finally, when prioritizing, make sure you include some "PTO" (personal time off) to relax – even briefly – between projects. No matter what anybody may tell you, taking time off to recharge your batteries is important! – Radio Guide –

MAXIMIZE COVERAGE MINIMIZE COSTS

with Bext FM Antennas

- Broadband Models for Multi-frequency
- Long Term Durability
- Real Tech Support

BEXT

888 239 8462

www.bext.com

Bay Country Broadcast Equipment

Buy • Sell • Trade

Your #1 Source for Quality Used Radio Broadcast Equipment

View our latest list of equipment on-line at:

www.baycountry.com

Or call and we will fax it to you.

All equipment sold with a 15 day return guarantee.

Turn Your Excess Gear Into Cash

Fax or email your list to us and we will respond with our offer promptly. We only buy good working equipment with traceable serial numbers.

Fax Your List Today – 443-596-0212



<http://www.baycountry.com>

(Website Updated Daily)

E-mail: sales@baycountry.com

877-722-1031 (Toll Free) 443-596-0212 (Fax)

7117 Olivia Rd, Baltimore, MD 21220

davicom

Davicom's Next Generation of
Intelligent Remote Site
Management System

360
CORTEX



cortex360.davicom.com



2018
TECHNOLOGY AWARD



ECONCO

Rebuilt Power Tubes



Approximately One Half the Cost of New

3,000 Hour Unconditional Guarantee

Call for Your Quotation



Phone: 530-662-7553 • Fax: 530-666-7760

Toll Free: 800-532-6626

www.econco.com

1313 Commerce Ave, Woodland, CA 95776

TRANSCOM CORPORATION

Serving the Broadcast Industry Since 1978

Visit Our Website - www.fmamtv.com

Send your e-mail requests to: transcom@fmamtv.com

Fine Used AM & FM Transmitters & New Equipment

AM	10 kW	1991	Nautel AMPFET10 - Solid State
	10 kW	2001	Nautel XL12 - Solid State
	10 kW	2002	Harris DX10, Solid State
<i>Please see our current listings on our website.</i>			
FM	55 W	2000	Harris DIGIT™ CD
	5.0 kW	1983	BE FM5A
	5.0 kW	1993	Nautel FM5, Solid State
	10.0 kW	1983	BE FM10A - Dual 5 kW
	10.0 kW	1996	Harris HT10, SS IPA, Single Phase
	10.0 kW	1996	Nautel FM10 - Solid State, Single Phase
	10.0 kW	2001	Harris Z10CD - Solid State
20.0 kW	2001	Harris HT20CD - Solid State	
20.0 kW	2004	Harris HT20CD	
<i>Please see our current listings on our website.</i>			

Used Misc. Equipment:

Bird Model 8932, 10kW Air-Cooled RF Load

Exciters:

Harris DIGIT™



Please go to our website for updated listings.
Retuning and testing available - call for quote!
OMB STL systems for radio, complete with antenna and cable for under \$5,000!

PO Box 26744, Elkins Park, PA 19027
800-441-8454 • 215-938-7304 • Fax: 215-938-7361



The Broadcasters' Desktop Resource

... edited by Barry Mishkind - the Eclectic Engineer

HOME | NEWS | ARTICLES | MANUFACTURERS & VENDORS | SERVICES | SUPPORT | RESOURCES | USED, BUY/SELL | SITE SEARCH | CONTACT

Looking for an Internet archive of broadcast news and articles on technical, IT, and managerial issues?

The Broadcasters' Desktop Resource is at: www.theBDR.net

Avoid missing out on anything - you are invited to sign up for the one-time-a-week BDR Newsletter. We promise to never flood your inbox!

Some things you might want to know about:

Check it out now!

<http://www.theBDR.net>

- 1/18 - [An overview of interesting things from CES 2017](#)
- 1/18 - [Original iPhone now a museum piece](#)
- 1/18 - [Spectrum Auction seems finally to be concluding](#)
- 1/12 - [Court stops evictions by American Tower](#)
- 1/11 - [FCC plans to remove letters and email from Public File](#)
- 1/11 - [Bill Sacks passes away](#)
- 1/9 - [Norway to abandon analog FM this year](#)
- 1/5 - [Obama nominates Rosenworcel back to FCC](#)
- 1/4 - [The Difference and Why It Is Important - Tom Osenkowsky](#)
- 1/2 - [The End Is Coming for AM8 and 139 degrees](#)
- 12/30 - [Enforcement Watch: Failure to ensure tower lit/painted: \\$25k](#)
- 12/28 - [Checking It Out: Road testing the Inovonics 531N FM monitor](#)
- 12/28 - [PSHAB issues initial report on the 2016 EAS NPT](#)
- 12/23 - [iHeart gets negative response from the ISDA](#)
- 12/21 - [Alternatives to Wired Ethernet Networks - Dana Puopolo](#)
- 12/20 - [Cumulus in trouble again with NASDAQ](#)
- 12/19 - [FCC Seeks comments to reduce EEO recruitment requirements](#)
- 12/15 - [The Worst: Walking in to Find No Joy at All](#)
- 12/14 - [Keep the Flu Out - Keep Your Staff In](#)
- 12/7 - [Checking It Out: The Inovonics 525N - Alan Alsbrook](#)
- 12/7 - [FCC Commissioner Ready to Fire up the Weed Whacker](#)
- 12/7 - [Spectrum Auction Is Not Making the FCC Look Very Good](#)

Service Guide Radio Equipment Products and Services

Consulting Professional Engineers

● Expert Witness Testimony

- FCC Applications
- Frequency Searches
- Co-location Studies
- Coverage Modeling & Maps
- Interference Analysis Studies
- RF Exposure Studies & Reports
- Custom Map Preparation

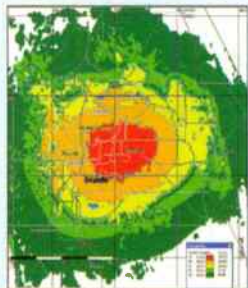

**Call us now
to discuss your
project needs.**

352-367-1725

RFEngineers, Inc.
alex@rfengineers.com

TLM-1 TOWER LIGHT MONITOR

Total Monitoring for Older Lighting Systems

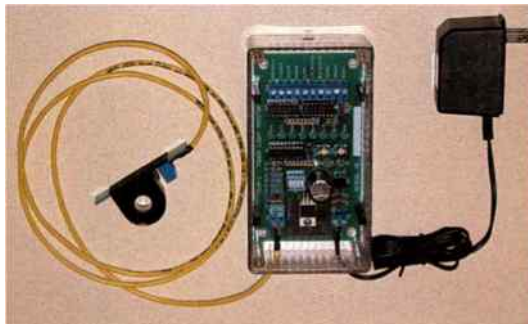

A microprocessor based system designed to monitor the status of FAA type A incandescent tower lights.

- Individual alarms for photocell, flasher, beacon & marker.
- Status outputs for lights on/off and beacon on/off.
- LED indicators for each alarm and status output.
- Opto-isolated fail-safe outputs for each alarm.
- Easy setup – one button calibration.
- Installs at the circuit breaker panel.
- Available through broadcast distributors.

FM Services

www.towermonitor.com • 336-667-7091

ICE KRACKERS®

The Solution Since 1979

NEED ICE DAMAGE PROTECTION FOR YOUR TOWER?

For over 35 years our US Patented product has been successfully used to protect guy wire anchor hardware and dampers used on towers all across the United States and Canada.

Our product doesn't wear out and is galvanized for rust protection. In most cases, the Ice Kracker can be installed in minutes and is supplied with all necessary hardware.

The average cost for a tower is about \$500.

icecrackers.com

800-747-8921

icecrackers@comcast.net

Mention this ad and
get a discount on your order.



AM-FM Transmitters

Pre-Owned – Tuned
and Tested to Your Frequency

www.Besco-Int.com

Rob Malany – Owner

321-960-4001 • sales@Besco-Int.com



The Leader in Broadcast Engineering Software!

- Create stunning "real-world" coverage maps, interference studies, and population reports with Probe 4™
- AM Pro 2™, used daily by FCC engineers, performs skywave and groundwave allocation studies and AM coverage mapping
- Find STL broadcast auxiliary and Part 101 microwave frequencies and generate PCN letters with Microwave Pro™
- Map FM stations and find upgrade possibilities using FCC minimum separations and contour-to-contour methods with FMCommander™

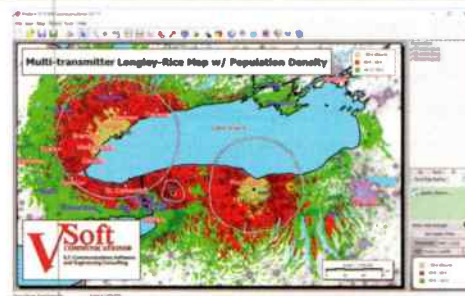

www.V-Soft.com - info@v-soft.com - 1-800-743-3684

Celebrating 35 Years of service
to the broadcast community.

RF is good for you!



RF Specialties® Group

www.rfspecialties.com

Check our website for the office nearest you.

Doug Vernier

Telecommunications Consultants

- FCC Applications for AM, FM, TV, DTV, LPTV, STL
- Upgrade and Due Diligence Analysis
- Frequency Searches
- Site Relocations
- Propagation Prediction with Custom Mapping
- Demographic Analysis
- Directional Antenna Design



We use V-Soft Software!

www.v-soft.com consulting@v-soft.com 800-743-3684

TRANSMITTING CAPACITORS MICA-VACUUM-CERAMIC

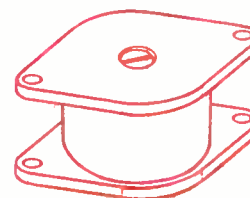

SURCOM ASSOCIATES, INC.
(760) 438-4420
LINK@SURCOM.COM

www.LightnerElectronics.com

From our Facility to yours

Design & Integration

Repairs & On-Site Service Calls

LIGHTNER ELECTRONICS www.lightnerelectronics.com
 Toll Free 1-866-239-3888 Shop online www.broadcastavsales.com

Radio-Classifieds.com

- Buy or Sell Your Used Equipment
- Place as Many Ads as You Like
- **FREE!** – There's Never Any Charge



Radio-Classifieds.com Latest 20 ads

Please register or log in.

Antennas [0]	Coders & AcPP [0]	Internet & Stream [0]	STL, RF U, TR [0]
Audio Amplifiers [0]	Comps, Dns & IT [0]	Microphones [0]	Satellite Gear [0]
Audio Decay [0]	Consoles & Mixers [0]	Monitors & Bars [0]	Speakers & Phones [0]
Audio Editing [0]	Directional Gear [0]	Phone & Hybrids [0]	Timers & Clocks [0]
Audio Processing [0]	EAX Gear [0]	RDS, RIBOS, SCA [0]	Tools & Test Gear [0]
Audio Routing [0]	Exciters & Genes [0]	Recorder & Player [0]	Towers & Coax [0]
Audio Storage [0]	Furniture & Racks [0]	Remote Control [0]	Transmitters [0]
Automation [0]	Grounding & Surge [0]	RF & TV Equip. [0]	MISC OTHER [0]

self aware
never self conscious

self aware
never self conscious

IP-12
MODULAR WEATHERPROOF NETWORKABLE CONSOLE

Powered by Media Magazines Inc - Publisher of *Radio World Magazine* | *Sound by Sound*

Gear Guide

Acoustics First Effective Sound Treatment

by Ron Erickson

Since the “radio bug” first bit me as a child, I’ve spent a lot of time visiting various radio stations. Of course, I’ve been on the air from many vastly different studios. One thing everyone in our business knows, without sound treatment on the walls, you get an undesirable hollow effect on the air. I’m sure some of you have been in studios where cardboard egg crates were attached to the ceiling or tacked onto the walls. Back in the summer of 1970, I was 16 and working on the air six to midnight, six nights a week from the old downtown Corvallis Oregon studios of KFLY AM & FM. Those studios made extensive use of cardboard egg crates for sound treatment. I didn’t give much thought to room acoustics back then, because I was busy “spinning the hits” and truthfully, talking to girls on the request line. Since that time, I’ve seen every kind of material you can imagine used as sound treatment, including draperies and carpeting on the walls. This article will introduce a company that will take your audio environment to a new level of visual beauty and sound functionality.

Before the treatment of sound became a business, Nick Colleran was a musician who started paying attention to the unique differences in recording studios and live venues. Together with wife Becky, they “listened to learn” everything they could about sound. In the 70’s they built a large scale recording studio. With limited information available and lack of off-the-shelf acoustical materials for studios, they built their own diffuser-bass traps, fabric-covered fiberglass absorbers and high-density barriers. After discovering anechoic wedge acoustical foam in an industrial magazine, they realized it would be a great product for recording and broadcast studios. It wasn’t too long after that, **Acoustics First** was formed with Becky Colleran as President and Co-Founder. The company is located in Richmond Virginia.

According to the list on their website, Acoustics First now offers 37 products, most of which are designed to affect the sound in your space, be it regular studio sized or as large as an auditorium. The products from Acoustics First are as diverse as the music on the radio. With limited space in this article, I’ll focus on just a few products I’ve selected from their sound treatment products. To see everything they offer, I suggest that you go on-line and explore the very informative website they

have built at www.acousticsfirst.com, and also watch the video demonstrations. Information and photos presented here are courtesy of their website.

Let’s start with the **Sonora® Fabric Wrapped Acoustic Wall Panels**. These are as beautiful as they are efficient.

They can be used in both small and large rooms to reduce echo and reverberation. These panels are manufactured from a rigid, high-density glass fiber acoustical board and covered with an acoustically transparent fabric. The edges can be ordered as square, beveled or radius.

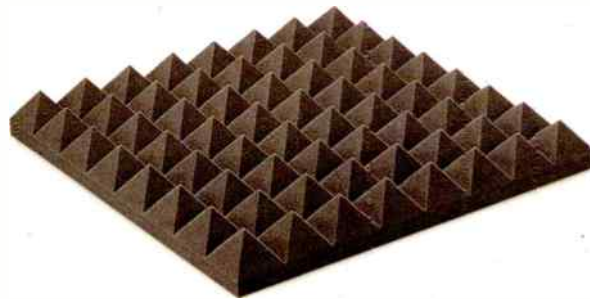

Here is a product you’ve seen more often on studio walls; **Pyramid Acoustical Foam**. It is available in your choice of 2", 3" or 4" deep, with each identical 2' x 2' sheet allowing for seamless installation. The typical and preferred installation is using contractors cement on both the wall and foam backs. Allow the glue to become tacky and then push the foam onto the wall. As an alternate installation, glue the foam to plywood and mount the wood on the walls. This is a good idea if your studio location may change in the future.

If your studio is in California, you’ll need to upgrade to **FireFlex™ Pyramid Acoustical Foam** in order to meet that state’s fire codes. Offered in two colors, light gray or white, FireFlex™ withstands constant temperatures up to 320°F, as well as meeting all Class I regulations for flame spread, smoke density, and fuel contribution. Check your local fire codes.

Cloudscape® Ceiling Tiles absorb noise and block sound transmission. These ceiling tiles are designed to fit into existing 2' x 2' suspended, drop tile ceiling grid systems and retrofit 2' x 4' grids by adding cross tees.

If you’re planning new studio construction, you may wish to consider adding mass-loaded vinyl also known as **BlockAid® Vinyl Sound Barrier**. BlockAid® can be installed over studs, sandwiched between layers of drywall or applied over existing layers of drywall, then covered with a finish material such as **Sound Channels® acoustical wall covering**.

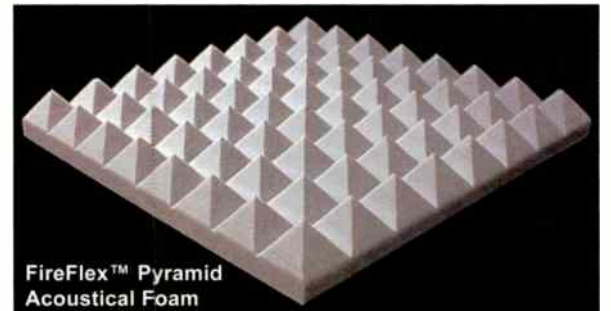

Sound Channels® Acoustical Wall Fabric is a dimensional fabric that offers excellent acoustical properties, unmatched fade resistance, and maintains a fire/smoke retardant Class A rating.

My hope is that this article will help you the next time you design a studio. Feel free to contact me if you have questions or comments at: ronerickson@gmx.com or call me anytime at 541-460-0249.

Remote Reboot of AC Powered Devices

**Stackley
Devices
LLC**
(609)
647
9677



**RemOutlet
Reboot
Mini**
\$179
Adjustable
Power
OFF Time

www.RemOutlet.com

PHASETEK INC.

Custom Phasing Systems

Phasetek, Inc. is dedicated to provide the broadcast industry high quality AM Phasing and Branching systems, Antenna Tuning units, Multiplexers, and RF components.

Phone: 215-536-6648
sales@phasetekinc.com
www.phasetekinc.com

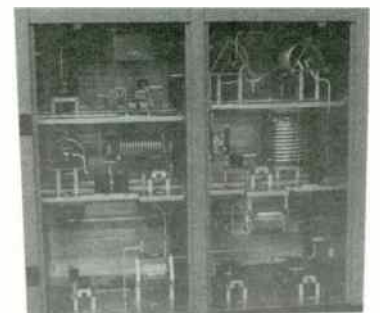

FINAL STAGE



RADIO ROUNDUP

The Radio Guide Event Register

Email your dates and info to: radio@rconnect.com

NATE Unite 2019

February 4-7, 2019

Grapevine, Texas

<https://natehome.com/annual-conference/nate-unite-2019>

Great Lakes Media Show

March 5-6, 2019

Lansing, Michigan

<https://michmab.com/programs-events/great-lakes-media-show/>

2019 NRB Convention

March 22-29, 2019

Anaheim, California

www.nrbconvention.org

NAB 2019 Spring Convention

Convention Center – Las Vegas, Nevada

April 6-11, 2019

www.nabshow.com

Texas Association of Broadcasters (TAB)

August 7-9, 2019

JW Marriot Downtown, Austin, Texas

www.tab.org/convention-and-trade-show

NAB Radio Show

September 24-27, 2019

Dallas, Texas

www.radioshowweb.com

Radio Guide Advertiser Info – January-February 2019

Advertiser - Page

Altronic - 22
 Angry Audio - 15
 Arrakis - 33
 Bay Country - 42
 BDR - 43
 Besco - 44
 BEXT - 42
 Broadcasters General Store - 19
 Broadcast Software Intl. - 35
 Broadcast Tools - 20, 47
 CircuitWerkes - 23
 Coaxial Dynamics - 39
 Davicom - 43
 Deva - 34
 DH Satellite - 30
 Econco Tubes - 43
 ESE - 47
 FM Services - 44
 GatesAir - 37
 Graham Studios - 47
 Henry Engineering - 2
 Ice Crackers - 44
 Inovonics - 1, 13
 Kintronic Labs - 36
 Lawo - 29

Website

www.altronic.com
www.angryaudio.com
www.arrakis-systems.com
www.baycountry.com
www.thebdr.net
www.besco-int.com
www.bext.com
www.bgs.cc
www.bsiusa.com
www.broadcasttools.com
www.circuitwerkes.com
www.coaxial.com
www.davicom.com
www.devabroadcast.com
www.dhsatellite.com
www.enco.com
www.eso-web.com
www.towermonitor.com
www.gatesair.com
www.graham-studios.com
www.henryeng.com
www.icecrackers.com
www.inovon.com
www.kintronic.com
www.lawo.com

Advertiser - Page

Lightner Electronics - 45
 Logitek - 11
 Mega Industries/MCI - 38
 Nautel - 7
 NAB - 41
 Phasetek - 46
 ProAudio.com - 5
 Propagation Systems (PSI) - 40
 Radio-Classifieds.com - 3, 45
 Radio Systems - 39
 RF Engineers - 44
 RF Specialties - 44
 SCMS - 27
 Shively - 32
 Smarts Broadcast Systems - 31
 Stackley Devices - 46
 Studio Items - 26
 Surcom - 44
 Telos Axia - 17
 Telos Omnia - 21
 Tieline - 9
 Titus Labs - 28
 Transcom - 43
 V-Soft Communications - 44
 Wheatstone - 3, 24, 25, 48

Website

www.lightnerelectronics.com
www.logitekaudio.com
www.mcibroadcast.com
www.nautel.com
www.nabshow.com
www.phasetekinc.com
www.proaudio.com
www.psibroadcast.com
www.radio-classifieds.com
www.radiosystems.com
www.rfengineers.com
www.rfspecialties.com
www.scmsinc.com
www.shively.com
www.smartsbroadcast.com
www.stackleydevices.com
www.studioitems.com
www.surcom.com
www.telosalliance.com
www.telosalliance.com
www.tieline.com
www.tituslabs.com
www.framtv.com
www.v-soft.com
www.wheatstone.com

TIME TO SYNCHRONIZE

ES-185E/NTP6 GPS Master Clock

Accurately generate time code with ESE's Master Clock via the 12-channel GPS receiver and output multiple types of Time Code, SMPTE-LTC/EBU, ESE, IRIG-B, ASCII (RS-232 & USB), and an extremely accurate 1PPS signal. Further reliability with dual battery back-up, and new control panel software. ESE's NTP6 feature provides an NTP server compatible with the latest version of Internet Protocol, IPv6. You can also easily interface with new or existing computers, automation and clock systems.

Visit www.eso-web.com for all your time synchronization needs.

ESE
www.eso-web.com
 +1-310-322-2136

Passing the Test

Universal 4.1 MLR»Web

The Universal 4.1 MLR»Web is a web based transparent four input, one output switcher/router with mechanical latching relays designed to pass AES or stereo balanced signals. The unit may be configured to monitor for stereo analog audio silence or loss of AES clock when configured for AES switching.

Broadcast Tools is a Veteran Owned Business
 Designed, Assembled and Tested
 in Washington State, USA.
www.broadcasttools.com

BROADCAST tools
 PROBLEM SOLVED

No 3-phase power? No Problem!

Operate any 3-phase broadcast transmitter from a 1-phase utility supply!

- Turn any location into a 3-phase site within hours!
- Save thousands \$\$ on utility line extensions
- Recommended by leading transmitter manufacturers
- True 3-phase, not open delta
- Over 1500 Radio & TV installations worldwide
- Rotary design stores energy and rides-through line transients far better than electronic devices.

If you have ANY questions about 3-phase electric power for your broadcasting application, do yourself a favor and call Kay Industries first!

Kay Industries
PHASEMASTER®
 Rotary Phase Converters

South Bend, IN 800-348-5257
 Fremont, CA 877-348-5257

The World Leaders in Single to Three-Phase Power Conversion

Precision | Innovation | Proven

GRAHAM STUDIOS
 Broadcast Furniture

815-222-3554
www.supportradio.com

866-481-6696 | www.graham-studios.com



FLASH OF BRILLIANCE

Audioarts Lightning strikes that brilliant balance between analog and digital. Four stereo buses for easy routing. Dual-channel phone module for trouble-free remotes and call-ins. Bluetooth and dual USB ports for direct access to laptops, tablets, and mobile phones, as well as applications such as editors and

automation. Plus, assignable AES input for connecting a digital source to any fader, and built-in A/D conversion for digital or analog program out. And while it looks and feels like its Wheatstone cousins, this digitally controlled analog console operates as a full standalone board. Cue thunderous applause.



LIGHTNING

Designed and Built in the USA by Wheatstone

phone 1.252.638-7000 | audioarts.com/lightning-rg | sales@wheatstone.com