

# Radio Guide

www.radio-guide.com

Digital Issue Now On-Line

January-February 2018 – Vol. 26, No. 1

## FM Composite Multiplex Signal in an STL



\*\*\*\*\*AUTO\*\*ALL FOR ADC 913  
K.M. RICHARDS  
K.M. RICHARDS PROGRAMMING SVC. S57 B6  
PO BOX 7427  
VAN NUYS CA 91409-7427  
4861

PRST STD  
U.S. POSTAGE  
PAID  
PERMIT NO. 410  
BEAVER DAM WI

**NEW Site Streamer™**  
AW/FM/HD Radio/DAB+/RDS



**INOVONICS**  
BROADCAST

**POWERFUL MONITORING AT YOUR FINGERTIPS**



## DON'T YOU WISH DRAFT PICKS WERE THIS EASY TO CHOOSE?

If you're calling the game, Henry's got the winning solution for complete control from the announcer's chair! Use Talent Pod to give your announcer personal control of his mic and headphones. Or choose the new Sports Pod to add Duplex Intercom and Remote Mic Control. Mix-and-match 'em to pitch the perfect game!

**WE BUILD SOLUTIONS.** DIGITAL SOLUTIONS. ANALOG SOLUTIONS. FUNCTIONAL. RELIABLE. AFFORDABLE.



Visit [www.henryeng.com](http://www.henryeng.com) for all of Henry's solutions!

Henry Engineering • NEW Phone: 562.493.3589 • email: [Info@henryeng.com](mailto:Info@henryeng.com)

World Radio History







Yeah. That Kind of Bass.

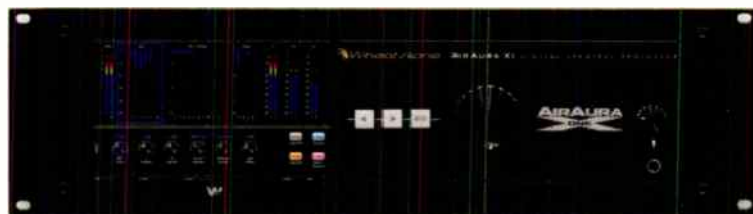

**It's Time You Tried a Different Processor**

Learn More: [wheatstone.com/X1](http://wheatstone.com/X1)

# Radio Guide

## Contents

January-February 2018

## In This Issue

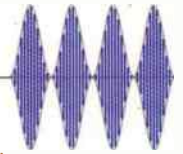

### Critical Content for Radio

**Cover Story** – by Junius Kim (page 6)

**FM Composite Multiplex Signal in an STL:** “Two methods of MPX interconnection are digital and analog. Each present a tradeoff in terms of required network bandwidth, signal quality, and compatibility. Digital MPX over AES offers the possibility of an all-digital processing chain, while analog MPX can offer greater flexibility and compatibility with legacy equipment.”

**Chief Engineer** – by Scott Schmeling (page 10)

**RF Transfer Switch Rebuild:** “This site has a backup and both transmitters are wired to an RF transfer switch. Most of the time a high reflected power is caused by a problem in the ATU, the line, or the tower itself – all of which are after the transfer switch.”

**Satellite Guide** – by Mike Hendrickson (page 20)

**Satellite Receive System Design:** “In my last article (Radio Guide Nov/Dec-17) I gave a brief history of the use of satellite communications. In this article I will provide some of the technical information that can be used in designing a satellite receive system used at a broadcast station.”

**Facility Focus** – by Sam Wallington (page 30)

**Dealing With Lightning:** “Keeping lightning voltage (up to a billion volts!) and current (perhaps thousands of amps) away from our equipment is not only a good idea, but it is very possible. The goal is to at least minimize damage – perhaps even eliminate it entirely.”

**Gear Guide** – Equipment for Radio (page 46)

**Inovonics Novia 272:** “This is a half rack unit with a digital Stereo FM Processor with RDS/RBDS – with a choice of input sources and a whole big bunch of other features ...”

<b>Cover Story</b> .....	6
<i>FM Composite Multiplex Signal in an STL</i>	
<b>Studio Site</b> .....	8
<i>Podcasting and Your Digital Footprint</i>	
<b>Chief Engineer</b> .....	10
<i>RF Transfer Switch Rebuild</i>	
<b>FCC Focus</b> .....	12
<i>Sexual Harassment? Your “#Times Up”</i>	
<b>Telemetry and Control</b> .....	14
<i>Integrating a Wireless Alert System Into Existing Panels</i>	
<b>Transmitter Site</b> .....	16
<i>Rebuilding an FM Transmitter Cavity</i>	
<b>Maintenance Guide</b> .....	18
<i>Air Conditioning Principles and Maintenance – Part 3</i>	
<b>Satellite Guide</b> .....	20
<i>Satellite Receive System Design</i>	
<b>Practical Engineering</b> .....	26
<i>Cheap &amp; Dirty Transmitter Hacks</i>	
<b>Facility Focus</b> .....	30
<i>Dealing With Lightning – Part 1</i>	
<b>In The Field</b> .....	34
<i>Should I Really Keep That?</i>	

<b>Operations Guide</b> .....	38
<i>Replace Yourself</i>	
<b>Small Market Guide</b> .....	42
<i>AM Again – Will It Go Away?</i>	
<b>Service Guide</b> .....	44 & 45
<i>Radio Equipment, Products, and Services</i>	
<b>Radio Classifieds</b> .....	45
<i>Buy and Sell Used Equipment On-Line – FREE of CHARGE</i>	
<b>Gear Guide</b> .....	46
<i>New Product Releases, Reports, and Information</i>	
<b>Final Stage</b> .....	47
<i>Convention, and Event Register – Advertiser Information</i>	

## Radio Guide

Volume 26 – Issue 1

Radio Guide Website: [www.radio-guide.com](http://www.radio-guide.com)  
Classified Ads: [www.radio-classifieds.com](http://www.radio-classifieds.com)

PO Box 20975, Sedona, AZ 86341

Phone: 928-284-3700 • Fax: 866-728-5764

Ray Topp (publisher & editor) – [radio@rconnect.com](mailto:radio@rconnect.com)

Radio Guide, ISSN 1061-7027, is published bi-monthly, six times a year, by Media Magazines Inc., PO Box 20975, Sedona, AZ 86341. Radio Guide is copyright 2018, Media Magazines Inc., and may not be copied, reproduced, or stored in any format, without the written permission of the publisher.



## Your Transmission Site General Manager

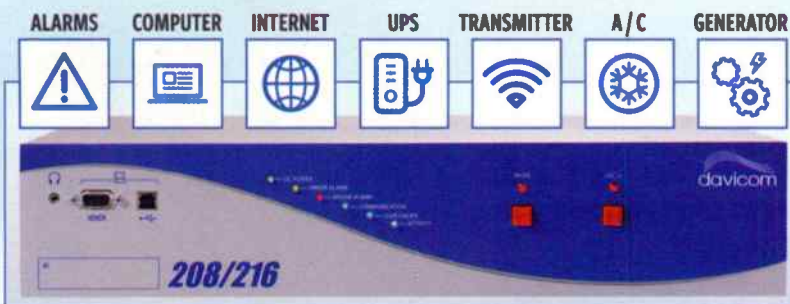

**The Davicom Site GM has the following qualifications:**

- SNMP Agent for legacy equipment
- SNMP Manager for SNMP devices at the site
- Web Server dispatcher
- PPP access for LAN backup by dial-up
- Modbus master
- Regular GPIO



Intelligent Monitoring Systems

T. 1.418.682.3380

[dvsales@davicom.com](mailto:dvsales@davicom.com)

## Bay Country Broadcast Equipment

Buy • Sell • Trade

Your #1 Source for Quality  
Used Radio Broadcast Equipment

View our latest list of equipment on-line at:

[www.baycountry.com](http://www.baycountry.com)

Or call and we will fax it to you.

All equipment sold with a 15 day return guarantee.

**Turn Your Excess Gear Into Cash**

Fax or email your list to us and we will respond with our offer promptly.  
We only buy good working equipment with traceable serial numbers.

**Fax Your List Today – 443-596-0212**



<http://www.baycountry.com>

(Website Updated Daily)

E-mail: [sales@baycountry.com](mailto:sales@baycountry.com)

877-722-1031 (Toll Free) 443-596-0212 (Fax)

7117 Olivia Rd, Baltimore, MD 21220



From the manufacturer who brought you **ACCESS**  
2USB

# ACCESS NX

## The Official IP Audio Codec of Winter

American-made for America's favorite winter sport.

NAB Booth #C2330



See The Video  
[www.comrex.com/access-nx/video](http://www.comrex.com/access-nx/video)



1-800-237-1776  
[www.comrex.com](http://www.comrex.com)

**COMREX**

## FM Composite Multiplex Signal in an STL

by Junius Kim - GatesAir

The emergence of high-bandwidth IP network connections is an enabler for the transport of the FM composite multiplex (MPX) signal in a Studio-to-Transmitter Link (STL). When architecting a STL network topology, transporting a MPX signal vs baseband FM components has advantages for centralized distribution and control.

Two methods of MPX interconnection are digital and analog. Each present a tradeoff in terms of required network bandwidth, signal quality, and compatibility. Digital MPX over AES offers the possibility of an all-digital processing chain, while analog MPX can offer greater flexibility and compatibility with legacy equipment. With the recent emergence of digital MPX, there is a need for bridging and interoperability between newer digital MPX equipment and older analog FM plant MPX infrastructure.

In FM broadcasting, the multiplexed signal (MPX) contains multiple components such as main audio, pilot tone, and Radio Data System (RDS) signal. In addition, Subsidiary Communications Authorization (SCA) channels may be generated which are modulated onto higher subcarriers. The MPX composite signal frequency spectrum bandwidth varies depending on components carried, but at a minimum, with RDS, it is 60 kHz and can be up to 99 kHz.

Stereo generation can be performed in the digital domain. Such digital processing produces a discrete time representation of an MPX signal formatted for interconnection using AES3. MPX over AES is carried at a sample rate of 192 kHz. Due to the Nyquist frequency, MPX over AES is band-limited to approximately less than 80 kHz. Digital MPX offers higher RFI immunity, simpler connections and distribution than analog MPX.

### MPX STL

An FM Studio-Transmitter Link (STL) using IP telecommunications can have several topologies. One common topology is where audio is transported from the studio to far-end transmitter site using an audio codec. The stereo generation is done at the transmitter site. Another possible STL topology is transport of the analog MPX signal using an MPX codec where the analog signal is digitized and processed. Such a codec can support different sampling rates and sampling word sizes. The sampling rate can be adjusted to transport the stereo audio plus RDS, or stereo audio plus RDS plus one or two SCA channels. This flexibility can adapt the codec to best suit the bandwidth of the STL IP network connection. The MPX over AES signal can also be transported on a codec supporting 192 kHz sampling.

STL transport of MPX offers several advantages over audio transport. The MPX generation process (stereo generation, RDS, and SCA modulation) is centralized and controlled at the studio site. With multiple transmitter sites, MPX generation is done once rather than being distributed out to the transmitter sites. With MPX over AES, a complete digital processing chain is preserved with no additional analog processes required.

### Digital MPX Over An STL

When MPX over AES is transported over an STL, the codec performs an end-to-end, bit-by-bit copy of the signal with no alterations. It is only necessary to transport the AES3 left channel sample word across the STL. Other AES3 data such as parity, synchronization, and metadata can be regenerated at the transmitter site to save network bandwidth. One channel of 192 kHz, 24-bit words has a data rate of 4.6 Mb/s.

To reduce the network bandwidth for MPX over AES STL transport, techniques such as sample rate conversion and word size reduction can be used. Sample rate conversion is the digital signal process of changing the sampling rate of a discrete time signal to obtain a new discrete representation of the underlying continuous signal. The 192 kHz sampled AES signal can embody a MPX signal of up to 96 kHz. Often, the MPX signal does not contain information up to this frequency. For example, if the MPX signal contains stereo audio and RDS only, then the frequency content is up to 60 kHz. If the MPX signal contains, in addition to this, a single SCA channel (sub-carrier at 67 kHz), then its frequency content is up to 75 kHz. In these cases, the AES3 signal can be sample rate-converted to a lower sample rate, such as 132 kHz (stereo audio plus RDS) or 162 kHz (sub-carrier at 67 kHz) without any loss of information.

Modern state-of-the-art sample rate converters have excellent performance. The THD and dynamic range can be greater than 125 dB with a near constant group delay and an amplitude vs frequency response characteristic close to the Nyquist rate. Using sample rate conversion in an STL, the AES over MPX signal can be sample rate converted at the studio site, and then sample rate converted back up to 192 kHz at the transmitter site.

AES3 defines a 24-bit word size. The theoretical maximum dynamic range for a digital representation of an analog signal using uniform quantization is 6 dB per bit. Therefore, 24-bit quantization can provide 144 dB of dynamic range. As a practical matter, this is more dynamic range than can effectively be generated by the FM stereo generator, or utilized by an FM exciter. In most cases, word size can be reduced without loss of quality. With 16-bit sampling, dynamic range is still a robust 96 dB. Further reduction in word size is possible with some tradeoff in quality.

Using sample rate conversion and sample word size reduction, the AES over MPX STL network bandwidth can be considerably reduced. Using 132 kHz sampling and 12-bit sampling the network payload bandwidth is 1.6 Mb/s.

### MPX Bridging

Analog MPX is compatible with most existing FM plant infrastructure, while digital MPX (MPX over AES) is a relatively new operating standard. For interoperability between the two, the MPX signal can be bridged from analog to digital, or vice versa. This is useful when interoperating between older FM equipment not supporting digital MPX and newer FM equipment that does. For example, an older FM stereo generator at the studio can interoperate with a new FM exciter through a MPX bridging device. See **Figure 1**.

Conversely, a new FM stereo generator can interoperate with an old FM exciter through a MPX bridge. See **Figure 2**.

This hybridized bridging device sits between digital and analog domains of operation. The bridging can be between co-located FM equipment or the bridging function can span an STL when it is integrated into a MPX codec.

### MPX STL Networking

The wide area network (WAN) payload bandwidth requirements for transporting an MPX signal varies, based on sampling rate and word size. MPX over AES has a data rate of 4.6 Mb/s. This data rate can be reduced when down sampling from 192 kHz to a lower sampling rate and reducing the sample word size.

Transport of an analog MPX signal has flexibility in the payload data rate because of settable options for sampling rate and sample word size. The sampling rate selection is made based on the services needed to be carried across the WAN. For example, 132 kHz sampling can carry stereo audio and RDS data, 162 kHz sampling carries an additional SCA channel, and 216 kHz sampling embodies the entire 99 kHz MPX spectrum.

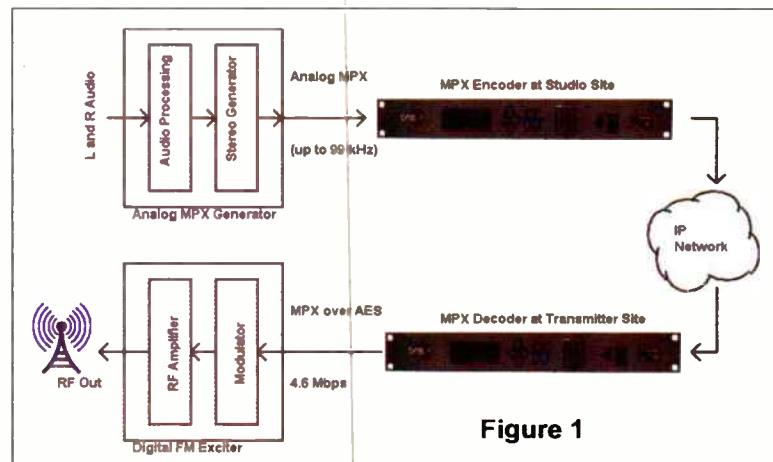

Figure 1

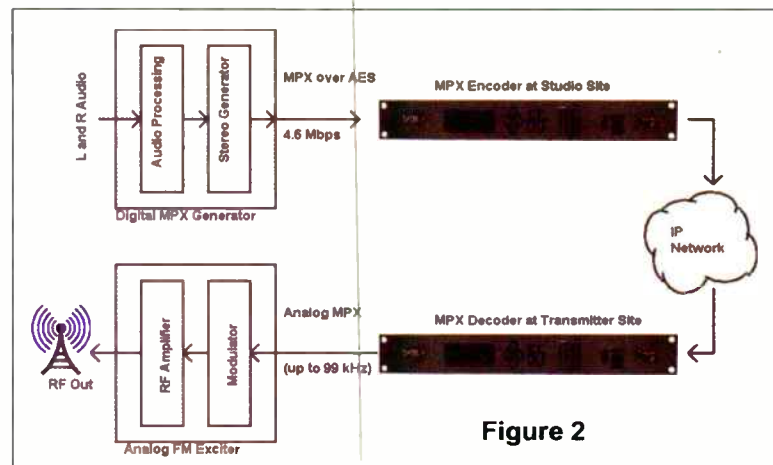

Figure 2

Usage of IP in broadcast applications is rapidly proliferating. IP based networks provide advantages in both reduced operational cost and flexible interconnection. The IP packetized transport of the MPX signal does add additional overhead for packet headers as well as delay associated with the packetization process. The packetization process needs to accumulate samples in a buffer prior to packet transmission. A higher number of samples in a packet results in lower overhead, lower packet rate and higher associated packetization delay. Conversely, the lower number of samples per packet translates to higher packet rate, higher overhead, and lower delay.

IP networks present impairments such as packet loss, jitter, and loss of network connectivity. Jitter can be mitigated by a receive jitter buffer. MPX streaming uses PCM encoding so lost packets results in missing data for that packet interval. Forward Error Correction (FEC) can be extremely effective for random packet losses, however if the packet losses occur in bursts, its effectiveness deteriorates. Redundant streaming over independent networks (network diversity) or redundant time delayed streams (time diversity) mitigate against burst packet losses. FEC and network/time diversity can be combined, and streaming parameters determined, after packet loss pattern analysis.

Junius Kim is an engineer with GatesAir, and part the GatesAir design team responsible for developing Intraplex IP Link MPX, a next-generation MPX codec.



# MAKING DIGITAL RADIO EASIER & AFFORDABLE

**HD MULTICAST+**

**IMPORTER/EXPORTER**

nautel

PWR GPS

HD



## **HD MULTICAST+** Importer/Exporter

Simple all-in-one solution. Cuts costs by 50%\* compared to prior equipment.

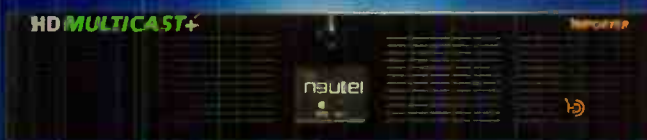

### **HD MULTICAST+** Importer

NEW Importer with  
higher performance



### **NV<sup>LT</sup>** Series

Now upgradable  
to HD Radio



### **VS** Series

HD PowerBoost!<sup>TM</sup>  
now included in VSHD



**Nautel Innovation:** Learn about Nautel's latest developments including seamless handoff HD Single Frequency Networks at [www.nautel.com/hd](http://www.nautel.com/hd)

**HD Radio**<sup>®</sup>  
Digital AM & FM

\* For domestic USA deployments of the Multicast+ Importer/Exporter.  
For international customers please contact your Nautel representative.

[nautel.com](http://nautel.com)

**nautel**



## Podcasting and Your Digital Footprint

*On Demand Audio is "Full Stream Ahead"*

by George Zahn

We're early into 2018, and if you've made or not made New Year's resolutions, here's one to consider. Whether we want to acknowledge it or not, radio is changing, and the digital content we can create appears to be the next generation of our growth. For all the radio promotions that tell us that a large percentage of people still check out AM and FM radio, the new wave of listeners will require more on-demand and on-line content.

You can't pick up a trade newsletter, e-mail, or publication without reading about streaming, podcasts, and the Amazon-Google battle for the "Internet of things," including voice commanded listening. That means that with all of our best talent and studio gear, and all the ways that they create radio magic, we start need to thinking outside the radio box as early as now.

Much of the equipment is already in place to do simple things such as creating our own podcast audio – in fact we have the advantage over the "do it from home" podcasters, for whom technical excellence is likely a secondary concern to generation of content. Most of our programming is easily recordable to digital audio, and our gear will sound better than a basic USB mic or a recording from a smart phone microphone.

Many of us also have the editing skills to make our content shine and the professional announcers to make our content stand out. Finally, we also already have the clear advantage of publicizing our podcasts and streaming media on our airwaves. In fact, failing to provide that reminder, on regular on-air and any print messages, is a significant opportunity lost.

### File Size Matters

Aside from the studio gear that we already understand, let's check the basics. If you're already recording and archiving shows you do, some simple editing can be done inexpensively on open source software such as Audacity, if you do not have more robust software. Software will not just allow you to edit your programs, but also to convert that audio to Internet-friendly files such as mp3 audio. If you're doing a talk program, converting to mono in mp3, and even slightly reducing to a sampling rate of 3200 kbps, will do well for most discussion content. A smaller file is easier to upload to the Internet, but shrinking the file too much can make the audio virtually unlistenable.

Once we have created the podcast audio, we have to get it somewhere where people can find it. One of our hosts at my station actually uploads to a free iTunes account and has people from across the country following her real estate program. The *Real Life Real Estate Investing* podcasts on iTunes total more than 200 episodes. Our Operations Director, converts the programs to mp3 and uploads them to iTunes each week.

Our station, WMKV, is also experimenting with self-podcasting many of our talk programs on our own site, to drive more people to our site. Again, a small amount of space allows many of our listeners to hear missed programs and to listen on their own schedule. We generally keep about three to four of each program up on the site to conserve space. This is also a great extra sell to our sponsors, whose mentions end up on the podcasts as well.

### Know Your Rights

Many stations do not make podcasts of their music programs simply because of additional music rights. In fact, using buy-out production music for your talk shows is a great way to lower any potential rights costs for podcasting. Of course if you're streaming music now, you are aware of the extra costs for streaming music on the Internet. When in doubt, it is best to consult with your broadcast attorney about any rights questions.

One of the other fun things about podcasting is creating audio in the field. Some non-station podcasters use a variety of smart phone apps that might make for some interesting options, for even broadcasters. Saving some audio elements such as standard program opens or closes, disclaimers, or other regular interstitials on your smart phone internal memory or memory card, allows you to utilize these higher fidelity mp3 files even if most of your content is recorded on the phone in the field – something you can always remind your listeners as you record.

There are many paid or free apps and tutorials to get you started into podcasting, and while most are geared to the non-audio professional, there are some pretty innovative features. Many audio apps for your phone will allow you to record (although in more limited fidelity if you're just using your phone's internal microphone) and even do some rudimentary editing on the road. Looking at just a few apps, including Anchor and Buzz Sprout, here are some digital "bells and whistles" that turned this broadcasters head.



Anchor, available at [www.anchor.fm](http://www.anchor.fm) or at google play or iTunes stores, allows a simple stacking edit system that allows you to create programmatic blocks on your smart phone, and label them to create a playlist that builds to one overall podcast. This is where pre-made themes, disclaimers, and/or bumps can be used to even make an "in the field" podcast sound like studio content.

### Fast Talking

Those listening on the same app have some novel playback options. There are icons and emoji's such as "clap" that allow the listener to send the podcaster feedback at specific points while listening to the podcast. That feedback can let us know what sections of the podcast are most or least popular. The app also allows customization for the listener to listen on the phone earpiece or the internal phone speaker. The feature that I thought was most interesting is the fact that the app allows the listener to speed up playback to listen to the same show in less time.

This feature has been used for years on classroom personal audio recorders.

For those seeking phone-in content, Anchor allows using incoming voicemail clips to incorporate phone response to a podcast, in much the same way you stack other segments of the podcast. The app also can add video content.

You can discover more about these and more apps on-line, including some basic tutorials on YouTube. It's a good practice to read site and independent reviews thoroughly and check with colleagues to see what works for them. Whether you're looking to start podcasting or try an app, it's sometimes best to start with one show and test it before publicizing it. You may find out that podcasting is simpler than you might think.

### I Stream, You Stream . . .

Beyond podcasting, are you aware of which digital sources your station's streaming is featured on. Another major battle is for the voice-commanded "Internet of things" market, including Google Home and Amazon's Alexa. Can someone who has these devices simply say "Hey Google, play (your call letters)" or "Alexa, Play (your call letters)" and have your station come up?

If you're streaming audio now, there's a good chance that your stream will appear in a number of sources including Tune In Radio or the Reciva radio data base that feeds many Internet radios. Others might be on iHeart Radio. Owners of Amazon's Alexa, for example, can link iHeart or Tune In Radio to their in-home devices.

Internet website streaming for radio is considered the "great leveler," giving equal on-line access to small public stations – as much as a 50 kW AM giant. Podcasts, and to a greater extent, streaming to in home devices, will continue to level the digital playing field unless new changes to net neutrality alter that terrain. Whereas Tune In was once just a smart phone app and a feature on Roku video boxes, their alignment with Amazon's Alexa platform brings Tune In, and potentially your station, to countless new listeners every day. With streaming as the audio source, reception issues in "trouble areas" for your station are now bypassed.

If you're not sure what your status is on resources such as Reciva and Tune In, it's easy to check by downloading the app and checking to see if you're there. If you're missing from their options, make a request to be included in the data base. If your station is already there, promote the heck out of it!

### Navigating the Future

I believe this is the next wave of promotion and gaining new younger listeners, while making current listeners even more engaged. The key is to promote it on air so that it becomes second nature to those who are beginning to use the newer technologies. The hope is that stations then can find ways to monetize the new service as well. At the very least, it becomes a nice added value to your sponsors, who receive wider distribution via differing audio platforms.

If you're successfully podcasting, I'd love to hear some tips on how you got started or what works well for your station, large or small. This column is a learning experience for me, and for all of us, as we continue to evolve as broadcasters!

*George Zahn is a Peabody Award winning radio producer and Station Manager for WMKV-FM at Maple Knoll Communities in Springdale, Ohio. He is a regular contributor to Radio Guide and welcomes your feedback. Share your stories with others by sending ideas and comments to: [gzahn@mkcommunities.org](mailto:g Zahn@mkcommunities.org)*



# VIA The Remote Codec of Choice...

When you compare Via with competing remote codecs the choice is clear...

VIA delivers #MoreOptions over IP, ISDN and POTS.

- Full duplex stereo program plus separate full duplex IFB communications
- 5 input digital mixer and configurable matrix router (3 XLR inputs, plus stereo analog line in, or stereo digital in/out)
- Built-in dual band Wi-Fi with integrated web-browser
- Dual LAN & USB ports & optional ISDN, POTS or LTE modules
- Schedule, dial, manage & hangup connections automatically
- Adjustable input EQ & compression, plus AGC limiting
- 6.5 hours of power with one internal battery
- Restrict user access to settings with Admin & Basic modes



Join the #ViARevolution

« VIA »



[www.tieline.com/videos](http://www.tieline.com/videos)

**Tieline**   
The Codec Company

317-845-8000 | [sales@tieline.com](mailto:sales@tieline.com) | [tieline.com](http://tieline.com)

World Radio History



# Chief Engineer

## RF Transfer Switch Rebuild

by Scott Schmeling

Some time ago we had an AM transmitter that suddenly indicated a high VSWR to the point where the transmitter would fold back to *zero* output. This site has a backup and both transmitters are wired to an RF transfer switch. Most of the time a high reflected power is caused by a problem in the ATU, the line, or the tower itself – all of which are *after* the transfer switch.

A quick visual inspection showed no obvious problems in either the line or the ATU. And the tower was upright! The transfer switch was activated and the backup put on air. The VSWR was nice and low, so it appeared the problem was possibly in the output network of the main transmitter. It was late in the day and I had an hour drive home. I would return later with a dummy load to troubleshoot the transmitter.

When I returned, I disconnected the output cable, connected the dummy load, and went to work. The transmitter is a Nautel ND5. Its output matching network is located in the top of the transmitter behind three panels. With those panels opened, I did a visual inspection of the components – everything looked fine. No discoloration. No obvious burn marks. So I checked connections. Everything was nice and secure. So I closed up the transmitter and applied power.

Before turning the RF on, I lowered the output power control as low as it would go. Then I watched the output and reflected meters as I pressed the RF button. No problem indicated, but *no output*, so I started turning the control up slowly. 10 Watts – no reflected. 50 Watts – no reflected. 100 Watts – no reflected? So I jumped up to 500, then 1000 Watts, and still *no reflected power!* It would appear that the transmitter was just fine. Hmm ... ?

So the *transmitter* is OK. And the *line*, *ATU*, and *tower* (antenna) are OK.

I love a good mystery, but this one's easy. All that's left is the RF Transfer switch. The first thing I did was remove the transfer switch and connect the main transmitter directly to the ATU. Again, I set the transmitter for very low power and ramped it up. Full power and almost *no reflected* – just like it should be!

Now for a closer look at that transfer switch ...

The first thing I noticed was major discoloration of the fingerstocks and the contact bars. There was also a buildup of what, at first, appeared to be melted plastic. But that buildup broke off easily using a small flat-blade screwdriver.

I'm convinced that it's not melted plastic. That's good, because I have no idea where plastic material would have come from.

Perhaps exercising the contactor a few times might have restored a good connection. But it would only have been temporary. I could see two options;

A. I could clean the pieces with Scotch-brite pads, Triple-ought steel wool, and a clean rag, or ...

B. I could replace the contact bars and fingerstocks with new parts.

I decided the best plan was to replace the contact bars and fingerstock contacts. Replacing the parts (essentially rebuilding the contactor) assures long-term reliability.



Old contact bars and fingerstocks.

Based on the label, this contactor was manufactured by Multronics. It appears Multronics is no longer in business, but the design is similar (if not identical) to EF Johnson, CSP, and early Kintronic Labs contactors.

Speaking of Kintronic Labs, they have done some redesigning of their contactors, primarily of the contact bar. Rather than being cylindrical, they are flattened on two sides (oval shaped when viewed from above). This change results in more surface contact area.

On the Kintronic Labs website ([kintronic.com](http://kintronic.com)) there is a very good 30-minute video on RF Contactor Maintenance and Adjustment. This video covers every aspect of the contactor from the solenoid coils and mechanical assemblies, to the actual RF switching portion. It's worth taking the time to watch.

I also searched high and low, looking for some type of downloadable service booklet for RF Contactors. I was looking for anything that could provide a little guidance through the process – especially concerning the proper alignment of the contact bars into the fingerstock. But I couldn't find anything.

Since the mechanics of this contactor were working properly, my focus was strictly on the RF switching. The first thing I did was take lots of pictures. (What did we do before smart phones put a camera in our pockets?!) I photographed each stage of disassembly – this is a wonderful aid when it's time to put it all back together.

The contact bars are held in place with 3/8 inch external retaining rings. Since I didn't have a retaining ring tool, this was an excellent opportunity to buy a

new tool! The only other tools you need are a screwdriver and some wrenches (as I recall, 3/8" and 1/2").

Disassembly is pretty straight forward ... likewise, reassembly. With the retaining clips removed, the contact bars can be replaced. Fingerstocks are secured with a small flat-head screw. However, the fingerstock *clips* (secured with a *large* flat-head screw and a 3/8" acorn nut) do not need to be removed.

I found it much easier to replace the fingerstocks if the stationary arms are removed from the assembly ... and to get the lower level stationary arms out, the moving arm has to be removed. After the fingerstocks and contact bars have been replaced, reassembly is basically the reverse order of the disassembly.



Stationary arms removed from assembly.

### Hints:

1. Center the moving arm in its mount before tightening it.

2. Position the stationary arms so the contact bar is fairly centered in the fingerstock before tightening.

3. Position the fingerstock MOUNTING CLIPS (slightly loosen the 3/8 acorn nut) such that the fingerstock is square with the contact bar.

My contactor rebuilding project is completed. I did my best to give it a good cosmetic cleaning while I had it apart and replaced my white tape labels with much nicer P-Touch labels. The contactor is not back in service yet, but it sure looks a lot better than it did!

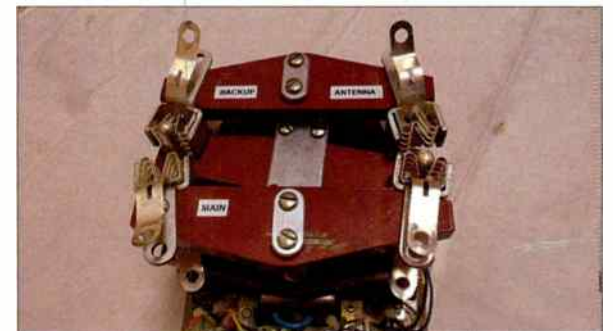

Refurbished Contactor

In that Kintronic video I told you about earlier they suggest using an "electrical compound lubricant." That compound is Dow Corning DC 4 Electrical Insulating Compound. However, the small quantity used would not insulate, but does lubricate the surfaces. I don't have any Dow Corning DC 4 yet, but I'm ordering some.

By the way, remember that "stuff" that I said looked like melted plastic in the fingerstock? I think it was built-up excess grease. If you do, in fact, rebuild an RF contactor, use that Dow Corning DC 4 very sparingly.

Until next time ... keep it between 90 and 105!

Scott Schmeling is the Chief Engineer for Minnesota Valley Broadcasting. You may email him at: [scottschmeling@radiomankato.com](mailto:scottschmeling@radiomankato.com)



# From analog FM to best-in-class HD Radio on your schedule and budget

Transition to superior digital with  
exceptional ease and affordability

## Flexiva™ Gen4 Engine HD Radio Solution

- High-efficiency transmitters with industry-leading performance, compliance
- End-to-end management for multichannel program transport and delivery
- Industry's most advanced quality and diagnostics with robust Flexiva excitors



TRANSPORT



TRANSMIT  
TELEVISION



TRANSMIT  
RADIO

# GATESAIR®

Connecting What's Next

[www.gatesair.com](http://www.gatesair.com)

Since 1922, GatesAir has remained the industry's most trusted supplier for the over-the-air TV and radio networks worldwide. World-class engineering and industry-leading innovation marry outstanding performance with the industry's highest reliability and operational efficiency. Our impeccable sales and service bring it all together for our valued customers.



**NABSHOW** Visit booth  
Where Content Comes to Life **N3703**



## Sexual Harassment?

### #MeToo Broadcasting Industry – Your “#Times Up”

by Gregg P. Skall – Womble Bond Dickinson (US) LLP

Workplace sexual harassment has catapulted into our collective consciousness since the recent revelations involving media mogul Harvey Weinstein. In recent months we have seen allegations of sexual misconduct against some of the most respected entertainment and media personalities, including television and radio veterans including journalist Charlie Rose, “Today Show” co-host Matt Lauer, and radio personality Garrison Keillor. However, this is not the first time the broadcast industry has experienced allegation of this nature.

A decade ago, broad reports of shocking harassment behavior was the subject of stories about the Sam Zell takeover of Tribune Broadcasting with his colleague Randy Michaels, formerly Jacor Communications. The *New York Times* reported, “Mr. Michaels and his executives’ use of sexual innuendo, poisonous workplace banter, and profane invective, shocked and offended people throughout the company.” In 2008, the Tribune board was made aware that not everyone appreciated the new cultural dynamics and the board accepted Michaels’ resignation, based in part on this behavior.

Another case in the early 2000’s revolved around sexually explicit talk on radio programs. In a lawsuit emanating from another station, owned and run by Jacor, a female personality discussed a variety of “sexual or adult nature” topics. Despite her participation in these routines, she filed a lawsuit claiming that her cohort referred to her appearance in a demeaning and sexually degrading manner.

While allegations of harassment in the broadcast industry are not new, the #MeToo movement and the cultural backlash we are experiencing today is ample evidence that this type of behavior will not be tolerated moving forward. Broadcasters who allow anything even close to it in the workplace could face serious legal action as well as increasingly bad publicity. Avoiding these issues is easier said than done as employers must face the challenges of consensual office romances that go sour and differing perceptions as to what is acceptable behavior in the workplace.

**Office Romance.** Employers must also recognize that office romance is inevitable. A December 2007 *Wall Street Journal* article, “Is Romance Still Allowed?” by contributing editor Kathy Young concluded, “Any notion of simply banishing romantic or sexual interactions at work will fail. Too many of us find lovers, partners, and spouses in the setting where we spend most of our waking hours.” She reported studies that show that even in the age of on-line dating, Americans continue to find love and sex at work. Similarly, a year ago the data company Report Linker surveyed 500 single, divorced and widowed adults, finding that 28% mentioned work as the way to meet partners, while only 20% used a dating app or website. In fact, millennials were actually more likely than other singles (30%) to view the workplace as a dating pool. Others report similar results.

There even is a high profile example. New York City mayor-elect Bill de Blasio, met his wife, Chirlane McCray, while working at city hall. Reportedly, she “had zero interest.” Undaunted, Mayor de Blasio flirted with her mercilessly ... calling nonstop and trying to steal an unwelcome kiss.” A later *Slate* magazine piece questioned whether this courtship sounded too much like sexual harassment, however, Ms. McCray was quoted saying he was “sweetly persistent, but ... always respectful.”

The de Blasio story points out how much the distinction between romance and harassment lies in the eye of the beholder. According to Ms. Young, “flirtation is mutual, innuendo is one-way.” The appearance of “mutual” could really be the result of a less powerful person “playing along” to placate the abuser. So, it is hard to tell and difficult to judge, and it can change. What starts as fully consensual can later be reinterpreted as abusive for a variety of reasons – including a soured romance, made more highly aware because of consciousness raising coming from the #MeToo movement. Indeed, federal courts have ruled a woman who willingly participates in, and even initiates, raunchy behavior at work can still successfully sue for sexual harassment once similar conduct becomes unwelcome.

**Outsiders’ Conduct.** Harassment can come from any place, anyone connected with the workplace including supervisors, co-workers and even non-employees. That last category is one for which broadcasters need to be keenly aware. Harassment can come from vendors and advertising clients as well as from other employees or supervisors. While an employer is charged with knowledge of what goes on in the workplace, it’s harder to tell what happens outside of it. Harassment incidents have been reported coming from time buyers and advertisers toward sales people. Employees who work outside the workplace should be made aware that outside harassment will not be tolerated, and to promptly report it and take action.

**Judgement & Balance.** This all takes a fair amount of discretion on behalf of the employer. Liana Kerzner, a Canadian television host, writer and producer believes that, “we need to be able to use judgment and separate men who are just awkward from men who use their power to intimidate.” Making the workplace too uptight will backfire. She writes that workplace stress can lead to inappropriate humor as a coping mechanism. “If you can’t joke around at work, you’re workplace doesn’t have the trust necessary for people to give the company their best.” Instead of formal rules, Ms. Kerzner argues, it is much more important to have strong workplace communication and responsive management so that employees can complain without fearing retaliation or overreaction.

That is difficult to achieve when workplace policies encourage rigid and punitive approaches, removing supervisor discretion and requiring human resources where protocols and policies will have to be implemented. This is particularly difficult for broadcasters who wind up having to report such instances on their license renewal form. An FCC agreement with the Equal Employment Opportunity Commission requires that, while harassment complaints are managed by the EEO Commission, they are reported back to the FCC, and the licensee has to report any such adjudication in its renewal application.

**Policies & Training.** So to discourage and minimize harassment in the workplace, broadcast employers should establish strong policies against harassment of any type, whether it be based on sex, race, religion, national origin, disability or any other protected category. The policy should include a statement that unwelcome and personally offensive verbal or physical sexual behavior is injurious to morale, interferes with work performance and creates a hostile or intimidating work environment – and such conduct will not be tolerated. Policies should provide a reporting mechanism, a pledge to investigate, take appropriate corrective

action and refrain from retaliation. The employer policy should also make clear that all complaints will be treated with confidentiality. It may be difficult or impossible to lay down precise rules of behavior. The interpretations are the hard part. The goal is to make the workplace *harassment free*; make the message clear that *unwelcome* advances, requests for sexual acts or favors, or other related verbal or physical contact, is not appropriate for the workplace.

Harassment training is also important. The employer should have sensitivity and educational session explaining what constitutes harassment in the workplace and how it is not tolerated by that employer. Employees should be trained to know that an employee believing that they have been the subject of sexual harassment should bring it to the attention of the station’s human resources department if it has one, or the designated EEO officer. Here is a place where state broadcaster associations can also be a substantial benefit by conducting such harassment training workshops. Training can also be done through a variety of videotape or on-line training sessions. Look to your state broadcaster association for good references.

In “Harassment Training Gets a Revamp,” *Wall Street Journal* columnist Sue Shellenberger reports that sexual misconduct is often an open secret among co-workers. Her lesson is that if you know that a co-worker is guilty of sexual harassment, you need to speak up, no matter how powerful the perpetrator. Emphasis must be on fostering a respectful workplace.

#### Where Do We Go From Here?

A good discussion of the #MeToo/TimesUp movement, and the quandary of how to deal with harassment and punishment, occurred in the January 14 edition of CBS Sunday Morning. Oprah Winfrey conducted a discussion with major Hollywood figures. If you missed it, here’s the link: (<https://www.cbsnews.com/news/oprah-winfrey-panel-on-times-up-movement/>). The overwhelming consensus was that the time is up for silence and deference to power in the workplace. But, there was also a discussion of at what point an apology should be accepted. Judgment and punishment should be appropriate and sometimes it is okay to say I accept your apology and move on. The important point is to have a well thought out policy and implement it consistently.

Now is the time to seriously review your existing employee manuals or create one. Review your discrimination policies and assess the office behavior in your own work environment. Behavior previously considered unwelcome but not over the line, can no longer be considered within the norm. Make sure your employee manuals and policies incorporate the principles described in this article. Have them drafted and reviewed by professionals who have studied the issues and articulate your policies consistent with legal principles that will be applied in any situation of alleged harassment.

Special Thanks to Richard Rainey of Womble Bond Dickinson’s Labor and Employment group for his help with this article.

*This column is provided for general information purposes only and should not be relied upon as legal advice pertaining to any specific factual situation. Legal decisions should be made only after proper consultation with a legal professional of your choosing.*

*Gregg Skall is a partner of the law firm Womble Carlyle Sandridge & Rice, LLC. He frequently lectures on FCC rules and regulations, represents several state broadcaster associations and individual broadcasters and other parties before the Federal Communications Commission in their commercial business dealings. Prior to private practice, Mr. Skall served as the Chief Counsel for the National Telecommunications and Information Administration and General Counsel to the White House Office of Telecommunications Policy.*



# Touch control made simple.



We've combined the latest in multi-touch technology with a suite of familiar controls in our new Helix line to give your operators everything they need for on-air or production. Whether you're looking for a scalable console for the studio or a comprehensive virtual console that can be used anywhere, Logitek's Helix can accommodate your requirements. Helix is powered by the JetStream AoIP platform, which brings you space-saving high-density I/O along with buckets of mix-minus and onboard processing.

**HELIX** Radio and **HELIX** Studio - only from Logitek.

  
**Logitek**

[radio.helixconsole.com](http://radio.helixconsole.com)



Curious about JetLink, a new way to send and receive broadcast-quality audio between two computers? Try our free version here:  
[get.jetlink.co](http://get.jetlink.co)

**JETLINK**



# Telemetry and Control

## Integrating a Wireless Alert System Into Existing Panels

by Michael Bradford

The present contract engineer was out of town for a few days and asked if I would respond to a “loud, shrill noise” coming from the building that was keeping the neighbors on edge. This response was to be a trip down memory lane. I had built this site over 35 years ago and turned over engineering when the station sold in the late 80’s. Same country roads, same falling-down barn on the corner, same dirt drive past the long-broken gate – and same tower badly in need of paint.

As I traveled the last mile, I tried to remember all that had occurred there, those many years ago. The scrape marks on the cement floor where I used my bumper jack and a 2x4 to move the Continental 20 kW transmitter into place when my “help” didn’t show up. The relay interface unit I built for automatic change-over to auxiliary transmitter. The hole in the generator front-panel from a 30.06 round that someone had fired from the roadway back in ’83. The piece of burned 3-inch transmission line where the inner spiral insulator had melted from extreme heat. (the EIA flange connector had been factory-installed without proper ground preparation). The propane tank out back where vandals had broken off the control valve assembly and emptied 300 gallons of propane within minutes, killing the grass all around the tank and rendering the generator useless.

As my memories cleared upon entering the compound, I opened the car door and heard that shrill sound of the audio alert on the generator; it was indeed loud and no wonder the neighbors had complained. In any case, I unlocked the generator enclosure door and hastened to turn the audible alert off. I flipped the switch for the control panel lights and found them very dim. Closer inspection found the battery voltage measured 9.35 Volts and was the cause of the alert. Further inspection found the battery charger had been chosen as residence for several field mice and chewing on various wires had killed the unit. I noticed the date tag on the battery was from 4 years ago and made a note to have the site manager order a new one. I had a new charger with me and made the necessary connections in anticipation of arrival of the new battery.

I wondered why the remote control hadn’t sent the proper alert when the battery voltage dipped below 11.95 volts or when the audible alert was tripped. I discovered the conduit I had installed years ago, to interconnect the generator control panel to the remote control inside the building,, was still there, but bent to one side with the control wires disconnected and taped to the conduit. No wonder no remote control alarm was sent. I would find out later that a new generator control panel had been installed to update everything two years earlier and the remote control wires had never been reconnected.

As I entered the main transmitter building, I noticed a “new” fire alarm control box on the wall adjacent to the main power service panel and the telephone network interface panel. There was a small hard-wire dialup modem between the fire alarm panel and the NI, but the RJ-11 plug was just dangling there. I also noticed a hard-wire Internet modem on the wall, with connection to a modem and a 5-port switch, with outputs to the remote control system for the transmitter, and a new audio processor. Although the old STL dual receiver package was still in the rack and plugged in, there was no audio output to the main exciter. Welcome to the new world I thought.

As I had previously installed several wireless alarm systems for remote transmitter sites in general, and their generator monitors in particular, I saw this as a prime target for a wireless alarm interface.

I have used products from Ayantra, Inc. in Fremont, California several times with great success. The units are primarily used to monitor remote off-road heavy equipment, generators, drainage pumps and as backups to existing alarm systems. Depending on the amount of inputs needed, the units monitor battery level, mains power availability, generator engine on/off status, alarm inputs from the generator and extra inputs assignable for what ever you need. Because the alarm inputs “look for” a change in status, you may utilize normally-open or normally-closed contacts and voltages anywhere from 12 VDC to 48 VDC to activate the alarms. I wrote up my report and recommendation for the station manager, after a check of the transmitter readings, intake filter condition, line pressure, and vacuumed some dust off the top of the transmitter.

Six days later I received an email from the site manager asking for a quote to add a wireless alarm interface at the site. I gathered my notes from the previous week’s visit and put together the parts list. I included a temperature sensor input for the building, interface with the generator control panel and backup for the fire alarm system. The temperature sensor is a \$50 electro-mechanical thermostat from Grainger Electric that is set for 45 degrees. Colder than that, an alarm is tripped. The existing fire alarm had an alarm output for high temperature, so I choose to interface with that, rather than use another thermostat. Interface with the generator was made simple by reconnecting the conduit and wires I had installed years ago and connecting to the “summary” alarm contacts on the generator control panel.

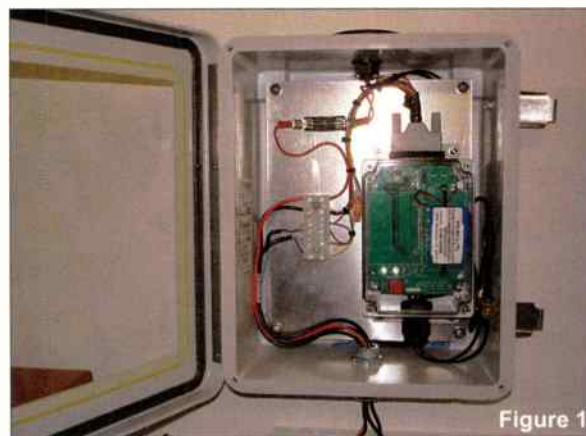

Figure 1

Connection to the fire alarm (see Fig-1) was simple, as this particular unit uses dry relay contacts with a SPDT configuration. I borrowed power for the Ayantra unit from the regulated 24 VDC output from the fire alarm to monitor the fire alarm battery status. The connections to the fire alarm relay contacts were easy, using 16 AWG stranded cable and weather-tight connectors. This Ayantra model has its own internal “keep alive” battery, making for a triple backup. The Ayantra unit utilizes CDMA technology via the Verizon wireless network and RF input is provided by a small “hockey puck” antenna. The antenna comes with a stud-mount (see Fig-2) or with 3M double-

sided tape. I choose the stud mount version and I especially like the split-nut mounting hardware (see Fig-3).



Figure 2



Figure 3

Further, to protect from moisture and the ever-present field mice, I enclosed the whole system in a Stahlin fiberglass window enclosure, using stainless steel hardware, a full rubber gasket and easy to drill or punch access holes. The Stahlin enclosures have an optional aluminum base-plate, which I find is great for drilling and taping mounting holes for the fuse holder, terminal strip, antenna, input hardware and the Ayantra module. The excess wires from the antenna (they come with 12 feet of cable) are easily tued underneath the aluminum base-plate.

After installation and putting the Ayantra unit through its “learn” cycle, I tested the various alarm inputs by shorting the contacts or removing the input voltage for a moment. I found between the time I simulated an alarm condition and the time my cell-phone chirped with a text message was just under 30 seconds.

Now there is backup for a transmitter alarm, generator or building fire alarm system, or loss of primary power to the building. The Ayantra website setup allows four recipients to receive email and/or text messages for all the various alarm channels, and you can custom label the messages for each alarm so recipients quickly understand the nature of the alert.

Because this site depends on rural Internet service via a hard-wire connection for remote control, telephone and audio, the wireless interconnect provides one more method to help the engineer and management become alerted to problems in a timely fashion. Now the engineer will know, in advance of making the trip to the site, if there is a generator battery failure before a storm hits and you have nothing but static. Likewise, a smoke or fire alarm alert will go directly to engineering and management, regardless of the land-line status at the site. Although the I-Net modem doesn’t have an auxiliary alarm connection, the Comrex modem does. Of course, the pure “quiet” on the air should be a dead give-away!

Michael Bradford began his career at WCCW in 1962, A CPBE since 1984, and currently a contract engineer, you may reach him at: [mbradford@trilon.net](mailto:mbradford@trilon.net)



FOR TRULY AUTHENTIC RADIO

# INTRODUCING THE NEW — NOVIA 272 —

FM PROCESSOR WITH STEREO GEN & DYNAMIC RDS

**PART OF THE NEW FAMILY**  
OF NOVIA PROCESSORS FOR AM, FM, & STEREO.

The Nova 272 is a comprehensive FM airchain processor and includes the Stereo-Multiplex generator as well as a full-function dynamic RDS/RBDS RadioData encoder. Setup is easy with 10 Factory Presets, and dayparting is supported. In addition to quick and easy front-panel setup, a dynamic web interface enables total remote control of the NOVIA 272 using any PC or mobile device. This interface also accepts streamed program sources, allows remote audio monitoring and provides full SNMP support.

**IN:** Analog, AES-Digital, Streaming      **OUT:** Composite MPX, Streams Processed Audio

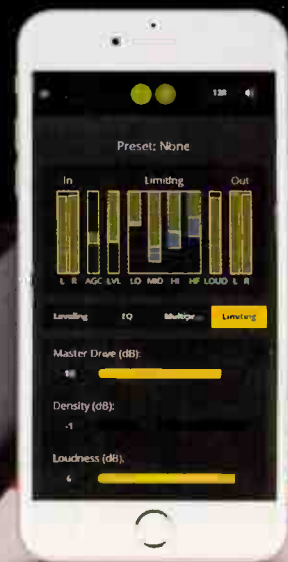

**i INOVONICS**  
BROADCAST



*A powerful and compact unit ideal for Rackpack bundles.*

[www.inovonicsbroadcast.com](http://www.inovonicsbroadcast.com) | [sales@inovonicsbroadcast.com](mailto:sales@inovonicsbroadcast.com) | tel: 831-458-0552



# Transmitter Site

## Rebuilding an FM Transmitter Cavity

by Bob Reit, CBT

I got a call from one of my clients that their Armstrong FM-3000-T transmitter was not making licensed power of 2084 Watts. Upon arriving on the site, it seemed like the plate tuning was off, and while adjusting it, I heard arcing sounds from within. "Not good" I thought, so I shut the Armstrong down and fortunately their Elcom Bauer backup transmitter started up without any problems – at least they would be on the air at full power while the Armstrong was being repaired.

Upon opening the enclosure and removing the tube and center cylinder I found the problem. The finger stock for the tuning slider was half burned up as shown in Fig 1 and Fig 2. My guess was, after all the years of service, the plating had worn off on enough fingers to cause a high resistance connection, which overheated and resulted in a runaway condition, as the remaining fingers were forced to carry the rest of the current.

I then called Armstrong about obtaining replacement parts, and after sending them a photo as well as the model and serial number of the transmitter, they told me that they had one plate finger ring in stock for four hundred dollars. I was hoping that the cylinder was not too badly pitted, but alas it had burned past the silver plating as well as the copper base layer, clear down to the brass as can be seen in Fig 3. Was this rig a "goner?" First thing to do was to get a quote on plating the cylinder. The best bid I received was for just under two hundred dollars, less than what the plate ring was going to cost. So the repair was judged to be economically viable, as there was nothing else wrong with the transmitter and the cost to repair was well under half the cost of a new 3,000 Watt FM transmitter.

So, time to set up the lathe. There was no way I was going to try to turn a workpiece this long without supporting both ends, but I did not have a pipe taper to fit the four inch

diameter tube, so I had to make one. I started with a four inch diameter 2 inch aluminum blank. After drilling a hole down the center (Fig 4), I bored a larger hole part way so that I could clamp on an inside diameter (Fig 5) so as to have most of the outside free for the final step of turning a slight taper, with the compound slide on the lathe set to 0.5 degrees to make a snug fit on the tube as shown in Fig 6. I did this step quite slowly, taking very light cuts so as not to go too far and have too loose a fit.



Figure 1



Figure 2



Figure 3

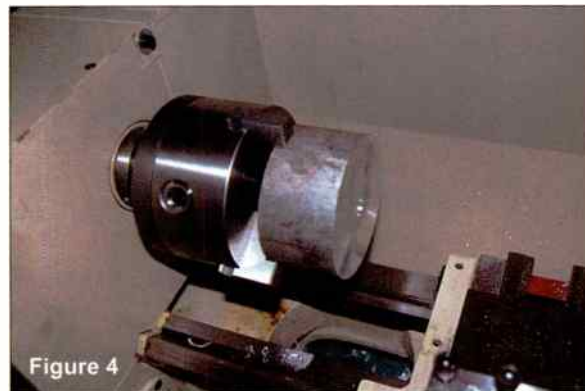

Figure 4



Figure 5



Figure 6

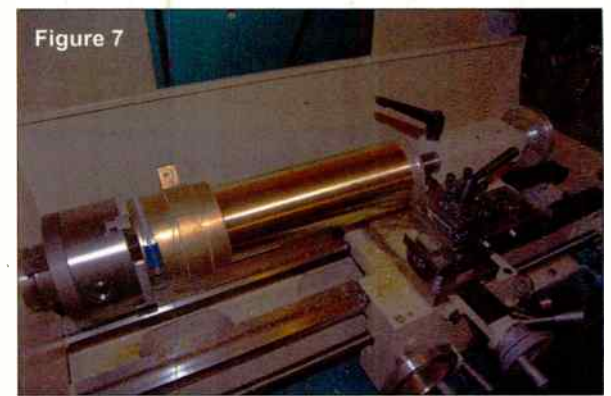

Figure 7

After making the aluminum taper, I mounted the cylinder on the lathe using a dial indicator to make sure that it was running true with no wobble or runout. Once set up, I turned down the cylinder to clean up the surface. I had to remove about 0.010 inches of material to remove all traces of pitting. Although the finish was not too bad after the turning operation (Fig 7), I wanted it at least as good as the original finish. So I sanded the piece down, first with 150 grit sandpaper, followed by a green pot scrubbing pad, which is about the same as 250 grit sandpaper in effect, followed by 500 grit sandpaper. Final polishing was done with 1000 grit paper. I did not feel a need to get it optically flat, as the finish was now a bit better than the original.

Without touching the completed surface with my fingers, I packed it up to send to the plating shop. I specified 0.0005 inch copper base layer, and 0.0012 finish silver plating. Although 0.0005 inch silver would have been enough for the conductivity required at 103.5 MHz due to skin effect, this part is subject to wear from the sliding plate ring while tuning the transmitter, so I wanted it extra thick so as not to have to do this again.

Fig 8 shows the part as received back from the plating shop. One might notice slight vertical marks on the cylinder. This is from test fitting the plate ring on the finished product. I'm sure glad that I opted for extra thickness of the silver plating.

Fig 9 shows the output cavity reassembled, ready for the back cover and testing. Upon completion of the repair, the transmitter made licensed power once again and the plate tuning is smooth like it should be.

Bob Reite operates his contract engineering firm, Telecentral Electronics, Inc. servicing radio stations in Pennsylvania and New York state and may be contacted at [br@telcen.com](mailto:br@telcen.com)



Figure 8



Figure 9



BUILT FROM THE GROUND UP FOR

# HD Radio®

**IN STOCK!**

OPTIMOD-FM 5700i



- Dual Optimized Processing Chains for FM and HD radio
- 12 Seconds of built-in HD radio diversity delay
- Remote TimeLock using Belar or DaySequerra mod monitors
- External 10 MHz reference input for SFN networks
- Full function RDS encoder



**COMPETITIVE  
CONSISTENT**



# Maintenance Guide

## Air Conditioning Principles and Maintenance

### Part 3

by Wiely Boswell

We have been going over conventional HVAC systems and each type has their advantages.

The “normal” ducted systems work well for large buildings. They circulate lots of air back through large filter systems. Outside fresh air is also brought in which pressurizes building space and helps lower indoor pollution. A typical ducted system can also incorporate a gas fired heat exchanger which is “the good heat” according to the gas companies. Zoned ducted systems can use vacuum or motor controlled duct dampers to balance and control temperature of various rooms in a building—ever heard a room thermostat hiss as you adjusted it? They can also have several stages of cooling (Y1, Y2) or heating (W1, W2, W3) to change fan speed in one or two steps, to add efficiency and respond to the demand. This is not to be confused with inverter technology with true variable speed. When using a heat system, you can advance from heat pump to one or two stages of electric resistance strips. Lots of variables exist in different systems.

Ducts can actually be dangerous when they grow mildew due to dark and moist conditions. Condensation trays in the “A” frame of the indoor unit grow all kinds of algae that stop up the drain line. It is so common that some systems, especially in an attic, will have a secondary overflow tray with a secondary drain. If you do not realize the first drain stopped up, the backup will stop up at some point and result in water damage to ceilings. One other preventative measure is a float switch in the tray that will shut down the entire system if the tray fills up. Techs will “blow” out the condensate with a small CO2 cylinder to clear the line. If you can get to your drain line outside, you can use a shop vac and just suck it out on a routine basis.

Legionnaires’ disease started from the water vapor mist out of an HVAC system that was growing Legionella bacteria. You can use Clorox or put special tablets such as AC-Safe in the condensate tray to stop algae growth and reduce drain stop ups. I was looking at various types of these tablets and, strangely enough, even found a Calif Prop 65 warning for cancer causing possibility with one of the products.

Poor or non-existent filter maintenance will make all of this worse. Your first indication of an issue is dark, dirty looking outlet vents. Duct cleaning can be done by several methods. I wish ducts could be installed where you could have easier access to the entire ducts themselves. The grills are removed and washed, some sort of vacuuming takes place, and a solution such as Microban disinfectant is sprayed in the ducts. I was told that right above the air handler is one of the worst areas requiring treatment. They will actually cut into the duct to gain access for cleaing.

Make note here that some drop-in ceilings will have intake room air go directly into the space above, and is considered a plenum space. There are no return ducts from each room, just a vent opening. That is why electrical cabling that is run in the ceiling must be plenum rated—fumes from a burning plenum rated cable are not as toxic as burning standard type cable insulation. This air can be sent throughout the whole building through the system. Building codes vary, but a smoke detector in the supply duct is required by code in larger commercial applications and should activate and shut the system down and set off the fire alarm. (see Figure 1)

These detectors located in unfiltered air just before the filters do get a lot of dust and can issue false alarms. In fact so many false alarms occur that monitoring companies typically will not do an instant callout to the Fire Department.



Fig 1 – Duct Smoke Detector

#### The Mini Split Advantage

The first thing that comes to mind is no ducts. It is just the wall mount unit parts like filter, fan blades, and drain line that need maintenance.



Fig 2 – Mini Split Inside

The mini split wall mount inside unit (see Figure 2) looks like a car dashboard stuck out on the wall. They come with a feature rich remote control and are very quiet. They also have options of recessed ceiling cassette indoor unit – one that can have an intake duct on the other side of the room, and a close to the floor model. One outdoor unit can handle 4 or more inside units, with independent control for each unit. The filters are more of just a mesh, like a window air conditioner, but some options exist for more elaborate filtering such as an electrostatic filter. Note the lack of filter maintenance (see Figure 3).



Fig 3 – Mini Split Dirty Filters

#### Another Advantage

The SEER efficiency ratings of inverter controlled cooling and heating is very high in comparison to conventional units. They are on the top end of the SEER (Seasonal Energy Efficiency Ratio) scale on the yellow Energy Guide ratings sticker. A typical Mini Split has a 15-23 SEER rating and with direct DC from a solar system assist, can bring it up to a SEER of 35!

Whenever you are dealing with any of these systems be careful, kill the power and check for stored voltage. A power disconnect at the outdoor unit is there for a reason, The NEC says it will be convenient access.

Installation is quite simple. The indoor unit only needs a 3” hole to run the bundle of R410a “Freon” lines, electrical power, and condensate drain to the outdoor unit. The condensate line, typically in this bundle, must have a down hill slope or use a separate condensate pump. If the drain stops up on a wall mount, water will run down the wall.

The main electrical supply connection is to the outdoor unit; the outdoor unit supplies power to the indoor unit. They typically also provide heat and are known to have good efficiency for a heat pump, operating at lower outside temperatures. I have not seen any type of emergency resistance heat in an indoor unit, as a standard heat pump would incorporate. Mini Splits are soft start devices with a ramp up cycle unlike the huge inrush current of a normal compressor.

You see these outdoor units overseas, up on second and higher floors. The outdoor unit is not very deep when compared with a standard unit and are easy to work with. They can simply be mounted on an outside wall with brackets. Some one told me (hearsay) when people move they will take their unit with them to the next apartment.

The outside fan also starts slow and ramps up as needed. Again, it is very quiet. I expect to see a window unit with inverter technology any day now.

The electronics is what makes this unit so efficient – it runs longer but at a lower power level. It makes a standard unit with a relay, capacitor, and time delay, look quite simple. The inverter circuit starts with surge protection and a line filter to keep electrical noise from going back into the supply wiring. The AC is rectified to about 100 Volts DC and then goes to a PWM ( pulse width modulated ) motor driver to control the speed of the compressor and thus the Freon flow.

They have now built most of this power control into high power ICs. I was looking into inverter technology when I found out the PWM Motor control is a whole new field of electronics.

Figure 4 shows some of the newest various Mitsubishi IPM (Integrated Power Module) modules that integrate IGBT (Insulated Gate Bipolar Transistor) type transistors. Multiple sensors throughout both indoor and outdoor system units, along with, thermostat settings, are used to determine heat load and can determine both the fans’ speed and the compressor speed. It could be thought of as not much more than a large switching power supply with sophisticated control.

What this means, is a repair involves a large circuit board swap and if you can obtain a spare you would be ready at a remote site to do a little swap out troubleshooting. A well know brand such as LG or Mitsubishi can have an advantage being able to supply parts. The various monitoring sensors may well be needed spare parts as well. The unit, being computerized, will display error codes in event of failures, and it may call out a sensor.

The units run at higher pressures and use R410A. A good installation will be pressurized with nitrogen for 12 -24 hours to ensure no leaks. They do have pre-charged quick connect line sets that allow a user to just connect the system together—a real DIY proposal. The outdoor unit comes with enough R410a to handle 20 feet or so of line and a formula for added ounces per ten feet, if long runs are required. Error codes need to be kept handy plus the documentation on Installation Company details for warranty purposes. Charging 410A is a specific procedure that requires the service manual. The balance of the two gasses R32 and R125 is critical and if a leak occurs, recommended recharge involves pulling down the system to 500 microns and then refilling as a liquid to maintain correct 50:50 ratio of gases.

The reverse valve and electronic expansion metering valve are both in the outdoor unit. This means both lines will be hot or cold when heating or cooling. To prevent sweating of lines you need to insulate both lines.

The summary here would be that Mini splits can save a lot of energy and, depending on the application, can be a great supplement to a large system. For any types to be reliable and efficient, routine inspections are the answer.

Wiely Boswell is Chief Engineer of Faith Broadcasting, Montgomery, AL; CBRE, CBNE, and SBE 118 Chairman. He may be contacted at: [Wiely@faithradio.org](mailto:Wiely@faithradio.org)

Fig 4 – IPM Modules







# Broadcasters General Store

Family Owned & Operated Since 1979

352-622-7700

www.BGS.cc

## BDI Offers Over 50 Audio Solutions for Broadcasters



The Audio Toolbox Family Automatic Digital Switchers for STL changeover, cross point routing or dual path IBOC Switching with AES, Analog L/R and composite base band models available



The AES-400 Series of Cost Effective Digital and Analog Audio Switchers for studio or transmitter site applications AES/Analog L/R with XLR or 75 Ohm AES BNC I/O for Television Applications



The B/16 Series Emergency Multi Pair Digital/Analog Audio Switchers with 8 or 16 balanced pair A/B Switching.

Tel. (914) 737-5032 [www.broadcast-devices.com](http://www.broadcast-devices.com)



## Industry Leaders in Design and Integration

We provide the highest quality in studio design and integration.

Custom furniture • Full integration services • RF services



### GRAHAM STUDIOS

Broadcast Furniture

(866) 481-6696 • [graham-studios.com](http://graham-studios.com)



(304) 416-3269 • [xenirad.com](http://xenirad.com)

### SECOND OPINION COMMUNICATIONS, INC.

(815) 222-3556 • [secondopinioncomm.com](http://secondopinioncomm.com)



## For Challenging Reception Scenarios



### AARON 650

FM REBROADCAST / TRANSLATOR RECEIVER

- Unique Software Defined Radio (SDR) front-end
- Unparalleled sensitivity, selectivity, and RF shielding
- Total control over bandwidth blend & multi-path mitigation with Manual Reception Processing
- Built-in Band Scanner™ and MPX, FFT
- No Dead Air—audio failover to SD Card or Web Stream
- Dynamic Web Interface for remote control & monitoring

## Guest Interviews Don't have to be Complicated.

Quality Interviews, Simple Setup.



# COMREX





# Satellite Guide

## Satellite Receive System Design

by Mike Hendrickson

In my last article (*Radio Guide Nov/Dec-17*) I gave a brief history of the use of satellite communications. In this article I will provide some of the technical information that can be used in designing a satellite receive system used at a broadcast station.

Before I go into depth, there is a topic that I need to mention. As all of us know, a satellite receive system does not need to be licensed by the FCC, but it *can* be licensed. If the receive system is licensed it is protected from any future interference from terrestrial microwave systems. The FCC is considering a rule making to make some of the satellite frequencies available to broadband services. The FCC is using its database of licensed systems to make an assumption that the satellite frequencies are underutilized. Please, if you are using a satellite system let your voice be known to your advocacy group and the FCC. Also consider licensing your system.

A satellite receive system can be looked at as simply an STL with an active repeater in the middle of the hop. Unlike designing a STL system, an engineer designing a satellite receive system has only the ability to change the receive antenna's location and gain, and the system losses, before the signal reaches the receiver. Like an STL system, the satellite receive system must be designed to tolerate signal fades without failing.

As the first step in the process of designing the receive system, let's look first at the uplink side of the satellite system. One consideration for the program provider is the cost of the satellite's space segment. This cost is based on the bandwidth required and the transmitted power of the satellite transponder. The wider the bandwidth used and the power transmitted, the higher the cost of the space segment.

The satellite transponder is an active repeater. The power of the satellite's transmitted signal is directly determined by the power of the received uplink signal. When the received signal's strength varies in power, the satellite's transmitted signal varies in the same manner. This means that if there is a fade that reduces the uplink signal, the transmitted power of the satellite will be reduced unless the uplink operator adjusts power to compensate for the fade. Many uplink operators do not continuously monitor the received signal level to determine if the uplink power should be adjusted.

An important item of information is a map of the satellite signal footprint. As an example, the map for Galaxy 16C band transponders shows a transmitted power level of 42.6 dBW. This is the power of one satellite transponder transmitting the full bandwidth of the transponder. For narrow bandwidth signals, such as audio programming, the power is much lower, such as +24 dBW.

The map also shows that the northern and southwestern parts of the U.S. receive a lower signal than does the central portion. (The Intelsat web site has a number of satellite coverage footprints: <http://www.intelsat.com/fleetmaps>)



Galaxy 16 C band Footprint

Along with the satellite signal map, another piece of useful information is the required signal level of the receiver. In most cases you can obtain that specification from the technical specifications in the receiver manual. The goal of the engineer should be to have a received signal as high as possible within the budget constraints of the station.

One of the most important factors in a reliable satellite receive system is the receive antenna. The size of the parabolic reflector of an antenna determines both the gain and beamwidth of the antenna. A larger parabolic reflector has a higher gain and narrower beamwidth than a smaller parabolic reflector. One factor that will affect both the gain and the beamwidth is the quality of the reflector, such as whether it is a mesh or solid reflector. The design of the antenna itself, whether it is a prime focal antenna, a

(Continued on Page 22)

**NEW!**

**RF SAFETY ONE STOP™ PRODUCT**



# EMCTD™ RF SAFETY SURVEY METER SYSTEMS

**EASY TO READ & OPERATE**  
**PROBES COVERING UP TO 40 GHz SPECTRUM**



**LBA Technology** | 252.757.0279 | 3400 Tupper Dr. Greenville, NC 27834 | [www.lbagroup.com](http://www.lbagroup.com)



# GREAT SOUND MATTERS MOST

The world's most successful stations have chosen Omnia.  
For over 20 years.

But we're not satisfied and we're not resting.  
We're raising the bar and making our products better every day.

Why? Because broadcasters depend on us for great sound.

We're obsessed with sound performance. We've worked in radio and we know what it takes to win.  
Great sound is the secret weapon. It's a key to ratings and revenue.

That's why we're never satisfied with what we did yesterday. That's why we have the largest team of  
processing experts in the world. That's why our founder works so late that he sleeps in his office some nights.  
That's why we're constantly introducing new techniques and new technologies.

Omnia will never stop innovating.  
And we'll never stop making broadcasters sound great.



[telosalliance.com/omnia-sound-matters](http://telosalliance.com/omnia-sound-matters)



## Satellite Receive System Design

– Continued from Page 20 –

cassegrain antenna, or an offset feed prime focus will also affect the gain and beamwidth. Finally, be sure the receive antenna is compliant with the two degree spacing of satellites. If you do not have a two degree compliant antenna you may receive interference from other satellites.

The antenna and LNB determine the initial signal-to-noise of the received satellite signal. Once the signal has been processed by the LNB there is nothing that can improve the signal-to-noise. Because of this, it is necessary to be sure that the initial signal is as good as costs permit.

Another factor that can affect the received signal is the type of coax that is used between the LNB and the receiver. The frequencies involved cover 950 MHz to 1,450 MHz. The loss in the cable needs to be kept to a minimum. For example, at 1.5 GHz, Belden 4505R (RG-59) cable has a loss of 9.3 dB/100 ft., Belden 2694RW (RG-6) cable has a lower loss of 7.8 dB/100 ft. and Belden 2731RW (RG-11) has the lowest loss of 5.1 dB/100 ft.

One consideration that is often overlooked is fade margin. While rain fade is a minor concern for the C band systems, it is a major concern for Ku systems. A receive system needs to be designed with an adequate margin for rain fade. There are various tools on the Internet that will help determine the amount of fade margin that is necessary at the receive location.

Let's look at a real world installation and see what happens (Figure 1). We're going to receive a signal that is

transmitted from a satellite C band transponder with a power of +24 dBW (+54 dBm). The free space path loss between the satellite and the receive antenna is about -195 dB. (Other losses, such as atmospheric loss, are being ignored in this example.) The receive antenna is a Satcom 1385 3.8 meter dish. When this dish is used for C band reception it has a rated gain of 42 dB in mid band. The LNB amplifier has a rated gain of 62 dB. This means the output of the LNB has an output signal of -37 dBm. The specifications of the XDS receiver in use state that it requires a signal in the range of -20 to -60 dBm. If the receiver were placed right at the output of the LNB the signal would be about in the middle of the range for the receiver, but who places the receiver at the output of the LNB?

The receiver was actually placed in an equipment rack located about 175 feet from the LNB. We initially used RG-59 cable between the LNB and the receiver. The loss of the cable was 16.3 dB. At this station there were four satellite receivers connected to the receive antenna through a four way splitter with a loss of 7.5 dB. There were two sets of paired F connectors inserting another 0.5 dB of loss. The signal was now at -61.3 dBm. In this real world example, the receiver did not have enough signal for reliable operation. It was too bad that we didn't do the loss figures before we installed the cable!

At this site I had used RG59. After we did the loss calculations we realized that we should have used RG-11 cable. After the RG-11 cable was installed the signal improved to a -53.9 dBm, an improvement of 7.4 dB. We would have saved labor, time and money if we had done the loss calculations instead of just going ahead with the installation.

If there is a concern about loss, a line amplifier can be inserted in the coax. The amplifier should be inserted close to the LNB. Why? The LNB is the first active device in the RF chain. As such it establishes the best signal-to-noise ratio you can have on the system. If the amplifier is placed a distance from the LNB there will be less signal to amplify and the additional noise from the coax and amplifier will be added in, resulting in a reduced signal-to-noise ratio. As long as the amplifier is not overloaded, place it close to the LNB.

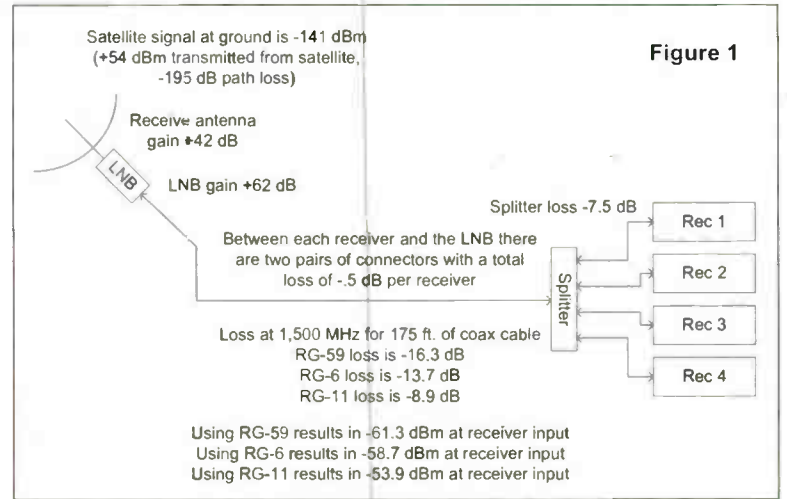

Next time, I intend to bring up the subject of licensing satellite receive systems and why it is a good idea to license the system. Until next time, Happy Engineering!

*Hendrickson, CPBE, CBNT is the retired Chief Engineer of American Public Media Group. He has been involved in Broadcast Engineering since 1969. Over this time period he has been involved with all aspects of broadcast engineering from the technical to the budgeting. He may be reached at: mikelakeville@gmail.com*

# ALTRONIC RESEARCH INC.

Performance By Design

## RF DUMMY LOADS for ALL YOUR APPLICATIONS

- AIR-COOLED
- HDTV
- HD
- WATER-COOLED



## ALTRONIC RESEARCH INC.

P.O. Box 249 Yellville, Arkansas 72687 870-449-4093 Fax: 870-449-6000

E-mail: [info@altronic.com](mailto:info@altronic.com) Web Site: <http://www.altronic.com>



# Sicon-8 Internet & Voice Remote Control



## The CircuitWerkes Sicon-8 Remote Monitor & Control

- Uses Dial-up, Internet Web server or free Siconcontroller Software!
- 8 channels of metering, status and control (expandable to 32) and up to 5 alarms per channel.
- No accessories necessary to control your site right out of the box.
- Auto-ranging, auto-calibrating meters make setup a snap.
- Includes: Function scheduler, auto-logging & alarm reporting.



## Internal Web Server



## Free Siconcontroller Software

The Sicon-8 lets you control your site via Internet with its internal Web server, via telephone, auto-answering cell phone or with our free software. Setup is a breeze using the Siconcontroller software that also includes scripting, e-mail alerts, multi-site management, virtual metering & much more!

# Web-Based Remote Controls w/Streaming Audio Option

Introducing the SiteSentry4 (4 channel remote control), SiteSentry2 (2 channel remote control) & WAM-2 audio monitor

- Web enabled remote controls with 6 relay outputs & 2 status inputs on all units.
- All units detect Stereo or Dual Mono Silence (independently adjustable channels).
- User-programmed relays (DPDT) close automatically or via Web control
- All products include onboard temperature sensor
- Internal logging with onboard e-mailing.
- Supports DDNS services and Netbios names
- Upgradable firmware. Keep your product current with downloadable updates!
- Streaming audio option encodes Ogg-Vorbis & decodes mp3 or Ogg-Vorbis.

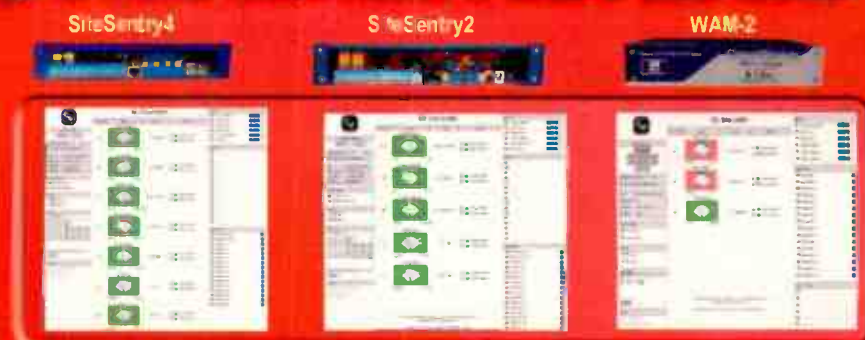

# Remote Broadcasting Solutions

Discover more online at [www.circuitwerkes.com](http://www.circuitwerkes.com)



## MicTel Mic/Line to Telephone Interface

- Outputs & Inputs for telephone handset, cellular phone or balanced line level at up to +10dBm.
- Operates up to 36+ hours on two 9V alkaline batteries.
- High quality, user-switchable, internal limiter prevents clipping.
- External power input with silent, auto-switching battery backup.
- Individual gain controls for send, receive & headphones levels.

## Unattended Dial-Up Broadcasts with the DR-10

- The DR-10 is a Dial-Up remote control with balanced, telephone audio input & output that can control many automation systems or your audio console for unattended remote broadcasts.
- Our Silencer™ option removes control tones from the audio path.
- Use the DPDT relays to insert the phone audio directly into the program path when necessary, especially for emergencies.



## TelTap Pocket-Sized Manual Telephone Coupler

- Can be used as a phone tap or a passive manual telephone coupler.
- Send or receive telephone audio.
- Compact size & low cost makes the TelTap a great addition to your remote kit for main or backup capabilities.

# Lots More CircuitWerkes Problem Solvers

- Transcon-16 - Move up to 16 contact closures from room to room over an audio cable
- DT-232 - Turns DTMF sequences into user-programmed serial outputs & action steps.
- FSK Encoders, decoders, transceivers and contact-to-FSK encoders/decoders.
- SUB-03 Subaudible tone decoder and SEN-6 Subaudible encoder.
- HC-3 telephone autocoupler and AC-12 rack of autocouplers
- DTMF-16 and DS-8 DTMF tone decoders

Find Full product info & downloadable manuals online at [www.circuitwerkes.com](http://www.circuitwerkes.com). 352-335-6555





four mics. four voices. four studios.  
one processor.



Not only does the M4-IP USB make four voices in up to four different studios sound amazing, it can also control, mix, and route them anywhere on your IP network.

See the difference The Intelligent Network makes: [wheatstone.com/M4](http://wheatstone.com/M4)

## M4-IP USB

GATES • DE-ESSERS • COMPRESSOR/LIMITERS • PARAMETRIC EQS • INTERNAL MIXERS • SILENCE SENSORS • 80 PRESETS & MORE x 4

 **Wheatstone**  
BROADCAST AUDIO PERFECTIONISTS®

phone 1.252.638-7000 | [wheatstone.com](http://wheatstone.com) | [sales@wheatstone.com](mailto:sales@wheatstone.com)

World Radio History



# Solid Precision, Raw Metal to Heavy Metal

(or pop, jazz, classical, hip-hop, AOR, CHR, top 40, oldies, talk, etc)



Learn more at [audioarts.com/air-4](http://audioarts.com/air-4)

Ultra-precise metalwork and fabrication using lightspeed-class materials and techniques. Made in the USA by people who've built their careers crafting these consoles. Audioarts AIR-4 is a Wheatstone-built analog thoroughbred, designed and manufactured to be the centerpiece of your studio for as long as you have a studio.

## AIR-4: Hardcore Pro From Start to Finish



 **AUDIOARTS ENGINEERING**  
EXCEPTIONAL CONSOLES · EXCEPTIONAL VALUE

AIR-4 is a truly pro 12-channel console, A/B, & Mix Minus. Super Quiet mic pres, built-in USB, hybrid-ready phone input, talkback, and much more. Major market features at a small market price. Perfect for any professional broadcast studio, remote, LPFM, podcaster, and streamer.

phone | 252.638-7000 | [audioarts.ccm](http://audioarts.ccm) | [sales@wheatstone.com](mailto:sales@wheatstone.com)

World Radio History



# Practical Engineering

## Cheap & Dirty Transmitter Hacks

Simple Transmitter Mods/Additions to Improve Efficiency & Performance

by Tommy Gray – CPBE, CBNE

I am always looking for ways to improve the efficiency and performance of older transmitters. In our part of the country, the economy dictates a couple of things. First, expensive transmitters, (i.e. Solid State, etc.) are out of the question, and number two, you have to keep the older ones going as long as humanly possible!

### A Good Place to Start

Along these lines I have, as have a great many of you, added to and/or modified existing transmitters to keep them humming and keep them operating both economically, and efficiently, while still keeping them legal. Sometimes your manufacturer may have already come up with recommended mods to help your unit. Check with them first.

One of the first things that usually gets retrofitted into an older FM transmitter is a new exciter. There are several reasons for this. Most older exciters are built with components that are all transistor based, and components to repair them are getting hard to find. Another reason is that they are not as stable, signal wise, nor are they as clean, signal wise, as the newer ones. The things I especially like about many of the newer exciters is the capability for remote monitoring, expanded interfacing for remote control – and usually they provide a very stable power output. All these things make them very desirable when using them with an older transmitter.

It has been my experience with transmitters, that many of the reliability issues can be traced back to the exciter. For example, spurious emissions from the transmitters can many times be traced back to an old exciter that is either failing or that needs maintenance. Another issue is frequency stability. The newer exciters will usually produce a signal that stays more closely on the authorized frequency and not drift as did in a lot of the older units. I cannot remember when the last time was that I had to adjust the frequency of a newer exciter, but I can tell you that, in years gone by, frequency adjustments were a common occurrence. I no longer carry around my counter except to make periodic measurements to assure compliance. Earlier, we had to make frequent measurements to assure that we were not drifting all over another channel!

Component aging in the form of capacitors, and transistors, can cause signal problems. Power output fluctuations, whereby the transmitter will not hold a stable output level, are a great many times the fault of an old exciter. Keeping in mind that these exciters were more than likely type-accepted for use with the particular transmitter you have. I have heard a great deal of discussion between engineers and FCC officials regarding retrofitting exciters into older transmitters. The general consensus is, that if it makes the transmitter more capable of producing a clean and legal signal it is something that is to be desired. If you are adding a type-accepted unit to your type-accepted transmitter you should not encounter a problem.

If you are concerned, then contact the manufacturer of your transmitter (if they are still in business), and if they do not offer a suitable retrofit unit, then tell them what you are wanting to do and they can tell you if it will fly or not. I personally have not had a problem, as in almost every case, my retrofitted transmitter performed much better than it did when brand new, and was a lot more stable and reliable.

### How to Do It

One thing you want to make sure of when retrofitting a new exciter into an older transmitter is maintaining necessary interfacing. One common thing you will need to do on most transmitters is provide a way of connecting your muting circuit to the new exciter, so that when you turn off the high voltage, the exciter mutes the RF output.

On many units there is a terminal strip on the back panel that has a couple of contacts to perform this chore. Some exciters have a “D” plug of some sort, where you can access the necessary contacts. Still others have a BNC connector for muting. Regardless of what type of interface the new exciter has, you will need to provide (more than likely) a contact closure to mute the output. Some exciters will require a normally-open set of contacts, and others will require normally-closed. Your exciter manual can provide you with the necessary information to interface the unit with your transmitter. If your old exciter used a muting circuit you can usually just connect to it, and worst case, use the old circuit to control a relay that will give you the necessary contacts.

### What If There is No Muting Circuit In the Transmitter?

Good question. Many old transmitter do not have one built in. In the past, some were provided by external relays, and or circuitry. What I have done on some transmitters that have a bleeder resistor string in the high voltage, is to add an additional resistor of the proper value to the bottom of the string.

(Continued on Page 28)

**More than JUST a SIGN**

103.7 KISS FM ON AIR

JAYS GoVideo! In Prog

1010 WINA ON AIR

A+E NETWORKS ON AIR

CUSTOM  
COLOR  
FONT  
LOGO  
LETTERING  
DESIGN

WWW.TITUSLABS.COM

TITUS TECHNOLOGICAL LABORATORIES



# Forge a Sound They Won't Forget

orban

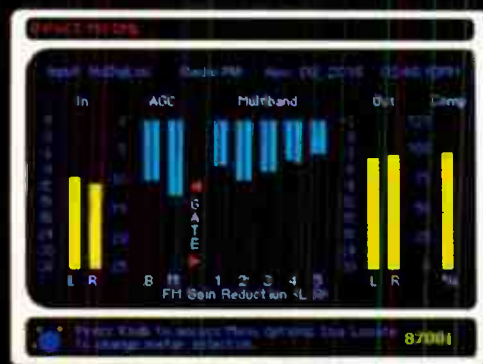

OPTIMOD

8700i DIGITAL AUDIO PROCESSOR



## Orban Optimod 8700i

Grab more listeners with your bold signature sound!

Contact us today  
to schedule your  
**FREE** Demo and ask  
us about Orban's  
Trade-Up Program.

- Xponential Loudness™ brings hyper-compressed music back to life
- Digital MPX (DMPX) 384/192 kHz AES3 digital composite output
- Exclusive "Multipath Mitigator" phase corrector reduces multipath distortion
- Dante™ Audio-Over-IP Connectivity provides a dual-redundant Ethernet connection
- Dual redundant power supplies and safety bypass relays keep you on the air



Your Price \$12,990

BEST OF  
SHOW  
AWARDS 2017

WORLD  
WINNER

CONTACT **SCMS** for **ORBAN** products

1-800-438-6040 | [www.scmsinc.com](http://www.scmsinc.com)

Broadcast Equipment Solutions | 19 reps across the U.S. and Latin America





– Continued from Page 26 –

and use the voltage dropped by it to control a relay, thus giving you a contact closure. A quick bit of circuit math will tell you what size you need. The relay will provide the necessary NO/NC contacts you need for muting, and when high voltage is removed, and the circuit dissipates the voltage present, the relay will drop out, and the exciter will mute as desired. Here is a simple schematic of just what I am talking about.

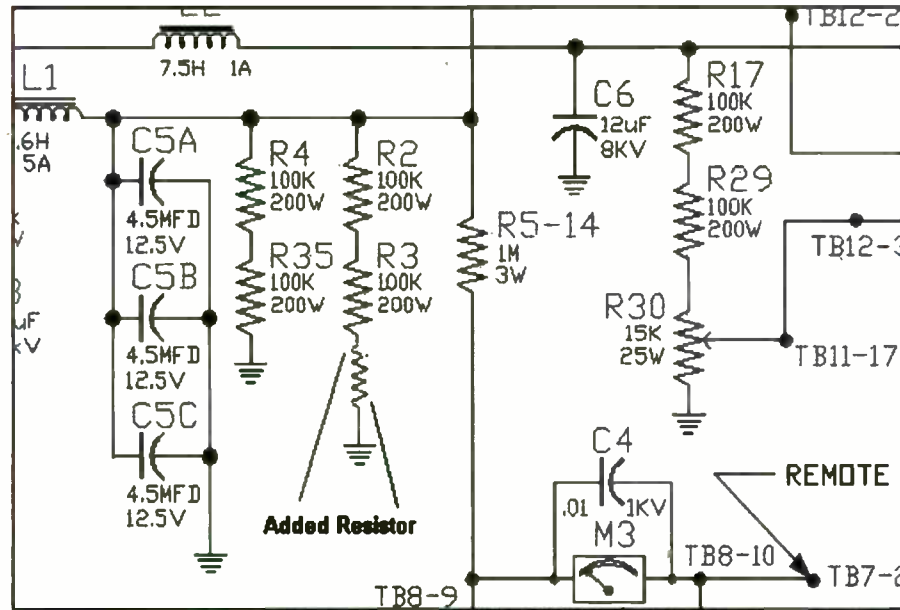

The relay is connected to the resistor and the contacts are connected to your exciter. The mod has worked well for many years on a lot of transmitters, and should in your case, if yours can provide the necessary internal circuitry.

### The "Gotcha"

One thing I need to mention, that I have run into a few times (a very few), is that some of the new digital transmitters with all the bells and whistles have very sensitive VSWR circuitry and when you turn the transmitter on you will get a VSWR trip on your new exciter. This will prevent it from working. Some manufacturers will tell you how you can change the sensitivity to prevent this trip. Others may require you to install an RF isolator between your exciter and the RF input on your transmitter, to maintain a constant impedance on the output of the exciter while the transmitter stabilizes.

On many others I have had issues with, it was caused by the IPA tube not presenting a 50 Ohm load when cold. Once the tube had warmed up a little, the exciter would come on line and work perfectly.

### A Reliability and Efficiency Mod

In the schematic I showed there are two sets of two bleeders in series, paralleled with each other. One problem I have run into, as have some of you I am sure, is bleeders burning up after a few year of service. This will not prevent the transmitter from working, but it will cause a safety hazard, if the string is open, when you

open the door of the transmitter for maintenance. High voltage will still be present on capacitors, etc., and you can get a nice little jolt from touching things you have been able to normally.

In the CCA transmitter the drawing came from, there were actually two strings of three not two strings of two as in the schematic. You may have already run into this before. This was done by the factory to help with the failure of the resistors at some time, I am sure. Every one of these transmitters I have worked on has three in each set, and not two as the schematic shows. What we did to make them last longer, was to rewire the resistors into one large string of 4 resistors and simply leave the two unused resistors in their holders for spare. (You could take them out, but I just left them in to keep them safe from damage in storage). When I measured the temperature of the strings before and after the rewire, I found a difference of about 50-60 degrees. This is the result of each resistor not having as much voltage dropped across it and therefore it will last much longer. This is a simple but effective mod that will save parts and, as cool as they will run, you may never have to change another bleeder. If you are not already, I would highly recommend that, during your routine maintenance inspections, you remove one end of the wiring from your bleeder string and measure each individual resistor to assure that they have not changed significantly in value. A large change in value or a reading outside the published tolerance is a good indication that your resistor is about to fail and should be replaced to keep you safe. The voltage in this transmitter fell off almost as fast as it did before the mod.

### Bottom Line

Sometimes you can make a few well thought out mods or changes to your transmitters, that can save you much time and money in the long run. Just use your head. Be safe!

*Tommy Gray is a retired veteran broadcast engineer currently staying busy doing engineering in the gulf south, through "Broadcast Engineering & Technology LLC", a Louisiana based Consulting and Contract Engineering Firm, serving the US. www.BEandT.com*

## LOW PROFILE MIC BOOMS: No Springs Attached (Microphone/Shockmount Optional)



AMB22-4MOT \$399



AMB16-4 MINI MOT \$399



HMB14-4MOT \$299



HMB8-4-MINI-MOT \$299



AMB-22-4 \$350



AMB16-4 MINI \$350



HMB14-4 \$250



HMB8-4 MINI \$250



AMB-22-4E \$299



AMB16-4E MINI \$299



HMB14-4E \$199



HMB8-4E MINI \$199



STUDIO ITEMS INC.

www.studioitems.com







**SMARTS**  
Broadcast Systems

(800) 747-6278

www.smartsbroadcast.com  
sales@smartsbroadcast.com

## Skylla



### Skylla's Smart Features:

**Smart** Special Events like ballgames, national and local.

**Smart** Satellite support, complete with incoming RBDS data, announcers, clocks, break-tracking, and automatic break fill.

**Smart** Automatic Downloads of audio from the Internet.

**Smart** Automatic Unattended Recording by time, closure, or both.

**Smart** Voice Tracking allowing people to voice track at the same time to the same log, both at the station and remotely. Also allows voice tracking to future yet-to-be-merged playlists.

**Smart** Design. For uptime and reliability: Linux. For data safety: RAID and machine-to-machine backups of audio and data.

## SkyllaPad



Simplify local sports broadcasts.

With features found only on SkyllaPad, broadcasting remote sporting events has never been easier.

You supply audio, SkyllaPad supplies control. With the touch of a button on a Smartphone, tablet, or laptop, you're on the air and in charge of your remote.

## SecGen

Traffic & billing software designed for you.

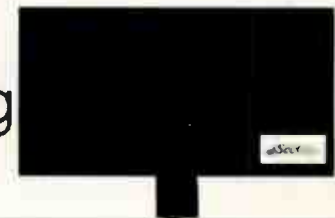

SecGen, the second generation of our original Smarts program, lets you define the setup by matching the program to your station's formats and breaks. Combined with the ability for single user, multi user, and remote user, SecGen can be customized to fit your needs.



**SMARTS**  
Broadcast Systems



# Facility Focus

## Dealing With Lightning – Part I

by Sam Wallington

Many years ago, I worked with a guy whose story for every problem at the radio station was, "Lightning got into it!" I am sure sometimes that was true, but I wondered: If that was really the reason for all the problems, why did he not do something to keep the lightning out? Maybe lightning just seemed too powerful to him, and he thought he was just at the mercy of nature and dumb luck.

Keeping lightning voltage (up to a billion volts!) and current (perhaps thousands of amps) away from our equipment is not only a good idea, but it is very possible. The goal is to at least minimize damage – perhaps even eliminate it entirely.

To control the effects of lightning, we first must understand it. Interestingly, we do not need to know the voltage, current, frequency, or other figures about lightning, to be able to protect our equipment (though it is fun to Google those statistics and data). Instead, I will tell you a story to provide a simplified view.

Wannabe C. Captain (Wan, for short) had always loved watching boats on the lake behind his house, so one day he decided that since it looked easy, he should have no trouble becoming a boat pilot. In fact, he decided to quit his job and start a ferry business, using half his life savings to buy five small boats from the dealer across the lake.

Wan had not hired any helpers yet, but figured he could get the boats home himself by simply tying them together and using one boat to tow the others. Luckily, he had a roll of string in his pocket, and he proceeded to tie the boats together in a line. Starting the motor on the front-most boat, he gently pulled away from the dock and began towing the boats to the other side. So far, so good.

Unfortunately, just after he left the safety of the harbor, a large ship flew by at great speed! The huge wave generated by the ship plowed into Wannabe's little armada, and as the boats began bobbing violently, the strings all broke. All the boats banged into each other, then began drifting away.

After an hour, and most of a tank of gas, spent darting all over to re-capture his stray boats and get them safely back to the dock, Wan realized that his plan was not very well thought out. From the shore by his house, he had not realized how powerful the waves from other boats could be! He sat down for a while. Each boat in my fleet is separate, he thought. When the big wave came through, one boat was rising while the next one was falling, which jerked the string so hard it broke. Hmm! This realization gave him an idea!

He walked down the pier and found the captain of a barge. This barge had a small crane for loading cargo, and

after a few minutes of conversation, Wannabe learned that the barge captain could load all five of the boats onto his barge, take them across the lake, and unload them at Wan's house. Happily, the barge captain did not want much money for this service. They struck a deal and were soon underway.

Once again, as they left the harbor, a large ship zoomed by! Wan tightly gripped the railing while he watched the huge wave approach the barge. But when it arrived, the barge simply rocked back-and-forth once, and they continued peacefully motoring toward home. What a relief! Soon the boats were safely tied up behind Wan's house and he was waving goodbye to the barge captain.

What Wannabe learned is the first thing we need to understand about lightning. If a big wave of lightning energy comes roaring into our facility, we must make the voltages in all our equipment rise and fall together. That way, there is never a time when there are several hundred volts between components, overloading circuits that expect no more than a few Volts. How do we do that? We "put them on a barge" by bonding them together, making sure nothing is left trailing behind.

For example, say we have a mixer, connected to a processor, connected to an STL transmitter, and, of course, each of those components is connected to the power company. All three components, along with the power source, must rise and fall together if a wave of lightning energy comes through.

Starting with the power. Power companies do not provide ground, they only provide one or more "hot" leads and a "neutral." The ground reference is established locally, at the main service entrance to the facility, often

*(Continued on Page 32)*



# fuhgeddaboutit!

Admit it; you'd love to forget all about your FM antenna. You'd be perfectly happy if it were to spend decades out of sight, out of mind, and out of your budget. You just want it to work; day in, and day out.

We understand.

Shively designs antenna systems to work flawlessly. Year after year. At any site. Under any conditions. For any power level. Happily, in the background.

FM First.

This was Ed Shively's vision in 1963, when he founded the company; and over 50 years later, we're still doing our best to be absolutely forgettable.

# Shively Labs®

A Division of Howell Laboratories, Inc. Bridgton, Maine 04009 USA

Call Toll-Free: (888) SHIVELY

Or visit us on the Web at: [www.shively.com](http://www.shively.com)

- An Employee-Owned Company since 1995 -





ARRAKIS SYSTEMS INC.

# All Arrakis consoles now have AoIP!

ARC-8  
only \$849



ARC-10  
from \$1,699



ARC-15  
from \$3,799



MARC-15  
from \$5,499

For more than 35 years, Arrakis Systems has led the way with ground breaking innovations in Radio. Now with SIMPLE-IP, all Arrakis consoles can be linked with the World Standard DANTE AoIP protocol for less than \$1,000 per studio. Visit our website today !!!



## SIMPLE-IP



Digilink-Xtreme



ACCENT furniture

Digilink-HD

[www.arrakis-systems.com](http://www.arrakis-systems.com)

970.461.0730

World Radio History



## Facility Focus

– Continued from Page 30 –

by a rod driven into the ground. That grounded point is then bonded to the neutral circuit as the power comes into the facility. Incidentally, neutral and ground should never be connected at any other location within the facility, or voltage will be put onto the “ground” circuit, creating a significant safety hazard.

Any equipment connected into that power circuit ground will now rise and fall together with the ground. However, the electrical wiring used to connect these together is pretty small, and if the items are separated by any real distance, the wire size may not allow larger currents to flow through unimpeded. That means that lightning may overwhelm the wire’s capability to keep the pieces rising and falling at the same time.

To overcome this problem, we can bond the grounds of the items together using large gauge cable (#2 or larger). If you were thoughtfully following Wannabe’s story, you might have thought that he also could have used very strong ropes to tie his boats together – this is the same idea. However, tying individual components together serially can become tedious and impractical for a typical facility using many components scattered all over – and can sometimes have unintended consequences such as ground loops. Instead, we build a ground system for the facility.

A facility ground system is intended to provide a single point of reference for ground for an entire building. All grounds tie back to this single point in a star configuration. I like to think of this the same as multiple

rivers emptying into a single lake. In the example above, the mixer might be plugged into power via a grounded outlet. The mixer ground is connected to the outlet ground, which is connected to the main breaker panel ground, to the service entrance ground, and finally to the single-reference-point ground. The processor and STL transmitter might be plugged into power via grounded outlets on a sub-panel. Their grounds go to the outlets, to the subpanel, to the main breaker panel, to the service entrance, and, you guessed it, to that same ground. If the ground conductor going to the sub-panel is of sufficient size, all the equipment will rise and fall together as lightning current moves through the system. Thus, we have put everything in the building on a “barge” of sorts, making sure that our delicate “strings” between components do not break.

At one facility, I took advantage of the need to pour a large concrete pad for a generator, and I put a bunch of ground rods under the pad and connected them together using large gauge copper cable. I tied the equipment in a nearby equipment room to that ground system, though most of the equipment was also grounded through the electrical panel (and possibly through their chassis and racks) to the main building ground. The main building ground was really good quality (with an excellent earth connection of about one-half Ohm – legal is 5 Ohms or less). A separate equipment room was tied solely to that main building ground through the electrical circuits. Can you guess what happened when lightning arrived? Yup. The driver chips for the circuit that ran between equipment rooms were toast. Why, when both rooms were well grounded?

The problem was that I now had two ground references for the building, that were 75 or 100 feet apart.

One under the new generator, and one at the main service entrance. As the lightning’s energy wave passed through and under the building, one equipment room rose before the other because they were tied to grounds that were physically separated – and suddenly hundreds of Volts ran through a 5-volt device driver. Poof! No more device driver.

There were two possible solutions to my design faux pas. First would be to use a large gauge cable to bond the two separate ground systems together. Considering the potential current that might be flowing through there, it might take a huge cable to pull that off. Instead, I simply cut the ground cable to my brand-new under-generator-pad ground. Now the electrical system handles things just fine (thank you) and there have been no further problems for about a decade and a half. Sadly, there is still bunch of copper under that generator!

There are many places where we might have unintentional grounds, or ground loops (where parts of a system, such as I describe above, are at different potential voltages, even if we might logically consider them “grounded”). For example, metal conduit cannot be considered a reliable ground, since all the parts are not intentionally bonded together for that purpose. Building steel is similar. Lots of pieces of metal, all interconnected (and often grounded), but because it is not intentionally bonded, cannot be relied on to provide ground or lightning protection.

Next issue, we will talk about reducing the chance that lightning gets into the system in the first place.

*Sam Wallington is VP of Engineering for Educational Media Foundation, and has 34 years of experience in broadcast engineering. He can be reached at [swallington@kloveair1.com](mailto:swallington@kloveair1.com)*

## AM Ground Systems Co.

[www.amgroundsystems.com](http://www.amgroundsystems.com)

1-877-766-2999

[eng@amgroundsystems.com](mailto:eng@amgroundsystems.com)

PHYSICAL  
AM SITE SERVICES

CONSTRUCTION

EVALUATION

REPAIR

SAMPLE, FEED & CONTROL LINE LOCATION, REPLACEMENT & REPAIR

MOM MODELING PREPARATION WORK

SERVING THE TECHNICAL AND CONSTRUCTION NEEDS OF AM BROADCASTERS FOR OVER 25 YEARS

- Has your AM station lost coverage?
- Is your AM ground system over 30 years old?
- Has your ground system been damaged or vandalized?
- Base impedance or DA pattern unstable?
- Dramatic system or range changes in wet-to-dry conditions?

All of the above are indicators of hidden ground system problems that may be reducing your coverage.

SAMPLE TOROID RETROFIT SOLUTIONS  
AND  
SAMPLE LINE REPLACEMENT  
FOR  
METHOD-OF-MOMENTS DA PROOFING

Contact us today for a no  
obligation quote on any of our  
services.

877-766-2999

[eng@amgroundsystems.com](mailto:eng@amgroundsystems.com)

WE EASILY ACCOMMODATE  
COMPRESSED  
TIME-LINE PROJECTS.

**Reliable, On-time Installation**  
**Firm Quotes**  
**Quality Workmanship**

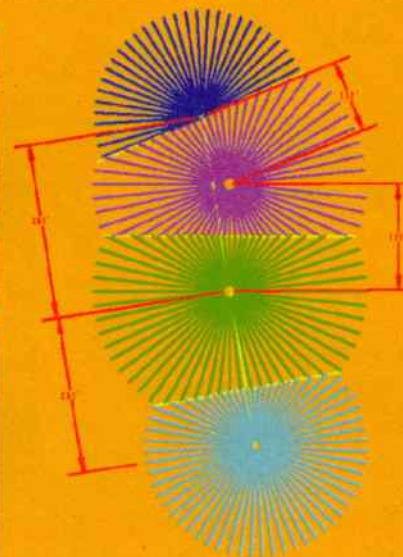



# Open the door to *your* possibilities!



**ON THE AIR**

Powerful, state-of-the-art automation with the flexibility to grow with you...

- The power of OPX in one stand-alone computer
- Easy to learn
- The power to handle the largest audio libraries
- Satellite and live programming
- Additional stations
- Remote voicetracking
- Remote control

## OPXONE



**Call (888) 274-8721**

**(888) BSI-USA-1**

**or email us at [sales@bsiusa.com](mailto:sales@bsiusa.com)**



# In The Field

## Should I Really Keep That?

by Jim Turvaville

"Hello, my name is Jim and I keep things." Sometime that is okay.

That is where we left the written confession last year about keeping things most people tend to throw away. Well, time has passed and a follow up is in order. And it's not just my wife's continual complaining about my propensity to collect things that precipitates a revisit to the topic – there are some real life experiences which make it relevant again.

Basically it is still true that "sometime that is okay"... but I'm here to say that sometime it is *not* okay, either; and I've been narrowing down the collections in my own life – somewhat. In that first installment, I attempted – however feeble – to justify the propensity for keeping the things that have been replaced by newer technology. While that literary therapy session was a good beginning, I've aged an entire year since then and life experiences have brought new insight on the subject that might bear sharing.

I was at a tower site with a client, where an antenna array had burned up from a lightning strike to the power divider. This was a Nicom BKG system composed of 8 bays. If you are familiar with that antenna it has a main 1x2 power divider that in turn feeds a pair of 1x4 power dividers to feed each bay. Being the high power version, the 1x2 power divider has 7/8" EIA flange in and out connections, so the jumper to each

1x4 power divider is also 7/8" cable with EIA flanges on each end. That main 1x2 power divider is what had been hit by lightning, so it, and the two jumpers, were replaced – the tower crew left the remnants on the ground for us to clean up. Hmm, only one end of each jumper was burnt, although each also had the nice professionally installed connector with the adhesive lined heat shrink on it, making repurposing that EIA flange a messy project. Not willing to let it go to scrap recycling, I cut the cable at a point about 18 inches from the connector and put it in my truck.

Sure enough, it was not a few months later that I was at another tower site 400 miles away which was being cleared for dismantling. The tower owner (one of the big companies) had decided to take the tower down and I had two clients operating FM stations on it which had to be moved on a time schedule. I was directed by the home office in Boston to get it cleaned up for their crew to arrive. Indeed, there were several abandoned runs of 7/8" coax on the tower, which coincidentally was identical to the stubs with the EIA flanges on them. Yep, those 7/8" cable Type-N Female connectors had no gooey heat shrink, so with minimal effort I removed the connectors and affixed them to my salvaged 7/8" stubs. Bingo – instant 7/8" EIA to Type-N Female adaptor. Was that a lot of trouble? Maybe, but the cost was really next to nill, except about 20 minutes

of my time; and now I have an adaptor that I can use and not be upset if it gets broken, lost or left behind. (See Figure 1) Moral of the story: Like bacon grease, you should save all manners of coax connectors, even if you are not sure how you can use them. Unlike bacon grease, they will not go rancid if left unrefrigerated.



Figure 1

In the first part of this story (*Radio Guide* May/June-16) I disclosed my collection of old computer gear. In the past year, I've made an effort to carefully analyze my inventory and dispose of things that truly will never have any useful life. While I've not dumped that box of 5-1/4" floppy discs or the old PC that has a drive that will read them, I have consolidated much of my inventory down to smaller components. That pile of old PC's has been reduced to a stack of possibly usable RAM strips, motherboards, drives, ribbon cables and power supplies with the cases donated to a guy who recycles metal. One thing that I do find multi-

(Continued on Page 36)



**DH 1-piece Antenna Sizes Available**  
From .6m to 5.0m

**DH Sectional Antennas Available:**  
1.8m ~ 2.4m ~ 2.7m ~ 3.0m  
3.7m ~ 4.2m ~ 4.5m ~ 5.0m

**Mount Options:**  
Fixed Az-El, Polar Tracking, Horizon to Horizon Tracking  
Fixed & Dual-Powered Gibraltar Az-El  
Dual-Powered Gemini Az-El

**For More Information: [dhsat@mhtc.net](mailto:dhsat@mhtc.net)**

**DH Is The Industry Standard!**  
For over 35 years, our 1-piece antenna has outperformed the rest! The 4-piece, 3.7m has the same accuracy because we use 8 computer generated templates and attach them to the back prior to cutting the antenna. This allows for ...

- Superior Quality
- Quick Delivery
- Easier Installs
- Cheaper Shipping
- Fits Into Service Elevators For Roof Installs

**Our New 4 or 8-Piece Freight "Shippable" Antenna**



**DHSatellite.com ~ 800-627-9443**



# ALWAYS ON. ALWAYS IN REACH.

GET THE EFFECT.

THRIVE ON.

.....  
DIGITAL STRATEGIES

.....  
SALES & MARKETING TACTICS

.....  
TRENDS & METRICS

**THE  
M.E.T.**  
MEDIA. ENTERTAINMENT. TECHNOLOGY.  
**EFFECT™**

Radio content is embraced by listeners wherever they are, whenever they want. From tactics to metrics, NAB Show® delivers the world's most eye-opening, hands-on environment filled with the tools and tech to always keep your programming in reach everywhere your audience is listening.

**THIS IS WHERE THE GLOBAL CONTENT ECONOMY THRIVES.**

APRIL 7-12, 2018 | LAS VEGAS, NEVADA USA

REGISTER TODAY: [NABSHOW.COM](http://NABSHOW.COM)

Free Exhibits Pass Code: FA07

**NABSHOW**  
*Where Content Comes to Life*



### Should I Really Keep That?

– Continued from Page 34 –

plying like rabbits in my collection are those handy universal power cords that seem to fit about 95% of our broadcast gear these days. That NEMA-5 connector appears everywhere, and the cord gets kept when the associated piece of gear finally goes the way of the dumpster. I literally have a 5-gallon bucket of them in the shop, and carry at least half a dozen of them with me at all times in the truck.

Do they come in handy? Of course, if you just need a cord for a piece of gear that has one missing, then they certainly do. But another idea worth sharing is taking the cords and combining them into one for electrical receptacle conservation. After all, tying three of them together to fit one plug is not that different from plugging all three into one plug strip, right? And when you have lots of things to plug in, that pull very little actual amperage, it is a wise use of your electrical outlets. My version looks like this and has the union sealed in rubber with the ends cut to differing lengths to minimize the extra cordage in the rack. (See Figure 2)

As a twist on these NEMA cords, a client of mine recently confessed to me a rather unique use he had for one in particular. He had disposed of a piece of gear and kept the cord – his wife loudly complained about him always keeping things for no reason. Not a couple of days later he went to the tower site, located over a mile inside a pasture with 3 fences between the public road and the tower. One of the gates was broken down, and upon conversation with the land owner, needed to be fixed to minimize cattle straying between pastures. The power cord came to perfect use as a gate

closure until the rancher arrived the next day to fix it properly. (See Figure 3).

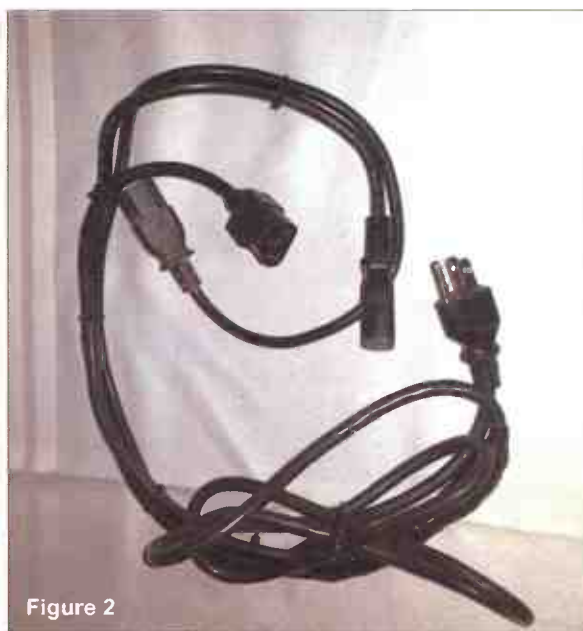

Figure 2

Visiting another client, I was both shocked and pleased to see they had kept their station's life collection of cart machines in the back room when they were decommissioned and replaced by a Windows XP machine running BSI Simian. And I mean they had the old Tapecaster "lock and load" machines, as well as the later ITC SP and WP units. They even kept the hundreds of Scotch Gold carts which went with the system, all stacked neatly on the shelves.

My inclination would be to toss them at first opportunity and free up valuable shelf space, or turn the cart machines into table lamps, like we've all seen a few times on-line.



Figure 3

But then a long-time friend and mentor of mine, who rebuilds vintage equipment and creates complete studios complemented with all vintage gear, emailed me and – totally coincidental to my experience – asked if I knew where to find some old cart machines. Suddenly, I had an answer; and just maybe a marriage birthed in heaven took place between them, saving working but antique equipment from the recycling plant. I'm expecting to see some of that gear one day on his website at <http://bobmayben.com/> – it's worth your time to browse his work.

While we may not really have need to keep those old cart machines any longer, maybe there is still a use for more things than some people think. At least, that's my story and I'm sticking with it until next year.

*Jim "Turbo" Turvaville is semi-retired from 39 years in full-time Radio Engineering and lives in Rural Wheeler County Texas in a "tiny house" where he maintains a small clientele of stations under his Turbo Technical Services ([www.jimturbo.net](http://www.jimturbo.net)) operation providing FCC application preparation and field work.*



Delivering total  
radio solutions for  
over 55 years.

Broadcast Electronics  
4100 N 24th Street  
Quincy, IL 62305

(217) 224-9600  
[www.bdcast.com](http://www.bdcast.com)

**commotion**  
Social Media and Mobile  
Solutions for Radio

**MARTI**  
ELECTRONICS  
Dependable  
STLs and RPUs

**STX 10**  
**STX**  
Modern & Efficient  
FM Transmitters & Exciters

**AudioVAULT**  
**FLEX**  
Flexible & Reliable  
Radio Automation

**AudioVAULT**  
**Xpresso**  
Streamlined  
Radio Automation



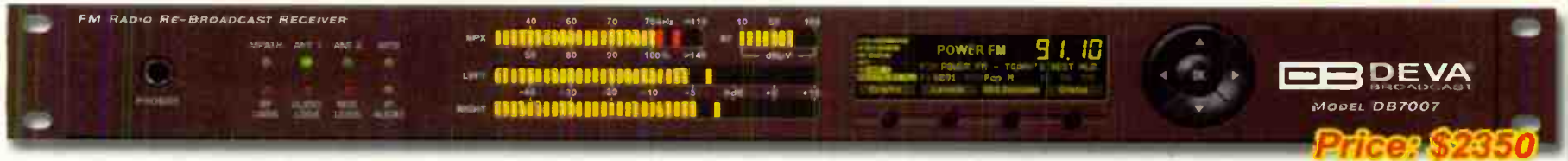

**Modulation Monitors • Rebroadcast Receivers • RBDS Encoders • Broadcast Tools**

## Kintronic Labs



*Solutions for FM Translator Installations on  
AM Towers*



FM Combiners for 2 or more FM Translators on AM tower

Model FMC-1.5 Isocoupler for low-loss isolation solution



Full line of Isocoils for co-locating 1 or more FM Translators on AM tower



*Introducing Two New Products*



**LAB4.50 Automatic Dehydrator**  
with 165,000 hour MTBF



**PowerAIM 150 Antenna Analyzer**  
Much-improved features at a lower cost!

ADDRESS: P.O. Box 845, Bristol, TN 37621

PHONE: 1-423-878-3141

EMAIL: ktl@kintronic.com



## Replace Yourself

by Steve Callahan

It was April of 1972. The young college student had successfully passed his first course in broadcasting, Radio Production 101, and now thought he knew all there was to know about doing a live “DJ” show. After all, he could now talk into a microphone, slip cue a 45 RPM record, and keep the board meters “out of the red” – so he thought he was ready for fame and fortune in broadcasting. Fortunately, he knew someone who knew someone who worked at the local 250 Watt daytime AM radio station, so he went there for an interview looking for a part-time summer job on the radio.

The combination studio and transmitter white wood frame building was at the end of a road, behind a beat-up house trailer, down by the river and you’d drive right by if not for the 100 foot tower and the big black call letters on the front of the building. As he went in the front door, the receptionist told him to go down the corridor to the air studio which was the second to the last door on the left.

Walking down what seemed like a very long corridor, he clenched his resume and a five-inch reel of tape with his best air check from his college class. As he walked, the speakers along the way told him that the employee he was there to talk with was also on the air at the same time.

As he had been taught in college, he waited for the red light to go out before he opened the studio door. He timidly entered the studio and heard the latest country music coming out of the studio speakers. The walls of the studio were covered from floor to ceiling with shelves filled with 33 RPM records – more records that this young future broadcaster had ever seen in one place. On the doors, ceiling and walls, where there were no record shelves, there were white, perforated ceiling tiles. The blue, five-pot mixing console was smaller than the one he had learned on at school, but he felt confident he could figure out which pot was for the microphone, which pots were for the two QRK turntables, which one was for the Ampex reel to reel, and which one was for the lone Tapecaster cart machine.

Sitting behind a stack of tape cartridges on the desk, the station’s Program Director introduced himself to the young broadcaster. In between song intros and live commercials, the PD asked the young broadcaster what he had learned at school. The young broadcaster tried very hard to be confident and concentrate on the answers to the PD’s questions, despite the fact that he was intrigued, and more than a little distracted, by all that the PD had to do to keep his show on the air. After a few

more questions, such as did he have the all important Third Class FCC License with Broadcast Endorsement, the PD thanked the young broadcaster for coming by the station and then he asked the most important question, “Can you start this Saturday?” \*

“Absolutely!” said the young broadcaster. After filling out the necessary employee paperwork with the receptionist, he was told that he would be paid the minimum wage at the time. The young broadcaster was walking on air as he left the small, white building and headed home. Finally, he was going to be on-the-air at a real radio station!

Saturday came very fast for the young broadcaster. Self-confident, and just a little bit nervous, he returned to the white radio station building. However, the PD wasn’t there but another DJ was, and his shift ended at the time the young broadcaster’s shift started.

The DJ didn’t hang around after his shift, so there was no training on the board with all it’s switches and buttons, no time to learn all of the myriad of details needed to take the transmitter readings twice an hour, play a station ID within two minutes of the top and bottom of every hour, play the commercials in the order listed on the legal-sized pages of the log, all while sharing the best in country music – which the young broadcaster had never really been a fan of before.

The young broadcaster jumped right in to his first real live radio show, but things did not go well. He got the station call letters wrong on-air and he wowed more than one record. He once started a 45 RPM single on 33RPM. While trying to quickly learn the world of country music by reading the album covers, he found

(Continued on Page 40)



COAXIAL DYNAMICS has been a leading manufacturer of precision equipment for the measurement and termination of RF Power since 1969. Our equipment is used by engineers in a wide variety of applications throughout the world.

Our products include:

- Directional Wattmeters for both Analog & Digital applications from 1 W to 100 kW and from 2 MHz to 2.3 GHz.
- Wattchman RF Monitor/Alarm Systems.
- Line Sections & Plug-In Elements.
- RF Loads - Dry, Oil, Water, and Air designs up to 200 kW.
- Low Pass Filters & Power Sensors.

6800 Lake Abram Drive, Middleburg Hts., Ohio 44130, USA  
440-243-1100 • Toll Free: 1-800-COAXIAL • Fax: 440-243-1101  
E-Mail: [sales@coaxial.com](mailto:sales@coaxial.com) • Web Site: [www.coaxial.com](http://www.coaxial.com)

- **Broadcast Equipment** •  
Wattchman - High Power Wattmeters - Elements
- **Line Sections & Meters** •
- **Termination Loads** •  
Dry - Oil - Water - Air





# got all these features in your DA?

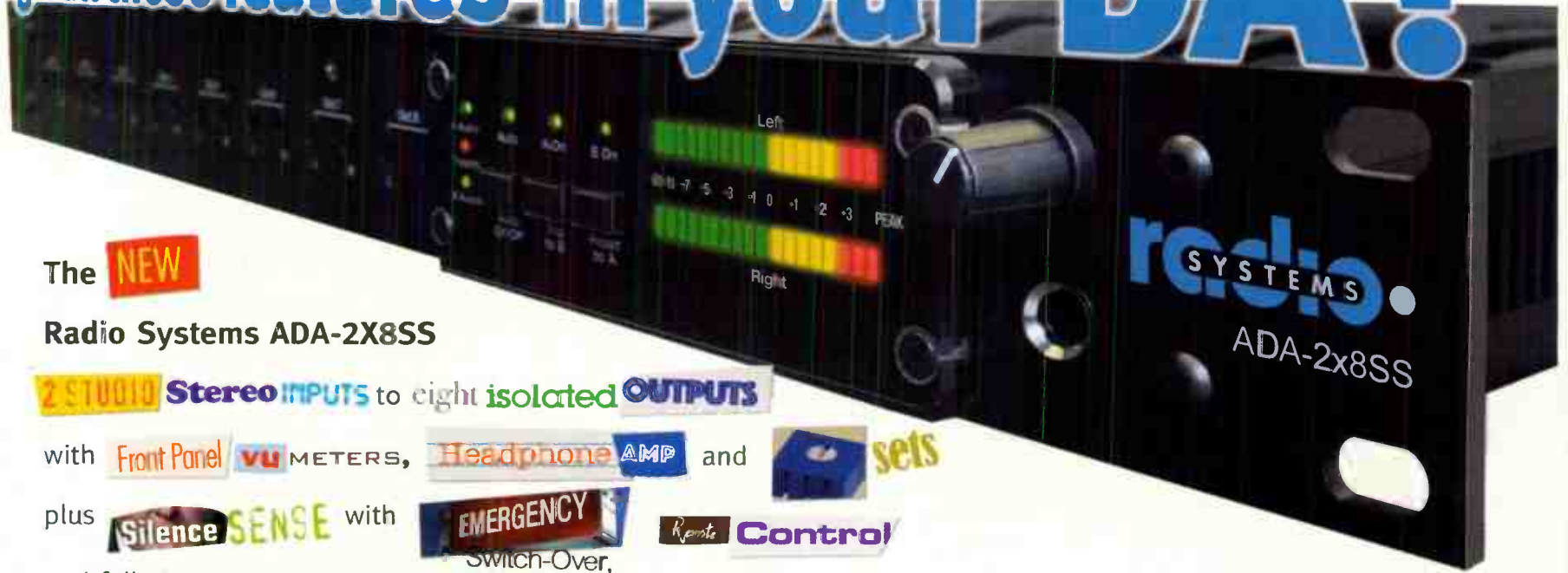

The **NEW**  
Radio Systems ADA-2X8SS

**2 STUDIO Stereo INPUTS** to eight **isolated OUTPUTS**

with **Front Panel VU METERS**, **Headphone AMP** and **sets**

plus **Silence SENSE** with **EMERGENCY Switch-Over**, **Remote Control**

and full **Studio Hub + Connectivity**.



601 Heron Drive • Logan Township, NJ 08085 • (856) 467-8000 phone • (856) 467-3044 fax • [www.radiosystems.com](http://www.radiosystems.com)

## broadcast your world

EM 5000 HE DIG PLUS

**FM & TV TRANSMITTERS  
MICROWAVE LINKS  
VERTICAL & CIRCULAR  
POLARIZATION FM ANTENNAS  
TV PANNELS  
STUDIO TO TRANSMITTER LINKS**

EM 1000 HE DIG PLUS



3100 NW 72nd. Ave. Unit 112 • Miami, FL — 33122 USA • [www.omb.com](http://www.omb.com)  
Pol. Ind. Centrovía • C/Paraguay, 6 (La Muela) • 50198 Zaragoza (Spain)



### Replace Yourself

– Continued from Page 38 –

himself more than once with a record running out and no record cued up. The transmitter readings were unreadable and the scheduled spots ran nowhere close to their scheduled times. After six hours of his first live radio debut, the young broadcaster was exhausted and discouraged in his performance. As he left the studio, the phone rang and it was the PD who had listened to the whole show at home. The young broadcaster was waiting for the words “don’t ever come back” but instead heard, “You did a good job, you’ll do even better next week.” The young broadcaster stayed at that radio station for two years and learned everything that needed to be done at a small station and even some tricks like doing production in audition while you’re on-air. It was in that same studio that he promised he would have his own radio station someday.

You’ve probably figured out that I’m the young broadcaster in the story. I made \$11.97 after taxes for that first six hour air shift and I still have a copy of the check. To this day, I still talk with my first Program Director, Ray Reed, whom I have thanked more than once for taking a chance on a young broadcasting student that he saw some promise in.

Have you thought about replacing yourself? Someone, somewhere gave you a first break on-air and you owe it to someone to “pay it forward” by giving someone else their first break.

It’s true that you just can’t walk into a radio station like I could back in 1972, especially if they don’t have a local studio anymore. But you can keep your eyes and ears open for someone who shows an interest in making radio their career.

I’m telling you that story because this same thing happened to me recently. My station did a lot, and I mean a lot, of local high school football games last season. At one game, I noticed a couple of high school students who seemed to be more interested in what was going on in the press booth than what was happening on the field. I started up a conversation with them and asked if they’d like to talk on the radio. Their faces lit up and they jumped in and did a pretty good job of providing some color commentary of their fellow students on the field. Last week, they asked if they could broadcast again next season.

A few of months ago, I met a young man that I’ll call Jimmie. He was a senior in high school and he seemed quiet and shy but said he was interested in television and radio. I noticed that Jimmie had difficulty walking, but the more I talked with him I saw that he really wanted to be involved in the media and was ready and willing to work and learn. I assumed that he would not be able to stand for hour after hour like other students have, for a part-time fast food job, so a radio board shift might just be the thing for Jimmie.

I was looking for a Sunday morning board operator because the fellow who had been doing it for nine years was moving on. My staff trained him on our Sunday programming lineup and then he got to do a Sunday by himself. Jimmie handled himself well on-air and did a

great job. One recorded show ran short so he filled to the top of the hour – something we hadn’t trained him to do but he figured out how to do it by himself. Jimmie can’t drive, so his father drops him off at the studio at 6:00 a.m. and picks him up at noon. His father says that Jimmie wakes him up an hour early on Sunday mornings so he can get to the radio station on time and not be late for his radio show. One of his relatives came to me and said I have no idea how much the Sunday radio show means to Jimmie and she wanted to thank me for giving him the opportunity. When I spoke to Jimmie at Christmas he said he was now planning to go to a local community college to major in radio, but he would still be around do his Sunday air shift.

I’ve heard from other station owners that no one is interested in radio as a career anymore and it’s hard to find good help. Take it from me, there are young people out there who want to learn how to broadcast a high school football game or do a weekend air shift. Look around when you’re doing your next remote. Visit your local community college, high school or trade school to see if they have a media class and talk to the instructor. Take an hour to speak to their class about radio and see if anyone would like to visit your station. The next time the Cub Scouts visit your radio station, take the time to put them on the air and share the magic with them. Who knows, you just might be starting someone on a career path that they will later thank you for.

*Steve Callahan, CBRE, AMD, is the owner of WVBF, Middleboro, Mass. Email at: wvbf1530@yahoo.com*

## Why Not Switch to



## Complete FM / TV Product Line

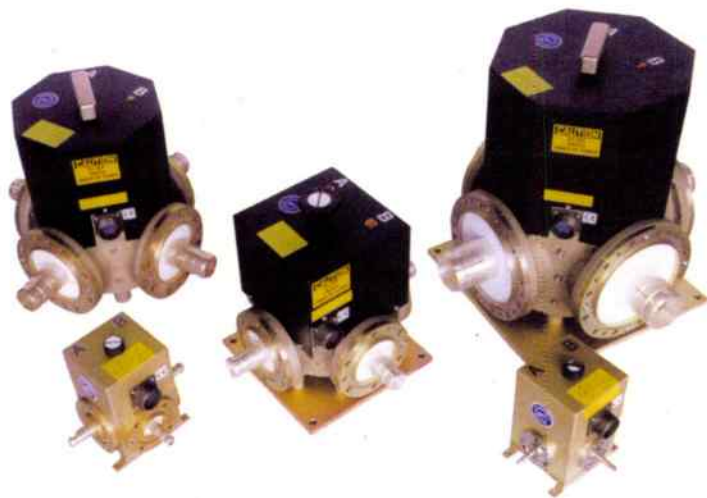

Coax switches available in  
Type-N and 7/16 DIN and  
7/8" through 6-1/8"

- Antennas
- Splitters
- Notch Filters
- Harmonic Filters
- Power combiners
- Channel combiners
- N +1 Switching Matrix

Control panels available.

A subsidiary of **MEGA** RF Solutions

[www.megaind.com](http://www.megaind.com)

Toll Free: 800-545-0608 | [www.mcibroadcast.com](http://www.mcibroadcast.com)



## Complex interface solutions at the click of a connector.

**sysflex**



**RDL**

SysFlex modules provide connectorized interface between data networks and analog and digital audio devices, networked and conventional amplifiers and other application-specific solutions. In RDL's tradition of versatility, SysFlex modules can be used right where they are needed: rack-mounted, surface-mounted, or unmounted. They are light-weight, compact and easy to install with simple, straightforward switch settings and LED indicators.

Modules quickly snap into the SysFlex rack mount and each is firmly secured with a single screw. The SysFlex racking system segregates network and power wiring from the audio and digital audio connectors. For connectorized network audio endpoints and A/V system components that provide unparalleled performance and advanced features without giving up simplicity and ease of installation, SysFlex is the industry's best value.

Learn more at [proaudio.com/sysflex](http://proaudio.com/sysflex)  
or call us at (800) 433-2105 for more information.

**PROAUDIO**  
com  
smart sound solutions

# Quality FM & TV Antenna Systems



FM PANEL



POWER-TILLER

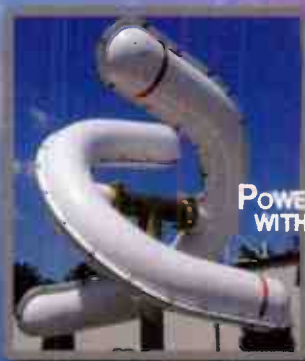

POWER-TILLER WITH RADOME

PSI is dedicated to designing and manufacturing the highest quality product. Working diligently with station engineers, consultants and outside vendors ensures that each project is completed to the customer's satisfaction.

Wide range of antenna models are available at all power levels, directional and non-directional, multi-station and more.

Additional products include..

- Transmission Line
- Combiners
- Filters
- Turnkey Systems

SLANT-V  
DIRECTIONAL



## Propagation Systems, Inc.

Phone: (814) 472 - 5540

Email: [sales@psibroadcast.com](mailto:sales@psibroadcast.com)

Fax: (814) 472 - 5676

[www.psibroadcast.com](http://www.psibroadcast.com)



# Small Market Guide

## AM Again – Will It Go Away?

by Roger Paskvan

The other day my PD asked my how much it cost to keep the two AM stations we have on the air each month. A quick calculation provided him with a figure of \$1,500 a month plus copyright costs. He replied, "Wow, it's almost a wash, or at most, a break-even, considering the limited amount of ads on our AM's. Why do we keep doing this? "Well let's go back and visit AM and how we got into this predicament.

AM was originally the only form of modulation that could be found on a radio. The original AM dial was assigned 540 to 1600 kHz and much later the FCC allowed the excursion to 1700 kHz. AM radio took off in the golden age of broadcasting, the mid 1930-40s. David Sarnoff, the CEO of RCA led the charge in the production of AM radios. Radio, first brought to the public as a novelty, now became a household item because of demand and increased production. Mr. Sarnoff wanted an AM radio in every living room, and just about succeeded.

This all changed when a new way to listen to radio was discovered. FM (Frequency Modulation) was introduced by Edwin Armstrong, born from his research to eliminate static from AM radio. FM was immediately considered a major threat to AM radio. The RCA Corporation fought the new concept with its major power and influence. The FM founder, Edwin Armstrong, a onetime

former employee of RCA, took-on the big company. FM made AM sound like poor fidelity music, but the RCA big boys did all they could to keep FM from getting into the public hands.

In a last effort to kill FM, RCA with its power and money, petitioned the FCC to move the FM dial from its original frequency band 42-50 MHz to 88-108 MHz. It was a clever ploy, because in the 1940s', reaching 88 MHz with existing technology was not easily possible. RCA won, AM was king, and no one but a select few spent the money or time to dial up what few FM stations there were on the new FM dial. Even in the late 50's FM stations programmed what kids today call "elevator music." There was talk that FM radio would die before it had a chance to be heard by the public.

FM station owner, Todd Storz, in an effort to evade bankruptcy, introduced top 40 music to the FM format and let people hear the major difference in sound quality. Once people started to hear more and more FM, its "quality" and sound started to draw sizeable audiences. Soon many listeners began moving away from AM and more towards FM radio. In 1961, the FCC allowed stereo broadcasting, giving FM a major niche over its big brother, AM. By the end of the 60's, FM had taken over and the preferred choice for music was frequency modulation.

AM listenership began to dwindle, leaving a small audience. This remaining audience tuned in for specific talk shows that stayed with AM radio.

Now if we look at the present dismal pathetic state of AM radio, nothing has really changed since the 1940's. The modulation process is still the same, although Class D modulation has improved efficiency. It's the same idea of changing the amplitude of the carrier. The bandwidth is narrow (10 kHz) and AM sounds almost like music through the telephone. The static is still there, and to quote the late RCA's chairman, David Sarnoff, "Static, like the poor, will always be with AM radio." So here we are in small markets with our AM transmitters, sucking up kilowatts, broadcasting to a smaller audience each month.

In January, 2018, the FCC, in an effort to help AM owners, opened up AM translator windows to give each AM market owner a place on the FM dial. Now is this helping out AM stations, or is it removing more listeners from the AM dial and replacing them on FM? If that's the AM solution, let's open some of the channel six (6) TV spectrum, now vacant, and leave a two MHz segment below 88 MHz for high power FM only, available to AM stations. Before you say everyone would have to get new radios, not really, since most car radios will tune down to 86 MHz. As AM stations migrate to their new high power home on the new extended FM dial, their ancient modulation station can be shut off. To really get this going, the new FM stations could be all digital.

It's an idea that could save small market AM stations and expand service to the general public. I hope the FCC reads this.

Roger Paskvan is a Professor of Mass Communications at Bemidji State University, Bemidji, MN. You may contact him at: [rpaskvan@bemidjistate.edu](mailto:rpaskvan@bemidjistate.edu)

Celebrating 35 Years of service  
to the broadcast community.



[www.rfspecialties.com](http://www.rfspecialties.com)

Check our website for the office nearest you.

## TRANSCOM CORPORATION

Serving the Broadcast Industry Since 1978

Visit Our Website – [www.fmamtv.com](http://www.fmamtv.com)

Send your e-mail requests to: [transcom@fmamtv.com](mailto:transcom@fmamtv.com)

### Fine Used AM & FM Transmitters & New Equipment

AM	5 kW	2003	BE AM5E - Solid State
	10 kW	2001	Nautel XL12 - Solid State
	60 kW	2007	Nautel XL60

Please see our current listings on our website.

FM	55 W	2000	Harris DIGIT™ CD
	3.5 kW	2000	Harris Z3.5CD, Solid State, Single Phase
	1.3-3 kW	2006	Harris Z6HD-HD Tri-Mode, Single Phase
	5.0 kW	1988	BE FM5A
	5.0 kW	1998	Nautel FM5, Solid State, Single Phase
	10.0 kW	1988	BE FM10A - Dual 5 kW
	10.0 kW	1996	Nautel FM10 - Solid State, Single Phase
	20.0 kW	1994	BE FM20B, Solid State IPA, New Final
35.0 kW	1991	BE FM35B, Solid State IPA, New Final	

Please see our current listings on our website.

#### Used Misc. Equipment:

Bird Model 8932, 10kW Air-Cooled RF Load  
Harris N+1 Controller

#### Exciters:

Harris DIGIT™  
Continental 802B  
New - 30W Synthesized



Please go to our website for updated listings.  
Retuning and testing available – call for quote!  
**OMB STL systems for radio, complete with antenna and cable for under \$5,000!**

2655 Philmont Ave, Ste 200, Huntingdon Valley, PA 19006  
800-441-8454 • 215-938-7304 • Fax: 215-938-7361



# ECONCO

## Rebuilt Power Tubes



*Approximately One Half the Cost of New*  
**3,000 Hour Unconditional Guarantee**  
 Call for Your Quotation



Phone: 530-662-7553 • Fax: 530-666-7760

Toll Free: 800-532-6626

[www.econco.com](http://www.econco.com)

1318 Commerce Ave, Woodland, CA 95776

# MAXIMIZE COVERAGE MINIMIZE COSTS

with Bext FM Antennas



- Broadband Models for Multi-frequency
- Long Term Durability
- Real Tech Support

**BEXT**

888 239 8462

[www.bext.com](http://www.bext.com)



## The Broadcasters' Desktop Resource

*edited by Perry Mashford - The Eclectic Engineer*

HOME | NEWS | ARTICLES | MANUFACTURERS & VENDORS | SERVICES | SUPPORT | RESOURCES | ABOUT | BUSINESS | SITE MAP | CONTACT

Looking for an Internet archive of broadcast news and articles on technical, IT, and managerial issues?

The Broadcasters' Desktop Resource is at: [www.theBDR.net](http://www.theBDR.net)

Avoid missing out on anything – you are invited to sign up for the one-time-a-week BDR Newsletter. We promise to never flood your inbox!

### Some things you might want to know about:

Check it out now!  
<http://www.theBDR.net>

- 1/18 - An overview of interesting things from CES 2017
- 1/18 - Original iPhone now a museum piece
- 1/18 - Spectrum Auction seems finally to be concluding
- 1/12 - Court stops evictions by American Tower
- 1/11 - FCC plans to remove letters and email from Public File
- 1/11 - Bill Sacks passes away
- 1/9 - Norway to abandon analog FM this year
- 1/5 - Obama nominates Rosenworcel back to FCC
- 1/4 - The Difference and Why It is Important - Tom Osenkowsky
- 1/2 - The End is Coming for AMCs and 139 dealers
- 12/30 - Enforcement Watch: Failure to ensure tower lit/painted: \$25k
- 12/28 - Checking It Out: Road testing the Invoxionics 523N FM monitor
- 12/28 - PSYAB Issues: Initial report on the 2016 EAS NPT
- 12/23 - iHeart gets negative response from the ISDA
- 12/21 - Alternatives to Wired Ethernet Networks - Dana Fuopolo
- 12/20 - Cumulus in trouble again with NA OAD
- 12/19 - FCC Seeks comments to reduce EEO recruitment requirements
- 12/15 - The Worst: Walking in to Find No Joy at All
- 12/14 - Keep the Flu Out - Keep Your Staff In
- 12/7 - Checking It Out: The Invoxionics 523N - Alan Alsbrook
- 12/7 - FCC Commissioner Ready to Fire Up the Wind Whacker
- 12/7 - Spectrum Auction is Not Making the FCC Look Very Good



## Redefining Radio Automation for the last 25 years.

With over 25 years of innovation, ENCO continues to provide stations with the best solutions to improve workflows and sound better, from advances in remote production and control to hardware virtualization to visual radio technology. To stay up-to-date on the latest advances in the broadcast industry, make your station an ENCO station with a OAD: Digital Audio Delivery.



### Visual Radio

Turn your radio station into a complete multimedia experience with automated camera switching, music video playout, and graphical overlays. Manually control every aspect of your production in real time, or let ENCO's award-winning automation take care of everything.

### enCloud

enCloud is a collection of mobile and web-based applications that allow you to manage your library and playlists, record voice tracks on your phone, tablet, or browser, and remote control your OAD automation system from anywhere in the world with an internet connection.



[www.ENCO.com](http://www.ENCO.com) (800) ENCO-SYS



# Service Guide Radio Equipment Products and Services



**MOORETRONIX**  
BROADCAST & INDUSTRIAL ELECTRONICS

## Our 18<sup>th</sup> Year

Our client list continues to grow. Thank you for your confidence and equipment purchases.

## We Re-Condition

Pacific Recorders BMX I-II-III, AMX, ABX and RMX, Stereo-Mixer and Mixer News-Mixer products.

## We Have

Replacement Wind Screens and Blast Filters for the SM-5B microphone.

## We Repair & Re-Crystal

STL Transmitters, STL Receivers, and RPU equipment.

See the "News-Update" page at our website.

Tel: 800-300-0733 Fax: 231-924-7812

[WWW.MOORETRONIX.COM](http://WWW.MOORETRONIX.COM)

E-Mail us at: [rmoorejr@aol.com](mailto:rmoorejr@aol.com)

[www.LightnerElectronics.com](http://www.LightnerElectronics.com)

From our Facility to yours | Design & Integration | Repairs & On-Site Service Calls

**LIGHTNER ELECTRONICS** [www.lightnerelectronics.com](http://www.lightnerelectronics.com)  
Toll Free 1-866-239-3888 Shop online [www.broadcastavsales.com](http://www.broadcastavsales.com)



## The Leader in Broadcast Engineering Software!

- Create stunning "real-world" coverage maps, interference studies, and population reports with Probe 4™
- AM Pro 2™, used daily by FCC engineers, performs skywave and groundwave allocation studies and AM coverage mapping

- Find STL broadcast auxiliary and Part 101 microwave frequencies and generate PCN letters with Microwave Pro™

- Map FM stations and find upgrade possibilities using FCC minimum separations and contour-to-contour methods with FMCommander™

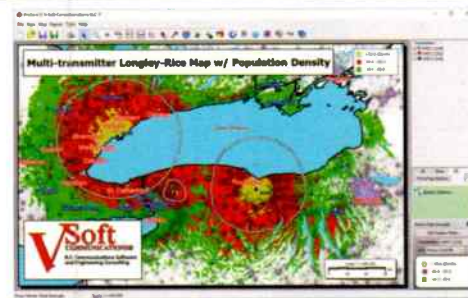

[www.V-Soft.com](http://www.V-Soft.com) - [info@v-soft.com](mailto:info@v-soft.com) - 1-800-743-3684

## TRANSMITTING CAPACITORS

MICA-VACUUM-CERAMIC

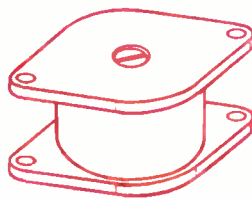

SURCOM ASSOCIATES, INC.  
(760) 438-4420  
[LINK@SURCOM.COM](mailto:LINK@SURCOM.COM)



## AM-FM Transmitters

Pre-Owned – Tuned and Tested to Your Frequency

[www.Besco-Int.com](http://www.Besco-Int.com)

Rob Malany – Owner

321-960-4001 • [sales@Besco-Int.com](mailto:sales@Besco-Int.com)



## A RECTIFIER TO FIT YOUR TRANSMITTER

Dean Technology has replacement rectifiers to meet the requirements of most AM and FM transmitters. We offer a wide range of standard parts, and can offer fast and cost effective custom solutions.

Many products are IN STOCK! Contact us for a quote or to place your order!

[www.deantechnology.com](http://www.deantechnology.com)



## Doug Vernier

Telecommunications Consultants

- FCC Applications for AM, FM, TV, DTV, LPTV, STL
- Upgrade and Due Diligence Analysis
- Frequency Searches
- Site Relocations
- Propagation Prediction with Custom Mapping
- Demographic Analysis
- Directional Antenna Design



We use V-Soft Software!

[www.v-soft.com](http://www.v-soft.com) [consulting@v-soft.com](mailto:consulting@v-soft.com) 800-743-3684

## M. Celenza

Communications Consultant

FM • LPFM • AM • DTV • STL • Translators

Preparation of Applications, Amendments, Channel Studies, New Allocations, Relocations, Interference Studies, and Coverage Maps  
We also repair broadcast equipment.

Call: 631-965-0816

41 Kathleen Crescent, Coram, NY 11727  
[celenzacomunications@verizon.net](mailto:celenzacomunications@verizon.net)

## Chris Scott & Associates

Visit our website

[www.scott-inc.com](http://www.scott-inc.com)

Ph: (270)781-5301

Fax: (270)781-1232

Bowling Green, Kentucky



AM Notch Filters

## DANGER



Old Safety Sign. High Liability! Replace Immediately!

[RFSigns.com](http://RFSigns.com)

- ANSI Z535.2 Compliant
- Easy to order



# Service Guide Radio Equipment Products and Services

## Consulting Professional Engineers

### ● Expert Witness Testimony

- FCC Applications
- Frequency Searches
- Co-location Studies
- Coverage Modeling & Maps
- Interference Analysis Studies
- RF Exposure Studies & Reports
- Custom Map Preparation

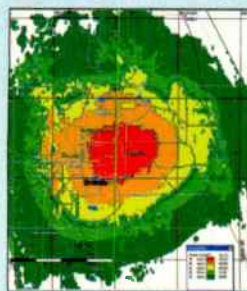

**Call us now  
to discuss your  
project needs.**

**352-367-1725**

**RFEngineers, Inc.**  
alex@rfengineers.com

## TLM-1 TOWER LIGHT MONITOR

Total Monitoring for Older Lighting Systems



A microprocessor based system designed to monitor the status of FAA type A incandescent tower lights.

- Individual alarms for photocell, flasher, beacon & marker.
- Status outputs for lights on/off and beacon on/off.
- LED indicators for each alarm and status output.
- Opto-isolated fail-safe outputs for each alarm.
- Easy setup – one button calibration.
- Installs at the circuit breaker panel.
- Available through broadcast distributors.

**FM Services**

www.towermonitor.com • 336-667-7091

## Ice Cracker

Need ice damage protection  
for your tower?

For over 35 years our U.S. Patented product has been successfully used to protect guy wire anchor hardware and dampers used on towers all across the United States and Canada. Our product doesn't wear out and is galvanized for rust protection.

In most cases, the Ice Cracker can be installed in minutes and is supplied with all necessary hardware. The average cost for a tower is about \$500. For additional information, call, email, or check our website.

*Mention this ad and get a discount on your order.*

**Ice Crackers Inc.®**

800-747-8921 • icecrackers@comcast.net  
www.icecrackers.com

# Radio-Classifieds.com

- Buy or Sell Your Used Equipment
- Place as Many Ads as You Like
- **FREE!** – There's Never Any Charge



[Home](#) [Register](#) [Login](#) [Submit ad](#) [Search](#)

## Radio-Classifieds.com

Latest 20 ads

Please register or log in.

Antennas [0]	Codecs & AoIP [0]	Internet & Stream [0]	STL, RPU, TSL [0]
Audio Amplifiers [0]	Computers & IT [0]	Microphones [0]	Satellite Gear [0]
Audio Delay [0]	Consoles & Mixers [0]	Monitors & Rcvrs [0]	Speakers & Phones [0]
Audio Editing [0]	Directional Gear [0]	Phone & Hybrids [0]	Timers & Clocks [0]
Audio Processing [0]	EAS Gear [0]	RDS, RBDS, SCA [0]	Tools & Test Gear [0]
Audio Routing [0]	Exciters & Gens. [0]	Recorder & Player [0]	Towers & Coax [0]
Audio Storage [0]	Furniture & Racks [0]	Remote Control [0]	Transmitters [0]
Automation [0]	Grounding & Surge [0]	RF & HV Equip. [0]	MISC OTHER [0]

Wheatstone

THE INTELLIGENT NETWORK

**self aware  
never self conscious**

This means your network is far more intelligent and efficient, so you don't have to continually mess with it. It just works. Cool, eh?

Wheatstone

AUDIOARTS

FLEXIBLE. AFFORDABLE. BUILT TO LAST.

**IP-12**

MODULAR WHEATNET-IP NETWORKABLE CONSOLE

Powered by Media Magazines Inc. - Publisher of Radio Guide Magazine | Contact Us



# Gear Guide

## Audio Processing

Inovonics NOVA 272

by Ron Erickson

I appreciate history, especially when it comes to radio station gear. If I had the time, space, and a boat-load of cash, I would love to build a broadcast museum. In my storage garage, I've collected tons of old Sparta gear including consoles, turntables, and cart machines. As a matter of fact, many of us who remember this era have gear like I do stashed in our garage or somewhere else.



Gates Sta-Level

When it comes to audio processing, a couple of items come to mind. For AM there was the The Gates Sta-Level and then the pair of Audiomax and Volumax units – for FM, you wanted the stereo version of the CBS FM Volumax. It's fun to look back and see where we've come from. Maybe I *will* build a broadcast museum, that is when I buy the right lotto ticket.



CBS FM Volumax

If it seems to you like the digital age has increased broadcast audio processing choices by leaps and bounds, you would be correct. The old gear was clipping with diodes and had no bells or whistles that enhanced anything.

Allow me to focus in on a product from Inovonics. I have been impressed many times by equipment created by them.

Remember the Ampex reel-to-reel tape decks? My first exposure to Inovonics products was when a station, where I was a DJ, replaced the old Ampex reel-to-reel recording amplifier with a solid state version, built by Inovonics. Absolute genius – the right product at the right time!



An Early Inovonics Model 370  
Magnetic Recording Electronics

Now Inovonics has done it again. Meet the Inovonics NOVA 272.



This is a half rack unit with a digital Stereo FM Processor with RDS/RBDS – with a choice of input sources and a whole big bunch of other features. When I first saw the Inovonics NOVA 272 at last years NAB show, it was such a small package that, honestly, I was a bit skeptical. How could Inovonics put so much into a half rack package?

I volunteer as the engineer for an LPFM station in Oregon and this allows me to experiment and test out various new pieces of gear in a real broadcast setting. This small station, like most of the LPFM's around the country, relies upon donations of money and cast off gear from larger operations. I removed the old limiter and installed the NOVA 272.

As soon as it was turned on, the difference was noticeable immediately. The station's format is oldies, so the management desired a punchy 60's style, heavy processed sound. By making only a few adjustments, I was able to make this LPFM station sound as loud as other full power stations in the market, which are all using much more expensive processing. The Tri-Band processing allows for the desired bass without loosing the more delicate high notes.

If you have a discriminating ear, you can fine tune the processing to match your custom processing desires.



Novia 272 Rear View

Inovonics has been shrinking the sizes of several units in the past few years. This one adapts to mounting in a half rack space along with another unit of the same size. The wall wart power supply can power two of these half sized units by using a jumper power cable, one to another. Above is the rear view of this unit.

The NOVA 272 incorporates a menu-driven setup, as well as an IP/browser interface compatible with any PC or mobile device. It took me no time at all to connect the 272 to the station transmitter, from the Composite Stereo BNC output. As I mentioned, this unit has three inputs: AES Digital, Balanced Analog left & right, and the streaming input. Should one fail, another may be activated automatically. I took advantage of the built-in streaming input and connected it to the Internet via the built in LAN Port. Dialing up the server address from the studio, the audio popped right on. Selecting the stream input on the unit, I listened through headphones to make sure the signal was good. I have also since tried the analog input with a back up audio computer onsite. The audio quality is exactly what you expect from an Inovonics product – pure and clean.

The NOVA 272 has a three channel digital processor reminiscent of the Inovonics model they called David III. The "David" series of processors was so nick-named after the Bible story of David and Goliath. In the story, young David slays the giant Goliath with a well placed rock thrown from his slingshot. So too, the David series from Inovonics took on larger, more expensive stereo processors and the very affordable small David processors have a history of beating out other audio boxes. Truly, this little box is nothing short of a processing miracle.

Getting more specific, the NOVA 272 processing combines "gain-riding" AGC, RMS. leveling, parametric EQ, enhanced bass "punch," multi-band compression, wide-band and independent high frequency final limiting and composite clipping. Need a quick set-up? Inovonics has included ten, preset processing choices and ten more user designed processing selections, so you can save your custom processing. The internal RDS/RBDS encoder is compatible with most automation systems so dynamic song title and artist information may be presented.

These days, stations on FM do more than just music. They may broadcast morning news blocks or sporting events. There is a "Daypart" option that switches the normal processing to something else during the departure from the regular format.

As if all this was not enough to sell this unit to broadcasters, it also features an IP interface allowing the user remote access to the functions. Program audio failure alarms can trigger local tally closures and it can send SMS or email to whomever you designate.

For any size station from the 100 Watt LP's to a Class C, if you want a low cost processor with all the innovations, or perhaps if you need a small processing miracle, this may be the right choice at the right price. List price from Inovonics is \$2,100, and it can typically be purchased for just under \$1,900 or less from broadcast suppliers.

*Ron Erickson is an engineer and owner of EBS. He is a lifelong broadcaster and he may be reached at ronerrickson@gmx.com*

**TIME TO SYNCHRONIZE**

**ES-185E/NTP6 GPS Master Clock**

Accurately generate time code with ESE's Master Clock via the 12-channel GPS receiver and output multiple types of Time Code, SMPTE-LTC/EBU, ESE, IRIG-B, ASCII (RS-232 & USB), and an extremely accurate 1PPS signal. Further reliability with dual battery back-up, and new control panel software. ESE's NTP6 feature provides an NTP server compatible with the latest version of Internet Protocol, IPv6. You can also easily interface with new or existing computers, automation and clock systems.

Visit [www.es-web.com](http://www.es-web.com) for all your time synchronization needs.

**ESE**

[www.es-web.com](http://www.es-web.com)  
+1-310-322-2136

**Precision | Innovation | Proven**

**RADIUS XP**      **MODULUX**      **BIRCHLINE TALK TABLE**

**GRAHAM STUDIOS**  
Broadcast Furniture

815-222-3556      866-481-6696 | [www.graham-studios.com](http://www.graham-studios.com)  
[www.supportradio.com](http://www.supportradio.com)



# FINAL STAGE



## RADIO ROUNDUP

The Radio Guide Event Register

Email your dates and info to: [radio@rconnect.com](mailto:radio@rconnect.com)

### NATE Unite 2018

February 19-22, 2018  
Gaylord Opryland Resort, Nashville, TN  
<http://natehome.com/annual-conference>

### 2018 NRB Convention

February 27- March 2, 2018  
Nashville, Tennessee  
[www.nrbconvention.org](http://www.nrbconvention.org)

### Great Lakes Media Show

March 6-7, 2018  
Lansing, Michigan  
<http://michmab.com/ProgramsEvents>

### NAB 2018 Spring Convention

Convention Center - Las Vegas, Nevada  
April 7-12, 2018  
[www.nabshow.com](http://www.nabshow.com)

### Texas Association of Broadcasters (TAB)

August 1-2, 2018  
Marriot Downtown, Austin, Texas  
[www.tab.org/convention-and-trade-show](http://www.tab.org/convention-and-trade-show)

### NAB Radio Show

September 25-28, 2018  
Orlando, Florida  
[www.radioshowweb.com](http://www.radioshowweb.com)

## Radio Guide Advertiser Info – January-February 2018

### Advertiser - Page

Altronic - 22  
AM Ground Systems - 32  
Arrakis - 31  
Bay Country - 4  
BDR - 43  
BEXT - 43  
Broadcasters General Store - 19  
Broadcast Electronics - 36  
Broadcast Software Intl. - 33  
Broadcast Tools - 47  
CircuitWerkes - 23  
Coaxial Dynamics - 38  
Comrex - 5  
Davicom - 4  
Dean Technology - 44  
Deva - 37  
DH Satellite - 34  
DM Engineering - 47  
Econco Tubes - 43  
Enco - 43  
ESE - 46  
GatesAir - 11  
Graham Studios - 46  
Henry Engineering - 2  
Inovonics - 1, 15

### Website

[www.altronic.com](http://www.altronic.com)  
[www.amgroundsystems.com](http://www.amgroundsystems.com)  
[www.arrakis-systems.com](http://www.arrakis-systems.com)  
[www.baycountry.com](http://www.baycountry.com)  
[www.thebdr.net](http://www.thebdr.net)  
[www.bext.com](http://www.bext.com)  
[www.bgs.cc](http://www.bgs.cc)  
[www.bdcast.com](http://www.bdcast.com)  
[www.bsusa.com](http://www.bsusa.com)  
[www.broadcasttools.com](http://www.broadcasttools.com)  
[www.circuitwerkes.com](http://www.circuitwerkes.com)  
[www.coaxial.com](http://www.coaxial.com)  
[www.comrex.com](http://www.comrex.com)  
[www.davicom.com](http://www.davicom.com)  
[www.deatechnology.com](http://www.deatechnology.com)  
[www.devabroadcast.com](http://www.devabroadcast.com)  
[www.dhsatellite.com](http://www.dhsatellite.com)  
[www.dmeengineering.com](http://www.dmeengineering.com)  
[www.econco.com](http://www.econco.com)  
[www.enco.com](http://www.enco.com)  
[www.es-web.com](http://www.es-web.com)  
[www.gatesair.com](http://www.gatesair.com)  
[www.graham-studios.com](http://www.graham-studios.com)  
[www.henryeng.com](http://www.henryeng.com)  
[www.inovon.com](http://www.inovon.com)

### Advertiser - Page

Kintronic Labs - 37  
LBA - 20  
Logitek - 13  
Mega Industries/MCI - 40  
Mooretronix - 44  
Nautel - 7  
NAB - 35  
OMB - 39  
Omnia - 21  
Orban - 17  
Phasetek - 47  
ProAudio.com - 41  
Propagation Systems (PSI) - 41  
Radio Systems - 39  
RF Specialties - 42  
SCMS - 27  
Shively - 30  
Smarts Broadcast Systems - 29  
Stackley Devices - 47  
Studio Items - 28  
Tieline - 9  
Titus Labs - 26  
Transcom - 42  
V-Soft Communications - 44  
Wheatstone - 3, 24, 25, 48

### Website

[www.kintronic.com](http://www.kintronic.com)  
[www.lbagroup.com](http://www.lbagroup.com)  
[www.logitekaudio.com](http://www.logitekaudio.com)  
[www.mcibroadcast.com](http://www.mcibroadcast.com)  
[www.mooretronix.com](http://www.mooretronix.com)  
[www.nautel.com](http://www.nautel.com)  
[www.nabshow.com](http://www.nabshow.com)  
[www.omb.com/en](http://www.omb.com/en)  
[www.telosalliance.com](http://www.telosalliance.com)  
[www.orban.com](http://www.orban.com)  
[www.phasetekinc.com](http://www.phasetekinc.com)  
[www.proaudio.com](http://www.proaudio.com)  
[www.psbroadcast.com](http://www.psbroadcast.com)  
[www.radiosystems.com](http://www.radiosystems.com)  
[www.rfspecialties.com](http://www.rfspecialties.com)  
[www.scmsinc.com](http://www.scmsinc.com)  
[www.shively.com](http://www.shively.com)  
[www.smartsbroadcast.com](http://www.smartsbroadcast.com)  
[www.stackleydevices.com](http://www.stackleydevices.com)  
[www.studioitems.com](http://www.studioitems.com)  
[www.tieline.com](http://www.tieline.com)  
[www.tituslabs.com](http://www.tituslabs.com)  
[www.fmamtv.com](http://www.fmamtv.com)  
[www.v-soft.com](http://www.v-soft.com)  
[www.wheatstone.com](http://www.wheatstone.com)

## Remote Reboot of AC Powered Devices

**Stackley  
Devices  
LLC**  
  
(609)  
647  
9677



**RemOutlet  
Reboot  
Mini**  
**\$179**  
  
**Adjustable  
Power  
OFF Time**

[www.RemOutlet.com](http://www.RemOutlet.com)

## Light Up Your Life and your "ON AIR" & "RECORDING" Signs



The DM Engineering Solid State Relay Pack is a self contained AC line switching device designed to operate "ON AIR" or "RECORDING" studio signs, or other incandescent lamps, spots or floods using a normally open contact closure and/or a low voltage DC input to control the output. The DC control input is not polarity sensitive.



The Solid State Relay Pack has the following features:

- \* Control input voltage range of 5-30 VDC or
- \* Control using Normally Open contacts or logic low
- \* Internally fused output with capabilities up to 5 amps @ 125 VAC, and supplied with a NEMA standard "U" ground 3 pin AC outlet connector.
- \* Directly compatible with most DME products
- \* 6 ft. input AC cord with NEMA standard "U" ground 3 pin plug
- \* Eurostyle DC and N.O. contact input screw type terminal block
- \* Zero-crossing technology is employed to eliminate noise



For more details on these and other innovative products for the broadcaster, call or visit us on the web at: [www.dmengineering.com](http://www.dmengineering.com) 1-800-249-0487

2174 Chandler St. Camarillo, CA 93010 (805) 987-7881

## Passing the Test



### Universal 4.1 MLR»Web

The Universal 4.1 MLR»Web is a web based transparent four input, one output switcher/router with mechanical latching relays designed to pass AES or stereo balanced signals. The unit may be configured to monitor for stereo analog audio silence or loss of AES clock when configured for AES switching.



**BROADCAST  
tools  
PROBLEM SOLVED**

## PHASETEK INC.

### Custom Phasing Systems

Phasetek, Inc. is dedicated to provide the broadcast industry high quality AM Phasing and Branching systems, Antenna Tuning units, Multiplexers, and RF components.

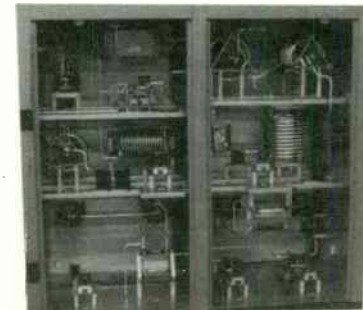

**Phone: 215-536-6648**  
**[sales@phasetekinc.com](mailto:sales@phasetekinc.com)**  
**[www.phasetekinc.com](http://www.phasetekinc.com)**





THE INTELLIGENT NETWORK



Learn more: [wheatstone.com/lxe](http://wheatstone.com/lxe)

## LXE: Your Forever Console...

Adapt to new technology, new techniques, and new workflows with LXE. Completely configure/reconfigure your console - every button, knob, and display on the surface is fully programmable using our intuitive ConsoleBuilder™ GUI/scripting interface.

With ScreenBuilder™ LXE, you can design dynamic custom touchscreen interfaces to augment LXE's extensive screen set. Beautiful to see and use.

Need more input faders? Enable up to four layers to double/triple/quadruple the number (up to 32) in the same footprint.

LXE is built to last in every way.



phone 1.252.638-7000 | [wheatstone.com](http://wheatstone.com) | [sales@wheatstone.com](mailto:sales@wheatstone.com)

World Radio History