

Radio Guide

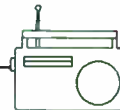

Technology Forum
Radio

May 1995

Radio Forum

editor/publisher

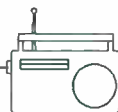

Isolation Kit

In last month's column, I published a list of ten specialized kits that you can assemble with easy-to-find parts. These kits can be used to provide the quick fix that may help to keep your station on the air until permanent repairs can be made.

The Kit

Lighting strikes, shorts, burnouts . . . I'm sure you've had your share. After the smoke clears, you're likely left with a dead transmitter that just sits there and continues to blow the wall breaker.

After a lighting strike (or sometimes for no apparent reason at all) a winding of a high voltage transformer, choke, or inductor can short to its metal frame and ground.

These large transformer/inductors have at least two things in common: They're expensive, and you don't keep them in stock.

Invariably, there's nothing you can do about a physical short to the frame/ground. But if there's not too much internal damage (such as a winding-to-winding short), you may be able to apply a quick fix to get back on the air.

That's where this simple Isolation Kit comes in handy. It consists of these components:

1. Insulating blocks: 2" thick, hardwood, ceramic, or plastic.
2. Large barrier type terminal strips.
3. Lengths of high voltage wire, #10 AC wire, and heavy gauge AC wire similar to that used to connect to the primary of your HV power transformer.
4. Electrical tape, and plastic milk bottles.

(continued on page 2)

FEATURE OF THE MONTH

TASCAM PA-20 MK II Dual Power Amp
BIG POWER FOR A LITTLE PRICE

For maximum flexibility, the PA-20 MK II is equipped with both XLR balanced and RCA

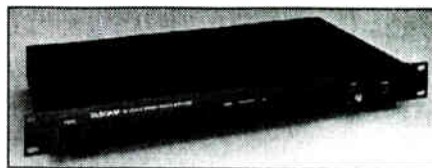

unbalanced input connectors. At 25 watts per channel, it excels in control room and production studio applications.

ABG Special Price **\$189⁰⁰**

Please call today!

MAIN SALES OFFICE
2342 S. Division Avenue
Grand Rapids, Michigan 49507
Phone: 800-999-9281
Fax: 616-452-1652

SOUTHEASTERN SALES OFFICE
200 Fareway Drive, Suite 2
Smithfield, North Carolina 27577
Phone: 800-369-7623
Fax: 919-934-8120

WESTERN SALES OFFICE
P.O. Box 1638
Palmdale, California 93550
Phone: 800-858-9008
Fax: 805-273-3321

For 35 years
AUDIO
broadcast group inc.

YOU MAY ALSO REACH US ANYTIME VIA ELECTRONIC MAIL
cServe: 75371,144
internet: support@abg.com

Info-Fax #108

Inside This Issue

Isolation Kit (editorial)	1
Contract Engineer List	3
Amp-Clamp: More Than a Meter	4
TFT 886/887 Modification Tip	4
Bredesen's Bytes (Industry Updates)	5
Local or Remote	6
Marti R-10/RPT-30 Interface	7
Satellite Radio Basics	8
Avcom EBS-100 Modification	9
Temperature Sensor Enclosure	10
Equipment/Product Information	11

Radio Guide

May 1995

Volume 7, Number 5

Radio Guide Publication

Raymond Topp (*editor and publisher*)

511 18th Street SE, Rochester, MN 55904

Phone: 507-280-9668

Fax: 507-280-9143

Our Contributing Technical Writers

George Whitaker - Arlington, TX

3505 Daniel, Arlington, TX 76014

Phone: 817-468-2586

John Bredesen - KLCC, Eugene, OR

3120 Nob Court, Eugene, OR 97405

Phone: 503-485-6869

Gordon Carter - WFMT, Chicago, IL

34 North Madison Ave., LaGrange, IL 60525

Phone: 312-565-5032

Andy Butler - Broadcast Electronics Inc.

P.O. Box 3606, Quincy, IL 62305

Phone: 217-224-9662

Frank Berry Ph.D.

190 112th Ave. N, #708

St. Petersburg, FL 33716

Phone: 813-577-0041

How to Submit Tech Tips

By BBS: Call our BBS at 507-280-4045, and leave your tech tips, info and articles.

By Disk: Send your tech tips and information on a 3.5" or 5.25" double, or high density floppy disk, in ASCII format.

By Compuserve: Leave E-Mail files to Radio Guide at Compuserve ID — **71203,2341**

By INTERNET: Leave E-Mail files to Radio Guide at Internet ID — **71203.2341@Compuserve.com**

The Radio Forum

Continued from page 1

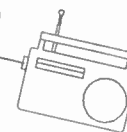

If you suspect, or can measure a short in the transformer/coil winding to the unit's frame, here's what you do. Remove the hardware holding the transformer in place and move the unit away from the transmitter metal frame. Although this is easy with low or medium power transmitters, those 50 kW AM's may have to be a bit more creative.

Take the insulating blocks and place them under the transformer base, isolating it from the cabinet of the transmitter. If the problem is only a short to the transformer frame, in many cases this will allow operation of the transmitter. However, it is wise to operate at low power. Remember that the transformer has been compromised and could be rendered useless if you try to make full power. This is obviously not a permanent solution, and a replacement should be ordered immediately.

There are times when the terminals, connections and wiring in the immediate vicinity of the transformer can be burned or melted. That's where the terminal strips, wire and tape come in handy. Use them to repair and insulate any damaged connections, until permanent repairs can be made.

The plastic milk bottles are good for placement around exposed wires, terminal strips, and for all-around isolation or insulation of various makeshift and temporary repairs. You can use a pocket knife to cut them to the size and shape needed. Two-liter soda bottles work well too.

Next month . . . the High Voltage Kit.

Ray Topp (editor)

Subscribe to:

Radio Guide

Subscriptions are \$12⁰⁰ per year.
Cash with order, or we will invoice you.

Radio Guide

511 18th Street SE, Rochester, MN 55904
Phone 507-280-9668 Fax 507-2809143

Radio Guide (ISSN 1061-7027) is published monthly, 12 times a year, by Media Magazines Inc., 511 18th Street SE, Rochester, MN 55904.

All material contained in Radio Guide is copyright 1995 by Media Magazines Inc., and may not be reproduced in any form without the written permission of the publisher.

Radio Guide Contract Engineers List

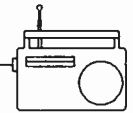

Call us at 507-280-9668 to be listed here.

Tom Rusk
T&M Enterprises
3 Sharondale Ct.
Maumelle AR 72113
501-851-0144

Tom Oja
ACM Communications
P.O. Box 6926
Napa CA 94581
707-257-6000

Rick Melzig
Broadcast Engineering Associates
340 Bella Vista Ave.
Los Gatos CA 95032
408-356-4230

Chip Morgan
CMBE
2340 Dartmouth Place
El Dorado Hills CA 95762
916-933-9330

Scott Dean
Dean Engineering
Box 25085
Fresno CA 93729
209-434-2358

Mike Callahan
KIS Radio
6255 Sunset Blvd.
Los Angeles CA 90028
213-466-8381

Mark Pallock
Marandee Broadcast Engineering
20739 Kinsbury Street
Chatsworth CA 91311
818-882-9475

Mark Sadacca
Southern California Radio Eng.
P.O. Box 1317
Crestline CA 92325
909-338-2551

Terry Gaiser
9451 Eucalyptus Drive
Bakersfield CA 93306
805-366-2211

Paul Montoya
Broadcast Service of Colorado
5945 West Mississippi Ave.
Lakewood CO 80226
303-727-9700

Bill Harris
E&B Services
2950 South Birch St.
Denver CO 80222
303-756-4843

Joel Humke
J.C. Humke & Associates
516 Zion St.
Aurora CO 80011
303-367-1515

Jim McDonald
Wind River Broadcast Center
117 East 11th St.
Loveland CO 80537
303-669-3442

David Schmidt
Mid-Atlantic Radio Service
P.O. Box 11502
Wilmington DE 19850
302-323-0338

Rick Brady
Spred Creative Enterprises
1625 East Pkwy.
DeLand FL 32724
904-822-9766

Mike McCarthy
McCarthy Radio Engineering
P.O. Box 445
Mount Prospect IL 60056
708-640-8965

Gordon Carter
Professional Audio Services
34 N. Madison Ave.
LaGrange IL 60525
312-565-5032

Art Reise
R.E.I.S. Inc.
308 Eastgate Ct.
New Lenox IL 60451
815-485-7377

Martin Hensley
Marcom Communications
6426 Maidstone Rd. #206
Indianapolis IN 46254
317-387-9667

Frank Hertz
Newman-Kees Engineering
8611 Slate Road
Evansville IN 47720
812-963-3294

Jack Maxton
Commercial Radio Service
Route 1 Box 21
Scammom KS 66773
316-479-6837

Tom Toenjes
Signal Specialists
6120 Riley Creek Rd.
St. Marys KS 66536
913-437-6549

David Smith
Dave Smith Engineering
P.O. Box 300
Stanford KY 40484
606-365-0959

Larry Baysinger
Larry Baysinger & Associates
8000 Casualwood Ct.
Louisville KY 40291
502-231-0723

Mike Patton
Michael Patton & Assoc.
12563 Parkciel Ave.
Baton Rouge LA 70816
504-292-4189

Ken Hoen
Teletech Inc.
23400 Michigan Ave. Suite 615
Dearborn MI 48124
313-562-4500

Dick Johnson
Custom Electronics
1044 Westwood Dr.
Faribault MN 55201
507-334-6735

Joe Bellis
RMF Associates
1522 Independence
Cape Girardeau MO 63701
314-651-4272

Larry Fuss
Contemporary Communications
P.O. Box 1787
Cleveland MS 38732
601-846-1787

Ted Fuller
Fuller Electronics
501 Helzig Ave.
Salisbury NC 28144
704-633-1009

Ken Bartz
Bartz Engineering Services
P.O. Box 7306
 Fargo ND 58109
701-237-3006

Walt Gradski
Radio Visions
P.O. Box 4732
Toms River NJ 08754
908-240-3119

Jim Stitt
Jim Stitt & Associates
621 Mehning Way Suite 1907
Cincinnati OH 45202
513-621-9292

Troy Langham
Radio Technical Group
1502 South Boulder Suite 206
Tulsa OK 74119
918-582-0817

James Boyd
Boyd Broadcast Technical Service
21818 SW Columbia Circle
Tualatin OR 97062
503-692-6074

Ronald J. Doto Sr.
Ronald J. Doto Electronic Maint.
4215 Liberty Rd. S
Salem OR 97302
503-378-7024

Ron Balonis
Mountaintop FM
118 Rice St.
Trucksville PA 18708
717-825-9898

Bill Spitzer
WLS Communications
P.O. Box 460
Rapid City SD 57709
605-343-6161

John U. Almon
5-9 Communications
105 Flintlock Dr.
Franklin TN 37064
615-790-7706

Kirk Harnack
Harnack Engineering Inc.
2561 Jenwood St.
Memphis TN 38134
901-377-5565

Wes Whiddon
3W Engineering
Route 3 Box 279
Conroe TX 77303
409-264-3660

Paul & Anita Easter
L&P Electronics
201 Gaslight Square
Corpus Christi TX 78404
512-884-8455

Dave Biondi
The Broadcast Service Co.
P.O. Box 27595
Houston TX 77227
800-350-4964

Mitchell Stern
M&R Associates
14 Kimberly Dr.
Essex Junction VT 05452
802-879-6589

Dave Hebert
Dave Hebert & Associates
P.O. Box 2442
Pasco WA 99302
509-545-9672

Terry Baun
Criterion Broadcast Service
5300 West Garfield Ave.
Milwaukee WI 53208
414-449-5300

List Your Contract Business Here

Amp-Clamp: More Than an Ammeter

John Stortz — St. Petersburg, Florida

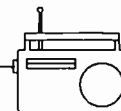

When I got my Simpson Model 150-2 Amp-clamp, I got a lot more than I expected. The Amp-clamp is mainly designed to be an add-on to their 260-line of VOM's, but they wisely added a calibration chart that helps the technician to use it with other brands of VOM's that have a 3 VAC scale, rather than the 2.5VAC scale of the 260.

A clamp-on ammeter is basically a step-up transformer with a split core, that can be opened to allow the core to be wrapped around a current-carrying conductor, without interrupting the circuit to be measured. The current-carrying conductor becomes the primary of the transformer. The secondary steps up the voltage to a level that can accurately be measured on the low voltage scale of a 260 (or equivalent VOM). The 150-2 is designed for measurements up to 300 amps. The lower range can be extended by making a multiple-turn primary. Two turns doubles the meter reading, three turns triples it, etc.

I have also used the Amp-clamp, connected to an audio amplifier, to look for stray AC magnetic fields around the station. Then I got the idea of trying the Amp-clamp with conductors carrying audio. Program lines (single conductors) can be checked for activity without breaking the circuit. Telephone lines can be checked and even recorded (with permission of the other person) using the Amp-clamp. That got me curious about frequency response. A quick call to Simpson revealed that the response is "good out to about 1 kHz" — that's the 16th harmonic of 60 Hz! With such frequency response, it is possible to look at non-sinusoidal currents with an oscilloscope, and lead to a most interesting discovery:

After our studio was modernized, we discovered that our little 5 kW generator no longer liked the load. Most modern equipment *really* operates on DC, rather than AC. Power supplies charge the input capacitor to the peak value of the AC voltage. Since the capacitor only partially discharges between each half-cycle, it only needs to be partially charged back up on the next half-cycle.

The net result is that most of the power being drawn from the AC power line is done so only during a short portion of each cycle. When this happens, you can no longer measure the current with conventional meters, such as the good ol' Simpson 260.

Getting back to the generator problem, our studio complex has a sub-feed that is rated at 120/240 @ 40 amps. The generator is rated at 120/240V @ 22 amps. "Normal" current on an RMS-type meter reads around 16A and 5A. The generator does not like that load, and computer back-up supplies will not switch back to the voltage coming from the generator.

Popping an oscilloscope across the AC line revealed the generator voltage was looking more like a square wave. Hooking the scope across the 260 input from the Amp-clamp (NEVER use a clamp-on ammeter without a proper load on the secondary!) revealed that the peak current was closer to 39 amps for around 5 milliseconds.

By balancing the studio load so that each leg was about equal, allowed us to continue using the same generator. Although some computers must still be shut down, at least we can stay on the air.

TFT 886/887 EBS, Modification Tip

David Solinske

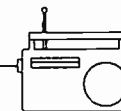

The TFT suggestion to just select the four second decode time (switch S-10) was not quite the answer for my 887's. It seems the 4 second decode switch took 5 seconds, any way I timed it.

In addition, the "re-pinning" of the CD4518, U10 for the encode length change, would not be good if the decoder did not meet specs.

I decided there is a free, simple way to change the timings which even provides a margin of safety. The two jumpers on U32 for selecting 50/60 Hz time base reference should be changed to 50 Hz. The 4 second S10-2 switch

will now decode in 3.8 seconds (at least on my units). The 12 second ENCODE switch, S9-2 then encodes for 9.5 seconds. Everything is legal, free, and provides safety margins!

There are two drawbacks to this method: 1) the 24 second encode timing used until July 1995 is now 19 seconds, so you may wish to wait and change it all on July 1st; 2) the front panel day counters will be off by a proportional error. But heck, even the TFT mod won't change the days till alarm.

Bredesen's Bytes (*Industry Updates*)

John Bredesen — Chief Engineer, KLCC, Eugene OR [503-726-2224 or e-mail jab@efn.org]

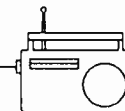

NAB, 1995, was another record breaker with over 83,000 attendees present with about 17,400 from foreign countries. Over half a million square feet of space was used, with 200,000 of that being devoted to radio and audio. This year, 992 exhibitors proudly showed what it takes to make one of the largest Conventions in the world.

And speaking of NAB, I've spoken to a couple people on Internet who were not aware that qualified persons can obtain free registration for the exhibits. Many, if not most, exhibitors have applications. Fill it out, mail it to the NAB, and they'll mail your badge, badge holder and magnetic "swipe" card to you ahead of the convention. Observe the deadline date by which you must mail the application form.

The main drawback to this free registration route is that you can't attend any of the workshop sessions.

I didn't get to participate in any of the test/demonstrations of the mobile digital broadcasts, but all reports I've gotten were positive. The USA Digital IBOC (In Band On Channel) process for both AM & FM was demonstrated and worked quite well. Multipath problems were apparently gone, unless the vehicle stopped in a dead zone, at which time the analog comparison signal was also gone. FCC Chairman Reed Hundt said that a Notice of Proposed Rulemaking dealing with IBOC would get off the ground within the next couple months. If a standard can be set using IBOC, it would save a lot of problems which would present themselves if a different frequency band were adopted for DAB, such as what band of frequencies, who would be granted channels in the new band, etc. It will leave the business of broadcasting in the hands of the professionals who know how to make the system work. Question that statement if you will.

We've been talking about the new EAS system for some time now. TFT demonstrated a working unit at the show, but I'm not aware that anyone else did. They didn't have a set price, but suggested that it would probably be under \$2,000, complete with three off-air monitoring receivers (AM, FM and a weather channel). The price can be reduced if you supply your own receiver. Of interest, the FCC has been petitioned to set the July, 1996 start date back . . . stay tuned. In the meantime, don't forget the July 1, 1995 deadline when you must have your present EBS decoders modified to respond in 3-4 seconds.

For those of you who have access to the Internet, there is a discussion group available for broadcast engineering types. You may subscribe by sending a message to:

talkin.tech_request@airwaves.com.

On the subject line, place the word SUBSCRIBE. Do not put anything in the body of the message. After you are automatically placed on the roster (by a computer), you will receive information regarding the protocol. It includes the e-mail address to be used to post to the group.

A little advice, if you subscribe to any newsgroup: be sure you save the information that is sent to you when you become enrolled in most news or discussion groups which gives instruction for that particular newsgroup. I promise that you'll need that information at some time in the future to turn it off! Think of the congestion in your mailbox if you go on an extended vacation and can't remember how to stop your mail. Save the instructions.

Streamlining Tower Clearance Procedures

One of the frustrating aspects facing engineers with antennas on multi user towers is the requirement which makes each station individually responsible for tower lighting and painting (if required on the license), even though the tower owner may, through written agreement, be the responsible party. The present requirements also makes each licensee responsible for modifying their license if a change of tower height occurs which has no impact on the station's antenna height above ground. Such an event might happen if the owner decided to, say, add 50 feet to the height of the tower. Seven stations on the tower: seven stations each must make identical modifications to their license. Last year the FCC reviewed about 17,000 applications, many of them for changes to the same structure.

The FCC has proposed revising Part 17 of the Rules and FCC Form 854 to provide a specific application for registration to be filed by the antenna structure owner, instead of each licensee or permittee. The registration will set forth coordinates, height, a unique registration number, and painting and/or lighting specifications, where applicable. The revised FCC Form 854 will also be used by the antenna structure owner to: 1) reflect an increase or decrease in the height of the structure; 2) correct coordinates; 3) reflect a change in existing painting and lighting specifications; 4) notify the FCC of the dismantling of the structure; or 5) notify the FCC of a change of ownership.

The FCC proposal would implement statutory language holding antenna structure owners primarily responsible for compliance with FCC painting and lighting specifications. Licensees will remain responsible for compliance with all tower rules, on a secondary basis, to ensure compliance if the tower owner fails to correct any violation.

Local or Remote?

Gordon Carter — Chief Engineer, WFMT, and Owner, Professional Audio Services

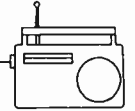

As you look at the title, do you immediately think of remote broadcasts? Or maybe remote control? How about local phone calls? Well, the reality is that this is about none of the above, except maybe local phone calls.

When you need something for your radio station, who do you call. If you are like most people I know in this business, you probably immediately think of one of the major broadcast suppliers. I won't mention any names here, but you probably have your favorite. While there is nothing wrong with any of these suppliers, I would like to suggest a few alternatives.

First of all, if you need specialized broadcast equipment, your choices are somewhat limited. Just remember that there is more than one supplier of broadcast equipment in the country. While it may take a few phone calls, check around with a number of suppliers. Many of them work on a discount system and will give you a price that is less than list. Some will give better prices than others, due to a number of factors.

Just because you got a good price from supplier A for the last thing you bought, call around anyway. If the brand of equipment you want this time is different from last time, you may find that supplier B has better prices on this brand. Some suppliers seem to have a higher volume on some brands than others, which may lead to larger discounts on that brand from that supplier.

If you are really looking for the best price, assume nothing. I once heard of a person who worked for a well-known manufacturer of computer accessories. As an employee he was entitled to a substantial discount on his company's products. One day he was checking out prices in a local computer dealer and guess what he found? Their selling price (available to anyone) for his company's products was actually less than his price with his discount. A little research saved him quite a bit of money.

This same idea applies to broadcast equipment. Ask lots of questions and you may get some answers you like.

Audio Gear

Most radio stations use equipment that is not specifically broadcast in nature. Much of the audio gear in a radio station is similar to that used in the recording studio business. This opens up a whole new world of suppliers. There are a number of small suppliers (read LOCAL) of professional and semi-professional audio equipment. Even some hi-fi stores carry some of this gear. There are even stores that sell nothing but "music" equipment. While it

is called music equipment, much of it is familiar to the broadcaster. You will find cassette machines, DAT machines, speakers, amplifiers, microphones, cables, and lots of accessories in these stores.

A local supplier may be able to give you a better price. In comparing prices, don't forget local taxes and shipping charges. The local supplier can save you shipping if you pick it up. Another possibility is that the local store may be willing to work a trade. Check this all out with your manager or sales manager, but it is a good way to help with cash flow. Again, shop around and ask questions.

Tower Riggers

Thinking local can even help with some of the really odd things in the broadcast world. If you are doing some tower work, for instance, some local companies might be able to help. If you are in an area where there are oil wells, you might be in luck. The main difference between tower riggers and oil riggers is the type of tower they work on. Both are used to climbing and working with ropes and such.

Check around and you may be able to find someone who does excellent work and is local. He might even be cheaper than some of the riggers you have used before. One thing for sure, he can probably save travel charges for you. Remember, he is local and doesn't need to travel 500 miles to get to your tower. Of course, be sure to check his references and make sure he carries adequate insurance, but you may be able to save some money

By the way, if you need pulleys, ropes, chains, or other things for some heavy lifting, check with some local industries. Most factories have this type of stuff on hand for their normal use. If they aren't using it, you may be able to borrow or rent it from them. This would be especially true if your station has a lot of community involvement. If you are a part of your local community, then other businesses are likely to be willing to help you out. Of course, if you are using any sort of heavy equipment they may want you to sign some waivers of liability, but if you bought that stuff you wouldn't have any recourse anyway, and you'd be out all that money.

Studio Furniture

Another place you should think local is studio furniture. "Studio furniture" you ask? Sure!

If you need studio furniture, check around. There is a wide range of suppliers of studio furniture out there, but chances are none of them are near you. If you are replacing

(continued on page 7)

Local or Remote?

Continued from page 6

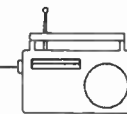

a whole control room, for instance, you could end up paying a tidy chunk of change to ship the new furniture to you. How about a local supplier?

You probably are laughing about now, since the closest supplier of studio furniture is 500 miles away. Try a local kitchen cabinet supplier. If they do the work themselves, as opposed to just selling pre-made cabinets, they can probably make exactly what you need. Talk to them, and show them your old cabinets. I tried this recently and the response I got from the kitchen cabinet guy was “This is easier than what I normally do — No drawers!” You may be able to get better furniture, that is built exactly to your specifications, for less money than a regular studio furniture supplier. It may take a bit more of your time to make sure it is done right, but you could save some money. Again, your biggest saving may be in shipping charges!

Keep Your Eyes Open

Now, before I really alienate the broadcast suppliers out there, let me explain a few things. I use broadcast suppliers regularly. I need them as much as they need me. They sell things that I just can't get anywhere else. Yes, I shop around for the best prices, but who doesn't? I think they know that, or at least suspect it.

You definitely can't get everything you need for your station locally, even if you live in a major metropolitan area (the broadcast suppliers don't seem to be located in those cities).

These suggestions are not meant to imply that the broadcast suppliers are expensive. You may find that they have the best prices. The main idea here is to just keep your eyes open and ask questions. Do your homework and it will pay off.

Marti R-10/RPT-30 Interface

Randy Kaeding — WCSE, Bridgman, Michigan

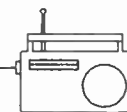

At our station, we have 161 mHz and 455 mHz receivers installed at the transmitter site, and then use 957 mHz to send the audio from one or the other, back to the studio. Recently, the 957 mHz transmitter received lightning damage, just a few days before we planned to broadcast from our annual Home and Garden Show.

Since we planned on using the 161 mHz frequency for

this, the 455 mHz equipment was configured as a “repeater.” This is probably nothing unusual, except I had to make up a cable to connect the Marti model R-10 receiver to the Marti RPT-30 transmitter, and I couldn't find the manuals. A quick call to the fine folks at Marti resulted in the cable connections shown below. This worked great and got us through the weekend with no glitches.

Socket on Marti R-10

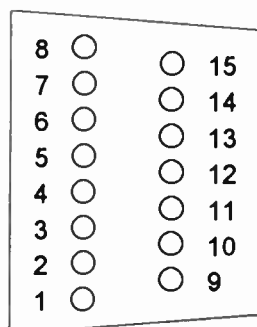

15 Pin Plug
(rear view)

Socket on Marti RPT-30

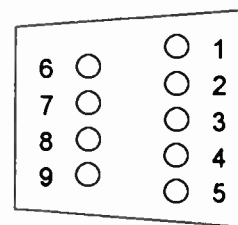
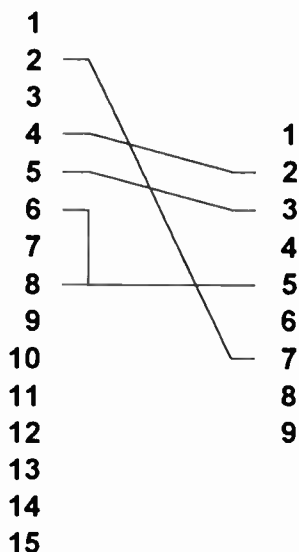

9 Pin Plug
(rear view)

Satellite Radio Basics

Tom Herrington — Universal Electronics, Columbus, Ohio



Why satellite basics in a profession where satellite audio is used on a daily basis? There is not a day goes by that I do not take many calls from stations as follows: "We are interested in buying an SCPC audio receiver to carry the United Press International Service. This services is on Spacenet 3, Transponder 17, and the frequency is 0.51 MHz." Then, follows the explanation that UPI is indeed carried on Spacenet 3, Transponder 17 at 0.51 MHz, but the transmission mode is FM/FM-FM², which is an audio subcarrier service below video, that is 0.10 MHz to 5.00 MHz in frequency, and is not an SCPC (Single Channel Per Carrier) mode. Note: This can also be call Single Carrier Per Channel.

The Basic Satellite Formats

Standard Audio Subcarriers

The standard audio subcarriers is the audio section of a normal video satellite transponder (unscrambled). The video information is carried on the frequencies from 0 MHz to approximately 5.00 MHz. The audio for the video is carried on 6.20 MHz and 6.80 MHz. Any other frequencies can, and are, used to carry other audio subcarriers not related to the video signal, in the 5.00 to 8.00 MHz range. A typical satellite transponder with unscrambled video, has one carrier. The video information and the subcarrier information both ride on this single carrier. To sum this up, any transmission mode that is shown to have a frequency from 5.00 MHz to 8.00 MHz, is a standard audio subcarrier. (See Figure 1)

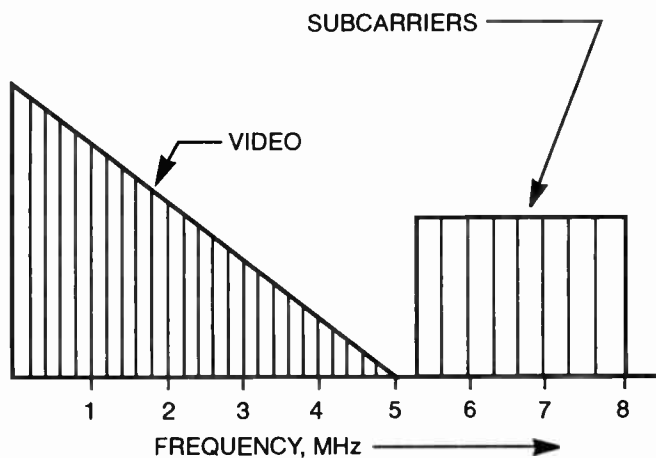

FIGURE 1 The standard subcarrier frequency plan. 6.8 MHz for video sound with 8 more 15 kHz audio channels.

Standard audio subcarriers can be carried in mono, discrete stereo, matrix and multiplex formats.

A modified subcarrier format also could be used in the audio subcarrier section. This is named Panda 1® and Panda 2® by the Wegener Company. Both of these require a special receiver. Panda 1® is a pair of stereo subcarriers with 15 kHz bandwidth, at 180 kHz spacing. Panda 2® is 7.5 kHz bandwidth, with 120 kHz spacing.

Another Hidden Audio Subcarrier FM² - FM/FM, Subcarriers Below Video, 0-5 MHz

Now that we have covered the well-known standard audio subcarriers on the satellites (Audio Subcarriers Above Video), a question arises. What if the frequencies below 5 MHz were not used or needed for video transmission? Is it possible to load this unused area with additional audio subcarriers? The answer is yes. In fact, this is the reason we refer to these lower frequency audio subcarriers as subcarriers below the video frequency area, that is, 0-5 MHz (the normal video frequency area).

Several years ago, a company started to use these below-video audio subcarriers, by leasing full transponders on several satellite, exclusively for transmission of audio subcarrier service over the transponder's entire frequency range of 0-8 MHz. These transponders do not normally carry any video signals because the frequency space normally used to carry the video signal is used for the transmission of additional audio subcarriers. (See Fig. 2)

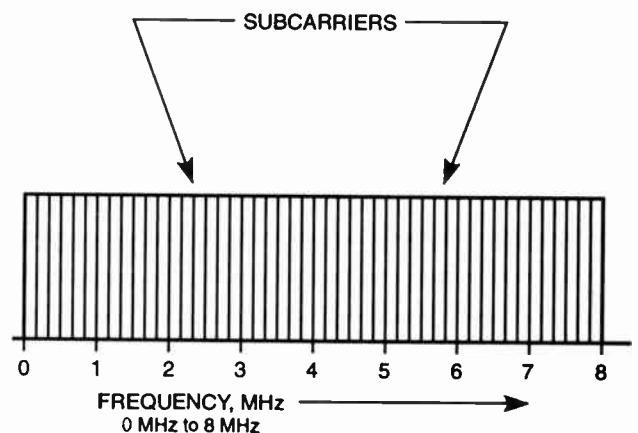

FIGURE 2 Non-standard transponder, no video, all subcarriers. Many narrow signals and subcarriers combined. The subcarriers from 0 MHz to 5 MHz are referred to as FM² or FM/FM transponders.

Satellite Radio Basics

Continued from page 8

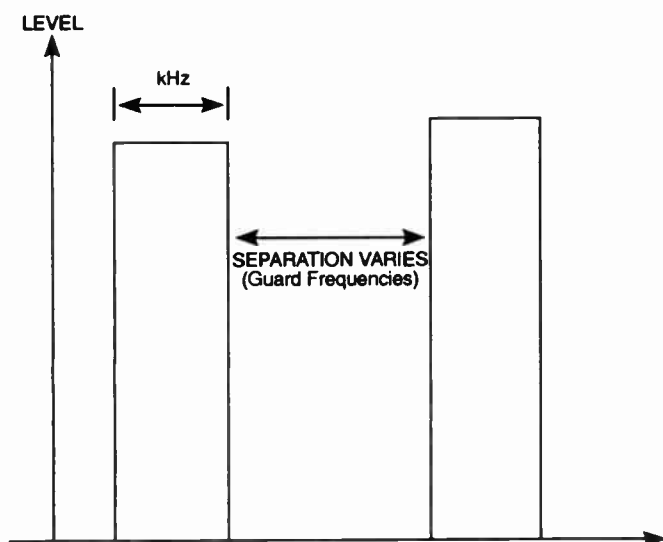
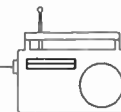

FIGURE 3 Typical spacing of SCPC channels. Separation varies along with bandwidth of each SCPC channel depending on the type of SCPC signal.

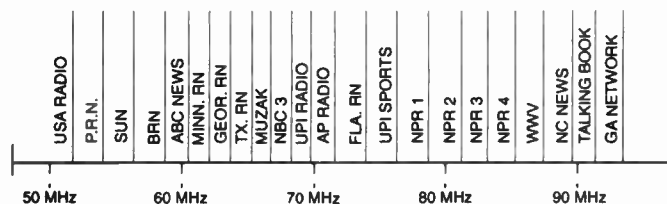

FIGURE 4 Typical (not actual) SCPC single transponder service assignments.

SCPC means Single Channel Per Carrier, or Single Carrier Per Channel. Both seem to be correct, as each narrow band channel has its own carrier which is modulated. The entire transponder is usually used for SCPC transmission.

The entire transponder frequency from 50-90 mHz is divided into many low-level carriers which are individually modulated on set frequencies.

In general, all SCPC signals are classified as narrow bandwidth signals. However, some are very narrow — narrow is 7.5 mHz and wideband is 15 kHz. (See Figure 3 and Figure 4)

Next time we'll discuss Phase Locked Loops, antennas and satellite equipment.

Editor's Notes: During the next few months, we'll be publishing more of Tom's information on radio satellite basics.

There's a wide variety of transmission formats, for satellite radio. We'll cover each one here, and go into depth on a few basic questions about what equipment you really need to get the job done.

What is SCPC? What Does SCPC Mean?

Many satellite users confuse SCPC with audio subcarriers. The two are distinctly different in the following way: The family of audio subcarrier transmissions are linked to the satellite video waveform and use this method to carry the subcarrier signal — one primary carrier.

The SCPC signals (channels) have their own independent carrier and each has its own spot frequency throughout the transponder on which they are being carried.

Avcom EBS-100 System Modification

From Bill Spitzer — KKLS, Rapid City, South Dakota

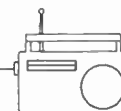

Editor: Bill called the other day and chewed me out for our lack of coverage of the Avcom model EBS-100 . . .

Avcom EBS-100 Encode Conversion

There are five pots on the back of the unit: P1-P5. Pot P3 is the one to use when changing the encode tone length. According to Bill, all that was needed was to adjust the pot until the encode tone measured 8 seconds. C37 and C38 are also involved in the timing, and may have to be changed.

Avcom EBS-100 Decode Conversion

Pot P2 is the adjustment for the decode tone length. However, you must first change C36 from 47uF to approximately 20uF. Then use P2 to adjust for a decode timing of 3-4 seconds.

So that's it! Now we've covered all EBS units out there — or have we? If you know of any other brands, give us a call or fax. We'd like to publish your conversion modifications . . . Editor

Temperature Sensor Enclosure

Dave Geho — DMG Enterprises, Yakama City, Washington

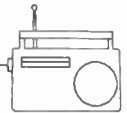

To ensure accurate temperature readings, one must place the remote sensor out of direct sunlight and wind. By building an enclosure you will be using some of the same methods used by meteorologists. Inept placement of your sensor will yield poor, unreliable results.

There are standard enclosures that are produced commercially, but are often fairly expensive. This guide will aid you in constructing your own, using locally available, and fairly inexpensive materials. The major component of this enclosure will be louvered shutters. These shutters should be either 12 or 15 inches wide. Most home improvement type stores will carry these.

The first thing you will need to do is cut the shutters so that you end up with four equal lengths, 16 inches long. Due to the fact that the construction of shutters varies slightly, one may have to stabilize the ends after cutting. This can be done with some ingenuity and some glue. No matter how you accomplish it, the main idea is a box with four shuttered walls. The roof and floor should consist of 3/8" or 1/2" plywood. Your results should look like the figure below.

The roof should overhang about 3 inches on all sides. The shutters should be oriented so that their slope faces out and down. Pilot holes will help to keep the wood from splitting. Glue and screw three of the four sides together, and then attach them to the floor by screwing from the

bottom of the floor (some glue here is also a good idea). On the top of the front wall glue and screw three, 1/4" spacers in order to make the roof sloped to allow for drainage. The fourth wall can now be attached using two hook and eye sets, so that it can be removed.

When selecting a place for your enclosure, keep these things in mind: it should be at least 15 feet away from the nearest building, on grass covered soil (if possible), away from concrete and pavement, and away from air conditioners, vents, etc. The data cable to the sensor unit should not exceed 75 feet in length.

Bury a 4-inch treated post, about 5 feet long, about 18 inches deep. If the soil is very soft, you may want to use concrete. After your pole is set (if concrete allow three days for curing), you can then attach the box; just screw from the inside of the box, through the floor. Pilot holes here will help to keep the pole from splitting. Glue is also an option here.

Next, drill a hole through the floor, alongside the edge of the post; make it large enough to accommodate 1/2" PVC pipe. This will be used for the sensor's data cable. Drill a 1/4" hole in one of the shutter walls to insert a dial type calibration thermometer. Next, paint all interior and exterior surfaces with a good quality exterior paint. At least two coats will help prevent premature fading and cracking. Lay down one coat, wait several hours, then lay another coat.

(continued on page 11)

Temperature Enclosure Construction Details

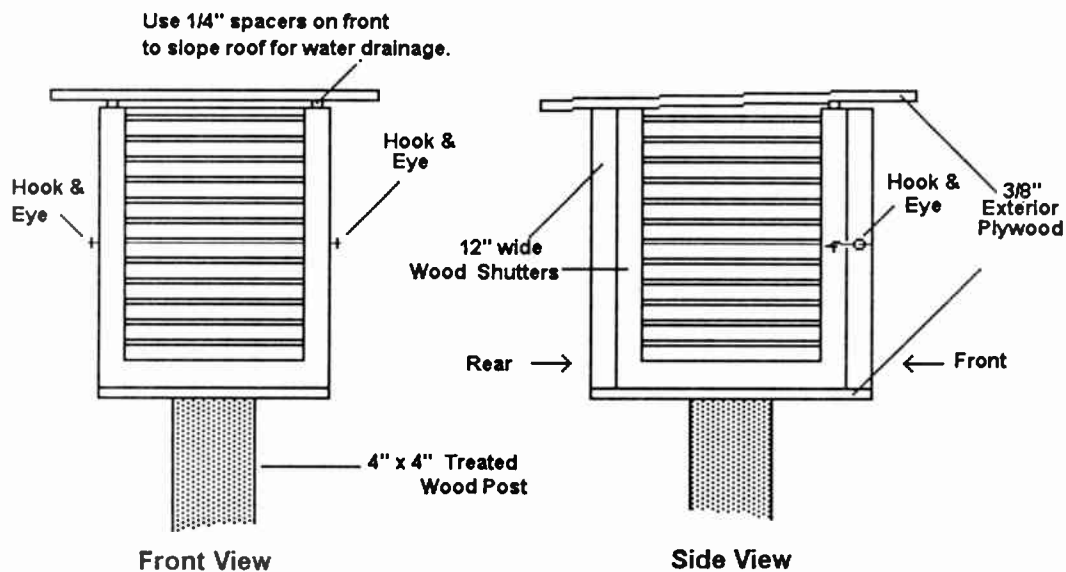

Temperature Sensor Enclosure

Continued from page 10

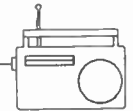

Mounting the Sensor

You will need two 1" x 1" blocks of wood, about 8 inches long. The mounting plate of the external sensor unit will be screwed to these blocks as shown here.

The blocks can then be screwed to the floor of the box. You will want to mount the unit in the center of the box, and route the data cable through the pipe you inserted earlier, in the floor next to the post.

Belden 8451 is not outdoor rated, so if you use it, it is recommended that the data cable be housed in PVC pipe, which may be buried.

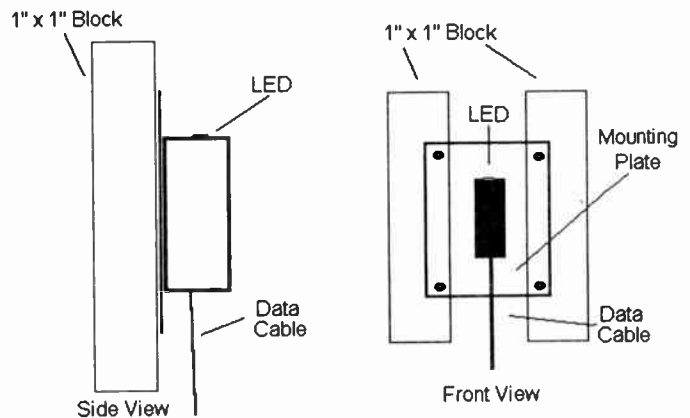

Radio Guide Quick-Tip

Here's a tip from the past. If you sprinkle mothballs around the perimeter of your transmitter building and/or doghouses, you won't have any problems with rats or mice. It really does work.

Radio Guide Quick-Tip

Install a continuous-roll, commercial style paper towel dispenser in the transmitter building. It's also nice to have some waterless hand cleaner (found in auto-supply stores).

FREE!

150 PAGE CATALOG WITH PRICES!

Radio & Computer Hotline
800-559-7388

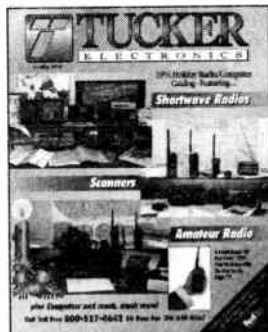

Communications Receivers • Scanners
Portable Receivers • RTTY and FAX Equipment
Amateur Transceivers • Computers
HT's & Mobile Transceivers • Test Equipment
Amateur & SWL Antennas
Books • Manuals • Accessories

TUCKER

ELECTRONICS

24 HOUR FAX: 214-348-0367
P.O. Box 551419 • Dallas, TX 75355-1419

BUY SELL TRADE

HARRIS ALLIED

317-962-8596

FAX 317-962-8961

3712 National Road West, P.O. Box 1487
Richmond, IN 47375

*Call our BULLETIN BOARD
for a current listing of the
broadcast industry's best
used radio equipment:*

317-935-0531

FREE demo video from UCANDO

UCANDO is "*Changing The Way The World Learns Electronics*"



- * Low Cost
- * High Quality
- * Learn Fast
- * Remember More
- * 16 Titles
- * approx. 1 Hour Each
- * Workbooks Included
- * Guaranteed



Low cost solution to your training needs!

Wouldn't it be great to have a staff fully trained in electronics? Well, now you can! Forget the astronomical cost of sending your staff to a technical school. **UCANDO has a high quality, low cost solution to your training needs.** Now you can train anyone at your station in the fundamentals of Basic, Digital, Radio, and TV circuits. UCANDO has 16 exciting titles to choose from. All titles are approximately one hour long and come complete with a student workbook. **Each UCANDO video is 100% computer animated and is guaranteed to teach your people more in less time** than is required by conventional learning methods. The best part is these videos retail for **only \$44.95 each!** Our price is far below industry standards. UCANDO titles include:

Part 1 Direct Current	Part 5 Amplifiers	Digital 3 Multiplexers	AM Radio
Part 2 Alternating Current	Part 6 Oscillators	Digital 4 Converters	FM Radio Part 1
Part 3 Semiconductors	Digital 1 Gates	Digital 5 Memory	FM Radio Part 2
Part 4 Power Supplies	Digital 2 Flip-Flops	Digital 6 CPU	TV Part 1

Keep your station's valuable equipment in top working order while keeping your training cost down. **Call or fax now to receive your free demo video** about UCANDO's exciting training video line.

Call 1-800-678-6113 or fax your request to 1-513-548-6124

UCANDO VCR Educational Products Co., P.O. Box 928 / 5290 Education Drive, Greenville, OH 45331

The **Radio Guide Product Pages**

New Equipment Reports, Products, and Services for the Radio Industry

DMG Enterprises TMP Temperature Sensors

Info-Fax #109

We would like to introduce you to the The TMP Line, from DMG Enterprises, a low cost alternative to the other temperature sensors available. They are simple, easy to install devices.

You can use a wide variety of power sources for the TMP Units. You can use their 110v adapter, or your own power supply from 9 to 28 volts DC; it should be clean with low AC ripple. Each TMP Unit uses approximately 30 milliamperes at 15 Volts. Their low power consumption allows use with battery backup systems to keep an eye on things, when commercial AC power fails. If you use multiple units at the same site, ask about their power supply expansion kits.

The TMP line has been designed to provide a linear output that has been tested to be compatible with many remote controls. The output is also Zener protected. Your remote control sees a fractional voltage representing the temperature; i.e., if the room is 75 degrees Fahrenheit, the TMP Unit provides 0.75V at its output. When configuring your remote control, you can simply use a linear calibration constant of 100.

The TMP Line Consists of Three Models

The TMP-1 is intended for indoor use; such as monitoring room temperature. The TMP-1 is just \$57.

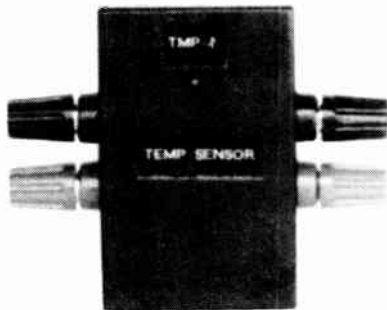

Model TMP-1

The TMP-2 has a base unit that mounts indoors, then a remote sensor to be placed outdoors, or in another environment such as on the exhaust chimney of a transmitter. The TMP-2 is Just \$87.

The TMP-3 has a base unit that mounts indoors, with an internal sensor, then a remote sensor to be placed outdoors, or in another environment such as on the exhaust chimney of a transmitter. The TMP-3 is Just \$107.

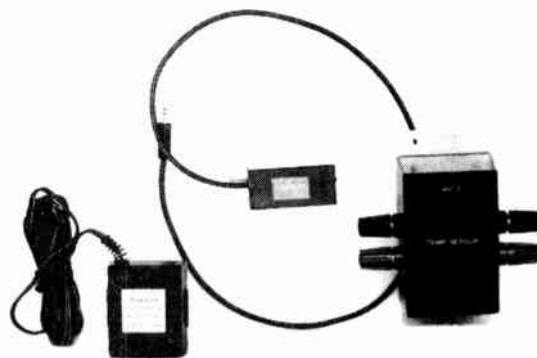

Model TMP-2/3

Some Application Info

The external sensor on the models 2 & 3 should not be mounted in a environment where it might exposed to temperatures exceeding 150 degrees F. The Base units should not be mounted in environments that would expose them to moisture.

Possible uses for the TMP include: Mounting the base unit in the transmitter building, and then mounting the external sensor outside, to let your operators know that de-icers may need to be enabled.

Another application might be to mount the remote Sensor on the outside of the transmitter exhaust stack to monitor temperature rise.

You can order the TMP Units:

1. By phone at 1-800-697-6659; Visa & MasterCard, or ship C.O.D. if you wish.

2. By Fax at 509-248-0756. Credit card info may be included; please provide card type, number, and expiration date and signature. C.O.D accepted by fax, as well.

3. By mail; your check or money order will be accepted, or credit card information may be included, please provide card type, number, and expiration date, and signature; or they can ship C.O.D. if you wish.

If you wish to use their power supply, add \$10. Power supply expansion kits allow multiple units to share one supply, and are just \$7.85.

Shipping is free, if a power supply is ordered with a TMP Unit, otherwise shipping is just \$6.95. If C.O.D., add \$10.45. You may qualify for discounts if you order more than five units at one time. If your TMP Unit fails within the first 90 days, DMG Enterprises will repair or replace it, at their option. If you have any questions please call their tech-support line at 509-577-0505.



WHY is HALL Electronics for YOU?

You'll like our GREAT PRICES on NEW & REBUILT EQUIPMENT. WE CARRY MOST BRANDS

You'll LIKE HALL's personal SERVICE - for one piece or an ENTIRE STATION. You are not a number to us; rather someone who needs a problem SOLVED.

We have an IN-HOUSE TECHNICAL SUPPORT TEAM. Our THREE full-time technicians give support after the sale and are always available to help with ALL your rebuilding or repair needs. WE STAND BEHIND OUR WORK. We are an authorized service center for Tascam and Otari.

Contact Rick or Jon . . . today!

WHEN YOU NEED GOOD PRICES & SERVICE,

Call Hall!

Phone 804-984-4255 Fax 804-984-3299

Info-Fax #101

Info-Fax #102

Need more information? Circle the Info-Fax numbers on Page 16

Info-Fax #103

Info-Fax #104

ERI - Trusted since 1943
for Proven Performance in
ANTENNA - FILTER
LAMBDA™ MOUNTING
TOWER-INSTALLATION

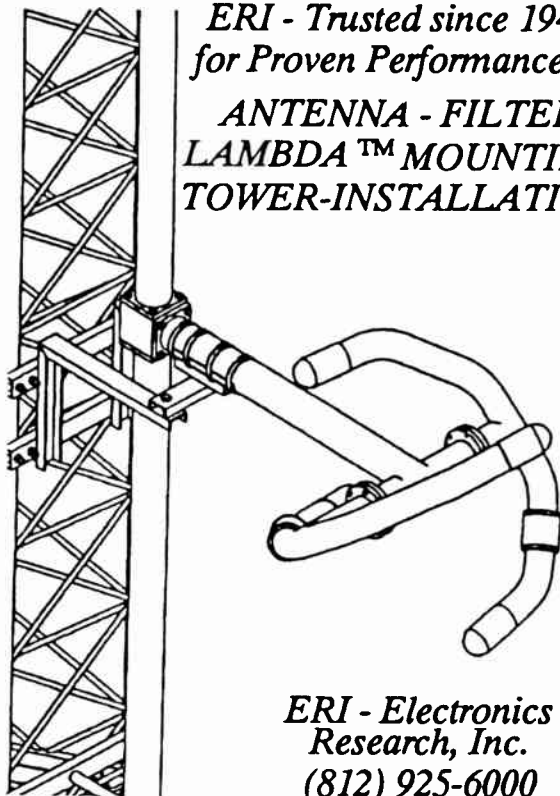

ERI - Electronics
Research, Inc.
(812) 925-6000

UNIVERSAL SCPC



XE-1000



SCPC BROADCAST
AUDIO RECEIVER

New, affordable, frequency-agile receiver, direct channel entry by keyboard, selectable companding 1:1, 2:1, 3:1, wide/narrow bandwidth, de-emphasis selectable, 950-1450 MHz, line output 600 ohms, muting, transponder agile, LNB power supply, 50-channel memory, full baseband output, high-quality audio. Every needed feature at a sensible price (lowest in the industry). Write or call for full information on this quality receiver—the answer for your station. Networks call for prices.

Phone: (614) 866-4605 Fax: (614) 866-1201

UNIVERSAL ELECTRONICS, INC.
Communications Specialists
4555 Groves Road, Suite 12 Columbus, OH 43232

Commercial Radio Company

Duttonsville School Dr., Cavendish, VT 05142
Phone 802-226-7582 Fax 802-226-7738



Transmitter Parts
RCA - Gates
Collins/Continental



Mica Transmitting Capacitors: Sangamo, CD, Sprague, Aerovox, Acushnet types: CM-15, CM-20, CM-25, CM-30, HT, HK, AT, AK, F1, F2, F3, 30B, E, 1996, 291, 292, 293, 294 & G5.

Fixed and Variable Vacuum Capacitors: Jennings, Dolinko & Wilkins, Mounting brackets and flanges. Vacuum relays.

Oil Filled Filter Capacitors: Plastic Capacitor Corp., 600 to 40 kV, 1 mFd to 30 mFd with special mounting brackets. Non-PCB oil capacitor replacements are available for most transmitters.

Ceramic RF Capacitors: Centralab, Jennings, Sprague, High Energy, 5 kV to 40 kV.

Variable Transmitting Capacitors: E.F. Johnson Co., Cardwell Condenser Co., insulated shaft couplings as used in phasors, variable transmitting capacitors.

Weschler-Westinghouse: RF ammeters, 0-0.5 amps through 0-50 amps, internal and external thermocouples, expanded and linear or square-law scales. Sizes are 3 & 4 inch, round and square. Special meters are available.

RCA: Transmitter, phasor and antenna tuning unit parts.

ULTRAMOD® . .UM2000

FM STEREO MODULATION SYSTEM



- The UM2000 is a complete FM processing and stereo generating system featuring:
- Dual band, stereo AGC and peak processors of exceptional clarity.
- Digitally synthesized stereo generator with separation exceeding 60dB at 1kHz, and typically 55dB at 15kHz.
- Dual composite outputs for feeding main and auxiliary transmitters or STL's. Very affordable.

WHY PAY MORE ... AND GET LESS?

HNAT HINDES inc

42 Elaine Street, RR1, Thompson, CT 06277
203-935-9066 203-935-9242

Info-Fax #105

Need more information? Circle the Info-Fax numbers on Page 16

Info-Fax #106

Info-Fax #107

Econco

Rebuilt Power Tubes

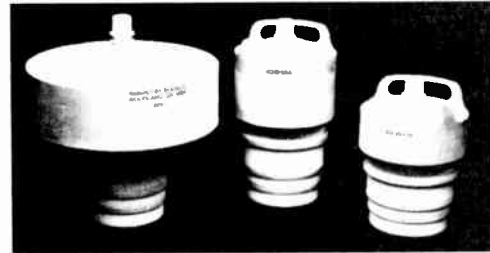

Approximately
One Half the Cost of New

Call for Our Price List

Econco

1318 Commerce Ave., Woodland, CA 95695
800-532-6626 Canada 800-848-8841

FCC Rules on Kahn POWER-side™

Motorola tried to deny broadcasters the right to increase coverage by using SSB — Kahn POWER-side™ equipment. But the FCC specifically ruled that the "Kahn POWER-side system ... may continue to be operated ..." as a mono improvement system. So you can now use POWER-side with Kahn independent sideband exciters to immediately increase coverage to listeners using any and all type of AM receivers.

Federal Communications Commission FCC 93-485:

21. Kahn "POWER-side" Operation. Several parties express concern over the continued acceptability under our rules of operating using the Kahn POWER-side AM single-sideband system. POWER-side operation, as distinct from Kahn stereo operation, involves an AM transmitter with two independent sidebands, containing identical program material, but with intentional level and frequency response differences. This system is implemented with a Kahn independent sideband stereo exciter and is claimed to have certain advantages for reception with monophonic receivers, particularly in adjacent-channel interference situations. CTI and Furr argue that adoption of the proposed standard would prohibit such an implementation. Motorola maintains that the Kahn POWER-side mode of operation is not stereophonic and questions its legality under the present rules.

22. Our AM rules do not include a definition of the term "stereophonic." However, generally accepted definitions of stereo service infer two or more channels of audio information designed to produce an audio "image" when demodulated by an appropriate receiver. On this basis, we find that stations employing the Kahn POWER-side system are not subject to the provisions of the stereophonic transmitting standard adopted herein and may continue to be operated, provided that the program material fed to both channels of the exciter is identical in content.

POWER-side™

PROBLEMS

Adjacent Channel Interference
Antenna Null Distortion
Co-Channel Interference
Power-Line Re-Radiation
Building Re-Radiation
Receiver Tuning
Low Fidelity Home Radios
Co-Channel Beat
Selective Fading

SOLUTION!

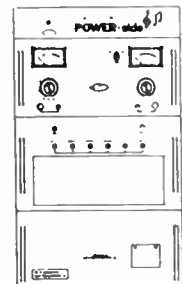

(516) 222-2221

POWER-side™

The solution to many of
AM radio's most serious
technical problems.

*From the developers of the AM STEREO system
that isn't afraid of the dark, and will let you drive right past FM Stereo.*

Kahn Communications, Inc.

222 Westbury Avenue, Carle Place, NY 11514

Radio Guide

Radio's Technology Forum

May-1995



INFO-FAX



Fax This Form to 507-280-9143

Personal Information

Please change my subscription mailing address.

Name: _____ Station: _____

Address: _____

City: _____ State: _____ Zip: _____

Phone: _____ Fax: _____

Free Product Information

Check out the product information on page 1 and pages 13-15 of this Radio Guide. Then circle each one from which you need more information, below.

#101 - Hall Electronics

#104 - Commercial Radio

#107 - Kahn Communications

#102 - ERI

#105 - Hnat Hinds

#108 - Audio Broadcast Group

#103 - Universal Elect.

#106 - Econco

#109 - DMG Enterprises

Your Short Tech Tip

If you have a tech tip for publication, please write it down here, and fax it to us right away at 507-280-9143.

Duplicate this sheet if you need more room.

Radio Guide

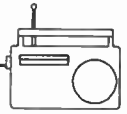

Radio's Technology Forum

June 1995

Bits and Pieces

This month we need to clear out a few things that have stacked up. Here goes . . .

Job Opening

First of all, I promised Brooke, at LBA Technology, that I'd post this job opening. In case any of you are planning a career move or change, here are the details:

AM ENGINEER

Extensive career experience in AM directional antennas, including design and field engineering. SBE Certification/EE/PE a plus. Opportunity with an international consulting firm. Some travel required.

**Contact: Win Donat, President
LBA Technology Inc.
PO Box 8026, Greenville, NC 27835**

Bald Mountain Labs EBS

Sandy Hanes called the other day, with a question regarding the Bald Mountain Labs model BML-574 E/D EBS encoder/decoder.

It took me by surprise, since I've never heard of it. It just goes to show, that no matter how long you work in a profession, there are still "unknown" pieces of equipment, that show up from time to time.

In any case, if you have or have access to any EBS-EAS modification information on the BML-574 E/D, please give me a call. I'd like to include it in a future issue. For that matter, if you have any modification information on any "unknown" EBS units, I'd like to have that as well.

Radio Guide Lifetime Subscriptions

All paid Radio Guide subscriptions have now been automatically converted to a no-charge, lifetime status.

From now on, at the beginning of each year, you will receive a subscription request card, to fill out with any address changes, etc.

To keep your free Radio Guide lifetime subscription coming, just mail or fax the card back to us. *Ray Topp*

FEATURE OF THE MONTH

TASCAM PA-20 MK II Dual Power Amp
BIG POWER FOR A LITTLE PRICE

For maximum flexibility, the PA-20 MK II is equipped with both XLR balanced and RCA

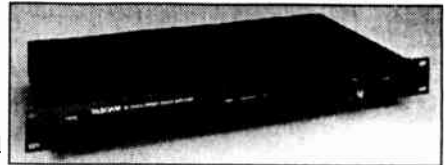

unbalanced input connectors. At 25 watts per channel, it excels in control room and production studio applications.

ABG Special Price \$189⁰⁰

Please call today!

MAIN SALES OFFICE
2342 S. Division Avenue
Grand Rapids, Michigan 49507
Phone: 800-999-9281
Fax: 616-452-1652

SOUTHEASTERN SALES OFFICE
200 Fareway Drive, Suite 2
Smithfield, North Carolina 27577
Phone: 800-369-7623
Fax: 919-934-8120

WESTERN SALES OFFICE
P.O. Box 1638
Palmdale, California 93550
Phone: 800-858-9008
Fax: 805-273-3321

For 35 years
AUDIO
broadcast group inc.

YOU MAY ALSO REACH US ANYTIME VIA ELECTRONIC MAIL
cServe: 75371,144
internet: support@abg.com

Inside This Issue

High Voltage Kit (<i>editorial</i>)	2
Contract Engineer List	3
RPU Applications	4
Make a List	6
Cart Machine Maintenance	7
Inexpensive Sound-Proof Wall	8
Event Counter/Timer	8
TFT Model 760-04 EBS Mod.	8
Harris MW-1/1A NRSC-2 Kit	9
CCA FM 2000D/E VSWR Mod.	9
SBE Participating BBS Systems	9
Satellite LNB Primer	10

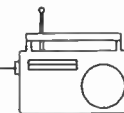

Radio Guide Publication

Raymond Topp (*editor and publisher*)

511 18th Street SE, Rochester, MN 55904

Phone: 507-280-9668

Fax: 507-280-9143

Our Contributing Technical Writers

George Whitaker - Arlington, TX

3505 Daniel, Arlington, TX 76014

Phone: 817-468-2586

John Bredesen - KLCC, Eugene, OR

3120 Nob Court, Eugene, OR 97405

Phone: 503-485-6869

Gordon Carter - WFMT, Chicago, IL

34 North Madison Ave., LaGrange, IL 60525

Phone: 312-565-5032

Andy Butler - Broadcast Electronics Inc.

P.O. Box 3606, Quincy, IL 62305

Phone: 217-224-9662

Frank Berry Ph.D.

190 112th Ave. N, #708

St. Petersburg, FL 33716

Phone: 813-577-0041

How to Submit Tech Tips

By BBS: Call our BBS at 507-280-4045, and leave your tech tips, info and articles.

By Disk: Send your tech tips and information on a 3.5" or 5.25" double, or high density floppy disk, in ASCII format.

By Compuserve: Leave E-Mail files to Radio Guide at Compuserve ID — **71203,2341**

By INTERNET: Leave E-Mail files to Radio Guide at Internet ID — **71203.2341@Compuserve.com**

High Voltage Kit

This is the second in our report of ten kits of parts and tools, that can help make life a bit easier.

First, here is a list of the items contained in the high voltage kit:

High Voltage Electrical Tape

High Voltage Putty

Ceramic Standoffs

High Voltage Wire

High Voltage Test Probe

Grounding Stick

The high voltage electrical tape and putty can be used to cover exposed conductors, connections, and burned insulation. 3M Company, among others, has an extensive line of professional electrical sealants, tape, and insulating materials. Any local electrical supply house can provide you with a catalog.

Ceramic standoff insulators can come in handy when isolating HV components, during emergency repairs. They can be found in old gear, or may be obtaining from some of the electronic surplus dealers found in the back of many electronics publications.

The high voltage wire is the obvious solution to old or destroyed HV wiring.

Get a high voltage test probe for your VOM, DVM, or mutimeter. Some models may have a self-contained meter, but use the ones that plug into your existing meter. With appropriate safety precautions, you can use the probe to get actual, accurate high voltage readings, that may otherwise be unavailable.

Each transmitter, phasor, equipment rack, and ATU should have a grounding stick, securely grounded to the frame. Make sure that all sticks present a secure ground; make it a part of your maintenance procedure.

By the way, always use protective goggles or glasses when using a grounding stick. You may come into contact with live AC, high voltage, or a fully charged power supply capacitor. Sparks can fly!

Ray Topp (publisher)

Radio Guide (ISSN 1061-7027) is published monthly, 12 times a year, by Media Magazines Inc., 511 18th Street SE, Rochester, MN 55904.

All material contained in Radio Guide is copyright 1995 by Media Magazines Inc., and may not be reproduced or stored in any form without the written permission of the publisher.

Radio Guide Contract Engineers List

Call us at 507-280-9668 to be listed here.



Tom Rusk
T&M Enterprises
3 Sharondale Ct.
Maumelle AR 72113
501-851-0144

Mike Callahan
KIIIS Radio
6255 Sunset Blvd.
Los Angeles CA 90028
213-466-8381

Mark Pallock
MBE Enterprises
20739 Kinsbury Street
Chatsworth CA 91311
818-882-9475

Mark Sadacca
Southern California Radio Eng.
P.O. Box 1317
Crestline CA 92325
909-338-2551

Terry Gaiser
9451 Eucalyptus Drive
Bakersfield CA 93306
805-366-2211

Scott Dean
Dean Engineering
Box 25085
Fresno CA 93729
209-434-2358

Tom Oja
ACM Communications
P.O. Box 6926
Napa CA 94581
707-257-6000

Rick Melzig
Broadcast Engineering Associates
340 Bella Vista Ave.
Los Gatos CA 95032
408-356-4230

Chip Morgan
CMBE
2340 Dartmouth Place
El Dorado Hills CA 95762
916-933-9330

Joel Humke
J.C. Humke & Associates
516 Zion St.
Aurora CO 80011
303-367-1515

Bill Harris
E&B Services
2950 South Birch St.
Denver CO 80222
303-756-4843

Paul Montoya
Broadcast Service of Colorado
5945 West Mississippi Ave.
Lakewood CO 80226
303-727-9700

Jim McDonald
Wind River Broadcast Center
117 East 11th St.
Loveland CO 80537
303-669-3442

David Schmidt
Mid-Atlantic Radio Service
P.O. Box 11502
Wilmington DE 19850
302-323-0338

Rick Brady
Sprud Creative Enterprises
1625 East Pkwy.
DeLand FL 32724
904-822-9766

Mike McCarthy
McCarthy Radio Engineering
P.O. Box 445
Mount Prospect IL 60056
708-640-8965

Art Reise
R.E.I.S. Inc.
308 Eastgate Ct.
New Lenox IL 60451
815-485-7377

Gordon Carter
Professional Audio Services
34 N. Madison Ave.
LaGrange IL 60525
312-565-5032

Martin Hensley
Marcom Communications
6426 Maidstone Rd. #206
Indianapolis IN 46254
317-387-9667

Frank Hertz
Newman-Kees Engineering
8611 Slate Road
Evansville IN 47720
812-963-3294

Tom Toenjes
Signal Specialists
6120 Riley Creek Rd.
St. Marys KS 66536
913-437-6549

Jack Maxton
Commercial Radio Service
Route 1 Box 21
Scammom KS 66773
316-479-6837

Larry Baysinger
Larry Baysinger & Associates
8000 Casualwood Ct.
Louisville KY 40291
502-231-0723

David Smith
Dave Smith Engineering
P.O. Box 300
Stanford KY 40484
606-365-0959

Mike Patton
Michael Patton & Assoc.
12563 Parkiel Ave.
Baton Rouge LA 70816
504-292-4189

Robert Reppe
Electronic Troubleshooting Svc.
2231 Bowersox Road
New Windsor MD 21776
410-875-4021

Ken Hoen
Teletech Inc.
23400 Michigan Ave. Suite 615
Dearborn MI 48124
313-562-4500

Dick Johnson
Custom Electronics
1044 Westwood Dr.
Faribault MN 55201
507-334-6735

Joe Bellis
RMF Associates
1522 Independence
Cape Girardeau MO 63701
314-651-4272

Larry Fuss
Contemporary Communications
P.O. Box 1787
Cleveland MS 38732
601-846-1787

Ted Fuller
Fuller Electronics
501 Heizig Ave.
Salisbury NC 28144
704-633-1009

Ken Bartz
Bartz Engineering Services
P.O. Box 7306
Fargo ND 58109
701-237-3006

Walt Gradski
Radio Visions
P.O. Box 4732
Toms River NJ 08754
908-240-3119

Jim Slitt
Jim Slitt & Associates
621 Mehring Way Suite 1907
Cincinnati OH 45202
513-621-9292

William Wolf
W@W Enterprises
2212 NW 119th St.
Oklahoma City OK 73120
800-942-5430

Troy Langham
Radio Technical Group
1502 South Boulder Suite 206
Tulsa OK 74119
918-582-0817

James Boyd
Boyd Broadcast Technical Service
21818 SW Columbia Circle
Tualatin OR 97062
503-692-6074

Ronald J. Doto Sr.
Ronald J. Doto Electronic Maint.
4215 Liberty Rd. S
Salem OR 97302
503-378-7024

Ron Balonis
Mountaintop FM
118 Rice St.
Trucksville PA 18708
717-825-9898

Bill Spitzer
WLS Communications
P.O. Box 460
Rapid City SD 57709
605-343-6161

John U. Almon
5-9 Communications
105 Flintlock Dr.
Franklin TN 37064
615-790-7706

Kirk Harnack
Hamack Engineering Inc.
2561 Jenwood St.
Memphis TN 38134
901-377-5565

David Armstrong
Armstrong Technical Services
13328 Firebrick Drive
Houston TX 77041
713-937-9240

Dave Biondi
The Broadcast Service Co.
P.O. Box 27595
Houston TX 77227
800-350-4964

Wes Whiddon
3W Engineering
Route 3 Box 279
Conroe TX 77303
409-264-3660

Tommy Gray
GrayTech Communications
110 Kreekview Dr.
Victoria TX 77904
512-572-3394

Paul & Anita Easter
L&P Electronics
201 Gaslight Square
Corpus Christi TX 78404
512-884-8455

Mitchell Stern
M&R Associates
14 Kimberly Dr.
Essex Junction VT 05452
802-879-6589

Dave Hebert
Dave Hebert & Associates
P.O. Box 2442
Pasco WA 99302
509-545-9672

Terry Baun
Criterion Broadcast Service
5300 West Garfield Ave.
Milwaukee WI 53208
414-449-5300

**If you have a
contract business,
you can be listed
here, at no charge.
Just call us at
507-280-9668**

RPU Applications

John Bredesen — Chief Engineer, KLCC, Eugene OR [503-726-2224 or e-mail jab@efn.org]

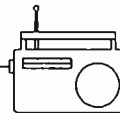

As this is the month of June, the first significant date in the change of EBS/EAS rules is less than a month away. By July 1st, you must have your present EBS two tone decoder modified to respond to the new, shorter tones. On that date, stations have the option of shortening outgoing tones to 8 seconds. Decoders must be modified to respond within 4 seconds in order to make sure they trip satisfactorily.

The March and April issues of Radio Guide have details on modifying the most common EBS equipment. Additionally, I've recently become aware of a company named "AddieTech, Inc" in LaGrange Park, Illinois which, for \$75, will modify your EBS equipment to comply with the new EAS rules. For this price they will modify both encoder and decoder with switchable tone and response lengths, check the power supply, check the units and supply written documentation and a guarantee. Return shipping is included. You may contact them at (708) 579-3749 for additional details.

I'm going to take the opportunity this month to tell you how one station uses its Remote Pickup Units (RPU) in a couple of applications which, apparently, are not too common. In all modesty, that station is KLCC-FM in Eugene, Oregon. If that sounds familiar, it's because it's my station, and you see it listed here at the top of the page each month.

In order to understand one of the applications, I need to give you a little background about the physical configuration of the station(s) first. KLCC, and its satellite station, KLCO, serve west central Oregon with a public radio service, including National Public Radio. KLCC in Eugene has an ERP of 81 kW (horizontal) and 53 kW (vertical). Eugene is at the very southern end of the Willamette Valley, about 100 miles south of Portland. Unfortunately, we are surrounded on three sides by mountains, and because of that, we've installed seven translators to serve communities which otherwise wouldn't receive either our service, or any public radio service at all.

Communities along "our" part of the Pacific Coast are located, generally, on a relatively narrow strip of land delineated by the Ocean to the west and the Coastal Range of mountains to the east. These mountains are not very high compared to the Cascades to the east of Eugene, but they do effectively block FM signals from stations in Eugene and other cities in the Willamette Valley.

Most of the coastal communities are rather small with populations in the few thousands, and we have translators located in two of them. There are a couple of almost

adjacent communities with a significant combined population, however, located about 90 miles NW of Eugene (the ocean is approximately 60 miles west). The area had absolutely no public radio service available, but is too large to cover effectively with a translator, or even two, so a decision was made several years ago to install a solid state transmitter between the two communities with an ERP of 3.2 kW. The transmitter site is located on a high ridge called Otter Crest. As part of the project we installed a two-hop bi-directional microwave system between our main transmitter site in Eugene and Otter Crest to carry program audio and transmitter control telemetry to KLCO, and monaural 15 kHz monitoring audio and telemetry back to the Eugene transmitter. Additionally, we have the standard STL and TSL links between the main transmitter and the studio which is located on the main campus of Lane Community College.

Eugene, like many communities, has outdoor musical activities at various times of the year. Years ago KLCC made arrangements to broadcast some of them live and in stereo. In the 1970s and 80s, the easiest way to get the signal back to the studio was via equalized phone lines which the phone company was glad to provide at a reasonable cost, even for this occasional type of service. By 1988, however, the cost for a two-day event had risen to an astronomical figure of over \$1,600. We continued to use this "service" of the phone company for a couple more years for musical remotes because it was either that, or not do them at all, at least on a live basis. As you might guess, the charges increased each time.

We did two remotes on a regular basis each year, which meant we were spending over \$3,000 to get the signal back to the studio. Reliance on the phone company also meant we were limited as to where we could do remotes; anything out of town was obscenely expensive, and therefore not practical. And there was one out-of-town event we really wanted to cover.

In 1991 we made the decision to purchase our own radio gear to bypass the phone company and to allow for a larger radius of operation. We ordered two identical Moseley RPL 4000 transmitter/receiver pairs and a pair of Scala 5 element antennas. The Moseley units were chosen because of the audio performance these systems provide in the wideband mode, including a frequency response to 14 kHz, and a signal to noise ratio of 68 dB.

(continued on page 5)

RPU Applications

(continued from page 4)



We also added an additional 950 MHz transmitter/receiver to the existing TSL link, which you may recall, was originally installed to bring monitoring audio back to the studio from the station on the coast. We then had a matched pair of 15 kHz mono links to the studio from the main transmitter site, which would also be the receiving site for the remote pickup transmitters.

The problem of RPU reception at the main transmitter site was solved neatly by using a “community” antenna with vertical polarization. Our 650 foot tower is used by multiple users, and one of them is a major two-way radio service provider who had installed an omnidirectional antenna quite high up on the tower to provide reception for their two way radio receivers. A preamp ahead of a 10 output signal splitter provided a good, quiet signal which is used by three broadcast stations for RPU signals.

We were concerned about coupling between our remote site transmitting antennas, which could result in intermodulation products being produced in the output devices of our RPU transmitters. We ordered and initially used a pair of ferrite isolators, but it turned out to be unnecessary. We use an antenna mounting configuration which provides about five feet of separation between antennas, and we’ve not had any problems.

The setup I’ve described isn’t that much different from that that many stations use except that it’s wideband audio and utilizes two channels for stereo. We’ve been using the setup for several years with great success. It also allows us to do a music remote from a wooded site about 17 miles out of town which is the home of the annual Oregon Country Faire, something which we were precluded from doing while we were tied to telephone company facilities.

We realized at the beginning that we were running a risk of interference from other users of the 450 MHz band, of which there are many, but we’ve had almost none. Occasionally we hear a low-level, but never-the-less raucous, sound sweeping from the right channel to the left. We think it’s a two way transmitter off frequency, but it happens so seldom that we’ve never had the opportunity to see it on a spectrum analyzer, so we’re only guessing.

The next application is quite different. Our service area covers several counties, and Lincoln County, where

the KLCO transmitter is located, is an important one in state politics, as is Lane County where the studio is located. Prior to the acquisition of the RPU equipment, we provided coverage for local and Lane County elections by dial-up phone. The cost of long distance calls and the lousy quality caused us to decide against providing coverage in Lincoln County.

However, after we had purchased the RPU gear, we realized we had the perfect audio path from the coast via the KLCO monaural monitoring link. The remote transmitter installation had proven reliable enough that we felt that we could eliminate the audio monitoring for short periods without jeopardizing service. This, of course, is also the case where we use the TSL for local stereo.

When we want to provide coverage from the Lincoln county courthouse where the election returns come in, we remove one of the RPU receivers from the rack in Eugene and reinstall it at Otter Crest (maybe we’ll be able to afford a second receiver someday!) where we have a permanently installed receive antenna for the purpose. Audio from the RPU receiver is substituted for the monitoring audio, and therefore automatically appears back at the studio on the BMX II audio board!

To obtain local coverage for Lane county returns, we take the remaining RPU transmitter to the Lane County Fairgrounds and feed it back to the studio on the remaining TSL channel which also appears on the audio board. Reporters at each of the two remote sites use the main program audio for cueing purposes. Cellular phones are used in addition for logistical reasons. With this setup, we are able to provide our listeners with aural characteristics which, with the exception of background noise, is very close to studio quality. It’s difficult at times to believe the three reporters aren’t in the same room talking to each other around the same table. As a matter of fact, we’ve had a couple calls from listeners who accuse us of faking the whole thing!

All in all, it has been a very worthwhile investment. While we can only count the remotes we were able to do with the phone lines, we’re only a couple years away from recovering our capital expenditures. In addition, the equipment has given us a flexibility that we didn’t have before.

Radio Guide Quick-Tip

Always bury your underground coaxial cables in a trench filled with sand. Punctures and kinks from rocks and foreign material will be eliminated.

Radio Guide Quick-Tip

Duplicate your transmitter schematics with a large-format copy machine, and scale to a larger size. They’re handy, and you won’t ruin your originals.

Make a List

Gordon Carter — C.E., WFMT, and Owner, Professional Audio Services [312-565-5032]

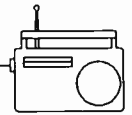

Quick! Give me a short list of the different types of people in the world!

Yes, it's a trick question. The correct answer (use the hints given in the question) is: 1) Those who make lists, and 2) Those who don't make lists

The next logical question is which type of person are you?

What does this have to do with broadcast engineering?

Let's Take a Look

Whenever you work on a project, you make a list. Maybe you don't write it down, but you make a list. In fact, you probably make quite a few lists. You make a list of the things you need for the project. Somewhere along the line you might make a list of the costs involved in the project, especially if you have to get the budget for it. You make a list, either written or mental, of the steps involved in completing the project. Depending on the type of project, you might make a list of the things you have to test in the completed project to make sure everything is working correctly. The larger the project, the longer the list. Also, larger projects may even require more lists.

There are other times when lists are important, too. Each day, when you go to work, do you make a list of the things you have to do. I used to say that this was quite silly, since you just do what you have to. But what happens when the work begins to pile up? Suddenly you can't deal with everything as it happens. If you do, you will never finish anything. Make a list of what you intend to do for the day before you start. After you make the list, put the items in the order of importance, with the items that are the most pressing at the top of the list. Sure, you may have some emergencies that may interrupt your work, but just add the emergencies to the list in their respective place.

A transmitter off the air immediately goes to the top of the list, but perhaps a flaky cart machine can be worked around for a while. If it can, or if you have another one you can plug in for the interim, do what you have to, and then get back to your list. Each time you complete an item on the list, mark it off, and include the amount of time it took you to complete. As you do this, you will find that at the end of the day you may actually have finished something. If you are lucky (or good) you will have completed your list. As you do this, and mark things off your list, you will begin to find that you feel like you are doing something productive. It may even make you want to go to work tomorrow and try to get a few more things off the list.

This type of daily list has another use as well. Keep the list. Mark the items that were added as emergencies. Then, when your boss asks you what you did all day, you can show him. You can even show him how long each item took you. In an extreme case this may even help save your job by showing that the company is getting its money's worth from you, and you're not just wasting your time at their expense.

There are other types of lists that can come in handy as well. An equipment inventory is a list. Is it useful? You bet! A current inventory is important if you ever have to make any sort of insurance claim, such as for fire or theft. A good inventory includes item description, manufacturer, model number, serial number, date of purchase, initial purchase cost, and other information. You may want to talk to your station's financial wiz before you put this together. You may want to make your inventory part of his financial records.

One of the most important parts of an inventory is to make sure you keep it current. If you have to scrap an item, add an item, or even just move it from one location to another, you may want to update the list. This type of list is often kept on a computer with some sort of spreadsheet or database program. If you keep your own list, make sure it is compatible with the financial one.

Budgets are another type of list. It is a list of things you need to buy and the costs of those items. When you put this one together, be sure to include all the "hidden" costs. This would include costs such as shipping, taxes, and some room for price increases. (Just because it costs a certain amount when you put the budget together is no guarantee that it will still be the same price when you get around to buying it.) Also, if it requires installation, be sure to include some room for outside contractors (if necessary), your own time (if applicable), and installation material (wire, connectors, etc.). Failure to include any of these items could get you in a real fix later.

Let's take a quick look at some of the mechanics of making lists. Of course, you can always jot them down on a piece of paper, but that may not be the best way. If you have to manipulate your list later, a written list will have to be copied. If you use a computer, you can probably copy the list quickly and incorporate it into whatever you need. Depending on the type of list you may have to add numbers or relate the list to other items. If so, you may want to consider a spreadsheet or relational database program.

(continued on page 7)

Make a List

Continued from page 6



Budgets work very well on spreadsheets. Parts lists or inventories might be better on a relational database. If you have your inventory on a relational database, you can save yourself a lot of typing and help yourself in the future as well. A properly set up relational database will be able to connect the type of machine with others of the same type. You only have to type repeated information once and establish the correct links in the program. If you put your maintenance records in it as well, you can use it in the future to look up the symptoms, and find out what you did before, with another machine, to correct the situation. I have

thought of doing this for quite some time, but have not yet done it. If you have something like this, I would like to hear from you.

As you start using lists for more things, you will probably find even more uses for them. Making lists is a good habit to get into. Just don't be like a person I once knew. He was so wrapped up in making lists that he made a list of everything he did in his job. It took him three weeks to make a list of the steps to doing a 20 minute close-up. Great idea, but a bit out of proportion. Don't let your boss find you doing this, or you may end up like my friend, out of a job.

Cart Machine Maintenance

Todd Petersen — Harris Allied, Richmond, Indiana

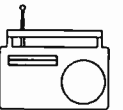

Our industry is moving in the direction of digital technology, but there are many stations that are still using cart machines. If you're responsible for the performance of these machines, some simple, routine maintenance can make them sound better, make them more reliable, and make them worth more when you decide to trade them in for your move to digital.

A key to keeping your machines in good shape, is setting up a basic maintenance schedule. This should include cleaning and aligning the heads, changing the pinch roller, re-capping the circuit cards, and a general cleaning of the machine. This schedule will depend on the amount of use the machines get, but it is better to do it often, than too little.

The heads should be cleaned once or twice weekly with alcohol on a cotton swab. While cleaning, check the heads for wear and grooves. Worn heads will reduce the frequency response of the machine and can make it impossible to align properly. If any problems are found, you will want to relap or replace the heads.

Check the alignment of the heads every three to six months, using the proper alignment procedure as listed in the manual. The pinch roller should be replaced at this time as well.

Re-capping the circuit cards isn't something that has to be done very often, but it can certainly help keep your machines running smoothly. The electrolytic capacitors can dry out, causing your audio to suffer, and, if you use cue tones, you can wind up with lots of dead air.

When doing your routine maintenance, listen to the motor, check to make sure it runs at the proper speed, starts OK, and doesn't make a grinding noise. This is an excellent opportunity to head off any problems before they manifest themselves on the air.

You may discover that the bearings need to be replaced. Here are a few things to remember that will make this process easier:

1. Replacement bearings can often be found locally. Even if the supplier has to order them, it may be faster and cheaper than ordering them from the manufacturer.

2. If you have a problem removing the old bearings, try using a small gear puller, but be careful not to bend the shaft.

3. when you put the new bearings in the machine, use caution; even the smallest dent in the new bearing's case can ruin it.

4. Use care not to damage the motor windings when the motor is apart.

5. Re-align the machine when you are done, to assure that the pinch roller rests square against the shaft when engaged. This is a good time to check the heads for proper alignment too.

A machine that doesn't start correctly, or doesn't run at a proper speed, may need the starting caps replaced. Be careful, these can stay charged, longer than you think!

Finally, take a few minutes too wipe the dirt and grime off the outside and get the dust out of the inside. Who knows the problems you can avoid by keeping the machine clean.

Inexpensive Sound-Proof Wall

Robert Hensler — Technical Director, Colorado Public Radio, Denver, Colorado

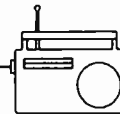

The budget is limited, but there is a noisy reverberant production room that needs soundproofing. It would also be great to color coordinate the walls with the furniture and carpet.

There is a system that I have been using for years, that costs just dimes per square foot. I have used it on six studios, a conference room and part of a large multi-purpose room. I use 2x4s, insulation, and burlap. The whole wall can be covered, or panels can be built on any portion of a wall. When finished, the room is dead, sound-proofed and looks very professional.

Burlap can be purchased at any cloth store. It comes in at least a dozen colors and costs about \$1.79 a yard in my area.

To build the system, glue, vertically, (I use liquid nails), wooden 2x4s to the existing drywall. They should be glued with the 2 inch side to the wall so that there is 4 inches of depth. Since the burlap is 48" wide, glue the 2x4s at 24" on center. This saves on the amount of 2x4s needed. Fill the space between the 2x4s with 24 x 4 inch insulation bats. If the bats have paper on one side, put the paper against the wall. Staple the burlap, with the color of your choosing, to

the 2x4s, over the insulation. The rest is finish work. I usually nail narrow strips of wood to the 2x4s. This hides the staples and the burlap seams. Don't forget some sort of kick board, and trim across the ceiling. The wood can be stained to match the wood of your furniture.

This system works particularly well for studios next to each other. If you do both rooms, the wall is then 4 inches of insulation, 4 inches of air space, and 4 more inches of insulation. Little sound will penetrate this wall. If the dividing wall is new construction, use six inch plates, stagger, and offset the 2X4 studs. Doing it this way, studs for the drywall on one side will not be used to hold the drywall on the other side. This will give even more isolation between rooms. Finish with the glued studs and burlap on each side. When the budget allows, I will suspend a new ceiling below the top of the burlap wall. Insulation is then stuffed in the air space above the new ceiling. I like to use track lighting when possible.

One last tip: When I put windows between production rooms, I use double pane glass. The air space between the two panes of glass gives added sound insulation. Two double panes does the trick.

Event Counter/Timer

Robert Hensler — Denver, Colorado

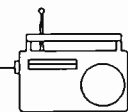

Do you need an event counter that will turn on and off a piece of equipment, at a pre-determined count? A delay on or off relay, with precision time to a tenth of a second? A control off, interval on, relay? A pulse or recycle relay?

I have found the relay for you, and it will do all of this and more. I'm using them all over Colorado Public Radio. I even keep a spare, in case I just need to count something.

It is self-contained with an LCD display, and five thumb-wheels to program the unit; it operates on 12 VDC. If you use it as a counter, the LCD will display the count. If you use it for time-delay, the LCD will show the elapsed time.

I first saw it advertised in my Newark catalog. I just happened to need a very precise, control on, delay off, relay at the time. I decided to try it and have used a dozen of them since.

It is part number CNT-35-26, and the last time I purchased one, it was just under \$80.00. I hope you read this in time for your next project.

TFT 760-04 EBS Mod.

John Stortz — WKES, Ft. Petersburg, FL

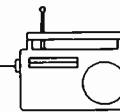

Here's a neat modification to the TFT, 760-04 EBS tone encoder.

TFT instructions call for us to cut the PC board trace between Z3, pin 1, and Z4, pin 4, and add a jumper between Z3, pin 1, and Z4, pin 9. Rather than doing that, I drilled 3 small holes thru the board so that I could mount a 3-pin Berg-type jumper. Two of the holes are drilled thru the original copper (which is to be cut anyway) in such a way that the center pin will connect to Z3, pin 1. See the area indicated by the TFT instructions — Fig. 2-3 (page 2-5, in the TFT PRIMER Guide to the New EAS. The original copper is removed in the area between the two Berg pins, and the pins are soldered to the original clad.

Now the jumper wire is added between Z4, pin 9, and the remaining Berg pin. With the Berg jumper in the one position, the tone duration remains the same. Changing the Berg jumper to the other position shortens the duration to about 9 seconds. Now I'm ready for the change July 1st!

Harris MW1 NRSC

Harris Broadcast — Quincy Illinois

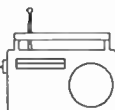

Harris has a NRSC-2 modification kit for its MW-1/1A line of AM transmitters.

Cost of the kit is \$325 per transmitter, including materials for modifying one spare PA module. If you have more than one spare PA module, use the second kit number to obtain additional parts at \$30 per kit.

Part No. 992-9216-001
NRSC-2 Modification Kit, MW-1/1A

Part No. 992-9216-002
NRSC-2 Mod Kit for a single PA module

Orders may be placed by contacting the Parts department. These prices are good through October 1, 1995.

If you have any questions or comments concerning the modification kit, please contact:

Harris Allied Broadcast — Radio Field Service
P.O. Box 4290, Quincy, Illinois, 62305
Phone: 217-222-8200 Ext 3528
Fax: 217-222-9443

Radio Guide Quick-Tip

Doghouse Kit:

- | | |
|--------------------------|---------------------------|
| 1. <i>Trouble-light</i> | 5. <i>Wasp Spray</i> |
| 2. <i>Flashlight</i> | 5. <i>Grounding Cable</i> |
| 3. <i>Extension Cord</i> | 7. <i>Rubber Boots</i> |
| 4. <i>Hard-Hat</i> | 8. <i>Toilet Paper!</i> |

CCA FM TX VSWR

Mark Pallock — Chatsworth, CA



CCA FM-20000D/E Exciter/Driver VSWR

If you have a CCA FM 20000D or E series transmitter, and have trouble maintaining a good VSWR match between the exciter and drive stage (the null on the VSWR is too sharp), try this to broaden out the IPA INPUT tuning/loading.

Add a 50pF, 15kV doorknob type capacitor from ground to the top terminal of the IPA input LOADING air-variable capacitor. Use 1/2-inch ground strap and mount the cap on the side of the IPA box.

Keep the strap as short as possible. 50pF seems to work well on the mid dial positions. If you are at extreme ends of the dial, you may have to experiment with different values.

Society of Broadcast Engineers EchoMail Conference Participating BBS's

This BBS list was obtained from the National SBE Bulletin Board. It can be reached at 317-253-7555

BBS	CITY	ST	TELEPHONE	NODE
Terraplex Amateur Radio	Fort McMurray	AB	403-743-4696	1:3402/4
StarScan (sm)	Montgomery	AL	334-279-7313	1:375/1
Bigfoot's RBBS-PC	Tucson	AZ	602-749-5968	1:300/11
The Broadcaster's BBS	Phoenix/Glendale	AZ	602-872-9148	1:114/91
1040 MIDI & Music BBS	Vancouver	BC	604-736-6330	1:153/7040
The Charlatan's Cabin BBS	Los Angeles	CA	213-654-7337	CHRCABIN
NOHO BBS	San Jose	CA	408-259-3864	NOHO
Mog-UR's EMS	Granada Hills	CA	818-366-1238	MOGUR
CBFCC Broadcasters	Aurora	CO	303-340-2053	1:104/42.0
Terry's Tavern	Derby	CT	203-732-0575	1:141/1275
Telcom Central	Miami Lakes	FL	305-828-7909	1:135/23
The Bear's Den BBS	Orlando	FL	407-678-BEAR	1:363/110
Benjamin Computer Service	W. Palm Beach	FL	407-687-9355	1:3609/16
Arcs & Sparks	St. Augustine	FL	904-461-9687	1:3620/16
Ancient City Wireless	St. Augustine	FL	904-823-3513	73:1602/1
Rock & Roll - Atlanta	Atlanta	GA	404-982-0960	ROCKROLL
North by Northwest Online	Boise	ID	208-345-0076	1:347/9
Sky's the Limit BBS	River Grove	IL	708-453-0998	1:115/453
Precision Board	Schaumburg	IL	708-980-9544	1:115/410
Radio Daze BBS	South Bend	IN	219-256-2255	RADDAZE
SBE Headquarters BBS	Indianapolis	IN	317-253-7555	SBE_HQ
Crossroads Broadcast BBS	Indianapolis	IN	317-878-4069	1:231/310
Tech-Net	Bloomington	IN	812-334-1172	TECHNET
Vetter Communications	Baton Rouge	LA	504-769-4038	1:3800/36
CALnet BBS	Detroit	MI	313-836-8275	73:4100/6
Lighthouse	Lansing	MI	517-321-0788	1:159/950
HAM>link< RBBS	Saint Paul	MN	612-426-0000	1:282/100
MacRefuge BBS	White Bear	MN	612-426-6687	1:282/24
[(hp)al	St. Paul	MN	612-642-5906	1:282/4020
Miss. Public Network BBS	Jackson	MS	601-982-6252	MSPUBNET
Montana MediaNet BBS	Missoula	MT	406-549-6325	MTMEDNET
Frequencies R Us	Raleigh	NC	919-851-3121	FREQUS
The Fifth Estate	Las Vegas	NV	702-898-9684	ESTATE
SBE Chapter 22 BBS	Syracuse	NY	315-477-9670	SYRACUSE
The Silicon Garden	Selden	NY	516-736-6662	WOODYBBS
The Free File Farm	Rochester	NY	716-352-1629	GT NET
The Gold Line BBS	Geneva	OH	216-466-6424	73:4300/2
D.M.U.G. BBS	Dayton	OH	513-259-0806	1:110/69
Retriever's Retreat	Edmond	OK	405-359-1540	73:6601/0
Engineering BBS	Oklahoma City	OK	405-848-1915	1:147/100
The Ham Radio Emporium	Owasso	OK	918-272-4327	1:170/801
Electric Windows Bboard	Beaverton	OR	503-645-4623	1:105/303
Carolina Connections BBS	Sumter	SC	803-499-4316	73:1300/1
The Dungeon BBS	Cleveland	TN	615-478-5918	1:362/669
THE PUB	Knoxville	TN	615-637-5388	73:1400/1
SPPE	Chattanooga	TN	615-870-5368	PETEXCH
WBBS	Conroe/Houston	TX	409-447-4267	1:106/4267
SBE Chapter #105 Houston	Houston	TX	713-923-7827	SBEHOU
RADIO ONLINE (Tm)	Amarillo	TX	806-352-9365	RADIO
Planet Vulcan	Salt Lake City	UT	801-266-2426	1:311/17
Frequency Forum/Scanner	Vienna	VA	703-207-9622	FFORUM
VideoPro BBS	Burke	VA	703-455-1873	VIDEOPRO
The Honey Board CBCS	Herndon	VA	703-834-0999	1:109/543
Tidewater SBE Medialink	Norfolk	VA	804-393-6390	SBEORFVA
The Computer Forum	Va Beach	VA	804-471-3360	CFORUM
The Eagles	Parkland	WA	206-531-8304	1:395/10
Second Opinion BBS	Milwaukee	WI	414-873-7807	SECONDOP
The RF Deck	Baraboo	WI	608-356-4777	1:121/53

Satellite LNB Primer

Tom Harrington — President, Universal Electronics, Columbus, Ohio

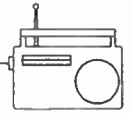

Two Basic LNB Types:

Free Running DRO Type LNB, TVRO Home Use

The typical “free running” DRO (dielectric resonator oscillator) type of LNB is found in the home satellite market (TVRO). These LNB’s have a frequency stability of ± 2 MHz, over a temperature range of -40° to $+60^\circ$ C, with 63 dB gain. The Kelvin noise temperature range is from 40° K to 25° K. The cost range can be from \$55.00 to \$100.00

This TVRO (home satellite) LNB is not recommended for broadcast use, for several reasons, regardless of the LNB’s degree of Kelvin rating:

1. High drift factors on narrowband signals are difficult for receivers to track, which places a burden on the receiver’s AFC circuits to try and track the signal.
2. These LNB’s normally have high phase noise factors, which are caused by the downconverter’s local oscillator moving or “jittering.”
3. The frequency stability is not adequate for use on SCPC, narrowband signals and narrow channels that are spaced only 150 kHz apart. This results in drifting into adjacent SCPC channels (See Figure 1)

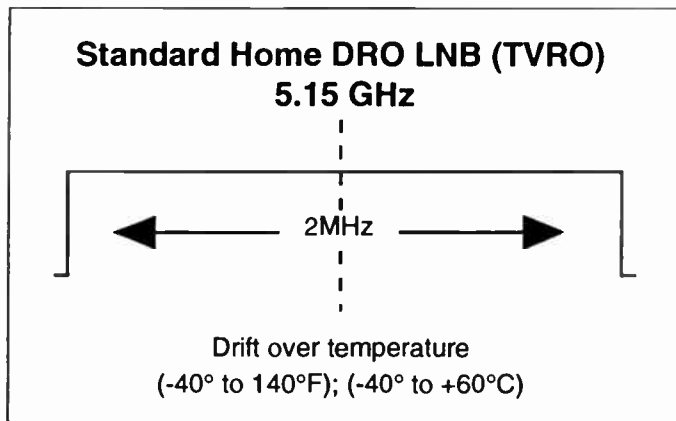

Figure 1 Standard TVRO-type LNB with frequency drift of ± 2 MHz over a temperature range of -40° to $+40^\circ$ F; not acceptable for SCPC use. Low Kelvin degree figures do not denote superior stability of an LNB—a 25° K LNB is not better than a 45° K LNB.

Broadcast Quality:

Phase-Locked Loop High Stability LNB

The logical choice for today’s broadcast satellite work is the phase-locked loop type LNB with high stability of ± 12 kHz, in a temperature range of -40° C to $+60^\circ$ C, or 2.3

parts per million, maximum drift of local oscillator. This is the required stability for SCPC (single channel per carrier) use and most narrowband digital transmissions. By limiting drift, all narrow band signals, which require high stability over temperature, are most easily “tracked.” Further, the burden on receiver AFC circuits to track the signal is minimized. (See Figure 2)

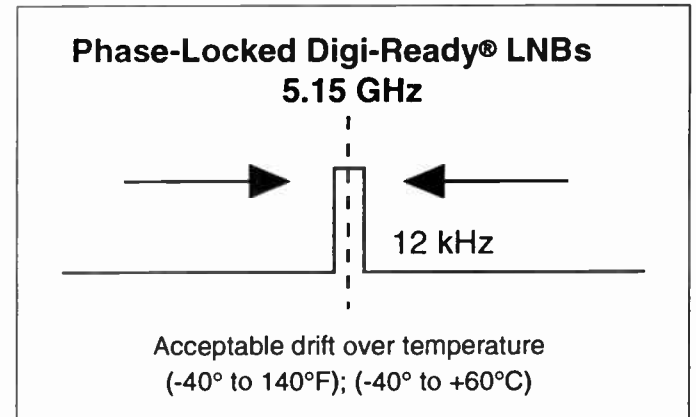

Figure 2 Frequency drift of Phase-Locked-Loop LNBs with a total frequency drift of ± 12 kHz over a temperature range of -40° to $+140^\circ$ F is acceptable stability for SCPC and digital satellite use.

New narrowband transmission systems, SCPC and digital formats, require low phase noise factors because these systems utilize phase variations as a key part of the digital modulation scheme. The ability to detect these subtle variations is hindered when the phase of the LNB’s downconverter local oscillator is moving or jittering, resulting in excessive “phase noise.” Low phase noise technology helps limit this condition to ensure optimum performance of these systems. (See Figure 3)

Explanation of Frequency Drift of LNB

There are several factors that must be understood regarding the stability of an LNB.

1. The Kelvin degree rating of your LNB has absolutely nothing to do with the frequency stability of the LNB. A 25° K rated LNB will not be more stable than a 45° K rated LNB. The standard home TVRO LNB has a drift factor of ± 2 MHz, which is acceptable for a wideband video transponder that is 36 MHz wide, with only one carrier present on the transponder — but not acceptable for SCPC systems.

(continued on page 11)



Continued from page 10

2. The SCPC channel (transmission) is narrowband and ranges from 7.5 kHz to 15 kHz. (In SCPC audio work, 7.5 kHz is narrow and 15 kHz is wide.) The SCPC transponder carries many channels (signals), each with its own carrier. This is how SCPC derived its name — SCPC: Single Channel Per Carrier.

LOW PHASE NOISE TECHNOLOGY

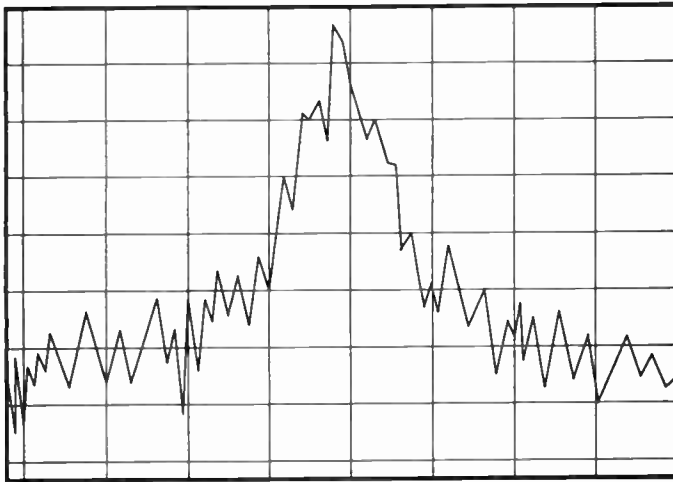

Typical DRO Phase Noise at 1 kHz Offset

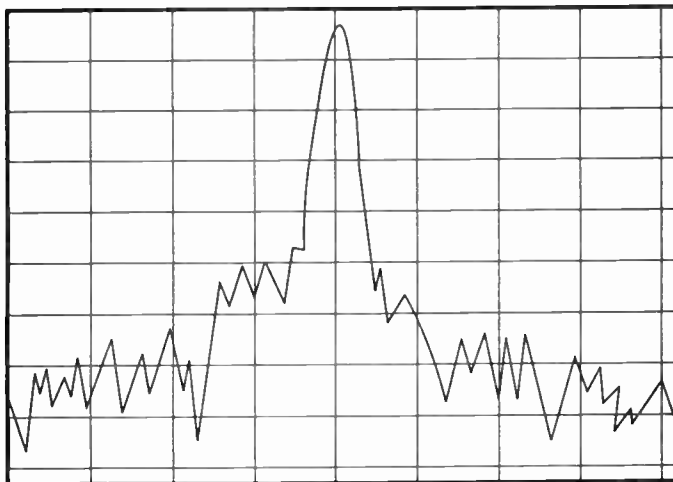

Phase-Locked-Loop Low Phase Noise Technology

Figure 3 Phase-Locked-Loop Technology results in low phase noise factor—as low as 63 dBc/Hz @ 100 Hz.

3. Any serious SCPC work requires an ultra-stable LNB. There are some commercial DRO LNB's that can hold a tolerance of ± 200 kHz in a temperature range of -30° to $+50^{\circ}$ C. These are not acceptable for SCPC work.

4. An LNB marked “commercial” is not necessarily a high-stability LNB. Check the local oscillator frequency stability specifications, which must be 2.3 PPM equals ± 12 kHz, over a temperature range of -40° C to $+60^{\circ}$ C.

Other Important LNB Factors

1. Many so-called LNB problems can be traced to the use of poor-quality coaxial cable. Use only a high grade RG-6 (75 ohm) coax cable throughout the entire system. The coax must have an 85% outer shield coverage. A recommended cable would be braid-coverage type coax. Do not use any TV-type, foil-type coax cable, as this coax will not carry the LNB voltages, and these are not sweep-tested to carry high frequency signals. The best frequency most of these foil types will carry, is 500 MHz. Coax cable that will carry 950 to 1450 MHz is required.

2. Use only commercial-grade, properly sized “F” connectors. Under no circumstances, use a “slip-on” type “F” connector anywhere in your system.

3. All outdoor “F” connectors should be sealed to keep out moisture, and prevent corrosion of the fittings, even if these connectors are inside an enclosure. Use “Coax-Seal” or Radio Shack Connector Sealant No. 278-1645. Place your LNB in a proper LNB cover.

4. After installation of the LNB, check the LNB voltage at the dish. The proper voltage should be at least 18 VDC, and deliver approximately 350 mA. If you are not getting 18-20 VDC at the LNB, you may have a coax problem caused by low-quality coax cable or bad “F” connectors.

Conclusion

Purchase the required commercial, high stability, phase-locked loop LNB at the start of your project. Do not skimp on the LNB! a \$90.00 TVRO LNB is not a good investment for a broadcast station. (I don't care what the home satellite guy tells the GM.)

The phase-locked loop LNB's are now very reasonable in price, and are readily available from commercial satellite distributors and satellite broadcast equipment manufacturers and distributors, as a stock item. Home satellite distributors usually do not stock commercial PLL LNB's.

BUY - SELL - TRADE

Contact us:

•TOLL-FREE •FAX •E-MAIL •COMPUSERVE •BULLETIN BOARD

Call us Toll-Free:

1-800-300-0733

Your Used Equipment Source

3712 NATIONAL ROAD WEST • P.O. Box 1487 • RICHMOND, IN 47375

FAX 317-962-8961 BULLETIN BOARD: 317-935-0531 (8,N,1)

E-MAIL: ceicher@harris.com Compuserve: 74031, 465

AUDITRONICS 224 ON-AIR CONSOLE

3 mic, 14 line inputs
Excellent Condition
ONLY \$7500

RADIO SYSTEMS RS-18 CONSOLE

Excellent Condition
18 channels w/ P&G Faders
Call for special price!

REMOTE METERS

- Burk ARC-16
- Moseley MRC 1620
- Burk TC-8
- Moseley TCS-2

Upgrade now, lots to choose from

CART MACHINES

- Fidelipac CTR-10/100 Series
- ITC Series One & ITC Deltas

Call today for a great deal!

FM EXCITERS

- Harris THE-1/MX-15
- BE FX50/FX30
- Continental 802 Series

Not ready for a DIGIT™, try one of these

DAT MACHINES

- Sony PLM-2300
- Radio Systems RS-6700

Let's make a deal!



CCS-CDQ 2000 Musicam

Stereo Encoder/Decoder combos
Compatible w/ISDN or SW56
ONLY \$3895 ea.

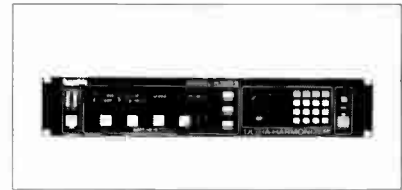

EVENTIDE H3000B Ultra-Harmonizer

Broadcast or Studio Processing
and Effects
Like new condition!
ONLY \$2195

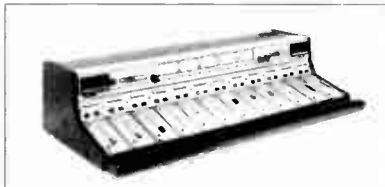

HARRIS GOLD MEDALIST Console

12 Channel Slide Pot
P&G Faders
Full remote capability
ONLY \$4495



DENON DN-970FA CD Cart Players

Full Featured, Pro CD Players
Uses standard CD carts
Demo units - low hours
ONLY \$995 ea.

Send us your used equipment lists

 **HARRIS
ALLIED**

The Right Tools!

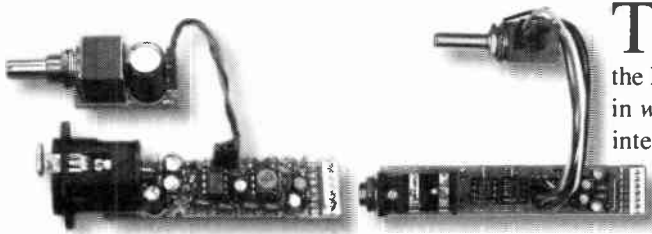

The right tools make the engineer's job a pleasure! And Benchmark provides the right tools. The jack mounted MP-3 mic preamp and the HPA-1 headphone amp are an engineer's dream come true. Drop them in *wherever* you have a need. Use the PS-1 wall mount power supply if internal power is not available. These devices provide truly outstanding performance at very low cost.

On the road or in the studio, the new MicMan™ Jr. is the dual mic-preamp of choice. Operating from internal batteries, or external supply the MicMan™ Jr. maintains the high quality that Benchmark is known for.

Need a mix-minus feed for that telephone talk show? That's just one way you can use the IFA-10 4-in, 4-out mixer. The individual gain controls at both the inputs and outputs add to the versatility. What else can it do? Use your imagination!

Fix audio problems at the source, before distribution, with the Jr. Audio Director™. Correct polarity problems and stereo reversal problems. Select left only, right only, normal stereo, or a mono mix. Use it at every tape machine and on every incoming house feed.

The Jr. Audio Director Plus™ extends the Jr. Audio Director™ line adding the ability to select from four different stereo or eight different mono sources, as well as to mix the selected sources to mono outputs, and control the right channel polarity. Add high current stereo headphone monitoring and mix ratio control from the assigned left and right inputs. Passively pre-mix the inputs with multiple selector switches depressed at each of the assignment banks. It's the ideal companion for four track tape machines, or for assigning and controlling audio from subcarrier demodulators at your satellite receiver.

The Audio World™ Interface is far more than the new standard in IHF to Pro interfaces! It provides the absolute finest audio performance available, bar none! Individual input and output level controls let you find the optimum gain setting. Line amp, stereo reversal, and mono mix are a pushbutton away. The power indicator and the bicolored signal presence / overload indicator LED round out the front panel. The external power supply (included) gives you total freedom from power supply induced hum. Best of all, the price is no more than that of other high quality interface devices.

Numerous other problem solvers are in the toolbox, including, a 2-in, 1-out mix amp, quad input and output interface devices, a 1-in 6-out DA, and a headphone amplifier box with balanced inputs. All of the chassis product will rack mount with available rack mount kits, or they may stand alone. Benchmark products carry a 5 year parts and labor warranty. And you can always call us for help in designing your system, or to answer your installation questions.

Benchmark is truly the measure of excellence. Call Rory Rall today for more information.

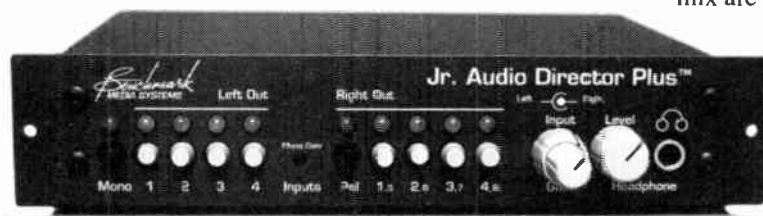
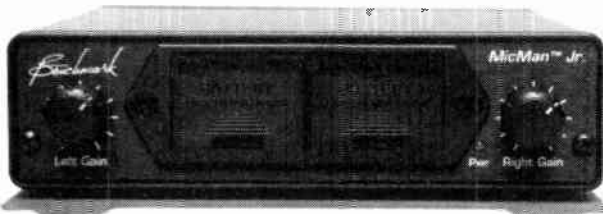

Benchmark
...the measure of excellence!™

BENCHMARK MEDIA SYSTEMS, INC.
Call 800-262-4675, FAX 315-437-8119

HE HALL Electronics

706 Rose Hill Drive
Charlottesville, VA 22901

This Months Engineering Problem Solvers

ITC Cart Machine OEM & Update Components

Updates:

HE Cap. Board - Replaces old FP Power Supply Capacitors in ITC & other Cart Machines. Complete kit includes all hardware.

SP, WP, & RP Models  \$ 39
3D Model \$ 49

HE Replacement Audio Card Stereo \$ 229
Mono \$ 199

HE Replacement 3 Tone Detector Card \$ 159

O.E.M. Parts

Mag-Head (MEC) longlife tape heads Stereo \$ 99
for ITC & most other models Mono \$ 75

Top bearing for ITC 3D model  \$ 65
Standard Motor bearings \$ 20

ITC SP, WP, RP Capstan Motors - Brand New \$ 175
Dialite Start, Stop, Etc switch (Bezel & Lens not included) \$ 5

Call us for the Best New & Completely Rebuilt Equipment!
(804) 984-HALL (4255) Fax: (804) 984-FAXX (3299)

UNIVERSAL SCPC

**NEW
Receiver!**

XE-1000



SCPC BROADCAST AUDIO RECEIVER

New, affordable, frequency-agile receiver, direct channel entry by keyboard, selectable companding 1:1, 2:1, 3:1, wide/narrow bandwidth, de-emphasis selectable, 950-1450 MHz, line output 600 ohms, muting, transponder agile, LNB power supply, 50-channel memory, full baseband output, high-quality audio. Every needed feature at a sensible price (lowest in the industry). Write or call for full information on this quality receiver—the answer for your station. Networks call for prices.

Phone: (614) 866-4605 Fax: (614) 866-1201

UNIVERSAL ELECTRONICS, INC.
Communications Specialists
4555 Groves Road, Suite 12 Columbus, OH 43232

*ERI - Trusted since 1943
for Proven Performance in
ANTENNA - FILTER
LAMBDA™ MOUNTING
TOWER-INSTALLATION*

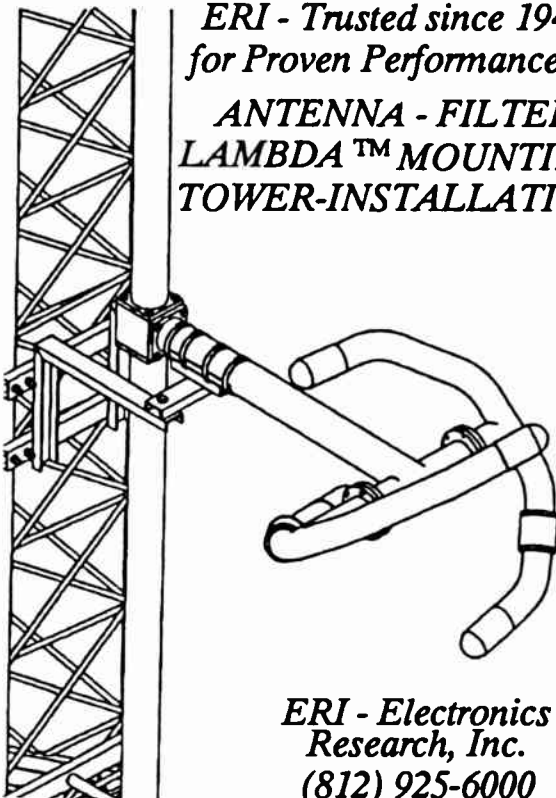

*ERI - Electronics
Research, Inc.
(812) 925-6000*

Commercial Radio Company

Duttonsville School Dr., Cavendish, VT 05142
Phone 802-226-7582 Fax 802-226-7738



Transmitter Parts
RCA - Gates
Collins/Continental



Mica Transmitting Capacitors: Sangamo, CD, Sprague, Aerovox, Acushnet types: CM-15, CM-20, CM-25, CM-30, HT, HK, AT, AK, F1, F2, F3, 30B, E, 1996, 291, 292, 293, 294 & G5.

Fixed and Variable Vacuum Capacitors: Jennings, Dolinko & Wilkins, Mounting brackets and flanges. Vacuum relays.

Oil Filled Filter Capacitors: Plastic Capacitor Corp., 600 to 40 kV, 1 mFd to 30 mFd with special mounting brackets. Non-PCB oil capacitor replacements are available for most transmitters.

Ceramic RF Capacitors: Centralab, Jennings, Sprague, High Energy, 5 kV to 40 kV.

Variable Transmitting Capacitors: E.F. Johnson Co., Cardwell Condenser Co., insulated shaft couplings as used in phasors, variable transmitting capacitors.

Weschler-Westinghouse: RF ammeters, 0-0.5 amps through 0-50 amps, internal and external thermocouples, expanded and linear or square-law scales. Sizes are 3 & 4 inch, round and square. Special meters are available.

RCA: Transmitter, phasor and antenna tuning unit parts.

ULTRAMOD® .UM2000

FM STEREO MODULATION SYSTEM

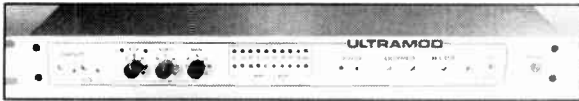

- The UM2000 is a complete FM processing and stereo generating system featuring:
- Dual band, stereo AGC and peak processors of exceptional clarity.
- Digitally synthesized stereo generator with separation exceeding 60dB at 1kHz, and typically 55dB at 15kHz.
- Dual composite outputs for feeding main and auxiliary transmitters or STL's. Very affordable.

WHY PAY MORE ... AND GET LESS?

H NAT H INDES inc

42 Elaine Street, RR1, Thompson, CT 06277
203-935-9066 203-935-9242

Econco

Rebuilt Power Tubes

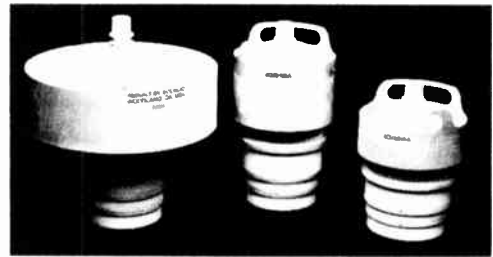

Approximately
One Half the Cost of New

Call for Our Price List

Econco

1318 Commerce Ave., Woodland, CA 95695
800-532-6626 Canada 800-848-8841

FCC Rules on Kahn POWER-side™

Motorola tried to deny broadcasters the right to increase coverage by using SSB — Kahn POWER-side™ equipment. But the FCC specifically ruled that the "Kahn POWER-side system ... may continue to be operated ..." as a mono improvement system. So you can now use POWER-side with Kahn independent sideband exciters to immediately increase coverage to listeners using any and all type of AM receivers.

Federal Communications Commission FCC 93-485:

21. Kahn "POWER-side" Operation. Several parties express concern over the continued acceptability under our rules of operating using the Kahn POWER-side AM single-sideband system. POWER-side operation, as distinct from Kahn stereo operation, involves an AM transmitter with two independent sidebands, containing identical program material, but with intentional level and frequency response differences. This system is implemented with a Kahn independent sideband stereo exciter and is claimed to have certain advantages for reception with monophonic receivers, particularly in adjacent-channel interference situations. CTI and Furr argue that adoption of the proposed standard would prohibit such an implementation. Motorola maintains that the Kahn POWER-side mode of operation is not stereophonic and questions its legality under the present rules.

22. Our AM rules do not include a definition of the term "stereophonic." However, generally accepted definitions of stereo service infer two or more channels of audio information designed to produce an audio "image" when demodulated by an appropriate receiver. On this basis, we find that stations employing the Kahn POWER-side system are not subject to the provisions of the stereophonic transmitting standard adopted herein and may continue to be operated, provided that the program material fed to both channels of the exciter is identical in content.

POWER-side™

PROBLEMS

Adjacent Channel Interference
Antenna Null Distortion
Co-Channel Interference
Power-Line Re-Radiation
Building Re-Radiation
Receiver Tuning
Low Fidelity Home Radios
Co-Channel Beat
Selective Fading

SOLUTION!

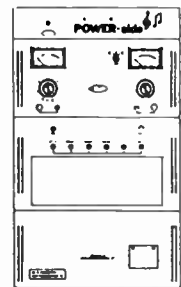

(516) 222-2221

POWER-side™

The solution to many of
AM radio's most serious
technical problems.

*From the developers of the AM STEREO system
that isn't afraid of the dark, and will let you drive right past FM Stereo.*

Kahn Communications, Inc.

222 Westbury Avenue, Carle Place, NY 11514

Radio Guide

511 18th Street SE, Rochester, MN 55904

The **Radio Guide** photo classifieds are designed to showcase — and sell — your high-end, used broadcast equipment.

Items such as transmitters, consoles, automation, digital audio, etc., are just some of the equipment that will be found in the **Radio Guide** classifieds.

Radio Guide classified ads are unique because they contain a photo of your gear — and they work!

PHOTO CLASSIFIEDS

Classified Ad Instructions:

1. Enter your personal information.
2. Enter your classified ad copy.
3. Include a photograph of your gear.
4. Mail this form, with photo, and \$15.00 to:

Radio Guide Classifieds
PO Box 7001, Rochester, MN 55903

Personal Information:

Name: _____ Station: _____

Address: _____

City: _____ State: _____ Zip: _____

Phone: _____ Fax: _____

Classified Ad Copy:

NOTE: Please limit your listing to one category, one piece of equipment, or one complete system.

JUN-95