

**RADIO SHACK DOES A SPEAKER DESIGN GUIDE FOR FIRST TIMERS**

TWO: 1996

US \$7.00

CANADA \$8.00

# *Speaker Builder*

THE LOUDSPEAKER JOURNAL

**A BIG, 3-WAY  
TRANSMISSION  
LINE SPEAKER**

**AN ELEGANT 2-WAY  
ACTIVE & ADAPTIVE  
CROSSOVER**

**ULTRA-SIMPLE ACTIVE  
CROSSOVERS WITH  
TWO MICROCHIPS**

**PASSIVE CROSSOVERS  
MADE EASY  
WITH X\*OVER 2.0**

**BUILD A BETTER CHEAP SPEAKER CABLE**



# Critics Judge InfiniCap

(bulletin posted on *The Audiophile Network*, to one and all)

Note: Mr. Blackburn's credentials as a sober critic are impressive. An engineer for a worldwide company, he is involved in the development and ongoing support of advanced digital imaging and storage systems. His articles have been published by *Stereophile* (he satirized pseudo-physics in high end audio), *The Audiophile Voice* (equipment and music reviews), and *The Sensible Sound* (music reviews). He is a regular contributor to *Positive Feedback*.

Msg#:19460 09-11-95 08:46:01 From: Doug Blackburn

I found a great sounding new cap — unbelievable sounding actually. I used to think [a highly regarded multiple section film and foil capacitor\*] sounded pretty good, but **these** caps are unreal. I tried these caps out in various locations in some of my equipment — power supply bypasses, in the audio signal path, etc. **Unreal** sound quality. These make [a highly regarded multiple section film and foil capacitor] sound **broken!** I'm **not kidding!** The difference is **very** large.

These are called InfiniCap. They are from the same people who came up with WonderCaps quite a few years back. These sound **nothing** like WonderCaps — far far far better. They aren't cheap, but they don't set new record high prices either.

These caps are well worth the price/performance. I look forward to many months of happy experimenting with these caps in other components.

\* The original posting explicitly states this capacitor's name. The above excerpt quotes the first, second, and last paragraphs in their entirety.

"The Audiophile Network is the granddaddy of cyberspace meeting places for audiophiles, and remains the insider's choice for audiophile information. Dateline phone #818-988-0452." — *Stereophile*, July 1995

## Here's what high end audio manufacturers have said:

- A high end speaker manufacturer:  
"InfiniCap does amazing things for our speaker! It's far better than all other audiophile capacitors. For example, compared to Hovland MusiCap, InfiniCap is more transparent, faster, more dynamic, and more open, with better separation of instruments and their harmonics, better inner detail, better stereo imaging with a wider stage — and bass that's richer with more weight, yet also tighter, faster, and better defined."
- A leading high end mfr of tube and solid state electronics:  
"The difference compared to MultiCap is astounding! Just amazing! Night and day!"

## New Wonder Solder UltraClear

For years, Wonder Solder has been the standard of the world:

"The best-known silver solder in the high-end audio community is Wonder Solder. Suffice to say, many manufacturers of high-end audio equipment use Wonder Solder." — Gary Galo, *The Audio Amateur* 3/94

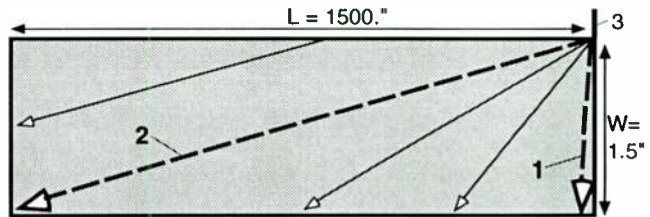
"An audibly superior solder with superb working properties and a pleasure to use. Several audio manufacturers have reported, after listening tests using Wonder Solder, significant sonic improvements over identical components assembled with their favorite solders. Use of Wonder Solder will provide greater transparency without the glare and brightness often associated with silver bearing solders." — Michael Percy, *Audio Consultant*

### Now there's new Wonder Solder UltraClear™

Stunning Ultra Transparency • Clean Purity • Natural Musicality  
You won't believe the sonic difference a solder can make, until you try new Wonder Solder UltraClear. For mere pennies you can solder (or reflow) a whole amp or speaker, and make it sound like one twice as expensive. Available with rosin or water soluble flux core, and in bars for tanks (we'll send rosin as standard sample).

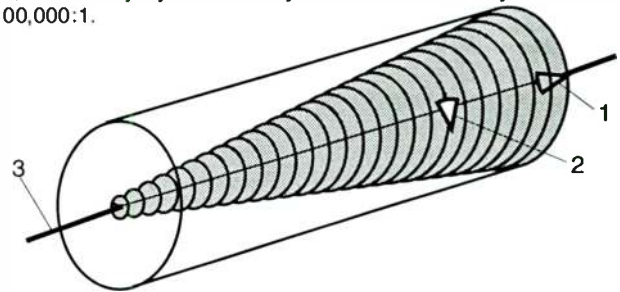
## What's Wrong with Your Capacitors?

For any capacitor to work, electric charge must get from the terminal (3) to all parts of the plate. It fans out over your capacitor's plate, following the diagonal paths shown. This creates a bad problem. Path 2 can be 1000 times longer than path 1. So your music doesn't all get through your capacitor at the same time. Some music gets through quickly, via path 1, but some of the same music signal takes 1000 times longer, via path 2. This time smears your music, so it sounds fuzzy, defocussed, and veiled, and perhaps muddy, clogged, honky, or glary.



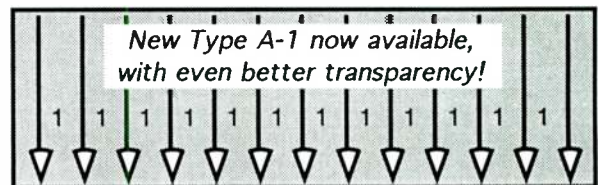
Your capacitors have another problem that's even worse. They roll up signal path 2 into a tight corkscrew coil (below). The inductance of any coil is multiplied by the number of turns squared, and there can be 1000 turns in an audio capacitor. So the inductance of path 2 can be a million times higher than straight path 1, delaying music a million times worse for some paths through the capacitor than for other paths. This capacitor actually smears music by a factor of 1,000,000:1.

Multiple capacitors with 10 sections reduce these problems a bit, but merely by 10. So they still smear music by a factor of 100,000:1.



## InfiniCap is Different!

Only the Wonder InfiniCap® capacitor cures all these problems. InfiniCap's unique design (patents pend) with metal ends eliminates long, diagonal, corkscrew signal paths like path 2. InfiniCap has an **infinite number of parallel paths**, which are all like path 1, as shown below.



These signal paths are all **short**, so InfiniCap is fast. These paths are all the **same length**, so all of your music signal gets through the capacitor at the same time. These paths don't make coil turns, so they don't have drastically differing inductances.

It's like an infinity of capacitors in parallel — **InfiniCap!** That's why **InfiniCap** sounds:

- transparent, open, and airy — instead of veiled or clogged;
- clean and pure — instead of smeared or dirty;
- clearly focussed, coherent — instead of defocussed or fuzzy;
- fast and delicate — instead of sluggish, hard, or splattered.

**InfiniCap gives you all the music at the same time.** InfiniCap reveals the subtle inner details, the magic that makes music sound real. Hear the amazing sonic difference yourself.

## Free sample InfiniCap!

Write: **TRT**, 408-b Mason, Vista CA 92084



**ACOUSTIC DESIGN...  
A MODERN ART!**



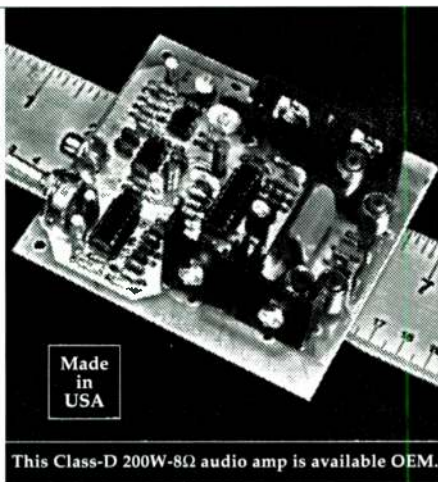
**D6G**

**MULTI-LAYERED HONEYCOMB CONE-LIGHT & STRONG!  
PATENTED DOUBLE MAGNETS WITH BALANCED CLOSED  
CIRCUIT STRUCTURE-POWERFUL ENERGY SOURCE!  
OPTIMIZED SMALL/THIELE PARAMETERS-EASY LOW-FREQUENCY DESIGN!  
3" COPPER CLAD ALUMINUM WIRE VOICE COIL-HIGH POWER HANDLING!  
ONE PIECE CAST ALUMINUM FRAME-RESISTS VARIATIONS!  
LONG EXTENSION DESIGN-HIGH LEVEL SOUND OUTPUT!**

**Hi-Vi RESEARCH®**

**100 SPY COURT, MARKHAM, ONTARIO L3R 5H6  
TEL: 001-905-475-3100, FAX: 001-905-475-8226**

**Design a PWM switching power amplifier into your next powered audio product... and do it without R&D.**



LGT Technologies provides OEM power solutions for audio designers requiring small size, ultralight weight, and clean high-efficiency output.

We offer a range of power modules, with ratings of 150 to 500 watts\*... optimized for full-range or low-frequency reproduction... with conventional linear power supplies or switching mode supplies. We can incorporate custom circuitry for your specific design onto the same circuit board... such as an active filter network or special processing.... all with little or no R&D expense.

LGT Class-D amps are stable and reliable, providing low distortion, and excellent frequency response. Contact Terry Taylor for full details and a development kit with demo board.

\*4Ω

895 Cherokee Boulevard Chattanooga, TN 37405

Sales Agent: **ACOUSTICAL SUPPLY INTERNATIONAL** ©1995 ASI

**Tel: 615-756-0706 Fax: 615-756-0860**

Reader Service #79

# Speaker Builder

## The Staff

Editor and Publisher

**Edward T. Dell, Jr.**

Contributing Editors

**Joseph D'Appolito** **Robert Bullock**  
**Richard Campbell** **John Cockroft**  
**David Davenport** **Vance Dickason**  
**Bruce Edgar** **Gary Galo**  
**G.R. Koonce** **Richard Pierce**  
**Bill Waslo**

Assistant Publisher

**Karen Hebert**

**Dennis Brisson** Managing Editor

**Swain Pratt** Associate Editor

**Courtney Howard** Editorial Assistant

**Suzanne Coté** Graphics Director

**Diane Luopa** Assistant Graphics Director

**Joan Ahern** Production Assistant

**Laurel Humphrey** Marketing Director

**Robyn Lasanen** Circulation Manager

**Doris Hamberg** Administrative Assistant

## Advertising Rates & Schedules

**Peter B. Wostrel** National Advertising Director

**Laura Brown** Advertising Assistant

(603) 924-7292 FAX (603) 924-6230

*The peculiar evil of silencing the expression of an opinion is, that it is robbing the human race; posterity as well as the existing generation; those who dissent from the opinion, still more than those who hold it.*

JOHN STUART MILL

*Speaker Builder* is published eight times a year in the interest of high-quality audio reproduction.

No material in *Speaker Builder* may be used in any form without the written permission of the publisher.

## Subscription Inquiries

A one year subscription to *Speaker Builder* is \$32. Canada please add \$8. Overseas rate is \$50 per year.

To subscribe, renew or change address write to the Circulation Department (PO Box 494, Peterborough, NH 03458-0494) or telephone (603) 924-9464 or FAX (603) 924-9467 for MC/Visa/Discover charge card orders. E-mail: [audiotech@top.monad.net](mailto:audiotech@top.monad.net).

For gift subscriptions please include gift recipient's name and your own, with remittance. A gift card will be sent.

## Editorial Inquiries

Send editorial correspondence and manuscripts to *Speaker Builder*, Editorial Dept., PO Box 494, Peterborough, NH 03458-0494. E-mail: [audiodiy@top.monad.net](mailto:audiodiy@top.monad.net). No responsibility is assumed for unsolicited manuscripts. Include a self-addressed envelope with return postage. The staff *will not* answer technical queries by telephone.

Printed in the USA. Copyright © 1996 by Audio Amateur Publications, Inc. All rights reserved.

## About This Issue

Industry observer **Arthur Rosenblum** serves up some food for thought, which may be unpalatable for some players in the market. After making his rounds at the Winter CES and noting new video and music formats, he senses a change in the air that has some music moguls concerned ("Houston, We Have A Problem Here..." p. 8).

**Robert D. Watson** presents the finishing touches, including measurements and test results, to his two-part transmission-line speaker project ("Design a Three-Way TL with PC AudioLab," p. 12). His method (with reliable design and measurement software) should encourage first-time TL speaker builders.

In "Make A Better Speaker Cable," p. 16, author **Eric Gilbert** proves that you needn't spend a lot of money to achieve quality sound. His simple fix to speaker cable results in a low-cost, low-inductance variety that is particularly well-suited to satellite and surround speakers.

In the first of two articles in this issue on crossover techniques, audio designer **Fred Janosky** offers a complete kit of parts—with case, PC boards, jacks, and a manual—to build an electronic crossover. This design is particularly useful for home theater or other applications requiring subwoofers ("The XVR-1 Two-Way Electronic Crossover Platform," p. 18).

We welcome aboard a new author, **Jack Cunniff**, a retired aerospace engineer, who takes us a step beyond both Backgaard and Koonce in examining crossover topologies ("Backgaard Revisited," p. 30).

This issue also provides some useful speaker-building tips for flush-mounting irregularly shaped drivers ("Tools, Tips & Techniques," p. 47) and building speaker stands for large boxes ("Wayland's Wood World," p. 34).

*Speaker Builder* (US 01-9-7929) is published every six weeks (eight times a year) at \$32 per year, \$58 for two years; Canada add \$8 per year; overseas rates \$50 one year, \$90 two years; by Audio Amateur Publications, Inc., Edward T. Dell, Jr., President, at 305 Union Street, PO Box 494, Peterborough, NH 03458-0494. Second-class postage paid at Peterborough, NH and an additional mailing office.

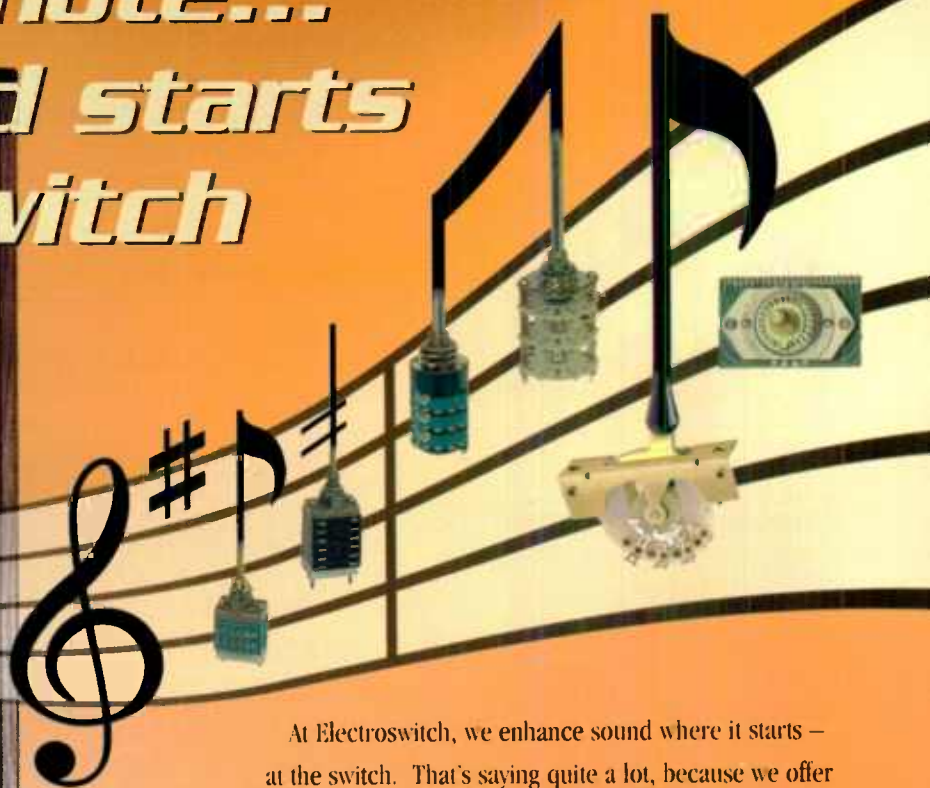
POSTMASTER:

Send address change to:  
**Speaker Builder**, PO Box 494  
 Peterborough, NH 03458-0494



# *Electroswitch*

*Note for note...  
the sound starts  
at the switch*



At Electroswitch, we enhance sound where it starts – at the switch. That's saying quite a lot, because we offer you the industry's widest selection of compact analog switches for sound equipment.

To get the finest, purest sound from today's analog speakers, amplifiers, tuners and musical instruments, you need a rotary switch. Digital switches simply don't cut it. Electroswitch gives you a hit parade of custom switch solutions and standard rotary switches – in 2-48 positions with 1-60 poles, and ratings from milliamps to 11 amps at 125 VAC. And we deliver your switches when you need them, with lead times from stock to 3 weeks.

Want the very best sound your high performance equipment can deliver? Start at the switch... Electroswitch.

For a **FREE** Electroswitch catalog, fax your request toll-free to: 1-800-909-9171, or call us at 919-833-0707.

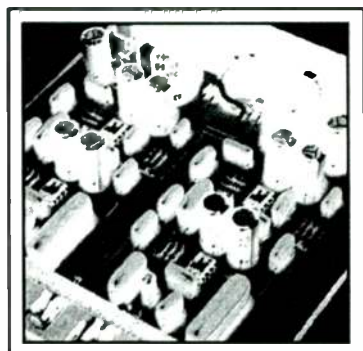


# Speaker Builder

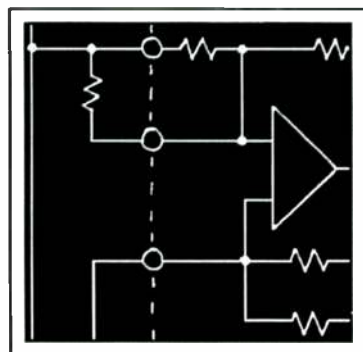
THE LOUDSPEAKER JOURNAL

VOLUME 17 NUMBER 2

APRIL 1996



18



30

## 12 Design a Three-Way TL With PC Audiolab

BY ROBERT D. WATSON

## 16 Make a Better Speaker Cable

BY ERIC GILBERT

## 18 The XVR-1 Two-Way Electronic Crossover

BY FRED JANOSKY

## 30 Baekgaard Revisited

BY J.F. CUNNIFF

## 42 SOFTWARE REVIEW X\*over 2.0

BY HANK ZUMBAHLEN

## 48 BOOK REPORT Advanced Speaker Systems

BY RICHARD CAMPBELL

### DEPARTMENTS

8 GUEST EDITORIAL  
BY ARTHUR ROSENBLUM

10 GOOD NEWS

34 WAYLAND'S WOOD WORLD  
BY BOB WAYLAND

47 TOOLS, TIPS & TECHNIQUES  
BY ROGER A. SIEDOW

51 SB MAILBOX

59 CLASSIFIED

60 AD INDEX

61 CLUBS

### KEEP IN TOUCH

**EDITORIAL** — Send letters, questions, and comments to: Speaker Builder, Editorial Dept., PO Box 494, Peterborough, NH 03458 USA, FAX (603) 924-9467, E-mail: audiody@top.monad.net.

Be sure to reference the issue, title, author, and page number of the article or letter in question; and if you request an answer from an author, please include a self-addressed envelope (and your FAX number and/or E-mail address, if applicable), with a loose stamp or postal coupon.

Due to the volume of correspondence, we cannot personally acknowledge or respond to each letter or query. All letters to the editor will be considered for publication unless you indicate otherwise. Speaker Builder reserves the right to edit your letters or technical queries for length and clarity.

Author guidelines are available by sending a self-addressed envelope with loose postage to the above address.

**CIRCULATION** — For subscriptions, renewals, back issues, or address changes, write to the Circulation Department (PO Box 494, Peterborough, NH 03458) or call (603) 924-9464 or FAX (603) 924-9467. E-mail: audiotech@top.monad.net.

**ADVERTISING** — Address advertising inquiries and information requests to the Advertising Department, Audio Amateur Publications, Inc., PO Box 494, Peterborough, NH 03458-0576, voice (603) 924-7292 or 1-800-524-9464, FAX (603) 924-6230.

**OLD COLONY SOUND LAB** — For product information and ordering, contact Old Colony Sound Laboratory, PO Box 243, Peterborough, NH 03458-0243, voice (603) 924-6371 and (603) 924-6526, FAX (603) 924-9467.



**Q:**

# What Makes MIT<sup>®</sup> MultiCap<sup>™</sup> Different from All Other Capacitors?

**A:**

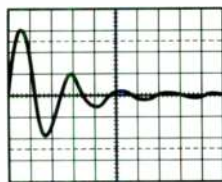
**Performance.** MultiCap's internal bypass design and superior construction deliver higher current capability, lower distortions and noise, greater dynamic range, better phase response, and more control of resonances.

The design of all capacitors other than the MultiCap — including the "special" capacitors that have recently come on the market — conforms to the long-time conventional standard, that is, single-wind metalized or film & foil. The design is called "extended foil construction." Some caps have stranded leads or expensive lead materials. Some have exposed metal ends. None of these alterations represents a significant change in basic design; hence performance will be similar among those caps, varying only with type and quality of materials used in the foil and the dielectric film. And in the integrity of construction techniques.

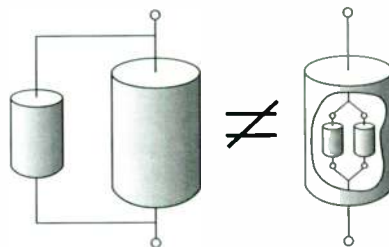
Metal-end caps, for instance, prove on testing and examination to be the typical single-wind film and foil capacitor — except that they do not have hermetically sealed ends. Degraded performance can be expected as moisture and contaminants in the air enter the dielectric through those non-sealed ends. Try the following test: Dip a metal-end cap and a MultiCap into water and then perform an Insulation Resistance Test. The MultiCap will not be affected, but the unsealed cap will short out — as it can when a user installs it on a PC board and then uses a fluid to clean the board. Copper alloy end material can also oxidize rapidly, and the copper and capacitor plate material are dissimilar metals that will corrode and generate false and unwanted signals due to electrolysis.

MIT uses the same basic extended foil construction, but with many significant enhancements that improve the performance in a way no other capacitor can (the techniques are patented). Note that a characteristic of any conventional capacitor in A/V use is that it **must** be bypassed. The other capacitors in use in audio have to be bypassed, externally, as some of their literature admits. The MultiCap alone is already bypassed internally (up to ten times), and we recommend further bypassing only for the very largest values. The MultiCap is not a single cap of 1000 + turns. It is ten smaller-value **high-speed** capacitors all wound in parallel to make up the total stated value. In other words, a 1 microfarad MultiCap is made up of 10 complete .1 microfarad capacitors joined internally in parallel. This is called "**internal bypassing**," or sometimes "self-bypassing." One MultiCap is like ten standard caps in parallel. And made with superior construction techniques.

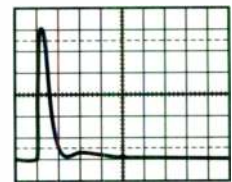
**Conventional Capacitor  
With External Bypass**



Multiple resonances in a 2 µf capacitor bypassed with an external .22 µf capacitor. Result: high distortion.



**MIT MultiCap<sup>™</sup>  
Showing Internal Bypass Concept**



Single resonance of the **high-speed**, internally bypassed MIT MultiCap. Result: low distortion.

**Externally Bypassing a Conventional Bypass Does Not Equal — in Measured or Sonic Performance — MIT's Patented Internal Bypassing, Which Further Reduces Distortions**

The artist's conception (right, above) illustrates two of the MultiCap's up-to-ten internal (bypass) sections as if they were small separate capacitors. The graphs at the sides of the illustration represent measurements performed at the MIT Laboratory on a good-quality film & foil capacitor, bypassed externally, compared to a film & foil MultiCap. MIT MultiCap<sup>™</sup> is protected by US Patent # 4,638,402.

**MIT** ELECTRONIC COMPONENTS

MUSIC INTERFACE TECHNOLOGIES<sup>™</sup>

For National & International Inquiries: Phone: 916/888-0394 Fax: 916/888-0783

## Guest Editorial

### WCES—"HOUSTON, WE HAVE A PROBLEM HERE..."

And we thought Tom Hanks, a.k.a. Jim Lovell, the earnest, everyman commander of *Apollo 13*, was talking about the explosion and loss of power on that spacecraft's troubled mission to the moon. That's what I thought after watching it lift off from a giant Runco screen and hearing and feeling its engines roar through a couple of hundred thousand dollars worth of Wilson Audio loudspeakers, Krell amplifiers powerful enough to launch a moon-bound rocket of their own, and an assortment of elegant devices that, in Wilson's demonstration room, could only be called "Watt-chamacallits."

The real problem may have been that as that rocket soared out of our vision, it was accompanied by a musical score that was the least important element in that sequence. That score had little more impact than the sound of the bricks that were being tossed by Macaulay Culkin and landing squarely on the head of one of *Home Alone 2's* dimwitted villains in another sequence that we viewed in that same Wilson demonstration. At the same time we learned that Wilson Audio is no longer in the business of recording audiophile records and CDs. I began to question: to what has high fidelity grown so faithful?

Video was the star of the 1996 Winter CES, and the industry gathered to pay homage to the driving force behind a record \$62 billion in 1995 consumer-electronics factory sales. It was not only manufacturers of big-screen televisions, digital satellite systems, and ground-breaking DVD players and AC-3 receivers who were celebrating the 150% increase in the number of households (10.8 million) that now contain home-theater systems. Loudspeaker manufacturers increased production to feed 1995's 67% growth in subwoofer sales, 60% growth in center-channel sales, and an increase of over 100% in sales of three-piece (left-center-right channel) speaker packages.

The announcement that there will be a number of Digital Video Disc (DVD) players on the market in the second half of 1996, with retail prices starting at \$500, created a charge at CES that was reminiscent of the introduction of CDs in 1983. Eventually all

movies, music recordings, and CD-ROM software will use these 5" discs that store upwards of 3.5 gigabytes of information. The recording industry has already adopted Dolby's AC-3 discrete, 5.1 channel system as the audio format for the videodiscs and players that will be sold in the US and Asia.

In April, a consortium of manufacturers will adopt standards for audio-only recordings on DVD, and, while it is not yet clear which standards they will be, the new medium will change "stereophonic" music reproduction as we know it. It is a virtual certainty that these discs' multichannel capabilities will impact the way music is created, recorded, and listened to for a long time.

Component manufacturers' memories extend far enough to recall the quadrasonic debacle of the '70s, and while the recording industry has not yet "signed on" to the multichannel recording concept, all of the hardware is either in place or en route. In addition to DVD, digital multichannel transmission will become the standard on cable for video and music delivery systems, satellite, commercial networks, and high definition-television (HDTV).

A few labels are already releasing recordings in Dolby Surround format, and the number is increasing. At the CES meeting of The Academy for the Advancement of High-End Audio (AAHEA), Tomlinson Holman, whose knowledge and influence in the multichannel arena are as considerable as they are "celebrated," announced a March conference in Los Angeles entitled, "WAMM '96." The World Alliance for Multichannel Music (WAMM) will bring together music composers, arrangers, producers, recording engineers, and hardware and software developers to explore what they call the "media of the future." It remains to be seen how strongly and how well multichannel hardware will drive the creative process.

Also speaking at this AAHEA meeting was Bob Stuart, representing the Acoustic Renaissance for Audio (ARA). ARA has proposed a set of standards that would ensure high-end performance for music in the new formats. The concern in Stuart's voice, echoed by Mike Elliott of Counterpoint, made it seem that the smart money in Vegas this year

was betting on the Sony standard, which compromises sound quality for manufacturing economies.

However compelling ARA's position is, the problem is not limited to higher versus lower performance standards. There is the broader issue of whether the electronic industry views music as an art form independent of visual media—or as merely a part of them.

While the technology exists to make music recording and reproduction in the new media exceed the quality of anything we have known, the voices speaking out to maintain the standards that audio—not audio/video—demands are being masked in much the same way that the Apollo rockets masked the film's fine music.

Nothing was more chilling in Las Vegas than a headline in *Twice, CES Show Daily*, the official daily publication of CES, announcing to the industry that "Developments at WCES Indicate Two-Channel Music is History." Describing many of the multichannel products dominating the Show, two-channel stereo was assigned a place next to analog turntables as existing solely for a "niche market." The problem is not that the reporter had the audacity to make such a claim; the problem is that there are so many indications that he was right.

I sought out a CEMA workshop entitled "Selling the Passion of Music and Film" as a place where the music might not just be relegated to the background. But when Michael Fremer, whose passion for music always makes him a good read, started singing the praises of Toshiba's impressive demonstration of the train wreck scene in *The Fugitive*, I got nervous. When another panel member explained that Americans listen to music in their cars, and watch television at home, I became sad. Finally, when a panel member—a sales manager of a quality speaker company—said that the music-listening experience doesn't have the same impact as TV, and that people have a passion for home theater that they never had for stereo music, I called Houston and said, "We have a problem here."

Arthur Rosenblum  
E-mail: ar422@ix.netcom.com





# Good News

## ■ TUBING KITS

A comprehensive line of heat-shrink tubing kits is now available. Specially developed "low-shrink" temperature tubing, with special shrink ratios to accommodate a wide range of wires, is standard. The kits can be field-installed using an ordinary hair dryer. Custom printing, tubing types, and colors are also available. Shmarkers, a division of Kimber Kable, Ogden, UT, (800) 746-2753.

*Reader Service #101*

## ■ GUTS AND ELBOW GREASE

Gene Pitts, after 25 years with *Audio Magazine*, has acquired *The Audiophile Voice* from The Audiophile Society of New York. Published by Pitts' newly established Guts & Elbow Grease Publishing Ltd., the magazine features a mix of high-end audio topics as well as reviews of equipment and recordings. *The Audiophile Voice*, PO Box 853, Upper Montclair, NJ 07043.

*Reader Service #106*

## ■ NEW LINE OF CAPS

Rel-Cap, maker of the MIT Multicap and Reliable Capacitors, releases the Rel AudioCap line of single-wind polystyrene capacitors. Available in a variety of sizes and voltages, they are designed for audio and video applications. The Segmented REL, a new metalized-film capacitor, may be purchased in 1-30 $\mu$ F 400-600V DC. Their fault-tolerant design, featuring separate segments, enables it to function even if one segment has failed. Rel-Cap, 12931 E. Sunnyside Place, Santa Fe Springs, CA 90760, (310) 946-8577, FAX (310) 944-7494.

*Reader Service #104*

## ▷ NEO CLASSICS

P-Series loudspeakers feature B&W in-house designed and produced drivers, and real wood veneer. The P6 includes B&W's trademark "tweeter on top" for enhanced response, time alignment, and dispersion. Both it and the P5 incorporate Kevlar 6.5" bass/mid drivers, and Cobex bass drivers mounted in separate, dedicated subenclosures that handle only deep bass (below 150Hz). The P4 has a single 6.5" Kevlar bass/mid driver housed in a special cabinet, utilizing a folded duct for reduced parallel surfaces and standing waves. A proprietary 1" alloy dome tweeter is used throughout the P-Series line. B&W Loudspeakers of America, 54 Concord St., North Reading, MA 01864-2699, (800) 370-3740, (508) 664-2870, FAX (508) 664-4109.

*Reader Service #102*

## ■ THE VALUE OF GOLD

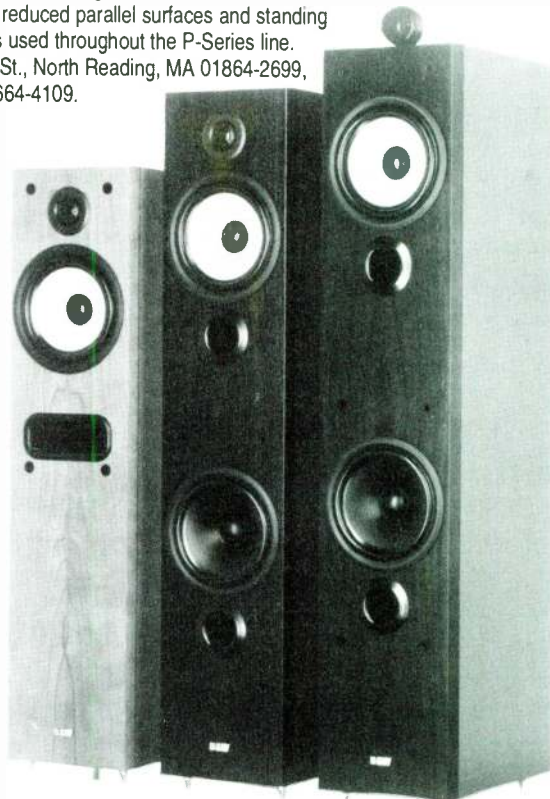
Produced in a combined effort by XLO Electric and Reference Recordings, the RX-1000 is a recording, test and burn-in CD ideal for home-theater systems. The 24-karat gold CD offers comprehensive information on system calibration, wiring and polarity, balance, speaker placement and evaluation, imaging and depth, soundstaging, component demagnetization and burn-in, and absolute phase. Six music tracks are included, allowing you to

identify the merits or demerits of your setup. Reference Recordings, Box 77225X, San Francisco, CA 94107, (415) 355-1892, FAX (415) 355-1949, E-mail rrec@aol.com.

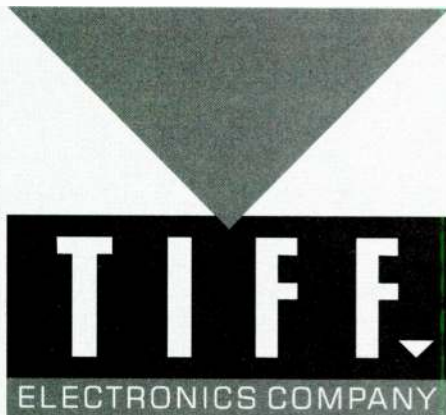
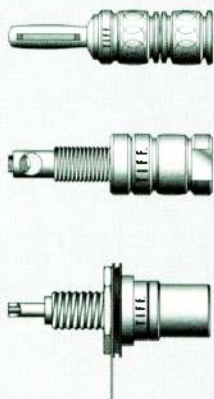
*Reader Service #107*

## ■ NEW LOCATION

On February 20, BostonAcoustics moved to new facilities at 300 Jubilee Drive in Peabody, MA. The company may be contacted by mail at PO Box 6015, Peabody, MA 01961-6015; or by phone at (508) 538-5000. Its accounting and finance department may be reached by FAX at (508) 538-5091.



## The Industry's Finest Connectors.



**TIFF** Electronics Company • 44 Pearl Pentecost Road / Winder, GA 30680 • (770)867-6300 / 2713 (Fax)



# Good News

## ■ THREE FROM PSB

PSB introduces three new products to its line: the Century 1000 compact tower speaker, and the Ambient I and II compact surround speakers. The Century 1000 sports dual 6.5" woofers, accentuated by a centrally-located tweeter, in a "two-and-a-half-way" configuration for increased linearity and balance of sound. For use in home audio/video systems employing surround-sound formats, the Ambient I and II utilize a dipole configuration and dual drivers mounted back-to-back. PSB, 633 Granite Court, Pickering ON L1W 3K1 Canada, (800) 263-4641, FAX (905) 263-4633.

*Reader Service #116*

## ■ HOME-THEATER SPEAKERS

Miller & Kreisel Sound presents two complete home-theater speaker systems designed for multichannel discrete digital systems. The S-85 and S-125 systems offer center-channel speakers with an angled-baffle for dynamic range and tonal balance, and a Phase-Focused crossover with integral high-pass filter for control of on- and off-axis radiation of sound. The speakers' Ferromagnetic Shielding System prevents picture distortion from magnetic fields when used adjacent to a TV. M&K Sound Corp., 10391 Jefferson Blvd., Culver City, CA 90232, (310) 204-2854, FAX (310) 202-8782.

*Reader Service #110*



## ■ SEMINARS RESCHEDULED

Synergetic Audio Concepts announces two schedule changes concerning their 1996 Sound System Seminars. The Advanced Sound System Design Seminar will now be held this summer, July 22-24; and the Sound System Operation Seminar has moved to April 29-30. For locations, please contact Synergetic Audio Concepts, 8780 Rufing Rd., Greenville, IN 47124, (800) 796-2831, FAX (812) 923-3610, E-mail patb@synaudcon.com.

## ■ INTERCONNECT UPDATE

Alpha-Core has applied patented Goertz low-inductance technology, boasting an impedance of 2-4Ω, to their all-purpose interconnect. The cable consists of two flat conductors, solidly composed of either oxygen-free copper or silver, encased within a semi-transparent polymer jacket. The signal cable is terminated with Teflon-insulated, black chrome RCA connectors which sport corrosion-resistant rhodium-plating. Alpha-Core, Inc., 915 Pembroke St., Bridgeport, CT 06608, (203) 335-6805, FAX (203) 384-8120.

*Reader Service #108*

## ■ WINSPEAKERZ 95

True Image Audio introduces WinSpeakerz 95, the Speaker Design Toolbox for Windows '95, for enclosure design and analysis. Featuring a graphical interface, this software offers an array of calculators to design passive crossovers; rectangular, trapezoidal, and bandpass cabinets; impedance compensation networks; and attenuators. Frequency scale end points are adjustable between 1Hz and 100kHz. The program allows information to be loaded from the Driver Database to the Workbench, where driver performance is evaluated. True Image Audio, 349 W. Felicita Ave., Suite 122, Escondido, CA 92025, (800) 621-4411, FAX (619) 480-8961, E-mail TIA Sharon@aol.com.

*Reader Service #112*

## ■ GO FOR THE GOLD

Sheffield Lab's Gold CDs undergo 20+→16 Ultra Matrix Processing to capture the essence of live studio recordings, defined bass, and tube-like high-end. Past compilations by Grammy-award winner Amanda McBroom and the late Harry James are the first to be released on High Density Gold CDs. Sheffield Lab Inc., 1046 Washington St., Raleigh, NC 27605, (919) 829-1154, FAX (919) 829-0047.

*Reader Service #105*

## ■ A MAGAZINE SPEAKS

TransMedia Communications presents *Listen to the Music™*, a music magazine you can hear. Each bimonthly issue is published on a CD-ROM, enabling you to hear new music samples, artist interviews, and feature stories covering all categories of music. *Listen to the Music™* is currently available for use with Windows PCs. TransMedia Communications, PO Box 36115, Canton, OH 44735-6115, (216) 493-2684, FAX (216) 966-7949.

*Reader Service #113*

## ■ DRIVE UNITS HIGHLIGHTED

Driver Design Limited's winter listing of loudspeaker components outlines three midbass driver units and one 10" instrument/PA speaker. The V5/12R 5 1/4" drive unit, encased in a steel

frame, features a coated paper cone with rubber surround, vented polepiece, and Kapton voice-coil former. The V6/20 and HOVR-6 are 6 1/2" units ideal for home-theater and sound-reinforcement speaker systems. The U10/30 instrument/PA speaker comprises a 1 1/2" voice coil with aluminum bobbin, curvilinear paper cone, M-roll surround, vented polepiece, and bumped backplate. Driver Design Limited, 1018 Maywood Dr., Martinez, CA 94553, (510) 370-1941.

*Reader Service #117*

## ■ PC-BASED FUNCTION GENERATOR

PC Instruments' new half-length card function generator, the PCI-303, can create six different 5MHz waveshapes, each including controls for frequency, amplitude, and DC offset. Using a half-slot ISA card (AT or XT bus), the generator has an output amplitude that is adjustable from 16Vpp to 100mVpp (8Vpp to 50mVpp into a 50Ω load). The BenchCom™ Software Bundle accompanies the PCI-303 purchase and includes programmer's libraries, DLLs, utilities, and graphics user interfaces. PC Instruments Inc., 9261 Ravenna Road, Bldg. B11, Twinsburg, OH, 44087-2449, (216) 963-0800.

*Reader Service #111*

## ■ SOUND&VIDEO CATALOG

A division of HAVE, Inc., Sound&Video announces a new mini-catalog of DIGIFLEX™ cables and other Voo-Doo Free™ no-nonsense products for the audiophile. The full-line cable listing includes balanced and unbalanced analog interconnects; DIGIFLEX™ Gold I digital interconnect, constructed of Canare's 75Ω coaxial cable and matched RCA connectors; and speaker cables. Sound&Video's array of video cables includes those for home-theater, composite video, serial digital component RGB sync video, and S-video. Sound&Video, 350 Power Ave., Hudson, NY 12534-2448, (518) 822-8800, FAX (518) 828-2008.

# DESIGN A THREE-WAY TL WITH PC AUDIOLAB

By Robert D. Watson

**P**art 1 of this article (*SB 8/95*) dealt with the theoretical and measured response of a transmission line woofer. In Part 2 I'll describe the design and construction of the power supplies, power amplifiers, and electronic crossovers, as well as the measured responses of the midranges and tweeter. Finally, I'll show the completed three-way, tri-amplified TL loudspeaker test results.

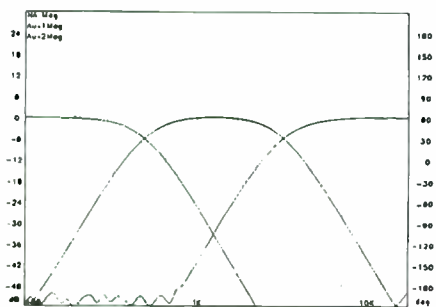
## POWER-SUPPLY DESIGN

The base of the loudspeaker contains the power-supply board and transformer for the power amplifiers and electronic crossovers. *Photo 1* shows the layout of the power supply, for which I used a toroidal transformer, from Toroid Corp. This transformer's dual 42V @ 12A secondary and 18,800 $\mu$ F electrolytic filter capacitors generate a  $\pm 55$ V power supply that easily handles the demands of the three 100W power amplifiers. There is also an independent  $\pm 18$ V regulated power supply for the electronic crossover network.

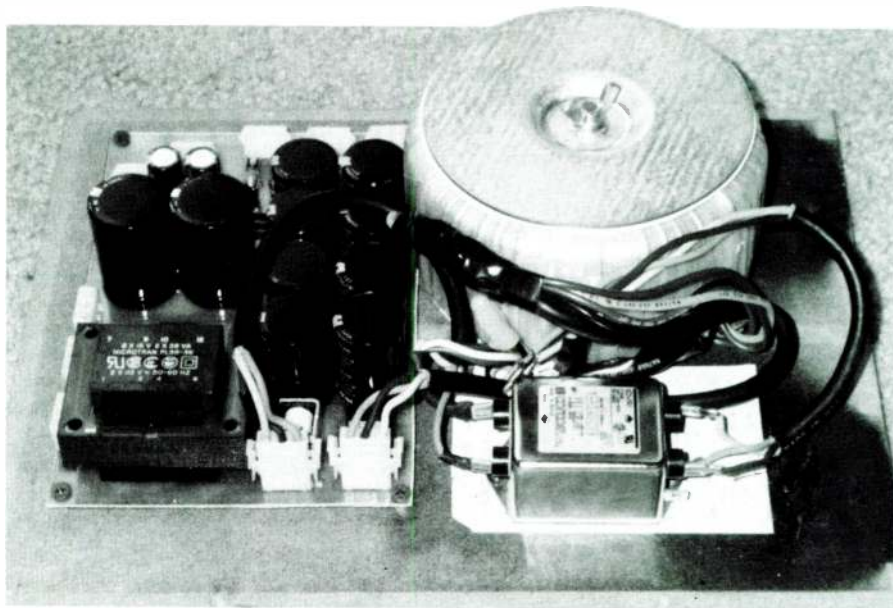
The input AC power is filtered to remove power-line noise. Both power supplies are activated remotely by a 12V relay mounted on the power-supply board, with the relay signal originating from my custom preamplifier, so turning it on also turns on the self-powered loudspeakers. The base of the loudspeaker has several ventilation holes in the rear to cool the power-supply assembly.

## POWER AMPLIFIER DESIGN

Mark V Electronics supplied the MOSFET TA-477 power amplifiers. These board kits have a three-stage differential amplifier with



**FIGURE 1:** PC AudioLab network-analyzer measured response of electronic crossover network.



**PHOTO 1:** Power supply.

silicon transistors and a MOSFET power output stage that uses the 2SJ50 and 2SK135 MOSFET power transistors. The circuit-board kits make construction easy. (Apparently, Mark V will soon replace this kit with a different one, the AF-2.) The rated output is 120W RMS into 8 $\Omega$  with <0.001% distortion.

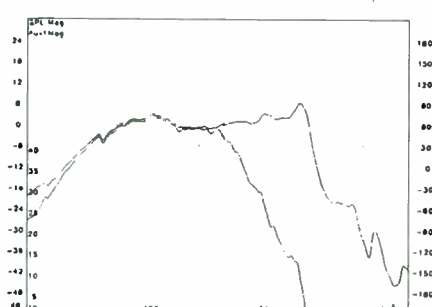
Unfortunately, these boards don't have any loudspeaker-protection circuitry or delayed turn-on capability, although Mark V does sell a separate protection circuit, the TY-25. Because of size limitations imposed by the TL cabinet design, I had to redesign the power-amplifier boards to make them more compact, and at the same time I added the

protection circuitry and voltage regulation for the driver stage.

I regulated the driver-stage power supply to  $\pm 50$ V, which limits the output power to 100W. Each of the three power-amplifier boards receives an independent  $\pm 55$ V power-supply rail and a 12V relay line for the loudspeaker-protection circuitry. To prevent high-frequency ground loops, the input stage, the driver stage, and the speaker each have separate ground-return lines to the power supply.

The rear recessed panel of the TL cabinet houses the three power-amplifier boards and heatsinks. *Photo 2* shows a close-up of the amplifier board and heatsinks attached to the panel, and *Photo 3* shows the rear of the TL cabinet with this panel in place.

I placed the heatsinks in the recessed cavity for aesthetic reasons, even though I knew this location would severely limit the convective heat transfer because of the lack of air flow over the heatsink fins. So far, this arrangement hasn't turned into a critical problem, even

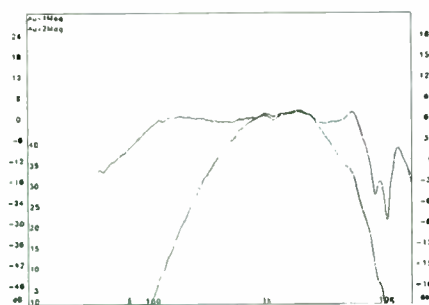


**FIGURE 2:** Loudspeaker-analyzer measured SPL response of Dynaudio 17W-75 woofer with/without crossover.

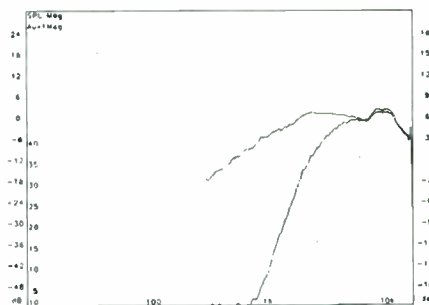
## ABOUT THE AUTHOR

Robert D. Watson is not only an M.D., but also has a B.S. in Electrical Engineering and Mathematics and an M.S. in Biomedical Engineering. He is an associate member of the Audio Engineering Society and the owner of MicroAcoustics Audio Software.





**FIGURE 3:** SPL response of ScanSpeak 8636M midrange with/without crossover.



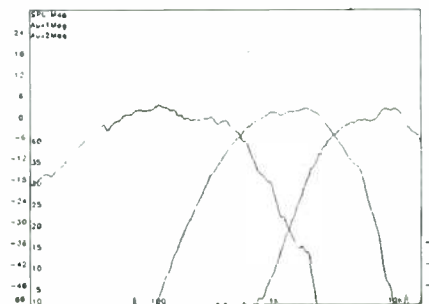
**FIGURE 4:** SPL response of Dynaudio Esotec tweeter with/without crossover.

when I run the loudspeakers at high output. The amplifiers do, however, run warmer than usual. With a bias current of 100mA, the heatsink temperature ranges from 110°F at the bottom to 120° at the top, so you can still touch them without discomfort. At a comfortable sound-level output, the temperatures rise another 20°, so then it hurts to touch the heatsinks. Several months of testing has caused no thermal breakdown, though I'd be interested in a better solution with the same aesthetic result.

### ELECTRONIC CROSSOVERS

One of the advantages of a triamplified loudspeaker is that you don't have to deal with bulky passive components to achieve a high-order crossover filter. I used Model XM9 electronic crossovers supplied by Marchand Electronics, which utilize a fourth-order constant-voltage design that provides in-phase low-pass and high-pass outputs. The slope of both outputs is 24dB/octave.

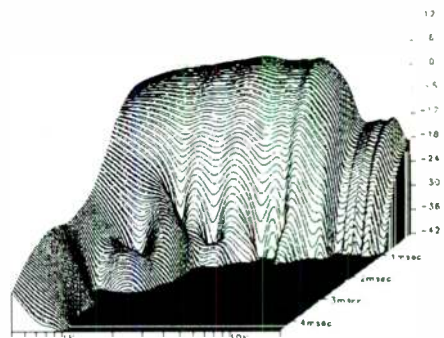
A three-way system requires two XM9s, which come either assembled or as kits and use high-quality metal-film resistors and polypropylene capacitors. Individual level controls for the low- and high-frequency output are available. You can also use a damping-control potentiometer that provides -8dB



**FIGURE 5:** SPL response of all three drivers.

to +6dB control at the crossover point to compensate for the individual drivers. You control the crossover frequency by changing the value of four resistors to range from 20Hz to 5kHz. The operational amplifiers provided with the kits are LF353s, but I replaced these with the faster, quieter, pin-compatible OP-275 from Analog Devices.

The custom preamplifier I designed has balanced differential outputs using Analog Devices' SSM-2142 balanced driver, so I had to add a balanced differential receiver, SSM-2141, to the crossover boards. Using the PC AudioLab network analyzer, I tested and adjusted the crossover networks. The analyzer sweeps the synthesizer through a user-defined frequency range and a number of fre-

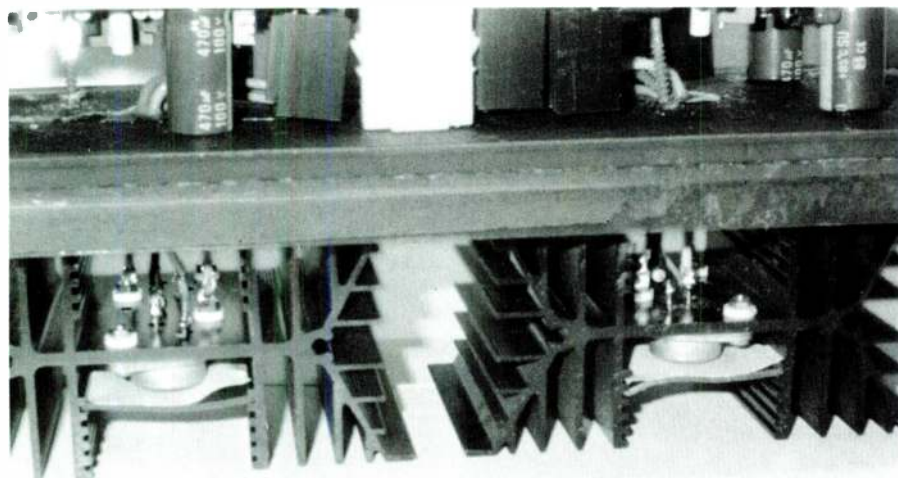


**FIGURE 6:** PC AudioLab impulse-analyzer measured SPL waterfall response of ScanSpeak 8636M midrange.

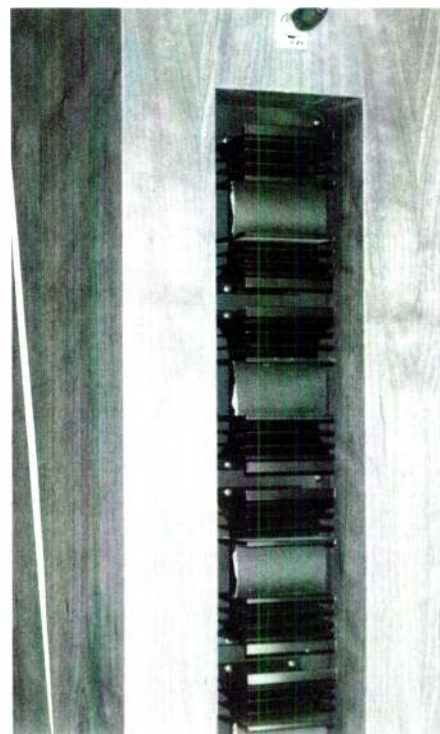
quency points and measures the relative magnitude and phase of the network. *Figure 1* shows the test result for the electronic crossovers. The crossover frequency points were 500Hz and 3.5kHz.

### FULL-FREQUENCY MEASUREMENT TECHNIQUES

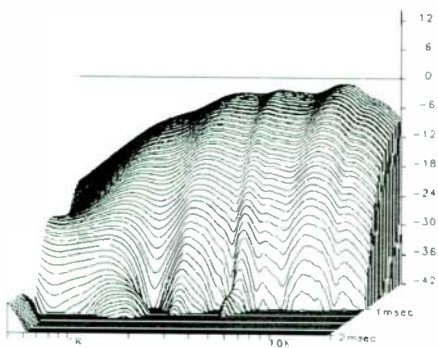
Full-frequency measurements of loudspeaker drivers can be difficult because of room-resonance effects. Unless you have an anechoic chamber available or want to put your speaker and microphone on a 10' tower, the most practical way to obtain a full-frequency measurement is to combine a near-field swept-frequency measurement with a gated impulse-response or MLS measurement. PC AudioLab ver2.0SE allows you to perform a near-field measurement using the loudspeaker analyzer



**PHOTO 2:** Close-up of power-amplifier board and heatsinks on rear panel.



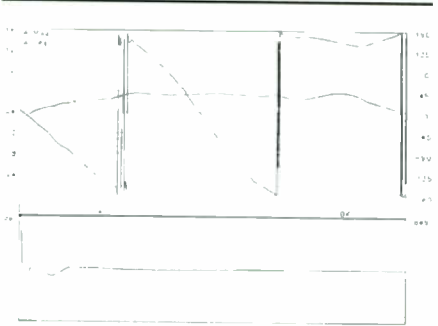
**PHOTO 3:** Rear panel in place, showing recessed heatsinks.



**FIGURE 7:** Impulse-analyzer measured SPL waterfall response of Dynaudio Esotec tweeter.

and then combine it with the impulse analyzer or MLS analyzer to derive a full-frequency SPL response.

The loudspeaker analyzer is set up to obtain a swept-frequency SPL using a calibrated microphone. You can choose the frequency range, number of frequency points to measure, and whether to perform a linear or logarithmic frequency sweep. The loudspeaker analyzer then sweeps the FM synthesizer through these test points to generate a magnitude/phase plot for the driver. Unlike other systems, which make assumptions regarding the minimum-phase behavior of a driver, PC AudioLab actually measures the phase-response relative to an acoustic plane you define.



**FIGURE 8:** SPL response of combined ScanSpeak 8636M midrange and Dynaudio Esotec tweeter.

## SOURCES

### Analog Devices

181 Ballardvale St., Wilmington, MA 01887  
(617) 937-1428, FAX (617) 821-4273

### Marchand Electronics, Inc.

PO Box 473, Webster, NY 14580  
(716) 872-0980, FAX (716) 872-1960

### Mark V Electronics

8019 E. Slauson Ave., Montebello, CA 90640  
(800) 521-MARK, FAX (213) 888-6868

### MicroAcoustics Audio Software

2553 Carpenter St., Thousand Oaks, CA 91362  
(805) 495-8945, FAX (805) 373-5714  
<http://www.vcnet.com/plab>

### Toroid Corp.

2020 Northwood Dr., Salisbury, MD 21801-7805  
(410) 860-0300, FAX (410) 860-0302

A near-field frequency response is used to measure the low-frequency response of a loudspeaker. By placing the microphone as close as possible to the driver, measurement errors caused by reflections and room reverberations are minimized. Microphone distances less than 10% of the driver radius will result in measurement errors less than 1dB. The upper-frequency limit for a near-field measurement is  $f \leq 2155.5 / r$  (where  $r$  is the driver radius in inches). After performing a near-field analysis, you can use either the impulse analyzer or MLS analyzer to measure a gated far-field response. The impulse analyzer uses the sound-card synthesizer to generate a brief impulse and then performs a 32k point FFT to derive the system response. The MLS analyzer performs a 32k point MLS analysis using a Fast Hadamard Transform to derive the system impulse response.

A window function is available in the impulse and MLS analyzer to eliminate undesired reflections from the analysis. You can also average multiple measurements to improve the signal-to-noise ratio. The windowing function removes unwanted reflections, but also limits the low-frequency analysis. Luckily, there is usually an overlap region where the near-field response and the gated far-field impulse/MLS response are both valid, and you can merge the curves using the loudspeaker analysis merge function.

Using this technique, I obtained the woofer, midrange, and tweeter-driver full-frequency responses shown in Figs. 2-4. These graphs also show the combined crossover-network and driver responses. Figure 5 shows the final woofer, midrange, and tweeter responses.

The PC AudioLab impulse and MLS analyzers can also generate time-energy waterfall plots from the impulse-response data. Figure 6 shows the waterfall plot of the ScanSpeak midranges, and Fig. 7 the plot for the Dynaudio tweeter. Figures 8 and 9 show the combined midrange and tweeter impulse response and waterfall plot. Using the PC AudioLab spectrum analyzer and the 32k point MLS waveform, adjustments of the relative gains and crossover damping factors to obtain a flat response are easily accomplished, since you get continuous feedback of changes in the system impulse response using this test setup.

## COMPLETE LOUDSPEAKER MEASUREMENT

There are several ways PC AudioLab can measure the SPL response. I have already described the use of the loudspeaker and impulse analyzers. I also tested the loudspeaker with AudioLab's spectrum analyzer, using the Japan Audio Society Test CD for a white-noise source. I used white rather than pink noise because the spectrum analyzer uses an FFT to calculate the frequency response, and white

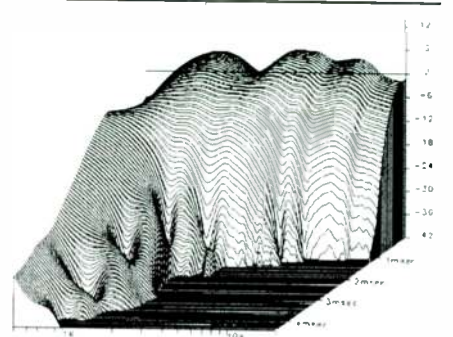
noise has uniform power per frequency, whereas pink noise has a uniform power per octave.

The spectrum analyzer can also perform time-averaged response. Figure 10 shows the time-averaged response of the TL speaker measured at 4' in a midsized room. I set the spectrum analyzer to perform a 16,384-point FFT, which gives approximately 3Hz resolution, and I applied a 1/3-octave smoothing filter. Figure 11 shows the response of the completed loudspeaker using a combined near-field/impulse technique for comparison. As you would expect, the room-resonance modes as well as microphone position can radically affect the measured loudspeaker response.

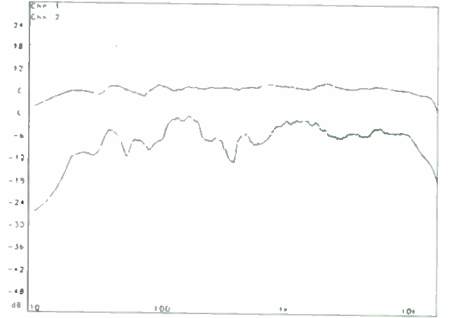
## PROOF OF THE PUDDING

Now that I've shown the technical side of this loudspeaker, how does it all sound? When I

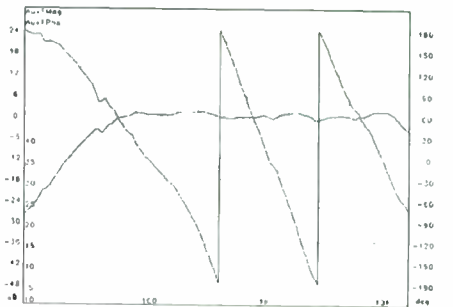
to page 57



**FIGURE 9:** SPL waterfall response of combined ScanSpeak midrange and Dynaudio tweeter.



**FIGURE 10:** PC AudioLab spectrum-analyzer measured white-noise SPL response of TL loudspeaker in midsized room.



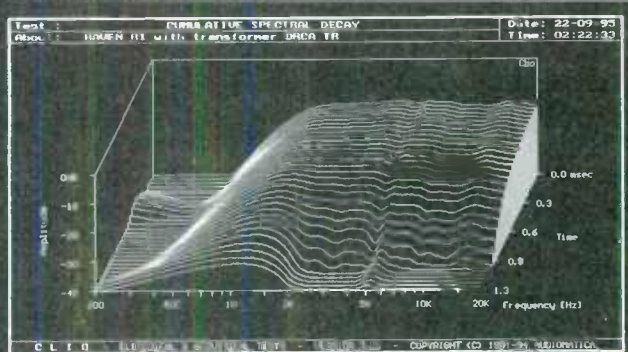
**FIGURE 11:** Loudspeaker-analyzer measured SPL response of TL loudspeaker.



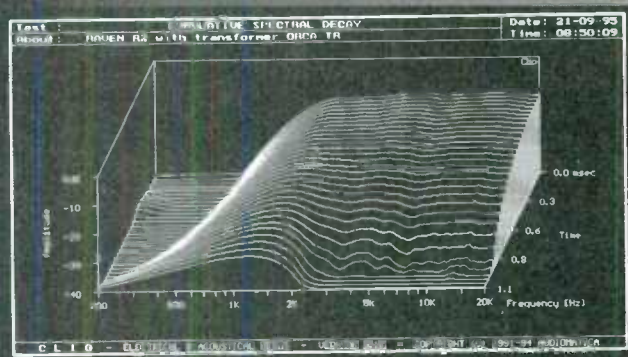
# RAVEN

## HIGH EFFICIENCY PURE RIBBON TWEETERS

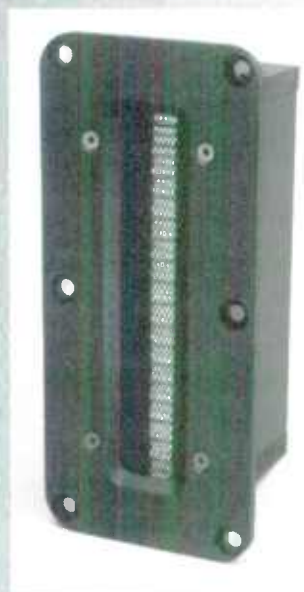
ORCA is sincerely proud of introducing these exceptional high frequency transducers from France. The RAVEN tweeter is a true ribbon tweeter, possibly the purest transducer available today. In a dome tweeter the signal is carried through the voice coil wire, and the sound is radiated by the dome attached to the voice coil. Here, the carrier of the electrical signal and the radiating diaphragm are one and the same part: the ribbon itself. Furthermore, the RAVEN ribbon is 100% pure conductive material, no metallized film. To have an idea of the high frequency performance of the RAVENs, imagine that the moving mass here is about 30 times less than a high quality dome tweeter. The music comes through effortless, almost immaterial. The special and massive NeFeB magnet of the RAVENs is five times more powerful than a conventional magnet. The result: the RAVEN R1 is capable of 118 dB peak with no measurable distortion (R2: 120 dB). At 10WRMS, that is continuous power now, R1 reaches 105 dB with less than 1% distortion, and R2, 107 dB. The RAVENs come with a specially designed matching transformer (very low distortion, low loss and wide bandwidth) for optimum coupling with your power amplifier. Now look carefully at the decay of these units!



**RAVEN R1**  
KGS 1.14  
LBS 2.5  
92 x 80 mm  
3.63 x 3.15 in.  
Moving mass:  
0.0061 g  
0.0002 oz.  
dB/W/m 95  
2 KHz to 40 KHz



**RAVEN R2**  
KGS 2.22  
LBS 4.9  
166 x 76 mm  
6.54 x 2.99 in.  
Moving mass:  
0.013 g  
0.0005 oz.  
dB/W/m 98  
2 KHz to 40 KHz



**RAVEN TRANSDUCERS** are distributed worldwide exclusively by ORCA Design & Manufacturing Corp.  
1531 Lookout Drive, Agoura, CA 91301 - USA  
TEL (818) 707 1629 FAX (818) 991 3072  
E-Mail: orcades@aol.com  
OEMs, stocking distributors and importers inquiries welcome. Goods now in stock in America.

# MAKE A BETTER SPEAKER CABLE

By Eric Gilbert

Many speaker cables on today's market offer dubious promises of improvements to a system's audio quality. These claims are based on some combination of the following factors: resistance, inductance, capacitance, and skin effect. The bottom line is that a speaker cable has one simple function: to make a low-impedance connection between your amplifier output and the loudspeaker.

The easiest method to lower the impedance of a speaker cable is keeping as short a length as possible. The factors involved are all linear. Therefore, reducing the cable length by 50% has the same effect as increasing the wire diameter (gauge) by 50%, as well as reducing both inductance and capacitance by 50%.

## THE PROBLEM

Unfortunately, you cannot always keep the speaker cable short. For example, in a surround-sound audio system, the rear channels will each probably require at least 20'. Also, of course, wiring to remote speakers located in a different room involves extended cable lengths.

In these cases the cable will have some degradation in the coupling of the speakers to the amplifier. Even fancy designer speaker cables often leave significant room for improvement. When you must locate speakers a distance away from the amplifier, the resistance and inductance introduced in series with the speaker may become significant. The capacitance of the cable produces a relatively high impedance in parallel with the low-impedance speaker, and, contrary to some claims, is rarely a concern, even for long cables.

## RESISTANCE

Adding resistance in series with your speak-

## ABOUT THE AUTHOR

Eric Gilbert has been an audio/speaker/acoustics hobbyist for some 15 years. He has an engineering degree, has been working in the electronics industry for eight years, and is currently operating a technical services and consulting company.

Conductors	Equiv. AWG	DC $\Omega$ /ft.(R)	nH/ft.(L)	pF/ft.
Zip cord	18	0.013	120	22
10	21	0.026	42	79
20	18	0.013	21	157
30	16	0.0086	14	237

**EQUATIONS**  
 Series resistance:  $R = r \times \text{feet}$   
 Series reactance:  $X = 6.28 \times L \times 10^{-9} \times \text{frequency} \times \text{feet}$   
 Total series impedance:  $Z = \sqrt{R^2 + X^2}$

ers has the obvious, but not serious, effect of attenuating the power delivered to the speakers. More significant are the effects of series resistance on frequency response.

First, series resistance will interact with the crossover and equalizing filters, which can cause shifts in the crossover frequencies and imbalance between the drivers. Second, a loss of amplifier damping will occur, resulting in greater peaking of the bass response near the resonant frequency.

## INDUCTANCE PROBLEM

Inductance introduces an attenuation and phase shift that varies with frequency. For instance, if a cable behaves inductively for frequencies above 10kHz, then the signals

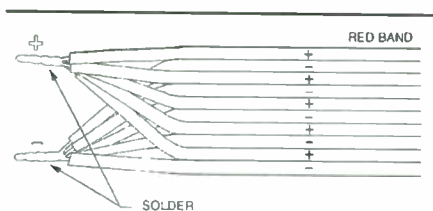


FIGURE 1: Illustration of ten-conductor cable.

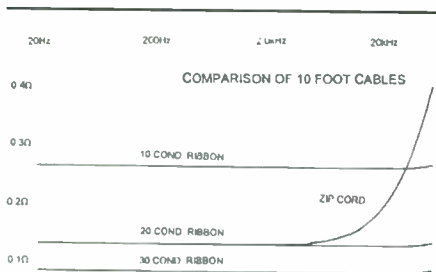


FIGURE 2: Comparison of 10' cables.

arriving at the speaker above 10kHz will be increasingly attenuated with increasing frequency. Also, the phase will progressively shift, starting at a frequency one decade lower, 1kHz in this case. While the importance of phase error is open to debate, using a cable with noninductive bandwidth of at least 150kHz will prevent phase error from being an issue.

Your speaker cable forms a large, one-turn, electrical loop, which acts as an inductor in series with your speaker. You might think that twisting the cable would help; but in reality the benefit is minimal, because the inductance is distributed along the entire length of the cable. This forms many small inductances in series, which add up to the same overall amount. To reduce inductance, the objective is to minimize the area inside the loop. If the cable is already as short as possible, then the only alternative is to minimize the distance between the conductors.

## A SOLUTION

A solution is to build your own speaker cable. I have found a way to make speaker cable that has very low inductance (i.e., wide bandwidth and good for long runs), pleasing aesthetics, and low cost.

One good way to shorten the distance between the centers of the conductors is to use many small-diameter wires of alternating polarity. The least expensive and easiest way is to modify off-the-shelf computer ribbon cable, which most electronics stores offer with various numbers of conductors, for as little as \$0.15/ft.

## Of Special Note Glass Audio

Issue 2, 1996

- A Single-Ended Pentode Amp
- In Search of the Perfect Tube
- We Talk With Dennis Had
- A Differential Amp for Electrostatics



## CONSTRUCTION

First, measure the length of cable required to connect the speaker to the amplifier. Next, determine the best cable "width" for your application, based on the cable length and the desired resistance. Use *Table 1* to help with the calculations.

Cut the ribbon cable to the desired length and, if necessary, peel off extra conductors to achieve optimal width. Separate the individual wires 2-3" from the end. Next, strip about 1/2" from the ends of each wire and gather wires 1,3,5... and twist their conductors tightly together. Similarly, twist the conductors of wires 2,4,6... tightly together (*Fig. 1*).

Finally, melt some solder into the twisted bundles of wire to secure them. Also, you should mark the ends for polarity.

## FEATURES

*Figure 2* compares cable performance. In addition to improving the quality of your system, other benefits include:

- no skin-effect problem in the audio frequencies (with multiple 28AWG conductors)
- no bulges in carpeting from running the cable
- easy to paint the same color as walls
- readily available materials



# If you build it, it will rock.

TCH offers you the ability to combine state-of-the-art speaker components to design and build your own custom loudspeakers. So whether your speakers will rock concert halls, disco floors or living rooms, TCH has over 500 items in stock and ready for immediate delivery.

**1-800-291-0389**

# TCH

1705 Broadway, Buffalo, NY 14212 Fax: 716-892-4302  
2955 Congressman Lane, Dallas, TX 75220

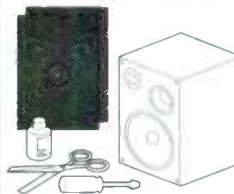
- Handles
  - Corners
  - Speaker Grills
  - Casters
  - Speaker Carpet
  - Clamps
  - Jack Dishes
  - Feet
  - Grill Cloth
  - Plugs & Jacks
- (\$50 min. order)



Reader Service #48

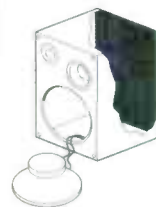
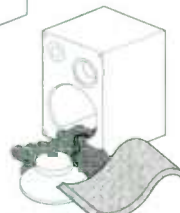
## DEFLEX SPECTRA Dynamics acoustic PANELS

The simplest and most cost effective way to upgrade your existing system



You need at least 2 Deflex panels for a pair of small bookshelf speakers, 4 panels for a pair of Tannoy 6's, and at least 6 panels for larger cabinets

Once you have gained access to the inside of the cabinet, remove foam and/or wool damping from the inside of the speaker (if fitted)



Place the flexible Deflex panel thru' the speaker cut-out and stick to the inside of the cabinet using the recommended adhesive

Now sit back and listen to the extra detail in sound, and far less distortion when played loud



### What the experts have to say...

"...a marked improvement was obvious from the first few bars of REM's *Automatic for the people* album..."  
**Hi-Fi News & Record Review - March 1994**

"...Deflex panels seemed to give greater tightness and control, improved internal clarity, and pitch definition - all without deadening the sound in any way..."  
**Audiophile - January 1994**

"...the result was sharper imaging, wider dynamics and a more natural sound..."

**CHOICE VERDICT**  
Sound Quality      
Value for money      
**Hi-Fi Choice - January 1994**

"...But one things for sure - the Deflex panels are no gimmick. They work..."  
**Audio Video - November 1994**

### Some Of Our Other Products:

- \*MIT MultiCaps... Better selection and the best prices anywhere!
- \*InfiniCap, Solen, SCR/AEON, Rel-Cap, etc., premium grade film capacitors.
- \*Kimber, Cardas, MIT, XLO, Acrotec, ultra high performance chassis wires.
- \*Non-inductive wirewound and power resistors from Mills, Caddock, others
- \*SOLO Copper Foil Air Core Inductors for no-compromise crossover designs.
- \*Cardas, Edison Price, Vampire, XLO, binding posts, banana plugs, etc.

Send for **FREE** catalog today!

**MICHAEL PERCY AUDIO**  
P.O. Box 526  
Inverness, CA 94937  
(415) 669-7181 Fax (415) 669-7558

Reader Service #21

# THE XVR-1 TWO-WAY ELECTRONIC CROSSOVER PLATFORM

By Fred Janosky

**B**iamplification is becoming ever more popular where very strong, tight, low-distortion bass is required. Subwoofers can certainly improve low-frequency output and reduce the main speakers' work while providing a more pleasurable listening experience. Most *SB* readers already know that permitting the subwoofer to handle the long, low-frequency excursions can reduce distortion across the entire audio spectrum and add a higher degree of sonic realism. Biamping, done properly with fine loudspeakers and electronics, greatly improves an audio system's performance.

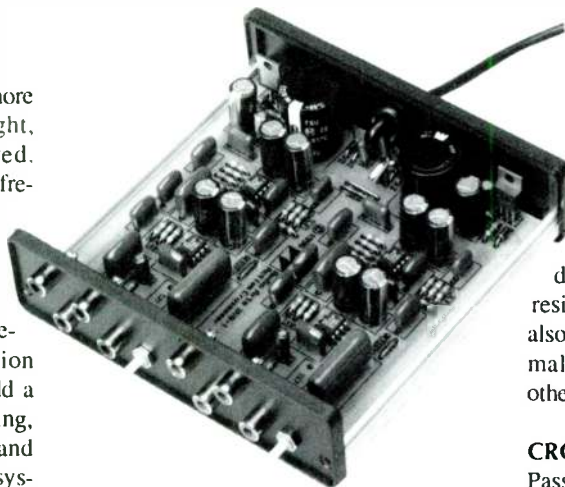
The current trend to home-theater systems is another reason to biamplify. Fine audio performance, which includes hefty low-end punch, makes watching a good movie more realistic and enjoyable. It's sensible to use small, limited-bandwidth, controlled-dispersion loudspeakers to complement the video display. You can locate subwoofers appropriately to provide powerful low-frequency reproduction. You may often resolve placement and decor concerns simultaneously by utilizing customized, built-in subwoofer modules.

## SOLUTION BY INVENTION

While biamplification may solve many problems, it created one for me when I could not find an electronic crossover that accurately preserved the original musical event and offered the features I needed at a reasonable price. Some offered much flexibility, but the audio performance suffered. Others offered fine audio performance but cost a small fortune. And virtually none offered the low-frequency equalization necessary for sixth-order bass-reflex subwoofers or other special low-frequency EQ. What's a speaker builder like myself supposed to do? Well, necessity

## ABOUT THE AUTHOR

Fred Janosky is an electrical engineer with MetEd/Penelec in Reading, PA, working with energy management, electronic controls, and mobile radio systems. His active involvement with audio has taken him from hobbyist and student to owner of an audio shop, and then to engineer and part-time audio-systems designer.



**PHOTO 1:** XVR-1 prototype with cover removed.

is the mother of invention.

This article describes a configurable electronic crossover designed for "subwoofing" and most other biamplification applications (*Photo 1*). The XVR-1 Electronic Crossover Platform features a complete kit of parts, including an attractive case, precision electronic components, PC board, and on-board power supply with external transformer. *Table 1* shows possible configuration options.

## HUNGRY DRIVER

Considering the bass driver's hunger for power, its complex impedance, and the associated complexity for passive crossover design, you can see why it's a good candidate for its own electronically tailored bandwidth and dedicated amplification. Stereo power amplifiers, each driving one channel's subwoofer and satellite speaker, permit you to use short speaker cables, thereby reducing related losses. Utilizing two identical amplifiers is sometimes called vertical biamping. Using dissimilar amplifiers—one dedicated to lower and the other to upper frequencies and drivers—is often called horizontal biamping.

Selecting a low crossover frequency between the subwoofer and main or satellite speakers permits the transition between speakers to occur outside the range where human hearing is most sensitive. Typically, frequencies below 200Hz are used, and many home-theater systems utilize 80Hz or lower between subwoofers and satellite speakers, which helps reduce audible discontinuities.

Passive crossover-network design at low frequencies reveals the need for very large inductors, with the potential for added series resistance. Power lost to series resistance reduces system efficiency. The bass enclosure's design must account for any added series resistance that affects Q factor. You must also consider inductor placement for minimal interaction between voice coils and other inductors.

## CROSSOVER COOKING

Passive crossover design at lower frequencies becomes even more problematic because of the enclosed woofers' varying complex impedance. Cookbook formulas for passive design rarely yield desired results unless circuitry is employed to compensate for varying impedance. However, adding passive compensation circuitry has its own problems, so it's easy to conclude that an electronic crossover may be the best solution at low frequencies.

The sonic results of biamping are often described as sounding tighter with more heft, weight, and punch. Other descriptions note a higher degree of openness, better imaging, less grain, more "quiet between the music," and higher definition over the entire audio spectrum. You may trace these results back to reduced intermodulation distortion and greater dynamic range, among other factors.

Over time, I've considered the design requirements for a stereo electronic crossover with an emphasis on subwoofer

**TABLE 1**

### CONFIGURATION OPTIONS OF XVR-1 ELECTRONIC CROSSOVER PLATFORM

<b>Buffer Amp:</b> Unity or greater overall gain
<b>Low Pass:</b> 6, 12, 18dB/octave
<b>Low EQ:</b> Sixth-order bass reflex equalization, subsonic filter, 24dB/octave cascaded low pass, bass equalizer; gain
<b>High Pass:</b> 6, 12, 18dB/octave
<b>OUT2:</b> Passive 6dB/octave, buffered passive 6dB/octave, (simultaneous use with high pass); line-through output
<b>Low Output:</b> Stereo or mono.



applications. In my design goals, the electronic crossover must:

1. perform well sonically, i.e., not sacrifice musical detail;
2. be elegant in its implementation;
3. be flexible to accommodate a variety of applications;
4. offer equalization circuitry for sixth-order bass reflex and other applications;
5. be affordable, but utilize precision-quality components;
6. be relatively small and attractive;
7. use available PC software to calculate frequency-determining components.

#### AID FROM AUTHORS

Bob Bullock published an excellent series of articles on crossover networks and filter design some time ago<sup>1</sup>. Following that series, Gary Galo produced a handy PC program that utilized Bullock's work in enabling the implementation of high- and low-pass filter networks using standard op-amp circuit topologies. The design process was off to a good start, especially as I already had Galo's Two-Way Active Crossovers software loaded on my PC.

Op amps can perform exceptionally well, providing you use the very best. The technol-

ogy has steadily improved, with many devices sounding exceptionally neutral and detailed. This is especially true of the latest designs made specifically for high-quality audio use.

Most loudspeaker designers develop a sense of what works best for them. My philosophy is that most subwoofer designs require fairly rapid-slope, low-pass crossover networks (12dB/octave or greater) if the woofer is not to "color" the upper frequencies. While slow-slope (6dB/octave) crossovers may be "transient perfect," their wide passband may allow too much high-

to page 22

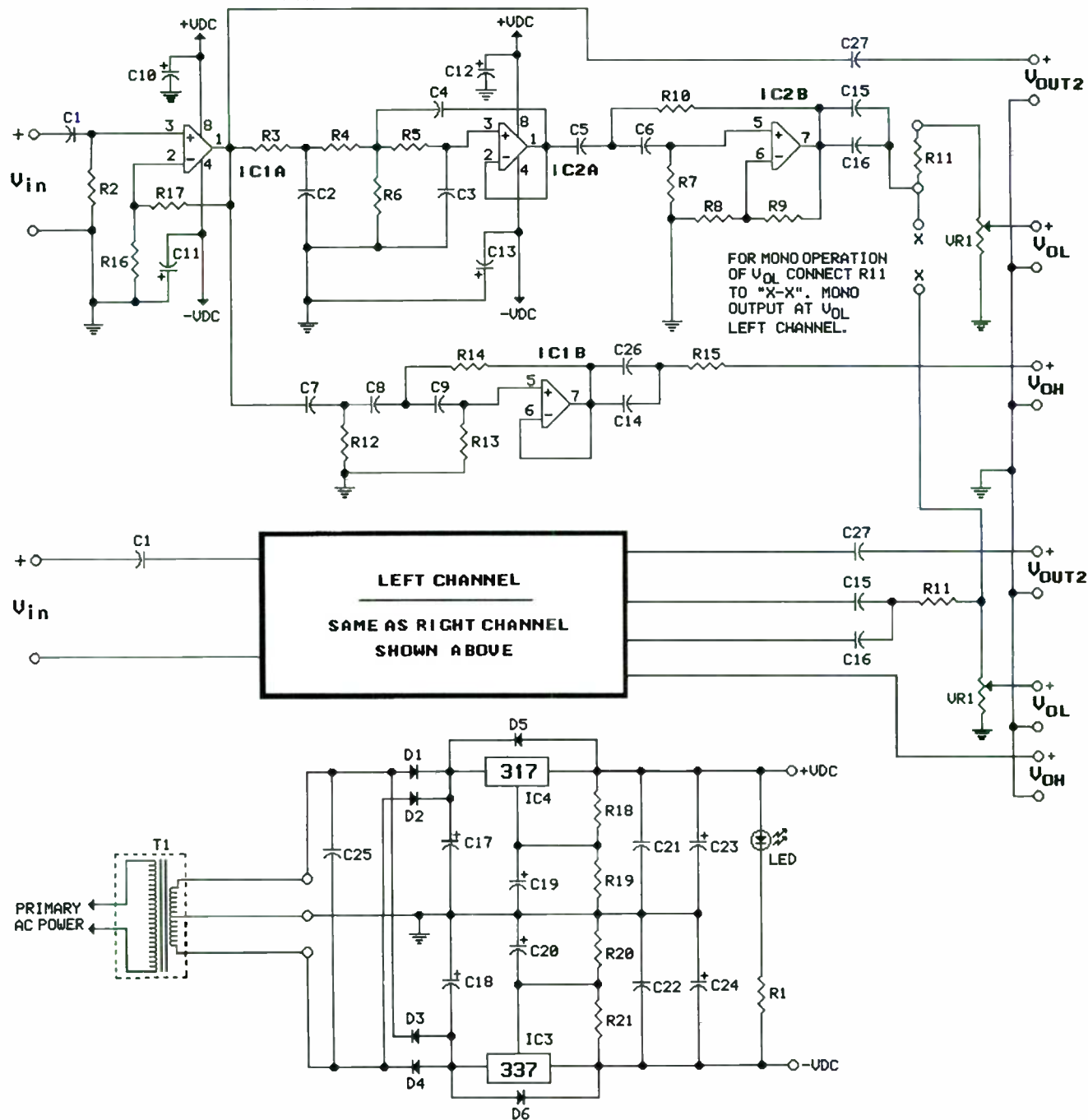


FIGURE 1: Schematic Diagram of XVR-1 Electronic Crossover.

# SYNCHRON....Coincidental Loudspeakers

The dream of every loudspeaker designer is to build a speaker with a smooth frequency response and good imaging. A smooth frequency response can be obtained by careful crossover design and use of quality drivers. Good imaging poses a problem that is not so easily solved, for the sound of the woofer and the tweeter should reach the listener at exactly the same point in time. Phase correction circuitry can be added to the crossover in order to achieve better imaging, but this type of design creates a precise image only in small areas of the listening room. Now a much improved design technique is possible due to the development of neodymium tweeter magnets. Their small mass allows a tweeter to be mounted at the base of the woofer cone, very close to the woofer voice coil.

Close positioning of the driver voice coils creates true imaging for any listening position in the room, because the sound generated by the woofer and tweeter originates from a single point source. The listener hears the music synchronized, in phase, and the result is unmistakably realistic.

The woofers in Synchron loudspeakers feature cast baskets, mineral filled polypropylene cones, PVC surrounds, Kapton formers, and ferrofluid cooling. The tweeters have aluminum domes with supronyl surrounds (3/4" on the SYN-519A and SYN-619A, 1" on the SYN-825A), neodymium magnets, diffuser/dome protectors, Kapton formers and ferrofluid cooling.

SYNCHRON SYN-519A 5.25"				
Technical Data	Symbol	Value	W/T	Unit
Nominal Impedance	Z	8/8		$\Omega$
Resonance Frequency	Fs	58/1500		Hz
Power Handling (IEC)	P	25/30		W
Sensitivity (1W/1m)	E	90/90		dB
Voice coil Diameter	$\emptyset$	33/19		mm
DC Resistance	Re	6/5.6		$\Omega$
Voice Coil Inductance	Lbm	50/-		$\mu$ H
X-Max peak		2/-		mm
Magnet Weight	m	.33/.008		kg
Force Factor	BL	6.5/2.5		TM
Suspension Compliance	Cms	1018/-		$mN^{-1}$
Mechanical Q Factor	Qms	1.8/-		
Electrical Q Factor	Qes	0.39/-		
Total Q Factor	Qts	0.32/-		
Equivalent Air Volume	Vas	14		Ltr
Moving Mass	Mms	7.8/0.19		g
Effective Piston Area	SD	.01/-		$m^2$
<b>Price Each</b>		<b>\$47.50</b>		

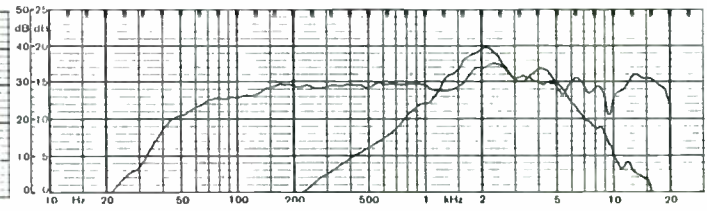
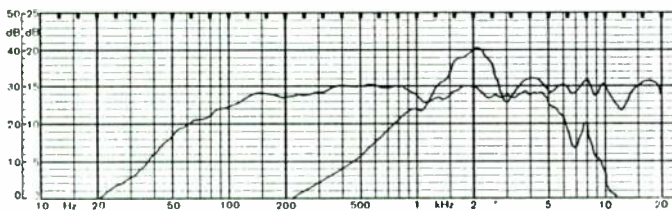


Suggested Box Alignments		
	Sealed	Vented
VB Ltrs	3.7	6
F3 Hz	125	85
Fb Hz	-	72
Vent $\emptyset$	-	1.5"
Vent L	-	3.3"

SYNCHRON SYN-619A 6.5"				
Technical Data	Symbol	Value	W/T	Unit
Nominal Impedance	Z	8/8		$\Omega$
Resonance Frequency	Fs	55/1500		Hz
Power Handling (IEC)	P	30/30		W
Sensitivity (1W/1m)	E	90/90		dB
Voice coil Diameter	$\emptyset$	33/19		mm
DC Resistance	Re	6/5.6		$\Omega$
Voice Coil Inductance	Lbm	47/-		$\mu$ H
X-Max peak		2/-		mm
Magnet Weight	m	.33/.008		kg
Force Factor	BL	7/2.2		TM
Suspension Compliance	Cms	803.3/-		$mN^{-1}$
Mechanical Q Factor	Qms	2.1/-		
Electrical Q Factor	Qes	0.44/-		
Total Q Factor	Qts	0.36/-		
Equivalent Air Volume	Vas	20		Ltr
Moving Mass	Mms	10.3/0.19		g
Effective Piston Area	SD	.013/-		$m^2$
<b>Price Each</b>		<b>\$49.00</b>		



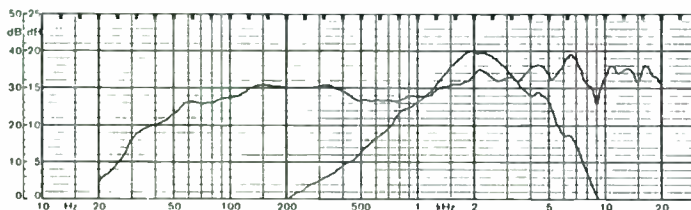
Suggested Box Alignments		
	Sealed	Vented
VB Ltrs	7.5	12
F3 Hz	105	65
Fb Hz	-	61
Vent $\emptyset$	-	2"
Vent L	-	3.8"



SYNCHRON SYN-825A 8"				
Technical Data	Symbol	Value	W/T	Unit
Nominal Impedance	Z	8/8		$\Omega$
Resonance Frequency	Fs	40/1500		Hz
Power Handling (IEC)	P	60/40		W
Sensitivity (1W/1m)	E	91/90		dB
Voice coil Diameter	$\emptyset$	42/25		mm
DC Resistance	Re	6/5.6		$\Omega$
Voice Coil Inductance	Lbm	58/-		$\mu$ H
X-Max peak		4/-		mm
Magnet Weight	m	.567/.013		kg
Force Factor	BL	9.1/3.18		TM
Suspension Compliance	Cms	808.4/-		$mN^{-1}$
Mechanical Q Factor	Qms	1.74/-		
Electrical Q Factor	Qes	0.36/-		
Total Q Factor	Qts	0.30/-		
Equivalent Air Volume	Vas	50		Ltr
Moving Mass	Mms	19.7/0.49		g
Effective Piston Area	SD	.021/-		$m^2$
<b>Price Each</b>		<b>\$58.00</b>		



Suggested Box Alignments		
	Sealed	Vented
VB Ltrs	11	16
F3 Hz	94	60
Fb Hz	-	54
Vent $\emptyset$	-	2"
Vent L	-	3.6"



Madisound is pleased to introduce the WS008A synchronized in-wall speaker system from Synchron. You will not find this type of sound quality in a conventional in-wall speaker.

The WS008A is constructed from a one-piece baffle and chassis to reduce vibrations. The woofer has a mineral filled polypropylene cone with a rubber surround and high temperature Kapton voice coil. The tweeter is a 1" Aluminum dome with a Neodymium magnet and ferrofluid cooling. The crossover is 24dB per octave, with polypropylene capacitors in the tweeter circuit for greater clarity.

The WS008A is easily mounted in existing drywall, or we have kits for framing in on new construction before drywalling. The frame and grill are white and can be easily painted to match your decor.

WS008A: 8 $\Omega$  impedance, 89dB sensitivity, 35-20KHz frequency response, 2.8KHz x-over, 3.8" depth. Cutout 210mm<sup>2</sup>

**Price per pair: \$220**

**New Construction Kit: \$18 /pr**

**MADISOUND SPEAKER COMPONENTS**  
 8608 UNIVERSITY GREEN  
 P.O. BOX 44283  
 MADISON, WI 53744-4283 U.S.A.  
 TEL: 608-831-3433 FAX: 608-831-3771  
 e-mail: madisound@itis.com  
 Web Page: <http://www.itis.com/madisound>

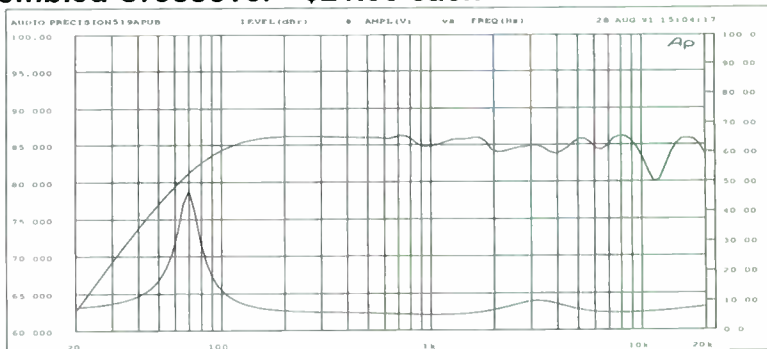
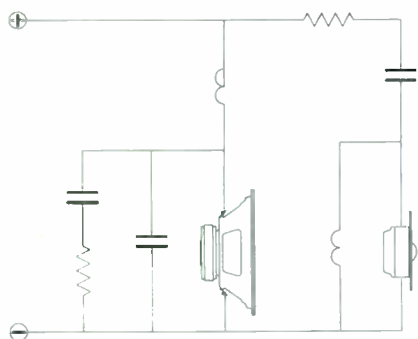


# Madisound Designed Crossovers for **SYNCHRON** Coincidental Speakers

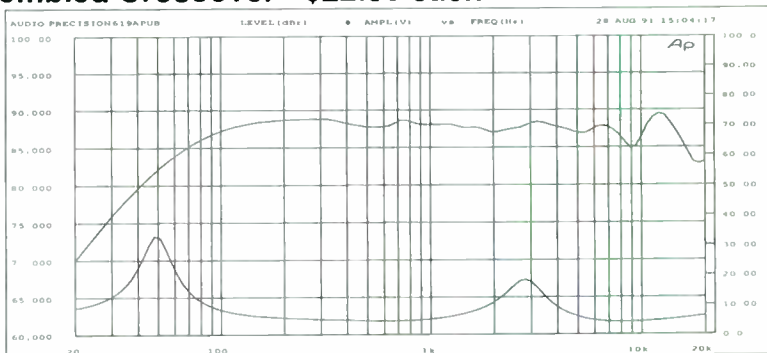
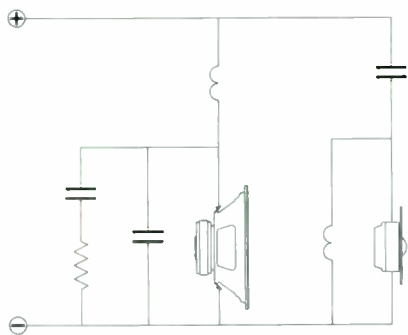
Madisound has designed the following crossovers for our Synchron Coincidental speaker line. We took accurate measurements of the Synchron speakers with Audio Precision test equipment for importation into the Leap crossover analysis program. After designing the crossovers in Leap, we did further testing with Audio Precision to ensure the accuracy of the Leap design. We were happy to discover that no further alterations were necessary.

The crossover designs have 12dB per octave slopes with impedance compensation on the woofer. The assembled crossovers feature Sidewinder 16 gauge air core inductors in series with the woofer and Polypropylene capacitors in series with the tweeter. The crossover parts are mounted on a glass epoxy circuit board for added strength.

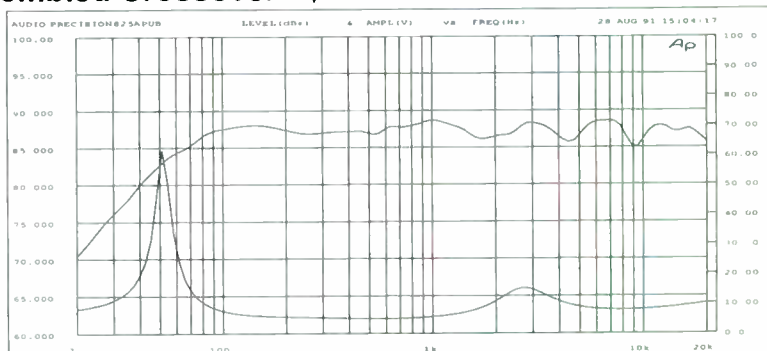
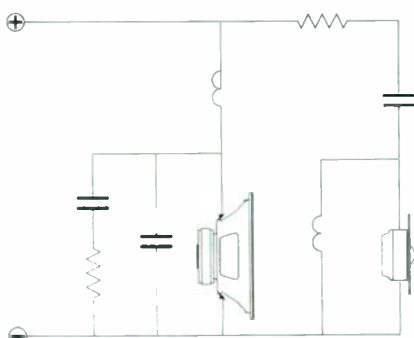
## SYN-519A Assembled Crossover - \$21.00 each



## SYN-619A Assembled Crossover - \$22.50 each



## SYN-825A Assembled Crossover - \$24.75 each



Ordering Information: All speaker orders will be shipped promptly, if possible by UPS. COD requires a 25% prepayment, and personal checks must clear before shipment. Add 10% for shipping charges. Residents of Alaska, Canada and Hawaii, and those who require Blue Label air service, please add 25%. There is no fee for packaging or handling, and we will refund or bill you to the exact shipping charge. We accept Mastercard, Visa or Discover on mail and phone orders.



**MADISOUND SPEAKER COMPONENTS**  
 8608 UNIVERSITY GREEN  
 P.O. BOX 44283  
 MADISON, WI 53744-4283 U.S.A.  
 TEL: 608-831-3433 FAX: 608-831-3771  
 e-mail: [madisound@itis.com](mailto:madisound@itis.com)  
 Web Page: <http://www.itis.com/madisound>



TABLE 2

### CROSSOVER COMPONENT CALCULATIONS & CONFIGURATION

A) Calculate:  $w = 2\pi f$ , where  $f$  is the desired crossover frequency, then,

B) For first-order filters:

Low Pass	High Pass
R3 = jumper	R12 = omit
R4 = jumper	R13 = $1/(C9)(w)$
R5 = $1/(C3)(w)$	R14 = omit
C2 = omit	C7 = jumper
C3 = $0.1\mu F$	C8 = jumper
C4 = omit	C9 = $0.1\mu F$

C) For second-order all-pass filters:

Low Pass	High Pass
R3 = jumper	R12 = omit
R4 = $1/(C3)(w)$	R13 = $1/(C8)(w)$
R5 = R4	R14 = R13
C2 = omit	C7 = jumper
C3 = $0.1\mu F$	C8 = $0.1\mu F$
C4 = $0.1\mu F$	C9 = $0.1\mu F$

D) For third-order filters:

Low Pass	High Pass
R3 = $1.02996/(C2)(w)$	R12 = $0.718057/(C7)(w)$
R4 = $7.34938/(C2)(w)$	R13 = $4.93947/(C7)(w)$
R5 = $1.32108/(C2)(w)$	R14 = $0.281943/(C7)(w)$
C2 = $0.1\mu F$	C7 = $0.1\mu F$
C3 = $0.01\mu F$	C8 = $0.1\mu F$
C4 = $0.1\mu F$	C9 = $0.1\mu F$

from page 19

frequency information to enter the subwoofer, making its natural rolloff characteristic critical, and aberrations from driver-response overlap very noticeable. This affects imaging, sound localization, polar and frequency response, and so on.

The end result may have consequences more severe than an imperfect transient response. Still, 6dB/octave crossovers have their place, and I recommend experimenting for yourself to determine what works best in your specific application.

As a rule, the acoustic rolloff rate of the main satellite speaker should match the rate of the subwoofer. In many cases, depending on the crossover frequency you select, the rolloff rate of the satellite adds to that of the electronic crossover, which means you may have to set the high-pass electrical slope rate differently than the low-pass rate to obtain the desired total acoustical slope rates.

In some cases, you may also need to select different frequencies to properly match and smooth the response near the crossover frequency. Hence, independent frequency and rolloff rates for both high- and low-pass filters become requirements of the design.

### SELECTING FILTERS TO FIT

In most of my work with loudspeaker crossovers, first-, second-, and third-order (6, 12, and 18dB/octave) electrical filters worked well as long as I chose them to fit the application. You need only one op-amp filter stage to realize first-, second-, or third-order rates for either high- or low-pass sec-

tions. However, you need two op-amp stages to realize the fourth-order (24dB/octave) rolloff rate.

The addition of another op-amp stage and the associated configuration complexity detracted from my desire for an elegant design. Much active circuitry with complex signal routing may also detract from the sonic performance of an audio circuit. Opting for the simple over the complex, I found it made sense to design for first-, second-, and third-order slope-rate configurations. (However, you have a potential option for 24dB/octave low-pass filter configuration by appropriately configuring and cascading the "EQ stage" with the preceding low-pass filter stage.)

Using the established op-amp filter models, you have the design basis for the frequency-determining crossover circuitry. In addition, you need a buffer stage in front of the filter stages to isolate them from unknown impedances that may derive from various preamplifiers (and cables) or from other front-end equipment. Typically, a buffer has unity gain. For increased flexibility, the PC board includes an option for this stage to supply gain. This feature may be useful to those utilizing a passive preamp or no preamp at all.

The low-pass signal flow proceeds after the buffer to the low-pass active filter, then to a final stage to supply gain and possibly equalization. Several options are available for this stage, which drives the level controls and ultimately the low-frequency power amplifier.

### TAILORED BASS

Configured as an equalizer for sixth-order bass-reflex subwoofers, this second-order filter network complements the bass driver/enclosure system, yielding the desired total acoustical response. You may also use this EQ stage to provide some extra bass to other subwoofer designs.

One reason sixth-order bass-reflex enclosures are interesting is that you can often obtain a very low cut-off frequency from relatively small enclosures. This can increase the WAF<sup>2</sup>, especially if you have many speaker systems in the same room.

One attribute of sixth-order bass-reflex systems is that the electrical response below the boost frequency rolls off at 12dB/octave. This is especially welcome for those who like to listen to vinyl. Subsonic frequencies wreak havoc with bass-reflex systems, causing excessive cone motion unless you use such an electrical filter. You may also opt to configure this stage as a subsonic filter with a flat pass-band for use with other bass-reflex designs.

At this point, I have to put in a plug for Top Box<sup>3</sup>, a PC-based software package for designing all types of bass enclosures,

including sixth-order bass-reflex systems. It provides all the required parameters that enable you to select the proper component values for the bass-equalizer circuitry for this electronic crossover in a sixth-order bass-reflex speaker design. If you desire a totally flat response below the crossover frequency, you may configure this stage to act only as a gain stage, allowing an adjustable range with the level controls.

TABLE 3

### XVR-1 PARTS LIST

#### Capacitors

C1 —  $1\mu F$  PPN 250V ( $\times 2$ )  
 C2-9 — configure;  $0.1\mu F$  PPN 100V ( $\times 10$ )  
 C5, 6 — optional/jumper; bass EQ  $0.1\mu F$  PPN ( $\times 2$ )  
 C3 — configure;  $0.01\mu F$  PPN ( $\times 2$ )  
 C10-13, 23, 24 —  $470\mu F$  Low ESR Electrolytic 16V ( $\times 10$ )  
 C14, 15 —  $0.47\mu F$  PPN 100V ( $\times 4$ )  
 C16, 26 —  $10\mu F$  BP Electrolytic 16V ( $\times 4$ )  
 C17, 18 —  $3300\mu F$  TSU Electrolytic 25V ( $\times 2$ )  
 C19, 20 —  $10\mu F$  Electrolytic ( $\times 2$ )  
 C21, 22, 25 —  $0.1\mu F$  mylar 250V ( $\times 3$ )  
 C27 — optional, calculate for passive high-pass filter ( $\times 2$ )

#### Resistors

R1 —  $2k \frac{1}{2}W$  ( $\times 1$ )  
 All remaining resistors  $\frac{1}{4}W$  1%:  
 R2 —  $60.4k$  ( $\times 2$ )  
 R3, 4, 5 — calculate & configure for low-pass filter ( $\times 6$ )  
 R6 —  $1M$  ( $\times 2$ )  
 R7 — optional/open; calculate for bass EQ ( $\times 2$ )  
 R8, 9 —  $5.1k$  ( $\times 4$ )  
 R10 — optional/open; calculate for bass EQ ( $\times 2$ )  
 R11, 15 —  $100$  ( $\times 4$ )  
 R11 mono —  $1k$  ( $\times 2$ ) install for mono bass only  
 R12, 13, 14 — calculate & configure for active high pass filter ( $\times 6$ )  
 R16 — optional/open; unity or additional overall gain ( $\times 2$ )  
 R17 — optional/short; unity or additional overall gain ( $\times 2$ )  
 R18, 21 —  $121$  ( $\times 2$ )  
 R19, 20 —  $1.3k$  ( $\times 2$ )

#### Miscellaneous

VRI — 5k sealed conductive plastic linear pot.  
 D1-6 — 1N4003 silicon diodes ( $\times 6$ )  
 IC1, 2 — OP275 ( $\times 4$ )  
 IC3 — LM337 ( $\times 1$ )  
 IC4 — LM317 ( $\times 1$ )  
 LED — T1 1.7V 20mA ( $\times 1$ )  
 Transformer — wall mount, 28V CT 300mA custom ( $\times 1$ )  
 Shoulder washer — fiber, between pots. and rear panel ( $\times 2$ )  
 RCA jacks (red) — gold/brass with washers ( $\times 4$ )  
 RCA jacks (black) — gold/brass with washers ( $\times 4$ )  
 Case — precision black anodized, custom  
 PC board —  $0.062"$  fiberglass, 2 oz. copper with solder-plating  
 Grommet — for lead-in from transformer

#### Ordering Information

A complete kit of parts to build XVR-1 is available for \$269 + \$10 shipping and handling from Audio Arts, RD 2 Box 3502, Wemersville, PA 19565; E-mail: fjanosky@prodi-gy.com. The complete kit includes precision custom black anodized aluminum case, silk-screened heavy 2 oz plated-copper fiberglass PC board, external transformer, electronic components (1% metal-film resistors, polypropylene film capacitors, low-ESR electrolytics, OP275 op amps, diodes, regulators), gold RCA jacks, and a manual. Resistors for 80Hz 18dB/octave crossover with flat bass EQ are also provided.



**Speaker  
Components**

**AIRBORNE**

LA PASSION DU HAUT-PARLEUR

**AUDAX**

**DYNAUDIO**<sup>®</sup>

**FEON**



**Peerless** 

**scan·speak**

**seas**

**vifa**



**SOLEN** INC.  
4470 AVENUE THIBAUT  
ST-HUBERT, QC J3Y 7T9  
CANADA

Tél.: (514) 656-2759

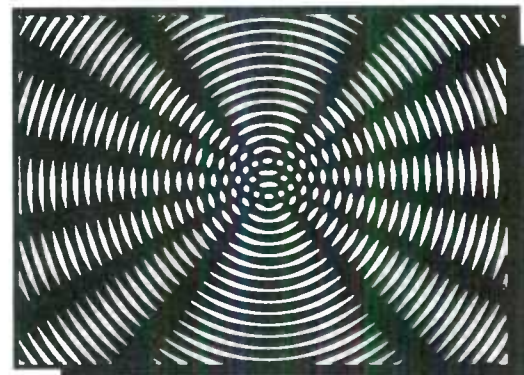
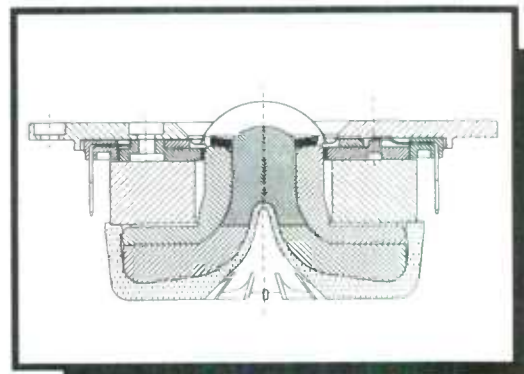
Fax: (514) 443-4949

**Catalogue 1996 • \$ 8.00**

Solen crossover  
components catalog included



*Music  
Forever*



## HIGH-PASS STAGE

Now consider the high-pass stage. For absolute purity, include a passive high-pass filter—no active circuitry used. This simple circuit utilizes one high-quality polypropylene capacitor to work with the input resistance of the power amplifier in forming a first-order high-pass filter.

Actually, this simple circuit is very useful, because many small acoustic suspension speakers roll off somewhere just below 100Hz at 12dB/octave. If you combine the crossover's passive electrical rolloff at 6dB/octave with the small speaker's 12dB/octave rolloff, an 18dB/octave rate is the total acoustical result. Then set the electronic crossover's low-pass 18dB/octave rate at the desired frequency to drive the subwoofer amplifier.

There are three options for the high-pass filter and associated signal flow. The first is described above: no active circuitry in the high-pass signal flow. The second option uses the buffer's output and a single capacitor. The third option uses an active filter configurable for 6, 12, or 18dB/octave. To preserve the audio signal in this critical band, all high-pass options drive the high-pass outputs directly, with no level controls in the signal-flow path.

## CAREFUL PLANNING

The project's next phase involves selecting components, PC-board design, mechanical design, assembly of prototypes, testing, and refinement. A good PC-board layout design takes a fair amount of time, even using a computer-aided-design (CAD) package. The idea is to utilize real estate very efficiently and logically with respect to signal flow.

The PC board should use adequate ground foil and heavy-weight copper. To keep signal degradation as low as possible, you should minimize wiring and electrical contacts, and you should locate components for the best signal-to-noise ratio. You also need to make the electronic crossover fairly small so it can be easily positioned (small size minimizes cir-

cuit-trace lengths, as well).

The case must be attractive, durable, and functional. Use gold-plated jacks for their fine electrical conductivity. I constructed several prototypes and tested them electrically and sonically to achieve a high level of performance.

## CHANNEL SCHEMATIC

Figure 1 shows the schematic for one channel. A logical place to start is at the input. C1 is a polypropylene input coupling capacitor that isolates IC1A from any DC component. R2 sets the input resistance of the electronic crossover at a value that is easily driven by most preamplifiers.

IC1A forms the noninverting buffer stage, which is configurable to supply gain calculated as follows:

$$\text{voltage gain} = (R16 + R17) / R16$$

In most cases, unity gain will suffice. You

accomplish this by keeping R16 open and using a jumper in place of R17. You may set gain accordingly.

IC2A forms the noninverting low-pass stage. You determine the order of the stage (1, 2, 3) by configuring resistors, capacitors, and jumpers, and you configure this and the high-pass stage by using the formulas in Table 2 or Gary Galo's "Two-Way" software to calculate resistor values for the crossover frequency and order you select. One nice feature is that you may use "standard" capacitor values, such as 0.1µF and 0.01µF, and resistors then become the variables. You can easily and inexpensively obtain a wide range of resistor values.

Continuing with the low-pass stage, R6 is a "return" resistor, with a value you may fix at 1M. C2, C3, and C4 typically may be 0.1µF and/or 0.01µF (or other values, if you desire), depending on the slope rate and crossover frequency. R3, R4, and R5 are the frequency-determining resistors. I recom-

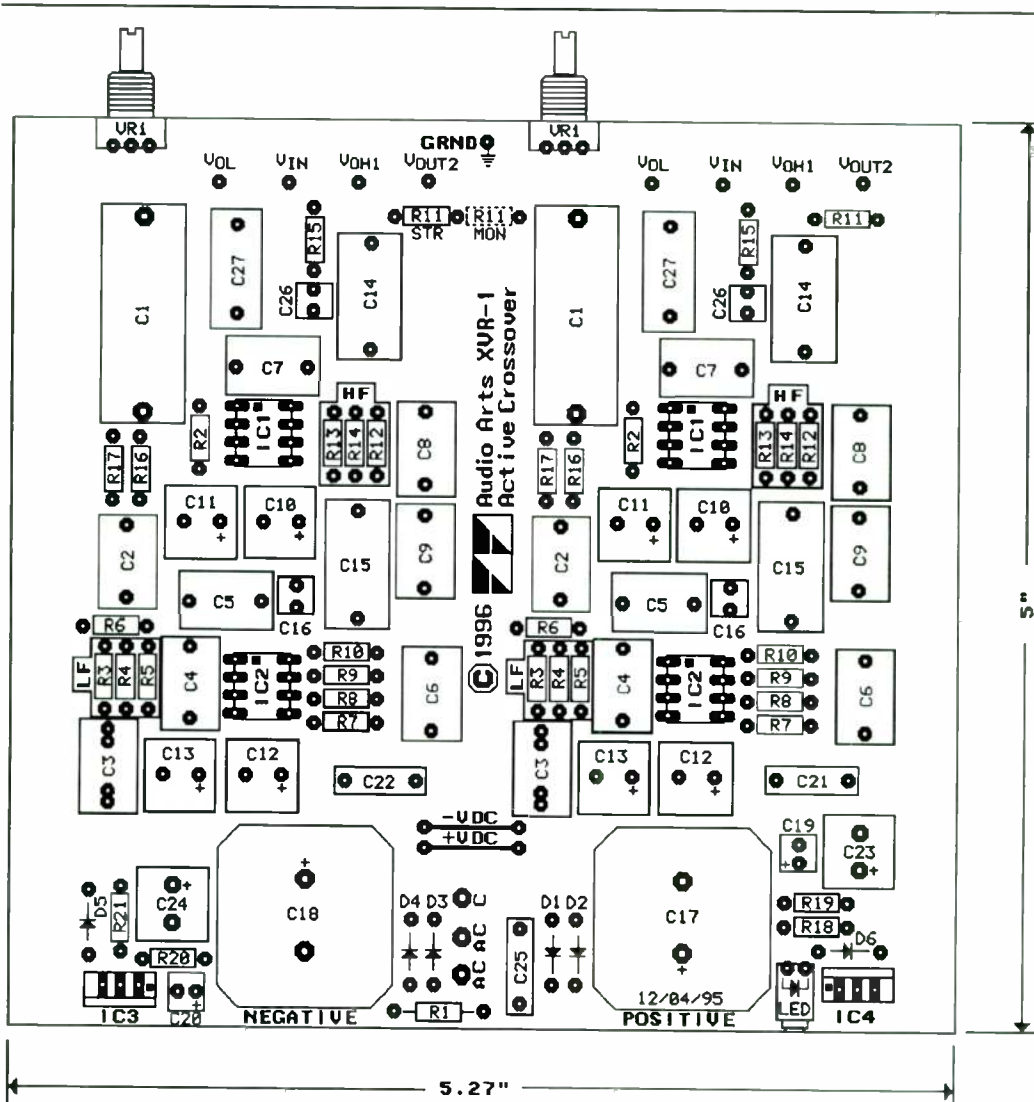


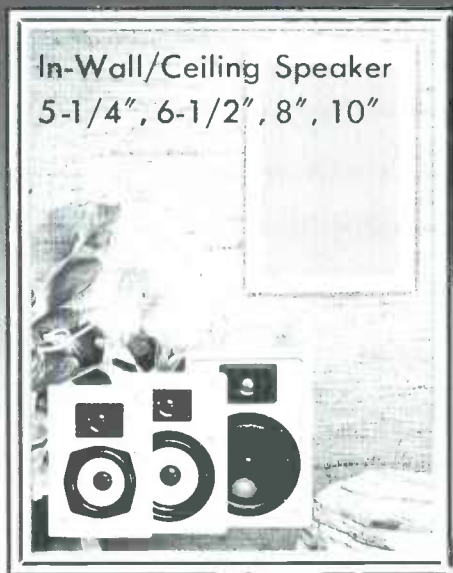
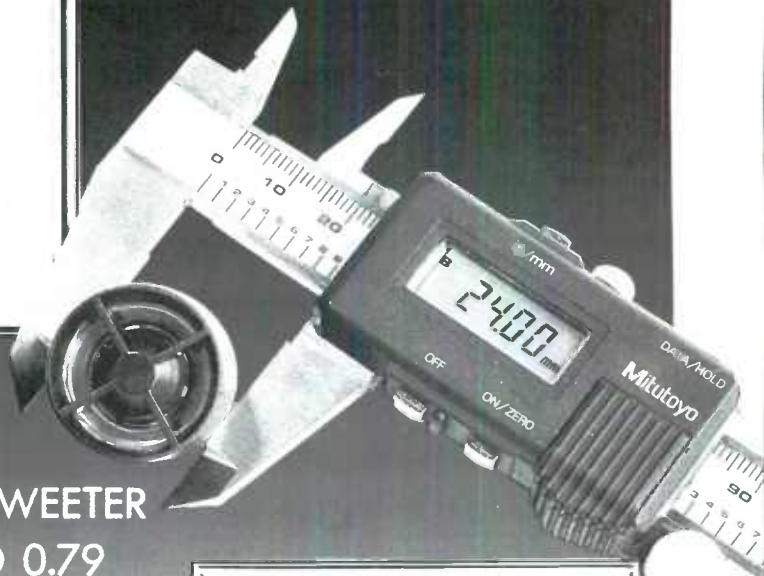
FIGURE 2: XVR-1 PC board layout.



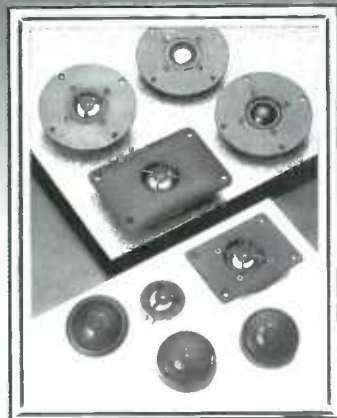
**\* SEPARATE CAR SPEAKER SYSTEM**  
**\* IN-WALL SPEAKER**      **\* TWEETERS**



φ 13mm Neirbon  
 Super-Tweeter



**DOME TWEETER**  
**@USD 0.79**



Surface/Angle/Flush  
 Mounting Kits

Can Light Style/Square In-Wall

**COST DOWN !!**

- ◎Best choice for cost saving effectively.
- ◎Most professional manufacturer for speakers.
- ◎Available for OEM design and free catalogues.

**Forgings INDUSTRIAL CO., LTD.**

SENT INQUIRY TO-ADD: P.O. BOX 1823, TAIPEI, TAIWAN, R. O. C.  
 TEL: 886-2-585-3316/7      FAX: 886-2-594-2708      ATTN: MS. CHI YING

ment avoiding excessively large resistor values, if the choice arises, to minimize noise potential.

Note that you'll be using all the resistors and capacitors in this stage only for the 18dB/octave version. For 12dB/octave networks, jumper R3 and omit C2. For 6dB/octave networks, jumper R3 and R4 and omit C2 and C4.

Advanced readers may want to derive transfer functions for specific filter types to complement their speaker-system design, and then calculate R and C values accordingly.

## FINISHING THE FLOW

Before getting into the high-pass stage, finish the low-frequency signal flow by proceeding to IC2B, which forms the noninverting EQ stage, either for sixth-order bass-reflex systems or for other applications. C5, C6, R7, and R10 are the components that form the equalizer. R8 and R9 add a little gain to this stage. I recommend that you use a gain of 2 here, which you achieve by utilizing 5kΩ resistors for both. Using the EQ stage with a sixth-order reflex enclosure, you'll need to determine the required boost and boost frequency for your design.

If you're not using a sixth-order reflex enclosure and want a totally flat response,

jumper C5 and C6, and leave R7 and R10 open. Again, use the 5k resistors for both R8 and R9. This will result in a flat response with a gain of 2, which should provide an adequate range over which to adjust the subwoofer level using the electronic crossover's potentiometers, VR1.

Note that you may configure this stage as a subsonic filter by configuring it as a high-pass filter with a very low frequency (about 20Hz or lower). A possible alternative is to configure it as a low-pass filter to be cascaded with the previous stage, enabling a 24dB/octave low-pass filter. I leave this to you to design and configure.

Another option included on the printed circuit board allows for summed low-pass (mono) output, which occurs by placing the right channel's R11 at a different location to effectively sum the outputs of both channels. You then use resistors of 1kΩ for R11, and this allows for a single subwoofer. The mono output is then available at the left channel's low-frequency output jack, LOW OUT.

## HIGH-PASS STAGE

The active high-pass filter stage is configured in the same way as above. C7, C8, and C9 are the standard-sized capacitors again,

and R12, R13, and R14 are the frequency-determining resistors (Table 2).

As before, only the 18dB/octave network requires all the components. For 12dB/octave high-pass networks, jumper C7 and omit R12. For 6dB/octave networks, jumper C7 and C8, and omit R12 and R14. C14 and C26, like C15 and C16, are coupling and bypass capacitors.

In relation to the high-pass stage, you can implement either passive first-order option. That's what each channel's extra RCA jack, OUT2, is used for. First, calculate the correct value capacitor and solder it between the input jack and the spare jack. (Note that C27 is not used in this case.) To select the proper capacitor, you must know the input resistance of your power amplifier and the desired high-pass crossover frequency. (This assumes that the output resistance of the preamplifier is relatively low, say 600Ω or less.) Calculate C as follows:  $C = 1/(2\pi fR)$ , where R is the input resistance of your power amplifier and f is the desired high-pass crossover frequency in Hertz.

The totally passive crossover option is quite useful and sonically pure, but there are cases where it won't work well. This may happen if you're using a passive preamp or

# HIGH PERFORMANCE ELECTRONIC CROSSOVER NETWORKS

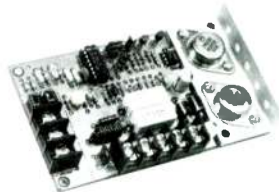
## THESE COMPONENTS AVAILABLE FULLY ASSEMBLED OR AS KITS



**XM9 Crossover Network** • 24 dB/octave slope • fourth-order constant-voltage design • Outputs in phase • Low noise • Controls on circuit board or panel • Settable crossover frequency from 20–5,000 Hz.



**XM16 Crossover Network** • 48 dB/octave slope • Eighth-order constant-voltage design • Outputs in phase • Low noise • Controls on circuit board or panel • Settable crossover frequency from 20–5,000 Hz.

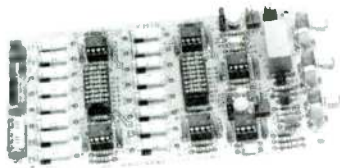


**XM9-C and XM16-C Custom Cabinets** (for home use) Accommodates 2 or 4 XM9 or XM16 Crossovers and PS10 (or PS15) power supply to make either 2-way or 3-way system. • Buy cabinet only, kit, or fully assembled with circuit boards.

**XM9-CA2 and XM9-CA3 Custom Cabinet** (for automotive use) Accommodates 2 or 4 XM9 or XM16 Crossovers and PS15 (or PS10) power supply to make either 2-way or 3-way system. • Buy cabinet only, kit, or fully assembled with circuit boards.

**PS10 Power Supply** (for home use) converts 120 VAC to dual 15 VDC supply • Regulated • Can support 8 crossover networks.

**PS15 Power Supply** (for automotive use) converts 12 VDC to dual 15 VDC supply • Can support 4 crossover networks.



**WMB "BASSIS" Bass Correction Equalizer** extends bass response by 1 to 2 octaves • Adjustable bass boost and damping • Rumble filter • 20 Hz subsonic filter.

**PM2 and PM22 Power Amplifier Modules** provide 75 watts RMS into 8 ohms • Complementary Darlington output stage • Integrated-circuit driver circuit • Over-current and over-temperature protection • Class A or Class AB operation.

**WRITE NOW FOR FREE LITERATURE ABOUT THESE AND OTHER MARCHAND PRODUCTS**

SEND YOUR NAME AND ADDRESS TO: MARCHAND ELECTRONICS, INC.  
P.O. Box 473 • WEBSTER, NY 14580 • PHONE (716) 872-0980 • FAX (716) 872-1960



**NEW!**

**velleman-kit**

HIGH-Q



GAVERE BELGIUM

**NEW!**

*proudly announces the appointment of*



**OLD COLONY  
SOUND LABORATORY**

*as*

**NORTH AMERICAN AGENT**

*for all Velleman products, including the*

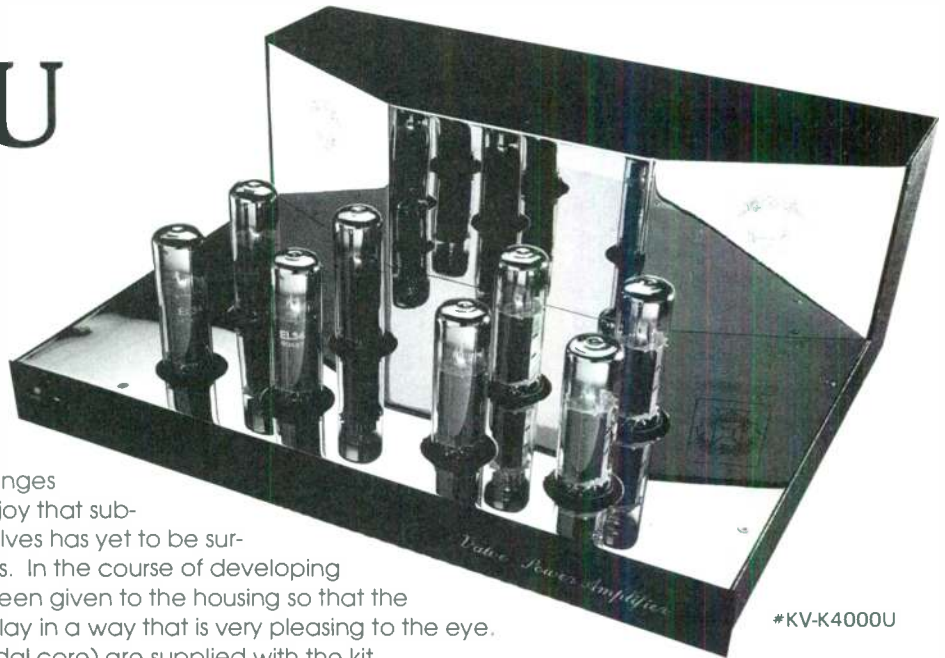
**BEAUTIFUL**

**K4000U**

**STEREO VALVE  
AMPLIFIER KIT**

*NOW ONLY*

**\$799\***



For most of us, a high power valve amplifier is unaffordable. This kit changes that, so that now everybody can enjoy that sublime "valve sound." The sound of valves has yet to be surpassed, either by transistors or by FETs. In the course of developing this amplifier, special attention has been given to the housing so that the expensive valves (tubes) are on display in a way that is very pleasing to the eye. Ultralinear output transformers (toroidal core) are supplied with the kit.

Output power: 2x200W music power; 2x95Wrms Class AB; 2x15W Class A. Load: 4 or 8 Ohms. Power bandwidth: 10Hz-60Hz (-3dB) at max output. Frequency range: 4Hz-100kHz (-3dB ref. 1W). Harmonic distortion: 0.08% (1kHz/1W), 0.63% (1kHz/max output power). Signal-to-noise ratio: 102dB (A-weighted). Channel separation: 67dB. Input impedance: 100k Ohms. Input sensitivity: 0dB (0.775mVrms) at 95W. Damping factor: 25. Weight: 20kg. Dimensions WxHxD: 16.6x5.1x13.7 in.

ALSO AVAILABLE:

- #KV-K4100 Solid State Digitally-Controlled Preamp Kit . . . Only **\$269\***
- #KV-K4500 Solid State Synthesized FM Tuner Kit . . . . . Only **\$269\***
- #KV-K4101 Infrared Remote Control Kit for K4100 or K4500 . . . . . Only **\$49\***

Please send me \_\_\_ kit # \_\_\_\_\_ @ \$ \_\_\_\_\_ \$ \_\_\_\_\_  
 \_\_\_\_\_ kit # \_\_\_\_\_ @ \$ \_\_\_\_\_

NAME \_\_\_\_\_

STREET \_\_\_\_\_

CITY \_\_\_\_\_ ST \_\_\_\_\_ ZIP \_\_\_\_\_

CARD NO. \_\_\_\_\_ EXPIRE \_\_\_\_\_

\*Plus shipping: 7% USA • 14% Other Surface • 25% Other Air

Handling **2.00**

TOTAL ORDER \$ \_\_\_\_\_

• MC • Visa • Discover • Check or Money Order in US \$ drawn on US bank •



**OLD COLONY SOUND LABORATORY**

PO Box 243, Dept. B962

Peterborough NH 03458 USA

24 Hrs.: Tel. 603-924-6371, 603-924-6526 Fax 603-924-9467

CALL OR WRITE TODAY FOR YOUR FREE VELLEMAN CATALOG!

World Radio History



**driver design limited**  
quality american-made loudspeakers

*Premium drivers for stage,  
studio and critical listening.  
Ask for them by name.*

**NEW FOR 1996**

V5/12R midbass. Coated cone, British rubber surround. An excellent choice for compact vented systems.

HOVR-6 pro midrange. Large magnet, edgewound aluminum voice coil, curvilinear cone. The best choice for high-output, high-fidelity systems.

Phone: 510-370-1941  
E-mail: DDL111@AOL.COM

Reader Service #42

one with considerable output impedance. An option on the printed circuit board overcomes this limitation by taking the signal after the buffer stage. You accomplish this by inserting C27 on the PC board. (C27 is calculated the same way as C.)

A summary of the three options for the high-pass filter network is as follows: 1) a totally passive single-capacitor filter between the INPUT jack and OUT2 jack; 2) one buffer op amp in the circuit using single-filter capacitor C27; and 3) the high-pass op-amp filter network with output at jack VOH1. Only the last option permits filter orders greater than one. You may configure the crossover to use either passive option for OUT2. With the active high-pass option via HIGH OUT, two high-pass outputs are available simultaneously.

**POWER SUPPLY**

For fine audio performance, a very robust, on-board regulated supply is included. The wall-mount transformer is external to the case, which not only helps minimize the possibility of noise entering the circuitry, but also keeps AC line voltage outside the case for greater safety. A full-wave bridge rectifier (D1-4) and large (3,300µF) capacitors for filtering both positive and negative rails sup-

ply variable IC voltage regulators that provide the DC source voltage.

Resistors R18, 19, 20, and 21 set the voltage, and capacitors C19 and 20 maximize ripple rejection. Low-ESR electrolytics (C23, C24) filter the DC supply rails, while eight more of the same low-ESR electrolytics are located near each op-amp pair to provide still more isolation and filtering, further reducing supply impedance. Film-shunt capacitors are included on the DC supply rails and at the AC input. The LED indicates "power on" and shows operation of both supply rails.

To maintain accuracy of the filter network, precision resistors are necessary. For best audio performance, use polypropylene film capacitors in the signal-flow path and for frequency-determining sections. Bipolar electrolytic capacitors (C16, C26) parallel the polypropylene output, coupling capacitors to extend the low-frequency response.

As for the op amps, not long ago Joe D'Appolito suggested that I try the relatively new OP275. Analog Devices' literature notes that OP275 "...combines both bipolar and JFET transistors to attain amplifiers with the accuracy and low-noise performance of bipolar transistors and the speed and sound quality of JFETs." Slew rate is listed at

# MENISCUS

# SPEAKERS -

**CAPACITORS -**

- Solen Poly.
- MIT Poly.
- Film types
- NP Elec.

**INDUCTORS -**

- Air Cored
- Super Ferrite
- Steel Laminate
- Ferrite
- 20-14 ga. OFC

**RESISTORS -**

- Wire wound
- Lynk
- 5 -25 Watt

**ACCESSORIES -**

- Terminal cups
- Gold pots
- Spkr. Cabinets
- Wire & ends
- Grille materials
- Black screws
- Port tubes/trim
- Spikes & cones
- Damping materials
- Design books
- X-over & box design support
- Sub woofer Amps.
- Custom in-wall systems.

**AUDAX**

**AUDIO CONCEPTS**

**DYNAUDIO**

**ECLIPSE**

**ETON**

**LEGACY**

**MADISOUND**

**SCAN SPEAK**

**SWAN**

**VERSA/TRONICS**

**VIFA**

**MENISCUS AUDIO GROUP**

2575 28th St. S.W.  
Wyoming, MI 49509  
phone (616) 534-9121  
fax (616) 534-7676  
E mail meniscus@iserv.net

Reader Service #12



25V/ $\mu$ S and bandwidth at 10MHz. Designed for high-performance audio applications, this device is capable of driving 600 $\Omega$  loads to 10V RMS, and shows a THD + noise specification of 0.0006% at 3V RMS. But the really big news is how good this device sounds: it's very neutral, open, and as "musical" an op amp as I have heard.

### FINAL STEPS

Construction is relatively straightforward, as you install all electronic components on the PC board (Fig. 2)—unless you choose the totally passive first-order high-pass option. First decide on crossover frequencies, slope rates, and any low-frequency equalization required, so that you may install appropriate component values and configuration. The op amps are static-sensitive, so I'd install them

### REFERENCES

1. "Passive Crossover Networks; Active Realizations of Two-Way Designs," Robert M. Bullock III, *Speaker Builder*, 3/85.
2. WAF: Acronym for "wife acceptance factor."
3. Top Box Speaker System Design Software, by Joe D'Appolito and Ron Warren, distributed by ORCA Design and Manufacturing Corporation.

last. Take care when handling them. The RCA jacks are panel-mounted and leads extend up to the jacks from the PC board. The only wiring is the cable from the external transformer, which enters from the case end opposite the RCA jacks.

An attractive precision-extruded black anodized case, approximately the size of a CD "jewel box," but 1/2" high, houses the circuitry. The printed circuit board slides neatly into the case's rails. Screws lock the case's chassis, top, and end panels together.

There you have it: an audibly pure, com-

pact two-way electronic crossover that meets a wide range of requirements for biamping and "subwoofering." I've used XVR-1 in my audio system with my CD player driving it directly, as well as in between my Audio Research Preamp and modified Transnova Power Amplifiers, and have been delighted with the results.

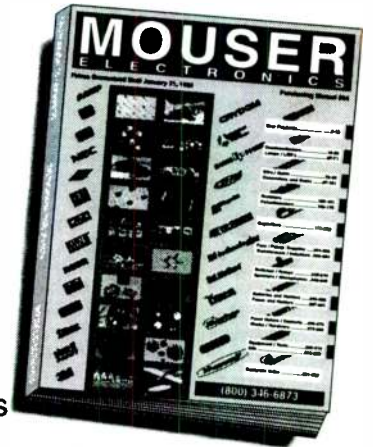
I believe the XVR-1 provides a fine platform on which to base your biamplified audio system. Does biamplification yield a new dimension in audio performance? You'll have to hear that for yourself!

# IN STOCK

**quality** \ 'kwäl - ət - ē \ *noun*

- An inherent and essential feature or element exhibiting a degree of excellence and superiority.  
*syn.* see **Mouser Electronics**

Call for your  
**FREE 324**  
page catalog  
**TODAY!**



61,601 Products  
120 Manufacturers  
All Orders Ship Same Day

- Passive Components
- Semiconductors
- Electromechanical
- Connectors/Cable
- Surface Mount and Through Hole

# MOUSER<sup>®</sup>

## ELECTRONICS

**800-992-9943**  
**FAX: 817-483-0931**  
<http://www.mouser.com>

958 North Main St., Mansfield, TX 76063

**Tube & General Purpose Projects**

**NEW** **LARGER SIZES**

**METAL CABINET**  
PANELS ARE .063" ALUMINUM BLACK OR GOLD. FRONT/REAR PANELS AVAILABLE FOR AN ADDITIONAL \$5.00.

**LC SERIES**  
.063" ANODIZED ALUMINUM. TOP AND BOTTOM PANELS ARE FIELD REMOVABLE. FRONT/REAR PANELS ARE .063" GOLD ANODIZED. OTHER PARTS BLACK ANODIZED. VENTED CAGES AND OAK END PANELS AVAILABLE.

MODEL	W x D x H (mm)	A	B	PRICE \$
LC-1	100 x 100 x 50	45.00	47.50	
LC-2	150 x 100 x 50	50.00	52.50	
LC-3	200 x 100 x 50	55.00	57.50	
LC-4	300 x 100 x 50	60.00	62.50	
LC-5	150 x 150 x 75	50.00	54.00	
LC-6	200 x 150 x 75	55.00	59.00	
LC-7	300 x 150 x 75	60.00	64.00	
LC-8	400 x 150 x 75	65.00	69.00	
LC-9	200 x 200 x 75	60.00	64.00	
LC-10	250 x 200 x 75	65.00	69.00	
LC-11	300 x 200 x 75	70.00	74.00	
LC-12	425 x 200 x 75	75.00	79.00	
LC-13	250 x 250 x 100	70.00	76.00	
LC-14	300 x 250 x 100	75.00	81.00	
LC-15	350 x 200 x 100	80.00	86.00	
LC-16	425 x 250 x 100	85.00	91.00	

ALL HARDWARE SUPPLIED.

### Audio Transformers for Tube Construction

Inputs - Line/Mic		POTS & SOCKETS ALSO AVAILABLE	
MODEL	PRI SEC CABE USE	PRICE \$	
AT-1	15k 60k A MIC INPUT	40.50	42.50
AT-2	15k 15k A LINE INPUT	40.50	42.50
AT-3	15k 60k B LINE OUTPUT	46.75	48.50

**Tube Outputs**

OT-1	5k A B EL84 3 WATT	9.00	11.00
OT-2	6k A 4.8 18 B EL84 10 WATT	12.00	16.00
OT-3	7k A 4.8 18 B EL84 20 WATT	18.00	24.00

ULTRA LINEAR DESIGN.

OUTPUT TRANSFORMERS DESIGNED FOR 5 AMPLE OUTPUT STAGES AND FEATURE FREQUENCY RESPONSE  $\pm 2$  dB 40 - 15k Hz.

**MENTION AD AND TAKE 5% OFF YOUR FIRST ORDER!**

FOR MORE INFO REQUEST CATALOG TB-1 WRITE OR FAX FOR OTHER CATALOGS, AUDIO SOLUTIONS, CONSTRUCTORS' HARDWARE, AUDIO SIPS and AUDIO TRANSFORMERS

Power Supply		
MODEL	SECONDARY CASE USE PRICE \$	
PT-1	125V 6V3 250mA AMP 9.00 11.00	
PT-2	250-0-250 5 6V3 2A AMP 18.00 24.00	
PT-3	300-0-300 5 6V3 2A AMP 20.00 26.00	
PT-4	400-0-400 5 6V3 2A AMP 24.00 30.00	
PT-5	180mA 3A 2A AMP	

**ORDER TODAY! (\$30.00 MINIMUM ORDER)**  
ALL PRICES INCLUDE WORLDWIDE SHIPPING!  
A IS USA, CANADA & MEXICO, B IS REST OF WORLD

ORDER (800) 634-3457 ■ FAX (800) 551-2749  
(702) 565-3400 ■ FAX (702) 565-4828  
SESCOM, INC. 2100 WARD DR. HENDERSON, NV 89015  
SESCOM, INC. is not responsible for inadvertent typographical errors and prices and specifications are subject to change without notice.

Reader Service #23

Reader Service #30

# BAEKGAARD REVISITED

By J.F. Cunniff

G.R. Koonce's article<sup>1</sup> on Erik Baekgaard's crossover technique<sup>2</sup> was stimulating on several levels and is worthy of additional effort toward simplification and cost minimization. In assessing the merit of Baekgaard's concept, it is important to view the "filler" channel it requires as the principal incremental cost incurred in return for a true all-pass, multiple-speaker topology. In many situations, the cost of a "filler" channel will be trivial.

## DESIGN FLEXIBILITY

Whereas Baekgaard addressed the goal of the all-pass crossover via passive RLC networks, Koonce exploited the active filter, consequently achieving a higher level of design flexibility. I, too, use active filters, but make use of some of the features that have become available in the 15 years since Koonce did his design work.

To ground my comments in a specific context, consider the system of Fig. 1, which represents the common but efficient configuration in which a pair of first-quality bookshelf speakers handles the full stereo passbands above some bass crossover frequency. Below that, a subwoofer channel delivers the high-amplitude, large-cone-excursion bass reproduction using summed left and right stereo signals. That subwoofer channel supplies the additional "filler" channel all-pass requires.

The core idea of Baekgaard's concept lies in the three equations defining the transfer functions of the high-pass, bandpass, and low-pass channels individually, and in the unity transfer function that results from summing the three channels.

$$\frac{e_{HP}}{e_{IN}} = \frac{s^2}{s^2 + (\omega_0/Q)s + (\omega_0)^2}$$

$$\frac{e_{BP}}{e_{IN}} = \frac{(\omega_0/Q)s}{s^2 + (\omega_0/Q)s + (\omega_0)^2}$$

$$\frac{e_{LP}}{e_{IN}} = \frac{(\omega_0)^2}{s^2 + (\omega_0/Q)s + (\omega_0)^2}$$

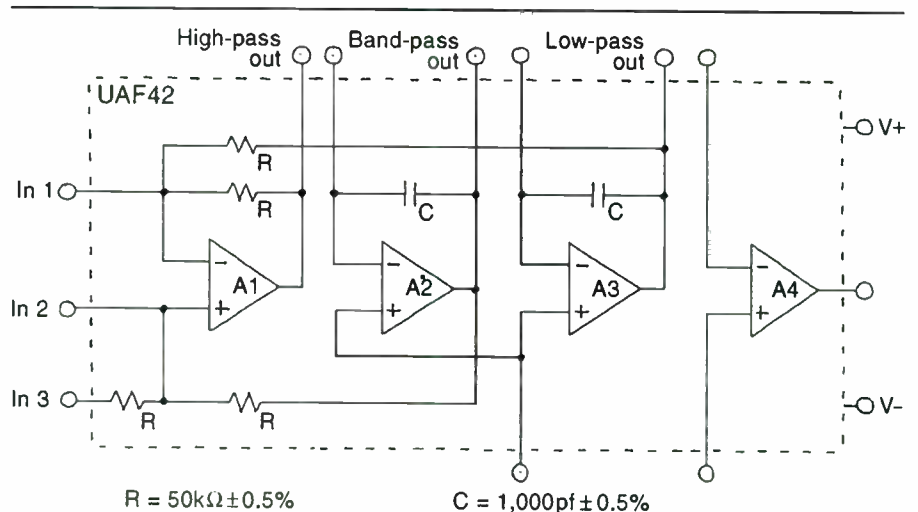


FIGURE 1: Functional representation of Burr-Brown's universal active filter UAF 42.

$$\frac{e_{HP} + e_{BP} + e_{LP}}{e_{IN}} = \frac{s^2 + (\omega_0/Q)s + \omega_0^2}{s^2 + (\omega_0/Q)s + (\omega_0)^2} \equiv 1$$

## ACTIVE-FILTER ADVANTAGE

Wide general recognition of the versatility and utility of active filters has led to their current availability as monolithic integrated circuits. No more the array of individual op amps such as Koonce labored with. Now you can get a complete state-variable filter with HP, BP, and LP outputs, and an uncommitted op amp in a single 14-pin DIP. Figure 1 shows a functional representation of Burr-Brown's Universal Active Filter, UAF 42. Figure 2 shows how you can use two UAF 42 state variable filters to implement Baekgaard's all-pass structure. Figure 3 is a circuit schematic showing all components for a complete implementation of Fig. 2.

The state-variable filter isn't the only way to implement Baekgaard's idea, but it has the powerful convenience that all of its parameters are independently adjustable. Just set two RC time constants via two external capacitors, set Q via an external resistor, add a summing resistor, and you're home free. Note also that, with the exception of the Q-setting resistor  $R_Q$

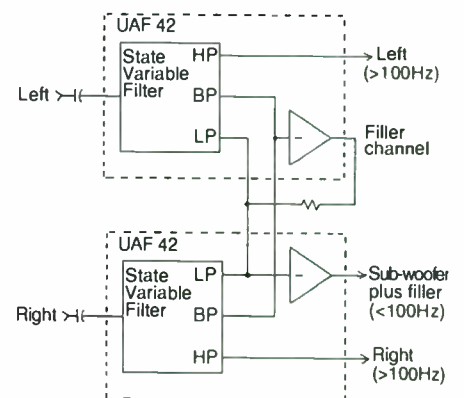


FIGURE 2: Baekgaard's all-pass crossover structure implemented with two universal active filter ICs.

(430kΩ) and the summing resistor  $R_F$  (68kΩ), all of the other 12 external resistors are 47kΩ. That uniformity allows you to get all 12 resistors from three of the five-resistor assemblies offered in 10-pin single-in-line and dual-in-line packages by

## ABOUT THE AUTHOR

Jack Cunniff is a retired electrical engineer who spent over 35 years in the aerospace industry. He is currently involved in designing and building "technical recreation" systems for his new home.



ORCA Design & Mfg Corp.  
1531 Lookout Drive  
Agoura, CA 91301 - USA  
tel: (818) 707 1629  
Fax: (818) 991 3072

by  
**FOCAL**

ORCA is bringing to you from France a whole new and exclusive line of fine drive units specifically designed by Kimon Bellas, ORCA, and by Gilles Brun, FOCAL SA. Why ACCESS ?

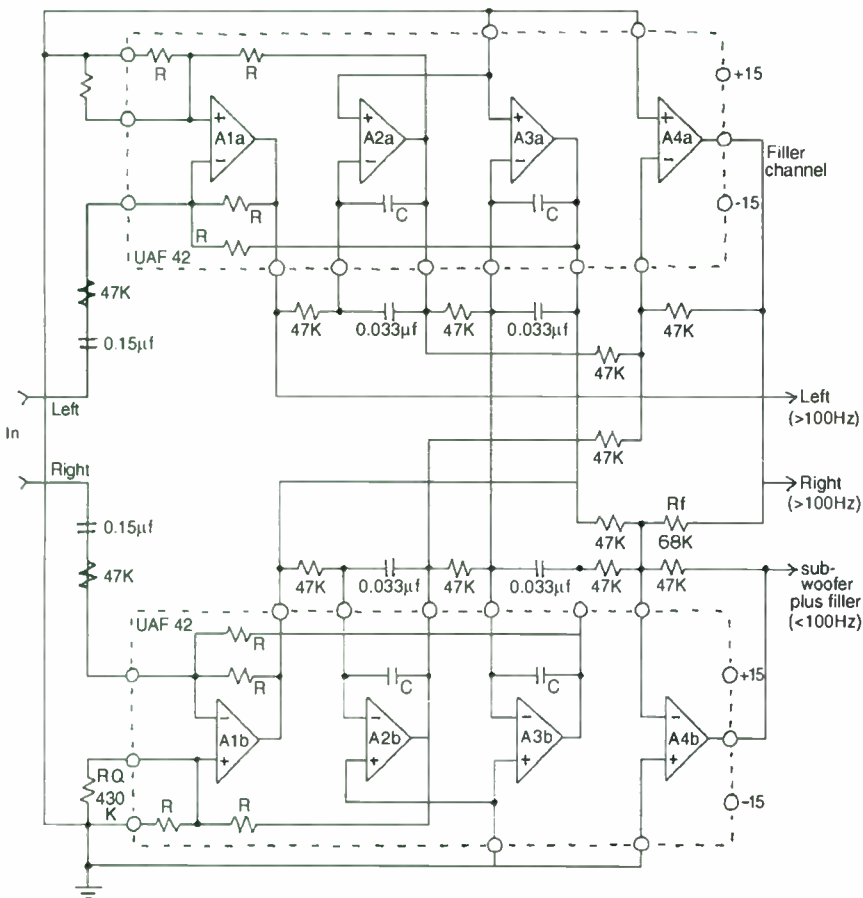
Well think of ACCESS as "entry level", "first step". In clear, these drive units have been designed in such a way that any beginner using no other measuring instrument than a set of good ears should have 100% success designing his first system. Indeed most of these units will do great without any X-over part, or at the most with a single inductor. Now don't be fooled, nothing is more difficult to engineer than a drive unit that is easy to use. Experts do know that. And expert designers will be the first ones to dive into the ACCESS catalog !

Also, think of ACCESS as "affordable". That maybe was the toughest challenge for us: to bring you this degree of performance and ease of use at the cost of ordinary paper cone units. We did not cut corners, we cut cost through good engineering. All units feature the finest hand coated paper cones (still an art at FOCAL), alloy cast frame and, needless to say, the legendary quality of FOCAL craftsmanship. The same hands who are making the world renown FOCAL drive units are making your ACCESS drive units.

Makes sense to you ? Call ORCA for your catalog. It includes full description of each unit, large scale curves and graphs, all parameters, and two computer simulated bass response for each ACCESS unit.



- ACCESS 4A Quick, high definition 4" midrange. Wide bandwidth (up to 12 KHz !). A natural and easy match for a highly transparent tweeter. . You pick the frequency and you pick the slope !
- ACCESS 4B Potent & detailed 4" midbass. Clean up to 7 KHz. Very robust low end. Ideal for mini audio-video systems and very small size high quality speakers.
- ACCESS 5A Efficient 5" midrange. Smooth. Superb definition. It needs a good 91-92 dB tweeter for an effective match. Great for surround systems and for high quality high output 3-way designs.
- ACCESS 5B Solid 5" midbass, in the FOCAL tradition. Gentle roll-off around 4 KHz. Like most other ACCESS units, it can be used both in sealed and in vented cabinet designs.
- ACCESS 6A Efficient (92 dB +) and transparent 6" midrange. A single inductor might be all you need to get the quintessence of this beautiful drive unit.
- ACCESS 6B Surprising weight in the low end, which is powerful and well defined. This little woofer does not seem to be much embarrassed by any signal.
- ACCESS 7A Extremely smooth 7" midrange / midbass. Excellent prospect for a simple efficient 2-way bass reflex , It can also be used in surround systems main speakers, with or without a subwoofer.
- ACCESS 7DB Outstanding 7" dual voice coil midbass. Powerful, crisp and efficient, this drive unit will play anything your amplifier will throw with panache and relentless enthusiasm.
- ACCESS 8A Very efficient (93 dB +) 8" midrange / midbass. One of the truly rare 8" that can be used in 2-way designs. You will need a very good and efficient tweeter to match this unit (at least 92 dB/W/m)
- ACCESS 8DB Outstanding 8" dual voice coil midbass. Efficient, smooth and crisp sounding it is also capable of handling large dynamics and true low frequencies with the authority of a much larger woofer.
- ACCESS 10A Impact & dynamics (94 dB/W/m). If a 10" midbass can make it to the tweeter range, this is the one. Its nearly perfect roll-off will allow direct wiring without filtering. Rare unit for 2-way 10" designs !
- ACCESS 10B Deep and musical 10" woofer. Ideal for medium size 3-way systems , with one of the 4", 5" or 6" ACCESS midranges. A classic.



**FIGURE 3:** Circuit schematic showing all components for a complete implementation of Baekgaard's all-pass crossover.

Bourns, Dale, and other manufacturers.

A reasonable choice of crossover for bookshelf speakers operating with subwoofer support would be in the vicinity of 100Hz. That would call for an RC time constant of 1.600µs (0.034µF with 47kΩ). Note that 1.000pF of that 0.034µF is internal to the UAF 42. First-order rumble suppression commencing at 21Hz comes from the 0.150µF input coupling capacitor.

stant of 1.600µs (0.034µF with 47kΩ). Note that 1.000pF of that 0.034µF is internal to the UAF 42. First-order rumble suppression commencing at 21Hz comes from the 0.150µF input coupling capacitor.

## INVERSION REQUIRED

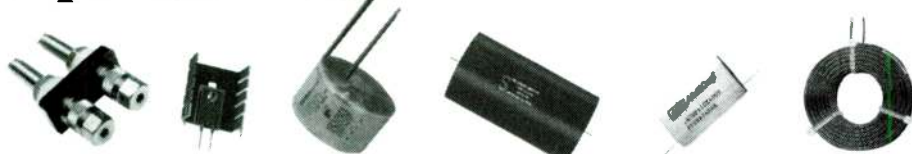
Note also that, since the state-variable filter is formed from a cascade of inverting stages, the bandpass output is reversed in phase from the low-pass and high-pass outputs. The needed additional inversion is acquired by summing left and right BP outputs in an inverting stage, A4a. Also, the level out of the BP channel is 3dB higher than the LP and HP levels. That is accounted for by raising summing resistor  $R_f$  to 68kΩ from the 47kΩ of all other summing resistors.

Our inability to perceive phase at frequencies below a few hundred hertz has fortunate aspects. Since we can't distinguish phase, we can't recognize the point of origin of low-frequency sound. Small benefits are the perceptual sufficiency of a single common subwoofer channel and the freedom to stash the subwoofer out of sight. With a Baekgaard topology having the crossover at 100Hz, the BP channel is simply not an obvious part of the subwoofer-channel electronics. The primary benefit of an all-pass structure used with subwoofers is the absence of amplitude-response ripples in the vicinity of the crossover frequency. And it seems amazing that you can build the complete Baekgaard crossover from two resistors, six capacitors, and five DIPs.

## REFERENCES

1. G.R. Koonce, "The Baekgaard Crossover Technique," (SB 2/95), p. 20.
2. E. Baekgaard, "A Novel Approach to Linear Phase Loudspeakers Using Passive Crossover Networks," (JAES, May 1977), pp. 284-294.

## Speak Out!



Whether you're designing and building a loudspeaker from scratch, or modifying an existing one, The Parts Connection has the premium quality parts you're looking for. We carry a comprehensive range of Spectra Dynamics acoustic panels, premium film capacitors from MIT, Infini Cap, Hovland MusiCap, Kimber Kap, WonderCap, Solen and others, Copper Foil Air Core Inductors from SOLO, premium power resistors from Caddock and IRC, as well as hook up wire, cables and connectors from Kimber Kable, AudioQuest, Goertz, van den Hul, WBT, Edison Price and Cardas Audio. The superior performance of these products will unleash the full potential of your designs and premium drivers, allowing your speakers to truly speak out!

For a copy of The Parts Connection Catalog and Resource Guide Vol. 2, send a \$10.00 cheque or money order or phone/fax with credit card info. The catalog will include a coupon good for a \$10.00 discount on your first order over \$100.00 or \$25.00 off your first order over \$250.00. Ask about our volume discounts of up to 30% off!

**THE PARTS CONNECTION**

A DIVISION OF SONIC FRONTIERS INC.

• MIT MultiCap • Infini-Cap • Kimber Kap • Solo • Hovland MusiCap • Solen • Siemens • Wima • Holco • Rel-Cap • Dralonc • IRC • Resista • Vishay • Mills • Caddock • Matsushita • TKD • Noble • Cardas • Kimber Kable • van den Hul • Discovery • AudioQuest • MIT • Alps • Bourns • Shalco • Elma • Electroswith • Gold Aero • RAM • Mallory • Panasonic HFQ • Nichicon • Elna • N.O.S. • Ruby Tubes • Crystal • Linear • Technology • Analog Devices • Edison Price • Motorola • UCC • International Rectifier • Hitachi • MagneQuest • Hammond • Vampire • Spectra Dynamics • Sonic Frontiers • Pearl • Tube Sockets • WBT • Neutrik • Sound Coat • Curcio Audio Engineering • Assemblage and other kits

2790 Brighton Road, Oakville, Ontario, Canada L6H 5T4

Tel (905) 829-5858 Fax (905) 829-5388

Toll Free Order Line 1-800-769-0747 (U.S. & Canada only)

E-Mail: TPC@sonicfrontiers.com - WWW: http://www.sonicfrontiers.com/TPC





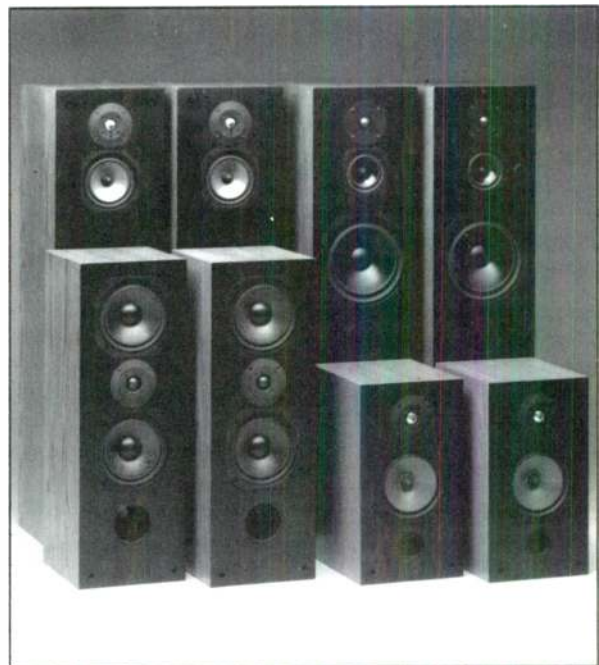
# ZALYTRON

## Presents Audax's Signature Series of Kits

- 4 Premium kits *designed by Vance Dickason, well renowned author of The Loudspeaker Cookbook.*
- *These complete kits feature patented Audax cone technology and are computer optimized for the highest fidelity and will satisfy even the most critical audiophile tastes.*
- *Zalytron Industries as an authorized Audax distributor is proud to offer these kits for the dedicated speaker builder. These kits can be purchased in parts or complete with beautifully, handcrafted veneer cabinets from Zalytron.*
- *Let our experience work for you and create your own musical enjoyment (with a little help from Audax and Zalytron). Call Zalytron Industries for further details.*

Zalytron specializes and offers the complete line of Audax drivers.

Build your own loudspeakers, have fun and save money!



**Zalytron Industries Corp.**  
469 Jericho Turnpike, Mineola, NY 11501  
Tel. (516) 747-3515 Fax (516) 294-1943

*Our warehouse is open for pick-up 10AM to 6PM daily, Monday thru Saturday. UPS orders shipped same day \**

*Minimum order \$50.00*

**Call or Write For Our Latest Catalog**

# Wayland's Wood World

## STANDS FOR LARGER SPEAKERS

By Bob Wayland



PHOTO 1: Cutting the tube to length.

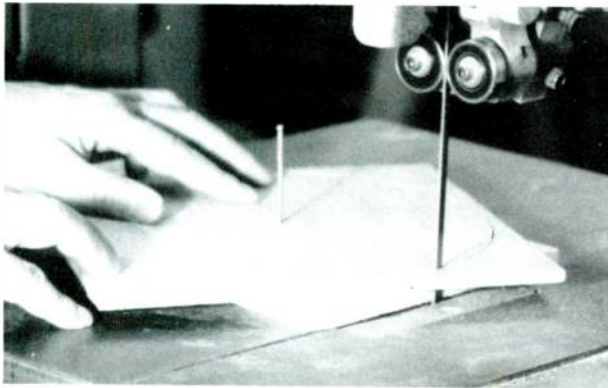


PHOTO 2: Cutting the attaching plate for the tube.

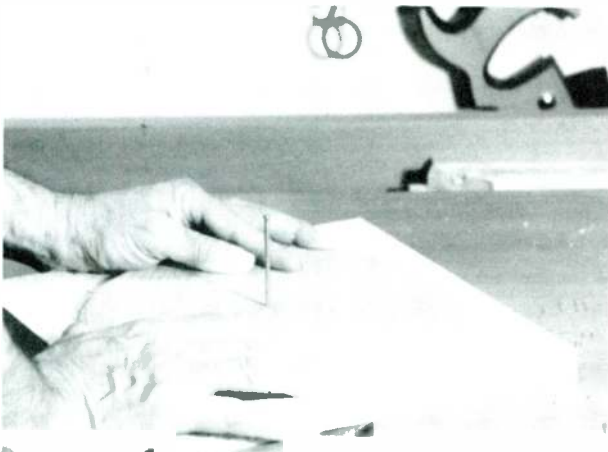


PHOTO 3: Using a nail to align the disk on the end plates.

In the last issue I made some suggestions for satellite speaker stands and promised that I would next discuss stands for larger enclosures. Accordingly, I present some general considerations and a specific suggestion. Please remember that this is an area in which you have a great deal of latitude to make something that fits your individual needs.

### FIRST THINGS

Perhaps it would help to review the main requirements for large speaker stands. Depending upon the placement of the mid-

and high-range drivers, the stand should put these components at listening level. Clearly this will be different for each design and each listening environment. I cannot devote space here to this important subject, but suggest you investigate the following software programs, all available from Old Colony Sound Lab: The Listening Room for IBM (SOF-TLR3BXG), Room Design Powersheet (SOF-RDP1BX), and SLM Sound Measuring Tool for MAC (SOF-SLM1M3G).

The other primary consideration is to isolate speaker-system vibrations so they do not couple into the surrounds; for example, low frequencies that couple into a wooden floor. The poorest speaker stand—and also the most common—is two shelves of wood separated by stiff supports, e.g., dowels or other pieces of wood. Such a structure transmits vibrations directly from

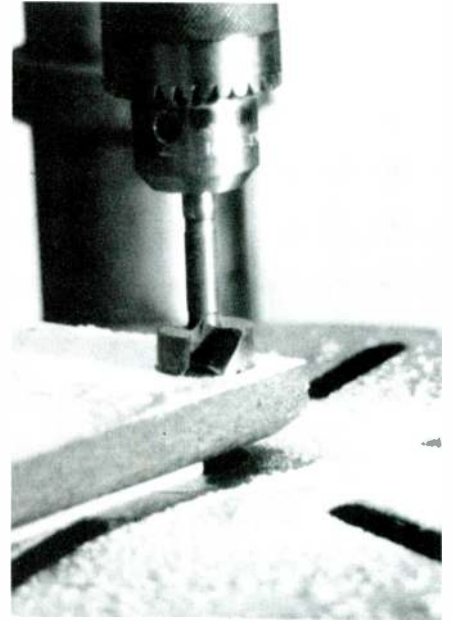


PHOTO 4: Drilling the holes for the tee nuts.

the speaker enclosure to the floor upon which you place the stand. The vibrational modes of the bottom plank depend upon shape and dimensions, as well as physical constants such as modulus of elasticity. The problem is that there is nothing to decouple the plank the speaker is sitting on from the plank that is sitting on the floor.

### DECOUPLING POINTS

There have been some attempts to minimize the transfer of energy by using sharp-pointed spikes to separate the bottom plank from the floor. I have a real problem with this idea. Somehow, driving a nail into the surroundings seems a destructive way to isolate the stand

### ABOUT THE AUTHOR

Bob Wayland is a physicist by training who has worked from the heights of astrophysics to the depths of geophysics. His interest in woodworking and speaker building was first kindled in high school.



# A&S speakers

3170 23rd Street  
San Francisco 94110  
(415) 641-4573  
(415) 648-5306 FAX

**ETON**<sup>®</sup>

**CERATEC**   
MADE BY CERATEC-THIEL

**DYNAUDIO**<sup>®</sup>

**SCAN-SPEAK**

**polydax**  
SPEAKER CORPORATION



**LPG**

**vifa**

**ULTIMATE**

 **Peerless**



**FOCAL**

**S** Solen Électronique Inc.

**WOODSTYLE PRODUCTS**

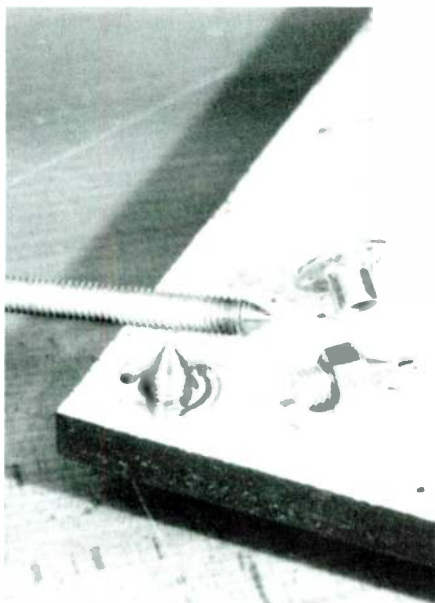
**seas**

**Linæum**<sup>™</sup>

**VMPS AUDIO**

*Eminence Speaker Corporation*

A & S SPEAKERS — Your source for the widest selection of hi-fi speaker systems, kits, cabinets and crossovers for every automotive and home hi-fi application.



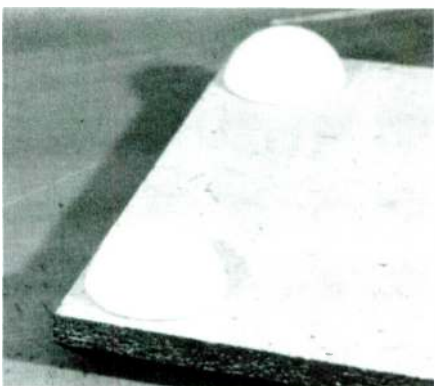
**PHOTO 5:** The components for a home-made spike.

from the floor. The argument that it is only a small point of contact ignores the basic concept of pressure (as in lb/in<sup>2</sup>). The only way to make the use of spikes valid is to locate them at null points of the vibrating bottom plank. I am sure there are great speaker builders who believe differently; please, let's start a dialog.

One acoustically successful technique is to make a harness for the enclosure and hang it from the ceiling. But don't use chain; a fiber or nylon rope is much better for providing isolation. The main problem is to maintain the orientation of the speaker. To stop rotation, I have strung fishing line from the corners to a nearby wall, but no matter what I tried, I did not like it and finally gave up. If you can stabilize your enclosure, this is the best bet for isolation. If not, then you may wish to consider some of the ideas given below.

#### DAMPED STANDS

To illustrate some of the basics of making a damped stand, I will describe a specific con-



**PHOTO 6:** Door cushions used as feet/isolation pads for the bottom plate.

struction, but the concepts are usable in almost any design that might meet your needs. The primary aim is that the finished stand should not only isolate the speaker from coupling into the structures of the listening room, but that it should also be aesthetically pleasing.

The heart of the stand is a common construction jig available from large lumber stores. This is the tubular form the building trade uses to make concrete columns (QUIK-TUBE is one brand name). It is a heavy-duty cardboard tube with a wall about 1/8" thick, treated on the inside to resist water absorption. It comes in diameters of 6"-12", in 2" increments. Be careful: the diameter is often not exact, and may vary from one section of tubing to the next for the same nominal measurement.

The first step is to determine the height of the completed stand that will place the speaker at the desired listening level. The length of the tube should be about 5" less than this height. One of the requirements for a good stand is that it have sufficient mass to dampen the vibrations transferred from the speaker. This is largely a function of the inside diameter of the tube, which you will fill with sand so it weighs at least 30 lbs. I suggest a tube diameter of at least 8".

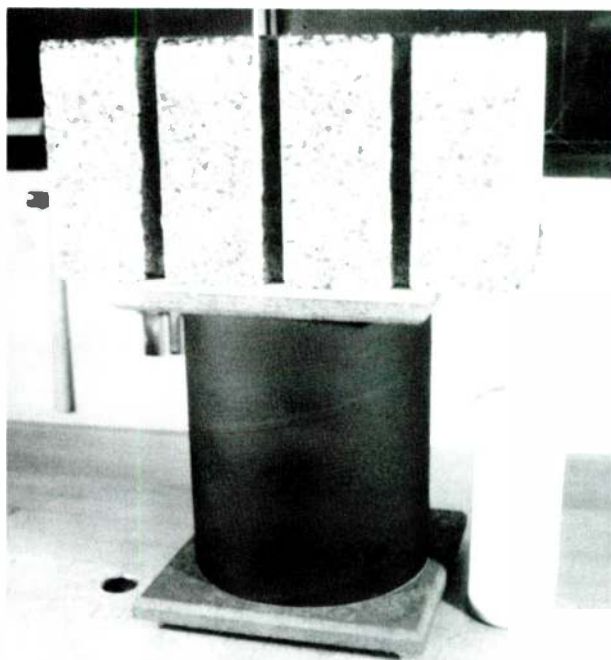
Before cutting the tube to length on your table saw, you can make it less cumbersome by rough-cutting it about 2" too long with a hand saw. Then, using a high fence and a blade height about 1/4" more than the wall thickness, carefully cut the tube to length. Place the factory-cut edge against the tall fence (add a board to the fence if needed) and push the tube into the saw blade until the blade is centered in the tube. Keeping the tube in this position, rotate it while pushing it firmly against the fence until the cut is finished (*Photo 1*). Now is a good moment to paint the tube, if that is your choice of decoration.

#### CAPPING THE TUBE

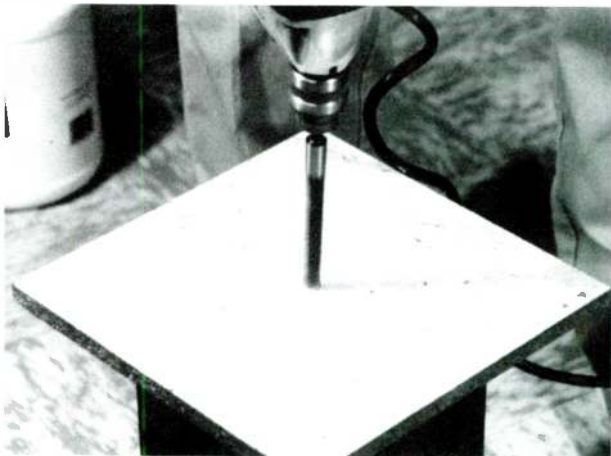
Next, make two plates to cap the tube. A set of

square plates is the sensible but uninspired choice. I'll use this to illustrate, but you should choose a shape for the bottom plate that reflects the decor of your listening room (the top plate will not show). Your choice is limited only by your imagination and wood-working skills.

The inside diameter of the tube in this stand is 8", and the top and bottom plates are 10" squares of 3/4" particleboard. The bottom plate should extend a minimum of about 3/4" to 1" beyond the outside of the tube. You can dress up the edge of the bottom, using whatever shape of router profile you please. The plate for my completed stand has a simple 45° chamfer. I chose a hard edge for this project, but you might prefer a soft one, such as one made with a roundover bit. If you plan to paint the bottom plate, now is a good time to do it.



**PHOTO 7:** Applying pressure to the assembled column. You can use clamps on each edge, but if you do so, be very careful to apply the same pressure with each clamp.



**PHOTO 8:** Drilling a fill hole in the top of the column.



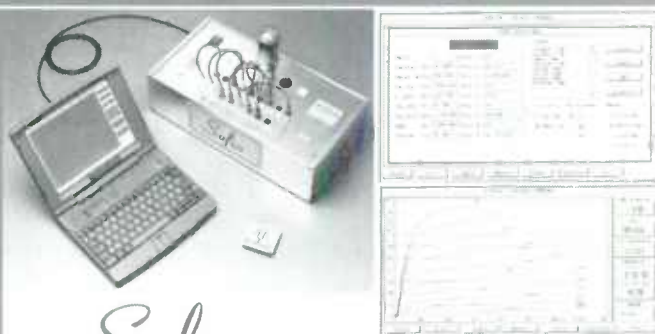


# AUDIOMATICA innovation in audio measurements



## CLIO

Complete system to measure electrical and acoustical systems. - Several measuring modes: full MLS and Sinusoidal capabilities with true phase and time, RTA, FFT, allowing room acoustics, loudspeaker anechoic response. QC for production lines. Environmental noise control. Scoring for competition car installation and more ... - 2 channels in with high dynamic range (16 bits), 2 fully programmable signal generators, variable sampling rate, supply for microphones. - Interactive, fast operation. Window-like mouse driven software.



## Sofia

- Unique computer controlled curve tracer to test vacuum tubes. - Complete characterization with curves and parameters of triodes and pentodes (also in pseudo-triode and ultra-linear configuration). - RS-232 driven. Highly reliable construction, flexible manual routing. 4 high resolution (16 bits) voltage generators for plate, grid, screen grid and heater. 3 high resolution (16 bits) input current meters. - Software includes: tubes directory, easy QC and matching of large production batches. Windows-like mouse driven user interface.

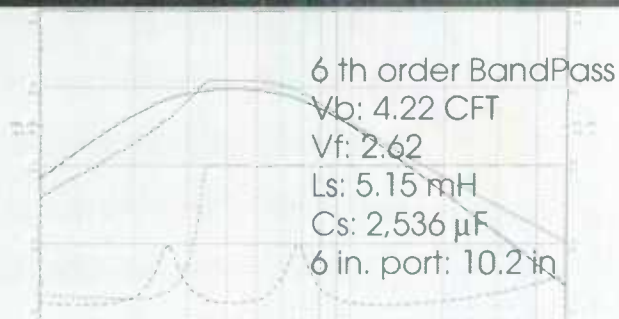
Exclusively from ORCA Design & Manufacturing Corp. Call for dealer & pricing.  
1531 Lookout Dr. Agoura, CA 91301 - USA - TEL (818) 707 1629 FAX (818) 99 3072

## FOCAL 12V726S

Fs 27.64  
Qes 0.44  
Qms 2.79  
Qts 0.38  
Vas 199.85 Liters  
Re 6.33  $\Omega$   
Wrms 175  
Lvc 1.24  
Xmax 9 mm  
Sd 510.7 sq. cm  
dB/W/m 91.8



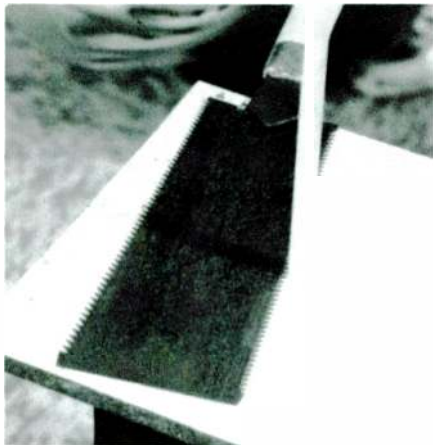
POLYGLASS cone  
Cast Frame  
High excursion  
Low distortion  
for high end subs  
and 3-way systems



The easy way to attach the tube to the plates is with a disk cut to the inside diameter of the tube. You could use one of the techniques discussed in my column on cutting circular holes (*SB 4/95*, p. 40), or you could cut a disk on your bandsaw. For the center pivot, you might use a 6-penny nail. After determining the diameter of the disk that will provide a snug fit, make a jig from some scrap material that you can clamp to the bandsaw



**PHOTO 9:** Filling the column with sand.



**PHOTO 10:** Sealing the column.



**PHOTO 11:** Placing the tile into the top of the box.

table with a pivot hole for the nail (*Photo 2*).

Mark and cut the disks. You want them to be accurately centered, so drill a hole for the nail at the exact center of each plate. This will align the disk (*Photo 3*) when you glue it to the plate.

### STABLE FOOTING

Before you put the bottom plate on the tube, it is a good idea to build in the feet. One solution I really like is the Sorbothane Vibration Mount, available from Edmund Scientific (\$14.50 for a set of four, plus S&H). They have the dimensional stability of a solid with the physical properties of a liquid. They will absorb 60% of the energy of the vibration, are 75% efficient in damping the vibrations, and have a 60 lb load capacity. I'll return to them later, but now consider spikes.

You can buy very good spikes from most of the speaker supply houses, but you can also make your own. You can obtain tee nuts, nuts, and threaded bar stock from your local hardware store. Normally, the largest-diameter tee nuts you will find are threaded for 3/8" bolts, so work with that size.

First, use a Forstner or bradpoint bit to cut a hole for the flange (*Photo 4*). Second, drill a hole for the neck of the tee nut. I usually oversize this a bit because it is hard to get the second hole exactly aligned. Using a good epoxy glue, anchor the tee nut into the base. *Photo 5* shows the spikes, with one of them in place. You make each spike by grinding a point on the threaded rod with a bench grinder. It is a good idea to use a thin lock nut to lock the spike in place.

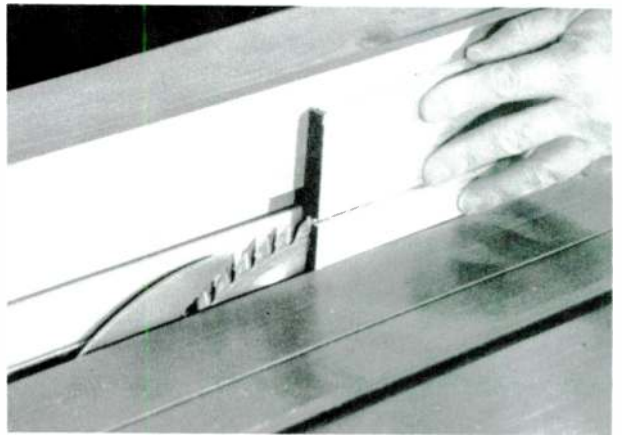
Other ways of isolating the stand from the floor include the Sorbothane Vibration Mounts mentioned above, which I think is better than using spikes. There is a cheap version available at your local hardware store: the door cushions you attach to a wall to keep a door knob from damaging it. If you use them as shown in *Photo 6*, the resulting isolation is amazing.

### COMPLETING THE COLUMN

The next step is to complete the column. Apply glue around the edges of the disks you

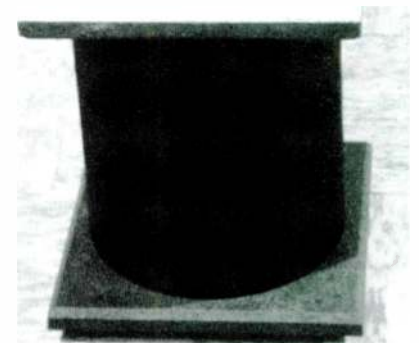


**PHOTO 12:** Cutting the first part of the groove for the sides of the top box.



**PHOTO 13:** Cutting the second part of the groove.

have made and attached them to the top and bottom plates. Be sure to apply adequate pressure to the assembled stand (*Photo 7*). After the glue is dry, drill a hole in the top



**PHOTO 14:** Polystyrene as a vibration-isolating material for the stand. This can easily be cut to size on your table saw and held in place with a soft-setting rubber glue.



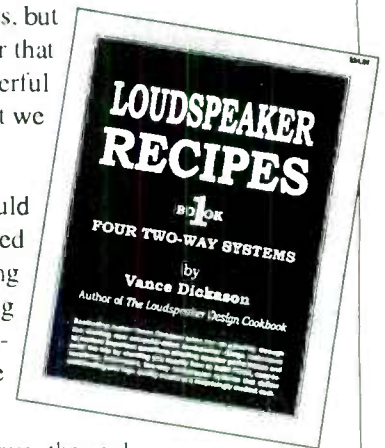
# WE GOOFED!

I don't like admitting I made a mistake any more than I guess anyone else does, but there isn't much point in just going along pretending you didn't when it is clear that you did. The plain truth is: **we just plain misnamed** Vance Dickason's wonderful book *Loudspeaker Recipes*. As a result most people looking at it think that what we have here are four nice recipes for four speaker systems.

**WRONG.** The speaker systems are fine, but they are **NOT the point**. We would have done a much more accurate job of putting a title to this book if we had called it: **Computer-Aided Loudspeaker Design**. Dickason's genius here is in setting out the issues any designer faces, amateur or professional mind you, in reaching a satisfactory set of design compromises on the use of a particular set of box, driver, and crossover components, and making them add up to the best possible loudspeaker with the aid of computer modeling programs.

While anyone can build the four designs in the book successfully, and many have, the real point of the book is that it enables its user to design for him- or herself literally thousands of speaker systems. The book is about computer-guided methodologies in making all the decisions required on the way to a successful project. Even if you do not use computer modeling to design speakers, the insight into the loudspeaker design process is extremely valuable.

So if you have already bought the book, go back and have another look at what sort of treasure you paid for but may not have recognized. Realize that you have in it much more than you expected. If you don't yet have it but are looking for a way to train yourself in using your computer to work out the necessary compromises with Mother Nature that are always necessary in any electronic/acoustic design, then get yourself a copy of our misnamed child, *Loudspeaker Recipes*. You'll give yourself the benefit of some of the best knowledge about CAD for loudspeakers available anywhere. — *Edward T. Dell, Jr., Publisher*



## You fools! Yes, now I understand!

Please send me \_\_\_ copies of BKAA30 at \$24.95 \$ \_\_\_\_\_  
I also include shipping of \_\_\_\_\_  
7% USA 14% Other Surface 25% Other Air  
Plus handling of 2.00  
Total order \$ \_\_\_\_\_

• Mastercard • Visa • Discover • Check/Money Order in US\$ drawn on US bank •

Name \_\_\_\_\_

Street \_\_\_\_\_

City \_\_\_\_\_ St \_\_\_\_\_ ZIP \_\_\_\_\_

Card No \_\_\_\_\_ Expire \_\_\_\_\_

Tel. No. \_\_\_\_\_ Today's Date \_\_\_\_\_

**Old Colony Sound Laboratory**  
PO Box 243, Dept. B962  
Peterborough NH 03458 USA  
Tel. 603-924-6371, 603-924-6526 Fax 603-924-9467



**PHOTO 15:** Large-cell bubble wrap used to dampen vibration for the stand. Again, use a soft-setting glue such as rubber cement to hold the wrap in place.

plate (Photo 8) and then fill the column with sand (Photo 9). (The sand you can buy for a child's sandbox is wonderful, for it is dry and free of all foreign matter.) Glue a dowel into the fill hole after pouring in the sand, and then cut it off flush with the surface (Photo 10).

Now, to make a top unit that isolates the speaker system one more level, you need a top that will fit over the outside of the top plate of the column. A simple box without a

top or bottom, but with a shelf in the middle part is one viable solution. The shelf is displaced far enough down from the top of the box to let you insert a tile flush with the top edge of the box (Photo 11). I used a 12" x 12" slate tile for its attractive appearance and added mass. To increase the isolation, place a vibration-absorbing material on top of the column and set the shelf on this material.

### CUTTING THE BOX

After you decide what isolating material to use, measure its thickness. To this add 3/4" (for the shelf) plus the thickness of the isolating material you choose to place under the shelf. After cutting the sides of the box to this dimension, you need to make a groove for the shelf and the tile (Fig. 1). The thickness of the sides of the box should be at least 1/2", but can be 3/4" if you don't happen to have 1/2" stock on hand. After setting the saw blade for a 1/4" depth, cut a groove at a distance from the top that equals the thickness of the shelf plus that of the tile (Photo 12).

Now raise the blade to the height of the thickness of the shelf plus the thickness of the tile and set the fence to remove 3/4" from the side as shown in Photo 13. Cut the sides to length at a 45° angle so that a shelf the size of the tile will just fit into the groove. You then assemble the box, using the techniques discussed in this column on making grille frames (SB 8/94, p. 47) and insert the tile into the top of the box (Photo 11).

There are numerous materials you can use



**PHOTO 16:** The completed speaker stand.

to decouple the top from the column. Common ones are closed-cell polystyrene (Photo 14), bubble wrap (Photo 15), or even a combination of the two. You then glue the box top in place on the column and set the speaker on the stand as shown in Photo 16.

The speaker shown is one I made about 20 years ago that has vibration problems in the walls of the box. Limited measurements with an old uncalibrated accelerometer indicated almost no coupling to the floor through the stand when I used all the isolation materials mentioned above. If, instead of the polystyrene or bubble wrap, you used Sorbothane Vibration Mounts to separate the top box from the column, I suspect that the transfer would be virtually undetectable.

### SOURCES

Old Colony Sound Lab  
PO Box 243, Peterborough NH 03458  
603-924-6371, FAX 603-924-9467

Edmund Scientific Co.  
101 E. Gloucester Pike, Barrington, NJ 08007-1380  
609-547-6250

The speaker stand described in this column is available to the first reader who contacts the author directly:

J. Robert Wayland  
500 Oakwood Pl. NE  
Albuquerque, NM 87123

The cost will be only \$25 (for the materials), plus shipping charges.

## Looking for a way to improve your image?

### Try some MUSICAPs!

■  
Polypropylene film and foil construction  
Stranded silver plated copper leads  
Extremely low DA, DF and ESR

#### WHAT THE REVIEWERS SAY...

"If you want see-thru, high definition, detail and listenability, try the Musicaps."

Joe Roberts, SOUND PRACTICES, ISSUE 6, 1994

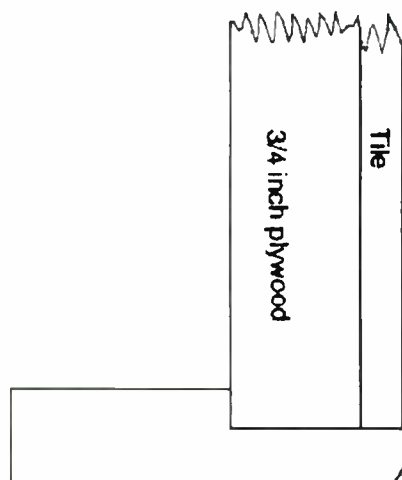
"The improved signal transmission of the Hovland foil capacitors elevated the (Ariel) speakers to a new level of naturalness, clarity, and immediacy."

Lynn Olson, Positive Feedback, Vol. 5, No. 4

To order contact one of the following:

- The Parts Connection 905-829-5858
  - Welborne Labs 303-470-6585
  - Sound Products, Inc. 503-761-0743
  - A & S Speakers 510-685-5252
  - North Creek Music Systems 315-369-2500
  - Allpass Technologies, Inc. 407-786-0623
  - Anchor Cross Co., Tokyo, 81-3-3203-5606
  - SJS Electroacoustics, England 44-1706-823025
- OEMs contact: Hovland Company at 209-966-4377

Reader Service # 73



**FIGURE 1:** Fitting the tile and shelf to the box.



Speaker Builder is on the Internet!

# AudioWeb™

Netscape - [AudioWeb Newsstand]

File Edit View Go Bookmarks Database Directory

Go to: <http://www.audioweb.com/>

AudioWeb NEWSSTAND power

**CLIO: A NEW SPEAKER TEST SYSTEM**  
FIVE: 1995 **\$7.00**  
CARCIN 8/95

*SpeakerBuilder*  
THE LOUDSPEAKER JOURNAL

**DESIGN A HORN WITH YOUR PC**

**THE FREELINE: A TINY TL**

**A MIKE/PROBE PREAMP**

**SPEAKER STANDS YOU CAN MAKE**

**MAKING ODD-BALL DRIVER CUTOUTS**

**Nuggets from Madisound's BBS**

audiomall classifieds member raffle  
newsstand what's new

| [About](#) | [AudioMall](#) | [Chat](#) | [Classifieds](#) | [Directory](#) | [Newsstand](#) | [Member](#) | [Raffle](#) | [What's New](#) |

webmaster@audioweb.com  
Copyright © 1995 CRC Internet Group, Inc.  
1995

[www.audioweb.com](http://www.audioweb.com)

For advertising and editorial information, please contact:

**AudioWeb**  
c/o CRC Internet Group, Inc.  
230 Sherman Avenue  
Berkeley Heights, NJ 07922  
908.464.7307  
[info@audioweb.com](mailto:info@audioweb.com)

World Radio History

# Software Report

## X\*OVER 2.0

Reviewed by Hank Zumbahlen

**Loudspeaker Parameters**

**Tweeter**  
 Tweeter Name? Dynaudio Esotar T-330D  
 Impedance (Z)? 8 ohms  
 Resistance (Re)? 5.2 ohms  
 Inductance (Le)? 0.07 mH  
 Qms? 0.33  
 Qes? 0.5  
 Sensitivity? 90 dB @ 283 V 1 W  
 No? 1  
 Net Z: 8.0 ohms  
 Net Re: 5.2 ohms  
 Net Sensitivity: 90.0 dB (283 V)

**Midrange**  
 Midrange Name? Eton 4-203  
 Impedance (Z)? 8 ohms  
 Resistance (Re)? 5.8 ohms  
 Inductance (Le)? 0.27 mH  
 Qms? 4.33  
 Qes? 0.28  
 Sensitivity? 92 dB @ 283 V 1 W  
 No? 2  
 Net Z: 4.0 ohms  
 Net Re: 2.9 ohms  
 Net Sensitivity: 95.0 dB (283 V)

**Woofer**  
 Woofer Name? Madisound 1252DVC  
 Impedance (Z)? 8 ohms  
 Resistance (Re)? 5.6 ohms  
 Inductance (Le)? 0.3 mH  
 Qms? 4.1  
 Qes? 0.39  
 Sensitivity? 88.5 dB @ 283 V 1 W  
 No? 1  
 Net Z: 8.0 ohms  
 Net Re: 5.6 ohms  
 Net Sensitivity: 88.5 dB (283 V)

Accept Cancel

FIGURE 1: Driver-data entry screen.

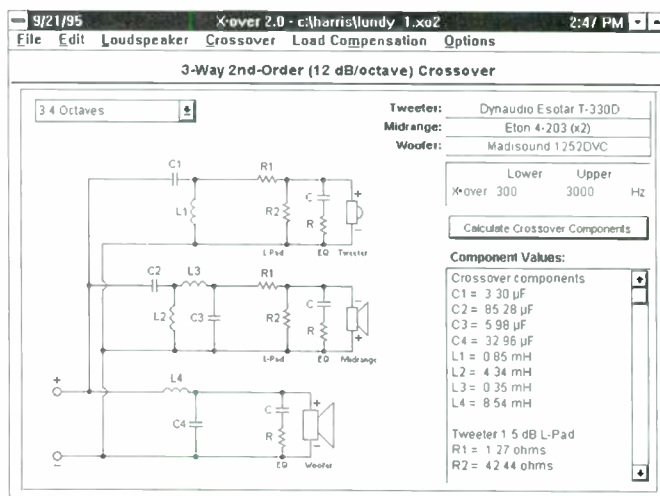


FIGURE 2: XO2 schematic screen.



### "SPECIALISTS IN THE ART OF SPEAKER REPAIR"

**FACTORY AUTHORIZED SERVICE:**  
 Advent, B-I-C, Bozak, EPI, RTR,  
 Cerwin-Vega, JBL Home & Pro

Speaker parts & adhesives,  
 cones, spiders & dust caps

3 Way Crossovers Circuit  
 Breaker Gold Plated Binding  
 Posts \$19.95 each!

Replacement grilles for Altec,  
 B-I-C, Cerwin-Vega, JBL & Marantz

Refoam kits available for 4", 5-1/4",  
 6-1/2", 8", 10", 12", & 15" speakers  
 - only \$29.95 (JBL slightly higher)

Special Closeout on rebuilt DYN  
 Audio Drivers: MR 17.75, W30-100,  
 W24-100, W17-75. BELOW COST!

*We Buy Dead Speakers: Altec, E-V & JBL*



**1-800-526-8879**



NO CATALOG AVAILABLE  
 CALL US FOR HARD TO FIND DISCONTINUED PARTS  
 4931 A-1 South Mingo / Tulsa, Oklahoma / 74146

X\*over 2.0, Harris Technologies, PO Box 622, Edwardsburg, MI 49112-0622. Available as SOF-XOV1B3G for \$29 plus \$3 s/h from Old Colony Sound Lab, PO Box 243, Peterborough, NH 03458, (603) 924-6526, FAX (603) 924-9467.

System requirements: MS-DOS 5.0 or later, Windows 3.1 or later. Hardware: 386 or better, 2MB RAM, 1.5MB hard-disk space, and 1.44MB in a 3½" floppy disk.

X\*over 2.0 is a good general design package for passive crossovers. While it does not sport the power of such packages as CAL-SOD—nor does it purport to—it is a very economical way to semiautomate the design process.

The X\*over 2.0 package includes a single high-density 3.5" floppy disk and a brief manual. It is designed to be used with Harris Technologies' companion software, BassBox 5.1, although it stands on its own merits.

#### INSTALLATION

Installation of the program could not be simpler. It is designed to run under Windows, so

#### REFERENCES

1. R. Bullcock, "Passive Crossover Networks," *SB* (1/85 and 2/85).
2. G.R. Koonce, "Crossovers for the Novice," *SB* (5/90).
3. Vance Dickason, *Loudspeaker Design Cookbook*, 4th ed., Audio Amateur Press, 1991.
4. H. Zumbahlen, "Zobels and all That" *Audio*, June 1995.



the standard installation procedures apply. From the Program Manager you select File, and then "Run" the setup program. (Type A:SETUP if you have the floppy in the A drive.) I encountered no problems with the installation.

At the end of this process, you will have a new Program Group in your Program Manager. Simply click on the icon to launch the program. My system is an IBM 720 Thinkpad with 16MB RAM and a 120MB hard disk, which is compressed using Stacker 4.0. I use the MS-DOS 6.22 operating system with Windows 3.1 and a monochrome VGA-compatible display.

### RUNNING THE PROGRAM

On starting the program I encountered my first surprise. (I could probably have saved myself some grief by looking at the manual before I started, but everyone knows that real engineers refer to the instructions only as a last resort.) The program dumped me into a blank screen, save for the menu bar on the top. It was not intuitively obvious what I was supposed to do next. To my way of thinking, the program should have initially provided a screen for entering the driver data (Fig. 1), since this is the first step in designing the crossover. This, however, is a minor quibble, as it takes only a couple of mouse clicks to reach this screen

once you figure where you want to go.

Entering the driver data is relatively straightforward—simply fill in the boxes with the required information. For example, to determine the crossover, you only need to enter the impedance. If you plan to add impedance compensation (highly recommended), then you must provide the Re and Le. To calculate the series notch, all the information is required. The program features several nice touches, such as the provision for multiple drivers in several configurations (Figs. 2 and 3). This includes a series/parallel arrangement for four drivers. Upon exiting, the program prompts you for level and impedance compensation. I give the authors high marks for including this often-neglected aspect of crossover design. Passive filters must be loaded with the correct impedance or the response will be in error. And while the Zobel (impedance EQ) won't flatten the curve completely, it comes close.

### FILTER TYPES

Several different filter types for two-way crossovers are available. One weak point of the manual is that it does not explain why you would choose one type over the other. The manual advises users to consult the *Loudspeaker Design Cookbook* if they are unfamiliar with crossover design. These users

are the target market for this product, so I believe the product's manual should contain this information. The *LDC* devotes several pages and figures on the differences, which are mandatory to understand when deciding which filter type to use.

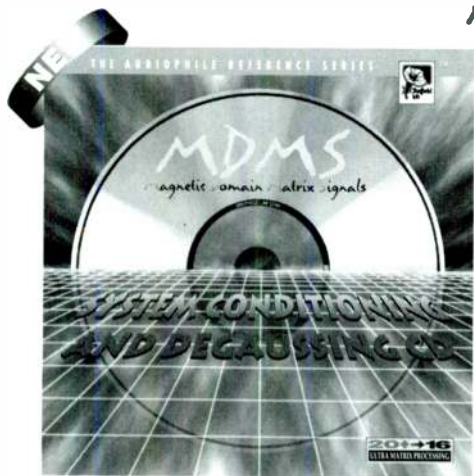
The situation becomes even worse for three-way crossovers. You can choose only the crossover frequencies. The *LDC* covers only one filter type, and the types are not even identified (as to Butterworth all-pass (APC), or constant power (CPC), to use Bullock's nomenclature). The *LDC* advises the reader to consult the Bullock papers as an alternative.

The fact that the software is making the calculation *much* less tedious should encourage branching out to other filter types. On the other hand, it may become too confusing and overwhelming for a novice speaker builder to wade through all the choices, but I still think that the authors missed a good opportunity here.

One of the problems with passive filters is the interaction of the sections. If you try to put the low-pass and high-pass sections too close together, peaks in the response will occur—sometimes referred to as excess gain. In all of the three-way designs in *LDC* (except for first order), the bandpass gain ranging from 0.85dB–2.84dB is given. This gain should be a factor for an L-pad on the midrange.

# ANIMAL MAGNETISM

MAGNETISM IS GIVING YOUR MUSIC SOMETHING TO GROWL ABOUT.  
TAME THE BEAST THAT LIES WITHIN YOUR SYSTEM WITH THE MDMS  
(MAGNETIC DOMAIN MATRIX SIGNALS) SYSTEM CONDITIONING  
AND DEGAUSSING CD



### THE EIGHT STEPS TO HOUSE BREAKING YOUR SYSTEM:

1. The MDMS signal will demagnetize ALL SYSTEM COMPONENTS at a "normal" listening level. (and you don't have to worry about blowing up your amplifier or speakers as with other demagnetizing discs!)
2. The specialized MDMS signal integrates a maximum amount of degaussing energy into a minimum amount of time.
3. Totally correlated signals for the maximum peak to average ratio.
4. The MDMS signal has a peak to average ratio of 20dB, meaning the peaks fully utilize the amplifier output for maximum degaussing.
5. 10 times the effective demagnetization as other discs.
6. Less than 1/100th of the heat dissipated as other discs.
7. Complete demagnetization of all frequency selective circuits (crossovers, tone controls, filters, etc.)
8. The acoustic level with the peaks at maximum will be just 1% of the available amplifier power!

ORDER DIRECT! ☎ (919) 829-1154 ☎ (800) 576-4745  
FAX: (919) 829-0047 FAX: (800) 576-5640



Sheffield Lab Inc.,  
1046 Washington St.,  
Raleigh, NC 27605

Reader Service #86

Speaker Builder 2/96 43

**PREMIUM  
CROSSOVER NETWORKS**  
*HIGH POWER 12DB PASSIVE*

YOU'VE DESIGNED BUILT AND LOADED  
YOUR ENCLOSURES  
WITH HI QUALITY SPEAKERS.  
YOU HAVEN'T SPARED ANY EXPENSE,  
YOU'VE SPENT TIME AND MONEY  
LET CROSSTECH AUDIO'S  
PREMIUM HI POWERED  
CROSSOVER NETWORKS  
FINISH OFF THE JOB  
DO IT YOUR WAY. THE RIGHT WAY!  
CUSTOM FREQUENCIES NOT A PROBLEM



30 Francine Lane Staten Island N.Y. 10314

Phone (718) 370-8399 Fax (718) 370-8297

Reader Service #85

**Tweeter: Dynaudio Esotar T-330D**

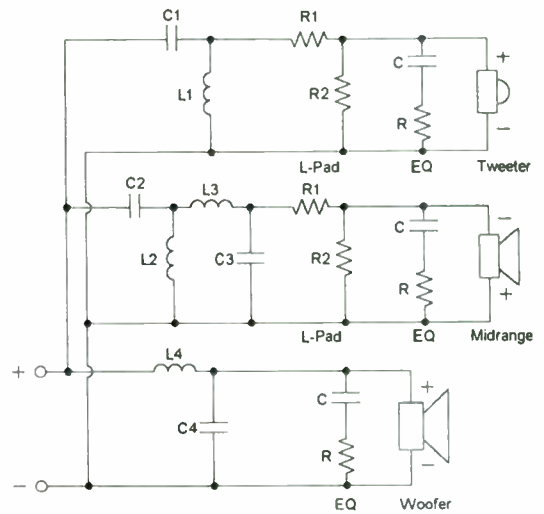
Z = 8.0 ohms  
Re = 5.2 ohms  
Le = 0.07 mH  
Qms = 0.330  
Qes = 0.500  
Sens = 90.0 dB (2.83 V)  
Number = 1  
NetZ = 8.0 ohms  
NetRe = 5.2 ohms  
NetSens = 90.0 dB (2.83 V)

**Midrange: Eton 4-203**

Z = 8.0 ohms  
Re = 5.8 ohms  
Le = 0.27 mH  
Qms = 4.330  
Qes = 0.280  
Sens = 92.0 dB (2.83 V)  
Number = 2 Parallel/Standard  
NetZ = 4.0 ohms  
NetRe = 2.9 ohms  
NetSens = 95.0 dB (2.83 V)

**Woofer: Madisound 1252DVC**

Z = 8.0 ohms  
Re = 5.6 ohms  
Le = 0.30 mH  
Qms = 4.100  
Qes = 0.390  
Sens = 88.5 dB (2.83 V)  
Number = 1  
NetZ = 8.0 ohms  
NetRe = 5.6 ohms  
NetSens = 88.5 dB (2.83 V)



**Crossover Network Components**

Lower frequency: 300 Hz  
Upper frequency: 3000 Hz  
3-way 2nd-order 3.4-octave  
C1 = 3.30 µF  
C2 = 85.28 µF  
C3 = 5.98 µF  
C4 = 32.96 µF  
L1 = 0.85 mH  
L2 = 4.34 mH  
L3 = 0.35 mH  
L4 = 8.54 mH

**Tweeter 1.50 dB L-Pad**  
R1 = 1.27 ohms  
R2 = 42.44 ohms  
**Tweeter Impedance EQ**  
C = 2.90 µF  
R = 5.25 ohms  
**Midrange 6.51 dB L-Pad**  
R1 = 2.11 ohms  
R2 = 3.58 ohms  
**Midrange Impedance EQ**  
C = 20.55 µF  
R = 3.63 ohms  
**Woofer Impedance EQ**  
C = 2.64 µF  
R = 8.25 ohms

FIGURE 3: Passive crossover design, courtesy of Asgard Audio.

Now Available:

**RADIOTRON DESIGNER'S HANDBOOK**  
by F. Langford-Smith  
**CD-ROM**

FOURTH EDITION COMPLETE

\$69.95 + \$3.95 S&H in USA.

Now, the bible for tube/valve enthusiasts, F. Langford-Smith's monumental RADIOTRON DESIGNER'S HANDBOOK (Fourth Edition, 1952, RCA reprinting of 1957), 1,498pp + 40pp Table of Contents, is available on a single CD-ROM disk. Full set-up instructions included for installing the controls enabling access to this storehouse of vacuum tube fundamentals. The 50 pages of the Index are also available line-by-line for lookup of any of the approximately 7,000 items. Pages may be printed on a suitable printer (24-pin dot matrix or, better, a laser or ink-jet type). The disk is packaged in its own jewel case with complete written instruction for installation and use.

From Langford-Smith's Preface: "This book has been written as a comprehensive, self-explanatory reference handbook for the benefit of all who have an interest in the design and application of radio receivers or audio amplifiers. Everything outside the field—television, radio transmission, radar, industrial electronics, test equipment and so on—has been excluded to limit the book to a reasonable size. An effort has been made to produce a handbook which, in its own sphere, is as self-contained as possible. Extensive references to other sources of information have been included for the reader who might require additional detail."

YES! Please send me \_\_\_\_\_ CD-ROMs at \$69.95 each \$ \_\_\_\_\_  
Plus shipping \$3.95 USA • \$6.95 Other Surface \_\_\_\_\_  
\$10.95 Other Air \_\_\_\_\_

Total Order \$ \_\_\_\_\_



**OLD COLONY SOUND LAB**

PO Box 243, Dept. B962  
Peterborough, NH 03458 USA  
Tel. 603-924-6371 FAX 603-924-9467

◆ SORRY, BOOK ITSELF NOT AVAILABLE ◆

This disk includes Adobe Acrobat® software for fully hyper-linked access to the book's pages via the Table of Contents. Equipment required: IBM 386 or compatible, MS Windows 3.1.

• Mastercard • Visa • Discover • Check or Money Order in US\$ Drawn on US Bank

Card# \_\_\_\_\_ Expire \_\_\_\_\_

Name \_\_\_\_\_

Street \_\_\_\_\_

City \_\_\_\_\_ State \_\_\_\_\_ Zip \_\_\_\_\_

Tel. \_\_\_\_\_ Today's Date \_\_\_\_\_



X\*over 2.0 does not mention it. This omission is my biggest problem with the package.

#### THE MANUAL

The manual included with the package is good in most respects. It covers the features of Windows very well (including some cut-and-paste tricks that I had not used before). It is a little short on the crossover design theory, however, and should mention why you would choose one type of crossover over another. Also, it needs a bibliography of crossover articles to shed some light on this process, since this is a program for rookies. For instance, the speaker impedance variation section on page 15 (I really did read the whole thing eventually) quite correctly points out that the impedance curve can be flattened with Zobel's (impedance equalization circuit) and with a series notch. A section on measurement, or at least a reference, would be good here. Later (p. 17), the user is told to test the design, but not given any clue as how to accomplish this feat.

#### USEFUL ADDITIONS

Several features would make this package much more useful. By including the ability to use asymmetrical crossover frequencies, the package would default to symmetrical frequencies but allow the user to vary them indi-

vidually. Also, modifying the Q of the filter is a useful trick when trying to turn "paper" designs into real-world designs. By varying the frequency and Q, you can compensate for the physical components' shortcomings, such as the limited response of real drivers, and the resistance of the inductor coils.

Another touch would be allowing the impedance compensation of the entire network to permit a benign load to the power amplifier. I also would have liked the ability to write the printer output to a file. These features may be "gilding the lily," and do not detract from the program's general usefulness. They may be beyond the scope of what the authors were trying to accomplish, but would be useful, even if they caused an incremental increase in the price of the software.

#### CONCLUSION

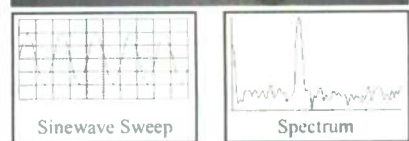
X\*over 2.0 scores an A for visuals. For technical merit I give it a B-, although this mark would have been better if the bandpass gain had been accounted for and more choices for three-way systems had been allowed. The program rates an A for quality of the output, and another A for ease of use.

Overall, the package rates a B+. This is a worthwhile entry-level crossover design package that gives a good return on a relatively small investment.

### Digital Storage Oscilloscope For \$189.95 ???

And much, much more!

O-Scope I turns PC-ATs into DSO, Spectrum Analyzer, Frequency Counter, DVM. DC-50KHz



Actual O-Scope I Captured Signals

For Orders and Inquiries Call: 1-800-980-9806  
For Technical Assistance: 1-713-777-0401

Allison Technology Corporation  
8343 Carvel, Houston, TX 77036  
FAX and BBS 1-713-777-4746

# High Performance - Low Price

Reader Special!  
#55-1530 Reg. \$34.95

SALE

**\$24.50**

You must supply this special code

CODE: SB29

SAVE  
**30%**

## MCM AUDIO SELECT™

### 12" Rubber Surround Woofer

- Poly Treated Paper Cone
- Rubber Surround
- 28Hz-3KHz Response
- 4ohm, 100W/150W RMS/Peak Capacity

MCM Electronics is the undisputed leader for supplying top quality speaker components at unbeatable prices. Take advantage of this tremendous offer, available for a limited time, only to Speaker Builder readers.

Call Today for FREE Catalog . . .

**1-800-543-4330**



MCM ELECTRONICS®  
650 CONGRESS PARK DR.  
CENTERVILLE, OH 45459-4072  
A PREMIER Company



FREE  
CATALOG

Hours: M-F 7 a.m. - 9 p.m.,  
Sat. 9 a.m. - 6 p.m. EST.

Fast delivery from  
distribution facilities near  
Reno, NV and Dayton, OH.

Price effective April 3  
through May 3, 1996

Authorized Original Parts Distributor  
**Panasonic/Quasar/Technics**

CODE:  
SB29

Reader Service #11

Speaker Builder 2/96 45

**1981** A Testing Unit for Speaker Parameters • Variable-Volume Enclosure • Thiele/Small Theory, Pt 1-3 • Easy to Make Enclosure Using Concrete Blocks • The Tractrix Horn: Good Dispersion From an Old Design • Diffuser Port for Small Boxes • Mini-Speaker Made From PVC Tubes • Closed vs. Vented Box Efficiency • Interview with P.G.A.H. Voigt • Dual 8" Symmetrical Air Friction Enclosure • Thiele/Small Calculator Computation • Thiele/Small Parameters for Passive Radiators •

**1982** Transmission Line Theory • Thiele/Small Sixth-Order Alignments • The Quad 63 • Table Saw Basics • AR-1 Mods • Active Crossover and Phase • Three Transmission Line Speakers • A Beginner's First Speaker • How Passive Networks Interact with Drivers • Horn Loaded Heil • Phase Correcting Active Crossover • Wind Your Own Inductors • Series and Parallel Networks • High Performance Corner Speaker • Using Zobel's to Compensate for Driver Characteristics •

**1983** Building the Two-Way Dynaudio • A Crossover That Offsets Speaker Impedance • Using a Calculator for Box Design • Choosing a Calculator • A Simple Peak Power Indicator • A Small Horn Speaker • Audio Pulse Generator • How to Use Speaker Pads and Level Controls • An Easy-to-Build Voltmeter for Speaker Measuring • Nomograms for Easy Design Calculations • Interview with KEF's Raymond Cooke • Build a Simple Wattmeter • A New Type of Speaker Driver •

**1984** Build an Aligned Satellite/Woofer System • BOXRESPONSE: A Program to Calculate Thiele/Small Parameters • Casting with Resins • A Phase Meter • An Interview with Ted Jordan • Building the Jordan-5 System • Self-Powered Peak Power Indicator • Closed Box Design Trade-offs • How to Build Ribbon Tweeters • Build a Dual Measurement Impedance Meter • A High-Power Satellite Speaker System • Build and Use a White/Pink Generator • Sound Pressure Level Nomographs •

**1985** OUT OF PRINT, some single issues still available at \$7 each •

**1986** The Edgar Midrange Horn • Sand-Filled Stands • Crossover Networks: Passive and Active • 5-sided Boxes • A 2 x 4 Transmission Line • The Free-Volume Subwoofer • Notch Filters • By-Wiring the LS3/5A • A Push/Pull Constant Pressure System • Current and Power in Crossover Components • The Unbox (Egg) • Upgrade Speakerlab's S-6 Crossover • Measure Speakers with Step Response • A Gold Ribbon System • A Visit with Ken Kantor • A Tractrix Horn Design Program • Reviews: Audio Concepts "G"; Seven TL Midranges; Focal's Model 280; the Audio Source RTA-ONE.

**1987** A Compact TL Woofer • Frequency Response and Loudspeaker Modeling, Pt 1-3 • A Manual Coil Winder • The Model-One Speaker • Designing a Listening Room • A Sixth-Order Vented Woofer • Tapered Pipe Experiments • Visiting Boston Acoustics • A Vented Compound System • The Octaline • Spreadsheets for Speaker Design • In Memoriam: Richard Heyser, Pt 1-2 • Using Non-Optimum Vented Boxes • Building Speaker Stands • Evaluating Driver Impedance Compensation • Tuning Bass Reflex • Six Woofers Compared • Bullock on Passive Crossovers: Alternate Bandpass Types • Fast, Easy Filter Calculations • A Mobile Speaker • Polk 10 Mod •

**1988** Electronic Turns Counter • Two-Way Design • Minimus-7 Mod • Dome/Midrange/Tweeter Array • Plotting Complex Impedances • A Driver Design Primer • A Cabinet Primer • Tuning Up Old Systems • Low-Cost AR-3 Upgrade • Electronic Time Delay • Enclosures Shapes and Volumes • Minimum-Phase Crossovers • Spot Sound Absorbers • How to Add a Subwoofer • The Swan IV System • Sub-Bass Power Boosting • The Unline: A Short TL • Active Filter Computer Design Program • Low-Cost Two-Way Ribbon • Amp-Speaker Interface Tester and Construction Plans • The QB<sub>3</sub> Vented Box is Best • A Pentagonal Box System • Keith Johnson Profile • Sheathed Conductor ESL • A Symmetrically Loaded System, Pt 1 • Ceramic Enclosure • Inductance Measuring Technique • Polk 10 Mods •

**1989** (4 Issue Set: VERY LOW STOCK) The Audio Laboratory Speaker System • A Passively Assisted Woofer • Digital Filter Tutorial • The Listening Arc Alignment • Small IC Power Amp & Crossover • Easy Surround Sound • Building Speaker Spikes • An Isobarik in a Thunderbird • Sheetrock Cabinetry • A Picket Speaker • Servo-Controlling AR-1 • Silent, Safe Muting System • Equalizing the Klipsch Cornwall • A Test Switcher • Visiting the Klipsch Kingdom • Rehab for Kitchen Music • Spreadsheet Design • A Subwoofer/Satellite System • Impedance Measurement as a Tool • Practical Passive Radiators • A Symmetrical Dual Transmission Line, Pt 1 • The Microline • A Voice Coil Wheatstone Bridge • Tweeter Q Problems •

**1990** Acceleration Feedback System • Cylindrical Symmetrical Guitar TLs • Compact Integrated Electrostatic TL, Pt 1-3 • Minimus-7 Super Mod • The Show (Bass Horn) • A Small Two-Way System • Helmholtz Spreadsheet • Heresy Upon a (Klipsch) Heresy • Beer Budget Window Rattler • Contact Basics • MDT Mini-Monitor Speaker System • Titanium + TPX + Polypropylene = Fidelity • Tom Holman, Skywalker, and THX, Pt 1-2 • Bud Box Enclosure • Klipschorn Throat Riddle • Modular Three-Way Active Speaker • CD Speaker System • SPEAKER DESIGNER Software • Symmetrical Isobarik • Novice Crossovers • Triamplified Modular System • Magnetic Crosstalk in Passive Crossovers • Mitey Mike Loudspeaker Tester • Symmetrical Loading for Auto Subwoofers • Improved Vented Box with Low Q<sub>TS</sub> Drivers • BOXMODEL Woofer System Design Software • Four Eight By Twos • Dynaco A-25 Mod • Klipschorn Throat Revisited •

**1991** Students Building Systems • Servo Subwoofers • An Apartment TL • LR Crossover for the Swan IV • More or Less Power • New Guidelines for Vented Boxes • The Pipes • Macintosh's Wave and Sound Programs • Creating Professional Looking Grilles • Octaline Meets D'Appolito • Using Radar to Measure Drivers • Deep Bass for GMC • PSpice LF Response Calculating • Pipe and Ribbon Odyssey • The Delac S-10 • Infrared Remote Volume Control • Backloaded Wall Horn Speaker • Mod for the Minimus 7 • Simplifying Cabinet Assembly • Fibrous Effects on TLs • The DOALS • Loudspeaker Cable • Speaker to Ear Interface • Speaker Sensitivity to Errors in T/S Parameters • TL Speaker Evaluation • Cable and Sound • Kit Reports: Little V; Audio Concepts' Sub-1 •

**1992** Rumreich on Box Design & Woofer Selection • MLSSA • Double-Chambered Reflex by Weems • Active Crossover and Delay • Electrical Circuit Bandpass Enclosure • A Dreadnaught System (satellite swivels) • Designing Real-World Two-Way Crossovers • 20-foot Ribbon Dipole Speaker • Biamping the Sapphire II • Capping Passive Crossovers • A High Quality Speaker Cabinet • 1/3-Octave Noise Source • Disappearing Loudspeaker • The A&S Soundoff Winner, Pt 1-2 • Alignment Jamming • Marc Bacon's "Danielle", Pt 1-2 • Double-Chambered Isobarik Bass • Ferguson's Pickup Installation • Electronic Counter for Coil Winding • Oakley on Speaker Placement • Making Your Room Hi-Fi, Pt 1 • More on Dust Caps • Spreadsheet for Nonoptimum Vented Box Design • Acoustic Resistance Tuned Enclosure •

**1993** Waslo's IMP, Pt 1-3 • Quasi-Monotonic Vented Alignments • Making Your Room Hi-Fi, Pt 2-3 • A&S Soundoff Winner, Pt 3 • Flexible Dipole Woofer • The Spline • Stalking F<sub>3</sub> • A Bi-Structural Enclosure • A Sixth-Order T/S Subwoofer Design • Speaker Enclosure Screws • Electric Bass Tri-Horn • Prism V Satellite/JBL Subwoofer, Pt 1-2 • Fiduct: Program for Designing Duct Software • Compact Coincidental Point Source Speaker • IMP: Measuring T/S Parameters • KIT REPORT: Rockford's Beginner Software/Driver Paks • SOFTWARE REPORT: Low Frequency Designer 3.01 • Three Affordable Measurement Microphones • Two Ways to Realize a Dream • Matching Driver Efficiencies • Two-Woofer Box System • Designing a Dual Voice Coil Subwoofer • SOFTWARE REPORT: Blaibox 1.2 • Tale of Three Speaker Projects • A&S Sound-off 1992 • Monolith Horn • Orbiting Satellites • Real-World Three-Way Crossovers • The Simplex • Living with a Speaker Builder • The IMP Goes MLS •

There's More 

Please send me the following back issues of Speaker Builder

- |                                    |                                    |                                    |                                    |
|------------------------------------|------------------------------------|------------------------------------|------------------------------------|
| <input type="checkbox"/> 1995 \$32 | <input type="checkbox"/> 1994 \$32 | <input type="checkbox"/> 1993 \$25 | <input type="checkbox"/> 1992 \$25 |
| <input type="checkbox"/> 1991 \$25 | <input type="checkbox"/> 1990 \$25 | <input type="checkbox"/> 1989 \$18 | <input type="checkbox"/> 1988 \$23 |
| <input type="checkbox"/> 1987 \$20 | <input type="checkbox"/> 1986 \$20 | <input type="checkbox"/> 1984 \$18 | <input type="checkbox"/> 1983 \$18 |
| <input type="checkbox"/> 1982 \$18 | <input type="checkbox"/> 1981 \$18 |                                    |                                    |

#### SHIPPING BACK ISSUES

UPS: Domestic ground service by value of order:  
 Less than \$60.00 - \$4.50      \$131.00-220.00 - \$8.50  
 \$61.00-130.00 - \$6.50      \$221.00+ - \$10.50

Canada: Add \$6.00 per year.

Foreign Air: Europe add additional 40% of total order.      **Total Magazines** \_\_\_\_\_  
 Other destinations: 50% of total order.      **Postage** \_\_\_\_\_

Foreign Surface: Add additional 20% of total order.      **TOTAL ENCLOSED** \_\_\_\_\_

Rates subject to change without notice. All remittance in US \$ only drawn on a US bank.

- Check or Money Order     Discover     MC     VISA

DISCOVER/MC/VISA NO.	EXP. DATE
NAME	ACCOUNT NO.
STREET & NO.	
CITY	STATE      ZIP

## Speaker Builder

Post Office Box 494, Dept. B96, Peterborough, NH 03458-0494  
 (603) 924-9464    FAX (603) 924-9467

Answering machine for credit card orders only—before 9:00 a.m., after 4:00 p.m. and weekends  
 Please have all information plus MC/VISA available.



# Tools, Tips & Techniques

## BAFFLING CUT

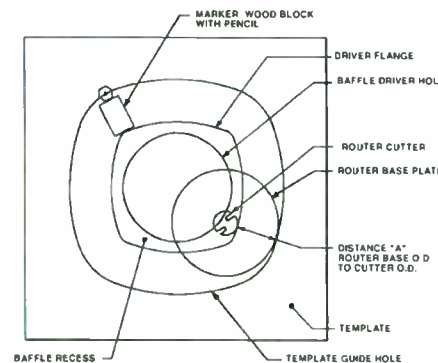
In answer to Matthew Everist's request (*SB* 3/95, p. 9) for a method of routing a clean recess in baffles for flush mounting of irregularly shaped drivers, here is a suggestion. This method also works well for making a "centerless" cut, that is, when the hole for the driver has already been cut out and is not there to support a center pin.

My method involves making a template to guide the outside edge of a router having a circular base plate. You may make the template of any rigid material 3/16" or greater in thickness. You might use two-ply corrugated cardboard (single-ply is not strong enough), plywood, masonite, thin pressboard, upson board, etc. Check clearances on your router to be sure the thickness of board you use will allow the router to run freely around the template cutout.

You mark the cutout in the template by placing the driver face down on the center of the template board. Measure the distance *A* from the outer edge of the router flange to the outer edge of the cutter you are using (*Fig. 1*). The cutter must have a radius no larger than the smallest radius of the driver flange. Make a marking device out of a small block of wood a few inches high, with a pencil securely fastened at one end

with rubber bands or tape. The distance from the inner edge of the wood block to the pencil's center should equal distance *A*. Draw the template cutout by moving the wood block around the driver flange, always keeping the inner edge of the wood block tangent to the driver flange.

Cut out the template guide hole using either a knife, jigsaw, keyhole, or sabre saw, whichever is appropriate. Cut away the entire pencil line, thus providing half the line's width for clearance between the baffle recess and the driver flange. Shim the pencil out to slightly more than distance *A* if you desire more clearance.



**FIGURE 1:** Marking the template and routing the recess.

Small irregularities in the template cutout are acceptable, as the outer flange will smooth them out like a big wheel going over small crevices. Crevices are OK; bumps are not.

## RECESS TIME

Clamp the template securely to the baffle, centered over the driver position. Set the router blade to the required recess depth. Lower the router onto the baffle, with the blade in the driver cutout and the router base firmly held flat to the exposed part of the baffle surface. Rout outward until the router base contacts the template guide hole, then run it around the guide hole. This should leave you a perfect outside edge matching the driver. "Wallow" the router around to clean up any material not removed in the recess area.

Note that the routing process is easier and the router more stable to handle if you do the routing before making the driver hole, and before the baffle is cut from its board. If you use a router to cut out the driver hole, you may also use a template, to avoid the "slip" you get when the router pivot pin (for round holes) falls away with the center slug.

Roger A. Siedow  
Norman, OK 73071-1219

## Speaker Builder

## BACK ISSUES Continued

**1994** Sanctuary Sonics • Modular Active Crossovers • A Full-Range Open-Baffle System • An Evolving Magnepan MG-1 • Low-Frequency AC-To-DC Converter • A Compact Bass Guitar Speaker • Measuring Speaker Impedance Without a Bridge • The Dynapleat • The Danielle II • The Birdhouse: A Sound-Reinforcement Subwoofer • The Linear-Array Sound System • A Revised Two-Way Minimonitor • Exploring the BUF 124 with Pspice • Signet's SL280B/U • Time Response of Crossover Filters • Converting Radio Shack's SLM To Millivolt Use • Acoustic Distortion and Balanced Speakers • Microphone Response Correction with IMP • More About the Birdhouse Bandpass • A 16Hz Subwoofer • D.H. Labs Silver Sonic Cables • The System III Loudspeaker • Exploring Loudspeaker Impedance • IMPcycling • The Linear-Array Chronicles • Book Report: Loudspeaker Recipes, Book One • The Woofer Test • A Large Ribbon You Can Build • Loudspeakers, A Short History, Pt 1-2 • Absolute SPL Sensitivity Measuring with IMP • The Damping Factor: One More Time • Cliffnotes for Loudspeaker University • Software Report: The Listening Room for Macintosh • Book Report: The Theory and Design of Loudspeaker Enclosures • A 15" Transmission Line Woofer • Inductor Coil Cross Talk • Quick Home Theater on a Budget • Silk Pursues: A Two-Way Salvage Design • Audio Phase Inductor •

**1995** The T-Rex Minisubwoofer • High Quality Use of Motorola's Piezo Driver, Pt 1 • The Achilles: A Two-Way Automotive Transmission Line • Driver-Offset-Related Phase Shifts in Crossover Design, Pt 1-2 • The Linear-Array Chronicles, Pt 3 • From Sad to Sparkle: A SAAB Story, Pt 1-2 • A Compact Two-Way PA, Pt 1-2 • The Baekgaard Crossover Technique • Rebuilding the KLH-9 Power Supply • KIT REPORT: Audax of America A652 • Satellites For a New System • Box Models: Benson Versus Small • PRODUCT REVIEW: Sapphire III Reference Monitor • The Spline Sidewinder Woofer • Focused Arrays: Minimizing Room Effects • A Flexible Four-Way System • Extending IMP: A Program Set • CD REVIEW: *My Disc* From Sheffield Lab • The Freeline: An Open-Pipe Transmission Line • Computer-Aided Bass Horn Design • A Mike/Probe Preamp For Sound-Card Measurements • Four-Poster Speaker Stands • Mining For Gold On the Madisound BBS • SOFTWARE REVIEW: CLIO Test System • The Waveguide Path to Deep Bass, Pt 1-3 • Stereo Bass: True or False? • A Morning Glory Midrange Horn • Testing a Simple Focused Array • PRODUCT REVIEW: LinearX's pcRTA • A Self-Powered Subwoofer for Audio/Video • Your Car's (and Living Room's) Bass Boost • Driver Temp and T/S • SOFTWARE REPORT: SoundBlaster 16 • A Push-Pull Planer Speaker Quest • PC Sound Overview • Design a Three-Way TL with PC AudioLab, Pt 1 • PRODUCT REVIEW: Audio Control C-101 • SOFTWARE REVIEW: Electronics Workbench •

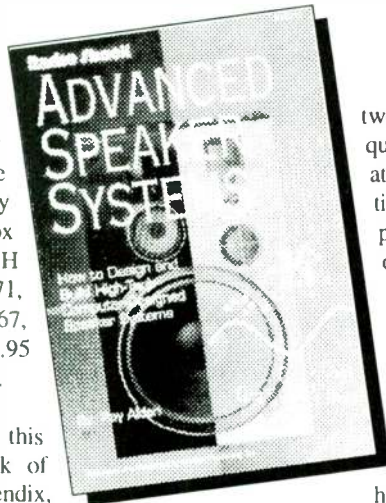
# Book Report

## ADVANCED SPEAKER SYSTEMS

Reviewed by Richard Campbell, Contributing Editor

**Advanced Speaker Systems** by Ray Alden is available from Old Colony Sound Lab, PO Box 243, Peterborough, NH 03458, (603) 924-6371, FAX (603) 924-9467, order #BKRS3, \$9.95 plus \$3 s/h in the US.

My first reaction to this diminutive paperback of 114 pages plus appendix, glossary, and index was, "Hummm—another book on loudspeaker design"; yawn. *Advanced Speaker Systems* by Ray Alden (Master Publishing, Inc., distributed by Radio Shack) fell open to page



two and I immediately noticed the quality of the illustrations associated with the spring-mass equations. I was also attracted to the page design, that elusive quality of a book that, when done right, removes the visual burden of a lousy page layout when reading both new and difficult information.

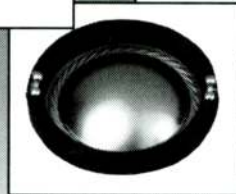
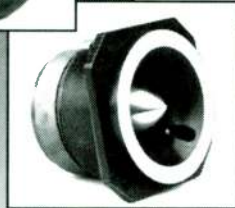
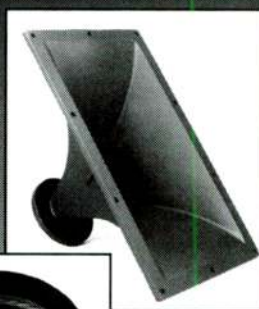
Ray Alden is a well-known contributor to *Speaker Builder*, and his work with high school kids in New York has received favorable publicity. Having Joseph A. D'Appolito, PhD, as contributing technical editor means you are in for good, solid, sensible, and clear mathematical explanations of loudspeaker operation.

### TANDY TUNNELVISION

I have it on good authority that the Radio Shack book department is quite limited in its printing capability and that the ensuing constraints give authors nightmares and migraines, and cause wastepaper baskets to overflow with discarded page makeup attempts. This may have had a positive effect in this case, because this book (actually a handbook) does not even take a breath between the covers.

It delivers high-density material in a rapid-fire manner, with little hand-holding. Here is an illustration, here is an equation, here is what it means, here is how you solve it on an RPN scientific calculator (Radio Shack, of course), here is a graph of the results. Bam! Next case. Using this highly compressed approach, this little book has

# The Source for Pro Sound Speaker Builders



Loudspeakers, Drivers, Horns, Tweeters, Crossovers, Hardware, Connectors... and much, much more!  
Image delivers virtually every component for the speaker builder.  
See for yourself. Call or FAX for your FREE catalog today!

**image**  
communications

5235 W. 65th Street • Unit D • Bedford Park, IL 60638  
1-800-552-1639 • Phone (708) 563-4950 • FAX (708) 563-4956

**EMINENCE**  
Loudspeakers, Drivers,  
Diaphragms and Recone Kits

**Electro Voice**  
Recone Kits

**McCauley**  
Loudspeakers & Drivers,

**Acoustician**  
Drivers, Horns, Tweeters,  
Diaphragms & Crossovers

**Waldom**  
Audio Products  
Hardware, Connectors, Etc.



everything essential you need to know about sealed and vented loudspeaker systems. And I mean everything.

In addition to an excellent two- and three-way crossover design section, *Adv. Systems* includes seven complete loudspeaker designs with cabinet drawings. Among them is a Joe D'A. ported 3/2 satellite measuring only 15" x 6" x 8 3/4", which you can combine with a very healthy push-pull bandpass subwoofer (described later in the book). All of the drivers are specified as Radio Shack part numbers, which means convenient one-stop shopping for any of the systems described. I've used RS drivers before, and although I was initially leery, I have not had any bad experiences with them. Listen for voice coil rubbing before leaving the store.

This book is unabashedly designed to sell Radio Shack parts and to push one type of box design software, TOP BOX™, and one type of crossover software, PXO™. The neophyte reader is not exposed to other superb and affordable Windows™ products such as BoxPlot™ or BassBox™ (Old Colony Sound Lab, #SOF-BAS1B3G, \$99 plus \$3, s/h) with its companion program, X•over™ (OCSL, #SOF-XOV1B3G, \$29 plus \$3); nor is a reference included for Bodzio Software's SSD Speaker System Designer Plus™ (OCSL, #SOF-SSD5WXG, \$269 plus \$5), a bit upscale but with powerful optimization routines. The source given for MLSSA is out of date by two years; DRA Labs is now at 4587 Cherrybark Ct., Sarasota, FL 34241, (813) 927-2617.

#### AWAY WITH WORDS

Glossaries can be entertaining or stifling, dry prose. Either way they are difficult and time-consuming to compose, and then subject to petty bombardment by the likes of me. In acoustics, dispersion is not "the spreading of soundwaves as they leave the speaker," and sound pressure level (SPL) has little to do with "loudness," even though a layman would understand either word's definition, in the context of this book. Likewise, "acoustic suspension" is not "a speaker designed for, or used in a sealed enclosure." Finally, the golden ratio definition ends solely with "...which often provides the best sound," whereas the reader of this quite technical book could have been told in the glossary about the distribution of box resonant modes in a few simple words (a good description occurs in the text).

The book offers no suggestions for crossover physical layouts. One crossover circuit, for system #7, has four coils, one carrying a large current. You could encounter trouble on a bad layout where the woofer series inductor is unwittingly magnetically coupled to the midrange coils.

The section on subwoofers includes a

lengthy discussion on the Isobarik form leading to an earth-shaking design using two 15" woofers in push-pull. In this Isobarik configuration, the two woofers are bolted face-to-face, the back side of one radiating upward into the cabinet and the back side of the other radiating downward toward the floor. The text states that "the result is that asymmetric nonlinearities, such as those caused by a single voice coil moving through a magnetic field of uneven strength or nonlinearities due to suspension system irregularities, are eliminated. In effect, second-order harmonic distortion is greatly reduced."

#### DESIGN CONCERNS

I'm not sure this is true. Yes, push-pull configurations are capable of canceling even-order distortions, but only when each driving element shares the load equally in a power sense. In the Chapter 6 example of a push-pull bandpass system, the two drivers are truly sharing the load in a power sense because each cone contributes equally to the pressurization of the chambers; i.e., they equally share a common load. One cone moving toward the magnet and the other moving away from the magnet sets up the asymmetric nonlinear cancellation



## THE WORLD'S MOST RESPECTED HI-FI MAGAZINE

**SUBSCRIBE TODAY AND GET  
THE NEXT 12 ISSUES FOR**

**\$65.00 USA    \$75.00 CANADA**

---

*Please send me the next 12 monthly issues of Hi-Fi News and record Review from the next available issue.*

Mr/Mrs/Miss/Ms \_\_\_\_\_  
Address \_\_\_\_\_  
Apt# \_\_\_\_\_  
City \_\_\_\_\_  
State \_\_\_\_\_ Zip \_\_\_\_\_

**METHOD OF PAYMENT**

Check enclosed (US dollars and drawn on a US bank)  
 Please charge my  Visa  Mastercard  American Express

Account No. \_\_\_\_\_ Exp.date \_\_\_\_\_  
Signature \_\_\_\_\_ Date \_\_\_\_\_  
 Please bill me

Return to Hi Fi News & Record Review, PO Box 384, Avenel, NJ 07001

**FOR FASTER SERVICE USE YOUR CREDIT  
CARD AND CALL TOLL FREE**

**☎ 800-688 6247**

AA41

in the common acoustic field.

However, no such commonly shared load exists for the push-pull Isobarik. Any asymmetric nonlinearities between the drivers end up pressurizing the air in the tunnel, a distinctly non-Isobarik behavior. Furthermore, investigations of a push-pull tunnel Isobarik speaker using small pressure microphones suggest the tunnel is anything but constant pressure over much of the valid operating range, particularly at high excursions. The AkAbak™ acoustic modeling program also shows interesting non-Isobarik behavior inside the tunnel.

The corrective action of a true push-pull arrangement depends on the interaction between the elements making up the push, pull, and the coupling between them. You can analyze the net effect by looking at the respective half-cycle energy storage capability of the coupling elements and/or their linear superposition. A vacuum tube push-pull power amplifier, for example, has nonlinear plates tightly coupled magnetically, and calls for both analytical approaches. The coupling medium (iron) has enormous half-cycle energy storage capability, giving the output transformer primary windings a coupling coefficient very close to unity. For all practical purposes, you can assume nearly perfect even-harmonic cancellation when superposing the positive-going and negative-going plate current characteristics on such a coupling.

On the other hand, the Isobarik loudspeaker pair is coupled with a quantity of air which has minuscule half-cycle energy storage capability compared to the two moving masses whose nonlinearities we are trying to cancel. I maintain that significant even-order distortion cancellation in a push-pull Isobarik tunnel or face-to-face construction is a myth.

I am also bothered that Isobarik drivers

are nearly always driven in parallel connection from a power amplifier with an extremely high damping factor, putting them into "constant-velocity" mode. Hooking the drivers in series is very different, so I am reluctant to say that it makes no difference how they are connected, as this book suggests. One way to model the Isobarik might be to regard the tunnel as a velocity device causing the pressure to divide equally between the box, the tunnel, and the radiation, which would also account for one-half  $V_{AS}$ . Obviously, more work needs to be done in this area.

### CONCLUSION

I had better conclude this review before I wear out my welcome with another digression. This wonderful little book grew out of Mr. Alden's decision to use speaker building as a vehicle for explaining mathematical abstractions to his students at New York's Stuyvesant High School. The great value in this birthing is that only what is truly important is presented, without extra fluff, tangents, anecdotes, and so forth, because that's the way good high school teachers teach. Combine that with the technical editorial skill of Joe D'Appolito, and this book becomes a real winner.

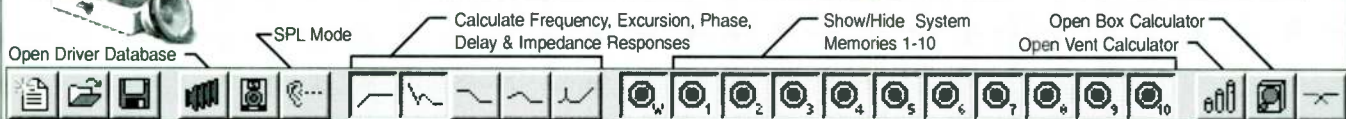
### OF SPECIAL NOTE Audio Amateur

#### Issue 1, 1996

- A 30W AF Amplifier for Cars
- On Power Amplifier Feedback Networks
- DIY PC Boards
- Mixers and Mike Preamps, Part 3
- A Fault Too Far
- Product Review: BK Power Amps

# The Speaker Design Toolbox®

## Introducing WinSpeakerz 95 for Windows 95!



**WinSpeakerz Driver Database**

Manufacturer	Model	Count
Alpine	1092AD	1
Alpine	1092	1
Alpine	1092B	1
Alpine	1092C	1
Alpine	1092D	1
Alpine	1092E	1
Alpine	1092F	1
Alpine	1092G	1
Alpine	1092H	1
Alpine	1092I	1
Alpine	1092J	1
Alpine	1092K	1
Alpine	1092L	1
Alpine	1092M	1
Alpine	1092N	1
Alpine	1092O	1
Alpine	1092P	1
Alpine	1092Q	1
Alpine	1092R	1
Alpine	1092S	1
Alpine	1092T	1
Alpine	1092U	1
Alpine	1092V	1
Alpine	1092W	1
Alpine	1092X	1
Alpine	1092Y	1
Alpine	1092Z	1

Try before you buy! We offer a FREE DEMO on America Online. Keyword: TIA. Join us in the TIA Speaker Design Forum. Everyone is welcome!

True Image Audio® 349 WEST FELICITA AVE., SUITE 122, ESCONDIDO, CA 92025 • email: TIA Sharon@aol.com Fax & INTL Inquiries: 619-480-8961

**WinSpeakerz - My Project.spk**

**My Project.spk:1**

The graph shows frequency response curves for a speaker design. The x-axis represents frequency in Hz, ranging from 20 to 5000. The y-axis represents SPL in dB, ranging from -10 to 140. Multiple curves are shown, representing different driver responses and system responses. The curves show a peak in the midrange and a roll-off at high frequencies.

**Driver and System Parameters**

Driver	1P155P
f <sub>td</sub>	= 53 Hz
Q <sub>ts</sub>	= 0.42
V <sub>max</sub>	= 0.5607 cu ft
Input Power	P <sub>in</sub> = 80 W
SPL @ 1 m	(3.281 ft)

**4th Order Vented Box**

Box Volume	V <sub>box</sub> = 0.482 cu ft
Closed Box Q	Q <sub>bc</sub> = 0.6478
Box Frequency	F <sub>bc</sub> = 40 Hz
Min Recommended Vent	S <sub>vent</sub> = 0 sq in
Vent Area	S <sub>vent</sub> = 0 sq in
Vent Length	L <sub>vent</sub> = 0 in

### A new generation of loudspeaker design tools!

- ✓ Quickly evaluate up to 18 box types- closed, vented, bandpass and isobarik .....multiple drivers too!
- ✓ Powerful Search & Sort Driver Database
- ✓ Shows all important *Excursion response*
- ✓ Adjustable frequency scale end points
- ✓ Crossover & Box Calculators
- ✓ English or Metric units
- ✓ Numerous Printed Reports
- ✓ System Requirements: Windows 95!

**30 Day MONEY BACK GUARANTEE!**

**Order Today!**

WinSpeakerz® for Windows® 95  
MacSpeakerz for Macintosh® **\$299**



# SB Letters

## TWO OHMS IT MAY CONCERN

An error has occurred in Fig. 3 of my "Super Simpline" article (*SB* 1/96, p. 19). The figure shows (in two places) a  $2\Omega$  resistor in series with the tweeter. The correct value of the resistor is  $3\Omega$ , as stated in the text and parts list. If you use the  $2\Omega$  resistor, the Super Simpline will sound shrill in most environments.

I also want to restate that after I submitted and proofed the Super Simpline article, I added 47 grams (about 1.7 oz.) of polyester fiberfill. This raised the original 4 oz. to about 5.7 oz. (113 grams to 160 grams). I first mentioned this in my letter in *SB* 8/95 ("Freeline Revisited," p. 57).

Now, I have recently noticed an omission in *that* letter. I neglected to state that I removed the  $10\Omega$  series resistor at the same time I changed the  $3.3\mu\text{F}$  capacitor to a  $4.0\mu\text{F}$  in the Freeline high-pass filter circuit.

John Cockroft  
Sunnyvale, CA 94087

## NON-PRO WRITERS

In reply to Steve Pleasant's letter (*SB* 6/95), I find his criticisms of *Speaker Builder's* articles unfair, especially considering the fact that *SB* relies primarily upon nonprofessional writers for its content.

As for the occasional use of equations and formulas by some authors, I'll admit that many go beyond my comprehension. On the other hand, most articles contain only rudimentary, if any, mathematics. Some authors do lean heavily on computers and test equipment, yet the opposite is also the case, with most writers relying only on their two ears for testing.

I myself am often critical of most articles, thinking they were either too technical or not technical enough; I've thought how much better a job I could have done writing a particular piece. But did I write a critical letter to the editor? No—I wrote my own articles, which, to my surprise, *SB* published.

What Mr. Pleasant apparently fails to perceive is that most of *SB's* articles are written, not by professional writers, but by average guys like myself who really enjoy building speakers. If our efforts fall short of perfection, please forgive us, but we write not because

we have to, but because we want to. While none of us is likely soon to win a Pulitzer, you can be sure that when it comes to cutting-edge technology in speaker building, no other publication comes close to *SB*.

As regards high-end drivers not often being featured, let me share this experience: Last year I wrote to all the high-end manufacturers requesting T/S parameters. I also asked if they would be interested in providing drivers to be featured in an article. To their credit, I received replies from Electro-Voice and Gauss; none of the others, including JBL and McCauley, even bothered to acknowledge my request. I think most high-end manufacturers are content to sell finished systems and simply aren't interested in the home-builder market, especially if those home-builts are likely to outperform the factory-made units.

In conclusion, if you find fault with *SB's* writers and really want to improve *SB*, write for it yourself. Show the rest of us what you can do.

Bill Fitzmaurice  
Laconia, NH 03246

## AD CLARIFICATION

I am very satisfied with your articles; however, some of the ads stretch things a bit. The "Infini-Cap" ad (*SB* 7/95, p. 6) claims that an inductance ratio of 1,000,000 to 1 "smears music by a factor of 1,000,000:1."

Least offensive to reality is the statement that the delay in a transmission line, L-C lumped or continuous, is proportional to  $\sqrt{L/C}$ , not to L.

## MAHOGANY SOUND

The Transmission Line Specialist  
P.O. Box 9044  
Mobile, AL 36691-0044  
334-633-2054

### Acousta-Stuf

The Very Best Damping Material For  
Speaker Systems. It Produces Deeper  
Bass, Cleaner Mids, And Greater  
Dynamic Range. Acousta-Stuf Costs  
\$9.50 Per Pound UPS Paid

### Q&ETLD

Quick & Easy Transmission Line  
Speaker Design Booklet & LOTUS  
1-2-3 Software Learn How To  
Design Optimizes 1/4 Wavelength  
TL Speakers. Q&ETLD Costs  
\$8.95 Plus \$2.05 P&H

### Acousta-Tubes

Round Paper Tubes For Building  
Cylindrical Speaker Enclosures.

Please Note Our New Address  
& Area Code  
Call Or Write For A Free Catalog

Reader Service #9

Get the information you need *fast!* Use this convenient list to request the products and services that interest you in this issue. Don't forget to mention *Speaker Builder!*

COMPANY	PRODUCT	FAX
Acoustic Technology Int'l	High-End Drivers	(905) 475-8226
Allison Technology Corp.	O-Scope II	(713) 777-4746
Harris Technologies	BassBox and X-over	(616) 641-5738
Hovland Co.	MusiCap Film & Foil Caps	(209) 966-4632
LinearX Systems, Inc.	LEAP	(503) 598-9258
Markertek Video Supply	Unique & Hard-To-Find Accessories	(914) 246-1757
Meniscus	Limited Edition Woofer	(616) 534-7676
MIT Electronic Components	MIT MultiCap	(916) 823-0810
Morel Acoustics USA	Speakers, Drivers	(617) 277-2415
Mouser Electronics	Free Electronic Catalog	(817) 483-8157
Parts Connection, The	Assemblage DAC-1 Kit	(905) 829-5388
Sescom, Inc.	Sheet Metal Boxes	(800) 551-2749 (USA) & (702) 565-4828
Solen Inc.	Speaker & Crossover Components	(514) 443-4949
TCH Umbra	Speaker Cabinet Hardware	(416) 299-6168

But my main gripe is the magnitude of the delay; even an ordinary audio cap has a self-resonance frequency of around 2MHz, corresponding to a delay of  $\approx 1/(2\pi \times 2\text{MHz})$ , or about 80ns. (That of about 80' of air at the speed of light.) This delay is about 0.6 degrees at 20kHz, whereas most loudspeakers have 180°–720° phase shift at this frequency! This delay of 80ns is about that of 0.001" of air to sound waves!

In summary, their "argument" is like saying "If the G string on a violin has one molecule of dust on it, but the D string has a million molecules of dust (about a trillionth of a microgram), then the music is smeared by a

million to one!"

Actually, if an audio signal were smeared by a 100:1, it becomes noise. If smeared by 1,000,000:1, it becomes rap!

This in no way criticizes your excellent magazine.

Dennis P. Colin  
Barnstead, NH 03218

*J. Peter Moncrieff, of Tomorrow's Research Today (TRT), responds:*

*Mr. Colin's main point questions whether the smearing problem cured by InfiniCap is sig-*

*nificant enough to matter. That's simple to answer—the proof is in the listening. Independent critics report that InfiniCap sounds much more focused, coherent, fast, and transparent than other capacitors, including special audiophile types such as multiple caps and film/foil musical caps.*

*Sober audio OEMs, who depend on picking the best capacitor to make their product sound best in a competitive market, have described this sonic difference as "Astounding!", "Amazing!", "Blew me away!" (their precise words, not mine). A number of OEMs (including major speaker-system manufacturers) have already changed to InfiniCap from these other audiophile capacitors, putting their money where their mouths are. Thus, the hard empirical evidence proves that the sonic difference is significant, and it scientifically overrides Mr. Colin's a priori speculations.*

*Mr. Colin's second point addresses technical issues. Here he has succumbed to a common mistake (even among engineers)—conflating two different kinds of delay and smearing. The first kind is propagation delay through a device or circuit (e.g., a delay line). This is the delay in absolute time that it takes for a waveform to appear, substantially intact and undistorted, at the output, after it has been presented at the input.*

*The second kind involves a distortion of the waveform itself, whenever it starts appearing at the output and regardless of the propagation delay. With this second kind of delay, some parts of the distorted output waveform take longer to rise or fall than they did in the input waveform, after the waveform gets started.*

*Our ad correctly keeps these two kinds of delay and smearing distinct, addressing them as two separate problems with two separate diagrams. Our first diagram addresses propagation delay, and shows that other capacitors have a 1000:1 smearing problem, which InfiniCap cures. This agrees with the 1000:1 propagation delay smearing Mr. Colin derives (from the root LC formula for propagation delay lines) when L varies by a ratio of 1,000,000:1—so he shouldn't have any technical quarrel with our ad.*

*Our second diagram is clearly introduced as addressing "another problem," the second kind of delay and smearing, which InfiniCap also cures. This problem is caused by the million-to-one inductance disparity for the various paths through conventional capacitors. Inductance distorts a waveform (such as music), causing it to rise and fall more slowly than it should. The delay in rise or fall is proportional to the time constant, which is proportional to the inductance (not the square root of inductance). In a conventional capacitor, some paths (e.g., corkscrew*

## Increase your electronics know-how and skills

The speed and intensity with which electronics penetrates our daily lives at home, at work, or in our car, tends to make us forget that we **can use electronics creatively** by building designs with a practical application and having the satisfaction of a successfully finished project. *Elektor Electronics*, which is distributed all over the world, can help you achieve these goals. Throughout the year, the magazine features original construction projects, informative articles and news on the gamut of electronics, science & technology, book reviews and information on new products. The past 11 issues contained 80 major and 97 minor construction articles, 21 articles of an educative or instructional nature, and 10 articles dealing with Science & Technology.

If you wish to increase your electronics know-how and skills, take out an annual subscription to *Elektor Electronics* by writing or faxing to

**World Wide Subscription Service Ltd  
Unit 4, Gibbs Reed Farm  
Pashley Road, Ticehurst  
East Sussex TN5 7HE, England**

**Telephone +44 580 200 657; Fax +44 580 616**

You will then have the convenience of having the magazine delivered to your home, and the peace of mind that you will not miss any issue. The current rate for an annual subscription (11 issues) is \$US 57.00 (post paid – airspeeded).

There are also a number of *Elektor Electronics* books geared to the electronics enthusiast – professional or amateur. These include data books and circuit books, which have proved highly popular. Two new books (published November 1993) are *305 Circuits* and *SMT Projects*. Books, printed-circuit boards, programmed EPROMs and diskettes are available from

**Old Colony Sound Lab  
PO Box 243, Peterborough NH 03458  
Telephone (603) 924-6371, 924-6526  
Fax (603) 924-9467**



path 2) have a million times higher inductance than other paths (e.g., path 1 straight through the middle). Thus, some paths distort the music waveform a million times worse than other paths, making it rise and fall a million times more slowly for some paths than others.

It's bad enough that the music waveform is so severely distorted by the high inductance of path 2. But the real problem in all conventional capacitors is the wide variation or spread of inductance for the different paths through the capacitor. In other words, if all paths were to have the same high inductance as path 2, then the music waveform would be distorted and slowed, but uniformly so for all paths, so this second kind of smearing would not occur. But since a conventional capacitor has a 1,000,000:1 inductance ratio for its different paths, a given input waveform outputs an infinite number of different-looking waveforms, some of which rise and fall a million times more slowly than other waveforms starting at the same time (actually more or less the same time, due to the 1000-fold variation in propagation delay, which is the first problem, and compounds the smearing).

Thus, all conventional capacitors simultaneously (more or less) put out many different versions of the music signal input, some ver-

sions rising and falling a million times more slowly than others. Their final output is the instantaneous sum of these wildly different versions of the input signal, with the many lagging waveforms corrupting the main (earliest) version. Even assuming Mr. Colin's figure of 2MHz as the inductance-caused self resonance frequency for the main short path, a million to one inductance ratio would smear music all the way down to 2Hz, thus corrupting the entire audio spectrum. That's why all these other capacitors sound smeared, defocused, veiled, dirty, and fuzzy compared to InfiniCap, which delivers one focused, coherent, clear version of the music signal input.

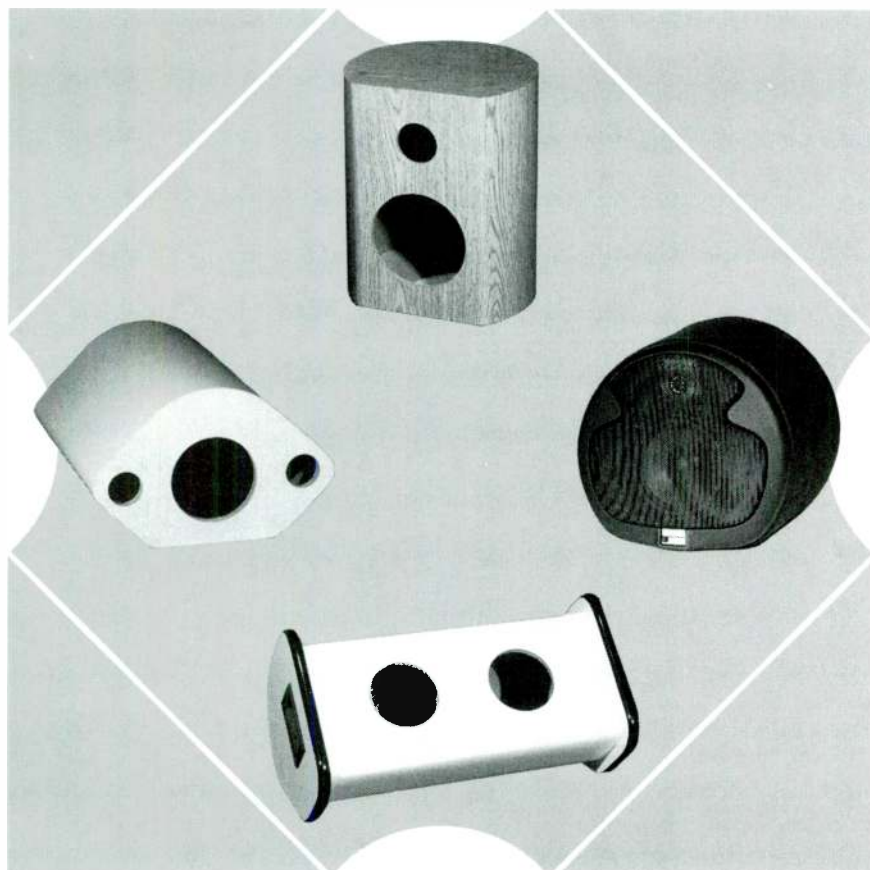
As our ad notes, multiple capacitors with ten coaxial sections reduce this problem a bit, but merely by ten, so they still smear music by a factor of 100,000:1. Hard-nosed engineers have compared InfiniCap to other audiophile capacitors, including these multiple capacitors, and have heard such dramatic improvements that they have been motivated to excitedly post raves on computer bulletin boards.

Incidentally, to correct some misinformation about InfiniCap in another capacitor's Speaker Builder ad, InfiniCap has always been available in two versions, a hot-rod

audiophile version that is built like a racing car for ultimate sonic performance without compromise, and a ruggedized version for OEMs whose mass-production assembly lines don't allow for respectful individual handling of parts. This rugged version has a clear seal over InfiniCap's unique metal ends and a sturdy plastic wrap, so anyone inclined to dunk capacitors in their coffee or play frisbee with them can indulge their whims. For those users who simply want to hear the best possible music from a capacitor, we recommend the hot-rod audiophile version of InfiniCap.

## ACTIVE CROSSOVER PROBLEM

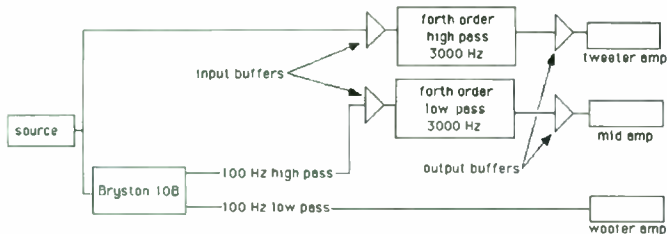
I am an amateur electronic hobbyist currently planning to build an active crossover for my home stereo system. My system includes Dynaudio drivers and a couple of Aragon amps with a Bryston 10B Sub active crossover. The version of my Bryston 10B has crossover points from 40-500Hz, so if I want to tri-amp three-way actively, I will have to run another crossover in series with the crossover I have. From a purist standpoint, this is not the cleanest way to direct



## Throw us a curve.

Give us your curves, your bases, your molded plywood shapes, and we'll make them for you out of our paper tubes. Our unique, Cubicon construction is a sturdy, light-weight, cost effective alternative to expensive, time-consuming, fabrication. So go ahead, throw us a curve. We seldom strike out.

Cubicon Corporation  
10176 Corporate Square Drive  
P.O. Box 28745  
St. Louis, MO 63146-1245  
Phone: 314/567-0667  
Fax: 314/567-0046



**FIGURE 1:** Active crossover.

music to each amp.

I think that by building my own active crossover I can avoid running two two-way crossovers in series. I have a couple of questions about the basic setup I have in mind (Fig. 1):

First, will I have phasing problems between my mid and tweeter if I send the signal for my mid driver through the 10B before the fourth-order 3kHz low pass to get the desired bandpass of 100Hz–3kHz? The 10B Sub crossover is switchable for first-, second-, and third-order Butterworth crossover operation. Will the answer to my first question depend on the slope setting (6, 12, or 18dB)?

My second question is, can I replace the BUF 124 buffer with the unity-gain buffer (PMI BUF03-AJ) used in Corey Greenburg's

passive buffered pre-amp? Corey's pre-amp, the BUF03-AJ, has the following specs:  $5.0 \times 10^{11}$ W input resistance and 2W output resistance; 250V/ $\mu$ s slew rate; 63MHz bandwidth; and a 70mA peak current drive capability.

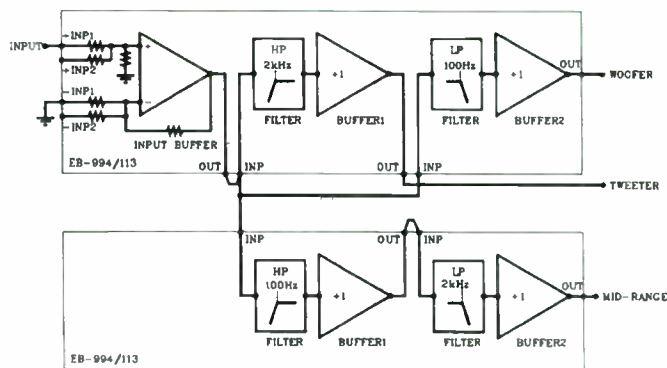
Benjamin Um  
Indianapolis, IN 46256

*Erno Borbely responds:*

*I am not familiar with the Bryston 10B. Consequently, I cannot comment on your crossover design.*

*However, I have included a block*

TYPICAL APPLICATION FOR EB-994/113



**FIGURE 2:** First-, second-, or third-order crossover for three-way loudspeaker.

*schematic of our EB-994/113 discrete crossover kit (Fig. 2), which is shown in a three-way system and can be used in your application. The EB-994/113 is a high-quality, single-board crossover designed for two- and three-way loudspeakers. The PCB provides an input buffer that you can configure for single-ended and balanced operation, and two unity gain buffers for the crossover network. Both buffers can be configured as LP and HP filters with 6, 12, and 18dB/octave slope. You can achieve 24dB/octave by cascading the two buffers.*

## If you like reading Speaker Builder you'll love reading the high-quality articles included in every issue of Audio Amateur

A journal dedicated to the fine art of audio construction. For 26 years, *Audio Amateur* has consistently provided the highest quality audio construction projects and articles for the do-it-yourself enthusiast. From articles devoted to construction projects of state-of-the-art amps to discussions of the best in power supplies, *Audio Amateur* provides the reader with a fascinating look inside audio. Whether you currently build your own audio equipment, like to take off the cover and modify your purchased equipment or just want to understand what it takes to make your music sound truly sensational, *Audio Amateur* is for you!

Enhance your music by increasing your audio knowledge. Let *Audio Amateur* introduce you to the world of audio do-it-yourself. Your increased knowledge and the ability to build your own audio will bring you double satisfaction, the satisfaction of a job well-done and the satisfaction of truly great sound. Order an issue of *Audio Amateur* today and examine the possibilities. Your satisfaction is guaranteed!



\_\_\_\_ **YES!** Please send my first subscription copy of *Audio Amateur*. When I choose to subscribe, I'll pay just \$16.95 for a one year subscription (that's four issues in all.) If I decide not to subscribe, I'll write "cancel" on the invoice and owe nothing. I am under no obligation. Canada please add \$4 postage. Overseas rates \$35 for one year. Remit in US\$ drawn on a US bank.

NAME \_\_\_\_\_

STREET & NO. \_\_\_\_\_

CITY \_\_\_\_\_ STATE \_\_\_\_\_ ZIP \_\_\_\_\_

### Audio Amateur Publications, Inc.

PO Box 576 Dept. B96, Peterborough, NH 03458-0576 Telephone (603) 924-9464 or FAX 24 hours a day (603) 924-9467  
Rates are subject to change without notice.



## THE SUM OF ITS PARTS

Subwoofer designs have always fascinated me. While I have seen much information regarding design and construction of crossovers, I have noticed little or nothing on summed output crossovers. The ability to use a single voice-coil transducer for both left and right signals is quite appealing for compact, low-cost systems.

How do you produce monophonic crossover output without affecting the channel separation of the input? I presume that in the case of an active crossover the impedance of the preamp outputs and amplifier inputs are factors. And what about the case of passive networks? What performance compromises are involved with such designs?

Greg Chabra  
Binghamton, NY 13905

*Dan Ferguson responds:*

*Before I attempt to answer your questions regarding monophonic subwoofer crossovers, I would like to comment on your statement concerning the appeal of using single-voice-coil transducers. This appeal depends on whether you already own a single-channel mono amplifier or a stereo amp that is "mono-bridgeable." While the latter is common in car stereos, it is much less so in home audio amplifiers. My experience is that a nonbridgeable stereo amplifier is a more cost-effective starting point for a subwoofer system.*

*Cost considerations aside, there should be no audible differences between a subwoofer system employing a mono amplifier and single-voice-coil driver and one using a split mono signal to simultaneously drive both channels of a stereo amplifier with outputs connected to a dual-voice-coil driver.*

*Now let's address your question concerning how a mono subwoofer crossover affects channel separation. In an "active" crossover (Fig. 3), the input section is referred to as a "summer," which literally adds the voltages from each of the channels so the output is the "sum" of the two (or more if needed). This same function is employed in any common audio "mixer."*

*Summing is usually accomplished by configuring the crossover's input stage as an inverting op amp with multiple inputs. Each input has an input resistor ( $R_3$ – $R_6$ ), which is connected to the op amp's inverting input. Also connected to this input is the feedback resistor ( $R_{18}$ ) from the op amp's output.*

*Together, these components form a "summing junction." When everything is working perfectly, the op amp drives the inputs and*

*feedback signals to zero at the summing junction. Because of this, the junction is also referred to as a "virtual ground."*

*If the op amp had unlimited bandwidth and zero distortion, it would be able to perfectly cancel all voltages at the summing junction and eliminate all crosstalk. Since it's an imperfect world, there is some small amount of interaction—typically in the range of  $-65$ dB. The amount of interaction depends on many factors, such as the overall quality of the components used and the relative impedances of the inputs, outputs, and feedback resistors.*

*It is possible to implement passive networks (for example, "The Simple Sidewinder*

*Woofers," SB 4/95, p. 8). Their main disadvantages are that component values depend on your ability to accurately determine the input impedance of the subwoofer power amplifier. Also, changes in crossover frequency and other factors require changing out all of the components. From a practical standpoint, crossover slopes are limited to about second order.*

*Active crossovers, on the other hand, are immune to amplifier input impedance, are capable of steep slopes, and offer the flexibility of variable crossover frequencies. From a purely theoretical standpoint, a mono passive circuit would have more crosstalk than an active one, but it should*

**Audio Amateur Publications, Inc.**

**announces a new service**

**for our subscribers**

**AAP  
FAX  
ON TAP**

**for information on our subscriptions,  
products and other services**

**CALL FROM YOUR FAX MACHINE**

**24 hours a day—7 days a week**

**603-924-6149**

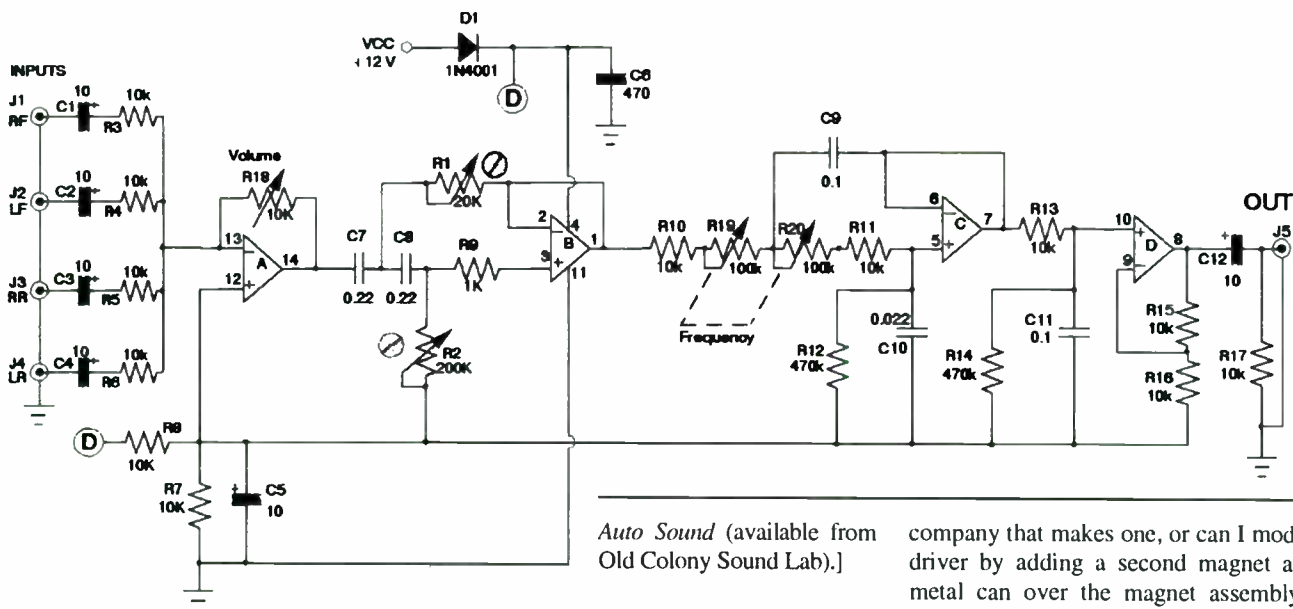
LOOK FOR THE  
FAX ON TAP

LOGO

THROUGHOUT THIS ISSUE



**Watch for more on this great new service!**



**FIGURE 3:** Subwoofer filter schematic.

still be inaudible if a proper design were executed. I prefer the active crossover, which gives more predictable results.

[Dan Ferguson is author of the popular *Killer Car Stereo on a Budget* and the new *Ultimate*

*Auto Sound* (available from Old Colony Sound Lab.)]

company that makes one, or can I modify a driver by adding a second magnet and a metal can over the magnet assembly? If anyone can advise me on how to solve my problem, I would greatly appreciate the help.

Russell Tinder  
Huntington Beach, CA 92647

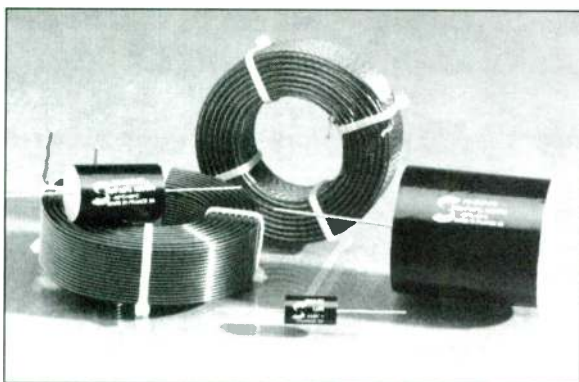
### SHIELDING PROBLEM

I am designing a pair of A/V speakers in an MTM configuration, using VIFA 6.5" mid-woofers and the new SEAS Excel tweeter, all of which are shielded drivers.

I want to use a 10" to 12" woofer in the same tower cabinet, but have not yet found a shielded driver of that size. Is there any

*If any reader wishes to offer Mr. Tinder helpful advice, please do so in a letter to Speaker Builder, and we will forward it.—Eds.*

## SOLEN



**SOLEN INC.**  
4470 Ave. Thibault  
St-Hubert QC J3Y 7T9 Canada  
Tel: 514-656-2759 Fax: 514-443-4949

## CROSSOVER COMPONENTS CATALOG

### HEPTA-LITZ INDUCTORS

Air Cored Inductors, Litz-Wire Perfect Lay Hexagonal Winding  
Values from .10 mH to 30 mH  
Wire Sizes from 1.3 mm (16 AWG) to 2.0 mm (12 AWG) 7 Strands

### STANDARD INDUCTORS

Air Cored Inductors, Solid Wire Perfect Lay Hexagonal Winding  
Values from .10 mH to 30 mH  
Wire Sizes from 0.8 mm (20 AWG) to 2.6 mm (10 AWG)

### FAST CAPACITORS

Fast Capacitors, Metallized Polypropylene  
Values from 0.10 µF to 300 µF  
Voltage Rating: 630, 400, 250 VDC

### CROSSOVER & SPEAKER PARTS

Metalized Polyester Capacitors, 1.0 µF to 47 µF, 160 VDC  
Non Polar Electrolytic Capacitors, 22 µF to 300 µF, 100 VDC  
Power Resistors 10 W, 1.0 Ω to 82 Ω, 8 Ω L-Pads,  
Gold Speaker Terminals, Gold Banana Plugs, Gold Binding Posts,  
Crossover Terminals, Port Tube & Trim Ring, Grill Fasteners,  
Car Speaker Grills, Screws, Nylon Ties, Speaker Books, Etc.



## Snake-Oil Warning

I have been reading your wonderful journals for quite some time and have come to rely on them. I am, however, concerned that they sometimes let in pseudo engineering, as in the recent speaker-wire debate.

The notion that somehow the higher audio frequencies move toward the outer surface of the wire is just not believable. Unfortunately, some have been taken in by this, and there is no end of vendors waiting to prey upon them, charge high prices for special speaker wire, and empty their wallets in the process.

While high frequencies do tend to move to the outer portions of wire, this happens in the high MHz and GHz frequencies, the prime examples being microwaves and microwave guide. Microwave guide is an example of skin effect in the extreme, where the wire is folded back on itself to form a rectangular guide. The high-frequency waves flow down to the center of the guide and to the antenna or detector.

Of the skeptics reading this, I ask how many have cellular phones permanently installed in their cars. These antennas use RG58U coaxial cable, which is fine at the high band, 150MHz, but it is a sieve at 800MHz and is used only because of its low cost.

Some people claim that they can hear the difference with the special wires, and that

sound is more open and defined. I believe they're trying to rationalize an expensive purchase. After all, they spent a lot of money, so it must sound better, right? There is much to be said for purchasing large-gauge speaker wire, especially for long cable runs where resistance is the determining factor, or where the amplifier has low power-supply voltage and high current. For short cable runs, any size will do.

Beware the snake-oil merchants; a fool and his money are soon parted.

Warren Bain  
Bristow, VA 22013

*In the view of the editor, if a listener says he hears a difference, he hears a difference. Others are welcome to suppose he doesn't. But that opinion is no more than that, a totally subjective idea. —E.T.D.*

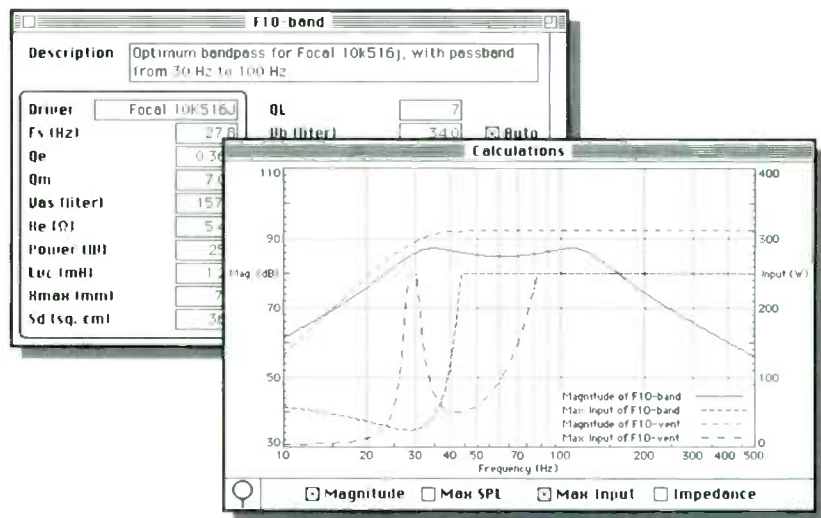
## TL Loudspeaker

from page 14

had finally eliminated all the electronic bugs, hums, and whistles, my wife couldn't believe the improvement over our old two-way design. Imaging and transient response are excellent.

My favorite test CDs for listening to

## TopBox for the Macintosh



## Introducing TopBox software for Macintosh computers

by Joe D'Appolito, Ron Warren, and Ralph Gonzalez. **TopBox** accurately predicts the response of sealed, vented, and bandpass loudspeaker configurations, allowing the user to compare their impact on frequency response, maximum output SPL, power handling, and impedance. Its intuitive interface provides unsurpassed power, speed, and flexibility.



### Design Types

- 2nd, 3rd, and 4th-order Closed Box
- 4th, 5th, and 6th-order Vented
- 4th and 6th-order Bandpass
- Round and rectangular vents, metric or English units

### Output Features

- High-resolution black & white or color graphs, with up to six overlay curves
- Graphs and tables can be imported directly by word-processing or page-layout applications
- Tables can be imported by spreadsheet applications

**TopBox** is distributed with an extensible library of popular drivers and several sample designs. Data can be shared with the PC version. **TopBox** is compatible with all Macintosh computers with at least 512k RAM.

Price: \$99.95. Dealer inquiries invited. Also available: **TopBox** for PC-compatibles.

"The Best of Both Worlds"



## HIGH END AUDIO & HOME THEATRE

### NEW RIBBON TECHNOLOGY

(AC-3 Ready)

Provides openness, transparency and smoothness over a wide bandwidth.

Mid and high modules, custom Ribbon kits for subwoofers, full range speakers and subs at

**FACTORY DIRECT PRICES.**

Internationally acclaimed by experts who say:

"...treble...extremely smooth, transparent, quick and clean."

"...soundstage illusion is near state-of-the-art, period."  
Bob Bottman, *Bound For Sound*, 4A 1994

"beautifully clear midrange and an uncanny tonal balance, make these speakers exceptional..." high end (not high price)...  
Ernie Fisher, *The Inner Ear*, Vol 6, #2

"The clarity of the ribbons was immediately noticeable..."

"...imaged superbly, both with audio and video sources..."  
Tim Parker, *The Sensible Sound*, Summer 1995

"...great openness and immense dynamics..." "...with no coloration whatsoever..."

Andrew Marshall, *Audio Ideas Guide*, Fall 1995

For complete details and expert reviews, call or write:

## NEWFORM RESEARCH

P.O. Box 475, Midland, Ontario L4R 4L3 Canada

(705) 835-9000 • Fax (705) 835-0081

<http://www.barint.on.ca/newform/>

Sold factory direct with 30 day trial, money back guaranty.

5 year manufacturer's warranty

# ORCA

1531 Lookout Drive • Agoura, CA 91301 • USA  
Tel: (818) 707-1629 • Fax: (818) 991-3072

midrange/tweeter combinations are Spanish guitar music or Bach flute sonatas. The sound is transparent, and you can hear every nuance of breath and guitar fingering. The bass is tight, with excellent clarity in the midbass region. As you might expect from the test curves, the low bass suffers from the limited diaphragm size and throw. If I were to do it

over again, I would replace the front-mounted woofer with two 12" woofers, one on each side. This would maintain the slim-line design, yet provide a larger bass presence. Instead, my next project will be a self-amplified subwoofer to complement these speakers, crossed over at approximately 80Hz.

I hope this article will help other speaker

builders in their endeavors. PC AudioLab finally gives hobbyist and professional audiophiles a low-cost tool for measuring their projects. Overall, there was a good correlation between the TLBOXMOD program and the measured results. Actually measuring the loudspeaker performance allows you to revise and optimize your loudspeaker and crossover designs. ▶

**SALE! PLUS FREE ADHESIVE!**

**MARKERFOAM™ ACOUSTIC FOAM GIANT 54" x 54"**

**Immediate Shipping**

2" Reg \$29.95 Now \$19.99 • 3" Reg \$39.95 Now \$29.99! **KILL NOISE QUICK!**

High performance, full-size sheets of super high density Markerfoam. EZ mount. Blue or gray. Super-effective sound absorption for studios. Markerfoam offers best value, looks professional & is proven in studios worldwide. Request Foam-Buyers Guide/Catalog, specs & free samples today VISA, MC, AMEX, COD, P.O.'s, QUANTITY DISCOUNTS.



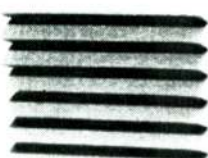
**MARKERTEK JUMBO SOUND ABSORB BLANKETS**

Heavy-duty 72"x80" padded blankets absorb sound wherever they're hung or draped. Fabulous for stage, studio & field use. Top professional quality at a super saver price! Weight: 6 lbs. Black, \$19.99.

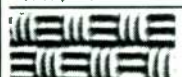
**MARKERTEK BLADE TILES™**

HIGH PERFORMANCE LOW, LOW COST!

\$3.49 per tile, 16x16x2" America's best acoustic tile value, only from Markertek! Charcoal. Also available 16x16x3" as shown, \$4.49 each.



**MARKERSTIK™** foam adhesive. FREE with any Foam purchase in this ad! Limited offer. A \$5.95 per tube value.



**SONEX**  
All the colors and sizes plus great prices!

**\* Get our FREE 149-page catalog of over 6,000 exclusive and hard-to-find supplies for audio & video.**

**800-522-2025** America's most unique catalog for audio & video!  
FAX: 914-246-1757

**MARKERTEK™**  
4 High St., Saugerties  
New York 12477 U.S.A. **VIDEO SUPPLY**

Reader Service #10

# FerroSound

The Solution Is Loud And Clear™

FerroSound ferrofluid retrofit kits for tweeter, midrange and compression drivers are now available through the Parts Express catalog. The generic tweeter kit contains a low viscosity ferrofluid in sufficient quantity for most 1" and smaller dome tweeters. Application specific kits for popular professional compression drivers are available for the following models:

Manufacturer	Model
B & C	DE-16
	DE-45
	DE-75
Electro Voice	DH-1A
	NDYM-1
Radian	450, 455
	4450, 4455
	735, 750
Eminence	4735, 4750
	1" exit

**CALL TOLL FREE**

Parts Express Customer Service  
**1-800-338-0531**

**Parts Express™**

# BassBox 5.1 for Microsoft WINDOWS™

Design low-frequency loudspeaker enclosures fast and accurately with BassBox software. Uses both Thiele-Small ( $f_s$ ,  $Q_{ms}$ ,  $V_{as}$ ,  $\eta_0$ ) and Electro-Mechanical ( $Q_{es}$ ,  $Q_{ms}$ ,  $C_{ms}$ ,  $M_{ms}$ ,  $R_{ms}$ ,  $BL$ ) parameters with equal ease.

Copyright © 1996 by Harris Technologies. All rights reserved worldwide. BassBox is a trademark of Harris Technologies. Other trademarks are the property of their respective companies. Computer and loudspeakers not included.

Includes a large driver database with over 1,300 drivers.

- ◆ Easy to use
- ◆ On-line help
- ◆ Hi-res mode
- ◆ Low price

- Design Types:**
- Optimum Vented
  - Extended Bass
  - Custom Vented
  - Band-Pass with Double or Triple Chambers
  - Passive Radiator
  - Optimum Closed
  - Custom Closed
- All designs can use multiple woofers (including Isobaric)

- Built-In Test Procedures:**
- Test and calculate loudspeaker parameters\*
  - Test and calculate passive radiator parameters\*

\*Requires basic test equipment: sine wave generator, frequency counter, power amplifier, 1 kohm resistor, voltmeter, ohmmeter, test box.

**Design Options:**

- Small and large-signal analysis. Examine one loudspeaker in several different boxes or...
- Examine several different loudspeakers in the same box.
- 6 graphs: normalized amplitude, 2.83-V amplitude, acoustic power, impedance, phase and group delay.
- Advanced vent calculator.
- Advanced box dimension calculator w/ 18 volume shapes.
- Accepts loudspeaker measured acoustic response.
- Accepts automobile or listening room interior acoustic response.
- Use English or metric units.
- Save and recall designs.

MasterCard **\$99.00**  
plus \$5.00 S&H (Canada: +\$6.00) (Overseas: +\$12.00)

**Tel: 616-641-5924**  
**Fax: 616-641-5738**

**Harris Technologies**  
P.O. Box 622  
Edwardsburg, MI  
49112-0622 U.S.A.

Also available:  
**X-over 2.0 passive crossover program for Windows.**  
X-over calculates the component values for 1st, 2nd, 3rd and 4th-order 2-way and 3-way networks, load compensating networks and L-pads. Regular price: \$29. (\$19 if purchased with BassBox.)

**Minimum System Requirements:**  
MS-DOS 5.0, Microsoft Windows 3.1 & compatible computer (386 or better CPU with at least 4 Mbytes of RAM), 7.5 Mbytes of free hard disk space, 1.44 MByte 3.5" disk drive and mouse.

Harris Technologies reserves the right to make changes without prior notice.



# Classifieds

## TRADE

**STATE-OF-THE-ART PASSIVE CROSS-OVERS** featuring Hovland MusiCaps. Software available, free design guide. **ALLPASS TECHNOLOGIES, INC.**, 2844 Charmont Dr., Apopka, FL 32703-5972, (407) 786-0623.

## ELECTROSTATIC

**KITS PARTS TRADE SECRETS**  
save \$\$\$ building, repairing, modifying ESLs  
CATALOG/START-UP MANUAL—\$5.00  
**DAVID LUCAS**  
924 HULTON ST. OAKMONT, PA 15139

**WANTED: LOUDSPEAKER SALES MANAGER.** Self-starting manager with minimum 5 years experience in engineering and sales in loudspeaker field to work with major accounts in development of drivers, crossovers, and related projects. Company will relocate the right person. Send resumé to: **CULVER ELECTRONIC SALES, INC.**, 13701 Cimarron Ave., Gardena, CA 90249, FAX (310) 532-9176.

**D.H. LABS has moved!!** For information and review reprints on our high-performance **SILVER SONIC** audio cables, hookup wires, and connectors, contact us at PO Box 31598, Palm Beach Gardens, FL 33420-1598, phone/FAX (407) 625-8998.

**THE BIRD HAS SPREAD ITS WINGS!** Your **CANARE SOURCE** for the **DIGIFLEX GOLD CABLES** introduces a complete line of audio, video, and speaker cables utilizing **HAVE/Canare** cable & connectors. Call for a free brochure. Dealer & club group inquiries invited. **SOUND & VIDEO**, a division of **HAVE, Inc.**, (518) 822-8800.

**NEW! BREAKTHROUGH SPEAKER PADS** expand tonal range, add clarity, optimize full range reproduction, protect surfaces from spike holes, dampen distortion-causing vibration, maximize coupling, \$7.95–\$69.95. **KLEIN TECH SYSTEMS**, 4262 Northlake Blvd., Palm Beach Gardens, FL 33410, (407) 863-2198, FAX (407) 845-9844. Dealers welcome!

**THE BEST MUSIC YOU MAY NEVER HEAR.** Free catalog. **CREATIVE MUSICIANS COALITION**, Dept. GBM, 1024 W. Wilcox Ave., Peoria, IL 61604, (800) 882-4262.

**ECHO BUSTERS** — Acoustic panels control echoes, reflections in your entire audio/video room for \$119.95. Nine-piece package covers 31 square feet. **MICHAEL KAY, INC.**, (516) 433-6990, FAX (516) 433-6794, E-mail: MikeARoe@aol.com.

**SPEAKER/CAR DAMPING MATERIAL** — Goodyear Acoustasheet .085" loaded vinyl with 1/4" acoustic foam lamination. Damp speaker cabinet resonance or quiet car interiors. Only \$2.48 per square foot delivered (10 square foot minimum). \$5 handling. **RICH MORRISON**, (800) 326-8372, 8 a.m.–5 p.m. weekdays, CST.

**SPEAKER FOAM AND CLOTH SURROUNDS** for professional repairers. **SFS ENTERPRISES**, (800) 669-2545, FAX (719) 475-0359.

**WE RE-CONE** all home, auto, or pro speakers. Re-foam kits, parts. **TRI-STATE LOUDSPEAKER**, (412) 375-9203.

## FOR SALE

More kid space, less rack space. Crown: IC150A, OC150A, D150A (set); three SA-2, two DC300A, four D75, two SA30+30, old 300A; DBX: two 400X, two 150X, two 150, two 100, 500; JBL: two 2309, two H93, two H5078, H5040, two 2340, (15) 2350, nine 2355, misc. All electronics mint, most with manuals. Mike, (607) 273-0901, 5–7 p.m. EST.

Audire ribbon driver S-18 units, 4"×24" size, use full-range in double pairs, new \$250 each, sell for \$80 each or best offer/trade. Ken Fritz, (804) 794-4107 evenings, (800) 426-1828 days.

Altec: 291A 1.4" horn drivers; 802D drivers; 811 horns; 421-A woofers; spare Acousta-voicing systems EQ filters in boxes; JBL: LE15A woofers; 375 drivers; H-93/L-91 horns; slot tweeters; E-140-16 woofers; K140 woofers; Dukane "175" type drivers by JBL; Pioneer SM-100 power amps, 75W/channel. David, (914) 688-5024.

Sorry you couldn't reach me, see my new phone number. Hundreds of rare classical LPs. Call or write for free list. Pair Parousound mini-speakers \$120; pair Dynaudio D76AFs 3" dome midrange \$150; Boston 10" car subwoofer driver, \$100. Jerry Feldstein, PO Box 580163, Bronx, NY 10458-0709, (718) 931-5326, evenings.

## WELBORNE LABS

**200 PAGE CATALOG and DESIGN MANUAL OF HIGH QUALITY AUDIO KITS and SUPPLIES!!!**

We've got Vacuum Tube and mosfet Amplifiers, Linestages Phonostages, Active Crossovers, Power Supplies, AC Line Conditioners and many other Audio Kits and Schematics.

### Parts and Supplies

Hovland MusiCaps, Kimber Caps, MIT MultiCaps, Solen WIMA and Wonder InfiniCaps; Caddock, Holco, Mills and Resista resistors; Golden Dragon, NOS RAM Labs, Sovtek and Svetlana tubes; Cardas, DH Labs, Kimber Kable Neutrik, Vampire and WBT connectors and wire; Alps, Noble and stepped volume controls; Enclosures, Books and other Supplies for DIY'ers. International Orders Welcome. For our Catalog and Manual, send \$12 (US/Canada) \$18 (International) or call (303) 470-6585, fax (303) 791-5783 or e-mail to: [wlab@ix.netcom.com](mailto:wlab@ix.netcom.com) with your Visa/Mastercard.

### WELBORNE LABS

P.O. Box 260198, Littleton, CO 80126-0198

Visit our Website for more info: <http://www.welborneilabs.com>

AR-3 loudspeakers: need pots, grilles, driver reconditioning, some cosmetic scratches, make offer; two 16"×36" tube subwoofers, 10" Pyle drivers, 125Hz lo-pass crossover, 96dB sound pressure level, good solid bass, both \$100; JVC JRS-600 receiver 180W RMS/channel at 4 $\Omega$ , \$750 new, will sell for \$75. Buzz, (301) 872-5982.

Carver amps: PT1250, \$700; PM1200, \$650; 2.0, \$650; PM200, \$325. Crossovers: Rane AC22, \$225; Brooks FDS310, \$400. Marantz PMD360 three-head portable cassette with foam-lined hard-shell case, \$320. Other pro equipment for sale. Call or write for more information. Dan Mahoney, 1176 NE Catawba Rd., Port Clinton, OH 43452, (419) 797-4417 or (419) 734-4766.

Classic coax studio reference monitors: pair 12" triaxials 39×15×13, oak, black grilles, \$600; pair Altec model 19, mint, walnut, \$1,750; pair JBL L-100, excellent, \$450; pair Altec 3841, excellent, \$400; pair Arza, excellent, \$300; EV T-35, \$100; EV SP12B, \$75; EV 15BW, \$100; JBL D123, \$100; JBL 2400 crossover, \$100; Stephens 152AX, \$250; EVX8 crossover, \$50; EVX36 crossover, \$50; Bose 12 speaker switch, \$50. Heerlein, (314) 579-0088.

University C15W, \$100; pair Cobraflex 2/T30s, \$150; pair EV8HDs with 1823M drivers, \$200; Altec 601A (blown tweeter), \$50; Madisound 15" DVC (NIB), 4 $\Omega$ , \$50; pair Madisound 10" 1052DVC, \$50; pair VMPS Super Tower IIIs, no mids, tweeters, or crossovers, cabinets need repair, \$400 (can't ship). Shipping extra. Dave, (216) 666-6805 before 10 p.m. EST (OH).

Stratearn midrange panels, one pair, 72" tall by 28" wide, 125–9.5kHz, 2 $\Omega$  impedance, oak baffles, extra drivers, \$700. You transport. Andy Catanzaro, (414) 466-8266, evenings (WI).

## SPEAKER BUILDER CLASSIFIED INFORMATION

**SUBSCRIBERS:** to receive your free 50-word For Sale & Wanted ads (for personal equipment only), mail or fax us the typed or printed text (NO ABBREVIATIONS) along with your name & address. Be sure to include which magazine & section of the Classifieds the ad should appear in.

**ALL ADS ARE SUBJECT TO RUN AT DISCRETION OF PUBLISHER/AD DIRECTOR**

PO Box 494, Peterborough, NH 03458-0494, FAX 603-924-6230

**AAP  
FAX  
ON TAP**  
603-924-6149  
24 Hrs • Ask For Doc.  
# 4104

Audio Research SP6E preamp with box and manual, mint, recent factory installed new volume pot, supply caps, jacks, NOS TL smooth plates, and Bugle Boy tubes; two pair Focal 8K415S 8" Kevlar woofers, new in sealed boxes; Teflon 22GA stranded silver-plated mil-spec wire, JAN oil caps 0.33µF/200V. Offers?? Interesting tube amp trades?? Robert, phone/FAX (707) 967-9854.

Pair Altec 515E, \$400; pair 291K, \$350; pair 210 enclosures, \$1,200; MR42 and MR64 Mantaray horn pairs, \$250 (seven pairs of each available); McIntosh MC240, \$1,200; Marantz 8b, \$1,400; pair Heath W5M (16458 opts), \$400; AR15, \$110. Mike Frye, (612) 475-2993.

Pair Focal T120k tweeters, modified by Audio Concepts, \$70; Rockford-Fosgate RF2000 300W/channel basic power amp (this is a home amp), \$285; Crown D150 basic power amp, very rough cosmetics but works, \$75; pair EV T35 16Ω tweeters, \$50; single AC12, looks bad but sounds great, \$25; pair Eton tweeters, hard to work with, \$20; KVA isolation transformer, \$15. Jerry McNutt, (601) 656-9277, 6-8 p.m. CST, have baby.

Altec 1569A power amp, \$150; Perreux 2150 power transformer 1000VA 60V+60V, \$50; 2500VA 30V+30V transformers, \$25 each; Sunsui 1000A tube tuner/amp, \$50. Ashby, (954) 723-5225.

Two Focal 7K 011DBL 7" Kevlar bass/midrange dual voice coil drivers, mint, \$150; ADC ten-band EQ/spectrum analyzer, \$75; two Focal T90K Kevlar tweeters, \$50; Cary SLA 70B signature, 60W/channel oil caps, mint, \$1,350. Split all shipping. Mr. Willes, (800) 227-6121, weekdays 9-5 CST.

Audio Concepts Sapphires III reference monitor with AC stands, \$495. Mr. Bengfort, (612) 861-1152 (MN).

Mobile Fidelity GeoDisc, new, \$10; Shure V15 type V cartridge, \$65; Toshiba HD2414 522M-byte IDE hard drive (2.5" laptop size), \$95; Trident 1M-byte video card, \$35; Epson Apex 80 dot matrix printer with three new ribbons, \$45; TI 486 DX2-80 with fan, \$40. Dan Patten, (801) 224-8080 (work) or (801) 225-8577 (home), 1768 North 980 West, Orem, UT 84057 or dpatten@miralink.com.

Nitty Gritty 2.5, \$200; SEAS PR17 coax, new, \$75; BBE 402 Sonic maximizer, \$150; Paradigm Titans, \$150. Canadian funds only. Stan, (604) 376-1487.

Sumo Charlie, \$100; McIntosh MA6100 integrated amp, \$400; AudioSource EQ Ten, new in box, remote, \$150; IMF RSPM Mark IV best British speakers, mint condition, make offer; Pioneer VSX10S, excellent, \$700. Steven, (310) 694-2208, 4-9 p.m. PST (LA area).

Hewlett-Packard 334A Distortion Analyzer, \$300 plus shipping. Phil Roy, (606) 341-1648 before 6 p.m., (606) 342-6809 after 6 p.m.

Pair Dynaudio Gemini speakers (15-W75, D260), oak cabinets, \$500; pair Dynaudio 21-W54, reconed, \$100; Dynaudio 19-W38, new, \$35 each; Hafler XL-280 power amp, \$225; Sumo Deilah II crossover, \$225. Accepting best offer—let's make a deal. Mike, (412) 283-2964.

Four monoblock Boak regulated 1500VA power supplies for Pass/Thagard A75 amp, \$150 each; Strathearn ribbon speakers modified by Audire, CA; raw panels with no face plates, eight available, \$400 takes all; will transport within 200 mile vicinity. All prices in US dollars. Nick Mastrobuono, 2086 Lakeshore, Samia, ON N7T 7H6, Canada, (519) 542-0964, FAX (519) 481-2731.

Rockford-Fosgate Punch 12s, 8Ω, used three months, good condition, \$75 each; AudioControl Richter Scale Series III, 24dB active crossover with separate bass EQ and warble tone generator, \$160. Best offers accepted. Ben, (919) 851-5812.

## WANTED

Urei 6150, 6250, 6300, 6500 amps, 1178 limiter; JBL 2360 horns; shifted magnet JBL Pro cones. Mike, (607) 273-0901, 5-7 p.m. EST.

Coaxial/triaxial speakers; Altec 601 or 604; Jensen G-510 and CX-225; Lowther full-range; Goodman; Tannoy; EV 12TRX/15TRX; any Western Electric. Sonny, (405) 737-3312, FAX (405) 737-3355.

Phase Linear 400 amp schematic; Marchand Basis; dbx 38X dynamic range expander; LS3/5A speakers; Audio Source Amp-1; single JBL 2245H 18" woofer. Still waiting to hear from Mr. Rowley (from Alaska). Angel Rivera, 7804-22nd Ave. West, Bradenton, FL 34209-5208, (941) 792-3870.

Electro-Voice X8, X36, SP8C, and T35; JBL K151s, 2402H, and 2405H, any condition; Pioneer Spec1, Spec4, D23, and SF-850; Cerwin-Vega 1800L, 3000L, 189JE, and 188EB, any condition. Carlos, (718) 465-6053.

Altec 1569A power amp schematic for conrad-johnson Premier Eight amp. Ashby, (954) 723-5225.

Single Dynaudio 17W75XL, reasonable. Jerry Feldstein, PO Box 580163, Bronx, NY 10458-0709, (718) 931-5326, evenings.

Dalquist LP1 crossover; Fisher 55A monoblock using 6550s; schematic for Sargent-Rayment SR2051 amp. Robert, phone/FAX (707) 967-9854.

Complete electronic turntable speaker testing system for use with LMS, MLSSA, etc.; dummy recording head; B&K/ACO and "in-ear" mikes. Bob, (520) 458-6072.

KEF B139 pair, in working order if possible, and a working circuit diagram for good tube amp. Bob, phone/FAX (718) 728-1324.

Tube compressors, limiters, EQs, reverbs, guitar amps, and broadcast microphones; also Altec A-7 components/cabinets or Klipsch LaScala, hopefully from Seattle area. Mike States, phone/FAX (907) 456-3419.

Single Optimization amp PA 250; single Partridge output UL2; Altec 1505B, 288, 515; JBL 2397/2328, 2370, 2380, 2397. Willie, (416) 251-3007 (Toronto, Canada).

## Ad Index

ADVERTISER	PAGE	ADVERTISER	PAGE
A & S Speakers	35	Raven Transducers	15
Acoustic Technology Int'l	3	TopBox	57
Acoustical Supply Int'l	4	Parts Connection, The	32
Allison Technology Corp.	45	Parts Express Int'l, Inc.	CV3
AudioWeb	41	Sescom, Inc.	29
Crosstech Audio, Inc.	44	Sheffield Labs	43
Cubicon Corp.	53	Solen Inc.	
Driver Design	28	Crossover Components	56
Electroswitch	5	Speaker Parts	23
Elektor Electronics	52	Speaker Works	42
Ferrolfluidics Corp.	58	TCH Umbra	17
Forgings Industrial Co.	25	TIFF Electronics Co.	10
Harris Technologies	58	True Image Audio	50
Hi-Fi News & Record Review	49	Zalytron Industries Corp.	33
Hovland Co.	40		
IAR-TRT	CV2	<b>CLASSIFIEDS</b>	
Image Communications	48	David Lucas, Inc.	59
LinearX Systems, Inc.	62	Welborne Labs	59
Madisound	20-21		
Mahogany Sound	51	<b>GOOD NEWS/NEW PRODUCTS</b>	
Marchand Electronics, Inc.	26	Alpha-Core, Inc.	11
Markertek Video Supply	58	Audiophile Voice, The	10
MCM Electronics	45	B&W Loudspeakers of America	10
Meniscus	28	Boston Acoustics	10
Michael Percy Audio	17	Driver Design Ltd.	11
MIT Electronic Components	7	M&K Sound Corp.	11
Morel Acoustics USA	CV4	PC Instruments, Inc.	11
Mouser Electronics	29	PSB	11
Newform Research, Inc.	57	Reference Recordings	10
Old Colony Sound Lab		Rel-Cap	10
CD-ROM	44	Sheffield Lab, Inc.	11
Kits	27	Shmarkers	10
Loudspeaker Recipes	39	Sound&Video	11
Orca Design & Manufacturing		Synergetic Audio Concepts	11
Access	31	TransMedia Communications	11
Clio & Sofia	37	True Image Audio	11



# CLUBS

If you are interested in joining a club or forming one in your area, contact the following:

## ARIZONA

**Arizona Audiophile Society**  
PO Box 13058, Scottsdale, AZ 85267  
Paul Christos, (602) 971-3979

## CALIFORNIA

**Tube Audio Enthusiasts**  
65 Washington St. #137  
Santa Clara, CA 95050  
John Atwood, FAX (408) 985-2006

**Greater South Bay Audiophile Society**  
Larry Fisher, (310) 599-6579;  
Dave Clark, (310) 427-4207

**San Diego Audio Artisans**  
Dennis, (619) 297-3352 eves.  
FAX: (619) 296-0927

**Los Angeles Loudspeaker Designers Group**  
Geoffrey, (213) 965-0449;  
Eduard, (310) 395-5196

**West Valley Audio Society**  
Woodland Hills, CA  
Barry Kohan, (818) 225-1341

**Bay Area Audiophile Society**  
Dennis Davis, (415) 381-4228

**Westside Speaker Builders**  
Cupertino, CA  
Phil Terzian, (408) 446-1336  
FAX (408) 446-4527

## COLORADO

**Colorado Audio Society**  
1941 S. Grant St.  
Denver, CO 80210  
(303) 733-1613

## CONNECTICUT

James Addison  
171 Hartford Rd., A-7  
New Britain, CT 06053

**Connecticut Audio Society**  
PO Box 116, E. Berlin, CT 06023  
Charles King, (860) 665-2881

## FLORIDA

**Gulf Coast Audiophile Society**  
5746 S. Lockwood Ridge Rd.  
Sarasota, FL 34231  
John R. Chait, (813) 925-1070

## GEORGIA

**Atlanta Audio Society, Inc.**  
4266 Roswell Rd. N.E., K-4  
Atlanta, GA 30342-3738  
Chuck Bruce, (404) 876-5659  
John Morrison, (404) 491-1553

## ILLINOIS

**Chicago Audio Society**  
PO Box 313, Barrington, IL 60011  
Brian Walsh, (708) 382-8433,  
E-mail sysop@nybble.com

**Prairie State Audio Construction Society**  
20 Wildwood Tr., Cary, IL 60013  
Tom, (708) 248-3377 days,  
(708) 516-0170 eves.

## INDIANA

**Tube Sound**  
c/o William Schumacher  
5417 Armstrong Ct.  
Indianapolis, IN 46237-2318

## LOUISIANA

**New Orleans High End Audio Society**  
PO Box 50231  
New Orleans, LA 70150-0231

## MASSACHUSETTS

**The Boston Audio Society**  
PO Box 211, Boston, MA 02126-0002  
E. Brad Meyer, phone/FAX (617) 259-9684,  
E-mail 72365.75@compuserve.com

## MICHIGAN

**Southeastern Michigan Woofer and Tweeter Marching Society**  
PO Box 721464, Berkley, MI 48072-0464  
(810) 544-8453,  
E-mail aa259@detroit.freenet.org

## MINNESOTA

**Audio Society of Minnesota**  
PO Box 32293, Fridley, MN 55432  
(612) 825-6806

## MISSOURI

**Greater Osage Thermionic Warming Group**  
7454 E. Fox Trot Lane  
Rogersville, MO 65742  
James Guillebeau, (417) 889-3355

## NEVADA (Las Vegas)

**Las Vegas Audiophile Society**  
Las Vegas  
Tarcisio Valente, (702) 435-7451

## NEW JERSEY

**New Jersey Audio Society**  
209 Second St., Middlesex, NJ 08846  
Frank J. Alles, (908) 424-0463  
Valerie Kurlychek, (908) 206-0924

## NEW YORK

**The Audio Syndrome**  
Nassau and Suffolk counties  
Roy Harris, (516) 489-9576

**Catskill and Adirondack Audio Society**  
PO Box 144, Hannacroix, NY 12087  
(518) 756-9894

Daniel Phinney  
29 Brian Dr., Rochester, NY 14624  
(716) 594-8118, 5-9 p.m. EST  
Long Island/Westchester County  
Publio Morera, (516) 868-8863

**Western New York Audio Society**  
PO Box 312, N. Tonawanda, NY 14150  
Denny Fritz

**The Gotham City Audio Society**  
c/o David Schwartz, President  
375 11th Street  
Brooklyn, New York 11215  
(718) 788-0917

## NORTH CAROLINA

**Piedmont Audio Society**  
1004 Olive Chapel Rd., Apex, NC 27502  
Kevin Carter, (919) 387-0911

## TENNESSEE

**Memphis Area Audio Society**  
8182 Wind Valley Cove  
Memphis, TN 38125  
J.J. McBride, (901) 756-6831

**TEXAS (Sweetwater)**  
Rick, (915) 676-7360

## UTAH (Salt Lake City)

**Wasatch Audio**  
Edward Aho, (801) 364-4204

## WASHINGTON

**Pacificnorthwest Audio Society**  
Box 435, Mercer Island, WA 98040  
Ed Yang, (206) 232-6466;  
Gill Loring, (206) 937-4705

**Vintage Audio Listeners and Valve Enthusiasts**  
1127 NW Brite Star Ln., Poulsbo, WA 98370  
(206) 697-1936

## ARGENTINA

**Buenos Aires Audio Club**  
Rincón 476  
1081 Buenos Aires  
Willy Pastrana, (011) 54-943-0007

**Figaro**  
Esparta 1680 5000 Res.  
Olivos Cordoba  
Esteban Bikic, (011) 54-51-684251

## BELGIUM

**West Europe Lowther Club**  
Avenue Plissart, 16  
1040 Brussels  
Victor Meunisse, FAX (011) 32-2-736-7394

## CANADA

**Montreal Speaker Builder Club**  
4701 Jeanne Mance, Montreal,  
PQ, H2V 4J5 Canada  
Andrew McCrae, (514) 281-7954

## CHILE

Christian Bargsted  
Los Gomeros 1542, Vitacura, Santiago  
(011) 562-538-0638

## GERMANY

**ESL Builders Group**  
Gunter Roehricht  
Bühlerstr.21, 71034 Böblingen, Germany

## INDONESIA

**Silo Ultac Audio Society**  
PO Box 6567 / SMS  
Semarang 50065  
FAX: (011) 62-24-603595

**Tube Audio Enthusiasts**  
Ignatius Chen  
FAX (011) 62-21-3868074,  
(011) 62-22-213277

## NETHERLANDS

**Audio Vereniging Midden Nederland**  
B. Doppenberg  
Brinkersweg 16, 8071 GT Nunspeet  
(011) 31-3412-57848

## SOUTH AFRICA

**Hi-Fi Club of Cape Town**  
PO Box 18262, Wynberg 7824, South Africa  
Chris Clarke, FAX (011) 27-21-7618862,  
E-mail chrisc@iaccess.8a

## UNITED KINGDOM

**London Live DIY Hi-Fi Circle**  
Brian Stenning, (011) 44-181-748-7489

If your club is not represented or if you are interested in starting up a club, simply send the information (club name, contact person, address, and phone/FAX number) to:

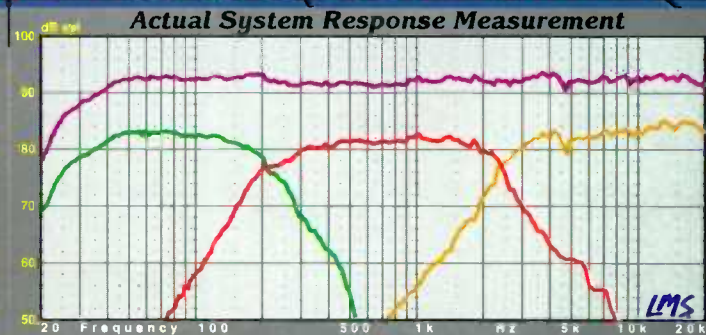
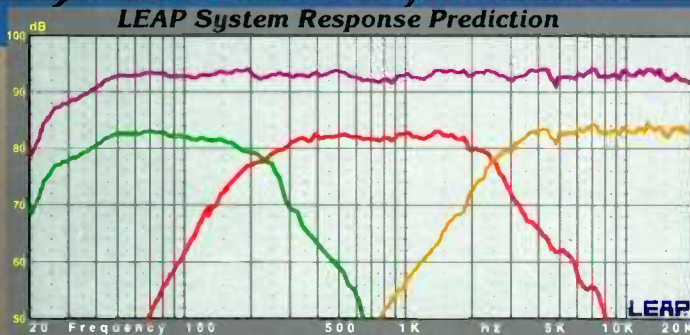
**Audio Amateur Publications, Inc.**  
Clubs  
PO Box 494  
Peterborough, NH 03458  
FAX (603) 924-9467



**New! LEAP**  
**Version 4.5**

**LEAP**

# Precision Development Tools for Precision Loudspeaker Design



**The Art and Science...** of loudspeaker system development today has become more complex than ever before. Competition is tough, and to compete each design must perform to the best of its ability, and make the most out of every dollar's worth of transducer cost. The simple approach of choosing a combination of seemingly appropriate transducers coupled with ordinary networks and filters, has given way to a painstaking process of meticulously blending selected transducers in combination with carefully devised and matched crossover designs.

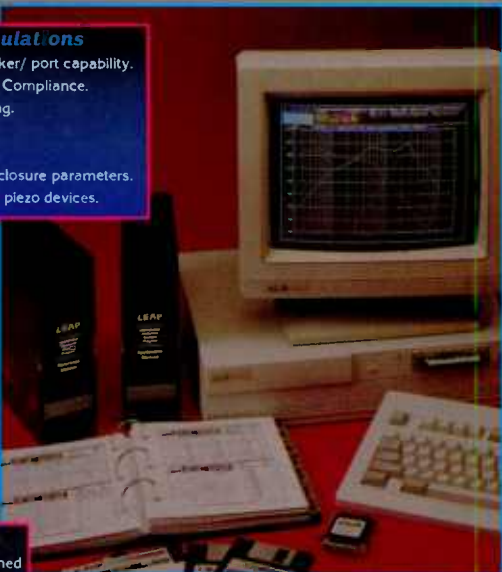
■ Seminars/Workshops available, call for details.

**LEAP** (Loudspeaker Enclosure Analysis Program) is a complete full range analysis package which provides virtually all of the tools necessary to develop precision loudspeaker systems, for today's demanding audio markets. Whether your applications are consumer audio, car stereo, professional audio, or custom esoteric marvels, LEAP provides the power, flexibility, and accuracy to investigate every possible design permutation. The open architecture and broad spectrum of features provided will dramatically reduce your development time, while improving the quality of the final result... and demonstrates why LEAP has become the #1 choice of professional loudspeaker designers world-wide!

- Advanced Transducer/Enclosure Simulations**
- ✓ Sealed, Vented, Bandpass, PR Simulations with multiple speaker/ port capability.
  - ✓ Large signal analysis of TempVC, and Non-Linear BL/ Ports/ Compliance.
  - ✓ Acoustic Parallel or Acoustic Series (Isobaric) Driver Mounting.
  - ✓ Port Standing Wave resonance modeling.
  - ✓ Frequency Dependent Revc and Levz modeling.
  - ✓ Library storage of 36 transducer parameters, and over 24 enclosure parameters.
  - ✓ Generic transducer modeling of electro-dynamic, ribbon, and piezo devices.

- Advanced System Analysis Features**
- ✓ Use simulation or Imported actual measured SPL/Z data.
  - ✓ 5-Way crossover system modeling, and more.
  - ✓ Time offset between transducers.
  - ✓ Active or Passive based crossovers.
  - ✓ Hilbert-Bode transform for deriving phase.
  - ✓ 22 Passive components per crossover section.
  - ✓ 16 Active filter blocks per crossover section.
  - ✓ Passive Network Optimizer for single/system response.
  - ✓ Active Filter Optimizer for single/system response.
  - ✓ Frequency ranges from 1Hz to 100kHz.

- Printer/Output Formats**
- When you wish to produce a hardcopy output of your finished designs and graphical data, LEAP supports a large number of printer standards, and even supports numerous desktop publishing graphic formats in both black & white and color! Portrait/Landscape orientations in any custom size and aspect ratio are user controllable.
- |                                  |                        |
|----------------------------------|------------------------|
| ✓ IBM/Epson 8 Pin Dot Matrix     | ✓ NEC 24 Dot Matrix    |
| ✓ Epson 24 Pin Dot Matrix        | ✓ TOSHIBA 24 Dot Mat   |
| ✓ HP LaserJet Series Printers    | ✓ HP DeskJet 500C      |
| ✓ HPGL Compatible Plotters       | ✓ PostScript Printers  |
| ✓ PostScript EPS/TIF/ B&W/Color  | ✓ DXF AutoCAD          |
| ✓ AI-Adobe Illustrator B&W/Color | ✓ TIFF, BMP, PCX Plots |



- Extensive Documentation**
- The two volume manual set comprises almost 1,000 pages of documentation which thoroughly covers the operation of the program and provides numerous examples of how to maximize your use and understanding of the program's many features. The Reference Manual describes all graphs, menus, commands, and their operation. This manual explains the unique and special non-linear speaker and port models, as well as proper use of the optimizers, importing data, and the many other utilities. The Application Manual provides many exciting examples showing how to use the powerful features of the system in a combined manner to perform both simple and complex design tasks. Both novice and experienced users alike will find this information invaluable for exploring the full power of the system. Additional information is also provided on loudspeaker measurements, design tips, filter calculations, and complete crossover system development for both passive and active based systems.
- ✓ 302 Page Reference Manual
  - ✓ 436 Page Application Manual

**Call for a free Demo Disk!**  
**TEL: (503) 620-3044**

- Development Utilities**
- |                                |                                  |
|--------------------------------|----------------------------------|
| ✓ Quick Cabinet Box Designer   | ✓ Crossover Network Designer     |
| ✓ Conjugate Network Designer   | ✓ Spkr Parameter Measurement     |
| ✓ Wire Table Calculator        | ✓ Voltage/Current/Imp Calculator |
| ✓ Multi-Curve Averages         | ✓ Motor Constants Calculator     |
| ✓ Import Data from ASCII Files | ✓ Export Data to ASCII Files     |



LinearX Systems Inc 7556 SW Bridgeport Road Portland, OR 97224 USA Tel: (503) 620-3044 Fax: (503) 598-9258

**International Dealers:** Argentina: Interface SRL (54-1)741-1389/Australia: ME Technologies 61(0)65-50-2200/Austria: Audiomax 49(0)71-31-162225/Belgium: Belram 32(0)2-736-50-00/Canada: Gerraudio 416-696-2779/Denmark: A&T Ljudproduktion 46(0)8-623-08-70/France: Belram 32(0)2-736-50-00/Germany: Audiomax 49(0)71-31-162225/Indonesia: Ken's Audio 62(0)21-639-5806/Italy: Outline snc 39-30-3581341/Korea: Sammi Sound: 82(02)463-0394/Luxembourg: Belram 32(0)2-736-50-00/Malaysia: AUVI 65-283-2544/New Zealand: ME Technologies 61-65-50-2254/Norway: A&T Ljudproduktion 46(0)8-623-08-70/Philippines: Dai-Ichi Denshi (63)-2631-69-80/Poland: Inter-Amcom 48(22)43-23-34/Singapore: AUVI 65-283-2544/Sweden: A&T Ljudproduktion 46(0)8-623-08-70/Switzerland: Audiomax 49-71-31-162225/Taiwan: Gestion Taycan Intl 886-2-786-3468/Thailand: AUVI 65-283-2544/The Netherlands: Duran Audio 31-41-80-15583/UK(England): Munro Assoc 44(0)171-403-3808.









**morel**



# High-Tech Audiophile Loudspeakers

For Further Information Please Contact: **morel acoustics USA**

414 Harvard Street  
Brookline, MA 02146  
Tel: (617) 277-6663  
FAX: (617) 277-2415

World Radio History



Typical Double-Magnet Woofer Cross-Section