

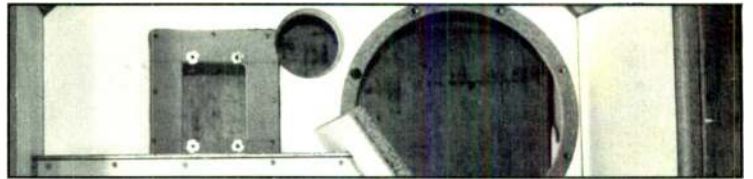

Speaker Builder

THE LOUDSPEAKER JOURNAL

**A FLEXIBLE
FOUR-WAY**



**NEW TESTS
USING IMP**

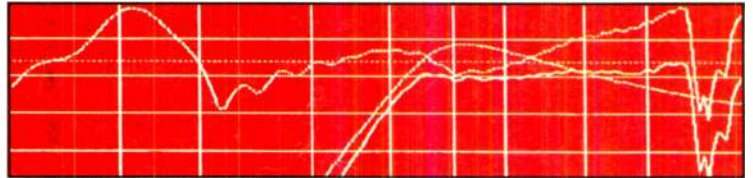

**NEW FOCUSED
ARRAY TRICKS**

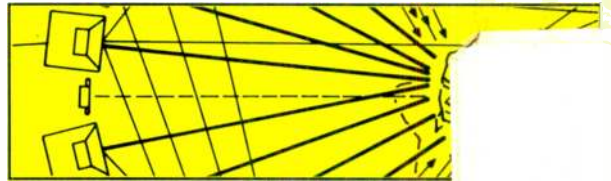

**CUT DRIVER
HOLES EASILY**

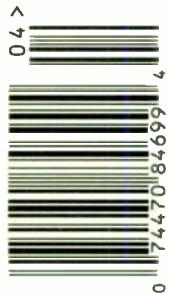
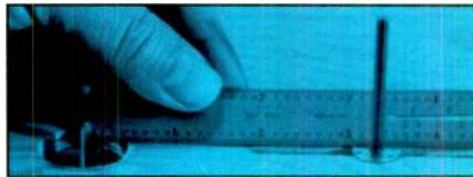

A0785740EXP# 8th of 95
DAVID B WEEEMS
BOX 99
NEWTONIA MO 64853

HOT TEST CD FOR YOUR CAR

FOCAL
technologie d'avant-garde



AUDIOM 15VX Polyglass 15" subwoofer

for your free copy of the complete FOCAL catalog: call or write Focal America, Inc.
1531 Lookout Drive, Agoura, CA 91301. USA. TEL: (818) 707-1629 FAX: (818) 991-3072

World Radio History

Good News

■ AUDIO CABLE

An audio cable engineered and optimized specifically for biwired speakers has been introduced by MIT. T2 Bi-Wire is based on the patented MIT Terminator™ technologies, which are designed to provide proper bass reproduction and midrange clarity with an efficient interface. A more recent development is the Multi-Bandwidth™ Terminator, in which separate networks are optimized for high and low frequencies. Music Interface Technologies, Auburn, CA 95602, (916) 888-0394, FAX (916) 888-0783.

Reader Service #102

⇒ DRIVER PROTECTION

Speaker-Knife is a high-speed transient/overload speaker-driver protector. Once triggered, the device either cuts out the audio and stays disconnected until the fault is corrected or instantly resets. Drivers and crossovers are protected from over-excitation, blown voice coils, and constant DC. The absence of batteries means there is no robbing of usable audio power or frequency response/dynamic range loss. All hardware is included. Dynastar Electronics, 926 E. Birch Ave., Fresno, CA 93720, (209) 435-0270.

Reader Service #103



⇒ DIGITAL PROCESSOR

TransDAC is the assembled version of the Assemblage DAC-1 DIY kit (available through The Parts Connection). The small chassis (9.5" x 2" x 7") houses a potted toroidal power transformer, low-ESR power supply capacitors, Crystal CS8412 input receiver, NPC 5813 digital filter, and two Burr-Brown PCM1702 20-bit DACs. The output stage is a direct-coupled, Class A design, utilizing high-speed Analog Devices AD844 and AD847 op amps, film and foil polypropylene capacitors, and 1% metal film resistors. A special introductory promotion pairs the TransDAC with the UltraJitterbug jitter-rejection device. Sonic Frontiers, Inc., 2790 Brighton Rd., Oakville, ON, Canada L6H 5T4, (905) 829-3838, FAX (905) 829-3033.

Reader Service #105

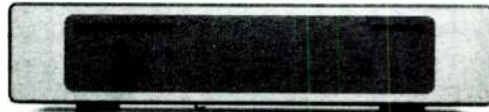

■ MEASUREMENT SOFTWARE

Liberty Audiosuite is a new measurement and analysis software package, utilizing multimedia soundcards based on the ADSP2115 DSP. The software is capable of measuring frequency and time-domain responses, impedances, spectra, distortion, anechoic behavior, room acoustics, and other characteristics of audio frequency electronics and loudspeakers. A choice of 14 sample rates from 5.5kHz to 48kHz is provided, with MLS/FFT and sine wave capability to 16,384 data points. Liberty Instruments, Inc., PO Box 1454, West Chester, OH 45071, phone/FAX (513) 755-0252.

Reader Service #101

■ WINDOWS FOR SOFTWARE

A Windows version of the Listening Room is now available. The program helps locate speaker and listener placements to minimize the deleterious effects of standing waves and boundary reflections. Besides a graphical interface, the new version features subwoofer placement, electrostatics, surround-sound speakers, openings and drapes, consideration of enclosure size and speaker placement on baffles, and accurate scaling of room diagrams. Windows 3.1 and a mouse are required. Sitting Duck Software, PO Box 130, Veneta, OR 97487, (503) 935-3982.

Reader Service #104

■ SPEAKER COMPONENTS

Speaker City U.S.A.® offers a product line and services for automotive speakers, stereos, amplifiers, and custom enclosures; home, studio, and musical instrument enclosures; speaker repairs; and home theater systems. Driver manufacturers represented are Dynaudio, Focal, Vifa, Scan Speak, Versa-Tronics, Audax, and Pioneer. The latest catalog features speaker repair services, design aids, driver dimensions and box size recommendations, driver technical specifications and descriptions, crossover components and hardware, and speaker kits, as well as completed systems. Speaker City U.S.A., 115 S. Victory Blvd., Burbank, CA 91502, (818) 846-9921, (800) 595-9924, FAX (818) 846-1009.

Reader Service #106

Speaker Builder (US ISSN 0199-7929) is published every six weeks (eight times a year), at \$32 per year, \$58 for two years; Canada add \$8 per year; overseas rates \$50 one year, \$90 two years; by Audio Amateur Publications, Inc., Edward T. Dell, Jr., President, at 305 Union Street, PO Box 494, Peterborough, NH 03458-0494. Second-class postage paid at Peterborough, NH and an additional mailing office.

POSTMASTER:
Send address change to:
Speaker Builder, PO Box 494
Peterborough, NH 03458-0494

The Industry's Finest Connectors.

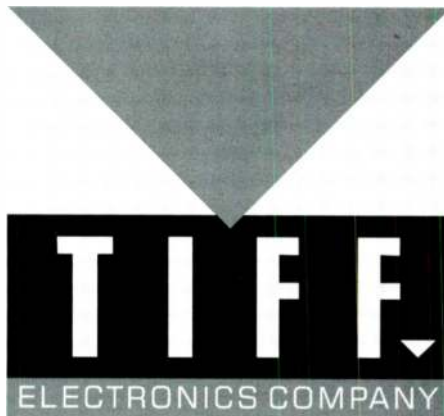

TIFF Electronics Company • 44 Pearl Pentecost Road / Winder, GA 30680 • (404) 867-6300 / 2713 (Fax)

Reader Service #72

NHT 1259

NOMINAL IMPEDANCE	4 ohm
MUSIC POWER	300 W
FREQUENCY RANGE	19-1000 Hz
SENSITIVITY (2.83 V)	90 dB
EFFECTIVE CONE AREA	507 cm ²
VOICE COIL RESISTANCE	3.4 ohm
VOICE COIL INDUCTANCE	1.2 mH
VOICE COIL DIAMETER	50 mm
VOICE COIL HEIGHT	34 mm
AIR GAP HEIGHT	8 mm
XMAX	13 mm
FREE AIR RESONANCE	19 Hz
MOVING MASS (MMS)	121 g
FORCE FACTOR (Bl)	9.6 TM
MAGNET WEIGHT	59 oz
QMS	2.6
QES	.56
QTS	.46
VAS	190 LTRS
KRM	28.89

A&S Speakers is pleased to be able to offer this custom made, high performance woofer from Now Hear This (NHT). This is the cost no object woofer used in the highly acclaimed NHT 3.3 system. Unlike almost all other woofers, the NHT1259, with its low resonance and exceptionally long voice coil is designed to produce deep bass in a small sealed enclosure when positioned within two feet of the rear wall. This design results in superior transients and minimal phase shift and group delay. Every construction feature contributes to the outstanding performance of this driver: the 50mm diameter, 34mm long, 2 layer voice coil allows long excursion, high thermal capabilities and tremendous output; the large bumped backplate and raised spider prevent bottoming at maximum excursions; the heavy cast frame minimizes energy transfer to the enclosure; and the rubber surround and polypropylene cone promise long term durability in every environment.

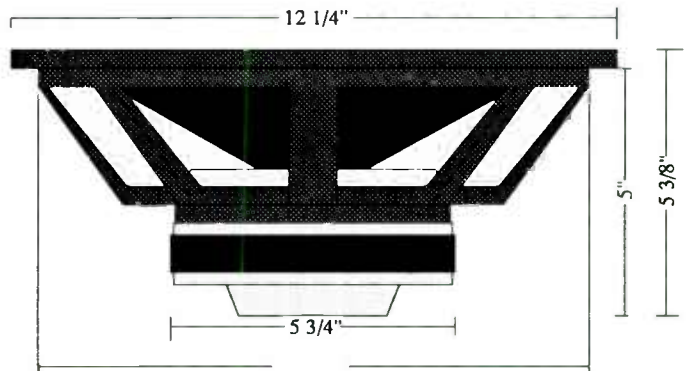

Price: \$149.00/each

*Cabinets and plans for our computer designed enclosure utilizing 14 internal braces are now available upon request.

LEAP

Loudspeaker Enclosure Analysis Program

Date: Jan 14, 1994
Time: Fri 2:58PM

DGL Library:
TEST DGL

DGL Entry: 4, Name: nht 12" lpa

MEASURED IN ROOM RESPONSE 2.6 CU. FT. SEALED ENCLOSURE

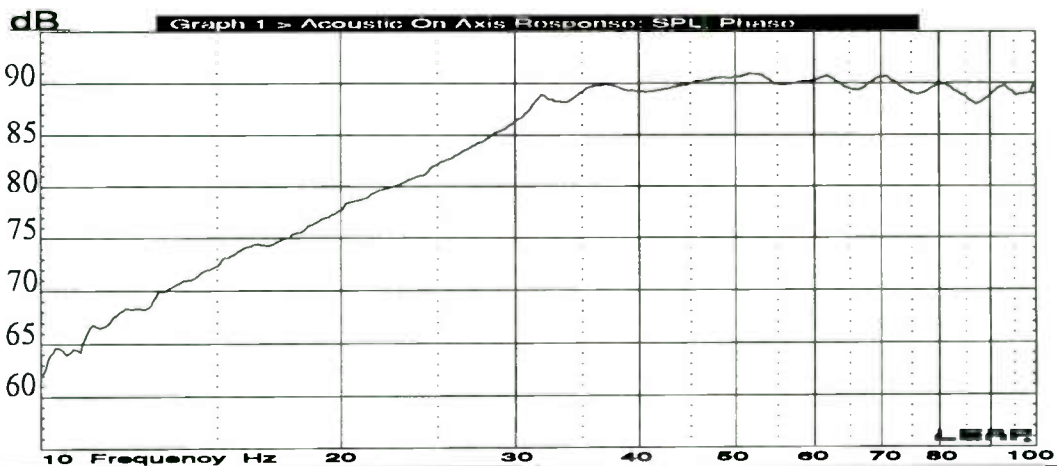

**A&S
speakers**

3170 23rd Street; San Francisco, CA 94110

Telephone: (415) 641-4573 Fax: (415) 648-5306

Editorial

The Computer Question

By now we are all weary, not to say jaded, when the discussion turns to speedy technological change. But such shifts in the way we do things need some perspective if we are to fulfill one of the most basic of philosophical precepts. Socrates said it well: "The unexamined life is not worth living."

My subject is computers. Whatever you think or have heard, or however you may view the computer revolution, step back with me for a few moments and consider some of the main issues.

The company which produces the magazine you hold in your hands has been doing its work and been managed by some form of computer technology since 1982. On June 1, we retired our first system, put in place 13 years ago and only now being decommissioned because of ongoing integration of the way we do business. Today our office houses 23 machines which handle circulation fulfillment, advertising sales management, financial controls, editing manuscripts, page production, and sales and shipping.

Eventually, we hope to offer online services for authors and readers alike, and at least one totally electronic periodical is in the works. You will have noticed that more and more of what appears in *Speaker Builder* is related in one or more ways to the computer as a multipurpose tool. It offers design capability for boxes, crossovers, zobel, not to mention fully integrated, multidriver systems. It allows you to first build a system on the computer, before building it in real time and space, as Vance Dickason's new *Loudspeaker Recipes*¹ illustrates so eloquently.

The computer's measurement capabilities are already pervasive and growing more refined with each passing day. Indeed, a well-equipped moderately powerful machine can fulfill most of the normal electronic test bench functions.

Unlike most technology, however, the cost of the computer has been dropping steadily since its introduction to wide use in the early 1980s. Our first IBM clone was an XT with 1M of memory, a mono monitor, two 5¼" 360K disk drives, and a 20M hard disk, all for \$1750. Today you can purchase an 80486 DX100 machine with 8M of memory, color monitor, 560M hard drive, and 1.2 and 1.4M floppy drives for that same price tag.

If you have put off doing anything about a computer for your speaker building activities, it may be because the whole matter seems so confusing and the vendors so unfamiliar that you just haven't made a start. Since this magazine is based on the do-it-yourself premise, I suggest you build your own. If that seems outrageous, it may be that you need a reliable, comprehensive introduction to the whole topic. I do make the suggestion without any reservations or trepidation, however. If you can use a screwdriver and read instructions, you can build your own machine, and keep it upgraded as the technology develops.

McGraw-Hill's *Windcrest* division has been publishing a series of guidebooks about computer hardware under the title *Build Your Own...PC*.² Aubrey Pilgrim, the series' author, has produced volumes on building all models from the lowly 8088, the IBM XT, to his latest which explores the Pentium processor-based devices. I might explain that there have so far been four successors to IBM's first design. These are all prefixed by the 80... designation. We've had the Advanced Technology (AT) step up, the 286, followed by the 386 and the 486. The latter number is a highly sophisticated device containing a math co-processor, which in the earlier 386 had been a separate chip.

All the while prices of these central processor units (CPUs) dropped steadily, plummeted in some instances, from their introductory prices. The increasing sophistication of the CPUs was accompanied by increases in processing speed. From the 4.7MHz per second XTs to the most recent Pentiums (aka 586) at speeds of 120MHz, we have seen a dazzling increase in the power of these smaller and smaller machines.

Pilgrim's latest volume, *Build Your Own Pentium Processor PC*, may seem to a beginner like starting at the top. In one sense that is so, but the book is an absolutely comprehensive first look at the whole machine, and neither its processor nor its speeds will be any bar to your understanding of how the whole IBM PC series of computers works and how to put one together—regardless of whether you intend to build a 386, a 486, or one of the new Pentiums. The basic elements of all the machines are the same.

There *are* variations, of course. You'll have choices of bus formats, monitors, disk drive formats, memory configurations, and much else. The basic hardware is absurdly easy to assemble, however. The box with power supply, the motherboard, memory, floppy disk(s), disk interface and ports board, monitor interface, hard disk, keyboard, and monitor can all be put together with moderate care using a Philips screwdriver. But Pilgrim takes you on a very comprehensive, easy-to-understand tour of IBM computer country that is the best overview I have seen for beginners. The Pilgrim book is also a handy manual for an experienced user's full understanding of the machine's basic operation.

Computers encompass a very large array of diverse information, and there are seemingly endless things which may be learned about them. A multitude of disciplines exist within the computing world, any one of which by itself can become a full-time avocation. After you have built your computer and installed an operating system, the software choices are a new, and larger, adventure.

You will be seeing more about computers in these pages in upcoming issues. The computer is also a music and data processing instrument. It has the developing capability to record and edit digitally encoded music, and it can be a handmaiden to composers, capturing and printing musical notation, as well as the sound itself.

Inevitably the computer will affect loudspeakers at all levels from materials research right to performance in your listening space. I suspect it will redefine the way we deal with issues of quality and performance. It is already pouring out mountains of new information about all the elements which comprise the loudspeaker interface. If you have been hanging back, it is time to step up across the new threshold and start finding your way around a new, exciting neighborhood.—E.T.D.

REFERENCES

1. Vance Dickason, *Loudspeaker Recipes*, Audio Amateur Press, 1994, ISBN 1-882580-04-4.
2. Aubrey Pilgrim, *Build Your Own Pentium Processor PC*, Windcrest/McGraw-Hill, 1994, ISBN 0-07-050164-5, \$19.95.

Design a PWM switching power amplifier into your next powered audio product... and do it without R&D.

LGT Technologies provides OEM power solutions for audio designers requiring small size, ultralight weight, and clean high-efficiency output.

We offer a range of power modules, with ratings of 150 to 500 watts*... optimized for full-range or low-frequency reproduction... with conventional linear power supplies or switching mode supplies. We can incorporate custom circuitry for your specific design onto the same circuit board... such as an active filter network or special processing.... all with little or no R&D expense.

LGT Class-D amps are stable and reliable, providing low distortion, and excellent frequency response. Contact Terry Taylor for full details and a development kit with demo board.

*4Ω

895 Cherokee Boulevard Chattanooga, TN 37405

Tel: 615-756-0706

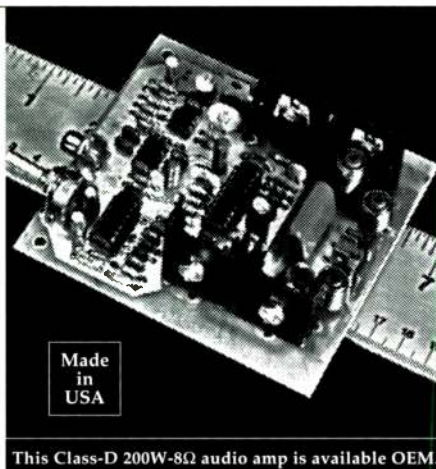

This Class-D 200W-8Ω audio amp is available OEM.

Sales Agent: ACOUSTICAL SUPPLY INTERNATIONAL

©1995 ASI

Fax: 615-756-0860

Reader Service #79

Speaker Builder

The Staff

Editor and Publisher

Edward T. Dell, Jr.

Contributing Editors

Joseph D'Appolito **Robert Bullock**
Richard Campbell **John Cockcroft**
David Davenport **Vance Dickason**
Bruce Edgar **Gary Galo**
G.R. Koonce **Richard Pierce**

Assistant Publisher

Karen Hebert

Dennis Brisson Managing Editor

Mary Wagner Associate Editor

Suzanne Coté Graphics Director

Production Assistants

Brian Jenkins **Diane Luopa**

Laurel Humphrey Marketing Director

Robyn Lasanen Circulation Manager

Allison Pelkey Administrative Assistant

Advertising Rates & Schedules

Martha L. Povey National Advertising Director

Laura Brown Advertising Assistant

(603) 924-9464 FAX (603) 924-9467

The peculiar evil of silencing the expression of an opinion is, that it is robbing the human race; posterity as well as the existing generation; those who dissent from the opinion, still more than those who hold it.

∞ JOHN STUART MILL

Speaker Builder is published eight times a year in the interest of high-quality audio reproduction.

No material in *Speaker Builder* may be used in any form without the written permission of the publisher.

Subscription Inquiries

A one year subscription to *Speaker Builder* is \$32. Canada please add \$8. Overseas rate is \$50 per year.

To subscribe, renew or change address write to the Circulation Department or telephone (603) 924-9464 or FAX (603) 924-9467 for MC/Visa/Discover charge card orders.

For gift subscriptions please include gift recipient's name and your own, with remittance. A gift card will be sent.

Send circulation and editorial correspondence to *Speaker Builder*, PO Box 494, Peterborough, NH 03458-0494. No responsibility is assumed for unsolicited manuscripts. All manuscripts must include a self-addressed envelope with return postage. The staff *will not* answer technical queries by telephone.

Printed in the USA. Copyright © 1995 by Audio Amateur Publications, Inc. All rights reserved.

About This Issue

Speaker Builder has always stressed the importance of reader feedback. Our lead article in this issue is a direct response to your interest in a published project and proof that your comments and suggestions do make a difference. Spurred by a reader request, contributing editor John Cockcroft reveals several woofer solutions (with a surprising orientation) for his Simpline speaker system ("The Simpline Sidewinder Woofer," p. 8). In keeping with the Simpline tradition, this project features simplicity with pleasing results.

If room effects plague your sound system, we offer two solutions. First, Bill Waslo demonstrates his analytical prowess with an array of drivers to deal with the effect of room acoustics on sound quality ("Focused Arrays: Minimizing Room Effects," p. 10). His proposal is an untested, but feasible, way to increase direct sound while reducing room reflections.

Second, contributing editor G.R. Koonce has developed programs for the IMP Audio Analyzer to help you establish the proper test setup and allow IMP files to be used by other programs to achieve a reflection-reduced environment ("Extending IMP: A Program Set," p. 24).

Ron McGhie offers a flexible, four-way vented speaker design that addresses the lack of dynamic range in home systems. His construction project results in a high-performance system in a modest box design ("A Flexible Four-Way System," p. 14).

In his latest installment of Wood World ("Shaped Hole Techniques," p. 40), Bob Wayland presents simple methods to produce professional-looking circular holes to mount a speaker, without the necessity of using heavy-duty equipment.

Finally, sound man Dan Ferguson reviews Sheffield Lab's new test CD, appropriately titled *My Disc*, to help you evaluate and analyze your system ("CD Review," p. 48). This useful tool features over 80 technical tracks and sound effects.

Speaker Builder

THE LOUDSPEAKER JOURNAL

VOLUME 16 NUMBER 4

JUNE 1995

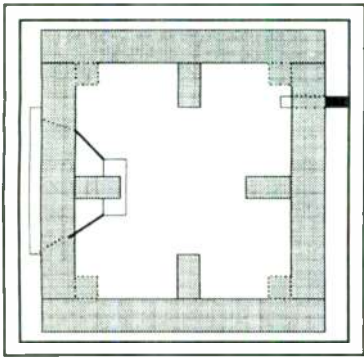

8

8 The Simpline Sidewinder Woofer

BY JOHN COCKROFT

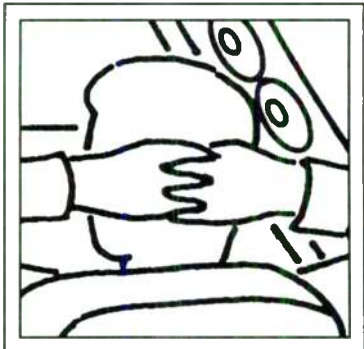

10

10 Focused Arrays: Minimizing Room Effects

BY BILL WASLO

14 A Flexible Four-Way System

BY RON MCGHIE

24 Extending IMP: A Program Set

BY G.R. KOONCE

48 CD REVIEW *My Disc From Sheffield Lab*

BY DAN FERGUSON

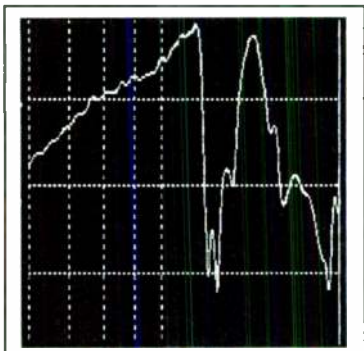

24

DEPARTMENTS

3 GOOD NEWS

5 EDITORIAL The Computer Question

40 WAYLAND'S WOOD WORLD
BY BOB WAYLAND

54 SB MAILBOX

59 CLASSIFIED

62 AD INDEX

THE SIMPLINE SIDEWINDER WOOFER

By John Cockroft

Of all of the speaker systems I have designed, the Simplines have made me the happiest and perhaps surprised me the most. They ask so little and give so much (sort of like the Little-Engine-That-Could).

From time to time I have considered using the Simplines as satellites, but for some reason never got around to designing a specific woofer for them. A letter from reader Harry Campbell renewed my interest in the matter.

THE SQUATLINE

I currently lack the facilities for construction, so I can't really design and test a woofer from scratch. But I have been able to do something. I dragged out an old speaker system which I call the Squatline. It was dutifully standing against a wall in the bedroom, trying hard to prevent dust from settling to the floor.

I sometimes thought of this speaker as a 2' long Shortline and at other times as a Microline for an 8" speaker. I disconnected the tweeter and the crossover, and hooked it up to the Simplines through an active crossover consisting of a couple of Marchand XM 1 PC boards and a homebrew power supply. At various times the crossover point was 125Hz and 200Hz.

After a lot of fiddling around, I eventually found what was seemingly the best location for the woofer cone in relation to the room. This turned out to be as close as possible to the junction between the floor and the rear wall, a position originally discovered and used by Roy Allison. In order to achieve this location, the Squatline (which, like the Simplines, has its woofer on its top face) had to lie on the floor with its back against the wall like some boxy house cat.

In this position, when I finally got the levels between the woofer and the satellites set correctly, I spent some time listening to different things: organ, heavy orchestral passages, things with a lot of transients, some swing and Dixieland, and vocals. The results were surprisingly good. The transition between the speakers couldn't be detected; everything seemed to float above the pile of

dead bones leaning up against the wall, totally inert and unconnected with the music. I was really enjoying this.

In the midst of this delicious pleasure, a black thought intruded. The woofer in the Squatline was an old Peerless model not currently being manufactured. *Ow*—that spoiled my day! I later realized I had an 8" Radio Shack 40-1024 woofer (their current 8" poly coned unit) in another system, which I had used for a while in the Squatline. At the time it had sounded OK. I located it, reinstalled it, and reset the balance. When I heard the sound, I was greatly relieved.

A SIDEWINDER IS BORN

Something would have to be done about the enclosure, though. It couldn't just lie around the floor in such an unhousebroken manner. The thing to do was to keep the same dimensions (because the music still sounded fine), but to build it upside down with the speaker at the bottom, on the side panel (see "Construction Details"). The Sipline Sidewinder—*why not?*

My first thought was that the active crossover wasn't exactly in keeping with the concept of simplicity. So I designed a passive crossover and breadboarded it on a piece of cardboard photo mount stock. It was a second-order filter with a Q of 0.5, and it crossed over at about 159Hz using 0.1µF capacitors. While it sounded beautiful, it wouldn't play very loud. My system consisted of a Carver CD player hooked up directly to an amplifier. There wasn't enough get up and go in the CD player to push through the passive filter.

After sitting around for a while with a pessimistic profile, I went to the closet and located my old Hafler

100 preamp. The 20dB gain in the preamp made the difference; it was playing loudly enough to satisfy me (and probably to annoy my neighbors). This system doesn't have to be *really* loud to sound good. Just moderately loud, or even a bit less, and you get a tremendous subjective feeling of reality.

I recently redid the crossover in an effort to make it as low impedance as possible (Fig. 1). It helped—the system will now play louder than I need.

FINDING RESISTOR VALUES

The crossover is designed so the amplifier's input impedance serves as the final resistor of the circuit's high-pass section. I know of no amplifier with the correct impedance. (And if I did, I don't have it.) The purpose of resistor(s) Rx in the circuit is to fool the crossover into thinking the impedance is correct. It must be of a value that, when paralleled with the input impedance, comes out to 10kΩ.

To find the value of the resistor, first look

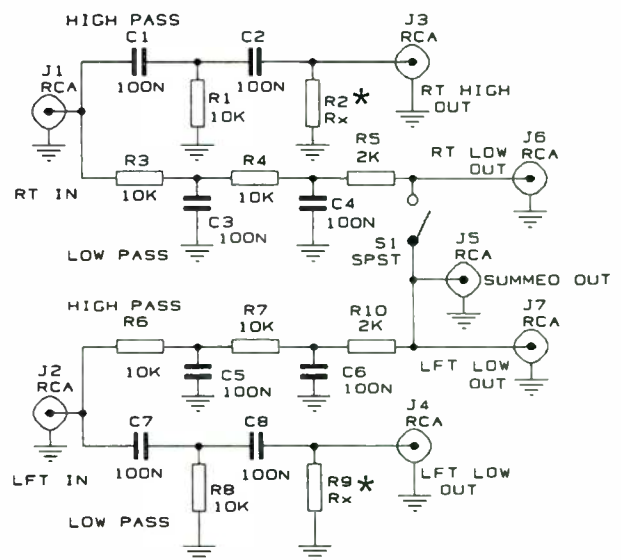

FIGURE 1: Passive line-level crossover for the Sipline satellite/woofer system (to be used between preamp output and amp input). Resistors: ¼W; Capacitors: monolithic or PC mount Mylar. *See text.

up the value of your amplifier's input impedance in your owner's manual. Enter that value in your calculator and press the 1/x key. Then press the minus key, enter 10,000, and again press the 1/x key. Now press the = key and the 1/x again. This will give you a minus number. If you ignore the minus sign, you will have the correct value of resistor Rx in ohms.

Example: amplifier input impedance is 30kΩ. 30,000 (1/x) 0.0000333 (-) 10,000 (1x) 0.0001 (=) -0.0000667 (1/x) -15,000. Ignore the minus sign and the answer is 15,000 ohms (15kΩ).

In spite of the fact that the crossover is second-order, and theoretically should function best when the satellite leads are reversed in relation to the woofer leads, I now find the system sounds better when the satellites are hooked up with the same polarity (plus to plus, minus to minus). This is probably due to the effect of the sound's different path lengths from the Simplines and the woofer to my listening position.

I suggest hooking up your system both

ways and retaining whichever polarity sounds best with your setup. Since most of the sound from this system is reflective, it is difficult to predict path lengths simply from looking at the setup arrangement. It might also be that, since I am using amplifiers from different manufacturers, one amplifier has its polarity reversed from the other. The key here is *whatever works!*

For use in a tape loop circuit, instead of between a preamp and an amp, a stereo volume control is required ahead of the crossover inputs because the record out jacks bypass the preamplifier volume control. The Radio Shack 271-1732 will work. (Don't enable the loudness control feature.)

I hope this gives you something to play with. Please write if you have any questions or comments. I'll probably keep this monstrosity hooked up. Thanks to Harry Campbell for that.

to page 56

CONSTRUCTION DETAILS

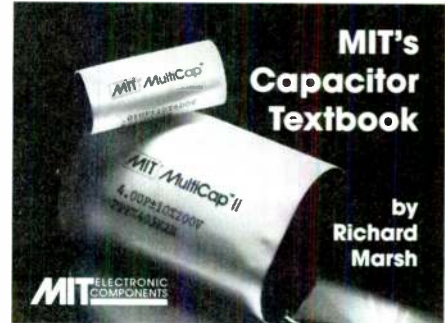
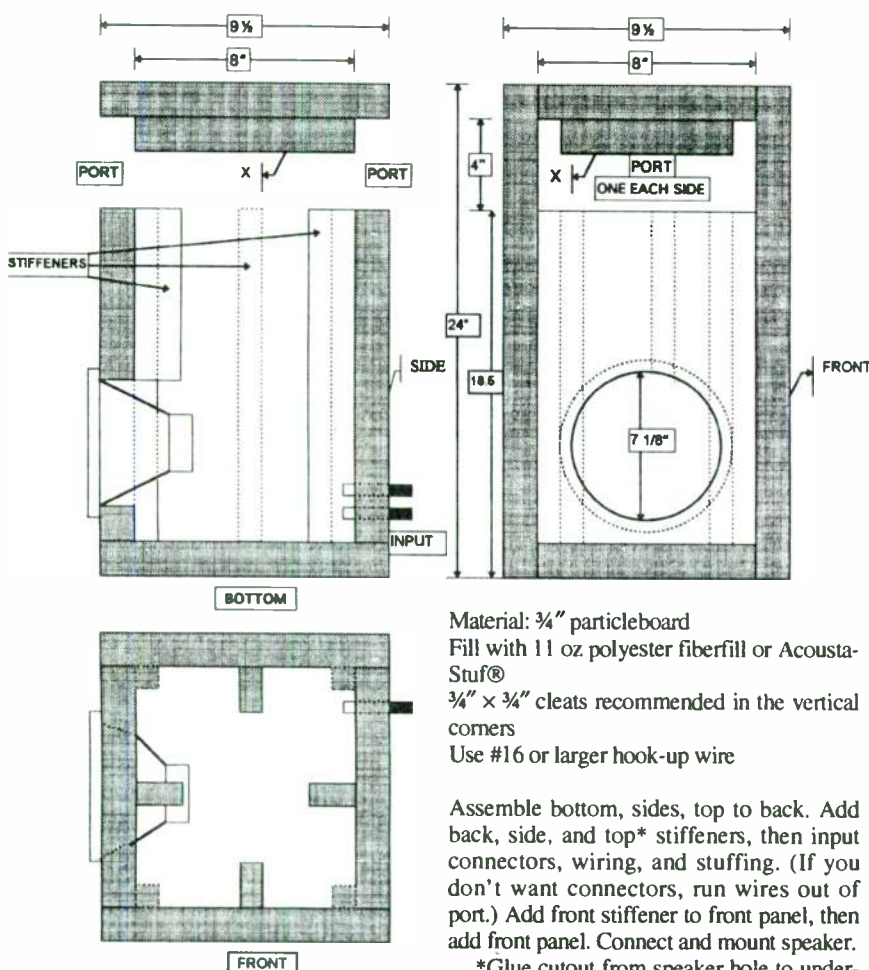

Debunking the Myths

Cap Myth #3

Some caps in audio applications sound fine without by-passing.

Cap Fact

All capacitors in audio applications need by-passing: coupling caps, crossover caps, power-supply electrolytics. Without by-passing, high-frequency performance and transient response will be compromised.

- **Problem:** Capacitors slow down at higher frequencies. The larger the capacitor, the slower the response.
- **Solution:** By-passing a larger slow cap with a smaller faster cap (MIT recommends 10% of the overall value) restores high-frequency performance.
- **Optimized Solution:** The patented MIT MultiCap - the only internally by-passed capacitor available. Each MultiCap is constructed by paralleling up to 10 sections, each 10% of the overall value.
- **Results:** Lower parasitics than possible with ordinary by-passing. Superior high-frequency performance in a single unit without additional, external bypassing.

The MultiCap is also an unequalled by-pass for power-supply electrolytics.

Watch for the next capacitor Myth!

"...the MIT capacitors... charge and discharge much faster. The speed of these caps also implies that they are passing only the signal present at that instant, leaving no residual effect from any previous signal."

From *The Audiophile Voice*, Vol. 2 Issue 1, p. 105 - a comparison of the ARC SP 9 Mk II & Mk III

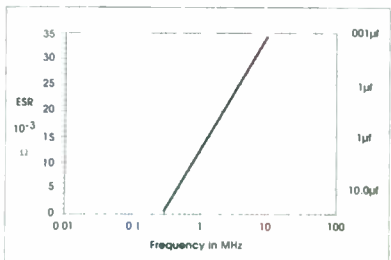

ESR vs. Frequency vs. Capacitance

Graph showing low distortion obtained by the decreased parasitics (ESR) of the self-bypassed MultiCap. MultiCap performance falls to the right of the line, indicating fewer parasitics, i.e., fewer colorations & increased accuracy. Measurements of standard caps, even with exotic foils, falls to the left of the line, indicating compromised performance. (Measured at MIT)

MUSIC INTERFACE TECHNOLOGIES®
 For National & International Inquiries:
 Phone: 916/823-1186 Fax: 916/823-0810

Reader Service #69

Speaker Builder 4/95 9

FOCUSED ARRAYS: MINIMIZING ROOM EFFECTS

By Bill Waslo

One of the most critical hardware components in an audio system is the listening room. Expensive electronics and loudspeaker components located in a poor room (or poorly placed in a good room) can, and often do, give less satisfying results than a less expensive system in an exceptional room.

Unfortunately, for many of us the room is often the least easily replaceable part of a stereo system. Our rooms are in our homes, which are part of neighborhoods, as are our kids' schools, and our jobs. We might think we have only a few choices in adjusting the room part of the system equation with room treatments (rugs, panels, absorbers), orientation of speakers and listening position, or by design of speakers and electronics to deal with particular room effects (floor-mounted woofers, in-wall speakers, equalizers).

A possible solution occurred to me when I read a recent AES journal article which

described a test in which listeners' preference was determined when speaker brand and position were varied. The room position was a more significant factor in perceived sound quality than the speaker model.¹

Interestingly, another article in the same journal described a totem-pole arranged microphone array for use in meeting rooms to achieve a directional pattern with main lobes in a donut shape peaking at the speaking positions around the room.² I thought if this works for microphones, it should work for speakers, too, and set out to discover an array of drivers to reduce the effect of room acoustics on loudspeaker sound quality.

MULTIPLE SPEAKERS

Driver arrays remind us of the marketing ploys often used to sell low-quality speakers ("Three midranges! Six tweeters! Four ports!"). Such designs prey on the "more is better" perception, and, if there is a technical

angle at all to the approach, it is usually toward improving dispersion. Some designs employ an array of drivers facing forward, backward, and/or sideways with the aim of increasing the amount of sound reverberating from room surfaces for a more diffuse sound and to increase the effect of the room's sonic signature.

My array is different; its purpose is to increase the intensity of the direct sound path while reducing that of the reflected paths, thus minimizing the sound characteristics contributed by the room. In a way, it is the antithesis of systems which enhance reflected energy, although both ideas use a driver array.

The use of multiple drivers to reduce reflections may seem counterintuitive at first, but radio antenna engineers have an analogous technique. They lower multipath distortion (which is a corruption of a direct radio signal by reflected signals) by utilizing directional antennas composed of an array of spaced elements. The antennas are advantageous in the transmit path, the receive path, or both wherein the array not only improves the echo rejection but also increases antenna gain or sensitivity to the radiated signal. The use of transducer arrays is also common in sonar and ultrasound technology.

OPERATION

So, how does it work? The concept is very simple, so I suspect it must have been thought of before. Yet neither I nor anyone I've talked to about this has seen or heard of such a system. Basically, each "speaker" consists of an array of drivers spread out on the front-left or front-right side of the room.

The critical characteristic is that each driver is placed the *same distance* from the listener's head (Fig. 1), but at different distances from the room boundaries and other reflecting surfaces. Ideally, they should be irregularly spaced from room surfaces to randomize the arrival times of the reflections at the listening position.

The direct signals arrive coherently (phase aligned) at the listening position, and thus the

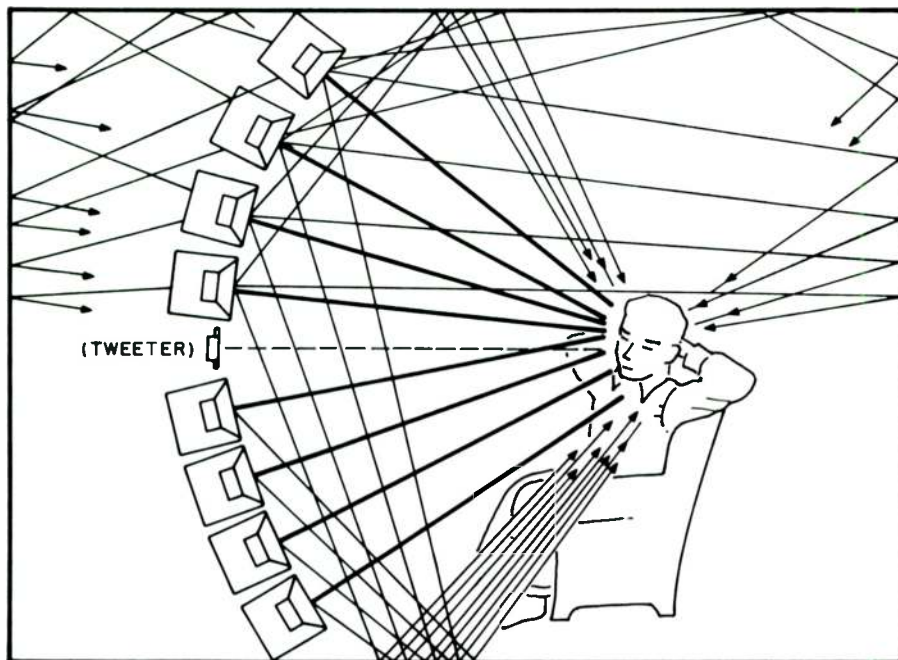

FIGURE 1: Direct signal paths are equal; reflected signal paths vary greatly. Only a fraction of the reflections are shown.

pressure sums directly (increasing 6dB for each doubling of the number of equally powered source drivers). The reflected signals, however, arrive at different times. Thus their strength sums (ideally) at 3dB for each doubling of equally powered sources. Two drivers arranged this way should have up to a 3dB (6 - 3) enhancement of direct over reflected intensity.

In general, the maximum decibel enhancement will go as $10 \log(N)$, where N is the number of drivers. Four phase-matched drivers should show 6dB of enhancement, and eight drivers can yield 9dB. This process is very similar to the noise-reduction-by-averaging scheme used in the basic IMP measurement system. However, reflection intensity, rather than noise reduction, is reduced relative to direct signal intensity (Fig. 2).

You can imagine that the listening position will be very critical. This setup is intended to be ultradirectional and foregoes the usually desired goal of loudspeaker omnidirectionality. But after spending thousands of dollars on equipment, doesn't an audiophile always sit in the one best seat, anyway? But you would not invite a large audio club over to listen to your focused array system. You can avoid the need to install a vise in your listening chair to precisely hold your head, if the higher frequencies (and perhaps some of the midrange) are not part of the array.

You could use a single tweeter of narrow dispersion characteristic in a traditional placement, or a controlled directivity (horn) tweeter, with other drivers arrayed widely around it. A single tweeter would also help preserve imaging and localization. You might notice the single tweeter, dual midwoofer setup as one of the characteristics of the D'Appolito configuration, which might be considered a "3dB enhancement" focused array for midrange fre-

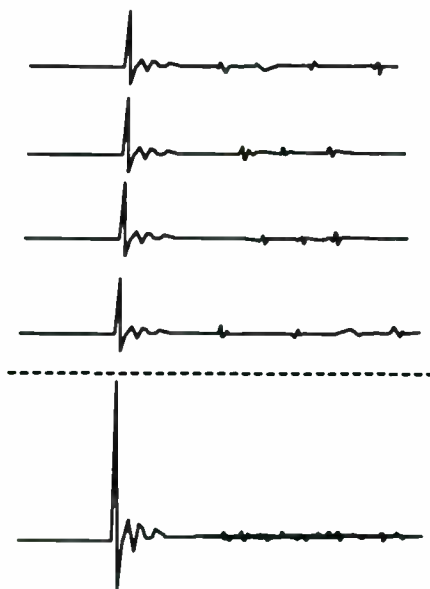

FIGURE 2: Impulse responses due to distributed drivers have the direct part aligned, but the reflected parts spread (top). The summation of these at the listening position reinforces the direct signal relative to the reflected signals (bottom).

quencies (although the D'Appolito configuration has other design goals).

IMPLEMENTATIONS

You can place the drivers in the arrays various different ways. You could install each into its own small cabinet or on its own stand, equidistant from the target listening point. This would locate them pseudo-randomly on the surface of an imaginary sphere centered at the listener's head as in Fig. 3. You could also locate some drivers at the sides or even behind the listener, but I suspect toward the

front would be more satisfying. Writing a computer program to help position the drivers could optimize the results.

You could combine the array into a set of less visually overwhelming "speakers" as a commercial product by installing them into long, inclined arc-shaped cabinets (Fig. 4). Other possible shapes of unified-box systems include X-shaped, S-shaped, and, of course, a full satellite-dish arrangement using many drivers. You might array your system with multiple midranges and multiple woofers for three-way, four-way, or more versions.

Some other variations you might consider are: arraying the drivers into a planar grid, with the arrival times aligned via electronic delays, or behind a porous screen of a projection video system. Another variation is to use ribbon drivers or electrostatic panels for the driver.

THE SOUND

If you are wondering what this will sound like, so am I. These days I spend more time with a computer keyboard than with a table saw, so I haven't tried this idea yet. I am presenting this approach to the *Speaker Builder* community to see whether I can tempt some of you. Here's your chance to possibly make modest audio history. Fire up your saws!

For a simple, first-time experiment, you could make about 16 satellite-sized mid-woofer cabinets, spread them out (in left and right sets), and arrange them for equal arrival times at ear level in your listening chair. The best way to align the drivers is by measurement of the impulse response as received at the listening position. A marked length of string is also usable for equidistant alignment. If you use a single tweeter for better sound, you may want to use separate amplifiers for midwoofer and tweeter for the test to more

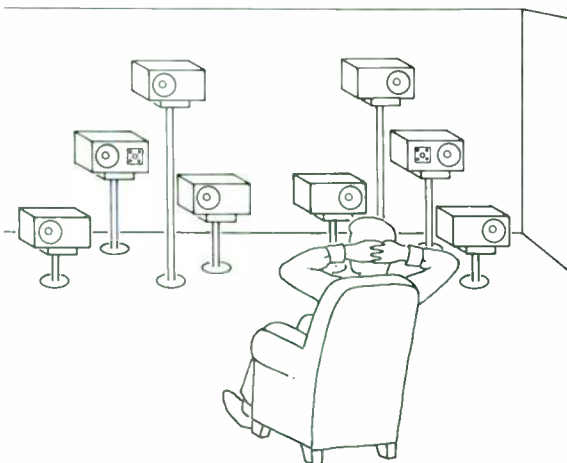

FIGURE 3: A "6dB enhancement" focused array using separate cabinets and stands.

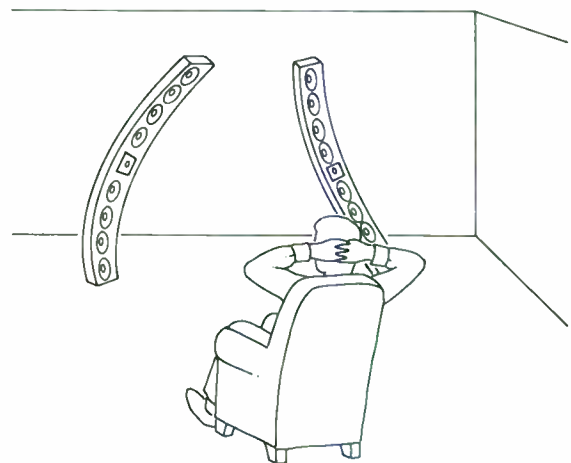

FIGURE 4: Inclined arc implementation of a focused array.

bullock and white software presents

BoxMODEL VER. 4.0

FEATURES INCLUDE:

Series and Parallel, Compound and Isobaric Designs
 Sealed, Vented and Passive Radiator Systems * On-Line Help
 Optimized Flat Alignments * Four Concurrent Designs
 Graphics Printer Dumps, Supports Over 300 Printers
 Over 1000 Driver Database File, 4" - 30" [48 Manufacturers]
 Equalized Alignments Thru 8th Order * Filter Assisted Alignments
 Includes Atmospheric Conditions In Design
 Displays Coefficients of Transfer Function
 Re-Designed User Interface * Pull-Down Menu Driven
 Includes Box, Port and Absorption Losses in Analysis
 Automatic File Save/Recall * DOS Real-Mode Application
 Single / Multiple Port Length Calculations
 Auto-Detect CGA, EGA, and VGA Display
 8088-80586, No Co-Processor Required, But Recommended
 Box Dimension Calculator * Fixed / Custom Ratios * Missing Dimension
 Separate Graphic Traces for Box, Driver, EQ, and Loss Contributions
 Toggle Between US and Metric Units
 Toggle Max Power Graph based on Resistance or Impedance

GRAPHS:

Maximum SPL * Relative SPL
 Voice Coil Impedance * Voice Coil Phase
 Acoustic Phase Response * Group Delay
 Transient Response * Driver Piston Excursion
 Vent Airspeed * Passive Radiator Excursion
 Maximum Input Power

\$59.⁹⁵

Plus \$3.00 Shipping in USA

OLD COLONY SOUND LAB

PO Box 243, Department

Peterborough, NH 03458-0243 USA

Telephone: (603) 924-6371 or (603) 924-6526 24-Hour FAX: (603) 924-9467

easily match the levels of the drivers as you add or subtract midwoofers to the array. In the final configuration, a suitable series-parallel arrangement may be possible for the midwoofers to convert to a passive crossover.

SOME NAYS

There may be some negatives with the array concept. As G.R. Koonce points out, your current recordings may not necessarily sound best in a reflection-reduced environment.³ This is the chicken-and-egg problem with recordings and speakers. Recordings are artistically made creations, not simply objective measurements of a sound field. A recording engineer uses techniques and mixes which will sound best on the speakers that he anticipates will be interpreting the recording. Typical mixes probably assume room effects. Since I've never heard of the existence of a focused array system, I doubt that any recordings have been monitored or produced with them in mind.

Koonce also notes that reflected energy may affect the imaging illusion. Remove it and things could become kind of dry. You might wonder if the result would be much different than headphone sound. Of course, the reflection reduction will not be total, and it may be desirable to lessen the room's colorations, but not eliminate all reverberent fields, or to restore the field by separate rear or side channel speakers, home-theater style.

There exists one best seat, at one best distance from the system. The result is intended to be very directional, and not just the way a planar speaker is directional. On the other hand, I've often felt that the planar speakers' semi-coherent image, which often seems to come from behind me (reflected off the back wall), is quite detrimental to realism. The arrays might cure that problem yet retain the advantages of directionality.

Another problem might be the frequency dependence of the effect. Expect it to diminish at very low frequencies. Additionally, frequency-dependent sidelobes in the radiated pattern may lend a coloration to the remaining reflected energy.

Focused array systems could also become rather expensive. Eight decent midwoofers per side can add up quickly. Driver manufacturers would be delighted if this became popular, and so would speaker-stand manufacturers if audiophiles embraced the arrangement of Fig. 3.

AND YEAS

Since I'm writing the article, I get to finish by listing some of the advantages of focused arrays. In addition to a smoother response, expect the following desirable effects:



THE NATURE OF MUSIC

A new multi-cultural, interdisciplinary approach to music is now available on 6 cassettes featuring lively discussion and 168 musical examples. Twelve award-winning audio programs, originally broadcast on National Public Radio and produced by ethnomusicologist Karl Signell and Deborah Jane Lambertson.

Typical Guests: Ethnomusicologists McAllester, Roseman, Feld, Nattiez; scholars Deutsch, Gardner, Barzun; musicians Menuhin, Zappa, Balfa.

Six audio cassettes in album with Listener's Guide, \$44.50 plus \$2.50 shipping and handling. Full 3-week money-back guarantee. To order call toll-free 1-800-243-1234, write, or fax us.

AUDIO-FORUM®

Suite P632, 96 Broad Street, Guilford, CT 06437
 Tel: (203) 453-9794 • Fax: (203) 453-9774

Topics

Performer
 Listener
 Commerce
 Time
 Creative Spirit
 Body
 Tools
 Words
 Brain
 Technology
 Meaning
 Defining

 Many other unusual music programs are listed in our 32-p. "About Music" catalog. Ask for a free copy.

Forgings TWEETER / SYNCHRONOUS SPEAKER

HUNDREDS OF OUTSTANDING TWEETERS
ARE AVAILABLE FOR EVERY OF YOUR PROJECT



Newest Tweeter with
one-piece diaphragm in Super
Duralumin, Titanium ...
material.



DOME TWEETER :
@USD 0.79



**Ø 13mm Neirbon
Super-Tweeter**



- ❑ Supreme know-how and continuous research
- ❑ Hi-quality products at the most competitive pricing
- ❑ Available for OEM design and free catalogues

You'll be surprised to find we're the one you've
been looking for !

FORGINGS IND. CO., LTD. / P.O. BOX 1823, TAIPEI, TAIWAN, R.O.C.
TEL: 886-2-585-3316/7 FAX : 886-2-594-2708 ATTN: MS. LU CHI YING

A FLEXIBLE FOUR-WAY SYSTEM

By Ron McGhie

In recent years, recorded material has placed an ever-increasing demand on domestic (home) speaker systems with respect to low-frequency output at high levels. My system, operated at its rated input power, can exceed 115dB SPL over a relatively long period of time, while remaining docile enough for chamber music at reduced levels (*Photo 1*).

DESIGN GOALS

For as long as I can remember, I've been interested in loudspeaker design. Speaker building, if done properly, is one of the most satisfying projects you can undertake, rewarding the builder with sound that rivals the best commercial units. In some cases the results are better than commercial designs: when you build for yourself, you're not concerned with cutting corners to lower production costs.

If you use quality components, pay strict attention to detail, and, most importantly, be realistic about your speaker's performance, you can be proud of your efforts.

Most systems fall short of reproducing the dynamic range present in live performances...until now. This system addresses that shortcoming. Considering the small size of my listening room, it is virtually idling 95% of the time.

SYSTEM REQUIREMENTS

My system requirements, in order of importance, were:

1. Wide bandwidth;
2. High efficiency;
3. Modest-sized enclosure;
4. High power-handling capacity.

The system adheres to the following principles:

1. You can extend bass response with relative ease as long as high-output requirements are not taxing.
2. High system efficiency and/or high-input capacity do not guarantee high output at low frequencies.
3. Diaphragm movement to achieve a given level of acoustic output is a function of the frequencies, the size of the diaphragm, and the

type of system. It is not related to system efficiency unless the loudspeaker is burned out electrically trying to achieve the desired diaphragm movement.

Table 1 lists the peak-to-peak excursion in inches required to achieve one acoustic watt at the frequency indicated for vented (and sealed) systems. This shows the decided advantage of vented systems over sealed systems in terms of driver excursion at low frequencies. It also shows the benefits of choosing a larger driver over a smaller one when you require high outputs at low frequencies. In its simplest form, acoustic watts = $\eta_0 \times$ power rating (thermal limit). Note also that X_{MAX} specifications are one-half the peak-to-peak value mentioned here, and $\eta_0 =$ Thiele/Small reference efficiency.

So, how do you handle inadequate excursion? Well, you can keep peak acoustic levels below one acoustic watt, design around a larger-diameter speaker, design around mul-

iple speakers, raise the low-bass limit, or use a system type which minimizes excursion requirements. The all-horn system is the obvious choice, if not for the sheer bulk of the low-frequency section, so I opted for vented technology, which provides a reasonable compromise between size, efficiency, and low-end response (f_3).

SELECTED COMPONENTS

My initial design considerations centered around a two-way vented low-frequency section and a horn-loaded high-frequency section; that is, basically a 15" vented woofer with a horn "top end" capable of 400Hz–20kHz. While the low-frequency section was solidifying on my computer program, based on the JAES papers by A.N. Thiele and Richard Small, I discovered a pair of Electro-Voice drivers, called the VMR (vented midrange), which are used in the S1803 professional keyboard system. The VMR (EV part #1803-0302) has the same 16 lb magnet structure as the woofer I have chosen, the DL15W, which is a relatively new driver from EV intended for the professional sound reinforcement market.

For the midbass I chose an EVM10M musical instrument driver, which also has a 16 lb magnet structure. The sensitivities of these three drivers are very closely matched, eliminating the need for bothersome padding networks. I then chose the EV ST350B wide-angle tweeter, with 120° dispersion that is ideal for off-axis listening. Also, choosing drivers from the same manufacturer virtually assures they have the same "sonic fingerprint," which is impor-



PHOTO 1: The completed speaker system.

ABOUT THE AUTHOR

Ron McGhie is a telephone worker in British Columbia and has been involved in the installation and maintenance of electromechanical and digital long-distance telephone switching equipment. As an amateur musician, he has played clarinet in the Air Force Band and currently plays violin with the New Westminster Symphony Orchestra. Residing in Port Coquitlam, BC, he is the father of three and in his 47th year at the University of Osmosis.

tant when you are designing a "system." Driver specs are in *Table 2*.

ENCLOSURE DESIGN

Traditionally, loudspeaker system design begins at the low-frequency section, which is usually the bulkiest and dictates the size and shape of the enclosure. I needed an f_3 of at least 40Hz (normal mode approximately equal to a B4 alignment). Since the midbass enclosure is integral with the main enclosure, I actually needed to design two boxes. I started figuring how large to make this box, which must be added to the main box volume (*Figs. 1 and 2*).

My f_3 for the midbass was to be around 100Hz. My calculations showed a new volume of 0.68 ft³, yielding an f_3 of 93Hz and an F_B of 82Hz. With a 3" diameter PVC vent of 7.065 in² and a vent length of 1.97", driver displacement volumes for the EVM10M and the VMR are 210 in³ each for a total of 420 in³ or 0.24 ft³. So I added this to the 0.68 ft³ net box volume for a 0.92 ft³ gross volume.

For the low-frequency section, 5.1 ft³ yields an f_3 of 38Hz (normal mode) and 28Hz B6 assisted (equalized step-down mode). I added 500 in³ or 0.28 ft³ for driver displacement of the DL15W and 0.92 ft³ for

TABLE 1				
PEAK-TO-PEAK EXCURSION				
Loudspeaker DIA. IN.	50Hz	40Hz	30Hz	20Hz
8	0.77 (2.3)	1.2 (3.6)	2.1 (6.3)	4.8 (14.4)
10	0.50 (1.5)	0.78 (2.3)	1.4 (4.2)	3.1 (9.3)
12	0.31 (0.90)	0.48 (1.4)	0.86 (2.6)	1.9 (5.7)
15	0.19 (0.60)	0.30 (0.90)	0.53 (1.6)	1.2 (3.6)
18	0.13 (0.40)	0.20 (0.60)	0.36 (1.1)	0.81 (2.4)

the midbass enclosure for a gross box volume of 6.3 ft³. Because the design assumes no box losses, I added 0.4 ft³ (over volume). This resulted in a 6.7 ft³ box with outside dimensions of 36 × 24 × 17.5 (HWD). Normal-mode tuning occurs with 2–4" vents totaling 25.12 in² for a resultant F_B of 35Hz and a vent length of 6.71".

You can reconfigure this system to an alignment approximately equal to a no. 15 B6 assisted step-down mode resulting in half-octave extension in f_3 (from an f_3 of 38 to 28Hz) by reducing the vent area by one-half (i.e., plugging one of the vents). The F_B falls to 26Hz as a result. Then, by adding 6dB of boost at 28Hz with an accessory equalizer, you restore flat response with a new system f_3 of 28Hz.

this extra preparation for another project. After assessing how much of each size I had, I made the bottom, back, and subenclosure out of the 7/8" material and the rest out of 1-1/8" material.

I rough-cut all panels slightly larger than the finished size, then squared, made true, and labeled (right top, left bottom, and so on) the pieces (*Fig. 3*). I then cut them to size and dadoed and rabbeted the panels where necessary and routed the vents and speaker openings. The midbass enclosure shares both the midrange driver (VMR) and the midbass driver (EVM10M). They don't interact with each other, though, since the VMR is a sealed-back unit.

Photo 2 shows interior details before you add the midbass enclosure to the box. Due to the angles involved I deemed it easier to cut and fit the midbass enclosure as I went along. The integral midbass enclosure plays a major role in stiffening the main box; its bottom also serves as a front-to-back stiffening brace. Because this runs diagonally, a broader range of panel and box resonances are suppressed. *Photo 3* shows the finished midbass enclosure within the main box.

Photo 4 and *Fig. 4* show baffle details with the tweeter opening recessed to provide voice coil alignment with VMR. Left and right baffles are mirror images of each other, and the midbass, midrange, and tweeter are clustered as close as physically possible.

Liberal glue and screw down all joints

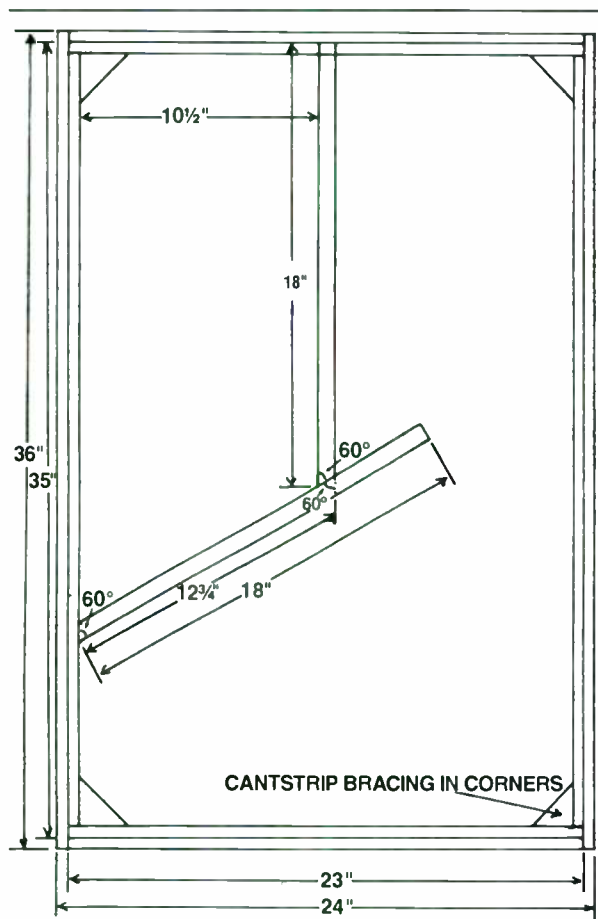

FIGURE 1: Front view with baffle removed.

CONSTRUCTION

The enclosure consists of 1-1/8" and 7/8" MDF particle-board. I acquired several sheets of what apparently used to be walls from a racquetball court. However, they were laminated on both sides with arborite, which I needed to skin off with a router wherever a glue joint occurred. Although these panels were extremely dense and heavy, I would probably not care to repeat

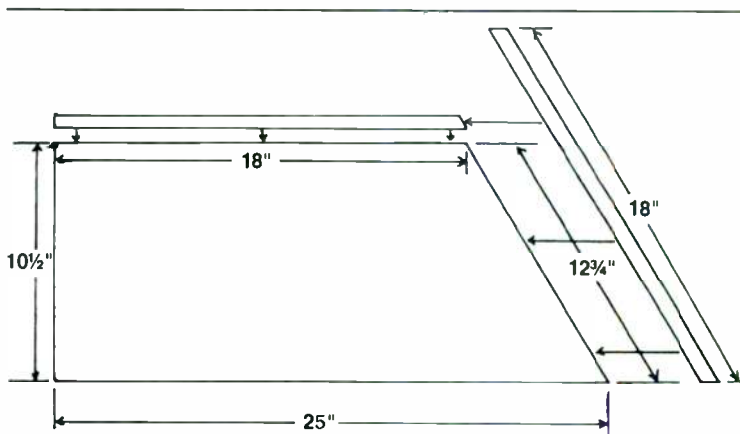

FIGURE 2: Midbass subenclosure.

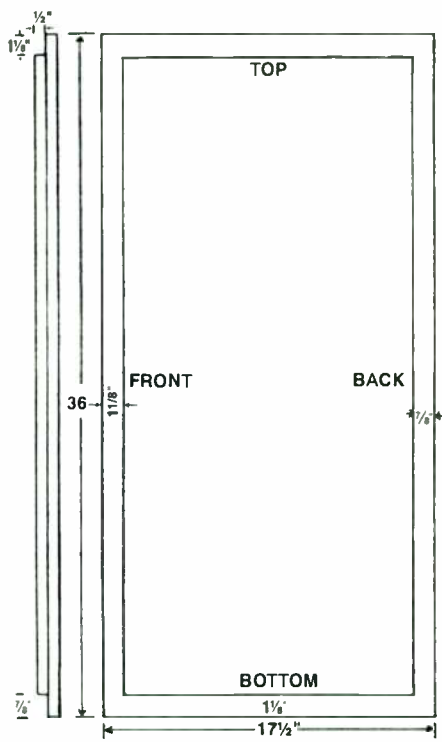

FIGURE 3: Sides.

along with the attendant panel bracing. Since the panels are not removable, access to the inside of the enclosure is through the speaker openings on the baffle. I caulked all interior joints with silicone sealant to ensure no box leakage. Cabinet damping is 2" fiberglass applied to three adjacent interior surfaces to make the boxes as inert as possible. As constructed, they weigh 220 lbs each with drivers installed. They also have minimal cabi-

net vibration when playing at loud levels and none when SPLs are more sane.

I used arborite to finish the top, bottom, front, and back, and will apply oak veneer to the sides later. The arborite gives a flawlessly smooth finish that is hard to duplicate by other means. I'll add a 1 1/2" base (not shown) before applying the veneer to the sides to prevent it from lifting when they are moved.

WIRING & TUNING

I designed the passive crossover and input panel with the idea that I would eventually biamp the system. The crossover points are 100, 350, and 3kHz. Of course, when biamping you can easily change the low-frequency crossover point. Figure 5 shows the input panel with straps and labeling for hooking up the system as an all-passive or biamp configuration.

Capacitors are Wonder-Caps® and inductors are all air core except for the 13MH and 24MH units, which are high-current ferrite core. Wiring is 10-gauge stranded throughout the crossover. I hot-glued the crossover components to the bottom of the enclosure and soldered them to terminal strips. The straps on the input panel make it

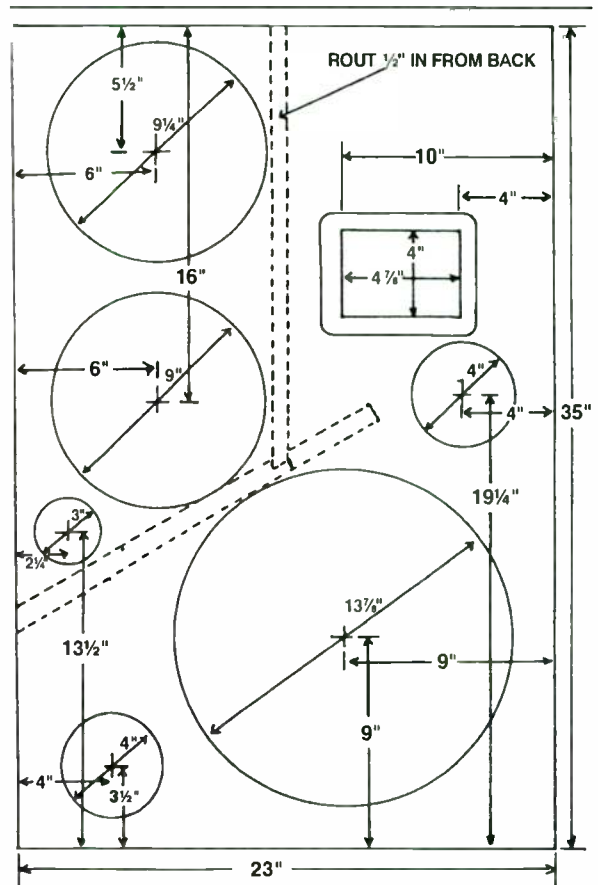

FIGURE 4: Baffle details.

easy to reconfigure from passive to active without opening the enclosure.

Wire individual drivers as noted in Table 3. You can easily reverse the DL15W polarity, since it appears directly on the input terminal strip. Of course, when biamping, you

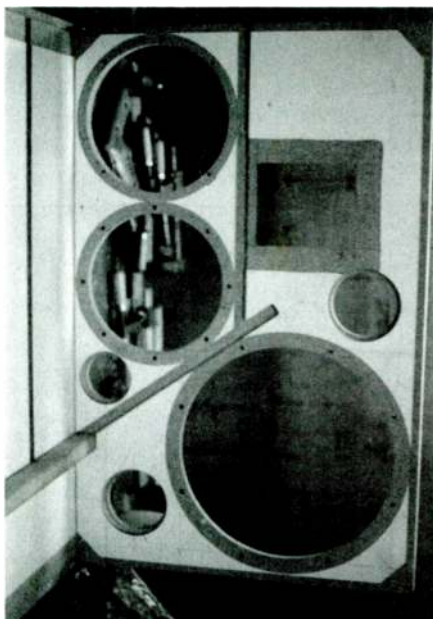

PHOTO 2: Inside view of box before mid-bass enclosure installation.



PHOTO 3: Midbass enclosure within main box.

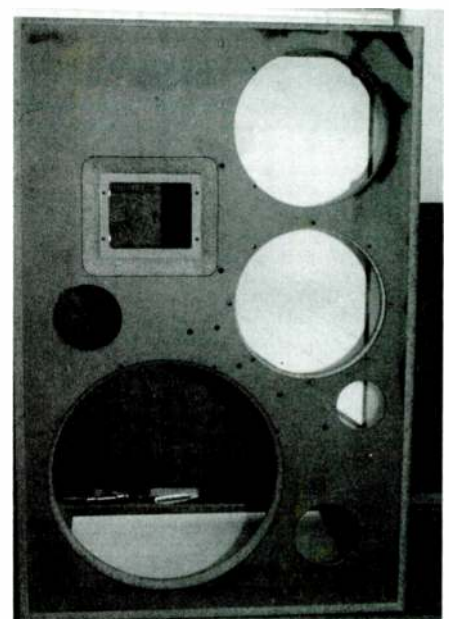

PHOTO 4: Front of enclosure showing driver and vent cutouts and recessed tweeter opening.

MIMESIS

To show the awesome capabilities of the Skaaning Loudspeakers, Madisound has developed a concept system known as MIMESIS.

MIMESIS is for the discriminating listener who wants a system that has a flat frequency response, impedance magnitude that varies less than 2 ohms throughout the audio frequencies (less than 1/2 ohm for the satellite), extremely wide dynamic range, clean transients, and bass output below 25Hz. This is achieved in a sealed box design without equalization.

MIMESIS cabinet plans, drivers and speaker accessories are available from Madisound. For our cabinet, we choose 1-1/8" MDF with a cherry veneer and Corian tops and bottoms. Madisound stocks the SK300-304 12" woofer, SK170-308 6.5" woofer and the T330D Dynaudio Esotar tweeter. We can also provide you with Deflex acoustic panels for internal dampening, as well as input terminals and Flatline cable internal and external wiring.

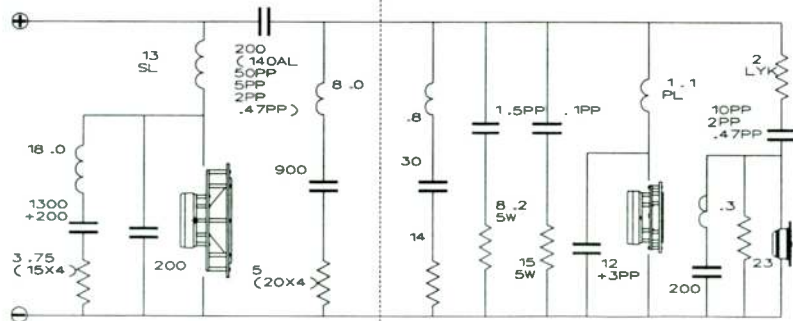

SK300-304

SK170-308

T-330D

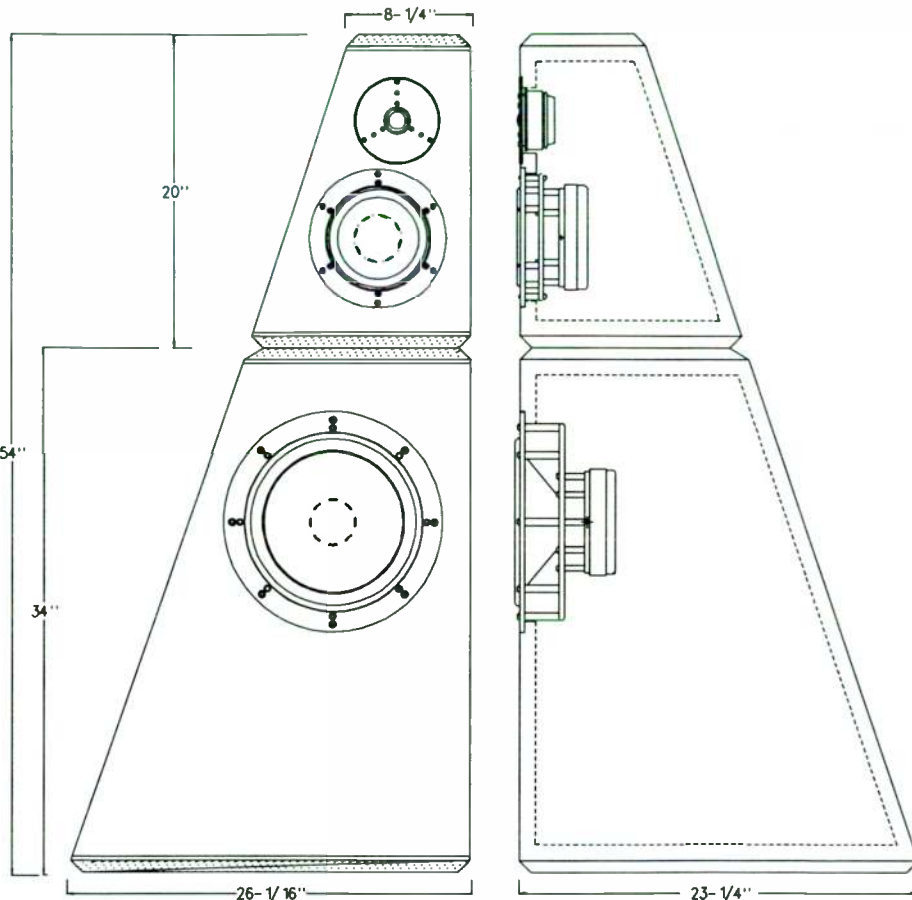

Madisound Speaker Components
 (8608 University Green)
 P.O. Box 44283
 Madison, WI 53744-4283 U.S.A
 Voice: 608-831-3433
 Fax: 608-831-3771

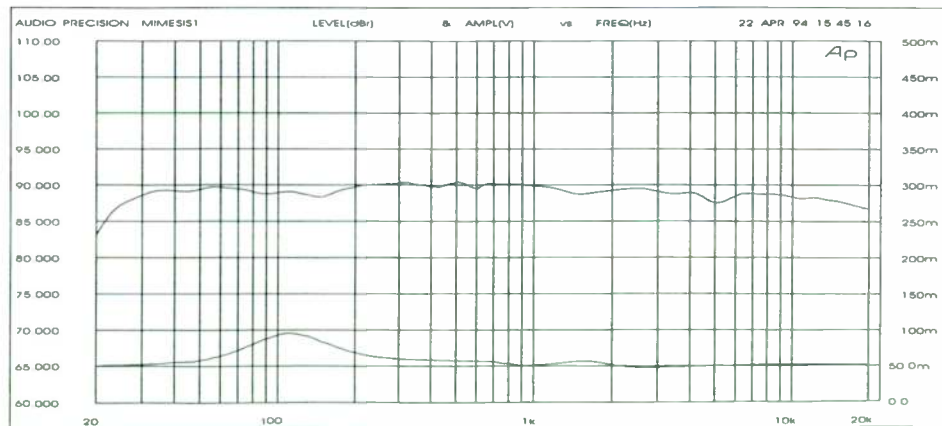

TABLE 2

DRIVERS AND SPECIFICATIONS

Low-Frequency:	Electro-Voice DL15W
Diameter	15"
F_S	30Hz
Q_{TS}	0.24
V_{AS}	8 ft ³
V_D	28.172 in ³
η_0	2.7%
Sensitivity	1W/1m/97dB
P_E	400W
X_{MAX}	0.22"
R_E	6.0Ω

Mid-bass: Electro-Voice EVM10M

Diameter	10"
F_S	65Hz
Q_{TS}	0.17
V_{AS}	1.4 ft ³
V_D	5.4 in ³
η_0	5%
Sensitivity	1W/1m/98.5dB
P_E	200W
X_{MAX}	0.11"
R_E	5.2Ω

Midrange: Electro-Voice VMR #1803-0302

With no published specs for this driver, I determined the following information:

Diameter	6.5"
Sensitivity	1W/1m/97dB
Power handling	50W RMS/500W PEAK
Dispersion	170° 500-1kHz

Horn tweeter: Electro-Voice ST350B

V/C diameter	1"
Frequency response	3k-15k ±3dB
Power handling	5W long-term average
Sensitivity	1W/1m/101dB
Horiz. disp.	120° @ 4kHz
	120° @ 8kHz
	110° @ 16kHz
Vert. disp.	90° @ 4kHz
	70° @ 8kHz
	50° @ 16kHz
R_E	6.2Ω
Directivity factor	$R_0(Q)$ 7.5 @ 4k

can achieve relative phase of the low-frequency section with a phase switch on the electronic crossover itself.

CROSSOVER COMPONENTS

Crossover components are available from many of the outlets familiar to *Speaker Builder* readers (Table 4). Don't substitute values unless, for example, you use two inductors in series to give you the desired value. You may choose to mount them in a fashion other than mine, but use the schematic as a wiring guide (Fig. 6).

Because of the difficulties of calculating a "true" net box volume (accurate measurements of driver displacements, crossover components, vent volume, and bracing can become involved, to say the least), a simple method for fine-tuning F_B is to make the vent longer (10% is usually enough) than

TABLE 3

RELATIVE PHASE CHART

ST350B	OUT
VMR	OUT
EVM10M	IN
DL15W	OUT

your design indicates. This noticeably lowers the box tuning below your target value.

By rocking an audio oscillator up and down below target F_B while holding a finger lightly on the woofer cone, you will find a null in the speaker's movement. This null occurs at box tuning. By applying the vent-end correction formula to the frequency where the null occurs, you will discover the proper length to produce your target F_B :

$$CHA L_V = CHA F_B 2L_V / F_B$$

where, $CHA L_V$ = required change in vent length in inches (negative value means reduce length, which will raise the F_B)

$$CHA F_B = F_B \text{ (required)} - F_B \text{ (actual)}$$

L_V = Initial vent length
 F_B = Initial box tuning frequency
 Depending on the accuracy of your oscillator, you can easily obtain results of <1dB error in F_B .

ACCESSORIES

This system accomplishes step-down equalization, when used, with the SEQ (EV's Sentry Equalizer unity gain device) in the Sentry III studio monitor, which provides 6dB of lift at a given frequency. Since the peak lift of the stock SEQ is at 28Hz, I did not need to modify it. By simply changing two resistors in each channel, you can change it to provide a peak lift at frequencies other than 28Hz. The SEQ, placed between the preamp and the electronic crossover, has the added benefit of acting like an infrasonic filter below cutoff. It has a three-position switch which provides high-frequency rolloff above 10kHz (0, -3, -6dB), depending on the "liveness" of your listening room.

My electronic crossover is an EV EX18 two-way stereo/three-way mono unit. The crossover points are continuously variable between 80Hz and 16kHz. It is a third-order (18dB/octave) device and level matching is

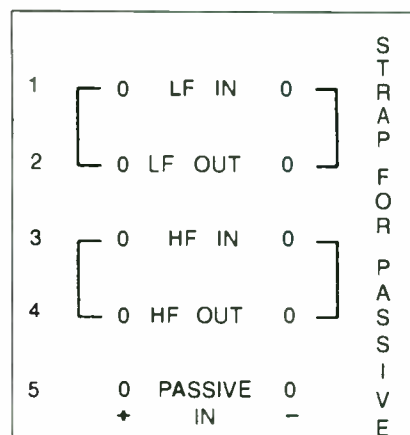

When operating in all-passive mode:
 Strap positive terminals 1 & 2
 Strap positive terminals 3 & 4
 Strap negative terminals 1 & 2
 Strap negative terminals 3 & 4
 Connect cables from amplifier to passive in terminals
 When operating in bi-amp mode:
 Ensure no terminals are strapped
 Connect low-frequency amplifier to LF in terminals
 Connect high-frequency amplifier to HF in terminals

FIGURE 5: Hookup instructions for passive configuration.

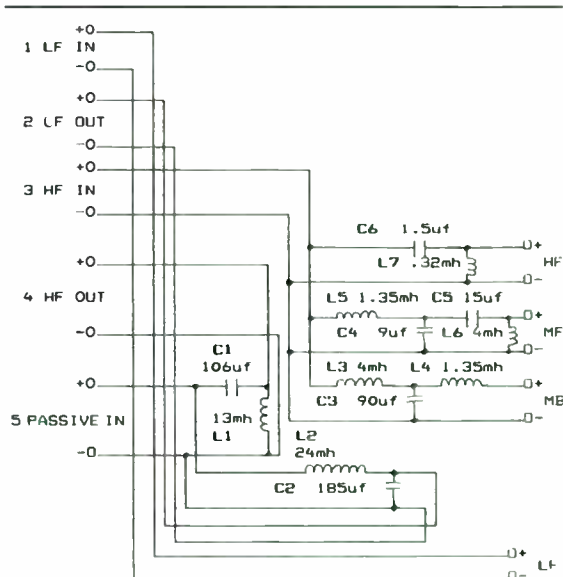

FIGURE 6: Passive crossover schematic.

TABLE 4

CROSSOVER PARTS LIST

VLF:	C1	106μF	100V min.
	C2	185μF	100V min.
	L1	13MH	High-current ferrite core
	L2	24MH	High-current ferrite core
LF:	C3	90μF	100V Solen Fast Cap or equivalent
	L3	4MH	Air core
	L4	1.35MH	Air core
MF:	C4	9μF	100V Solen Fast Cap or equivalent
	C5	15μF	100V Solen Fast Cap or equivalent
	L5	1.35MH	Air core
	L6	4MH	Air core
HF:	C6	1.5μF	100V Solen Fast Cap or equivalent
	L7	0.32MH	Air core

ZALYTRON

YOUR ONE STOP SHOPPING CENTER

FOCAL

VIETA

Cabasse
A THORNBY INTERNATIONAL COMPANY

morel

SR

PHILIPS

Polydax
speaker corporation

seas

ZALYTRON
CUSTOM WOOFERS

l'atelier audio

AGCUTON

ZALYTRON PRESENTS THE NEW LINE OF HOME THEATER KITS FROM FOCAL

SURROUND SPEAKER A 100

Bass reflex with slot-vent
H x W x D: 31 cm x 20 cm x 12 cm
(12.1/4" x 7.7/8" x 4.3/4")

Don't be fooled, this is a small but very potent home theater two way unit. You can use it as a front and/or rear speaker in any of the popular surround sound systems. The speaker mounted on a wall can generate a wide range of frequencies with surprising power thanks to a few special Focal Features:

- The 5N 412-DBL mid bass drive unit is one of the best Focal makes, combining dynamics (dual voice coil wiring) and natural sound.
- The TC 90 tweeter unit is of the latest generation of concave dome units with field replaceable moving assembly.
- The slot-vent open on the top of the enclosure couples with the wall and ceiling to naturally increase the bass output.



CENTER SPEAKER A 200

Bass reflex with front slot-vent
H x W x D: 18 cm x 50 cm x 22 cm (7.7/8" x 19.3/4" x 8.5/8")

The A200 center channel offers very low distortion, natural sound and high power handling. It features two 13 cm (5.1/4") midbass units of the same size and of the same cone technology as on the A 100, so that the same timbre will be produced harmoniously and consistently throughout your whole Home Theater system. The tweeter is also the same as on the A100 speaker, again to blend seamlessly with the other speakers. All units here are carefully shielded to protect your TV or your monitor from any magnetic interference coming from the very powerful magnets of the Focal units.



FOCAL

COMPACT B 300

Bass reflex with front slot-vent
H x W x D: 34 cm x 18 cm x 27 cm (13.3/8" x 7.1/8" x 10.5/8")
Certainly a small bookshelf speaker by its size, the B 300 is a real size performer, thanks to its unique dual voice coil mid bass unit and to the special crossover designed by Focal which uses the second voice coil in parallel with the first for a natural bass extension. In a 8.5l net internal volume (0.3 cu. ft.), this unique arrangement provides a -3dB response at 60 Hz! The tweeter is from the latest generation of Titanium dioxide concave dome tweeters with field replaceable moving assembly. A unique impedance adaptation device, positioned in front of the dome, controls its high frequency dome break up for an extended and sweeter, almost "silky", treble. This system will play loud enough for most mid size listening rooms, without ever become fatiguing. All crossover components have been carefully selected (we use high quality metalised polypropylene caps).



Send stamped self addressed envelope for a Focal Kit Brochure showing all their new kits.

ZALYTRON INDUSTRIES CORP.
469 JERICHO TURNPIKE, MINEOLA, N.Y. 11501
TEL. (516) 747-3515 FAX (516) 294-1943

Our warehouse is open for pick-up 10AM to 6 PM daily, Monday thru Saturday — UPS orders shipped same day • Minimum order \$50.00

CALL OR WRITE FOR OUR LATEST CATALOG

PANEL CUTOUTS

Building a speaker system of this size requires a fair amount of wood. Therefore, careful layout procedures can minimize expense. Since not many of you will construct these speakers out of 1-1/8" and 7/8" material as I did, please adjust the dimensions in the construction plans to your material's thickness (Fig. A).

I suggest a minimum 1" thick MDF, but you may use 3/4" as long as you add panel bracing to the larger expanses to avoid resonances. You can't use too much bracing in an enclosure as long as you keep in mind that everything you add takes away from the final box volume.

You'll need just under 2 1/2 sheets of MDF for this project. You may use the leftover material for extra bracing or for another project. To make

each section more manageable, I suggest rough-cutting from A to A, B to B, C to C, and so forth. The dimensions are slightly larger than finished size. Once you cut all pieces as shown, trim them to finish size as shown on the enclosure plan drawings. Note that I chose to rout in 1/2" on those pieces which fit in this manner. If you choose not to do this, or to rout in more or less, adjust dimensions accordingly (Fig. B).

The finished sizes are:

Baffle: 23" x 35" (two required).

Back: 23" x 35" (two required). The back view is not shown since it is essentially the baffle without cutouts. Remember, how-

ever, to rout in the diagonal for the front-to-back brace, which is also the bottom of the midbass subenclosure. You also need an opening for the input recessed terminal strip made of leftover wood.

Bottom midbass subenclosure: 18" x 16.5" (two required). Cut the end that butts with the enclosure side at 60°.

Right side/left side: 36" x 17.5" (four required). If you rout the back of the midbass subenclosure into the sides, do so on only one right and one left panel as these are mirror-image devices. A simple butt joint will also work.

Back subenclosure: 11 1/4" wide (25" one

side, 18" one side) (two required). If you are not routing into the sides as noted above, adjust width by the depth of the rout.

Sides of subenclosure: 7 1/2" x 18" (two required). Angle end to butt against subenclosure bottom 60°.

Top: 17 1/2" x 23" (two required). Rout in as shown on opposite sides of these mirror-image panels.

Bottom: 17 1/2" x 23" (two required). I used cantstrip for the corner bracing, although other methods such as biscuit corners are acceptable. Refer to Bob Wayland's series on biscuit joinery (SB 4/94 and 5/94).

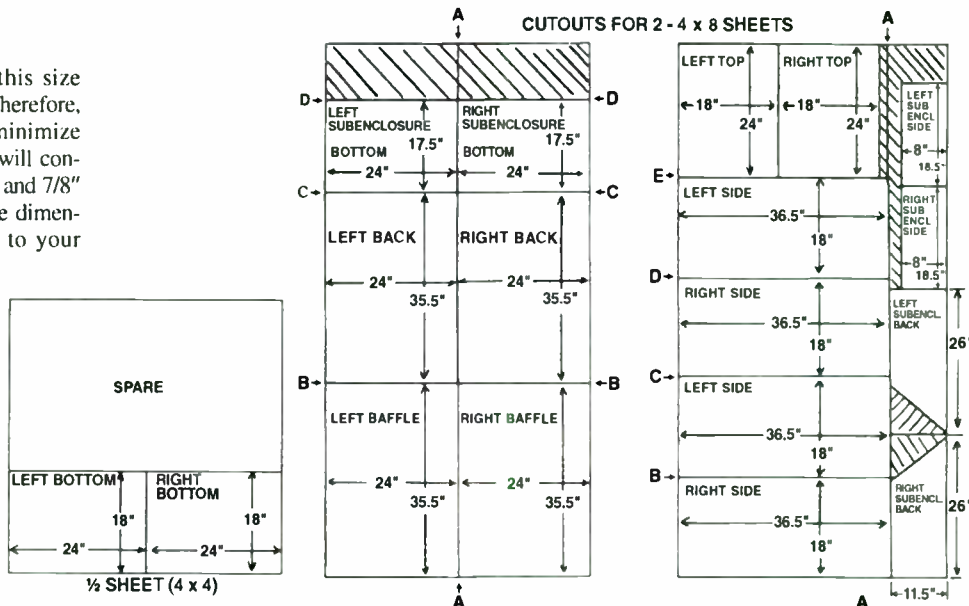

FIGURE A: Panel cutouts.

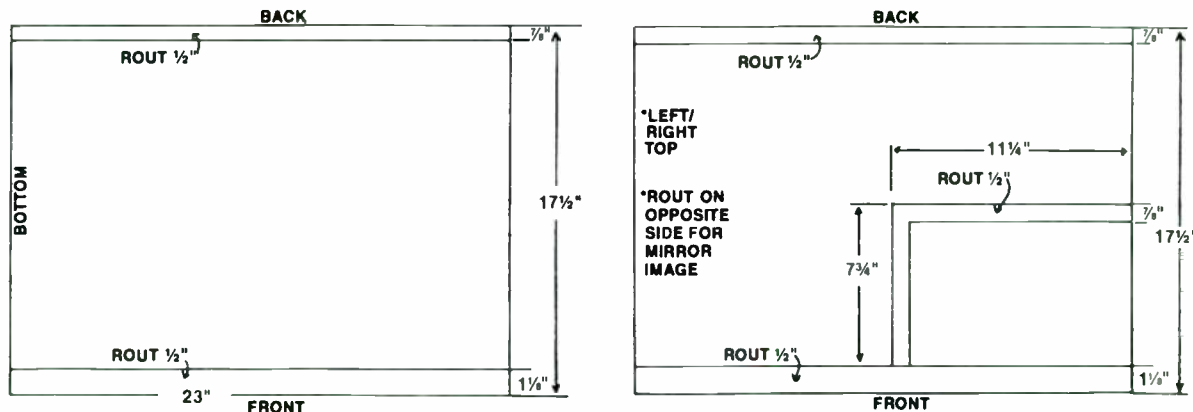

FIGURE B: Routing specs.

accomplished by increasing or decreasing the high-frequency output.

The addition of the active crossover, however, is another story. It will sound "different" than an all-passive system. I used a real-time analyzer (RTA) for initial level matching between the high- and low-frequency sections. Consider these as ballpark settings,

since you must use your ears for the final adjustments. By listening to varied program material, I found I was making minor level adjustments every week or so. Long-term listening is the only solution; your memory is capable of telling you what is too much and what is too little.

After a month or two, I used an RTA

again to see what the final reading looked like. Because of their size, I positioned the units away from room boundaries only for extended-length listening, then returned them to more "less imposing" locations for casual, everyday listening.

The more noticeable benefit of biamping, however, is the smaller load on the amplifiers

Accept no substitutes - insist on

Genuine Pyle
Pyle
Speakers and Components

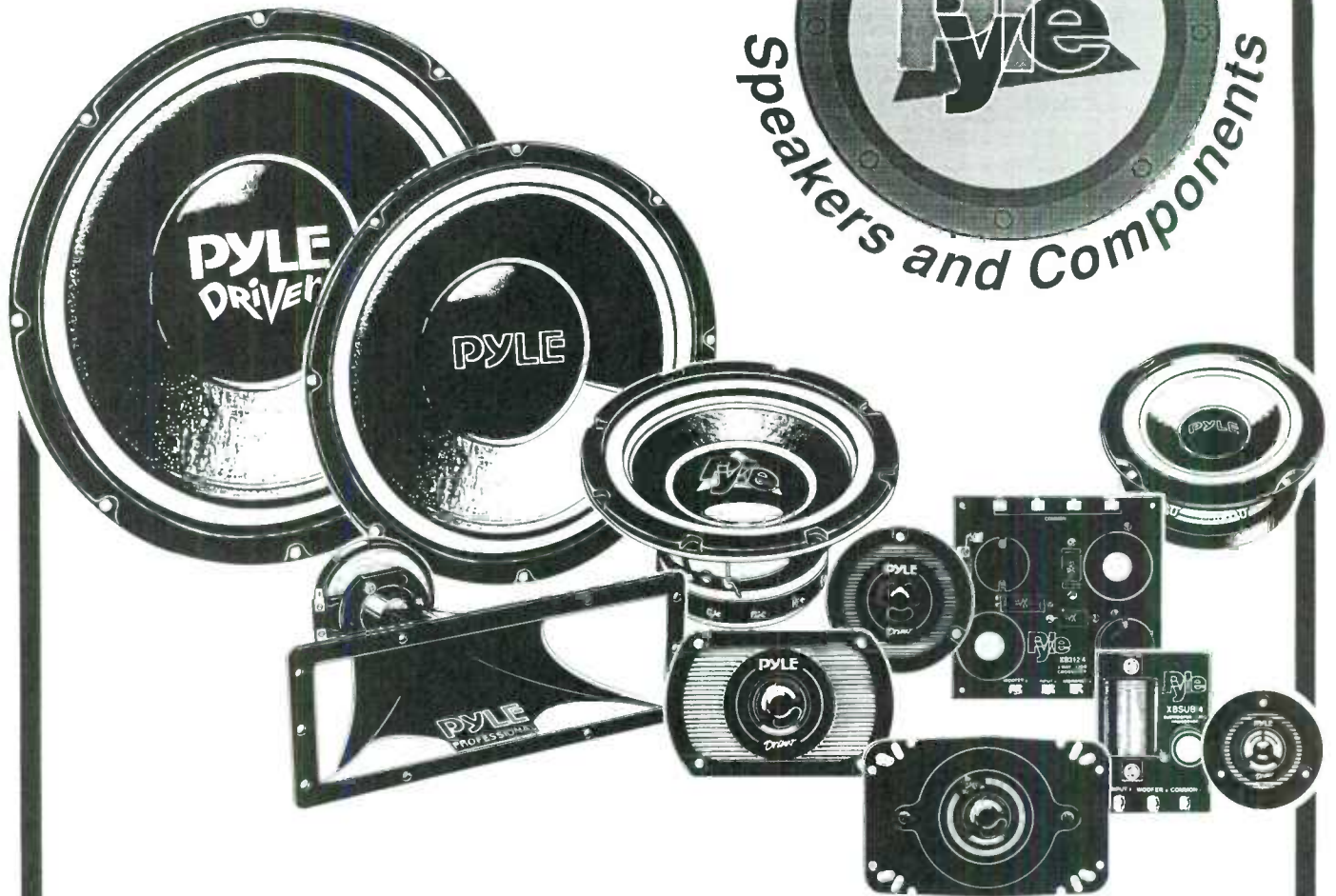

- Over 200 speaker models
- Sizes range from 1" tweeters to 18" massive motor subwoofers
- Parameters and recommended enclosures available for all woofers

PYLE

PYLE INDUSTRIES, INC. • 501 CENTER ST.
HUNTINGTON, IN 46750 • (219) 356-1200

H A Harman International Company

Made in U.S.A.

Reader Service #49

Turn Your Multimedia PC into a Powerful Real-Time Spectrum Analyzer

Features

- Dual channel FFT Analyzer
- Narrowband and 1/3 Octave
- Real-Time, Record, Playback, or Post Process
- Time Series, Spectrum, Phase, 256 Color Spectrogram and 3-D Surface plots
- FFT sizes through 16,384 pts
- Digital Filtering
- Signal Generation
- Decimation and Triggering
- Overlap Processing

Applications

- Acoustic Research
- Distortion Measurements
- Noise Analysis
- Frequency Response Testing
- Vibration Measurements
- Transfer Function Measurements

System Requirements

- 386/486/Pentium and Windows 3.1
- Windows compatible sound card
- 4 MB RAM minimum
- Mouse and Math coprocessor
- 256 Color VGA (for spectrogram)

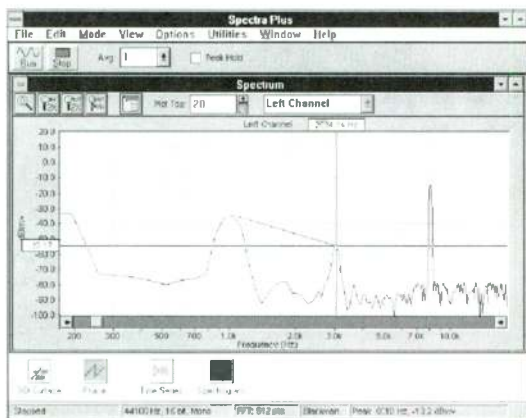

\$395 Software only

\$629 Software plus pro quality* sound card

*DC-19kHz flat to 0.2 dB, THD < 0.005%, SIN - 90 dB
2 channel, 16 bit, 44.1 kHz sampling.

PCMCIA sound cards also available

Call Now for Free Demo Disk! 1-800-401-3472

PHS

Pioneer Hill Software
24460 Mason Rd. NW
Poulsbo, WA 98370

Affordable Signal
Processing Software

Spectra Plus
Professional Edition

Tech Info: 360-697-7733

Fax: 360-697-7730

BBS: 360-697-7717

Reader Service #7

SPEAKERWORKS

"SPECIALISTS IN THE ART OF SPEAKER REPAIR"

FACTORY AUTHORIZED SERVICE:
Advent, B-I-C, Bozak, EPI, RTR,
Cerwin-Vega, JBL Home & Pro

Speaker parts & adhesives,
cones, spiders & dust caps

3 Way Crossovers Circuit
Breaker Gold Plated Binding
Posts \$19.95 each!

Replacement grilles for Altec,
B-I-C, Cerwin-Vega, JBL & Marantz

Refoam kits available for 4", 5-1/4",
6-1/2", 8", 10", 12", & 15" speakers
- only \$29.95 (JBL slightly higher)

Special Closeout on rebuilt DYN
Audio Drivers: MR 17.75, W30-100,
W24-100, W17-75. BELOW COST!

We Buy Dead Speakers: Altec, E-V & JBL



1-800-526-8879



NO CATALOG AVAILABLE

CALL US FOR HARD TO FIND DISCONTINUED PARTS
4931 A-1 South Mingo / Tulsa, Oklahoma / 74146

when you band-limit them. IM distortion is not propagated into the driver hierarchy when you use a low-level crossover. This, along with an apparent increase in dynamic range, improved transient response, and improved amplifier/speaker coupling, results in a decidedly "cleaner" sound, free of problems with multi-way passive crossovers.

RESULTS

So, how did my project turn out? Well, the time I spent with the paperwork was worth the effort. I was pleased how well everything seems to work together, with no one section taking over. I suppose that is the way a system should work. I'm not ruling out the possibility of any tweaking down the road, but no glaring mismatches are evident so far.

The system's sound belies its appearance in that it doesn't sound as dramatic as you would think. But then that's what I set out to build. It enables you to listen "through" your music collection. Depending on the source material, however, the sound ranges from "quite up front" to "distant."

I find myself listening to the music rather than the speakers. When the power is applied, though, it can produce incredible SPLs. You really don't realize how loud it is until you try to talk to the person next to you.

Some might consider this overkill in a home system, but I believe I have more than adequately achieved what I set out to do, and if a system is not being pushed to its limits, it will sound better than one that is. In closing, my thanks to Ralph and Dave.

SUGGESTED READING

1. A.N. Thiele, "Loudspeakers in Vented Boxes," JAES (May/June 1971).
2. R.H. Small, "Vented Box Loudspeaker Systems," JAES (Sept. 1973).
3. R.J. Newman and J.N. White, "Constructing Loudspeaker Systems With Predictable Performance," R-e/p (Aug. 1980).
4. J.N. White, "Loudspeaker Athletics," JAES (May 1973).
5. "Pro Sound Facts No. 7: DL Series Woofers—Plans For Recommended Enclosures and Small/Large-Signal Performance in These Enclosures," EV Publication (Oct. 1984).
6. "Pro Sound Facts No. 1: TL Bass Box Step-Down Equalization Through the Modification of a Sentry III Equalizer," EV Publication (Aug. 1975).

SOURCES

Electro-Voice, Inc.
600 Cecil St., Buchanan, MI 49107

Solen, Inc.
4470 Thibault Ave., St. Hubert, QC J3Y 7T9, CANADA
(514) 656-2759, FAX (514) 443-4949

SOLEN SPEAKER COMPONENTS

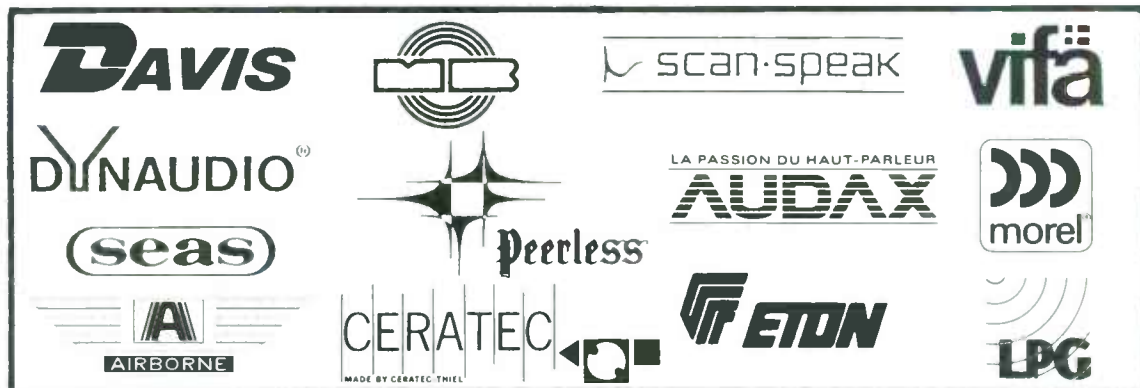

CROSSOVER, SPEAKER COMPONENTS



FAST CAPACITORS

Metallized Polypropylene (Non-Polarized)
 Values from 1.0 mfd to 200 mfd.
 Voltage Rating: 250 VDC / 150 VAC



SOLEN INDUCTORS

Perfect Lay Hexagonal Winding Air Cored
 Values from .10 mH to 30 mH
 Wire sizes from #20 AWG to #10 AWG



HEPTA-LITZ INDUCTORS

Seven Strands Litz-Wire Constructions
 Values from .10 mH to 30 mH
 Wire sizes from #16 AWG to #12 AWG

SOLEN CROSSOVERS

Custom Computer Design
 Passive Crossover for Professional, Hi-Fi and
 Car Hi-Fi, Power up to 1000 Watt

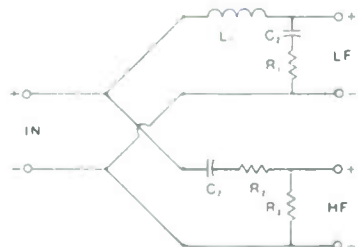

CROSSOVER, SPEAKER PARTS

Gold Speaker Terminals, Gold Banana Plugs
 Gold Binding Posts, Crossover Terminals
 Power Resistors, Mylar Capacitors,
 Bi-Polar Capacitors, Plastic Grille Fasteners,
 Nylon Ties, Car Speaker Grilles, Speaker Books,
 Speaker Kit Brochure, Miscellaneous Parts



SOLEN INC.

4470 Thibault Ave.
 St-Hubert, QC J3Y 7T9
 Canada

Tel.: (514) 656-2759

Fax: (514) 443-4949

COMPUTER AIDED DESIGN FOR ENCLOSURE AND CROSSOVER AVAILABLE TO CUSTOMER

Catalog \$6.00 refundable.

EXTENDING IMP: A PROGRAM SET

By G.R. Koonce

The IMP Audio Analyzer by Liberty Instruments is a speaker testing device covered in several previous issues of *Speaker Builder*.¹ With its associated software it lets you run impedance and acoustic tests for drivers and speaker systems on your computer. You quickly learn that a

time-windowed tester does not solve all your problems with real-room testing. You must still carefully plan the test layout and use common sense to interpret your results. The IMP software also generates data files that other programs can process.

This article covers a set of programs that I

developed to work with IMP on an IBM-compatible computer. Two of the programs help you set up your tests, while the other three post-process data from IMP tests saved as files.

The Liberty Audiosuite software recently introduced by Liberty Instruments works with a sound card to provide testing capability exceeding that offered by IMP. Liberty Audiosuite will output files compatible with those generated by IMP that can be post-processed by the programs discussed in this article. While the article discusses IMP-generated files, these files could actually be generated by either IMP or Liberty Audiosuite.

ECHO-FREE TESTING

The purpose of time-windowed testing is to help eliminate room effects, which are normally reduced by near-field testing or test signals with some bandwidth to break up room resonances such as warble tone sinusoids or noise. Near-field testing, using fixed frequency sinusoids, simply overwhelms the room interference by a high signal-to-interference ratio. It works very well and is my favorite technique, but unfortunately, it has an upper frequency limit and

Model used by program:

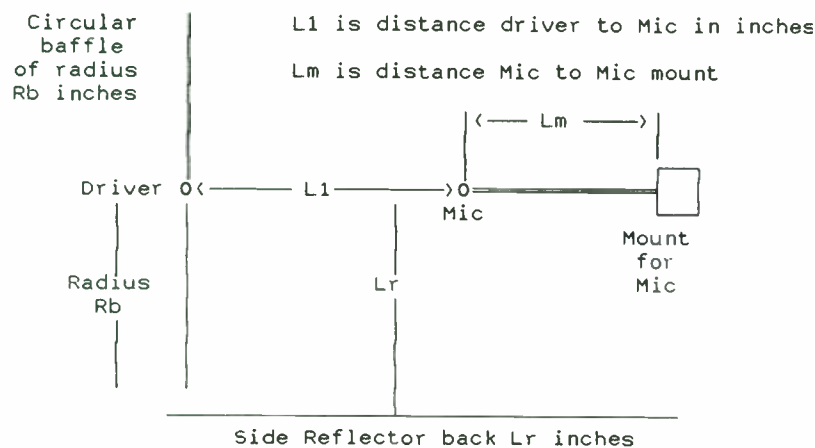

M to Menu, nul to next page:

FIGURE 1: Setup model used by IMPSpace. [In his programs the author follows the standard abbreviation for microphone. SB adopts an alternative style, mike.—Ed.]

FFT window Tw =	2.20 mS	Min Freq of Interest Fmin =	1000.0 Hz	
Period of Fmin Tp =	1.00 mS	Ratio Tw/Tp =	2.2000	
Minimum Mic length to mount Lm =	21.70 inches		01-17-1995	
Dvr to Mic L1 inches	To Side Refl. Lr inches	Baffle Radius Rb inches	All echoes must be delayed mS	Delay FFT window mS
9	25.81	25.42	3.86	0.664
12	27.04	26.40	4.08	0.885
15 - - -	28.22	27.27	4.31	1.106
18	29.35	28.06	4.53	1.327
21	30.44	28.77	4.75	1.549
24 - - -	31.49	29.42	4.97	1.770
30	33.49	30.56	5.41	2.212
36	35.38	31.53	5.85	2.655
42 - - -	37.17	32.37	6.30	3.097
48	38.89	33.09	6.74	3.540
60	42.10	34.29	7.62	4.425
72 - - -	45.09	35.23	8.51	5.310
84	47.89	36.00	9.39	6.195
96	50.53	36.64	10.28	7.080

R to enter new data, nul to Menu:

FIGURE 2: Sample result from IMPSpace.

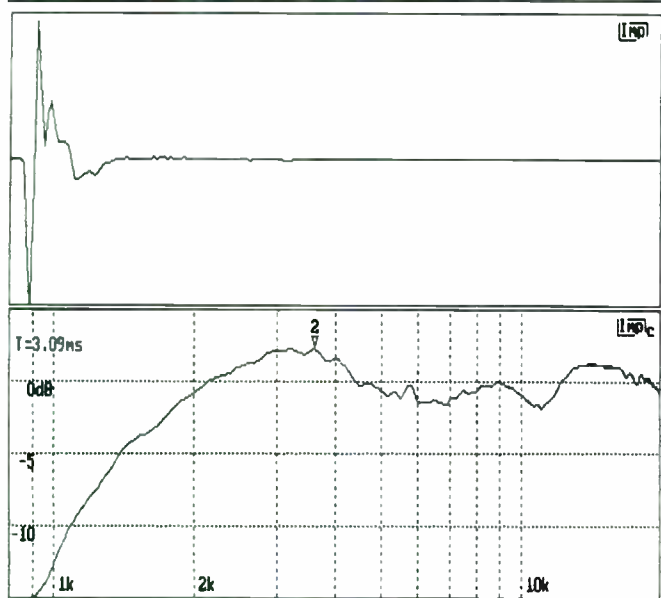

360.0Hz: -24.9dB -17.4° Δ -27.15dB 3600.Hz: 2.237dB 139.3°
FIGURE 3: Tweeter measurement with clean time response window.

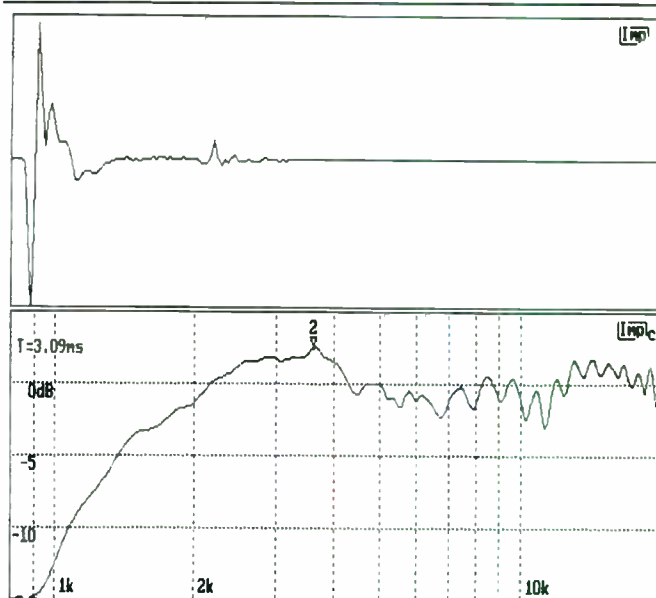

360.0Hz: -23.4dB -20.5° Δ -25.95dB 3600.Hz: 2.475dB 141.6°
FIGURE 4: Tweeter measurement with echo introduced.

becomes very messy with multiple-output systems, such as multiple woofers, vented box, or passive radiator systems, covering the same frequency range.

The time-windowed technique avoids the room interference by processing the direct signal from the driver/system to the microphone and blocking room reflections by not processing data arriving after a certain time. This works well if you are careful with your test setup so that all echoes are sufficiently delayed.

Time-windowing's problem is that it puts a lower test-frequency limit on your result. You simply can't derive the 5Hz response of a system with only a 0.5ms sample of its output. Thus, you must make sure all objects that can generate an unwanted reflection are sufficiently far back, and use the proper window width with IMP for the desired results. The IMPSpace and IMPRoom programs help you set up your tests.

IMPSPACE PROGRAM

This program allows you to establish the requirements for an absolutely anechoic test of a driver: no unwanted echoes in the time window to be processed. You will probably only be able to establish such a test setup within a room with tweeters, i.e., drivers with the response down to about 1kHz. IMPSpace assumes you mount the driver flush in a baffle of adequate diameter to avoid the edge effects of the baffle, place all side reflectors back the necessary distance, and use a test microphone of sufficient length to avoid reflections from the microphone mount. *Figure 1* shows the model used by IMPSpace.

To use the program you enter the intended FFT window width (1–300ms), the minimum frequency of interest (51Hz–5kHz), and optionally the microphone-to-driver spacing (5–100"). If you do not enter microphone-to-driver spacing, the program will present a scan of spacings. The program indicates the minimum microphone length to its mounting, the minimum baffle radius, and the distance of all side reflectors from the test setup. IMPSpace will warn you if the width of the specified FFT window is incompatible with the desired test low-frequency limit. The program information section defines the rules the program uses.

Figure 2 lists the results for a test with a 2.2ms FFT window for 1kHz. Note that a microphone length of 21.7" is required to accomplish this test. For various microphone-to-driver spacings, *Fig. 2* includes the indicated time by which all echoes must be delayed, along with the approximate delay before the FFT window should start.

Figure 3 shows the time response (3.09ms) and the FFT-generated frequency response for a tweeter. This setup complies with the IMPSpace requirements, except no baffle was used, and the bare tweeter was suspended well off the floor, facing upward. The test microphone was 33" long from the end to the mount and hanging down from the ceiling. The time response is very clean, and so is the resultant unsmoothed frequency response.

Figure 4 shows the same tweeter in the same test setup, except a microphone stand is set back about 1' from the test path and introduces an echo at about 1ms. Note how this single echo source messes up the FFT-

generated frequency response of the tweeter by introducing numerous wiggles in the basic shape and making it difficult to identify true wiggles in the response.

The purpose of IMPSpace is to allow you to set up tests that produce clean results (*Fig. 3*). Note that you will not always obtain results this clean even with careful test methodology. I tried six different tweeter types in the same test setup, and only two produced time responses as clean as *Fig. 3*. The fault is not the test setup, but that many tweeters internally produce echoes, which are correctly considered part of the tweeters' response. If you are sure your test setup is clean, then you can identify such tweeters.

Remember, IMPSpace is designed to keep all reflections out of the test FFT window and is useful only with tests down to about 1kHz. As the FFT window becomes wider, you simply can't make the microphone long enough, or the baffle big enough, or position all the side reflectors back far enough. You must keep the microphone-to-driver spacing above a minimum for a valid response from the entire tweeter structure, which is developed in the next program.

IMPROOM PROGRAM

This program is based on the excellent article by Stuck and Temme,² who discuss the requirements to perform valid near-field and far-field tests. In general they show that you are best off using near field at low frequency and far field at high frequency. If all is well, you can overlap the two results to produce the total system response curve, which the IMP software is capable of doing.

IMPRoom offers the following:

1. For individual drivers, it will help establish the proper near-field test setup and test upper-frequency limit, both theoretical and real world.

2. For individual drivers or complete systems, it will help establish the proper far-field test setup and lower test-frequency limit.

3. For valid far-field tests, it will aid you in converting the result to a 1m reference, as is normally used.

When working with near-field testing of an individual driver, the program accepts a driver diameter input—either piston or nominal—and assumes the piston diameter is 80% of nominal. Optionally, you can enter the size of the structure (baffle or enclosure) housing the driver, which will affect the real-world near-field test frequency limit.

The program reports the maximum microphone-to-driver spacing for error less than 1dB, the theoretical upper test-frequency limit for 1dB error based on driver piston diameter, and (if you entered the structure size) the real-world test upper-frequency limit for 1dB error based on structure size. The decibel values to correct the measured response to a 1m reference are provided for 2π SR (steradian) and 4π SR radiation. Figure 5 shows a sample result for near-field testing, which does not require time-windowed measurement, so this portion of the program is useful for steady-state sine-wave testing.

For far-field testing of a driver, you again enter driver diameter, the dimensions for an entire enclosure, and the room dimensions. If your room supports an optimum valid far-field test of the driver/enclosure, then the program will display the test setup and limits (Fig. 6). The program includes the time delay before starting the FFT window, the window width, and the minimum valid test frequency for the indicated test conditions.

Here I disagree with Stuck and Temme, who use the minimum frequency as the period of the FFT window, which I believe is optimistic with IMP's rectangular window. So my program reports a frequency twice this value. You can determine your own value. Note that the output also provides corrections for converting the response to a 1m reference for a point source (decays 6dB per 2:1 distance increase free field) and a line source (decays 3dB per 2:1 distance increase free field).

If your room is not big enough to support a valid far-field test for your driver/enclosure with optimum echo suppression, then the program will offer the following options: you can either proceed with the best setup for the room—even if not a valid far-field test distance, in which case you can't convert to a 1m reference—or enter a microphone-

No Title Entered

Near Field Test Data & Limitations:

Driver Cone diameter = 6.800 inches.

Baffle dimensions: Height = 15.00 inches.
Width = 12.00 inches Thickness = 0.500 inches.

Maximum Mic to driver distance for 1 dB error = 0.374 inches.

Maximum theoretical test frequency for 1 dB error = 634.0 Hz.

Maximum real world test frequency for 1 dB error = 224.3 Hz.

Note: Use an FFT window width at least 2 times the period of the minimum frequency of interest.

To convert Near Field SPL to 1 meter reference:
For 2π sr free field radiation Subtract: +27.29 dB
For 4π sr free field radiation Subtract: +33.31 dB

FIGURE 5: Sample output from IMPRoom for near-field test.

Demo Plot of Testing Enclosure in Large Room

Far Field Test Layout & Limitations:

Room Dimensions: Length = 20.00 feet
Width = 18.00 feet Height = 12.00 feet

Test setup for Enclosure along center line of room's length:

Front of Enclosure out 7.071 feet from one end wall.

Mic out same distance from other end wall.

This gives Mic to source distance of 5.858 feet.

Center of front panel is set at 6.000 feet off the floor.

Enclosure dimensions: Height = 1.500 feet Width = 1.000 feet
Depth = 0.750 feet.

FFT window should start at about 5.190 ms.

Maximum FFT window length is about 6.641 ms.

Minimum valid frequency for test is about 301.1 Hz.

To correct result to a 1 meter reference:
For Point Source correction is +5.03 dB
For Line Source correction is +2.52 dB

FIGURE 6: Sample output from IMPRoom for far-field test.

to-driver/enclosure spacing to give valid far-field results, which may severely limit the low-frequency test limit due to early echoes. You can play around with various spacings until you achieve acceptable results.

IMPRoom has one further capability: when you enter the test distance used for a far-field measurement, the program calculates the decibel conversions for a 1m reference, as described previously. The program also allows you to enter data in metric or US standard units. All output screens let you display the

results in inches, feet, centimeters, or meters, and whichever dimension you choose will be used in printouts. This program has mouse support but can be keyboard-operated.

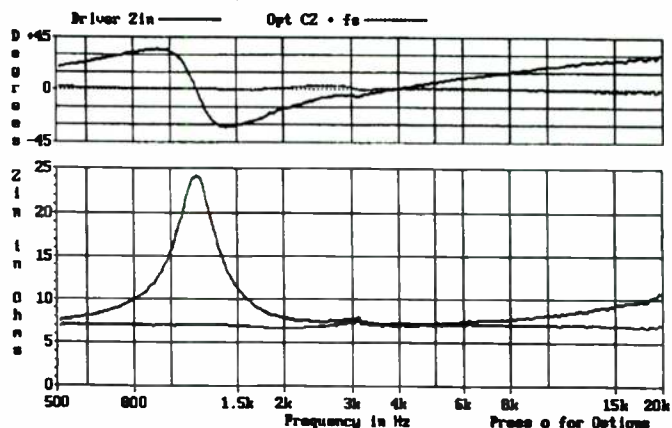

FIGURE 7: IMPZobel Z_{IN} plot for tweeter 1 with Complex Zobel with f_s correction.

Announcing

The First Ever

Efficient Speaker Design Competition

GRAND PRIZE

Welborne Labs

Laurel II 300B Amplifier Kit

featuring

MagneQuest

"First Series"

Hand wound

Output Transformers

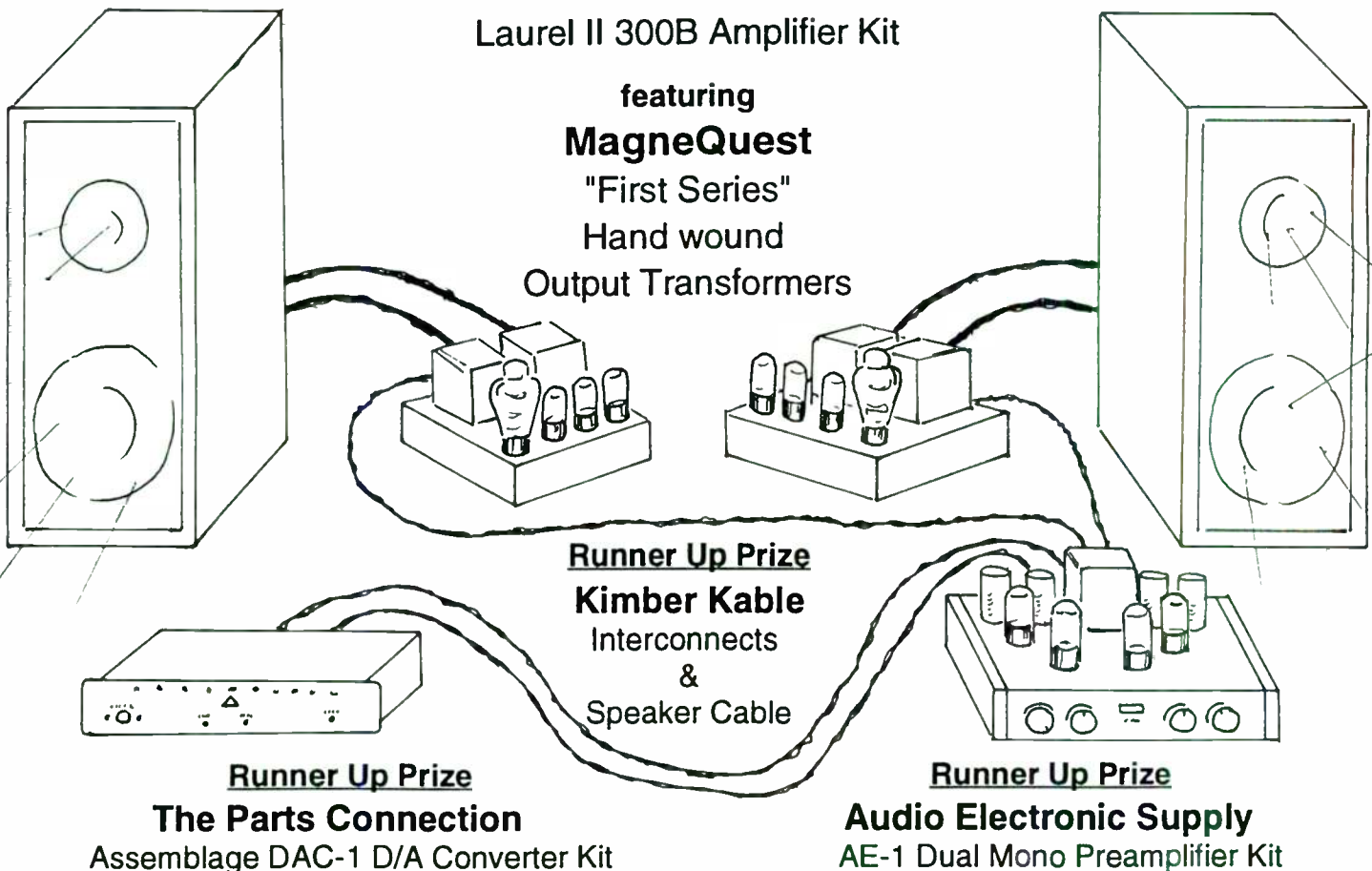

Runner Up Prize

Kimber Kable

Interconnects

&

Speaker Cable

Runner Up Prize

The Parts Connection

Assemblage DAC-1 D/A Converter Kit

Runner Up Prize

Audio Electronic Supply

AE-1 Dual Mono Preamplifier Kit

Plus many other exciting prizes including **Hovland MusiCaps**, and subscriptions to **Sound Practices**, **Positive Feedback**, and **Speaker Builder**. Everyone is a Winner!

Since our decade is shaping up to be the era of the low-powered single-ended amplifier, what could be more timely than a contest devised to spotlight efficient speakers that can showcase the dynamics, power, and sonic glory these wondrous little amps can provide? Mainstream speaker manufacturers are saying that it can't be done, but you know it can!!! So break out those driver catalogs and sharpen your table saws, the competition is about to begin!

All judging will be performed by the prestigious Colorado, Oregon, and Philadelphia audio societies
Construction articles for the winning designs to be published in **Speaker Builder**, **Positive Feedback** & **Sound Practices**

Entries must be received by September 31, 1995

For ground rules and entry form, send a stamped, self-addressed, business size envelope to one of these audio clubs:

Oregon Triode Society
4106 N.E. Glisan
Portland, OR 97232

Philadelphia Audio Society
P.O. Box 91
Devon, PA 19333

Colorado Audio Society
1941 S. Grant Street
Denver, CO 80210

POST-PROCESSING FILES

IMP is capable of outputting frequency response and impedance data in ASCII (text) files, with the .FRD and .ZMA filename extensions, respectively. They cannot be called back into IMP but can be used by other programs. If you use the original IMP software, you should save the time response files (including the Cal response) so IMP can retrieve the files and generate new .FRD or .ZMA files if needed. If you use IMP/M software or Liberty Audiosuite, you can save .FR2 or .ZF2 files, which can be recalled, but the following programs will only work with the ASCII .FRD and .ZMA files.

IMPZOBEL PROGRAM

This program works with an IMP-generated .ZMA file to develop Zobel for drivers. It will develop a range of Zobel from the simple, usual two-component variety to a complex seven-component variety that will flatten the driver impedance around the resonance range right up through high frequency. The complex Zobel are based on Victor Staggs' excellent article on driver impedance (*SB 5/94*, p. 28). IMPZobel works with IMP-generated .ZMA files but will allow keyboard entry of data sets (frequency in hertz, impedance magnitude in ohms, impedance phase in degrees), with a minimum of five sets

Complex Zobel for Dome Tweeter
Driver Zin Data from: TWEETER1.ZMA
Complex Zobel with f_s Correction:

Schematic for Complex Zobel with f_s Correction

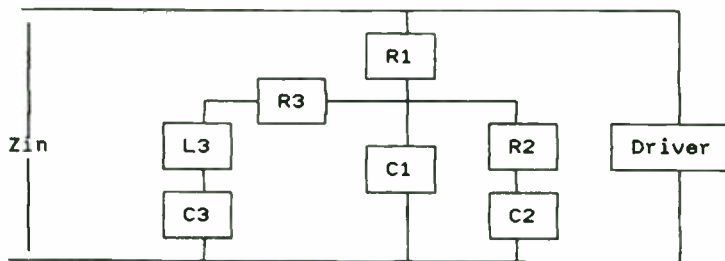

Component Values: R1 = 7.000 ohm R2 = 4.296 ohm R3 = 2.865 ohm
C1 = 0.253 uFd C2 = 0.822 uFd C3 = 11.35 uFd
L3 = 1.647 mHy

Driver Data: Re = 7.000 ohm fs = 1,164 Hz Rmax = 24.10 ohm
Qms = 4.204 fm = 4,000 Hz

Model Data: Ra = 11.41 ohm Rb = 17.10 ohm Ca = 33.62 uFd
La = 0.040 mHy Lb = 0.012 mHy Lc = 0.556 mHy

FIGURE 8: Schematic for Complex Zobel with f_s correction for tweeter 1.

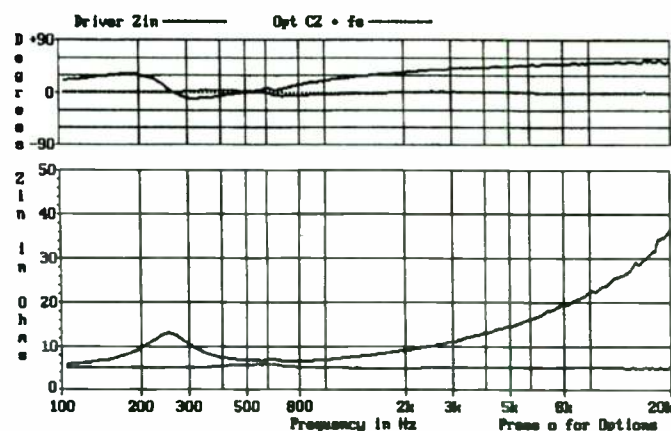

FIGURE 9: IMPZobel Z_{IN} plot for midrange with Complex Zobel with f_s correction.

required and a maximum of 50 sets allowed. You can write keyboard-entered data to a .ZMA type file for future use.

The program prompts you for the path to the .ZMA files, and then displays a directory of this path. You can select the proper .ZMA file by number. File size must be no greater than 30K; if the file is rejected as too big, call your original data back into IMP and generate a file which covers a narrower frequency span or reduce the file size as discussed later in this article.

Technologie

MDB

Affordable Excellence from Canada
L'excellence Abordable du Canada

Now featuring the new FOCAL Hi-Fi and Audio-visual kits, with three compact speaker kit models and a center channel plus four brand-new column speakers! Advanced technology including dual voice-coil drivers, sandwich Kevlar and Polyglass cones, flat ribbon voice coils, concave dome tweeters with phase plugs, tioxid domes, Axon capacitors, high-quality inductors, and more!

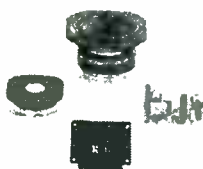

Technologie MDB

4000 Terrasse Jean XXIII, St. Hubert, Québec J4T 3L6 Phone (514) 891-6265 Fax (514) 443-5485

AEON 250 VDC 5% FINE CAP



Metallized polypropylene capacitors for loudspeaker passive network.

Another brand of metallized polypropylene capacitors ? Well, not exactly ... At Orca we have been thinking for a while about how to make polypro caps more affordable for a larger number of speaker builders, people who use caps only for speaker passive X-over network. We thought that it would be tremendous if we could offer a line of polypro caps that would

be so affordable that people would have no reason to use cheap mylar, as they would be able to get for not much more money a much much better cap. As you know, even extremely powerful solid state amps (we are talking KW here) can barely produce rail voltage higher than 60 V. So it is safe to assume that a 100 VDC cap would be a pretty robust cap to use in a passive loudspeaker network. So to be really safe, we decided to make all the AXON cap of our FINE CAP basic line 250 VDC. Now that's about where the compromises start and stop. On the other hand for example, you may or may not know that when a cap value is said to be 10.0 μF with 5% precision, it means that the manufacturer of caps sets its winding machine to 9.7 μF and then produces this series with 2% tolerance (not very difficult with numeric controlled winding machines). The result: the manufacturer saves more than 3% in material, the precision is respected, but chances are all your caps will measure on the low side ! Orca made the special arrangement that all the AXON caps were to be wound with 5% precision with the target value set at exactly the nominal value. That means now, as most of you do, and rightly so, expect, that you should find a much greater proportion of caps very close to exactly 10.0 μF, if not 10.0 μF exactly! As for the rest, we could display here all sorts of figures and graphs that would only makes sense to 1% of our customers, but what for ? We can simply tell you this is the first polypro cap at a price closing on mylar caps. It is made by the same company that makes all our high voltage and very high voltage SCR caps, as well as our film and foil caps. Some of the best loudspeaker manufacturers have already made that easy choice. Now see for yourself and ... let your ears make the call.

Value μF	Diameter mm	Length mm	SRP US\$	Value μF	Diameter mm	Length mm	SRP US\$
1.0	11	21	1.23	12.0	25	33	3.56
1.5	12	22	1.44	15.0	25	38	4.18
1.8	13	22	1.49	20.0	29	38	5.16
2.2	15	22	1.58	24.0	29	43	5.98
2.7	14	25	1.67	30.0	32	43	7.30
3.0	15	25	1.73	33.0	32	48	7.74
3.3	16	25	1.78	41.0	35	48	9.32
3.9	16	25	1.83	50.0	37	53	10.96
4.7	18	27	1.96	51.0	37	53	11.16
5.6	18	30	2.10	56.0	39	53	12.00
6.0	19	30	2.20	62.0	39	53	12.98
6.8	20	30	2.33	75.0	43	58	15.12
8.0	20	33	2.91	82.0	45	58	16.28
8.2	21	33	2.97	91.0	47	58	17.50
9.1	22	33	3.08	100.0	49	58	18.76
10.0	23	33	3.23	120.0	51	63	21.98
11.0	24	33	3.38	130.0	54	63	23.38

STOCKING DISTRIBUTORS:

W.A.R. AUDIO AUSTRALIA
tel:(61)-9-242-5538 fax:(61)-9-445-2579
SPEAKERS ETC...
tel: (602) 272 6696 fax: (602) 272 8633
TECHNOLOGIE MDB
tel: (514) 526 8851 fax: (514) 443 5485
ZALYTRON INDUSTRIES
tel: (516) 747 3515 fax: (516) 294 1943

OEMs & EXPORT

Contact **Kimon Bellas**
or **John Sangalli**
tel: (818) 707 1629
fax: (818) 991 3072
ORCA
1531 Lookout Drive
Agoura, CA 91301
USA

NOW AVAILABLE:

FILM / FOIL 630 VDC CAPS for electronics and bypass from 0.1 μF to 1.0 μF.
POLYPRO ULTRA HIGH VOLTAGE 1200 VDC 20 μF for power supply & tube electronics

Driver Zin Data from: MIDRANGE.ZMA

Complex Zobel with fs Correction:

Schematic for Complex Zobel with fs Correction

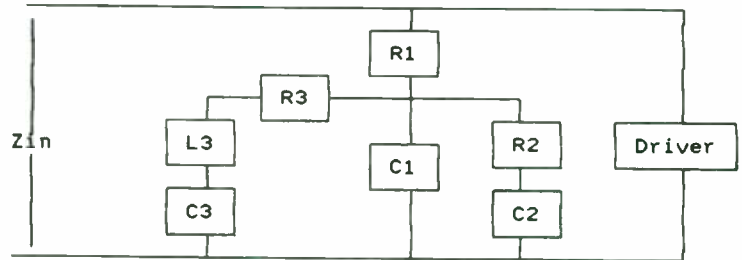

Component Values: R1 = 5.070 ohm R2 = 4.288 ohm R3 = 3.241 ohm
 C1 = 10.53 uFd C2 = 15.86 uFd C3 = 83.15 uFd
 L3 = 4.541 mHy

Driver Data: Re = 5.070 ohm fs = 259.0 Hz Rmax = 13.00 ohm
 Qms = 2.280 fm = 510.0 Hz

Model Data: Ra = 5.995 ohm Rb = 7.930 ohm Ca = 176.7 uFd
 La = 0.408 mHy Lb = 0.271 mHy Lc = 2.137 mHy

FIGURE 10: Schematic for Complex Zobel with f_s correction for midrange.

Once the file is accepted, you enter a frequency range to process/plot that can contain all or simply a portion of the frequency range of the IMP data file. You may then select a number of points to process up to the maximum in the file falling within the process/plot frequency range.

If you use too many points, the program will take a very long time to run. You might wish to start with only 20 or so points and then increase the number later for better plots. I find 150–200 points produce very good plots. The program has an information screen to aid you in picking the proper portion of the impedance curve for Zobel development. The program also allows entry of an optional driver name to appear on the plots and printouts.

IMPZobel provides four approaches:

1. Specified Simple Zobel: series R-C across the driver terminals, where you supply the component values. This allows evaluation of a Zobel design you already have. It is equivalent to simply trying the values and testing with IMP, except you don't need the various components.

2. Optimum Simple Zobel: series R-C designed by the program for best performance. The program varies R and C to produce the lowest phase error squared for the portion of the driver Z_{IN} curve with positive phase shift.

3. Specified Complex Zobel: you enter the values for the four components (two resistors and two capacitors) constituting a Complex Zobel. Again, this is equivalent to simply trying the values with the driver and testing via IMP, but you don't need the components. Attempting to determine the proper Complex Zobel values by trial and error can be frustrating.

4. Optimum Complex Zobel: the program tries to model the driver using Victor Staggs' schematic. If the model is successfully generated, you can develop three different Complex Zobels:

(a) normal Complex Zobel with two resistors and two capacitors to flatten the driver impedance at high frequency;

(b) network to correct driver impedance about resonance f_s . Network is a series R-L-C;

(c) combination of Complex Zobel with f_s correction to flatten the driver impedance over its full-frequency range. This network consists of the seven components composing the two networks above, but not all component values are the same.

The development of a Simple Zobel is common knowledge, so I will not discuss it

Everything You Need To Build Awesome Enclosures!

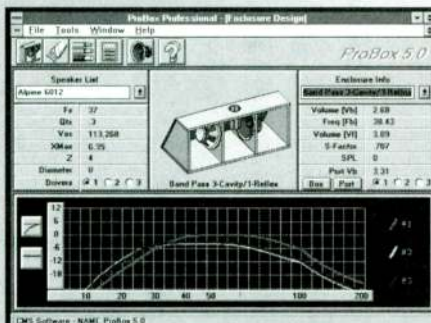

ProBox 5.0 Speaker Building Software for Windows

Calculates every practical configuration from sealed enclosures to triple-cavity iso-vent enclosures. Equipped with detailed and yet easy to read displays & full color diagrams. Multiple Box Design Viewing • Multiple Response Curves • IASCA Wire Calculator • Breakdown of Shapes & Sizes in a Cut Sheet Diagram • Database to Store Box Designs

WOODWORKING PROJECTS FOR CAR AUDIO SYSTEMS

Production Line Woodworking Skills • Five-Sided Boxes for Mini Trucks • Wood-Bending • Contouring • Tools & Their Uses (Such As Routers)

HOW TO CONSTRUCT A SPEAKER ENCLOSURE

Acoustic Theory • Formulas for Areas, Volumes, Displacements & Port Lengths • Parameters • Acoustic Suspension & Bass Reflex Enclosures

HOW TO DESIGN & BUILD EXOTIC ENCLOSURES

Isobaric, Band Pass & Iso-vent Enclosures • Best Enclosures for Particular Speaker • Tuning Frequency • Vent Design • Standing Wave Modes

ProBox 5.0 Speaker Building Software

\$99.95

Video Prices:

WOODWORKING PROJECTS FOR CAR AUDIO SYSTEMS \$49.95
 HOW TO CONSTRUCT A SPEAKER ENCLOSURE \$49.95
 HOW TO DESIGN & BUILD EXOTIC ENCLOSURES \$49.95

Special Discounted Offer!
 All 3 Videos with Software \$199.95

TO ORDER
 1-800-467-6263



National Academy of Mobile Electronics

7867 Dunbrook Road, Suite E • San Diego, CA 92126
 Phone: 619-695-1784 FAX: 619-695-3864



Skaaning Loudspeakers

These loudspeakers are a perfect blend of accurate performance, robust construction, and elegant industrial design. The SK170 is a mid bass driver for use in a sealed system, a woofer for small vented systems, or a bandpass subwoofer. Applications include recording monitors, compact hi power audio.

The SK300 combines the dynamic range of professional stage woofers and the accuracy of hi-fi woofers. It is designed for use as a subwoofer in Audio, Home Theatre, and Professional applications. It is also available as a Dual Voice Coil unit at 4 ohms per coil: SK300-344DVC.

To show the awesome capabilities of Skaaning Loudspeakers, Madisound has developed the Mimesis system for exhibition at a recent Stereophile show. The Mimesis has extremely wide dynamic range, clean transients, and unequalized bass output extending below 25 Hz in a sealed cabinet.

Ejvind Skaaning was the founder and guiding force behind the well respected Danish companies of Scanspeak and Dynaudio. Mr. Skaaning's engineering skill and innovative designs are fully expressed in his new line of loudspeakers.

Technical Data	Symbol	SK170-308	SK300-304	Unit
Nominal Impedance	Z	8	4	Ω
Resonance Frequency	Fs	37	18.38	Hz
Power Handling Nominal	P	200	350	W
Sensitivity (1W/1m)	E	90	91	dB
Voice coil Diameter	\emptyset	77	77	mm
DC Resistance	Re	5.49	3.4	Ω
Voice Coil Inductance	Lbm	.243	.557	mH
Voice Coil Length	h	10	30	mm
Former		Aluminum		
Wire		Aluminum		
Number of Layers	n	2	2	-
Basket		210mm \emptyset Die Cast Aluminum	350mm \emptyset Die Cast Aluminum	
Cone Material		Mineral Filled Polypropylene		
Surround Material		Rubber		
Magnet Size		170mm OD x 20mm H, 77mm ID	170mm OD x 24mm H, 77mm ID	
Force Factor	BL	7.4737	9.5235	NA ⁻¹
Height of Magnet Gap	He	20	10	mm
Linear Excursion peak	Xmax	5	10	mm
Suspension Compliance	Cms	1161.44	1052.72	μmN^{-1}
Mechanical Q Factor	Qms	1.704	1.722	-
Electrical Q Factor	Qes	0.365	0.308	-
Total Q Factor	Qts	0.300	0.262	-
Moving Mass	Mms	15.98	71.24	g
Effective Piston Area	S	0.017	0.0515	m ²
Equivalent Air Volume	Vas	47.66	396.48	Ltrs
Leap Motor Constants	Krm	160.172	4.037	m Ω
	Kxm	448.881	31.023	mH
	Erms	0.308	0.720	
	Exms	0.140	0.540	
Price Each		\$400.00	\$680.00	



SK170-308

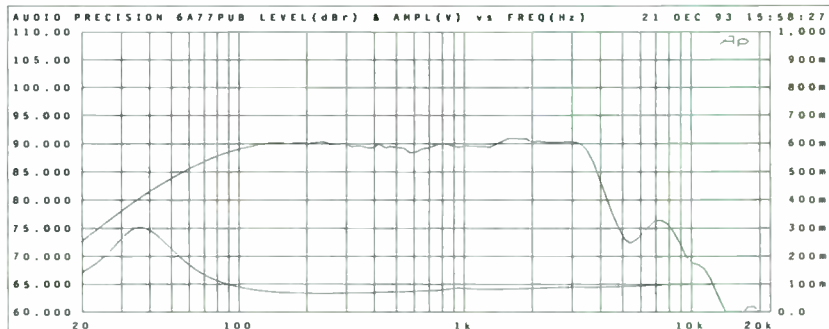

SK300-304

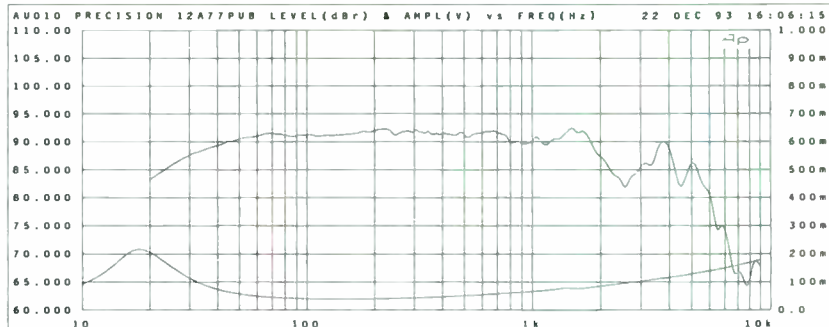

Madisound Speaker Components; P.O. Box 44283, Madison, WI 53744 U.S.A.; Tel 608-831-3433, Fax 608-831-3771

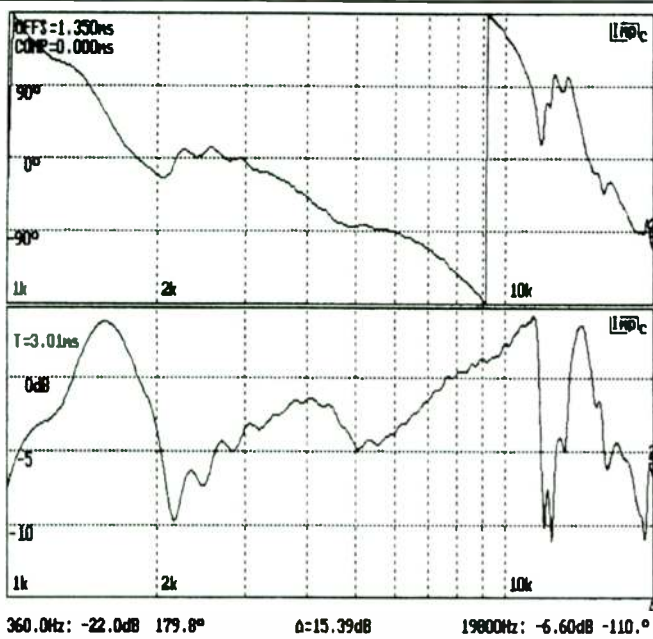

FIGURE 11: IMP frequency response plot of tweeter 2.

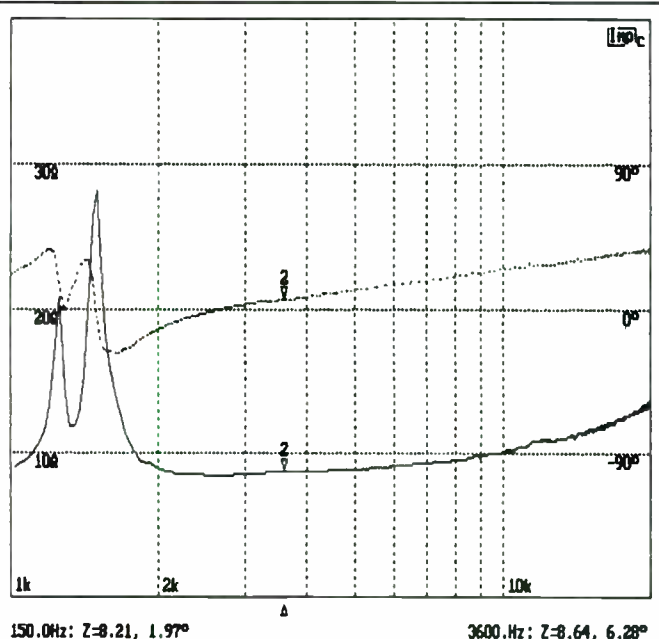

FIGURE 12: IMP impedance plot of tweeter 2.

further. The Complex Zobel is another matter. While the Simple Zobel is based on the driver assumed represented by a series L-R at high frequency, the Complex Zobel includes the effects of eddy currents and is far better at correcting the driver Z_{IN} to a pure resistance.

COMPLEX ZOBLER

With IMP, measure the driver impedance from below f_s to a high enough frequency that the impedance is rising. Then output a .ZMA file for this data. Using the markers for IMP, locate and record the resonant peak

resistance (R_{MAX}) and the frequency (f_M) where the phase goes through zero above resonance.

Now perform a T/S extraction to obtain the driver DC resistance (R_E), driver resonance (f_s), and driver mechanical Q (Q_{MS}). Print or record the T/S parameter data. With IMPZobel, import the .ZMA file and select Design Optimum Complex Zobel. The program prompts for the extra data listed above, then tries to model the driver Z_{IN} curve, and, if successful, allows design of the three networks described above.

It is possible the model generation

loop will fail to properly converge. The program will report this, and, if the error is not fatal, will allow you to proceed with using the model. You should plot the model Z_{IN} and driver Z_{IN} to see how well the model fits the driver before using any network designs. Certain loop failures are fatal, and you can't use the model, since network design equations involve dividing by zero.

You should try again with a different number of data points or a different frequency range portion of the driver Z_{IN} curve. The program offers information screens on what portion of the driver Z_{IN} curve to use for

The Speaker Design Toolbox

FRIENDLY LOUSPEAKER DESIGN SOFTWARE FOR THE MACINTOSH

2nd Order Closed Box

3rd Order Closed Box

4th Order Vented Box

4th Order Symmetric Bandpass Box

5th Order Asymmetric Bandpass Box

6th Order Symmetric Bandpass Box

Rectangular Box Calc

Trapezoidal Box Calc

Bandpass Box

4th Order Banded Box

5th Order Asymmetric BP Box

6th Order Symmetric BP Box

File Edit Analysis Display Vent Box Crossover

JBL 2240 Subsystem

Driver and Subsystem Parameters

6th Order Symmetric BP Box

Unit

One 2 inch i.d. Tube

Two 2 inch i.d. Tubes

Three 2 inch i.d. Tubes

Four 2 inch i.d. Tubes

Five 2 inch i.d. Tubes

Six 2 inch i.d. Tubes

Seven 2 inch i.d. Tubes

Eight 2 inch i.d. Tubes

Nine 2 inch i.d. Tubes

Ten 2 inch i.d. Tubes

Eleven 2 inch i.d. Tubes

Twelve 2 inch i.d. Tubes

Thirteen 2 inch i.d. Tubes

Fourteen 2 inch i.d. Tubes

Fifteen 2 inch i.d. Tubes

Sixteen 2 inch i.d. Tubes

Seventeen 2 inch i.d. Tubes

Eighteen 2 inch i.d. Tubes

Nineteen 2 inch i.d. Tubes

Twenty 2 inch i.d. Tubes

NEW! BANDPASS ENCLOSURE ANALYSIS \$299.00 PLUS! WinSpeaker™ FOR WINDOWS COMING SOON

MacSpeakerz v3.0 provides everything you need to stay competitive in today's loudspeaker market...Easily, Accurately and Elegantly. MacSpeakerz enables you to expertly design these enclosures: • Closed • Vented • 3rd Order Closed • 4th Order Bandpass • 5th Order Bandpass • 6th Order Bandpass • Plus Isobarik variations on all of these! Includes: • Crossover Calculators • Box Calculators • Sound Pressure Level • Large, Expandable Driver Library (800 drivers) • Manual (with friendly tutorial) • Free Customer Support! Call for a demo disk today!

MacSpeakerz FROM True Image Audio 349 WEST FELICITA AVENUE, SUITE 122, ESCONDIDO, CALIFORNIA 92025

PHONE (800) 621-4411 8:00-5:00 PST, MON-FRI, FAX (619) 480-8961 24 HRS. A DAY, OUTSIDE THE U.S.A. PHONE/FAX (619) 480-8961



THE SPEAKER WORKS, INC.

1021 E. Camelback Rd.

Phoenix, AZ 85014

(602) 230-0344 FAX (602) 230-8533



VERSATRONICS INC. QUALITY SPEAKERS

POLYPROPYLENE

DOB100R-PP/8 4"

- Polypropylene Cone
- Rubber Surround
- Excellent Mid/Bass
- Superior for Monitor Systems

Specifications

Impedance 8 Ohm
 Resonance 65 Hz
 Upper Frequency ... 10,000 Hz
 SPL 1W/1M 84 dB
 Power Handling 50 W
 Qts 0.41
 Vas 4.54 L
 Voice Coil 25.5 mm
 Magnet 10 Oz.



\$14.62 EA

DOB130R-PP/8 5-1/4"

- Polypropylene Cone
- Rubber Surround
- 2-Way Reflex Systems
- Excellent for Car-Stereo

Specifications

Impedance 8 Ohm
 Resonance 45 Hz
 Upper Frequency 9,000 Hz
 SPL 1W/1M 87 dB
 Power Handling 50 W
 Qts 0.49
 Vas 13.88 L
 Voice Coil 25.5 mm
 Magnet 10 Oz.



\$17.58 EA

FQB165R-PP/8 6-1/2"

- Polypropylene Cone
- Rubber Surround
- Closed Box or Small Bass
- Excellent Power Handling

Specifications

Impedance 8 Ohm
 Resonance 36 Hz
 Upper Frequency 8,000 Hz
 SPL 1W/1M 86 dB
 Power Handling 60 W
 Qts 0.36
 Vas 29.26 L
 Voice Coil 35.5 mm
 Magnet 18 Oz.



\$25.91 EA

FQB210R-PP/8 8"

- Polypropylene Cone
- Rubber Surround
- Smooth Response
- Medium Size Base Reflex Enclosure

Specifications

Impedance 8 Ohm
 Resonance 33 Hz
 Upper Frequency 6,500 Hz
 SPL 1W/1M 87 dB
 Power Handling 60 W
 Qts 0.44
 Vas 75.73 L
 Voice Coil 35.5 mm
 Magnet 18 Oz.



\$31.05 EA

SHIELDED SPEAKERS

DOB100R-PP/8SC 4"

- Double Magnet with Cup
- Home Theater Center Channel
- Computer Multimedia
- Sealed Box Enclosure

Specifications

Impedance 8 Ohm
 Resonance 65 Hz
 Upper Frequency ... 10,000 Hz
 SPL 1W/1M 85 dB
 Power Handling 60 W
 Qts 0.35
 Vas 6.3 L
 Voice Coil 25.5 mm
 Magnet 5 & 10 Oz.



\$19.17 EA

DOB165R-PP/8SC 6-1/2"

- Double Magnet with Cup
- Home Theater Center Channel
- Computer Multimedia
- Vented Enclosure

Specifications

Impedance 8 Ohm
 Resonance 36 Hz
 Upper Frequency 6,000 Hz
 SPL 1W/1M 86 dB
 Power Handling 80 W
 Qts 0.30
 Vas 35.28 L
 Voice Coil 25.5 mm
 Magnet 5 & 10 Oz.



\$23.74 EA

ANY QUESTIONS? — CALL US
 We accept VISA - Mastercard - Check — No C.O.D.
 220 PAGE CATALOG \$10.00

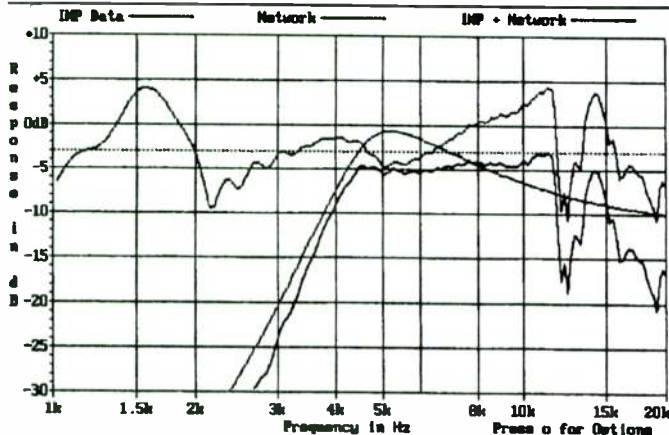

FIGURE 13: IMPPCoEq frequency response plot for tweeter 2 with equalization.

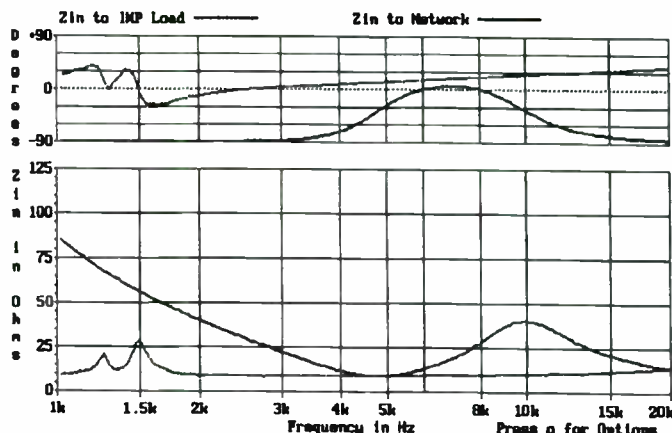

FIGURE 14: IMPPCoEq Z_{IN} plot for tweeter 2 with equalization.

development of Optimum Simple and Complex Zobel, and also shows all the equations used in the computations.

Figure 7 plots the raw driver Z_{IN} for a dome tweeter and Z_{IN} with a Complex Zobel with f_s correction; the result is an impressively flat and nearly resistive input impedance. Figure 8 shows the network schematic and component values along with the input data and model component values. The program will display and print the model schematic.

Figures 9 and 10 show the corresponding information for a drum midrange driver. Here it is clear the high-frequency impedance rise of the driver has been effectively canceled. Note on Fig. 9 that the IMP file contained 1,327 data points, but I used only 200 in the computations and plots. Again carefully consider the number of data points you use to avoid an unmanageably large impedance data printout. IMPZobel allows

you to plot the input .ZMA file alone, which, if it is the only data you have, might sometimes be useful, since IMP does not recall .ZMA files.

IMPPCOEQ PROGRAM

The IMP Passive CrossOver and Equalizer program takes the frequency response and input impedance data for a driver or system via .FRD and .ZMA files and places a passive network ahead of the driver/system for doing crossover (CO) or equalization. The passive network is composed of four branches: a serial branch (Z_a) at the input, then a shunt branch (Z_b) to ground, a second series branch (Z_c), and finally a shunt branch (Z_d), with the .ZMA file impedance across this last shunt branch.

The program plots the frequency response for the IMP .FRD data, the network from input at Z_a to output across Z_d (and across

the .ZMA impedance), and the combination of the network with the .FRD response. This shows what the output of the driver/system represented by the .FRD file would be with this passive network. The program plots input impedance (magnitude and phase) to the .ZMA file and into the network with the .ZMA load. It also prints tabulated data for frequency response or impedance (again, be careful the number of printed pages doesn't become too large).

Each branch of the network may be:

1. a short circuit to omit the branch, if Z_a or Z_c ;
2. an open circuit to omit the branch, if Z_b or Z_d ;
3. a resistor;
4. a series resistor and inductor (resistor may be 0Ω);
5. a parallel resistor and capacitor (resistor may be omitted);
6. a series resistor, capacitor, and inductor (resistor may be 0Ω);
7. a parallel resistor (may omit), capacitor, and inductor, with a second resistor in series with the inductor that may be set to zero.

PROGRAM OPERATION

The program prompts for the path to the .ZMA and .FRD files, and then displays a directory of .FRD files; you may select the desired file by number. The file must be no bigger than 20K. The program then presents a directory of .ZMA files so you can select the matching impedance file, which is also limited to 20K and must have the exact same frequency entries as the .FRD file. You must thus be careful to generate both these files with the same IMP setup.

You can then select the frequency range over which to process data and plot/print results, and also select the number of data points to use; 150–200 will provide good plots and limit the number of printed pages. The network is then entered branch by

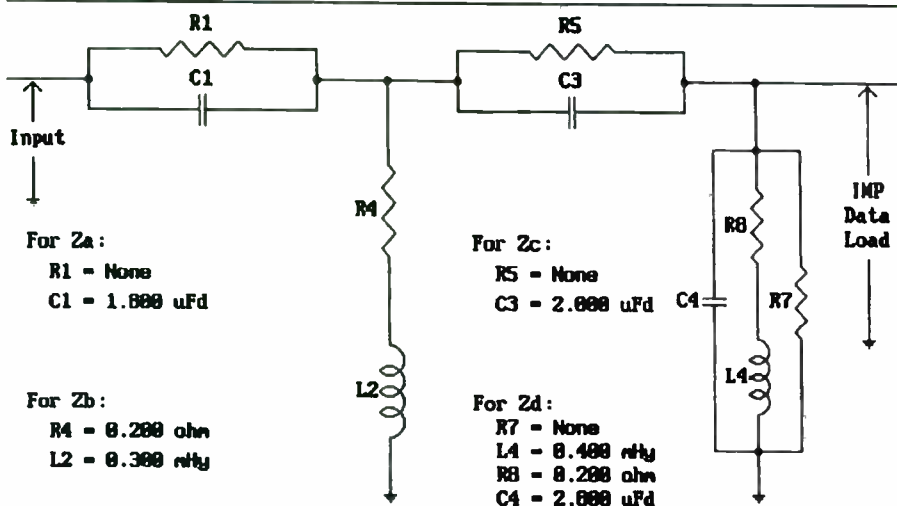

Component values & Branch topologies may be changed from the Main Menu

Any key to Main Menu =

FIGURE 15: Schematic for equalizer network used with tweeter 2.

NOW IN PRINT!

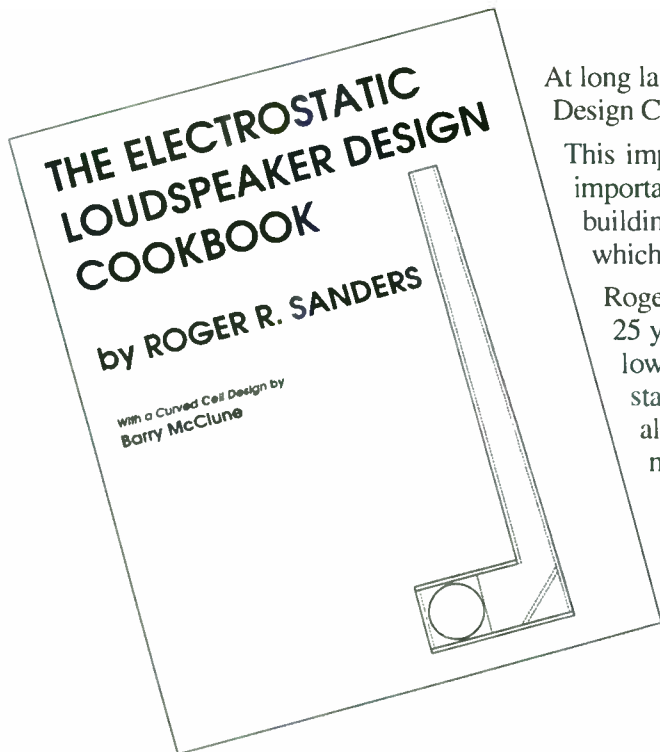

At long last and by popular demand, The Electrostatic Loudspeaker Design Cookbook is ready for shipment throughout the world!

This important volume is an encyclopedic exploration of all the important issues, tradeoffs, and technical questions involved in building the radiating, electrostatically-charged panel surfaces which make up the electrostatic loudspeaker.

Roger Sanders has been building electrostatics for more than 25 years and has consulted with and advised hundreds of fellow enthusiasts worldwide. Here he offers easy-to-understand construction advice for both flat and curved panels, along with plans for the necessary interfaces, drive requirements, and power supply and crossover suggestions.

In addition, he gives you guidance for building low-frequency systems to supplement the electrostatics, for complete frequency coverage.

The Electrostatic Loudspeaker Design Cookbook is fully indexed; has a thorough, descriptive glossary; provides excellent information on parts sources; and is capped by a complete bibliography of the literature on this fascinating loudspeaker topology.

AND NOW ONLY \$34.95

1995, 206pp., 8 x 10½, softbound

#BKAA20

NOTE: Also available is #BKT6, Electrostatic Loudspeaker Design and Construction by Ronald Wagner, \$19.95. This book is not necessarily redundant and is in fact complementary to #BKAA20 in a number of ways.

YES, please send me:

___ BKAA20 @ \$34.95 _____

___ BKT6 @ \$19.95 _____

ADD →
7% USA surface
14% USA second day
14% Other surface
25% Other air

SHIPPING
HANDLING _____ 2.00
TOTAL _____

CHECKS/M.O. MUST BE IN US \$ DRAWN ON US BANK

NAME _____

STREET _____

CITY _____ ST _____ ZIP _____

MC/VISA/DISCOVER # _____ EXP _____

DAYTIME TEL. _____ DATE _____



OLD COLONY SOUND LAB

PO Box 243, Dept. B95, Peterborough NH 03458
Tels. 603-924-6371, 603-924-6526 Fax 603-924-9467

World Radio History

branch; finally, the complete network appears on screen. The Main Menu allows you to edit (change values but not topology) the network or modify (total reentry) each branch individually. The program then allows plotting or printing the frequency response and impedance results.

This is not an automatic optimization program; you must manually modify the network. However, the program allows you, from any plot, with a single keypress, to call up any branch for editing or redefining and then return to the updated plot. From a plot, press O for a list of available options.

ROTTEN TWEETERS

Figure 11 shows the IMP frequency response curve of one of a pair of tweeters you wish you had never purchased! They drop dead at about 12kHz and are not flat anywhere. You will never make great tweeters out of them but would like to use them from about 4kHz up to their 12kHz limit in a pair of utility boxes. Figure 12 shows the IMP-generated tweeter input impedance. Note the double peaks at resonance; IMPZobel would never be able to model these jewels!

I briefly played around with IMPPcoEq to obtain the results in Fig. 13. The network

produced a crossover (CO) around 4.5kHz and a response flat from there to about 12kHz. Figure 14 shows the resulting input impedance with the network, which looks acceptable.

Figure 15 shows the passive network, which initially looks very complex. Note, however, that R1, R5, and R7 are omitted. Also, R4 and R8 are really the inductor resistances. The network consists of two capacitors and two inductors—not a high price to use these tweeters considering it is also the CO.

WIMPY BASS

As another example, assume you own small, closed box systems that are great but lack bass extension (Fig. 16). You play them at low level for background sound, so power capability is not a problem. Could you extend the bass without constructing new boxes? The .FRD file for Fig. 16 and the corresponding .ZMA file are fed to IMPPcoEq.

Figure 17 is the result of briefly playing with IMPPcoEq. The bass has been extended from about 60Hz down to about 45Hz. The network response shows that about 7dB of voltage gain is required to accomplish this. How is this possible when we know passive networks can't provide power gain?

Figure 18 shows the Z_{IN} plots from IMPPcoEq and gives the answer to our question. The voltage gain is obtained by the input impedance dipping to about 1Ω. Your amplifier may not like this.

The point is you have learned this sitting at your computer without winding coils and possibly harming the amplifier. I recommend more work with IMPPcoEq to develop a network with less bass extension but a more acceptable input impedance. Figure 19 shows the schematic of the network that was developed, consisting of one each resistor, capacitor, and inductor.

The network branch values are shown on the plots, and a schematic of the network with component values is displayed on screen in VGA mode. If you cannot print the graphic screens, reduce the number of data points and print out a frequency response or impedance list, which will contain the component values for each branch.

IMPEQLZR PROGRAM

Unlike IMPPcoEq, which places a passive network right at the driver/system input, the IMP Equalizer program is designed for developing slow, smooth downslope equalizers that are introduced into the electronics, possibly between the preamp and the amplifier. It is not an equalizer circuit design program but an equalizer function design program. It will show

Increase your electronics know-how and skills

The speed and intensity with which electronics penetrates our daily lives at home, at work, or in our car, tends to make us forget that we **can use electronics creatively** by building designs with a practical application and having the satisfaction of a successfully finished project. *Elektor Electronics*, which is distributed all over the world, can help you achieve these goals. Throughout the year, the magazine features original construction projects, informative articles and news on the gamut of electronics, science & technology, book reviews and information on new products. The past 11 issues contained 80 major and 97 minor construction articles, 21 articles of an educative or instructional nature, and 10 articles dealing with Science & Technology.

If you wish to increase your electronics know-how and skills, take out an annual subscription to *Elektor Electronics* by writing or faxing to

**World Wide Subscription Service Ltd
Unit 4, Gibbs Reed Farm
Pashley Road, Ticehurst
East Sussex TN5 7HE, England**

Telephone +44 580 200 657; Fax +44 580 616

You will then have the convenience of having the magazine delivered to your home, and the peace of mind that you will not miss any issue. The current rate for an annual subscription (11 issues) is \$US 57.00 (post paid - airspeeded).

There are also a number of *Elektor Electronics* books geared to the electronics enthusiast - professional or amateur. These include data books and circuit books, which have proved highly popular. Two new books (published November 1993) are *305 Circuits* and *SMT Projects*. Books, printed-circuit boards, programmed EPROMs and diskettes are available from

**Old Colony Sound Lab
PO Box 243, Peterborough NH 03458
Telephone (603) 924-6371, 924-6526
Fax (603) 924-9467**

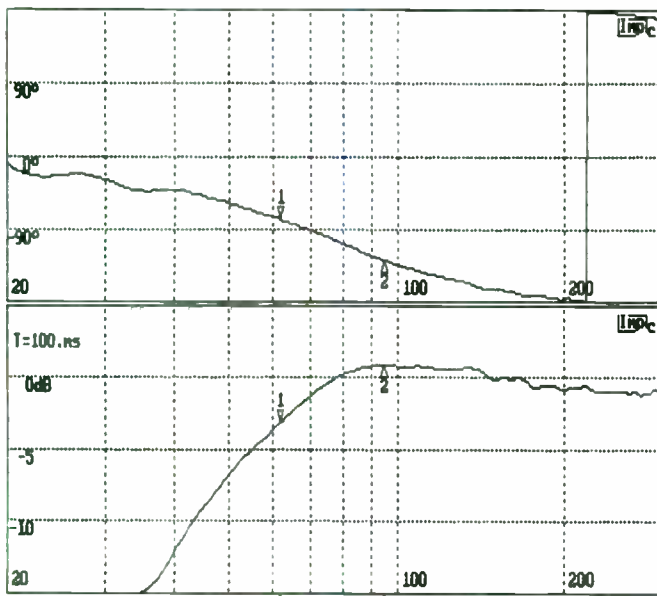

61.87Hz: -3.09dB -77.0° 63.948dB 94.68Hz: 0.850dB -128.°

FIGURE 16: IMP frequency response plot of closed box system box 1.

simple passive implementations for the various equalizers developed, but basically helps develop the shape of the equalizer function.

The program takes in a frequency

response .FRD file and applies one or two sections of equalizer to that response. The equalizer slopes are always negative, increasing loss with frequency. Each of the two sections can be -6dB/octave or -12dB/octave , and you can omit the second or both sections. Omitting both will let you plot the IMP .FRD file, which might be use-

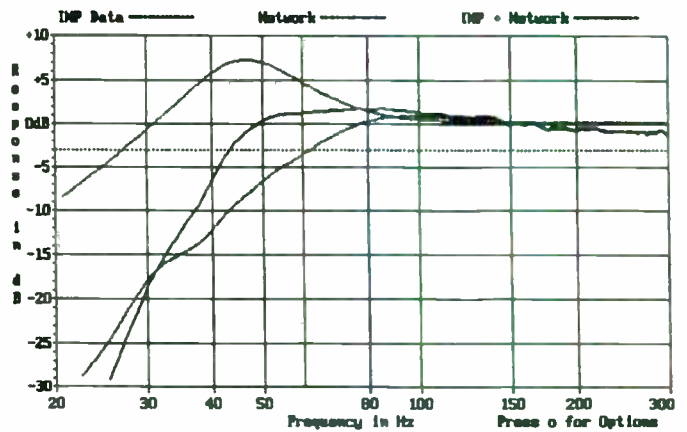

FIGURE 17: IMPPcoEq frequency response plot for box 1 with equalization.

ful if you did not save source data files, since IMP does not recall .FRD files.

The program first enters a path to the .FRD files, then displays a directory so you can select a file by number. The maximum file size is 50K. You can then select a frequency range to process/plot that includes all or a portion of the IMP data range. This program processes all points in the IMP data file that fall within the selected process/plot frequency range. You next enter a normalization frequency that must be inside the .FRD

range. You then enter a normalization frequency that must be inside the .FRD

The Source for Pro Sound Speaker Builders

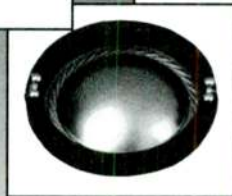

Loudspeakers, Drivers, Horns, Tweeters, Crossovers, Hardware, Connectors... and much, much more!
Image delivers virtually every component for the speaker builder.
See for yourself. Call or FAX for your FREE catalog today!

EMINENCE
Loudspeakers, Drivers,
Diaphragms and Recone Kits

Electro Voice
Recone Kits

McCauley
Loudspeakers & Drivers.

Acoustician
Drivers, Horns, Tweeters,
Diaphragms & Crossovers

Waldom
Audio Products
Hardware, Connectors, Etc.

image
communications

4301 W. 69th St. • Chicago, Illinois 60629 • (312) 585-1212 • FAX (312) 585-7847 • 1-800-552-1639

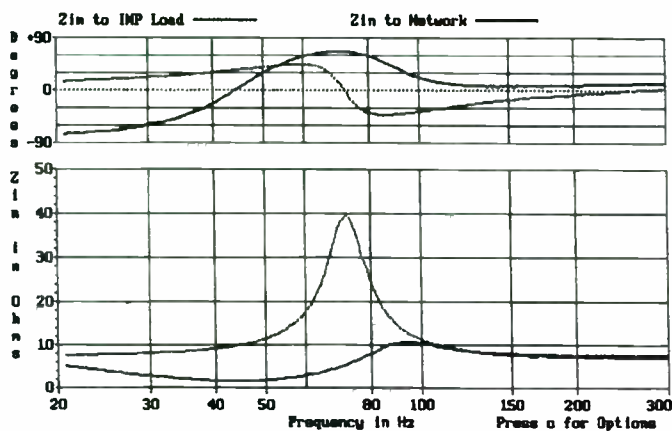

FIGURE 18: IMPPcoEq Z_{IN} plot for box 1 with equalization.

data file frequency range; the actual normalization frequency is displayed, and is the closest frequency in the .FRD file to what you entered.

At this frequency all plots (.FRD data, network, and network plus .FRD data) will be 0dB. This allows all three curves to appear on a single plot. It can affect the looks of the results but does not affect the results themselves. The program also accepts an optional name to appear on the plots/printouts.

You can then define the equalizer network. For the first section you can select: none (omits second section also), -6dB/octave, or -12dB/octave. If you select an equalizer, you must enter the frequency where the equalizer goes from flat to the specified slope (2Hz-5kHz), and also the

the program does not require this. If you set $f_d = f_u$, you obtain a total equalization of 6dB per section (either -6 or -12dB/octave slope). Setting f_u less than f_d can produce equalizations less than 6dB. I kept the allowable ranges for f_d and f_u entry very wide to make the program generally useful. If you select dual -12dB/octave sections with $f_d = 2\text{Hz}$ and $f_u = 20\text{kHz}$, you get over 240dB of equalization!

The program survived this, but be warned if you feed in wild numbers you may get tossed out to DOS! You also must read the equalizer design component values carefully, since resistor and capacitor values can be very large or very small.

IMP EQUALIZER RESPONSES

The program will output tabulated frequency

point where the equalizer breaks back to flat (2Hz-20kHz). All of this program's equalizers start flat, break down at the specified slope, and then return to flat.

The second section has the same options, and has independently defined down break (f_d) and up break (f_u) frequencies. Normally, you would work with f_u well above f_d , but

response data, in addition to the plot. You may preview this on the screen to determine how many points to output. While the program processes all IMP data file points in the selected frequency range, you have the option to output only every Nth point, where N is 1-10. If you select print output, the program will indicate the number of pages in the printout and let you escape it.

Once you develop your equalizer function, the program displays information about it and shows a simple passive implementation with two resistors and one capacitor per -6dB/octave slope. You may enter one resistor value (10Ω to 100kΩ), and the program will provide the capacitor and other resistor value. You can print these text screens with the Shift/Print-Screen keys.

While I used IMPPcoEq to extend the response of a small closed box system, IMPEqlzr is useful when you need a smooth, slow equalization over a wide frequency range, as in correcting the response of an open baffle system. Figure 20 shows the response of a baffle-mounted driver which we will pretend represents the response of your prototype open baffle woofer. Note that this is real-room far-field data, so I included 1/3 octave smoothing to give the basic response shape.

Suppose you experiment with this system, using it up to the 500-600Hz range. The present bass response is down 10dB from the 600Hz response, and thus not worth trying. Figure 21 shows that IMPEqlzr can flatten the general response to make testing the system meaningful. The response is now within ±3dB from about 45-700Hz. The equalizer response shows that 10dB of gain is being used at low frequency, so be careful of the power delivered to the system.

Figure 22 shows the nonnormalized gain figures for the equalizer, along with how to implement the circuit. Note that an additional 13dB of attenuation occurs from 600Hz up until the equalizer is "flat" again. This must be factored into the CO design.

THE IMP-AID DISK

The IMP-Aid disk distributed by Old Colony Sound Lab contains the five functional programs described above. In addition, a menu program (IMPMenu working with XMenu) calls the individual programs for you, and provides additional information about the programs. All the data (.FRD and .ZMA) files used in this article are on the disk. They are straight ASCII files, so you can print or browse through them to see the format used with these file types. Also, a ReadMe.Txt file tells how to install and run the programs. To print this two-page file, log onto the drive containing the IMP-Aid disk and use:

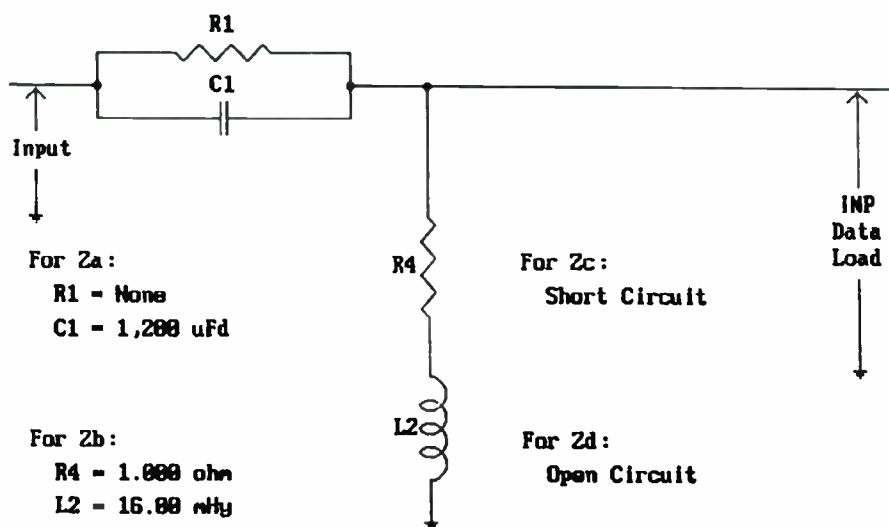

Component values & Branch topologies may be changed from the Main Menu

Any key to Main Menu ■

FIGURE 19: Schematic for box 1 equalizer network.

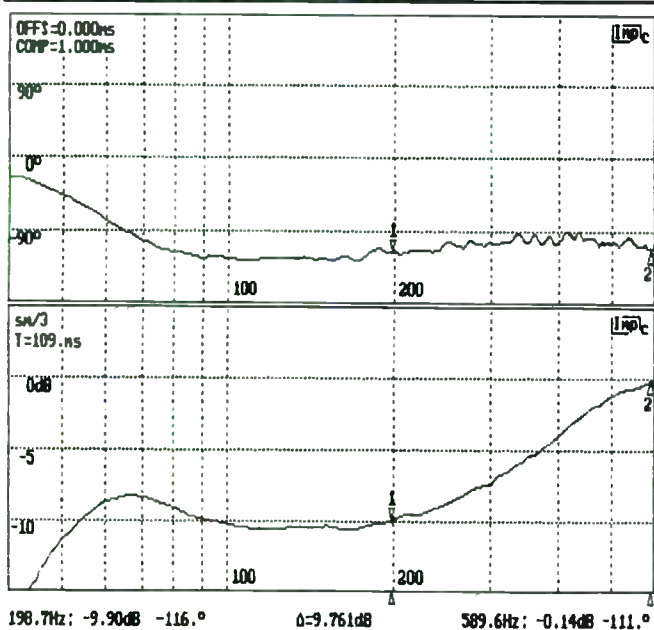

FIGURE 20: IMP frequency response plot for open baffle system box 3.

Type ReadMe.Txt >pm <Enter>

All programs run under DOS on an IBM-compatible computer. The programs should not be DOS version sensitive, but have only been tested with versions 3.21 and 5.0. VGA 640 x 480 pixel 16-color graphics capability is required for all programs (including the Menu system), except for IMPSpace, which always runs in text mode. The programs do not have the ability to print graphic screens. About 280K available memory is required. Some of the programs are floating-point computation intensive, so a fast computer with coprocessor is beneficial.

Since I developed these programs over a long period, they use a variety of interfaces. Details of these differences are included in the Information section of the Menu system. All interfaces are text-based; however, the Menu system and IMPRoom have mouse support.

The programs are supplied on a single high-density 5.25" (1.2M) or a single high-density 3.5" (1.44M) disk. To reduce the total program size, three of the programs are self-extracting compressed .Exe files. No special action is required on your part to load and run these files, which act just like ordinary .Exe files but require more memory than their file size indicates.

FILE SIZE REDUCTION

It is possible with IMP and very easy with Liberty Audiosuite to generate .ZMA or .FRD files that are too large for the post-processing programs described above. To solve

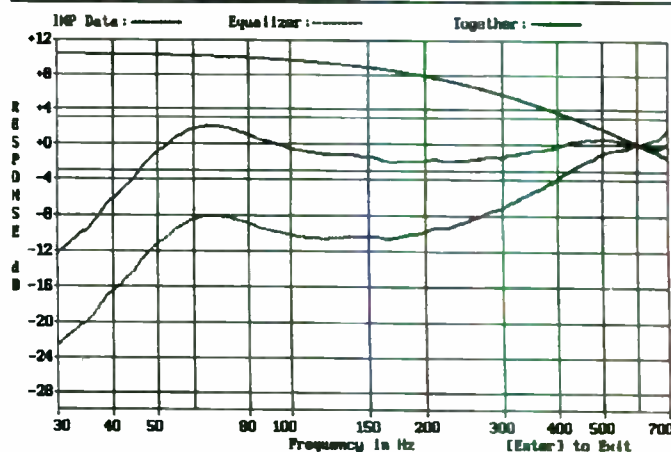

FIGURE 21: IMPEqlzr frequency response plot for box 3 with equalization.

this problem the utility program Reduce.Exe is included on the IMP-Aid disk. This program must be

called directly, as it is not included in the menu system; the program requires VGA graphics capability and offers mouse support. See the program information section of Reduce.Exe for details of its oper-

ation. In general it takes every Nth line from the original file and writes them to a new file, where N is set to provide the file size you desire. The first and last lines of the original file are always retained so the frequency span of the file is not reduced. ReadMe.Txt on the IMP-Aid disk discusses running Reduce.Exe.

Two Section Equalizer Performance

0dB	Slope	Performance for Total Equalizer	
First Section	-6dB/oct	fd1 = 300.00 Hz	Real Gain = -4.68 dB
	fu1	fu1 = 1600.00 Hz	Real Gain = -18.98 dB
	fd2	fd2 = 900.00 Hz	Real Gain = -14.32 dB
Second Section	-6dB/oct	fu2 = 1200.00 Hz	Real Gain = -16.87 dB
	fu2	fg = 600.00 Hz	Real Gain = -10.41 dB
		Infinite frequency	Real Gain = -23.39 dB

M to Main Menu, nul to Design page:

Two Section Equalizer Design

First Section: -6dB/oct Second Section: -6dB/oct

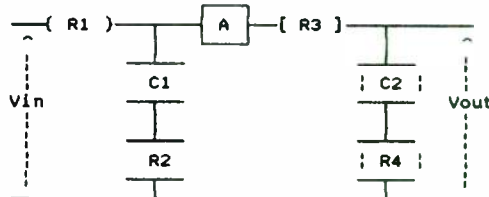

Note: [A] equals a Unity gain Buffer Amp.

R1 = 53.33 Kohms	R2 = 10.00 Kohms	C1 = 0.009947 uFd
R3 = 13.33 Kohms	R4 = 10.00 Kohms	C2 = 0.013263 uFd

Enter Value of R2 (10 to 100000), nul to Exit - Ohms:

FIGURE 22: Design and performance of equalizer for box 3.

Wayland's Wood World

SHAPED HOLE TECHNIQUES

By Bob Wayland

Mounting a speaker needn't involve free-cutting saber saws and sanding drums. The results with these, all too often, are disappointing. There are easier ways to produce far more acceptable, professional-looking mountings. This column explains how to make circular holes for both small and large speakers.

FOR SMALL HOLES

The mounting holes for smaller speakers less than 5-6" in diameter are simpler to make than for larger speakers, due to a number of well-designed hole cutters (Photos 1, 2, and 3). The expansion bits are used in a hand brace to give you great control. To improve your hole cutting, clamp a backup board behind the hole you're drilling. This helps in two ways: the backup board provides a base into which the screw tip of the expansion bit can continue, and prevents tearout of the board on the back side of the drilled hole.



PHOTO 3: Expansion bits for use with a brace. The maximum radius is limited, usually to less than 2".

Of course, you can use a hand power drill with hole saws and Forstner bits, but this requires a very steady hand and a keen eye to keep the drill perpendicular. If you don't, the saw will produce excess heat and result

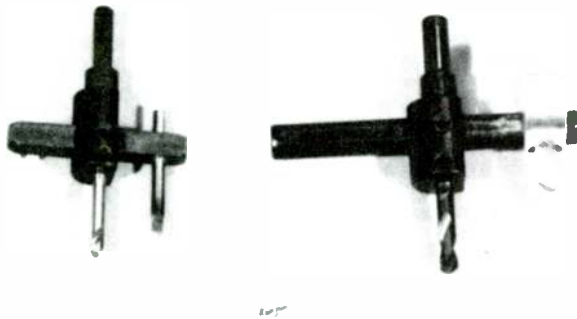

PHOTO 1: Adjustable fly circle cutters for drill presses.

in a cockeyed hole. Use a drill press whenever possible.

Forstner bits produce one of the cleanest holes and have the distinct capability of making flat-bottomed holes (Photo 4). They are available in diameters up to 3-1/8" from most woodworking and mail-order supply houses. Use bits larger than 2" only in a drill press.

However, they are not cheap; expect to pay up to \$25 for a 2" bit. You might also consider a spur bit, which must be used only at 90° to the surface. They usually cost about 50% more than Forstner bits.

One of the most useful cutters for 2-6" holes is the fly cutter (Photo 1). (Most people refer to them as circle hole cutters.) This is simply a cutting bit attached to the end of a movable arm, which is anchored in a mandrel into which a bit is attached to provide a well-defined center for the rotation. Because tremendous forces act on the cutting tip and arm, be sure to clamp your work to the drill press table and keep your hands away.

I prefer a fly cutter with a counterweight at the end of the arm to provide damping and increased angular momentum (Photo 5). You will usually have better luck if you use a low-to-medium speed (500-1,000 rpm).

The accumulation of cutting debris can cause heat, so raise the bit often to help clear the debris and cool the bit. Again, a backup board is helpful in controlling tearout on the back side of the hole. Although you can cut

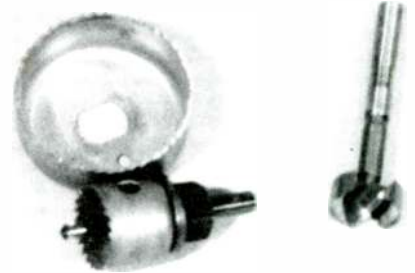

PHOTO 2: Fixed radius hole cutters include hole saws (left) and Forstner bits (right).

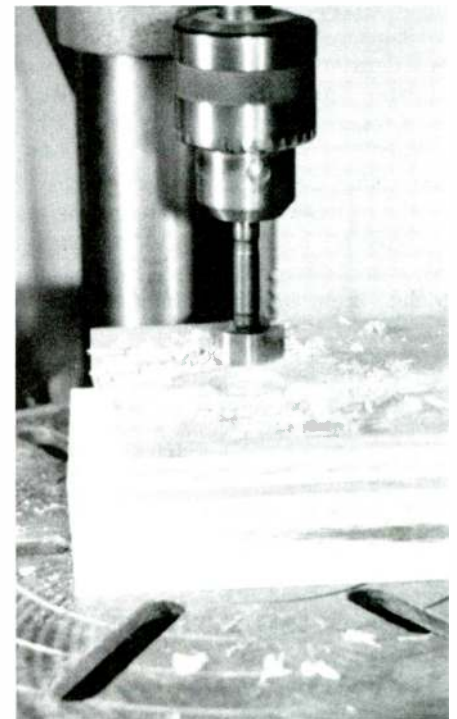

PHOTO 4: Forstner bit to drill a flat-bottomed hole. Note the backup board under the board being drilled.



OLD COLONY SOUND LAB

P R O D U C T S H O W C A S E

SLM

**measuring tool
for M A C**

by Dr. Victor Staggs

It's a sound level meter! It's a real-time spectrum analyzer! And it uses a minimum of added hardware—usually none!

Mac SLM uses the sound input facilities in modern Macintosh® computers, or it uses external devices. It automatically accommodates 8 bit words at 22.254 kHz or 16 bit words at 44.1 kHz, so you can use whichever you want for measuring acoustical or electrical signals.

The sound level meter mode gives you flat, A, B, or C weighting, and it puts big numbers on the screen that you can see from across the room. It uses white graphics on a black screen to help save your portable's batteries. You can use the Apple microphone or your own, and still keep Mac SLM calibrated.

The spectrum mode displays the spectrum of sound in 1/3, 1/6, or 1/12 octaves. You can use free running or time averaging mode, and you can fix or free the reference level to detect level shifts quickly. You can subtract background noise from a system measurement to improve your data, and store and edit an automatically generated calibration curve.

You can save spectrograms to disk and print them later, and you can preview them before printing. Mac SLM's amplitude resolution is as good as that of your screen or printer.

Mac SLM is perfect to use with commercially available test CDs. You can measure speakers, optimize their room placement, gather design data, measure amplifier distortion, and test filters. Outdoors you can measure noise pollution and exposure of your hearing to damage by noise, test sound-producing devices such as horns and sirens, test your car's engine better than with a stethoscope, and do a million other things you couldn't do before, because you couldn't afford an expensive spectrum analyzer.

System requirements are System 7®, 640K of free RAM, 640 by 400 screen pixels or more, and a 68020, 68030, or 68040 CPU with separate or internal FPU (math coprocessor), or a PowerPC® Macintosh®. It will run in any Mac CPU, but more slowly without the FPU. Sorry, not usable with original Mac 128K, 512K, Plus, 512KE, SE, SE/30, Classic, Classic II, or Color Classic.

SOF-SLM1M3G

\$74.95

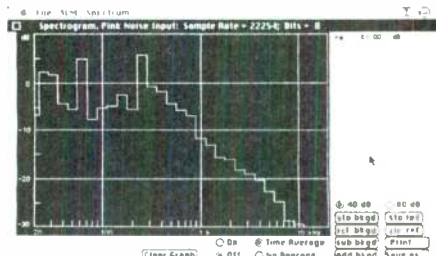

Digital Projects For Musicians

Craig Anderton, Bob Moses, Greg Bartlett



Three renowned authors and musicians have combined many years of experience and knowledge in order to create this entertaining and original volume geared toward today's musical enthusiasts. Bursting with twenty-five projects, this comprehensive book explains and implements the technological advancement that has revolutionized music: MIDI, Musical Instrument Digital Interface. Each exciting and useful chapter of this substantial work is illuminated by helpful diagrams, photographs, charts, part layouts and specifications to elevate your understanding of music and instruments while allowing you to harness, and possibly rediscover, the vast potential for creativity and musical ability that lies within you. Included in the

informational chapters are basic electronics theories and knowledge about computer hardware and software, the basics of MIDI, essential tools and parts, and various instructions for building one-of-a-kind devices such as transmitters, remote controls, monitors, filters, mappers, and numerous other devices and gadgets. 1994, 364pp., 9 x 12, softbound.

BKAM5

\$24.95

PIANO SERVICING, TUNING, & REBUILDING

Arthur A. Reblitz

Soon to be as widely read and popular as its predecessor, this second edition offers all of the information necessary for the successful restoration and maintenance of any type of piano. The first volume, with sales of over 45,000 copies, played a major role in helping technicians and hobbyists rebuild and maintain numerous instruments in pristine condition. The extensive information presented within this enlarged and enhanced text includes an introduction to the many styles and types of pianos; the names and functions of the various parts; elaborate instruction on cleaning and fixing many components; and, regulating and adjusting concepts and applications. The author also elaborates on tuning theory, terminology, and procedures. Clearly written and amply illustrated, this reference book and instruction manual is an invaluable tool for professionals, students, and hobbyists alike. 1993, 327pp., 8 1/2 x 11, softbound.

BKV3

\$29.95



PRINCIPLES OF VIBRATION AND SOUND

Thomas D. Rossing, Neville H. Fletcher

BKSV8

\$49.95

If you are interested in gaining a clear and fundamental understanding of room and musical instrument acoustics, as well as the basics of noise and vibration, you should buy this insightful text. With the use of impressive graphs, charts, equations, and illustrations, the authors relay valuable information on the physics of mechanical vibrating systems with an emphasis on normal modes of vibration. Free and forced motions of a simple harmonic oscillator, vibrations of one-dimensional and two-dimensional systems, strong and weak coupling with mechanical and electrical examples, nonlinear systems, and self-excited oscillators are discussed in elaborate detail. With allusions to material previously presented in the volume, the concluding third of the book presents a clear discussion of the propagation of sound in air with respect to radiation, transmission, absorption, and diffraction. 1995, 247pp., 7 1/4 x 10 1/2, hardcover.

PRINCIPLES OF



ANECHOIC ORCHESTRAL MUSIC RECORDING CD

This offering from the Pure Gold Collection of Denon is considered THE standard for anechoic music evaluation. Using elaborate equipment and techniques, the engineers recorded Masahiko Enkoji conducting the Osaka Philharmonic Orchestra as it played on a specially treated stage at the Minoo Civic Center in Osaka. Six sections cover: I. Anechoic Recording Program. II. Anechoically recorded samples for evaluation. III. Samples of sound with simulated reverberation. IV. Instrumental combinations and score reading. V. Differences in sound recording method. VI. Test signals for measurement of room acoustics.

Elaborate English/German/French 39-page manual features graphs, diagrams, photos. Japan, 1988, 53:49.

CDDEN4

\$21.95

DENON.

DENON AUDIO TECHNICAL CD

This CD contains a large number of test signals and musical excerpts which can be used not only to thoroughly check the playback performance of a CD player, but also to evaluate other audio components as well, such as amplifiers, tape decks, and loudspeakers. It can further be used to measure the acoustic properties of a listening room and to carry out comparative listening tests. It offers a wide range of applications far beyond the scope of conventional test records. Sections include Announcement for Basic Checks; Source Material for Listening Tests; Test Signals for Basic Checks; CD Player Test Signals (S/N, THD, freq resp, etc.); Various Measurement Signals I (freq spot of sine wave); VMS II (freq, level, phase sweep of sine wave); VMS III (toneburst, impulse, band noise); and Source Material for Sound Quality Evaluation. 23-page English/German/French manual also includes graphs. Japan, 1984, 60:55.

CDDEN2

\$17.95

DENON.

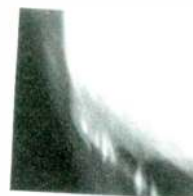

DENON AUDIO TECHNICAL CD

DENON.

DENON AUDIO CHECK CD

Equipped with this CD, a CD player, a stereo amp, and a pair of high fidelity loudspeakers, you should be able to judge the fidelity and accuracy of the various elements of your sound system—from program source to listening room. In preparing this release, Denon successfully attempted to satisfy both the objective school of sound system evaluation, which counts on empirical measurement, and the subjective one, which maintains that only a good pair of ears on the head of an intelligent listener can be the true judge. Sections include Audio Test Tracks, with voice announcement for basic checks, test signals, silence, sweep signals, and white noise; and (Musical) Source Material for Sound Quality Evaluation, which includes twelve excerpts between three and six minutes long. 19-page English/German/French manual includes graphs. Japan, 1985, 58:13.

CDDEN3

\$17.95

DENON.

OLD COLONY SOUND LAB

PO Box 243, Dept. B95

Peterborough NH 03458 USA

24-Hr. Tels.(603) 924-6371, 924-6526

Fax(603) 924-9467

Please include SHIPPING:

USA surface — add 7% to order

USA UPS second day — add 14% to order

Other surface — add 14% to order

Other air — add 25% to order

AND HANDLING: \$2 per order. Thank you!

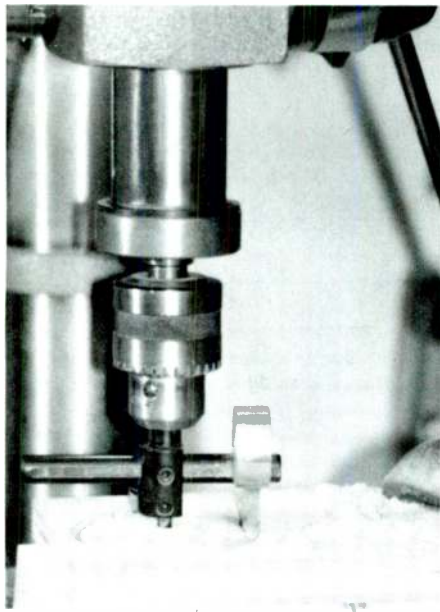

PHOTO 5: A counterbalanced fly cutter to cut a hole. This helps cut down on chatter at the cutting bit. (Note the clamp on the right side.)



PHOTO 6: Cutting the adjustment slot for the router jig, with the mounting holes and the center hole marked and drilled out. The mounting screw holes have been countersunk so the screws will not scratch the surface of your piece.

holes bigger than 5" with a fly cutter, it is not a good idea. Also, if you plan to remain whole into old age, use a drill press, never a hand drill!

FOR LARGE HOLES

Larger midrange and woofer speakers require larger holes, some up to 15". Fly cutters are not the answer. If you have a saber saw or router, you can easily make a simple jig that really works. If you have a fence for your router, you can perform professional-quality

work. (More on this later.)

You can make the jig for your saber saw or router from a piece of scrap 1/4" material (plywood works fine). The following techniques apply to both a saber saw or router, although I don't like saber saws for this purpose. They produce serviceable holes, but they do not work as well as a router.

If you're using a router, remove the faceplate from the bottom. On a piece of 1/4" plywood, 18-24" long and at least as wide as the faceplate, transfer the position of the holes

STEEP SLOPE ELECTRONIC CROSSOVERS

CREATE A SPEAKER SYSTEM WITH PHENOMENAL CLARITY

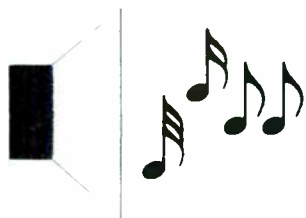

- Drivers are usable as true pistons over a limited range of 2.5 octaves
- Steep slope crossovers exploit full use of this range
- A remarkable clarity of sound results, obvious to even the untrained ear

Our professional multi-way electronic crossovers offer steep slopes up to 66dB/octave (11th order)

Send for product literature: crossover systems, matched filters, filter kits, precision capacitors, and more!

SUSSEX TECHNICAL CORP.
FAX (214) 495-6434

6114 TURNBERRY DR.
GARLAND, TEXAS 75044

Reader Service #77



PHOTO 7: Screw, washer, lock washer, and T-nut assembled into the slot in the plywood jig slot.

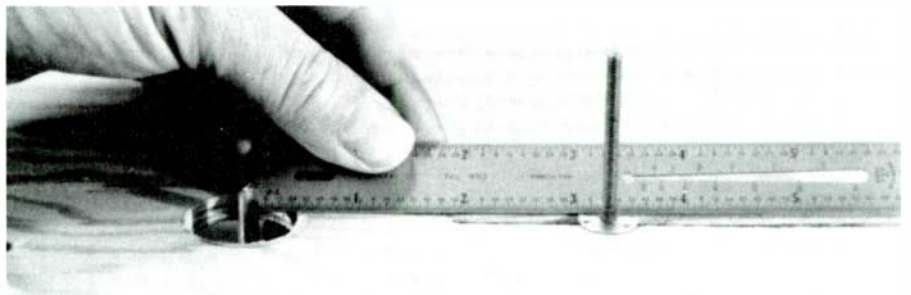



PHOTO 8: Adjusting the circle cutting jig using a ruler to set the radius. The far side of the router bit determines the radius.

(Photo 6) and drill them out, countersinking the mounting holes to accept the original mounting screws. Draw a line parallel to one edge of the plywood, using the center of the center hole as a guide.



**THE WORLD'S
MOST RESPECTED
HI-FI MAGAZINE**

**SUBSCRIBE TODAY AND GET
THE NEXT 12 ISSUES FOR**

\$65.00 USA \$75.00 CANADA

Please send me the next 12 monthly issues of Hi-Fi News and record Review from the next available issue.

Mr/Mrs/Miss/Ms _____
 Address _____
 _____ Apt# _____
 City _____
 State _____ Zip _____

METHOD OF PAYMENT

Check enclosed (US dollars and drawn on a US bank)
 Please charge my Visa Mastercard American Express

Account No. _____ Exp.date _____
 Signature _____ Date _____
 Please bill me

Return to Hi Fi News & Record Review, PO Box 384, Avenel, NJ 07001

**FOR FASTER SERVICE USE YOUR CREDIT
CARD AND CALL TOLL FREE**

☎ 800-688 6247 AA41

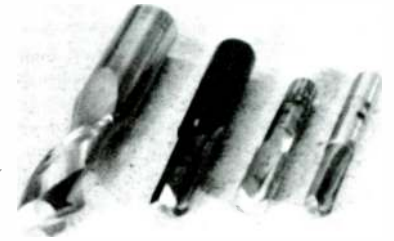

PHOTO 9: Straight bits for routing. My favorite is the spiral bit on the left.

Measure the outer diameter of the threaded portion of a 6-32 x 1/4" T-nut. This is the width of your cut, which should not extend to the center hole or through the end of the board opposite the center hole.

One way to make the cut is on a table saw with the spreader removed (Photo 6). Align the plywood so the slot will start inside the piece about an inch from the edge. Gently lower the plywood onto the running saw blade while firmly holding the back edge in place. (I removed the blade guard to take this photo. Use the blade guard, whenever possible, while working on a table saw.)

Make the cut, stopping before the center hole. If the width of the cut is not enough to accept the shank of the T-nut, you'll need to make a second cut.

Put a washer and lock washer on a 1/4" 6-32 bolt, and screw it into the T-nut with the washers on top of the plywood (Photo 7). Tightening the screw locks the assembly in place to act as a pivot around which to cut a circle. You can adjust the screw pivot of the assembled system to provide a specified radius (Photo 8).

You will need a straight bit for your router (Photo 9). I prefer the spiral-flute solid carbide bit, which costs about \$15-\$25 from Grizzly Imports. It will keep the cut clear of chips and produce clean, sharp cuts. If possible, use 1/2" shanks for added stability.

Next, mark the location for the hole



PHOTO 10: Laying out the circle.



PHOTO 11: Using the jig and router.

(Photo 10) and drill a center hole big enough to just accept the screw pivot. Now, simply rotate the jig about the pivot (Photo 11), cutting out a circle. For best results with a router, don't try to cut all the way through on the first pass; cut about an eighth of an inch at a time. If you use a backup board, the pivot screw should extend down into it, which keeps the cutout stock in place as you make the final cut.

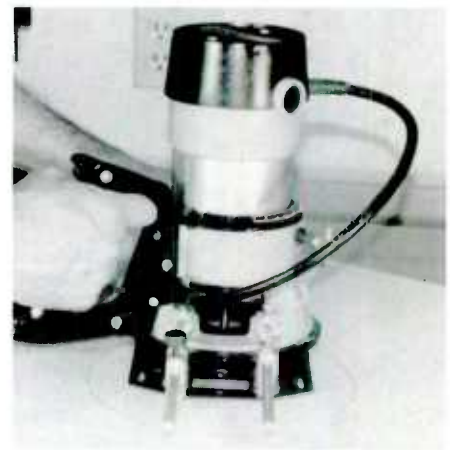

PHOTO 12: Using a modified router fence.

USING ROUTER FENCES

You can use this basic idea to modify a router fence (also called a router edge guide) to make holes. The fence replaces the plywood jig. Some manufacturers have built this into their fences, but other models require slight modifications.

The guide on the fence is usually a stamped-out piece of sheet metal with a flat surface flush with the base of the

MCM AUDIO SELECT™

High Performance Plus,
Attractive Prices

Woven Carbon Fiber Series

Designed to accommodate the most serious audiophile, these drivers utilize one of the most rigid and lightweight cone composites available. The use of carbon fiber results in dynamic bass response, superb midrange clarity and an extremely natural top end roll off. Other features include rounded over steel baskets, vented pole piece and a high compliance rubber surround. Available from 6½" to 10", with prices ranging from \$23 to \$50

In addition to the complete line of MCM Audio Select speakers, the MCM Electronics catalog is packed with hundreds of accessories from names you know: AMS, Pyle, Eminence, Pioneer, Electro Voice and others. There's also MCM's complete line of electronic components, repair parts, tools, test equipment and more. Over 21,000 products in all, are stocked and ready to ship. Call for your free MCM catalog today.



FREE
CATALOG



For a FREE Catalog, Call...

1-800-543-4330

Product Questions 1-800-824-TECH(8324)



MCM ELECTRONICS™
650 CONGRESS PARK DR.
CENTERVILLE, OH 45459-4072

A PREMIER Company

Hours: M-F 7 a.m. - 9 p.m., Sat. 9 a.m. - 6 p.m. EST.

Serving you coast to coast! Distribution Facilities in Dayton, OH and Reno, NV.

S823

Reader Service #11

Speaker Builder 4/95 45

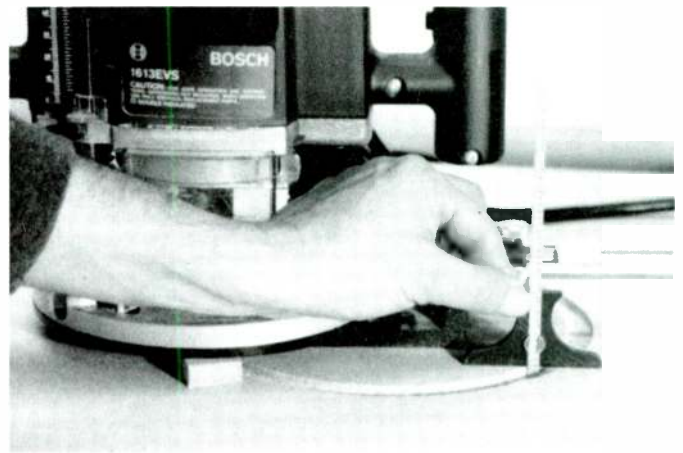
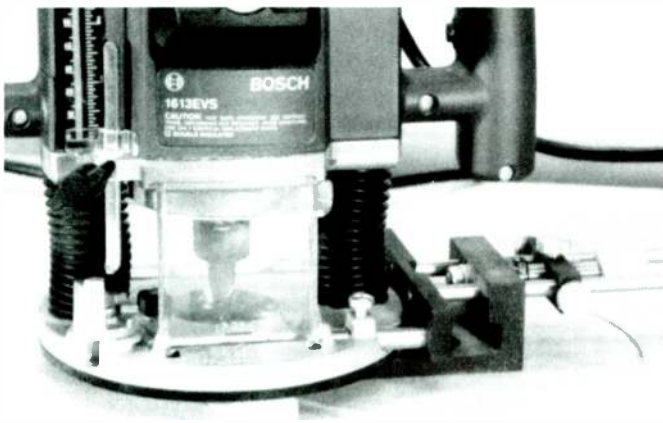

PHOTO 13: Micro Fence attached to a plunge router.

PHOTO 14: Checking the depth of cut for a recessed ring that doesn't go through the board.

router. Draw a center line between the two rods extending from the base. If there is not a hole on this line, you will need to make one. You can mount a screw through this hole to use as the pivot. Follow the same procedure as described above for the homemade jig, except substitute the fence for the jig (*Photo 12*).

If your router fence extends below the plane of the base, you will need to make a wooden spacer that mounts on the bottom

of the router—just thick enough to bring the bottom of the fence and the spacer bottom into the same plane. Instead of the screws as pivots, use spacers and standoffs. As audiophiles we normally use them to separate or mount electronic boards, but the round ones make perfect pivots. Those with a 8–32 threaded stud are good choices. Be sure the spacer is long enough to penetrate your board and at least 1/4" into the backup board.

STEP BY STEP

All of the above methods produce perfectly acceptable holes for mounting your speakers. Another, rather expensive, device you can purchase to make quality holes is the Micro Fence (*Photo 13*). This router fence (\$98 from Micro Fence) is an after-market addition that is precision made for professional results. It is custom-manufactured to fit individual routers. You can set the position of the fence with a precision of 0.001".

KIT CLOSEOUT !!!

Once in a **GREAT** while, we bid a sad **ADIEU** to a **SELECT** number of our **FAITHFUL** kit friends. But their retirement to **KIT HEAVEN** can be your **GAIN**, as we offer you **ONE LAST CHANCE** to order them. We will make **ONE LAST BATCH** of the kits below **ONLY** if there is **SUFFICIENT INTEREST**.

We will **TAKE RESERVATIONS** for the kits below **ONLY BY CREDIT CARD** and **ONLY UNTIL TUESDAY, AUGUST 1, 1995!** Shortly thereafter, we will notify all respondents **BY MAIL** whether there was sufficient interest to make their kit(s). For **DESCRIPTIONS**, consult your Old Colony catalog #6. **NO CHARGES WILL BE MADE PRIOR TO KIT(S) SHIPMENT.**

YES! Please reserve for me the following kit(s) at the price(s) shown if there is sufficient interest.

Please ship via SURFACE \$10 per kit AIR \$20 per kit

QTY	KIT	DESCRIPTION	PRICE \$
—	KC-4A	Elec 2-Way Xover (spec Hz: 60,120,240,480,960,1920,5k,10k)	29.00
—	KC-4B	Elec 3-Way Xover (spec TWO freqs from KC-4A)	34.00
—	KH-2	Speaker Saver	79.00
—	KJ-6	Capacitance Checker	104.00
—	KK-6H	Waldron Xover High (spec range: 19-210;43-465;88-960;190-2100; 430-4650;880-9600;1900-21k)	84.00
—	KK-6L	Waldron Xover Low (spec range from KK-6H)	79.00
—	KSBK-C1A	Jung Elec 2-Way Xover (spec Hz: 60,90,120,250,500,1k,2k,5k,10k)	49.00
—	KSBK-C1B	Jung Elec 3-Way Xover (spec TWO freqs from KSBK-C1A)	74.00
—	KSBK-E2	Peak Power Indicator	27.00

NAME _____

STREET _____

CITY _____ STATE _____ ZIP _____

MCVICA/DISCOVER # _____ EXP. DATE _____

DAYTIME PHONE _____ DATE _____

OLD COLONY SOUND LAB

PO Box 243, Dept. B95
Peterborough, NH 03458 USA
Tels. 603-924-6371, 603-924-6526
Fax 603-924-9467

*All sales final*No discounts apply*Note: PCBs will still be available for most projects*

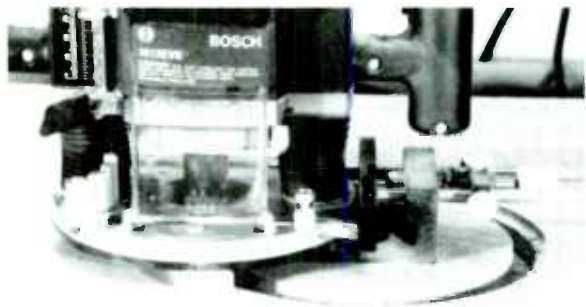

PHOTO 15: Making the final through cut on a two-stepped speaker mounting hole.



PHOTO 16: Final configuration of the two-step mounting hole.



PHOTO 17: Speaker mounted in the board. Note how closely the speaker fits into the hole. This set of cuts was made on particleboard; MDF produces even better results.

Before you can use it to cut circles, you must modify the main body of the fence. As above, find the center line on the plate between the two rods extending from the

router base. Drill a hole with a #59 drill about 1" in from the surface nearest to the router on the center line. Tap the hole for an 8-32 thread. Then attach a circular spacer with an 8-32 stud by screwing it into the hole.

The shoulder of the spacer will help provide support of the spacer that now becomes your pivot for cutting circles. The spacer should be long enough to extend into the backup board. Because the main body of the fence will be flush with the top of the board

you are cutting, you will need to attach a block of wood to the base of the router to keep the base parallel to the board. *Photo 13* shows this spacing block under the base of the router. Be sure to mount the board outside the circle you are cutting.

Normally I prefer to mount the speaker so the front of the mounting flange is flush with the mounting board. This requires a two-or-more-stepped hole, with one recessed ring that doesn't go completely through the board. Of course, if the speaker frame is more complex, you may need to cut more than two steps. Measure the radii and the depths needed for each ring.

Assuming that the shallowest ring is on the outside, set the radius 1/32" less than you need. Make a very shallow test cut. Measure the radius and then, using the micro adjust feature, set the fence to meet your exact requirements. Start cutting the ring, stopping often to measure the depth (*Photo 14*).

Move the fence to the next radius. Correct as above after you make a very shallow test cut. Continue this process until you have made the final through cut (*Photo 15*). Drill the holes for attaching the speaker and apply any necessary sealant. The speaker should fit snugly into the finished hole (*Photo 16*). The results of your efforts should be enough to make any speaker builder proud (*Photo 17*).

You can use the technique outlined above for producing stepped holes with either the jig or the standard fences. My next column describes how to make mountings for irregularly shaped speaker flanges. 

SOURCES

Grizzly Imports
PO Box 2069
Bellingham, WA 98227
(800) 541-5537

Micro Fence
11100 Cumpston St. #35
No. Hollywood, CA 91601
(818) 766-4367



All your life they've called you "picky", hard to please. **WRONG!** Truth is, you're a perfectionist! You want it done

RIGHT!

You want to build your speakers and you want them to be **PERFECT!** "You are there" imaging, great dynamics, powerful, clean bass, **REALISM!** You demand durability and affordability. You can build them. All you need are world-class designs and the parts to put it all together.

An ACI Parts Kit is the answer to your prayers.

ACI's are the only kits available that have received over 20 great reviews in magazines from Speaker Builder to Stereophile. Choose from six great models including the reference quality **Sapphire III** and the 250 watt **Titan "smart amp"** powered sub.

Be picky, build your **PERFECT ACI speakers.** Call or fax us today!

ACI div.
Audio Concepts, Inc.
La Crosse, WI

Phone: (608) 784-4579
Fax: (608) 784-6367

Reader Service #6

CD Review

MY DISC FROM SHEFFIELD LAB

By Dan Ferguson

My Disc, Sheffield Lab Recordings, 1046 Washington St., Raleigh, NC 27605, (919) 829-1154, FAX (919) 829-0047. [Available as #CDSH3 for \$29.95 plus \$3 S/H in US from Old Colony Sound Lab, PO Box 243, Peterborough, NH 03458-0243, (603) 924-6371, FAX (603) 924-9467.]

One of the real frustrations for audio hobbyists and sound enthusiasts is the inability to measure objectively the performance of our handiwork. Few hobbyists have access to expensive test equipment and more often than not final evaluation of a construction project becomes very subjective. In addition, we have difficulty evaluating our own creations without bias.

The need for assistance was recognized 30 or 40 years ago, and from time to time test records and CDs have appeared on the market as answers to the problem. A new CD, *My Disc* from Sheffield Lab, is being billed as slanted toward the needs of auto sound. However, I find it suitable for any audio application.

As the third in Sheffield Lab's "Audiophile Reference Series," this disc was a joint effort with auto sound authority Richard Clark of Autosound 2000. The disc's ambitious intentions are accurately described

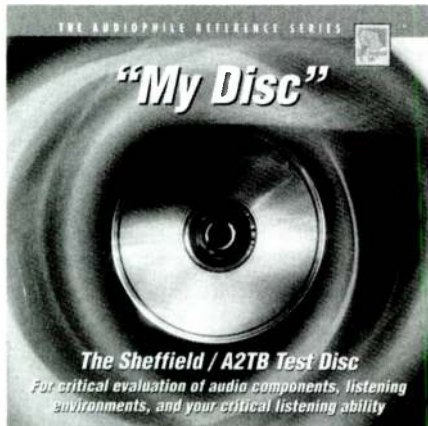

by Mr. Clark in the instruction booklet introduction. *My Disc* is intended to be a singularly complete test medium for everything from the listener's ears and ability to distinguish nuances in program material to the equipment and listening environment.

To accomplish such a comprehensive agenda obviously requires a large amount of information, which *My Disc* has: 74 minutes worth on 86 tracks. While this may seem a little overwhelming at first, once the tracks are grouped by category the disc's uses become clear. In my opinion, the tracks could be better organized. To aid our discussion I have

regrouped them into Music, Imaging, and Technical Tracks. The first two categories are simply for listening, while some test equipment is needed for most of the third.

MUSIC TRACKS

Tracks 1-6 are examples of various types of recorded music (pop, jazz, and classical) selected for their exceptional ability to demonstrate a playback system's detail and imaging. The instruction book points out the features on which the listener should focus to make the evaluation.

I found these tracks to be both enlightening and disappointing: the former from an "ear training" standpoint and the latter from a system builder's standpoint. *My Disc* enabled me to see clearly that the imaging of my home and car systems was less than ideal in some areas. System analysis aside, these tracks are very enjoyable listening.

IMAGING TRACKS

Track 19 is simply a recording of a person counting, and serves as a "reality check."

Tracks 20 and 21 identify right and left channels.

Track 22 is a channel-to-channel phase check. As a person speaks, the right and left channels are switched in and out of phase



Filters with less filter.



Whether you're modifying, rebuilding, or designing crossovers from scratch - using premium quality resistors, inductors, capacitors, wire and connectors will have your creations and drivers performing to their maximum potential. These exceptional components, generally reserved for state-of-the-art manufacturers, stay true to the original signal - resulting in less degradation - less music filtered out. Call The Parts Connection for further details or to let us know what you need.

We are feverishly working on our much-expanded 1995 Catalog with many new part lines, more technical info, schematics and lots of other great stuff! Keep an eye out.

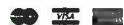

2790 Brighton Road, Oakville, Ontario, Canada L6H 5T4
Tel (905) 829-5858 Fax (905) 829-5388

Toll Free Order Line 1-800-769-0747 (U.S. & Canada only)

• MIT MultiCap • Wonder Cap • Kimber Kap • Solo • Hovland MusiCap • Solen • Siemens • Wima • Holco • Rel-Cap • Draloric • IRC • Allen-Bradley • Jensen • Resista • Vishay • Mills • Caddock • Matsushita • TKD • Noble • Cardas • Kimber Kable • van den Hul • Discovery • Audioquest • MIT • Alps • Bourns • Shalco • Elma • Electroswitch • Gold Aero • RAM • Mallory • Panasonic HFQ • Nichicon • Elna • N.O.S. • Ruby Tubes • UltraAnalog • Burr-Brown • Crystal • Linear Technology • Analog Devices • Edison Price • Motorola • UCC • International Rectifier • Hitachi • MagneQuest • Sonic Frontiers • Pearl • Tube Sockets • WBT • Neutrik • Sound Coat • Curcio Audio Engineering • Assemblage and other kits

THE PARTS CONNECTION
A DIVISION OF SONIC FRONTIERS INC.

for comparison. The test makes actual phase conditions easily recognizable and would be extremely valuable in auto sound applications where wiring errors are so easily made. I've actually had to remove the speakers in a client's car with an imaging problem just to inspect the wiring and verify polarity.

Tracks 25 and 26 consist of three people speaking and describing their locations as right, left, and center. I suspect this series would be a good test to determine whether you are overdoing a center channel (if you're fortunate enough to have one).

Tracks 27-32 contain specially

recorded musical passages which test lateral imaging by shifting from normal stereo to mono, panned left, back to center, right, and finally back to center. This gave both of my systems a real workout, and enabled me to easily detect some minor weaknesses in my truck's front soundstage.

TESTING PARAMETERS

The remainder of the disc is devoted to a variety of technical tracks capable of wringing out your entire playback system, from your CD player's digital-to-analog converters to the overall phasing and response. But before

TCH

YOUR *Handles • Corners*
ONE *Speaker Grills • Casters*
SOURCE *Speaker Carpet*
FOR *Jack Dishes • Feet • Clamps*
SPEAKER *Grill Cloth*
CABINET *Plugs & Jacks*
COMPONENTS

- OVER 500 ITEMS IN STOCK FOR IMMEDIATE DELIVERY
- \$50 MINIMUM ORDER



TCH

Phone 800-291-0389
 Fax (716) 892-4302

1705 Broadway
 Buffalo NY 14212

Reader Service #48

World Radio History

Digital Storage Oscilloscope For \$189.95 ???

And much, much more!

O-Scope I turns PC-ATs into DSO, Spectrum Analyzer, Frequency Counter, DVM. DC-50KHz

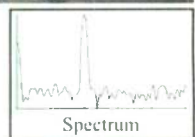
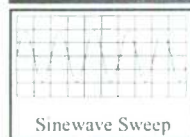

Actual O-Scope I Captured Signals

For Orders and Inquiries Call: 1-800-980-9806
 For Technical Assistance: 1-713-777-0401

Allison Technology Corporation
 8343 Carvel, Houston, TX 77036
 FAX and BBS 1-713-777-4746

Reader Service #64

ENCLOSURES



PANELS ARE .063" ALUMINUM

- In stock for fast delivery
- Designed for small lot production
- Flat panels for easy fabrication
- Shipped unassembled
- Also available in all black for an extra charge

Dual Slope Cabinets

MODEL	W x D x H (in)	\$
DS-1	4 x 6 x 4	40.00
DS-2	6 x 6 x 4	43.00
DS-3	8 x 6 x 4	46.00
DS-4	10 x 6 x 4	49.00
DS-5	12 x 6 x 4	52.00
DS-6	18 x 6 x 4	55.00
DS-7	4 x 8 x 6	50.00
DS-8	6 x 8 x 6	54.00
DS-9	8 x 8 x 6	58.00
DS-10	10 x 8 x 6	62.00
DS-11	12 x 8 x 6	66.00
DS-12	18 x 8 x 6	70.00

Rack Chassis

MODEL	W x D x H (in)	\$
1RU5	19 x 5 x 1.75	34.00
1RU7	19 x 7 x 1.75	36.50
1RU10	19 x 10 x 1.75	38.75
1RU12	19 x 12 x 1.75	42.75
1RU15	19 x 15 x 1.75	45.75
1RU17	19 x 17 x 1.75	48.75
2RU5	19 x 5 x 3.5	36.50
2RU7	19 x 7 x 3.5	38.75
2RU10	19 x 10 x 3.5	41.25
2RU12	19 x 12 x 3.5	45.25
2RU15	19 x 15 x 3.5	48.25
2RU17	19 x 17 x 3.5	51.25
3RU5	19 x 5 x 5.25	46.00
3RU7	19 x 7 x 5.25	48.50
3RU10	19 x 10 x 5.25	51.00
3RU12	19 x 12 x 5.25	54.00
3RU15	19 x 15 x 5.25	57.00
3RU17	19 x 17 x 5.25	60.00

PANELS ARE .063" ALUMINUM

LOWER PRICES!
 (800) 634-3457
 Order Today!



SESCOM STOCKS ALL TYPES OF ENCLOSURES
 FREE EXPANDED 1995 CONSTRUCTOR'S CATALOG

PREPAID ORDERS SHIP GROUND FREE
 (48 STATES, CANADA & MEXICO)

SESCOM, INC.

2100 WARD DR. HENDERSON, NV 89015 USA
 USA/CANADA (800) 634-3457
 FAX (800) 551-2749
 (702) 565-3400 FAX (702) 565-4828
 TECH LINE (702) 565-3993 M-Th 9 am to 4 pm (PST)



Reader Service #23

Speaker Builder 4/95 49

we proceed, let's discuss some practical aspects of testing with *My Disc*.

In order to use many of the technical sections with any real effectiveness you will need an accurate microphone such as Old Colony's Mitey Mike or a sound level meter (SLM) like those sold by Radio Shack. The SLM has the advantage of being self-contained with everything you need in one compact package. The disadvantage is, at a retail price of \$29.95, it has obvious accuracy limitations. [The analog version may be improved by adapting it for use with Mitey Mike. See C.L.P. Carrington, "Converting Radio Shack's SLM to Millivolt Use," SB 4/94, p. 12.—Ed.]

On the other hand, the Mitey Mike has terrific accuracy but you need some way to read its output. Here, an accurate, "true RMS" meter is required. Most of them are quite expensive and yet have limited bandwidth, rendering them incapable of covering the entire audio spectrum. All of this can be somewhat perplexing.

I decided to make some trial measurements with my Radio Shack SLM and compare the results with those of my DOD real-time analyzer. I got surprisingly good agreement between 20Hz–12.5kHz, at which point the SLM response begins to fall off. The calibration curve supplied with my SLM shows

the meter beginning to fall off in that region and being down 20dB at 20kHz. It appears to be down approximately 5dB at 16kHz and 11dB at 20kHz, which is a flatter response than expected.

I would say that my Radio Shack SLM will give good results between 20Hz–12.5kHz. Beyond that, the calibration is somewhat unknown. Armed only with *My Disc*, a \$29.95 SLM, some time, and a great deal of patience, you should be able to tune your system reasonably well within that range.

TECHNICAL TRACKS

Tracks 7 and 8 are reference level 1kHz sine waves at -20dB f_s and 0dB f_s , respectively. The liner notes indicate that these demonstrate the 20dB headroom available on CDs, and that 0dB is the highest recordable signal level in that medium. I regard these tracks as being in the "general information" category.

Tracks 9–18 are ten warble tones (one per track) which are one octave wide and centered at 20, 62, 125, 250, 500, 2.5k, 5k, 10k, 15k, and 19kHz. Most of these are located near some popular graphic equalizer center frequencies, which should aid in system tuning. As most speaker builders know, warble tones are used to minimize the effect of standing waves in an attempt to remove the response of the listening space from the mea-

surements. I found this section extremely easy to use and an excellent starting point for tuning a graphic equalizer.

Track 23 consists of polarity pulses which are intended to be used with a polarity checking instrument.

Track 24 is a clipped 1kHz sine wave intended for use with an oscilloscope as a signal tracer.

Tracks 33–42 test the linearity and accuracy of your CD player's A/D converter by playing a reference musical passage at successively lower levels. Linear reproduction of low-level signals has always been the most difficult task for digital systems. So, if the music sounds clean through each iteration, your A/D converter is working well. My Sony with 4x oversampling began to hiss audibly at -40dB. At successively lower signal levels, the hiss increased proportionately. This was certainly the first I had heard anything other than music from my CD player. The problem is I don't know whether a threshold of -40dB is good or bad performance.

Track 43 is "correlated" pink noise (identical signals to both channels). Pink noise is composed of all frequencies, at random, with equal energy (not amplitude) contained in each octave. In my opinion this is the most valuable track, but only if you have access to

Speaker Builder

THE LOUDSPEAKER JOURNAL

A

NAME _____

STREET & NO. _____

CITY _____ STATE _____ ZIP _____

I have enclosed: Check or Money Order
 MC VISA Discover

Card No. _____ exp date _____

SUBSCRIBER SERVICES

- Check here if this is an address change
 New Subscription Renewal
 Gift (see below)

1 Year, \$32 2 Years, \$58

Canada add \$8/year. Remit in US\$ drawn on a US bank only.
Overseas rates: \$50, 1 year; \$90, 2 years.
Rates subject to change without notice.

TELL OTHER SPEAKER BUILDERS ABOUT US!

Print their names & addresses below. We'll take care of the rest.

NAME _____

NAME _____

STREET & NO. _____

STREET & NO. _____

CITY _____ STATE _____ ZIP _____

CITY _____ STATE _____ ZIP _____

(When giving a gift subscription—fill in the recipient's name & address here.)

We try to keep our subscription process as trouble-free as possible, however, if you have a problem we want to help to correct it as soon as possible. Call or write with all the pertinent information including your account number.

Call us during business hours at (603)924-9464 or FAX us at (603)924-9467.

Our FAX machine is on duty 24 hours a day.

Speaker Builder, PO Box 494, Peterborough, NH 03458-0494 USA.

a real-time analyzer (RTA). I own an inexpensive (\$300) DOD RTA-II, and it is a real joy to be able to measure the results of my efforts with some degree of accuracy. Using this track and the RTA produced a delightful-sounding tuning of the new ten-band Jensen graphic equalizer in my truck. A friend described the sound as smooth and textured, and likened it to sipping old, expensive whiskey.

Incidentally, these pink noise tracks last only about a minute. So you will need to program your CD player for that single track in repeat mode.

Track 44 consists of "uncorrelated" pink noise, which means the noise in each channel was recorded independently. While I have not encountered this before, the instruction book states it can aid in tuning a system where the listener is not equidistant from each speaker (like in a car). The recommendation is to tune with both correlated and uncorrelated noise, then compromise between the two. From a practical standpoint I found this somewhat tedious; however, if a person were building an auto sound system for competition purposes, it may provide an edge.

Tracks 45 and 46 demonstrate the logarithmic concept of decibels through a series of volume changes.

Tracks 47-56 contain 30 bands of pink noise (1/3 octave each) from 25Hz to 20kHz. If you wish to measure the response of your system and don't own an RTA, these tracks make *My Disc* invaluable. As discussed previously, you will need some type of sound level measurement equipment to use this. For pure convenience, the SLM is hard to beat. Even so, this is a tedious process that requires quite a bit of patience.

To equalize your system, draw a graph with 30 points on the "X" axis and about 20 divisions on the "Y" axis. As the disk cycles through the bands, plot the sound levels on the graph. Adjust your equalizer settings accordingly and repeat the process. With a little perseverance, you can duplicate the results obtained with an RTA.

Even if your system does not incorporate a graphic equalizer, these tracks can serve other uses. One would be to determine the best settings for individual driver L-pads or bass and treble controls.

Track 57 is a continuously swept warble tone from 20Hz to 20kHz, which "subjectively" evaluates your system's overall smoothness. In addition, it's another outstanding tool to provide a final check with your SLM after Tracks 47-56.

Track 58 is similar to the preceding track, except the frequency range is 100-20Hz for subwoofer evaluation.

Track 59 contains low-distortion sine waves at 90 individual frequencies from 10-99Hz. The instructions suggest using them to find the resonant frequency of low-frequency drivers, and, consequently, as a signal generator. This would work well if the frequencies were in 0.1Hz increments; as it is, they are of limited value. However, if a CD were developed with finer frequency increments, I could envision measuring a driver's Thiele/Small parameters simply by plugging into a CD player's headphone jack!

Tracks 60-62 are a low-distortion swept sine wave from 20Hz to 20kHz, primarily for evaluating electronic components.

Track 63 is an accurate musical tone (A at 440Hz) which can serve as a reference to tune musical instruments, similar to a tuning fork.

If this section were expanded to all 88 piano tones, you could conceivably tune anything accurately.

Tracks 64-66 are tone bursts at different frequencies, which test the transient response of various components. A microphone and

SALE! PLUS FREE ADHESIVE!

MARKERFOAM™ ACOUSTIC FOAM GIANT 54" x 54"
Immediate Shipping

2" Reg \$29.95 Now \$19.99 • 3" Reg \$39.95 Now \$29.99! KILL NOISE QUICK!
 High performance, full-size sheets of super high density Markerfoam. EZ mount. Blue or gray. Super-effective sound absorption for studios. Markerfoam offers best value, looks professional & is proven in studios worldwide. Request Foam-Buyers Guide Catalog, specs & free samples today VISA, MC, AMEX, COD. P.O.s. QUANTITY DISCOUNTS

MARKERTEK JUMBO SOUND ABSORB BLANKETS
 Heavy-duty 72"x80" padded blankets absorb sound wherever they're hung or draped. Fabulous for stage, studio & field use. Top professional quality at a super saver price! Weight: 6 lbs. Black, \$19.99.

MARKERTEK BLADE TILES™
 HIGH PERFORMANCE
 LOW, LOW COST!
 \$3.49 per tile, 16x16x2"
 America's best acoustic tile value, only from Markertek!
 Charcoal. Also available 16x16x3" as shown, \$4.49 each.

MARKERSTIK™ foam adhesive. FREE with any Foam purchase in this ad! Limited offer. A \$5.95 per tube value.

SONEX
 All the colors and sizes plus great prices!

*** Get our FREE 149-page catalog of over 6,000 exclusive and hard-to-find supplies for audio & video.**
800-522-2025 America's most unique catalog for audio & video!
 FAX: 914-246-1757

MARKERTEK™
 4 High St., Saugerties, NY 12477 U.S.A. **VIDEO SUPPLY**

Reader Service #10

FOCAL

AUDAX

SPEAKERS

QUALITY DRIVERS & MORE

etc.

AEON

ACCUTON

ERSE ELECTRONICS

ORCA CONNECTORS

We Offer A Complete Line Of Kits
Also Specializing In Speaker Repair

2730 W Thomas Rd.
 Phoenix, AZ 85017
 Phone (602) 272-6696

Request a FREE catalog

FAX (602) 272-8633

(Mntn Std Time)
 10:00 AM-7:00 PM Weekdays
 10:00 AM-5:00 PM Saturdays

Reader Service #71

Speaker Builder 4/95 51

Hi-Vi Research Inc. Canada

Majoring in producing and designing HI-END speakers/electro-acoustical systems and amplifiers, located in the Ontario, Canada area, has immediate opportunities in the areas of:

- Drivers Designer
- Horns Designer
- Tweeters Designer
- Loudspeakers Designer
- Planar Magnetic Speaker Designer
- Professional Loudspeaker Designers
- Electro-Acoustic System Designers
- Electrostatic Speaker Designer
- Hi-end Amplifiers Designer & Engineer

Three years experience is essential.

Hi-Vi Research Inc. Canada is an equal opportunity employer, offers a competitive salary, and a comprehensive benefits package. If you would like to join our team, send resume to:

100 Spy Court,
Markham, Ontario L3R5H6
Fax (905) 475-8226

MAHOGANY SOUND

The Transmission Line Specialist
P.O. Box 9044
Mobile, AL 36691-0044
334 633-2054

Acousta-Stuf

The Very Best Damping Material For Speaker Systems. It Produces Deeper Bass, Cleaner Mids, And Greater Dynamic Range. Acousta-Stuf Costs \$9.50 Per Pound UPS Paid.

Q&ETLD

Quick & Easy Transmission Line Speaker Design Booklet & LOTUS 1-2-3 Software. Learn How To Design Optimized 1/4 Wavelength TL Speakers. Q&ETLD Costs \$8.95 Plus \$1.80 P&H.

New For 95 Acousta-Tubes

Round Paper Tubes For Building Cylindrical Speaker Enclosures.

Please Note Our New Address & Area Code

Call Or Write For A Free Catalog

oscilloscope are needed to make the best use of these tracks.

Tracks 67 and 68 are square waves at 100 and 1kHz, respectively. A good application for these tracks is "time alignment" of individual drivers. Again, a mike and oscilloscope are required.

Tracks 69 and 70 demonstrate the concept of dynamic compression of conventional recordings prior to CDs. They can also be used to check the accuracy of tape deck recording level meters. Incidentally, if your meters are accurate at all frequencies, you should be able to employ them with a microphone as a SLM.

Tracks 71-76 are a sine wave, initially with a very low 0.004% distortion and increasing in steps to 10%. These tracks check the calibration of a distortion analyzer (very expensive) or simply function as ear training.

Tracks 77-82 are similar to the preceding ones, except the signal source is music. The main application here is ear training and a test of your ability to distinguish distortion. It is quite surprising to learn the extent to which music can mask the distortion levels that were so easily detected in the previous sine wave test.

Tracks 83 and 84 demonstrate the concept

You're sold on state-of-the-art drivers.

Goertz low-inductance wire: the measurable difference.

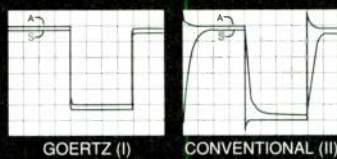

Goertz MI low impedance speaker cables—high purity copper or silver flat, solid conductors ideal for both internal and external speaker use. The patented Goertz design virtually eliminates high-frequency rolloff, skin effect below 50 kHz, hum from power wiring, and cross talk.

Alpha-Core foil-conductor air core inductors, available in 12, 14 and 16 AWG, also minimize

high-frequency rolloff and skin effect below 100 kHz, reduce power loss, and eliminate saturation distortion. High winding tension and vacuum fusing of faces

provide consistent values and maximum stability.

Used together, these new components provide a signal path between amplifier and transducer that is "as distortion-free as possible within the limits of present technology."

Why settle for run-of-the-mill inductors and wire?



"...both Dave and James at Ambrosia Audio feel it to be one of the best speaker cables around when you consider the cost (heck, forget the cost—I think it's great regardless!)... dynamics and punch out the kazoo... this stuff is highly recommended."

—The Earful, October 1994

"Better bass, understandably, but—surprise! Greatly enhanced highs! And excellent definition."

—Clark Johnson, Positive Feedback, October 1994

Alpha-Core Inc.

915 Pembroke Street,
Bridgeport, CT 06608 USA
(203) 335-6805 / (800) 836-5920

of "group delay." I found the effects to be very subtle.

Tracks 85 and 86 are the sounds heard on pit row at the Indianapolis Motor Speedway. According to the instructions, they are best appreciated by listening through headphones. I must agree. These are nice novelties that add to the overall comprehensive nature of *My Disc* but are of lesser value in system testing.

IN CLOSING

With the number of test CDs and records on the market, someone seeing an ad for *My Disc* might be tempted to say, "Oh no, not

another one!" This one, however, just may be different and better. It definitely meets its ambitious objectives, and I heartily recommend it.

MANUFACTURER'S RESPONSE

Thank you very much for your very thorough review of My Disc. This is truly a project designed for anyone who wishes to gain a better understanding of their system's capabilities. I would like to mention only a couple of points.

One of the reasons My Disc is selling so well, despite the ever-growing population of test software available today, is that it was

designed for the listener to make more accurate judgments about the performance of a given playback system. But the unique feature about this newest member in Sheffield's catalog of "Test Tools" is its focus on allowing the listener to evaluate his/her own critical-listening ability, not just the performance capabilities of the audio system in a given environment. We feel that educating the listener is the most important key in helping an individual to understand, develop, and improve a sound system. This is dependent upon the listener having some idea about his/her own hearing capabilities.

The other point which Mr. Ferguson certainly makes clear, but that I would like to emphasize even further, is, despite the fact that My Disc was created in cooperation with Richard Clark (the highly distinguished engineer from Autosound 2000), this disc is equally useful as a home-audio test product as it is in the car. This might be an important point to make, especially considering that although Ferguson tried out My Disc in his car, I would imagine that the bulk of the folks who subscribe to Speaker Builder are home-audio enthusiasts.

Quentin Libby
Sheffield Lab Recordings

CFAC™
Copper Foil Air-Core Inductor
Extremely Designed For Precision Audio Transducer Driver Crossover Network.

*"The CFAC Inductor far exceeds anything I have used in the past."
"Gone are the colorations I previously attributed to various drivers. It is now obvious that the colorations were in fact caused by interior inductor."*

**Arnie Nudell, President
Genesis**

"CFAC Inductor is a product that have advanced the state-of-the-art, providing me with a product that is the most sonically pure component available. They are, simply, the best..."

**Robert Grost, President
Unity Audio**

- Minimized Skin Effect up to 100kHz
- Reduce inductor coloration
- Low DC resistance
- Low AC resistance
- Higher precision coil reactance
- Uniform current density
- Very high winding density
- Computer optimized coil size
- No saturation distortion
- No hysteresis distortion
- Made in USA

AVAILABLE AT:

MICHAEL PERCY (415) 669-7181, SONIC FRONTIERS (416) 847-3245, HANDMADE (215) 432-5732

For Catalog: Solo Electronics, 2462 Tripaldi Way, Hayward, CA 94545, USA. Tel:(510)887-8016 Fax:(510)887-1657

CFAC INDUCTOR - CLOSE TO THE IDEAL INDUCTOR

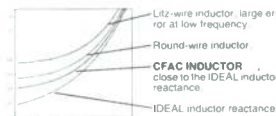

At low frequencies, inductor resistance error caused by the coil resistance will affect the accuracy of the crossover network and bass transit response.

CFAC INDUCTOR is more close to the ideal inductor reactance, which provide more accurate crossover frequency and improve bass transit response

CFAC INDUCTOR - ELIMINATE SKIN EFFECT

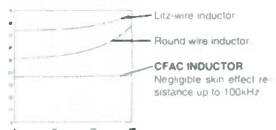

Skin Effect Resistance
Skin Effect will cause the inductor resistive load increase, power loss, non-uniform current density in the conductor, signal amplitude decrease and phase delay. Sound quality will be degraded. The ultra thin structure (0.003" thick) of the CFAC INDUCTOR is specially designed to minimize the Skin Effect

51,092
ELECTRONIC COMPONENTS

Whether you order 1 part or all 51,092...MOUSER stocks and...ships same day!!

CALL...(800) 992-9943

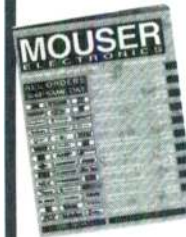

for your
FREE CATALOG

958 North Main St.
Mansfield, TX 76063

MOUSER®
ELECTRONICS
Sales & Stocking Locations Nationwide

Reader Service #40

Reader Service #30

Speaker Builder 4/95 53

SB Mailbox

CORRECT TEST RESULTS

The incorrect Fig. 7 was included in "Box Models: Benson Versus Small" (*SB* 3/95, p. 14). The correct curves are shown in *Fig. 1*.

G.R. Koonce
Liverpool, NY 13088

AR, PHONE HOME

In a recent letter to "SB Mailbox" (*SB* 2/95, p. 60), I mentioned the source for Acoustic Research loudspeaker replacement parts, but included the incorrect telephone number. The following is the complete, corrected information:
Alex Barsotti, AB Tech Services
26 Pearl St. #25, Bellingham, MA 02019

(800) 225-9847, (508) 966-0004,
FAX (508) 966-2204.

Tom Tyson
High Point, NC 27262

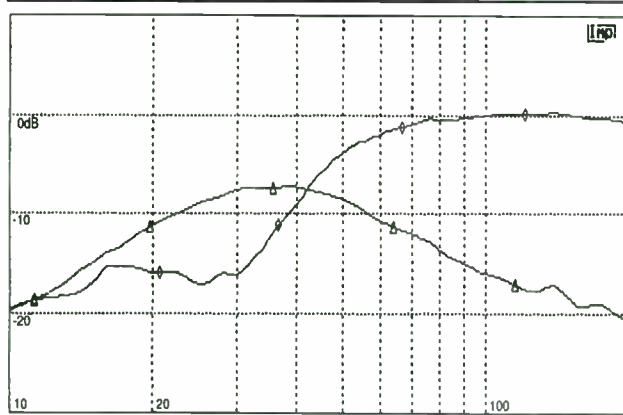

△ memory trace:
Benson Article curves - Part NF response with port loaded
◇ file LSYDURFR:
Benson Article curves - Driver NF response with Port loaded

FIGURE 1: Figure 7 for "Benson Versus Small" article.

REMEMBRANCE

The passing of my old friend Raymond Cooke OBE was more than a little personally distressing, since once again, the band of my generation of audio enthusiasts is depleted by someone we can ill afford to lose. They are all a special breed, whose interests are entirely music-driven. This is in contrast to what I see as a disturbing trend, an excessive interest in the mechanics and insufficient regard for the end product which, after all, surely is what matters.

It was a search over many years for a remarkable performance of the *Dream of Gerontius* that led me back to Raymond, whose love of Elgar was well-known, and the composer's greatest achievement. It was characteristic of the man that he called me from his hospital bed



Subscription Form

P.O. Box 754, Manhasset, N.Y. 11030 - 0754
Telephone: 516 627 3836 Fax: 516 627 1972

Please charge my Credit Card with the amount indicated. (All major Credit Cards accepted)

Name:

Signature:

Address:

City:

State:

Zip:

Telephone: 516 627 3836 Fax: 516 627 1972

I wish to subscribe right now - and receive monthly copies of Hi-Fi World Air Speeded direct from the Publisher in London U.K. to the N.Y. Office

I enclose my payment to: **FRJ/HI-FI** as checked below

1 Year - 12 Issues \$66 (U.S.)

U.S. FUNDS ONLY PLEASE - Add \$10 U.S. for Canada.

A great mainstream magazine full of product reviews, features and music reviews. In our regular free DIY Supplement (banded on) are in-house designed amplifiers and loudspeakers for the home constructor, as well as DIY letters, pages full of useful design advice, kit reviews and kit news. You'll find reviews here available nowhere else, on titanium-anode 300Bs for example, books from around the world, vintage products and FFTs from the USA.

Our in-house designers and laboratory produce unique valve amplifier designs, including transformers, for the DIY Supplement. Our loudspeakers are designed around hi-tech. Polydax carbon-fibre and, in future, HDA drivers - all available in the USA.

Coming in 1995: an all-valve phono stage, including MC; an electrostatic speaker kit that runs at 13kV; an HDA loudspeaker; a twin-300B single-ended power amplifier, plus much more.



300B triode 28watt push-pull amplifier. Switchable feedback, unique driver transformers, dual choke power supply, welded steel chassis. Weight 44lbs. \$1160 - valves & carriage extra

Other Models include:
28watt push-pull (300B)\$ 1160
20watt push-pull (5881).....\$ 540
17watt single-ended (5881).....\$ 890
4watt single-ended (6080).....\$ 525
Line valve preamp (6922)\$ 400
Carriage extra

For further information on our range of kit valve amplifiers and loudspeakers, please contact us at the address below.
Distributor enquiries welcome.

World Audio Design
64 Castellain Road, Maida Vale
London. W9 1EX, England
Tel: (+44) 171 289 3533
Fax: (+44) 171 289 5620

to confirm that he had the recording, and we discussed ways of getting it to me. Yes, it was that precious. Sadly, there were many problems to be overcome first.

It was Betamax, made on a PCMF1 to the NTSC standard, and there was a delay before I had a pair of DATs that I could play and evaluate. It had not weathered the years well, requiring extensive editing and repair work.

Despite a solid week's work on the computer, finishing it appropriately on Easter Sunday, it saddened me I could not have completed it before his death a few days earlier. So he never heard this remarkable recording, now restored to pristine glory. Fortunately, his love of the work was shared with Jennie, his wife; so I was able to return it for the pleasure I hope it gave her.

Reg Williamson
Kidsgrove, Staffs, UK ST7 4DE

HORN DESIGN

Thanks for the excellent article on the show horn ("The Show Horn," SB 2/90, p. 10). I've always been in awe of the power of a bass horn, but had no idea how to design

one. I now believe it is within my reach. All the formulas work, but I still have a few questions.

Through what point do you measure the length of a horn, especially around a turn? Does the horn expand through a turn? How do you determine an appropriate size for a throat area?

I've also read Rick Steiners' article ("A Back-Loaded Wall Horn Speaker," SB 4/91, p. 10). Can you tell me the difference between your free space horn and a wall horn? Are the alpha, M-factor, mouth-area, and horn-expansion curve equations the same as for the free space horn?

M. Brewer
Alton, IL 62002

Contributing Editor Bruce Edgar responds:

Thank you for your compliments on the show horn article. I usually measure the length of the horn along the center of the duct. This procedure also applies to turns. Afterwards, I usually draw in the diagonal reflectors.

The horn expands through a turn. The entrance and exit areas conform to the horn expansion through the turn, but don't try to

have the horn expand exactly in the turn. The diagonal reflector prevents an exact expansion through the turn.

The optimum throat formula in my article gives the best results. I only deviate from the formula when the driver has excellent sensitivity (i.e., 99 dB). A good rule of thumb is a throat size that is 50% of the driver area.

A free space horn has a mouth size given by the following formula

$$A_M = \frac{1}{4\pi} (c/f)^2$$

where c = speed of sound, f = flare frequency, and A_M = mouth area that is one-fourth of a free space horn. The acoustical images behind the wall and the floor effectively multiply the area of the mouth by a factor of four.

The alpha, M-factor, and throat-area calculations are independent of the mouth area. You select your driver based upon bandwidth (mass rolloff frequency and flare frequency) and throat area. Run out the horn expansion based upon mouth-boundary requirements. Determine the folding scheme, and draw out the horn expansion. It's that simple. 

HIGH PERFORMANCE ELECTRONIC CROSSOVER NETWORKS THESE COMPONENTS AVAILABLE FULLY ASSEMBLED OR AS KITS



XM9-CA2 and XM9-CA3 Custom Cabinet (for automotive use) Accommodates 2 or 4 XM9 or XM16 Crossovers and PS15 (or PS10) power supply to make either 2-way or 3-way system. • Buy cabinet only, kit, or fully assembled with circuit boards.

PS10 Power Supply (for home use) converts 120 VAC to dual 15 VDC supply • Regulated • Can support 8 crossover networks.

PS15 Power Supply (for automotive use) converts 12 VDC to dual 15 VDC supply • Can support 4 crossover networks.

XM9 Crossover Network • 24 dB/octave slope • fourth-order constant-voltage design • Outputs in phase • Low noise • Controls on circuit board or panel • Settable crossover frequency from 20–5,000 Hz.

XM16 Crossover Network • 48 dB/octave slope • Eighth-order constant-voltage design • Outputs in phase • Low noise • Controls on circuit board or panel • Settable crossover frequency from 20–5,000 Hz.

XM9-C and XM16-C Custom Cabinets (for home use) Accommodates 2 or 4 XM9 or XM16 Crossovers and PS10 (or PS15) power supply to make either 2-way or 3-way system. • Buy cabinet only, kit, or fully assembled with circuit boards.

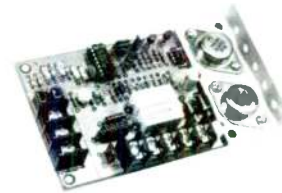
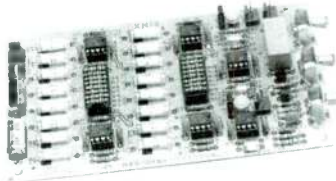

WM8 "BASSIS" Bass Correction Equalizer extends bass response by 1 to 2 octaves • Adjustable bass boost and damping • Rumble filter • 20 Hz subsonic filter.

PM2 and PM22 Power Amplifier Modules provide 75 watts RMS into 8 ohms • Complementary Darlingon output stage • Integrated-circuit driver circuit • Over-current and over-temperature protection • Class A or Class AB operation.

WRITE NOW FOR FREE LITERATURE ABOUT THESE AND OTHER MARCHAND PRODUCTS

SEND YOUR NAME AND ADDRESS TO: MARCHAND ELECTRONICS, INC.

P.O. Box 473 • WEBSTER, NY 14580 • PHONE (716) 872-0980 • FAX (716) 872-1960

Reader Service #28

Speaker Builder 4/95 55

Looking for a way to improve your image?

Try some MUSICAPs!

MUSICAP® film and foil capacitors deliver 'you are there' imaging along with exceptional dynamics, clarity and focus. Their ability to present correct timbre and depth of field along with true inter-transient silence is unequalled.

WHAT THE REVIEWERS SAY...

"If you want see-thru, high definition, detail and listenability, try the Musicaps."

Joe Roberts, SOUND PRACTICES, ISSUE 6, 1994

"The improved signal transmission of the Hovland foil capacitors elevated the (Ariel) speakers to a new level of naturalness, clarity, and immediacy."

Lynn Olson, Positive Feedback, Vol. 5, No. 4

To order contact one of the following:

- The Parts Connection 905-829-5858
- Welborne Labs 303-470-6585
- Anchor Cross Co., Tokyo, Japan 81-3-3203-5606

For international distribution contact:

Gold Aero Inc. at 818-841-5541/ fax 818-842-3825

OEMs contact: Hovland Company at 209-966-4377 or fax 209-966-4632

Reader Service #73

Simpline Sidewinder

from page 9

EPILOGUE

I have discovered another speaker which works well in the Sidewinder: the 8" Parts Express treated paper cone woofer (#295-240). This unit is more rugged in appearance than the Radio Shack 40-1024, and it has a vented pole piece. (It's also much cheaper.) As it is a drop-in replacement, all the holes match. Both speakers perform well in the Sidewinder.

In balancing the woofer with the Simplines, I found I needed no attenuation on the high-pass sections. I set the control on my Parasound HCA-800 somewhere between the 2:30 and 3:00 positions. If the midrange gets muddled with the woofer in place, you have it turned up too high. Another clue that the woofer is set too high is a fairly prominent bass line that lacks the natural transients.

Maintaining midrange clarity and developing the proper transient feeling are to me the most straightforward and easiest ways to balance (any) satellite to a woofer. The settings I have indicated will probably be different for you, unless you are using the same amplifiers; however, they may serve as a starting point. Your ears will dictate the correct position.

This system works well with a single summed woofer set between the Simplines, and may save you time and money. If you decide to make two Sidewinders, placing the input terminals in the lower center of the side panel (instead of the lower rear corner, as shown in the drawings) will enable you to use either one as a right or left channel. It would save the effort of creating a mirror-image pair to maintain the symmetry of the stereo system.

I think you should wind your sides in opposite directions, on alternate days, to keep your symmetrical integrity. You'll like what you hear.

LET'S HEAR FROM YOU

Speaker Builder needs reader feedback in the form of letters, questions, queries, and tips. Tell us your problems and concerns, your reaction to articles, your latest audio construction adventure. Our departments answer reader questions and let you share your knowledge and experience or show off your handiwork. Whether you're seeking help with a problem or offering a solution, SB wants to hear from you. Remember, it's your magazine, and your contribution can help make it even better.

Send your entries to:

Speaker Builder
Editorial

PO Box 576 Peterborough, NH 03458

UMBRA™

"POWERED SUBWOOFER" "KIT"

Driver: 2 x 12" ECLIPSE
Alignment: 3 cu. ft. 6th order vented
Amp.: 200 Watts into 4 ohm
Resp.: 18 - 100 Hz
X-over: 55 Hz or 90 Hz, 12dB/oct.
Adjustable gain
Adjustable phase
Speaker or line level input
Cabinet: Oak veneers and solids,
27.5"x16"x16", "Spiked"
Price: \$650.00
450.00 without cabinet

Make your day - order one today!

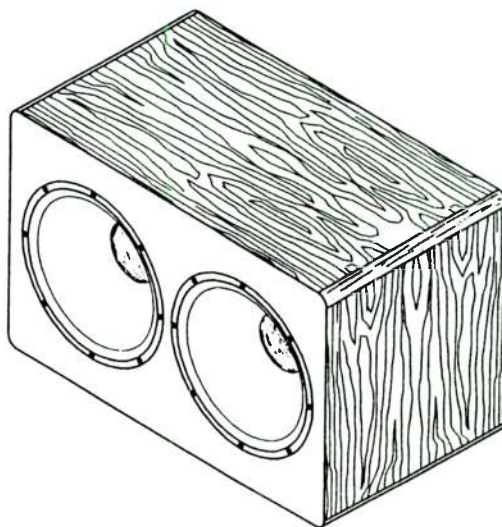

MENISCUS

2575 28th St. S.W. #2
Wyoming, MI 49509
(616) 534-9121
Fax (616) 534-7676

1981 A Testing Unit for Speaker Parameters • Variable-Volume Enclosure • Thiele/Small Theory, Pt 1-3 • Easy to Make Enclosure Using Concrete Blocks • The Tractrix Horn: Good Dispersion From an Old Design • Diffuser Port for Small Boxes • Mini-Speaker Made From PVC Tubes • Closed vs. Vented Box Efficiency • Interview with P.G.A.H. Voigt • Dual 8" Symmetrical Air Friction Enclosure • Thiele/Small Calculator Computation • Thiele/Small Parameters for Passive Radiators •

1982 Transmission Line Theory • Thiele/Small Sixth-Order Alignments • The Quad 63 • Table Saw Basics • AR-1 Mods • Active Crossover and Phase • Three Transmission Line Speakers • A Beginner's First Speaker • How Passive Networks Interact with Drivers • Horn Loaded Heil • Phase Correcting Active Crossover • Wind Your Own Inductors • Series and Parallel Networks • High Performance Corner Speaker • Using Zobel's to Compensate for Driver Characteristics •

1983 Building the Two-Way Dynaudio • A Crossover That Offsets Speaker Impedance • Using a Calculator for Box Design • Choosing a Calculator • A Simple Peak Power Indicator • A Small Horn Speaker • Audio Pulse Generator • How to Use Speaker Pads and Level Controls • An Easy-to-Build Voltmeter for Speaker Measuring • Nomograms for Easy Design Calculations • Interview with KEF's Raymond Cooke • Build a Simple Wattmeter • A New Type of Speaker Driver •

1984 Build an Aligned Satellite/Woofer System • BOXRESPONSE: A Program to Calculate Thiele/Small Parameters • Casting with Resins • A Phase Meter • An Interview with Ted Jordan • Building the Jordan-5 System • Self-Powered Peak Power Indicator • Closed Box Design Trade-offs • How to Build Ribbon Tweeters • Build a Dual Measurement Impedance Meter • A High-Power Satellite Speaker System • Build and Use a White/Pink Generator • Sound Pressure Level Nomographs •

1985 OUT OF PRINT, some single issues still available at \$7 each •

1986 The Edgar Midrange Horn • Sand-Filled Stands • Crossover Networks: Passive and Active • 5-sided Boxes • A 2 x 4 Transmission Line • The Three-Volume Subwoofer • Notch Filters • By-Wiring the LS3/5A • A Push/Pull Constant Pressure System • Current and Power in Crossover Components • The Inbox (Egg) • Upgrade Speakertab's S-6 Crossover • Measure Speakers with Step Response • A Gold Ribbon System • A Visit with Ken Kantor • A Tractrix Horn Design Program • Reviews: Audio Concepts "G"; Seven TL Midranges; Local's Model 280; the Audio Source RTA-ONE •

1987 A Compact TL Woofer • Frequency Response and Loudspeaker Modeling, Pt 1-3 • A Manual Coil Winder • The Model-One Speaker • Designing a Listening Room • A Sixth-Order Vented Woofer • Tapered Pipe Experiments • Visiting Boston Acoustics • A Vented Compound System • The Octaline • Spreadsheets for Speaker Design • In Memoriam: Richard Heyser, Pt 1-2 • Using Non-Optimum Vented Boxes • Building Speaker Stands • Evaluating Driver Impedance Compensation • Tuning Bass Reflex • Six Woofers Compared • Bullock on Passive Crossovers: Alternate Bandpass Types • Fast, Easy Filter Calculations • A Mobile Speaker • Polk 10 Mod •

1988 Electronic Turns Counter • Two-Way Design • Minimus-7 Mod • Dome/Midrange/Tweeter Array • Plotting Complex Impedances • A Driver Design Primer • A Cabinet Primer • Tuning Up Old Systems • Low-Cost AR-3 Upgrade • Electronic Time Delay • Enclosures Shapes and Volumes • Minimum-Phase Crossovers • Spot Sound Absorbers • How to Add a Subwoofer • The Swan IV System • Sub-Bass Power Boosting • The Unline: A Short TL • Active Filter Computer Design Program • Low-Cost Two-Way Ribbon • Amp-Speaker Interface Tester and Construction Plans • The QB₃ Vented Box is Best • A Pentagonal Box System • Keith Johnson Profile • Sheathed Conductor ESL • A Symmetrically Loaded System, Pt 1 • Ceramic Enclosure • Inductance Measuring Technique • Polk 10 Mods •

1989 (4 Issue Set: VERY LOW STOCK) The Audio Laboratory Speaker System • A Passively Assisted Woofer • Digital Filter Tutorial • The Listening Arc Alignment • Small IC Power Amp & Crossover • Easy Surround Sound • Building Speaker Spikes • An Isobarik in a Thunderbird • Sheetrock Cabinetry • A Picket Speaker • Servo-Controlling AR-1 • Silent, Safe Muting System • Equalizing the Klipsch Cornwall • A Test Switcher • Visiting the Klipsch Kingdom • Rehab for Kitchen Music • Spreadsheet Design • A Subwoofer/Satellite System • Impedance Measurement as a Tool • Practical Passive Radiators • A Symmetrical Dual Transmission Line, Pt 1 • The Microline • A Voice Coil Wheatstone Bridge • Tweeter Q Problems •

1990 Acceleration Feedback System • Cylindrical Symmetrical Guitar TLs • Compact Integrated Electrostatic TL, Pt 1-3 • Minimus-7 Super Mod • The Show (Bass Horn) • A Small Two-Way System • Helmholtz Spreadsheet • Heresy Upon a (Klipsch) Heresy • Beer Budget Window Rattler • Contact Basics • MDT Mini-Monitor Speaker System • Titanium + TPX + Polypropylene = Fidelity • Tom Holman, Skywalker, and THX, Pt 1-2 • Bud Box Enclosure • Klipschorn Throat Riddle • Modular Three-Way Active Speaker • CD Speaker System • SPEAKER DESIGNER Software • Symmetrical Isobarik • Novice Crossovers • Triamplified Modular System • Magnetic Crosstalk in Passive Crossovers • Mitey Mike Loudspeaker Tester • Symmetrical Loading for Auto Subwoofers • Improved Vented Box with Low Q_{TS} Drivers • BOXMODEL Woofer System Design Software • Four Eight By Twos • Dynaco A-25 Mod • Klipschorn Throat Revisited •

1991 Students Building Systems • Servo Subwoofers • An Apartment TL • L-R Crossover for the Swan IV • More or Less Power • New Guidelines for Vented Boxes • The Pipes • Macintosh's Wave and Sound Programs • Creating Professional Looking Grilles • Octaline Meets D'Appolito • Using Radar to Measure Drivers • Deep Bass for GMC • PSpice LF Response Calculating • Pipe and Ribbon Odyssey • The Delac S-10 • Infrared Remote Volume Control • Backloaded Wall Horn Speaker • Mod for the Minimus 7 • Simplifying Cabinet Assembly • Fibrous Effects on TLs • The DOALS • Loudspeaker Cable • Speaker to Ear Interface • Speaker Sensitivity to Errors in T/S Parameters • TL Speaker Evaluation • Cable and Sound • Kit Reports: Little V; Audio Concepts' Sub-1 •

There's More 

Please send me the following back issues of Speaker Builder

- | | | | |
|------------------------------------|------------------------------------|------------------------------------|------------------------------------|
| <input type="checkbox"/> 1994 \$32 | <input type="checkbox"/> 1993 \$25 | <input type="checkbox"/> 1992 \$25 | <input type="checkbox"/> 1991 \$25 |
| <input type="checkbox"/> 1990 \$25 | <input type="checkbox"/> 1989 \$18 | <input type="checkbox"/> 1988 \$23 | <input type="checkbox"/> 1987 \$20 |
| <input type="checkbox"/> 1986 \$20 | <input type="checkbox"/> 1984 \$18 | <input type="checkbox"/> 1983 \$18 | <input type="checkbox"/> 1982 \$18 |
| <input type="checkbox"/> 1981 \$18 | | | |

SHIPPING BACK ISSUES

UPS: Domestic ground service by value of order:
 Less than \$60.00 - \$4.50 \$131.00-220.00 - \$8.50
 \$61.00-130.00 - \$6.50 \$221.00+ - \$10.50

Canada: Add \$6.00 per year.

Foreign Air: Europe add additional 40% of total order. **Total Magazines** _____
 Other destinations: 50% of total order. **Postage** _____

Foreign Surface: Add additional 20% of total order. **TOTAL ENCLOSED** _____

Rates subject to change without notice. All remittance in US \$ only drawn on a US bank.

- Check or Money Order Discover MC VISA

DISCOVER/MC/VISA NO.	EXP DATE
NAME	ACCOUNT NO.
STREET & NO.	
CITY	STATE ZIP

Speaker Builder

Post Office Box 494, Dept. B95, Peterborough, NH 03458-0494
 (603) 924-9464 FAX (603) 924-9467

Answering machine for credit card orders only—before 9:00 a.m., after 4:00 p.m. and weekends
 Please have all information plus MC/VISA available.

Focused Arrays

from page 12

- Increased efficiency, because the sound intensity will concentrate at the listening position.
- Higher volumes (at least at midrange frequencies) without bothering neighbors and family. The sound peaks where you are, not where they are.
- Minimization of listening-room-induced colorations, allowing more of the original performance hall's acoustics to be heard.
- Sound quality similar to that provided by the same type speakers in other rooms (including the speaker sales rooms). If future

recordings are monitored and mixed using these arrays, you should benefit from a closer replication of the recording artists' and engineers' original intent.

- Improvement of both imaging and clarity by reduction of early reflections,⁴ an advantage that may be reduced if sidelobes cause strong variations in the remaining reflected frequency response.
- High system SPL capability, due to the large effective area of all the lower-frequency drivers.
- Reduced distortion because of the increased overall efficiency (pattern gain) and the reduced displacement (due to the large radiating area) per driver.

Time and testing will indicate whether the

above results are achievable and worthwhile. If you get a focused array up and running near Cincinnati before I do, let me know. I'd love to hear one. I welcome your comments and criticisms (c/o the editor). 

REFERENCES

1. Olive, Schuck, Sally, and Bonneville, "The Effects of Loudspeaker Placement on Listener Preference Ratings," *JAES*, Vol. 42 (Sept. 1994): 651.
2. Khalil, Jullien, and Gilloire, "Microphone Array for Sound Pickup in Teleconference Systems," *JAES*, Vol. 42 (Sept. 1994): 691.
3. G.R. Koonce, personal correspondence, October 1994.
4. D. Queen, "The Effect of Loudspeaker Radiation Patterns on Stereo Imaging and Clarity," reprinted in *Loudspeakers*, Vol. 2 (AES Anthology): 69.

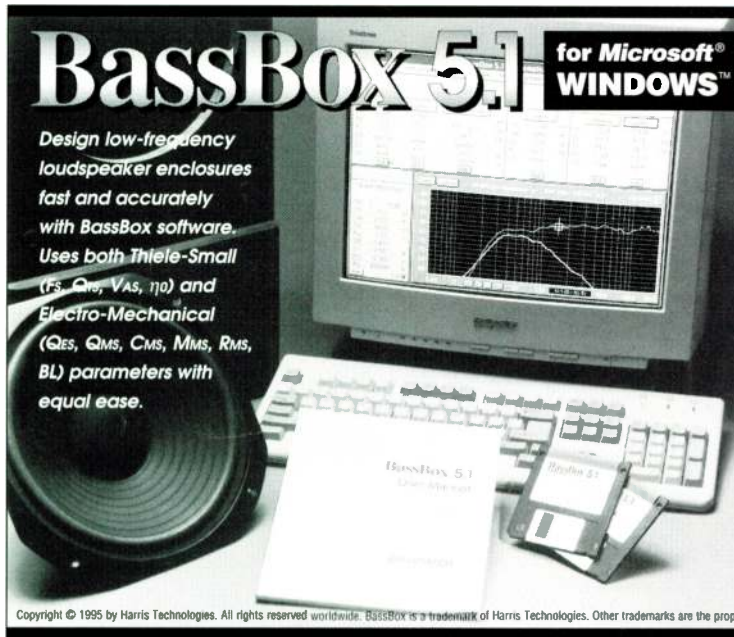

BassBox 5.1 for Microsoft **WINDOWS**

Design low-frequency loudspeaker enclosures fast and accurately with BassBox software. Uses both Thiele-Small (F_s , Q_{ms} , V_{as} , η_0) and Electro-Mechanical (Q_{es} , Q_{ms} , C_{ms} , M_{ms} , R_{ms} , BL) parameters with equal ease.

Copyright © 1995 by Harris Technologies. All rights reserved worldwide. BASSBOX is a trademark of Harris Technologies. Other trademarks are the property of their respective companies. Computer and loudspeakers not included.

Includes a large driver database with over 1,300 drivers.

- ◆ Easy to use
- ◆ On-line help
- ◆ Hi-res mode
- ◆ Low price

Design Types:

Optimum Vented
Extended Bass
Custom Vented
Band-Pass with Double or Triple Chambers
Passive Radiator
Optimum Closed
Custom Closed
All designs can use multiple woofers (including Isobaric)

Design Options:

Small and large-signal analysis. Examine one loudspeaker in several different boxes or... Examine several different loudspeakers in the same box. 6 graphs: normalized amplitude, 2.83-V amplitude, acoustic power, impedance, phase and group delay. Advanced vent calculator. Advanced box dimension calculator w/ 18 volume shapes. Accepts loudspeaker measured acoustic response. Accepts automobile or listening room interior acoustic response. Use English or metric units. Save and recall designs.

Built-in Test Procedures:

Test and calculate loudspeaker parameters*
Test and calculate passive radiator parameters*

*Requires basic test equipment: sine wave generator, frequency counter, power amplifier, 1 kohm resistor, voltmeter, ohmmeter, test box.

 **\$99.00**
plus \$5.00 S&H
(Canada: +\$6.00)
(Overseas: +\$12.00)

Tel: 616-641-5924
Fax: 616-641-5738

Harris Technologies
P.O. Box 622
Edwardsburg, MI
49112-0622 U.S.A.

Also available:

X-over 2.0 passive crossover program for Windows.
X-over calculates the component values for 1st, 2nd, 3rd and 4th-order 2-way and 3-way networks, load compensating networks and L-pads. **Regular price: \$29.** (\$19 if purchased with BassBox.)

Minimum System Requirements:

MS-DOS 5.0. Microsoft Windows 3.1 & compatible computer (386 or better CPU with at least 4 MBytes of RAM). 7.5 MBytes of free hard disk space. 1.44 MByte 3.5" disk drive and mouse.

Harris Technologies reserves the right to make changes without prior notice.

Speaker Builder

1992 Rumreich on Box Design & Woofer Selection • MLSSA • Double-Chambered Reflex by Weems • Active Crossover and Delay • Electrical Circuit Bandpass Enclosure • A Dreadnaught System (satellite swivels) • Designing Real-World Two-Way Crossovers • 20-foot Ribbon Dipole Speaker • Biamping the Sapphire II • Capping Passive Crossovers • A High Quality Speaker Cabinet • 1/3-Octave Noise Source • Disappearing Loudspeaker • The A&S Soundoff Winner, Pt 1-2 • Alignment Jamming • Marc Bacon's "Danielle", Pt 1-2 • Double-Chambered Isobaric Bass • Ferguson's Pickup Installation • Electronic Counter for Coil Winding • Oakley on Speaker Placement • Making Your Room Hi-Fi, Pt 1 • More on Dust Caps • Spreadsheet for Nonoptimum Vented Box Design • Acoustic Resistance Tuned Enclosure •

1993 Waslo's IMP, Pt 1-3 • Quasi-Monotonic Vented Alignments • Making Your Room Hi-Fi, Pt 2-3 • A&S Soundoff Winner, Pt 3 • Flexible Dipole Woofer • The Spline • Stalking F_3 • A Bi-Structural Enclosure • A Sixth-Order T/S Subwoofer Design • Speaker Enclosure Screws • Electric Bass Tri-Horn • Prism V Satellite/JBL Subwoofer, Pt 1-2 • Fitcut: Program for Designing Duct Software • Compact Coincidental Point Source Speaker • IMP: Measuring T/S Parameters • KIT REPORT: Rockford's Beginner Software/Driver Paks • SOFTWARE REPORT: Low Frequency Designer 3.01 • Three Affordable Measurement Microphones • Two Ways to Realize a Dream • Matching Driver Efficiencies • Two-Woofer Box System • Designing a Dual Voice Coil Subwoofer • SOFTWARE REPORT: Blaubox 1.2 • Tale of Three Speaker Projects • A&S Sound-off 1992 • Monolith Horn • Orbiting Satellites • Real-World Three-Way Crossovers • The Simplex • Living with a Speaker Builder • The IMP Goes MLS •

BACK ISSUES *Continued*

1994 Sanctuary Sonics • Modular Active Crossovers • A Full-Range Open-Baffle System • An Evolving Magnepan MG-1 • Low-Frequency AC-To-DC Converter • A Compact Bass Guitar Speaker • Measuring Speaker Impedance Without a Bridge • The Dynapleat • The Danielle II • The Birdhouse: A Sound-Reinforcement Subwoofer • The Linear-Array Sound System • A Revised Two-Way Minimonitor • Exploring the BUF 124 with Pspice • Signet's SL280B/U • Time Response of Crossover Filters • Converting Radio Shack's SLM To Millivolt Use • Acoustic Distortion and Balanced Speakers • Microphone Response Correction with IMP • More About the Birdhouse Bandpass • A 16Hz Subwoofer • D.H. Labs Silver Sonic Cables • The System III Loudspeaker • Exploring Loudspeaker Impedance • IMPcycling • The Linear-Array Chronicles • Book Report: Loudspeaker Recipes, Book One • The Woofer Test • A Large Ribbon You Can Build • Loudspeakers, A Short History, Pt 1-2 • Absolute SPL Sensitivity Measuring with IMP • The Damping Factor: One More Time • Cliffnotes for Loudspeaker University • Software Report: The Listening Room for Macintosh • Book Report: The Theory and Design of Loudspeaker Enclosures • A 15" Transmission Line Woofer • Inductor Coil Cross Talk • Quick Home Theater on a Budget • Silk Purses: A Two-Way Salvage Design • Audio Phase Inductor •

Classified

TRADE

STATE OF THE ART PASSIVE CROSSOVERS. Parts and software available. Design Guide, \$2 (refundable). **ALLPASS TECHNOLOGIES, INC.**, 2844 Charmont Dr., Apopka, FL 32703-5972, (407) 786-0623.

D.H. LABS manufactures top quality audiophile hookup wires, cables and connectors for the most demanding applications. For more information and review reprints, contact us at 6633 Glenway Dr., W. Bloomfield, MI 48322, phone/FAX (810) 851-1296.

PRODUCTION TIME AVAILABLE for high-quality, precision home or pro audio cabinets in your choice of beautiful finishes. Service the West Coast since 1982. **IMAGINEERING**, (800) JET-7000.

ELECTROSTATIC electronics, transformers, Mylar®, information. From author **ROGER SANDERS**, (503) 742-7640.

ELECTROSTATIC

/// KITS /// PARTS /// TRADE SECRETS ///
Save \$\$\$ building, repairing, modifying ESLs
SEND \$2.00 FOR CATALOG
/// DAVID LUCAS ///
924 HULTON RD., OAKMONT, PA 15139

HIGH-END KEVLAR CONE DRIVERS AND SPEAKER PARTS. Factory direct. **SPEAKER-WORLD TECHNOLOGY**, (510) 490-5842.

HUNDREDS OF ECONOMICAL WOOFERS, MIDS, and TWEETERS, for home, car, or pro-sound. Free catalog. Dealer inquiries? **SRS**, 1839 No. Circle, Colorado Springs, CO 80909, (719) 475-2545.

SPEAKER HEADACHE?? Call the Speaker Doctors for free friendly estimates. We can re-cone any speaker. Home, audio, or pro speakers, parts, re-foam kits, etc. **TRI-STATE LOUD-SPEAKER**, (412) 375-9203.

FOR SALE

Korg DP80 digital piano with stand, damper pedal, 76 keys, amp output, 16 voices, MIDI capability, \$600 or best offer. (603) 924-8776.

Marchand XM9AA Eco with Boums pots, \$200. Jim, (718) 979-7555.

Tape decks: ReVox A77 two-track stereo (biased for Ampex 456), \$650; Teac A-2340 (right rear treble weak), \$250; Teac A-4010S (needs new forward-play head), \$75; old Tandberg crossfield head deck, \$125. Prices include shipping. Dave Bessey, 559 Valencia St., San Francisco, CA 94110-1114.

25 NOS Vitamin Q 0.22µF 400V, \$5 each or 5 for \$20; 50 0.033µF Astron, \$3 each or 10 for \$22; Peerless output transformer #15A65, \$65 or best offer. Matt, (510) 548-8736, Wed. thru Sun., 12-5 (PST).

OTL power transformers: 4,000VA, 110+110V AC 4A, 56+56V AC, 48+48V AC 8A, asking \$100; 530VA, 110+110V AC, asking \$65; four 7,500µF 200V DC caps, asking \$20 each; Target TTF1 18" x 14" amp floor stand, new, asking \$45; six Telefunken NOS Diamond Bottle 6DJ8 tubes, \$50 each. Ashby, (305) 475-5225.

Pair Altec 288 16Ω, Alnico, \$450; pair 291 8Ω, \$400; pair 808 or 802, \$225; pair Community horns for 288/291, \$150; Scott 310E tube tuner FM stereo MPS; JBL 2421A drivers, titanium diaphragms; heavy duty 800Hz crossovers; Altec 811 horns; Altec 32C horns. David, (914) 688-5024.



The Ribbon Source

Our new technology Ribbons have the **musicality and air of large electrostatics** but are mono-polar, high impedance drivers in easy to drive and place packages. They will simplify your designs and upgrade your audio or video systems sound.

Ribbons are 8", 15" and 30" in full range systems, kits and Modules. **Tubes love them!** Ask for specs and international reviews.

Newform Research Inc.
1-705-835-9000 Fax: 705-835-0081
Custom mfgs and overseas distributors sought.

IMP with MLS upgrade plus calibrated Mitey Mike, \$400; pair Cabasse 21NDC 8" woofers, \$250; pair Dynaudio D-260 tweeters, \$100. Don Vogel, 1461A 5th Ave., Ft. Knox, KY 40121, (502) 942-5039.

Three KEF model 90 center/satellite speakers, two white, one black, super clean, original packaging, \$80 each (includes COD shipping). Larry Rasmussen, (360) 435-5263.

Premium Grade Parts

Don't Pay More!

Absolutely the best selection of audiophile grade parts at fair prices! Extensive deep in stock inventory featuring these vendors and many more. Free catalog! MIT MULTICAP... better selection than any other source WONDER CAP, SOLEN, SCR, REL-CAP, NICHICON MUSE, BLACK GATE, ELNA, CADDOCK, VISHAY, MILLS, HOLCO, RESISTA, Dale, TKD, ALPS, NOBLE, Elma, Shalco, EAR DEFLEX PANELS - ultimate in speaker enclosure damping CARDAS, KIMBER, ACROTECH, & pure silver chassis wires, HEXFRED diodes, SOLO foil inductors, all types of audio connectors, silver contact toggle & rotary switches, stepped attenuator kits, hospital grade plugs, tubes, tools, ICs, super selection of damping materials & feet. International/overseas orders are especially welcome! Phone (415) 669-7181 or fax (415) 669-7558 for a catalog. **Michael Percy, Box 526, Inverness, CA 94937**

ReVox B77 open reel recorder, \$500; dbx 124 four-channel dbx-II processor, \$100; Nakamichi 700-II three-head cassette recorder, \$400; Yamaha DSP-1 soundfield processor, \$450; Altec 838A (1962) speaker systems, \$450/pair; more equipment, video tapes, CDs. Stamp gets list. Darroch, 1807 Elm Crest, Arlington, TX 76012.

Bose 1801 power amp 400/400W, \$300; Spectra Sound 100W 70V audio transformers, \$40 each; 12,000µF 200V DC caps, \$5.50 each; 1,300µF 450V DC caps, \$4 each; Grass Valley 900 series video DAs and more. Don, (609) 665-6512, eves. (EST).

JBL 2245H, \$190; pair Dynaudio 24W100, \$160; Dynaudio D76AF, \$50; ADC SS-525X analyzer with pink noise and mike, \$150; Sony PSX55 turntable with Shure V15-VMR, \$100; Nakamichi 582 cassette deck, \$100. Phil Roy, (606) 341-1648.

B&K pro 5, preamp, mint, \$225; Dynaco ST-80 amp, 2 x 40, \$100; electronic crossover two-way rack mount, \$100. Everything works perfectly. Andrew, (514) 281-7954, Montreal.

Two Polydax PR300TO 12" 97dB woofers, new, \$175; two Black Widows 15" #1502-8, new, \$200; University 15" C15HC, new, \$125; two Seas 4 1/2" PHRC, new, \$40; two Heath W5 amps, \$275; McIntosh C29 preamp, mint, \$675; Bogan DB-20, \$75. Raul Gil, (201) 751-5959.

Pair Aria 5 with Accuton tweeter, Zalytron enclosures, \$700; pair Dynaudio D28AF, \$30; pair 17W75, \$45; pair Focal 10V516J, \$125; pair Madisound 1054, \$25. John, (208) 853-4045, FAX (208) 853-4005.

Silver-plated Teflon TFE insulated wire AWG#12, \$10 per 10' section. Shipping extra. George, (216) 586-6707.

Sunn SPL 915R 15", \$50; blue egg crate foam, 34" x 72" x 2", \$10 per sheet. Dave, (216) 666-6805.

Pair Infinity Kappa 7.1s, black oak, approx. three years left on five-year transferable warranty, mounted on beautiful Sumiko polished aluminum spiked feet, \$89; Kappa video, \$200; Sony TA-E2000EST digital preamp with REAL imported hardwood side panels, \$895. Prices are not negotiable. Matthew, (314) 939-6000 (MO).

WANTED

One EV T25A driver with serial number close to 15527. Matt, (510) 548-8736, Wed.-Sun 11-6 (PST), FAX (510) 548-5999.

Used LMS, SYSid, MLSSA, TEF 20, and Heathkit intermodulation distortion analyzer. Bob, (520) 458-6072.

Speaker builders interested in exchanging design ideas for upcoming contests. Phil, (520) 579-1446.

Pair Dynaudio D28 (not AF); pair Seas SB17RCY; pair Scan-Speak 25W/8562; pair Philips 5061; pair Focal 12VX; pair Audax HM17070; QUAD 405-2; General Radio 1201B power supply; Music Reference RM4 head amp; Theta preamp. Trades ok. Frank, (818) 243-0171 (CA).

ElectroVoice full range 8" model SP8B or SP8C. Fred Sutton, 1230 S. Helberta, Redondo Beach, CA 90277, (310) 316-4406.

Tube hi-fi, theater amps/preamps and speakers: Altec, Jensen, McIntosh, Marantz, Craftsman, Dynaco, Heath, Eico, etc. **SUNSHINE SOUNDS**, (405) 737-3312.

Altec 291-16A diaphragms; JBL 2402 bullet tweeters; JBL 2330 adaptors (mounts 1.4" driver to 2" horn). Bob, (804) 523-0711

Copy of original alignment instructions for Harman-Kardon Citation III, copy of original alignment instructions and schematic for Scott 310D and Heath BC-1A. Hafkenschiel, (415) 851-2779.

CLASSIFIED



INFORMATION

Four types of Classified Advertising are available in *Speaker Builder*:

FOR SALE: For readers to sell personal equipment or supplies.

WANTED: Help readers find equipment or services.

TRADE: For any business or private party selling equipment, supplies or services for profit.

CLUBS: Aid readers in starting a club or finding new members.

PRICING

All advertising is \$1.50 per word, \$10 minimum per insertion. Deduct 5% for an 8x contract. Please indicate number of insertions. Payment **MUST** accompany ad. *No billing for word classified advertising.*

AD COPY

A word is any collection of letters or numbers with a space on either side. No abbreviations; please spell out all words. Count words, not letters. Ad copy should be clearly typed or printed. Illegible ads will be discarded.

SUBSCRIBERS

Receive *free For Sale, Wanted, and Club* advertising; 50 words maximum; each additional word just \$.20. Please only one ad per category, per issue.

Please include your name, address, and telephone number. If **TRADE** please indicate number of insertions on the ad. All free ads are run only once, then discarded. Ad questions, copy and copy changes cannot and will not be answered on the phone. All correspondence must be in writing addressed to:

Speaker Builder

Classified Department
PO Box 494
Peterborough, NH 03458-0494

Ad Index

ADVERTISER	PAGE	ADVERTISER	PAGE
A & S Speakers	4	Parts Connection, The	48
ACi	47	Parts Express International, Inc.	CV3
Acoustical Supply International	6	Pioneer Hill Software	22
Allison Technology Corp.	49	Pyle Industries, Inc.	21
Alpha-Core Inc.	52	Sescom, Inc.	49
Audio-Forum	12	Solen Inc.	23
Elektor Electronics	36	Solo Electronics	53
Forgings Industrial Co.	13	Speaker Works	22
Harris Technologies	58	Speaker Works Inc., The	33
Hi-Fi News & Record Review	44	Speakers Etc.	51
Hi-Fi World Audio Publishing	54	Sussex Technical Corp.	43
Hi-Vi Research Inc. Canada	52	TCH Umbra	49
Hovland Co.	56	Technologie MDB	28
Image Communications	37	TIFF Electronics	3
Madisound		True Image Audio	32
Mimesis	17	Welbome Labs	27
Skaaning Speakers	31	Zalytron Industries Corp.	19
Mahogany Sound	52		
Marchand Electronics, Inc.	55	CLASSIFIEDS	
Markertek Video Supply	51	David Lucas, Inc.	59
MCM Electronics	45	Michael Percy	59
Meniscus	56	Newform Research, Inc.	59
MIT Electronic Components	9	TC Sounds	60
Morel Acoustics	CV4	Welbome Labs	60
Mouser Electronics	53		
National Academy of Mobile Electronics	30	GOOD NEWS/NEW PRODUCTS	
Old Colony Sound Lab		Dynastar Electronics	3
BoxModel Software	12	Liberty Instruments, Inc.	3
Electrostatic Loudspeaker Design Cookbook	35	MIT Electronic Components	3
Kit Closeout Sale	47	Sitting Duck Software	3
New Products	41-42	Sonic Frontiers, Inc.	3
Orca Design & Manufacturing		Speaker City USA	3
Axon Caps	29		
Focal	CV2		

CLUBS

If you are interested in joining a club or forming one in your area, contact the following:

ARIZONA

Arizona Audiophile Society
PO Box 13058, Scottsdale, AZ 85267
Paul Christos, (602) 971-3979

CALIFORNIA

Tube Audio Enthusiasts
65 Washington St. #137,
Santa Clara, CA 95050
John Atwood, FAX (408) 985-2006

Greater South Bay Audiophile Society
Larry Fisher, (310) 599-6579;
Dave Clark, (310) 427-4207

Los Angeles Loudspeaker Designers Group
Geoffrey, (213) 965-0449;
Eduard, (310) 395-5196

West Valley Audio Society
Woodland Hills
Bary Kohan, (818) 225-1341

COLORADO

Colorado Audio Society
1941 S. Grant St.,
Denver, CO 80210
(303) 733-1613

CONNECTICUT

James Addison
171 Hartford Rd., A-7,
New Britain, CT 06053

Connecticut Audio Society
129 Newgate Rd., E. Granby, CT 06026
Richard Thompson, (203) 653-7873

FLORIDA

Angel Rivera
Bradenton, FL 34206
(813) 792-3870

GEORGIA

Atlanta Audio Society, Inc.
4266 Roswell Rd. N.E., K-4,
Atlanta, GA 30342-3738
Chuck Bruce, (404) 876-5659;
John Morrison, (404) 491-1553

ILLINOIS

Chicago Audio Society
PO Box 313, Barrington, IL 60011
Brian Walsh, (708) 382-8433,
E-mail sysop@nybble.com

Prairie State Audio Construction Society
20 Wildwood Tr., Cary, IL 60013
Tom, (708) 248-3377 days,
(708) 516-0170 eves.

MASSACHUSETTS

The Boston Audio Society
PO Box 211, Boston, MA 02126-0002
E. Brad Meyer, phone/FAX (617) 259-9684,
E-mail 72365.75@compuserve.com

MICHIGAN

Southeastern Michigan Woofer and Tweeter Marching Society
PO Box 721464, Berkley, MI 48072-0464
(810) 544-8453, E-mail
aa259@detroit.freenet.org

MINNESOTA

Audio Society of Minnesota
PO Box 32293, Fridley, MN 55432
(612) 825-6806

NEVADA (Las Vegas)

Tarcisio Valente, (702) 435-7451

NEW JERSEY

New Jersey Audio Society
209 Second St., Middlesex, NJ 08846
Frank J. Alles, (908) 424-0463; Valerie
Kurtychek, (908) 206-0924

NEW YORK

The Audio Syndrome
Nassau and Suffolk counties
Roy Harris, (516) 489-9576

Catskill and Adirondack Audio Society
PO Box 144, Hannacroix, NY 12087
(518) 756-9894

Daniel Phinney
29 Brian Dr., Rochester, NY 14624
(716) 594-8118, 5-9 p.m. EST

Long Island/Westchester County
Publio Morera, (516) 868-8863

Western New York Audio Society
PO Box 312, N. Tonawanda, NY 14150
Denny Fritz

NORTH CAROLINA

Piedmont Audio Society
1004 Olive Chapel Rd., Apex, NC 27502
Kevin Carter, (919) 387-0911

TENNESSEE

Memphis Area Audio Society
8182 Wind Valley Cove, Memphis, TN 38125
J.J. McBride, (901) 756-6831

TEXAS (Sweetwater)

Rick, (915) 676-7360

UTAH (Salt Lake City)

Wasatch Audio
Edward Aho, (801) 364-4204

WASHINGTON

Pacificnorthwest Audio Society
Box 435, Mercer Island, WA 98040
Ed Yang, (206) 232-6466;
Gill Loring, (206) 937-4705

Vintage Audio Listeners and Valve Enthusiasts
1127 NW Brite Star Ln., Poulsbo, WA 98370
(206) 697-1936

CANADA

Greg Boboski
70 Sumter Cres., Winnipeg, MB R2T 1B9
Canada
(204) 694-7024

Montreal Speaker Builder Club
4701 Jeanne Mance, Montreal,
PQ, H2V 4J5 Canada
Andrew McCrae, (514) 281-7954

Toronto
M.A. Martin, (416) 968-6101,
monty@camtwh.eric.on.ca

CHILE

Christian Bargsted
Los Gomereros 1542, Vitacura, Santiago
(011) 562-538-0638

GERMANY

ESL Builders Group
Gunter Roehricht
Bühlerstr.21, 71034 Böblingen, Germany

SOUTH AFRICA

Hi-Fi Club of Cape Town
PO Box 18262, Wynberg 7824, South Africa
Chris Clarke, FAX (011) 27-21-7618862, E-mail
chrisc@iaccess.8a

UNITED KINGDOM

London Live DIY Hi-Fi Circle
Brian Stenning, (011) 44-81-748-7489

If your club is not represented or if you are interested starting up a club, simply send the information (club name, contact person, address and phone/FAX number) to:

Audio Amateur Publications, Inc. Clubs
PO Box 494
Peterborough, NH 03458
FAX (603) 924-9467

Get Serious!



Parts Express is serious about providing the novice, as well as the advanced speaker builder, with some of the finest components and accessories currently available for loudspeaker construction. Raw drivers, enclosure resonance damping material, port tubes, spikes, 14-20 gauge inductors, polypropylene capacitors, power resistors, loudspeaker design software, audio test equipment, and too many other items to possibly list here, are available to you at very reasonable prices! We stock every item we advertise and most orders are shipped within 24 hours of placement. Our technical support staff can help the novice builder select the best drivers for a particular application, choose appropriate enclosure volumes and even help calculate crossover values. So call now for your copy of our free 212 page catalog and get serious about speaker building!



LEAP

NOW AVAILABLE!!! Parts Express is proud to announce that we are now a U.S. distributor for the most advanced loudspeaker design software currently available ... LEAP Version 4.5 (Loudspeaker Enclosure Analysis Program) and the LMS (Loudspeaker Measurement System). Call for more information on these and other exciting new products from Linear X!



Parts Express™

CALL TOLL FREE

1-800-338-0531

CATALOG

© February 1995



Made in England

High-Tech Audiophile Loudspeakers



Typical Double Magnet Woofer Cross Section

For Further Information Please Contact: **morel acoustics** USA
414 Harvard Street
Brookline, MA 02146
Tel: (617) 277-6663
FAX: (617) 277-2415

Reader Service #1

World Radio History

Dedicated To Quality



Parts Express is dedicated to bringing serious speaker builders the finest products currently available. We have recently become a distributor for Linear X and now carry their superb loudspeaker design program, LEAP Version 4.5, plus the outstanding LMS loudspeaker measurement system. We are also very pleased to announce that Parts Express is now an authorized distributor for Morel Acoustics. Morel's unique vented magnet system and large diameter Hexatech voice coils provide smooth frequency response, high power handling, and astonishingly low levels of distortion. We also carry the high performance line of drivers from Audax, featuring the revolutionary High Definition Aerogel and Carbon Fiber cone materials. For high quality crossover networks, we stock Solen polypropylene capacitors, 14 gauge air core inductors from ERSE, Solo copper foil air core inductors, and Monster Cable speaker wire. Our software programs for enclosure design include BassBox 5.1, Quick Box from Sitting Duck Software, and Loudspeaker Architect 2.01 from N.A.M.E. Call now for your copy of our FREE 212 page catalog and to get the details on these and many other quality products.

FREE



Parts Express

CALL TOLL FREE

1-800-338-0531

CATALOG

340 E. First St., Dayton, Ohio 45402-1257, Phone: 513-222-0173, Fax: 513-222-4644

SOURCE CODE: SBM



Made
in
England

High-Tech Audiophile Loudspeakers

For Further Information Please Contact:

**morel
acoustics USA**

414 Harvard Street
Brookline, MA 02146
Tel: (617) 277-6663
FAX: (617) 277-2415

World Radio History



Typical Double Magnet Woofer Cross Section