

# Speaker Builder

THE LOUDSPEAKER JOURNAL

**\$75 RESURRECTION FOR  
JUNKED AR2ax PAIRS**

**THE LINEAR ARRAY  
BECOMES HARDWARE**

**LOUDSPEAKER 101:  
PIERCE ON THE Qs**

**CHECKING YOUR SYSTEM  
WITH *PC AUDIOLAB***

**MAKING A FRAME  
FOR THE GRILLE**

**ARE HORNS GOOD STUDIO MONITORS?**

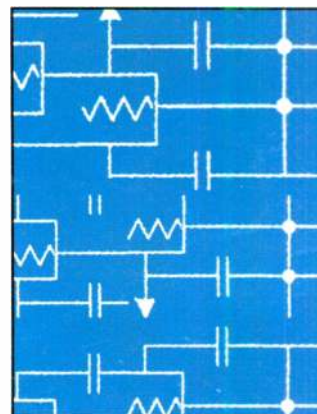
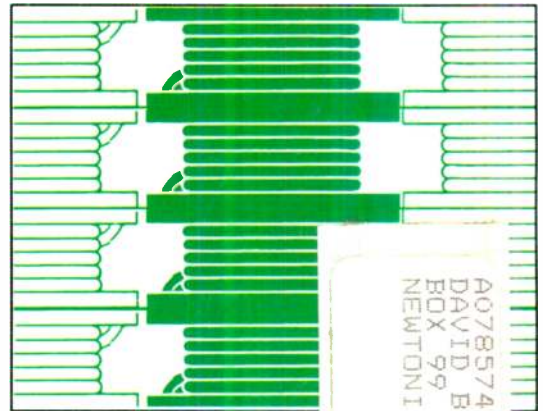

A0785740EXP: 8th of 94  
DAVID B WEEMS  
BOX 99  
NEWTONIA MD 64853

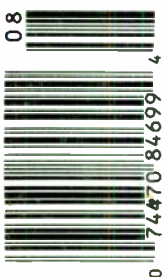



New!

LEAP

Version 4.5

LEAP

# Precision Development Tools for Precision Loudspeaker Designs

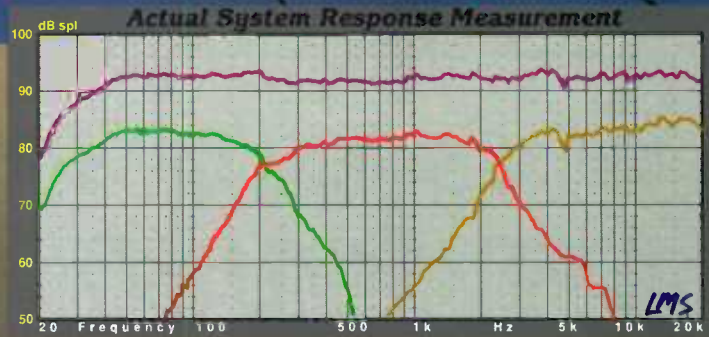
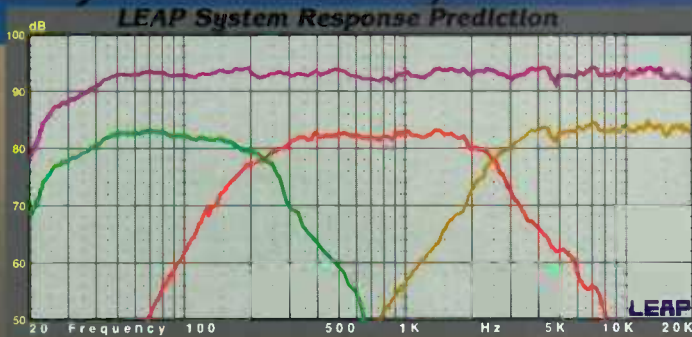

**The Art and Science...** of loudspeaker system development today has become more complex than ever before. Competition is tough, and to compete each design must perform to the best of its ability, and make the most out of every dollar's worth of transducer cost. The simple approach of choosing a combination of seemingly appropriate transducers coupled with ordinary networks and filters, has given way to a painstaking process of meticulously blending selected transducers in combination with carefully devised and matched crossover designs.



**LEAP** (Loudspeaker Enclosure Analysis Program) is a complete full range analysis package which provides virtually *all* of the tools necessary to develop precision loudspeaker systems, for today's demanding audio markets. Whether your applications are consumer audio, car stereo, professional audio, or custom esoteric marvels, LEAP provides the power, flexibility, and accuracy to investigate every possible design permutation. The open architecture and broad spectrum of features provided will dramatically reduce your development time, while improving the quality of the final result... and demonstrates why LEAP has become the #1 choice of professional loudspeaker designers world-wide!

### Advanced System Analysis Features

- ✓ Use simulation or imported actual measured SPL/Z data.
- ✓ 5-Way crossover system modeling, and more.
- ✓ Time offset between transducers.
- ✓ Active or Passive based crossovers.
- ✓ Hilbert-Bode transform for deriving phase.
- ✓ 22 Passive components per xover section.
- ✓ 16 Active filter blocks per xover section.
- ✓ Passive Network Optimizer for single/system response.
- ✓ Active Filter Optimizer for single/system response.
- ✓ Frequency ranges from 1Hz to 100kHz.

### Printer/Output Formats

- When you wish to produce a hardcopy output of your finished designs and graphical data, LEAP supports a large number of printer standards, and even supports numerous desktop publishing graphic formats in both black & white and color! Portrait/Landscape orientations in any custom size and aspect ratio are user controllable.
- ✓ IBM/Epson 8 Pin Dot Matrix
  - ✓ Epson 24 Pin Dot Matrix
  - ✓ HP LaserJet Series Printers
  - ✓ HPGL Compatible Plotters
  - ✓ PostScript EPS/TIF- B&W/Color
  - ✓ AI Adobe Illustrator B&W/Color
  - ✓ NEC 24 Dot Matrix
  - ✓ TOSHIBA 24 Dot Mat
  - ✓ HP DeskJet 500C
  - ✓ PostScript Printers
  - ✓ DXF AutoCAD
  - ✓ TIFF, BMP, PCX Plots

### Advanced Transducer/Enclosure Simulations

- ✓ Sealed, Vented, Bandpass, PR Simulations with multiple speaker/ port capability.
- ✓ Large signal analysis of TempVC, and Non-Linear BL/ Ports/ Compliance.
- ✓ Acoustic Parallel or Acoustic Series (Isobaric) Driver Mounting.
- ✓ Port Standing Wave resonance modeling.
- ✓ Frequency Dependent Revc and Levic modeling.
- ✓ Library storage of 36 transducer parameters, and over 24 enclosure parameters.
- ✓ Generic transducer modeling of electro dynamic, ribbon, and pinzo devices.

### Extensive Documentation

The two volume manual set comprises almost 1,000 pages of documentation which thoroughly covers the operation of the program, and provides numerous examples of how to maximize your use and understanding of the program's many features. The Reference Manual describes all graphs, menus, commands, and their operation. This manual explains the unique and special non-linear speaker and port models, as well as proper use of the optimizers, importing data, and the many other utilities. The Application Manual provides many exciting examples showing how to use the powerful features of the system in a combined manner to perform both simple and complex design tasks. Both novice and experienced users alike will find this information invaluable for exploiting the full power of the system. Additional information is also provided on loudspeaker measurements, design tips, filter calculations, and complete crossover system development for both passive and active based systems.

- ✓ 502 Page Reference Manual
- ✓ 416 Page Application Manual

■ Seminars/Workshops available, call for details.

Call for a free  
Demo Disk!  
TEL: (503) 620-3044



LinearX Systems Inc  
7556 SW Bridgeport Rd  
Portland, OR 97224 USA  
Tel: (503) 620-3044 Fax: (503) 598-9258

**International Dealers:** Argentina: Interface SRL (54-1)778-2713/Australia: ME Technologies 61(0)65-50-2200/Austria: Audiomax 49(0)71-31-162225/Belgium: Belram 32(0)2-736-50-00/Brazil: SDS Equipamentos 55(0)11-887-7597/Canada: Gerraudio 416-696-2779/China: Rhyming Industrial 86(7620)562-011/Denmark, Finland: AET Ljudproduktion 46(0)8-623-08-70/France: Belram 32(0)2-736-50-00/Germany: Audiomax 49-71-31-162225/Indonesia: Ken's Audio 62(0)21-380-2118/Italy: Outline snc 39-30-3581341/Korea: Samml Sound: 82(0)2-463-0394/Luxembourg: Belram 32(0)2-736-50-00/Malaysia: AUVI 65-283-2544/New Zealand: ME Technologies 61-65-50-2254/Norway: AET Ljudproduktion 46(0)8-623-08-70/Poland: Inter-Americom 48(22)43-23-34/Singapore: AUVI 65-283-2544/Spain: Audio Equipment Services 34(94)681-81-20/Sweden: AET Ljudproduktion 46(0)8-623-08-70/Switzerland: Audiomax 49-71-31-162225/Taiwan: Gestion Taycan Int 886-2-562-3883/Thailand: AUVI 65-283-2544/The Netherlands: Duran Audio 31-41-80-15583/Turkey: Silver Productions 44(0)722-336221/UK(England): Munro Assoc 44(0)71-379-7600.



## IMPROVED SURROUNDINGS

Canadian PSB Speakers has debuted two new models designed for use in the center channel of Dolby Surround Pro Logic and surround-sound home theater systems. The PSB 200C is a vented design with dual 5.25" injection-molded polypropylene drivers and a centrally mounted 1/2" poly-flare tweeter. The Stratus C5 has dual horizontally deployed 5.25" mid/woofers and two central, ferrofluid-cooled, 1/2" poly-flare tweeters. PSB International, Inc., 633 Granite Ct., Pickering, ON L1W 3K1, Canada.

Reader Service #101

## RACK ATTACK

Sescom Electronics' new product brochure features the Rackem 'N' Stackem™ series of half-rack audio accessories. Designed to work in a very compact environment, the units can be placed on a tabletop, in small tabletop half-racks, full standard racks, or wherever convenient. Other products listed in the brochure include switch boxes, stereo crossovers, dual-mike line drivers, six-channel headphone stereo amplifiers, mono monitor bridge adapters, relay boxes, stereo phase meters and tone controls, and audio testers. Sescom, Inc., 2100 Ward Dr., Henderson, NV 89015, (800) 634-3457, FAX (800) 551-2749.

Reader Service #116

# Good News

## DEVELOPING AIR MASS

Beals Brothers Acoustic Design has developed Air Mass Technology for auto sound products. With AMT the air mass acts as an acoustic amplifier, allowing the system to generate a lot of bass with not much driver cone motion. The results are lower distortion (second harmonic lowered by 20dB), greater output (3-5dB), and greatly reduced enclosure size. Beals Brothers, 2165 Lehigh Station Rd., Pittsford, NY 14534-2675, (716) 367-2610, FAX (716) 334-8215.

Reader Service #108

## SAW SUBSTITUTE

The Spira Cut System from Roto Zip features a complete line of Zip Bits for fast, precise cutting through ceramic tile, paneling, plastic laminates, plywood, drywall, and other materials. The hand-held, high-speed tool does the work of a jig-saw, reciprocating saw, router, and sabre saw. Roto Zip Tool Corp., 1861 Ludden Dr., Cross Plains, WI 53528, (800) 521-1817, (608) 798-3737, FAX (608) 798-3739.

Reader Service #112

driver cone motion. The results are lower distortion (second harmonic lowered by 20dB), greater output (3-5dB), and greatly reduced enclosure size. Beals Brothers, 2165 Lehigh Station Rd., Pittsford, NY 14534-2675, (716) 367-2610, FAX (716) 334-8215.

## FRIED CONES

The new drivers available from Fried Products, including those incorporating the m.a.r.s. technology, offer: a cone material free of high-frequency peak; a magnetic system which is linear at all excursions; and a four-layered voice coil system with a driver Q of approximately 0.2. Fried Products Corp., 1323 Conshohocken Rd., Norristown, PA 19401-2707, (800) 255-1014, FAX (610) 277-4390.

Reader Service #114

Speaker Builder (US ISSN 0199-7920) is published every six weeks (eight times a year), at \$32 per year, \$58 for two years, Canada add \$8 per year, overseas rates \$50 one year, \$90 two years, by Audio Amateur Publications, Inc., Edward T. Dell, Jr., President, at 305 Union Street, PO Box 494, Peterborough, NH 03458-0494. Second-class postage paid at Peterborough, NH and an additional mailing office. POSTMASTER: Send address change to: Speaker Builder, PO Box 494, Peterborough, NH 03458-0494



**HOW THE INDUSTRY HAS RECEIVED OUR NEW FERROFLUIDS.**

## The audio world enjoys added performance with FerroSound.

The new generation of FerroSound ferrofluids represents the great leap forward that the audio industry has been waiting for.

These innovative fluids enable speakers to match ongoing improvements in the rest of the sound system. Applied to the voice coil, they withstand unprecedented sound pressure levels and heat. They also reduce spectral contamination (distortion) and power compression effects.

Results: longer-lived speakers with greater dynamic range — and an authentic performance boost that's audible from first note to last.

No wonder knowledgeable listeners in home hi-fi, auto sound, and even professional audio are jumping at the chance to audition speakers with FerroSound. For more information, call today at 603/883-9800 — or fax 603/883-2308.

**FerroSound**  
The Solution Is Loud And Clear™

Ferrofluidics Corporation, 40 Simon Street, Nashua, NH 03061

© 1994. FerroSound and related graphics are registered trademarks of Ferrofluidics Corp.

Reader Service #51



# EXPERIENCE!

Nothing compares to being at a live musical performance...  
but Audax's experience can bring you close. We use cutting  
edge materials and processes—including ultra-light, rigid, maximally  
damped HD-A cones—to capture the subtlety and emotion of live music.  
Join the audiophiles who depend on Audax as their number one source for a complete  
line of loudspeaker products, many patented worldwide. And experience for yourself what  
these customers already know: Audax manufactures the highest quality loudspeaker components  
in the world, giving your system an unparalleled sonic advantage. **Let our expertise perform for you.**

For your 1994 catalogue or list of authorized distributors, contact Polydax Speaker Corporation, the U.S. subsidiary of Audax Industries, France.

**polydax**  
SPEAKER CORPORATION

[www.audax.com](http://www.audax.com)  
**AUDAX**

POLYDAX SPEAKER CORPORATION 10 Upton Drive Wilmington, Massachusetts 01887 Tel: 508.658.0700 Fax: 508.658.0703



## ■ BASS BOOSTER

AudioControl's latest addition to its Performance Advantage line is the Phase Coupled Activator Series Three. The digital subharmonic restoration system has speaker level inputs that allow you to connect the unit and a subwoofer to any system, even one without preamp outputs for a subwoofer. Other features include a 24dB/octave Linkwitz-Riley electronic crossover with frequency programmability. AudioControl, 22410 70th Ave. West, Mountlake Terrace, WA 98043, (206) 775-8461, FAX (206) 778-3166.

Reader Service #102

## ➔ REMOTE CONTROLLED

Parasound has introduced its first multimedia processor/preamplifier, the P/SP-1000. The Dolby™ Pro Logic A/V control center offers complete remote operation of customized home theaters. It comes equipped with three audio/video inputs, with switching capability for both NTSC composite and S-Video, and two audio inputs which are compatible with any typical analog line-level source. A "preamp direct" switch controls a straight-wire connection from the source to an exterior amp. Parasound Products, Inc., 950 Battery St., San Francisco, CA 94111, (800) 822-8802, (415) 397-7100, FAX (415) 397-0144.

Reader Service #103

## ■ CABLE NEWS

GOERTZ MI loudspeaker cables employ the "Laminax" technology of combining metal foil and strip conductors with a variety of dielectric materials (used in electronics for EMI and RF shielding purposes and as winding conductors in high- and line-frequency transformers and inductors). The result is a thin cable with high dielectric strength. The conductors have a low characteristic impedance that matches that of loudspeakers, which the makers claim results in virtual elimination of distortion. Alpha-Core, Inc., 915 Pembroke St., Bridgeport, CT 06608, (203) 335-6805, FAX (203) 384-8120.

Reader Service #106

## ■ FRESH G.R.A.S.

Scantek has released the latest series of microphone preamplifiers manufactured by G.R.A.S. Sound & Vibration: Types 26AA, 26AB, and 26AC. The units are ideal for 1", 1/2", 1/4", and 1/8" microphones, with or without polarization voltage, and for high-impedance input stages for instrumentation. They can also be used for accelerometers and hydrophones. Their frequency range is from less than 1Hz to greater than 200kHz, with supply voltages from below 28V to above 130V.

Reader Service #109

Another recent G.R.A.S. release from Scantek is the Type 50AI sound intensity probe. Based on a new microphone venting system, the unit has built-in remote control for the Norsonic 840, 01dB, and other leading intensity analyzers. The 50AI comes equipped with a pair of Type 40AI Sound Intensity Microphones and stainless-steel Type 26AA microphone preamplifiers. Scantek, Inc., 916 Gist Ave., Silver Spring, MD 20910, (301) 495-7738, FAX (301) 495-7739.

Reader Service #110

← Reader Service #21

# Good News

## ■ NEW GALAXY

Galaxy Audio has acquired Valley Audio Products of Merriam, KS, and will be relocating the business in Wichita. Under its new ownership, the company will be known as Valley Audio. With a product line dating from the 1970s (it was originally known as Allison Research), Valley Audio introduced the first dynamics processing capabilities for studio recording. The company manufactures electronic signal processors including the Kepex®, Gain Brain®, Model 401 microphone processor, Dyna-Mite®, X-Gate, and the Model 730 Dyna-Map™ digital processor. Valley Audio Products, 625 E. Pawnee, Wichita, KS 67211, (800) 800-4345, (316) 265-9500, FAX (316) 263-0642.

Reader Service #113

Continued on page 8



## HOLOGRAPHIC INJECTED MOLDED GRAPHITE SUBWOOFERS MADE IN THE USA.



The combination of stiff, light-weight components of Graphite together with Polypropylene insure proper damping & musical accuracy.

Holographic cones are up to 60%

lighter and ten times stronger than conventional cones. Coupled with large vented magnetic structures, Kapton voice coils and insulated lead wires, the Holographic woofers produce tight & dynamic bass response.

Model: CW110-4	\$139.00*	Model: CW112-4	\$159.00*
Surround: Butyl Rubber		Surround: Rolled Foam	
Re: 3.27 Ohms	Le: 0.56 Mh	Re: 3.28 Ohms	Le: .93 Mh
Qm: 9.34	Qe: 0.33	Qm: 7.77	Qe: 0.57
Qt: 0.32	X-Max: 4.6 mm	Qt: 0.53	X-Max: 5.5 mm
BL: 7.21 T-M	VC Diam: 1.5"	BL: 9 T-M	VC Diam: 2.5"
Gap Height: .3100"	Fs: 19Hz	Gap Height: .3750"	Fs: 33Hz
Zmax: 96.2 Ohms	MMS: 42.6 g	Zmax: 48.3 Ohms	MMS: 67.02 g
CMS: 1.5574 MM/N	RMS: .5597 N*sec/m	CMS: .3433 MM/N	RMS: 1.798 N*sec/m
Vos: 9.19 cuft.	SD: 433.88 Sqcm	Vos: 4.37 cuft.	SD: 506.71 Sqcm
VD: 158.66 cc	Magnet: 56 oz	VD: 277.52 cc	Magnet: 70 oz
SPL: 90 dB	Winding: .625"	SPL: 91 dB	Winding: .750"

\*Prices include UPS freight & COD charges in the contiguous USA. Dealer inquiries welcome.

# CADENCE

Call Toll-Free 800/477-2328  
6519 Highway 9 North  
Howell, NJ 07731

Reader Service #60

Speaker Builder / 8/94 5



...Finally, a complete low cost PC based measurement solution for all of your loudspeaker and audio measurements. Use your home/office computer and the CD quality 16 bit sound cards from Media Vision or Soundblaster to actually measure the performance of your loudspeakers, electronics and crossovers. VERSION 2.0 now available!

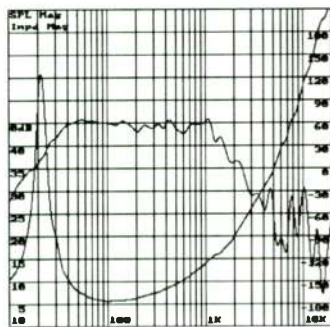

**SYSTEM REQUIREMENTS:**

- 386/486 IBM AT compatible
- 4 Mb RAM memory
- Math Coprocessor
- VGA Graphics Display
- Media Vision or SoundBlaster 16 bit sound card

**PRODUCT HIGHLIGHTS**

- OSCILLOSCOPE
- SPECTRUM ANALYZER
- NETWORK ANALYZER
- DISTORTION ANALYZER
- LOUDSPEAKER ANALYZER
- IMPULSE ANALYZER
- ROOM ACOUSTICS ANALYZER
- DETAILED MANUAL
- TEST CABLES
- GRAPHICAL USER INTERFACE
- PRINTER OUTPUT SUPPORT
- MOUSE SUPPORT
- EXPORT/IMPORT FILES
- \$300 CHECK/MONEY ORDER

**MICROACOUSTICS  
AUDIO SOFTWARE PRODUCTS**

2553 CARPENTER ST, THOUSAND OAKS, CA. 91362 (805) 495-8945 PHONE/FAX

Reader Service #20

## About This Issue

Fed up with all the blather about Chuck and Di and Burt and Loni? Well, some marriages are more compatible. Witness computers and audio. The union of these two technologies to perform speaker measurements is well-represented in this issue.

**Julian Bunn** introduces his high-flying AIRR ("Anechoic and In-Room Response," p. 10) measurement program, which takes advantage of the capabilities of the popular SoundBlaster sound card on your PC. With this program, you can turn your computer into an inexpensive tool for surprisingly sophisticated system analysis.

Another example of our reliance on computers in audio work is PC AudioLab from Microacoustics. **Richard Campbell** reviews this program ("Software Report," p. 49), which offers PC readers a handy, low-cost solution for system measurements.

In this age of environmental awareness and recycling efforts, it's appropriate to show you how to inject new life into old speakers. **Hilary Paprocki** ("Reviving the Classic AR2ax," p. 20) guides you through the restoration of Acoustic Research speakers in 15 easy-to-follow steps.

*SB* is pleased to reprint, from the March 1994 issue of *Studio Sound*, the results of an exhaustive five-year study of horn loudspeakers to determine their suitability for studio use ("Round the Horn," p. 24). The results of this research, which one of the authors used as the basis of his doctoral dissertation, are significant and should affect future designs. **Philip Newell** and **Keith Holland** also detail the horn cutoff phenomenon, a little-understood, but important, key in studio design.

**Philip Witham** returns...this time with a prototype. And while he plans more testing of his 60-channel dipole speaker, initial results indicate that his Linear-Array concept works to produce a better, "more realistic, more pleasing" sound than with stereo. The next steps involve further tweaking, building, and electronics. Stay tuned.

**Dick Pierce** has a lot on his mind these days. He takes the opportunity in this issue to explore such diverse topics as free online advice (sometimes worth every penny) ("Guest Editorial," p. 9) and the Q-rinous significance of Thiele/Small parameters ("Loudspeakers 101," p. 70).

In his latest installment ("Wayland's Wood World," p. 47) woodsmith **Bob Wayland** offers some useful tips for putting the finishing touches on speaker projects.

# Speaker Builder

**The Staff**

Editor and Publisher

Edward T. Dell, Jr.

Contributing Editors

- |                   |                |
|-------------------|----------------|
| Joseph D'Appolito | Robert Bullock |
| Richard Campbell  | John Cockroft  |
| David Davenport   | Vance Dickason |
| Bruce Edgar       | Gary Galo      |
| G.R. Koonce       |                |

Director of Outside Projects & Personnel  
Karen Hebert

Dennis Brisson Managing Editor  
Mary Wagner Associate Editor

Glenn Galloway Graphics Director  
Production Assistants  
Brian Jenkins Diane Luopa

Laurel Humphrey Circulation Director  
Circulation Assistants  
Robyn Lasanen Lea Peterson

**Advertising Rates & Schedules**

Martha L. Povey National Advertising Director  
Laura Brown Advertising Assistant  
(603) 924-9464 FAX (603) 924-9467

*The peculiar evil of silencing the expression of an opinion is, that it is robbing the human race; posterity as well as the existing generation; those who dissent from the opinion, still more than those who hold it.*

∞ JOHN STUART MILL

*Speaker Builder* is published eight times a year in the interest of high-quality audio reproduction.

No material in *Speaker Builder* may be used in any form without the written permission of the publisher.

**Subscription Inquiries**

A one year subscription to *Speaker Builder* is \$32. Canada please add \$8. Overseas rate is \$50 per year.

To subscribe, renew or change address write to Circulation Department or call (603) 924-9464 or FAX (603) 924-9467 for MC/Visa/Discover charge card orders.

For gift subscriptions please include gift recipient's name and your own, with remittance. A gift card will be sent.

Send circulation and editorial correspondence to *Speaker Builder*, PO Box 494, Peterborough, NH 03458-0494. No responsibility is assumed for unsolicited manuscripts. All manuscripts must include a self-addressed envelope with return postage. The staff *will not* answer technical queries by telephone.

Printed in the USA. Copyright © 1994 by Audio Amateur Publications, Inc. All rights reserved.



# Speaker Builder

THE LOUDSPEAKER JOURNAL

VOLUME 15 NUMBER 8 DECEMBER 1994

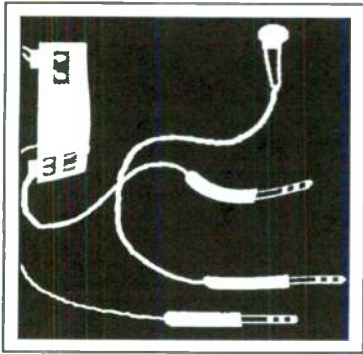

10

## 10 AIRR: Anechoic and In-Room Response Measurement

BY JULIAN J. BUNN

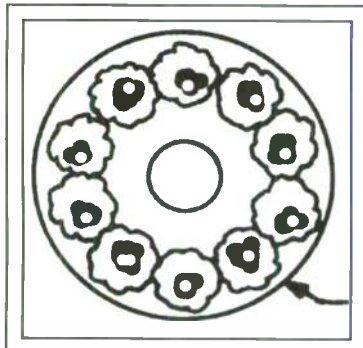

20

## 20 Resurrecting a Pair of AR2AXs

BY HILARY PAPROCKI

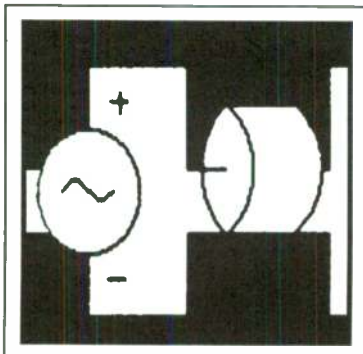

38

## 24 Round the Horn

BY PHILIP NEWELL AND KEITH HOLLAND

## 38 The Linear-Array Chronicles, Part 2

BY PHILIP WITHAM

## 49 SOFTWARE REVIEW:

### PC AudioLab

BY DICK CAMPBELL

## DEPARTMENTS

- |    |  |    |                                    |
|----|--|----|------------------------------------|
| 3  | GOOD NEWS  | 61 | SB MAILBOX                         |
| 9  | EDITORIAL The Newbies Are Back<br>BY DICK PIERCE | 67 | CLASSIFIED                         |
| 47 | WAYLAND'S WOOD WORLD<br>BY BOB WAYLAND           | 69 | AD INDEX                           |
| 59 | TOOLS, TIPS & TECHNIQUES<br>BY JAMES T. FRANE    | 70 | LOUDSPEAKERS 101<br>BY DICK PIERCE |

## ■ ER OPERATIONS

Recent technological advances in electrorheological (ER) fluids offer performance features such as operation over a temperature range of -50°C to 150°C; finer-particle formulations, carefully matched densities, and other techniques to decrease settling problems and increase stability; softer, nonabrasive particles; and higher shear stresses. ER-based adhesives and coatings, when used on nonhorizontal surfaces, convert to a higher viscosity when an electrical field is applied. Call Technology Catalysts International at (703) 237-9600, FAX (703) 237-7967, for details.

Reader Service #111

## ■ COMPACT DRIVER

The newest design in high-frequency ribbon loudspeakers is the SA 8535 Neodymium Compact Driver from Stage Accompany, a Dutch manufacturer of professional sound systems. It has a frequency range of 1kHz-30kHz, sensitivity of 103dB @ 1W/1M, and a power handling of 60W RMS with 1kW peak (200ms). The recommended crossover point is 1kHz or higher (12dB/octave minimum). Stage Accompany USA, 4106 Fox Run Trail #6, Cincinnati, OH 45255, (513) 528-4035, FAX (513) 528-4037.

Reader Service #104

# Good News



## ■ INSTALLATION BREEZE

The new 9757 two-way speaker from Fultron Car Audio is designed to match virtually every 5X7 and 6X8 bolt pattern on the market. The easy mounting units have polypropylene cones, flexible surrounds, polyimide dome tweeters, and strontium magnets. Impedance is 4Ω; resonant frequency of 75Hz; 50Hz-20kHz frequency response, with a maximum power handling capability of 80W. Sensitivity is 88dB. Fultron, 122 Gayoso, PO Box 177, Memphis, TN 38101-9988, (901) 525-5711, FAX (901) 525-7993.

Reader Service #105

## ■ SCOPING PCS

The O-Scope I converts your PC into a digital storage oscilloscope. It captures and displays DC, audio, and low-end ultrasonic frequency input signals. A 128-point frequency spectrum analyzer mode, suitable for use in measuring distortion to 1% and determining frequency response, is also included. The device is powered from 12V DC, draws less than 40mA of current, and works with AT-compatible computers. Trace sweeps can be frozen onscreen, saved to disk, or output to a printer. The O-Scope I can also provide voltage, frequency, and period calculations. Allison Technology Corp., 8343 Carvel, Houston, TX 77036, (800) 980-9806, FAX (713) 777-4746.

Reader Service #107

## Speaker Testing with CLIO is easy, accurate, and very, very affordable.

**CLIO is accurate...** CLIO is a precision 16-bit audio front end for your PC, and with a "Windows-like" interface, is very easy to learn and use.

**CLIO is sophisticated...** Acoustic test gear must consider time vs. frequency to provide a complete acoustic picture. CLIO measures in both time and frequency domains for thorough analysis of loudspeakers, auto interiors, and room acoustics.

**CLIO is open-ended...** System hardware is 2-channel I/O with a variable sampling rate; and since CLIO is software-based, its functionality will grow.

**CLIO is affordable...** Pricing is \$1,695 complete, but our introductory offer is even better. Call now for details and a demo disk.

ACUSTICAL SUPPLY INTERNATIONAL

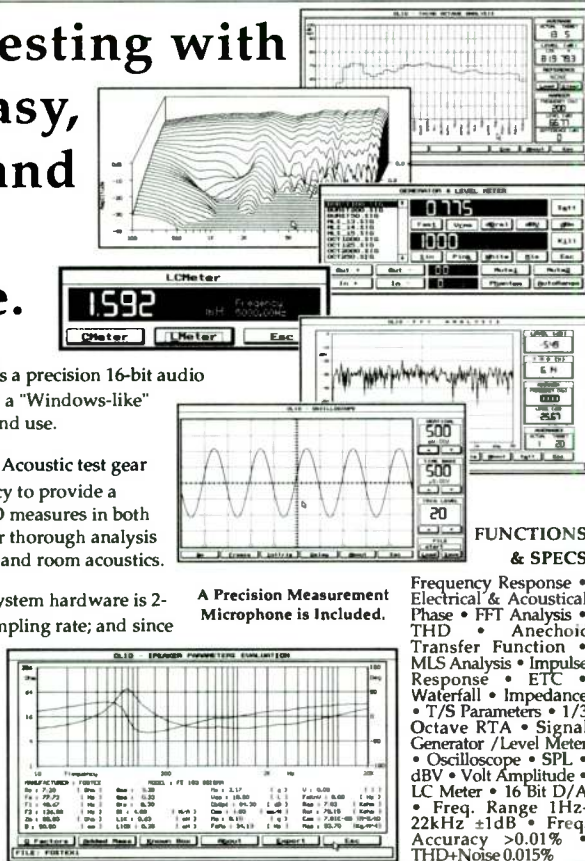

A Precision Measurement Microphone is Included.

### FUNCTIONS & SPECS

Frequency Response • Electrical & Acoustical Phase • FFT Analysis • THD • Anechoic Transfer Function • MLS Analysis • Impulse Response • ETC • Waterfall • Impedance • T/S Parameters • 1/3 Octave RTA • Signal Generator /Level Meter • Oscilloscope • SPL • dBV • Volt Amplitude • LC Meter • 16 Bit D/A • Freq. Range 1Hz-22kHz ±1dB • Freq. Accuracy >0.01% • THD+Noise 0.015%

## Speakerphile™



A project management database for loudspeaker designers and engineers.

- **Component Data:** Detailed information on thousands of woofers, tweeters, hardware.
- **Source Data:** Manufacturer, distributor, and sales rep contact information.
- **Queries and Searches:** Quickly find a needed component by its design parameters.
- **Project Management:** Assign selected components to user-defined projects. Includes cost, profit, and marketing analysis models.
- **Reference:** Electronic, acoustic, design.
- **Utilities:** Unit conversion and design tools.
- **Connections:** Import, export, and linking.
- **Version 1.0 for Windows \$495.00**

Special Offer for Charter Users...

\$99.00

A professional pre-release version is available for charter users who purchase Speakerphile before 12/31/94.



100 Cherokee Blvd., Suite 211 Chattanooga, TN 37405 • Tel: 615-752-1720 • Fax: 615-752-1725 • Compuserve: 73504,2436 • AOL: Acoustical • Internet: ttaylor

Reader Service #68



---

# Guest Editorial

---

## The Newbies Are Back

By Richard Pierce

Well, it's the fall semester, and all the pubescent newbie experts are back in town, a-rarin' to go. They bring with them the same old notions the last ten generations brought. They're clueless, and the thing they are most clueless about is exactly how clueless they really are.

I have just shut down two private e-mail threads from two kids whose combined age is less than my own, and neither of whom was even born when I was doing loudspeaker design consulting.

For example, one of these, a 19-year-old college sophomore who admits to no knowledge of physics or electronics, who conceded to not knowing the technical lexicon of loudspeakers and acoustics, whose *only* reference text on loudspeakers is Vance Dickason's *Loudspeaker Design Cookbook*, and whose only qualification seems to be as a "\$45 per hour car audio installer," chose to try to re-educate me on how speakers work. He was sorry I was so stupid, but all I had to do was to just look up in Dickason what he was talking about. On at least two occasions I tried to get a specific page citation, but he seemed strangely silent, then proceeded to redefine what "isobarik" meant in the context of loudspeakers.

It's something of a small tragedy when this happens, like clockwork, every September, when a new incoming class discovers, simultaneously, the Internet, their interest in some topic, and testosterone, and confuses all. I clearly remember when I was 19, and I knew *absolutely everything*, and I was so soundly trounced in a technical discussion, there was almost no body left to identify.

The first thing I definitely knew after that was that I definitely *did not* know *absolutely everything*, and that piece of knowledge has stayed with me as I strove in the subsequent years to try to learn absolutely everything.

### WRONG IS WRONG

Yes, some of you may say, this is all true, but aren't we being a bit hard on these kids? After all, what harm can they do?

Well, in these cases, they were offering advice to people with specific questions, and their answers were just plain wrong. Wrong is wrong, whether it comes from the mouths of babes or adults. Wrong is wrong, because the physical reality of loudspeakers, and all other physical realities, pays no heed to either good intentions or a child's innocence.

And, when someone else with good intentions takes that wrong

answer and then tries to make it work, and it doesn't, the outcome is, as often as not, discouragement resulting in that person assuming, quite incorrectly, that *he* is at fault, not the person who provided the wrong information, and he *is* thus deterred from pursuing what may be a good path.

The person cannot be excused simply because he didn't know better. Wrong is wrong, no matter what the source. And wrong information has no business in a technical news group, no matter how good the source's intentions.

### CHEAP EXPERTISE

Vern Mastel, in a recent guest editorial in *TAA* 2/94 ("Hoodwink City USA," p. 7), was most articulate about the subject:

"...Cheap expertise...It is not something to be avoided, it is to be attacked like a cancer. Far too many armchair experts are spouting opinions, although their expertise is often limited to what they have read or heard. True experts hold their opinions very dear and don't broadcast them unless they are accompanied by substantial experience and data. 'Cheap expertise' is always offered on the basis of 'knowing it all.' The true experts have an appreciation for how much they don't know."

Another area Mastel deals with is the subject of one of these people pressing on regardless of his lack of familiarity with the terminology:

"Avoid technical shorthand? No, up to a point. The standard practice of the technologically illiterate is to overcomplicate the simple and oversimplify the complex. Correct terminology cannot be compromised. Converting technical concepts into 'layman' terms often results in technical nonsense [as it did in the case at hand—rdp]. The intent of correct terminology is not to bury the novice, but rather to properly express a concept or discuss a design."

Yes, Vance Dickason's book is a good book—probably the best of its kind—for its purposes, which is as the title says, a "cook-book" intended specifically and exclusively for amateur loudspeaker enthusiasts. But it is hardly the reference text on loudspeaker theory.

So, our young friends, welcome to the fray, and join us who have been here for a long time. But watch where you step, because you may learn firsthand where the term "hooley" comes from.

And, I suppose, for the rest of us, some patience.



# AIRR: ANECHOIC AND IN-ROOM RESPONSE MEASUREMENT

By Julian J. Bunn

After enjoying Bill Waslo's articles on the IMP system ("The IMP," *SB* 1/93, 2/93, 3/93, 4/93, 6/93), I realized that the SoundBlaster™ card I recently installed in my PC might be able to perform similar analysis functions, under software control.

## SYSTEM FEATURES

I drew up some specifications for a suitable program to include:

1. Facilities for measuring both loudspeaker and amplifier response as a function of frequency;
2. The possibility of subtracting the two;
3. An oscilloscope-like display of the audio signals being picked up by the card;
4. A graphical display of the frequency response;
5. Some means of adjusting the range of frequencies that would be covered.

To restrict the portion of the digitized signal to exclude the part caused by reverberation in the listening room, the tool needed to allow the signal to be "windowed" by adjusting graphics markers on the display. I was interested in measuring response to pulse signals and also to signals from a test CD, for example, sine tones, pink and white noise, and so on. Whereas the pulse signal would require averaging in the time domain to reject background, these other signals would require averaging in the frequency domain. An important capability was to be able to switch between the two.

Finally, I required that the lowest resolvable frequency should be adjustable, maybe at the expense of data acquisition speed. The result was the AIRR (Anechoic and In-Room Response) measurement program.

## ABOUT THE AUTHOR

Julian Bunn was born in Yorkshire in 1959. He studied physics at the University of Manchester and subsequently earned a Ph.D. at the University of Sheffield. He now works at an international organization in Geneva, and lives with his wife and two daughters in a small village in nearby France.

## REQUIREMENTS & OPERATION

Despite not being as complete or professional a tool as the IMP, AIRR will allow you to make quite sophisticated audio response measurements. It may therefore be attractive to some readers as a "poor man's IMP." (I resisted the temptation of naming the program PIMP!)

To use the program, you will need a DOS-based PC, a SoundBlaster (or compatible) sound card, EGA or VGA graphics, a microphone (usually supplied with the sound card), and about 500K of free disk space. A math co-processor is *not* required. The faster your machine, the better the results from AIRR will be.

Readers of the IMP articles in *SB* will be familiar with the basic principle employed by AIRR, which is to produce a single pulse of very small width and then feed it to the audio system to be measured. The sound reproduced by the audio system is then picked up, using either a microphone or a

direct electrical connection, and digitized by the sound card. The data is passed to a fast Fourier transform, and the frequency decomposition of the sound is obtained. This is then plotted in a graphics window on the PC, using the traditional logarithmic axes.

## SOUND CARDS

A sound card is a printed circuit board in a slot on the motherboard of a personal computer and allows both recording and playback of digital sound. The card often comes as a package of parts including the electronics, a microphone, connecting leads, and a bundle of software. The board itself sports a sophisticated lineup containing an analog-to-digital converter (ADC), digital-to-analog converter (DAC), frequency modulation (FM), and mixer chips.

These days, the digital components are predominantly available in 16-bit versions (thus, a "16-bit card"), although 8-bit cards are still available and may be picked up very cheaply (but will not work with AIRR).

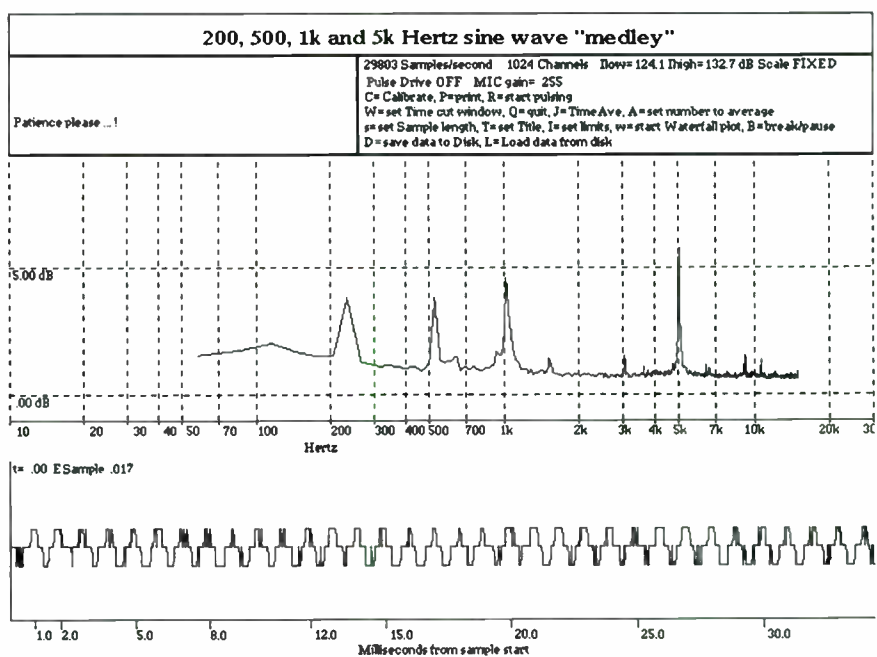

FIGURE 1: AIRR results from frequency averaging signals picked up via the microphone for four sine wave tracks played from a test CD.



Typical use of a sound card is for sound "bite" playback and multimedia applications such as games, voice recognition, document annotation by voice, interfacing to a CD drive in the PC, and so on.

The sound card may also be interfaced to and controlled by custom-built software. Sounds picked up by the microphone, after on-board digitization by the ADC, can be processed in just about any way that we wish. By suitably programming the on-board mixer, the signals from the line-in socket on the card can be treated instead of those from the microphone, or the two inputs can be mixed together.

Conversely, by programming the DAC, you can synthesize and feed to the line-out socket any desired waveform. (There is, however, some upper limit on the frequency of the signals that may be produced; I will cover this point later.) So, for a modest outlay of \$100 or so we have a piece of equipment to perform arbitrarily complex digital signal processing.

### PROGRAMMER WOES

Unfortunately, it's not quite as straightforward as that! Sound cards are notoriously difficult to configure correctly, and it is rumored that over 50% of them are returned "broken" to the vendor because of configuration errors. Why?

The answer is that the software drivers that come with the card, and which take care

of how data is transferred to and from the electronics, require you to correctly specify several pieces of configuration information before the card will function properly. You, as the installer, are presented with the often confusing task of correctly setting Interrupt Request Lines (IRQs), Direct Memory Addresses (DMAs), and I/O address possibilities offered by the configuration utilities. In particularly unpleasant cases, you even need to change jumper settings on the board itself, if they conflict with other equipment settings.

[I strongly recommend Jeffrey Prosis's excellent volume titled "DOS 6 Memory Management" (ZD Press, Emeryville, CA, \$29.95, ISBN1-56276-097-1), which explains not only memory management in DOS 5 and 6 but also clarifies matters of DMA and IRQs thoroughly and clearly.—ETD]

Even with a correctly installed card, you may encounter problems such as insufficient memory for running CD-based multimedia sound applications, "choppy" audio due to badly sized buffers, and so on. (Having said all this, you may be lucky and discover that the card slots in and works the first time. Of the four cards I have installed, this happened just once.)

Once you have dealt with these problems, the next major hurdle to overcome is obtaining the necessary information on programming the card. It is rare indeed to find this sort of detail in the card's documentation. Obtaining it usually involves a visit to the rel-

evant forum on CompuServe™, or downloading the appropriate FAQ (Frequently Asked Questions) list on the Internet News groups.

Finally, with a correctly configured sound card, the programming information described, and a decent language compiler for the PC, you are ready to code up a custom sound application.

### CALIBRATING THE CARD

For this application, the most important aspect of the program to address is calibration. Unless only very subjective results are required, we must accurately measure how fast the card can digitize a sound, so we can calculate the sample rate. The sample rate achieved tells us the maximum frequency that may be resolved by the system (the lowest frequency is determined by the length of time we choose to gather samples).

Nyquist (of telephony theory fame) showed that for a maximum sampling frequency of  $W$  the signal bandwidth is  $W/2$ . For example, if the ADC on the card, under program control, can digitize and move a voltage level into main memory 20,000 times a second, then the maximum resolvable frequency is 10kHz. By calibrating the sample rate, the labels on the axes of the frequency and time plots can be positioned correctly, and we can be confident that a peak in the frequency response is really at the indicated frequency.

The AIRR calibration method uses the callable interface to the system clock on the PC to measure the time required to read into main memory a large number of 8-bit samples in so-called "direct-mode" ADC (as opposed to DMA mode). Using a large number of samples is important for two reasons:

1. The interface to the system clock only returns a system time measured to the nearest hundredth of a second.
2. The more measurements made, the smaller the derived calibration error.

The card is thus calibrated by (a) taking a reading,  $T_1$ , from the system clock; (b) digitizing and moving 200,000 voltage levels in the ADC into main memory; and (c) taking a final reading,  $T_2$ , from the system clock. The rate is then  $200,000/(T_2-T_1)$ . By default, the digitizations are made in blocks of 512 at a time. One block is henceforth referred to as a "sample" in the text, although it actually contains  $N$  separate measurements.

Several factors affect the number obtained for the rate:

- the speed of the software drivers controlling the card
- the speed of the sound card electronics
- the speed of the CPU and memory
- the efficiency of the machine code (the compiled program) that runs in the CPU.

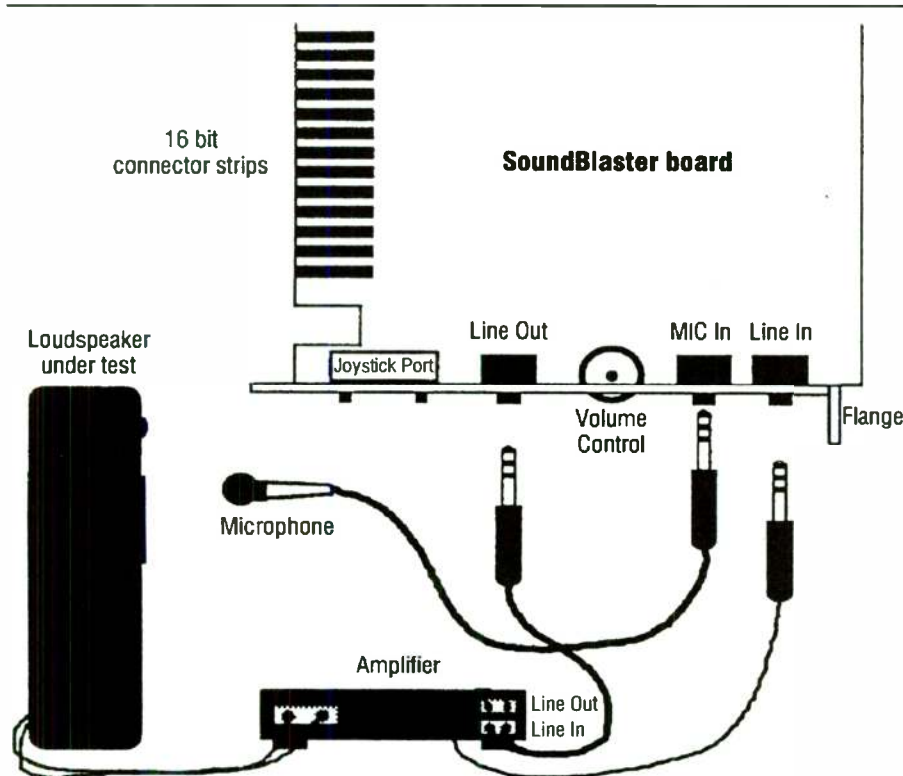

FIGURE 2: Showing the scheme for connecting external components to the sound card. Note that, to minimize distortion, the volume control should be positioned about midway.



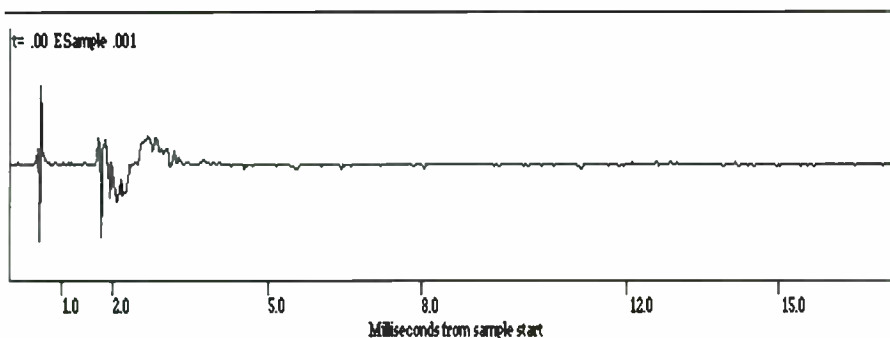

FIGURE 3: The result of time averaging pulses from the microphone. Note the crosstalk "blip" at around T=0.6ms (see text).

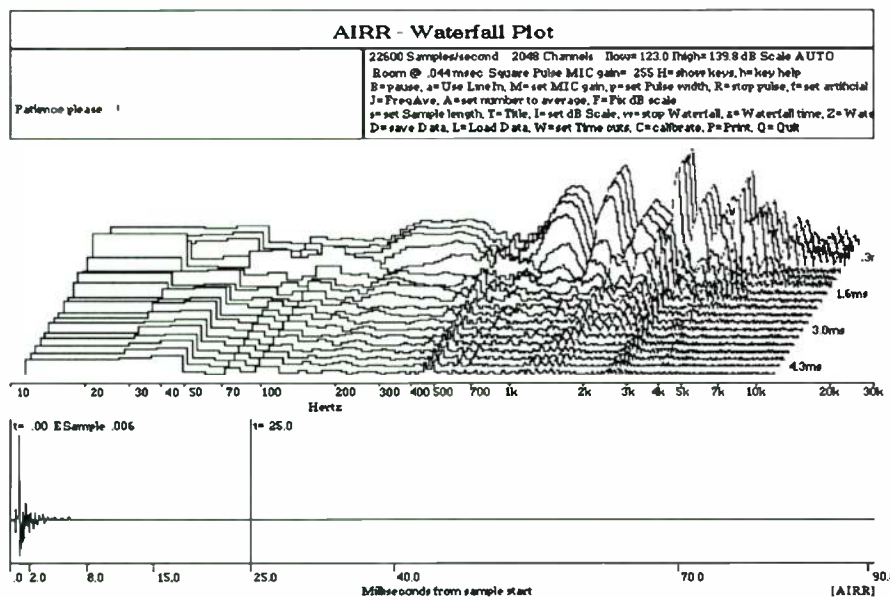

FIGURE 4: The waterfall plot.

## DATA COLLECTION

To optimize the data collection rate, it is thus helpful to have a fast processor, fast memory (and plenty available), and the latest drivers from the sound card manufacturer. (Avoid loading the drivers "high" or using, for example, QEMM 7.0™ to load the driver. I have observed very poor collection rates under these conditions.)

In practice, on a 386DX PC with a 40MHz chip and 500K of spare memory, the rate normally achieved is in the region of 30,000 digitizations per second (a less recent version of the driver produced 24,000 per second), or, in other words, a maximum frequency point on the plots at 15kHz. On machines with faster CPUs (such as the 486 or Pentium series), this rate may be higher. (In the next version of AIRR, I intend to improve the data collection speed by using either assembler or DMA.)

You can check the accuracy of the AIRR calibration in one of several ways. The most obvious is to feed the sound card with a sine wave signal of precisely known frequency, such as that from a test CD or calibrated signal

generator, and observe the position of the peak that results in the frequency plot. For this, AIRR is switched into no pulse and frequency averaging mode, and the signal sampled.

Note that AIRR must be in the frequency averaging mode, since averaging in the time domain would result in a uniformly flat signal. This is because there is no oscilloscope-like triggering employed on the input signal, so each sample would tend to begin at a different position on the waveform. To demonstrate this method, Fig. 1 shows the result of frequency averaging the sound picked up from continuous playing of four sine wave tracks of different frequency from a test CD (the AIRR screen grabs have been converted from color to black and white for the purpose of including them in this article).

## AIRR DISPLAY FEATURES

The screen is divided into five regions. The topmost box displays the title, which may be altered if desired. Beneath and to the left is an I/O box for brief information on the current status, and also as an input box when you're required to enter text or other data.

For example, when specifying the number of samples over which to average, a prompt appears in the box showing the minimum and maximum values allowed as input, together with the current value. An attempt to enter a number other than in the correct range results in a message to that effect, and a chance to try again. To the right of this is a status box detailing the current running conditions and showing the sample rate as calculated by the last calibration pass, the number of channels/digitizations that are currently being sampled as a block, and the calculated lower and upper limits of the amplitude in the time domain plot. The following line indicates the mode of operation: room response, amplifier response, no pulse or artificial feed.

In room mode, the gain being used for the MIC input on the sound card is shown. [The AIRR program messages and prompts follow the standard abbreviation for microphone. Speaker Builder prefers the alternative style, mike.—Ed.] For amplifier mode the gain on the line input is shown. Then, for the pulse modes of operation, the width of the pulse appears, followed by its type (square or sin(x)/x). Immediately below these two lines of information is a list of command letters that may be typed, with a brief description of the function of each.

Next down the screen is the region devoted to the frequency response plot. Both axes are plotted on logarithmic scales. The program continually adjusts the vertical axis towards showing the whole spectrum curve without clipping. For the waterfall plots, the vertical axis is not shown. Beneath the frequency plot appears the time domain plot. This shows the amplitude of the sample as a function of time in milliseconds from the start of the sample. The x-axis is relabelled whenever a calibration is performed.

Again, the vertical scale is continually adjusted so the whole signal appears in the plot. The positions of the time domain cut variables are shown as vertical lines and associated text; positioning the cuts is achieved by entering new values in the I/O box after selecting the appropriate option key. Also shown is the "sample energy," which is simply the integrated area beneath the sample. This is calculated by summing the absolute value of each digitization and dividing the result by the data rate; it gives some measure of the power in the pulse.

## PULSE GENERATION & COLLECTION

A single pulse of minimal width is generated by sending a nonzero byte to the DAC on the sound board, immediately followed by a zero byte. This causes the analog signal level at the DAC output to go high, then low, reproducing a pulse of width typically in the region of 50ms, corresponding to a first pole in the frequency domain at 20kHz. The pulse

# Forgings TWEETER / SYNCHRONOUS SPEAKER

HUNDREDS OF OUTSTANDING TWEETERS  
ARE AVAILABLE FOR EVERY OF YOUR PROJECT

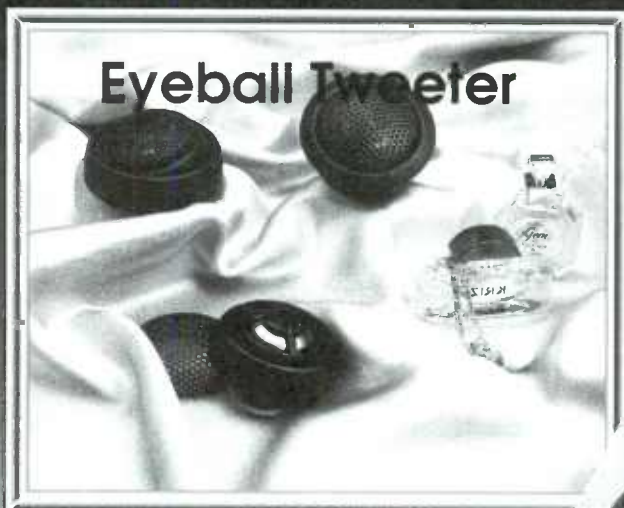

Newest Tweeter with  
one-piece diaphragm in Super  
Duralumin, Titanium ...  
material.

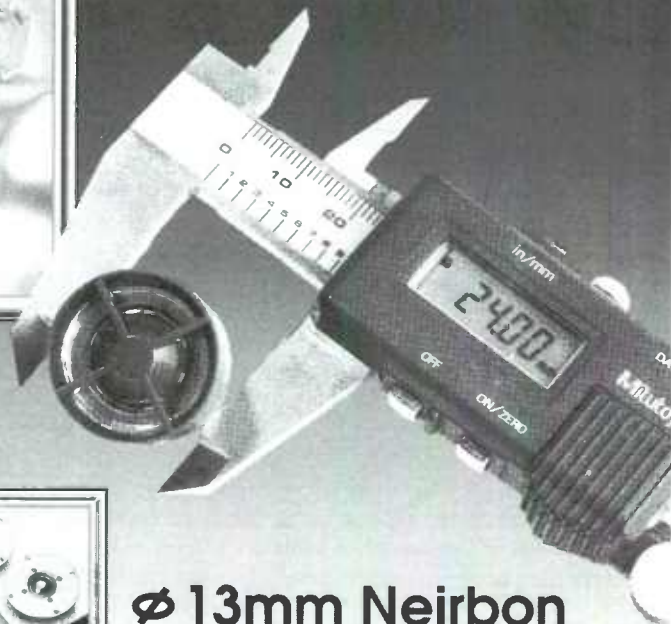

**DOM TWEETER :**  
**@USD 0.79**



**∅ 13mm Neirbon  
Super-Tweeter**

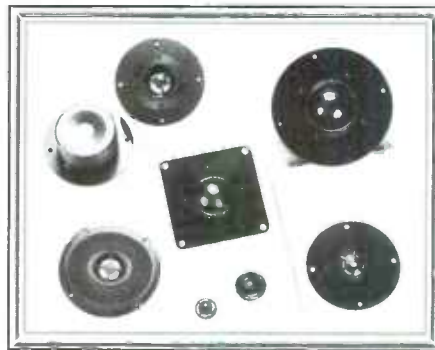

- ☐ Supreme know-how and continuous research
- ☐ Hi-quality products at the most competitive pricing
- ☐ Available for OEM design and free catalogues

You'll be surprised to find we're the one you've  
been looking for !

**FORGINGS IND. CO., LTD. / P.O. BOX 1823, TAIPEI, TAIWAN, R.O.C.**  
**TEL: 886-2-585-3316/7    FAX : 886-2-594-2708    ATTN: MS. LU CHI YING**



TABLE 1

## FUNCTIONS (AND ASSOCIATED KEYS) SUPPORTED BY AIRR

TABLE 1  
FUNCTIONS (AND ASSOCIATED KEYS) SUPPORTED BY AIRR

Description	Key	Input Required
Set the number of samples over which to average	A	Integer
Toggle between measuring signals from MIC or line-in socket	a	None
Freeze the display, and stop sampling until a key is pressed	B	None
Calibrate the AIRR data collection rate	C	None
Write current response data to disk	D	Name of file to store ASCII data
Toggle automatic or fixed scale in the frequency domain plot	F	None
With pulse generation, check what a perfect component would produce as a frequency response	f	None
Show this table	H	None
Select help on a key	h	None
Specify upper and lower limits on the vertical axis of the frequency domain plot	I	Upper and lower limits in dB
Toggle between averaging the time or frequency domains	J	None
Load response data from disk	L	Name of file with data
Set the level of the on-board amplifier for MIC or line inputs	M	Level from 0 to 255
Plot the screen into a .PCX file	P	Name of file to contain PCX data
Specify the width of pulses to send. Also used to change pulse type	p	Square pulse width (+ve values) or Sin(x)/x pulse width (-ve values)
Quit AIRR	Q	None
Toggle pulse generation on or off	R	None
Toggle the subtraction of the previously measured frequency response from the current response on or off	S	None
Set the sample length	s	Power of 2 in the range 4 to 12 (giving sample lengths from 16 to 4,096)
Change the title	T	New title
Show the AIRR version number	V	None
Specify the cut points in the time domain plot	W	Upper and lower cut point positions, in milliseconds
Toggle the waterfall plot off and on	w	None
Select the number of FFTs to cover the waterfall plot	Z	Number in range 2 to 100
Select the time duration of the waterfall plot	z	Time in milliseconds

begins its journey through the electronic components on the sound card, and then into the attached audio components under test.

Two possibilities exist: either the component under test is a loudspeaker and associated amplifier, or it is the amplifier itself. In the former case, the pulse travels through the amplifier circuitry, is reproduced as sound by the loudspeaker system, and then converted back to an electrical signal by the microphone, and fed back into the sound card via the line-in socket. *Figure 2* shows the standard setup for connecting the various components.

### SIGNAL PROCESSING

The pulse that is picked up by the sound card is digitized into a series of 8-bit voltage levels. (The 8-bit mode is used in the current version for simplicity; my next version will benefit from 16-bit mode, although the increase in the resolution on the *magnitude* of the signal that this affords will not significantly affect the results.)

As already mentioned, the *number* of digitizations that are taken of the incoming signal and the *rate* at which they are gathered determine the lowest and highest frequency components that may be resolved. For example, if the sample rate is 20,000 digitizations per second, and 1,024 are taken, then we have a "window" on the arriving pulse that is about 1/20 of a second long, and so we can in principle resolve frequencies down to 40Hz.

In AIRR, you may select the number of digitizations that are taken to make up the window on the incoming pulse, with the

restriction that this number is a power of two. This limitation simply arises from the number of data points that may be passed as a sample to the FFT. By default, AIRR uses blocks of 512, but offers a choice ranging between 16 to 4,096 in powers of two. The smaller the number of data points in the window, the quicker the data is collected, and the faster the turnaround occurs. Larger sample sizes afford lower frequency measurements.

Each sample block of N digitizations is passed through the FFT, which decomposes it into a set of amplitudes in N/2 bins of frequency. "Cuts" may be placed on the incoming signal, so that effectively only a portion of it is transformed. The amplitudes of the signal outside the cut limits are set to the quiescent value. By default, the cut lines are at  $T=0.0$  and  $T=(\text{Sample Length})/(\text{Sample Rate})$ , so the whole sample is within the cut.

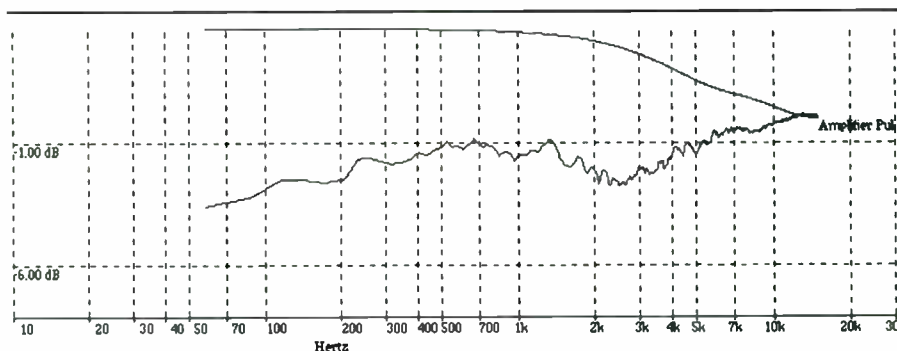

FIGURE 5: The smooth curve shows the response of the amplifier to the input pulse; the wobbly line is the response of the loudspeaker/amplifier combination, corrected by this curve.

*Figure 3* shows the AIRR results for a signal arriving at the microphone input. Just before the pulse, an excursion from the quiescent level of the signal can be observed. This is due to crosstalk between the ADC and DAC signal paths on the sound card: it is the pickup of the outgoing pulse generated by the ADC, and is an ideal candidate for cutting with the cut lines. In this case you might specify a lower cut position at 1.0ms.

The upper cut line is for excluding the part of the sample starting from the first of the small pulses (such as wall reflections) that appear at the microphone. Making this upper cut allows AIRR to measure the anechoic response of the components under test. Without the upper cut, AIRR measures the so-called "in-room" response.

### WATERFALLS

The waterfall plot is useful for observing the spectral response of the system under test as a function of time. It can show unwanted acoustic resonances in loudspeaker cabinets, for example. The waterfall plot is generated by taking the FFT of the whole time domain sample, then the whole sample after  $\Delta T$  seconds have elapsed, then after twice  $\Delta T$  seconds, and so on. Then the set of FFTs is plotted on a pseudo-3D plot with time along the z-axis. Waterfall plots have already been covered in *SB* (Bill Waslo, "Letters," reply to P.P.N Thompson, *SB* 1/94, p. 66).

AIRR offers a waterfall plot option that lets you specify the length of time the z-axis should span and the corresponding number of FFTs that should be taken over this time. The time is counted from the lower cut position, or zero, whichever is larger. The program defaults to plot 30 FFTs evenly spaced over 5ms. *Figure 4* shows the waterfall plot generated by AIRR for a loudspeaker system.

The disadvantage of the waterfall plot is the time it takes to calculate and display. Normally, you will only invoke the waterfall plot option once a satisfactory standard response plot has been obtained by averaging over many sound samples.



# SOUND PERFORMANCE.

## Brought to You by Speaker Materials of DuPont KAPTON®.

Everything — from Louis Armstrong to Led Zeppelin — sounds better coming out of loudspeakers designed with DuPont KAPTON. A truly sensational speaker material, KAPTON improves acoustics and stands up to high wattages and harsh environments better than any other.

You've probably heard about the success of KAPTON in voice coils...and now it's available for other speaker parts, too.

Precision-formed parts of KAPTON exhibit a high stiffness-to-weight ratio — better than conventional speaker materials.

Voice coils of KAPTON are non-conductive and non-magnetic, with a broader frequency response than aluminum in both high and low

ranges. No matter where it's found in the speaker, KAPTON enhances acoustical performance.



SPIDERS OF KAPTON

And unlike aluminum and paper, KAPTON resists heat damage to glue joints. It stays cool and dry when the power, heat and humidity are turned up. So not only do your speakers generate better sound — even under environmental extremes — they last longer, too.

Available as flat film for voice coils or as precision-formed spiders, cones, surrounds and domes, KAPTON is extremely lightweight and stiff. And it won't dent,

tear or crease, for added durability and easier speaker manufacturing.

### Sound Good?

Want to hear more about how KAPTON can improve the acoustics and durability of speakers you design? Just call 1-800-356-6714.

We'll put you in touch with our applications engineers. We'll also send you sample film and technical information on designing speakers using KAPTON parts. We're sure that once you evaluate DuPont KAPTON for yourself, you'll be impressed with its sound performance.



CONES OF KAPTON



DOMES OF KAPTON





## SUBTRACTING RESPONSE PLOTS

When measuring loudspeaker response, it is important to understand the extent the signal is being distorted before arriving at the loudspeaker. To do this, you need to measure the response of the system up to, but not including, the loudspeaker. Then you subtract that response curve from the response curve obtained for the whole system, loudspeaker included. This leaves the desired curve (which, however, is still affected by any non-linear response due to the microphone).

The current response curve being measured can be adjusted in this way in AIRR. To correct for amplifier response, you first measure the amplifier response using the "line-in" source, then swap to measuring the response using the microphone, and then select the subtraction option, "S." Figure 5 shows the result of subtracting an amplifier response curve from the loudspeaker curve in this way.

## STORING SPECTRA ON DISK

Frequency response data may be stored on disk as ASCII text, which can then either be read back into AIRR at a later date or imported into another tool such as a spreadsheet. When a saved response curve is read back into AIRR, it appears in gray on the same axes as the current frequency response plot, so you can easily see the difference. If the data has been stored in the file at a different resolution (sample length) than currently in use, then the program performs either interpolation between existing data points or removal of excess data points.

The restored data may be subtracted from the current data if desired. This is useful, for example, if you have a set of data points that describe the response of the microphone being used. By keeping the data in a file you can, while measuring a loudspeaker response curve, load the microphone response and then subtract it from the curve.

## MODIFYING PULSE SHAPE

The program offers a choice of two kinds of pulse—square or following  $\sin(x)/x$  behavior. AIRR's default is a square-wave pulse of the shortest possible duration, in this case, the time to send the DAC high then low with two sequential high-level language instructions at maximum speed. In practice, this works out to be slightly faster than reading a sample (which also requires two sequential instructions, but to the ADC instead).

## ACKNOWLEDGEMENTS

I am indebted to the staff from Creative Labs who answered some of my questions on CompuServe (GO CREATIVE) and provided the information I needed to program the SoundBlaster. In addition, I'd like to thank Ken Morse, a fellow CompuServe member with whom I bartered FFT code in exchange for an invaluable list of SoundBlaster command bytes.

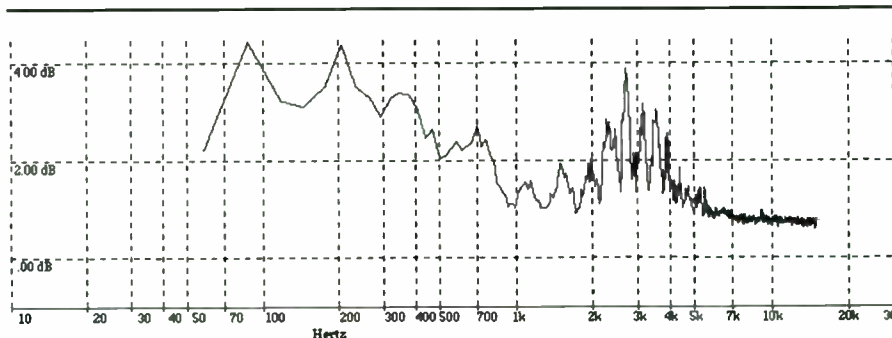

FIGURE 6: Frequency response for a loudspeaker system as measured using the microphone supplied with the SoundBlaster board.

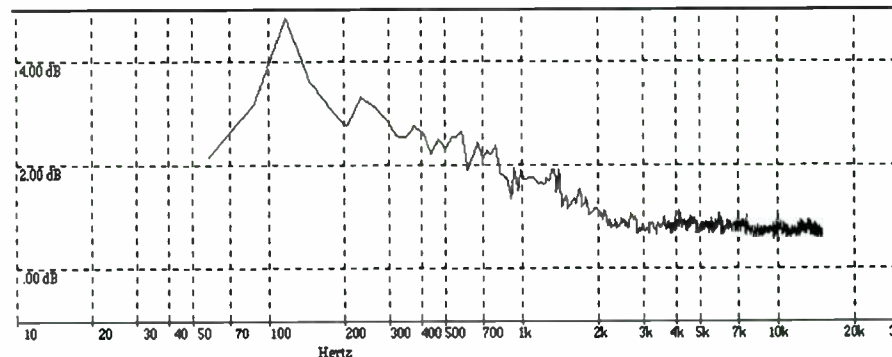

FIGURE 7: The response as measured using the Yamaha MM-110 microphone, for the same loudspeaker system.

Measurements indicate that the pulse duration obtained in this way is around two-thirds of the duration to read one ADC digitizing. To increase the width of the pulse sent by AIRR, press "p," then enter a number, N, which is used as a multiplier. The effect is to send the DAC to a preset level, the same level to the DAC N-1 times, then a zero level.

If you are unsure what the response of a distortion-free audio component would be to a wide pulse of this sort, then you can see by requesting AIRR to "send" the pulse directly to the FFT. This is achieved using "F" for artificial feed. As the width of the pulse sent increases, the first pole of the frequency response decreases in frequency. By experimenting with pulses of various widths, you will observe that the shape of the frequency response curve is that of  $\sin(x)/x$ .

For pulse widths equal to the sample length itself, the  $\sin(x)/x$  curve is very apparent. It turns out that the inverse FFT of a  $\sin(x)/x$  signal is just a band-limited flat spectrum. This is the result of  $\sin(x)/x$  pulses in telephony, where guaranteed bandwidth of digital signals is crucial.

AIRR's  $\sin(x)/x$  pulse form causes a suitable set of levels to be sent to the DAC on the card. Due to the way the current version of AIRR works, and as with wide square pulses, the time for the first DAC-generated voltage excursion to travel through the system and be picked up by the ADC must be greater than the time to send the whole pulse shape to the DAC. Otherwise, the digitiza-

tion of the signal will start too late to pick up the pulse start. This can be avoided by suitably reducing the width of the pulse.

## MICROPHONE ISSUES

Microphone response clearly plays a crucial role in the accuracy of the spectra obtained using AIRR. A poor microphone (one with an uneven response over the range of frequencies to be measured) is useless for making measurements. You usually end up measuring the response curve of the microphone itself! The microphone packaged with my SoundBlaster board bears the inscription "CT329" and, just beneath, "Impedance 600Ω." No other documentation accompanied it.

Using a microphone of accurately known characteristics, such as the Mitey Mike, is clearly more advantageous. In this case, every spectrum obtained with AIRR using the Mitey Mike could be corrected on a point-by-point basis using a software lookup table. The best solution would, of course, be to measure the response of the microphone directly, using AIRR. I confess to having no idea how this might be achieved.

My Yamaha EQ-500 graphic equalizer came with a microphone for measuring and correcting in-room response (using a pink

This program is available as SOF-AIR1B36 for \$49.95 plus \$3 shipping in the USA from Old Colony Sound Lab, PO Box 243, Dept. B94, Peterborough, NH 03458.

# ZALYTRON

YOUR ONE STOP SHOPPING CENTER

FOTAL

VIETA

Cabasse  
LA REFERENCE EN HAUTE FIDELITE



seas

morel

ZALYTRON  
CUSTOM WOOFERS



PHILIPS



Polydax  
speaker corporation

l'atelier audio  
F A N A S E

ACCUTON

**THE ULTIMATE SYSTEMS CONTINUE!!**



CABASSE  
SUPER A-3 PARTS  
**\$2115**  
CABINETS **\$999**

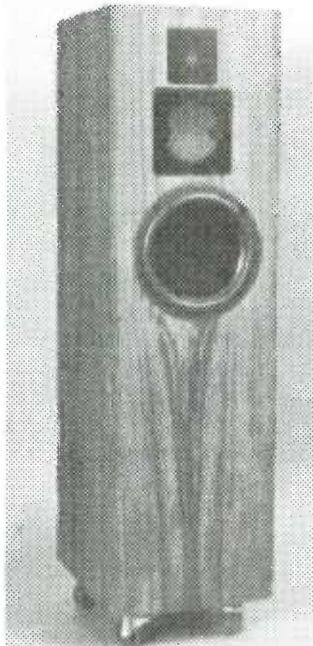

CABASSE  
A-3 PARTS  
**\$1230**  
CABINETS **\$799**

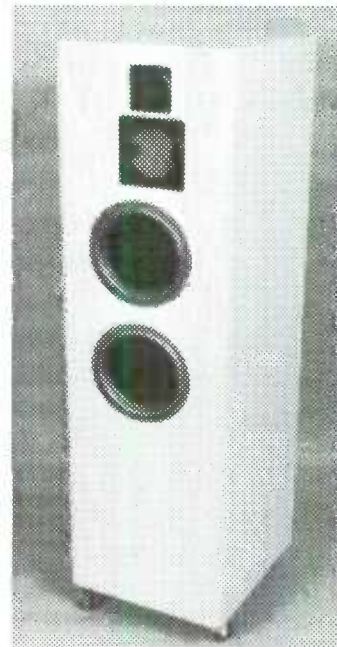

CABASSE  
A-3 PLUS PARTS  
**\$1650**  
CABINETS **\$999**

**ZALYTRON INDUSTRIES CORP.**

**469 JERICHO TURNPIKE, MINEOLA, N.Y. 11501**

**TEL. (516) 747-3515**

**FAX (516) 294-1943**

Our warehouse is open for pick-up 10AM to 6 PM daily, Monday thru Saturday  
UPS orders shipped same day • Minimum order \$50.00

**WRITE OR CALL FOR ALL YOUR SPEAKER NEEDS OR INQUIRIES**



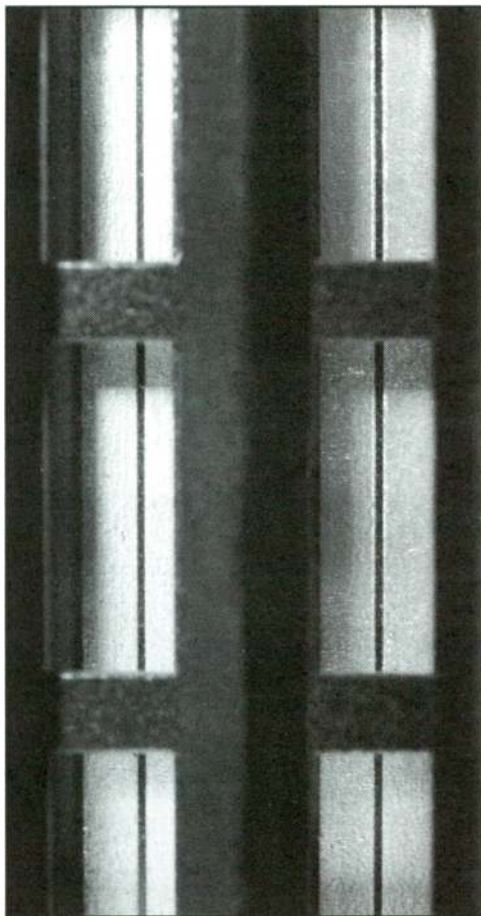

# ACCULINE

## PLANAR LINE SOURCE



Model 2.8  
Dipole Transducer  
 $\pm 3\text{dB}$  120Hz to 19KHz  
2 ohms resistive  
87dB/1W/1M  
Power handling:  
200W RMS  
Size:  
28 $\frac{1}{4}$ H x 4 $\frac{1}{8}$ W x 1 $\frac{3}{16}$ D

**Breathtakingly transparent.  
Very wide dynamic  
range.**

\$499/pr. Introductory price  
Dealer inquiries invited

(702) 832-5402 • FAX (702) 832-5407  
P.O. Box 8888 • Incline Village, NV 89452

A DIVISION OF  
**BOHLENDER GRÆBENER**  
CORPORATION

Reader Service #57

noise generator). This microphone appears to be of good quality and is labelled "Electret Condenser Microphone MM-110." It is powered by a single AA-size battery. By using it instead of the SoundBlaster microphone to make some comparative measurements of a loudspeaker, I obtained the spectra shown in Figs. 6 and 7. (These spectra were for frequency averaged pink noise.) As you can see, there are significant differences!

### ELECTRONICS QUALITY

Apart from the microphone, another aspect of the AIRR system which might introduce nonlinearities into the measurements is the quality of the electronics on the sound card itself. The frequency response of the on-board amplifiers, mixers, DAC, and ADC are all important.

Without professional-grade equipment to measure the response, I looked up a recent review of 24 sound cards published in *PC* magazine.<sup>1</sup> The review lists the recording and playback frequency response of each card. Both of the Creative Labs SoundBlaster cards showed a frequency response flat to within 1dB from 100Hz up to 20kHz. Signal-to-noise (S/N) ratios were in the region of 70dB, and total harmonic distortion (THD) around 0.75%. Incidentally, one of the SoundBlaster cards (Basic Edition) was awarded Editor's Choice.

### CONCLUSION

The latest generation of sound cards for the PC offers you a sophisticated tool with which to develop audio signal processing software. The AIRR program profits from the programming interface to a SoundBlaster card by implementing a spectral analysis function with fast Fourier transforms.

The current version of AIRR supports many functions (Table 1), but the scope for improvement to the initial design of AIRR is considerable. My "to-do" list includes optimizing the execution speed, using DMA transfers rather than direct access commands, including phase response plots, and implementing a choice between the existing square and  $\sin(x)/x$  pulses, MLS (à la IMP) and pink and white noise as the stimuli.

*[Although Creative Labs' SoundBlaster card is popular, in its minimal forms it supports only a single brand of CD-ROM drive, its own. If you own a popular brand of CD-ROM, you will need to keep its interface card in your computer, in addition to the SoundBlaster card. If you buy SoundBlaster's more expensive "multi-CD" card, you can save a computer slot. MediaVision's 16-bit card is SoundBlaster-compatible—Ed.]*

### REFERENCES

1. John R. Quinn, "Big Audio Dynamite," *PC Magazine*, Vol. 13 No. 7, April 1994.

Reader Service #5



C-101 Series III Equalizer/Analyzer

## Measure, Analyze & Equalize

- **10 band Real Time Spectrum Analyzer & Calibrated Microphone:** allows accurate analysis of listening room using built in digital pink noise generator
- **Integral trificated sliders:** provides highest levels of reliability for equalizer sliders
- **High-speed, low noise op-amps:** advanced components for improved sound quality
- **Digital audio switching:** provides shorter signal paths for better noise rejection
- **Sharp 18dB/octave subsonic filter:** removes power wasting, speaker damaging subsonic frequencies
- **Fully regulated power supplies:** maintains constant power levels for consistent performance and lower distortion
- **Made in USA with a 5 year parts & labor warranty**

**AudioControl**<sup>®</sup>  
making good stereo sound better.

Electronic Engineering & Mfg., Inc.  
22410 70th Avenue West • Mountlake Terrace, WA 98043 • 206-775-8461 • Fax 206-778-3166  
SHIPMENT TO FORMER SOVIET BLOCK NATIONS NOW PERMITTED.

# We'll tell you no lies...



## Titan Powered Subwoofer

The most reasonably priced, high-performance powered subwoofer available today. Titan's dynamic range and clarity improves any stereo or home theater system.

- \* Flat response from 20-150Hz,  $\pm 3$ db
- \* Adjustable crossover frequency of 50-150Hz 12 db/octave
- \* Amplifier delivers 250 watts RMS with less than .5% distortion
- \* Long Excursion Proprietary 12" woofer
- \* Current sensing feedback reduces distortion; prevents driver damage
- \* Protection circuit senses and limits excessive input levels
- \* Height: 26 1/2", Width: 13 1/2", Depth: 15 1/2"

(plus shipping and handling, and 5% sales tax in WI only.) Call for finish availabilities.

**ACI (Audio Concepts, Inc.)**

**901 South Fourth Street, La Crosse, WI 54601 (608) 784-4579 Fax (608) 784-6367**

*Reader Service #6*



# RESURRECTING A PAIR OF AR2AXs

By Hilary Paprocki

I wouldn't want a Porsche. Honest. If you gave me one, I'd sell it today. The incremental value at those price levels is meaningless, compared to what you could do with the money. You could fly a plane. You could knock down a slum building and plant trees. You could bum the world for a year. If it's a car I need, show me an early Pinto with a 350 engine and we can talk.

With this kind of attitude, you can imagine that I get a kick out of finding old speakers at garage sales and determining what kind of performance can be squeezed from them. Last summer's big find was a usable table saw and a pair of Acoustic Research 2ax speakers, all for \$75.

## A HIP COMPANY

Younger readers should know about Acoustic Research. The company gets credit for inventing and commercializing sealed-box loud-speaker systems at the beginning of the '50s. At that time, a normal hi-fi speaker occupied about a cubic yard or more. And even at that size, the bass didn't really go very low. When the tiny AR-1 woofer system was introduced, at about 1.5 ft<sup>3</sup>, it changed the world.

AR was one of the first successful companies in hi-fi history to fine-tune their products primarily by ear. This caused their products to stand out from the norm in all kinds of ways. When everyone else was using electrolytic capacitors in their crossovers, AR used special film caps. The midrange driver's low-pass filter was a slice of fiberglass wool in front of the cone. The company provided extra wire terminals for biampifying.

When other companies advertised frequency-response curves, AR was holding live-versus-recorded demonstrations. We're talking 40 years ago here. AR was a very, very hip company, and led to what we now call the high-end in methods and philosophies.

## HI-FI HOT ROD

As a result of my restoration project, the AR2ax speakers are making very acceptable sounds in my bedroom right now. If you enjoy building hi-fi hot rods, these classic speakers make a fine project. In case you encounter a pair of boxes you'd like to play with, I'd like to share with you some of my

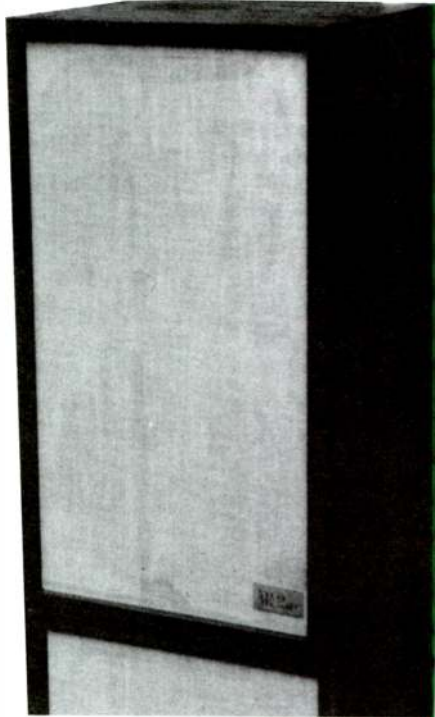

PHOTO 1: One of the treasures the author uncovered on the garage sale circuit last year was this AR2ax speaker.

observations during the restoration, in a list, in no particular order.

1. The woofers had foam suspensions, and as you can imagine, the 25-year-old foam was crumbling. The drivers can be refoamed, which means that the suspensions can be replaced. Pro-Cone in Rochester (716-328-9770) did an amazing job with mine. You can't tell that the speakers aren't brand new.

2. My pair included one blown tweeter, but what seems like a blown tweeter in yours might just be a bad level control. The AR2ax has controls on both the tweeter and midrange drivers. The control contacts often corrode. Use the remaining good controls to find the right tonal balance, measure the resistances among the three pot terminals, and replace the controls with good 5W fixed resistors.

While you're soldering, notice that when you replace the tweeter and midrange level pots with resistors, you end up with one resistor across each driver, and then one resistor in series with that combination, going to the input terminals. There's no reason not to locate these resistors up by the drivers. That way, when you perform final tuning, you don't need to repeatedly haul all that fiberglass in and out of the cabinets. Just pop out

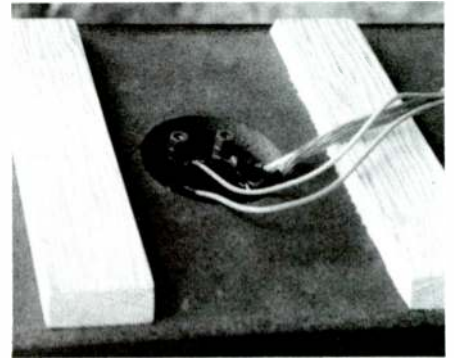

PHOTO 2: The speaker back panel showing the biwiring and the "minimum-effort, minimum-intrusion" braces.

the midrange or tweeter, and its level-control resistors will be right there (*Fig. 1*).

Of course, if you don't mind the exposed clutter, you can just build the crossovers outside the box. There are sonic advantages to doing it this way. Some crossover components are microphonic and really shouldn't be in the box.

3. If your blown tweeter really is, then you'll need to perform a quick repair. The old capacitors may short or change value. If this allows low frequencies into the tweeters, they'll pop. To be safe, replace the original capacitors with good Mylar® (or fancier) new ones. I used Mylar with 0.1µF polypropylene bypasses in parallel, because that's what I had lying around.

4. And while you're at that, you can give the speaker a faster, more agile, more detailed sound by lowering the woofer/midrange crossover frequency just a tiny bit. What was good sound according to '50s' standards is considered sluggish and slow today.

Add 1µF to the original 6µF midrange capacitor value, and five turns of wire to the woofer's crossover inductor coil. It's easy to do, even with the coil inside the box. Just use some 18GA enameled wire. Feed the AR inductor wire (the end that went to the woofer) back through the hole in the flange of the bobbin so it's free, and solder on a length of new wire. As you add the five turns, pull the wire so that it is good and tight and bring the new wire through the flange hole and up so you can solder it right to the woofer terminal (*Fig. 2*). This will decrease your midrange

# Madisound Stocking Stuffers

QTY	Description	Price
600	<b>Sreco 1 ohm 50 watt</b> 5% sand cast wire wound <b>resistor</b> , 19 x 19 x 91mm	\$0.90
150	<b>Sreco 5.4 ohm 25 watt</b> 10% sand cast wire wound <b>resistor</b> , 12 x 13 x 64mm	\$0.40
1100	<b>Sreco 10 ohm 25 watt</b> 10% sand cast wire wound <b>resistor</b> , 12 x 13 x 64mm	\$0.40
11,000	<b>Mallory 1.33 mfd Mylar</b> capacitor, axial, 10%, 250V, 10 x 25mm, 43mm leads	10 / \$2.00
6,000	<b>Siemens 2.2 mfd mylar</b> cap., 5%, 250V, 20 x 10 x 31mm, PC mount	10 / \$3.00
3,600	<b>Midwec 3.0 mfd mylar</b> cap., axial, 20%, 400V, 19 x 15 x 45mm, 48mm leads	10 / \$5.00
2,400	<b>KSC 4 mfd electrolytic</b> cap., 10%, 100V, axial, 10 Ø x 19mm, 52mm leads	10 / \$1.50
750	<b>West-cap 4.6 mfd mylar</b> cap., axial, 10%, 450V, 18 Ø x 45mm, 57mm leads	\$0.90
2,000	<b>Marcap 6.8 mfd mylar</b> cap, 10%, 100V, dipped, 15 x 29 x 27mm, 34mm lead	\$1.00
16,000	<b>Matsushita 10 mfd mylar</b> , 10%, 100V, dipped, 14 x 24 x 30mm, 34mm leads	\$1.20
170	<b>Solen 60 mfd poly.</b> cap., 250VAC/400VDC, 5%, 44 Ø x 70mm, 50mm leads	\$10.00
3,000	<b>Tecate 600 mfd electrolytic</b> , 100V, 10%, radial, 25 Ø x 50mm, 25&37mm lead	\$2.00
450	<b>Tecate 1300 mfd electrolytic</b> , 100V, 5%, axial, 30 Ø x 70mm, 42mm leads	\$4.00
3,000	<b>D-cup input terminal</b> , All brass gold plated posts, 3-way, 4 1/8" Ø , 3" Ø hole	\$3.50
300	<b>Audax DW6x11M</b> 8 ohm <b>tweeter</b> , 14mm poly dome, 96dB, 45W, 6 x 11 cm	\$6.00
220	<b>Audax TW74Ti</b> 8Ω, 10mm titanium dome <b>tweeter</b> , 90dB, 25W, Fs 3K, 74mmØ	\$6.00
400	<b>Peerless 1730 2"</b> cone <b>tweeter</b> , 8Ω, 88.5dB, 100W, Fs 1.5K, 62mm sq.	\$7.00
140	<b>Philips AD163 1"</b> textile dome <b>tweeter</b> , 8Ω, Fs 1.3K, 50W, 92dB, 92 x 80mm	\$10.00
160	<b>Peerless 1546 1"</b> textile dome <b>tweeter</b> , 8Ω, 92dB, 100W, Fs 1K, 100mm Ø	\$13.00
50	<b>Focal T90Ti 1"</b> titanium dome tweeter, 8Ω, 92.5dB, Fs 800Hz, 75W, 92mm sq.	\$39.00
16	<b>Focal 4V111 4"</b> Polyglass <b>midrange</b> , 88.5 dB, Fs 70.4Hz, Vas 5.1ltrs, Qts .32, 75W, F3 160Hz in 1.3 ltrs sealed, smooth to 11KHz, cast frame 110mm sq.	\$50.00
474	<b>Audax IN130W0 5.25"</b> Carbon fiber autosound <b>woofer</b> , 4W, 90dB, Fs 69Hz, Qts 0.82, Vas 9.1 ltrs, F3 of 60 - 70Hz in 10 - 60 ltrs sealed, 126mm round frame with dog ears, mounting holes Ø from 130 to 147mm, Depth 52mm	\$15.00
33	<b>Davis 13KLV5A 5.25"</b> <b>woofer</b> 8Ω, Kevlar cone, 87.5dB, Fs 56Hz, Vas 8 ltrs, Qts .37, X-max 4mm, 50W, F3 106 in 3 ltrs sealed, 65Hz in 5.5 ltrs vented	\$42.00
20	<b>Focal 6K412L 6"</b> <b>woofer</b> 8Ω, Kevlar cone, 90.5 dB, Fs 43Hz, Vas 26.9 ltrs, Qts .322, Xmax 4mm, F3 95Hz in 7 ltrs sealed, 65Hz in 11 ltrs vented, 165mmØ	\$85.00
10	<b>LPG 160CWD 6.5"</b> poly cone autosound <b>woofer</b> 4W, 88dB, Fs 48Hz, 100W, Vas 14 ltrs, Qts 0.29, F3 70Hz in 6 ltrs vented, cast frame 186mm Ø	\$48.00
20	<b>Davis 17KLV6A 6"</b> Kevlar cone <b>woofer</b> 8Ω, 90dB, Fs 42.4Hz, Vas 36 ltrs, Qts .39, Xmax 3.5mm, F3 75Hz sealed, F3 45Hz vented, cast frame	\$50.00
155	<b>Dynaudio 19W38 4Ω</b> Poly cone <b>woofer</b> , 89dB, Fs 46Hz, Vas 17.6 ltrs, Qts .37, X-max 3mm, Maximum excursion 13mm, 70W, 1.5" VC, F3 of 88 Hz in 7 ltrs sealed, F3 of 54Hz in 11 ltrs vented, smooth to 5KHz, special purchase.	\$55.00
16	<b>Davis 20KLV8A 8"</b> Kevlar cone <b>woofer</b> 8Ω, 92.1dB, Fs 38.5Hz, Vas 82 ltrs, Qts 0.38, F3 70Hz in 34ltrs sealed, F3 43Hz in 60 ltrs vented, cast frame.	\$80.00
12	<b>Davis 20SCA8 8"</b> Carbon Fiber cone <b>woofer</b> 8Ω, 93dB, Fs 41.4Hz, Vas 65 ltrs, Qts 0.3, F3 95Hz in 14 ltrs sealed, F3 60Hz in 22 ltrs vented, cast frame, smooth	\$85.00
16	<b>Focal 8K516</b> Kevlar cone <b>woofer</b> , 8Ω, 90.5dB, Fs 34Hz, Vas 58.7 ltrs, Qts 0.3, F3 60Hz in 21 ltrs sealed, F3 40Hz in 35 ltrs vented, cast frame 210mm sq.	\$115.00
23	<b>Dynaudio 24W75XL</b> poly cone <b>woofer</b> 4Ω, 90dB, Fs 32Hz, Vas 92.4 ltrs, Qts 0.46, F3 48Hz in 70 ltrs sealed, F3 30Hz in 90 ltrs vented, 3" Ø Voice coil	\$75.00

**NOTE !!! one cubic foot = 28.3 liters = 1728 cubic inches; 25.4mm = 2.54cm = 1inch - Expires 2/28/95**

Ordering Information: All speaker orders will be shipped promptly, if possible by UPS. COD requires a 25% prepayment, and personal checks must clear before shipment. Add 10% for shipping, residents of Alaska, Canada and Hawaii, and those who require Blue Label air service, please add 25%. There is no fee for packaging or handling, and we will refund to the exact shipping charge. We accept Mastercard or Visa on mail or phone orders.



**Madisound Speaker Components**  
 (8608 University Green)  
 P.O. Box 44283  
 Madison, WI 53744-4283 U.S.A  
 Voice: 608-831-3433  
 Fax: 608-831-3771



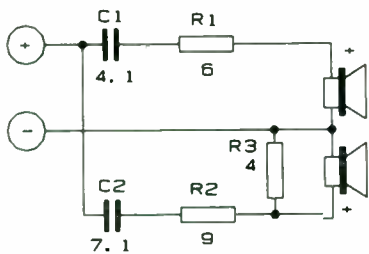

FIGURE 1: Schematic of the author's speaker system, after replacing the pots.

driver's power handling capacity, but unless you routinely blow speakers, don't worry about it. Mine are still fine.

Incidentally, it's amazing how sensitive this adjustment is. Only three turns add a woofy boom to many recorded voices (especially Louis Prima, and you certainly don't want to shortchange him). At six turns you begin to move toward an artificially detailed hi-fi-microscope sound. If you're dealing with these kinds of sonic qualities in your homemade system, try tinkering with turn counts on the woofer inductor.

For reference, I made these observations with a quad-regulated Dynaco Stereo 70 amplifier with a mostly stock circuit and GE 6CA7s. I know they're not hip tubes, but I was going for durability.

5. I bought a new AR tweeter to replace the blown one in my pair. It cost a million dollars, and the remaining old one failed soon after. Maybe the tweeters deteriorate over time too. Maybe you should consider buying new modern tweeters from one of the *Speaker Builder* advertisers.

I sent letters to several of them asking what would be a good replacement for the tweeters in this particular three-way speaker. One company sent a scrawl that I couldn't read. Another company sent a stack of photocopied pages that must have cost a fortune, but didn't recommend any of the products described. Another company recommended a midrange driver. I recommend you don't bother asking. Just find out what one of the similar good commercial systems uses, and get those.

6. You *will* use solder joints instead of slip-on terminals for all the drivers and components, won't you? Use nice wire inside the boxes, too, such as the solid 18GA pure cop-

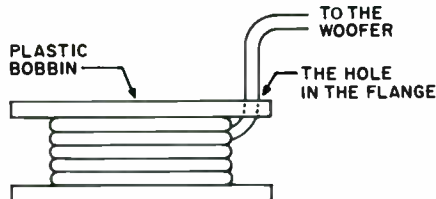
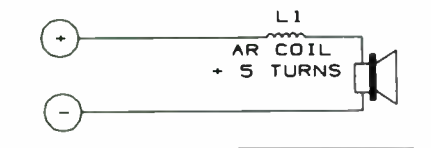

FIGURE 2: The AR woofer inductor.



per hookup wire at Radio Shack or the enameled stuff you bought for the crossover.

7. Notice also that the high-frequency and midrange speakers are out of phase with the woofer as the speaker was originally built. That did produce a nice simulated depth in the sound, but if you switch them around so they're back in phase, you can achieve surprisingly accurate instrumental tones.

8. Of course, you may wish to experiment with this. Since you won't be using the level controls, you now have more than enough holes in the terminal board to mount two pairs of binding posts—one pair for the woofer and one isolated pair for the mid-tweet bank. This lets you switch around the mid-high phase relative to the woofer, plus you can now use separate amplifier cables for the woofer and the mid-tweet, individually chosen for their respective relevant qualities.

9. I'm using some old Monster Cable for the woofer and two runs of Belden 1242A telephone wire (one four-wire cable hot, one four-wire cable common) for the uppers, crimped together into one pair of spade lugs where they meet the amp.

Imagine a fancy speaker cable consisting of eight strands of 99.9999% pure copper, each strand individually insulated in a special low-dielectric absorption polyethylene material. Sound like nine bucks a foot? Spend nine cents and get 1242A.

10. Don't forget to put a little epoxy on the terminal posts when you mount them on the terminal plate to keep them from spinning when you tighten the speaker cable ends onto them.

11. And while you're in there, why not brace the cabinet? I used two 3/8" x 1" ribs across the baffle inside, glued on edge between the woofer and the mid-tweet holes. Cutting another baffle board to double-thick the original is even better, if you're not going to use the grilles. The heavier the baffle the better. On the back, I added two 3" x 3/4" fir ribs flat to the outside. With beveled ends, they aren't visible from the front. Don't stuff the box full of wood; you need air in there (Fig. 3).

12. The blue temporary gasket silicon sold by the auto parts store (Permatex or Prime Seal) makes a great sealer for the drivers when you mount them to the baffle.

13. This is wacky, but it works: buy some rubber cement and a bag of cotton balls at your local drugstore. Arrange the cotton balls in a circle on the tweeter and midrange

mounting plates and rubber-cement the balls in place. This prevents uncontrolled diffraction and does wonders for the focus and smoothness of your sound. They'll come off easily if you don't like them (Fig. 4).

14. The cabinet finish should not be a big deal, unless you found a pair in fabulous '50s limed oak. If that's the case, preserve them as well as you can. I suggest you avoid silicone polishes, which in the long term can have regrettable effects.

If your boxes are the usual oiled walnut, sand 'em down with 120, then 220, in a sanding block. If some scratches remain, ignore them. Oil the veneer with linseed oil, thinned with turpentine, on a pad of fine steel wool. The old-timers suggest that you oil wood every day for a week, every week for a month, and every month for a year. Just make sure the oil is well-thinned, and keep the steel wool hairs way away from the drivers.

15. Concrete blocks are okay for stands, but fix them so they don't rock. A cheap masonry bit will zoom right through a cinderblock, allowing you to install plastic anchors and lag screws to act as feet—three top and three bottom (tripods, as you know, don't rock). Watch out for scratching your wood, though. You could use the holes to install unfinished wood drawer knobs, which work fine and won't mar hard floors.

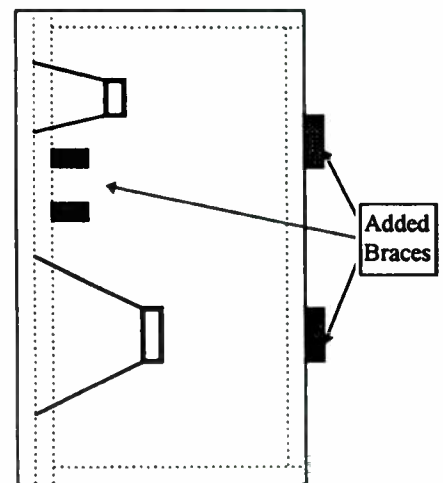

FIGURE 3: Bracing the inside and back of the cabinet.

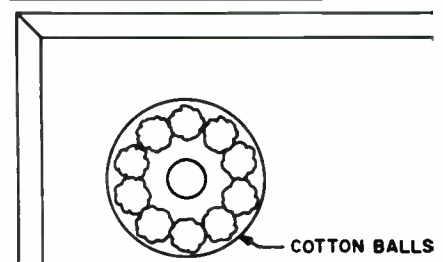
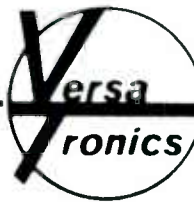

FIGURE 4: According to the author, adding cotton balls to the tweeter and midrange can improve the sound of your system.



# VERSA-TRONICS INC.

P.O. BOX 87, AMHERST, NH 03031 • 603-883-1960 • FAX 603-886-1592

## NEW SHIELDED SPEAKERS

• HOME THEATER • MULTIMEDIA •



**4"**  
**DOB100R-PP/8SC**

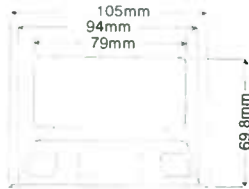

**6 1/2"**  
**DOB165R-PP/8SC**

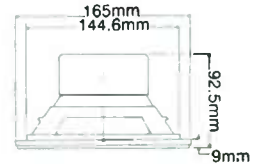

GENERAL INFORMATION			
Impedance	Z	8.0	Ohms
D.C. Resistance	Rdc	6.3	Ohms
Resonance Freq.	Fs	65.0	Hz
Characteristic			
Efficiency Level	SPL	85.0	dB1W/1M
Power Handling		60.0	*W
Upper Frequency		10,000	Hz
Cone Material		Carbon Fiber Polypropylene	
Surround Material		Rubber	
Total Weight		0.940	Kg
PARAMETERS			
Mechanical Q Factor	Qms	1.88	
Electrical Q Factor	Qes	0.43	
Total Q Factor	Qts	0.35	
Equivalent Volume	Vas	6.3	L
VOICE COIL			
Xmax		2.0	mm
Diameter	d	25.5	mm
Winding Length	h	10.0	mm
Layers	n	2.0	
Former Material		Aluminum	
Height of Gap	hg	6.0	mm
Inductance	L	0.56	mh
MAGNET			
Weight		226+150	Kg
Flux in Gap	0	0.505	mWb
Flux Density	B	1.05	T
Force Factor	BL	4.98	N/A
SUSPENSION			
Moving Mass	Mms	5.73	g
Mechanical Resistance	Rms	1.065	Kg/s
Suspension Compliance	Cms	1.435	mm/N
Emissive Diameter of Diaphragm	D	8.416	cm
Effective Piston Area	Sd	55.63	cm <sup>2</sup>

\*Music Power

GENERAL INFORMATION			
Impedance	Z	8.0	Ohms
D.C. Resistance	Rdc	6.3	Ohms
Resonance Freq.	Fs	36.0	Hz
Characteristic			
Efficiency Level	SPL	86.0	dB1W/1M
Power Handling		80.0	*W
Upper Frequency		6,000	Hz
Cone Material		Carbon Fiber Polypropylene	
Surround Material		Rubber	
Total Weight		1.020	Kg
PARAMETERS			
Mechanical Q Factor	Qms	3.49	
Electrical Q Factor	Qes	0.33	
Total Q Factor	Qts	0.30	
Equivalent Volume	Vas	35.28	L
VOICE COIL			
Xmax		1.75	mm
Diameter	d	25.5	mm
Winding Length	h	9.5	mm
Layers	n	4.0	
Former Material		Aluminum	
Height of Gap	hg	6.0	mm
Inductance	L	1.437	mh
MAGNET			
Weight		226+150	Kg
Flux in Gap	0	0.394	mWb
Flux Density	B	0.82	T
Force Factor	BL	7.44	N/A
SUSPENSION			
Moving Mass	Mms	12.65	g
Mechanical Resistance	Rms	0.834	Kg/s
Suspension Compliance	Cms	1.493	mm/N
Emissive Diameter of Diaphragm	D	12.82	cm
Effective Piston Area	Sd	129.06	cm <sup>2</sup>

\*Music Power

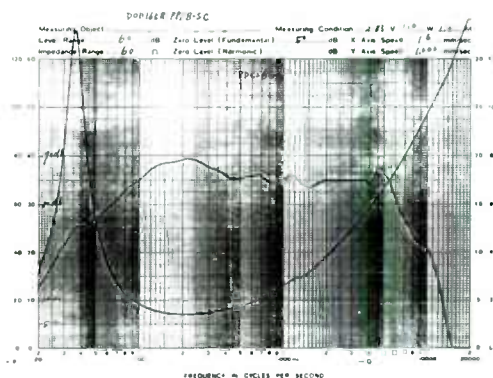
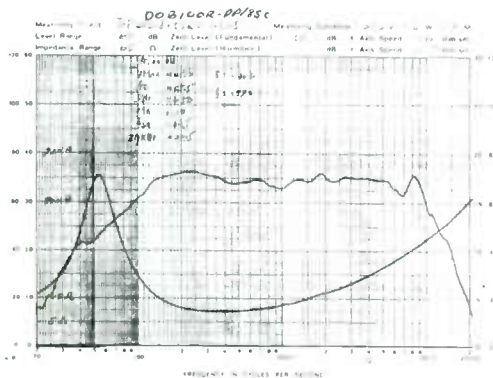

DISTRIBUTED BY

**Speaker City**  
115 S. Victory • Burbank, BA 91502  
Tel. (818) 846-9921 • Fax (818) 846-1109

**The Speaker Works**  
1021 E. Camelback • Phoenix, AZ 85014  
Tel. (602) 230-0344 • Fax (602) 230-8533

**Toutant Electronics**  
246 E. 131st Street • Cleveland, OH 44108  
Tel. (216) 451-6325 • Fax (216) 451-0226



# ROUND THE HORN

By Philip Newell and Keith Holland

Together with higher efficiency and far-field propagation qualities, a horn's generally higher output capability allows it to still play a role in studio monitoring. The debate about horns versus direct radiators for such purposes has continued for decades. Few horns have been developed solely for studio use, thus most studio systems using horns have "borrowed" technology from the worlds of cinema, sound reinforcement, and public address.

At the Institute of Sound and Vibration Research [ISVR] at Southampton University, England, Keith Holland engaged in a five-year study to discover whether there was further potential for the studio use of midrange horns. One of the main objectives was to determine whether some of their less favorable characteristics were a function of horns *per se* or were inherited as aspects of the borrowed nature of the technology.

This article discusses the findings of the above research program, details aspects of horn performance considered undesirable for studio purposes, and separates the individual physical parameters of horn design which give rise to many unwanted acoustic properties. The conclusion attempts to define the limits of horn performance within which the greatest number of unpleasant sonic attributes can be eliminated. The work was based on physical and mathematical analysis of the problems, closely related to a rigorous series of listening tests.

## WHAT HORNS DO

Horn use for public address and cinema loudspeaker applications is almost universally accepted as

*This article first appeared in Studio Sound, March 1994, pp. 59-70, and is reprinted here with kind permission from Spotlight Publications, London.*

good practice. Indeed in many of these instances, no viable alternative exists, since some requirements, such as high electroacoustic efficiency and flexibility of directivity control, are only easily achieved by horns. Changes in music recording techniques have resulted in a tendency towards larger control rooms.

Concurrently, control room acoustic-design philosophy tends towards lower reverberation times, and, in many, true reverberation does not exist at all. In these relatively large and acoustically "dead" control rooms, a borderline case has been reached between studio monitor systems and small public address/sound reinforcement systems. Numerous designers have attempted to develop direct-radiator technology to meet these needs, but the many fine existing systems usually require very high amplifier power, and live much of their working lives

close to their power-handling performance limits.

On the other hand, systems using horn-loaded midrange systems, even in very large control rooms of 60m<sup>2</sup> or more, are rarely driven much beyond 20% of their design power-handling capacity. So they exhibit a long and stable working life, together with lower amplifier power requirements and a good reserve of damage tolerance. Another desirable attribute of horn loudspeakers is their tendency to produce an output in the form of a spherical expanding wave, free of many of the lobing problems of the pistonically derived output from direct radiators.

No one type of drive system claims overall superiority here, since many subjective aspects of performance differ greatly from one listener to another. However, if some of the negative attributes of one system can be detected, isolated, and ultimately circumvented, then it will provide designers of future systems with more options in their quest for optimum design requirements.

## TEST PROGRAM

The basis of the research work was to find links between measurable characteristics of horn performance and perceived subjective sonic characteristics. To reduce some of the tedium and general impracticability of first manufacturing, then setting up experiments to measure each interesting development suggested by the research, a one-parameter computer analysis technique was developed, then rigorously tested against actual measurements of real horns. This technique has already been published,<sup>1,2</sup> together with the development of an acoustic impedance tube measurement system,<sup>3</sup> which made practical the rapid measurements for the physical/numerical cross correlations.

An extensive program of listening tests was carried out over

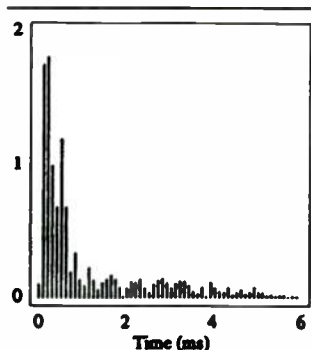

FIGURE 1A: Quad Electrostatic—original type.

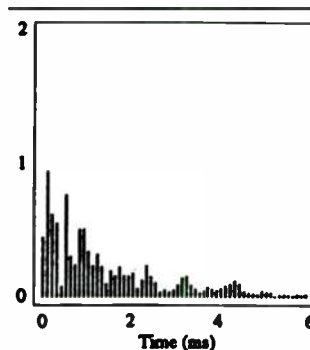

FIGURE 1B: Son Audax PR17-HR100-1AK7 cone midrange driver.

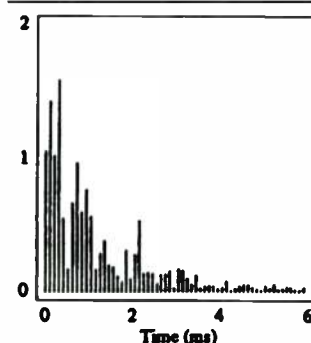

FIGURE 1C: Fostex H351-HA21 horn with Emilar compression driver.

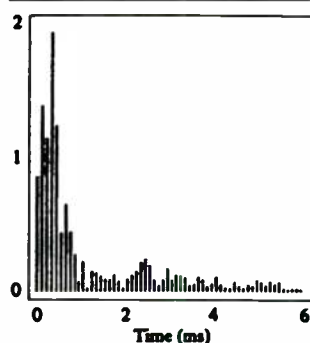

FIGURE 1D: High-frequency section of Tannoy 15" dual concentric.

a six-month period in the large anechoic chamber of the ISVR, and again, a general outline of this procedure has been published.<sup>4</sup> Measurements of nonlinearities, both in the horn flares themselves and in the horn/driver combinations, were cross-referenced with the results of the listening tests, and a finite amplitude model was developed to predict nonlinearities in different flare shapes.<sup>5,6</sup> Cepstral analysis was undertaken to isolate the different horns' discrete reflection patterns not easily discernible from conventional measurement techniques.<sup>7</sup>

Holland compiled the research project into a thesis, for which he received his PhD at Southampton University in December 1992.<sup>8</sup> Since the individual aspects of the research are so well-documented in the references above, this article concentrates on the less widely promulgated aspects of the conclusions.

#### FOUR GROUPS

The listening tests involved over 7,000 comparisons of 20 different drive units and nine different sounds. The drive units consisted of horns of many different flare shapes, moving coil direct radiators, and an electrostatic. The nine sounds were essentially nonmusical, but contained different combinations of transient and steady-state or tonal content. They were band-limited 1–6kHz on playback, to avoid problems solely due to horn cutoff or other out-of-band anomalies.

It was hoped that the different combinations would help to isolate any "horn sound" which the units may possess. The initial question was whether all the horns would group together, either on some of the sounds or on all of them. After the results had been numerically, statistically, and "common sense" analyzed, there were groupings, but not in ways which had been anticipated.

Of the four reference "archetypes" to which other samples were compared, two were direct radiators and two were horns. The direct radiators included a Quad Electrostatic (Fig. 1A) and a Son Audax 6½" moving coil unit (B). The two horn archetypes were a Fostex H351/HA21 long (490mm) sectoral horn driven by an Emilar EK175 drive unit (C) and the "high" frequency section of a Tannoy 15" dual concen-

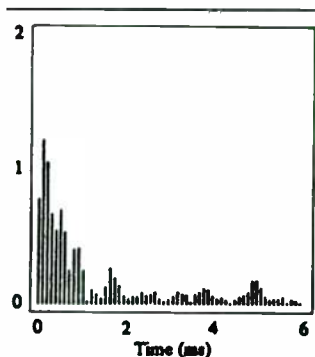

FIGURE 2A: Metal horn with Emilar EK175 compression driver.

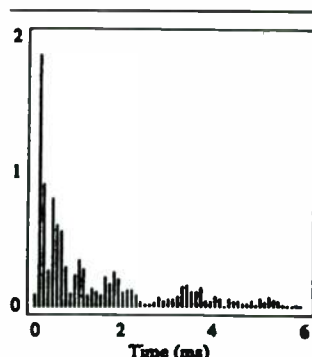

FIGURE 2B: JBL 2105 cone driver.

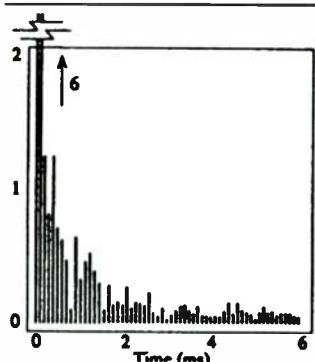

FIGURE 2C: JBL 2121 cone driver.

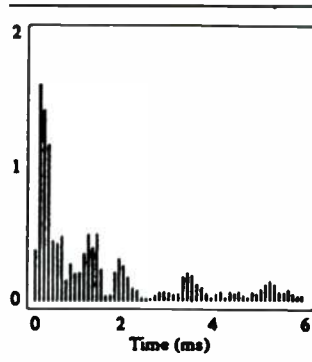

FIGURE 2D: AX1 axisymmetric horn with EK175 driver.

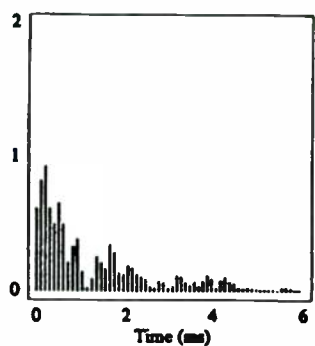

FIGURE 2E: Reflexion Arts horn with EK175 driver.

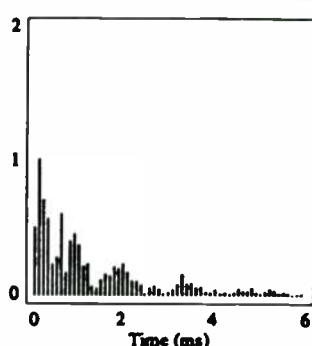

FIGURE 2F: Son Audax PR17-HR100-1AK7 cone midrange driver.

tric, with the bass cone forming the high-frequency horn flare (D).

#### FINDINGS

In general, the horns with a throat-to-mouth distance of more than about 350mm were deemed to sound like the Fostex horn, while the horns with a throat-to-mouth distance of less than 350mm were generally judged to sound like the Son Audax direct radiator cone. Within each of the long/short groups, however, there were some odd exceptions.

One of the "long" horns was a Fostex wooden-flared sectoral horn, measuring 440mm from throat to mouth. Possibly more than any other horn, this one sounded like the Son Audax direct radiator cone. It consisted of a very short "throat extension," cou-

pled to what were effectively large semicircular lips with a horizontal flare of 140°. The horn produced undesirable throat impedance plots, suggesting an uneven pressure amplitude response when connected to a driver. Yet, in auditioning before the tests began, the horn was generally considered "musical," pleasant to listen to, and most definitely not hornlike.

Among the short horns, 350mm or less, two failed to group with the direct radiator. One was the AX2, specifically designed for the tests as a result of the "seminumerical" one-parameter modeling and information gleaned from the use of the impedance tube. The horn was 180mm from throat to mouth and possessed a rapid flare which prior analysis had suggested as a requirement for a desirably smooth mouth termination, avoiding any sudden cross-sectional changes where the mouth meets the baffle. The horn showed an overall similarity to the Tannoy dual concentric, which was also a short, axisymmetric horn.

The third nongrouping horn was a Yamaha aluminum sectoral horn, which was a "borderline" 300mm in length. Not surprisingly, this horn straddled groups B and C in Fig. 1, but also gave many results dissimilar to any of the archetypes. Only on four of the nine sounds did it clearly group with B or C.

#### NONLINEAR DISTORTION

The first attempts to explain these anomalies—and the "break" at 300mm to 350mm—focused on nonlinear distortions. Much has been presented on the subject of horn distortion, to the extent that some circles believe that harmonic distortion makes many horns sound hard and unpleasant. Three predominating sources of this harmonic distortion exist:

1. electromechanical limitations of the drive unit, including thermal power compression effects, suspension nonlinearities, and magnet/gap problems;
2. nonlinearity produced as a function of the volumetric changes between the diaphragm and the phase plug on positive and negative half-cycles;
3. distortion produced by nonlinear propagation within the horn itself, which can, at very high levels, lead to shock formation.<sup>9</sup>



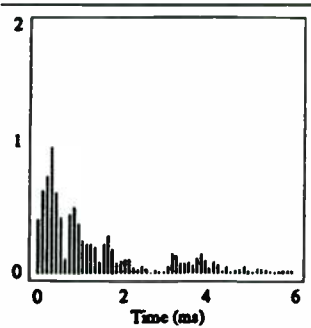

FIGURE 2G: Reflexion Arts horn with EK175 driver with lips sawed off.

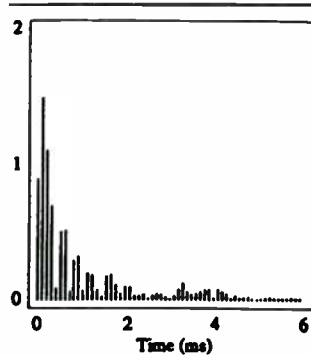

FIGURE 2H: AX2 axisymmetric horn.

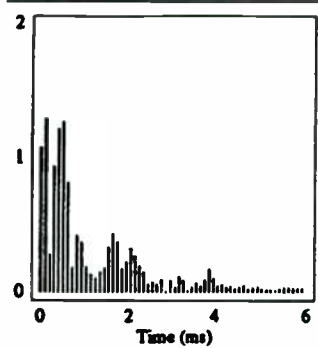

FIGURE 2I: Yamaha horn with EK175 driver.

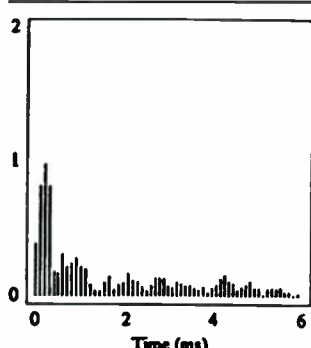

FIGURE 2J: Fostex H320 wooden radial horn with EK175 driver.

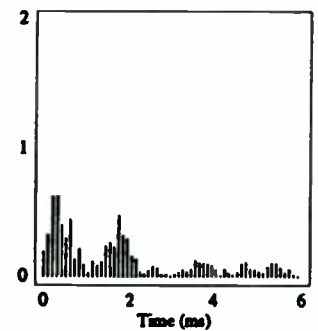

FIGURE 2K: JBL 2307-2308 horn/slant plate combination with EK175 driver.

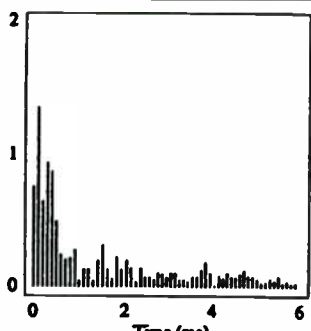

FIGURE 2L: Altec sectoral horn with EK175 driver.

To test the less well-documented third cause, a finite amplitude model was devised for computer prediction. Most standard horn equations are calculated on the basis of infinitesimal wave amplitude, but in reality, usable sound waves have finite amplitudes. Superimposed on the initial sound waves are reflections from the mouth and obstructions within certain horns, plus complications due to phase dispersion within the horn flare.

The model proved highly successful and gave good correlation with measured results, which used a Community M4 as a signal source (capable of producing signals with less than 1% harmonic distortion, even at 150dB). The complicated and unwieldy test setup required two specially treated adjoining rooms, so once adequate verification of the computer model had been achieved, the computer model was certainly the most prac-

tical choice for further study on other horns.

### MEASUREMENTS

The measured results (*Table 1*)—comparing harmonic distortion levels of a direct radiating cone, an electrostatic, and two horn loudspeakers, all used in the listening tests—show that at low levels (below 90dB) at 3m, there is no significant difference in distortion levels of the different devices. At very high levels, e.g., >110dB, very few drivers can produce such continuous sine wave levels, so comparison is not really relevant. Furthermore, certain audiological reasons also reduce the relevance of very high-level measurements in a studio environment.

From the above measurements and the computer analysis of the finite amplitude

TABLE 1

### MEASURED HARMONIC DISTORTION LEVELS OF DRIVERS UNDER TEST

P(3m) = 75dB SPL

L.S.	f (Hz)	Input (v)	2nd	3rd	4th	5th
QUAD	1K	2.04	-59	-60	-69	-66
	2.8K	5.6	-62	-49	-	-
	5K	3.5	-66	-51	-	-
AUDAX	1K	1.01	-59	-54	-68	-
	2.8K	0.75	-61	-60	-	-
	5K	0.64	-62	-59	-	-
JBL	1K	0.2	-53	-75	-77	-
	2.8K	0.18	-38	-27	-46	-38
	5K	0.19	-47	-31	-59	-
EMILAR	1K	0.24	-61	-66	-	-
	2.8K	0.17	-58	-73	-70	-
	5K	0.3	-47	-57	-	-

P(3m) = 85dB SPL

L.S.	f (Hz)	Input (v)	2nd	3rd	4th	5th
QUAD	1K	6.02	-57	-57	-80	-
AUDAX	1K	3.8	-54	-49	-78	-67
	2.8K	1.7	-57	-57	-	-
	5K	2.5	-47	-67	-	-
JBL	1K	0.67	-42	-44	-60	-59
	2.8K	0.44	-43	-36	-49	-
	5K	0.54	-41	-37	-61	-
EMILAR	1K	0.73	-50	-55	-76	-
	2.8K	0.44	-49	-65	-73	-
	5K	0.87	-38	-54	-71	-

P(3m) = 95dB SPL

L.S.	f (Hz)	Input (v)	2nd	3rd	4th	5th
QUAD	1K	10.1	-50	-44	-79	-69
AUDAX	2.8K	5.7	-49	-49	-	-
	5K	7.7	-37	-57	-	-
	1K	2.0	-41	-49	-55	-53
JBL	2.8K	1.5	-35	-53	-67	-53
	5K	2.1	-29	-55	-	-
	1K	2.45	-40	-53	-68	-59
EMILAR	2.8K	1.4	-40	-55	-61	-63
	5K	2.9	-29	-48	-71	-

P(3m) = 105dB SPL

L.S.	f (Hz)	Input (v)	2nd	3rd	4th	5th
QUAD	1K	7.8	-26	-41	-58	-51
JBL	2.8K	4.4	-27	-43	-55	-57
	5K	7.1	-19	-37	-60	-
	1K	10.5	-28	-32	-45	-55
EMILAR	2.8K	4.4	-29	-52	-57	-59
	5K	8.8	-20	-36	-51	-

model, it was possible to attribute the distortions to one of the three main causes previously mentioned. Much second harmonic distortion can be attributed to propagation nonlinearities, with most higher-order harmonics being driver-related. None of this, however, falls into any sort of pattern when cross-correlated with the similarities and groupings in the listening tests.

Indeed, whichever ways the results were dissected and analyzed, no link could be demonstrated between harmonic distortion and audible similarity. Some units with up to 20dB difference in distortion levels sounded similar, while others of almost equal distortion figures sounded totally different. From the



## **A&S speakers**

Proudly presents  
THE A/V CENTER 3  
A THREE PIECE A/V SYSTEM  
Featuring  
TITANIUM DOME, SHIELDED TWEETERS  
VIFA SHIELDED WOOFERS

**A&S  
speakers**

Call or write  
for information  
about our A/V  
packages.

The A/V Center 3 is an upgraded version of our popular Center of it All system. The A/V C3 uses the same high quality *Vifa* bass-mid as the Center of it all, but now utilizes a tweeter recently developed by *Audax* that has a special resonance damping compound applied to its **titanium** diaphragm that dramatically reduces harshness while still maintaining the detail of a high quality metal dome. The high fidelity of the A/V C3 makes these speakers equally well suited for audio only, home theater, center channel, and, as the main speakers in your A/V system.

**A&S  
speakers**

3170 23rd Street; San Francisco, CA 94110  
Telephone: (415) 641-4573 Fax: (415) 648-5306





PHOTO 1: Discossette Studio 3 in Lisbon, Portugal.



PHOTO 2: The Namouche Studio in Lisbon.

results of these tests and analyses, nonlinear distortions were most emphatically *not* responsible for any characteristic horn sound.

#### AMPLITUDE AND PHASE

Pressure amplitude response (frequency response) was another prime candidate for producing sonic similarity or dissimilarity. After the tests were completed, a Waveform Spectral Similarity index was calculated for each loudspeaker on each sound. This was derived by calculating the root-mean-squared error between the spectra of the original signal and that radiated by each loudspeaker.

Comparisons were made for speaker-to-filter input and speaker-to-speaker for each sound. A reasonably good connection was achieved here (around 80% similarity) between the calculated waveform similarity and the listening tests. Unfortunately, some results refused to correlate, in a most glaring way. Usually, when a sample driver which was deemed to be sonically similar to an archetype failed to show a similar pressure amplitude response, then a strong similarity was noted in the phase response. This has so far not been adequately explained.

Certainly, the agreement between the listening test results and the comparisons between the spectra of the reproduced signals indicates that much of the acoustic similarity was due to the on-axis amplitude frequency response, but clearly, this was not the sole reason.

For example, a JBL 2370/2426 combination was very similar in its waveform spectral similarity to the Son Audax cone driver for all nine of the test signals. Yet in the listening tests it showed a reasonable similarity

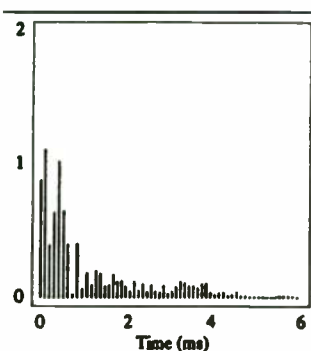

FIGURE 2M: Altec 806C multicolor horn with EK175 driver.

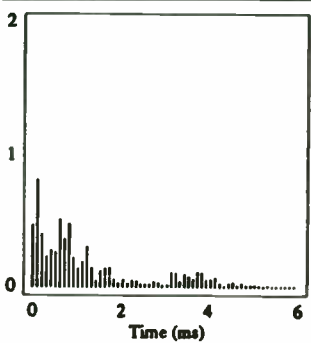

FIGURE 2O: Vitavox sectoral horn with EK175 driver.

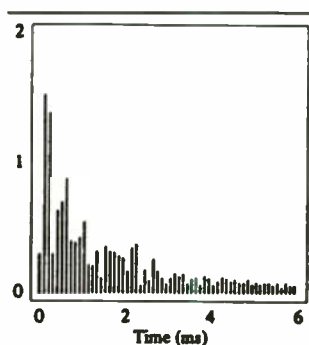

FIGURE 2N: Starr Singing Throat wooden gramophone horn with EK175 driver.

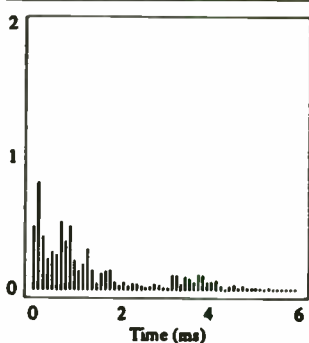

FIGURE 2P: JBL 2370 with JBL 2426 driver.

on only one of the nine sounds. It closely resembled the Fostex horn on five of the signals, and was judged similar to none of the archetypes on the other three signals. The phase response of the JBL combination was more similar to the two horns (archetypes C and D).

#### CEPSTRAL ANALYSIS

With neither amplitude, phase, nor harmonic distortions clearly explaining the sonic similarities or otherwise of the different drivers, it was decided to make further studies in the time domain. To further identify any reflections that may be produced at the mouth or within the flare of a horn, a form of power

cepstrum was calculated from the modulus of the measured throat impedance. In this type of analysis, the frequency-domain representation of the throat impedance's modulus is treated as a spectrum; the power cepstrum is then calculated using Fourier transforms.

Cepstral analysis was first defined in the mid-1960s to help separate echoes from "clutter" in seismic research. The power cepstrum of a transfer function is the Fourier transform of the log of the transfer function's amplitude. Each driver's power cepstrum was plotted using a y-axis scaled in nondimensional decibels and an x-axis plotted in terms of both time and distance.

Figure 2 shows the power cepstra of the units used in the tests. The plots proved to be very revealing, since they are very effective in showing reflections. In a conventional pressure amplitude plot, a reflection would appear as a comb-filtering effect, but on a complex spectrum, this can be difficult to recognize. On a power cepstrum, however, reflections exist as single spikes along the time/distance axis, and can thus readily be recognized.

In general, the cepstral analysis demonstrated that the audible similarity groupings from the listening tests could be described in terms of the reflection patterns shown in the power cepstra. The various reflections and resonances produced in the cone of a direct radiating loudspeaker can give rise to irregularities in the frequency response function that are similar to those due to mouth reflections in short (sub 350mm) horns. This explained the anomalous behavior of the "long" Fostex wooden horn in the listening tests.

**Accept no  
substitutes -  
insist on**

Genuine Pyle  
**Pyle**  
Speakers and Components



- Over 200 speaker models
- Sizes range from 1" tweeters to 18" massive motor subwoofers
- Parameters and recommended enclosures available for all woofers

**PYLE**

PYLE INDUSTRIES, INC. • 501 CENTER ST.  
HUNTINGTON, IN 46750 • (219) 356-1200

**H** A Harman International Company

*Made in U.S.A.*



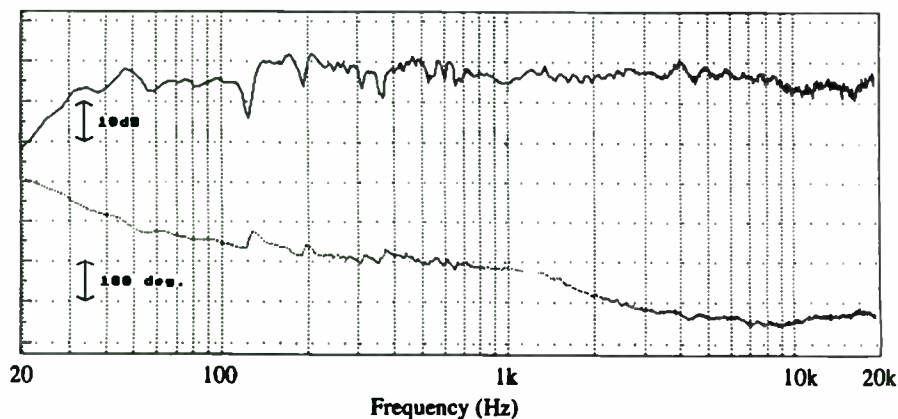

FIGURE 3: Frequency response and phase response of AX2-TD2001 combination on axis, in room, at 2m.

As previously mentioned, the horn sounded similar to the direct radiating cone, but the cepstral analysis showed that the true horn was the 150mm throat section only, with the 140° horizontal wooden flare acting only as waveguide “lips” for directivity control. The unevenness in the throat impedance was largely due to the abrupt, horn-to-lip termination at about 150mm from the driver diaphragm. The horn was consequently reclassified as a 150mm horn with 290mm lips (the shortest horn tested), explaining the similarity between this horn and the direct radiators. You should note that no absolute dividing line exists between horns and direct radiators, since a direct radiator can be considered a 180° conical horn of zero length.

### PROBLEMATIC SPEAKERS

The longer horns, even those with relatively good mouth termination (usually easier to achieve in a long horn), are identified

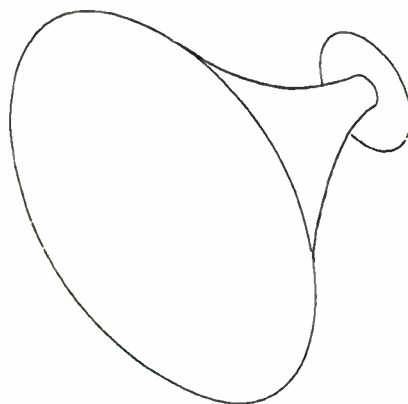

FIGURE 4: Axisymmetric horn geometry.

as horns by the temporal spacing of the reflections. Even when the reflections are significantly lower in level than those of the short horns, we recognize the greater separation in time of these reflections as a horn-like sound.

Cepstral analysis revealed that the two horns—one long and one short—not identi-

fied in the listening tests as sounding like archetypes *B* or *C* exhibited only minimal mouth reflections. The long horn, though showing some similarity, but not a particularly strong resemblance, to archetype *C*, was considered somewhat similar to the electrostatic (archetype *A*). The short horn showed a considerable sonic resemblance to the Tannoy dual concentric (archetype *D*).

Both the Tannoy and the Quad Electrostatic have their roots in 1950s design, yet are still in daily use in “quality control” suites. These units had their historic “difficulties” in the low- and high-frequency ends of their performance, but both had a clear midrange, suiting them well to quality control applications. Apart from reasons of inadequate (woolly) bass and limitations on maximum sound pressure level, these loudspeakers also lost favor as studio monitors because their sound was not representative of other loudspeakers in general. From the cepstral analysis the reason for this is clear, but it poses an interesting philosophical point: should a monitor loudspeaker be rejected because it does not possess the midrange problems inherent in most other production loudspeakers?

While the electrostatic (archetype *A*) was deemed similar to the sample loudspeakers on a relatively small number of occasions, it was frequently noted that one of the nine test signals (a recording of a waterfall, band-limited 1–6kHz on playback) sounded more “wet” on *A* than on any other loudspeaker; a testament to its reality.

### DESIGN IMPLICATIONS

Throughout the tests, we watched for evidence of the horn’s construction material showing any patterns in the sonic test results. Other than

*Continued on page 34*

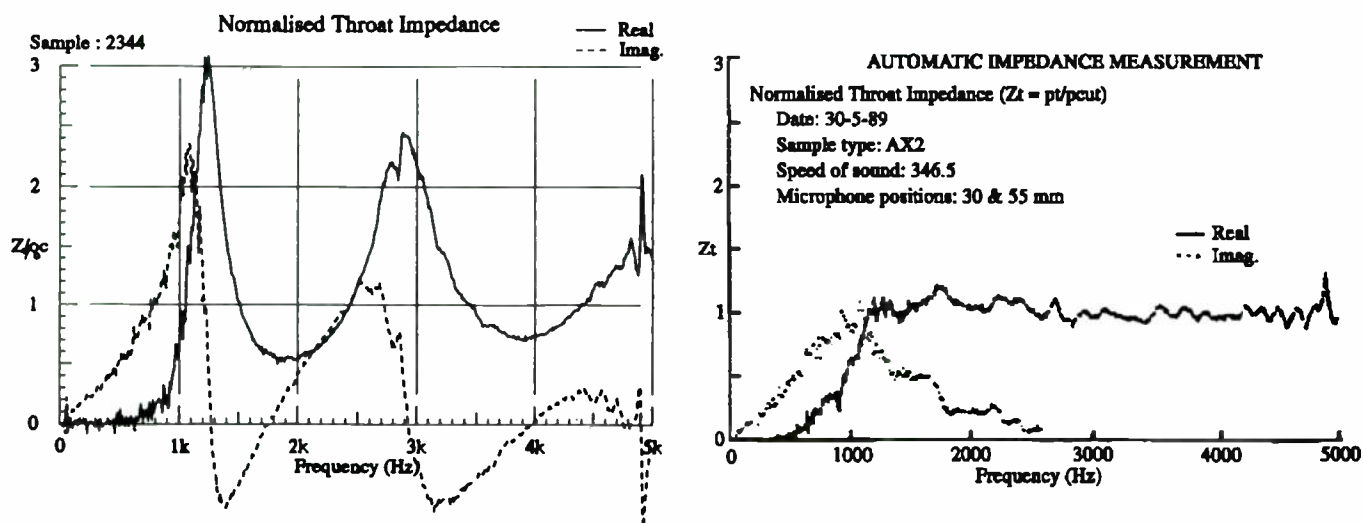
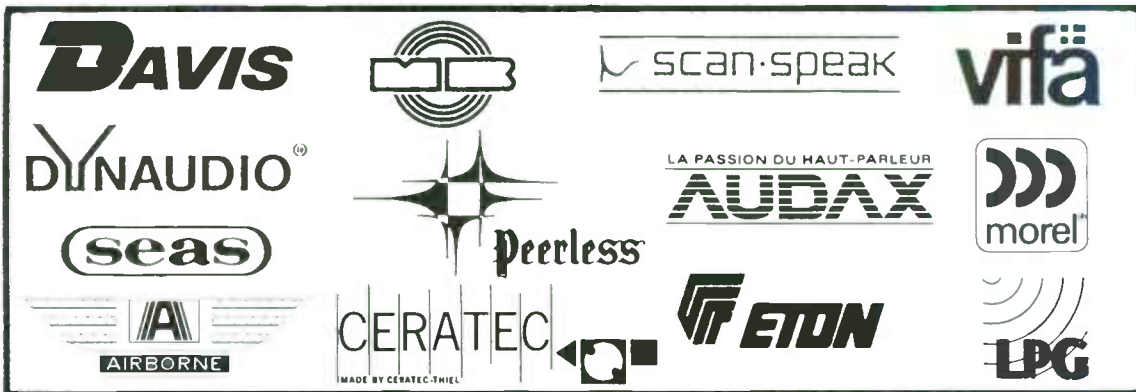

FIGURE 5: Throat impedance plot of a typical constant-directivity horn (left). Throat impedance of AX2 axisymmetric horn (right).

# SOLEN SPEAKER COMPONENTS



## CROSSOVER, SPEAKER COMPONENTS



### FAST CAPACITORS

Metallized Polypropylene (Non-Polarized)  
 Values from 1.0 mfd to 200 mfd.  
 Voltage Rating: 250 VDC / 150 VAC

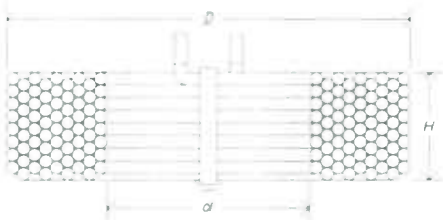

### SOLEN INDUCTORS

Perfect Lay Hexagonal Winding Air Cored  
 Values from .10 mH to 30 mH  
 Wire sizes from #20 AWG to #10 AWG

### HEPTA-LITZ INDUCTORS

Seven Strands Litz-Wire Constructions  
 Values from .10 mH to 30 mH  
 Wire sizes from #16 AWG to #12 AWG



### SOLEN CROSSOVERS

Custom Computer Design  
 Passive Crossover for Professional, Hi-Fi and  
 Car Hi-Fi, Power up to 1000 Watt

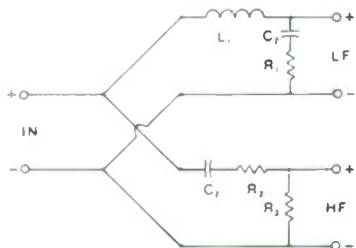

### CROSSOVER, SPEAKER PARTS

Gold Speaker Terminals, Gold Banana Plugs  
 Gold Binding Posts, Crossover Terminals  
 Power Resistors, Mylar Capacitors,  
 Bi-Polar Capacitors, Plastic Grille Fasteners,  
 Nylon Ties, Car Speaker Grilles, Speaker Books,  
 Speaker Kit Brochure, Miscellaneous Parts



**SOLEN INC.**  
 4470 Thibault Ave.  
 St-Hubert, QC J3Y 7T9  
 Canada  
 Tel.: (514) 656-2759  
 Fax: (514) 443-4949

**COMPUTER AIDED DESIGN FOR  
 ENCLOSURE AND CROSSOVER  
 AVAILABLE TO CUSTOMER**

Catalog \$6.00 refundable.

NEW 1994 CATALOG

NEW 1994 CATALOG





## AEON 250 VDC 5% FINE CAP

Metallized polypropylene capacitors for loudspeaker passive network.

Another brand of metallized polypropylene capacitors ? Well, not exactly ... At Orca we have been thinking for a while about how to make polypro caps more affordable for a larger number of speaker builders, people who use caps only for speaker passive X-over network. We thought that it would be tremendous if we could offer a line of polypro caps that would be so affordable that people would have no reason to use cheap mylar, as they would be able to get for not much more money a much much better cap. As you know, even extremely powerful solid state amps (we are talking KW here) can barely produce rail voltage higher than 60 V. So it is safe to assume that a 100 VDC cap would be a pretty robust cap to use in a passive loudspeaker network. So to be really safe, we decided to make all the AXON cap of our FINE CAP basic line 250 VDC. Now that's about where the compromises start and stop. On the other hand for example, you may or may not know that when a cap value is said to be 10.0  $\mu$ F with 5% precision, it means that the manufacturer of caps sets its winding machine to 9.7  $\mu$ F and then produces this series with 2% tolerance (not very difficult with numeric controlled winding machines). The result: the manufacturer saves more than 3% in material, the precision is respected, but chances are all your caps will measure on the low side ! Orca made the special arrangement that all the AXON caps were to be wound with 5% precision with the target value set at exactly the nominal value. That means now, as most of you do, and rightly so, expect, that you should find a much greater proportion of caps very close to exactly 10.0  $\mu$ F, if not 10.0  $\mu$ F exactly! As for the rest, we could display here all sorts of figures and graphs that would only makes sense to 1% of our customers, but what for ? We can simply tell you this is the first polypro cap at a price closing on mylar caps. It is made by the same company that makes all our high voltage and very high voltage SCR caps, as well as our film and foil caps. Some of the best loudspeaker manufacturers have already made that easy choice. Now see for yourself and ... let your ears make the call.

Value $\mu$ F	Diameter mm	Length mm	SRP US\$	Value $\mu$ F	Diameter mm	Length mm	SRP US\$
1.0	11	21	1.23	12.0	25	33	3.56
1.5	12	22	1.44	15.0	25	38	4.18
1.8	13	22	1.49	20.0	29	38	5.16
2.2	15	22	1.58	24.0	29	43	5.98
2.7	14	25	1.67	30.0	32	43	7.30
3.0	15	25	1.73	33.0	32	48	7.74
3.3	16	25	1.78	41.0	35	48	9.32
3.9	16	25	1.83	50.0	37	53	10.96
4.7	18	27	1.96	51.0	37	53	11.16
5.6	18	30	2.10	56.0	39	53	12.00
6.0	19	30	2.20	62.0	39	53	12.98
6.8	20	30	2.33	75.0	43	58	15.12
8.0	20	33	2.91	82.0	45	58	16.28
8.2	21	33	2.97	91.0	47	58	17.50
9.1	22	33	3.08	100.0	49	58	18.76
10.0	23	33	3.23	120.0	51	63	21.98
11.0	24	33	3.38	130.0	54	63	23.38

### STOCKING DISTRIBUTORS: BIG COVE RESEARCH

tel: (205) 722 9867 fax: (205) 430 3961

**SPEAKERS ETC...**

tel: (602) 944 1878 fax: (602) 371 0605

**TECHNOLOGIE MDB**

tel: (514) 526 8851 fax: (514) 443 5485

**ZALYTRON INDUSTRIES**

tel: (516) 747 3515 fax: (516) 294 1943

### OEMs & EXPORT

Contact Kimon Bellas

or John Sangalli

tel: (818) 707 1629

fax: (818) 991 3072

**ORCA**

1531 Lookout Drive

Agoura, CA 91301

**USA**

### COMING SOON:

**FILM / FOIL 630 VDC CAPS for electronics and bypass from 0.1  $\mu$ F to 1.0  $\mu$ F.**

**POLYPRO ULTRA HIGH VOLTAGE**

**1200 VDC 20  $\mu$ F**

**for power supply & tube electronics.**



## A better speaker damping material...

If you've been building speakers for some time, you know how much guesswork goes with speaker damping and stuffing. The choices seem endless: fiberglass, wool, Dacron, flat foam, convoluted foam, felt, tar, plus various "magic" compounds that you're invited to brush or pour into your new cabinets. Everyone has their own recipe, and who knows if it's a recipe for disaster? Or what effects the vapors emitted by these chemicals might have on the glues that bond your woofer surround to its cone and chassis? In this era of costly, space-age drivers and computer-assisted design, we think such risks are

totally unacceptable. So we went to work to find the ideal solution.

The problems are fairly well-known: a driver transforms electrical energy into mechanical energy. This mechanical energy is transformed into acoustical energy which is radiated to the outside of the cabinet - the useful front wave - and to the inside - the sometimes-useful back wave. Unfortunately, it is also transmitted through the frame of the driver to the cabinet itself, which acts as a very large "cone" of very small excursion. This means that the spurious resonances and vibrations of the cabinet have to be controlled in a predictable and reproduceable way. That's how we came to BLACK HOLE 5 and the BLACK HOLE PAD.

First, THE PAD. It's a thin (1/16 inch) black flexible viscoelastic damping material (filled vinyl copolymer) with maximum performance between 50 and 100 degrees F (we hope that that covers the temperature range of your listening room) and excellent flame resistance - it meets UL94 V-O. Thanks to its outstanding damping characteristics, THE PAD will dramatically reduce the vibration energy stored in the walls to which it is applied.

Easy to cut and apply, THE PAD has a pressure-sensitive adhesive back: simply peel off the release paper and press hard onto a clean surface. You can use THE PAD on just about anything you suspect of vibrating: driver frames, thin panels like car doors, and, of course, the walls of your speaker cabinets. And it can be used to recess a driver without using a router: just laminate enough layers to match the thickness of the driver frame and apply to the front baffle. Finally, it is the ideal material for "constrained layer" wall construction, where two panels are laminated on each side of a damping material for optimum transmission loss. Because THE PAD has a fine grain leather finish, you can wrap an entire cabinet exterior and give it an attractive appearance at the same time!

For applications which require **maximum damping, isolation and absorption**, we've developed BLACK HOLE 5. One and 3/8" thick, BLACK HOLE 5 is a high-loss laminate that provides optimum acoustical damping performance. It consists of five layers:

Thin diamond-pattern embossing, densified with a polyurethane film surface. This unique surface layer dramatically improves the performance of the whole acoustical system, especially the lower mid-range and mid-bass frequencies where simple acoustical foam loses its effectiveness.

One-inch deep polyester urethane foam, structurally optimized for acoustical damping. Highly effective at "soaking" maximum sound energy with minimum thickness.

Barrier septum, 1/8 inch thick. Made of limp flexible vinyl copolymer loaded with non-lead inorganic fillers, it is a "dead wall" that isolates the vibrations in the walls of your cabinet from the vibrations created inside the enclosure.

Polyester urethane flexible open-cell foam, 1/4 inch thick. Thanks to special vibration-isolation characteristics, it decouples the vibrating structure (the wall) from the rest of the damping system, thus optimizing performance.

High-loss vibration damping material, same as The Pad. It is strongly bonded to the cabinet wall with pressure sensitive adhesive.

These layers are laminated using an adhesive-free mechanical and thermal process, thus optimizing performance and eliminating the risk of solvent fume damage. BLACK HOLE 5 can be used in any enclosure, as well as for acoustical panels to improve the characteristics of your listening room. **YOU PROVIDE THE MUSIC; BLACK HOLE FIVE WILL TAKE CARE OF THE NOISE!**

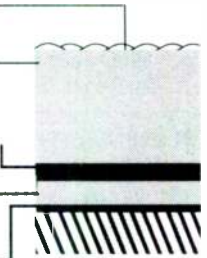

**orca**

1531 Lookout Drive  
Agoura, CA 91301 U.S.A

818-707-1629  
FAX 818-991-3072

**AEON**Cables

*New from ORCA!*

AX-ON (Greek axon, axis): that part of a nerve cell through which impulses travel away from the cell body. AXON 8 speaker cable combines outstanding design features with component quality usually associated with the most expensive cable. With eight AXON 1 solid-core conductors and utilizing mylar/ polypropylene construction, AXON 8 offers outstanding performance for amp-speaker connections and perfectionist internal speaker wiring. Our superb AXON 1 AWG 20 solid core conductor is also available separately. Oxygen-free and 99.997% pure, it is ideal for most internal wiring applications.



Outer insulation: UL approved TPE

Cable geometry: non interleaved spiral

Individual conductor insulation: 105 degree Celsius, UL approved PVC

Cable equivalent gauge: total - AWG 11, 2 conductors - AWG 17, 4 conductors - AWG 14

Individual conductors: solid core AWG 20 copper, long-grain and ultra-soft, free of all contaminants and oxygen.

Cable core: crushed polypropylene

Inner envelope: mylar film

Reader Service #32





PHOTO 3: Liverpool Music House in England, where the measurements for Fig. 3 were taken.

## THE PHENOMENON OF HORN CUTOFF

The following description of horn acoustics grew out of a request to Keith Holland to answer the frequently asked question, "Why do horns have a cutoff frequency?" A thorough literature search had failed to reveal a physical explanation, and the subsequent formulation of a physical theory of horn behavior has led to useful extension of the one-parameter modeling exercise.

Horns are waveguides with a cross-sectional area which increases, steadily or otherwise, from a small throat at one end to a large mouth at the other. An acoustic wave within a horn must therefore expand as it propagates from the throat to the mouth, at a rate dependent upon the horn's local flare rate. A comparison between the wave propagation (nonexpanding and expanding) in two simple acoustic systems may help to explain the physics of horn behavior.

### PLANE VS. SPHERICAL

In the first instance (nonexpanding), consider the propagation of a one-dimensional free progressive plane wave, such as a low-frequency sound in an infinite pipe. A wavefront, defined as an isophase surface, undergoes no change in cross-sectional area as it propagates, and the normalized acoustic impedance at any point along or across the pipe, ignoring losses, is purely resistive and equal to one. A plane velocity source placed anywhere along the pipe thus has no reactive acoustic loading at any frequency, either as added mass or as stiffness.

In the second instance (expanding), consider the propagation of a three-dimensional free progressive spherical wave, radiating from a monopole point source. In this case, a wavefront continually expands as it propagates, and the normalized acoustic impedance at any point is dependent upon both the distance from the source and the frequency. The impedance approaches unity, and hence is largely resistive at high frequencies and large radii, but is reactively dominated at low frequencies and small radii.

If the radius and the frequency are equal to the speed of sound divided by  $2\pi$ , the impedance's reactive and resistive parts

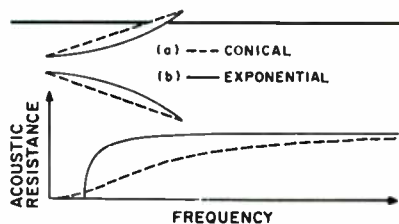

FIGURE A: Comparison between the normalized throat resistance of an exponential and a conical horn of comparable size (ignoring reflection from mouth). The acoustic resistance curves are typical of the frequency responses expected from such horns.

will be equal in magnitude. A spherical velocity source of finite size will therefore be subjected to either resistively or reactively dominated acoustic loading, depending on the size of the source and the frequency of vibration. The only physical difference between the propagation of waves in these two systems is the expansion or "stretching" of the spherical wave as it propagates; similar to the stretching of a balloon skin as it inflates.

### WAVE EXPANSION

In the case of the plane wave, a forward or positive particle velocity is accompanied by a positive increase in pressure at the same point, due to the parallel motion of adjacent particles, and sound is thus radiated. With the spherical wave, however, because an outward positive velocity causes adjacent particles to move apart, the positive, plane wave-like radiating pressure is accompanied by a negative stretching pressure due to the expansion. The plane wave-like propagating pressure is proportional to, and in phase with, the velocity, and independent of frequency and radius. The nonpropagating stretching pressure is proportional to displacement, inversely proportional to the frequency and radius, and in phase-quadrature ( $90^\circ$ ) with the acoustic particle velocity.

*Continued on page 36*

*Continued from page 30*

certain materials having specific problems due to bad design or construction, evidence indicated that any well-damped, solid material can be used to manufacture horns. Obviously, certain materials lend themselves more easily to the manufacture of different shapes, and some materials have probably had sonic characteristics attached to them because they are found only on certain generic designs.

## WAVE SHAPES

Investigations into the wavefronts from the different horns showed that the axisymmetric designs generated waves resembling flattened spherical caps, midway between a true spherical expanding wave and a plane wave from the mouth. The waves leaving rectangular horns were spherical expanding waves which struck the walls of the horn at  $90^\circ$ .

Early in the tests, bubble-blowing experiments were performed: wire loops were bent into the mouth shapes of the horns. Only circular, or nearly circular, mouths produced complete bubbles; rectangular shapes caused the bubbles to tear apart before they could leave the wire.

Also, rectangular horn designs produced disturbed responses when listened to or measured from a position  $90^\circ$  to any discontinuity, such as waveguide plates, the top/bottom-to-sidewall junctions, and any other departures from a smooth surface. The mouth shape and any internal discontinuities tend to produce reflections from the mouth or strange aberrations in the off-axis responses. All these signs pointed to axial symmetry as the only viable option for the highest-quality reproduction.

## AXIAL SYMMETRY

For public address and sound reinforcement applications, directivity is a prime factor in horn design; in studio monitoring, the on-axis  $\pm 20^\circ$  response, together with an off-axis response which changes its frequency balance smoothly and uniformly, is usually far more important.

In the above tests and cepstrum plots, the axisymmetric AX2 horn was driven by an Emilar EK175 compression driver (Fig. 2H). A small reflection can be seen at about 50mm from the diaphragm. This was due to the slightly differing flare rates of the driver throat and the throat of the horn. When mated to the TAD TD2001 compression driver, the flares match exactly and the reflection disappears. Its falling high-frequency response also closely matches the gradually narrowing directivity of the AX2 horn, producing a smooth on-axis pressure amplitude response, together with an off-axis response where the fall-off of high frequencies takes place in a smoothly controlled manner (Fig. 3).

Monitor systems using the TD2001/AX2

# DAVIS



# DAVIS

## THE SPEAKER WORKS, INC.

1021 E. Camelback Road  
Phoenix, Arizona 85014  
Phone (602) 230-0344

WE MADE A SPECIAL BUY ON A QUANTITY OF DAVIS ACOUSTICS MOST POPULAR WOOFERS AND WE ARE PASSING THE SAVINGS ON TO YOU. THESE WOVEN KEVLAR AND WOVEN CARBON GRAPHITE DRIVERS ARE AMONG THE FINEST THAT FRENCH TECHNOLOGY HAS TO OFFER. OUR PRICING IS FAR AND AWAY THE BEST YOU WILL FIND ANYWHERE SO PLACE YOUR ORDERS NOW! INVENTORIES OF SOME MODELS LIMITED.



**25GCA10W**  
10 in. woven carbon fiber  
Cast Frame  
1.5 in. VC  
Foam Anulus  
100 Watts  
91.4 db 1W/1M  
Vas 237.7 L.  
Fs 24.6 Hz.  
Qts. .33  
X max 10 mm.  
COST \$89.00



**20MC8A**  
8 in. woven carbon fiber  
Cast Frame  
1.0 in. VC  
Welbex Anulus  
60 Watts  
91.5 db 1W/1M  
Vas 77.7 L  
Fs 39.8  
Qts. .46  
X max 8 mm.  
COST \$67.50



**20KLV8A**  
8 in. woven kevlar  
Cast Frame  
1.5 in. VC  
Welbex Anulus  
80 Watts  
92.1 db 1W/1M  
Vas 81.7 L.  
Fs 38.5 Hz.  
Qts. .38  
X max 6 mm.  
COST \$79.50



**17RCG-DB**  
6.5 in. woven carbon fiber  
Stamped Frame  
DUAL 1 in. VC  
Welbex Anulus  
60 watts  
89 db 1W/1M  
Fs 50 Hz.  
Qts. .627  
Vas 20.57 L  
Cost \$69.00

ALL VOICE COILS 8 OHM

WE HAVE SUGGESTED ENCLOSURE PLANS FOR ALL MODELS. THE 17RCG-DB ALONG WITH THE PEERLESS CC-1 DOME TWEETER MAKES UP INTO A WONDERFUL CLASSICAL AND JAZZ LOUDSPEAKER. WE'LL BE HAPPY TO SUPPLY PLANS.

ANY QUESTIONS - CALL US  
F.O.B. PHOENIX VIA UPS  
We Accept VISA - MasterCard - Check - No C.O.D.





PHOTO 4: Regiestudios, featuring a 40-track ADTA setup, in Amadora, Portugal.

combination are now used commercially (Photos 1-4), particularly in very nonreflective control rooms where the on-axis response is highly important. These monitor systems, especially in inexperienced hands, suffer from some of the criticisms formerly leveled at the Quad Electrostatics and Tannoys and are not necessarily representative of other loudspeakers. But, at the same

## REFERENCES

1. K.R. Holland, F.J. Fahy, C.L. Morfey, and P.R. Newell, "The Prediction and Measurement of the Throat Impedance of Horns," *Proceedings of the Institute of Acoustics*, Vol. 11(7), Reproduced Sound 5, pp. 247-254, 1989.
2. K.R. Holland, F.J. Fahy, and C.L. Morfey, "Prediction and Measurement of the One Parameter Behaviour of Horns," *JAES*, Vol. 39(5), pp. 315-337, 1991.
3. F.J. Fahy, "Rapid Method for the Measurement of Sample Acoustic Impedance in a Standing Wave Tube," Letter to the Editor, *Journal of Sound Vibration*, Vol. 97(1), p. 168, 1984.
4. P.R. Newell and K.R. Holland, "Do All Mid-Range Horn Loudspeakers Have a Recognisable Characteristic Sound?," *Proceedings of the Institute of Acoustics*, Reproduced Sound 6, pp. 249-258, 1990.
5. K.R. Holland and C.L. Morfey, "A Model of Finite Amplitude Sound Propagation in Horns," *Proceedings of the Institute of Acoustics*, Vol. 12, Acoustics 90, 1990.
6. K.R. Holland and C.L. Morfey, "Finite Amplitude Sound Propagation in Waveguides of Variable Area," Presented at the 12th International Symposium on Nonlinear Acoustics, Austin, Texas, 1990.
7. K.R. Holland, "The Use of Cepstral Analysis in the Interpretation of Loudspeaker Response Measurements," *Proceedings of the Institute of Acoustics*, Reproduced Sound 9, pp. 65-71, 1993.
8. K.R. Holland, PhD Thesis, Southampton University, 1992.
9. P.R. Newell, "Monitor Systems—Midrange Horns, Part 2," *Studio Sound*, Vol. 31(a), pp. 62-72, September 1989.
10. M.A. Dodd, "A Wide Dispersion Constant Directivity Dual Concentric Driver," Presented at AES 92nd Convention, Vienna, 1992, AES Preprint No. 3257.

time, many experienced engineers praise the ability of these systems to pinpoint fine detail. Most studios use large and small monitor systems—one representing "truth," the other a "real world" mix—for the most viable partnership.

In many ways, the AX2 could well define the limits of midrange horn design. The axisymmetric shape (Fig. 4) seems to be the only one which can produce an output free of response irregularities caused by pillars,

plates, other obstructions, or surface junctions. Horns much more than 300mm in length begin to produce horn-like sounds unless the mouth termination is close to perfect.

Given that the flare rate dictates the throat cutoff frequency, and mouth size controls the smoothness of the low-frequency termination to the room, then a horn with a low cutoff frequency and a smoothly flared mouth would be of such great length and mouth

*Continued on page 64*

*Continued from page 34*

The wave expansion, and hence the stretching pressure, effectively reduces the resistive part of the impedance at low value of the distance/frequency ratio, and increases the reactive part. Such positive reactance is usually associated with added mass, but in spherical waves no extra inertia is involved when compared to plane waves. The usual description is therefore inadequate to explain this property.

In this case, the positive reactance is clearly due to "negative stiffness," not added mass. The region near a small source where this reactance dominates is the hydrodynamic near field of the source; its extent is frequently dependent. The outside region where resistance dominates is the far field.

## FLARE RATES

The concept of stretching pressure can be applied to horns by considering their flare rates, which are defined as the ratio of the rate of change of wavefront area with distance, to the area of the wavefront. A conical horn has a flare rate inversely proportional to the distance from the cone apex. A spherically radiating source can be considered a special case of a conical horn, and thus shares the same expression for flare rate.

At any given frequency, the radius at which the impedance's resistive and reactive parts are equal in magnitude occurs where the above mentioned frequency/distance ratio is equal to unity. The flare rate at this radius is equal to twice the free field acoustic wave number (the wavelength divided by the speed of sound) and is identical to the flare rate in an exponential horn with this cutoff frequency. With flare rates below this value, resistive, far-field-type propagation takes place, and with flare rates above this value, reactive, near-field-type propagation occurs. Using this physical concept, the difference in behavior between different types of horns can be explained.

The flare rate's radial dependence in a conical horn, which shares the propagation properties of a spherical wave, gives rise to a gradual transition from the reactive, near-field-dominated propagation associated with the stretching pressure, to the resistive radiating, far-field-dominating propagation as any wave propagates from throat to

mouth. This transition in a conical horn from near to far field, reactive to resistive dominance, is gradual with increasing frequency and/or distance from the apex; distinct "zones" of propagation are thus not clearly evident.

## EXPONENTIAL VS. CONICAL

Since the property of resistive loading gives horns their greater efficiency when compared to direct radiators, as the resistive loading rises, the radiating efficiency rises. From the above, the characteristic gradual throat impedance cutoff slope of a conical horn should be readily appreciated (Fig. A).

On the other hand, an exponential horn has a flare rate which is constant with distance along the horn. Therefore, at frequencies below cutoff, the reactive, or near field, type of propagation dominates throughout the entire length of the horn. Below cutoff, if the horn is sufficiently long, an almost totally reactive impedance exists everywhere within the horn. Conversely, above cutoff, the resistive, far field, type of propagation dominates, again almost everywhere throughout the horn's length.

Above cutoff, propagation within an exponential horn is physically similar to a spherical wave of large radius, with minimal stretching pressure. Below cutoff, propagation is dominated by the stretching pressure and is thus similar to a spherical wave of small radius. Clearly, the abrupt cutoff phenomenon of an exponential horn occurs because the transition from resistive to reactive propagation occurs simultaneously throughout the entire length of the horn as the frequency is reduced below cutoff, producing the typical throat impedance characteristics of the exponential horn (Fig. A).

The use of conical horns in audio is thus limited because for practical horn sizes, the resistive loading, and hence high radiating efficiency, rises only gradually, and thus the useful high-efficiency radiation only begins to develop into a uniform response at much higher frequencies than in a comparably sized exponential horn. At frequencies below cutoff, the reactive propagation is somewhat similar to the reactive loading of direct radiators, and thus falls to the comparably low radiating efficiency of a direct radiator of the same throat size.—PN, KH





# THE LINEAR-ARRAY CHRONICLES

By Philip Witham

If you have followed the two previous articles in *SB* on the Linear-Array concept (3/94, p. 28 and 5/94, p. 43), you know I've been building a cheap proof-of-concept speaker prototype to test whether the idea makes a large improvement in imaging. Well, I can now say that it works, and pretty much as the theory said it would, with some exceptions and unanswered questions.

All in all, Murphy let me off easily this time in the reality-meets-theory department. (We are dealing with speakers, after all, a craft known as a *strange attractor* to chaos mathematicians.) I think this was because I sacrificed 12 drivers—burned their little hearts out—and the gods were appeased.

## THE PROTOTYPE

I now have a 60-channel dipole speaker (*Photo 1*) using little “full-range” dynamic drivers, spaced 40mm ( $\approx 1.6''$ ) apart. The total active width is just under 8', and the baffle is about 4' high. The drivers are made by Kobitone (from Mouser Electronics, 25SP500).

The microphone (*Photo 2*) is built to handle 60 channels, but is only “stuffed” with 48 at the moment—6' worth. It uses Panasonic WM-60AT omni mike capsules, also set at 40mm intervals. The mikes extend a few inches away from the horizontal structure to reduce acoustic interference. The mike can fold up to 4' x 4' for transport. The microphone structure is made of soldered copper tubing and fittings (plumbing parts), with a wood base.

Built on the vertical structure of the mike is the electronics box, with two 32-channel preamp PC boards (*Photo 3*). Two fat 50-pin ribbon cables plug into the microphone and speaker to handle all the interconnections (*Photo 4*). Power is from a small regulated DC supply which plugs into the back of the speaker. The DC runs along the ribbon cables to the preamp, where it is regulated again.

The little 600 $\Omega$  drivers (*Photo 5*) are driven directly by the preamp's op amps, with no “power amp” stage. The total power output rating would be about 6W RMS, so we're not about to shatter any windowpanes here. *Photo 4* shows the connections at the back of the speaker. A search for 50- to 100-pin connectors and cable yielded precious

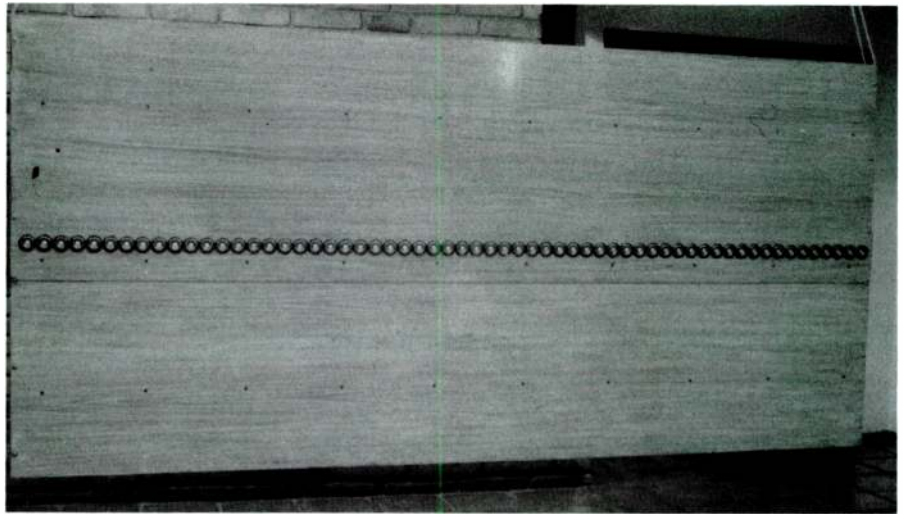

PHOTO 1: The author's 60-channel line-array speaker.

few choices, most being very expensive. The ribbon cable connectors, on the other hand, are very easy to use, with little “Ejector/Latch” levers on the sockets for easy unplugging. A pair of scissors and a bench vise are all you need to make up a cable of any length, and the parts and cable are inexpensive.

Also, flat cable is available in  $\frac{1}{2}''$  diameter round jacketed/shielded versions which are less expensive than conventional multiconductor cable. I still wound up with two cables to handle 64 channels. The mike preamp is designed to cut off the bass below 100Hz to reduce wind noise problems, and the speaker can't handle bass below this point anyhow. This limitation shouldn't get in the way of tests of imaging, though.

## WHAT'S IT SOUND LIKE?

*Everybody, including myself, was astonished to find that it was impossible to distinguish between my own voice, and Mr. Edison's recreation of it.—Anna Case, Metropolitan Opera soprano, 1915*

A friend and fellow speaker experimenter turned me on to this little bombshell of a quote, which he keeps posted on the wall of his audio lab. So, with that as a warning, a disclaimer: I've spent enough time with the prototype to state some things as facts. But I haven't done many methodical or blind listening tests yet. So the degree to which vari-

ous observations are true is still to be determined. For the sake of brevity this time, I'll avoid couching my statements in careful, scientific terms.

The following listening tests were mostly conducted with the microphone set up outdoors. The speaker was indoors, in a typical largish rectangular room. The system had only 6' of active width and 48 channels at the time. The gain was set so that the reproduced sound level was a bit higher than the level at the mike.

Ambient outdoor noises and whatever noisemaking objects I had lying around served as the test sources. Some wind chimes hung on a stand and activated by remote control (a rope) were especially useful. Voices are also very useful. The observations of about five other listeners who heard the system only occasionally differed from mine.

## THEORY vs. REALITY

When listening to the speaker, you hear the sound coming from the level of the drivers, and it is *mostly* limited to a left-to-right angle somewhat smaller than the width of the array. Certainly, the left-to-right imaging accuracy is superb. It is solid, unambiguous, and better by far than anything I have heard before. It appears equally good for distant sources (airplanes, dogs, birds) as for sounds near the mike. A sound source angle can be

located when listening to the speaker, then compared to the sound outside at the mike (seen from the relative angle of the mike), and the two always match.

The imaging does not break down as you move left and right, with the apparent position of the source fixed in space until its direction puts one end of the array too close. Then the apparent direction bends around that end of the array, fixed on the end of the speaker rather than at some point behind, and the volume drops. This happens when there is less than about 1' of extra array width to the side of the direction of the source (i.e., if you draw an imaginary line between your listening point and the virtual image point, and look at where this line passes through the speaker array, the imaging works if you have at least 1' of extra array to either side).

This leads to reality-versus-simple-theory modification #1: I need an 8' array width, instead of the 6' originally planned, to reproduce a nice wide soundstage without having to sit too close to the speaker.

The image is not affected by head rotation, remaining fixed and natural. Or, I should say, it is affected by head rotation just as it is with natural sound.

The mike obviously does not distinguish between sources above, behind, in front, or below. They all sound as if they are coming from a plane on the level of the speaker drivers. This is sometimes surprising in that otherwise the imaging is so good, the complete lack of correct vertical and "surround" imaging is obvious. The overall sound is very natural, and blends into the room more realistically than stereo, but then, an airplane flying left to right in front of you rather than overhead is odd.

### IN YOUR FACE

The perspective on sound sources changes with listener movement about the room, as it should. This is most startling when two sounds are present simultaneously—one a distant source, say, an airplane apparently straight ahead, and another source up close, say, chimes close to the center of the mike. As you walk from the left to the right, the airplane sound remains at a fixed angle to you. The chimes start out to your right, pass the direction of the airplane in the center, and wind up on your left. The angle between the two flips as you proceed by the chimes.

In this way, with your movement, the "depth" location of sound sources is clear. It's not so easy or clear if you stay in your seat, however. The depth sensation is much weaker than the L-to-R sense. Perhaps this is partially due to the omni microphone, which tends to pick up a lot of "ambience"—reflected sound—even with close sources. Perhaps not.

The L-to-R "soundstage" width continues

to widen as you move closer to the speaker, and indeed it is almost 180° when you put your face right up there. Even at this distance most sounds do not seem to be coming from the speaker so much as "out there" (vertical height excepted). It is clear that the imaging is not just a stereophonic illusion, but honest-to-god wavefronts moving off the speaker from the different directions. There is no fixed speaker location where a sound is

apparently coming from, distant sources move with you horizontally.

Sounds coming in at the mike at extreme angles ("end-fire," or nearly so) are reproduced at extreme angles. When you are up close to the speaker, they appear way down towards the end. If you back away from the speaker, they disappear, and are heard at a much quieter level "somewhere in the room." Often, from a typical listening posi-



PHOTO 2: The microphone, measuring 8' wide.

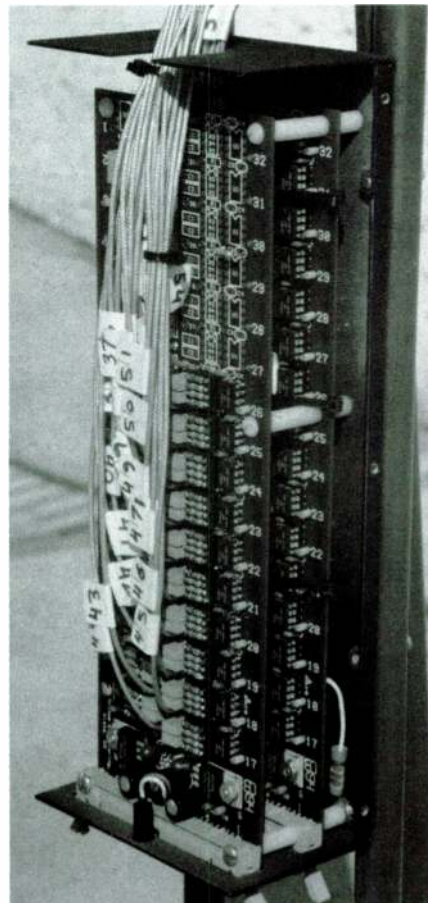

PHOTO 3: Closeup of the preamp located on the mike's vertical structure.

tion, these end-fire sounds are audibly louder where they bounce off the side walls of the room than directly from the speaker. Different sounds bounce about the room differently and are sometimes heard from odd directions.

The dipole nature of the speaker is helping to spread ambient sound around the room behind the speaker, but I have not decided whether a dipole is the best way to go yet. It is clear that the array is producing ambient sounds which blend into the room more effectively than does stereo.

### BUGS, CATS, AND CHIMES

The sound of bugs outside at night and other ambient noises are very convincing. After a while, they blend into the background as if I had several windows open, not as strong a sense of sound coming from the speaker, just an enjoyable presence in the room. Then, when I unplug the system, poof, all gone! It is rather startling to realize that subconsciously you felt it was coming in through the windows. The overall effect is stronger and more pleasing than in stereo.

I believe I need to introduce a new term to describe something important about the sound of the array. "Image complexity" would be a good term to use. Stereo by comparison sounds as though it is simplifying the sounds it reproduces. The array sound is rich in image character.



For example, my wind chimes consist of about 40 bamboo tubes and a set of ten or so solid metal rods all bumping into each other. The array reproduces this as a bunch of little sounds located in *different* places very close to each other (packed into a single vertical plane, unfortunately). I'm not certain how best to quantify this yet, but I will measure how close two sound sources can be before they blend together.

In comparison, stereo's treatment of this same scenario will produce a nice sound, but the images of the separate sounds will be smeared together and *simplified*. Ditto for the natural reverberation. Stereo also tends to produce a large image from small, close-miked sources. The array is inclined to make things sound more merely life-sized. I am reminded of a plot of the polar dispersion of a violin, at just one frequency, which is lumpy and varied with angle. Stereo samples this mess from a few points in space and assumes that this sample of the instrument's output is all we need to hear.

The Linear Array reproduces a much more complex sound. My impression is that this has a lot to do with my dissatisfaction

with stereo: that the ear can take in and distinguish many separate, complex sound sources simultaneously, and cannot distinguish as many details from stereo (through speakers). I am also vaguely dissatisfied with the terms "image" and "imaging," since marketing hype and overenthusiasm have so

abused these and many other related words that they lose their usefulness. I try to keep my English feet on the ground and just report what I hear.

I can attest that cats are convinced much more by the array than by stereo. I had a good laugh watching a cat's head swinging back

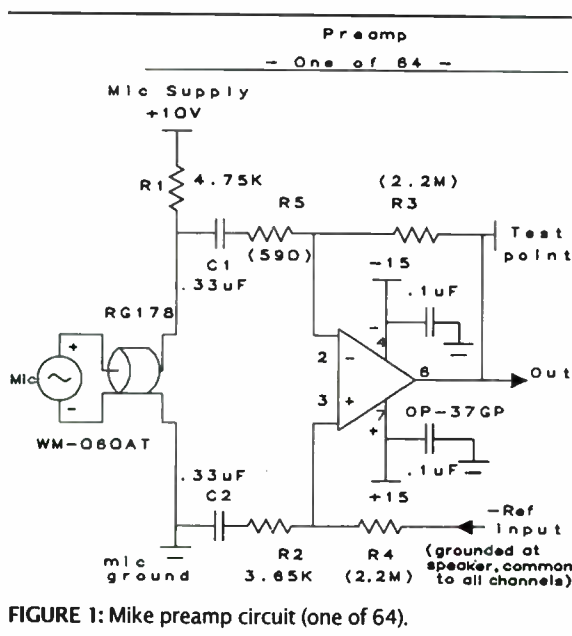

FIGURE 1: Mike preamp circuit (one of 64).

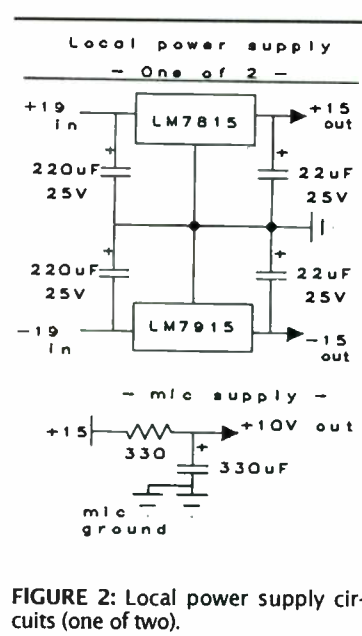

FIGURE 2: Local power supply circuits (one of two).

## Electrostatic Loudspeakers

"No other speakers on this planet unravels detail as well, while preserving music delicacy."

*Dick Olsher, Stereophile, March 1994, vol. 17 No.3.*

Amantis Audio ELP-48, 6"x48" electrostatic panels with interlocking frames. Designed to operate as a single transducer, or in arrays of 3, 5, or more. Adjust the array's curvature to suit your dispersion preferences.

The ELP-48 features:  
 Vacuum coated diaphragms.  
 Insulated perforated panels.  
 Precise and constant diaphragm tension.

Amantis Audio components:  
 High voltage power supplies, step-up audio transformers, equalizers and crossovers.

**Amantis Audio inc.**  
 184 North Main St.  
 Champlain, NY, 12919  
 (514) 383-0475

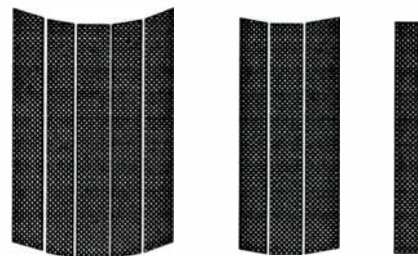

Dealer and OEM inquiries welcomed!

and forth with a moving (reproduced) sound when he sat underneath the speaker, looking up. Our cats ignore the stereo system when it is playing. Incidentally, I heard the sound from the same direction his head pointed.

### THE ALIAS EFFECT

As far as image aliasing and the top two octaves of the spectrum, testing with the metallic wind chimes is encouraging. The chimes produce strong, distinct 5–10kHz fundamentals according to my scope. The calculated end-fire (worst case) image aliasing limit of this array is 4.3kHz. If the chimes are placed up a few inches from the mike, most of the mike array is at close to 90° from the chimes, which is a tough test of the system. The result is an image of a number of separately located “ting” noises spread about 1' wide where the actual spread of the chimes is 4".

The overall sound is located where it should be, but I believe I am hearing the individual chime rods displaced up to half a foot from where they should be. I think this is aliasing, and each particular frequency is moved in its own way, like rearranging the locations of the separate rods. But this is as good as I hoped it could be. Much better than stereo!

At no time did the chimes show up well

away from their proper locations. Some treble, which ideally would appear to come from just one area, is heard coming from all across the array. This is at a lower level than the main image, and is probably aliasing, as

well as reflections in the environment around the mike.

I believe I am hearing the apparent effect of 5–15dB of extra gain effectively added to distant sources, relative to what they

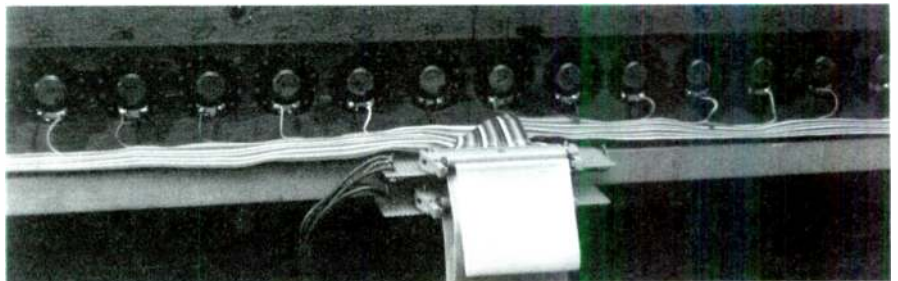

PHOTO 4: Connections and the two 50-pin ribbon cables at the back of the speaker.



PHOTO 5: The 600Ω drivers.

### We've moved!

Sales and engineering are now both at:

**Technologie MDB**  
4000 Terrasse Jean XXIII  
St. Hubert, Quebec J4T 3L6

Technologie

**MDB**

Affordable Excellence from Canada  
l'Excellence Abordable du Canada

Single daytime phone and  
after-hours hotline:

(514) 891-6265

Fax:

(514) 443-5485

**Have yourself a Merry Little Christmas** listening to your favorite music with our **incredible Christmas special** for *Speaker Builder* readers. Between Dec. 10 and Dec. 24, call us to get the deal of a lifetime while supplies last. All sales must be paid by check or money order made payable to Technologie MDB before Dec. 31, 1994. Add 20% for shipping and handling - we will refund overpayments. No other discounts applicable. Sales are final, except for obvious driver defects. All prices shown in U.S. funds - Canadian residents use exchange rate of 1.40 and add applicable taxes. Don't wait - you may never see prices this low again on the planet for these fine drivers! Sorry, no rain checks - first come, first serve only limited to the drivers we have in stock and to sale dates. **ADDITIONAL DISCOUNT of 15%** on drivers for all kit orders from our catalog.

Driver	Regular price	Sale price	Driver	Regular price	Sale price
Cabasse Dom 2 tweeter	41	35	Focal 7V013 bass-mid	70	60
Cabasse Dom 4 tweeter	84	71	Focal 7V412 bass-mid	87	74
Focal T90Ti tweeter	49	42	Focal 7K01 DBL bass-mid	91	77
Focal T120Ti tweeter	72	61	Focal 7K415 bass-mid	111	94
Accuton C211 tweeter	155	132	Focal 8V012DB bass-mid	80	68
Accuton C222 tweeter	194	165	Focal 8V412 bass-mid	92	78
Accuton C277 mid	233	198	Focal 8N515 bass-mid	106	90
Focal 4V211 mid	60	51	Focal 8K415S bass-mid	118	100
Focal 4K111 mid	73	62	Focal 8K516J woofer	148	126
Focal 5N411 bass-mid	62	53	Cabasse 21M18 bass-mid	154	131
Focal 5K013L bass-mid	81	69	Focal 10V01 woofer	127	108
Focal 6V013L bass-mid	67	57	Focal 10V516J woofer	156	133
Focal 6V415 bass-mid	87	74	Focal 10K516J woofer	190	162
Focal 6K412L bass-mid	100	85	Focal 12V726 woofer	192	163
Cabasse 17NDLB bass-mid	156	133			

Other goodies available *only* from MDB:

- The 1995 kit and driver catalog is available as of January 1. Please send \$5.00 check or money order to cover printing + S&H. *We've slashed 5-15% from all kit prices and added real winners to our lineup.* MDB optimizes each system design to extremely exacting standards, but doesn't waste money on expensive gimmicks, delivering world-class excellence at rock bottom prices.
- Unit 4 of the I.DIS speaker design course is now ready for shipment. Don't be left behind!

Reader Service #18



"should" be. Things become quieter as they move away, but not as fast, perhaps, as is natural. This effect is possibly predicted by theory: distant sources come out with narrow dispersion, while close sources are reproduced with wide dispersion. As a result, the close sounds will lose amplitude faster as a listener moves away from their virtual location. I am working to pin down this area of theory.

### MORE TESTING REQUIRED

I will measure live-versus-reproduced sound levels at various distances to quantify this. But it is interesting that I can hear conversations 300 yards away just as well from the speaker as when I stand outside and listen. A related effect is the reduction in the overall mike noise level resulting from the sheer number of channels. Theory predicts that if you add more channels and reduce the gain of the individual channels to keep the same overall gain, the total noise power will be reduced to  $1/N_{\text{CHANNELS}}$ . Or, in terms of amplitude:

$$-10 \text{ Log } N \text{ decibels}$$

which for stereo is -3dB, and for 48 channels is -17dB. This is true as far as I can determine, since the prototype uses very noisy little 4mm diaphragm electret mikes,

and I hear only a modest noise level.

The \$4 "full-range" drivers have some definite problems:

1. They can't handle the full output level of the microphone preamp without breaking their super-fine voice coil wires. I've replaced 12 so far, mostly casualties of wind noise and a (ahem!) feedback experiment.

2. They have a bass emphasis around 250Hz that was not bad when I tested a single driver by itself but is bad in the full system. They attenuate the midrange from 1-4kHz and have a nasty resonance at 5kHz or so. From the back, they sound even worse.

It's surprising how pleasant and listenable this speaker is, used as a Linear Array, considering how bad it sounds when driven by mono or stereo. The bass emphasis was obnoxious, though, when a friend played his acoustic guitar for my mike. It is possible that an effect of this array configuration is a gradual decrease in sensitivity with frequency of up to 2dB per octave, overlaid on the individual driver response.

The dipole design has a few drawbacks. Sounds produced "end-fire" are also produced off the back side in the same direction as from the front, heading off towards a side wall. The two versions cancel each other well at lower frequencies. I wish to hear

these end-fire sounds strongly, bounced off the walls, since this could help reproduce "hall ambience." A dipole can't do that as well. Also, strong reflections off the wall behind the speaker occur. These may or may not help with the imaging, but I notice that the speaker baffle blocks much of it from a normal listening position.

This has an interesting effect on my stereo system, when I set its speakers up against either side of the baffle. The imaging from the stereo is much worse with the baffle there, especially in depth and height. I sense that much of the "height" imaging from stereo is the result of room acoustics. I'd like to try the array as a boxed speaker.

### WHAT'S IN THAT BOX?

Figure 1 is the schematic of the mike preamp. I omit the connector pin numbers and the remote power supply. The supply produces  $\pm 19V$  regulated DC at up to 1A, and uses three-terminal IC voltage regulators. The power is regulated at both ends to eliminate AC hum noise coupling in the long ribbon cable, and to provide a solid supply at the preamp despite the cable resistance.

Figure 2 is the circuit of the regulators at the mike. Each preamp channel is a differential amplifier for good noise and crosstalk

## With a Little ..

Sometimes an idea is so simple that it just gets by you. That is, until you see the answer.

A lot of people tell us they just need a headphone jack on their high-end system. But they really aren't interested in the portability of our other HeadRoom amps.

So folks, here it is. Think of the Little HeadRoom like a high-end headphone jack at a reasonable price, \$199.



It uses the same headphone electronics module as our Supreme (reviewed in *Stereophile* Jan 94, follow up in Feb 94) but it's in a new enclosure, and has a cord mount AC supply for use at home. It's slightly less articulate than our other models, but it is far, far better than the headphone jack you're currently using. We'll stake our 30-day money-back guarantee on it. Give us a buzz at 1-800-828-8184 for a **Little** information.



Try the Little HeadRoom/Grado SR60 combo, \$249 and killer sound. Heck, buy the SR60's alone at \$69 for the best audio bucks you've ever spent.

.. You Get a Lot of  
 HeadRoom

rejection. It is not a particularly good diff-amp in terms of common mode rejection ratio, but it is less expensive than any alternative. The IC is the lowest grade (GP) version of the OP-37, which costs about \$1.80.

The circuit may be a bit odd if you are used to the standard four-resistors-and-an-op amp diff-amp configuration. R5 should be the same as R2, right? No. The microphone is used as a current source rather than a voltage source (the typical way these mike elements are used). The result is higher gain with higher amp speed (lower feedback resistor value) and lower noise. The mike's output is the drain pin of an FET, and thus works well as a current source.

The mike itself has about a 15k impedance, which in parallel with R1 becomes about 3.6k, the same as R2. C1 and C2 decouple DC from the input and, in this case, also filter out wind noise below 100Hz. R5 tunes the common mode rejection and response at high frequencies. The -Ref input to R4 is a pseudo-differential output trick that reduces crosstalk and AC hum. Due to the long cable between the mike preamp and whatever unit is at the receiving end (speaker, amp, recorder), there is likely to be a difference between the ground voltages at either end.

I am running a separate ground sense line back to the preamp from the (speaker/recorder) end of the cable. This sensed ground reference is added to the output by each preamp channel. All channels on each PC board use the same reference. Not enough wires exist in a practical cable to use a fully differential output design! The "mike supply" is RC filtered, since this point is essentially a second input to each amp that is just as sensitive as its mike input. Without this filter, the noise and crosstalk would be very high.

#### SYSTEM SPECS

All resistors are 1% metal film types, and C1 and C2 are polyester film (no space for more audiophile-approved types). I will parallel these with nonpolar electrolytic caps when I mike the bass below 100Hz. The mike elements and their coax cables are soldered in with no connectors, since the 0.5mA bias supply through them would play havoc with

any contact resistance. I can just imagine wiggling 60 connectors to eliminate a scratchy noise!

The components with values in parentheses are built on DIP headers, so they can be swapped out to change the gain. *Table 1* lists some values for various gains. I've only tested the preamp at 60dB gain, so be forewarned if you use this circuit that the lower gain settings may require changes. The op amp may oscillate at high frequency at lower gain. A 100Ω resistor in series with the output to the cable should solve that. You may need to substitute an OP-27 (the OP-37's slower sister) or

another type for a 20dB gain setting.

The gain numbers I list are relative to the voltage you would see from the mike into the normally used 2.2k supply/load resistor, or across the mike's internal 2.2k resistor. Note that the very high gain I am using is intended for driving the speaker directly, and is so high that the preamp will clip with a rather low sound level at the mike. A more appropriate level for use with an amp or recorder would be 20-30dB.

The total electronics noise to 20kHz, measured with a resistor in place of the mike, is 2.1μV RMS (referred to the input). I can't

# TCH

**YOUR** *Handles • Corners*  
**ONE** *Speaker Grills • Casters*  
**SOURCE** *Speaker Carpet*  
**FOR** *Jack Dishes • Feet • Clamps*  
**SPEAKER** *Grill Cloth*  
**CABINET** *Plugs & Jacks*  
**COMPONENTS**

• **OVER 500 ITEMS IN STOCK FOR IMMEDIATE DELIVERY**

• **\$50 MINIMUM ORDER**



# TCH

**Phone 800-387-5122**  
**Fax (716) 892-4302**

**1705 Broadway**  
**Buffalo NY 14212**

TABLE 1

#### GAIN SETTING VALUES

Gain	R3,R4	R5
60dB	2.2M	590
50dB	698k	187
40dB	221k	59
30dB	69.8k	18.7
20dB	22.1k	5.9

Reader Service #48

Speaker Builder / 8/94 43



measure or hear any AC hum from it. The noise from the microphone element measures 70 $\mu$ V RMS. Obviously, the preamp doesn't add much to the total noise level. The maximum output level is 9V RMS. THD is high with the 600 $\Omega$  speaker load and 60dB gain.

At 8V output level, THD is typically 0.01% at 200Hz, 0.1% at 2kHz, and 1% at 20kHz. Without the speaker load, THD is 0.05% at 20kHz, and about 0.005% at 2kHz. THD would also drop in proportion to the gain setting. The frequency response of the preamp is +0,-0.1dB from 800Hz to 21kHz, and -3dB at 70kHz. The low cutoff is -3dB

at 132Hz. Crosstalk at the speaker terminals between any combination of channels is -50dB or better at any frequency, which is better than you need.

#### FUTURE EXPERIMENTS

Before formal testing, I will fully stuff the system out to 60 channels and eight glorious feet. Then I will adjust each individual channel for equal gain. The mike sensitivities currently vary by  $\pm$ 3dB or so. Then I will conduct the following tests in as unbiased, methodical, and blind a manner as practical, with a handful of individual listeners:

- Closed box around back of speaker without the large baffle—differences versus dipole?
- Source location in contrast with apparent position map
- General performance of 30 channels (80mm spacing)
- Minimum separation between sound sources before they blend together, 30 and 60 channels
- General listener comments—preferably to live music
- Frequency response at various source and listening positions (1/3-octave warble tones, calibrated to remove mike and source errors)
- Volume level versus source and listening distance, live versus reproduced

Available soon from Liberty Instruments, Inc.

The **Liberty Audiosuite** component test system for Frequency/Transient Response, Impedance, Distortion, and Spectral Energy

- **MLS testing** ... dual channel for fast, accurate and complete measurements
- **Gated Sinewave testing** ...for high dynamic range results at your choice of frequency points... with real (not just assumed) phase angle measurements
- **Steady State Sinewave testing** ...including measurement of harmonic distortion components as low as 0.03%; distortion vs. frequency plotting
- High purity multiprecision **programmable signal generator**
- **Impedance measurements** .... for analysis of electronic components and automatic determination of loudspeaker Thiele and Small parameters
- **Energy vs. Time displays** for acoustical analysis of rooms and speakers
- **Dual Channel Oscilloscope function** with movable markers
- **Waterfall plots** ...Cumulative Spectral Decay for resonance investigations
- **Powerful Data Conversion facilities** ...provide conversion between FFT derived data (constant frequency increments) and log frequency format spacing... or map data to user-defined frequency lists for ultimate compatibility
- **Programmable automatic operations** for efficient research testing or cost effective production testing
- Choice of **13 Sample Rates up to 48 kHz**, with digital/analog antialiasing
- **ASCII data export** for compatibility with popular design/simulation packages
- **2-channel, 16 bit acquisition**, with software controlled input/output gains
- Utilizes versatile and powerful, yet inexpensive **DSP-Based soundcard** (the Personal Sound Architecture family of soundcards featuring the **ADSP2115** processor) ...additionally provides standard compatible multimedia sound and synthesis functions
- **Easy, familiar operation** with on-line HELP
- Special discount for registered users of Liberty Instruments' portable IMP system

More than just an adaptation for an old-technology FM synthesis PC game board, **Liberty Audiosuite** is a high performance system based on advanced DSP and signal acquisition technology providing one of the most sophisticated measurement systems available. You can spend much more and not approach its versatility or capability. If you already have a kilobuck+ measurement system, you can still get the **Liberty Audiosuite** as an inexpensive afterthought...but bet you'll do more with **Liberty Audiosuite**!

availability: Early 1995



**Liberty Instruments, Inc., P.O. Box 1454, West Chester, Ohio 45071**

#### WHAT'S NEXT?

After all that, we'll have definite proof of the merits of the idea, and I'm sure the next steps will be to build a better speaker and more electronics, and to beg or borrow a gang of ADAT recorders. I could then record music and cart the system around for demonstrations.

I'd like to clear up a bit of terminology that seems to be misused: a line array with enough channels for the job is *not* "N-channel stereo," since it does not rely on your hearing mistakenly fusing the separate speaker sound sources to produce a "stereo illusion," but actually reproduces the various different wavefront directions regardless of whether a human is listening or not. And no Zen jokes please! (If no one is there to listen, does your stereo image well?...aargh.) It is an "N-channel line array." The hearing mechanism in use is your natural binaural one.

A correction to the last Linear Array article in the 5/94 issue: the polar plots were captioned as "Measurements," which they are not. They are simulations. Lastly, I'd like to thank Mr. Dell and *Speaker Builder* magazine for their support and interest. 

## Your Privacy Preserved On Request

We're very selective about making our subscribers' names available to organizations whose products, services or purposes we consider will be of interest or value. However, if you prefer that we keep your name to ourselves, please send a postcard to our circulation department saying so.

Reader Service #67

**STRUCTURAL HEARING:  
TONAL COHERENCE IN MUSIC**

**BKD17  
\$12.95**

*Felix Salzer*

In this two-volumes-bound-as-one book written by a pupil of the late Heinrich Schenker, the phenomenon of tonal organization in Western music is explored by means of a detailed analysis and discussion of more than 500 musical examples ranging in time from the Middle Ages to such moderns as Bartók, Hindemith, Prokofieff, and Stravinsky. Used in all important music schools, this book starts with basic definitions and simple examples, and trains the reader not only to hear successions of tones, melodic lines, and progressions of chords, but also to understand their structural coherence and significance. It is invaluable for musicians and all who are seriously interested in music, whether as a student, critic, performer, or conductor. 1952, 1982, 672pp., 5 3/8 x 8 1/2, softbound.

**HARMONICS: A FIELD HANDBOOK  
FOR THE PROFESSIONAL AND NOVICE**

**BKS49  
\$24.95**

*Mark Waller*

Many operational problems can be solved through an understanding of power system harmonics. As life/safety issues become more and more important in the world of electrical power systems, the need for harmonic analysis becomes ever greater. This book is the essential guide to understanding all of the issues and areas of concern surrounding harmonics and the recognized methods for dealing with them. Covering nonlinear loads, multiple PCs, notching, K-factor transformers, and much more, this volume is a useful tool for system and building engineers, electricians, maintenance personnel, and all others concerned about protecting and maintaining the quality of electrical power systems. 1994, 132pp., 7 3/8 x 9 1/4, softbound.

**WHAT'S A SEQUENCER?**

**BKHL5  
\$5.95**

*Greg R. Starr*

Sequencers are becoming a fact of life in today's music scene. These wonderful tools are now available to you at home, where you can use them to produce exhilarating and inspiring music without a lot of fuss and without having a big-budget recording contract or large family inheritance. If you own a sequencer, this book will cover both the basics of using it and the more advanced goodies that are available on some models. If you don't have one and are thinking of buying one (or a keyboard with one built-in), you'll find enough info here to ask the right questions to decide which model is right for you. 1990, 62pp., 6 x 9, softbound.

**THE PENGUIN GUIDE TO JAZZ  
ON CD, LP & CASSETTE**

**BKP9  
\$22.95**

*Richard Cook, Brian Morton*

You'll find the answers to all your jazz recording questions in this volume, the first comprehensive, critical listing covering all jazz recording currently available. From the earliest days of the Original Dixieland Jazz Band to the most recent recordings by today's young stars, each entry has been carefully rated by leading jazz critics Richard Cook and Brian Morton. Included are musical and biographical info; full lineup details; recording information; accurate label/number details; authoritative critical ratings; full index; and special sections for "Anthologies" and "Various Artists" collections. United Kingdom, 1992, 1287pp., 6 x 9 1/4, softbound.

**HOW TO TEST ALMOST EVERYTHING ELECTRONIC**

**BKMH10  
\$14.95**

*Delton T. Horn*

This third edition has all the practical, hands-on guidance you need to troubleshoot efficiently with today's electronic test equipment. Filled with helpful examples of typical circuits and easy-to-follow instructions, the book shows you how to pinpoint problems in all types of electronic systems, from TVs to VCRs to computers. In addition to learning how to use multimeters, oscilloscopes, signal generators, logic probes, voltmeters, and ohmmeters, you'll be taught how to repair mechanical components and how to use flowcharts when troubleshooting. 1993, 326pp., 7 3/8 x 9 1/4, softbound.

**LOUDSPEAKER SOF-LAD1B3G  
ANALYSIS AND DESIGN \$134.95  
PROGRAM (LADP) SOFTWARE  
FOR WINDOWS**

*G&J Technologies*

This new loudspeaker engineering tool for Windows combines visual interface and electroacoustics into a flexible loudspeaker designer and analyzer. Modeling, small signal analysis, and design for ported (standard or isobarik), sealed (standard or isobarik), bandpass, tubed, and horn-loaded enclosures are provided. For ported enclosures, the design can be changed to see the effects of different port frequencies and/or box volumes. Bandpass enclosures of orders four through seven can be designed and effects of changing the rear and/or front box tuning, or changing the rear and/or front volume, can be tested. Tubed enclosures, ideal designs for truck speakers, can be designed for any diameter. Large signal analysis is provided for ported (standard, series isobarik, or parallel isobarik) and sealed (same) enclosures. An active high pass filter (orders one through four) can be used to act as a subsonic or rumble filter. Large signal analysis shows the relative on-axis response (SPL) at one meter, as well as the maximum input wattage per frequency. Port dimension calculation for all designs and one to four ports is also available, as is enclosure dimension calculation for all types covered.

LADP also can design high- and low-pass filters of order one through four. Individual types include Linkwitz-Riley, Chebyshev, Legendre-Papoulis, Butterworth, and Bessel. Bandpass filters of order one or two can also be constructed for all the above types except Bessel. Small signal analysis can show up to three filters at a time and include the dB response and phase angle. Further, the polarity of the high-pass filters can be reversed to show the effects of in-phase and out-of-phase filter designs.

Loudspeaker directional quality can be seen graphically as a polar plot. The off-axis response is shown from -90 degrees to +90 degrees. This can be a useful tool in determining the upper cutoff frequency of a low-pass or bandpass filter, and the high frequency "beaming" effects of the speaker can also be tested. If you have a sinewave generator, voltmeter, frequency counter, and 1000-Ohm and 10-Ohm resistors, you can also measure Thiele-Small parameters. A graph of the voice coil impedance in free air can be shown, as well as the output parameters: Vas, Qts, Qes, Qms, Ras, Mas, and Cas.

Some basic architectural acoustics such as room reverberation, impulse response, and room modal frequency distribution can also be explored with LADP. A graphical room modal frequency response will help the user to determine how the room reacts to certain frequencies, as will the decay response to a tone burst for frequencies at 125, 250, 500, 1000, 2000, and 4000Hz.

On-line help provides a supplement of information for each dialog box. It also contains helpful hints for designing, building, and testing enclosures and crossovers, as well as general car stereo information. Background information on acoustics, electrical/stereo components, and speaker designs is also available, as are a glossary, program overview, program utilization info, graph interpretation guide, and definition of every prompted input.

NEW IN LATEST VERSION: addition of network drive search at installation time; replacement of vented enclosures with eq by sixth-order active-filtered enclosures, schematic and print capability; replacement of sealed enclosures with eq by fourth-order active-filtered enclosures, schematic and print capability; addition of cone excursion and port air exit velocity calculations to the Loudspeaker Sound Pressure option; addition of summed loudspeaker(s)' acoustical response and loudspeaker enclosure system phase modeling into the Crossover/Driver Interaction option; improvement of bandpass enclosure modeling transfer functions, with more custom designing options for bandpass analysis; improvement of Windows system resource usage in the repaint routines; and addition of passive radiator design and analysis.

All output can be printed to the Windows default printer in either portrait or landscape mode. System requirements: 2Mb RAM, 3.3Mb hard disk space, MSDOS5.0 or later, Microsoft Windows 3.1 or later, math coprocessor. 2 x 3-1/2" DS/HD.



<p><b>OLD COLONY SOUND LAB</b> PO Box 243, Department B94 Peterborough, NH 03458-0243 USA 24-Hour Lines: Telephone: (603) 924-6371 or (603) 924-6526 FAX: (603) 924-9467</p>	<p><b>OUR DISCOUNT POLICY</b></p>		<p><b>PLEASE BE SURE TO ADD SHIPPING CHARGES</b></p>					
	<p>Order Value</p>	<p>Discount</p>	<p>Shipping Charge According to Destination and Method Desired (\$)</p>					
<p>&lt;\$50.00</p>	<p>0%</p>	<p>United States</p>		<p>Canada</p>		<p>Other</p>		
<p>\$50.00-\$99.99</p>	<p>5%</p>	<p>Order Value</p>	<p>Surface</p>	<p>Air</p>	<p>Surface</p>	<p>Air</p>	<p>Surface</p>	<p>Air</p>
<p>\$100.00-\$199.99</p>	<p>10%</p>	<p>&lt; \$50.00</p>	<p>3.00</p>	<p>7.50</p>	<p>5.00</p>	<p>7.50</p>	<p>10.00</p>	<p>20.00</p>
<p>&gt;\$200.00</p>	<p>15%</p>	<p>\$50.00-\$99.99</p>	<p>4.00</p>	<p>15.00</p>	<p>7.50</p>	<p>15.00</p>	<p>20.00</p>	<p>30.00</p>
		<p>\$100.00-\$199.99</p>	<p>5.00</p>	<p>20.00</p>	<p>15.00</p>	<p>20.00</p>	<p>30.00</p>	<p>40.00</p>
		<p>&gt; \$200.00</p>	<p>6.00</p>	<p>30.00</p>	<p>25.00</p>	<p>30.00</p>	<p>40.00</p>	<p>50.00</p>
<p>Mastercard, Visa, Discover, check or money order in US funds drawn on US bank.</p>								





**AIRR (ANECHOIC SOF-AIR1B3G IN ROOM RESPONSE) \$49.95**

**SOUNDBLASTER SOUND CARD SPEAKER RESPONSE SOFTWARE**

*Julian J. Bunn*

NEW FROM SWITZERLAND! AIRR is a program that offers a cheap alternative to loudspeaker measurement for owners of PCs equipped with a SoundBlaster or compatible sound card. Based on the principle of pulse mode excitation of the loudspeaker followed by Fast Fourier Analysis, AIRR features full color real-time plotting of both the digitized pulse received by the microphone and the frequency response of the loudspeaker system. AIRR is controlled by a single key stroke and data entry at the keyboard, and full on-line help is supported. You can toggle between several

modes of operation, which include Loudspeaker/Amplifier response measurement, Time/Frequency averaging, Square/Sin(x)/x pulse types, and Pulse On/Off. For anechoic measurements, cut markers allow a window to be placed over the time data in order to remove the part due to room reflections. Frequency response spectra obtained can be stored as ASCII files on disk, which then can be subsequently read back in by AIRR and subtracted from and/or overlaid on the current spectrum. Using the subtraction feature allows corrections to be applied for amplifier or microphone response. The AIRR display itself can be "captured" into a PC Paintbrush (PCX) file, which may then be included as graphics in a document.

The AIRR software includes operating instructions combined with on-line help, last minute changes and instructions, the AIRR article itself from *Speaker Builder* 8/94 (in Word), and a sample file containing microphone response data. AIRR requires a PC equipped with a SoundBlaster 16 sound card (or compatible, such as the MediVision Pro 16); VGA screen with at least 640 x 480 resolution, preferably color; microphone (usually supplied with the sound card, although a calibrated microphone such as Old Colony's Mitey Mike is often desired); and loudspeaker to test! Math coprocessor not required. 1 x 3-1/2" DS/DD.

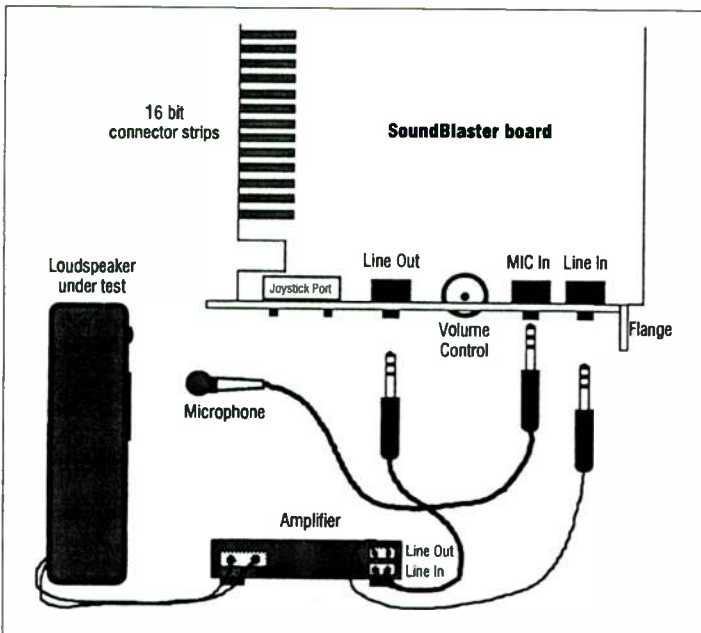

**THE COMPLETE GUIDE TO HIGH-END AUDIO**

*Robert Harley*

**BKAP1  
\$29.95**

Written for beginners and experienced listeners alike, this is the first book that tells you everything you need to know about buying and enjoying high-quality hi-fi. In 13 easy-to-read and fact-filled chapters, the author, a Consulting Technical Editor for *Stereophile*, shares secrets on how to get the maximum enjoyment out of audio. This book has it all, from nuts and bolts tips on hi-fi equipment to suggestions on becoming a better listener.

With this book, you'll find out how to get high-end sound at low prices; identify the weak links in your present system and upgrade where it will do the most good; discover how to tweak your system to get maximum performance from equipment you already own; learn how to read equipment reviews and determine why the components that sounded so good in the showroom don't sound so good at home; identify the qualities that will make you a more appreciative and perceptive listener; and best of all, learn how to keep hi-fi fun! 1994, 450pp., 7 x 10, softbound.

**CHRISTMAS IN EARLY AMERICA CD: 18TH CENTURY CAROLS AND ANTHEMS**

**CDAL1  
\$16.95**

*The Columbus Consort*

This unique CD will make a great stocking stuffer for any audiophile, including you! Recorded in The Netherlands and produced in Germany by Channel Classics, *Christmas in Early America* brings a new sound to the holiday season, as well as an interesting and superbly crafted conversation piece. The Columbus Consort consists of the delightful mix of two violins, cello, bass, organ, and vocal quartet. Thirty-page booklet in English/French/German includes historical background as well as lyrics. 1993, 55:40.

Contents: [1] "How Beauteous Are Their Feet" (Supply Belcher). [2] "How Beauteous Are Their Feet" (Samuel Holyoke). [3] "Anthem for Christmas" (Benjamin Carr). [4] "If Angels Sung a Savior's Birth" (Joseph Stevenson). [5] "Th'Almighty Spake, and Gabriel sped" (Samuel Holyoke). [6] "Comfort Ye My People" (Samuel Holyoke). [7] "Hark! The Glad Sound" (John Jenkins Husband). [8] "While Shepherds Watched Their Flocks by Night" (Musgrave Heighington). [9] "While Shepherds Watched Their Flocks by Night" (Jacob French). [10] "While Shepherds Watched Their Flocks by Night" (William Billings). [11] "Unto Us A Child Is Born" (Johann Friedrich Peter). [12] "Prince of Peace, Immanuel" (John Antes). [13] "Hail Infant Newborn" (David Moritz Michael). [14] "To Us A Child Is Born" (Johannes Herbst). [15] "Thou Child Divine" (Johann A.P. Schulz). [16] "Meine Seele erhebet den Herrn" (Jeremiah Dencke). [17] "Hosanna! Blessed He That Comes in the Name of the Lord" (Christian George). [18] "Magnificat anima mea Dominum" (Charles Theodore Pachelbel).

**SOUND SYSTEMS FOR YOUR AUTOMOBILE**

**BKS48  
\$16.95**

*Alvis J. Evans, Eric J. Evans*

Whether you're starting from scratch or upgrading, this book will show you in easy-to-follow steps how to plan your system, choose components and speakers, and install and interconnect them to achieve the best sound quality possible. Installations on specific types of vehicles are discussed, including separate chapters on coupes and sedans, hatchbacks, pick-up trucks, sport utility vehicles, and vans, so you're sure to find the information you need for your vehicle. Also included are a complete glossary and an entire chapter devoted to speakers. 1993, 124pp., 6 x 9, softbound.

**AMAZING KOONCE UTILITY DISK #1**

**SOF-KUD1BXG  
\$7.95**

*G.R. Koonce*

This valuable disk contains two programs to benefit just about anyone! CONVERT1.EXE displays instantaneous, simultaneous English and metric values for linear, area, and volume measurements in inches, feet, yards, millimeters, centimeters, and meters. The volume screen also includes liters. On-screen help (hardly needed) is available. PRECRES2.EXE requires VGA to display its amazing wares: instantaneous interpretation of metal film resistor color bands! You can either enter a value and see the band colors appear on the screen, or enter the colors of your mystery resistor and have the program tell you its value. Good for up to 10 megohms, and includes three significant digits, multiplier, and tolerance. Printer option. IBM, requires VGA, 1 x DS/DD—PLEASE SPECIFY DISK SIZE.

**OLD COLONY SOUND LAB**

PO Box 243, Department B94  
Peterborough, NH 03458-0243 USA  
24-Hour Lines:  
Telephone: (603) 924-6371 or  
(603) 924-6526 FAX: (603) 924-9467

**OUR DISCOUNT POLICY**

Order Value	Discount
<\$50.00	0%
\$50.00-\$99.99	5%
\$100.00-\$199.99	10%
>\$200.00	15%

Mastercard, Visa, Discover, check or money order in US funds drawn on US bank.

**PLEASE BE SURE TO ADD SHIPPING CHARGES**  
Shipping Charge According to Destination and Method Desired (\$)

Order Value	United States		Canada		Other	
	Surface	Air	Surface	Air	Surface	Air
<\$50.00	3.00	7.50	5.00	7.50	10.00	20.00
\$50.00-99.99	4.00	15.00	7.50	15.00	20.00	30.00
\$100.00-199.99	5.00	20.00	15.00	20.00	30.00	40.00
>\$200.00	6.00	30.00	25.00	30.00	40.00	50.00

# Wayland's Wood World

## GRILLE FRAMES

By Bob Wayland

The treatment you give your speaker grille attracts attention to your craftsmanship and shows off the care and pride you have put into your enclosure design. Sure, the real part of your speaker is everything else, but we are judged by that first appearance. This column is for the builder who wishes to finish the speaker enclosure with an attractive window dressing.

### TABLE SAW JIG

Most enclosures are square or rectangular, although some interesting ones are not. The traditional approach sets off the exposed speakers with a frame, onto which a covering or grille—usually of cloth, metal, or plastic—is placed. I will first describe a table saw jig that helps ensure the grille frame pieces are cut to the correct angle, which I call the *reference angle*. It is the angle made by the frame at any corner of your speaker. If your

speaker is rectangular, the reference angle is 90°. (I will also suggest how to use this guide with radial arm saws.)

You can easily adapt the design for angles other than 90°; just use the non-90° angle for the reference angle. If your enclosure is irregular, you can have more than one reference angle. For the smallest size jig you need a *mounting board* of at least 16" x 24". I used an old piece of 3/4" A/B pine plywood, but just about any flat surface will work fine.

Now you need to cut two *guide bars* to fit snugly into the miter slots on your table saw. These should be made from hardwood or metal. For most saws, the cross-section dimensions are about 3/8" x 3/4". The length of the guide bars should be at least the width of the mounting board (16" if you are using the minimum size jig). You will gain a bit of stability if you cut the guides a few inches longer than the minimum. The problem, however, is that the dam things stick out, so you must be careful not to catch yourself on the jig or other protrusions.

Place the guide bars in the miter guide slots

guide bars (making sure the long dimension is perpendicular to the miter guide slots). The enlarged hole will allow you to make any fine adjustments that you might need.

### CUTTING SQUARE CORNERS

Next you will need a guide, mounted on the mounting board, for your reference angle. If

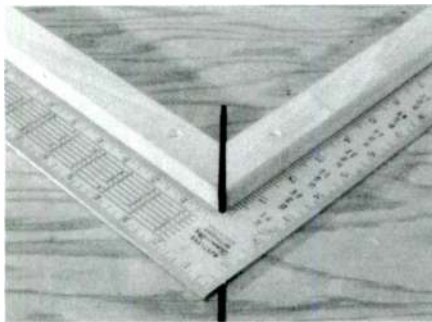

PHOTO 1: Using a framing square to check the reference angle on the jig.

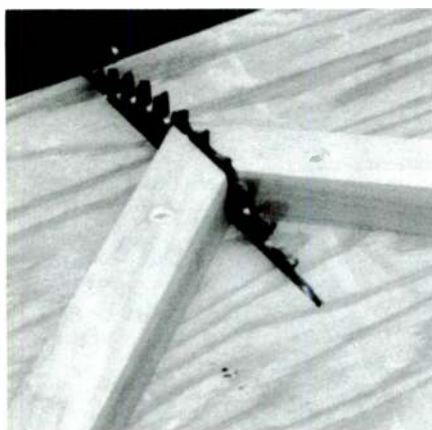

PHOTO 2: Cutting the slot in the jig. Note that the top of the saw blade has just passed the apex of the guide.

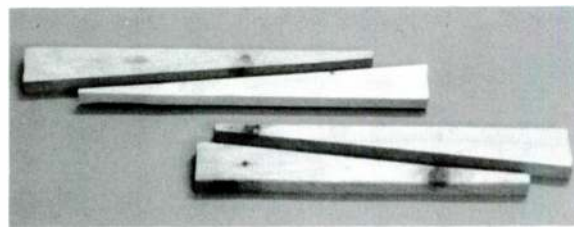

PHOTO 3: Wedges for clamping the sides in place on the jig. It is a good idea to cut a few extras.

on your saw. Carefully align the mounting board so that the long dimension is perpendicular to the miter guide slots and the centerline of the mounting board passes through the saw blade. Drill guide holes through the mounting board into the guide bars, being careful not to drill into your saw table. Remove the mounting board and drill out the guide holes so they are about 1/16" larger than the flat-headed screw you will use to attach the mounting board to the guide boards.

Be sure to countersink the screw holes. If you are using wooden guide bars, put some glue on them; otherwise, drill and tap the guide holes in the metal bars for the attachment screws. With the guide bars in their slots, replace the mounting board on the

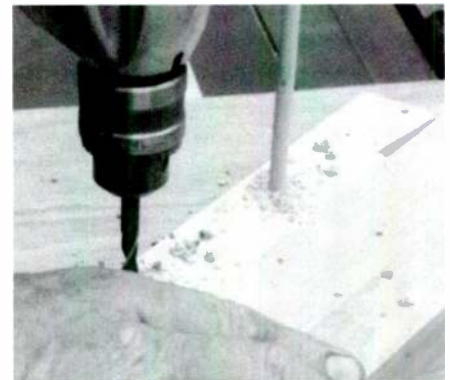

PHOTO 4: Aligning the wedges to give proper clamping of the frame sides.

you plan to cut a number of different angles, make a set of separate guides for each. The easiest reference angle guide to make is a solid isosceles (two sides equal) triangular piece of wood with the base opposite the reference angle.

Of course, it is critical that your saw is perfectly aligned when you make the guide. Attach the guide to the top plane of the mounting board so that the side opposite the reference angle, the base, is parallel to the long dimension of the mounting board (perpendicular to the guide bars). The apex of the

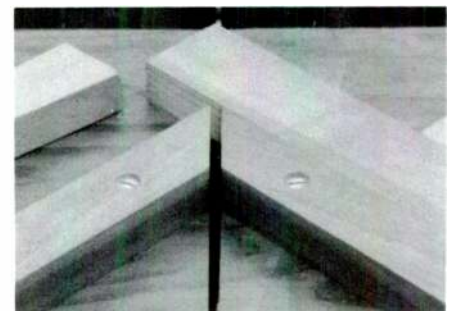

PHOTO 5: Clamping the side piece for the initial cut on the jig.



triangle should be about 3" from the front edge of the mounting board and on the centerline of this board.

You can accomplish the same effect as the reference angle guide by cutting two guide strips, at least 12" long, from straight 1" x 2" stock. Place the strips on the mounting board so that they intersect the centerline at an angle one-half the reference angle. *Photo 1* shows how to do this for a reference angle of 90°. (It is important that the strips exactly form the reference angle.) Attach the strips to the mounting board at the correct angle about 3" from the forward edge of the mounting board to the intersection of the guide strip with the board's centerline. If you will always be cutting the same angles, it is a good idea to glue the strips in place; however, if you plan to cut different angles, attach them with a minimum of two screws each.

### CLAMPING DOWN

Once you have attached the reference angle guide(s), put a fine-toothed blade on the saw you will use to cut the miters for the corners of your grille frame. Then, with the jig in place, cut just past the apex of the guide(s) over the arbor of the saw (*Photo 2*).

When you use this jig, clamp the sides of the grille frame to be cut tight against the reference angle guides. If you don't clamp the sides, they will almost always slip during the

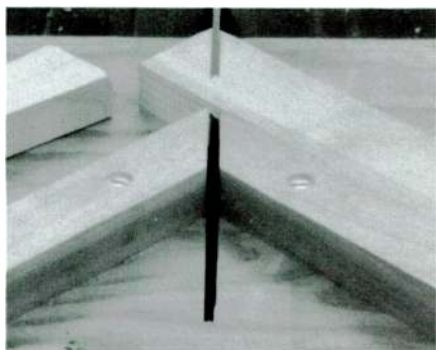

PHOTO 6: Making the initial cut of the clamped side piece.



PHOTO 7: Removing a tight wedge.

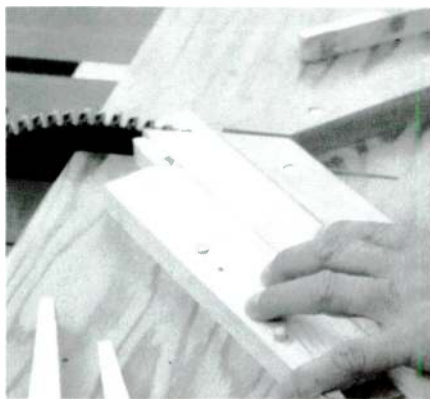

PHOTO 8: Cutting the opposite end of the side piece. Be sure to check that the piece has the correct orientation.

cutting and produce an unwanted gap in the corner joint. You can do this with C clamps or with hold-down clamps that attach to the mounting board. When you use C clamps, you risk denting the wood and having the clamps get in the way of the saw blade. But the hold-down clamps are relatively expensive, and you'll be spending money for something you will only occasionally use.

The wedge is a simple, inexpensive alternative. Cut four wedges (*Photo 3*) from scrap stock, the same thickness as the grille sides, about 10" long and 1.25–1.5" wide at the thickest part. On the long dimension of two wedges measured in thirds, drill 1/4" holes perpendicular to the flat side at the first and second points. Now with the grille side piece next to the reference angle guide, place one drilled wedge and one undrilled wedge as shown in *Photo 4*.

Using the holes as guides, drill a 1/4" hole into the mounting board. Put a 1/4" dowel into the hole to act as a guide, and drill the other hole in the wedge so that the top edge is parallel to the side piece. Repeat this operation on the other side. Cut four 1" long pieces from a 1/4" dowel and insert them through the drilled wedges and into the mounting board. Now it is a simple matter to tap the wedges tight to clamp the sides firmly in place.

Also, if the side pieces are smaller or larger than it is possible to clamp with your wedge spacing, drill a new set of holes in the mounting board and move wedges to fit as needed. Or you can drill a series of holes with about 1" spacing and be ready for anything!

You can also use this same basic jig with a radial arm saw. Make the jig as described above, but don't attach the miter guide bars and don't cut through the mounting board. Clamp the mounting board to the saw table so the saw blade will cut through the apex of the reference angle guide. It is essential to accurately align the kerf with the saw blade each time you use it.

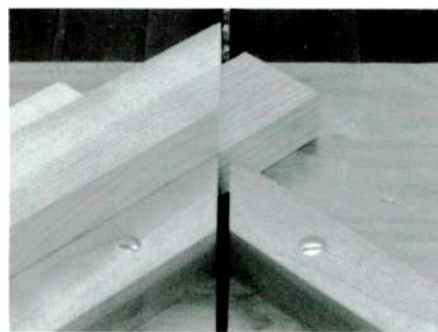

PHOTO 9: Using a cut piece to check the alignment for making a second identical piece.

### CUTTING A GRILLE FRAME

The wood you use to make your grille frame should be straight-grained and free of knots or other irregularities. If you have a choice, use quartersawn boards, often sold by specialty lumberyards for facings on cabinets. To be absolutely certain the frame members are exactly the same thickness and width, you can often cut all the frame members from the same board.

After choosing the material for the grille

*Continued on page 66*

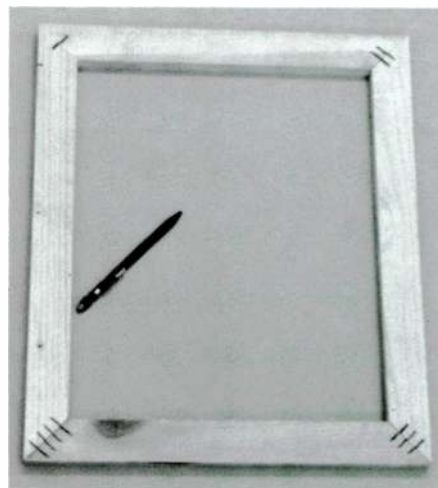

PHOTO 10: Marking the order of the joints for your frame. In practice, you need only make light marks that can be easily erased, not the heavy ones used here for illustration.

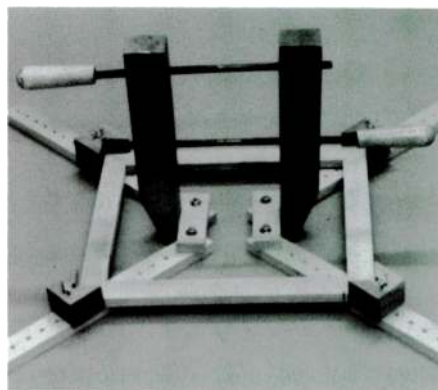

PHOTO 11: Clamping the grille frame for gluing.

# Software Report

## PC AUDIOLAB

Reviewed by Richard Campbell  
Contributing Editor

PC AudioLab<sup>®</sup>, Microacoustics Audio Software Products, 2553 Carpenter St., Thousand Oaks, CA 91362, (805) 495-8945. System requirements: IBM 386/486 AT; 4MB RAM memory; VGA graphics display; SoundBlaster<sup>®</sup> or Media Vision<sup>®</sup> 16-bit sound card.

PC AudioLab from Microacoustics Audio Software Products is a very ambitious program. Since I did not run all of it under ideal circumstances, I will start this review with a few words of counsel.

A review for *SB* readers is difficult at best for any graphics-intensive software package. Everyone reacts differently when faced with the personal nature of the user I/O (i.e., what you must do to the mouse or the keyboard to get some action, and what you see on the screen as the result). Each user is apt to love or hate the things that, respectively, I hate or love. It's all about what we are used to.

This program turns a PC into a digital laboratory instrument, of which I have used many, so my interpretation of its actions is judged in light of this experience. Another person currently using an oscillator, voltmeter, and scope would be mighty impressed by its capabilities. My annoyance might be your deliverance.

A program's full capability is best learned from the manufacturer's brochure. If you like what I say, send for the brochure and decide on the functionality and applicability to your case based upon that information and not wholly upon this review. I have six different loudspeaker/box design software packages which give exactly the same numbers because they can each add two and two and get four, but they differ dramatically in how they relate to me, the user.

Software should be robust, stable, nimble, unimposing, well structured, thoughtful in screen presentations, and come with a very good manual. After several days of working with PC AudioLab I am beginning to have fun with it. I have mastered the keystrokes and mouse buttons, and I am inside the programmer's head. Since the software drives a commercial multimedia I/O card, nimbleness is *not* one of its virtues.

### WHAT'S INSIDE?

Your PC essentially becomes a two-channel digital scope with lots of bells and whistles.

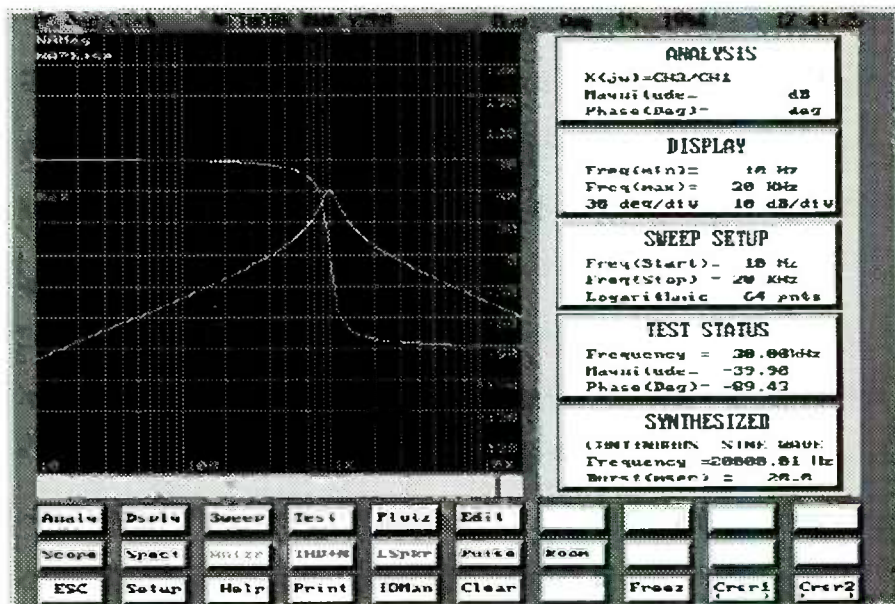

FIGURE 1: Typical PC AudioLab display screen

The program author supplied me with a beta test Version 2.0, and I used the SoundBlaster 16 board from Creative Labs as the hardware interface for signal generation and data acquisition. This popular card is widely used in MIDI and multimedia applications, so many potential PC AudioLab users need only purchase the software. The program addresses the sound card directly, not requiring any SoundBlaster software drivers or environment statements. It can also talk to the Media Vision Proaudio Spectrum 16 card.

An important fact is that the package uses a DOS extender, in this case one

called Ergo. It manages memory above 1MB in its own way, and is a good solution for memory-hungry programs and for those which use DMA and need large blocks of RAM with data structures habitually transcending 64K segment boundaries.

The big problem with DOS extenders is that they conflict with existing memory managers. In fact, conflicts are so certain no matter how much RAM you have that you might just as well trash all the memory managers in your CONFIG.SYS file before attempting to run this program. After all the blood, sweat, and tears working to stuff everything you need into

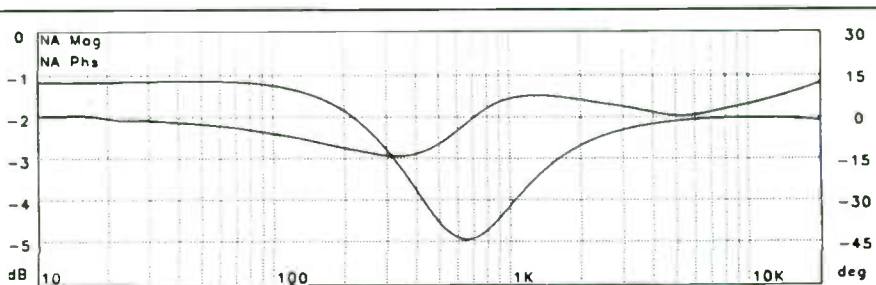

FIGURE 2: Transfer function magnitude and phase for a passive notch filter with a 5Ω resistive load.



RAM's nooks and crannies, you can run this large and complex program with just two statements in CONFIG.SYS: FILES=40, BUFFERS=30.

I suggest making a clean-boot floppy, or activating one of the modern DOS configuration selection features that can show a menu prior to boot. You can call a menu item "audio," which will then produce an ultra-simple boot for running PC AudioLab. [MS DOS 6 and Novell DOS 7 both allow a multi-boot facility to configure memory in various configurations.—Ed.]

### INSTALLATION

The entire program installs into a single directory consuming 2,964,240 bytes. My beta copy uses the SoundBlaster card, so the distributed version may take more or less space. Also, the disk space allocation is dynamic, as the program always saves the last thing you were working on and restores it next time around. A software security system requires the master floppy be in a drive to start the program. Installation takes only a few minutes, and is effortless thanks to the EZI® installer. If you don't prepare your machine for a clean boot prior to installation, there are plenty of dire warnings about what to do before running it.

I had clean-booted my computer but left the disk cache functional. Even though I have a

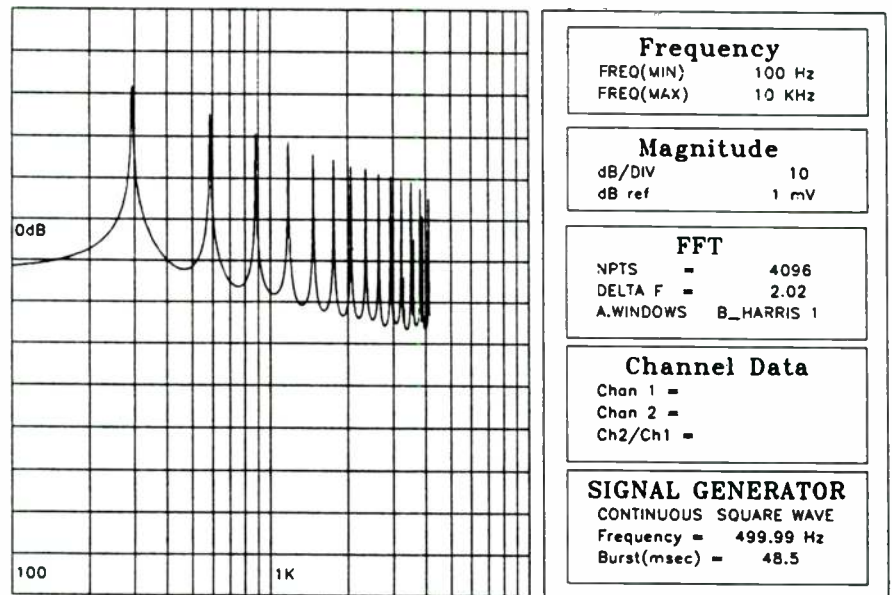

FIGURE 3: Spectrum analysis of 50% duty cycle half-triangle function generator output.

486-33 with eight megs, the presence of SUPERPCK caused a bizarre problem alluded to in the manual. Repeated punching of the left mouse button caused the screen to scroll up. An error message apparently was being written in the same color as the background, and when it got to the bottom the background

scrolled up. Goodbye, SUPERPCK. I'm now stuck with slow disk reads, because when I call for a screen dump the graphics print driver takes forever.

Problems with the software protection scheme were largely my fault. Whenever I tried a new function I had to rearrange my

**FOTAL**

**ACCUTON**

**ORCA CONNECTORS**

**SR**

**SPEAKERS**

QUALITY DRIVERS & MORE

etc.

**Regulus**

CUSTOM SPEAKER CABLES & INTERCONNECTS

AUDIO **ERSE** ELECTRONICS

INDUCTORS

**polyda**

SPEAKER CORPORATION

Speaker Kits Available

**We Offer State Of The Art Speaker Components and Kits  
(Specializing in Speaker & Crossover Design)**

**Request a FREE catalog**

1828 W Peoria  
Phoenix, AZ 85029  
Phone (602) 944-1878 FAX (602) 371-0605

(Mntn Std Time)  
10:00 AM-7:00 PM Weekdays  
10:00 AM-5:00 PM Saturdays

lab, so the program ran in fits and starts. Seems like every third time I tried to boot some bizarre event would happen. More than once I started it with the master floppy in Drive B to see the Drive A light come on, then go out—*novissima verba!* Once I was interrupted by a phone call, and when I got back Drive B was spinning and a message read “put master floppy in drive \_\_\_”—*obiit sine prole!* Several times the message “cannot enable A20” appeared, and if I simply retyped the command line everything was fine. (Maybe I should consult Wotan.)

I can't blame the program author for incorporating protection, but other truly stable systems are available. Furthermore, they allow backing/restoring the protected directory to floppies or tape, provided the directory is restored on the same computer. I run a suite of room acoustics analysis programs with a retail value of \$11,000 which are software-protected in this fashion. I am allowed a preset number of loads but an unlimited number of restores from a backup copy onto the same CPU.

#### GETTING FAMILIAR

You work with screen pushbuttons. As you move the mouse, different buttons flash and the left mouse button (LMB) activates a particular one. The scope display is on

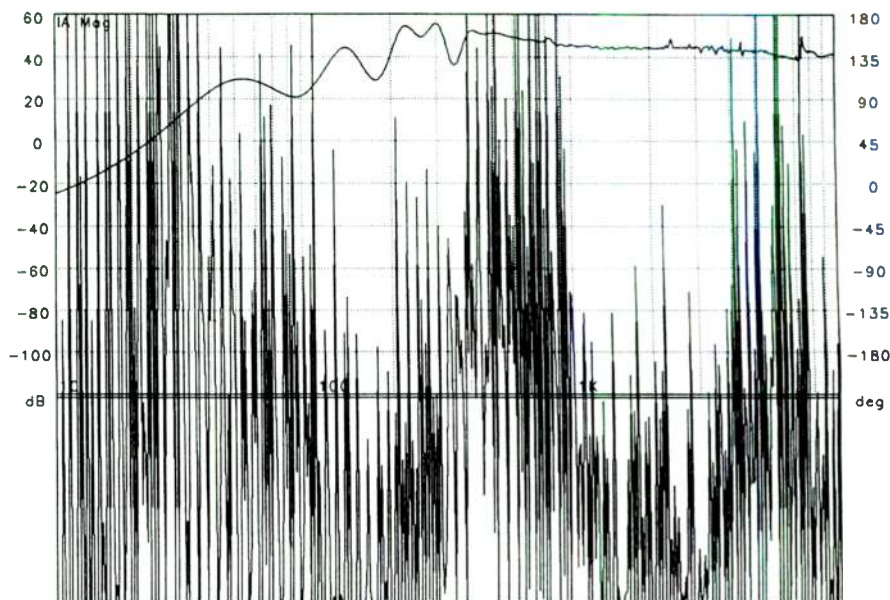

FIGURE 4: Loudspeaker impulse response 2cm from cone using a GRSLM calibrated microphone. The bottom window is supposed to display the average of ten impulses, but the scaling is incorrect so the points are scattered vertically over the whole plot.

the screen's upper left, the acquisition and signal settings are reported in five large boxes to the right, while the action buttons are along the bottom. I can't show you a typical screen from my computer because, of the three screen grabbers I own, none

would allow PC AudioLab to load with them while they were TSRs. Plenty of screen shots appear in the manual, however, so something must work with this program. The program author has kindly supplied a screen shot (Fig. 1).

# MENISCUS

Proudly supplies:

#### CAPACITORS -

- Polypropylene
- Mylar
- NP Elec.

#### INDUCTORS -

- Air Core
- Ferrite Bobbin
- 20 - 14ga. OFC

#### RESISTORS -

- Wire wound
- Non - Inductive
- 5 W - 25 W

#### ACCESSORIES -

- Terminal cups
- Gold posts
- Speaker cabinets
- Wire & connectors
- Grille cloth & fasteners
- Black screws
- Port tubes & trim
- Spikes & cones
- Damping materials
- Design books
- Custom foam grilles

**MENISCUS - 2575 28th St. SW #2 - Wyoming, MI 49509**  
 (616) 534-9121 FAX (616) 534-7676

## SPEAKERS -

**AUDIO CONCEPTS**  
**CERATEC**  
**DYNAUDIO**  
**ECLIPSE**  
**ENTRÉE**  
**ETON**  
**EMINENCE**  
**FOCAL**  
**MB**  
**MADISOUND**  
**MAGNAT**  
**MOREL**  
**POLYDAX**  
**PEERLESS**  
**SCAN SPEAK**  
**SWAN**  
**VERSA/TRONICS**  
**VIFA**



The three rows of ten action buttons are used depending upon which measuring function is currently active. The bottom row controls the system and readout cursor; the middle row selects a function; the top row allows you to detail that function. In the event your mouse gets eaten by the cat (which the manual says sometimes happens), there are logical ways to access the screen buttons: F1-F10 for the top, Alt-same for the middle, and Ctrl-same for the bottom. Unfortunately, no clues appear on the screen for these substitutes.

As a first step, be sure the software can talk to the SoundBlaster card. Push the <Setup> button and read what the top right box reports for DMA channel and I/O address. Between the SoundBlaster and PC AudioLab manuals, plenty of good advice is available for getting it right. A <Help> button elicits some highly condensed but well-written contextual help inside the upper left scope-screen box. I used DMA Channel 5 and port 220 for the SoundBlaster.

### SCOPE & SIGNAL GENERATOR

Now let's see if the signal generator will run. Plug a Walkman-type headset into the SoundBlaster output port, BUT DO NOT PUT IT ON BECAUSE YOU DON'T KNOW WHAT THE AUDIO LEVEL WILL BE! Place the headset where you can hear it squeal. If <Oscil> (scope) in the middle row does not light red, push that button first. Then select <Sigen>, which appears on the top line because it's a scope detail setting. Ahhh...the mouse won't go to <Sigen>.

Once the scope is switched on, and while it is reading and processing the input to the SoundBlaster card, it cannot service the mouse. Two solutions to this problem exist.

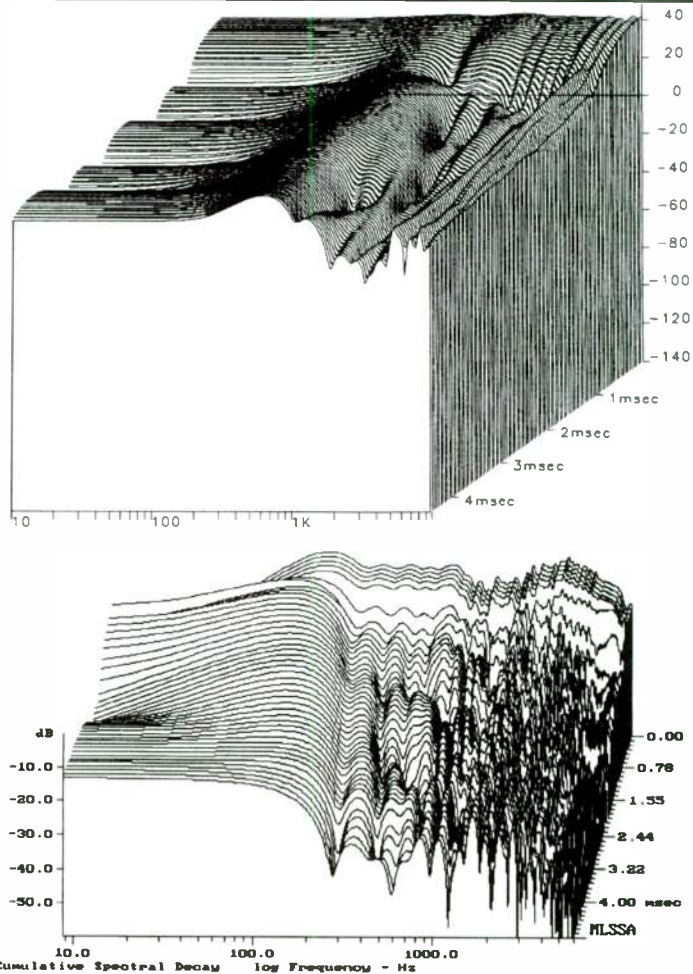

FIGURE 5: Cumulative spectral decay plots from PC AudioLab (top) and MLSSA (bottom) for the same experimental setup. The top plot illustrates the need for additional facility for scaling and zeroing the data.

One is to type Ctrl-F8, which is a <Freeze> button. At the end of the acquisition cycle, this button turns red and you can now use the

mouse to freely access the other buttons. The second solution is to hold down the LMB until the acquisition cycle stops, placing you

## THE SOUND OF PROFESSIONAL MONITORS AT A PRICE THAT SOUNDS EVEN BETTER

NOW YOU CAN MAKE AN EXCELLENT MONITORING SYSTEM FIT YOUR BUDGET.

For over a quarter of a century Wilmslow Audio have been "the firm for speakers" stocking the widest range of speaker drive units and speaker kits from most of the leading manufacturers and designers. Hi-fi products, Professional monitors, and Public Address equipment—all selected for sound design and reliability and in keeping with the Wilmslow Audio philosophy of value for money.

### •SPL1

Near field monitor, reflex loaded design, utilising drive units manufactured by MOREL. Flatpack cabinets machined from 18mm M.D.F. **Cost £196**

"A really good monitor for under £200"

"I was immediately impressed by the sound which was surprisingly powerful and solid for such a small unit"

Paul White, Recording Musician, May, 1990

### •VOLT HOME STUDIO MONITOR

It's not a case of "these are good for a kit," these are good—full stop. The combination of bass extension and total "honesty" will be appreciated. **Cost £420**

### •ATC K50/K100

A joint venture using the highly acclaimed ATC Loudspeaker Technology and Wilmslow Audio, has resulted in the ATC K50 and ATC K100 Loudspeaker kits.

Available in  
 •ATC K50 (Passive) - £1,850 (Active) - £2,895  
 •ATC K100 (Passive) - £1,950 (Active) - £2,995

Wellington Close, Parkgate Trading Estate, Knutsford,  
 Cheshire WA16 8DX England

Telephone: 0565 650605 FAX: 0565 650080

All major credit cards accepted.

UK PRICES SHOWN. PLEASE CONTACT US STATING DESTINATION FOR ACCURATE QUOTATION.

FULL CATALOGUE AVAILABLE: £3.50



# Wilmslow Audio

Reader Service #50

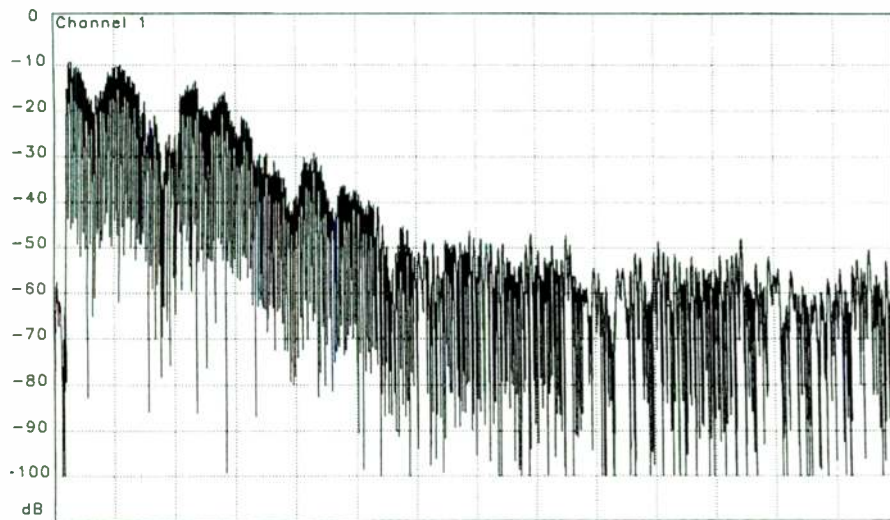

FIGURE 6: Room analyzer plot of small lab space using 20 averages of a 500Hz tone burst.

in a temporary freeze. This allows you to move the mouse to the desired button and activate it by releasing the LMB.

Clicking on <Sigen> changes the top row of buttons to <Style>, <Freq>, <Wave>, two-burst control, and <Done>. Click <Style> to continuous, then select <Freq> and type in 1000.00 Hz, and <Wave> until sine appears. Click <Done> and adjust the SoundBlaster volume control to hear the tone.

You now have a sense of how PC AudioLab looks and feels. As with all programs, it takes a while, but the rewards are really worth it because this one can do lots of things.

#### DISTORTION ANALYZER

With this great feature you can select the start and stop frequencies of a log or linear sweep between 10Hz and 10kHz, and the number of

test points up to 1,000. Forty log points provide a suitably smooth screen display.

The program dwells at each frequency long enough to collect data and compute an FFT, then selects the second and third harmonic amplitude relative to the fundamental for plotting. The dwell is about two seconds per point, so you have a full frequency display of distortion in a minute and a half. Very useful. The residual distortion (output connected directly to input) climbs from 0.1% at 100Hz to 1% at 10kHz.

Just for fun, I ran the sweep through the RA2100 reference power amplifier and connected its output to a resistor in series with a 1A, 40V Schottky diode to ground. I then made a distortion run on the resulting nearly half-sine pulses and the harmonic levels were dead-on.

#### NETWORK ANALYZER

This very flexible function allows you to take ratios of both channels' FFTs, for example, to compute transfer function in magnitude and phase. As a test, I chose an all-too-familiar loudspeaker passive equalizer on which I am working, with the EQ's output connected to Channel 1. I ran the test signal from the card directly into Channel 2, told the program to trigger on that, then plotted the ratio of Channel 2 to Channel 1 (Fig. 2).

# MCM AUDIO SELECT™

High Performance Without  
the High Price

Perfectly Imaged,  
Phase Synchronized,  
Sound



Enjoy the latest true breakthrough in acoustic design technology: **MCM Audio Select's, Syncrosound Series.**

A strategically mounted tweeter at the base of the woofer cone offers reproduction from a centralized point, the same design on the leading edge of today's high end systems.

Get complete Syncrosound details with the MCM Electronics catalog. It is packed with hundreds of accessories from names you know: AMS, Pyle, Eminence, Pioneer, MCM Audio Select and others. In addition, there's MCM's complete line of electronic components, repair parts, tools, test equipment and more. Over 21,000 products in all, are in stock and ready to ship. Call for your free catalog today.

FREE  
CATALOG



For a FREE Catalog, Call...

**1-800-543-4330**

Product Questions 1-800-824-TECH(8324)

New hours: M-F 7 a.m. - 9 p.m., Sat. 9 a.m. - 6 p.m. EST.



**MCM ELECTRONICS™**  
650 CONGRESS PARK DR.  
CENTERVILLE, OH 45459-4072  
A PREMIER Company

SB-19

Serving you coast to coast! Distribution Facilities in Dayton, OH and Reno, NV!

Reader Service #11

Speaker Builder / 8/94 53



I have data from MLSSA and also computed in SPICE for this network, and the PC AudioLab data was essentially identical to these methods. For other purposes, you can choose from several combinations of sums and ratios.

#### LOUDSPEAKER ANALYZER

Two features of this analyzer include an acoustic and an impedance measurement. The manual says SPL, which is fuzzy because the term implies a measurement system whose 0dB point is calibrated to 20 $\mu$ Pa RMS sound pressure. This equipment can measure only relative level in decibels. I

noticed several files in the directory concerning microphone calibration, but no mention is made of this in the manual and no such screen button is displayed. I suspect that my manual has not caught up with my software version. Let's assume there will be a provision for mike calibration in the V2.0 release.

A provision also exists to measure acoustic phase response. The program asks you to type in the distance from loudspeaker to microphone, although I'm not sure what it does with that information. If the intention is to compensate for the fixed propagation delay, it is virtually guaranteed never to work properly. You simply do not know which part

of the driver (or the cabinet) is responsible for the radiation at any particular frequency, especially as the wavelength gets smaller.

One of MLSSA's more elaborate sections measures acoustic phase by the only sensible method I know: locate the exact acoustic center for a defined frequency band by flattening the excess phase response and crank in that value of delay time. The PC AudioLab acoustic phase response zigzags all over the screen and is an utterly useless plot. Of course, in flaming yellow it's the brightest thing on the screen. At least you can click it off if you don't like it.

The distance you enter is possibly used in some sort of TDS analysis, but I doubt it. Of course, the relative SPL plot is quite useful.

The impedance measurement does what it is supposed to do, except that the display can't be scaled (impedance phase can be scaled 2 $\times$ ). The display window has 0-40 $\Omega$  for the lower two-thirds of the left axis. When I measured a 4 $\Omega$  speaker system with an  $R_{ES}$  of 15 $\Omega$ , the plot was all scrunched at the bottom. This particular measurement has the potential to destroy the sound card input circuits if you become brainless about return signal limitations. By switching on cursor readout, you can get the exact value (to experimental accuracy) anywhere along the curve.

#### SPECTRUM ANALYZER

Figure 3 is a printout of the spectrum analyzer connected to an external function generator set for 50% duty cycle half-sawtooth at 300Hz. The beautiful distribution of harmonics is a clue as to the reason this peculiar waveshape appears on most high-quality function generators.

The spectrum analyzer control panel has two buttons, <Burst> and <Click>, which allow triggering of either a programmable tone burst or an impulse from the sound card output port while PC AudioLab is in analyzer mode. Additional comments about some of the parameter choices for the spectrum analyzer are included later in this review.

#### IMPULSE ANALYZER

Clicking the <Pulse> button produced a FORTRAN run-time error as it tried to read a configuration file. After comparing it with other \*.CFG files and noting the possible corruption, I "rolled my own" and it worked. The resulting impulse configuration was pretty weird, but once into the program I modified it. I suspect that something went wrong in the file decompression process during installation.

Many people who could run PC AudioLab with little trouble would be stopped in their tracks by that kind of error. The manufacturer's FAX and phone lines would be buzzing. That's why, upon opening a new software package, you look first for the page in the

**If you like reading  
Speaker Builder you'll  
love reading the  
high-quality articles  
included in every  
issue of**

**Audio Amateur**  
THE JOURNAL FOR AUDIOPHILE CRAFTS

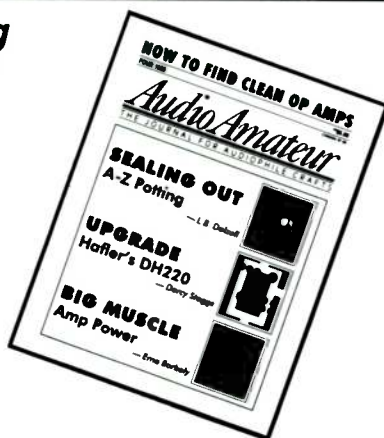

Now beginning its 25th year of publication, *Audio Amateur* is full of audio information for the thoughtful and capable music lover. Contained in its pages are articles dealing with how audio equipment works, as well as articles devoted to construction, modification and much more.

Recent selections from *Audio Amateur* include a "high-end" Line level preamp by Erno Borbely, building a 75W Class A amp, an amplifier/speaker protector circuit and an article on choosing the best op amp for your task.

Send for your **FREE** trial issue of *Audio Amateur* today and experience the kind of information you need—to improve your audio knowledge—to improve the quality of sound for the music you love.

**YES!** Please send my first subscription copy of *Audio Amateur*. When I choose to subscribe, I'll pay just \$16.95 for a one year subscription (that's four issues in all.) If I decide not to subscribe, I'll write "cancel" on the invoice and owe nothing. I am under no obligation. Canada please add \$4 postage. Overseas rates \$35 for one year. Remit in US\$ drawn on a US bank.

NAME \_\_\_\_\_

STREET & NO. \_\_\_\_\_

CITY \_\_\_\_\_

STATE \_\_\_\_\_

ZIP \_\_\_\_\_

**Audio Amateur Publications, Inc.**

PO Box 576 Dept. B94, Peterborough, NH 03458-0576

Telephone (603)924-9464 or FAX 24 hours a day (603)924-9467

Rates are subject to change without notice.

manual defining customer support. If you don't see a mailing address and a telephone or FAX number, send it back!

The impulse scope screen is divided into two sections: the top looks like a scope; the bottom shows the actual impulse response coming into Channel 2. The concept is that Channel 1 receives the impulse directly from the signal generator and Channel 2 receives the response from the device under test. Both channels undergo a 2,048 FFT, and the complex ratio is taken CH2/CH1. The resulting magnitude and phase are shown in the upper portion of the display box.

### GLITCHES

While acquiring impulse responses from a test setup, the Channel 2 input to the SoundBlaster card went dead. I recycled everything but could not get it to respond. The card had to be replaced, which caused a major delay in completing this review. The timing was terrible, because 48 eager acoustics students had just begun their eight-week course, effectively depleting my brain for that period.

Much later, with a new card, I was able to resume my work with the impulse response section and compare it with MLSSA measurements. I positioned a precision SLM microphone in the near field (2cm) of a small box-mounted driver and ran ten consecutive accumulating pulses. I connected the sound card's output to an HP465A DC-coupled power amplifier set to a gain of ten and the mike preamp output directly to the sound card, knowing the SLM would not overload the input (however, if an overload does occur, PC AudioLab beeps a warning). Everything looked fine on the screen. You can watch each time domain pulse in the bottom window and the accumulating frequency domain FFT in the top window.

Then something went wrong. The upper window was fine, but the lower one blew up into a scattering of dots all over the screen. It even printed that way, as you can see in Fig. 4. I suspect that the sum of the N-point amplitudes was not being divided by N to make the final plot.

A peculiar facility available in this mode is the ability to edit the frequency domain plot, granted on the grounds that sound cards occasionally produce display-ruining glitches. You correct them with the mouse—actually move the amplitude points around to wherever you wish.

Figure 5 shows the cumulative spectral decay waterfalls produced with PC AudioLab and MLSSA using the same test setup. I tried to rescale the former, but changing the front-end acquisition gain didn't work. (There are still seven empty buttons—can we have one that moves the plot up and down?)

The plot can be rotated in 90° increments for viewing all sides of the box. If you see one you wish to print, however, you're in for a surprise. View #1 is always printed no matter which one is on the screen.

### ROOM ANALYZER

I ran this function only to verify that it works. I do a lot of room acoustics measurements, and I can't compare this program's simple results to the factors I consider important. Figure 6 shows a typical result of applying this feature in a small noisy room: an echogram of 20 averaged 500Hz tone-burst acquisitions. It looks like 40dB of dynamic range if you eyeball the envelope.

A lot of data post-processing is required to elicit useful room acoustics quantities which are comparable to current mainstream calculations. The cursor readout seems to move only one index at a time, even with the middle (high-speed) mouse button pressed. With this much data to scroll, some 10x or 100x jump facility is needed.

### PRINTING

No driver is available for an ink-jet printer, so I selected HP LaserJet. Fortunately, HP DeskJets talk PCL and do very well with laserjet drivers, but I had to set the resolution to 150 DPI to get a dark enough printout. Since ink jets are so popular, I hope they will

# CFAC™

## Copper-Foil Air-Core Inductor™

Extremely Designed For Precision Audio Transducer/Speaker Driver Crossover Network.



*"The CFAC Inductor far exceeds anything I have used in the past."*

*"Gone are the colorations I previously attributed to various drivers. It is now obvious that the colorations were in fact caused by interior inductor."*

**Arnie Nudell, President  
Genesis**

*"CFAC Inductor is a product that have advanced the state-of-the-art, providing me with a product that is the most sonically pure component available. They are, simply, the best..."*

**Robert Grost, President  
Unity Audio**

**Minimized Skin Effect up to 100kHz**  
 Reduce inductor coloration  
 Low DC resistance  
 Low AC resistance  
 Higher precision coil reactance  
 Uniform current density  
 Very high winding density  
 Computer optimized coil size  
 No saturation distortion  
 No hysteresis distortion  
 Made in USA  
**AVAILABLE AT:**  
**MICHAEL PERCY (415) 669-7181, SONIC FRONTIERS (416) 847-3245, HANDMADE (215) 432-5732**  
 For Catalog: Solo Electronics, 2462 Tripaldi Way, Hayward, CA 94545, USA, Tel: (510) 887-8016 Fax: (510) 887-1657

**CFAC INDUCTOR - CLOSE TO THE IDEAL INDUCTOR**



At low frequencies, inductor resistance will affect the accuracy of the crossover network and bass transit response. CFAC INDUCTOR is more close to the Ideal inductor reactance, which provide more accurate crossover frequency and improve bass transit response.

**CFAC INDUCTOR - ELIMINATE SKIN EFFECT**



**Skin Effect Resistance**  
 Skin Effect will cause the inductor relative load increase, power loss, non-uniform current density in the conductor, signal amplitude decrease and phase delay. Sound quality will be degraded. The ultra-thin structure (0.003" thick) of the CFAC INDUCTOR is specially designed to minimize the Skin Effect.



# OHMITE



#### SPECIFICATIONS:

- 10 WATT NON-INDUCTIVE WIREWOUND.
- 1% TOLERANCE.
- TEMPERATURE COEFFICIENT:  $\pm 50$ ppm/ $^{\circ}$ C.
- OVERLOAD: 10 TIMES RATED WATTAGE FOR 5 SECONDS.
- MAXIMUM OPERATING VOLTAGE: 720 VAC.
- DIELECTRIC WITHSTANDING VOLTAGE: 1000 VAC.

#### SPECIAL FEATURES:

- SILICONE-CERAMIC CONFORMAL.
- CERAMIC CORE.
- ALL WELDED CONSTRUCTION.

#### AVAILABILITY:

0.249 $\Omega$ , 1.00 $\Omega$ , 1.21 $\Omega$ , 1.50 $\Omega$ , 1.82 $\Omega$ ,  
2.00 $\Omega$ , 2.21 $\Omega$ , 2.49 $\Omega$ , 2.74 $\Omega$ , 3.01 $\Omega$ ,  
3.32 $\Omega$ , 4.02 $\Omega$ , 4.53 $\Omega$ , 4.99 $\Omega$ , 6.19 $\Omega$ , 6.81 $\Omega$ ,  
8.06 $\Omega$ , 10.00 $\Omega$ , 15.00 $\Omega$ , 20.00 $\Omega$ , 49.9 $\Omega$ .

Don't compromise the sound of your \$50 tweeter with a 304 sand cast resistor. Experience the extraordinary clarity of North Creek's OHMITE precision power resistors, the most advanced power resistors made by the world leader in resistor technology. Please call or write for our complementary catalog.

## North Creek Music Systems

PO Box 1120, Old Forge, NY 13420  
Voice/Fax (315) 369-2500.

Reader Service #17

# SPEAKERWORKS

## "SPECIALISTS IN THE ART OF SPEAKER REPAIR"

FACTORY AUTHORIZED SERVICE:  
Advent, B-I-C, Bozak, EPI, RTR,  
Cerwin-Vega, JBL Home & Pro

Speaker parts & adhesives,  
cones, spiders & dust caps

3 Way Crossovers Circuit  
Breaker Gold Plated Binding  
Posts \$19.95 each!

Replacement grilles for Altec,  
B-I-C, Cerwin-Vega, JBL & Marantz

Refoam kits available for 4", 5-1/4",  
6-1/2", 8", 10", 12", & 15" speakers  
- only \$29.95 (JBL slightly higher)

Special Closeout on rebuilt DYN  
Audio Drivers: MR 17.75, W30-100,  
W24-100, W17-75. BELOW COST!

We Buy Dead Speakers: Altec, E-V & JBL



# 1-800-526-8879



NO CATALOG AVAILABLE  
CALL US FOR HARD TO FIND DISCONTINUED PARTS  
4931 A-1 South Mingo / Tulsa, Oklahoma / 74146

be added in a future release. Either the printer drivers take a long time to load or the page image is being assembled on disk, because there is much churning before the printer comes alive.

#### THE MANUAL

A lot of reasonably well-presented information is contained in some 80 pages: clear screen shots, well-written text (if a bit terse), and an extensive Q&A-style review at the end encapsulating frequently asked questions (FAQs to us info highway nerds).

If you have no background in sampled-data theory, you will be scratching your head a bit. Admittedly, an applied software manual is not the place to provide such information, but it would be nice if the author had provided a few references.

For example, in the chapter on the Spectrum Analyzer, the section describing the effects of full- and half-Hanning, Hanning, and Blackman tapering windows (selectable within the program) takes three paragraphs. In one of my colleague's textbooks, 19 pages are devoted to this same subject, preceded by 533 pages of preliminary material. Some well-meaning speaker builder may be unaware that something went terribly wrong in his analysis setup.

#### CONCLUSIONS

PC AudioLab is a viable contender for those who have only \$300 to spend on a PC-based digital acquisition, processing, and display program. I believe its problems will be sorted out in time. And, if you need help running it, you will talk with a very knowledgeable and helpful person who intends to continuously maintain and upgrade the program.

Although using a multimedia I/O card for this purpose is great in theory, it has real problems in practice. The usable output signal is 100-500mV. There must be a whopping output coupling capacitor on the card I was using, because even with a 25k resistor to ground it took many seconds to discharge the floating 2.5V DC. You could be unlucky enough to connect the PC card output to a system that does not want any DC. Both of my test power amplifiers are direct-coupled, for example, and if I connect them to the sound board output port I could get an unexpected and substantial pulse into the load.

To use the program you must invest in auxiliary equipment. A low-distortion, wideband voltage amplifier with precision gain steps from 1 to 20 would be useful in the signal source path. And a correctly applied precision voltage divider is essential to protect the PC card's input circuits from excessive return signal. You'll need two of them. In addition, a pair of back-to-back diodes across each input

would help. In a printed warning message Microacoustics disclaims any damage to the sound board. *Caveat emptor* or *caveat venditor*—you must decide.

Even though PC AudioLab emulates a scope, I wouldn't run it without a real one, as well. I'm wary of a signal's actual condition or waveshape to trust the sound board out of hand. Maybe with enough experience....

#### PRAISES & COMPLAINTS

**Most Mind-Blowing Feature:** The cursor control buttons are ingenious, but it would take too many words to explain how they work. If the author actually created this technique of button/mouse control, I sure hope he patented it.

**Most Annoying Features:** (A) It's too s-l-o-w. I am biased because I use high-speed digital instruments every day. MLSSA displays a 65,536 FFT-based incoherency plot (full-frequency, full-excitation distortion) in the time it takes PC AudioLab to get through its first data point. Of course, MLSSA is ten times more expensive. (B) An input channel overload must continuously fire interrupts, because it's devilishly slow moving the mouse to the button that provides relief.

**Most Worrisome Feature:** The odd runtime error that pops up for no apparent reason. Is there a universal divide-by-zero or file read-error trap yet to be written? Also, what about

the message "cannot enable A20" which occurs once every five or six start attempts? Why only occasionally on the same computer with the same boot sequence? Digital systems aren't supposed to work this way!

**Most Frequent Feature:** <Ctrl-F8>. It's easy to get messed up pressing screen buttons while the acquisition is in progress, even though the manual repeatedly says BE PATIENT. <Ctrl-F8> eventually lights the <Freeze> button, and you breathe a sigh of relief knowing you can manipulate through button fields without delay and without screwing something up.

**Most Intelligent Feature:** The screen layout is really elegant and makes you feel as though you are using a real instrument (which it is).

**Cutest Feature:** The little red light that tells you when the acquisition is in progress, although I've not yet figured out exactly how it relates to the acquisition cycle.

**Most Comprehensive Features:** Signal generator waveshape selections; network analyzer plotting choices.

**Potentially Most Useful Feature:** The cursor readout, but only if a mouse button sequence or keyboard command could automatically locate the cursor on successive peaks of the FFT display. Too much fidgeting is required to find the peak, and the VGA screen display resolution doesn't help. Also,

why can't the cursors read out from the auxiliary channels? Why does the cursor read 33.65dB at 495.62Hz, and the exported value for the same data point reads 35.48dB?

**Feature I Personally Dislike:** The severe limitations imposed by the I/O hardware. (Nothing to do with the program, of course.) You must have external auxiliary amps and voltage dividers to apply the system to most audio situations. I also noticed significant leakage of the sampling frequency from the SoundBlaster card during a portion of the acquisition cycle which could raise havoc with other laboratory instruments.

**Dumbest Feature:** Measuring acoustic phase based upon typing in the distance from driver to microphone.

**Features I Would Like to See:** Automatic protection against Nyquist sampling violations; one-keystroke move of cursor(s) to FFT peaks; average-max-min readout of certain data over a test band.

**More Advice:** Do not export zero-frequency point on FFTs; show number of PSACC averages on screen as they accumulate; get rid of acoustic phase (or do it differently); exported data should be quote and comma delimited.

In the event you are scratching your head about some of the digital signal processing words and phrases used in this review, I would like to recommend a book which is

## The Source for Pro Sound Speaker Builders



Loudspeakers, Drivers, Horns, Tweeters, Crossovers, Hardware, Connectors... and much, much more!

Image delivers virtually every component for the speaker builder.  
See for yourself. Call or FAX for your FREE catalog today!

**image**  
communications

4301 W. 69th St. • Chicago, Illinois 60629 • (312) 585-1212 • FAX (312) 585-7847 • 1-800-552-1639

**EMINENCE**  
Loudspeakers, Drivers,  
Diaphragms and Recone Kits

**Electro Voice**  
Recone Kits

**McCauley**  
Loudspeakers & Drivers,

**Acoustician**  
Drivers, Horns, Tweeters,  
Diaphragms & Crossovers

**Waldom**  
Audio Products  
Hardware, Connectors, Etc.



available through Old Colony Sound Lab, *Digital Signal Processing Experiments* by Kamas and Lee [#BKPH7, \$34.95 plus \$3 shipping in USA—Ed.]. This is a great DSP beginner's book with software and a unique connect-the-boxes structure which is easy to learn. Happy sampling!

#### MANUFACTURER'S RESPONSE

I'd like to thank Dick Campbell for his extensive and thoughtful review of our software package. In the lengthy process of his review, PC AudioLab started from Version 1.0 and progressed to a beta test copy of Version 2.0. The advantage of sending a beta version to a reviewer is that they get to see the latest/greatest version; the disadvantage is that they review the "warts" before they can be removed. Subsequently, many of the glitches and headaches in the beta version which Dick experienced have been removed (including the plotting malfunction in Fig. 4, the "odd run-time errors," and so on). As anyone who is familiar with software knows, nothing is truly stable and "bug-free" (I can't even count how many times my Windows programs have crashed, destroyed files, and the like). For his problems with the disk protection scheme and intermittent "cannot enable A20" error message, I would recommend finding a good computer expert, since the vast majority of other users haven't shared his experiences and for those few who did, there was a simple work-around.

A few comments about the LoudSpeaker Analyzer acoustic phase measurement are in order. When the SPL measurement is first started, the user is given the option of entering the distance of the microphone to the speaker to compensate for a fixed propagation delay. Rather than making assumptions about a loudspeaker's minimum phase behavior and using Hilbert Transforms, PC AudioLab will actual-

ly measure the phase shift. If the distance entered is zero, then the resulting phase plot, while accurate, will indeed "zig-zag all over the screen," since the measured phase includes not only the drivers' inherent phase shift but also the phase shift introduced by the time delay between loudspeaker and microphone. There are several ways to determine the correct distance so that a minimum phase plot is generated. Using either the Impulse Analyzer or Room Analyzer, one can determine the flight delay of an impulse or tone burst.

Another important reason for entering the loudspeaker-to-microphone distance is when you wish to combine a near-field swept frequency response with the far-field impulse response. In order to avoid a discontinuity in the combined phase response at the merge frequency, both the near-field and far-field measurements must be referenced to the same acoustic plane. This is accomplished by applying a time shift to remove the appropriate delay from each measurement. An excellent article by Struck and Temme (JAES, June 1994, Vol. 42, No. 6) describes this method of obtaining the complete free-field response of a loudspeaker without the need for an anechoic chamber. By using the LoudSpeaker Analyzer for the near-field response and the Impulse Analyzer for the far-field response, we can merge these two test results to arrive at a full-frequency loudspeaker response.

A few comments about loudspeaker impedance measurements. Both the SoundBlaster and Media Vision sound cards have small on-board amplifiers (4W output). We recommend using this amplified signal output for impedance measurements since the line-out jacks of these sound cards can't drive the low impedance loads of most loudspeaker drivers. The impedance measurements should be performed using low excitation voltages (<1V)

since Thiele-Small parameters are based on small-signal models. Using this test setup will minimize the chance of overloading the sound board inputs. The line-out jack of these sound cards should be used for other measurements, especially THD measurements, since the on-board amplifier adds approximately 10dB to the noise floor (which is why the reviewer residual distortion measurements were higher than normal for these cards).

We've taken several of the author's suggestions to heart so that you can now change the impedance plot scaling to make it easier to display low-impedance drivers and measure Thiele-Small parameters. The Spectrum Analyzer can now perform FFT smoothing along with power spectral averaging (PSACC) and will also display a 1/3-octave bar graph RTA display. The Room Analyzer section has been modified so that the envelope of response is calculated and displayed along with improved cursor movement. Also, if microphone calibration data is available, PC AudioLab will use this data for measurement compensation.

PC AudioLab was developed for audio professionals and amateurs who may not have the necessary \$20,000+ to purchase the best laboratory gear or can't take all of that test equipment to a remote location. We're flattered by the comparison with such equipment, and, as shown in this review article, the results obtained by our program (using a \$120 sound card) are identical. Soon we will support Creative Labs latest SoundBlaster board, the AWE32. With this board, maximum length sequence (MLS) analysis will also be possible. We're not aware of any other test measurement system that can do so much for so little. ▶

Robert D. Watson  
Microacoustics

# BassBox™ 5.0

for Microsoft  
**WINDOWS™**

**Driver Database**  
with over 1,000 drivers.

**Design speaker boxes fast and accurately with BassBox software. Accepts both Thiele-Small (Fs, Qms, Vas, η) and Electro-Mechanical (Qes, Qms, Cms, Mms, Rms, BL) parameters with equal ease.**

- ◆ Easy to use
- ◆ On-line help
- ◆ Large driver database
- ◆ Low price

#### Design Types:

Maximally Flat Vented  
Extended Bass Vented  
Custom Vented  
Band-Pass Vented  
Passive Radiator  
Optimum Closed  
Custom Closed  
Multiple Woofer designs (including Isobaric)

#### Built-In Test Procedures:

Test and calculate loudspeaker parameters\*  
Test and calculate passive radiator parameters\*

\*Requires basic test equipment: sine wave generator, frequency counter, power amplifier, 1 kohm resistor, voltmeter, ohmmeter, test box.

#### Design Options:

Small and large-signal analysis  
Examine one loudspeaker in several different boxes or...  
Examine several different loudspeakers in the same box  
Convert between T-S and E-M parameters  
Three graphs: Amplitude, Acoustic Power, Impedance  
Can use multiple ports  
Box dimension calculator with 18 different volume shapes  
Can use loudspeaker measured acoustic response  
Use English or metric units  
Read BassBox 4.0 & 3.0 files  
Save and recall designs

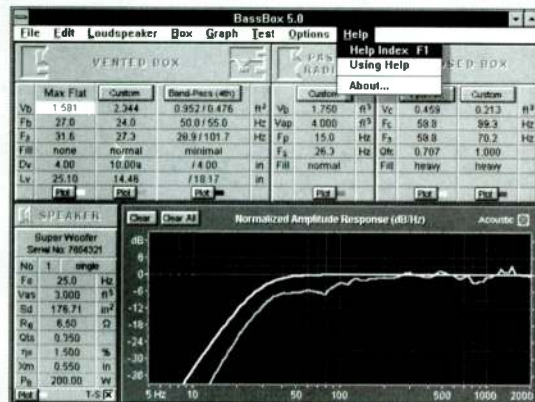

Copyright © 1994 by Harris Technologies. All rights reserved worldwide. BassBox is a trademark of Harris Technologies. Other trademarks are the property of their respective companies.



**\$99.00**



plus \$4.00 S&H  
(Canada +\$6.00)  
(Overseas +\$12.00)

**Tel: 616-641-5924**  
**Fax: 616-641-5738**

**Harris Technologies**  
P.O. Box 622  
Edwardsburg, MI  
49112-0622 U.S.A.

Also available:

**X•over 2.0 passive cross-over program for Windows.**

X•over calculates the component values for 1st, 2nd, 3rd and 4th-order 2-way and 3-way networks, load compensating networks and L-pads. **Regular price: \$29.** (\$19 if purchased with BassBox.)

#### System Requirements:

MS-DOS 5.0, Microsoft Windows 3.1 & compatible computer (IBM® PC w/ 386SX or better), 1.44 MB/byte 3.5" disk drive and mouse, 4 MB/bytes RAM recommended.

Harris Technologies reserves the right to make changes without prior notice.

# Tools, Tips & Techniques

## EMULATING DIPOLAR AND BIPOLAR SPEAKERS

Loudspeakers come in all shapes, sizes, finishes, price ranges, and sound radiation patterns. Let's focus on the latter group, specifically concurrent front and rear radiation models, which may be either dipolar or bipolar.

In dipolar systems, the back radiation is a mirror image of the front, but occurring 180° out-of-phase with the front. This situation happens most often with planar speakers, such as electrostatic or planar magnetic, in which the front and back waves are simultaneously generated by the back and forth movement of a diaphragm. Thus a positive pulse to the front is accompanied by a rarefaction at the back. At the lower frequencies where the sound wave length is longer than the width of the driver, it is nearly omnidirectional, wrapping around the speaker and causing some degree of cancellation between the out-of-phase front and back waves.

With bipolar systems, the back radiation is in phase with the front radiation, eliminating most of the front-to-back cancellation. Bipolar speakers have another set of drivers facing the rear and wired in-phase with the front-facing drivers.

Compounding these effects is the reflected sound from the wall behind the speakers. Proper positioning of the speakers can be very critical in obtaining the most benefit from this reflected radiation. It can add greatly to the quality of the music, but can also cause frequency response aberrations.

### BACKWARD THINKING

There has always been a faction of music lovers who prefer the imaging and added ambience of sound reproduction possible with di- or bipolar radiation. Over the years, many box-type loudspeaker enclosures have used one or more rear-firing drivers, usually a tweeter and midrange, to add ambience from rear wall sound reflections.

At least one current loudspeaker is fully bipolar, with an equal complement of drivers front and back, wired in series. Then there is, of course, the 25+ year-old Bose 901 series that has eight of its nine drivers facing the wall behind the speakers. Most of the dipolar and bipolar speakers on the market are expensive, and many have the reputation of requir-

ing tedious experimentation with placement to derive the best sound.

If you're considering dipolar or bipolar speakers, but don't wish to invest large sums, some reasonably priced enclosures designed primarily for use as side speakers in a surround sound system are now available. The downside is that they may have sonic problems of their own when used as the main speakers in a system. They may not have been designed with complete spectral accuracy in mind, given their intended role as ambience enhancers.

If you've tried to emulate dipolar or bipolar speakers by placing similar or identical speakers in close proximity, with a forward- and a backward-facing pair, you may have experienced unsatisfactory results, irrespective of their dipolar or bipolar wiring configurations (*Fig. 1*). My experiments have shown that the problem with this paired arrangement occurs when the rear radiation sound level is equal to the front; there will often be only a very limited location range in which they will sound good. The offset centerlines of the front- and rear-firing drivers possibly contribute to the placement problems.

### SIMPLE SOLUTION

My variation, with which I am quite happy, uses a 25Ω variable resistor from Radio Shack in series with the "hot" terminals of the rear-facing speakers (*Fig. 2*). This resistor decreases the output of the rear speakers about 10dB relative to the front

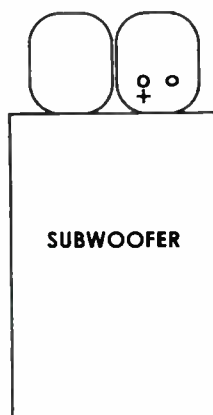

FIGURE 1: A typical dipolar or bipolar operating configuration.

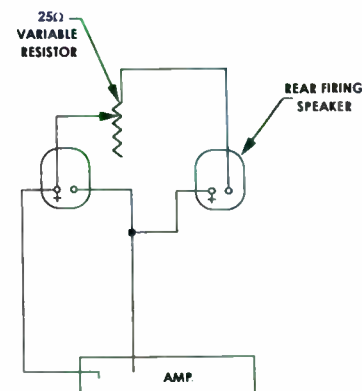

FIGURE 2: The author's variable resistor solution to control the output of rear-firing speakers.

when in the fully decreased (25Ω) position. My setup is dipolar in effect because of the out-of-phase wiring of the front- and rear-firing speakers, but could just as easily be bipolar. The dipolar configuration sounds better to my ears.

My system features four Cambridge SoundWorks ambience speakers, with two facing forward and the other two paired with the first and facing backwards. The 25Ω resistor allows adjustment of the sound level of the rear-firing pair to compensate for speaker position and room characteristics. The four speakers reside two each on top of a pair of VMPS Smaller Subwoofers®, which fill in the lower octaves.

The result is a broad soundstage extending well beyond the outer edges of the speakers, a precise localization of performers across the soundstage, and a re-creation of a sense of the ambience in which the recording was made. This setup reveals deficiencies in a recording as well as its good attributes. It is also very revealing of microphone techniques.

The rear-firing speakers can be different than the front-firing ones—even in spectral balance, to a degree—and still give good results. The resistor enables you to make very fine adjustments to compensate for speaker differences. If you don't care for the effect, the system can easily be restored to its original configuration.

James T. Frane  
Orinda, CA 94563



**1981** A Testing Unit for Speaker Parameters • Variable-Volume Enclosure • Thiele/Small Theory, Pt 1-3 • Easy to Make Enclosure Using Concrete Blocks • The Tractrix Horn: Good Dispersion Bass From an Old Design • Diffuser Port for Small Boxes • Mini-Speaker Made From PVC Tubes • Closed vs. Vented Box Efficiency • Interview with P.G.A.H. Voigt • Dual 8" Symmetrical Air Friction Enclosure • Thiele/Small Calculator Computation • Thiele/Small Parameters for Passive Radiators •

**1982** Transmission Line Theory • Thiele/Small Sixth-Order Alignments • The Quad 63 • Table Saw Basics • AR-1 Mods • Active Crossovers and Phase • Three Transmission Line Speakers • A Beginner's First Speaker • How Passive Networks Interact with Drivers • Horn Loaded Heil • Phase Correcting Active Crossover • Wind Your Own Inductors • Series and Parallel Networks • High Performance Corner Speaker • Using Zobels to Compensate for Driver Characteristics •

**1983** Building the Two-Way Dynaudio • A Crossover That Offsets Speaker Impedance • Using a Calculator for Box Design • Choosing a Calculator • A Simple Peak Power Indicator • A Small Horn Speaker • Audio Pulse Generator • How to Use Speaker Pads and Level Controls • An Easy-to-Build Voltmeter for Speaker Measuring • Nomograms for Easy Design Calculations • Interview with KEF's Raymond Cooke • Build a Simple Wattmeter • A New Type of Speaker Driver •

**1984** Build an Aligned Satellite/Woofer System • BOXRESPONSE: A Program to Calculate Thiele/Small Parameters • Casting with Resins • A Phase Meter • An Interview with Ted Jordan • Building the Jordan-5 System • Self-Powered Peak Power Indicator • Closed Box Design Trade-offs • How to Build Ribbon Tweeters • Build a Dual Measurement Impedance Meter • A High-Power Satellite Speaker System • Build and Use a White/Pink Generator • Sound Pressure Level Nomographs •

**1985** OUT OF PRINT, some single issues still available at \$5 each. •

**1986** The Edgar Midrange Horn • Sand-Filled Stands • Crossover Networks: Passive and Active • 5-Sided Boxes • A 2 x 4 Transmission Line • The Free-Volume Subwoofer • Notch Filters • By-Wiring the LS3/5A • A Push/Pull Constant Pressure System • Current and Power in Crossover Components • The Unbox (Egg) • Upgrade Speakerlab's S-6 Crossover • Measure Speakers with Step Response • A Gold Ribbon System • A Visit with Ken Kantor • A Tractrix Horn Design Program • Reviews: Audio Concepts "G"; Seven TL Midranges; Focal's Model 280; the Audio Source RTA-ONE •

**1987** A Compact TL Woofer • Frequency Response and Loudspeaker Modeling, Pt 1-3 • A Manual Coil Winder • The Model-One Speaker • Designing a Listening Room • A Sixth-Order Vented Woofer • Tapered Pipe Experiments • Visiting Boston Acoustics • A Vented Compound System • The Octaline • Spreadsheets for Speaker Design • In Memoriam: Richard Heyser, Pt 1-2 • Using Non-Optimum Vented Boxes • Building Speaker Stands • Evaluating Driver Impedance Compensation • Tuning Bass Reflex • Six Woofers Compared • Bullock on Passive Crossovers: Alternate Bandpass Types • Fast, Easy Filter Calculations • A Mobile Speaker • Polk 10 Mod •

**1988** Electronic Turns Counter • Two-Way Design • Minimus-7 Mod • Dome/Midrange/Tweeter Array • Plotting Complex Impedances • A Driver Design Primer • A Cabinet Primer • Tuning Up Old Systems • Low-Cost AR-3 Upgrade • Electronic Time Delay • Enclosure Shapes and Volumes • Minimum-Phase Crossovers • Spot Sound Absorbers • How to Add a Subwoofer • The Swan IV System • Sub-Bass Power Boosting • The Online: A Short TL • Active Filter Computer Design Program • Low-Cost Two-Way Ribbon • Amp-Speaker Interface Tester and Construction Plans • The QB<sub>3</sub> Vented Box is Best • A Pentagonal Box System • Keith Johnson Profile • Sheathed Conductor ESL • A Symmetrically Loaded System, Pt 1 • Ceramic Enclosure • Inductance Measuring Technique • Polk 10 Mods •

**1989** (5 Issue Set: VERY LOW STOCK) The Audio Laboratory Speaker System • A Passively Assisted Woofer • Digital Filter Tutorial • The Listening Arc Alignment • Small IC Power Amp & Crossover • Easy Surround Sound • Building Speaker Spikes • An Isobarik in a Thunderbird • Sheetrock Cabinetry • A Picket Speaker • Servo-Controlling AR-1 • Silent, Safe Muting System • Equalizing the Klipsch Cornwall • A Test Switcher • Visiting the Klipsch Kingdom • Rehab for Kitchen Music • Spreadsheet Design • A Subwoofer/Satellite System • Impedance Measurement as a Tool • Practical Passive Radiators • A Symmetrical Dual Transmission Line, Pt 1-2 • The Microline • A Voice Coil Wheatstone Bridge • Tweeter Q Problems • A Dipole Subwoofer for the Quad • Adjusting Woofer Properties • Modifying Paradigm's 7se •

**1990** Acceleration Feedback System • Cylindrical Symmetric Guitar TLs • Compact Integrated Electrostatic TL, Pt 1-3 • Minimus-7 Super Mod • The Show (Bass Horn) • A Small Two-Way System • Helmholtz Spreadsheet • Heresy Upon a (Klipsch) Heresy • Beer Budget Window Rattler • Contact Basics • MDT Mini-Monitor Speaker System • Titanium + TPX + Polypropylene = Fidelity • Tom Holman, Skywalker, and THX, Pt 1-2 • Bud Box Enclosure • Klipschom Throat Riddle • Modular Three-Way Active Speaker • CD Speaker System • SPEAKER DESIGNER Software • Symmetrical Isobarik • Novice Crossovers • Triamplified Modular System • Magnetic Crosstalk in Passive Crossovers • Mitey Mike Loudspeaker Tester • Symmetrical Loading for Auto Subwoofers • Improved Vented Box with Low Q<sub>75</sub> Drivers • BOXMODEL Woofer System Design Software • Four Eight By Twos • Dynaco A-25 Mod • Klipschom Throat Revisited •

**1991** Students Building Systems • Servo Subwoofers • An Apartment TL • L-R Crossover for the Swan IV • More or Less Power • New Guidelines for Vented Boxes • The Pipes • Macintosh's Wave and Sound Programs • Creating Professional Looking Grilles • Octaline Meets D'Appolito • Using Radar to Measure Drivers • Deep Bass for GMC • PSpice LF Response Calculating • Pipe and Ribbon Odyssey • The Delac S-10 • Infrared Remote Volume Control • Backloaded Wall Horn Speaker • Mod for the Minimus 7 • Simplifying Cabinet Assembly • Fibrous Effects on TLs • The DOALs • Loudspeaker Cable • Speaker to Ear Interface • Speaker Sensitivity to Errors in T/S Parameters • TL Speaker Evaluation • Cable and Sound • Kit Reports: Little V; Audio Concepts' Sub-1 •

**1992** Rumreich on Box Design & Woofer Selection • MLSSA • Double-Chambered Reflex by Weems • Active Crossover and Delay • Electrical Circuit Bandpass Enclosure • A Dreadnaught System (satellite swivels) • Designing Real-World Two-Way Crossovers • 20-foot Ribbon Dipole Speaker • Blampering the Sapphire II • Capping Passive Crossovers • A High Quality Speaker Cabinet • 1/3-Octave Noise Source • Disappearing Loudspeaker • The A&S Soundoff Winner, Pt 1-2 • Alignment Jamming • Marc Bacon's "Danielle," Pt 1-2 • Double-Chambered Isobarik Bass • Ferguson's Pickup Installation • Electronic Counter for Coil Winding • Oakley on Speaker Placement • Making Your Room Hi-Fi, Pt 1 • More on Dust Caps • Spreadsheet for Nonoptimum Vented Box Design • Acoustic Resistance Tuned Enclosure •

**1993** Waslo's IMP, Pt 1-3 • Quasi-Monotonic Vented Alignments • Making Your Room Hi-Fi, Pt 2-3 • A & S Soundoff Winner, Pt 3 • Flexible Dipole Woofer • The Spline • Stalking F<sub>3</sub> • A Bi-Structural Enclosure • A Sixth-Order T/S Subwoofer Design • Speaker Enclosure Screws • Electric Bass Tri-Horn • Prism V Satellite/JBL Subwoofer, Pt 1-2 • Fittcut: Program for Designing Duct Software • Compact Coincidental Point Source Speaker • IMP: Measuring T/S Parameters • KIT REPORT: Rockford's Beginner Software/Driver Paks • SOFTWARE REPORT: Low Frequency Designer 3.01 • Three Affordable Measurement Microphones • Two Ways to Realize a Dream • Matching Driver Efficiencies • Two-Woofer Box System • Designing a Dual Voice Coil Subwoofer • SOFTWARE REPORT: Blaubox 1.2 • Tale of Three Speaker Projects • A & S Sound-off 1992 • Monolith Horn • Orbiting Satellites • Real-World Three-Way Crossovers • The Simplex • Living with a Speaker Builder • The IMP Goes MLS •

Please send me the following back issues of Speaker Builder

- |                                    |                                    |                                    |                                    |
|------------------------------------|------------------------------------|------------------------------------|------------------------------------|
| <input type="checkbox"/> 1993 \$25 | <input type="checkbox"/> 1992 \$25 | <input type="checkbox"/> 1991 \$25 | <input type="checkbox"/> 1990 \$25 |
| <input type="checkbox"/> 1989 \$21 | <input type="checkbox"/> 1988 \$23 | <input type="checkbox"/> 1987 \$20 | <input type="checkbox"/> 1986 \$20 |
| <input type="checkbox"/> 1984 \$18 | <input type="checkbox"/> 1983 \$18 | <input type="checkbox"/> 1982 \$18 | <input type="checkbox"/> 1981 \$18 |

### SHIPPING BACK ISSUES

UPS: Domestic ground service by value of order:  
 Less than \$60.00-\$4.50      \$131.00-220.00-\$ 8.50  
 \$61-\$130.00-\$6.50      \$221.00+ -\$10.50

Canada: Add \$6.00 per year.

Foreign Air: Europe: add additional 40% of total order  
 Other destinations: 50% of total order.

Foreign Surface: add additional 20% of total order.

Rates subject to change without notice. All remittance in US \$ only drawn on US bank.

Check or Money Order     Discover     MC     VISA

NAME _____	ACCOUNT NO. _____
STREET & NO. _____	
CITY _____	ST _____
ZIP _____	
MC / VISA NO. _____	EXP. DATE _____

## Speaker Builder Magazine

Post Office Box 494, Dept. B94 Peterborough NH 03458-0494  
 (603) 924-9464 FAX (603) 924-9467

Answering machine for credit card orders only—before 9:00 a.m., after 4:00 p.m. and weekends  
 Please have all information plus MC/VISA available.

# SB Mailbox

## POWER OUTPUT MIX-UP

Thank you for publishing my reply to Edwin Myers' query in *SB Mailbox* (*SB* 6/94, p. 57). I noticed an error in transcription, resulting in a confusing statement. The final sentence of the third paragraph should have read: for example, a 200W woofer with 100dB efficiency would match well with a 50W tweeter with 106dB efficiency, assuming proper level matching of components.

Bill Fitzmaurice  
Laconia, NH 03246

## TROUBLE WITH EQUATIONS

Thanks to Ed Dell and staff for publishing my article on the loudspeaker impedance curve ("Exploring Loudspeaker Impedance," *SB* 5/94, p. 28), which was motivated by the

uneven showing of designs submitted for the A&S Speakers Sound-Off. The article's goal was to provide a bridge between material appearing in the *JAES* and the needs of the practical loudspeaker system designer.

Between my reading the publisher's proofs and the article's appearance in print, the usual gremlins surfaced to make random alterations to the copy. First, the expression  $EXP$ , appearing in the subscript of many equations, should not be subscripted. This is the exponential function, written  $EXP(x)$ . I hope this causes no difficulties.

On p. 32, the equation following Equation (2) shows the independent variable  $X_p$  written in the numerator of a fraction. The  $X_p$  and the equals sign should be moved to the left of the fraction bar. Also in this equation, the slanted lines following three of the letters M are really fraction bars, as in Equation (A1).

Victor Staggs  
Orange, CA 92667

## MISPLACED EQUALIZER

In the 5/94 issue of *Speaker Builder*, D.E. Stenton states on page 18 of his "System III Loudspeaker" article that "the high-pass equalizer stage to each filter provides another phase inversion..."

Not so. As his Fig. 5 circuit on page 12 shows, the high-pass equalizer section is *non-inverting*, and there is no reason to have it in the signal path feeding the high-pass filter.

The proper location for this high-pass equalizer is *after* the low-pass filter. The junction of R4 and R9 could then be used as the signal input.

Both the high- and low-pass filters could be configured as noninverting, unity-gain, third-order filters. Walt Jung's *Audio IC Op-Amp Applications* book shows how to do it.

In the 3/94 issue of *Glass Audio*, Fred Forsell mentions in his letter on page 43 that the serial data stream must be inverted at the input to the DAC if an inverting audio stage is used at the DAC output.

## Roy Allison's Famed Tweeter Now Available

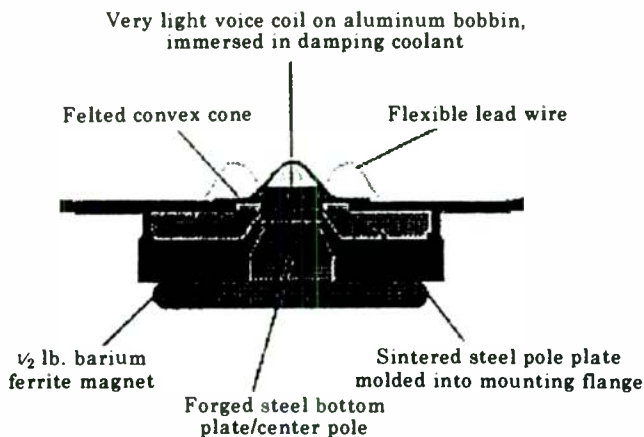

Roy Allison's Convex Dome Tweeter is world renowned for its almost perfect dispersion pattern. Edgar Villchur said of Roy Allison upon hearing this tweeter for the first time, "The student has surpassed the teacher." No other tweeter in the world creates such an even power response throughout the listening area. This is due to the pulsating hemisphere created by its unique design.

**New Low Price – \$41.00 each**

*For Specifications and Ordering*

**Call 1-800-227-0390**

# RDL ACOUSTICS

26 Pearl Street, #15  
Bellingham, MA 02019

Reader Service #39

Speaker Builder / 8/94 61



Burr-Brown's data on the PCM-58 and PCM-63 DA chips shows an inverting I-V op amp stage on the connection diagrams. This usually feeds a noninverting buffer output.

Utilizing the Curcio pre-preamp or a mu follower, both inverting circuits, along with a resistor for I-V conversion, should maintain proper absolute phase.

Tom Tutay  
Ft. Walton Beach, FL 32549

D.E. Stenton responds:

Thanks to reader Tom Tutay for pointing out

the text error describing the active equalizer and filter circuits. The high-pass equalizer is indeed a noninverting amplifier stage.

Although I intended to place the high-pass equalizer in front of the high-pass/low-pass filter stages as a buffer amplifier, in practice it should not be necessary to insert a buffer since the input resistance to the filter stage is twice the value of R9, or approximately 24kΩ. As Mr. Tutay correctly points out, the high-pass equalizer stage could follow the low-pass filter and the junction of R4 and R9 could then be used as the signal input.

To maintain proper phase at the input and output, the equalizer stage could be replaced

by an inverting amplifier. The Burr-Brown op amp book, *Operational Amplifiers—Design and Application*, shows an example of an op amp inverter circuit design. Readers who wish to develop a better understanding of these types of active filters should consult the article "An Electrically Tunable Low-Pass Filter" (*The Audio Amateur*, 2/73). The discussion presented in this article can equally be applied to high-pass filters.

Alternatively, you can replace the high-pass/low-pass active filters with noninverting unity-gain amplifiers, as indicated in Mr. Tutay's note.

Readers should also be aware of the incorrect unit that was specified in the last line of the last paragraph of the section describing calculations in Part 1 (p. 10). The value of the resistor in Fig. 7 is 0.5Ω, not 0.5W.

## MORE POWER

In SB 6/94 ("SB Mailbox," p. 57), Edwin H. Myers, Jr. asked, "how much power will go to each component in a three-way system?" I would like to draw Mr. Myers' attention to an interesting and useful technical paper titled "Signal Power Spectrum Aspects in Loudspeaker Design" (*JAES*, Vol. 32, No. 9, September 1984, pp. 673-676).

This article, written by H. Mayr, provides

## Come Out of the Closet

Fine craftsmanship seems to be in short supply these days, but fortunately, *Speaker Builder* has a large store from which to draw. Most SB readers are, by nature, craftsmen who have the ability to build beautiful equipment for their home-listening pleasure.

So what's the problem? Too few of you are sharing your craftsmanship with the rest of us. Our Craftsman's Corner bin is nearly empty. All we need is a little more "audience participation" to restock our files.

If you have built an especially attractive or distinct piece of equipment, why not take some black and white photos of it and write a description of your efforts? Because this is a "showcase" feature, we can use only high quality photos—but if your design does not lend itself to photography, why not share your idea via our Tools, Tips and Techniques department? We pay modestly for submissions to both departments.

Whichever vehicle you choose, it's time to come out of the closet and reveal yourself as the talented craftsman you are. It's up to you to keep the craft of speaker building alive. Send your submissions to:

Audio Amateur Publications, Inc.,  
Editorial Dept., PO Box 494,  
Peterborough, NH 03458-0494  
FAX (603) 924-9467



# THE WORLD'S MOST RESPECTED HI-FI MAGAZINE

SUBSCRIBE TODAY AND GET THE NEXT 12 ISSUES FOR  
**\$65.00 USA \$75.00 CANADA**

Please send me the next 12 monthly issues of Hi-Fi News and record Review from the next available issue.

Mr/Mrs/Miss/Ms \_\_\_\_\_

Address \_\_\_\_\_

Apt# \_\_\_\_\_

City \_\_\_\_\_

State \_\_\_\_\_ Zip \_\_\_\_\_

### METHOD OF PAYMENT

- Check enclosed (US dollars and drawn on a US bank)  
 Please charge my  Visa  Mastercard  American Express

Account No. \_\_\_\_\_ Exp. date \_\_\_\_\_

Signature \_\_\_\_\_ Date \_\_\_\_\_

Please bill me

Return to Hi Fi News & Record Review, PO Box 384, Avenel, NJ 07001

**FOR FASTER SERVICE USE YOUR CREDIT CARD AND CALL TOLL FREE**

**☎ 800-688 6247**

AA41

AC1

## Active Crossover Kit

*totally modular design  
class-A discrete circuitry  
balanced & unbalanced i/o  
2 and 3 way system capability  
1st, 2nd, 3rd and 4th order networks*

a  
*Jean-Claude Gaertner/Erno Borbely*  
design  
sold exclusively through  
**Welborne Labs**

Call, fax, or write us for more information.  
Or send \$10 for our complete 200 page  
design manual and catalog featuring  
other audio kits plus our full line of  
audiophile quality parts and supplies.

P.O. Box 260198  
Littleton, CO 80126  
PH: 303-470-6585  
FAX: 303-791-5783  
Visa & Mastercard accepted

## THE LEGENDARY



### STRATHEARN AUDIO Pure Ribbon Driver

Mid Range - High Frequency  
Perfectly made in Germany.

#### Specifications:

Frequency response: 450-20000 Hz  $\pm 3$  dB  
Crossover point 2 units = 350 Hz  
Crossover point 3 units = 250 Hz  
Power handling: 100 Watts RMS  
Sound pressure level:  
87 dB / 1 w / 1 m / 8 Ohm transformer  
90 dB / 1 w / 1 m / 4 Ohm transformer  
Dimensions: 135 x 595 x 30 mm  
Weight: 3,3 kg

Price: **\$399**

incl. transformer  
Payment per MasterCard  
or American Express Card.  
Distributor enquiries welcome.  
Brochure & technical data  
on request.



**hifisound**  
EXPORT DIVISION

Jüdefelderstraße 35 + 52  
D-48143 Münster  
Phone: (011)-49-251-5 83 30  
Fax: (011)-49-251-4 39 56

Reader Service #53

a technical description to calculate the power division between drivers in a multiway loudspeaker system, as well as techniques for estimating the driver vibration amplitudes in actual use. As you would expect, the power split depends on the chosen crossover frequencies, and you can take this into account fairly easily using the data Mayr provides.

To cite an example presented in the paper, a three-channel system with the following channel limits, 20-500Hz, 500-3,150Hz, and 3,150-20kHz, will have a power split 72% : 27% : 1%. Mayr assumes that the signal is a wideband one with a continuous spectrum as defined in the German standard DIN 45 473, which was designed for checking the power handling capacity of loudspeakers.

Although the findings depend on the spectral characteristics of the assumed signal, they represent a good starting point for any analysis of loudspeaker power handling. I hope that Mr. Myers and others find these results to be of interest in their loudspeaker building endeavors.

Witold Waldman  
Audiosoft  
Melbourne, Australia

## HISTORICAL PERSPECTIVES

"Loudspeakers: A Short History" by Gary Galo (*SB* 6/94, p. 18) is probably the most interesting article I have ever read in your magazine. Having worked with loudspeakers for the past 43 years, I was pleased to read Gary's effort to bring the younger set up to speed regarding the players in the history of quality loudspeaker development; otherwise, they might believe the plethora of acoustic junk that is on the market is all there ever was.

We should be most thankful to people such as Ed Villchur and Henry Kloss for developing (without computers, thank god) acoustic suspension technology. Ed May of JBL must be credited for his pioneering efforts with tuned port systems, even though I personally detest them. I was shocked and dismayed to see Henry Kloss purveying Band Pass subwoofers (?) in his Cambridge line. As Paul Klipsch would say, "sheer heresy."

Thiele and Small certainly contributed, but I submit their contributions benefited the software writers and sellers more than the average speaker builder. I carefully scan each *SB* issue hoping to read something above the technical masturbation on meaningless subjects. How many more times must we suffer through the intricacies of biscuit joints?

*Speaker Builder* should be about building reasonably simple, high-quality, and non-lunatic-fringe loudspeakers. In other words, put

## Resistance.



VISHAY & CADDOCK  
Metal foil and  
film resistors that  
are without equal.



## Capacitance.



SOLEN, MIT MULTICAP,  
HOVLAND & KIMBER KAPS  
Choose from our selection  
of the world's finest.



## Inductance.

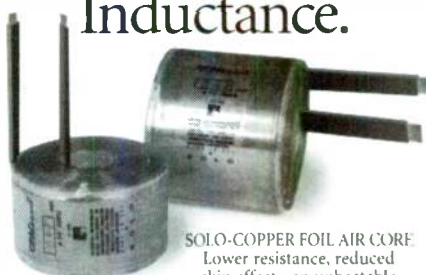

SOLO-COPPER FOIL AIR CORE  
Lower resistance, reduced  
skin effect - an unbeatable  
sounding inductor.

## Performance.



KIMBER KABLE,  
AUDIOQUEST  
& CARDAS  
Precision crafted  
wire, interconnect  
and connectors.

To receive The Parts Connection 1994 Catalog  
and a \$10 discount coupon good on your first  
order over \$100, send \$5 along with your mailing  
address or call with credit card information.

## THE PARTS CONNECTION

A DIVISION OF SONIC FRONTIERS INC

2790 Brighton Road, Oakville, Ontario, Canada L6H 5T4  
Toll Free Order Line 1-800-769-0747 (U.S. & Canada)  
Telephone (905) 829-5858 Facsimile (905) 829-5388

MIT MultiCap • Wonder Cap • Kimber Kap • Solo • Solen  
Siemens • Hovland MuliCap • Wima • Holco • Rel-Cap  
Draloric • Vishay • Caddock • Mills • Matsushita • TKD  
Noble • Cardas • Kimber Kable • Discovery • Audioquest  
MIT • ClearAudio • Alps • Bourns • Shallco Attenuators  
Elma • Electrowitch • Nichicon • Gold Aero • RAM  
Mallory • Ruby Tubes • Linear Technology • Motorola  
Analog Devices/PMI • Edison Price • International Rectifier  
MagneQuest • Sonic Frontiers • Pearl • Tube Sockets  
WBT • Neutrik • Curcio Audio Engineering • Kits

Reader Service #26

Speaker Builder / 8/94 63



# Affordable, 1/3 Octave, Real Time Analyzer With Memories & SPL Display Under \$1000

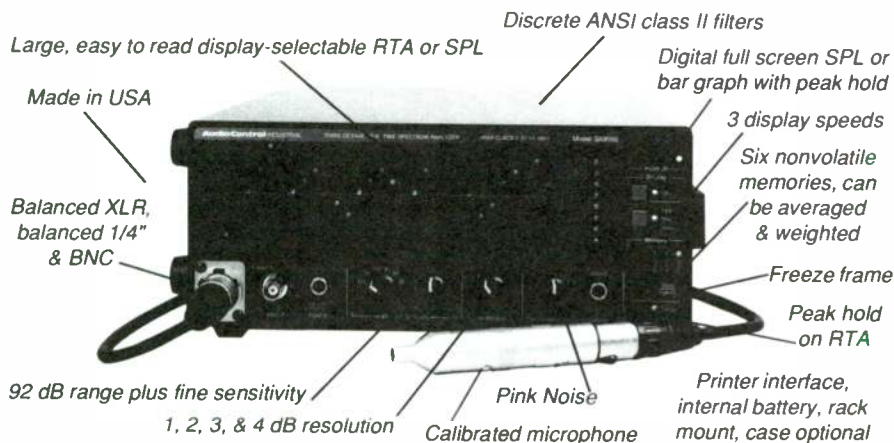

Printer interface, internal battery, rack mount, case optional

- SA-3050A with Mic \$ 995
- Rack Mount \$ 55
- with Battery & Printer Interface \$1300
- Soft Case \$ 59
- A/C Weighted Filter \$ 44

## AUDIO CLASSICS, LTD

34 Gardner Place • Walton, NY 13856 • Phone 607-865-7200 • Fax 607-865-7222

Reader Service #56

### SPEAKER BUILDER FAX BACK

Get the information you need fast! Use this convenient list to request the products and services that interest you in this issue. Don't forget to mention *Speaker Builder!*

COMPANY	PRODUCT	FAX
Amantis Audio	<i>Electrostatic Loudspeakers</i>	(514) 858-7605
Bohlender-Graebener Corp.	<i>Acculine Magnetic Planar Spkrs</i>	(702) 832-5407
Cadence Sound Systems	<i>Full Line Catalog</i>	(908) 370-5553
Dupont Company	<i>KAPTON®</i>	(800) 879-4481
Ferrofluidics Corporation	<i>Ferrofluids</i>	(617) 575-1068
German Physik	<i>DDD-Converter</i>	(011) 49-694-940-963
Harris Technologies	<i>BassBox 5.0</i>	(616) 641-5738
hifisound Saerbeck	<i>Strathearn Ribbon Drivers</i>	(011) 49-251-43956
Image Communications	<i>Loudspeakers, Horns, Drivers, Parts</i>	(312) 585-7847
LinearX Systems, Inc.	<i>Leap and LMS</i>	(503) 598-9258
Newform Research, Inc.	<i>No Holds Barred</i>	(705) 835-0081
Polydax Speaker Corp.	<i>Audax Kit Plans</i>	(508) 658-0703
Solen Inc.	<i>1994 Catalog</i>	(514) 443-4949
TCH Umbra	<i>Umbra Powered Sub. Kit</i>	(416) 299-6168
Technologie MDB	<i>Focal, Cabasse, Accuton, LDIS</i>	(514) 443-5485
The Parts Connection	<i>Assemblage DAC-1 Kit</i>	(905) 829-5388
Welborne Labs	<i>Active Crossover Kit</i>	(303) 791-5783

*Don't Delay FAX Today!*

most of your contributing editors out to pasture and find some new blood that your mainstream subscriber can more easily relate to. In my mail-order business selling drivers and speaker builder parts, I regularly speak with *SB* subscribers, who are mostly looking for down-to-earth info they can comprehend.

Carl Roberts  
The Speaker Works, Inc.  
Phoenix, AZ 85014

Contributing Editor Gary Galo responds:

While I appreciate Mr. Roberts' compliments on my article, his comments on *SB* articles in general are subject to debate. During its 15-year history, *Speaker Builder* has offered articles at the forefront of current loudspeaker mathematics and technology, and gained considerable respect in professional circles. Several of *SB*'s contributing editors and authors have presented papers on these subjects at Audio Engineering Society conventions, as well.

One of this magazine's strengths is the variety of viewpoints and technical levels their authors address. It is important that *SB* continue to offer a forum for differing opinions (such as yours and mine), as well as address the needs of readers of varying abilities—from beginner to advanced. I suggest that technically advanced articles, by well-respected authors in the field, lend greater credibility to the articles aimed at beginners, since they show a commitment to excellence at all levels.

The ground-breaking work of Olson, Villchur, Kloss, and others is an extremely important part of our heritage. However, the work of their successors, including Thiele and Small, is equally important. Prior to the research of Thiele, Small, and Benson, loudspeaker design involved as much art as science. Today, vented and closed-box loudspeaker design is mathematically predictable to a degree not previously possible. The average speaker builder has benefited enormously from their work. Through the personal com-

### PREVIEW Glass Audio

Issue 4, 1994

- Inside the Russian Tube Industry
- Headphone Helper
- Balance in Push-Pull Amps
- Rectifying Your Drivers
- Purist Tube-Regulated Supply

# 47,114 ELECTRONIC COMPONENTS

Whether you order 1 part or  
all 47,114...MOUSER stocks  
and...ships same day!!

CALL...(800) 992-9943

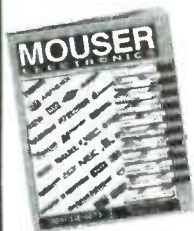

for your  
**FREE  
CATALOG**

2401 Hwy 287 N.  
Mansfield, TX 76063

## MOUSER<sup>®</sup> ELECTRONICS

Sales & Stocking Locations Nationwide

Reader Service #30

### RACKEM 'N' STACKEM™ SERIES



Boxes		
MODEL	DESCRIPTION W x H x D (in)	PRICE \$
RSB-3	7.5 x 1.85 x 3	25.00
RSB-5	7.5 x 1.85 x 5	31.25
RSB-7	7.5 x 1.85 x 7	38.00
RSB-9	7.5 x 1.85 x 9	45.00
RSB-11	7.5 x 1.85 x 11	51.50
RSB-13	7.5 x 1.85 x 13	58.25

- Half rack size for small and dense constructing
- Full line of accessories
- Can be used on table or in rack
- Three colors available; clear standard, for black or gold add \$5.00 per box

(800) 634-3457  
Order Today!



Table Top Racks		
MODEL	DESCRIPTION W x H x D (in)	PRICE \$
RSR-4	11.4 x 15.2 x 11	80.00
RSR-6	11.4 x 18.8 x 11	85.00
RSR-10	11.4 x 22.6 x 11	70.00
RSR-12	11.4 x 26.4 x 11	75.00
RSR-6-19	20.9 x 15.2 x 11	70.00
RSR-6-19	20.9 x 18.8 x 11	75.00
RSR-10-19	20.9 x 22.6 x 11	80.00
RSR-12-19	20.9 x 26.4 x 11	85.00

- Four models available in half and full rack widths
- Clear, black and gold anodized finishes
- Constructed of 1.0" square aluminum tubing

SESCOM STOCKS ALL TYPES OF ENCLOSURES  
FREE EXPANDED 1995 CONSTRUCTOR'S CATALOG

PREPAID ORDERS SHIP GROUND FREE  
(44 STATES, CANADA & MEXICO)



SESCOM, INC.  
2100 WARD DR. HENDERSON, NV 89015 USA  
USA/CANADA (800) 634-3457  
FAX (800) 551-2749  
(702) 565-3400 FAX (702) 565-4828  
TECH. LINE (702) 565-3993 M-Th 8 am to 4 pm (PST)

Reader Service #23

puter and accompanying software, the non-mathematical builder can put such research into practice without an engineering degree.

### Horn Study

Continued from page 36

size that close coupling to other drivers would be almost impossible. The AX2 has a cutoff frequency of around 750Hz, but is so smooth in its response that it can be used through cut-off. This is the lowest cutoff frequency that can be achieved, consistent with a flare which smoothly blends into the baffle, originating from a 1" throat in a diaphragm-to-mouth distance (with TD2001) not exceeding 300mm.

### HORNS Q & A

However, a high-efficiency horn system, usable from below 1kHz to over 20kHz, with a 12½" mouth diameter, capable of producing very high fidelity and a maximum output of 125dB at 1m, is certainly a useful tool. And, it most definitely is not horn-like in its sound. Clearly, when the many variables are fully understood and appreciated, horn systems which do not possess typical horn-like vices can be produced. Attention to detail is a prerequisite, as is a comprehensive knowledge of the caveats.

Two further questions about horn design arise as a result of this research, both requiring further investigation:

1. Given the extreme sensitivity to small disturbances in the throat region, can the Tannoy concept of having an actual gap in the horn (the voice-coil gap of the bass cone) ever be expected to produce optimal results? More particularly, when that gap is modulated by high levels of bass driver movement, can a variable length, variable flare, gapped throat ever be expected to produce optimal results?

2. The results show that any abrupt flare rate changes within the horn can, and will, cause reflections that superimpose themselves on the transfer function. Since the concept of constant-directivity horns relies upon flare-rate changes of no subtle nature, can the best results ever be achieved from constant-directivity horns?<sup>10</sup>

Figure 5 shows the measured throat impedance plot of the AX2 compared to that of a widely used constant-directivity horn of reputable manufacture and similar dimensions. However, this should not overly concern manufacturers of constant-directivity horns, since the bulk of their sales are in the public address/sound reinforcement fields, where their smooth coverage of a desired area far outweighs the sonic subtleties discussed here. For studio purposes, though, constant-directivity horns would not seem to be the ultimate solution.

DDD 360° Dipolar Bending Wave Converter

# YES, IT REALLY EXISTS!

High-End Technology made in Germany



This driver delivers a genuine full-range 360° dipolar output, is currently available as OEM and/or with the ArtNOISE custom-built cabinet.

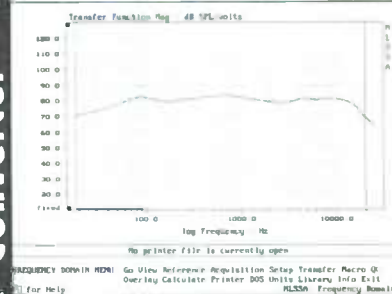

These measurements are taken without any form of filtering. Frequency Range: -6 dB at 20 Hz, from 150 Hz to 16 kHz ±2.5 dB, -3.5 dB at 16 kHz and above.

Resonance Frequency: 91 Hz  
Coincidence Frequency: 220 Hz  
Dipole Resonance Fre.: 6 kHz  
Sensitivity: 87 dB/W/m  
Output Characteristic: 360° toroidal  
Impedance: Z(1kHz)=4 Ω  
Nominal Power Handling: 120 W  
Frequency Range: (see above)

Distributor enquiries welcome.  
Fax (011)-49-69-4940963

## GERMAN PHYSIKS

HIGH END TECHNOLOGY

Postbox 10 26  
D-63 506 Hainburg  
Germany

Reader Service #42

Speaker Builder / 8/94 65



# Mahogany Sound

2610 Schillingers Rd. #488  
Mobile, AL 36695  
(205) 633-2054

TRANSMISSION LINE SPECIALISTS

## Q&ETLD

**QUICK & EASY TRANSMISSION LINE SPEAKER DESIGN** is a new booklet that is a must for TL fans. It offers a step-by-step design procedure that really works. All you need is a calculator with a square root key, and imagination. There is also a computer diskette for use with Lotus 123, and a 6 1/2" 2-way TL project called *The Mini Monolith TL*.

Q&ETLD is \$8.95 postage paid.

## ACOUSTA-STUF

ACOUSTA-STUF is absolutely the best sound absorption fiber for transmission lines. You should order one pound per cubic foot of enclosure.

ACOUSTA-STUF costs \$8.95 per pound, UPS paid.

WRITE OR CALL  
FOR A FREE CATALOG

Reader Service #9

## Grille Frames

Continued from page 48

frame, you are ready to use your jig to cut the sides. Scrupulously measure the outside dimensions that the frame will fill. Then cut the pieces so they are at least 2" longer than the finished dimensions. Clamp one piece with wedges in the right miter so it extends a bit past the center cut on the jig (Photo 5). The saw height should allow the gullet between the teeth to be at the surface. Slowly push the jig through, cutting the miter (Photo 6). If you encounter any difficulty getting the wedges out, you can use another as a driver (Photo 7).

Without turning the piece over, rotate the side to the left guide and align it so that the cut will produce the required finished length (Photo 8). Square frames require two sets of two pieces with the same dimensions. After you have made one piece and cut one end of the second piece, you can use the original piece to align the second piece (Photo 9). Repeat until you have cut all sides of the frame.

## ASSEMBLY

I usually mark each joint (on the back side, of course), starting with one mark for the first joint, two marks for the second joint, and so on (Photo 10). If I didn't do this, I would mix up the sides and destroy a grain pattern that I have thoughtfully chosen (e.g., book-matched sets for opposing sides). Using a soft lead pencil, you can erase the marks after the frame is assembled.

The final assembly step is clamping the frame together and gluing and fitting it to the enclosure. We've already discussed gluing requirements and the woodworking tip that the shorter the time between cutting and gluing, the better the joint (SB 2/94, p. 46). Clamping is another subject we have discussed (SB 1/94, p. 58). The secret is applying the correct amount of pressure. If your frame is square, the jig described in SB 1/94 is one of the best ways to solve this problem (Photo 11).

You are now half done. In the next issue, I will discuss ways to dress up the frame, strengthen the joints, and attach the grille to your enclosure.

## REPRINTS

For quality reprints in quantities of 100 or more, contact:  
**REPRINT SERVICES/  
SPEAKER BUILDER,**  
315 5th Avenue N.W., St. Paul, MN  
55112,  
(612) 633-1862.

## DESIGN TOOLS THAT SPEAK YOUR LANGUAGE!

For years loudspeaker builders have been waiting for this. Affordable software programs to design and simulate your special speaker system. Programs you don't have study on, but are ready to use immediately.

NETCALC is the state of the art crossover design program using an **interactive** or **automatic optimizer**. And with its **graphical** speaker editor and network editor you can easily enter your data.

**BOXCALC** \$99 DOS software for enclosure design of closed and ported designs, including a database of 1200 drivers

**NETCALC** \$149 DOS software for crossover design, optimization and system simulation

Dutch Elektor Loudspeaker Special  
"We recommend NETCALC without restrictions, only to play with it is worth it"  
Together with BOXCALC  
"An ideal combination to compute and simulate practically every aspect"  
Voice Coil (oct. 1993)  
"...NETCALC offers a lot of features for not much money"

### ORDER INFORMATION:

To order a copy of BOXCALC or NETCALC please send a personal or bank check in US \$. The software will be delivered by airmail, postage is included. Dealer inquiries are welcome.

**ARIBA**  
Baroniehoeve 32  
5244 HZ Rosmalen  
the Netherlands  
FAX + 31 4192 15841 (24h)

Reader Service #43

## SALE! PLUS FREE ADHESIVE!

**MARKERFOAM™ ACOUSTIC FOAM GIANT 54" x 54"**  
Immediate Shipping

2" Reg. \$29.95 Now \$19.99 • 3" Reg. \$39.95 Now \$29.99! KILL NOISE QUICK!  
High performance, full-size sheets of super high density Markerfoam. EZ mount. Blue or grey. Super-effective sound absorption for studios. Markerfoam offers best value, looks professional & is proven in studios worldwide. Request Foam-Buyers Guide/Catalog, specs & free samples today. VISA, MC, AMEX, COD, PO's. QUANTITY DISCOUNTS.

**MARKERTEK JUMBO SOUND ABSORB BLANKETS**  
Heavy-duty 72" x 80" padded blankets absorb sound wherever they're hung or draped. Fabulous for stage, studio & field use. Top professional quality at a super saver price! Weight: 6 lbs. Black, \$19.99.

**MARKERTEK BLADE TILES™**  
HIGH PERFORMANCE  
LOW, LOW COST!  
\$3.49 per tile, 16x16x2". America's best acoustic tile value, only from Markertek! Charcoal. Also available 16x16x3" as shown, \$4.49 each.

**MARKERSTIK™** foam adhesive. FREE with any Foam purchase in this ad! Limited offer. A \$5.95 per tube value.

**SONEX**  
All the colors and sizes plus great prices!

Get our FREE 149-page catalog of over 6,000 exclusive and hard-to-find supplies for audio & video.

800-522-2025 America's most unique catalog for audio & video!  
FAX: 914-246-1757

**MARKERTEK™**  
4 High St., Saugerties New York 12477 U.S.A.  
**VIDEO SUPPLY**

Reader Service #10

## TWO WAYS to get the products, services and information you need from our advertisers!

**1 CALL OR FAX...** and be sure to tell them you saw their ad in *Speaker Builder*.

Some even offer special discounts to our readers!

**2 FILL OUT THE CARD...** Nearly every advertisement has a corresponding reader service number. Use the reader service card in this issue to request more information. Please mail all cards within 60 days of receipt of magazine.

# Classified

## TRADE

ELECTROSTATIC parts, supplies, exotic circuits. Free catalog. **DAVID LUCAS, INC.**, 924 Hulton Rd., Oakmont, PA 15139, (412) 828-1967, FAX (412) 828-0422.

## NEW! Kit Monoblock Single-Ended Class A MOSFET Amp

"It Thinks it's a Triode"

- **SIMPLE, STEP-BY-STEP ASSEMBLY MANUAL**
- **ALL PARTS - FULL KIT •**

- **'TUBE SOUND' - MOSFET RELIABILITY & POWER**
- **40 WATTS @ 8Ω - DC COUPLED - 450VA XFMR**
- **HIGH PERFORMANCE, FULLY ENGINEERED**
- **DELUXE POWDER COAT ALUMINUM CHASSIS**
- **FACTORY REPAIR & ASSEMBLY AVAILABLE\***

[some soldering/electronic experience suggested, DVM required]

Quantity Limited - Order now, don't be left out!

Special introductory price **\$449** /channel

Plus S&H/NY add tax Release date: Dec 15, 1994

\*For full details Call or write:

BEAR Labs 4 Jennings Road  
Hannacroix NY 12087 USA  
(518) 756-9894 FAX (518) 756-3092



**WIDER, DEEPER, MORE HOLOGRAPHIC SOUNDSTAGE:** *Room Acoustics Handbook* \$14.95, Monarchy 22a DAC \$695, Level 1 Mod \$295, digital cable \$125, loudspeakers from \$995. **MACH 1 ACOUSTICS**, RR #2, Box 334A, Wilton, NH 03086, phone/FAX (603) 654-9826.

**STATE-OF-THE-ART PASSIVE CROSSOVERS AND COMPONENTS.** Custom coil winding our specialty. Free Design Guide. **ALLPASS TECHNOLOGIES**, PO Box 453, Amityville, NY 11701, (516) 598-1320.

**HIGHLY ACCLAIMED AUDIO/VIDEO POWER CORD.** Unique configuration serves as low frequency EMI filter. Superb audio with pinpoint resolution of visual detail. Money back guarantee!! **SOUND APPLICATIONS**, phone/FAX (510) 548-5721.

**MANUFACTURER CLOSE-OUT** on loudspeaker components and cabinets in oak, walnut, and black oak. Satellites in black MDF as well as subwoofers. Call or write for details. **MARQUIS SPEAKER SYSTEMS**, 901 Charity St., Abbeville, LA 70510, (318) 893-6803.

**ACT AUDIO GIVES GOOD SOUND!** Computer analysis of your listening room. Send SASE for details. **ACT AUDIO**, 619 Moon Clinton Rd., Corapolis, PA 15108.

## FOR SALE

Aragon 18K preamp with IPS power supply, mint, \$650; Monarchy 22A DAC with balanced output, mint, \$525; Vandersteen 2C speakers with stands, excellent, \$575. Doak Wattingney, (504) 738-1235.

Yamaha B-6 stereo basic amp, The Pyramid, 200W/channel, \$300; Kenwood KM107 stereo basic amp, 150W/channel, \$185; two Knight KN600HC 12", 35W, 8Ω, 2-way speakers, \$130; two Audax HD24B45 8Ω, 9½" woofers, \$80. All plus shipping. Stan, (216) 288-9480.

Music Reference RM-5 MK III tube preamp, brand new, full factory warranty, solid cherry case, wonderful sound, *Audiophile* "A" rate. List price, \$1,450. Will sell for \$1,200. Kurt, Santa Barbara, (805) 961-7590 or 964-9789.

NAD 2155 amp, 55W/channel, 150W bridged, 3dB dynamic headroom, very good condition, \$150 plus shipping. Mike Dawson, 1035 West 57th Pl., Davenport, IA 52806, (319) 326-7026 days or (319) 391-2761 after 4 p.m. CDT.

FEP shrink tubing, flourinated ethelene propylene. Vastly superior second generation Teflon, astoundingly transparent sonics, 175°C shrink temperature, very easy to work with, dielectric constant approximately 7. Mylar shrink tubing also available. J. Weil, phone/FAX (510) 548-5721.



## AVAILABLE NOW!

TC SOUNDS makes no-compromise drivers with linear motor-structures (underhung), high-compliance linear mechanical systems, and stiff lightweight composite diaphragms. Individual T/S-parameters for 8", 10", 12", 15" (5.5" & 18" soon). Call (619) 622-1212, or FAX (619) 622-9293.

Looking for new home. KSS Audio 100W stereo direct-coupled OTL amp, asking \$3,000; Tektronix 2213A 60MHz dual trace oscilloscope with accessory pouch & two X10 probes, (Tucker price, \$895) asking \$500. Ashby, (305) 475-5225.

### Premium Parts & Accessories

The largest selection of audiophile capacitors, resistors, connectors, chassis wires in North America. MIT MultiCaps, Wonder Caps-solder-wire, SCR, Solen cap, Rel-Cap: Vishay, Holco, Caddock, Mills, Resista resistors: MIT, CARDAS, KIMBER, NIMTEC, & silver chassis wires, custom cables, SOLO foil inductors: all types of audio connectors: silver contact toggle, rotary switches & stepped attenuator kits. HEXFRED rectifiers, ANALOG DEVICES. HUBBELL hospital grade plugs & outlets. Tubes, feet, damping sheets & compounds, tools and many accessories. Extensive inventory - good prices and good service! Phone (415) 669-7181 or fax 669-7558 for a catalog. **Michael Percy, Box 526, Inverness, CA 94937**

Rotel RCD955AX CD, \$250; pair Peerless 831727 10" woofers (modified, new), \$140; pair new Focal 120TiO2 tweeters, \$125; Focal Audio 7K midranges, \$80 each, four for \$300; pair MB Quart 210TC 8" woofers, \$180; Sony, Kenwood, Toshiba receivers, needing minor repairs, \$35 each; Alpine 7903 car CD player, newly refurbished, \$225; pair new MTX RTP-154 15s, \$250. Geoff, (417) 831-3447.



## SPEAKER BUILDER CLASSIFIED ORDER FORM

**TRADE**— for any business or private party, selling equipment, supplies, or services **FOR PROFIT. FOR SALE**— to sell *personal* equipment or supplies. **WANTED**— to find *personal* equipment, supplies, or services. **CLUBS**— to help readers start and maintain club membership.

**PRICE:** All ads are \$1.50 per word. Deduct 5% for an 8X contract. \$10 minimum per insertion. **Payment must accompany ad.**

**FREE ADS:** Subscribers receive free For Sale, Wanted and Club ads up to 50 words. Over 50 words .20 per word, \$10 minimum. Name, address and phone number must be included with ads.

**SUBMITTING COPY:** A word is any collection of letters or numbers with a space on either side. Copy must be clearly typed or printed. *Illegible ads will be discarded.* Submit copy by mail, fax, or data transfer (ASCII, WordPerfect 5.0 or 5.1, Word for Windows, Word for DOS, Windows Write, or Word Star 3.3- 5.5 formats)

**QUESTIONS?** Write or fax us at the address below.

For Sale     Wanted     Club     Trade, No. of insertions \_\_\_\_\_

**USE BLOCK LETTERS IF PRINTING. NO ABBREVIATIONS.**

1	2	3	4	5
6	7	8	9	10
11	12	13	14	15
16	17	18	19	20
21	22	23	24	25
26	27	28	29	30
31	32	33	34	35
36	37	38	39	40
41	42	43	44	45
46	47	48	49	50

**Please charge to my:**     DISCOVER     MASTERCARD     VISA

CARD NUMBER \_\_\_\_\_ EXP. DATE \_\_\_\_\_

CHECK/MONEY ORDER ENCLOSED

Subscription Account Number: **A**

NAME \_\_\_\_\_

COMPANY \_\_\_\_\_

STREET & NO. \_\_\_\_\_

CITY \_\_\_\_\_ STATE \_\_\_\_\_ ZIP \_\_\_\_\_

PHONE \_\_\_\_\_

**AAP, Inc. — Classified Dept.**

**PO Box 494, Peterborough, NH 03458**

**FAX 603-924-9467**

**Data 603-924-6230**

Pair Dynaudio D28AF, \$60; pair Dynaudio 17W75, \$90; pair Radio Shack 12", \$50. Dave, (216) 666-6805 (OH).

Infinity Emims, \$75 each; Dynaudio 30W100 drivers, unused, \$125 each; pair Sequerra T-1 ribbon tweeter, \$600. Douglas S. Robinson, 20735 Timberlane Dr., Elkhorn, NE 68022, home (402) 289-0886, work (402) 779-2531, 8-5.

Heath IG-5218 audio generator, BSR sound level meter, *Loudspeaker Design Cookbook*, *Speaker Builder* magazine from January 1988 to present, all for \$140. Jim, (606) 441-9684.

### SPEAKERS — Go Factory Direct and **\$SAVE!**

- 90-Day Home Trial
- Leading edge design for Home Theater and traditional systems
- Satisfaction guaranteed
- Upgrades and service plus complete speaker systems from \$200 to \$6,000 per pair.
- Call for free catalog & dealer listing

## 800-783-1553

Ohm Acoustics, 241 Taaffe Place,  
Brooklyn, N.Y. 11205

H-P 180A oscilloscope, \$100; nifty cart for same, \$25; Fisher 2421 tuner, \$50; Dyna PAT-4 preamp, \$50; J. Curtis, PO Box 758, Stevens Point, WI 54481, (715) 341-5880.

McIntosh literature for electronics & speakers, call for list; crossover coils, 6mH #19 wire, \$15/four; E-V T-3500 Ionovac specs & instructions 1957, 11 pages, \$6; other Ionophone articles, 8 pages, \$5; *Men of Hi-Fi & Hi-Fi Workbench*, recorded programs from the '60s, swap for others. Roger, (407) 862-5143.

Audio Concepts JC12 woofer, \$60; pair Vifa P17WJ-00 40Q, \$40; pair Vifa D26TG-05 6Q, \$15. All perfect, plus shipping from California. C. B. Parkinson, 4337 Marina City Dr., #247, Marina Del Rey, CA 90292, (310) 823-0124.

### The Ribbon Source

Our new technology Ribbons have the **musicality and air of large electrostatics** but are mono-polar, high impedance drivers in easy to drive and place packages. They will simplify your designs and upgrade your audio or video systems sound.

Ribbons are 8", 15" and 30" in full range systems, kits and Modules. **Tubes love them!** Ask for specs and international reviews.

**Newform Research Inc.**  
**1-705-835-9000 Fax: 705-835-0081**  
Custom mfgs and overseas distributors sought.

Aria 3 cabinets, (sold new \$400) accept \$190 or best offer; pair Dynaudio 17W75XL 8Ω, \$140 or best offer. All in excellent condition. Jerry, (601) 264-6971.

McIntosh MC2002 power amp, mint, \$1,050; Carver S7T mono amps, mint, \$1,050; Soundcraftsman PP4 power amp, mint, \$450; H-K Citation 11 preamp, excellent, \$100; H-K Citation 12 preamp, excellent, \$100; Philips 12" woofer mid tweeters, \$5 each. Paul, (914) 528-1510.

Early Yamaha Audiophile level turntable: YP-800 direct drive turntable with YA-9 tonearm and Ortofon M20FL cartridge, includes disc washer and Shure stylus gauge, excellent condition, \$100 or best offer plus shipping. Peter S., (207) 872-8577.

McIntosh stereo power amps: 2200, \$1,000, two 2120, \$650 each; MR-G5 tuner with multiplier, \$450; Marantz Model 7 preamp, \$1,350, Model 8 amp, \$1,000; Counterpoint SA-20 amp, \$1,000; Crown Macro Reference amp, Esoteric version, \$2,250; JBL 2395 plate lens horns, 1" & 2" throat drivers. David, (914) 688-5024.

Pair Vandersteen 2As, original owner, need foam & grille, electrically excellent, \$185; Fosgate 3602 surround processor with box & manual, mint, (originally \$1,100) \$225; D'Appolito originals 20ARS matched drivers, 3/4" & 1" acrylic enclosures, separate back for crossovers, gray/black with matching S&D, don't like sound, \$650 or trade. David, (310) 924-2666.

Altec-Lansing Model 15 speaker system, very good condition, 12" woofer, horn mid/tweeter with Tangerine phase plug, walnut veneer, \$350 or best offer. Prefer local delivery or you pick up. Steve, (610) 759-3218 (eastern PA), leave message.

JBL: four 117H-1 8" woofers, factory sealed, \$45 each; pair 2404H bi-radial horns, \$250. Dynaudio: pair 21W54, \$125; pair D-52AF, \$95; pair 30W54, \$175. Scan-Speak: pair D-2008, \$40; pair 25W8561, \$140; SEAS: pair H297, \$15; four P14RCY, \$20 each. Pair Electro-Voice ST350B, \$115; pair Vita D25AG-05, \$25. Clay Jordan, (404) 969-8319, 6-10 p.m. EST.

**STATEMENT OF OWNERSHIP, MANAGEMENT AND CIRCULATION**  
(Required by U.S.C. 3685.) Date of Filing, Sept. 30, 1994. Title of Publication: SPEAKER BUILDER. Frequency of issue: Eight times a year (every six weeks).

Annual subscription price \$32. Location of the headquarters or general business offices of the publishers: 305 Union St., Peterborough, NH 03458-0576. Publisher: Edward T. Dell, Jr., PO Box 494, Peterborough, NH 03458-0494; Managing Editor: Dennis Brisson. Owner: Audio Amateur Publications, Inc., PO Box 576, Peterborough, NH 03458-0576. Stockholders owning or holding 1 percent or more of the total amount of stock: Edward T. Dell, Jr., PO Box 576, Peterborough, NH 03458-0576. Known bondholders, mortgagees, and other security holders owning 1 percent or more of total amount of bonds, mortgages or other securities: None.

	Average # copies each issue during preceding 12 months	Single issue nearest to filing date
Total # copies printed	14,333	14,000
Newsdealer sales	510	592
Mail subscriptions	10,033	9,085
Total paid circulation	10,543	9,677
Free distribution complimentary	148	150
Total distribution	10,691	9,827
Office use, leftover	3,516	4,173
Return from news agents	126	0
Total	14,333	14,000

I certify that the statements made by me above are correct and complete.  
Publication No. 529-310 Edward T. Dell, Jr., Publisher

# WANTED

Single or pair Focal 7K011-DBL; Motorola T03 2N5686-5684. David, (310) 924-2666.

10V516 woofer; two AC-10 rubber surround drivers; three Variovents or equivalents; two 100W L-pads; two Scan-Speak D-2905 tweeters; two 12Mh Sledgehammer iron core inductors. Jim, (708) 425-6719, 5-10 p.m. CST.

Information on replacement voice coils for JVC DynaFlat ribbon tweeters and Radian/Emilar replacement voice coils. Want to buy Audio Precision test equipment. Dan Patten, 1768 N. 980 W., Orem, UT 84057, work (801) 224-8080 or home (801) 225-8577.

Service and/or owners manuals for Phase Linear model 700 power amp (direct-coupled solid state). Scott Roberts, 4533 N. Channel Ave., Portland, OR 97217, (503) 285-2904.

Knowledgeable speaker builder/audio entrepreneur with professional background in Quality Assurance and electronics seeks position or association with audio company in New York or southeastern states. P.M. Audio, (516) 868-8863.

## Electronic

by  
**ACE AUDIO CO.**

• est. 1973 •  
RD3 Box 351  
Homer City, PA 15748  
write for free flyer

## Crossovers

## Ad Index

ADVERTISER	PAGE	ADVERTISER	PAGE
A & S Speakers	27	Sescom, Inc.	65
ACI	19	Solen Inc.	31
Acoustical Supply International	8	Solo Electronics	55
Amantis Audio	40	Speaker Works	56
Ariba	66	Speakers Etc.	50
Audio Classics, Ltd.	64	TCH Umbr	43
AudioControl		Technologie MDB	41
C-101 Series III Equalizer/Analyzer	18	The Parts Connection	63
Real Time Analyzer	64	The Speaker Works, Inc.	35
Bohlender-Graebener Corp.	18	Versa-Tronics, Inc.	23
Cadence Sound Systems	5	Welborne Labs	63
Dupont Kapton®	15	Wilmslow Audio Ltd.	52
Ferrofluidics Corporation	3	Zalytron Industries Corp.	17
Forgings Industrial Co.	13		
German Physiks	65	<b>CLASSIFIEDS</b>	
Harris Technologies	58	Ace Audio Co.	69
HeadRoom	42	BEAR Labs	67
Hi-Fi News & Record Review	62	Michael Percy	67
hifisound Saerbeck	63	Newform Research, Inc.	68
Image Communications	57	Ohm Acoustics Corporation	68
Liberty Instruments, Inc.	44	TC Sounds	67
LinearX Systems, Inc.	CV2		
Madisound		<b>GOOD NEWS/NEW PRODUCTS</b>	
Home theater speakers	37	Acoustical Supply International	3
Stocking stuffers	21	Allison Technology Corp.	8
Mahogany Sound	66	Alpha-Core Inc.	5
Markertek Video Supply	66	Antique Electronic Supply	3
MCM Electronics	53	AudioControl	5
Meniscus	51	Beal's Brothers	3
MicroAcoustics	6	Fried Products Corp.	3
Morel Acoustics	CV4	Fultron	8
Mouser Electronics	65	Parasound Products, Inc.	5
North Creek Music Systems	56	PSB International	3
Old Colony Sound Lab	45-46	Roto Zip Tool Corp.	3
Orca		Scantek, Inc.	
Axon Caps	32	Preamps	5
Axon Cables/Black Hole	33	Sound Intensity Probe	5
Parts Express Int'l, Inc.	CV3	Sescom, Inc.	3
Polydax Speaker Corp.	4	Stage Accompany	8
Pyle Industries	29	Technology Catalysts	8
RDL Acoustics	61	Valley Audio Products, Inc.	5



# Loudspeakers 101

## MINDING THOSE Qs

By Dick Pierce

Last time, we explored a little of the history and philosophy behind the Thiele/Small parameters and looked at two of these parameters: resonant frequency and the “equivalent volume of compliance.” Now we’ll consider a class of parameters that, to many, are very mysterious in their nature but are just as important as the others.

### SYMBOL OF QUALITY

To understand the Q parameters,  $Q_{MS}$ ,  $Q_{ES}$ ,  $Q_{TS}$ , and others, which don’t seem to relate to everyday or intuitive experience, we need to take another little trip back into history. In the early days of radio, people were looking for a way to describe the quality of inductors, which were used, along with capacitors, to form the electrical resonant circuits that radios used for tuning and selectivity.

An inductor was considered high quality or “high-Q” if it had very little electrical resistance or losses compared to its inductance. It was considered “low-quality” if its electrical losses were high. Thus, the Q factor, or simply the Q, of a coil was a measure not so much of the quality in general, but specifically of the amount of energy that was lost to electrical resistance and, thus, could not be utilized for the resonant action of the circuit.

The higher the Q of a coil, the less energy was dissipated by the resistance of the coil. The result was a resonant circuit with a high-Q coil that exhibited a very sharp, narrow, and precise resonance, which is essential for accurate and selective tuning of radios.

### ENERGY LOST

The Thiele/Small Q parameters are quite similar. They indicate how much energy is dissipated through different loss mechanisms in the driver. Two important losses or “resistances” occur in a loudspeaker driver: electrical and mechanical. Each of these Q numbers is a direct measure of the ratio of each of these losses to the total driver reactance at the driver’s resonant frequency.

Unlike inductors used in radio frequency work, a high Q does not necessarily mean *better*. In fact, in some cases lower Qs indicate higher quality. In the case of loudspeaker drivers, a lower Q indicates better damping

and control of the loudspeaker at low frequencies. Even so, an optimum range of Qs exists, depending upon application. Above or below this range may result in less than the best performance:

The mechanical Q,  $Q_{MS}$ , is a measure of the mechanical losses or “resistance” of the driver, primarily due to frictional losses in the suspension itself. It’s very similar to the action of a shock absorber in an automobile suspension.

A lower  $Q_{MS}$  (in the range of 1–5 or so) generally indicates a lossy suspension, one that is good at terminating and controlling the flexing of the cone. However, this is only a very general rule, and there are examples of very high-quality drivers with comparatively high  $Q_{MS}$  values.

### ELECTRICAL LOSSES

The electrical Q,  $Q_{ES}$ , is a measure of the electrical losses of the driver, primarily due to the simple electrical resistance of the voice coil. Usually, the driver’s electrical Q is significantly lower than its mechanical Q, indicating that more energy is dissipated electrically than mechanically. That means the electrical Q is more important than the mechanical Q in controlling the speaker around resonance.

In practical loudspeakers, most of the electrical resistance in the loudspeaker circuit is in the voice coil. The total contribution of resistance from the crossover, speaker leads, and amplifier is almost always far lower and relatively insignificant compared to the voice coil. This contradicts the popularly held notion that reducing, for example, the speaker wire resistance from a tenth to a hundredth of an ohm can make a profound difference in how the speaker behaves at low frequencies (the effect is sometimes referred to as “damping factor”). But that’s a story for another time.

In general, lower values for  $Q_{ES}$  indicate higher quality. You can infer that a lower  $Q_{ES}$  can mean a relatively larger magnet, for example.

### MORE Qs

The total Q,  $Q_{TS}$ , combines mechanical and electrical resistance, and is a measure of the total losses that damp the motion of the cone. More importantly, it gives an idea about the

suitability of a driver for a given application. As a general (but not inviolable) rule,  $Q_{TS}$  figures below about 0.40 indicate the driver is suitable for vented box applications, whereas closed box systems are well suited by drivers with a  $Q_{TS}$  ranging from about 0.35 to about 0.60. But these are only guidelines. There are certainly instances where a given application demands other values.

Another set of Q numbers relates to losses in the enclosure or vent.  $Q_A$ , for example, refers to the losses caused by any absorptive filling in the enclosure.  $Q_L$  refers to “leakage” losses in the enclosure. And  $Q_P$  is a measure of the losses in the vent or port due to air friction and turbulence effects. The combined measure of these losses is called  $Q_B$ . All of these enclosure Q values are usually a result of these losses measured around the system resonance (in the case of sealed boxes) or the enclosure resonance (for vented boxes).

We can also consider the “system” Qs, in the case of sealed boxes. For example, the  $Q_{TC}$  of a sealed box system describes the total system Q at resonance. In this case, the number directly relates to performance (since it describes the system as a whole). We can derive the response of a system from its  $Q_{TC}$ . For example, a  $Q_{TC}$  of 0.707 results in a “Butterworth” response, which is the flattest response possible.  $Q_{TC}$  values less than this indicate drooping, overdamped response, whereas greater  $Q_{TC}$  values indicate a peaked response and boomy sound.

### A QUESTION OF DIMENSIONS

Let’s take a little detour here. The Q parameters of a loudspeaker are referred to as “dimensionless,” since they have no units. If the  $Q_{MS}$  of a loudspeaker was, say, 3, you might ask, “3 what?” Well, it’s just 3, describing a ratio between two similar units (in this case, impedances, or losses).

Other units are “dimensioned” numbers, describing how much of something you have. For example, the  $V_{AS}$  of a speaker is always specified in liters, cubic meters, or cubic feet. The resonant frequency,  $f_s$ , is measured in hertz (cycles per second), or even radians per second. But the Qs, as with other dimensionless numbers, are nothing but factors or ratios.

I’ll discuss some other examples of both dimensioned and dimensionless numbers in upcoming issues.



# Get Serious!

**P**arts Express is serious about providing the novice, as well as the advanced speaker builder, with some of the finest components and accessories currently available for loudspeaker construction. Raw drivers, enclosure resonance damping material, port tubes, spikes, 14-20 gauge inductors, polypropylene capacitors, power resistors, audio test equipment, and too many other items to possibly list here, are available to you at very reasonable prices!

We stock every item we advertise and most orders are shipped within 24 hours of placement. Our technical support staff can help the novice builder select the best drivers for a particular application, choose appropriate enclosure volumes and even help calculate crossover values. So call now for your copy of our free 188 page catalog and get serious about speaker building!

**FREE**



**CATALOG**

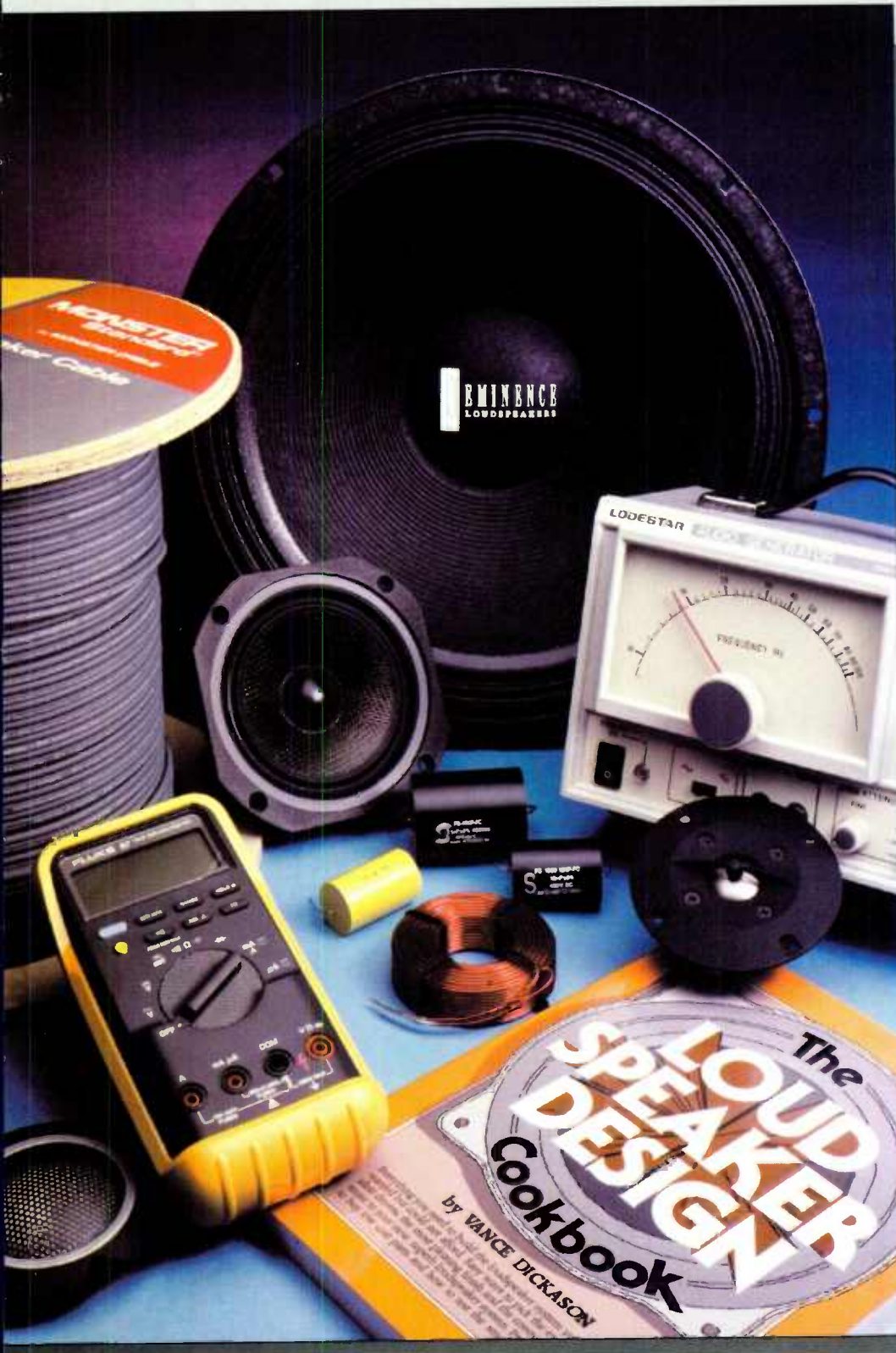

**Parts Express**  
International Inc.

CALL TOLL FREE

**1-800-338-0531**

340 E. First St., Dayton, Ohio 45402-1257, Phone: 513-222-0173, Fax: 513-222-4644

© October 1994





Made  
in  
England

# High-Tech Audiophile Loudspeakers

For Further Information Please Contact: **morel acoustics USA**

414 Harvard Street  
Brookline, MA 02146  
Tel: (617) 277-6663  
FAX: (617) 277-2415

World Radio History



Typical Double Magnet Woofer Cross Section.