

Speaker Builder

THE LOUDSPEAKER JOURNAL



**MITEY MIKE
MEASURES**

*Fishin'
with us!*

ETON AMERICA, Box 9274, Grand Rapids, MI 49509-0274

- 3 Layer Kevlar—
Honeycomb Diaphragm
HEXACONE
- 70% Greater Stiffness
- Cast Aluminum Chassis
- Rubber/PVC Surround
- Edgewound Ribbon Wire
- All Parts Weighed and
Matched
- DTB Diffraction Foam
- ETON Caps—
1% Polypropylene
- New Metal Dome
MID-RANGE



4-203/25 HEX

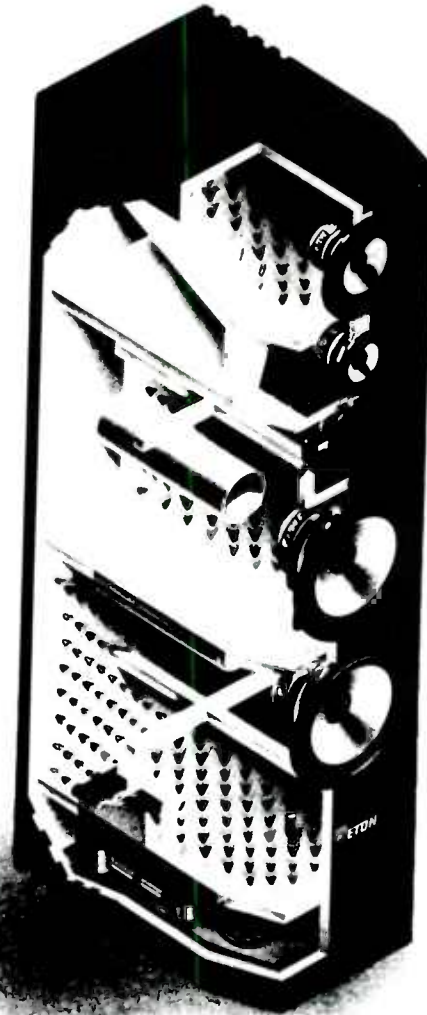

KIT VELOCE 550 DTB

If you have any questions, please do not hesitate to contact us.

A&S SPEAKERS
3170 23rd St.
San Francisco, CA 94110
(415) 641-4573
FAX: (415) 648-5306

AUDIO CONCEPTS
901 S. 4th St.
LaCrosse, WI 54601
(608) 784-4570
(800) 346-9183

MADISOUND
8608 University Green
Box 4283
Madison, WI 53711
(608) 831-3433
FAX: (608) 831-3771

MENISCUS
2442 28th St., S.W.
Suite D
Wyoming, MI 49509
(616) 534-9121
FAX: (616) 534-7676

SOLENELECTRONIQUE INC.
4470 Ave. Thibault
St. Hubert, QC
Canada J3Y 7T9
(514) 656-2759
FAX: (514) 443-4949

ETON DEUTSCHLAND, Phone 47 91 2078, FAX 47 91 2070

ETON®

SB Mailbox

ERRATA

I noticed what obviously must be a drafting typo in *Speaker Builder* 4/90, p. 39, Fig. 4, the crossover circuit.

The junction of C64 and R67 should be connected to the junction of R64 and R66.

Burt Cossey
Hesperia, CA 92345

VAPOR CAPACITOR

I just read the article "A Balanced Line Design" by Alan Watling (*SB* 3/90), but am unable to locate C1, C2 0.0 μ F ceramic discs.

Can you tell me where I might find components of this magnitude? I'm sure their quality would be unexcelled.

Rocco Santori
San Francisco, CA 94119

I wish we knew where to find them, as well. But look no further. There is at this writing no such animal, and what you read was a typo. C1 and C2 in Fig. 1 are 0.01 μ F ceramic discs.—Ed.

THEORY vs. PRACTICE

Mr. Ricart's active loudspeaker (*SB* 4/90) is very well-conceived, with excellent coverage on choices of drivers and op amps. I hope to see more articles like this

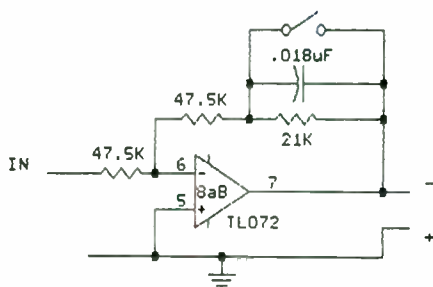

FIGURE 1: Add a switch to short the capacitor.

which detail the concerns and compromises confronting the amateur speaker builder.

My question regards diffraction loss compensation (or lack of it) for the midrange enclosure. Mr. Ricart notes the loss occurs below the 450Hz cutoff for his 9" baffle width. Yet, the D'Appolito SWAN IV satellite begins its loss at 850Hz with a similar baffle width.

How are diffraction loss and enclosure width related? I previously believed their loss would begin at the half-wavelength dimension, or about 750Hz in this case.

Matthew Honnert
Carol Stream, IL 60188

Fernando Ricart replies:

Mr. Honnert's letter raises an interesting point. In theory, a loudspeaker radiating into free space suffers an output loss with decreasing frequency when compared to a loudspeaker radiating into a hemisphere. This loss begins at a frequency with a $\frac{1}{2}$ wavelength equal to the smallest baffle dimension and approaches 6dB at low frequencies. In practice, radiating into free air is rarely achieved due to the surrounding boundaries, therefore the actual loss is somewhat less than the theoretical maximum.

It is difficult to place a loudspeaker the size of mine, and with as many wires connected to it, out in the middle of the room. Therefore, design work took place about one foot from the back wall. In this position, $\frac{1}{2}$ -octave pink noise measurements with the midrange operating at full range show a relatively flat output to about 500Hz and falling to around 2dB below reference at 250Hz.

These curves led me to ignore diffraction compensation for this design. They were also the main factor in keeping the crossover frequency at 450Hz. For designs such as the SWAN or the Linkwitz with their 200Hz and 100Hz, respectively, crossover frequencies, this effect cannot be ignored. I also believe the SWAN's designer intended his loudspeaker to be used away from walls since this is the way I heard it demonstrated at a hi-fi show two years ago.

Those who wish to use compensation with this design can do so by adding op amp #8 to the Linkwitz board and use the circuit (Fig. 1) as a starting point. If this circuit is introduced, the output to the midrange will be out-of-phase relative to the woofer and tweeter. Therefore, the midrange's polarity must be inverted when connected to the amplifier. I recommend adding a switch to short the capacitor in the circuit, and cancel the equalization to allow comparison.

Cover Acknowledgment

I would like to note an acknowledgment for the *SB* 5/90 cover photo. I'd like to thank my brother, Steve Schwefel, for lending me his medium format camera, tripod, and light metering equipment. And for his invaluable pointers on proper photographic technique, without which, the fine detail of this photo would not have been possible.

Also, a note of thanks to the staff of *SB* for the fine job with processing and blow up. When I look at the photo, I want to get out my Phillips screwdriver and start dismantling the drivers!

Bill Schwefel
Jackson, WI 53037

THREE-WAY CORRECTIONS

I wish to note the following corrections to my "Modular Three-Way Active Loudspeaker" article (*SB* 4/90).

1. On amplifier 6b (Fig. 4) there should be a node between C64, R67, R66, and R64, not a jumper.

2. In Fig. 5 there should be a node between C102, R104, R105, and R102, instead of a jumper.

3. In the Table above Fig. 5, F_3 should be above Hz and not above Q_{TS} .

4. Audio Concepts has significantly changed specifications for the AC12 woofer. The following circuit changes, therefore, are necessary in the table:

| | |
|-----------|----------------|
| C101 | 0.33 μ F |
| C102, 103 | 0.056 μ F |
| C104 | 0.15 μ F |
| R101, 102 | 24.9k Ω |
| R103, 104 | 17.4k Ω |
| R105, 106 | 54.9k Ω |

The unequalized resonance (f_c) is now 46Hz. The new equalized F_3 is now 32Hz with 7dB of boost. The diaphragm's moving mass seems significantly lighter than previously specified.

Continued on page 73

Editorial

WHEN ALL ELSE FAILS, LITIGATE

In a world where the achievement of peace seemed at last possible, and where, the communistic world has generally renounced an economic ideology which was the basis for forty years of "cold war," it is depressing to consider the spectacle of some of America's largest technical companies engulfed in a orgy of legal suits and counter-suits. It would almost appear that since we cannot engage in dropping atomic bombs on enemies, US high tech companies, as an alternative, are attacking each other on grounds of patent infringement.

Lotus Development is suing Borland International, Microsoft and Apple Computer are suing each other over something many people suspect they both originally borrowed, without permission or royalties, from Xerox. Intel and Advanced Micro Devices, Motorola and Hitachi have been involved in suits.

I find it curious to reflect on the relative merits and shortcomings of the economic systems of state capitalism and private capitalism. The first lacks enough self interest (greed) to work and the latter is now severely threatened by an overabundance of the same commodity. We have been through a decade of loosening restraints on how private capitalistic enterprises function in this country. On balance we find ourselves with a corrupted and discredited banking system, a more and more heavily burdened class of very poor and a growing class of super rich.

I cannot refrain from noticing, since we are faced with a possible 23% increase in second class postal rates next February, that we are still attempting to operate the US Postal Service with a system of management thoroughly discredited by the USSR's abandonment of state capitalism. I certainly hope someone finally notices that it is impossible to run a business with a bureaucracy.

It is difficult to escape the conclusion that decisions about US business are made purely on considerations of profit, nothing else. The end result will be what we are already seeing, unbridled aggressiveness and greed. The people who use these companies' products will not benefit from legal hassles, and if we realize that a growing portion of what we pay for products must pay legal and lawyer's fees, we ought not to be too happy about the situation. Lawyers are a lot like fire hydrants, necessary in emergencies, but fire prevention is a better answer.

It is important to differentiate here between those who sue in response to outright theft of ideas, and those who do so to retain exclusive right to patents which by law ought to be shared on some sort of royalty basis. If AT&T had refused to license others to make transistors where would we be today? If Lotus can keep exclusively for itself the "look" of the spreadsheet interface, then every spreadsheet user will be inconvenienced merely to push profits at Lotus ever higher.

Anyone who lifts his or her head for a few minutes to survey the world economic scene will realize that American businesses could hardly pick a less appropriate time for fighting with each other.

The situation now developing in our country has, classically, bred revolution. I doubt we will have mobs in the streets, although there are some cities where this has happened in our recent memory. It is not outside the realm of possibility it could happen again. But the more subtle and pervasive effect is a general sense among most people of sad cynicism about business generally, as well as deepening disenchantment with government and politicians generally. And the level of helpless anger seems to me more evident in more people every day. Aggressive rudeness seems more pervasive. Just note how many more people are running red traffic lights.

I believe a large part of the economic "slowdown," that euphemism we are using instead of talking about a recession, is due to lack of confidence by the consumer. Times are bad because people generally are discouraged, frightened or both. That miasma is causing what we fear.

America has the strength and power to do wonderful things. But we won't do them if the profit-oriented managers make all the decisions. We won't do them if every person's goal is self preservation.

The best example I know of is IBM's decision to use the Intel 8088 microprocessor as the basis for their new personal computer's operating system. Programmers who understand instruction sets of the available central processing units will tell you, most of them without frothing at the mouth, that the choice was a disaster. Several other chips would have been better choices. But the decision at IBM was not made by the technical staff, it was made by the business types. The fact that the installed base of IBM and IBM-type clones based on Intel's line of processors is now in excess of 22 million bears almost no relation to the processor. The power and influence of the IBM name has sold the machine to business and individuals. But the machine could be far, far better in the opinion of most people, with Motorola's 6800 or 68000 series in it.

Somewhere in the capitalist mixture we need the enthusiast, the dreamer, the person who reaches into the unknown just out of curiosity. Many of you say nice things about this publication and how much you enjoy it. Very little of the credit for its existence is rightfully mine. Most of it belongs to the authors who make it possible. They are the dreamers, the curious, searching for answers to the puzzles, for ways around the obstacles, for better and easier answers. Unless that ingredient can find its way back into capitalism's future, in balance with intelligent, prudent, and humane managers, capitalism has no better future than did communist economics.

—E.T.D.



TEKTON 21
6 in. diam VC

The **TEKTON** Infra-bass drivers are uniquely featured to offer true extension below audibility. Uncompromising design in collaboration with Kimon Bellas called for machined steel motor assemblies, massive cast frame and immense magnet structure.

High power (over 1.2 KW at 20 Hz) and long throw (close to 1 in. each way) guarantee the deepest and tightest bass available anywhere today.

Tm to Orca Dsgn & Mfg Corp.

Exclusively from
Watters Sound Wave Co (214)991-6994
 4320 Spring Valley, Dallas TX 75244
 Orca, Dsgn & Mfg Corp. (818)707-1629
 1531 Lookout Dr. Agoura CA 91301



TEKTON 18
5 in. diam VC

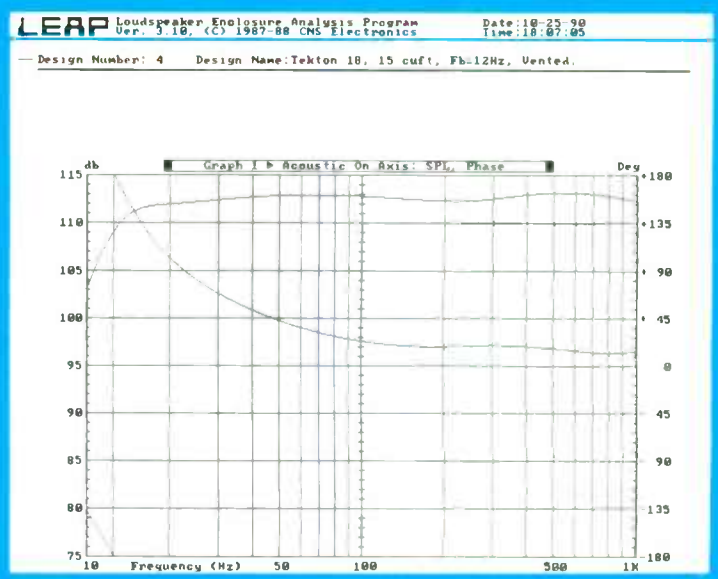
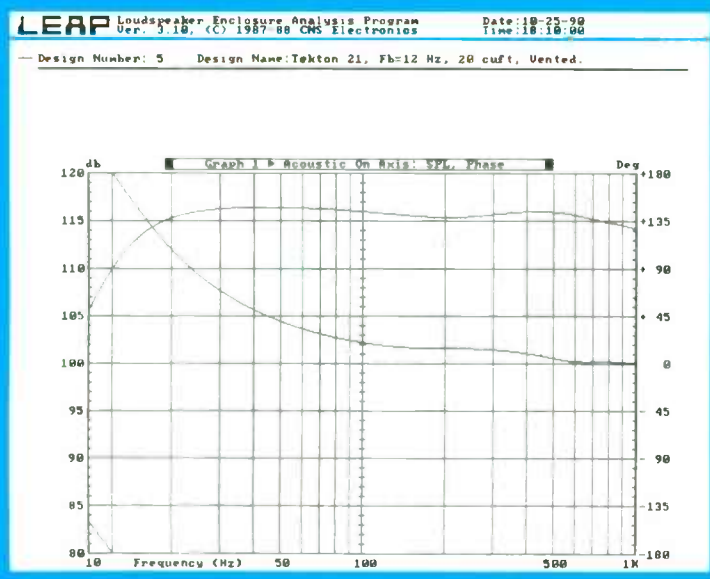

DOUBLE DISCOUNT DAYS!

AT

OLD COLONY SOUND LAB

SEE PAGE 44



Speaker Builder

Edward T. Dell, Jr. *Editor/Publisher*
Karen Hebert *General Manager*

Contributing Editors

Joseph D'Appolito Robert Bullock
John Cockroft David Davenport
Vance Dickason Bruce C. Edgar
Gary Galo G. R. Koonce
Richard Pierce

Robin Florence *Managing Editor*

Maria Bane *Editorial Assistant*

Christine Holt *Graphics Director*

Edward Roane *Graphics Assistant*

James Butler *Graphics Assistant*

Katharine Gadwah *Circulation Director*

Doris Hamberg *Circulation Assistant*

Helen Senechal *Circulation Assistant*

Dorothy Watson *Advertising Assistant*

Techart Associates *Drawings*

Advertising Rates & Schedules

Rally Dennis

PO Box 494

Peterborough, NH 03458

Advertising Phone: (603) 924-6710

Editorial and Circulation Offices

Post Office Box 494

Peterborough, New Hampshire 03458

(603) 924-9464

FAX: (603) 924-9467

Speaker Builder is published bi-monthly by Edward T. Dell, Jr., PO Box 494, Peterborough, NH 03458. Copyright © 1990 by Edward T. Dell, Jr. All rights reserved. No part of this publication may be reprinted or otherwise reproduced without the written permission of the publisher.

All subscriptions are for the whole year. Each subscription begins with the first issue of the year and ends with the last issue of the year. A sample issue costs \$4 in the US, \$5 in Canada.

Subscription rates in the United States and possessions: one year (six issues) \$25, two years (twelve issues) \$45. All sets of back issues are available beginning with 1980. Canada add \$4 per year for postage. Overseas rates available on request. Subscribers residing outside the US and Canada are served by air.

To subscribe, renew or change address in all areas write to Circulation Department or call (603) 924-9464 for MC/Visa charge card orders. For gift subscriptions please include gift recipient's name and your own, with remittance. A gift card will be sent.

A Note To Contributors

We welcome contributions for possible publication in the form of manuscripts, photographs or drawings, and will be glad to consider them for publication. Please enclose a stamped, addressed return envelope with each submission. While we cannot accept responsibility for loss or damage, all material will be handled with care while in our possession. Receipt of material is acknowledged by postcard. Payment is on publication.

Speaker Builder (US ISSN 0199-7920) is published bi-monthly at \$25 per year; \$45 for two years, by Edward T. Dell, Jr. at 305 Union St., Peterborough, NH 03458 USA. Second class postage paid at Peterborough, NH and additional mailing office.

POSTMASTER: Send address changes to SPEAKER BUILDER, PO Box 494, Peterborough, NH 03458.

About This Issue

This largest issue ever of *Speaker Builder* leads off with the test device every speaker builder dreams about. Where do you find a cheap way of measuring response of your new design? Bruel & Kjaer will sell you a nice one for several thousand if you are willing to stand in line for their hand-made units. As usual, one of our clever, hard-working editors comes to our rescue. Joe D'Appolito's Mitey Mike adorns our cover this time—and the photo is his daughter Nina's work. You can build your very own version of the Mitey Mike for under \$50 (p. 10).

Next, Matt Honnert shows us how to try symmetrical loading for those woofers back in the trunk or the hatch (p. 20). Contributing Editor G.R. Koonce unlocks the mysteries of how to use a low Q_{TS} driver in vented boxes (p. 23). Another of our Contributing Editors, Bob Bullock, introduces his new software BOXMODEL beginning on page 26. It does lots of new tricks, including vented, closed, and passive radiator models.

Tom Nousaine, like many readers, builds systems for friends. He shares one such project which he calls 8x2s, starting on page 38. Reviews around this time: Gary Galo looks at Audio Concepts' Sapphire II kit, Jim Frane measures effects of Radio Shack's foam grilles, and Dave Davenport revisits Focal's Egg.

In the crow eating department, Contributing Editor Bruce Edgar will tell you about his latest adventure with a horn throat that he thought worked one way but which, alas, works differently.

Speaker Builder

THE LOUDSPEAKER JOURNAL

VOLUME 11 NUMBER 6

NOVEMBER 1990

FEATURES

10 MITEY MIKE: FOR LOUDSPEAKER TESTING

BY JOSEPH D'APPOLITO

20 SYMMETRICAL LOADING FOR AUTO SUBWOOFERS

BY MATTHEW HONNERT

23 IMPROVED VENTED BOX WITH LOW Q_{TS} DRIVERS

BY G.R. KOONCE

26 BOXMODEL—AN AID TO WOOFER SYSTEM DESIGN

BY ROBERT M. BULLOCK, III

38 FOUR EIGHT BY TWOs

BY THOMAS NOUSAINE

53 MODIFYING DYNACO'S A-25

BY LEN MOSKOWITZ

91 THE KLIPSCHORN THROAT REVISITED

BY BRUCE EDGAR

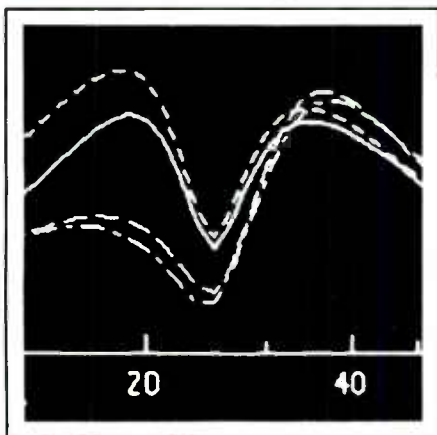

26

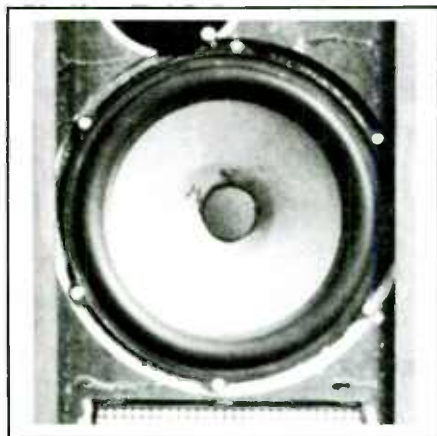

53

DEPARTMENTS

- | | |
|--|---|
| 3 MAILBOX | 70 KIT REPORT The Egg Revisited BY DAVID DAVENPORT |
| 4 EDITORIAL | 93 TOOLS, TIPS & TECHNIQUES |
| 57 KIT REPORT Sapphire II BY GARY GALO | 96 VINTAGE DESIGNS Universal 3-Way |
| 63 KIT REPORT Listening Room BY G.R. KOONCE | 97 CLASSIFIED |
| 67 PRODUCT REVIEW Foam Grille BY JAMES T. FRANE | 101 GOOD NEWS |
| | 106 POX HUMANA |

Now Available by Popular Demand!

BULLOCK ON BOXES

BY ROBERT W. BULLOCK III
with Robert White

Since 1980, readers of *Speaker Builder* magazine have delighted in the scope and clarity of Bob Bullock's explanations of vented-box loudspeaker systems. Now, for the first time, these articles have been collected into a single invaluable volume: *BULLOCK ON BOXES*.

This book is an easy-to-read guide to designing and building vented-box systems based on Thiele/Small models. And in addition to the background theory and descriptions of the models, *BULLOCK ON BOXES* carefully covers a host of related information drawn from numerous resources. Computer modeling, as demonstrated by the authors' BOXRESPONSE and BOXMODEL programs, is also explained in clear detail.

A professor of applied mathematics at Miami University (Ohio) since 1966 and long-time hands-on speaker buff, Dr. Bullock brings an unparalleled range of experience to the pages of *BULLOCK ON BOXES*. Fully indexed and referenced, with glossary, bibliography, and more than 100 illustrations, *BULLOCK ON BOXES* is a practical handbook and lasting reference indispensable to every serious speaker builder. Order yours today!

CHAPTERS:

- Thiele, Small, and Vented Loudspeaker Design
- Determining Design Parameters for Your Loudspeaker
- Fine Points of Vented Speaker Design
- Alternative Alignments (incl. Fourth Order)
- T/S Calculator Programs (TI-58/59, HP-67/97)
- BOXRESPONSE: An Apple Program for the Thiele/Small Models
- Realizing BOXRESPONSE's Potential
- BOXMODEL: An Aid to Woofer System Design
- Correspondence & Updates

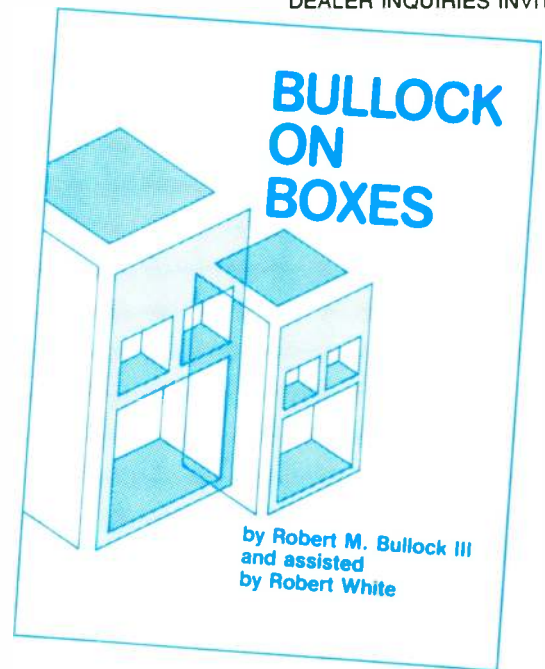

BKAA8 1990, 8½" × 11" **\$10.95**

SPECIAL OFFER: For a limited time only, purchase *BULLOCK ON BOXES* and receive your choice of software package below at \$5 off the regular retail price. Order **BKAA8/S**.*

*Because of taxation requirements, software not available to residents of CT.

SOFTWARE PACKAGES AVAILABLE (Sale Prices Shown):

- BOXRESPONSE \$20**
Apple (not Mac) #BOX1A5 Commodore #BOX1C5
IBM #BOX1B5 Comm. Cassette #BOX3CC
- BOXRESPONSE WITH GRAPHICS \$45**
IBM only #BOX2B5G
- BOXMODEL WITH GRAPHICS \$45**
IBM only #MOD3B5G

(NOTE: In general, BOXRESPONSE automatically generates alignments for a given driver. BOXMODEL does not do this, but instead compares up to four given alignments simultaneously. Both programs display various performance aspects of passive-radiator or vented-box systems.)

CK MO MC/VISA

NAME _____

STREET & NO. _____

CITY _____ STATE _____ ZIP _____

MC OR VISA NUMBER _____ EXPIRE _____

- YES!** Please send me ____ *BULLOCK ON BOXES* at \$10.95 each! **BKAA8 \$** _____
- SOFTWARE, TOO!** Please send me one *BULLOCK ON BOXES* at \$10.95 **BKAA8/S** _____
PLUS my choice of software package # _____ at only \$ _____! **BKAA8/S** _____

POSTAGE AND HANDLING (see below) _____

TOTAL ORDER \$ _____



OLD COLONY SOUND LAB

PO Box 243, Dept. B90
Peterborough, NH 03458-0243
(603) 924-6371 / 924-6526
FAX: (603) 924-9467

Answering machine for credit card orders only:
before 9:00 a.m., after 4:00 p.m. and weekends.
Have all information plus MC/VISA available.

- POSTAGE AND HANDLING:**
- U.S.—Book only: \$1.75 first book, 50¢ each additional.
Book plus software: \$2.25.
 - Canada—Book only: \$4.50 first book, 50¢ each additional.
Book plus software: \$5.00.
 - Other—Add 20% to order.

FOCAL

Focal and Joe d'Appolito are glad to offer you a collection of generic designs of 6th order bandpass subs.

1531 Lookout Drive, Agoura, CA 91301 USA

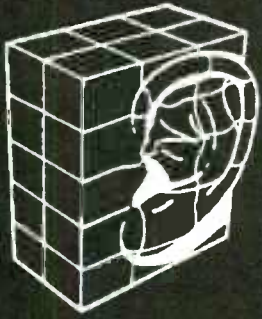

Did I hear MORE SUBWOOFERS!

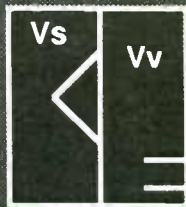
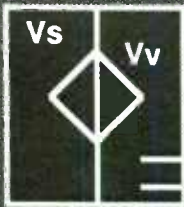
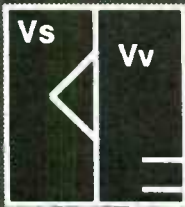

Vs and Vv are NET INTERNAL volumes.
 Vs: Dacron 16oz / cu ft.
 Vv: 1.5 in. foam
 Sv: vent area
 Lv: vent length

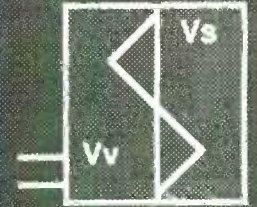
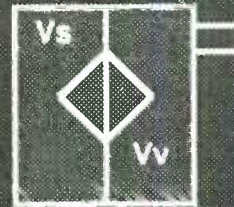

| ARIA 10 | ARIA 10 P-P | ARIA 8 | | AUTO 10 SUB | AUTO 8 SUB |
|---------------|-----------------|--------------|-------------------------------|-----------------|-----------------|
| 10V516 | 10V516 (two) | 8V416 | Driver | 10V516 (two) | 8V416 (two) |
| 4.8 | 4.8 (each) | 4.5 | Re | 4.8 (each) | 4.5 (each) |
| 250 | 500 | 250 | Power (W) | 500 | 500 |
| 90 | 87 | 88 | dB/W/m | 89 | 94 |
| 111 | 111 | 108 | Max dB SPL | 114 | 117 |
| 48 / 1.7 | 24 / .85 | 28 / .99 | Vsealed (l / cu.ft.) | 14 / .5 | 35 / 1.24 |
| 51 / 1.8 | 26 / .92 | 21 / .74 | Vvented (l / cu. ft.) | 22 / .78 | 50 / 1.77 |
| 45 | 45 | 52 | Fcenter (Hz) | 58 | 58 |
| 126.7 / 19.64 | 81 / 12.56 | 81 / 12.56 | Sv (cm ² / sq.in.) | 81 / 12.56 | 182 / 28.27 |
| 27.4 / 10.78 | 38.7 / 15.23 | 35.3 / 13.9 | Lv (cm / in.) | 25.4 / 10 | 21.3 / 8.4 |
| 1,172 | 1,220 (on each) | 1,297 | C (microF) | 1,306 (on each) | 1,499 (on each) |
| 11.0 (.3 Ohm) | 10.0 (on each) | 8.0 (.3 Ohm) | L (mH) | 6.0 (on each) | 5.0 (on each) |

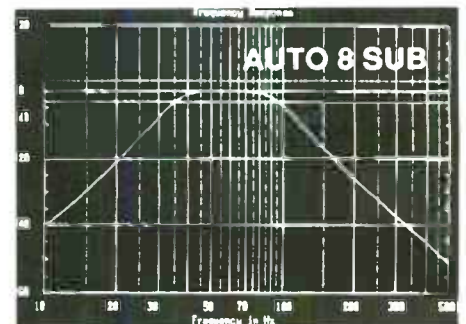
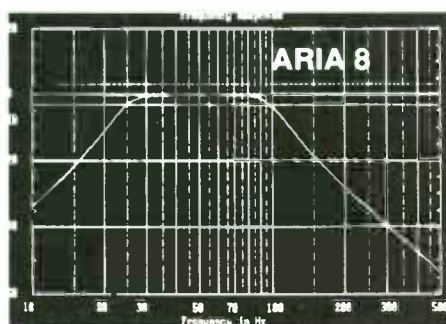
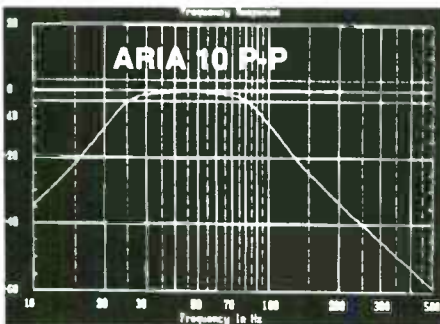
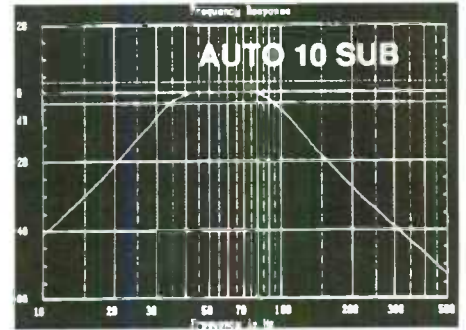
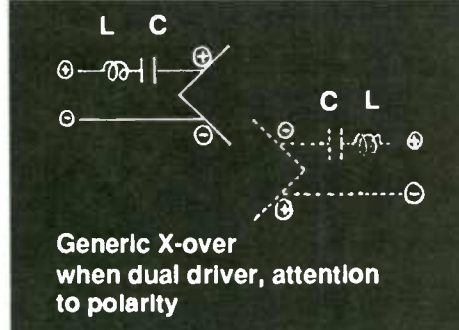
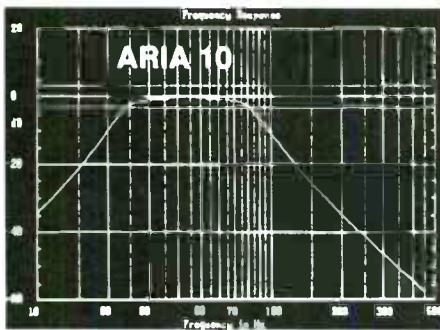

MITEY MIKE: FOR LOUDSPEAKER TESTING

BY JOSEPH D'APPOLITO
Contributing Editor

"I often say that when you can measure what you are speaking about, and express it in numbers, you know something about it; but when you cannot express it in numbers, your knowledge is of a meagre and unsatisfactory kind; it may be the beginning of knowledge, but you have scarcely, in your thoughts, advanced to the stage of Science...."

—Lord Kelvin

You have just completed your latest loudspeaker project, and you begin listening to it with great anticipation. As initial impressions fade, you are left with the growing realization that your newest jewel is "too bright," or "too forward," or "bass heavy," or...well, something is wrong.

Your ears, as wonderful (dare I say golden) as they are, cannot quite pinpoint the magnitude or the location of the problem. A good microphone could help isolate the problem, but it's too expensive. Days and perhaps weeks of tweaking lay ahead. If the preceding scenario sounds familiar, read on. We may just have the answer.

TEST MIKES. Of course, our ears must be the final judge of a loudspeaker system's quality, but ability to make ac-

curate acoustic measurements during the system design phase, and final system tuning is invaluable. Manufacturers' response curves for drivers must be used with care. They often comprise the average of many drivers, and may not be representative of your particular samples.

These response curves are often obtained with the driver mounted on a large open-backed baffle (e.g., an IEC standard baffle). The frequency response of that driver in your cabinet may be very different, due to different baffle areas, edge treatment, or enclosure volume. Once your system is assembled, correct crossover network operation and proper level matching of the various drivers must be confirmed, a process best done by direct acoustic measurements.

A good microphone is at the heart of

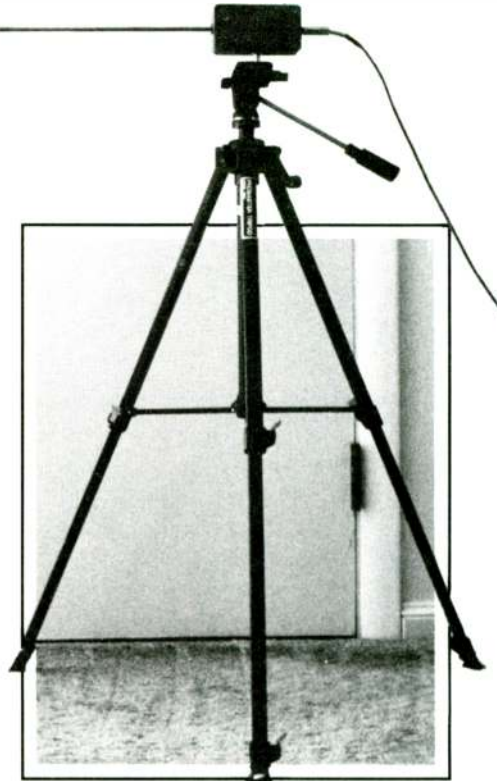

PHOTO 1: Mitey Mike mounted on a camera tripod.

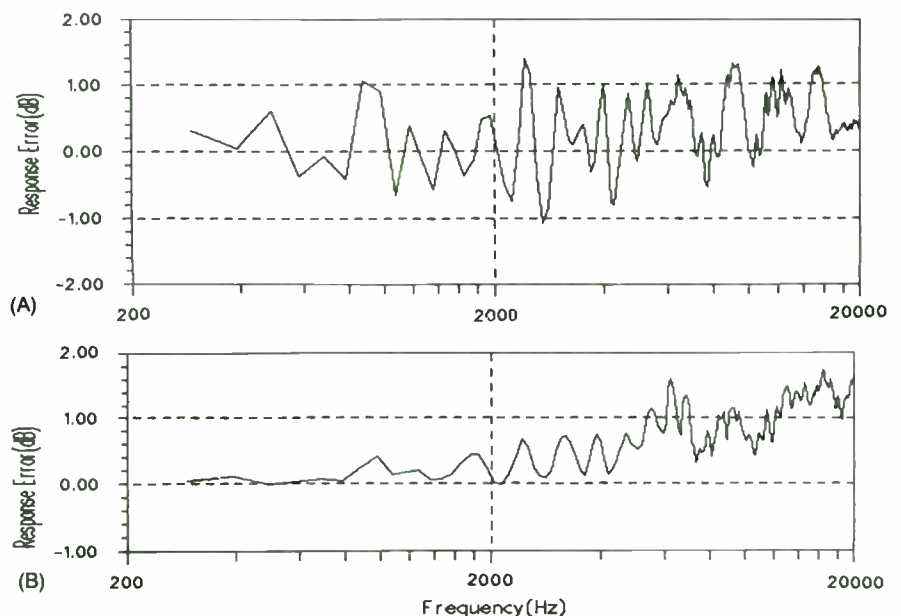

FIGURE 1: Mitey Mike calibration curves. (a) Cartridge #1, (b) Cartridge #2.

ABOUT THE AUTHOR

Joseph D'Appolito, SB contributing editor and author of many papers on loudspeaker system design, holds several degrees in electrical and systems engineering, including a PhD. He currently develops acoustic propagation models and advanced sonar signal processing techniques at an analytical engineering services company in Massachusetts. A long-time high-end audio enthusiast, he also designs high fidelity loudspeaker systems for Focal America and private label retailers in the US and Europe.

TABLE 1

| MITEY MIKE SPECIFICATIONS | |
|---------------------------|---|
| Response (rel. 1kHz) | ± 1 dB, 20Hz-10kHz ± 2 dB, 10kHz-20kHz -3dB @ 3Hz and 25kHz |
| Sensitivity | 39mV/Pa, ± 2 dB |
| Max Undistorted SPL | < 120dBA |
| Wideband Noise Level | > 42dBA |
| Power Consumption | 5mW typ / 7mW max. |

any acoustic measurement system. What constitutes a good microphone for loudspeaker testing? The four key requirements, in my opinion, are:

- Flat free-field frequency response;
- High, undistorted SPL capability;
- Good measurement repeatability;
- Long-term stability.

To meet frequency response accuracy requirements for contemporary loudspeaker systems, a test mike should have a free-field frequency response of at least 20Hz to 20kHz. Minimally, the frequency response between 20Hz and 10kHz should be within ± 1 dB. Above 10kHz relax this requirement to ± 2 dB. Of course, the more nearly flat the better. "Free-field" means the microphone's presence should not change the pressure field it is measuring. That is, the microphone should measure the SPL that would exist at the point of measurement if the mike were not there.

SMALL AND STABLE. This means the microphone cartridge diameter must be small compared to the shortest wavelength measured. For our purposes, the diameter should be no more than $\frac{1}{2}$ ", and preferably closer to $\frac{1}{4}$ ". Assessing loudspeaker power response and distortion requires a test mike which can handle SPLs of 120dB, or more, without distortion.

Repeatability refers to the variation of microphone characteristics from turn-on to turn-on. We wish to make a set of measurements one day, and be able to repeat those same measurements on another day. Of course, atmospheric conditions, (temperature and humidity) affect measurement repeatability. Short-term repeatability should be on the order of ± 0.3 dB.

Long-term stability refers to a mike's aging traits. There may be long periods when a microphone is not in use, sitting on a shelf under varying temperature and humidity conditions. A good microphone's characteristics won't change after long shelf periods. Long-term fre-

quency response stability should also be ± 0.3 dB.

NOISE AND DOLLARS. One microphone characteristic missing from my list is self-noise level. Top-quality recording and laboratory test mikes have noise levels of 15dBA or less. Since loudspeaker testing is generally conducted at reference SPLs of 90dB or more, noise levels of 40-45dBA can be tolerated.

If your budget is unlimited a laboratory grade microphone from Bruel & Kjaer is yours for \$3,000 and up. Mikes from ACO are in the \$1,200-\$1,500 range. Below lab grade, fine test and measurement microphones from Neutrik and Josephson Engineering are available for about \$200-\$250. All require additional amplification and/or power supplies, adding to their cost. Incidentally, all these mikes are omnidirectional.

Surprisingly, most recording and public address mikes, even expensive ones, are unsuitable for loudspeaker testing, rarely meeting the frequency response requirement. This is especially true of directional mikes (cardioid, hypercardioid, and so forth) which display a low-frequency proximity effect. Directional mikes' low-frequency response depends upon the sound source's size, and its distance from the microphone.

ENTER MITEY MIKE. For several years Panasonic has manufactured a small back-electret, FET buffered, omnidirectional microphone cartridge (WM-063T). I purchased 10 cartridges four years ago, and tested them against a lab grade mike I had on loan. The capsules had amazingly flat response, and differed by no more than 1dB below 10kHz from unit to unit. All met our frequency response specification.

Figure 1 illustrates two typical error response curves for the complete microphone system, including cartridge and

TABLE 2

MITEY MIKE OUTPUT VOLTAGE vs SOUND PRESSURE LEVEL

| SPL (dB) | OUTPUT VOLTAGE | |
|----------|----------------|-----|
| | RMS mV | dBm |
| 120 | 775 | 0 |
| 110 | 245 | -10 |
| 100 | 77.5 | -20 |
| 90 | 24.5 | -30 |
| 80 | 7.75 | -40 |
| 70 | 2.45 | -50 |

supporting electronics. The curves demonstrate differences in frequency response of a loudspeaker, as measured by a reference mike (Neutrik Type 3882, Ser. No. HF883), and two WM-063T cartridges installed in Mitey Mike. Cartridge 1 has a frequency response within 1dB of the reference mike throughout the audio range. Cartridge 2 shows more peaking above 10kHz, but well within desired specifications. Cartridge 1 is exceptional, while cartridge 2 is more typical of what you can expect from Mitey Mike. Generally, the cartridges show an elevated response of 2dB or so above 12kHz.

Table 1 lists expected performance from the complete Mitey Mike system. Periodic testing over the past four years has produced worst case deviations from the original 1dB curves. The RMS deviation is less than 0.5dB, including errors from all test chain sources (mikes, amplifiers, sound source, meters, test oscillator, and environmental conditions), and implies even better long-term stability for the mike.

The Panasonic cartridge does, however, have two problems. First, its self-noise level is somewhat high at 38dBA. More importantly, its sensitivity changes with supply voltage. In Table 1, sensitivity is listed at 39mV per Pascal (Pa). A Pascal is a unit of pressure in the SI system equal to one Newton per square meter. In more familiar terms, this

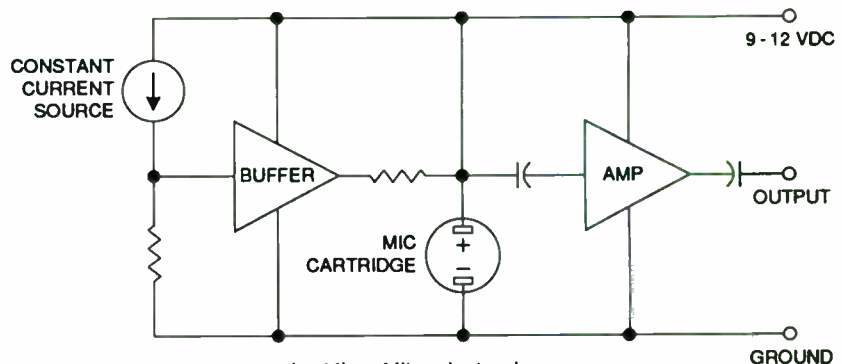
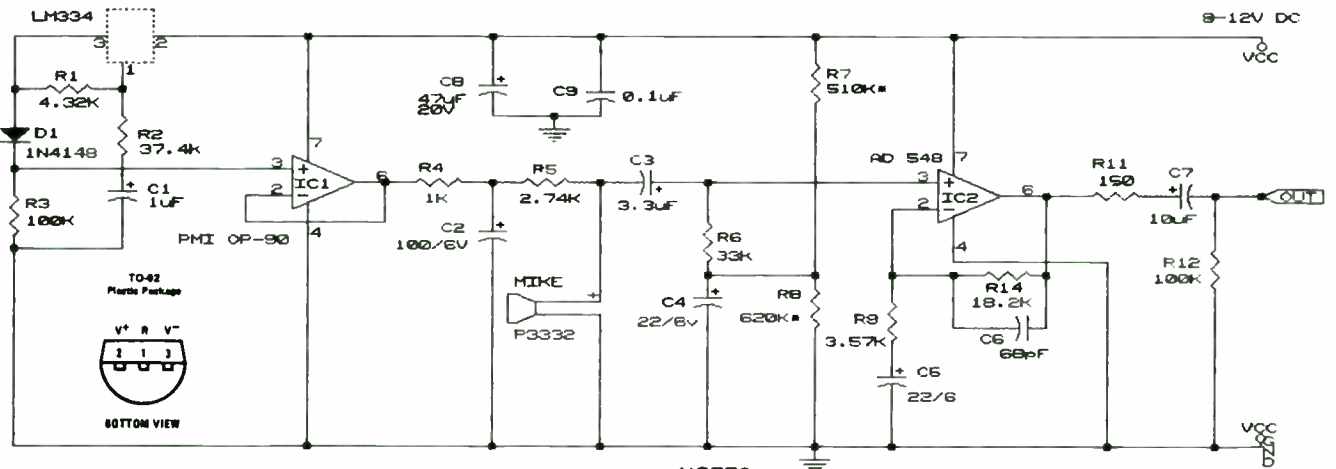

FIGURE 2: Functional diagram for Mitey Mike electronics.



NOTES:
Resistors marked with asterisk should be at least $\pm 5\%$, all others $\pm 1\%$. All polarized (with +) capacitors are tantalum types, to conserve space. See text for alternatives to IC1 and IC2.

FIGURE 3: Schematic diagram of Mitey Mike electronics.

means the cartridge will put out 24.5mV at an SPL of 90dB. At a nominal capsule supply voltage of 3V, sensitivity changes about 3dB per volt. Therefore, a 0.1V change in supply voltage causes the mike output voltage change to exceed our short-term repeatability goal.

These problems aside, clearly the Panasonic cartridge can form the basis for a very good test and measurement microphone. Let's see what it takes to get there.

MIKE ELECTRONICS. Figure 2 is a functional diagram of the microphone electronics. The mike is battery-powered to avoid problems and circuit complications associated with phantom or remote powering. To reduce battery size, and at the same time extend battery life, I placed my emphasis on low-power design, setting a current drain goal of one milliamp or less. With test sessions lasting four hours or more, I didn't want to be concerned with battery life.

The electronics consists of a constant current source and resistor forming a micropower voltage reference, a micropower op amp buffer powering the mike cartridge, and a low-power op amp buffer/gain block. The combination draws 550 μ A from a 9V battery, and can drive 50 feet of shielded cable with no loss in frequency response. Complete specifications for Mitey Mike are in Table 1.

POWER STUFF. Figure 3 is a schematic diagram of the microphone electronics. At the time I began this project, no inexpensive micropower voltage references were available. However, a three terminal current source, the LM334, supplies a current directly proportional to temperature, and as such is the basis for

a very accurate solid state thermometer. A few extra parts converts the LM334 into a constant current source. Passing that constant current through a temperature-stable resistor results in constant voltage.

Referring to Fig. 3, resistor R1 sets the LM334's current output level. Diode D1 and resistor R2 temperature-compensate the LM334. Most of the LM334's bias current passes through R1, but about 10% of it is pulled off by R2. As temperature increases, voltage across D1 drops, causing current through R2 to fall, thereby decreasing the LM334 bias current. If R2 is properly selected, the bias current decrease will be just enough to keep the LM334 output current constant with changing temperature.

R1 and R2 were selected to produce a 30 μ A constant current, resulting in a constant 3.0V across the 100k Ω resistor R5. C1 reduces reference voltage noise generated by the LM334's noise current. IC1 operates at unity gain to buffer reference voltage, and power the mike cartridge. This PMI OP-90 op amp supplies output currents up to 5mA, while drawing a quiescent current of only 16 μ A. Unfortunately, micropower op amps tend to be noisy. R4 and C2 filter the mike cartridge supply voltage; R5 is the WM-063T's load resistor; C3 serves as a DC blocking capacitor while coupling the AC mike output to IC2.

WHOSE AMP? IC2, an Analog Devices AD548 op amp, amplifies the microphone output, and provides the low-impedance, high-current capability required to drive long shielded lines. This op amp has a full power bandwidth of 70kHz in this application, while drawing only 160 μ A quiescent current. Resistors R7

TABLE 3
MITEY MIKE PARTS LIST

RESISTORS
All resistors $\pm 1\%$ metal film unless otherwise specified.

- R1 4.32k
- R2 37.4k
- R3 100k
- R4 1k
- R5 2.74k
- R6 33.2k
- R7 510k 5% carbon film
- R8 620k 5% carbon film
- R9 3.65k
- R10 18.7k
- R11 150
- R12 100k

CAPACITORS
All capacitor values are in microfarads, and are bead tantalum unless otherwise specified.

- C1 1.0
- C2 100/6V
- C3 3.3
- C4 22/6V
- C5 22 6V
- C6 68pF NPO ceramic
- C7 10
- C8 47/10V
- C9 0.1 metalized film

ICs AND SEMICONDUCTORS

- IC1 OP-90 Precision Monolithics
- IC2 AD-548 Analog Devices
- IC3 LM334 National
- D1 1N4148

Microphone Capsule:
Panasonic WM-063T available from Digi-Key, Thief River Falls, MN 56701-0677.

and R8 set the DC operating point for IC2. C4 filters the bias voltage and shorts any power supply noise voltage to ground. R7 and R8 have been adjusted to obtain symmetric clipping from IC2, thereby maximizing its output swing at a supply voltage of 9V. R9 and R10 set the AC gain of IC2 to 6.12, while C5 returns the IC2's

Continued on page 14

The Recipe for the Finest Speakers ...



The Xennon 3-100 resembles a traditional 3-way system; but its awesome power and precise reproduction soon makes the listener compare the Xennon to the very best systems in the world. As with all Dynaudio products, it is the dynamic range that makes the first favorable impression; other speaker systems play loud, but only Dynaudio can reproduce all output levels with an identical sonic balance and no evidence of compression. The Xennon 3-100 is a good choice for the listener who listens to large symphonic works but also wants the intimacy of small ensemble pieces.

The Xennon 3-100 is available in kit form with cabinets for under \$1000. Drivers, crossovers and plans are available for under \$700.



The MYRAGE is a superlative system. It has multiple chambers with two 100 mm voice coil woofers, two advanced three inch dome midranges, and the legendary ESOTAR limited production high frequency transducer. The bass is awe inspiring; vocals are silky; the imaging is well defined. The dynamic range can approach 125 db, yet the MYRAGE responds effortlessly. If you wish to own the best, and you want the satisfaction of assisting in the creation, the MYRAGE is the system for you.

The Myrage system is available in kit form with cabinets for under \$1700. Drivers, crossovers and plans are available for \$1300.



The IMAGE II is a state of the art system designed especially for audio enthusiasts who have space limitations or budgetary restraints. If you are willing to give up a half octave of the the deepest bass (from 35 to 50 Hz), you may experience the wonder of Dynaudio for a price so modest it borders on the miraculous. With the IMAGE II, you have superb imaging, a result of precise phase and time delay, refined in a very sophisticated 12 element filter. The dynamic range and lack of compression will startle you. After assembly, you will enjoy the overall smoothness and clarity which has earned Dynaudio drivers a world-wide reputation for excellence.

The Image II is available in kit form with cabinets for under \$500. Drivers, crossovers and plans are available for under \$350.

Begins with the Finest Ingredients



| Model | D28AF | 17W75 | Esotar T330 | D52AF | 30W100 |
|------------------------|----------|---------|-------------|---------|--------|
| Diameter mm | 110 | 177 | 140 | 145 | 300 |
| Voice Coil Diameter mm | 28 | 75 | 28 | 54 | 100 |
| Frequency Range Hz | 1.8K—20K | 45—3.5K | 1.8K—22K | 600—7K | 25—900 |
| Resonance Freq. Hz | 700 | 42 | 800 | 350 | 24 |
| Sensitivity 1w/1m db | 91 | 89 | 91 | 91 | 91 |
| Power Capability DIN w | 300@3K | 150 | 300@3K | 200@800 | 450 |



| Model | 24W100 | D21AF | 15W75 | D76AF | Variovent |
|------------------------|--------|----------|-------|---------|-----------|
| Diameter mm | 240 | 110 | 145 | 145 | |
| Voice Coil Diameter mm | 100 | 21 | 75 | 75 | |
| Frequency Range Hz | 35—3K | 2.5K—30K | 60—5K | 500—5K | |
| Resonance Freq. Hz | 32 | 600 | 55 | 180 | |
| Sensitivity 1w/1m db | 90 | 91 | 88 | 88 | |
| Power Capability DIN w | 120 | 600@5K | 120 | 180@600 | |

Aperiodic damping device. Used for sealed box alignments to lower system Qtc, effectively allowing the use of a smaller box. Diameter 125mm.

**Available from your
Dynaudio Specialist:**

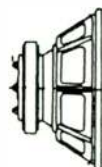

Madisound Speaker Components
8608 University Green
Box 4283 Madison WI 53711
Phone: 608-831-3433
Fax: 608-831-3771

Fast Reply #KE20

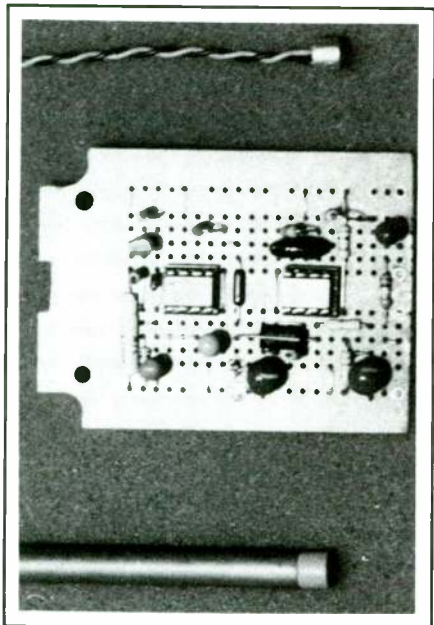

PHOTO 2: Microphone cartridge, wand and electronics board.

Continued from page 12

gain to unity at DC so that its DC operating point is solely a function of the bias divider resistors R7 and R8.

At first glance, a 6.12 gain for IC2 may seem a bit odd. Mitey Mike is designed for use with wideband AC voltmeters having calibrated dB scales. It is common practice to set these meters' 0dB reference point to a voltage corresponding to one milliwatt into 600Ω, i.e., 0.775V. When referenced to this power and impedance value, voltage and power ratios expressed in decibels (dB) are given the special suffix "m", i.e., dBm. With a 6.12 gain, a 0dBm reading corresponds to an SPL of 120dB. Meter readings and their corresponding SPLs are listed in Table 2. As you can see, the odd gain of 6.12 provides a direct and convenient correspondence between meter readings and sound pressure levels.

If the PMI OP-90 and the Analog Devices AD548 are not available, you may substitute TL061s for both ICs with no sacrifice in performance. Current drain will increase, however, to about 750μA. If you don't mind the extra drain, you can make the board smaller by using the dual TL062. As an alternative to the PMI OP-90, use one of the programmable "LINMOS" CMOS op amps from

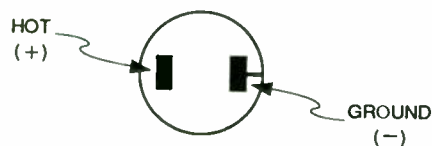

FIGURE 4: Microphone cartridge terminals.

Texas Instruments. The TLC271 programmable op amp draws only 50μA quiescent current in the "medium" bias mode with noise specs just a little worse than the OP-90.

MIKE CONSTRUCTION. The completed microphone measurement system is shown in Photo 1. As I mentioned, our mike's presence must not disturb the sound pressure field we are trying to measure. The microphone cartridge must not only be small, its supporting structure must not produce undesirable reflections, which could cause measurement errors. I lacked the facilities to construct a streamlined case for the microphone. I chose to distance the cartridge from the electronics package by mounting it in the end of an 18" wand, assembled with rigid brass tubing available at hardware stores and hobby shops.

Look at Photo 2 before reading how the wand is put together. First we must solder appropriate leads to the cartridge. With a diameter and length of only 6mm, the cartridge is small, difficult to handle, and easily damaged. The easiest way to hold the cartridge while soldering wires to it is to drill a 1/4" hole in a 1/4" thick piece of plywood or Masonite and place the cartridge in the hole with the solder pad terminals facing upward.

Next, take two 30" lengths of #24 AWG hookup wire, one black, and carefully twist them together. After tinning the wires, solder them to the cartridge pads using a conical tip in a soldering iron of no more than 25W. Solder the black wire to the ground terminal pad, the one that connects to the cartridge case (Fig. 4). Slip a 1" length of 1/4" diameter heatshrink tubing over the cartridge body and wires.

Then apply heat only to that portion of tubing covering the wires. Be careful not to heat the mike cartridge. The heatshrink tubing electrically isolates the mike cartridge from the conductive brass wand. Photo 3 shows the cartridge, with wires connected to it.

TEST AND TUBE. It's a good idea now to test the cartridge before continuing. Use Fig. 5's test circuit. Connect an oscilloscope with a sensitivity of at least 0.1V/cm or sensitive AC voltmeter to the indicated output terminals. Whistle loudly into the mike. You should get a strong indication on either the scope or the meter.

You need two brass tubes to build the microphone wand if you can find only the common 12" lengths in hobby shops and hardware stores. These are available in graduated diameters. I used one with

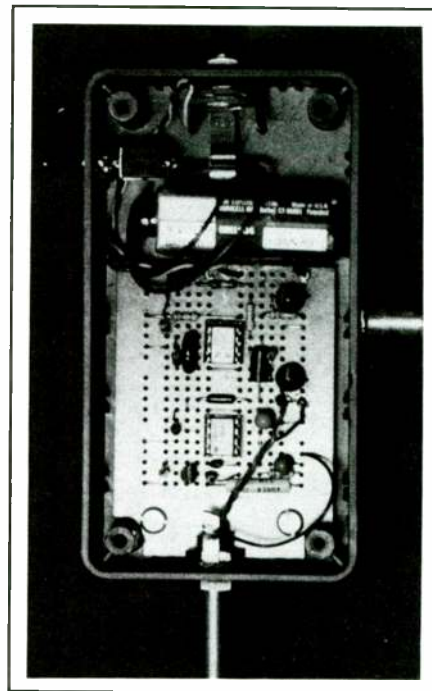

PHOTO 3: Complete microphone electronics package.

an outer diameter (OD) of 1/4" and another with a 3/32" OD. Cut an 8" length off the larger diameter tube and carefully deburr the cut end.

Place a small amount of soldering flux on one end of the smaller tube, and insert it into one end of the larger tube to a depth of 1". Heat the joint with a 25-50W iron and flow rosin core solder into the joint. Wipe away any excess and let the assembly cool.

The cartridge leads now can be inserted into the larger tube's open end, and fed through to the opposite end. The cartridge should be held in place with silicone rubber glue at the large end of the wand. Although not necessary, you may wish to fill the entire wand with silicone rubber to damp sound-induced vibrations. First feed the twisted pair of microphone cartridge leads through the wand, leaving the cartridge dangling at the end of a few inches of lead. Then fill the wand with damping glue, and pull the leads through so the cartridge fits snugly in the end of the wand. Photo 3 shows a completed microphone wand.

ELECTRONICS PACKAGE. I mounted
Continued on page 16

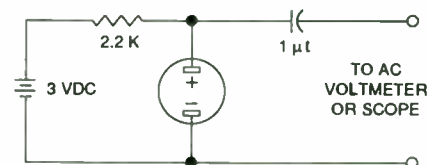

FIGURE 5: Microphone cartridge test circuit.

A&S speakers

3170 23rd Street
San Francisco 94110
(415) 641-4573
(415) 648-5306 FAX

ETON[®]

DYNAUDIO[®]

SCAN-SPEAK

polydax
SPEAKER CORPORATION



 **PHILIPS**

ULTIMATE



FOCAL

S Solen Électronique Inc.

WOODSTYLE PRODUCTS



seas

Parasound
VMPS AUDIO

Eminence Speaker Corporation

Write or call for the complete plans, write-up and review of the brand new **BLACK DAHLIA KIT**, designed by **DICK OLSHER**, the highly regarded reviewer for *Stereophile Magazine*.

Fast Reply #KE572

Continued from page 14

the microphone electronics in a Radio Shack plastic project case (Cat # 270-222) which is $4\frac{7}{8}'' \times 2\frac{1}{16}'' \times 1\frac{1}{16}''$. The brass wand supports not only the microphone cartridge, it also shields the microphone leads. The wand support bushing, a $\frac{1}{4}''$ ID threaded bushing, is mounted in the center of one end of the case. Place a solder lug under the bushing nut, and use it to return the brass wand to ground.

If you do not have a $\frac{1}{4}''$ ID bushing, a $\frac{1}{4}''$ phone jack will work just as well. Remove all lugs and tines from the jack assembly, except the ground lug which you can use to ground the wand. At the other end of the case are an output jack and a miniature on/off toggle switch. I glued a $\frac{1}{4}''$ -20 tee-nut to the bottom of the case so I can attach the mike to a camera tripod (Photo 1).

The microphone electronics are in Photo 3. I didn't draw a printed circuit layout. The circuit is simple, however, and easily laid out on a 3" length cut from a Radio Shack experimenter printed circuit board (#276-170). The suggested component layout is given in Fig. 6. Note many resistors are mounted on-end to save board space. All electrolytic capacitors use bead tantalums to conserve board space. I used sockets for IC1 and IC2. The recommended 9V alkaline battery is held with a Radio Shack battery clamp.

TESTING, TESTING. The circuit is straightforward, and rarely needs special trimming or adjustment. The first time you power up, however, check a few critical voltages to ensure everything is working correctly. First check the output of IC1's voltage, pin 6. It should be 2.8-3.2V. Outside these limits, check the voltage across R5 with a high impedance voltmeter for proper operation of IC1.

Voltage across R5 should be the same as that at pin 6 of IC1. If IC1 is working correctly and voltage is still low, R1's value may be decreased slightly to increase LM334's output current. Similarly, if the voltage is too high R1 should be increased. Voltage across the mike cartridge should be 1.8-2.2V, depending on the amount of current it draws. Of the 10 units I measured, mike current was 150-300 μ A. Finally, with a 9V supply, the DC level at IC2's output should be 5V.

USING MITEY MIKE. One could write a book on loudspeaker response measurement techniques. I'll stick with two procedures you can use in your

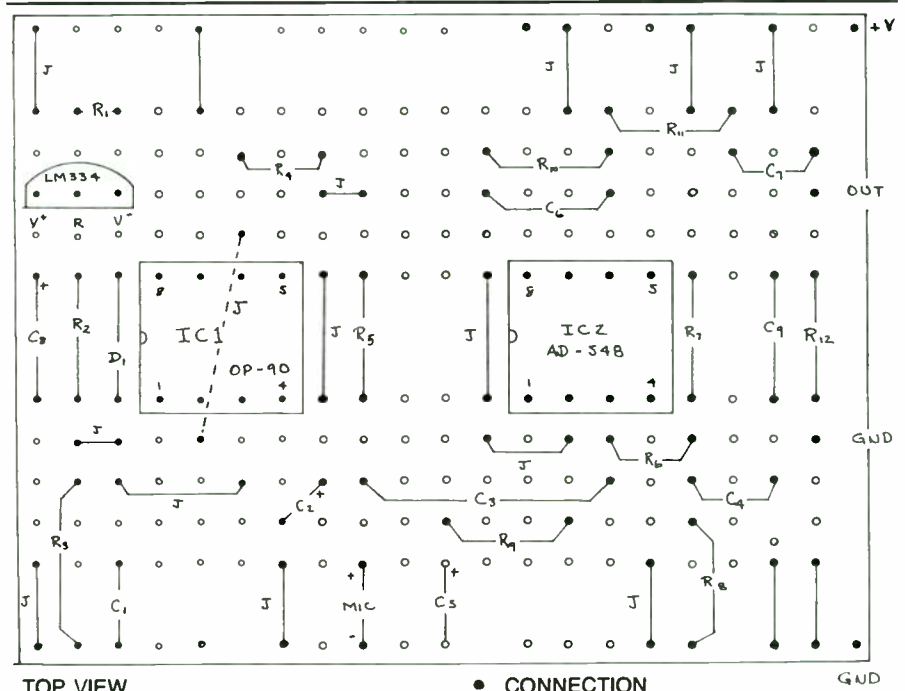

FIGURE 6: Component layout for Mitey Mike electronics perforated board.

listening room, namely, near field and one meter frequency response measurements. You will only need a wideband AC voltmeter with dB scales, a power amp to drive the loudspeaker, a warble tone oscillator such as that Dick Crawford described, (TAA 1/79) and, of course, Mitey Mike. More on the reason for a warble tone oscillator later.

There's a widespread belief among audiophiles, and even experts, you cannot make accurate response measurements in typical listening rooms. It's not necessary to hang your latest creation 25 feet in the air, or bury it in the back yard with its baffle flush with the ground, to get good data. Understanding room limitations, using the right instrumentation, and keeping your microphone relatively close to the drivers you are measuring, can produce very good results.

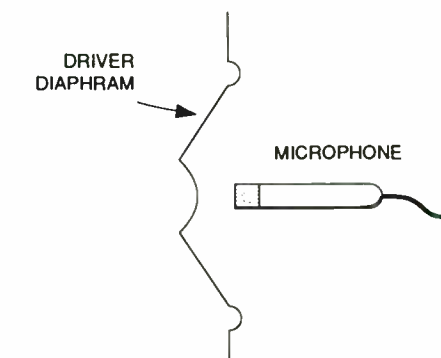

FIGURE 7: The near field frequency response measurement technique.

Let's talk a little about room acoustics first. At low frequencies where wavelengths are comparable to room dimensions, standing wave modes are widely and irregularly spaced in frequency, producing gross variations in loudspeaker/room response. At higher frequencies, where wavelengths are much smaller than room dimensions, standing wave distributions are very dense in frequency—numerous and very close together. Under these conditions, loudspeaker/room interaction is smooth as long as speaker and microphone are far from reflecting surfaces.

TERMS & TECHNIQUES. In technical terms, the low-frequency region is referred to as the "discrete standing wave" region because standing waves are widely spaced and easily observed. The high-frequency region is called the "statistical standing wave" region, because standing waves are so numerous and so closely spaced in frequency they are better described by a statistical distribution than by a direct enumeration. In typical home listening rooms with volumes of approximately 2,500 ft³ the transition between discrete and statistical standing wave regimes occurs somewhere between 300-400Hz. Below 400Hz, I use the near-field technique. Above 400Hz, I prefer one meter measurements.

I should define the term "near field" before proceeding. It's most easily de-

Continued on page 18

ZALYTRON

YOUR ONE STOP SHOPPING CENTER



Polydax



PHILIPS



Build a High Class Speaker for Christmas
Bring the Joy of Music into your Home!

Limited Edition - Special Purchase



- Focal 10K 515/A **\$89**
- Focal 8K 415/A **55**
- Focal 7C03DBE **35**
- Focal 120KF **39**
- Morel MDT 29 **25**



ARIA 5 \$75 Ea.

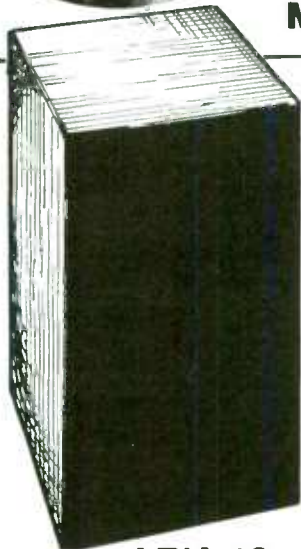

ARIA 10

Complete System \$250.00

LIMITED EDITION
POLYDAX HD13B25RSC2N12
 AVAILABLE IN SINGLE OR DUAL COIL
 Q_{ts} 0.29 V_{as} 23 F_s 351 **\$19.00**
EXCELLENT FOR MTM SYSTEMS

- PANASONIC RIBBON TWEETERS**
- EAS-10TH200D **\$25.00**
- EAS-10TH400A **\$39.00**

**New Vieta 5 1/4" woofer,
 1" dome tweeter and
 10" subwoofers**

NOW IN STOCK!!!

**ARIA 5 Kit (without cabinet)
 \$359⁰⁰ complete**



This cabinet features 1 1/4" **High density partical board** for better sound quality and is available in matte black, gray, oak or walnut laminate, with your choice of black or gray grill. Driver holes are precision cut to meet your exacting needs.

OUR WAREHOUSE IS OPEN FOR PICK-UP 10AM TO 6PM DAILY, MONDAY THRU SATURDAY
UPS ORDERS SHIPPED SAME DAY • MINIMUM ORDER \$50.00

ZALYTRON INDUSTRIES CORP.

469 JERICHO TURNPIKE, MINEOLA, NY 11501

TEL. (516) 747-3515

FAX (516) 294-1943

FOR ALL YOUR NEEDS - WRITE OR CALL AND ASK FOR ELLIOT!

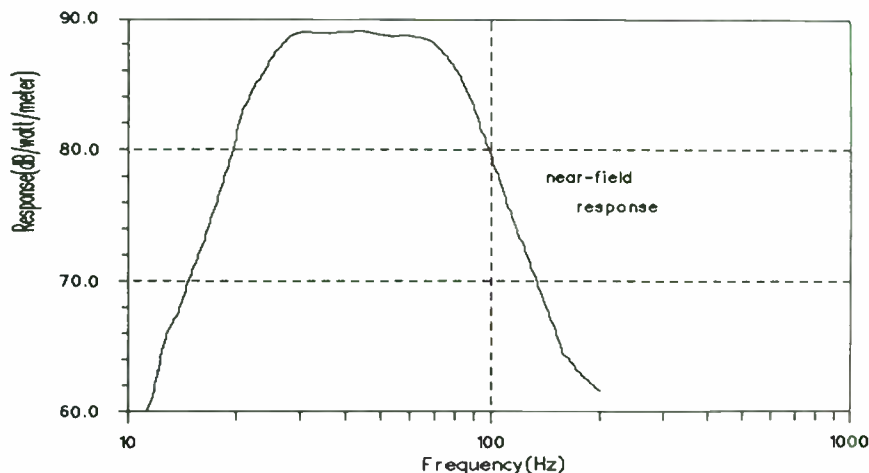

FIGURE 8: The Aria Ten near field frequency response.

Continued from page 16

efined, perhaps, by saying what it is not. In a driver's far field sound pressure level falls off inversely with distance, and the driver looks like a point source. As the distance between the microphone and the driver shrinks compared to the driver diaphragm diameter, the axial sound pressure distribution at higher frequencies varies rapidly, because sound pressure contributions from different parts of the diaphragm arrive at the microphone with differing phases.

The distance from the driver where the transition between near field and far field response occurs is a function of driver size and frequency. For all mid-range and tweeter drivers, and for most woofers, you are well into the far field at one meter.

We use the near field measurement technique to overcome the effects of low-frequency discrete standing waves. D.B. Keele describes this technique in his excellent paper.¹ I shall only highlight his approach here. Referring to Fig. 7, place a microphone very close to the driver diaphragm's center (less than 1/2"), so the sound pressure level produced dominates any energy which has been reflected from room boundaries. Keele shows that a direct mathematical relationship exists between near field sound pressure and the half-space far field anechoic response.

NEAR AND FAR. Near field measurements produce the true anechoic response of a driver for frequency wavelengths which are long, compared to the diaphragm's diameter. Pressure waves created at the cone's outer edge must travel a longer distance to reach the microphone than those coming from the cone center. They may, at higher frequencies, arrive out of phase causing

near field response cancellation not observable at normal listening distances, that is, in the far field. Equation 1 gives a practical upper-frequency limit to the near field technique in terms of driver diameter

$$f_{MAX} > 4300 / D \quad (1)$$

where f_{MAX} is in hertz and the driver diameter, D , is in inches. For a typical 12" woofer with an effective cone diameter of 10", the upper-frequency limit is 430Hz. Equation 1 shows near field measurements are valid throughout the entire discrete standing wave frequency range for woofers of 12" diameter or less. The near field technique is not limited to woofers. For a typical 5" mid-range driver with an effective cone diameter of 4", near field response measurements are valid up to roughly 1kHz, while 1" tweeter's can be made out to 4kHz.

Although you can use the near field technique with midrange and tweeter drivers, it does not yield a driver's one meter sensitivity directly. Thus, it's not as useful as one meter measurements for matching driver levels. Since midrange and tweeter units operate exclusively in the statistical standing wave regime, you can make reliable far field measurements at microphone/loudspeaker separations of one-half to one meter.

PUT IT WHERE? When making far field measurements, place the driver or loudspeaker system as far as possible from reflecting walls, while ensuring the distance from any two or more walls is not identical. Dominant reflections will be from the floor. Above 300-400Hz, you can eliminate these reflections by placing thick fiberglass bats on the floor between the speaker and the micro-

phone. Any residual room effects irregularity can now be smoothed out using the warble tone test signal to average through the ripples.

I have not distinguished between individual driver testing and system testing. Individual driver testing is simpler because the driver axis is clearly defined, and microphone placement relative to that axis is unambiguous. Because of the separation between multiple drivers, however, path lengths between each driver and the test mike will be different. System response will change, often drastically, with mike location. In system testing, one must define the listening axis, and the location along that axis where response is measured.

Systems with widely spaced drivers may not integrate well at one meter. Unfortunately, if the mike is placed much farther away from the system under test, the ratio of direct to reflected sound will decrease, and wall, floor, and ceiling reflections will begin to distort the measured response. Under these conditions I have found system response often can be more accurately predicted with a computer program, such as LMP, CALSOD or XOPT, than it can be measured. Individual driver responses, including the effect of their crossover, are measured and used with one of the programs to compute system response on any desired axis.

RESPONSE MEASUREMENT. I'll conclude with two examples. If you have ever tried measuring the subwoofer's frequency response in your listening room with conventional techniques, you know it's an impossible task. However, near field measurements are a piece of cake. Figure 8 shows the ARIA TEN's

Old Colony Sound will offer several kits in relation to this article.

A full kit of all parts with an etched circuit card, box, single-piece wand and microphone will be available. Those who wish to be notified of availability date for this kit please use Fast Reply #170. The kit will be available with a calibrated capsule at an additional charge. Those interested in circuit cards only, please use Fast Reply #178.

Crawford's Warble Tone generator with a power supply, complete kit of parts, board, and a punched, painted, and silk-screened case also will be available. The generator will be offered at a special price in combination with the D'Appolito Microphone kit. Those interested in the Warbler kit please use Fast Reply #184.

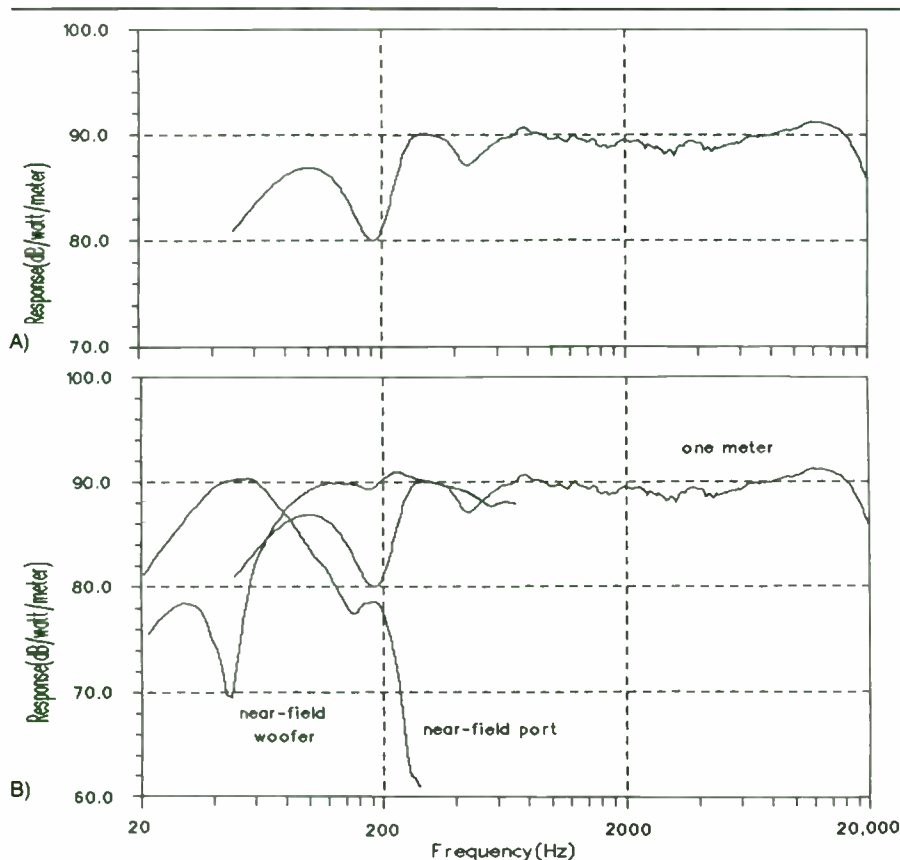

FIGURE 9: The Signature 717 frequency response; (a) One meter response; (b) Combined near field and one meter responses.

near field response to a swept $\frac{1}{3}$ -octave warble tone. The ARIA TEN, which I designed for Focal America, is a sixth order band-pass subwoofer in which all radiation comes out of a slotted port.

I obtained the measurement by placing Mitey Mike at the port exit's center in line with the enclosure's outer wall. The plot shows a smooth anechoic response with 3dB down points at 24 and 82Hz. Above and below these points, response falls off at 18dB/octave. Incidentally, the measured near field response agrees perfectly with computer model predictions.

Figure 9 shows the Signature 717's frequency response, a compact, stand mounted system designed for A&S Speakers of San Francisco. The data for Fig. 9a were taken at one meter in my living room using a swept $\frac{1}{3}$ -octave warble tone. Notice the response data are quite smooth down to about 400Hz, where the first room induced response dip, a mild floor dip, occurs. A second, more pronounced dip is seen at 160Hz, so 400Hz seems to be the lower limit for one meter measurements in my living room.

Data below 400Hz was obtained via a slight modification of the basic near field approach. The Signature 717 uses two closely spaced 7" mid-bass drivers in my

$\frac{3}{2}$ geometry. To get the contribution from both drivers simultaneously, the loudspeaker was placed on 2" spacers facing downward on a concrete floor. This created an acoustic center on the floor between the two drivers. I placed Mitey Mike at the center point and took a frequency response to get the dual mid-bass driver's contribution to the overall curve from 400Hz downward. This procedure is sometimes referred to as the "ground plane" approach.

Finally, I placed Mitey Mike at the center of the rearward firing port to get its contribution. All three curves are shown in Fig. 9b. Notice the near field woofer response has a deep notch at 42Hz, which is the box tuning frequency. At this same frequency, the port output has reached a maximum (I guess, the bass reflex principle really works.) Port and woofer contributions are equal at about 80Hz. Figure 9b shows low-end port response, and therefore the low-end system response, is down 3dB relative to 1kHz at 36Hz. ▶

REFERENCES

1. Keele, D.B. Jr. "Low-Frequency Loudspeaker Assessment by Near Field Sound Pressure Measurement," *Journal of the Audio Engineering Society*, Vol. 22, No. 3, April 1974.

Only One.



Now you need only one microphone to cover a whole range of tasks. The Josephson C-602 has our new vacuum-deposited gold condenser capsule with selectable omni and cardioid directional patterns. Select bass rolloff or flat response for close-up or far field use. The wide dynamic range and very low noise make it suitable for all kinds of sound environments. The \$400 price makes it suitable for all kinds of sound budgets. It's made in Germany by MB Electronic, famous in European broadcast, recording and film studios since 1966. Hear it at your favorite pro audio dealer, or call us for more information.



JOSEPHSON ENGINEERING
3729 Corkerhill,
San Jose, Calif. 95121
(408) 238-6062

Fast Reply HKE320

SYMMETRICAL LOADING FOR AUTO SUBWOOFERS

BY MATTHEW HONNERT

I was enthused with Jean Margerand's article, "The Third Dimension: Symmetrically Loaded," (SB 6/88) and have designed and built several versions for automotive use. My development work, and on-the-road experience may help fellow speaker builders.

Symmetrical loading offers many automotive advantages, such as:

1. High-power handling capacity using relatively small drivers. Reduction in cone excursion and distortion this loading technique offers, allows reduction in driver and enclosure size.

2. Minimal (or no) crossover requirements. The 12dB/octave acoustic roll off is adequate for most automotive applications due to occupants' proximity to the speakers. An electronic, even passive, crossover is helpful but not necessary. In most basic systems, the subwoofer is simply wired in parallel to the main full-range speakers.

3. Compact size and flexible dimensions. Low-profile or irregularly shaped enclosures can be built for any hatchback, sedan, or van.

4. Cost. Small drivers and enclosures are generally inexpensive. A simple crossover network reduces cost even more.

I recently built two subwoofers, one for a mini-van, the other for a hatchback coupe. Both use dual 6" woofers, yet design parameters and installation were unique.

For the Voyager Van, dual Peerless TP165F drivers occupied a common

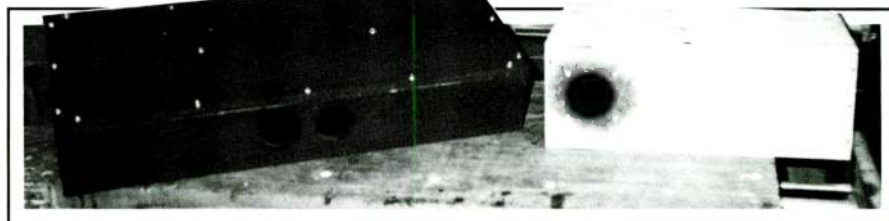

PHOTO 1: The assembled enclosures. Finishing touches are up to the builder.

back chamber, with a single 3½" I.D. duct venting the front chamber. It is driven by an 80W bridged amplifier via a 140Hz Linkwitz-Riley low-pass filter. Covered in matching carpeting the enclosure resides under the middle bench seat for near-factory-look.

I was less concerned about size in my VW Scirocco commute car, but I wanted good performance and low cost. Twin Becker 906A171 drivers are mounted in separate back chambers, cones mounted push-pull. The common front chamber vents to the top through dual 3" ducts. The enclosure is long and sloped to fit directly behind the back seat. Originally, I amplified this design as a stereo subwoofer, each woofer in parallel with its respective full-range main speaker. For more power and flexibility, I now drive it in mono with a bridged 50W amp via a dash-mounted electronic crossover.

Comparing the two designs yields some interesting notes. Both are tuned to about the same center frequency with equivalent bandwidths of 40-170Hz. The van system, admittedly less efficient, seems more strained even with the larger power amp. The VW system "pressurizes" the vehicle with solid bass. On-the-road experience and bench testing yielded practical guidelines for high performance, and low-cost, automotive designs:

- Use woofers with moderate or low f_s/Q_T values, under 100 if possible. A low V_{AS} will also reduce box size and/or allow a higher efficiency design align-

ment. Small woofers with small magnets and loose suspensions work well, and cost less.

- Try using woofers with long mechanical excursion limits. The Peerless drivers I used, as well as Dynaudio and others, tend not to bottom out when overdriven. Their excursion peaks at some limit, but no rapping sound occurs. I have successfully used other drivers that do bottom, but you'll appreciate the extra margin, especially with some power amplifiers which pulse the woofers at turn-on or turn-off.

- Duct diameter is important, and must be considered for its effects on annoying wind noise and ultimate sound-level. I use the formula:

$$\text{Minimum Area (inches)} = 0.02 \times \text{Vent Freq. (Hz)} \times \text{Cone Displacement (in}^3\text{)}$$

For typical tuning frequencies and drivers, see minimum vent diameters (Table 1).

You will find it is often difficult to design the minimum vent diameter into com-

TABLE 1

| WOOFER | CONE DIS. | VENT FREQ. | VENT DIA. |
|--------|-------------------|------------|-----------|
| 6" | 6 in ³ | 60-80Hz | 3" |
| 8" | 13 | 60-80Hz | 4.5" |
| 10" | 25 | 50-70Hz | 6" |
| 12" | 42 | 50-70Hz | 2 x 6" |

ABOUT THE AUTHOR

Matthew Honnert has a BSEE degree, and is Senior Applications Engineer at Syntronic Instruments, Inc., a manufacturer of precision deflection yokes. He has designed and built more than 60 speaker systems, including Strathearn and Swan IV derivatives, over the past 20 years. He is married and has two young sons.

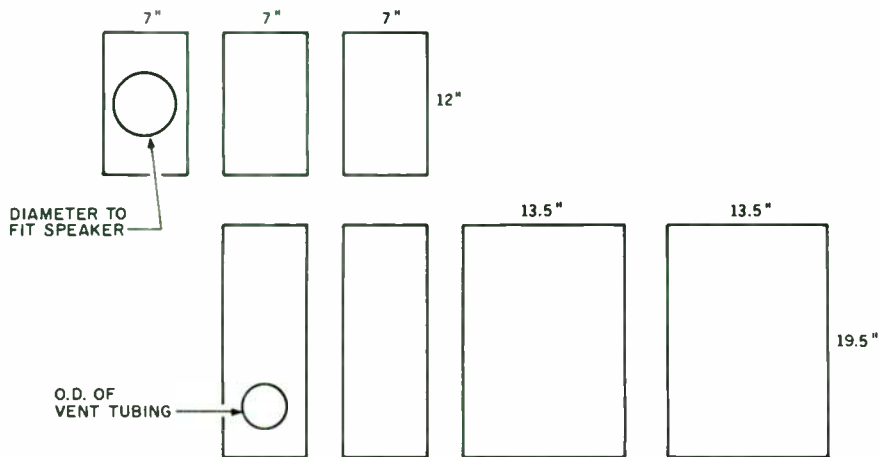

FIGURE 1: The finished pieces with speaker and vent apertures.

pact enclosures. For best results, even a 6" woofer requires a front chamber of more than 0.25 ft³ for a manageable duct length. If you use dual drivers, dual ducts (or equivalent duct area) must be engineered as well. It is likely drivers with large magnets, or small equivalent air volumes (V_{AS}) will perform best with higher "S" alignments.

- Power bandwidth influences efficiency, and power handling. I usually set f_L at 40Hz as a start, knowing that typical program music has little energy below that. It's fruitless trying to reproduce lower frequencies in a moving vehicle. Cone excursion, however, dramatically increases beyond half-power frequencies f_L and f_H . Smaller drivers, and short-throw voice coils, can be coaxed into high power applications by setting f_L considerably lower, perhaps 30Hz, since improved cone loading reduces cone excursion in the useful frequency range. Efficiency will suffer, but amplifier power is getting cheaper nowadays.

- For automotive applications, the upper half-power frequency, f_H , can be significantly higher than in quality home systems. A vehicle has many surfaces close to the subwoofer, and even at 180Hz, a rear mounted subwoofer isn't readily detected unless it is 8-10dB louder than the full-range speakers. When used without a complementary low-pass filter (crossover network), I would limit f_H to about 140-150Hz, with a filter, 180-200Hz is satisfactory.

A simple series inductor is useful in crossovers when the subwoofer is to be strapped (in parallel) across the full-range amplifier outputs. The 6dB slope is mild, yet it reduces wasted power at frequencies above f_H . Series resistance must be accounted for in subwoofer design, yet low-impedance power amplifiers may enjoy the reduced load.

I prefer electronic crossovers for various reasons. They improve system clarity by relieving the full-range speakers from the low frequencies; they allow easy balance adjustments between subwoofer and full-range speakers; and they increase sound levels dramatically, even with relatively small power amplifiers.

The latter results from summing the amplifier voltages. Assuming the midpoint of acoustic power is about 200Hz in a moving vehicle, if we use two similar power amps via an electronic crossover (for frequencies above and below this) we essentially double available amplifier output voltage to the total system. Since power is proportional to voltage-squared, we *quadruple* to equivalent power. This "totem poling" of amplifier voltage swings often allows multi-amped systems to outperform larger single-amp systems. Even using a simple low-pass *only* filter (as found in accessory equalizers), you still get balance control and significantly improved clarity. The full high-pass/low-pass filters are icing on the cake.

A LOW-COST DIY DESIGN. I've evaluated drivers from Polk, Radio Shack, Peerless, Becker, Focal, Dynaudio, and Universal. The Dynaudio is good, very costly, and has a fairly short linear excursion. The Becker is also very good, if you can find one. The others, except the Radio Shack, have too high an f_s/Q_T for efficient and practical design. We'll use the Radio Shack 40-1011. The cost is reasonable and it is widely available.

After several hours of break-in, the Theile parameters were considerably different from those Radio Shack advertised. This is not surprising, but I hope my test speakers are representative of those found nationally in stores. Measured versus advertised parameters were:

| RADIO SHACK 40-1011 | | |
|---------------------|--------|---------------------|
| PARAMETER | TESTED | ADVERTISED |
| f_s | 36 | 50Hz |
| Q_T | 0.35 | 0.6 |
| V_{AS} | 1.7 | 2.6 ft ³ |

For the enclosure parameters, I selected a moderately sized enclosure:

$$\begin{aligned}
 V_B &= 870 \text{ in}^3 \\
 V_F &= 582 \text{ in}^3 \\
 \text{VENT} &= 3" \text{ I.D.} \times 9.1" \text{ long}
 \end{aligned}$$

SUIT THE SPACE. This design provides cutoff frequencies at 42 and 140Hz, with a relatively high efficiency of -2dB. All dimensions are for a single driver, and must be doubled for dual drivers (use two of the specified vents). A stereo design results from attaching together two identical enclosures.

Many dimensional ratios will suit the available space simply by adding V_B and V_F together (the volume of the vent has already been factored into V_F), and dividing the key dimensions. Since the drivers are about 7" in diameter and the

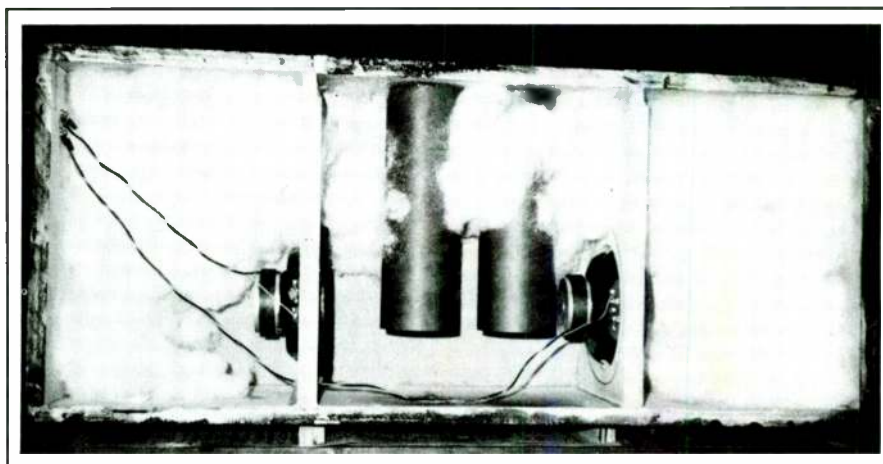

PHOTO 2: The vent can be made from materials such as cardboard, phenolic, or plastic.

vent requires about 12" internal space (vent length plus one vent diameter), I will arbitrarily use internal dimensions of 7:12:17.25". Allowing 3/4" for the internal partition, the inside dimensions are about 7:12:18". Additional volume for the driver isn't necessary, as it is closely offset by the mounting aperture in the partition.

Use the following cutting list for each enclosure:

| QTY. | SIZE |
|------|---------------|
| 3 | 7" x 12" |
| 2 | 7" x 19.5" |
| 2 | 13.5" x 19.5" |

These sizes are based on 3/4" plywood or particle board. Using thinner material, calculate a revised cutting list. *Figure 1* illustrates the finished pieces with speaker and vent apertures. The vent duct can be made from materials such as cardboard, phenolic, or plastic. If the I.D. is 3" as specified, the enclosure's tuned frequency will be near 75Hz.

Assemble the enclosure's sides first, all pieces of 7" width. For the simple butt joints, I suggest a heavy adhesive such as paneling cement ("Liquid Nail") for its gap-filling feature and strength. Use nails or screws as well, since the adhesive requires overnight curing. The driver mounts in the larger aperture between the two chambers, while the vent is installed in the smaller chamber (*Fig. 2*).

The driver should be bolted or screwed in place, the magnet side facing the larger back chamber. Now the vent can be glued with panel cement or caulking, its end flush with the outer panel surface.

Next, install a side panel (13 1/2" x 19 1/2"). Bring the speaker terminals out before adding the last panel. A simple "zip cord" or a more elaborate feed-

through can be used. Toss in a handful of fiberfill in the rear chamber, and seal down the last panel. A felt gasket works well if you opt for a removable panel).

Now is a good time to test the subwoofer for buzzes or air leaks. Connect it to an amplifier and play some heavy music. You won't hear much, but caulk any leaks.

Finishing cosmetics are up to the builder. I suggest paint to seal the wood. Automotive (non-backed) carpeting is easy to install with spray contact cement, and looks "factory."

This system's efficiency is slightly lower than typical automotive full-range speakers, making a simple parallel connection less than exciting. Satisfactory connections, in order of preference, are:

1. Separate monaural (or bridged stereo) amplifier and electronic crossover with adjustable gain control. Depending on the main full-range speaker's bandwidth, a low-pass *only* filter may be adequate for the subwoofer. Maximum volume is available if high- and low-pass networks are used. Gain control at-your-fingertips is recommended for exploring music's hidden lower frequencies.

2. A main power amplifier with opposite phase outputs simultaneously can drive main and subwoofer speakers, with close balance and good output. Some power amplifiers, such as Alpine and Rockford-Fosgate, have one channel inverted from the other, allowing you to connect the subwoofer across its "plus" terminals, and full-range speakers across their respective stereo outputs. This drives the woofer with twice the normal voltage, raising its relative output by 3dB, and more nearly matching the full-range main speakers.' Additional crossovers aren't necessary. A passive low-pass network may be added to the sub-

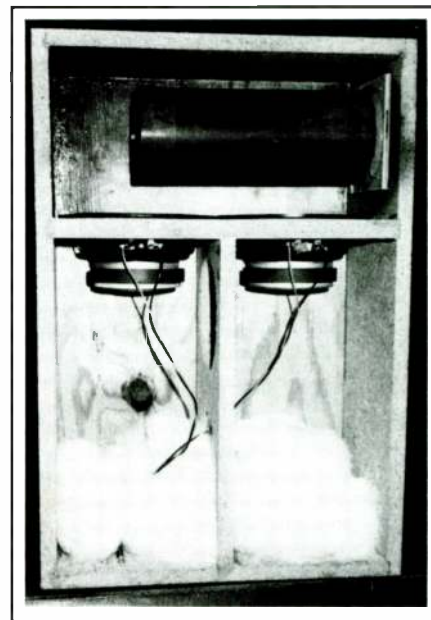



PHOTO 3: The rear chamber stuffed with fiberfill.

woofer, if wished, for reasons outlined earlier.

3. A standard stereo power amp can drive both full-range speakers *and* parallel stereo subwoofers, but requires an L-pad for the full-range speakers to match their sensitivities to the subwoofers.' Fortunately, most automotive speakers are overdamped, and not greatly affected by the L-pad's series resistance. For best results, the amplifier should have at least 40W per channel and low-impedance (high-current) capability. As noted above, a passive low-pass filter at about 150Hz would be a worthwhile enhancement.

I believe symmetrical loading provides an ideal, and cost-effective way to install a quality subwoofer into your vehicle. *SB* readers experimenting with the technique are sure to find a rewarding construction project, as well as obtaining very healthy bass performance. 

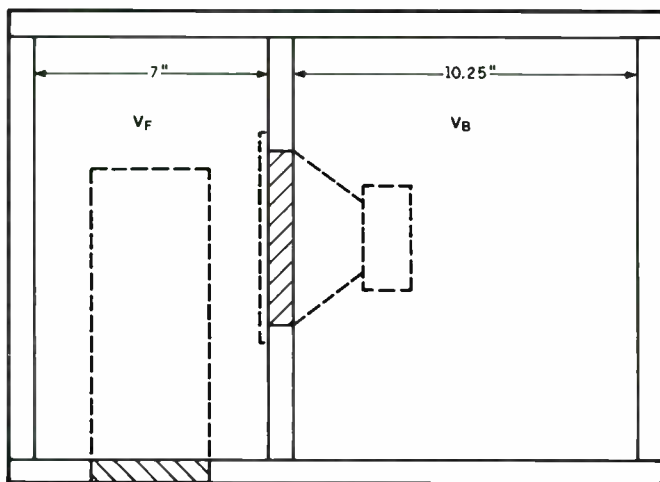

FIGURE 2: The driver mounts in the larger aperture between the two chambers.

Addendum

The problem of weak bass in my van system has been linked to inadequate enclosure rigidity. The symmetrical-loading technique generates tremendous internal pressure and requires a minimum panel thickness of 3/4". (My van system used 1/2" for low profile.) The pressure also blew out the foam surrounds on my Becker drivers. I now recommend the woofers be rear-mounted when possible.

The van now utilizes a single Seymour Sound 8" woofer, instead of the original dual 6" Peerless drivers. Power capacity is not as high, but efficiency is better, and sound quality is equivalent.

IMPROVED VENTED BOX WITH LOW Q_{TS} DRIVERS

BY G. R. KOONCE
Contributing Editor

In "The QB_3 Vented Box Is Best," (SB 5/88) I expressed my preference for the sound of QB_3 aligned Vented Box (VB) speaker systems, and why they might offer superior performance. I had a problem finding drivers which offered a sufficiently low -3dB cutoff frequency (F_3) to make a worthwhile system. Small woofers, say less than 8", commonly have a Q_{TS} sufficiently low (below 0.4) to provide QB_3 alignments. It's important with small drivers to move F_3 as low as possible for acceptable system performance. The last couple of years I've accomplished this by deviating from classical alignments to enhance F_3 performance. The results have been very satisfactory.

A caveat: I have no design equations. It is purely trial and error. One requirement is the ability to plot a VB system's response. I have computer programs which do this, almost a necessity as

numerous plots are required. Review Old Colony's offerings to see if software to graph VB response is available. The equations to determine VB's response are shown in the sidebar. I must, unfortunately, leave the problem of plotting VB response to the reader.

The basic approach examines the optimum QB_3 response for your driver to establish net box volume (V_B) and box tuned frequency (F_B). I have found increasing box size and modifying the tun-

ing will drop F_3 , sometimes dramatically. Figure 1 shows the QB_3 response for a large driver with $Q_{TS} = 0.258$, $F_S = 19\text{Hz}$ and $V_{AS} = 12.8\text{ft}^3$ in an enclosure with $V_B = 3.08\text{ft}^3$ net. F_3 's value of 36Hz is disappointing for a driver with an F_S of 19Hz. Figure 2 illustrates results of raising the enclosure size and playing with the tuning. Note that V_B of 6 ft^3 allows an F_3 of about 27Hz, a great improvement. The penalty is a slight dip in the response (1dB), and possibly giving

TABLE 1

PERFORMANCE COMPARISON

| Driver | V_B (ft ³) | F_S (Hz) | F_3 (Hz) | F_B (Hz) | Align. |
|---------|--------------------------|------------|------------|------------|--------|
| Large— | 3.08 | 19 | 35.7 | 28.6 | QB_3 |
| Figures | 4.00 | 19 | 32 | 30 | Mod |
| #1 & #2 | 6.00 | 19 | 27 | 28 | Mod |
| Small— | 0.138 | 62 | 101.9 | 84.1 | QB_3 |
| Figures | 0.200 | 62 | 88 | 80 | Mod |
| #3 & #4 | 0.400 | 62 | 72 | 77.5 | Mod |

System Amplitude Response - dB vs Log Frequency

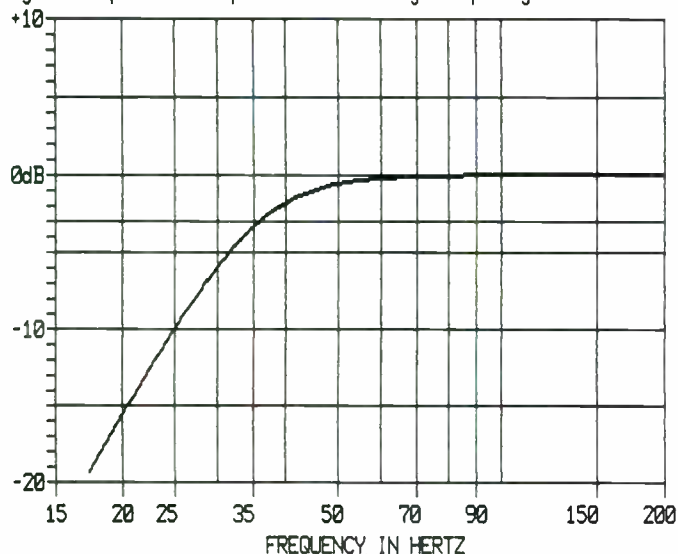

FIGURE 1: Optimum QB_3 response for large driver— $V_B = 3.08\text{ft}^3$

System Amplitude Response - dB vs Log Frequency

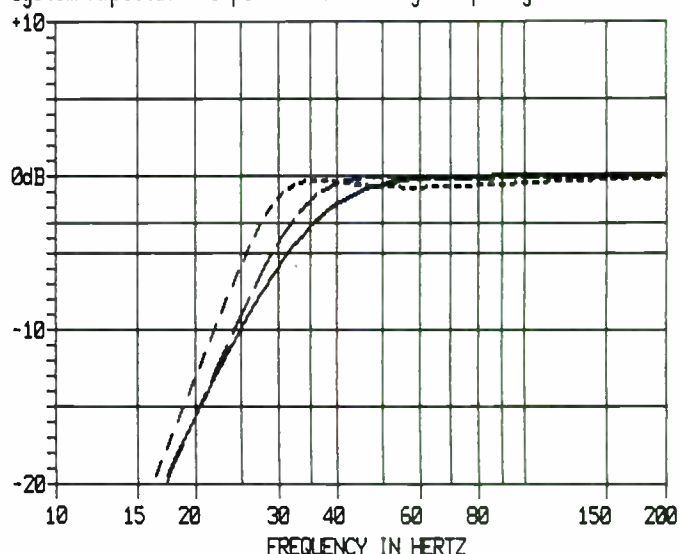

FIGURE 2: Modified responses for large driver.

Computing Response of a Vented Box System

Response in dB = $20 \log_{10}(R)$

where R is linear response as follows:

$$R = \frac{(F_N)^4}{\sqrt{[(F_N^4 - C F_N^2 + A)^2 + F_N^2 (D F_N^2 - B)^2]}}$$

Where: $F_N = F/F_{SB}$ F = the frequency of interest—Hz

F_{SB} = Driver resonance in V_B —Substitute F_S for design

$A = (F_B / F_{SB})^2$ F_B = Box tuned frequency—Hz

$B = A / Q_{TS} + F_B / (Q_B F_{SB})$ Q_{TS} = Total driver Q

Q_B = Box Q (Normally 7 is used)

$C = 1 + A + V_{AS} / V_B + F_B / (Q_B F_{SB} Q_{TS})$

V_{AS} = Equivalent compliance volume of driver

V_B = Enclosure net volume—same dimensions as V_{AS}

$D = 1 / Q_{TS} + F_B / (Q_B F_{SB})$

up some Q_{B3} response advantages. The slight dip occurs in a range where passive crossovers produce a slight peaking, which would somewhat offset the dip. Six ft³ enclosures are not popular these days, but any enclosure over the optimum Q_{B3} volume of about three ft³ would allow reduced F_3 with this driver.

Figure 3 offers a more practical application, the optimum Q_{B3} response for a small driver with $Q_{TS} = 0.288$, $f_s = 62$ Hz and $V_{AS} = 0.43$ ft³. The system's F_3 frequency is about 102Hz, making construction moot. Since the Q_{B3} optimum V_B is only 0.138 ft³, there should be no problem considering larger enclosures. The larger you make the enclosure the

lower you can push F_3 , but the more severe the response dip. Figure 4 demonstrates the performance with the enclosure volume raised to 0.2 and 0.4 ft³. With $V_B = 0.4$ ft³, the system has about 2dB response ripple with F_3 pushed to about 72Hz. This ripple in a small driver has not been a problem, at least in my experience. A more conservative V_B of 0.2 ft³ shows about 1.5dB droop and an F_3 of about 87Hz. Perhaps playing with the tuning could further improve performance. Playing with the tuning and enclosure size makes response curve plotting by hand unacceptable.

I proposed in "The Q_{B3} Vented Box" the "improved" performance I heard stemmed from the fact the system cutoff

(F_3) was above the two major system resonances (F_B and f_s) so major system output did not occur at these frequencies. This technique is pushing down the F_3 point. How do these modified systems fare in keeping resonances suppressed? Table 1 lists the results for the two driver examples. It is clear the procedure did not push F_3 down to f_s , but it certainly will put F_3 below F_B . If the enclosure size is excessively increased over optimum Q_{B3} , then the box resonance (F_B) will be in the passband. A potential penalty is paid, not only in the response ripple, but also in moving the system resonances closer to the system pass-band. This is still better than the C_4 alignment, which has both f_s and F_B in the pass-band.

I have used this approach with moderation on large drivers, and with excess on small drivers. Final results in all cases, so far, have been good. Could this be proof the advantage of Q_{B3} alignment is simply the low driver Q, and thus good woofer damping, and not in any way related to the suppressed system resonances? I don't know the answer. I do know that systems with these low Q drivers sound better. I will continue using them, even if I can't explain the perceived superior performance.

This technique enables construction of systems with a lower cutoff frequency with low Q drivers. They may no longer be Q_{B3} , but they sound good. Let me hear from any builders using this, or similar, technique with low Q drivers.

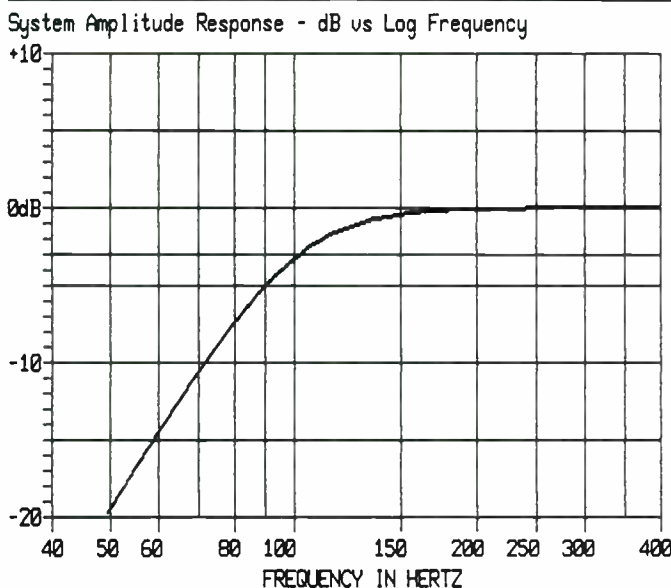

FIGURE 3: Optimum Q_{B3} response for small driver— $V_B = 0.138$ ft³

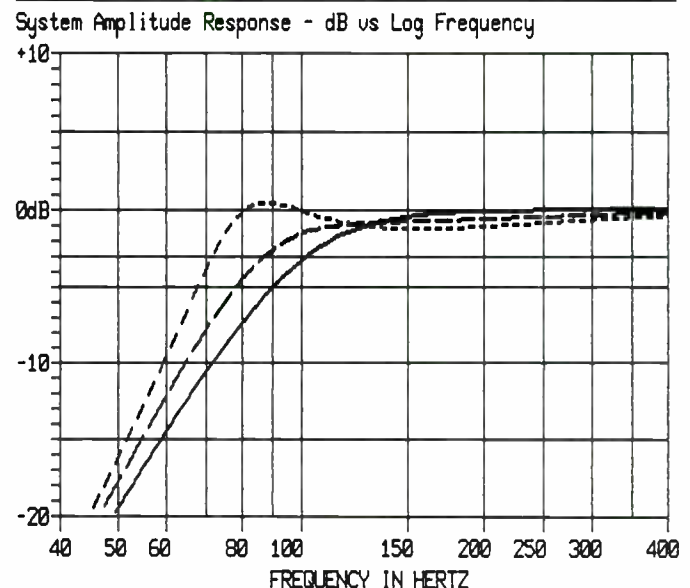

FIGURE 4: Modified responses for small driver.

World Famous
PYLE DRIVER® SPEAKERS...

Your Source for
Quality Woofers, Midrange,
Tweeters and Crossovers



- Over 200 speaker models and sizes available
- Parameters available for every loudspeaker
- Recommended cabinet sizes available for all woofers

Pyle is the source for all your loudspeaker needs!



Pyle Industries, Inc. • 501 Center St. • Huntington, IN 46750 • (219) 356-1200

Fast Reply #KE120

BOXMODEL—AN AID TO WOOFER SYSTEM DESIGN

BY ROBERT M. BULLOCK, III
Contributing Editor

In 1984 I wrote an Apple program called BOXRESPONSE which appeared in SB.¹ Its purpose was to allow the Thiele/Small model of a woofer system to be used in a practical way for the design and analysis of either a vented-box or a closed-box with or without equalization.

I had wanted to include Small's passive-radiator model² as well, but this proved to be more complicated than I cared to deal with. I was also interested in investigating the three box losses (absorption, leakage, port) separately rather than lumping them together in the leakage loss as is done in Small's models. These two facts led me to derive a new model that included all three common box types simultaneously and the three separate loss factors as well. The derivation of this new model was presented at the AES Convention in 1989.³ Using this generalized model I wrote a new version of BOXRESPONSE for the IBM PC. This version is currently available through Old Colony.

Although it is a powerful program it is rather awkward to use because of the way data entry is handled. Also, there is no way to directly compare more than two alternative designs, and passive-radiator system parameters are not handled in the standard way. Because of these and other shortcomings I have written a new program for studying woofer systems by the Thiele/Small models. It is called BOXMODEL and will be offered by Old Colony. With it you can easily compare as many as four systems at once and data entry is extremely fast and easy. Overall, I think it is a great improvement over IBM BOXRESPONSE.

If you are interested in programs of this type mainly for calculating optimal alignments, then BOXRESPONSE is still the program for you. BOXMODEL does

not support this capability. It was not included because I wanted to make the comparison features as convenient as possible, and because I considered alignment calculation to be of only marginal value. Why depend on somebody else's ideas of the "best alignment" when in BOXMODEL you have the capability to look at any alignment and decide whether it is appropriate for your circumstances.

The rest of this article is divided into three sections. The first explains the operation of the program in some detail. The purpose for doing this is to permit reference to the program in later discussion and to allow this article to serve as the documentation for the program. The second part discusses two topics that may not be so well known: passive-radiator systems and acoustic losses. The last part consists of a couple of examples showing how the program can be used.

For the most part the symbols used in

the program for system data are those first used by Small in his papers on box systems. If you are a regular reader of *Speaker Builder* most of them should be familiar to you. If you are not, then you should consult my SB series⁴ on vented-boxes where most of them are described. Some symbols related to losses and passive-radiators may be new to you, but they are described below.

I. PROGRAM MECHANICS

MACHINE REQUIREMENTS. BOXMODEL is designed for an IBM PC or compatible with at least 384K of RAM and running DOS 2.x or higher. The program will run on a machine without graphics capability, but I don't really recommend it because the graphics presentations are extremely important in making design decisions. The program will recognize and use MDA, CGA, EGA, VGA, MCGA or Hercules video

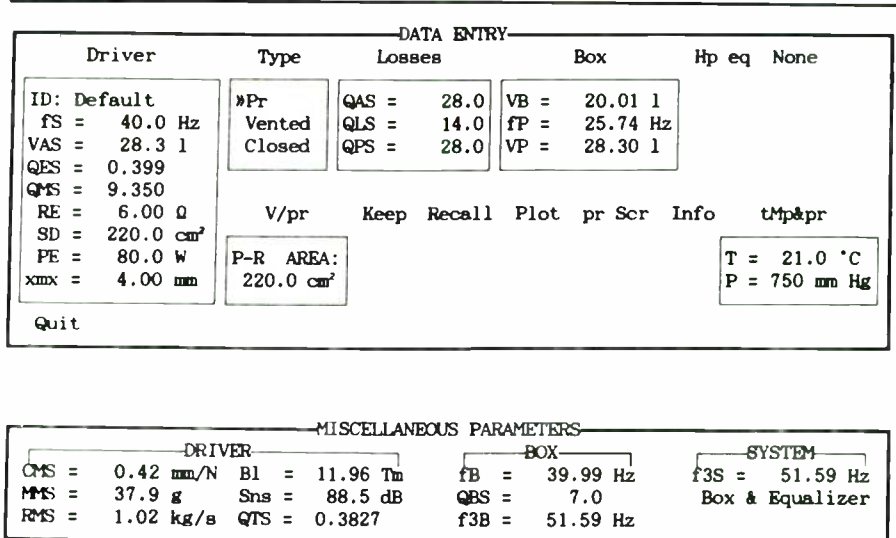

FIGURE 1: A typical display screen with no equalizer.

adapters. I believe it should also be usable with any adapter that is capable of emulating the high resolution modes of these adapters, but I have not been able to verify this. Color capability is not necessary, but it is also highly recommended.

Some of the data calculations in the program involve many floating point operations, so a co-processor is highly recommended. As a matter of fact, the program's number crunching on my 4.77MHz 8088/8087 combination is slightly faster than it is on the department's 16MHz 386 machine without a co-processor. So, if you can possibly swing it, a co-processor is well worth it for this kind of application. They are available for about \$100.

To summarize, minimum requirements for the program are an IBM PC or clone with at least 384K running DOS 2.x or higher. To get the most out of the program you should have a graphics card of one of the types mentioned above. To avoid waits of one to two minutes you should have a co-processor. Color makes for a pretty screen.

PROGRAM OPERATION. The program starts with a title screen. Hitting any key will take you to the main work screen for the program. This screen is divided into two windows as shown in Fig. 1. All of the data entry you (the user) do occurs in the top window called "DATA ENTRY." The bottom window is called "MISCELLANEOUS PARAMETERS" and contains various program calculated parameters of interest. You never work in this window.

DATA ENTRY. All units are in the meter-kilogram-second system. If you are used to working in the foot-pound-second system, the HELP facility will usually provide you with an appropriate conversion factor.

The data entry section consists of two menus and several data windows. The main program menu is free form and consists of the items DRIVER, TYPE, LOSSES, BOX, HP EQ, KEEP, RECALL, PLOT, PR SCR, INFO, Tmp&Pr, and QUIT, which are always displayed, as well as the items Eqdata and V/PR, which appear only when needed. Items are selected by pressing the capitalized letter of the item. You can also move from item to item with the Left arrow and Right arrow keys and select an item by pressing the Enter key. You can also quit the program by pressing the Esc key.

If you select DRIVER, TYPE, LOSSES,

| DATA ENTRY | | | | |
|----------------------------|----------|------------|--------------|------------------------------|
| Driver | Type | Losses | Box | Hp eq Order = 2 Eqdata |
| ID: Default | Pr | QAS = 28.0 | VB = 20.01 l | Cnr = 42.00 Hz |
| fS = 40.0 Hz | Vented | QLS = 14.0 | | Dmp = 0.4400 |
| VAS = 28.3 l | >>Closed | | | |
| QES = 0.399 | | | | |
| QMS = 9.350 | | | | |
| RE = 6.00 Ω | | | | |
| SD = 220.0 cm ² | | | | |
| PE = 80.0 W | | | | |
| xmx = 4.00 mm | | | | |
| Quit | | | | T = 21.0 °C P = 750 mm Hg |

| MISCELLANEOUS PARAMETERS | | | |
|--------------------------|---------------|----------------|-----------------|
| DRIVER | | BOX | SYSTEM |
| CMS = 0.42 mm/N | B1 = 11.96 Tm | fC = 62.15 Hz | f3S = 40.49 Hz |
| MMS = 37.9 g | Sns = 88.5 dB | QBS = 9.3 | Box & Equalizer |
| RMS = 1.02 kg/s | QTS = 0.3827 | f3B = 79.39 Hz | |

FIGURE 2: A typical display screen with an equalizer active.

BOX, V/PR or Tmp&Pr, then the cursor will move into the window below the selected item and you can either make a menu selection in the TYPE menu or enter new data in any of the other windows. Note that one item in the TYPE menu is marked with an >> to indicate that it is the current selection.

To enter data, first move the cursor to the data item you want to change by using the Up and Down arrow keys. Then move into the data field with the Right arrow key. The cursor will move to start of the data item. Then the overwrite mode is active and you can simply write in what you want. The Left and Right arrow keys let you move to any field position. The Space Bar and Back Space keys delete characters. Once you have edited to your satisfaction, striking the Enter key will take you out of the field and you can move on to another field with the Up or Down arrow keys or move back to the main menu by hitting the Enter key again.

If you are in a data field and have modified it, but then decide you want to keep the original value, hit Esc. This will move you out of the field but preserve the original value. If you decide you really didn't mean to edit any of the fields in a window, hit Esc rather than Enter and the cursor will move back to the main menu and all of the fields in the window will be returned to the values they had on entry.

Any other main menu selection will cause a window to pop up. With KEEP, RECALL and PLOT the window will contain a menu. Move to your selection with the Up and Down arrow keys and select with Enter. To cancel the menu, use Esc. Selecting the PLOT main menu item will cause a menu to pop up in

which you choose how many systems are to be displayed. After you select from this menu there is a delay during which extensive calculations are done. Then another menu appears from which you pick the type of plot you want. This menu also has a choice to allow you to turn the coordinate grid on and off. Plotting is faster without the grid, but the grid makes it easier to estimate values. After a plot is done, striking any key will return you to the plot type menu and you can select any other type. When you are done plotting, hitting Esc in this menu will return you to the main menu. As always, Enter selects an item and Esc backs you out of the menu.

INFO. The INFO item supplies help information of a general nature. You can page through five screens of information before returning to the first page. You return to the main menu anytime by hitting Esc.

PR SCR. The selection PR SCR is provided for machines without a PrtScr key. It will send the system data currently on display to an attached printer if it is on line. Otherwise, nothing will happen. The window borders may look somewhat strange if your system doesn't support the IBM higher order character set, but all of the data should be sent correctly. This PR SCR function is not capable of dumping graphics screens to a printer. For this purpose you will need your own utility.

TMP&PR. The Tmp&Pr selection is provided for those who prefer to use their own values for ambient temperature and barometric pressure. The default values are in the window when the

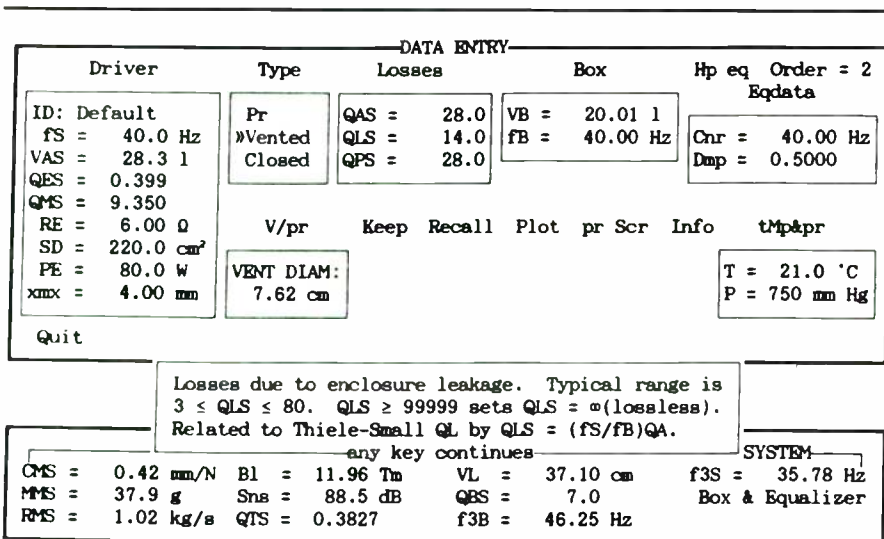

FIGURE 3: A help message displayed while the cursor is on the Q_{LS} item in the LOSSES window.

program starts. Changing these values will alter entries in the MISCELLANEOUS PARAMETERS window only.

TYPE, LOSSES, BOX, HP EQ, V/PR.

These selections enable the necessary information about the system to be entered and will be discussed in more detail below. The operation of the selection HP EQ does require a bit more explanation though. Selecting it will cause a small window to open. Use the Right arrow key to move into this window and enter the order of the equalizing filter you want to use. Picking order 0 causes the word None to appear and no further action is necessary. If you choose 1, 2 or 3 then a second window pops up below the menu item and the cursor is moved into it. Here you enter the data on the equalizer. This window will stay on view as long as an equalizer is in use. An ex-

ample showing a second-order equalizer is in Fig. 2. It will disappear when you select an order 0 equalizer. Then the word None will reappear.

HELP. The program also has a help feature. If you are unclear about the role of a particular menu item or data field, move the cursor to the item and hit F1. If there is anything I felt needed to be said about the item, a window with a help message will pop up as in Fig. 3. On a color system the window will be green with yellow text. If it doesn't tell you what you want, then try the INFO selection. If there is no reference in either place, then it is not worth knowing!

KEEP, RECALL. The system description on display is referred to as system A for identification. As many as four systems can be remembered by the pro-

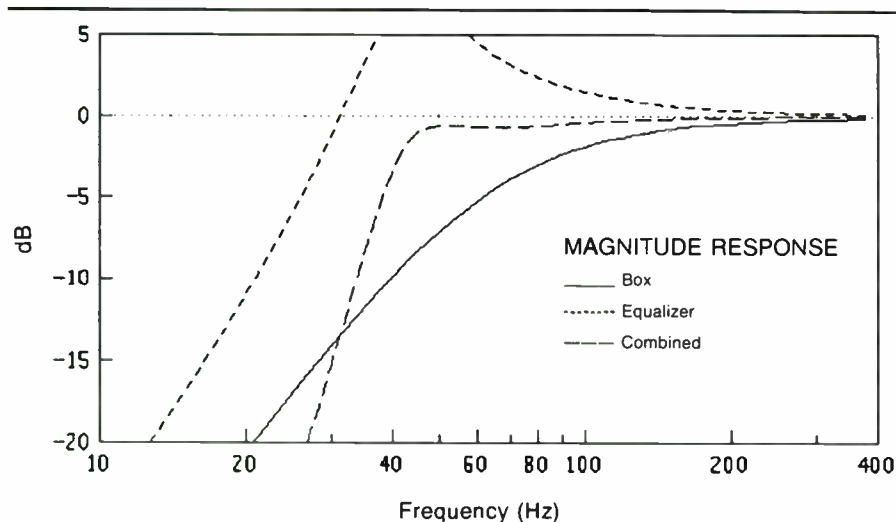

FIGURE 4: Small-signal response curves for the system shown in Figure 2.

gram. The other three are referred to as B, C and D, naturally. You can KEEP the currently displayed system as B, C or D by choosing which in the KEEP menu. If you want to recall the system later, use RECALL. This function not only redisplay the selected system, but it simultaneously stores the currently displayed system in the location freed up by the recall. In other words, if you RECALL system X (= B, C, or D) then the action actually is to exchange A and X.

PLOT. The plotting setup is quite nice, I think. You can do plots for system A alone of small-signal magnitude or phase, input impedance magnitude or phase, large-signal response, cone excursion, and PR excursion or vent air speed if either are applicable. If the system is equalized, then three graphs are shown in the small-signal magnitude plot: the box alone, the equalizer alone and the combined response. An example of this is shown in Fig. 4. When large-signal response is plotted, the sensitivity is also plotted for comparison. Further, the maximum excursion is plotted with the cone excursion function. Finally, for any large-signal graph, you are asked to set the input power before the graph is drawn. You can use this capability to determine how much power can be supplied before your excursion limit is exceeded. When this is determined, you can use this power input to graph SPL and find out how loud the system will play without distortion.

Large-signal graphs in BOXMODEL are not the same as they were in BOX-RESPONSE. In the latter program when graphing maximum SPL, the input power was controlled to keep cone excursions at or below X_{MAX} . In BOX-MODEL this is not done, so you have to look at the cone excursion plot separately to decide whether a particular input level keeps excursions below X_{MAX} . Thus the SPL plots in BOXMODEL represent valid responses.

You can also plot system A together with any combination of the other three systems on the same axes. This makes it easy to compare consequences of various design alternatives, including those of using the same driver in different box types. An example of this is shown in Fig. 5 where A is an equalized closed-box, B is a closed-box, C is a vented-box and D is a passive-radiator, all with the same box volume. If you have sufficient color capability, each graph will have a different color. Even without color you can distinguish the

Continued on page 30

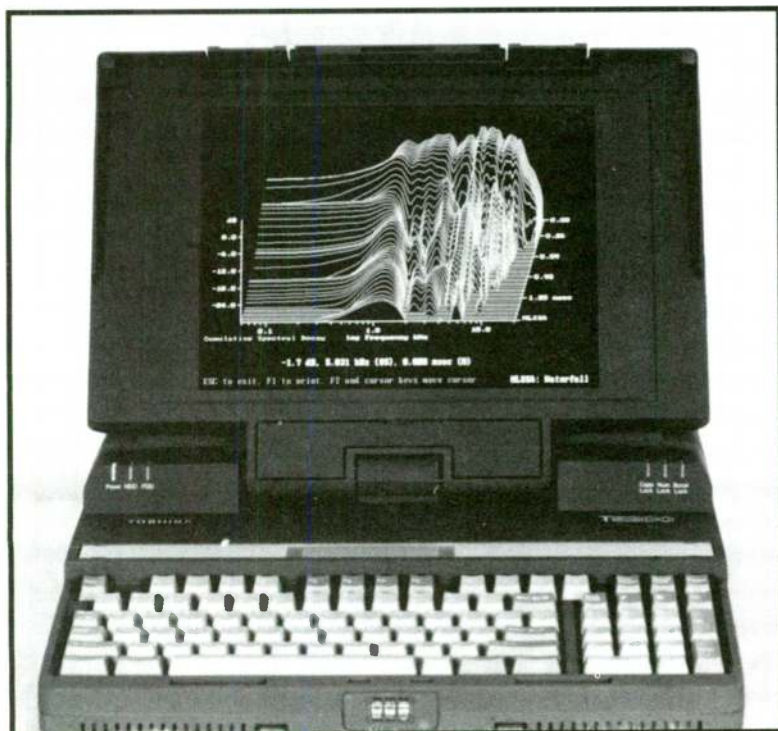

MLSSA.

Now even
non-experts can
make meaningful
acoustical and
loudspeaker
measurements.

The MLSSA™ (pronounced "Melissa") Acoustical Measurement System makes fast and accurate measurements of drivers, loudspeaker systems, sound reinforcement systems and room acoustics.

The cost-effective DRA MLSSA system consists of a custom designed plug-in card and powerful software that install into IBM or compatible personal computers including portable computers for field measurements. The software's intuitive menu system is easy for beginners to learn yet doesn't hinder experienced users. Start making meaningful measurements in hours rather than days, weeks or months.

MLSSA uses advanced maximum-length sequence (MLS) measurement technology for fast noise-resistant measurements. Instrument bandwidth extends to over 40 kHz for ultrasonic coverage of tweeter drivers.

MLSSA also offers an extensive and growing list of post-processing functions including energy-time curves for room reflection analysis, STI and RASTI for speech intelligibility estimation and 3D cumulative-spectral-decay plots for loudspeaker performance evaluation. Thiele-Small speaker parameter measurements are also available as an option.

To learn more call or write for literature and a free demonstration disk.

INTERNATIONAL DISTRIBUTORS: **Germany, Austria:** Harmonic Design, West Germany, Tel +49 07042/7085, Fax +49 7042/78411; **England, Ireland, Hong Kong:** Munro Associates, England, Tel +44 01-480 7121, Fax +44 01-702 3834; **Sweden, Finland:** Lab Gruppen, Sweden, Tel +46 300-16823, Fax +46 300-14246; **Switzerland:** ANADA AG, Switzerland, Tel +41 01/810 30 22, Fax +41 01/810 43 45; **Denmark:** Monitor Technology, Denmark, Tel +45 66 14 59 58, Fax +45 66 14 91 81; **Norway:** Ingenior Per Grov AS, Norway, Tel +47 (02) 307760, Fax +47 (02) 327743; **Australia:** Audio & Recording, Sydney, Tel +61 (02) 666-9935, Fax +61 (02) 666-3752; **Italy:** Audio Link, Italy, Tel +39 0521/598723, Fax +39 0521/598848; **Holland:** Stage Accompany, The Netherlands, Tel +31 2290-12542, Fax +31 2290-11192; **Canada:** Westbury Sound, Ontario, Tel (416) 752-1371.

DRA Laboratories • 607 W. Nettletree Rd • Sterling, VA 22170 • Tel (703) 430-2761 • Fax (703) 430-0765

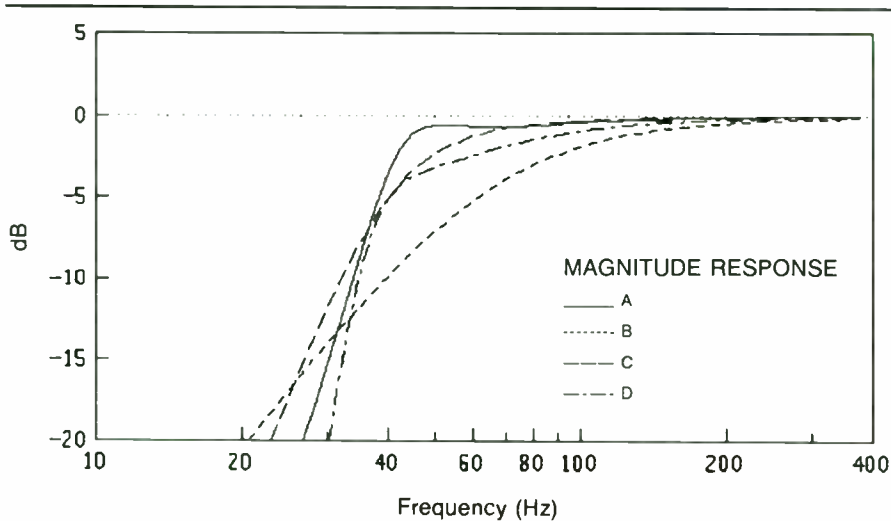

FIGURE 5: Small-signal responses. D is Figure 1 system, C is Figure 3 system, B is Figure 2 system without equalizer and A is with equalizer.

Continued from page 28

separate graphs because each uses a different line style. Finally, a legend above the graph shows the correspondence between system and line style and/or color.

WINDOW CHANGES. The data entry section of the display changes depending on what type of system you are working with. Figure 1 shows a passive-radiator system and Fig. 3 a vented-box. Note that the BOX window changes because different information is required for these types. Also, the V/PR window changes from showing the area of the passive-radiator to showing the diameter of the vent. When a closed-box is chosen as in Fig. 2, the V/PR window is hidden because it is no longer needed. Also, the BOX window reduces to one row because only one parameter is needed.

MISCELLANEOUS PARAMETERS.

The window is just that. Any system pa-

rameter that may be of interest is calculated by the program and displayed here. The significance of most of them is self-evident, but a few need comment.

In the list of DRIVER parameters Q_{TS} is the parallel combination of Q_{ES} and Q_{MS} , and Sns is the calculated sensitivity of the driver at 1m with input voltage $\sqrt{R_E}$. This is the usual 1W/1m specification when the load impedance is R_E , and it usually is fairly close to manufacturers' spec sheet values.

The item Q_{BS} in the BOX list is actually the parallel combination of Q_{AS} , Q_{LS} and Q_{PS} . It should be quite close to your measured value of Q_L . There may be some discrepancy because the letter S means that these Q's are referred to driver resonant frequency, while a measured Q_L is referred to the box-vent or box-passive-radiator resonant frequency. More on this below.

The next item in the BOX list is f_B for a passive-radiator system, vent length for

a vented-box or f_C for a closed-box. In a PR system f_B is not an adjustable parameter, but depends on the resonant frequency of the passive-radiator f_p , which is adjustable. This is the reason f_B doesn't appear in the data entry section for a passive-radiator.

The vent length for vented-boxes is calculated from the standard formula for one flanged and one unflanged end using the speed of sound as determined from the ambient atmospheric conditions given in the Tmp&Pr window.

The final item in the BOX list is the box cutoff frequency f_{3B} . This cutoff applies only to the box acting alone, whether or not there is an equalizer in the system. The complete system -3dB frequency is listed under SYSTEM and includes the effect of any equalizer. These cutoff frequencies are calculated by a numerical procedure that can go awry. If this happens then usually the phrase 'Bad value' will appear rather than a number. Nevertheless, you should be suspicious of any extremely small number because it probably means an untrapped bad value. Usually this happens only when you have specified a really wild set of parameters. If you change to a more reasonable set, a reasonable number should reappear in this position.

II. NEW IDEAS. Most of the system component parameters should be familiar to you from their Thiele/Small origins. The exceptions are probably the parameters specific to passive-radiator systems and the separate system losses.

PASSIVE-RADIATOR SYSTEMS. For passive-radiator design the adjustable parameters are the box volume V_B , the volume equivalent compliance of the passive-radiator suspension V_p and the mass of the passive-radiator cone as reflected by its resonant frequency f_p . As a practical matter for the home builder, once a passive radiator has been chosen V_p becomes fixed. This means that V_B and f_p are the only adjustable parameters and f_p can only be decreased because you can increase the mass of the passive-radiator but you can't decrease it. In any case, if you are going to tackle a passive-radiator design you should consult the article by Koonce⁵ for appropriate techniques for measuring V_p and f_p .

SYSTEM LOSSES. Probably the least understood data requirements are the losses. In general, a loss is the acoustic equivalent of a resistance. A Q number

Continued on page 32

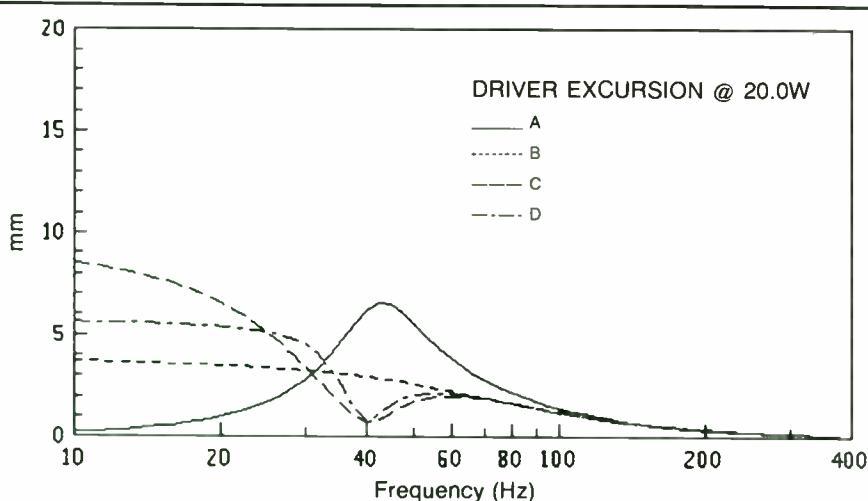
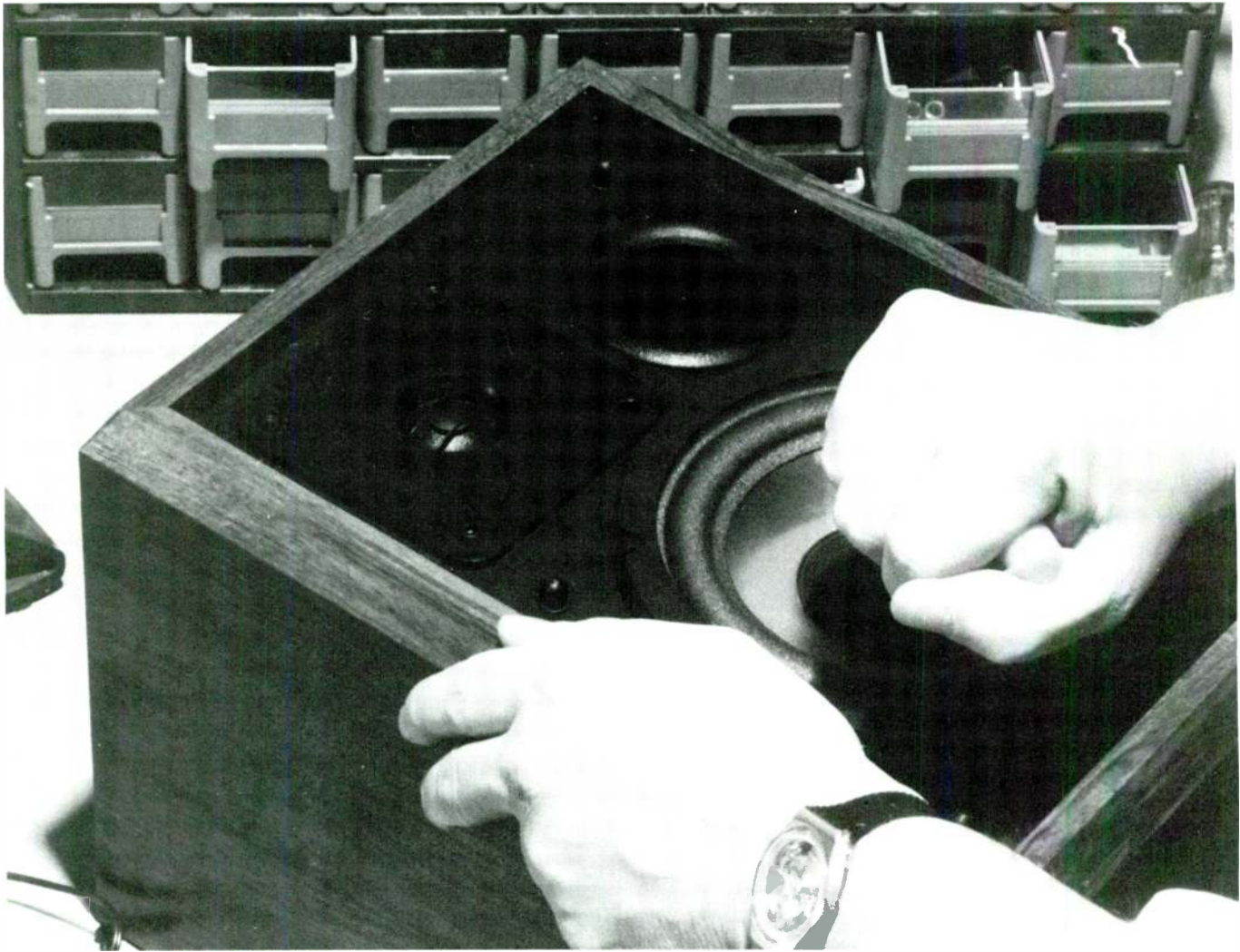

FIGURE 6: Cone excursions at 20W input for the systems in Figure 5.



Innovative components for creative hands.

Whether you're the weekend hobbyist or the serious installer, you know where the sound comes from. Speaker builders all over the world are choosing MTX drivers and components because they mean better sound for your money. Consistent specs. Superior reliability. From our famous bass drivers, mid-ranges and tweeters to our indestructible grille kits and state of the art crossovers, you can rely on MTX, the most installed speakers in the world.

MTX®

MTX • Makers of the world's best loudspeakers and sound components • Winslow, IL
The Mitek Group • One Mitek Plaza • Winslow, IL 61089 • 815/367-3000

Fast Reply #KE186

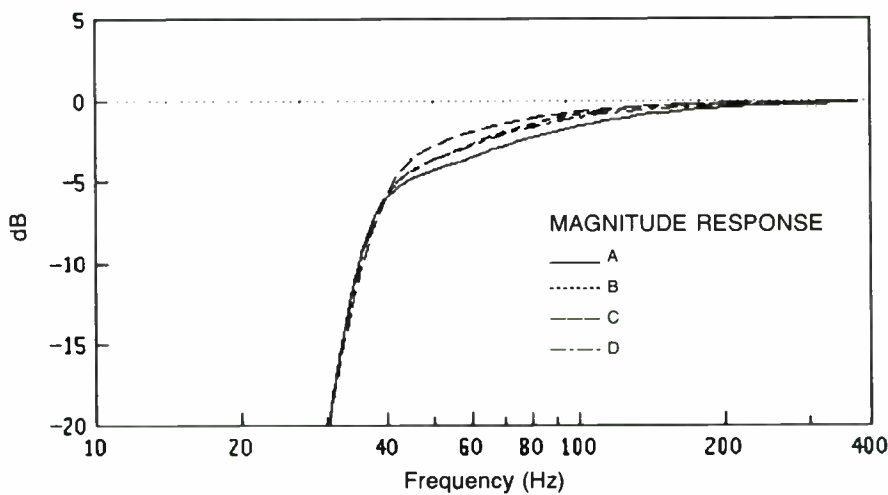

FIGURE 7: Figure 1 system with various loss distributions. See text for details.

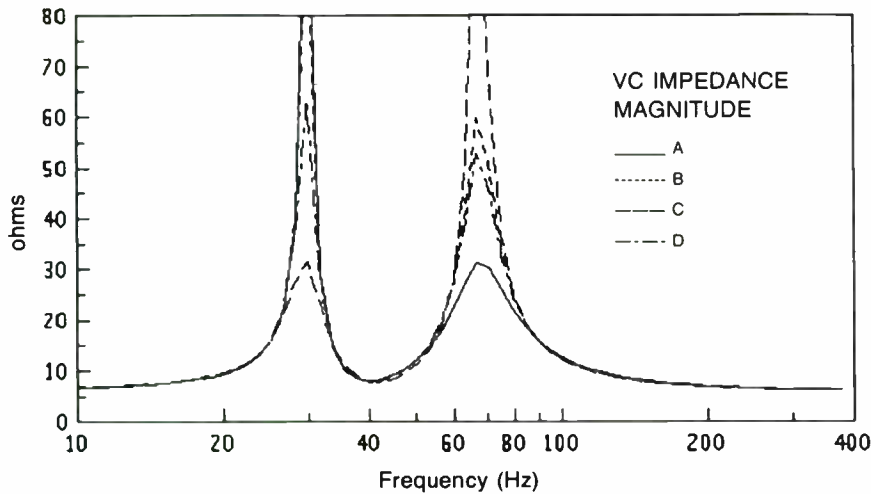

FIGURE 8: Same systems as in Figure 7, but showing voice-coil impedance magnitude.

Continued from page 30

is a representation of a loss at a particular frequency. Small identified three potential losses for vented-boxes and passive-radiators: Q_A related to the box lining or stuffing, Q_L related to air leakage from the box, and Q_P related to the vent or passive-radiator. In his work he always referred these Q numbers to the resonant frequency f_B . The problem with this is that f_B is usually a variable in design so that these quantities would have to be recalculated with every system change. To avoid this problem I introduced Q_{AS} , Q_{LS} , Q_{PS} , which are the three Qs related to the driver resonant frequency. This change also allows Q_{AS} and Q_{LS} to apply to closed-boxes where Q_A and Q_L are undefined.

You can convert from Q_A , Q_L , Q_P to Q_{AS} , Q_{LS} , Q_{PS} in passive-radiator and vented-box systems with the following formulas:

$$\begin{aligned} Q_L &= hQ_{LS} \\ Q_{AS} &= hQ_A \\ Q_{PS} &= hQ_P \end{aligned}$$

where h is the Thiele/Small parameter: $h = f_B/f_S$. The quantities Q_A , Q_L and Q_P are not defined for closed-boxes. For most reasonable systems, h is close enough to 1 so that differences between the two Q sets are negligible. Thus, in the discussion I will use the two sets interchangeably.

As you will recall, when you measure system loss in a vented-box, all you really measure is a single quantity called Q_B defined by

$$1/Q_B = 1/Q_A + 1/Q_L + 1/Q_P \quad (Q-EQ)$$

It is usually assumed that Q_A and Q_P are very large for vented-boxes so that Q_B and Q_L are approximately equal. Thus, when you say $Q_L = 7$ for a vented-box, this really means $Q_B = 7$, and box absorption and vent/PR losses are negligible.

To say that a loss is negligible means that it could be removed from the model without significantly changing the model responses. This can be accomplished

theoretically by setting the particular negligible loss to the value ∞ . This can be done in the program by entering the largest possible value: 99999.9. The program recognizes this as a signal to delete that particular loss, and it will replace the number in the loss window with ∞ . For example, if you entered $Q_{AS} = 99999.9$ and $Q_P = 99999.9$ then the program would show $Q_{AS} = \infty$ and $Q_{PS} = \infty$. With these values you are working with Small's original model. Most alignment tables are based on his model, so if you are starting with a table alignment, this loss setting should give you a response based on Small's model. You could then compare it with responses using other values of Q_{AS} and Q_{PS} . This would give you some idea of how the actual response might vary from the intended one. When you do this remember that the value you use for Q_{LS} in Small's alignments is really Q_{BS} , so when you change the other Qs make sure that Q_{BS} stays the same by requiring that the equation $(Q-EQ)$ is always satisfied.

The formula $(Q-EQ)$ for Q_B also applies to passive-radiator systems. In this case, Q_A is usually assumed to be negligible. So, a measured Q_B consists of contributions from both Q_P and Q_L . Small [2, p. 600] addresses the question of how to measure Q_B for a passive-radiator, as well as how to allot the measured value between Q_L and Q_P . His recommendation is to allot about 30-40% of the value of Q_B to Q_L and the remainder to Q_P . It is possible that you may know a value for the mechanical Q of the passive radiator, Q_{MP} . If so, then you can get a reasonable value for Q_{PS} with

$$Q_{PS} = (f_S/f_P) Q_{MP}$$

The advantage of having Q_{AS} and Q_{LS} available for closed-boxes is not as clear as it is for vented-boxes and passive-radiators. The main reason is that closed-boxes are usually *filled*, while the others are *lined*. This probably makes Q_{LS} negligible and only Q_{AS} really matters. But there is a further complication because of the filling. As the amount of filling material increases, the air compressions in the box move from adiabatic to isothermal. This causes the net acoustic compliance of the box to increase and this tends to counteract the resistive loss. For the details of this mechanism⁶

When using the model for a closed-box it is probably best to set $Q_{LS} = \infty$ and work only with Q_{AS} . As you decrease Q_{AS} you may also want to increase V_B to

Continued on page 34

THE REALLY BIG SALE!

Some of you were very disappointed when you called too late for our "Hot Summer Sale" and heard the words "SOLD OUT"! A few of you were downright ANGRY! Don't let it happen to you AGAIN! Jump on our REALLY BIG SALE NOW!

**Quantities are limited, when these BIG speakers are gone, they're gone!*

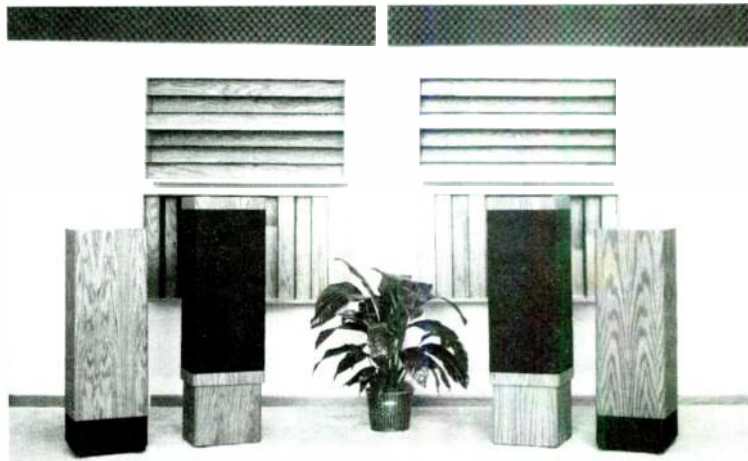

Choose the Sapphire, (pictured with Saturn subs), BIG brother to the Sapphire II which is highly recommended by Gary Galo in this issue of Speaker Builder. Regular price for full kit pair is \$999 plus \$99 for the pedestals. Only 30 pair of unfinished oak are left and will be sold at \$799 including the pedestals! Add \$50 for shipping.

Save BIG on Saturn subwoofers with four piece modular crossover for adding to the Sapphire or Sapphire II. The Saturn is by far the lowest priced subwoofer on Stereophile's recommended list. The regular price is \$899 but it's on sale now for only \$699 if purchased with Sapphires.

Save BIGGEST on the *Premier System One* which includes satellites, stands, outboard passive crossovers, and dual woofer modules. Expect superb definition, imaging and clarity. The compact, attractive woofer modules are designed to be "tucked away" and used as end tables. Thousands heard and loved the *Premier System One* at the New York High-End Hi-Fi show last April. Save \$700 by building the limited edition full kits! Clear lacquered oak full kit \$1199 plus \$60 shipping, black lacquered oak for \$1299 plus \$60 shipping. Super BIG savings!

Continued BIG savings on the G2R, the classic 10" 3-way speaker which was well reviewed in High Fidelity. Regularly sold at \$499 a pair full kit walnut or oak, we put this speaker on sale in the last issue of Speaker Builder for only \$399 plus \$45 shipping. Sales have been so great we've decided to continue the offer for you smart Speaker Builder subscribers until February 15. BIG, BIG, BIG!!!

*The purpose of this sale is to create much needed warehouse/production space. We reserve the right to end sale pricing when stocking levels are sufficiently reduced. Our 30 Day money-back guarantee applies to all the above, but at these low prices buyer is liable for all shipping charges if the speakers are returned.

Call 608-784-4570 for assistance in choosing which Audio Concepts, Inc. speaker kit to purchase. Or call 1-800-346-9183 to place your order or request our latest literature.

AUDIO CONCEPTS, INC.

901 S. 4th St. La Crosse, WI 54601 FAX: 608-784-6367

Fast Reply #KE1344

| DATA ENTRY | | | | |
|--|-------------------------|---------------------------------|--------------------------------|--------------------------------|
| Driver | Type | Losses | Box | Hp eq Order = 2 Eqdata |
| ID: JBL 2235H fS = 23.0 Hz VAS = 340.0 l QES = 0.350 QMS = 1.182 RE = 6.30 Ω SD = 880.0 cm ² PE = 300.0 W xmx = 8.50 mm | Pr »Vented Closed | QAS = ∞ QLS = 7.0 QPS = ∞ | VB = 102.09 l fB = 24.64 Hz | Cnr = 29.98 Hz Dmp = 0.6007 |
| V/pr | | Keep Recall Plot pr Scr | Info | tMp&pr |
| VENT DIAM: 7.62 cm | | T = 21.0 °C P = 750 mm Hg | | |
| Quit | | | | |

| MISCELLANEOUS PARAMETERS | | |
|--|---|-----------------------------------|
| DRIVER | BOX | SYSTEM |
| CMS = 0.31 mm/N MMS = 152.5 g RMS = 18.64 kg/s | B1 = 19.92 Tm VL = 16.47 cm QBS = 7.0 f3B = 47.14 Hz | f3S = 29.94 Hz Box & Equalizer |
| Sns = 92.7 dB QTS = 0.2700 | | |

FIGURE 9: Initial parameters for JBL 2235H based system.

| DATA ENTRY | | | | |
|--|-------------------------|--|--------------------------------|--------------------------------|
| Driver | Type | Losses | Box | Hp eq Order = 2 Eqdata |
| ID: JBL 2235H fS = 23.0 Hz VAS = 340.0 l QES = 0.350 QMS = 1.182 RE = 6.30 Ω SD = 880.0 cm ² PE = 300.0 W xmx = 8.50 mm | Pr »Vented Closed | QAS = 28.0 QLS = 14.0 QPS = 28.0 | VB = 120.00 l fB = 25.00 Hz | Cnr = 30.00 Hz Dmp = 0.6000 |
| V/pr | | Keep Recall Plot pr Scr | Info | tMp&pr |
| VENT DIAM: 10.78 cm | | T = 21.0 °C P = 750 mm Hg | | |
| Quit | | | | |

| MISCELLANEOUS PARAMETERS | | |
|--|---|-----------------------------------|
| DRIVER | BOX | SYSTEM |
| CMS = 0.31 mm/N MMS = 152.5 g RMS = 18.64 kg/s | B1 = 19.92 Tm VL = 28.57 cm QBS = 7.0 f3B = 47.50 Hz | f3S = 28.76 Hz Box & Equalizer |
| Sns = 92.7 dB QTS = 0.2700 | | |

FIGURE 10: Minor parameter adjustment of JBL based system.

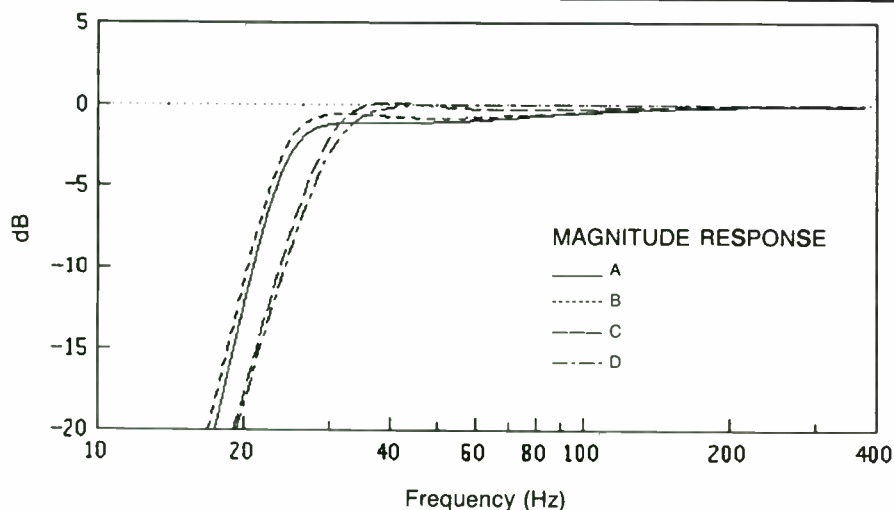

FIGURE 11: Small-signal responses of various JBL based systems described in text.

Continued from page 32

mimic the behavior just described. When you are satisfied that what you have is reasonable, you may want to assign a finite value to Q_{LS} to see how

an unintended system leak would alter the response.

One final comment on closed-boxes. The use of a Dynaudio variovent is ad-

vocated by some as a good loading method. I believe you can model such a system as a closed-box with a finite value of Q_{LS} chosen to represent the variovent. I have not experimented with this to verify it, but I would be interested in hearing from anyone who does.

The real advantage of having separate Q_s in this model is that you can allocate the total loss to three separate sources in various ways and see how much this changes system response. The default values for these three quantities in BOX-MODEL are $Q_{AS} = 28$, $Q_{LS} = 14$, $Q_{PS} = 28$. This gives a total loss Q of $Q_B = 7$, the standard assumption. However, if you have more than the usual stuffing in your box and you believe the box is quite air tight, then you may want to assign $Q_{AS} = 14$, $Q_{LS} = 28$ and $Q_{PS} = 28$. (Note that the higher the Q number, the less loss it represents.) This still gives $Q_B = 7$, but with more of the loss in the box lining rather than the box leakage. In this way you can investigate various scenarios and see how much your system response might vary from your intended response.

III. EXAMPLES. Now that you know something about the operation of BOX-MODEL, I would like to present some examples illustrating ways the program might be used.

DIFFERENT BOXES. Lets use the parameters given in Fig. 1 and make (B) a closed-box and (C) a vented-box. Also, lets take (A) to be the same closed-box with an equalizer with $Cnr = 42\text{Hz}$ and $Dmp = 0.44$. The small-signal responses are shown in Fig. 5. As you might expect, the simple closed-box has the poorest low frequency response. But the equalized closed-box has the best! Even so, it may not be the best choice. To see why, lets look at the cone excursions at 20 watts input shown in Fig. 6. The excursions of the equalized closed-box (A) are much greater than in the other two systems and exceed the linear limit x_{mx} by a fair margin over a wide band of frequencies around 40Hz. Thus, it is more likely to produce audible distortion in this band. For a commercial system, I would tend to steer clear of it because it would be easier to damage the woofer.

When you plan to use an equalizer to shape the response of your woofer, I suggest you keep close watch on the excursion requirements it imposes. If you use a high Q filter, it is quite possible that you may wind up driving the woofer

Continued on page 36

Here are three fine quality products exclusively brought to you by Kimon Bellas. We are not talking "magic". The only reason these products have been selected is simply that for a minimum expense they will allow you to clearly improve the sonic quality of your system. Attention to details often pays off many times.

These products are in stock at the following distributors:

Big Cove Research 105 Catherine Drive, Owens Cross Road, AL 35763 Tel: (205) 881-8677

Speakers Etc... 1828 W. Peoria, Phoenix, AZ 85029 Tel: (602) 944-1878

Watters Sound Wave Co. 4320 Spring Valley, Dallas, TX 75244 Tel: (214) 991-6994 Fax: (214) 991-5016

Zalytron Industries Corp. 469 Jericho Turnpike, Mineola, NY 11501 Tel: (516) 747-3515 Fax: (516) 294-1943

OEMs: for quantity orders, please contact directly Focal America, Inc. at (818) 707-1629 or Fax: (818) 991-3072



SCR metallized polypropylene capacitors self-healing, non inductive and moistproof, these capacitors represent an exceptional value

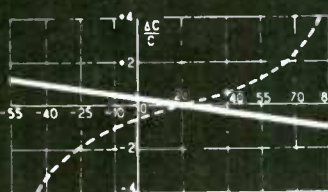

Variation of capacitance vs temp.(C)

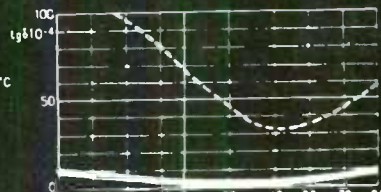

Loss angle Tg vs temp (C)

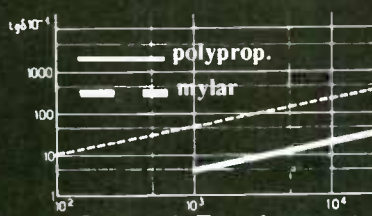

Loss angle Tg vs freq.

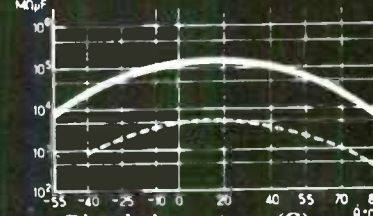

Insulation vs temp (C)

400 VAC/630VDC reinforced metal. polypropylene (tested at 1,000 VAC).

Faster rise time than lower voltage caps.

Ideally suited for X-overs as well as electronics.

5% precision

Ultra compact winding (stronger high voltage film allows a higher tension winding than lower voltage film) reduces microphonics. Polyurethane filled core and encapsulation.

Thick PVC heat shrunk envelope (not tape wrap).

14 AWG Teflon damped silver coated pure copper leads.

Dissipation factor at 20 C. 1 KHz : from .1 microF to 20 microF : Tg < 12. 10⁻⁴.

| value | Diuameter | Length | retail | \$ | | \$ | | \$ | | \$ | |
|-------|-----------|--------|--------|-----|-------|-------|------|--------------------------------|-------|------|------|
| 010 | | | 1.45 | 3.0 | .875 | 1.125 | 2.38 | 10.0 | 1.375 | 1.75 | 4.27 |
| 0.22 | | | 1.48 | 3.9 | .937 | 1.5 | 2.67 | 12.0 | 1.375 | 2.5 | 4.83 |
| 0.33 | | | 1.53 | 4.7 | 1.0 | 1.5 | 2.86 | 15.0 | 1.375 | 2.5 | 5.49 |
| 0.47 | | | 1.58 | 5.6 | 1.0 | 1.625 | 3.06 | 20.0 | 1.5 | 2.5 | 6.10 |
| 1.0 | .625 | .875 | 1.94 | 6.8 | 1.0 | 1.75 | 3.37 | Any special value upon request | | | |
| 2.0 | .75 | 1.125 | 2.16 | 8.0 | 1.125 | 1.75 | 3.74 | | | | |

l'atelier audio

Precision machined spikes and inserts. A clever universal system to control and drastically reduce unwanted floor coupling.

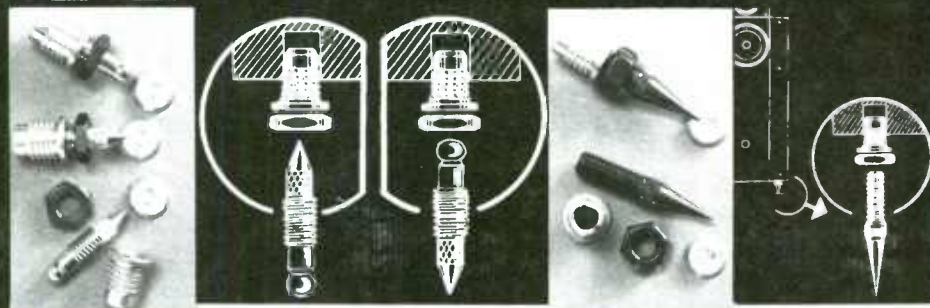

Part in bulk suggested retail per part

| | |
|---|------|
| Solid brass insert (hole diam.: 10mm = 3/8) (hole depth: 14mm = 9/16) | 1.40 |
| Black steel nut (8mm = 5/16) | 0.15 |
| Black steel single spike (8mm X 43mm)=(5/16 X 1.11/16) | 1.25 |
| Chrome steel double spike (8mm X 30mm)=(5/16 X 1.3/16) | 1.85 |
| Solid brass protector (diam. 13mm = 1/2) | 0.85 |



FOCAL

Polished brass binding posts. Accept RCA plug or up to 4 AWG naked wire. Shaft is long enough for 3/4 in. wall thickness. Suggested retail per piece in bulk: \$ 4.25

| DATA ENTRY | | | | |
|--|------------------------|--|--------------------------------|--|
| Driver | Type | Losses | Box | Hp eq Order = 3 Eqdata |
| ID: JBL 2235H fS = 23.0 Hz VAS = 340.0 l QES = 0.350 QMS = 1.182 RE = 6.30 Ω SD = 880.0 cm ² PE = 300.0 W xmx = 8.50 mm | Pr Vented Closed | QAS = 28.0 QLS = 14.0 QPS = 28.0 | VB = 120.00 l fB = 25.00 Hz | Cr1 = 12.00 Hz Cr2 = 24.00 Hz Dmp = 0.4500 |
| V/pr | | Keep Recall Plot pr Scr | Info | tMp&pr |
| VENT DIAM: 12.70 cm | | T = 21.0 °C P = 750 mm Hg | | |
| Quit | | | | |

| MISCELLANEOUS PARAMETERS | | |
|--|---|-----------------------------------|
| DRIVER | BOX | SYSTEM |
| CMS = 0.31 mm/N MMS = 152.5 g RMS = 18.64 kg/s | B1 = 19.92 Tm VL = 41.31 cm QBS = 7.0 f3B = 47.50 Hz | f3S = 24.95 Hz Box & Equalizer |
| Sns = 92.7 dB QTS = 0.2700 | | |

FIGURE 12: Final parameter settings for JBL system.

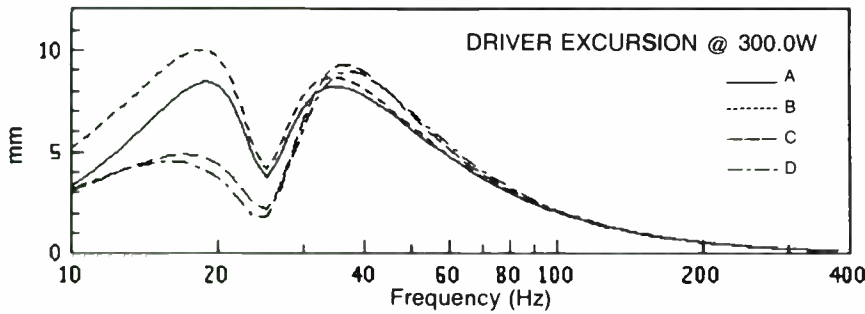

FIGURE 13: Cone excursions for JBL systems.

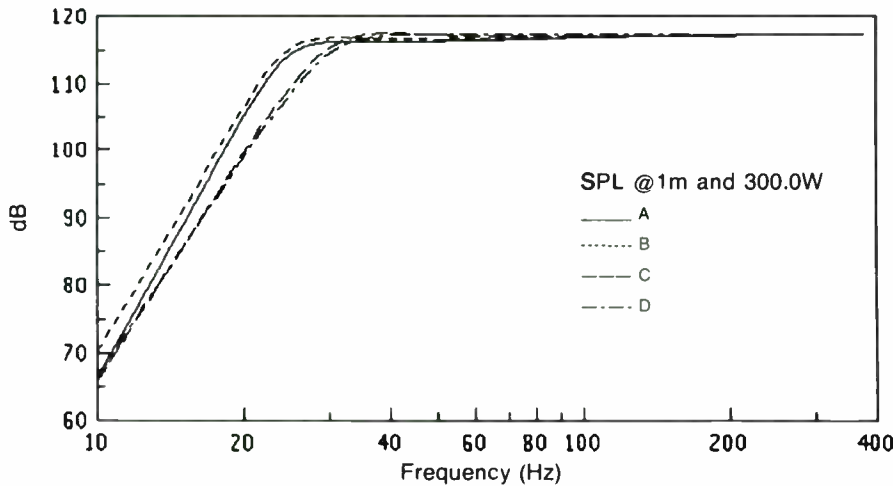

FIGURE 14: Maximum SPL graphs for JBL systems.

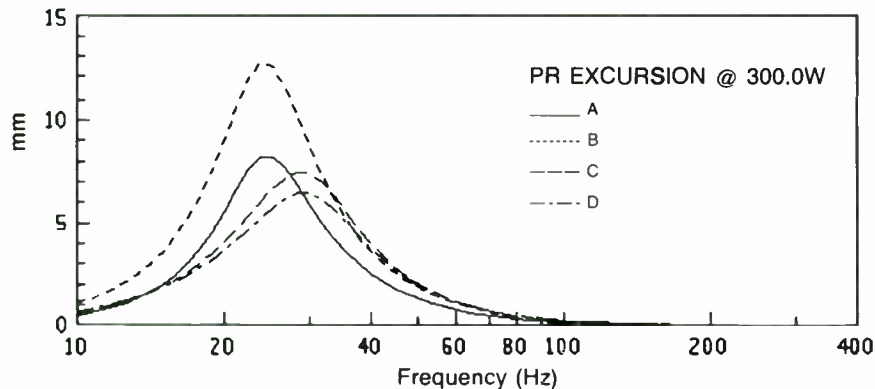

FIGURE 15: Vent air speeds graphs for JBL systems.

Continued from page 34

hard enough to damage it without even realizing it.

EFFECT OF LOSSES. Let's take the passive radiator as defined in Fig. 1 but with $Q_{AS} = 20$, $Q_{LS} = 10$ and $Q_{PS} = 20$ as the basic system and call it (D). Note that $Q_{BS} = 5$. Now compare it with the three possible systems in which all the loss is concentrated in one Q , keeping $Q_{BS} = 5$. In particular, let $Q_{AS} = 5$, $Q_{LS} = \infty$, $Q_{PS} = \infty$ be (A); $Q_{AS} = \infty$, $Q_{LS} = 5$, $Q_{PS} = \infty$ be (B); and $Q_{AS} = \infty$, $Q_{LS} = \infty$, $Q_{PS} = 5$ be (C). The response graphs are shown in Fig. 7. Notice first that these variations in loss assignment have only a small effect on overall response. Also, the response of the basic system all but coincides with that of the system where all the loss is concentrated in Q_{LS} . Small⁷ remarked that this is generally true and is one of the reasons he chose to ignore Q_{AS} and Q_{PS} .

This information can also be interpreted in another way for purposes of verifying a system. Suppose the parameters above are those of a system you have measured with $Q_L = 5$. Then Fig. 7 indicates that the model predicted response of your system is somewhere between the two extreme curves in that figure. So, you can set some sort of tolerance on the response due to variations in system loss distribution.

The graphs of the voice-coil impedances for these systems in Fig. 8 are also of interest. Notice that in system (A), where the loss is concentrated in Q_{AS} , the high-frequency impedance peak is quite short, as is the low-frequency peak

REFERENCES

1. R. M. Bullock, III and White, B., "BOX-RESPONSE, An Apple Program for the Thiele/Small Models," *Speaker Builder*, p. 13, Issue 1, 1984.
2. R. H. Small, Passive-Radiator Loudspeaker Systems Part I: Analysis," *J. Audio Eng. Soc.*, vol. 22, p. 592, 1974.
3. R. M. Bullock, III, "A Unified Model for Closed-Boxes, Vented-Boxes and Passive-Radiators with Losses," presented at the 87th Convention of the Audio Engineering Society, October, 1989.
4. R. M. Bullock, III, "Thiele, Small, and Vented Loudspeaker Design," *Speaker Builder Magazine*, Issue 4, 1980 and Issues 1, 2, 3, 1981.
5. G. R. Koonce, "Finding fP for Passive-Radiator Speakers," *Speaker Builder*, p. 25, Issue 4, 1981.
6. R. H. Small, "Closed-Box Loudspeaker Systems Part I: Analysis," *J. Audio Eng. Soc.*, vol. 20, p. 798, 1972.
7. R. H. Small, "Vented-Box Loudspeaker Systems Part I: Small-Signal Analysis," *J. Audio Eng. Soc.*, vol. 21, p. 363, 1973.

in system (C), where the loss is concentrated in Q_{ps} . This looks like it could be a signal that absorption loss or passive-radiator loss is dominant. It could also possibly indicate a physical problem in the system. For example, there may be an excess of filling material or a mechanical impediment to the free motion of a passive-radiator.

WOOFER DESIGN. Figure 9 shows the parameters for a JBL 2235H driver for possible use in a vented subwoofer. By subwoofer I mean a system with as much high-output low-frequency-extension as possible. For this reason, I started with a sixth-order quasi-Butterworth Type 1 alignment with $Q_L = 7$. The relevant parameters are listed in the figure.

This system is kept as D. Next, I rounded off the box and equalizer parameters and distributed the losses differently. Also, I increased the box volume to make the vent easier to design. The result of these changes is listed in Fig. 10 and kept as system C. The response curves of these two systems can be seen in Fig. 11. As you will note, the small changes made do not substantially alter the response.

Next, I started lowering the equalizer corner and damping until $f_2 = 24\text{Hz}$ and $Dmp = 0.45$. This configuration is kept as system B. I now have a system f_3 of about 24Hz. The final change is to go to a third-order equalizer by adding a first-order corner at 12Hz. This configuration is system A and its complete parameter set is shown in Fig. 12. The

reason for this last change can be found by looking at the cone excursion curves at 300W input in Fig. 13. The excursion of system B exceeds X_{MAX} at very low frequencies. The additional filter section pulls the excursions back below X_{MAX} at all frequencies as graph A in Fig. 13 shows. The small-signal response of systems A and B are shown in Fig. 11. The graphs of maximum SPL at 300W in Fig. 14 show that system A should be capable of about 115dB at 25Hz without exceeding its X_{MAX} at any frequency! System B excursions would have exceeded X_{MAX} in order to play equally loudly.

The only remaining problem can be seen in Fig. 15 where system B using twin 3" vent tubes has a vent air speed

Continued on page 87

SPEAKER COMPONENTS

CROSSOVER COMPONENTS

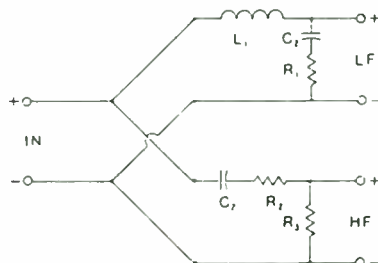
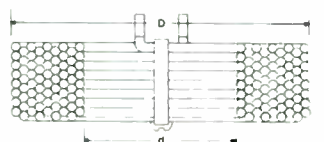
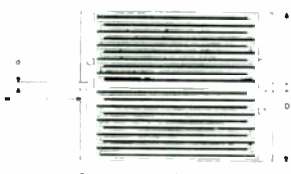

FAST CAPACITORS

Metallized Polypropylene (Non-Polarized)
Values from 1.0 mfd to 200 mfd.
Voltage Rating: 250 VDC / 150 VAC

SOLEN INDUCTORS

Perfect Lay Hexagonal Winding Air Cored
Values from .10 mH to 30 mH,
Wire Sizes from #20 AWG to #10 AWG

HEPTA-LITZ INDUCTORS

Seven Strands Litz-Wire Constructions
Values from .10 mH to 30 mH
Wire sizes from #16 AWG to #12 AWG

SOLEN CROSSOVERS

Custom Computer Design
Passive Crossover for Professional, Hi-Fi and Car Hi-Fi, Power up to 1000 Watt.

CROSSOVER, SPEAKER PARTS

Gold Speaker Terminals, Gold Banana Plugs
Gold Binding Posts, Crossover Terminals,
Power Resistors, Mylar Capacitors,
Plastic Grill Fasteners, Nylon Ty-Wraps
Grill Cloth, Car Speaker Grills, Misc. Parts.



SOLEN INC.
4470 Thibault Ave.
St-Hubert, QC J3Y 7T9
Canada
Tel.: (514) 656-2759
Fax: (514) 443-4949

COMPUTER AIDED DESIGN FOR ENCLOSURE AND CROSSOVER AVAILABLE TO CUSTOMER

Product specifications and prices available upon request.

Fast Reply #KE1063

FOUR EIGHT BY TWOS

BY THOMAS NOUSAINE



PHOTO 1: Finished system, installed without grille.

When my friend LeRoy Murphy asked me to help him design a speaker system for his home, I'd heard it all before. It had to go "here," it could only be "so big," it had to sound great but he "couldn't spend more than \$300," and can you top this, it had to "match his birch furniture." Sound familiar? Murphy wanted an 8" two-way system with good sound, reasonable cost, and manageable size. State of the art? No way. The 8 x 2 format does, however, offer an excellent compromise on size, performance, and cost. The blue plate special on the luncheon menu!

ABOUT THE AUTHOR

Tom Nousaine is director of Capital Recovery for Ameritech in Chicago. He has worked in telecommunications for nearly 20 years. He is also a contributing editor to Car Stereo Review, writes product reviews for The Sensible Sound, and is secretary of the Chicago AES. He has been active in loudspeaker design and construction since joining SMWTMS and subscribing to TAA in the mid 1970s.

Commercial two-way designs with 8" woofers are popular, and with good reason. They offer true 50Hz low-end potential in a 1-2 ft³ box, and excellent price to performance ratios. An 8" woofer is the smallest size which can deliver good, believable bottom end. Sorry, I don't believe 6" woofer systems can deliver adequate loudness without high distortion at frequencies below 80Hz.

An 8 x 2's economics are great because few parts and minimal materials are needed. Only two drivers, woofer and tweeter, and one crossover per side are required. The reasonably-sized cabinets mean a pair usually can be cut from a single piece of 8 x 4 ft. stock, and a maximum of 30 ft² of veneer or plastic laminate will cover an enclosure's six sides. A 1-2 ft³ box easily can be slipped inside the UPS size limit. It's no wonder so many commercial systems use this format.

Of course we all know there are short-

comings. So what's the price of an 8 x 2? An 8" driver cannot provide true subwoofer performance. All you can expect is 40-50Hz low-end at best. On the other hand, 50Hz is usually as much as most people need or want. Upgrading to full bandwidth (20Hz-20kHz) is easy, however, with a separate subwoofer.

Other compromises are required with this format as well. Most tweeters cannot handle much power below 2.5kHz. When used above 1kHz or so, most woofers exhibit narrowing dispersion and a frequency response peak. Therefore, a typical 8 x 2 will have a 3kHz crossover, a pinched dispersion pattern above 1kHz, and a nasty frequency response peak somewhere around 2kHz. Commercial designs often ignore this peak. It requires a passive equalization network to fix it, adding to the parts count and cost.

MURPHY'S SYSTEM. I tried to capitalize on the format advantages and *minimize* the disadvantages while working inside the allotted speakers' 11½" x 12" x 25" bookshelf space. I've had plenty of firsthand experience building 8" two-way speakers, and felt the thrill of great sounding, simple to build, and economical home-brew systems so I knew we had a good chance for success. I will outline the Murphy system from start to finish, however, I've listed important parameters for three other successful 8" two-way systems in *Table 1*. They all work well, providing a good spread of box styles, drivers, and performance options available to the home builder.

A great 8 x 2 begins with a large diameter tweeter, which can be crossed over at 2kHz to avoid as much of the woofer response peak as possible. The SEAS H297 1¼" soft dome tweeter fits the bill. The tweeter was crossed over to an exceptional Carbonneau 8" (29-905) al-

TABLE 1

8" TWO-WAYS: SEVERAL GOOD ALTERNATIVES

| | RS-1 | RS-2 | LG-1 | Murphy 1.1 |
|----------------------|---------------------------|--------------------------------|---------------------|----------------------|
| Woofers | KEF B200 SP1054 | KEF B200 SP1039 | Peerless TD205R | Carbonneau 29-905 |
| Tweeter | Polydax HD10025 | Polydax HD10025 | Morel MDT28 | SEAS H297 |
| Crossover | KEF 104aB | Custom | Custom | Bigfoot |
| High-pass | 3-pole 3kHz | 3-pole 3.1kHz | 3-pole 2.85kHz | 3-pole 2.1kHz |
| Low-pass | 2-pole | 3-pole | 3-pole | 3-pole |
| Notch Filter | 2kHz | 2kHz | 2kHz | none |
| Cabinet | | | | |
| Style | Ported QB ₃ | Sealed w/EQ | Ported w/ripple | Ported B4 |
| V _B | 1 ft ³ | 1 ft ³ | 1.4 ft ³ | 1.05 ft ³ |
| F _B | 41Hz | 48Hz | 42Hz | 40Hz |
| F ₃ (est) | 48Hz | 40Hz | 47Hz | 40Hz |
| F ₃ (act) | 50Hz | 40Hz | 50Hz | 45Hz |
| | | Bass EQ + 6dB 40Hz | | |
| Stuffing | no | 1 lb. polyester fiberfil | no | no |

ready on hand, and mostly free of the above-1kHz response peak I've found in all other 8" drivers.

I also used a Madisound Bigfoot 3-pole 2kHz passive filter. A word about passive filters: I had been in the habit of brewing my own crossovers for some time. My normal routine included winding my own inductors, making precise capacitor values by paralleling caps, wiring the crossover, hooking the drivers to it, measuring the voltage drive at the speaker terminals and then tweaking the values to get the right slopes.

On my last few projects, however, I purchased Madisound Bigfoot networks built to spec, specifying a slope and turn-over frequency, and telling them which drivers I'd be using. Within a week I receive a completed network which works exactly as specified—and each for \$20 or less. That was a deal I couldn't afford to pass up. Even if the network didn't function exactly as I wanted, they would be easy to tweak and I would be spared the drudgery of winding coils, measuring a bunch of capacitors, and building up a circuit board.

Next we had to choose a bass cabinet alignment which would optimize the system within the enclosure size limitation the bookshelf imposed. This meant the box could have a maximum of 1.05 ft³ internal volume for a ported enclosure, and a 1.4 ft³ equivalent for a stuffed sealed enclosure. Normally I resist ported enclosures tuned above 35Hz because they tend to drone, however with the 8 × 2 format we were going to need all the help we could get below 50Hz. A ported

enclosure gives you added sensitivity at low frequencies. The drawbacks are a bit of hangover with certain alignments, and no driver loading at very low frequencies.

SPECS AND MORE SPECS. We measured the Carbonneau woofer's Thiele/Small characteristics. As expected, they were close but not exactly on spec. Typically, I find woofers to be 10-20% high on free air resonance, even with cruel overnight break-ins, and Q values are usually somewhat higher than specified. There will also be differences between the two drivers which may require different size enclosures. The relationships between Q and resonance for sealed boxes usually calls for the same box size. Ported enclosures may require adjustments. Don't be surprised if your speakers fail to live up to manufacturer specified characteristics.

The Carbonneau woofer's characteristics indicated the B4 alignment was possible with cabinet tuning of 40Hz. I believed the ported enclosure offered the best set of compromises. The sealed enclosure's size we envisioned would have resulted in a high 50-60Hz system resonance, and a relatively high system Q. Neither was acceptable. Table 2 gives the vented/sealed box comparison.

Cabinet layout was also problematic. The space required a horizontal cabinet, but the tweeter couldn't be placed directly above the woofer. We decided to mount the woofer midway in the cabinet, the duct as close as possible to the wall. We mounted the tweeter as high as possible in the cabinet, and mirror imaged to-

ward the inside. This design also afforded vertical speaker placement.

After selecting the basic components, we decided on an MDF enclosure, stained birch wood veneer, dual banana connectors on 3/4" centers, and a swim-suit fabric grille cover held with Velcro hook and loop fasteners. The grille cover frame was cut from 1/4" plywood. The fabric, selected to complement the room decor, was wrapped and stapled to the rear. Select fabric which allows light to pass. If you can see through it, you probably can hear through it.

The following outlines the procedure for designing and building a high-quality 8 × 2 using components selected for the Murphy system. Using this information, plus design tools published in SB, almost anyone can make a high-performance 8 × 2 using drivers specified here or with other drivers and crossover slopes. Nothing is sacred about these designs. They all have worked successfully, but none is perfect.

Step By Step:

1. Decide whether you need an 8 × 2 by answering the following questions:

- Is space a problem?
- Is cost a limiting factor?
- I never listen to organs and cannons?
- Do I plan to upgrade (subwoofer)?

If you answered yes to all these questions, read on. If you answered no to any of these questions consider another design.

TABLE 2

DESIGN OPTIONS: TYPICAL 8" TWO-WAY SYSTEM
(fixed cabinet size)

| Carbonneau | Woofer 1 | Woofer 2 |
|--|----------------------|----------------------|
| Q _{TS} | 0.4 | 0.37 |
| F _S | 40.5 | 39.5 |
| V _{AS} | 1.32 | 1.37 ft ³ |
| Sealed and Stuffed: | | |
| V _B (net) | 1.4 ft ³ | 1.4 ft ³ |
| F _B | 40Hz | 40Hz |
| F ₃ | 56Hz | 56Hz |
| Q _T | 0.57 | 0.52 |
| Ported: Approx. B4 alignment | | |
| V _B (net) | 1.05 ft ³ | 1.05 ft ³ |
| F _B | 40Hz | 40Hz |
| F ₃ | 40Hz | 40Hz |
| F ₃ (measured = approx. 45Hz close mic) | | |

TABLE 3

PANEL CUTS REQUIRED

| | |
|---|-------------------------------------|
| 4 | 10 1/2" × 24" top and bottom panels |
| 4 | 10" × 24" front and back panels |
| 4 | 9" × 10" end inserts |

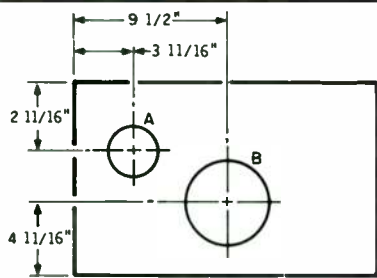

A - TWEETER HOLE = 3 3/8" DIAMETER
 B - WOOFER HOLE = 7 5/16" DIAMETER
 PORT DUCT = 2 1/2" DIAMETER ANYWHERE ON CABINET

FIGURE 1: Murphy system's front panel.

2. Find a good, smooth woofer such as the Carbonneau 29-905. A low F_s (45Hz or lower) is good, Q values from 0.33 to 0.45 are optimal, and an equivalent air compliance of less than 1.5 ft³ is also important if the cabinet must fit in a small place.

3. Search for a tweeter with a low resonance, a relatively large diameter, and good power handling. I like Polydax and Dynaudio tweeters, but most of them cannot be used successfully below 3kHz. I recommend the SEAS H297 1 1/4" dome.

4. Buy your drivers before proceeding. Measure their Thiele-Small parameters, and use a real time analyzer, if you can find one, to check frequency response in free air.

- Select a crossover point and slope that best matches the woofer's high-frequency performance as close to 2kHz as possible, but within the tweeter's power handling capability. For the Carbonneau and SEAS we selected a 3-pole (18dB/octave) 2kHz filter. Table 4 supplies values for all system crossovers except the KEF 104 aB. These are good overall choices, but if you have good measuring equipment you may find slopes which are a better acoustic match for your drivers.

- Select a cabinet topology. Bob Bullock's easy-to-use design tables are an ideal choice.

- Design the cabinet. Remember, your ideal box figure is net for *internal volume*, therefore you must select dimensions accordingly. Add 10% for the woofer structure's volume, internal bracing, and crossover inside the box.

5. Build the enclosure. Table 3 gives panel dimensions for the Murphy system. A lumberyard will cut particle board or 3/4" plywood panels for you. I have had good luck with almost any particle board for these relatively small enclosures. Assemble the cabinets minus the front panel (Fig. 1). Use dry wall

screws, driven in with an electric screwdriver, to hold the panels while the yellow glue dries.

Use stringer, hardwood or pine works well, as a frame around the front opening, spacing it so the front panel will be flush to the sides when completed. Remember to allow clearance for your panel gasket. If you are "resonance wary," use stringer all around the interior joints. Be sure to rub a bead of glue into the joints from the inside to ensure an air-tight seal.

Glue one piece of 1" closet pole, laterally spanning the cabinet's interior, behind the woofer area. Fasten the pole on each side from the outside with a drywall screw. This will add to the structural integrity of the cabinet, and give you a convenient handle for moving the cabinet during finishing.

6. Cut the speaker and duct mounting holes, and attach the drivers to the front panel. Cut a 2" hole in any cabinet panel in which you wish banana connectors mounted. Mount the bananas on a piece of thin hardboard or plywood 3" x 3" square, and this inside the cabinet with glue and drywall screws. Temporarily mount the duct to the front panel with a Mortite seal, making the duct 1 1/2" longer than your calculations indicate.

7. Tune the system using the constant current impedance measurement method. The impedance minimum between the twin bass reflex peaks is the system's resonant frequency. Because the duct was intentionally cut oversize, the box resonance will probably be too low. Trim it by removing about a 1/2" of duct. Remeasure, and keep trimming until you reach the right frequency.



PHOTO 2: Owner Murphy with installed system.

8. Assemble the system for test. Attach the banana jacks and drivers to the crossover with 16-gauge zip cord. Mount the front panel to the cabinet with 1 1/4" dry wall screws spaced about 6" apart, using foam weather strip or Mortite as a gasket.

9. Audition the system in its intended environ. If you have access to an RTA, measure system performance in free air at one meter and at the listening position with the speakers in the normal position. Because the Murphy system was intended for corner wall mounting, and for listening a minimum of 30° off-axis, the tweeter level was set about 6dB higher than the woofer's. Adjust the tweeter level resistor to match your taste and system positioning.

HEAR, HEAR. Listen carefully to the upper midrange/lower treble. If the system sounds shrill, hollow, or blatty try reversing the tweeter's polarity. If the system sounds poor with either polarity, reconcile yourself to a 2kHz notch filter (Fig. 2). If needed, build the notcher in Table 4. Install the filter in series with the speaker outside the cabinet, and ad-

Continued on page 42

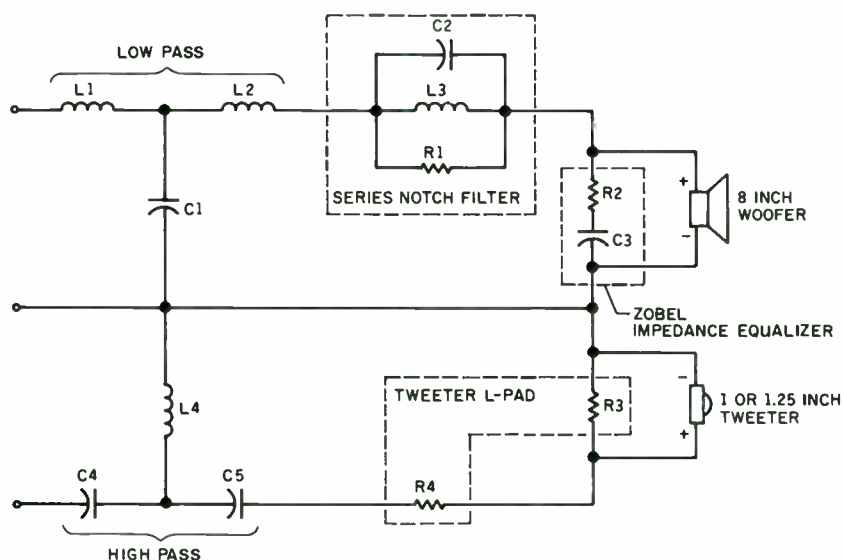

FIGURE 2: Crossover network including a notch filter, Zobel, and tweeter L-pad.

DYNAMIC RESPONSE 15 W-75

DYNAUDIO®



Whenever DYNAUDIO introduces a new type of speaker driver, it is not just an upgrading, but a unique and entirely new construction based on proven DYNAUDIO principles.

The 15 W-75 is a woofer for small 2-way bookshelf systems and satellite enclosures as well as a low/mid in multiway designs.

| | | | | |
|----------------------|--------------------|-----|------|---------|
| | | | 4 Ω | 8 Ω |
| Dia. | 145 mm | Md | 12.7 | 11.6 g |
| Vc | 75 mm | Re | 3.0 | 4.9 Ω |
| Fs | 55 Hz | Bl | 5.37 | 6.50 Tm |
| Sd | 87 cm ² | Qts | 0.33 | 0.34 |
| X _{max} P-P | 5.5 mm | Vas | 7.1 | 7.8 l |

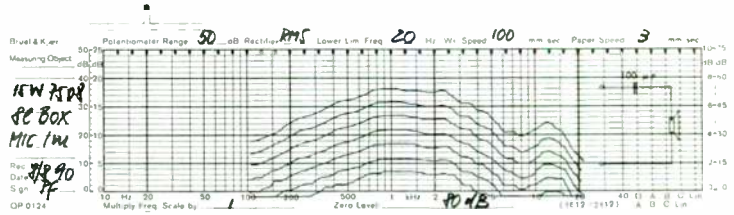

Measured with gating: 10 m/S window

The curves show that input power peaks of even 1,000 watts are reproduced with full dynamics, and no compression is observed

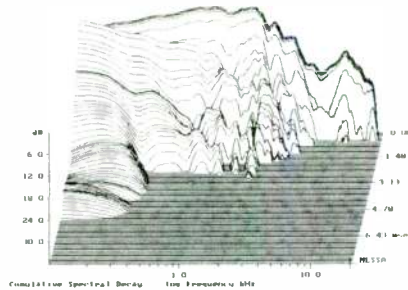

The MLSSA waterfall shows the well controlled behaviour both for time and frequency.

Die cast, PHA-cone, aluminium hexactcoil[®] wire and former.



manufacturer of the most dynamic speakers.

Dynaudio is available from these fine dealers:

Speaker City
10615 Vanowen Street
Burbank CA 91505
(818) 508-1908

Circle Sound
2772 W. Olympic Blvd.
Los Angeles CA 90006
(213) 388-0624

A & S Speakers
3170 23rd Street
San Francisco CA 94110
(415) 641-9228

Solen Electronique
4470 Ave. Thibault
St. Hubert, QC J3Y 719
Canada (514) 656-2759

The Meniscus Group
3275 Gladiola Avenue
Wyoming MI 49509
(616) 534-9121

Madisound Speaker Components
Box 4283
8608 University Green
Madison WI 53703
(608) 831-3433

Audio Concepts
901 S. Fourth St.
La Crosse WI 54601
(608) 784-4570

Fast Reply NKE118



PHOTO 3: Rear view of grille with author.

Continued from page 40

just the Q resistor for a flat response. A larger value sharpens the notch, and a lower value mellows it. Typical values range between 3-10Ω. Be sure to try the reversed polarity if a pleasing balance is elusive.

10. When you are satisfied the system is working correctly, remove the front panel from the enclosure and the drivers from the front panel. If your filter and crossover was mounted outside, place it inside the cabinet now, gluing the components with silicon sealer. Be sure to fix the wires so they won't later rattle. Now you can complete the front enclosure and front panel.

FINISHING TOUCHES. The cabinet should be finished on at least five sides. Purists will want to finish all six, but we finished all except the back. Craft-backed

real wood veneer is available in many varieties, and costs less than Formica laminate. Most veneer can be applied with contact cement. The veneer we used is available in 24" sheets, up to eight feet long.

We "folded" a 24" sheet over the front and top sides, making the speakers appear to be cut from a single sheet of wood. Some Craft-glue-backed veneers can be applied with an iron. We'll describe the contact cement method.

11. Sand all box edges square, filling any small blemishes with spackling compound and then sanding smooth.

12. Apply veneer to the box, cutting it with a razor knife about 1/8-1/16" oversize. Make sure your cuts follow the grain around the box. Spread cement on the veneer back and on the box surface. Carefully join the two surfaces. Bow the veneer slightly so first contact is made in the middle of the cabinet surface. Then roll out both ends so they affix themselves smoothly.

Once applied, use a paint roller to flatten the veneer from the center outward, making sure the edges are firmly glued. If you find bubbles in the middle, slit them with a razor, add some contact cement in through the hole and press the veneer firmly.

Trim both ends of the first piece flush with a router or a razor knife. Trim all other pieces. The joining piece will then be trimmed to a 45° angle. A router with pilot bearing works best. If you trim with a router you may have to use the 600# grit sandpaper to polish the small shiny "track" your router bearing will make on the veneer.

13. Apply finish material to the front panel. I recommend at least part of it be covered with Cushion-All velour contact paper for a soft flocced effect.

14. Finish the cabinet with multiple coats of tung oil finish. Wipe on all coats over a freshly sanded and tacked surface. The surface quality determines the quality of the final coat. Use a soft, lint-free rag to wipe on a *thin* first coat. Let dry, then carefully rub the surface lightly with 600# grit sandpaper using cooking oil as a lubricant. Clean the surface with mineral spirits and wipe dry. Add another coat, and repeat until the finish is satisfactory. We applied nine coats, but I have done up to 15. Even with low-gloss tung oil, the surface will be somewhat glossy after six coats.

Be sure to sand every coat. All drying finish coats will collect dust. If you don't remove the dust the finished surface will have a slightly "dirty" feel to it. We get rid of the dust by gently sanding the sur-

face so the base coat is completely smooth and clean.

If you finish all six sides, you may have to put on a coat, let dry, spin the cabinet, coat the remaining sides, dry, sand and start again. Although this seems like a complicated process, time spent on applying the finish and sanding is really quite brief. The sanding is more like polishing in that little pressure is required and takes little time. Wiping on the finish goes quickly because it results in a very thin coat. The drips and sags which accompany brush applied finishes are absent with the wipe-on method.

On the Murphy system we put dry-wall screws into the front panel stringer

Tweaking Your 8 × 2

Three tuning techniques are often needed in any speaker project. The passive notch filter is a commonly-needed, but often neglected one. The Zobel impedance matching network is very common and used to make sure the woofer has an impedance value at the crossover point, which is of a given value and electrically similar to a resistor.

Finally the L-pad is used to match the tweeter sensitivity to that of the woofer. The final values employed in our four 8" × 2" two-ways will be specified. Values for the RS-1 are not included because the KEF 104aB filter had these circuits built in and I didn't reverse engineer them. Of course, the Murphy system didn't require the notch filter nor did Madisound employ a Zobel.

TABLE 4

COMPARISON OF SYSTEMS

| | RS-2 | LG-1 | Murphy 1.1 |
|--------------------|------|------|------------|
| 2kHz Notch | | | |
| R1 (Ω) | 10 | 3 | N/A |
| C2 (μF) | 10 | 10 | N/A |
| L3 (mH) | 0.67 | 0.67 | |
| Zobel | | | |
| C3 (μF) | 10 | 20 | N/A |
| R2 (Ω) | 10 | 7 | N/A |
| Tweeter Pad | | | |
| R3 (Ω) | 5 | 8 | omit |
| R4 (Ω) | 5 | 4 | 6 |
| Low-pass | | | |
| L1 (mH) | 0.56 | 0.56 | 1.25 |
| L2 (mH) | 0.19 | 0.19 | 0.4 |
| C1 (μF) | 10.1 | 10 | 13.6 |
| High-pass | | | |
| L4 (mH) | 0.22 | 0.22 | 0.35 |
| C4 (μF) | 6.4 | 6.4 | 7.8 |
| C5 (μF) | 19.3 | 19.3 | 15 |

PARTS LIST

MURPHY'S SYSTEM

| | Estimated Cost |
|--------------------------------|------------------------------|
| (2) 8" woofers | \$25-50 each |
| (2) 1 1/4" tweeters | \$13-20 each |
| (1) 4' × 8' sheet MDF | \$45 |
| 25 ft ² veneer | \$2.60 per ft. your junk box |
| drywall screws/staples | |
| yellow glue | |
| walnut stain | |
| 16 oz. Tung Oil finish | \$10 |
| (2) banana jacks | \$2.60 each |
| internal wire | junk box |
| (2) Bigfoot crossovers | \$20 each |
| 4' Cushionall contact paper | \$1.99 per foot |
| 12 oz. cooking oil | kitchen cabinet |
| Mortite rope caulk | on hand |
| 2' 2" PVC | \$1.50 per ft. |
| (2) 13" × 25" 1/4" plywood | on hand |
| assorted 2W dropping resistors | 60¢ each |
| 4' swim suit cloth | \$1.99 per yard |
| Estimated total cost: | \$250-\$320 |

strips and left them sticking out far enough so the cabinet could be placed upside down, resting on the screw heads with no finished surface touching the work surface. Every morning I spent 20 minutes sanding and wiping a new coat on each surface, and repeated this each evening. Thus nine coats were applied in less than a week.

15. After you've achieved the right patina, you're ready to assemble the system. Remount the drivers in the front panel. If you use Cushion-All, you won't need gaskets for the drivers. Otherwise, use silicon glue or foam weather stripping for a sealer-gasket. Glue the duct with silicon glue, and then solder all connections. Attach the front panel with dry wall screws.

PERFORMANCE ANALYSIS. How do these three systems sound? I believe the Murphy is the best overall, followed

TOOLS DESIRED: (Measurement)

signal generator (Heath IG-18 or equivalent)
1 k 2W resistor
VOM, DMM, or equivalent
RTA or Radio Shack SLM
Test CD with pink noise (or noise generator)
Router

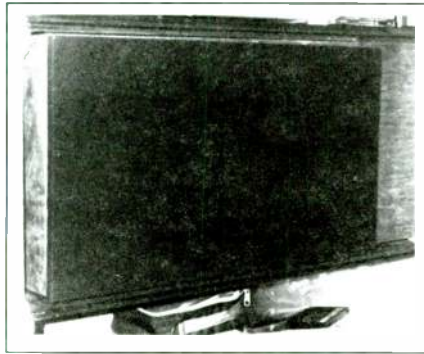

PHOTO 4: Finished system, installed with grille.

by the equalized sealed box. The ported system with the Morel tweeter finishes last but they are all audiophile quality.

The Morel/Peerless LG-1 ported system has a brash character the others lack, possible due to the Morel tweeter, which seems noticeably harsher than the

TOOLS REQUIRED: (Construction)

soldering pencil
table or radial arm saw (unless lumber yard will cut)
sabre, jig, or coping saw
screwdriver (electric preferred)
sandpaper (several sheets medium and #600 grit)
plane or sander

others. The equalized KEF RS-2 system sounds the most "audiophile." This speaker's dispersion narrowing is pronounced, and the dynamic range is the most limited. It gets to be mated to a subwoofer. Eventually we matched it to my "Passively Assisted Woofer System" (SB, 2/89). The RS-1 KEF system has a clean sound, and is relatively sensitive.

The Murphy system, engineered for a specific application, and designed to enhance performance in the crossover region is the best. Clean and open, its imaging is excellent at any reasonable listening position. Dispersion is rather narrow in spite of attempts to improve it, and bass sounds deeper than it really is. The response graphs were taken at 70dB SPL, and the 25Hz bass is not available at really loud levels. It is surprisingly good, and 50Hz can be rendered with authority. Go get 'em. ▶

YOUR MAGIC NUMBER HELPS US ANSWER FASTER

This number, which appears in the upper left corner of your mailing label, is your key to a speedy reply.

Neutrik SpeakOn™ Connectors... safe for sound

A speaker/amplifier interconnect that is virtually indestructible and ensures safe conditions for audio equipment and operators.

Another Neutrik innovation

Neutrik USA, Inc. • 195-S3 Lehigh Ave. • Lakewood, NJ 08701-4527
TEL: 201-901-9488 • FAX: 201-901-9608



DOUBLE DISCOUNT DAYS—SEE ORDER FORM FOR DETAILS!

SALE ENDS JANUARY 13, 1991

KITS • COMPONENTS



What's Included?

Kits include all parts needed to make a functioning circuit, such as circuit boards, semiconductors, resistors and capacitors. Power supplies are not included in most cases. Unlike kits by Heath, Dyna and others, the enclosure, faceplate, knobs, hookup wire, line cord, patch cords and similar parts are not included. Step-by-step instructions usually are not included, but the articles in *Audio Amateur*, *Glass Audio*, and *Speaker Builder* are helpful guides. Article reprints are included with the kits. Our aim is to get you started with the basic parts—some of which are often difficult to find—and let you have the satisfaction and pride of finishing your unit in your own way.

POWER AMPLIFIERS

JOSEPH CURCIO

GK-B1: STEREO-70 MODIFICATION KIT [GA 1:89] Joe has regulated all voltages in his new amp design (except filaments) and drives the outputs with a constant current cascode differential driver, direct coupled to a triode-configured output stage. Field tested for two years in over two dozen sites, the Curcio ST-70 fits within the existing chassis, using the power and output transformers as well as several other parts from the original unit. Old Colony's kit includes boards and all needed parts right down to new mica-filled sockets for the output tubes. All parts are exceptionally high quality and the sound is the best available from the venerable ST-70 chassis. **\$345**

ERNO BORBELY

KP-3A: BORBELY 60W MOSFET AMPLIFIER. [2:82] All parts for one channel (except "L" choke) including board, driver and output heatsinks. **\$90**

KS-1: BORBELY SERVO 100 MOSFET POWER AMP. [1:84] One channel includes all parts, board and output heatsinks. **\$150**

KS-3: BORBELY DC 100 MOSFET POWER AMP. [2:84] One channel includes board, all parts, and output heatsinks. **\$160**

KS-3PA: SERVO 100, DC 100 POWER SUPPLY. [2:84] Two channels, includes two 10 μ F @ 75V caps, one bridge, fuses and one 500VA toroidal transformer. **\$175**

KS-3PB: SERVO 100 or DC 100 MONO POWER SUPPLY. [2:84] One channel with all parts and 225VA toroidal transformer. **\$125**

KS-3TA: SERVO 100, DC 100 TOROIDAL TRANSFORMER, 500VA ONLY. **\$140**

KS-3TB: SERVO 100, DC 100 TOROIDAL TRANSFORMER, 225VA (mono). **\$88**

KS-1M: COMPLETE BORBELY SERVO 100 MONO AMP with KS-3PB POWER SUPPLY. [1:84] Each **\$275** Two or more, Each **\$260**

KS-1S: BORBELY SERVO 100 STEREO AMP with KS-3PA POWER SUPPLY. **\$450**

KS-3M: BORBELY DC 100 MONO AMP with KS-3PB POWER SUPPLY. [2:84] Each **\$285** Two or more, Each **\$270**

JAMES BOAK

KJ-8A: DYNACO MARK III POWER SUPPLY MOD. [1:78] All parts needed to add a solid state regulated power supply to the Dynaco Mark III, including heatsink. The kit also includes all parts necessary to add a balance and adjustable, independent bias control for the Mark III. **\$38**

NELSON PASS

KJ-5-7: CLASS A 40W AMP A40. [4:78] This bipolar design from Nelson Pass of Threshold Corporation is as rugged as it is clean. Kit contains two boards (3" x 3") and all parts for two channels, including eight heatsinks and all parts for one $\pm 44V$ @ 8A [KJ-5-4] stereo power supply. **\$465**
West of Rockies, **\$475**

PASS-CITATION MOD

KM-7: MOSFET CITATION 12 MOSFET MODIFICATION. [2:81] Complete kit, two channel, all parts to modify Harman-Kardon's Citation 12. **\$170**

K. LANG

KV-2S: LANG CLASS A MOSFET POWER AMP. [2:86] A compact 20W per channel design from Germany which utilizes 4 push/pull power MOSFETs. Especially well-suited for multi-amp systems. Kit includes two circuit boards, all parts, two power supplies ($\pm 24V$ @ 100mA; $\pm 15V$ @ 8A) with toroidal transformers and article reprint. Stereo pair. **\$285**

KV-2DM: LANG CLASS A MOSFET POWER AMP. [2:86] Includes two amplifier channels and two each of the input and output power supplies for dual-mono operation (each channel independently powered). **\$350**

WILLIAM Z. JOHNSON

KH-6B: AUDIO RESEARCH ST-70-C3. Modification kit construction booklet. **\$5**

CD PLAYERS

KW-1: MAGNAVOX CD PLAYER MODIFICATION. Improves frequency response. Includes two Signetics NE5535, two Panasonic HF series 330 μ F capacitors and four 3.92k, 1% metal film resistors. **\$12**

KW-2: MODIFICATION. As above, but with two AD-712 op amps in addition to the NE5535s. **\$16**

KX-1A: DISC STABILIZER. Set of 3 Mod Squad Tiptoes, 3 Sorbothane feet and 25 AudioQuest CD Rings. **\$70**

CDR/25: CD RINGS. Set of 25 AudioQuest CD Stabilization Rings with locator. Improves the tracking ability of any CD player. Set **\$25**

KY-1: BEERS' BUDGET CD MOD. [1:89] Kit provides POGGE-4 improvements without additional wiring or circuit boards. Complete parts for assembling amplifier modules and replacing DAC components. Article reprint included. Soldering skills required, not recommended for beginners. **\$95**

CDPV/2 PIERRE VERANY TEST DISCS. More than 100 demo tracks and equipment tests are contained on this 2 CD set. Detailed instruction booklet is included. In addition to list price, please add \$2.25 shipping and handling. Set **\$34**

PREAMPS

JOSEPH CURCIO

KS-6: CURCIO VACUUM TUBE PRE-AMP. [5:84] Contains board, all parts, jacks, tubes & sockets for amplifier/regulator. With master power supply, including board and transformers. No enclosures supplied. **\$135**

KT-1: CURCIO TUBE PRE-AMP. [2:85] Contains board with all parts, bridge, relay & socket, tubes & sockets, heatsinks, and switches. Power supply with transformers included. **\$385**

KV-3: AUTO MUTE. [1:86] Turn-on delay for power amp and speaker protection. **\$18**

ORDER BY FAX OR PHONE 24 HOURS/DAY!

SULZER PREAMP POWER

KL-4A: OP AMP PREAMP VOLTAGE REGULATOR. [2:80] Sulzer $\pm 15V$ regulator, 30mA capacity. All parts and board. Requires $\pm 21V$ filtered DC input. No transformer, filter caps, or rectifier. **\$40**

KL-4B: SULZER RAW DC SUPPLY. Triad F-91X transformer, diodes and two 5,000 μF @ 35V capacitors. Will power two KL-4A supplies. Diagram supplied for construction. **\$60**

KL-4C: SULZER RAW DC SUPPLY. Same as KL-4B but contains ILP $\pm 22V$ toroidal transformer. **\$85**

KL-4D: ILP $\pm 22V$ toroidal transformer only. **\$55**

FILTERS & SPEAKER SAVER

KF-6: 30Hz RUMBLE FILTER. [4:75] Two channel universal filter card supplied with WJ-3 (F-6) circuit board and all basic parts, 1% metal film resistors and 5% MKM capacitors for operation as an 18dB/octave 30Hz rumble filter. Kit may be adapted as two- or three-way single channel crossover with added capacitors and resistors. **\$30**

KH-2: SPEAKER SAVER AND OUTPUT FAULT DETECTOR. [3:77] Two-channel kit provides turn-on and off protection. Fast optocoupler circuitry prevents damage from transients. Additional parts provided offer speaker protection in the event of amplifier failure. Kit includes circuit board, all board-mounted components, power supply parts and article reprint. **\$65**

MIXING AND RECORDING

KF-3: GATELY POWER SUPPLY. Regulated $\pm 18V$, 100mA per side. EG-2 circuit board, all parts, includes transformer and heatsink. **\$52**

CROSSOVERS

For KC-4A choose *ONE* frequency from those listed below. For KC-4B choose *TWO* frequencies from the list. *NO OTHER FREQUENCIES ARE AVAILABLE FOR STOCK KITS.*

60, 120, 240, 480, 960, 1920, 5k or 10kHz.

KC-4A: ELECTRONIC CROSSOVER, KIT A. [2:72] Single channel, two-way. All parts and C-4 circuit board. Includes new LF351 ICs. Suitable supplies include KE-5 and KF-3. **\$14**

KC-4B: ELECTRONIC CROSSOVER, KIT B. [2:72] Single channel, three-way. All parts and C-4 circuit board. Includes new LF351 ICs. **\$18**

KK-6L: WALDRON TUBE CROSSOVER: Low pass. Single channel, 18dB/octave, Butterworth, [3:79] includes three-gang pot, level control, 12AX7 tubes, board and three frequency range determining capacitors. *Specify ONE frequency range per kit please.* (Hz.): 19-210; 43-465; 88-960; 190-2100; 430-4650; 880-9600; 1900-21,000. Single channel **\$60**

KK-6H: WALDRON TUBE CROSSOVER: High pass. Single channel, 18dB/octave, Butterworth, [3:79] includes three-gang pot, level control, 12AX7 tubes and three frequency determining capacitors. Please specify *one* of the frequencies above. No other can be supplied. **\$62**

KK-7: WALDRON TUBF CROSSOVER POWER SUPPLY. [3:79] All parts, including board, transformer, fuse, semiconductors, line cord, capacitors. Will power four tube crossover boards (8 tubes), one stereo bi-amped circuit. **\$110**

SBK-A1: LINKWITZ CROSSOVER/FILTER. *Speaker Builder's* [4:80] first kit, including all parts and board for one channel of the three-way crossover/filter/delay. 24dB/octave at 100Hz and 1.5kHz and 12dB/octave below 30Hz, with delayed woofer turn-on. Board is 5½ x 8½". Requires $\pm 15V$ supply, not included. Use the Sulzer supply KL-4A with KL-4B or KW-3. Per channel **\$75** Two channels **\$140**

SBK-C1A: ELECTRONIC CROSSOVER. [SB 3:82] 30Hz filter adapted as a single channel, two way crossover. Can be 6, 12 or 18dB per octave. Includes WJ-3 (F-6) PC board, 4136 IC, quality parts. Choose frequency of 60, 90, 120, 250, 500, 1k, 2k, 5k or 10k. Power supply required. Can use the KL-4A/4B or KW-3. **\$32**

SBK-C1B: THREE WAY, SINGLE CHANNEL CROSSOVER. [SB 3:82] Contains two each SBK-C1A. Choose high & low frequency. **\$60**

SBK-C1C: TWO CHANNEL, COMMON BASS CROSSOVER. [SB 3:82] Contains two each SBK-C1A. Choose one frequency. **\$64**

AIDS & TEST EQUIPMENT

KE-2: REGULATED POWER SUPPLY. [4:74] $\pm 15V$ @ 1.5A. Lab quality device but excellent for powering system components. Includes board, all board mounted parts plus two LM395K regulators. Transformer and filter caps not included. **\$51**

KE-5: OLD COLONY POWER SUPPLY. $\pm 18V$ @ 55mA balanced, includes all parts, board and transformer. Not regulated. **\$20**

KH-7: PRECISION 101dB ATTENUATOR. [4:77] All switches, 1% metal film resistors to build Gloeckler's prototype. Chassis, input/output jacks not included. **\$65**

KJ-6: CAPACITOR CHECKER. [4:78] All switches, ICs, resistors, 4½" D'Arsonval meter, transformer and PC board to measure capacitance, leakage and insulation. **\$90**

KK-3: THE WARBLER OSCILLATOR. [1:79] Switches, ICs, transformer, and PC board for checking room response and speaker performance without anechoic chamber. **\$70**

KL-3: INVERSE STEREO RIAA NETWORK. [1:80] Two channels, 1% polystyrene caps and metal film resistors, gold jacks, cast aluminum box, solder lugs and alternate 600 or 900 Ω R₂/C₂' components. **\$45**

KL-6: MASTEL TIMERLESS TONE BURST GENERATOR. [2:80] All parts with circuit board. No power supply. **\$24**

KM-3: CARLSTROM/MULLER SORCERER'S APPRENTICE/PAUL BUNYAN. [2,3:81] Includes six boards and all parts including power supplies. No chassis or knobs. Two article reprints. **\$290**

KP-2: TWO TONE INTERMODULATION FILTER. [1:82] All parts, circuit boards, 1% resistors included. **\$26**

SBK-D2: WITTENBREDER AUDIO PULSE GENERATOR. [SB 2:83] All parts, board, and power supply included. **\$80**

SBK-E4: MULLER PINK NOISE GENERATOR. [SB 4:84] All parts, board, 1% MF resistors, capacitors, ICs, and toggle switches included. No battery or enclosure. **\$35**

SYSTEM ACCESSORIES

KC-5: GLOECKLER 23-POSITION LEVEL CONTROL. [2:72] All metal film resistors, shorting rotary switch & two boards for a two channel, 2dB per step attenuator. Choose 10k or 250k Ω . **\$74**

KH-8: MORREY SUPER BUFFER. [4:77] All parts & board for two channel output buffer to isolate tape outputs in your preamp from distortion originating in a turned-off tape recorder. Many uses for this versatile matchmaker. Requires power supply. **\$22**

KM-10A: SWITCHBOX. [2:81] (6½ x 4 x 2") Black with white letters with 5-position DP silver contact, steatite switch, five inputs, and one output with RCA jacks, nickel-plated, and five ground posts. **\$45**

KM-10B: Same as 10A but with 12 gold-plated jacks. **\$55**

KP-5: AUDIO SWEEP MARKER ADDER. [2:82] All parts and circuit board (no power supply) for adding two adjustable markers to a swept audio signal, 20Hz-100kHz. **\$32**

SBK-D1: NEWCOMB PEAK POWER INDICATOR. [SB 1:83] All parts & board. No power supply required. **\$7** Two for **\$11**

SBK-E2: NEWCOMB NEW PEAK POWER INDICATOR. [SB 2:84] All parts & board, new multicolor bar graph display; red, green & yellow LEDs for one channel. No power supply needed. **\$14** Two for **\$22**

BOOKS *from Old Colony Sound Lab*

BUILDER'S GUIDES, general

BKAA-4 KILLER CAR STEREO ON A BUDGET by Dan Ferguson. Now you've got a simple choice when it comes to upgrading your car stereo. Instead of paying a few thousand to a high-end dealer, you can pay only a few hundred. With a good in-dash unit in place, you need only follow author Dan Ferguson's instructions for buying and replacing your front speaker, main speakers, and adding the killer—a subwoofer with enclosure, power amp and crossover. An easy cure for ho-hum auto sound. 1989, 118pp., spiralbound. **\$19.95**

MH-2 HOW TO MAKE PRINTED CIRCUIT BOARDS by Joel Goldberg. All the basics on making your own circuit boards are covered both in theory and in practical advice: design and layout, artwork preparation, photo layout, silk screening, and etching. 1980, 117pp., softbound. **\$8.90**

S-25 ELECTRONIC PROTOTYPE CONSTRUCTION by Stephen D. Kasten. Here's a great book for either the beginner looking to try electronic prototyping for the first time or the expert looking for a handy reference guide. Areas covered include wire wrap and related techniques such as solder pad and perfboard assembly. This book will help you through all the pitfalls of PC board design, and will help you put the project together in an attractive but functional package. 1983, 399pp., softbound. **\$17.95**

S-27 DESIGN OF OP AMP CIRCUITS by Howard Berlin, W3HB. Op amps are a versatile and inexpensive integrated circuit. They can be used for linear amplifiers, differentiators, integrators, voltage and current converters, comparators, rectifiers, oscillators and more. The text includes 37 different uses and applications for op amps. Beginners will find this book helpful. 1977, 221pp., softbound. **\$12.95**

S-32 HOW TO READ SCHEMATICS by Donald E. Herrington. This book teaches the recognition of schematic symbols, their use and function in diagrams, and the interpretation of diagrams for design, maintenance, and repair of electronic equipment. Especially helpful to the novice kit builder. 1989, 258pp., softbound. **\$14.95**

T-8 ENHANCED SOUND: 22 Electronics Projects for the Audiophile by Richard Kaufman. Twenty-two cost efficient projects are offered which can increase the capabilities of your audio system, and improve its performance. Discussions on theory, design applications and construction techniques are also included. A sampling of the projects...surround sound decoder, passive image enhancer, auxiliary input switch, tone controls, amplifier bridging circuit, modern infrasonic filter, Linkwitz-Riley crossover, improved dipole, helical antennas, and more. Over 100 illustrations. 1988, 170pp., softbound. **\$11.95**

T-10 ACOUSTIC TECHNIQUES FOR HOME AND STUDIO [2ND ED.] by F. Alton Everest. Learn how to improve your audio system by changing your listening room's characteristics. This cookbook of theory, method and construction ideas is fully illustrated and written in easy-to-understand language. 1984, 344pp., softbound. **\$18.95**

BUILDER'S GUIDES, specific (cookbooks)

S-9 REGULATED POWER SUPPLIES [3RD ED.] by Irving M. Gottlieb. Static and dynamic characteristics, regulation techniques, IC regulation. 1981, 424pp., softbound. **\$21.95**

S-10 IC OP AMP COOKBOOK [3RD ED.] by Walter G. Jung. Jung's popular classic in a revised and expanded edition. One hundred pages are added to cover new devices, applications and manufacturer's data sheets. With over two hundred practical circuits with component values, this cookbook is one of Old Colony's best selling technical volumes. It belongs on every electronics bookshelf. 1986, 580pp., softbound. **\$21.95**

S-13 AUDIO IC OP AMP APPLICATIONS [3RD ED.] by Walter G. Jung. This new, updated version of a classic reference source is probably the best book available on the subject. Mr. Jung is not only a recognized authority on op amps, but has an enthusiast's interest in audio quality and actively pursues new techniques for better sound reproduction.

Like his previous books in this series, this edition is in "cookbook" style, and includes actual circuits with component values which may be incorporated in working projects. The book also details the most common pin-outs, manufacturer listings and a wealth of other resource material. A must for any audiophile who constructs or modifies equipment. 1987, 250pp., softbound. **\$19.95**

S-14 ACTIVE FILTER COOKBOOK by Don Lancaster. A practical, user-centered volume with everything you need to build your own active filters. Explains the various types and how to select the best for the circuit. 1975, 240pp., softbound. **\$15.95**

S-17 IC TIMER COOKBOOK [2ND ED.] by Walter G. Jung. A full introduction to the IC timer, the types, and general usage pointers. Many surprisingly useful audio related uses. An excellent practical and theoretical volume with lots of reference data. 1983, 430pp., softbound. **\$17.95**

S-18 TTL COOKBOOK by Don Lancaster. Everything the beginner will need to know about transistor logic elements and usage. It has become a reference guide for engineers as well. 1974, 335pp., softbound. **\$14.95**

S-26 CMOS COOKBOOK [2ND ED.] by Don Lancaster. CMOS is low cost and widely available, and it uses an absolute minimum of power. It's also fun to work with and very easy to use. This book offers practical circuits and does not dwell on math or heavy theory. Eight chapters cover just about every aspect of CMOS usage. Projects include high-performance op amps, TV typewriter, digital instruments, music synthesizers and video games. 1977, 414pp., softbound. **\$18.95**

DICTIONARIES

P-2 DICTIONARY OF ELECTRONICS [2ND ED.] by E. C. Young. This remarkably compact reference covers electronics from A-battery to Z-parameters with succinct, concise definitions and illustrations. A quick reference completely revised and updated with lots of added charts and reference data. 671pp., softbound. **\$8.95**

P-3 A NEW DICTIONARY OF MUSIC [3RD ED., first pub. 1958] by Arthur Jacobs. Alphabetically arranged entries covering composers, individual musical works, orchestras, performers, conductors, musical instruments, and technical terms. 1973, 458pp., softbound. **\$8.95**

S-22 MODERN DICTIONARY OF ELECTRONICS [6TH ED.] by Rudolph Graf. This book should be in every library. It has more than 20,000 terms unique to electronics and other closely related fields. From angstrom to zoom lens, you'll find it in this updated dictionary. 1984, 1,152pp., hardbound. **\$39.95**

T-9 THE ILLUSTRATED DICTIONARY OF ELECTRONICS [4TH ED.] by Rufus P. Turner and Stan Gibilisco. This outstanding offering from TAB Books contains over 27,000 terms and definitions. Clearly written and detailed with over 450 illustrations, it is an excellent reference for hobbyist and researcher alike. 1988, 648pp., softbound, 7 1/2 x 9. **\$24.95**

U-1 THE AUDIO DICTIONARY by Glenn White. This lively and entertaining mini-encyclopedia covers the terminology and basic concepts relative to sound recording, sound reinforcement, and musical acoustics. Also includes historical anecdotes and a discussion on digital audio. 1987, hardbound. **\$29.95**

BKAA7 THE AUDIO GLOSSARY by J. Gordon Holt. Authored by the founder of *Stereophile* and one of audio's most famous gurus, this new best seller is a comprehensive overview of over 1,900 technical and subjective audio terms explained in precise yet at times humorous fashion. Foreword by Peter W. Mitchell, 27 illustrations. Hardbound includes dust jacket; limited edition is autographed, with gold-embossed binding. 1990.

BKAA7/S Softbound \$9.95

BKAA7/H Hardbound \$17.95

BKAA7/L Limited \$30.00

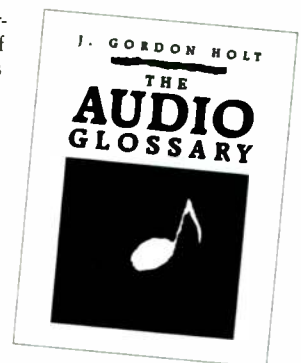

LOUDSPEAKERS (see also Sound Engineering)

BKAA-1 AUDIO AMATEUR LOUDSPEAKER PROJECTS. A collection of 25 loudspeaker construction projects. These are the complete articles as they appeared in *Audio Amateur* (1970-79). Since 1980, *Speaker Builder* magazine has been the forum for these authors and designers. Although some of the projects are showing their age, many embody ideas that can be developed using our newer knowledge and insights. The electrostatic devices are still unsurpassed by anything done since. The collection is a rich source of both theory and practice as well as design. 1985, 135pp., softbound, 8½x11. **\$20.00**

BKAA-2 THE LOUDSPEAKER DESIGN COOKBOOK [3RD ED.] by Vance Dickason. Everything you need to build the loudspeaker system you have always wanted but could not afford. Easy ways to pick the exact box size, the ideal drivers, the most pleasing finish and the correct way to feed your music to your new superb loudspeaker system. Proven designs, where to buy low cost parts and how to test the results for yourself. 1987, 82pp., softbound, 8½x11. **\$19.95**

S-11 HOW TO BUILD SPEAKER ENCLOSURES by Alexis Badmaieff and Don Davis. The "whys" and "hows" of speaker enclosures. Drawings and instructions cover infinite baffle, bass reflex, and horn types plus combinations. 1966, 144pp., softbound. **\$6.95**

T-12 DESIGNING, BUILDING AND TESTING YOUR OWN SPEAKER SYSTEM—WITH PROJECTS by David B. Weems. This 7¾" by 9¼" hands-on softbound manual packs an incredible amount of useful info into its 208 pages, including easy directions for ten projects. **\$16.95**

W-1 HIGH PERFORMANCE LOUDSPEAKERS [3RD ED.] by Martin Colloms. A thorough revision of the 2ND ED. (1980) updates and expands this authoritative volume. The author surveys new developments in the four-year interim and adds some highly original proposals for low frequency alignments, listening tests and much else. Colloms' book is indispensable for the serious speaker builder. 1985, 313pp., hardbound. **\$38.95**

GUIDEBOOKS & DATABOOKS

D-4 A MANUAL OF VENEERING by Paul Villiard. This book is a clear, well-written manual on the craft of veneering which explains how to turn out your own hardwood veneers beautifully and economically. Mr. Villiard shows you all the techniques of veneering: how to match veneers; how to glue, clamp, tape, and edge veneered panels; how to veneer curved panels; and how to inlay, finish, and repair veneers. 65 illustrations and photos, index, 174pp., softbound. **\$4.95**

N-6 LINEAR DATABOOK 1. First book in a comprehensive 3-vol. set of specifications and applications. Topics covered, with example circuits, include voltage regulators, op amps and buffers, voltage comparators and instrumentation amplifiers. 1988, 1,250pp., softbound. **\$16.95**

N-7 LINEAR DATABOOK 2. This second volume includes information on active filters, analog switches and multiplexers, both analog-to-digital and digital-to-analog converters, temperature sensors and voltage references. 1988, 920pp., softbound. **\$10.95**

N-8 LINEAR DATABOOK 3. The third book in this series focuses on audio, video and radio circuits. Also included is information on an array of special functions. 1988, 750pp., softbound. **\$10.95**

N-678 LINEAR DATABOOKS. As above, complete 3-volume set. **\$35.00**

N-9 LINEAR APPLICATIONS HANDBOOK. Heavily indexed and cross-referenced, this 1,220-page bible features hundreds of well-explained linear-IC circuits covering virtually every type of electronic device imaginable. 1986, softbound. **\$16.95**

P-1A THE NEW PENGUIN GUIDE TO COMPACT DISCS AND CASSETTES by Edward Greenfield, Robert Layton and Ivan March. An invaluable companion to their best selling *Stereo Records and Cassettes Guide*, this most recent offering is extensive in its coverage of compact discs. Comparative reviews are included that assess the best versions of material available. 1988, 1,366pp., softbound. Please add \$1.00 per book for shipping, in addition to postage. **\$19.95**

S-30 TUBE SUBSTITUTION HANDBOOK [21ST ED.] by Howard W. Sams Engineering Staff. This guide contains more than 6,000 receiving tube and 4,000 picture tube substitutes. Includes American to foreign and foreign to American equivalents. Tube basing diagrams provide a reference for pinouts. 1980, 128pp., softbound. **\$6.95**



SOUND ENGINEERING, REFERENCE WORKS

B-1 LOUDSPEAKER AND HEADPHONE HANDBOOK edited by John Borwick. This comprehensive technical volume fully covers the theoretical and practical aspects of loudspeaker and headphone design, operation and performance. Distinguished contributing authors include: Glyn Adams, Peter J. Baxandall, John Borwick, Martin Colloms, Laurie Fincham, R.D. Ford, Mark R. Gander, Stanley Kelly, Peter Mapp, C.A. Poldy, Desmond Thackeray, Floyd E. Toole and J.M. Woodgate. An invaluable reference textbook for the dedicated speaker builder. 573 pp., hardbound. **\$110.00**

BKX-1 PERCEPTION OF REPRODUCED SOUND edited by Soren Bech and O. Juhl Pedersen. A collection of 18 papers from the symposium held at Gammel Avenaes, Denmark, in September 1987. This gathering of professionals reviewed the subjective evaluation of reproduced sound and assessed its importance for the electroacoustic industry. Participant authors include: T. Poulsen, R. Plomp, H. Staffeldt, J. Blauert, F.F. Toole, A. Gabrielsson, S. Bech, N. Kousgaard, M. Williams, V. Hansen and G. Thiele. All offer highly informative presentations. 165pp., hardbound. **\$35.00**

MH-1 HANDBOOK FOR ELECTRONICS ENGINEERING TECHNICIANS [2ND ED.] by M. Kaufman and A.H. Seidman. A comprehensive compendium of electronic facts. Component selection, circuit analysis, power supplies, IC uses and characteristics, op amps, transistors, batteries and tubes. A one-volume encyclopedia on how components work and how to choose the best of them for your application. Includes seven new chapters on topics such as logic analysis, fiber optics, active filters, digital test gear and microprocessors. 1984, 752pp., hardbound. **\$49.95**

MH-4 AUDIO ENGINEERING HANDBOOK edited by K. Blair Benson. A complete desktop resource for engineering professionals and students. Topics covered include Digital Audio, Broadcast Transmission Technology, Microphones and Amplifiers, Analog and Digital Disk/Tape, Film Recording and Reproduction, Studio Production and Noise Reduction. Also provides a listing of up-to-date standards and recommended international practices. Among the Handbook's 33 authors are audio industry experts such as: Dr. R. Cabot, R. Dolby, T. Holman, Dr. T. Doi, H.G. de Haan, Dr. J. Bloom and L. Tyler. More than 700 illustrations. 1988, 1,056pp., hardbound. **\$86.95**

PH-1 HANDBOOK OF SIMPLIFIED SOLID-STATE CIRCUIT DESIGN [2ND ED.] by John Lenk. Design rules for basic circuitry including audio amps, integrated circuits, wave forming and shaping plus power supplies. Assumes basic theoretical base. Discusses purposes and types of testing. **\$39.95**

S-19 SOUND SYSTEM ENGINEERING [2ND ED.] by Don and Carolyn Davis. A thorough introduction to sound systems for halls, studios, outdoor locations and much else; now expanded! 1986, 665pp., hardbound. **\$49.95**

S-28 HANDBOOK FOR SOUND ENGINEERS: The New Audio Encyclopedia edited by Glen Ballou. Thirty-one sections covering just about every aspect of audio engineering from room acoustics, loudspeakers and amplifiers, to soundfield measurements and image projection. A complete audio reference library in itself, the most comprehensive and authoritative work on audio available. 1987, 1,250pp., hardbound. **\$79.95**

TUTORIAL

BKAA-3/1 AUDIO ANTHOLOGY (Vol. 1). A fascinating look at sound reproduction as presented in the pages of *Audio Engineering* magazine. Features 38 articles from May 1947 to December 1949. Compiled by editor, designer and author, C.G. McProud, this series will be of interest to all audio enthusiasts. Reprint Ed. 1987, 124pp., softbound, 8½x11. **\$16.95**

BKAA-3/2 AUDIO ANTHOLOGY (Vol. 2). More on amplifiers, loudspeakers and enclosures, and phonograph equipment. 45 articles from *Audio Engineering* magazine, January 1950 to July 1952. Reprint Ed. 1989, 124pp., softbound. **\$16.95**

BKAA-3/3 AUDIO ANTHOLOGY (Vol. 3). Covers September 1952 through May 1955. Along with discussions on stereophonic developments, includes designs for 18 preamps and filters, 8 power amps, and 12 loudspeaker systems. 43 articles, 124pp., softbound. **\$16.95**

BKAA-3/S AUDIO ANTHOLOGY SET (Vols. 1-3). As above, normally a \$50.85 value. **\$42.00**

BKAA5 LOUDSPEAKERS—THE WHY AND HOW OF GOOD REPRODUCTION by G.A. Briggs. Out of print for more than 40 years, this concise introduction to audio basics goes far beyond speakers, drivers, and boxes to include discussion of just about every audio phenomenon. Liberally illustrated, *Loudspeakers* is a pleasant tour through the early audio years and a provocative survey of the right questions about quality reproduction. 88pp., softbound. **\$6.95**

BKAA6 THE WILLIAMSON AMPLIFIER by D.T.N. Williamson. In 1947, this power amplifier, using excellent-quality push/pull output tubes, a special output transformer, and a highly filtered power supply, became an overnight success. Published by exclusive arrangement, this booklet is not only a singular resource but also an important historical document which will give the reader unique insight into the tube designer's challenges. 40pp., softbound. **\$4.95**

D-3 MUSIC, PHYSICS AND ENGINEERING [2ND ED.] by Harry F. Olson. A thorough introduction to the physical characteristics of sound and the relationship of sound to musical instruments by the former head of staff at RCA's lab for acoustical and electromechanical research at Princeton, NJ. A classic by one of the giants in the audio field. Easy to read chapters on acoustics, mikes and recording, recording and playback systems, as well as an electronic music chapter. 1967, 460pp., softbound. **\$8.95**

P-8 INTRODUCING MUSIC by Otto Karolyi. Even if you've listened to music for years, you may be surprised at how little you know about its fundamentals. A beautifully basic and spare introduction to the grammar and vocabulary of music—enough to understand the language without speaking it. It will deepen almost any non-musician music lover's pleasure in listening. 1965, 174pp., softbound. **\$5.95**

RR-1 THE ARRL HANDBOOK FOR THE RADIO AMATEUR edited by Bruce S. Hale. Although written for radio amateurs, this book is a valuable source of technical information for anyone interested in the theory and use of electronics. 1990, 1,170pp. **\$23.00**

S-4 UNDERSTANDING IC OPERATIONAL AMPLIFIERS [3RD ED.] by Roger Melen and Harry Garland. Basic course in semiconductor electronics. Covering integrated op amp circuitry, design factors, bias current, offset voltage, frequency compensation and slew rate. 1987, 212pp., softbound. **\$12.95**

S-29 PRINCIPLES OF DIGITAL AUDIO [2ND ED.] by Kenneth C. Pohlmann. A state-of-the-art reference text on digital audio technology. Comprehensive material on fundamentals, recording and reproduction is presented in this completely up-to-date handbook written both for engineers and audiophiles. 1989, 350pp., softbound. **\$29.95**

T-7 BASIC ELECTRONICS COURSE [2ND ED.] by Norman H. Crowhurst. This highly recommended textbook defines literally every aspect of electrical behavior and state-of-the-art electronics. Included are fundamental building blocks of theory and practice such as Kirchhoff's Laws, properties of resistance, electron flow, magnetic fields and power calculations. 430pp., softbound. **\$17.95**

T-11 UNDERSTANDING ELECTRONICS [3RD ED.] by R.H. Warring. The basics of electronics are presented here in a clear, concise, and thoroughly understandable fashion, with excellent explanations of solid-state theory, FETs, and fundamentals such as resistance, capacitance, and inductance. Also included is an introduction to the design of solid-state amplifiers and circuit boards. 1989, 205pp., softbound. **\$11.95**

NEW KIT! ADCOM GFA-555 MOD

Based on Kit Ryan's article in *The Audio Amateur* (4/89), this power regulation circuit is intended to upgrade ADCOM's GFA-555, but will work with any 80V-in that requires 60V-out regulated @ 10A. A very versatile and popular mod, with article reprint included.

KY-2

Per channel \$99

OLD COLONY ALSO OFFERS many high-quality metal film resistors and polypropylene caps. Please forward SASE for free listing of values and prices.

PARTS

Connectors & Cable

SCXT7: RCA-TYPE AUDIO PLUG. Gold-plated, top-of-the-line, solderless stack-up plug with safety collar.

Pair \$18* Two or more pair Each \$17

SCXT8: RCA-TYPE AUDIO JACK. Counterpart to SCXT7, gold-plated. Mounts from front of panel. Nylon insulators included.

Pair \$16 Two or more pair Each \$15

PHONO JACK A. Mounts in ⅜" hole from rear of panel (up to ¼" thick). External hex nut ensures tight installation. Gold-plated hardware included.

Pair \$7.50

NYLON INSULATING WASHERS. One flat/one shoulder, 10 pairs per set.

⅝" size—Fits Phono Jack A \$1.50

¼" size—Suitable for ¼" phono jacks \$1.50

SB7550B: PHONO PLUG. Gold-plated, fully shielded. Features spring strain relief. Accepts cable diameter up to .24" (such as Neglex 2534).

Pair \$7.50

SCBPG: GOLD-PLATED BINDING POSTS. Red and black. 30A, 1000V AC, five-way.

Pair \$6.50

SCBNG: GOLD-PLATED BANANA PLUGS. Stackable, leads held by internal set-screw. Red and black.

Pair \$6.50

SCSLG: GOLD-PLATED SPADE LUGS. For ¼" post, accepts 10-12 gauge wire. Solder or crimp.

Pair \$1.50

518: APATURE SPEAKER CABLE. This heavy 12-gauge oxygen-free copper, linear crystal cable has an ultra flexible clear jacket. Terminate with SCBNG or SCSLG.

Twin Lead, per foot \$1.60

2534: NEGLEX AUDIO CABLE. Low capacitance, high performance interconnect made with OFHC wire by Mogami. Copolymer insulated with spiral shield. Available in blue, black or yellow (specify with length).

Per foot \$1.25

2477: NEGLEX SPEAKER CABLE. Low impedance, high definition cable made with Mogami OFHC wire and copolymer insulation.

Per foot \$2.50

2515: NEGLEX HOOK-UP WIRE. Oxygen-free copper, super flexible, 18-gauge with cross-link polyethylene insulation. 25 foot spool in red or black. Specify. **\$10.00**

Potentiometers

Alps offers the finest in precision rotary controls. All mounting hardware is included.

VR-10KB: Stereo volume control, no detents. Two sections matched within ± 2dB. Size: body 25H x 25.3W x 27D (pins project 5mm above height measurement). Shaft length 13mm beyond mounting bushing. **\$40**

VR-50KB: Stereo volume control, no detents, as above. **\$32**

VR-100KB: Stereo volume control, no detents, log taper, tracking error less than 2dB. Dimensions as above. **\$32**

VR-100KD: Stereo balance control, single center detent. **\$32**

VR-100KJ: Stereo volume control, log taper, 31 detents. Taps at 14k for a "loudness" control. Heavy cast aluminum 34 x 33.5 x 40mm case. **\$22**

VR-250KB: Stereo volume control, ideal for tube-type preamps and all Dynaco PAS preamps. Dimensions as above. **\$42**

DISCOUNT: \$25-\$75 = 20%, \$75 and up = 30%.

CIRCUIT BOARDS

Old Colony's circuit boards are made of top quality epoxy glass, two ounce copper and reflowed solder-coated material for ease of constructing projects which have appeared in *Audio Amateur*, *Glass Audio* and *Speaker Builder* magazines. Many also have the component layout printed right on the board!

The builder needs the original article (indicated by the date in brackets) to construct the project. Articles are not supplied but are available through *Audio Amateur Publications*.

AUDIO AMATEUR

A-1: WILLIAMSON TWIN 20 POWER AMPLIFIER. (RW-8) 3 x 5" [1:70] Each **\$8.35**

A-2: WILLIAMSON TWIN 20. Power supply board. (RW-9:2) 2 1/2 x 3" [1:70] Each **\$6.85**

B-2: WILLIAMSON-WATLING 4+4 MIXER. Staked terminals. (RW:AW) 3 1/2 x 5" [2:71] Each **\$10.00**

B-5: WILLIAMSON TWIN 20 PREAMP. Stereo. (RW-11) 3 3/8 x 8" [2:71] Each **\$16.00**

B-7: V. U. METER. (DG-7-A) 1 1/4 x 3" [3:71] Each **\$8.00**

C-4: ELECTRONIC CROSSOVER. Board takes 8 pin DIPs, ten eyelets for variable components. (DG-13R) 2 x 3" [2:72] Each **\$10.00**

C-5: GLOECKLER VOLUME CONTROL. 23 position wafer. (FG-1) 3 x 3" [2:72] Each **\$5.50**

D-1: HERMEYER ELECST AMP II. 4 1/2 x 4 7/8" [3:73] Each **\$12.00**

E-2: REGULATED LAB POWER SUPPLY. ± 15V. (Ref. 1) 4 3/8 x 3 1/8" [4:74] Each **\$8.00**

F-3: GATELY ± 18V POWER SUPPLY. Regulated. (EG-2) 2 1/4 x 4" [2:75] Each **\$8.00**

F-6: 30Hz FILTER/CROSSOVER. High pass or universal filter or crossover. (WJ-3) 3 x 3" [4:75] Each **\$10.00**

G-1: GATELY PEAK DETECTING OVERLOAD INDICATOR. Two channel. (EG-3) 1 1/2 x 2 1/2" [2:3:76] Each **\$6.40**

H-2: SPEAKER SAVER. (WJ-4) 3 1/4 x 5 1/4" [3:77] Each **\$13.25**

H-4: GATELY MICROMIXER. Input. 15 pin plug-in gold edge. (MIC-10S) 8 1/4 x 3" [3:77] Ea. **\$17.00** Five or more, Each **\$15.00**

H-5: GATELY MICROMIXER. Output. 15 pin plug-in gold edge. Two channel. (MIC11-005) 12 3/4 x 3" Each **\$26.20**

H-7: GLOECKLER 101dB ATTENUATOR. (FG-3) 2 x 2" [4:77] Each **\$8.00** Five for **\$35.00**

H-8: MORREY SUPER BUFFER. Two channel. (WM-3) 1 1/2 x 2 1/2" [4:77] Each **\$8.00**

J-4: DIDDEN AUDIO ACTIVATED POWER SWITCH. (J-4) 3 x 4 1/4" [3:78] Each **\$7.55**

J-5: PASS A-40 POWER AMP. One channel. 3 x 3" [4:78] Each **\$6.00**

J-6: SCHROEDER CAPACITANCE CHECKER. (CT-10) [4:78] 3 1/4 x 6" Each **\$9.95**

K-3: CRAWFORD WARBLER. 3 1/4 x 3 3/8" [1:79] Each **\$11.20**

K-6: WALDRON TUBE CROSSOVER. (Two needed per 2-way channel.) 2 x 4 1/2" [3:79] Each **\$12.00** Four **\$40.00**

K-7: WALDRON TUBE CROSSOVER POWER SUPPLY. 5 x 5 5/8" [3:79] Each **\$12.95**

K-11: WILLIAMSON 40/40 POWER AMP. One channel. 3 x 5" [4:79] Each **\$7.00**

L-1A: BOAK POWER AMP REGULATED SUPPLY. Plus or minus supply for power. 2 3/4 x 4 1/8" [1:80] Each **\$8.00**

L-2: WHITE LED OVERLOAD & PEAK METER. One channel. 3 x 6" [1:80] Each **\$18.70**

L-4: SULZER OP-AMP PREAMP POWER SUPPLY. ± 15V supply for preamps. 4 3/8 x 4" [2:80] Each **\$12.00**

L-6: MASTEL TONE BURST GENERATOR. 3 1/2 x 6 5/8" [2:80] Each **\$15.75**

L-9: MASTEL PHASE METER. 6 5/8 x 2 1/8" [4:80] **\$11.25**

M-1: MULLER-CARLSTROM. Sweep Generator-Oscillator. (Two required.) (CM-2) 2 3/16 x 5" [2:81] Each **\$8.50** Pair **\$14.00**

M-2: MULLER-CARLSTROM. Log Sweep Board. (CM-4) 2 x 2 1/8" [2:81] Each **\$5.00**

M-3: MULLER-CARLSTROM. Sweep Power Supply. (CM-5) 2 5/8 x 3 3/8" [2:81] Each **\$6.50**

M-4: MULLER-CARLSTROM. Logger Board. (CM-3) 3 1/2 x 4" [3:81] Each **\$9.25**

M-5: MULLER-CARLSTROM. Logger Power Supply. (DG-12B) 2 1/2 x 2 3/4" [3:81] Each **\$5.00**

M-6: CARLSTROM IM FILTER. Intermodulation Filter. 2 5/8 x 3 3/4" [1:82] Each **\$6.50**

P-3: BORBELY 60W POWER AMP. (EB-60) 3 3/8 x 6 1/8" [2:82] Each **\$11.75**

P-5: SWEEP MARKER ADDER. 3 1/2 x 2 3/4" [2:82] Each **\$6.20**

P-6: ADVENT MIKE PREAMP UPDATED. (K5) 3 7/8 x 2 3/8" [3:82] Each **\$18.75**

R-2: BORISH DIGITAL DELAY. 5 3/4 x 9" [1:2:83] Each **\$79.80**

R-4: DIDDEN MAIN PWR AMP. 4 5/8 x 6 3/8" [4:83] Each **\$30.00**

S-1: BORBELY SERVO 100 AMP. 4 1/8 x 6 1/2" [1:84] Each **\$16.00**

S-3: BORBELY DC 100 AMP. 6 1/2 x 4 1/8" [2:84] Each **\$16.00**

S-5: KRUEGER MOD FOR MORREY IG-18. 2 11/16 x 2 1/8" [3:84] Each **\$7.60**

S-6: CURCIO VACUUM TUBE PRE-PREAMP AMP/REGULATOR. 4 3/4 x 2 3/4" [5:84] Each **\$12.35**

S-6A: CURCIO VACUUM TUBE PRE-PREAMP MASTER POWER SUPPLY. 4 3/4 x 3 3/4" [5:84] Each **\$10.35**

S-8: DIDDEN FAN CONTROL. 6 1/4 x 1 1/8" [4:84] Each **\$11.25**

T-1: CURCIO VACUUM TUBE PREAMP/AMP REGULATOR. 10 11/16 x 6 1/16" [2:85] Each **\$36.00**

T-1A: CURCIO VACUUM TUBE PREAMP MASTER POWER SUPPLY. 3 3/16 x 2 11/16" [2:85] Each **\$8.00**

T-2A: BORBELY R1AA-1. 3 7/8 x 3 7/8" Each **\$10.50**

T-2B: BORBELY R1AA-2. 3 7/8 x 5 7/8" Each **\$15.00**

T-2C: BORBELY TAPE BUFFER. 1 1/2 x 3 7/8" Each **\$5.45**

T-2D: BORBELY LINE BUFFER. 3 7/8 x 5 1/8" Each **\$9.50**

T-2S: BORBELY PREAMP BOARD SET. Eight boards. [4:85; 1:86] Set **\$90.00**

T-2F: BORBELY PREAMP POWER SUPPLY. (Two required.) 3 7/8 x 4 7/8" Each **\$12.00**

V-2: LANG CLASS A MOSFET AMP. 5 11/16 x 6 1/16" [2:86] Each **\$21.40**

V-3A: CURCIO AUTO MUTE. 1 1/2" x 2" Each **\$8.00**

W-3: BORBELY IMPROVED POWER SUPPLY. 4 1/4 x 5 1/2" [1:87] Each **\$16.00**

X-3: CHATER 40W MOSFET AMP. Two sided, one channel. 4 x 6 3/4" [2; 3:88] Each **\$28.00**

X-3A: CHATER AMP POWER SUPPLY. 3 1/2 x 6" [2; 3:88] Each **\$14.00**

X-4A: VIKAN CAR AMPLIFIER. 4 x 5" [4:88; 1:89] Each **\$23.20**

X-4B: VIKAN PWR SUPPLY. 4 1/4 x 5 1/4" [4:88; 1:89] Each **\$17.00**

Y-2: RYAN ADCOM GFA-555 POWER SUPPLY REGULATOR. (One per channel required.) 3 x 6 1/4" [4:89] Each **\$28.50**

SPEAKER BUILDER

SB-A1: LINKWITZ CROSSOVER. 5 1/2 x 8 1/2" [4:80] Each **\$25.50**

SB-D2: WITTENBREDER PULSE GENERATOR. 3 1/2 x 5" [2:83] Each **\$11.85**

SB-E2: NEWCOMB PEAK PWR INDICATOR. 1 x 2" [2:84] Each **\$3.90**

SB-E4: MULLER PINK NOISE GENERATOR. 4 1/4 x 2 3/16" [4:84] Each **\$9.40**

GLASS AUDIO

GB-1A: CURCIO ST-70 POWER SUPPLY. 5 x 9" [1:89] Each **\$27.00**

GB-1B: CURCIO ST-70 DRIVER BOARD. 3 1/4 x 7" [1:89] Each **\$17.00**

PARTS

Tubes

Siemens 6DJ8 \$ 9.50

Siemens 12AX7 \$ 9.50

Mullard 12AU7 \$ 7.00

National 6CA7 pair \$32.00

National 6L6GC pair \$28.00

TRW socket SKT9R pc board mount, 9 pin \$ 5.00

Integrated Circuits

Signetics NE5534 \$4.75

Signetics NE531 (8-pin DIL) \$4.25

Signetics NE5535 (8-pin dual FET op amp) \$6.00

Signetics LF351N (8-pin op amp) \$1.25

Analog Devices AD-711 (8-pin DIL single FET op amp) \$2.40

Analog Devices AD-712 (8-pin DIL dual FET op amp) \$3.50

Analog Devices AD-712KN Military (8-pin DIL dual FET) \$11.25

Analog Devices AD-713 (quad op amp) \$10.00

Motorola MC34081P input op amp \$2.50

Et cetera

MSLD-32: OLD COLONY SOLDER. Manufactured by Alpha Metals, our product features a highly activated organic flux (2.2%) with a water-soluble resin derivative of rosin which allows post soldering residues to be removed with a water wash. An article reprint, *Soldering: The Basics* by Marc Colen is included. 63/37 Tin/Lead, .032" diameter. 30 foot spool is 2 oz. **\$7.50**

KM-6: CRAMOLIN CONTACT CONDITIONER. Kit consists of one two-dram vial of Red for old contacts, one two-dram vial of Blue for new contacts, lint-free applicators and full instructions for use. This military grade contact cleaning compound dissolves and removes oxides and their effects on all non-soldered contacts in audio systems from cartridges to speaker terminals. **\$20**

DISCOUNT: \$25-\$75 = 20%, \$75 and up = 30%.

OLD COLONY'S USER-FRIENDLY SOFTWARE

BEST SELLERS

Speaker Designer™

Release 1.2 by **Stuart E. Bonney**

A loudspeaker system design aid and modeling tool for use with both closed and vented systems over the frequency range from 10 to 300Hz. Computes and displays system frequency response, power handling capabilities, and relative sound pressure level (SPL) outputs for each of 26 discrete frequencies over this range. Includes one year support by the author when the user registers this Shareware product. Each **\$19.50**

IBM 5¼" 360K DS/DD

SPD-1B5

Loudspeaker Modeling Program

by **Ralph Gonzalez** (SB 1, 2, 3/87)

LMP produces a full-range frequency response prediction for multi-way loudspeakers, including the effect of the crossover driver rolloffs, interdriver time delay, diffraction loss, etc. (Includes author support.) Each **\$17.50**

Specify:

Apple II 5¼" SS/DD

LMP-1A5

Apple Macintosh 3½" SS/DD

LMP-2M3G

IBM PC/XT/AT 5¼" DS/DD

LMP-2B5G

Commodore 64 5¼" DS/DD

LMP-1C5

"Souped-Up" LMP provides professional quality graphics and a fast, friendly user interface. Remains compatible with LMP data files and is available for IBM PC (CGA, EGA, VGA or Hercules graphics) and Macintosh computers. The Macintosh version also provides square wave analysis with audible output.

Each **\$49.50** (upgrade price \$39.50*)

Specify:

IBM PC/XT/AT 5¼" DS/DD

LMP-3B5G

Apple Macintosh 3½" SS/DD

LMP-3M3G

*Original LMP disk or sales receipt must be included w/ order

Driver Evaluation and Crossover Design

by **G. R. Koonce** (SB 5/88)

Disk 1 evaluates the suitability of drivers for closed, vented and passive radiator enclosures, and allows detailed designs of vented boxes.

Disk 2, in addition to driver evaluations, allows the design of first-, second- and third-order crossovers. 5¼" IBM 360K DS/DD. Each **\$12.50**

Specify:

Driver Evaluations

DRI-1B5

Crossover Design

CRS-1B5

Active Filter Design

by **Fernando Garcia Viesca** (SB 4/88)

Calculates component values for Butterworth filters in four configurations: High and low-pass in second- and third order. (Includes author support.) Each **\$17.50**

IBM 5¼" 360K DS/DD

ACT-1B5

Two-Way Active Crossover Design

by **Gary Galo** (SB 5/88)

Performs the calculations for the eight two-way active crossover designs described by Bob Bullock using formulas exactly as given in the articles; plus a program to calculate V_{TH} . (Includes one year user support.) Each **\$20**

Specify:

IBM 5¼" 360K DS/DD

TWO-1B5

IBM 3½" 720K DS/DD

TWO-1B3

Stepped Volume Controls

by **Joseph O'Connell** (TAA 4/88)

These ready-to-run Mac programs come on a 3½ inch SS/DD disk initialized as a 400K disk for compatibility with all machines. Also included are the Pascal source codes, should you wish to customize them for your own use. Program A. Precisely matches the resistor values to the measured or estimated source and load impedances, yielding great accuracy. Your volume control can have 3 to 99 positions. The program will ask you how many dB each step should be attenuated and has provisions for a standard audio taper or any other taper you devise. Program B. Calculates the taper that will result with your actual resistor values, because you are limited to standard values or with series and parallel combinations. It can also show the effects of different source and load impedances on the taper. Both programs (contained on the same disk) allow you to save their output to a text file and include author support via mail. Each **\$25**

Apple Macintosh 3½" SS/DD

SVC-1M3

BULLOCK & WHITE SOFTWARE

BOXRESPONSE

Model-based performance data for either closed-box or vented-box loudspeakers with or without a first- or second-order electrical high pass filter as an active equalizer [SB 1/84]. The program disk also contains seven additional programs as follows:

Air Core: This program was written as a quick way of evaluating the resistance effects of different gauge wire on a given value inductor. The basis for the program is an article in *Speaker Builder* (1/83, pp. 13-14) by Max Knittel. The program asks for the inductor value in millihenries (mH) and the gauge wire to be used. (NOTE: only gauges 16-38.)

Series Notch: Developed to study the effects of notch filters in the schematics of some manufacturers. Enter the components of the network in whole numbers (i.e., 10 for 10μF and 1.5 for 1.5mH) and indicate whether you want one or two octaves on either side of resonance. Output is frequency, phase angle and dB loss.

Stabilizer 1: Calculates the resistor-capacitor values needed to compensate for a known voice coil inductance and driver DC resistance.

Optimum Box: A quick program based on Thiele/Small to predict the proper vented box size, tuning and -3dB down point. It is based only on small signal parameters, therefore, it is only an estimate of the response at low power (i.e., limited excursion).

Response Function: Calculates the small signal response curve of a given box/driver combination after inputting the free-air resonance of the driver (f_s), the overall "Q" of the driver (Q_{TS}), the equivalent volume of air equal to the suspension (V_{AS}), the box tuning frequency (f_B), and the box volume (V_B). Output is the frequency and relative output at that frequency.

L-Pad Program by Glenn Phillips: Appeared in *Speaker Builder* (2/83, pp. 20-22). It is useful for padding down a tweeter or midrange while still retaining the same load as the driver itself.

Vent Computation by Glenn Phillips: Calculates the needed vent length for 1, 2 or 4 ports of the same diameter. Input box volume in cubic feet and required tuning frequency (f_B), output is vent length and vent area for each case.

Medium: 5¼ SS/DD Disk. Price, **\$25** (unless otherwise specified) postpaid USA; in Canada, add \$4; overseas, add \$6.

Specify:

BOXRESPONSE

Apple BOX-1A5

Commodore 64 (Disk) BOX-1C5

IBM BOX-1B5

IBM Plus Graphics

BOXRESPONSE BOX-2B5G **\$50**

PASSIVE CROSSOVER

This disk is a result of Mr. Bullock's extensive research concerning first-, second-, third-, and fourth-order passive crossovers in *Speaker Builder* 1, 2 & 3/85; **\$25**

Specify:

PASSIVE CROSSOVER CAD

Apple PAS-1A5

Commodore 64 (Disk) PAS-1C5

IBM PAS-1B5

IBM Plus Graphics

CROSSOVER CAD PAS-2B5G **\$50**

CALSOD

Computer-Aided Loudspeaker System Optimization and Design by **Witold Waldman**

CALSOD is a new entry into the field of crossover network optimizing software available for the IBM PC desktop computer. It combines the transfer function of an LC network with the acoustic transfer function of the loudspeaker, by using some form of iterative analysis. CALSOD creates, through the process of trial-and-error curve fitting, a suitable transfer function model which it can then optimize. The program is the subject of CALSOD author Witold Waldman's research paper "Simulation and Optimization of Multiway Loudspeaker Systems Using a Personal Computer" which appeared in the *Audio Engineering Society Journal* for September 1988, pp. 651-663. CALSOD differs considerably from other software since it models the entire loudspeaker output of a multiway system, including the low-end response, and the summed responses of each system driver.

The program performs a lot of tricks. One of the more spectacular of these allows the designer to specify the location of the driver acoustic centers using an XYZ coordinate system. Thus, if the designer ex-

pects to mount a driver combination on a flat baffle, the summed response can be optimized to compensate for rearward displacement of a woofer's acoustic center with respect to a tweeter. CALSOD can model up to seven drivers at a time in a four-way system giving the summed response and acoustic phase response of the entire system.

The CALSOD program comes on a single 360K floppy, and requires one directory and two subdirectories in installation, plus access to the DOS GRAPH-TABL file, which it uses for a couple of special symbols. The 133-page User Manual, provided on a second disk, is well written, adequately describes the various program functions, and contains an excellent tutorial example, which demonstrates the use of the program. The files for the worked example contained in the manual also come on the program disk, so users can follow the design process and use and modify the files as they learn the procedures.

Specify:

IBM 2 x 5¼" 360K DS/DD . . . CAL-2B6 **\$65.00**

IBM 3½" 720K DS/DD CAL-2B4 **\$67.50**

NOTE: OLD COLONY SOFTWARE SHOWN ON THIS PAGE IS NOT RETURNABLE FOR REFUND OR CREDIT. ALSO, BECAUSE OF UNREASONABLE TAXATION REQUIREMENTS BY THEIR STATE, WE REGRETFULLY ARE UNABLE TO SELL SOFTWARE TO RESIDENTS OF CONNECTICUT.

PETERBOROUGH, NH 03458-0243

PO BOX 243

OLD COLONY SOUND LAB

THANK
YOU



3 FOLD
TOP
DOWN



2 FOLD
BOTTOM
UP

4

TAPE OR STAPLE SECURELY

PRICING: Prices, except as noted, include shipping in the continental USA. The minimum order is \$10. A \$2 service charge will be added to orders of less than \$10. Prices are subject to change as our costs change. WE RESERVE THE RIGHT TO MAKE PRICE CHANGES WITHOUT NOTICE.

ORDERING: Please use the ORDER FORM provided and include part number, quantity and price. Please print clearly and include your Magic Number if you are a subscriber. Please include a ZIP code in your address. The ORDER FORM is designed to help us quickly and accurately process your order. We reserve the right to refuse mail orders not made using the ORDER FORM or orders under the \$10 minimum.

TELEPHONE ORDERS: Telephone orders are welcome between the hours of 9:00 a.m. and 4:00 p.m. EST, Monday-Friday. Orders for parts are to be made on the ORDER FORM provided. Payment for telephone orders is by MC/VISA only. Our TELEPHONE ORDER NUMBER IS (603) 924-6371 or 924-6526. Our answering machine for MC/VISA orders during non-business hours is (603) 924-6371. FAX: (603) 924-9467 (24 hours).

PAYMENT: All remittances **MUST BE IN US FUNDS.** Payment for telephone orders may be made by MasterCard or VISA. Mail order payment may be made by MC/VISA, money order, cashier's check or personal check. If payment is made by personal check, allow up to two weeks for check clearance before your order is shipped. Should a check be returned for any reason, there will be a \$10 service charge.

SHIPPING: UNLESS NOTED, FREIGHT IS PREPAID BY OLD COLONY. All orders shipped USPS first class mail or by UPS. Allow two to three weeks for delivery. Include appropriate funds for special handling (UPS next day or second day). UPS requires a street address. If you cannot receive UPS delivery, please include an extra \$2 for insured service via Parcel Post. We cannot accept responsibility for safety or delivery of uninsured Parcel Post shipments. **Absolutely no COD shipments.**

BOOKS, RECORDINGS, CDs, and SOFTWARE: The shipping/handling charge is \$1.75, plus 50¢ each additional item. **No returns.** According to the Connecticut Dept. of Revenue Services, Regulation #27, Section 12-426-27, in order to sell software to residents of Connecticut, we must register with the department as well as collect taxes for the state from the purchaser. We regret to inform our customers that we will not sell software to anyone from Connecticut, as it will prove to be too costly and burdensome.

OVERSEAS ORDERS: For orders to be shipped outside the US, add 20% to the total order to cover shipping.

DISCOUNTS: All products are subject to double discount, **except magazine subscriptions.** Double discount is **20%** on orders \$25 to \$75 and **30%** on orders of \$75 or more. **DOUBLE DISCOUNT SALE ENDS January 13, 1991.**

RETURNS: If you wish to return all or part of an order for any reason, please call or write first. If we are in error, correction will be made promptly, without charge. If the error is not ours, adjustment will be made at our discretion. We will send you a **return authorization label.** A restocking fee of 20% will be charged on returns. Merchandise considered not fit for resale will be returned without credit or refund. A \$2 fee will be charged on exchanges. All returns must be made within **30 days of invoice date.** Books, software, CDs, and recordings are not eligible for return or refund.

WARRANTY: We warrant that all items sold conform to the quality and specifications set forth. We make no representations. We accept no responsibility whatever for further use by the customer. We accept no monetary liability in excess of the original cost or replacement of the material if originally defective or damaged in transit.

MODIFYING DYNACO'S A-25

BY LEN MOSKOWITZ

The Dynaco A-25 speaker system made its debut amid raves in 1969. A two-way system in slightly more than a cubic foot box, it was truly a bookshelf speaker. Considering its list price was only \$79.95, (in 1969) and that it sounded better than speakers costing two or three times more, it's not surprising Dynaco sold lots of them. Almost 20 years later many are still around.

For its day, the A-25 had something near a flat frequency response, specified at ± 5 dB from 47Hz-20kHz. It achieved this using what might today be considered a strange configuration: a two-way system using a 10" woofer. Two-way systems more commonly use 6½" or 8" woofers, because it's easier for a tweeter to cross over seamlessly to a small woofer than to a large one. Most tweeters having good high-frequency responses tend to lose their low-frequency response around 3kHz.

Most 10" drivers' frequency response falls off rapidly above 1.5kHz. It's a rare tweeter which can go down that low, and still provide a balanced high end. Many manufacturers choose a smaller woofer with better high-frequency performance sacrificing bass performance in favor of simpler tweeter matching. Dynaco managed these trade-offs differently. It chose the SEAS 25 TV-EW 10" woofer. The 25 TV-EW is a rare large driver because it maintains performance up to the relatively high frequency of approximately 2.2kHz (Fig. 1). It also gives better than average bass performance when installed in a small box.

ABOUT THE AUTHOR

Len Moskowitz does artificial intelligence research for Bendix Test Systems Division in New Jersey. He is also an amateur musician and enjoys improving the sounds produced by his instruments and stereo.

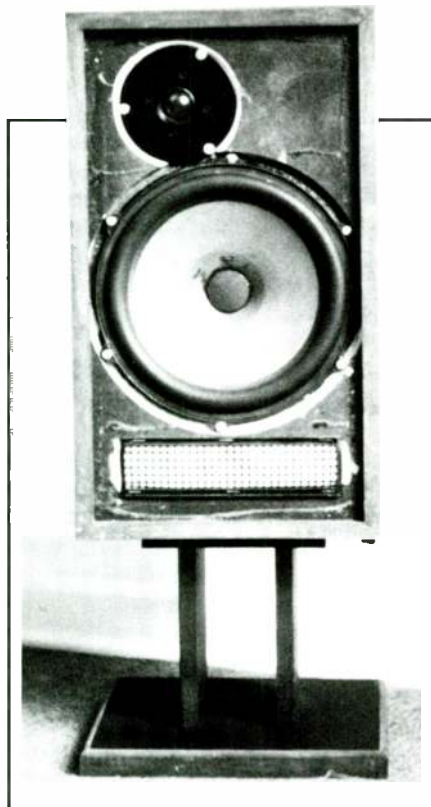

its high-frequency response (Fig. 2). On the high end, the 87H started rolling off above 12kHz, and was down ± 3 dB at 15kHz and 6-8dB at 20kHz.

This certainly wasn't audiophile performance, but was quite good for its price. Its dispersion wasn't specified, but listening proves it's not wonderful. One reviewer said he could hear a 12kHz tone at 30° off-axis and a 15kHz tone on-axis. The Dynaco A-10 and A-50 used the same SEAS tweeter.

YET ANOTHER TACK. Considering that acoustic suspension speakers such as the AR-3a and AR-5 were all the rage 20 years ago, it's surprising Dynaco took another approach. The A-25 is an aperiodic vent design, rather than a sealed or ported box. The reviews recounted how Dynaco tested each A-25, loading the vent until bass response was optimized. The SEAS 25 TV-EW woofer, with its paper cone and rubber surround, had a nice flat response.

When set in a properly loaded aperiodic system, it provided considerably lower bass than you'd expect from a box this small. In John Cockroft's article, "The Shortline: A Hybrid Transmission Line," (SB 1/88) he said that aperiodic vented systems are similar to very short transmission lines. The A-25's bass

The 25 TV-EW's high cut-off frequency made finding a compatible tweeter possible. The SEAS 87H 1½" fabric dome tweeter provided a good compromise between matching the woofer's cut-off and smooth high-frequency performance. It was reasonably flat down to around 1.7kHz, without giving up too much of

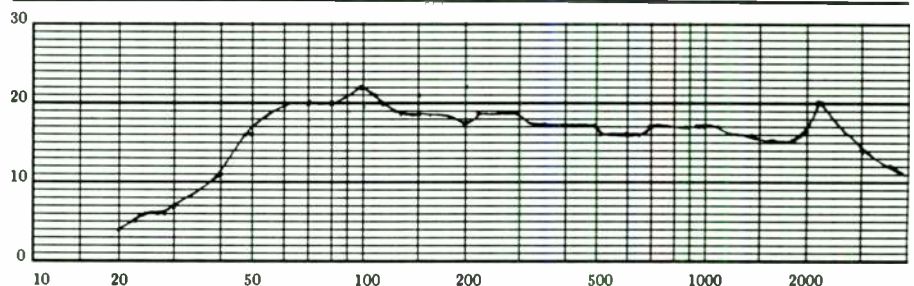

FIGURE 1: SEAS 25 TV-EW frequency versus amplitude response.

Zero Level: 70 dB

Authorized Distributors Include:

- A & S Speakers**
3170 23rd Street
San Francisco, CA 94110
(415) 641-4573
- AudioLab of GA., Inc.**
5269-2 Buford Hwy.
Atlanta, GA 30340
(404) 455-0571
- Circle Sound**
2772 West Olympic Blvd.
Los Angeles, CA 90006
(213) 388-0624
- Gold Sound**
4285 South Broadway
Englewood, CO 80110
(303) 789-5310
- Madisound Speakers**
8608 University Green
Middleton, WI 53562
(608) 831-3433
- Martin Sound**
28 Alpha Park
Cleveland, OH 44143
(216) 442-2286
- Parts Express**
340 East First Street
Dayton, OH 45402
(513) 222-0173
- Select Distributors**
6036 S.W. 23rd Street
Miramar, FL 33023
(305) 985-2698
- Solen Incorporated**
4470 Thibault Avenue
St. Hubert, QC J3Y 7T9 CANADA
(514) 656-2759
- Speaker City**
10615 Vanowen Street
Burbank, CA 91505
(818) 508-1908
- Speakers, Etc.**
1828 West Peoria
Phoenix, AZ 85029
(602) 944-1878
- Zalytron Industries**
469 Jericho Turnpike
Mineola, NY 11501
(516) 747-3515

Fast Reply #KE668

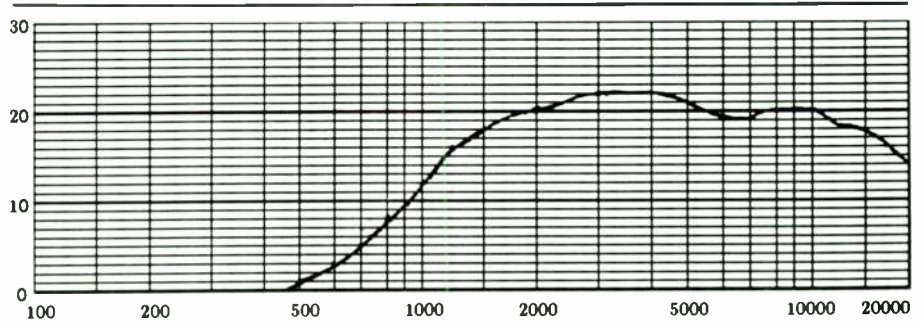

FIGURE 2: SEAS 87H frequency versus amplitude response.

Zero Level: 0 dB

sound shows this resemblance; its transient performance is notably tight and well-controlled. While a box this small can't reproduce the lowest music octave it does get pretty close.

The A-25's crossover is a deceptively simple affair. Since the woofer's response rolls off steeply above 2.2kHz, Dynaco didn't bother installing a low-pass filter, but provided the tweeter with a first order high-pass filter implemented in an interesting way (Fig. 3). Dynaudio currently uses a similar circuit in one of their systems (the Twynn). The amplifier feeds a 4.7 or 5μF capacitor, initially a non-polarized electrolytic, and later what appears to be a film capacitor.

The signal is fed to a resistive network, consisting of a series resistor (R1) preceded by a second resistor (R2) in parallel to the driver and R1. R2 has a minimum value of 10Ω, and R1 1.2Ω. Four 1.2Ω resistors can be added to R1 or R2 using a five position selector switch. When a resistor is switched from R1, it is added to R2, providing a variable level control which also varies the crossover's -3dB turnover point.

I analyzed the network with the SPICE network simulation program. Its performance with an 8Ω resistive load is summarized in Table 1. I was surprised that at its normal setting, Dynaco designed for a 2.5kHz crossover point. This is a bit beyond the woofer's capabilities, and the A-25's sound suffers.

WHAT TO UPGRADE? The A-25 has weathered the years reasonably well. While bass performance is excellent, compared with modern designs of similar size, the woofer's downward tilt in the midrange between 100Hz-2kHz sounds like a slight depression in clarity. The tweeter's high-frequency performance hasn't fared well. Compared to modern designs, its roll-off above 12kHz is clearly audible as a lack of air and detail. The tweeter imparts harshness to strings, cymbals, and synthesizers, and its restricted dispersion makes the pre-

ferred listening area smaller than we like.

THE FUN BEGINS. While I was in the mood to upgrade my old stereo system, I decided to see what could be done about my A-25s. The first step was to determine the A-25 drivers' characteristics. Ed Laurent, SEAS' US contact, kindly dug out a set of old specification sheets. Clearly replacing the 87H was my first priority. I searched old *Speaker Builder* articles and vendor catalog sheets for a suitable replacement, concentrating on response flatness between 2-20kHz, broad dispersion, at higher frequencies, sensitivity similar to the 87H's (91dB), and compatible mounting characteristics. I found the perfect solution: Dynaudio's D28-AF.

Recommended and used in many *Speaker Builder* projects the tweeters are favorites of manufacturers and hobbyists. They have an amazingly flat frequency response (Fig. 4), wonderful dispersion characteristics, sensitivity equal to the 87Hs, and are similar in size. Frequency response extends to below 2kHz, with a resonant peak comfortably far below that at 700Hz.

Impressed after hearing them in Thiel's CS2.0 speakers, I ordered a pair from Madisound for less than \$100. (Zalytron and Audio Concepts also stock them.) Analyzing the crossover and determining how the upgrade should proceed, a friend, Michael Hennedy,

Continued on page 59

TABLE 1

| 8Ω RESISTIVE LOAD | | | |
|-------------------|-----------|---------------------|-----------------------------|
| R1 (Ohms) | R2 (Ohms) | Insertion Loss (dB) | Crossover Freq. (kilohertz) |
| 11.0 | 10.0 | 4.7 | 1.3 |
| 8.8 | 12.2 | 3.8 | 2.0 |
| 6.6 | 14.4 | 2.0 | 2.5 |
| 4.4 | 16.6 | 2.0 | 2.5 |
| 2.2 | 18.8 | 0.9 | 2.9 |

PRESIDENT

ultra

high end

loudspeaker

components

polydax
SPEAKER CORPORATION



*The Prestige Line illustrates the
ability of Audax Industries to
develop a driver without any
compromise in sonic quality.*



Norsorex Sound

This unique and amazing synthetic compound offers an incredibly high coefficient of internal damping to terminate any undesirable vibrations.



TPX Cone Material

An advanced formulation polymer that offers the properties of high internal damping, stiffness, and low density to the cone diaphragm. Outperforms all other conventional cones materials.



Supra Magnet Technology

Magnetic circuit concept which fully immerses a short length voice coil into an unconventionally wide magnetic gap. Since the voice coil never leaves the magnetic field, this design permits better transient response, reduces harmonic distortion and provides motional linearity.



Pure Titanium Formers

To assist in maximizing the transfer of energy from the voice coil to the diaphragm, while maintaining sensitivity and power handling, Audax engineered the complete Prestige Line to employ this refinement.

At Polydax, we view the design of a loudspeaker as a combination of elements embodied in a complex variety of compromises. When development on a new line of ultra high end loudspeaker components began, our commitment was to choose these compromises in such a manner as not to sacrifice sonic performance in any way. The extent of our success is most evident in the resulting family of drivers, appropriately named the Prestige Line.

Our emphasis on formulating breakthrough technologies has dated back to over half a century ago, when the company was first established. From the pioneering of our proprietary cone material, TPX, to the invention of the Supra magnetic technology, our passion to set new standards for supplying the highest quality loudspeaker components has never been stronger. We are confident that, from an engineering standpoint, every product in the Prestige Line offers you more advanced design than has ever been previously available.

The overall quality of any system is characterized by the concessions made in design, materials and workmanship. Polydax has taken the necessary steps to ensure that your system will not be compromised with our Prestige Line.

T E C H N O L O G Y

P R E S T I G E
MIDA-100
 4" MIDRANGE

The research objective was to obtain a balanced tonality with perfect equilibrium across a wide pass band (+/- 1dB from 450 Hz to 6.5 kHz).

The performance of this new driver is unmatched, and the smooth response allows applications to employ a minimum of crossover equalization.

The remarkable TPX material exhibits excellent properties of damping, rigidity and low mass, making it ideal for use as a diaphragm. Coupled to a surround made of NORSOREX, all undesirable

distortion generated from cone ringing is eliminated.

The Pure Titanium former ensures that energy transfer from the voice coil to the cone is maximized. The Supra Magnet structure guarantees motional linearity over the full cone excursion.

An ultra rigid, die cast Zamac chassis and a pure

NORSOREX phasing plug complete this design to make it the ideal choice for your next system.



Dramatic transient response results from the unobstructed venting of the magnetic structure.

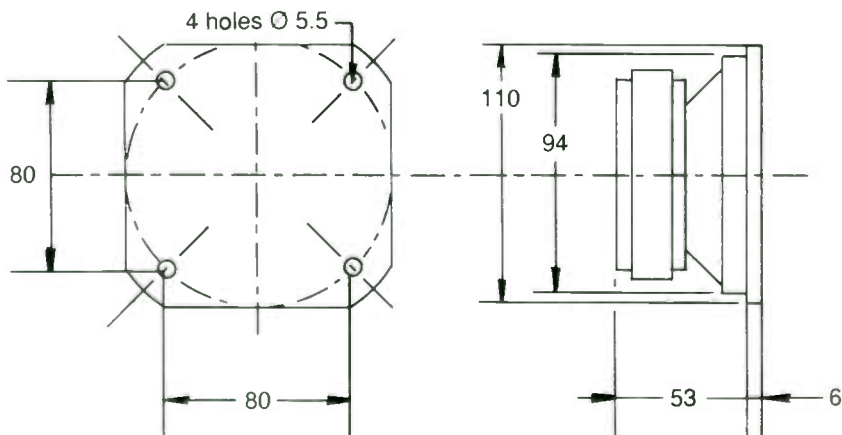

All dimensions in millimeters

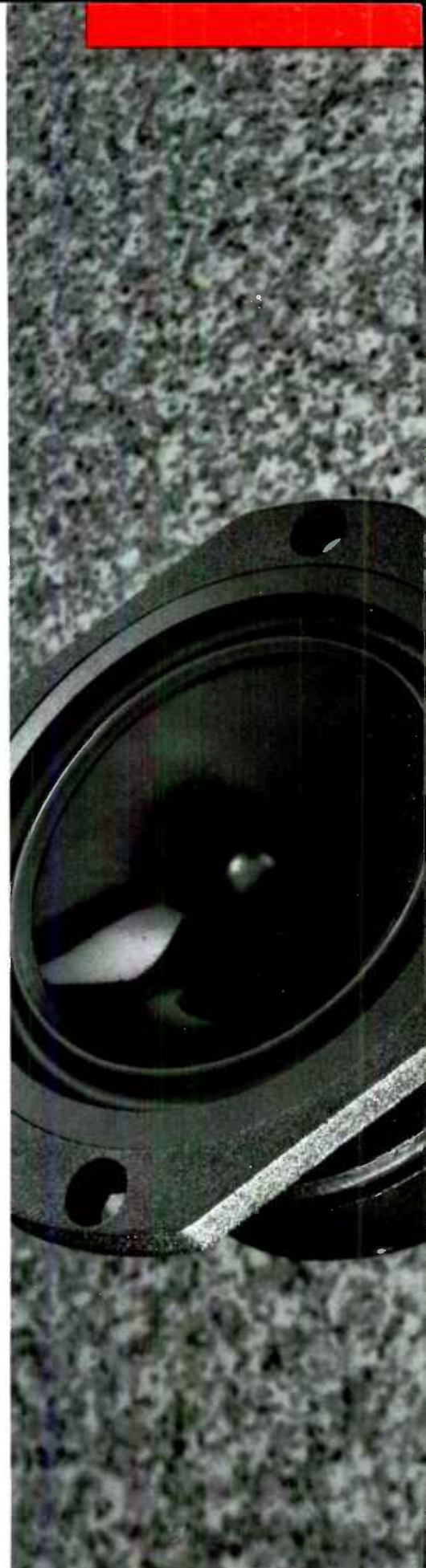

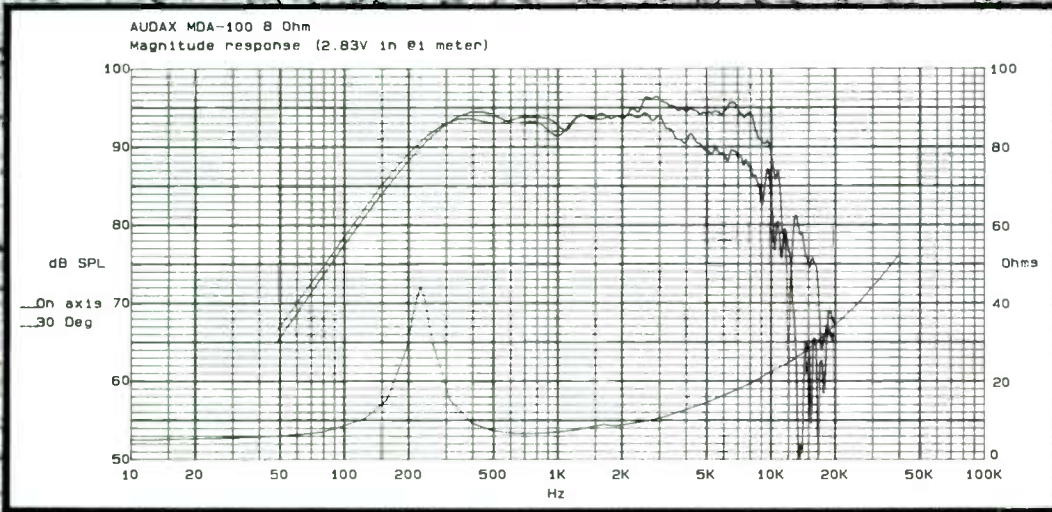

OSKGRAPH

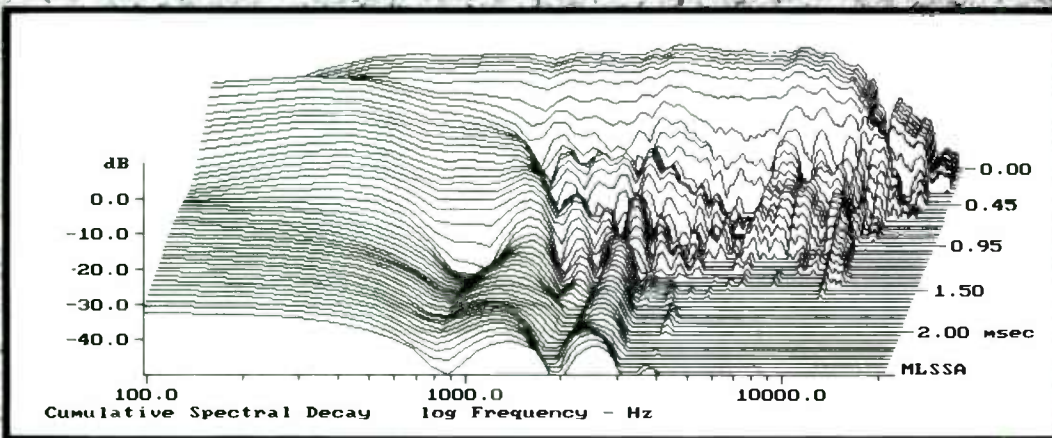

PRESTIGE MDA-100

4" MIDRANGE

| Technical Characteristics | Symbol | Value | Units | Technical Characteristics | Symbol | Value | Units |
|---------------------------------|--------|----------|----------------|--|--------|-------|-------|
| Nominal Impedance | Z | 8 | Ohms | Voice Coil Length | h | 3.2 | mm |
| Minimum Impedance | Zmin | 7 | Ohms | Number of Voice Coil Layers | n | 4 | - |
| DC Resistance | Re | 5.2 | Ohms | Flux Density | B | 1.28 | T |
| Voice Coil Inductance | Lbm | 280 | uH | Flux in Gap | Ø | 0.512 | mWb |
| Resonant Frequency | Fs | 230 | Hz | Stray Flux | Fmag | - | A/m |
| Suspension Compliance | Cms | 2.0E-02 | mN-1 | Force Factor | BL | 5.72 | NA-1 |
| Mechanical Q Factor | Qms | 4.06 | - | Height of Magnetic Gap | He | 5 | mm |
| Electrical Q Factor | Qes | 0.65 | - | Linear Excursion | Xmax | 1 | mm |
| Total Q Factor | Qts | 0.56 | - | Diameter of Magnet | ØA | 84 | mm |
| Mechanical Resistance | Rms | 0.80 | kg/s | Height of Magnet | Hb | 15 | mm |
| Moving Mass | Mmd | 2.5E-03 | kg | Weight of Magnet | - | 0.348 | kg |
| Effective Piston Area | S | 58.1E-04 | m ² | Characteristic Efficiency Level * | E | 92.5 | dB |
| Volume Equivalent of Air at Cas | Vas | 9.4E-02 | m ³ | Nominal Power Handling | P | 60 | W |
| Voice Coil Diameter | d | 25.3 | mm | Mass of Speaker | - | 0.98 | kg |
| Voice Coil Former Material | - | Titanium | - | * adjusted for 1 Watt reading at 1 meter | | | |

polydax
SPEAKER CORPORATION

10 Upton Drive
Wilmington, MA 01887

(508) 658-0700
Fax (508) 658-0703

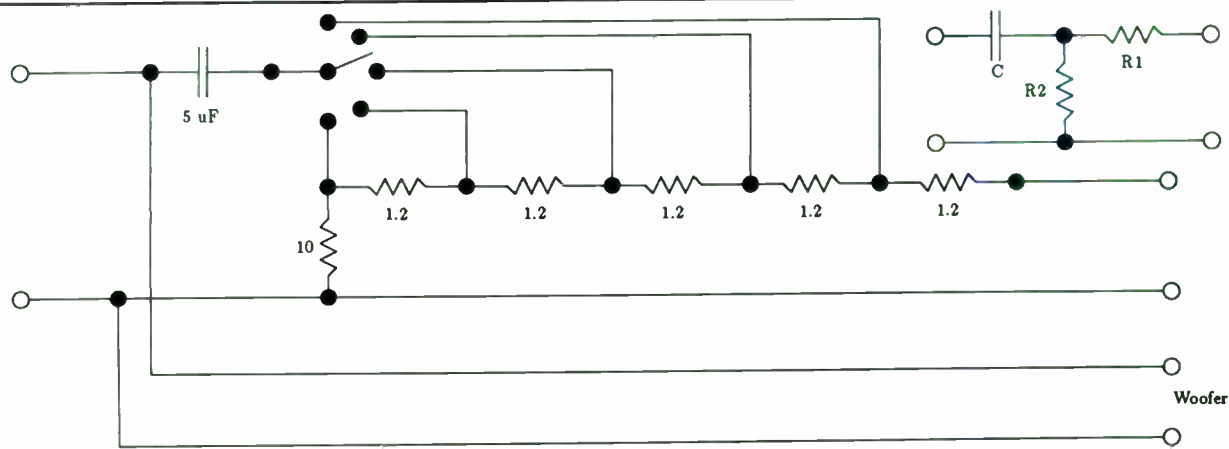

FIGURE 3: Stock Dynaco A-25 crossover schematic (simplified network at top right).

TABLE 2

CROSSOVER POINTS

| R1 (Ohms) | R2 | Insertion Loss (dB) | Crossover Freq. (kilohertz) |
|-----------|------|---------------------|-----------------------------|
| 11.0 | 10.0 | 4.7 | 1.5 |
| 8.8 | 12.2 | 3.8 | 1.7 |
| 6.6 | 14.4 | 2.9 | 1.9 |
| 4.4 | 16.6 | 2.0 | 2.1 |
| 2.2 | 18.8 | 0.9 | 2.5 |

Continued from page 54

came up with an impedance model for the D28-AF (Fig. 5). We used this model and the SPICE network modeling program to determine crossover performance.

MAKING THE MODIFICATIONS.

Removing the 87Hs, which were sealed to the baffle with a viscous sealant, I noted the two A-25s weren't quite identical. One speaker's tweeter was mounted 1/4" further forward than the woofer. The hole for this tweeter wasn't bevelled to finesse the tweeter into the baffle, but instead had straight walls. This system also used a non-polarized electrolytic capacitor in its crossover. The other A-25's tweeter was mounted

at the woofer's depth and the mounting hole was bevelled out to the baffle. The crossover used what looked like a film capacitor. Before mounting the new tweeters, I bevelled the first unit's tweeter hole, brought it to the same depth as the second, and replaced both capacitors.

The D28-AFs almost drop into the 87H's mounting positions. I opened the hole 1/4" with a medium grit sanding drum mounted on a power drill. Once the tweeter fit comfortably, I drilled holes for the mounting screws, caulked the rear of the tweeter mounting plates with silicon rubber, soldered the signal leads, and screwed the tweeters in place.

To complement the new tweeters, I upgraded the crossovers with Solen Chateauroux polypropylene capacitors, also available from Madisound. Since the Dynaudios could accommodate a lower crossover, I decided to use a slightly larger 6uF capacitor, lowering the crossover point to 2.1kHz for the -2dB selector switch position. Insertion losses and crossover points for the modified crossover are in Table 2. The capacitors were positioned inside the box near the selec-

tor switch, and were fixed in place with silicon caulk.

HOW THEY SOUND. I played with the crossover selector switch, settling on the position that's one notch above the normal—where the modified A-25 is head and shoulders above the stock model. The new tweeters provide transparency and air common in speakers costing 10 or 20 times more. Horizontal imaging is solid, but it lacks depth, perhaps due to cabinet diffraction effects. While bass response is still missing that bottom octave, it is as tight and clean as it has ever been.

At first I put the speakers on the floor about two feet from the side wall, and a foot from the rear wall. There, the mid-bass was a bit too full. Then I placed the speakers on 9" stands, putting the tweeter about 26" off the floor and angled slightly back. This, coupled with moving the speakers further out into the room, made the fullness disappear. The result: a nicely balanced spectrum, and a very pleased music fan.

FUTURE PLANS. When I continue the upgrade, I'll remove the A-25's grille moldings and add some felt or Soundcoat acoustic foam around the tweeters, with an eye toward reducing cabinet diffraction—and hopefully improving imaging. The next step will be replacing the 25's TV-EW woofer with its more modern counterpart, the 25 F-EW, which has an

Continued on page 87

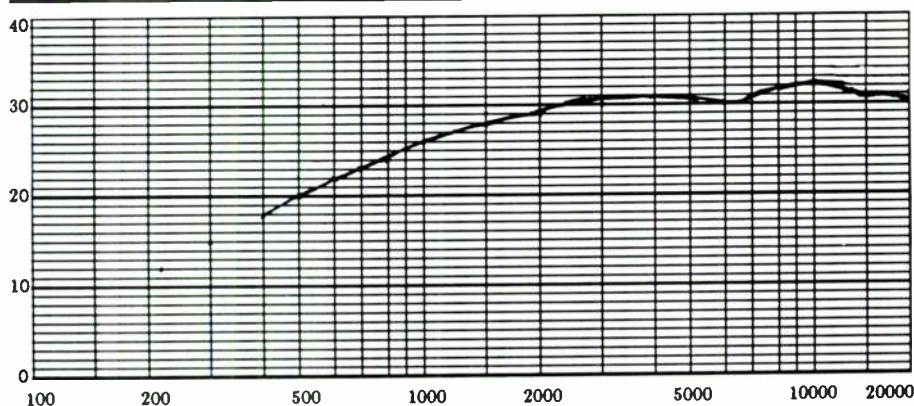

FIGURE 4: Dynaudio D-28AF frequency versus amplitude response.

Zero Level: 70 dB

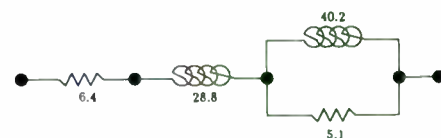

FIGURE 5: Simplified SPICE impedance model for Dynaudio D-28AF.

Kit Report

Audio Concepts' Sapphire II

By Gary Galo, Contributing Editor



PHOTO 1: Front view of the Sapphire II mounted on the AC Stands. The grille cloths are attractive, but should be removed for the best stereo imaging.

Manufacturer's Specifications: Tweeter: Modified Focal T120KT; Woofer: Focal 7K011DBL; Frequency response: 65Hz–20kHz \pm 3dB; Crossover: Minimum phase design; Tweeter: Quasi first-order; Woofer: First-order on voice coil 1; Upper midrange response shaping network on voice coil 2. Crossover frequency: 3kHz; Sensitivity: 89dB, 1M/1W; Impedance: 7 Ω nominal, 4 Ω minimum; Dimensions: 16" \times 10" \times 10"; Height on stands is 40".

Price: Full kit—\$699/pr. plus \$30 shipping; Parts kit—\$479/pr. plus \$15 shipping; Assembled—\$759/pr. plus \$30 shipping; Optional stands—\$99 (black), \$119 (white) plus \$15 shipping. Manufacturer: Audio Concepts, Inc., 901 South Fourth St., La Crosse, WI 54601, (800) 346-9183 (orders only), FAX (608) 784-6367, technical help, (608) 784-4570.

Audio Concepts has been offering high-quality loudspeaker components and kits to speaker builders since 1977. Under the guidance of its president, Mike Dzurko, Audio Concepts has offered loudspeaker builders many kits known for their atten-

tion to detail and technical refinement. Supplying drivers and other components, the firm has been selective in choosing product offerings, unlike many other distributors, who offer nearly every driver made by nearly every manufacturer.

The Audio Concepts catalog contains what they believe are the best products in each component and price category. They carry several products not found in other distributors' catalogs, including AC Spikes for coupling speakers to the floor, gold-plated spade lugs which will fit around the largest amplifier binding posts, AC Foam for enclosure lining and room treatment, as well as the excellent AudioQuest loudspeaker cables.

The Sapphire II is based on Audio Concepts' older Sapphire loudspeaker, but is housed in a smaller enclosure. The Sapphire II falls into the "mini-monitor" class, and can be used as a stand-alone system. They can also be used as satellites, along with a pair of subwoofers, if you wish truly deep bass. My review samples arrived in four well-packed cartons, one containing the two enclosures, one containing the drivers, crossovers, and hardware, and two containing the optional black stands. When purchased as a full kit, The Sapphire II is just that. Every item needed to complete the loudspeakers is included, down to the last screw.

Drivers and Loading

The Sapphire II enclosure design was a joint effort between Audio Concepts and Jack Caldwell, a familiar name to builders of high-quality loudspeaker kits. Caldwell has designed several loudspeakers for Audio Concepts, and is well-known for the SOTA Panorama. Like the earlier model, the Sapphire II enclosure is an aperiodic design containing a vent stuffed with damping material which relieves internal pressure in the region near system resonance. Aperiodic loading provides much better control over the woofer's cone motion than acoustic suspension designs.

In an acoustic suspension enclosure, the trapped air inside the enclosure is quite

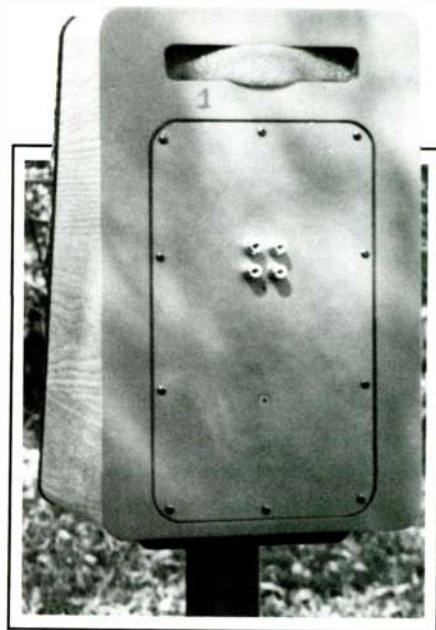

PHOTO 2: Rear view of the Sapphire II showing the four gold-plated binding posts, which allow bi-wiring. The rear panel, fastened with 12 screws, doubles as the crossover mounting board.

reactive at low frequencies. Its "springiness" causes the woofer to make large excursions in the area around system resonance. The excessive cone motion, in turn, substantially raises the system's impedance at the resonance frequency.

The Sapphire II enclosures contain a slot in the rear which is stuffed with a foam plug, and they are also heavily damped internally. Each is filled with a synthetic damping material which Audio Concepts calls AC Stuff.

The aperiodic loading effectiveness is illustrated in Fig. 1, which is the Sapphire II's impedance curve. The system resonance frequency was impossible to pinpoint. The impedance rises to 5.1 Ω between 70Hz–80Hz, with no further rise at any specific frequency in this region. This shows exceptionally well-controlled cone motion at low frequencies. The system is also very low Q. Caldwell claims the Q is slightly higher than 0.5.

The impedance falls to 3.5 Ω at 20Hz. Although this is well below the system's low-frequency cutoff, your amplifier will

ACCUTON

Ceramic concave dome

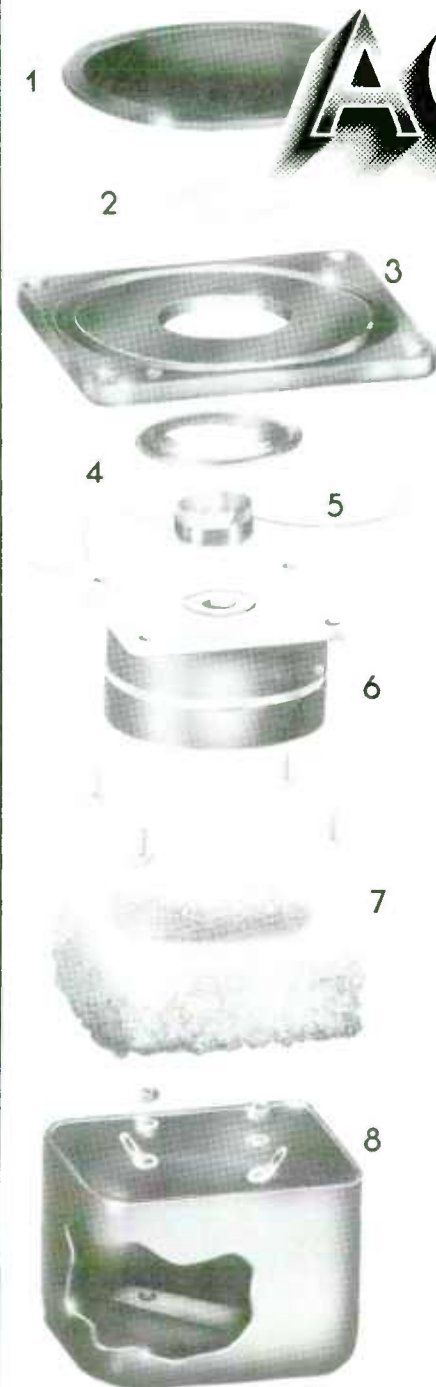

- 1 Transparent protective screen
- 2 Pure aluminum oxyde concave diaphragm made by a special process involving electrolysm and laser beam cutting. Computer calculated dome shape takes maximum advantage of the suprar drive (energy transfer from the voice coil to the dome) achieved by concave domes over traditional convex domes.
- 3 Zinc die cast high mass high damping plate. Profited back channels.
- 4 Elaborate suspension system (including fluid)
- 5 Extremely rigid voice coil cemented to dome for optimum energy transfer.
- 6 Dual ferrite high precision magnetic assembly
- 7 Damping envelope.
- 8 Protective cover provides reaction-free damping of the sound waves emerging from behind the diaphragm and its suspension.

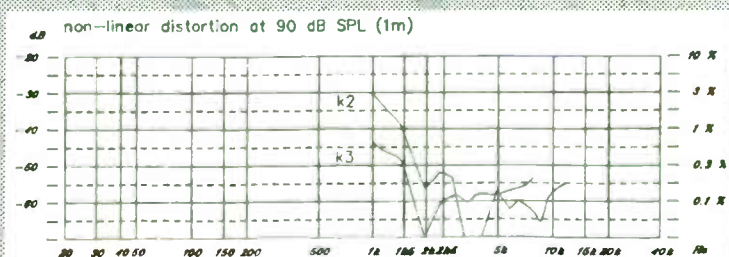
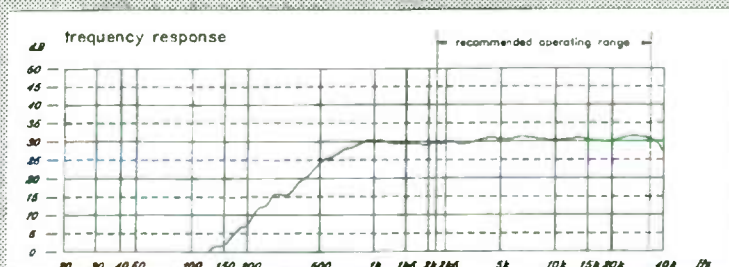
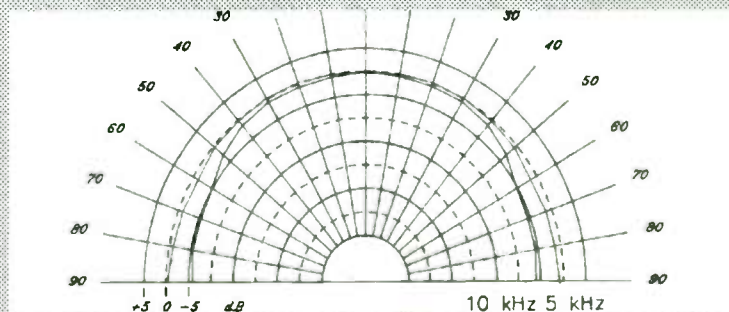

Anatomy of C2-11
Ceramic dome tweeter

Some may already have heard of them. Some may even have heard them. A truly memorable experience. It is with great enthousiasm that I am introducing to you the ACCUTON C2-11 tweeter and the ACCUTON C2-77 midrange. Technology is very often promoted for itself (for obvious marketing reasons) and it would be tempting to do this here. But the ACCUTON ceramic concave dome drive units offer a much higher prowess. If the true art of manufacturing acoustic transducers is to make them "invisible", the ACCUTON C2-11 and C2-77 are authentic "chefs d'oeuvre", so transparent they are to music. Kimon Bellas.

Exclusively from ORCA, Dsgn & Mfg Corp.
1531 Lookout Drive, Agoura, CA 91301 USA

Suggested retail per unit: C2-11 : \$ 188.00 C2-77: \$ 274.00

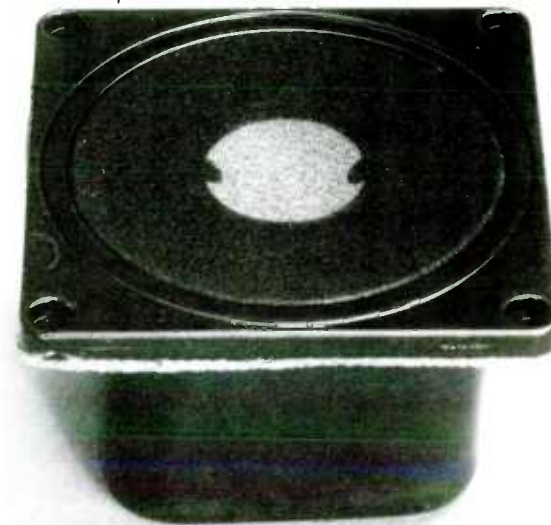

US Distributors:
 A & S Speakers (415) 641-4573 FAX (415) 648-5306
 3170 23rd Street, San Francisco, CA 94111
 Modisound Speakers (608)831-3433 FAX(608)831-3771
 8608 University Green Box 4283, Middleton, WI 53711
 Speakers Etc. (602) 944-1878
 1828 West Peoria, Phoenix, AZ 85029
 Transducer Technology (214) 991-6994 FAX 991-5016
 4320 Spring Valley Road, Dallas, TX 75244
 Zolytron Industries (516) 747-3515 FAX (516) 294-1943
 469 Jericho Turnpike, Mineola, NY 11501

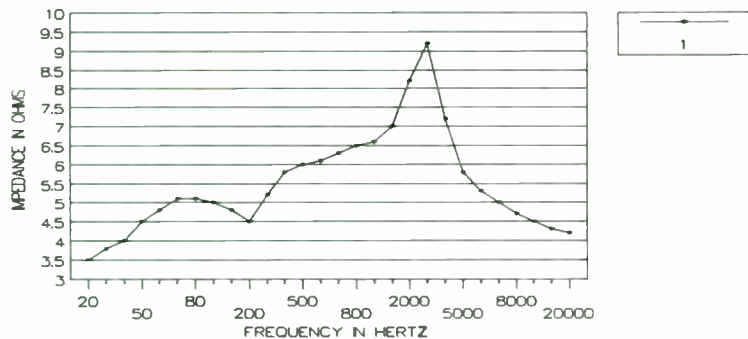

FIGURE 1: Impedance curve for the Sapphire II. Both samples were identical.

still be driving the loudspeaker at this frequency. I recommend a power amplifier with sufficient current capability to drive low impedance loads with low distortion levels. Audio Concepts says as little as 40W per channel is adequate for the II, but recommend 50-150W per channel for optimum performance.

Remember, power output alone is not the issue. An amplifier which delivers 100W per channel into an 8Ω resistor, but falls apart trying to drive a 3.5Ω load, isn't a good choice. A lower power amplifier maintaining low distortion and stability into low impedance loads, will deliver much better performance than a high-power amplifier which can only maintain low distortion into 8Ω resistors. The Sapphire II is not particularly efficient, so a 100W per channel amplifier is *not* overkill.

Each Sapphire II contains one Focal 7K011DBL woofer, and one Focal T120KT tweeter. The woofer cone uses Focal's patented K2 Kevlar 1mm sandwich, consisting of a compound of synthetic resin (serving as a bonding agent) and microballs of foam between two layers of Kevlar cloth. The sandwich combines low mass with excellent rigidity, and the cone is suspended with a rubber surround. The cast frame further improves the driver assembly's rigidity.

The 7K011DBL is a dual-voice coil driver, each having a nominal impedance of 8Ω. Focal recommends designing the crossover so one voice coil operates in both the bass and midrange frequencies, while the other covers low frequencies only. By designing a response-tailoring network for the second voice coil, the low-frequency response of the driver can be extended. The second voice coil has a different purpose in the Sapphire II, which I'll explain shortly.

The tweeter's concave dome, made of Kevlar cloth, is actually larger than the voice coil, allowing the driver to operate as a nearly point source at high frequencies. Focal manufactures several T120 tweeter variations, but the KT version in the Sapphire II has a rear-vented pole piece. Audio Concepts modified the tweeter, adding aperiodic damping and sealing off the rear vent. The result is a tweeter with well-controlled internal resonances. Audio

Concepts uses an AC felt tweeter ring on each tweeter to control diffraction.

Crossover Design

Jack Caldwell designed the minimum phase crossover. Audio Concepts does not supply a schematic with the kit, although a pictorial illustration is included in the manual. I sketched out the crossover circuit, but Caldwell wants it to remain proprietary and asked us not to publish it with the review. I believe this runs contrary to the spirit of kit building and the philosophy of *Speaker Builder*, but we have respected his wishes. I don't believe that publishing this schematic does any harm to the designer.

Anyone wishing to steal the design for commercial purposes would surely want to hear the loudspeaker first. You would normally have to purchase the kit in order to do this. After buying the loudspeaker, you will be free to sketch out the schematic yourself. No one would borrow a design strictly on the strength of a review.

The crossover frequency is around 3kHz, and the high-pass filter looks like a second-order, 12dB/octave filter. The tweeter's actual acoustical rolloff, how-

ever, is quasi first-order. A first-order, 6dB/octave filter feeds the primary woofer voice coil. As mentioned, the second voice coil is not used to extend the woofer's bass response, instead, a series LCR network forms a small notch filter centered at 3.7kHz. This corrects for a small time domain aberration in this region. The design goal was to reproduce a holographic, three-dimensional soundstage with very precise imaging.

Cabinet Construction

The enclosures, (*Photos 1 and 2*) are superbly constructed. No effort was spared in making the enclosure as acoustically inert as possible. Extensive internal bracing helps eliminate enclosure panel flexing. They are braced top to bottom, side to side, and front to back. The design uses a sloping front panel, which improves the drivers' alignment by time, and breaks up resonances which can develop in conventional rectangular enclosures.

The enclosure is made of ¾" medium density fiberboard (MDF). Mike Dzurko said he experimented with several MDF densities before finding the one he believed would best control cabinet resonances.

The sloping front panel is routed to ¼" to allow mounting the drivers flush. The enclosure's interior is coated with Acoustical Magic, a latex-based paint containing titanium, and other ingredients which resistively absorb cabinet resonances. The brand name may sound like high-end audio mysticism, but it appears to be highly effective.

The cabinets are as attractive as any commercial loudspeaker I've seen. The four front-to-rear corners, top and bottom, are rounded and a one-piece walnut veneer surrounds the top and sides, joined on the bottom where the joint won't be visible.

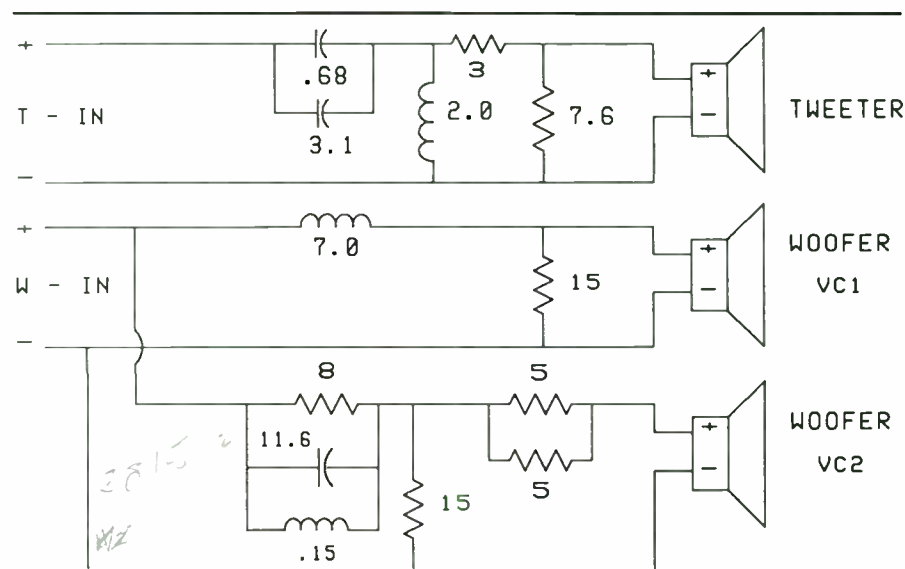

FIGURE 2: The Sapphire II minimum phase crossover. The LCR notch filter on the second woofer voice coil corrects a time domain aberration at 3.7kHz.

The veneer work is *outstanding*. (The joints are so perfect I had difficulty finding them.) The front and back are painted gray, and the attractive black grille cloths can easily be removed. The enclosure is a first-class piece of cabinetwork.

The rear panel has a large routed opening where the crossover board is mounted. The crossover is not mounted onto a printed circuit board, instead crossover components are glued to a two-layer Masonite laminate, which when fastened to the enclosure forms the main portion of the rear panel. Two 1/2" PVC spacers are placed between the laminate and the internal bracing. A pair of long screws go through the rear panel and spacers, and are threaded into the internal brace, tightly coupling the rear panel laminate to the internal bracing, reducing the possibility of rear panel resonances. *Photo 2* shows a rear view of the loudspeaker.

The inside of the laminate is coated with Acoustical Magic, and the back is painted gray to match the rest of the enclosure's rear panel. Silicon sealant and epoxy fasten crossover components. The coils are first glued with the silicon seal, then after the silicon has cured four beads of epoxy are added to increase the mounting's strength—yet another step to ensure the absence of enclosure vibration. The crossover components, properly glued, further deaden the enclosure's rear panel. The manual claims this arrangement is sonically superior to mounting crossover components on a printed circuit board, and I agree.

The crossover uses premium grade components, including IAR Wonder Caps and Chatteauroux polypropylene capacitors. AudioQuest F-14 cable is used for all internal wiring, and contains four solid core, high-purity copper conductors. It is a high-quality, cost-effective cable, flexible enough to make it practical for internal wiring.

Audio Concepts made provisions for bi-wiring the Sapphire IIs. Two pairs of gold-plated binding posts are mounted on the rear panel, one feeding the woofer crossover section, and another for the tweeter. The posts are the ones Audio Concepts supplies with their AC Cup, but the plastic cup is not used on the IIs. They are mounted directly on the Masonite. I'm sure Jack and Mike believe, as I do, a plastic cup would compromise the rear panel's structural integrity. The posts (among the finest quality I've seen) stick out beyond the back panel, making easier connections. The heavy-duty posts can accept 10-gauge wire, or be used with banana plugs, or the large gold spade connectors.

Assembly

The kit includes a 15-page illustrated manual covering assembly, setup, and operating instructions. For builders adventurous enough to purchase the parts

kit, helpful suggestions for constructing the cabinets are included. Unless you own quality power tools and possess woodworking skills to match, you're probably better off purchasing the full kit with factory-assembled enclosures. Illustrations are included for all cabinet dimensions, including the complex internal bracing.

The manual warns: "These drawings may be used as a guide for building your own cabinets... and should not be taken as certified diagrams..." The complex angles of the sloping front panel and in-

ternal bracing will require a fair amount of custom fitting. To duplicate performance the full kit offers, you'll must use the *exact* materials supplied with the full kit, including the same MDF grade. I don't mean to discourage the hard-core builder, but I wish to present a realistic assessment of the task.

Assembling the full kit is an enjoyable project. Although the assembly instructions are generally good, a few points need clarification. What follows are assembly instructions, (in *italics*) along with my

1000 WATTS!



NOW THERE ARE THREE

Our 12" Monster Sub advanced the State-of-the-Art of woofers and subwoofers considerably, setting new standards for the speaker industry. Now it is joined by our 15" and 18" models, and all three are available in 4 ohm and 8 ohm versions. But power is not everything. The MS 1000 subwoofers are near **INDESTRUCTIBLE** and very, very accurate . . . the closest thing to the Perfect Woofer.



HIGH FIDELITY SPEAKERS . . . *simply the best!*

Hart Professional Marketing • P.O. Box 186 • Kent, WA 98035

Fast Reply #KE551

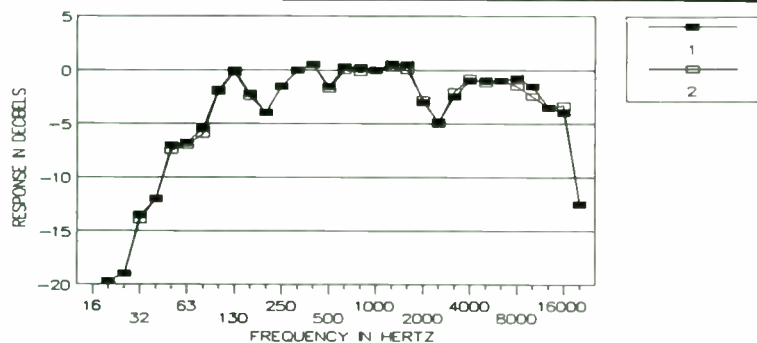

FIGURE 3: One-third octave warble tone response with the microphone on-axis and positioned midway between the woofer and tweeter.

additional comments. I have quoted the manual as written.

1. Carefully unpack your parts kit. Check to see that you have all the parts listed on the parts list. NOTE: Hardware for installation of the speakers is in a small bag stapled to the inside of the cabinets when ordering a full kit. Both of my bags had broken loose during shipment, and I found them elsewhere in the carton. Locate the staples used to fasten the bags to the enclosure and remove them.

2. Vacuum the inside of the cabinets to make sure that they are totally free of any dust or chips.

3. Use silicon sealant to attach the plastic spacers around the two inside screw holes on the crossover board. Note that the longer spacer is for use on the hole closest to the binding posts. Allow to dry. The two screw holes will probably be filled with Acoustical Magic. Ream them out with an awl, or the supplied screws. You may have to bend crossover leads slightly in order to make room for the spacers. To ensure the spacers are tightly coupled to the rear panel, I recommend using long 6/32 bolts, washers, and nuts to hold the spacers in place while the glue is curing. Put washers on the bolts, and insert the bolts through the holes in the rear panel. Place a bead of silicon sealant around one end of each spacer. Put the spacers over the bolts and fasten in place with another flat washer and nut. Tighten the bolts just enough to pull the spacers snug against the rear panel. After the silicon seal has cured overnight, remove the no longer needed bolts.

4. Install the AC Stuff™ into the enclosure. There are four 13" x 18" pieces of AC Stuff™ per speaker. The internal bracing divides the enclosure into four vertical partitions. Install one piece of AC Stuff in each partition.

5. You will notice that there is an aperiodic port on the upper cabinet rear. This is to be stuffed with one 2" x 7" piece of convoluted foam. Refer to Sheet 2 in the back of the manual. The contoured side of the foam faces the inside of the enclosure. Be sure the foam is tight against the enclosure's inside edges.

6. Mount the crossover into the back of the cabinet using foam tape to seal. Do not

overtighten. It is important to get a secure air-tight seal. Use caution with the three long center screws. They are inserted in straight to avoid splitting the cabinet brace. Cut a length of foam tape two inches longer than necessary to cover the outer perimeter of the crossover board cutout. Peel off the backing and carefully press the sticky side against the cabinet. Press firmly to make sure the tape doesn't peel off. After covering the opening's entire perimeter, trim the foam to an exact fit. You can even cut it 1/16" longer than necessary. The foam will compress to form a tight fit with the other end.

Carefully push the crossover leads between the AC Stuff and the front/rear brace. Route the wires so the tweeter leads come through the small driver hole and the woofer leads come through the larger one. Place one pair of woofer leads on each side of the brace. Carefully press the cross-

over board into position, making sure none of the wires are caught between the plastic spacers and the brace. Make sure the foam tape remains in position. Install the 10 black screws around the board's perimeter. Note there are only two long center screws per enclosure.

7. Install the foam tape around the driver mounting holes. The tape should be installed with the sticky side toward the cabinet. It should be such that it is on the outside edge of where the driver will be. See notes on installing tape, which I added to Step 6.

8. Hook up the leads from the crossover to the tweeter. The tweeter has a polarity marking, (usually a red dot), near the positive terminal. Take your time pushing the connectors on, they are delicate. This is probably the hardest part of the whole kit assembly, but Tweak™ or Cramolin™ will help slide the connectors on. Be patient. You may find a small needle nose pliers helps. Install the tweeter using the small screws, and do not overtighten.

The contacts the push-on connectors add will compromise loudspeaker performance, albeit to a small degree.

Audio Concepts, understandably, doesn't wish to bear responsibility for warranty replacement of drivers damaged due to improper soldering technique. If you're competent at soldering, I recommend removing the connectors and soldering the wiring to the terminals to avoid damaging the drivers. First, test each driver's continuity from the terminals to the voice coil using a Volt-Ohm-Milliammeter (VOM) on the RX1 scale. There should be very low resistance, and a clicking sound each

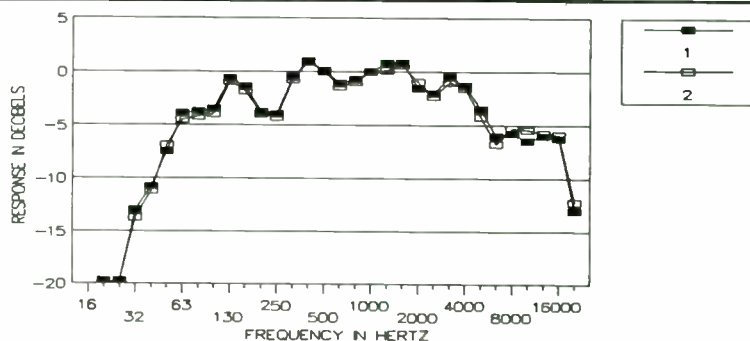

FIGURE 4: One-third octave warble tone response with the microphone 15° off-axis and at a height of 28".

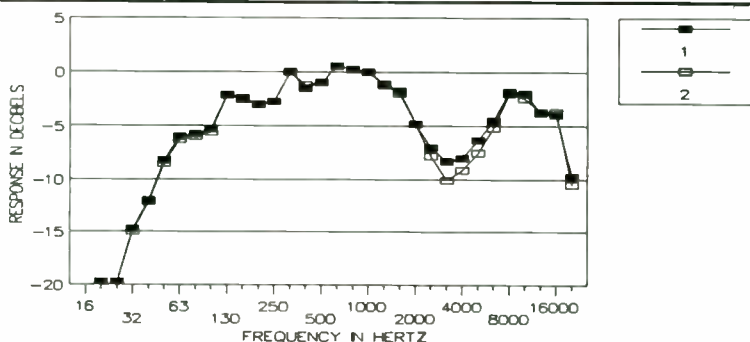

FIGURE 5: One-third octave warble tone response with the microphone 15° off-axis and at a height of 41".

time you make the connection. Most digital meters don't click due to high internal resistance, which is why I recommend the primitive analog VOM.

If the driver is "open" after soldering, you'll know your error, not the manufacturer's, caused the failure. Caveat: soldering the terminals will void the drivers' warranty, so give this recommendation careful consideration. The Focal drivers are well-constructed, so they should stand up to any careful soldering procedure. Pressing the tweeters into the cutout, be sure the wires are not pinched between the driver magnets and the bracing.

9. Attach the wires to the woofer observing the polarity markings near the terminals. Note that there are two sets of wires and that the woofer has two sets of terminals. The connections are interchangeable. All the comments I made in Step 8 apply here, as well.

10. Install the woofers using even pressure on all attachments. Caution: it is easy to press too hard or unevenly and push your tool through the cone. Be careful! Again, don't pinch the wires between the magnets and the bracing.

11. Hook up the Sapphire IIs to your system and try at low volume level to ensure correct hookup.

12. Allow 20-30 hours of break-in time before the speakers sound their best.

When you finish assembly, gently push each woofer cone inward a short way. If the foam stuffing in the aperiodic vent has been installed properly, the woofer will appear sluggish when it returns to its resting position. If it bounces back quickly, you have a leak around the stuffing. You can pull the foam back to ensure the foam is tight against the enclosure's inside edges. Give each enclosure a few knuckle-raps—you'll be impressed by the enclosure's deadness.

The AC Stands are screwed into the bottoms of the Sapphire IIs ensuring tight coupling, but be sure to center the stand on the enclosure's bottom. The AC Spikes contain 1/4-20 threads and are screwed into the MDF at the base of the stands, allowing easy leveling. Be sure all four spikes make contact with the floor beneath your carpet.

Measurements

I ran frequency response curves on the Sapphire IIs using an Old Colony 1/3 octave Warble Tone Generator (which I built) and a Josephson Engineering Measurement Microphone. All measurements were made at 1W, with the microphone at one meter. The grille cloths were removed. My initial measurement was directly on axis, the mike vertical and midway between the woofer and tweeter (Fig. 3). Sample 1 is the loudspeaker I used as the left channel, and Sample 2 the right.

Both loudspeakers were moved to the same position for the measurements. You'll notice the two samples are within

0.5dB of each other throughout their operating range—very good, indeed. It's easy to misinterpret this graph. There are two noticeable dips in response, one at -4dB and another at -5dB. Notice there is little activity above the 0dB reference (set at 1kHz). Over most of their range, the Sapphire IIs are actually flat ± 2.5 dB.

Since first-order crossovers are more sensitive, vertically, to microphone (and ear) position than even order crossovers, or D'Appolito arrangements, I thought it would be worth investigating other microphone position responses. Caldwell told me the loudspeaker's high-frequency balance was best with the ear 15° off the tweeter axis. He recommended "toeing them in" slightly, but having the two

speakers' intersection behind the listening position so the listener is 15° off-axis, and the ideal vertical position is near the bottom of the woofer.

I normally sit in a director's chair when I'm critically listening. My ears are 41 inches from the floor, one inch above the II's top. I decided to measure them at two vertical positions, both with the mike 15° off-axis. Figure 4 shows the response at woofer bottom 28" off the floor. Here, the high frequencies roll off sooner, and the low-frequency roll-off is more gradual, relative to Fig. 3.

I also measured response at my normal listening position. This mike position produced the most erratic upper midrange response (Fig. 5). Figure 6 shows the

DAVIS

ACOUSTICS

MADE IN FRANCE

**ADVANCED TECHNOLOGY
IN THE SERVICE OF MUSIC**



**High technology speaker drivers-
Composite material cones-
Carbon Fiber, Kevlar, Aramid Glass,
Graphite Cellulose, High power magnet,
Colorationless, Low distortion,
Very high dynamic, High power handling**

DAVIS

ACOUSTICS

Exclusively imported by:
Solen Electronique Inc.
4470 Thibault Ave., St-Hubert, QC J3Y 7T9 Canada
Tel: 514-656-2759, Fax: 514-443-4949

Fast Reply #KE1342

Speaker Builder / 6/90 61

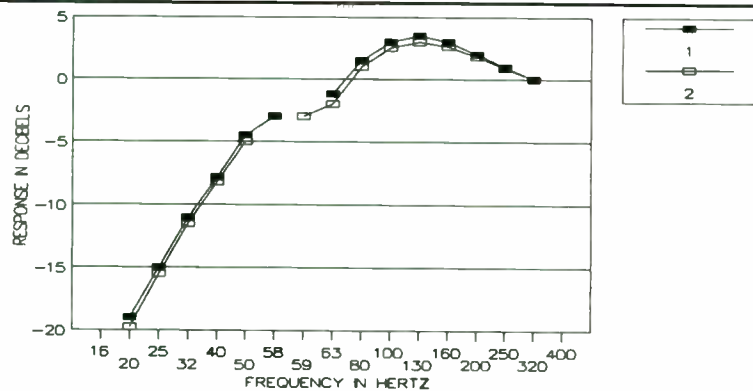

FIGURE 6: The Sapphire II near field response using 1/3-octave warble tones. The curve is expanded to show the -3dB point for each sample.

woofers' near field response from 20Hz-320Hz. Note the horizontal axis expansion at the low-frequency cutoff point. The -3dB point was 58Hz for Sample 1 and 59Hz for Sample 2.

Listening Evaluations

My evaluations were conducted using pre-production prototypes of two Adcom power amplifiers which Victor Campos, Adcom's director of product development, lent to me. The first was the GFA-585, a stereo version of the GFA-565 monaural amplifier, now on the market for several months. The 585 contains circuitry identical to the 565, but has fewer output devices and operates at a lower power output level. It is rated at 250W/channel into 8Ω, but 8Ω doesn't indicate its real capabilities. The 585 will drive low impedance, reactive loads with ease, due to its high current design.

The 585 offers more than brute power. It's a refined amplifier, featuring exceptional inner detail, a large soundstage, natural highs, with dynamics and low-end to burn. Most impressive, it reveals subtle dynamic shadings and articulations other amplifiers mask. The 585 production units should be on the market soon at a price of about \$1,200. (A comparably-powered Krell costs nearly \$6,000.)

I also used a prototype of the GFA-545 II amplifier, an updated version of Adcom's 100W/channel GFA-545. The old 545 was a good amp, except for a somewhat edgy high-end. The 545 II's high and low-end, and the imaging have been improved. Both Adcom amps contain circuitry flat to DC, due to the absence of capacitors in the feedback loop. A servo circuit keeps the output DC offset at a low level. A premium quality film coupling capacitor at the input prevents introduction of any DC to the circuitry which the servo might not correct. The 545 II performed very well with the Sapphire IIs.

Other equipment consisted of my "way beyond POOGE-4" Magnavox CDB-650 CD player and an Adcom GFP-565 pre-amplifier. I also recruited a second pair of ears for evaluative listening. Those belong to Lorelei Murdie, concert halls

manager at the Crane School of Music, and an avid audiophile and music lover. Her work exposes her, like myself, daily to live classical music, and she is perceptive and critical about music reproduction.

Her system consists of an Adcom GFP-565 pre-amp, a POOGE-4 Plus CDB-650 and an Adcom GFA-545 power amp. Her loudspeakers are Vandersteen 2CIs. I have spent many hours listening to her system, and know its characteristics well. We evaluated the new Adcom power amps on her system before I connected them to the speakers.

The Real Test Begins

Before listening to the Sapphire IIs, I broke them in for about 45 hours on FM interstation noise. Even after break-in, the sound continued to improve for about a week. Mike said he noticed continuous improvement for up 80 hours, which reinforces my findings. A somewhat hollow quality in the lower-midrange/upper bass region disappeared after complete break-in. All listening was done with the grille cloths removed, (Dzurko agrees this provides the best sound) since the grille frame introduces diffraction which degrades the imaging.

So, how do the Sapphire IIs sound? In a word, marvelous. It is one of the finest loudspeaker systems I have ever auditioned. No loudspeaker in the "mini monitor" class is expected to deliver any real low bass. The Sapphire IIs don't, but their second order rolloff (Fig. 6) is gradual enough to provide a semblance of the bass, even if the bottom octave and a half is missing. Their low-end is clean and well-defined.

What strikes you first about the Sapphire IIs is their imaging. They reproduce a three-dimensional soundstage as realistically as any I've heard from a dynamic loudspeaker. Depth perspective is so convincing you'll often think you're listening to a dipole. The depth is so great Lorelei thought it was almost too deep compared to the width. I recently purchased one of the new Mercury Living Presence CDs, the Schoenberg/Berg/

Weber disc with Antal Dorati and the London Symphony (Mercury 432 006-2). The spatial cues they reproduced are uncanny. Within the first five seconds of the Schoenberg *Five Pieces for Orchestra*, you'll hear the orchestral sections jump around the soundstage, ending with the trombones way back, and slightly right of center. Try finding a loudspeaker with more accurate imaging than the Sapphire IIs.

I found the depth/width relationship becomes much more realistic with careful speaker positioning. I followed Caldwell's advice, angling them so my listening chair was 15° off-axis. Angled this way, the soundstage is wider, even though there is a very slight reduction in depth. The Sapphire IIs reproduce a more realistic rectangular soundstage with the 15° off-axis positioning. I also found bi-wiring the loudspeakers (double runs of AudioQuest indigo blue cable) opens up the soundstage even more.

The Sapphire IIs have excellent inner detail in the midrange and treble. At moderate listening levels, they have an almost electrostatic-like transparency. They never sound like typical "box" loudspeakers. Audio Concepts has successfully eliminated the sound of the enclosure. Lorelei and I did notice the midrange loses some resolution at higher volumes, particularly if the recording contains a lot of bass. Forcing the driver to attempt to reproduce the low-end taxes the cone, causing some resolution loss in the midrange. They lose far less midrange detail, when driven hard, than most small dynamic loudspeakers. Aperiodic loading used to control woofer cone motion has really paid off.

I'm amazed how powerful these little loudspeakers can sound, within their frequency range limits. Aside from the lack of low bass, the Sapphire IIs fill a fairly large room with clean, natural sound. Their tonal balance is neutral. Various vertical listening positions I tried revealed no changes in tonal balance as significant as the frequency response curves might suggest. Ear level is less critical at a normal listening distance than it is when you're only one meter away from the loudspeaker.

No portion of the frequency spectrum is more prominent than any other. The extreme top doesn't have quite the ease or extension of the Dynaudio D-28/D-21 combination I use in my own reference system. The Sapphire II, however, is superior to my loudspeaker (SB 1, 2/82) in midrange detail and soundstage presentation. The woofer and tweeter integration is seamless.

They reproduce instrumental timbres with amazing accuracy, again resembling a fine electrostatic in this regard. In fact, I've heard more than one electrostatic with far more sonic coloration than they

Continued on page 89

Software Report

It Tells You And Your Speakers Where To Go

The Listening Room, V3.01s by **Sitting Duck Software**, PO Box 130, Veneta, OR 97487. Includes one 5¼" disk and manual. Suggested list price, \$29.95.

Reviewed by *G.R. Koonce*
Contributing Editor

This interesting software package is designed for positioning speakers, and the listener, in such a way as to minimize standing wave effects and other room generated influences. At low cost, you'll be using software which is fun, and produces sound benefits.

This program resulted from Ralph Gonzalez' (math and spatial geometry) and Bill Fitzpatrick's (programming and interface) combined efforts. One part of the program allows you to investigate standing wave effects on the sound you hear. If you own a computer with graphic capability, another allows investigation of early reflection effects, via a Boundary or ER plot.

As explained in the documentation, standing waves can affect your system's apparent frequency response, as well as the transient decay time of your listening environment. The manual discusses these effects, and describes how to use the program to position the speakers and listener for best results. The program can also be used to position turntables and other equipment, minimizing acoustic feedback problems.

The Boundary plot shows the effects of early reflections from the floor, ceiling (optional), side and rear walls. Again, the manual explains what you are trying to accomplish. Sitting Duck Software will include a printed manual, but at this writing it's only on the disk as README.DOC.

Note this file is "paged" for simplified printing by entering: TYPE README.DOC < PRN.

Computer Requirements

The program is designed for any IBM-compatible computer running DOS 2.11 or later, and having 256K or more RAM. To take advantage of the Boundary plot software you must have graphic capability. The software supports Hercules, CGA color, EGA color or VGA color graphics, and has printing capability for the text and graphics. I have never seen a program in this price range which would print screen graphics.

All review information pertains to running the program on an AT-compatible with EGA color graphics, and containing a co-processor. I have run several versions of the software, but all comments and figures pertain to the latest version which I received, the 3.01s.

Program Description

The program needs no installation, and can be run right from the floppy disk (a copy of course) if desired. Initially, when you run the program the floppy disk should *not* be write protected, as the printer setup is saved to disk. Start the program by typing: TLR, or by calling up the batch file ROOM.BAT (per the instructions, but labeled RUNME.BAT on my disk).

After the screen "greeting," you enter the room dimensions. The program accepts room lengths and widths from 72-420" and notes that the width represents the wall along which your speakers are placed. Room heights from 72-180" are supported with the option to delete height

effects for special conditions. The program allows movement of speakers and listener over only one-half of the room dimensions, a limitation which prevented investigation of my usual speaker construction and testing area.

After entering room dimensions, you move on to the standing wave portion. Figure 1 shows the best my computer could do reproducing the screen. There are two basic modes to choose. The default is the symmetric mode: the two speakers are placed the same distance in from the side walls and equidistant from the rear wall. The listener is symmetrically placed along the room width.

This is a good mode to learn, even if it does not fit your listening conditions. On the screen's left is a graph showing H, L, and W symbols for the effects of standing waves on the frequency response over 20-220Hz. You can observe the effects of moving the listener relative to the back wall and the floor, and of moving the speakers relative to the front wall, side walls, and floor.

On my computer, response to moving anything was nearly instantaneous, that is, seeing the H, L, and W symbols in their new locations. This makes experimenting with various locations fun and effortless. Note that positions are dimensioned in inches and that you want to use a speaker height which represents the system's low-frequency output locations—generally the woofer or possibly a port.

Pressing "A" puts you in the asymmetric mode: the two speakers can be positioned independently, and the listener moves relative to the side walls. In this case, due to the asymmetry, you'll notice more H, L, and W symbols on the

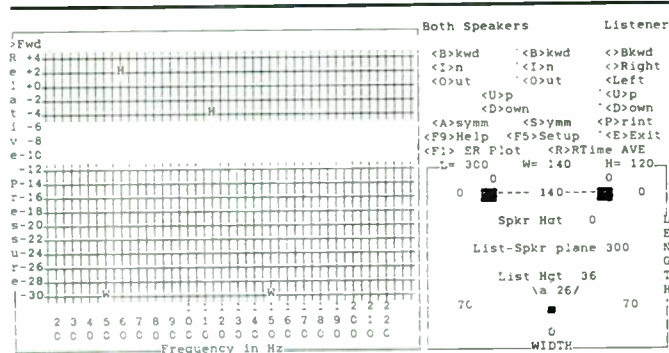

FIGURE 1: Screen for standing waves.

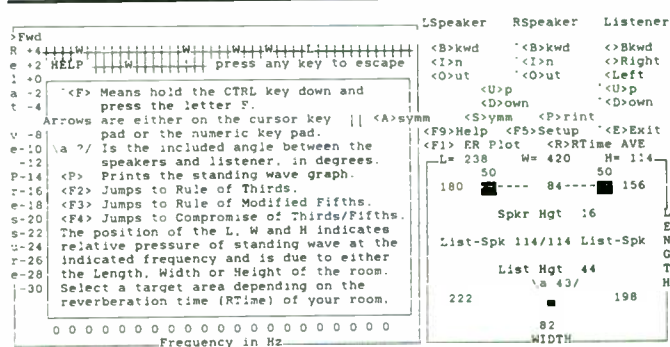

FIGURE 2: Help screen.

DON'T COLOR YOUR SOUND

KEVLAR® & WOVEN CARBON DRIVERS
BY VERSA-TRONICS
PRESENTS TRUE UNCOLORED REPRODUCTION



Only Versa-Tronics Presents:

- 4", 5-1/4", 6-1/2", 8", 10" and 12" Woofers
- Die Cast Alloy Baskets
- Rubber Surrounds
- Aluminum & Kapton Voice Coil Formers
- Excellent Damping
- European Cone Materials
- Polymer Dust Caps
- Extremely light cone material

Available at the following distributors:

Just Speakers
3170 23rd St.
San Francisco, Ca. 94110
(415) 641-9228

Speakers, Etc.
1828 W. Peoria
Phoenix, Az. 85029
(602) 944-1878

Toutant Electronics
246 E. 131st Street
Cleveland, Ohio 44108
(216) 451-6325

Speaker City
10615 Vanowen
Burbank, Ca. 91505
(818) 508-1908

Speaker Works
2539 E. Indian School Rd.
Phoenix, Az. 85016
(602) 956-6344



VERSA-TRONICS INC.

Amherst, NH 03031

LRS^{ELECTRONICS}

Concave Aluminum 1" Dome Tweeter

Linear Piston Behavior
from
1600 Hz to 26000 Hz



(Actual size is 4 7/8" square)

High Power Handling
and Low Distortion

Team up with eight
or six inch precision
hand crafted woofers
to enjoy a superbly
articulate and transparent
loudspeaker system

Full application support
and design information
is always available

Please call or write for
further details:

7 Kelsey Road
Lee, NH 03824
603-659-5335

Fast Reply NKE387

Continued from page 64

2. Resolution (low, medium, high, and average).
3. Maximum frequency of the plot (200Hz-1kHz).
4. Whether there is a ceiling. (Toggle)
5. Stop time (2-100mS).
6. Printer setup.

The option meanings are fully explained in the manual, and won't be covered here. Keep in mind options selected can significantly affect the Boundary plotting time. *Figure 4* illustrates a sample Boundary plot using the asymmetric mode. It took 80 seconds to put the two curves on the screen, but this is a complex plot and most should be much quicker. The number in the plot's lower left corner (556 in *Fig. 4*) is the frequency of the minimum dip on the last curve plotted.

Application

Does using The Listening Room really make a difference? It sure does. I had a perfect chance to investigate this. I normally build and test speaker systems in my garage, making it a seasonal activity. This past winter I added a heated room behind the garage so I could work during the winter months. I moved my homebuilt "standard" speakers into the new room for background music and possibly some serious listening.

The sound quality was terrible. Male voice was so bad it approached unintelligibility. Serious listening was impossible, and for background listening I resorted to small desk speakers. The room has a rug on the concrete floor and storage shelves across one end which form a diffuser behind the speakers. The low ceiling and remaining walls are "hard" with little sound absorbing furnishings. I was sure only major room modification could make a significant improvement.

When The Listening Room arrived, I believed it was an ideal chance to see if it could offer any improvement. *Figure 5* is a typical output from the program's standing wave section, obtained by pressing "P." It shows the results for my original speaker and listener placement. There are more symbols shown here because I was using asymmetric mode. Which speaker produces which symbols cannot be distinguished in the printout, but can on the screen.

After some fun playing with The Listening Room, I arrived at the results in *Fig. 6*. I wasn't able to move all the symbols into the Target Area, as the manual warns you. I could not believe, however, *Fig. 6* represented a major improvement over *Fig. 5*. Playing music proved this wrong—the sound was greatly improved. The room needs more work to be "right," but The Listening Room is definitely a valuable tool for setting up your listening environment.

The Boundary plot in *Fig. 3* shows the results for the modified speaker placement. Note how the placement information is presented. Certain program limitations prevented modeling the garage's listening environment which I use in the summer.

What goes on in your listening room also goes on inside your enclosure in standing wave effects. Would it be possible to use The Listening Room to investigate these effects? This is not the program's intended application, and has certain limitations. I gave it a try, though, by scaling all dimensions 10:1 (frequency will be scaled by the same number).

Figure 7 shows the standing wave plot for a 30" high (length) × 14" deep (width) × 12" wide (height) enclosure. The driver (speaker) was positioned 12" from the top and centered on the front panel. The 6" port (listener) was centered on the front panel, but right against the bottom with its center 1.4" up the front panel. As *Fig. 7* illustrates, this is a terrible port location. All sorts of standing wave patterns are causing high levels at the inside end of the port. This agrees with my experience: locating the inside end of the port close to any wall is a poor choice.

Figure 8 indicates improvement after raising the port's center line 6" up the front panel. Investigating standing wave effects with The Listening Room can be a useful side application of the program—within limits.

Conclusion

The Listening Room includes two demonstration programs, ROOMDEMO.EXE and ROOMDEMO.DOC, which you are free to pass on to friends. If you do not have access to an IBM-compatible computer, Sitting Duck Software will analyze your room. The usual cost is \$20, but the company will analyze two rooms for the price of one for *Speaker Builder* readers.

Send a SASE to Sitting Duck Software (address above) for the special work sheet to describe your listening room. Identify yourself as a *Speaker Builder* reader when ordering worksheets or using this service.

It is a good, reasonably priced program, which has the benefit of investigating speaker and listener positioning—no need to push around a lot of furniture. It provides fast screen and print output of standing wave effects. With computer graphic capabilities, it offers a somewhat slower pace on screen and printing Boundary plots. Although there are some placement limitations, The Listening Room makes modeling your listening room fun and worthwhile.

Bill Fitzpatrick, of Sitting Duck Software, added the following comments on the program's capabilities. The program does not require nor recognize a co-processor. The latest version allows listener movement throughout

Continued on page 90

Product Review

For Perfection, Grille Your Own

By James T. Frane

When you've completed those new speakers, you may want to add the finishing touch by making grilles. Perhaps the fastest and easiest material to use is acoustically transparent open-cell plastic foam. AR, JBL and other loudspeaker manufacturers have used them in the past. Unfortunately, the sole source for this type of material seems to be Radio Shack. I say unfortunately because it would be nice to have a variety of choices.

I decided to investigate Radio Shack's grille foam—which I'll refer to as RS—to see how well-suited it was for use as speaker grilles. I was particularly interested in its effect on frequency response and imaging performance. I already have grille frames for my speakers that consist of a particle board frame covered with polyester cloth. I conducted listening evaluations and made on- and off-axis frequency response measurements to compare RS with the particle board/cloth grilles and with the speakers with no grille installed.

Available in either brown or black, RS has a strip of adhesive-backed Velcro to hold the foam to the front baffle. The back surface is flat and smooth, while the front is a pattern of raised squares created by deep grooves cut vertically and horizontally. The foam is transparent through the grooves, but nearly opaque through the squares.

Using a sharp knife, I cut the foam to size. Next, since my tweeters are of the dome type and protrude slightly from the face of the front baffle, I skived off just enough of the material on the backs of the foam grilles to ensure clearance for the tweeter domes. I then applied the Velcro strips to the front baffle at a few places, installed the RS, and sat back to listen.

A slight but definite shift in the frequency balance occurred. With the speakers aimed at the listening position, the upper mids to the treble range were a little less prominent with grilles installed. With the speakers toed in so that they crossed in front of the listening position, the upper bass region seemed to be boosted, with little or no differences at the mid to upper ranges of the spectrum, compared to having no grilles installed. In both cases, I found no appreciable differences in frequency response between the RS and stock grilles.

Imaging, however, was a different

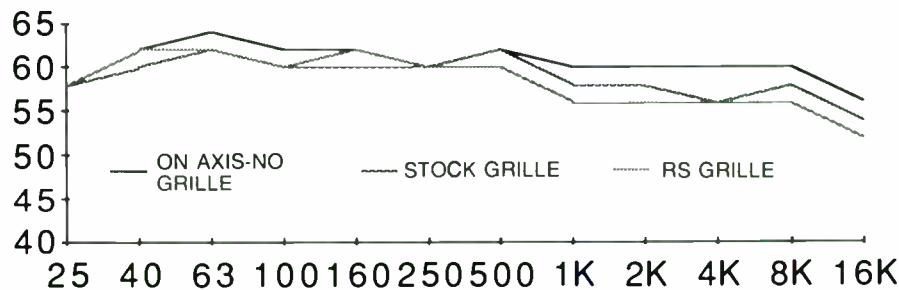

FIGURE 1: Comparative on-axis frequency response curves.

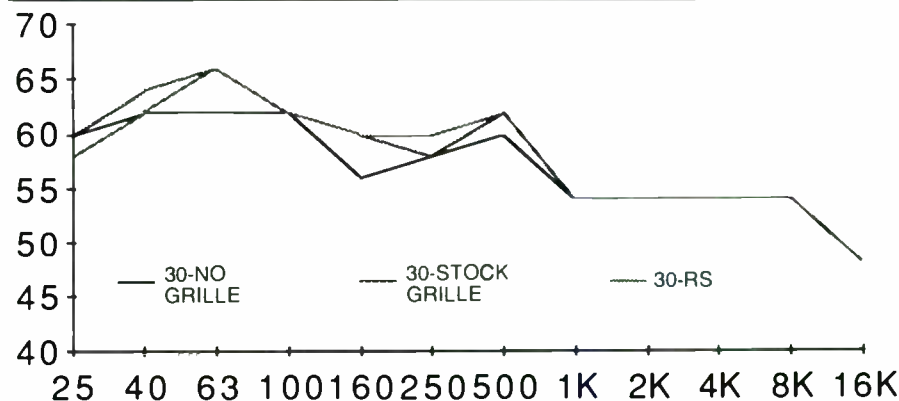

FIGURE 2: Frequency response of each configuration.

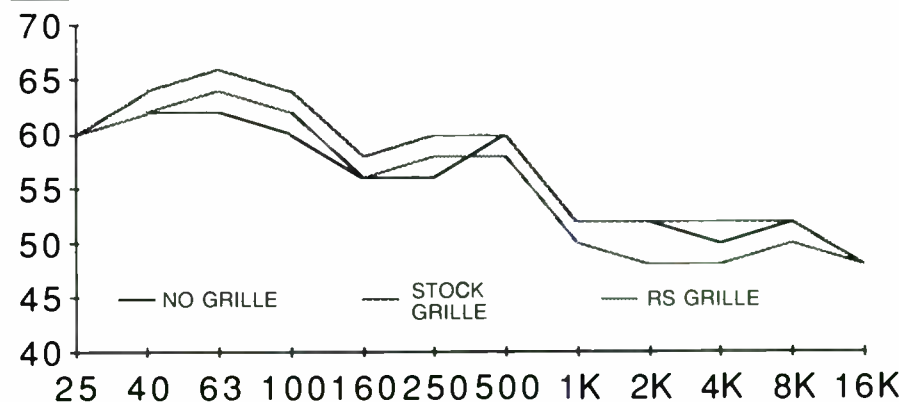

FIGURE 3: Plot of frequency response at 45° off-axis.

story. Both the soundstage width and depth were diminished with the RS as compared to either the stock grilles or no grilles. I was a bit surprised at this, because the RS was advertised as being acoustically transparent, and also because it did away with the particle board frames which might otherwise cause diffraction and deteriorated imaging.

Measurement Set-Up

Since each configuration sounded slightly different, I made frequency response measurements to determine why. I took measurements on axis, at 30°, and at 45° off the speaker axis. All readings were taken with the other speaker silent to avoid delayed-input errors.

Continued on page 69

J. GORDON HOLT

If you had to invent a new language, where would you begin?

Back when high quality sound reproduction was a new idea and **J. Gordon Holt** was a staffer at *High Fidelity* magazine, manufacturers and journalists alike depended on the simple technical quality tests which everyone accepted as the yardsticks for performance. As the industry grew, equipment got better, competition fiercer, and technical reviewing became more crucial to sales managers. Before long, **J. Gordon** began to realize that reviewing was becoming more and more accommodating, and where the reviewers continued to rely on the standard tests, the measurement data began to look more and more alike.

Finally, in frustration, **Holt** left Great Barrington and headed for home in Pennsylvania where he founded *Stereophile* magazine in the spare room of his mother's house. He became convinced that although equipment tests and measurements were important, they no longer accounted for the differences he could hear. Two devices could easily measure the same and yet sound quite different.

Holt abhorred the tendency of the larger magazines to depend almost entirely on measurements, which he saw as a safe way to review without disturbing the manufacturer with any bad news. Not only that, he realized that not one of the US audio publications was publishing reviews that were critical of equipment. In fact, in some cases they were ignoring some flaws.

However, if the reviewer wishes to review how equipment sounds, he faces a severe problem. Our sense of hearing has the smallest vocabulary of any of our five senses. Thus, **Gordon** faced the difficulty of describing sound differences with all too few words with which to do it. He not only had to invent the techniques and disciplines of

what has become known as "subjective reviewing" but also the language with which to do it.

Today, the magazine he founded has become a major force in audio quality judgments around the world. And almost all the vocabulary definitions are his work.

Seldom will you have the opportunity to purchase a reference work backed by so much primary research and experience. Few reviewers have spent more time and energy in an honest search for a defined, factual account of what matters in good sound reproduction techniques. In audio equipment reviewing, **J. Gordon Holt** is not only a pioneer but a master.

THE AUDIO GLOSSARY is the first publication of not only a vocabulary for sound description, but also a comprehensive overview of over 1,900 audio terms: technical and subjective. Your copy is waiting—at your favorite dealer—or order direct using the coupon below.

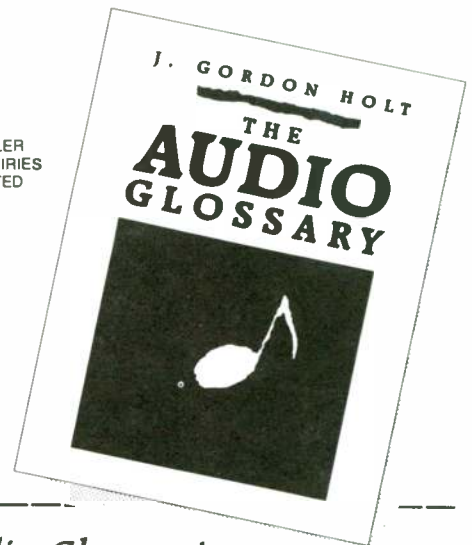

DEALER
INQUIRIES
INVITED

YES! Please send me *The Audio Glossary!*

| | | | | |
|---|---------------|---|-----------------------------|-------------------------------|
| _____ Softbound BKAA-7/S @ \$9.95 | TOTAL \$_____ | <input type="checkbox"/> CK/MO enclosed | <input type="checkbox"/> MC | <input type="checkbox"/> VISA |
| _____ Hardbound w/ dust jacket BKAA-7/H @ \$17.95 | \$_____ | NAME _____ | | |
| _____ Autographed Limited Edition BKAA-7/L @ \$30 | \$_____ | STREET & NO. _____ | | |
| Please add \$1.75 shipping for first book. 50¢ each add'l | \$_____ | CITY _____ | STATE _____ | ZIP _____ |
| TOTAL ORDER \$_____ | | MC/VISA _____ | EXP. _____ | |

OLD COLONY SOUND LAB

PO Box 243, Dept. B90
Peterborough, NH 03458-0243 USA
(603) 924-6371 / 924-6526 / FAX: (603) 924-9467

Answering machine for credit card orders only: (603) 924-6371 before 9:00 a.m., after 4:00 p.m., and weekends.
Have information plus MC/VISA available.

• also available at your favorite audio dealer •

Continued from page 67

For all measurements, I positioned the microphone 24" from the front baffle at a height midway between the tweeter and the midrange/woofer. The sound source was the built-in pink noise generator of an ADC SS-525X equalizer/analyzer. The measurement readouts were taken from the fluorescent bar graph frequency response display of the same unit—which is graduated in 2dB increments—using the calibrated microphone to match this equalizer.

Measurements

Figure 1 shows the comparative on-axis frequency response curves with the stock grille, no grille, and the RS. The bare speakers provided the response nearest to flat. Some attenuation of frequencies above 1kHz resulted with both the stock grille and with the RS, the RS having the more detrimental effect.

Figure 2 shows the frequency response of each of the configurations, with the microphone 30° off-axis. Here, both the stock grille and the RS peak at 63- and 500Hz.

Figure 3 plots the frequency response curves at 45° off-axis. As you can see, everything evens out a bit, with the stock grille having the marginally smoothest curve above 1kHz. The RS also introduces attenuation of some frequencies, particularly above 1kHz. It is not as acoustically transparent as it could be, probably because of the block pattern cut in the front surface of the foam.

On the plus side, however, RS is inexpensive, readily available and convenient to use. And, if its effect on frequency response is complementary to your speakers, this material might actually improve their performance. ▶

LETTER WRITERS AHOY . . .

We need your cooperation in the matter of your welcome letters to authors and other readers. Please enclose a stamped and addressed envelope if you expect a reply. If the author/reader lives outside the USA, please include two International Postal Reply coupons (available at your post office) instead of stamps on your envelope.

In questioning authors, please leave room in your letter for replies which should relate to the article, be framed clearly, and written legibly. Please do not ask for design advice or for equipment evaluations.

Letters to authors or other readers cannot be acknowledged, unfortunately. Any letter which does not comply with the requests above will not be answered.

Speaker Design on the Mac!

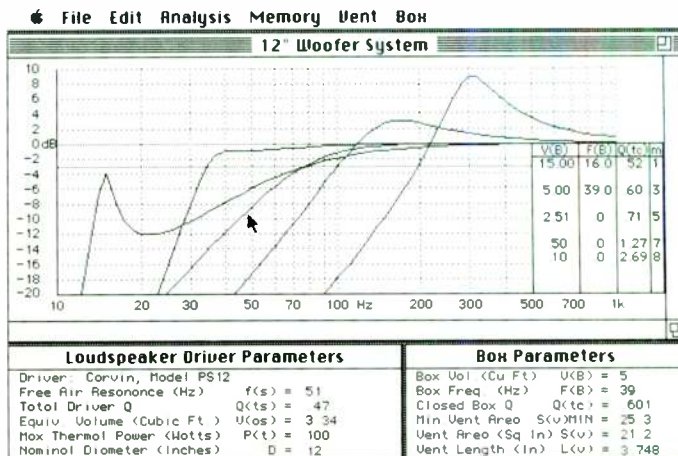

MacSpeakerz™

The Speaker Design Toolbox™

- Plots Response of any Driver / Box Combination
- Closed (Air Suspension) or Vented Enclosures
- Large Driver Library Included (easily expandable)
- Build an Optimum Enclosure on the First Try!
- Runs on any Macintosh™ Computer

from True Image™
349 W. Felicita Ave., Suite 122,
Escondido, CA 92025

To Order Software and Speaker Design Reference
Send \$145.00 plus \$3.00 shipping
for Charge Card Orders call: 619-480-8961
(California Residents add 7% sales tax)



Fast Reply #KE544

A Quality Texture Look Without Laminating Costs and Labor! Designed For Use On Speaker Cabinets

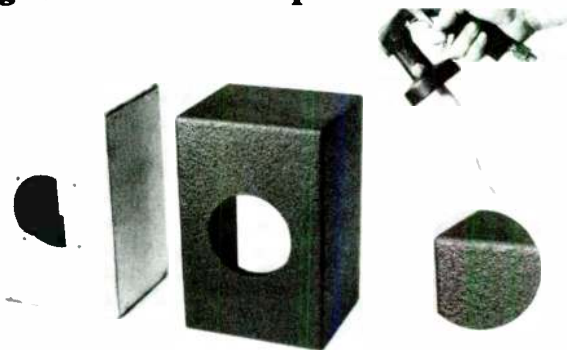

RESTORES OLD WORN OUT SURFACES

TEXTURELAC Spray finish produces a three-dimensional look that resembles a pebble, stucco or leather texture. It can be handled within 15 minutes of spraying and eliminates most sanding, spackling or extra paint operations. Dries to a hard mar-resistant and washable finish.

—Can reduce production spray room material and labor costs by 70 percent or more—

TEXTURELAC Is formulated for use on all wood, and composition woods, plastics and metal castings. It is available in most opaque colors.

For a trial order or swatch panel of TEXTURELAC with descriptive literature call or write:

Abilene Research and Development Corp.
PO Box 294, Hewlett, NY 11557 (516) 791-6943

Fast Reply #KE66

Speaker Builder / 6/90 69

Kit Report

Focal Egg Update

By David W. Davenport

Normally, when I complete a review for *Speaker Builder* I move on to my next project. In the case of the Focal Egg II, however, which I reviewed in *SB* 6/89, a few loose ends needed tying up.

The first was a request (*SB* Letters 1/90) by reader Mark Skiles that I evaluate the cellulose 7C014-DBE driver in the Egg II. Due to the success Dave Wilson, among others, had using cellulose-coned drivers in their designs, I agreed an evaluation of the 7C014-DBE was in order.

I requested a pair of drivers from Focal, and Kimon Bellas was kind enough to import them from France. They are not now generally available in the USA. The 7C014-DBE's ribbed, doped paper cone is thinner and more flexible than the Neoflex cone of the 7N412-DBE. The dust cap is sealed, similar to the dust cap on the older 7N402-DB.

The 7C014-DBE's sound is pleasant, with a lot of space and ambience. It exhibits a "laid back," softer presentation, compared to the Neoflex unit. The 7N412-DBE, however, provides better dynamics and more "authority" along with better detail definition. The Neoflex driver also has better overall tonal balance, as well as deeper and cleaner bass. The cellulose 7C014-DBE is a fine driver which I could live with, and may even prefer in some systems, however, my nod still goes to the Neoflex for the Egg II.

In my *SB* 6/89 review, I reported the 7K011-DBE Kevlar driver exhibited a slightly dark cast in the Egg II. I have since briefly listened to this driver together with the T120K tweeter in a different system configuration, a modified 333 kit. I can't go into detail because I didn't perform a full evaluation, but this configuration didn't exhibit the dark cast which I heard in the Egg II.

I am surprised at the qualitative differences observed, rather than the quantitative effects I expected. I believed that since the three types of drivers were so similar,

any differences in the sound of the drivers used in the Egg II could be attributed to the different cone material. It would follow,

therefore, observed characteristics would hold true from one system to the next.

This was not the case, and I now realize

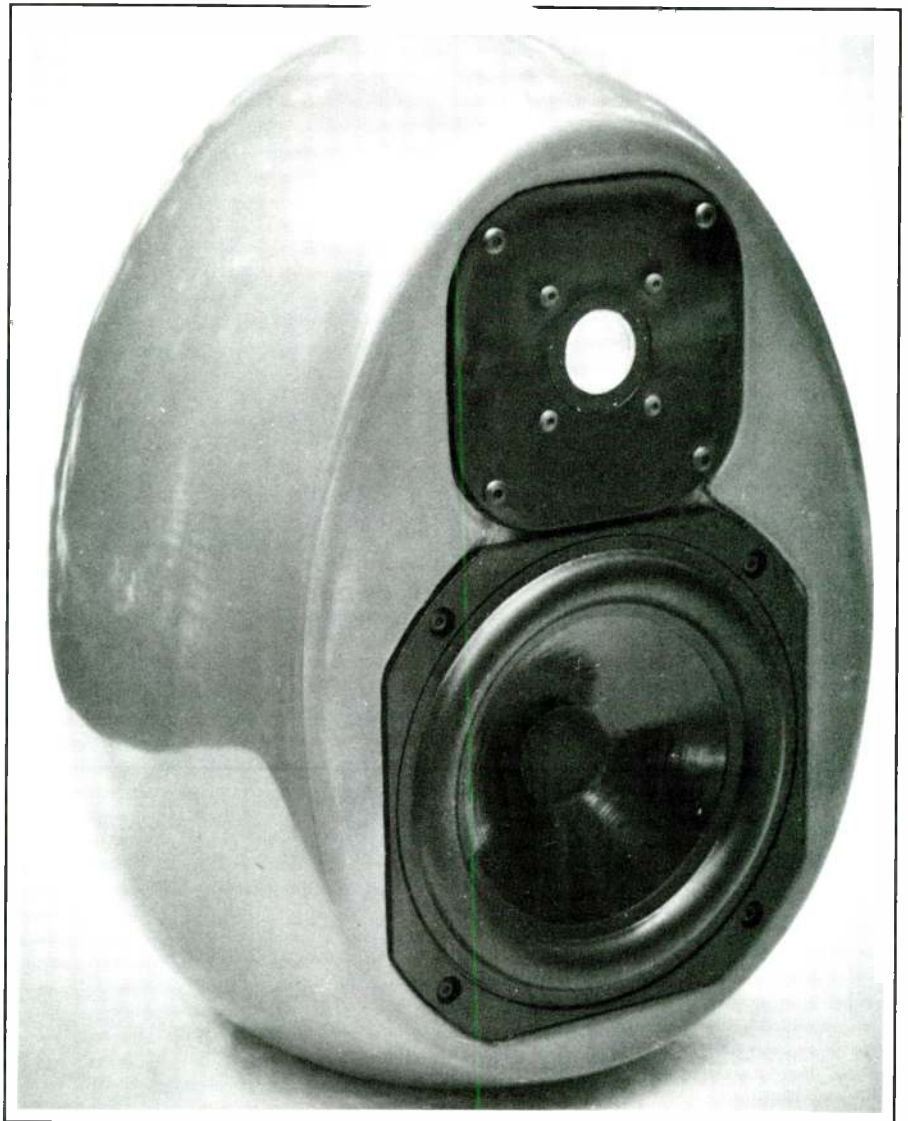

PHOTO 1: The cellulose 7C014-DBE in the Egg 2 provides ample space and ambience.

the dark cast I reported was not solely a characteristic of the 7K011-DBE.

A Further Refinement

In *SB* 1/88, I discussed the special considerations of providing impedance compensation for a dual-coil driver. A first-order approximation is possible by connecting the two voice coils in parallel for measuring inductance, and then splitting the compensation equally between the two coils. As reported in the 6/89 review, the result was an 8Ω resistor in series with a 22μF capacitor across each coil.

A further refinement (effecting a small difference) provides the following: a 10Ω resistor in series with a 30μF capacitor across the coil driven through the 2mH inductor; and a 4Ω resistor in series with a 52μF capacitor across the coil driven through the 4mH inductor.

I'm sure you are familiar with the Focal Aria Seven, a D'Appolito design using a pair of 7K011-DBLs and a T120K tweeter—the same tweeter the Egg 2 uses. In the Aria Seven's design, Joe D'Appolito chose to provide compensation for the T120K's resonance peak. This compensation takes the form of a series resonant circuit consisting of a 5Ω resistor, 1.2mH inductor (including 1.7Ω inherent resistance), and a 46μF capacitor. Curious about this compensation's effect, I ordered a pair from Madisound and installed them in the Egg IIs.

I was surprised at the effect. The sound was generally smoother, but that wasn't what impressed me. Rather, it was the effect on the ambience, which was cleaner and better focused. The depth and width presentation was strikingly improved. I could sense the location and dimensions of empty space—instruments existed within this space. I sum up the result with a comment from my listening notes: "more musically involving." I strongly recommend this modification to anyone with a T120K in their system.

CONSUMER ALERT: A fellow speaker builder, in whom I have complete confidence, has reported a potential component interaction problem. The problem is a break-up of the sound, along with high distortion. As far as he can determine this only happens when a dual-coil driver is connected to a vacuum tube amplifier through a long (approximately 15-ft.) high-capacitance cable.

He recreated the problem with two amplifiers, as well as two models of dual-coil drivers. I haven't experienced the problem in my system, which uses seven tube amplifiers and four dual-coil drivers. The difference is I use a 5-ft. length of Monster Powerline II between my amplifiers and speakers.

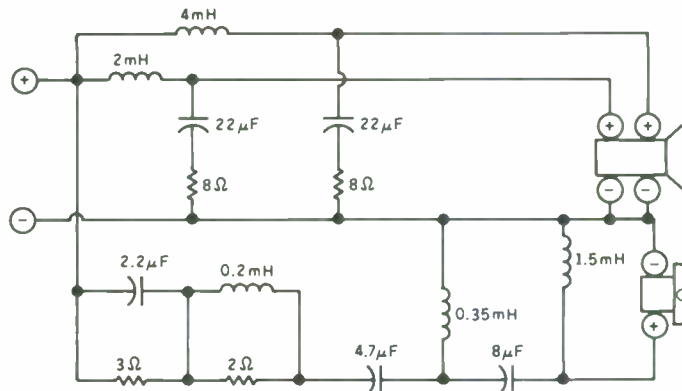

FIGURE 1: The original schematic.

Music so real you want to touch it!



Sapphire II

Look for Gary Galo's review of the **Sapphire II** in your next issue of *Speaker Builder*.

For more information on the **Sapphire II** and our other fine speaker kits, call 1-800-346-9183.

AUDIO CONCEPTS, INC.

901 S. 4th St., La Crosse, WI 54601

(608) 784-4570



SHY AUTHORS
SEND YOUR LETTER TO
THEM VIA US—with your
STAMPED ENVELOPE

BOXES & BINDERS

• FOR YOUR TECHNICAL LIBRARY •

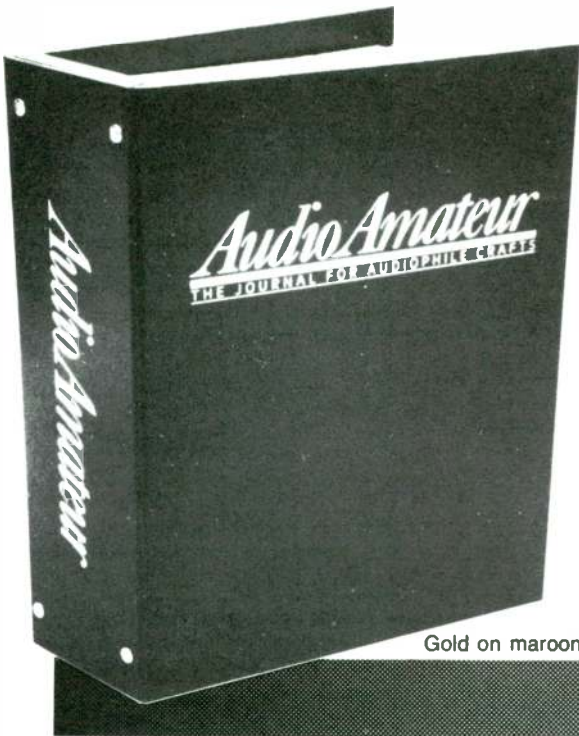

Gold on maroon

THE BINDER

A "loose wire" heavy book binder cloth construction case holds twelve issues of your magazines in a readily accessible format. The logo is hot stamped on cover and spine.

EACH \$12

Three or more, \$10 each

Shipping:
Postpaid in US.
Canada and Caribbean, please add \$4 for one, \$2 for each additional binder.
Overseas, please add \$4 per binder.



Silver on blue

THE BOX

Library quality boxes. 4 1/4 x 9 1/4 x 12" high, brown woodgrain, folding corrugated boxes with handle/label holder to identify contents. Holds 12 issues of *Audio Amateur* or *Speaker Builder* or other valuable magazines in your technical library. Each order supplied with pre-printed labels for each magazine.

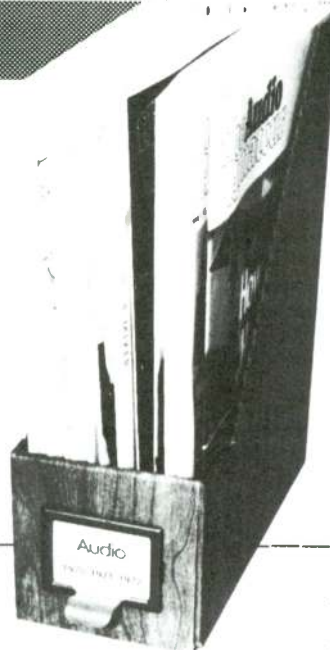

\$8 pair
\$12, four

Shipping:
Postpaid in US.
Canada and Caribbean, please add \$3 for each set of two, \$1 for each additional set of two.
Overseas, please add \$3 per set of two boxes.

| QTY. | | PRICE |
|------|-------------------------------------|-------|
| ___ | Audio Amateur binders @ \$12 | _____ |
| ___ | Audio Amateur binders @ \$10 (3+) | _____ |
| ___ | Speaker Builder binders @ \$12 | _____ |
| ___ | Speaker Builder binders @ \$10 (3+) | _____ |
| ___ | Boxes @ \$8 (2) | _____ |
| ___ | Boxes @ \$12 (4) | _____ |

POSTAGE _____
TOTAL _____

MC VISA CK/MO

_____ AUDIO AMATEUR MAGIC NO.

_____ SPEAKER BUILDER MAGIC NO.

_____ NAME

_____ STREET

_____ CITY

STATE

ZIP

_____ MC/VISA

EXP.

AUDIO AMATEUR PUBLICATIONS, INC.

PO BOX 576, DEPT. B90
PETERBOROUGH, NH 03458-0576

(603) 924-9464

FAX: (603) 924-9467

Answering machine for credit card orders only: (603) 924-9464 before 9:00 a.m., after 4:00 p.m. and weekends.
Have all information plus MC/VISA available.

SB Mailbox

Continued from page 3

5. I have tested two samples of the short coil version of the TX1125JSN mid-range. In free air, the resonance is about 155Hz with a Q_T of 1.0. Enclosed in SEAS' subenclosure, the resonance is about 185Hz with a Q_T of about 1.2. This would require the following circuit adjustments:

| | |
|---------|----------------|
| C64, 65 | 0.001 μ F |
| C63 | 0.056 μ F |
| C66 | 0.33 μ F |
| R63, 64 | 113k Ω |
| R65, 66 | 453k Ω |
| R67, 68 | 19.1k Ω |

The long coil version is still listed in the A&S Speakers catalog. I believe that unit is preferable since it allows experimenting with lower crossover frequencies.

6. An op amp, widely available, and which can also be used is the LF353. Its performance is similar to that of the TL072.

Fernando Ricart
Voorhees, NJ 08043.

tsk, tsk

I've been a *Speaker Builder* subscriber for several years, and have always enjoyed receiving the latest issue. But the issue I just received (*SB 4/90*) was very disappointing.

On the cover is what looks like a penitentiary surrounded by a barbed wire tank trap. I'm not interested in grape cultivation. Shouldn't there be a photograph on the cover more representative of the magazine—namely a "loud-speaker?"

The editorial on page 8 also strays from *SB* precepts. I really don't want the magazine to tell me which amplifiers, cables, and cartridges, I should be using. Numerous other audiophile publications thoroughly cover system integration and use, most of which I already ascribe to.

In Mailbox, pages 87-91, Mr. Cockroft and Mr. Nounsaine seem to have nothing better to do than insult each other's alignments. Why don't they quit mincing words and shoot it out? Not with bullets but with speakers. How about an independent panel reviewing each one's speaker project, and announce a winner? In the future I'd like to see less hostility between *SB* contributors.

Alan Ersen
Sacramento, CA 95823

Speaker Builder 4/90's cover is a view of Skywalker Ranch, the Lucasfilm headquarters building where sound reproduced by loudspeakers is of vital interest. I trust California's department of tourism will not hear about reader Ersen's disdain for two of California's principal exports. —Ed.

THE MUSICAL DONUT

Two years ago, I built two Klipschorns. They have everything a music lover could want: dynamic range, bass response, and low harmonic and intermodulation distortion. My wife, a string teacher, who plays in several local symphonies, uses the system during practice. She says it is the closest thing to a real orchestra she has ever heard.

Being a perfectionist, I believe there is room for improvement. There is a definite "hole in the middle," (the corner speakers are 26 feet apart) and I need a center speaker to develop a better wall of sound.

The question is this: Do you recommend your Show Horn (*SB 2/90*) for filling the void between two Klipschorns? Data in the article makes it appear to be ideal. Would you recommend your midrange horn for use with the bass horn, and which one? Which tweeter?

L. Paul Monohan
Reston, VA 22091

Contributing Editor Edgar replies:

Twenty-six feet is obviously too much separation for good stereo. Two solutions come to mind. First, build two artificial corners, such as recommended in the Paul Klipsch interview (*SB 4/89*), place your corner horns in them, and reduce the separation until "the hole in the center" is filled in to your satisfaction. Depending on your room decor, this solution may or may not be a good one.

The second solution is the route you mentioned. The "show horn" would be a good candidate for a center-fill bass horn with its rectangular shape. Yes, my mid-horns are a valid choice. For the tweeter, I am afraid your choices rapidly narrow down to the venerable T-35.

I recommend that you closely examine artificial corners. Not only is it less effort and money, but I've always liked two-channel stereo for the best imaging. You could follow Klipsch's recommendation in the interview for electronically generating a center channel, but imaging quality suffers.

DRIVERS' RANGE

I built your compact transmission line subwoofers (*SB 1/85*) using 8" drivers. Now I would like to use 10" drivers. Is it possible to use dual 10" drivers, and which 10" drivers would be the best?

I have just completed the SWAN satel-

lites and plan to use your subs, since I was so pleased with the results of my first pair, which were smooth and seamless.

Joseph Jennings
Tacoma, WA 98467

Craig Cushing replies:

Enlargement of my TL subwoofer design is practical and relatively easy. I've already modified the box to accommodate a pair of 8" drivers, (the 64" cross-sectional area is tailor-made for such a modification) and further upsizing to utilize a pair of 10" drivers would be worthwhile. Naturally, the box would also need some lengthening to take advantage of the driver complement's likely lower F_s .

For proper flow, increase the line cross-section to 10½-11" square, (which would substantially enlarge the cabinet's footprint) and make sure the chamber behind the woofers is taller to accommodate both drivers. Stacking the drivers vertically is probably the easiest way. A cabinet height increase of 6-8" would probably be sufficient to optimally extend low-frequency response. You must, however, calculate actual line length based on the F of your drivers' F_s .

My first choice for drivers would be the Eclipse 1038s (available from Madisound or Meniscus). They're rugged, accurate, and relatively inexpensive. Gary Galo has tested them and likes them in the TL format. Although I haven't heard them yet, specifications for the Peerless CC Line 260 SWR look excellent—particularly the long linear excursion. I don't think you'd go wrong using either driver.

Let me know how your project comes out.

WHAT PRICE SYMMETRY?

I have been experimenting with many speaker systems for the past 15 years. In 1988, I embarked on a project to build a no-holds-barred two-way satellite system. The result was a system incorporating the Dynaudio T-330 Esotar tweeter and the Eton 7-380/32 7" Kevlar woofer. The cabinet construction is two concentric Sonotube walls with sand and lead sheet in the internal space, and the inner walls coated with Acoustic Magic.

The system is ported with 2" PVC pipe ducting. The crossovers are outboard and are first-order networks at 2.7kHz with impedance compensation. The extraordinary power-handling capability of both drivers makes the 6dB/octave crossover a reasonable choice.

I have been pleased with the results. The sound is smooth, and detailed. These high-quality drivers are as fast and effortless as anything I have heard. I run the satellites down to 80Hz at which point an active crossover rolls them off (24dB/octave) in favor of a pair of subwoofers.

My question is as follows. For the past

Music to your eyes.

Speaker cabinets for the custom builder.

Grenier Cabinets offers a full line of speaker cabinets and stands that allow you to custom design your own speaker system.

You can choose from 25 models in several different styles of oak and walnut veneer. The cabinets come fully assembled and unfinished, allowing you to create just the right finish to match your room. Lacquer and matte-laminated finishes are available in all colors of Formica,[®] Wilson Art[®] and Pionite.[®]

Choice of brown or black grille cloth. Stands can also be made to complement the cabinets. Round holes cut for drivers at nominal charge. Terminal plates and ports available.

Call or write for our new, color brochure and price list.

Formica[®] is a registered trademark of the Formica Corporation. Wilson Art[®] is a registered trademark of Ralph Wilson Plastics. Pionite[®] is a registered trademark of Pioneer Plastics Inc.



Grenier Cabinets, 5901 Jennings Road,
Horseheads, NY 14845. (607) 594-3838

Fast Reply **NKE166**

couple of years, I followed discussions in *SB* about the symmetric D'Appolito driver configuration. I wonder if this system design would pay dividends in my own system. It would be relatively straightforward to add another Eton woofer to each speaker to produce the symmetric configuration.

My current system, however, requires roughly a 4dB tweeter attenuation to properly match the two drivers. Adding another woofer in series will result in the same acoustic output; adding the second woofer in parallel will result in a 6dB boost to the low end. In either case, I am not certain whether the simple crossover I now use would give satisfactory results.

Does Mr. D'Appolito (or anyone else) have any insights on using these particular drivers. Is there any preferred way to passively cross these drivers, or must I bite the bullet and bi-amp? I believe one could build a really superb system with these drivers—though it certainly is pricey.

Randy Simon
Belmont, CA 94002

Joe D'Appolito replies:

Yes, you could use your drivers in my driver configuration. The system should be designed along the lines of the ARIA SEVEN of the Signature 717 systems which use similar drivers. Running the woofers in parallel would give you an extra 2dB sensitivity, which could be used to partially compensate for low-frequency diffraction loss.

The crossover frequency you are using is a little high for the driver separation you'll be forced to accept. I say forced because the T-330 is very large for a 1" tweeter. You need not bi-amp, but the passive design will be non-standard. I'm afraid you'll have to judge for yourself whether the results are worth the cost.

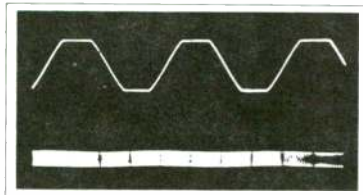
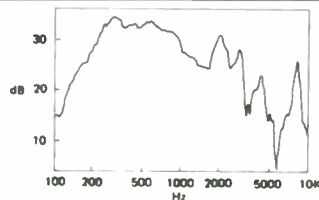
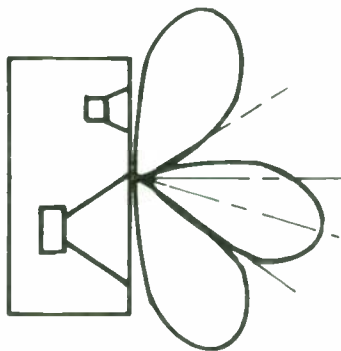

Technical Audio Insight

Technical Paper Series from Audio Control

Send the coupon below (or a photocopy) today for the complete series of Audio Control technical papers by author and sound engineer Rick Chinn. Normally \$1.50 each (\$1.00 plus \$.50 shipping), receive all 7 for only \$5.00.

- No. 101 The Effect of Car Acoustics on Automobile Sound Systems
- No. 102 Crossover Networks from A to Linkwitz-Riley
- No. 103 Level Matching
- No. 104 Crossover and Biamplication
- No. 105 How Recordings are Made
- No. 106 Constant Q and Equalizers
- No. 107 Real Time Spectrum Analyzers as a Sound Tool

- Send all 7 technical papers. My hard earned \$5 is enclosed
- Send Richter Scale information

Name _____
Address _____
City _____ State _____ Zip _____

AudioControl
22313 70th Ave West • Mountlake Terrace, WA 98043
(206)775-8461 • FAX (206)778-3166

Fast Reply **NKE123**

SIXTH-ORDER SENSE

I have several bass reflex woofers, and would appreciate information about how to construct sixth-order bandpass woofer boxes. I think I've read everything which talks "around" the subject. For ordinary

"SITA! SITA!"

CARE

When the world cries "Help!"
CARE is there.

1-800-242-GIVE

people in the real world, how sensitive are the boxes to tuning?

Thank you for your assistance.

Edward Endicott
San Francisco, CA 94122

Joe D'Appolito replies:

You make a sixth-order symmetric response bandpass subwoofer by cascading a fourth-order acoustic bandpass subwoofer with a series LC circuit. That simple description of the sixth-order bandpass, however, belies the design process difficulty. The series LC circuit isn't simply an external bandpass crossover network, but an integral element of the electroacoustical design. In addition to the parameters which influence bass reflex system design, F_{SA} , V_{AS} , Q_{TS} , V_B , F_B , and Q_B , sixth-order bandpass response is also greatly influenced by the resonant frequency and Q of the series LC network.

The sixth-order design has many advantages over the fourth-order design. For the same passband, the sixth-order system can be up to 6dB more efficient. The LC circuit also controls low-frequency cone motion and greatly reduces out-of-band spurious responses due to standing wave resonances in the front volume and organ pipe resonances in the port. Because the series LC circuit Q is easily controlled, it is usually possible to obtain flat response in the passband over a wide range of drive parameters. This should be contrasted with the fourth-order design, where passband ripple is almost inevitable.

A full description of the sixth-order design process is too complex for a reply here, but I am preparing an article on this subject for future publication.

ISOBARIK OPTIONS

I am writing because I like Isobarik speaker design. I read your article, "An Isobarik System," (SB 3/85) and have some questions I'm bold enough to trouble you with.

I built a three-way system using Madisound drivers/crossovers. I used their recommendations for the HD2 4B45 10". The results were disappointing. There wasn't much bass, and what was there was muddy (using as a test the 32Hz organ note from Zarathustra on a London CD).

I wrote to Madisound, and at their suggestion returned the drivers for testing. They had quite a different real vs. advertised T/S profile. F_S is 40 instead of 23, Q_{TS} is 0.495 instead of 0.31, and V_{AS} is 56L instead of 268L. So, I rebuilt the boxes with the new figures. The results are better—worth the extra work—but to me they still sound a little muddy in ported enclosures. Is it common for speakers to be so far off advertised specifications? How can one design speaker systems if data is so unreliable, and if one does not have equipment and skills to test them?

Now about the Isobarik. In the interest

of deep, clean bass, I have been eyeing the VMPS 15" woofers in the A & S catalog. They are inexpensive enough that I could use a couple, each in subwoofer boxes of modest dimensions. Using Dickson's tables, for a Q_{TC} of 1, I'd make a box of 6.1³ (minus 1.5³ for the tube, which would be the same as 9.7³ for a single driver).

The boxes I have in mind would look like Fig. 1.

The speakers would fire downward. The rear baffle (the top in this case) will be made of 1" slate. It's polished and quite attractive, and very dense. I'd put 3" ball casters under the floor must be

1. How far above the floor must the

Continued on page 78

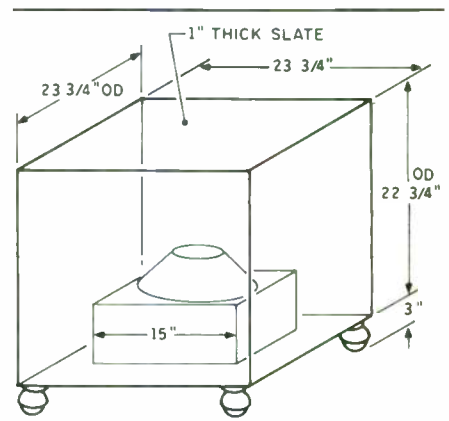
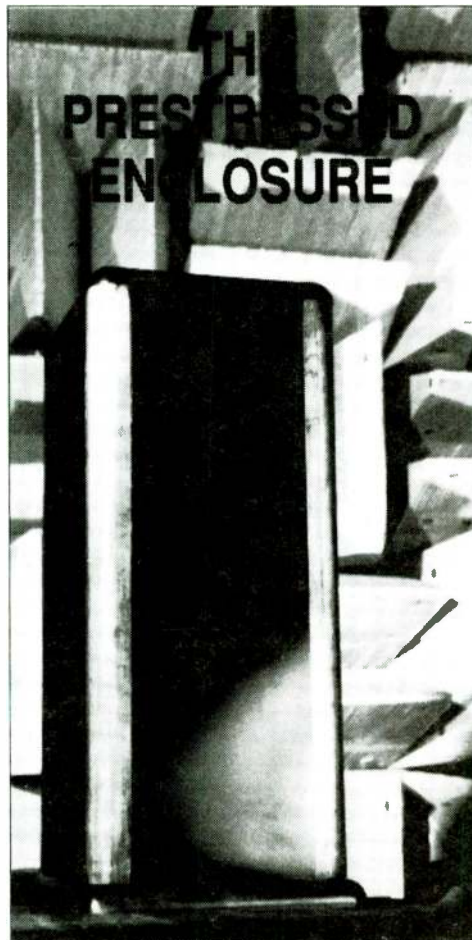

FIGURE 1: Box dimensions and design.



ADVANCED ENCLOSURES ENGINEERED TO YOUR DIMENSIONS

GREGENG will design and fabricate enclosure panel components to the height/width/depth specifications of your next loudspeaker project.

The Audibility of Enclosure Panel Resonances has been determined through controlled listening tests.* As illustrated below, the SPL developed by panels of typical enclosures is unacceptable.

GREGENG Composite Honeycomb Panels Thin aluminum sheets bonded to a HIPS plastic honeycomb core possess bending rigidity ten times that of 19mm thick fiberboard. Solid hardwood is used for the less critical top and bottom panels and radiused edge pieces.

A network of **Internal Tensioned Cables** (patent pending) attached between enclosure panels produces a grid of forces pulling inward and prestressing each panel. A simple, inexpensive alternative to rigid internal braces is provided.

Enclosures are shipped as unassembled kits with or without the hardwood components. A free brochure will be sent on your request.

* References to research literature are given in the brochure.

GREGENG

9737 Macleod Trail, P.O. Box 42206,
Calgary, Canada T2J 7A6

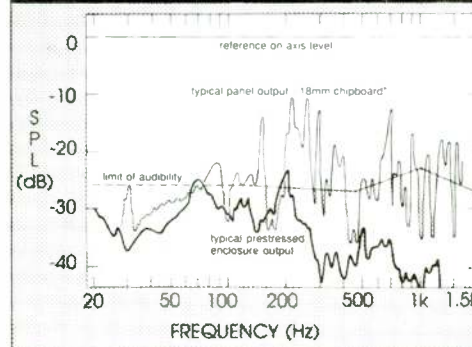

Fast Reply NKE699

Speaker Builder / 6/90 75

Speaker Builder's Publisher announces:

THE WORLD'S FINEST RECREATIONAL ELECTRONICS JOURNAL



THE POWER

Elektor Electronics USA is a 76-page monthly with an average of 14 articles per issue, covering virtually every technology. Over 80% are construction features which include circuit diagrams, schematics, parts lists, and sources. The magazine's service department will supply circuit cards, software, firmware, and front panels for most projects.

Tutorial articles by outstanding authorities explain the latest technological developments.

Elektor Electronics USA construction projects are written, with few exceptions, by staff engineers who design and test them with the aid of staff technicians and support people. All project prototypes are built and thoroughly tested before publication and also reviewed by the Dutch government's equivalent of the US Underwriters Laboratories.

Elektor Electronics USA originates in Beek, The Netherlands. The multilingual staff not only produces the magazine's content, but also translates the articles into Swedish, English, French, German, Spanish and Portuguese. The magazine is published in separate editions for Sweden, Germany, England, The Netherlands, France, Spain, Portugal, Greece, India and Pakistan—and now The United States and Canada. The North American edition will feature new product and conference news as well as reader correspondence and free classified ads.

Become a subscriber to *ELEKTOR ELECTRONICS USA* at almost 25% OFF THE REGULAR SUBSCRIPTION PRICE of just \$19.95 for eleven monthly issues. (Save \$8 off the regular \$28 annual rate.)

We're so sure you'll be delighted, we guarantee it: ALL your money back if you are not completely satisfied, for any reason. No ifs, no buts, period.

O.K. Ed, sign me up as a subscriber to *Elektor Electronics USA**

___ One year (11 issues) @ \$19.95 CK MO MC VISA

___ Two years (22 issues) @ \$37.95

Please add \$8 per year for Canadian postage.

* Available to subscribers in USA and Canada, only.

THE FUN

SAMPLES FROM SIX RECENT ISSUES:

A Facsimile Interface for the IBM-PC, Automatic Power-down for PCs, A Mini EPROM Viewer, A MIDI Master Keyboard, Remotely Controlled Stroboscope, Rear Window Wiper Coupler, A Four-sensor sunshine recorder, Power Zener Diode, An Electronic Load, PLL sine wave generator, A Horn Loudspeaker, Intro-scan for CD Players, A PC Servicing Card, Centronics A-D/D-A converter, Acoustic Temperature monitor, Experimental all-waveband ferrite rod antenna, Image segmentation, Budget sweep/function generator, Transistor characteristic plots, An RS-232 Splitter/Multiplier, Digitally controlled preamplifier, All Solid State Preamplifier (2 parts), A Visual Hard Disk monitor, Coded locking security circuit, The digital model train: (13 parts), A wiring allocation tester, A video line selector, A Q meter, A Video mixer, Bridge Rectifiers for high output AC-DC and Multiplier use, Automatic Power line isolator switch, A 3-pen, 20" plotter with parallel port, An AC Millivoltmeter, An FM tuner board for your PC.

NAME _____
ADDRESS _____
CITY _____ STATE _____ ZIP _____
MC/VISA _____ EXP. _____

AUDIO AMATEUR PUBLICATIONS

PO Box 876, Dept. B90

Peterborough, NH 03458-0876

(603) 924-9464 FAX: (603) 924-9467

Answering machine for credit card orders only:
before 9:00 a.m., after 4:00 p.m. and weekends.
Have all information plus MC/VISA available.

Elektor Electronics USA

- Video line selector
- Q meter
- Automatic mains switch
- RS232 splitter
- Bridge rectifiers revisited
- Coded locking circuit



TYNorge
 (MUSIKK) OG VANS APART

1845 DENN TV-FILM
 1900 "HJEMMET'S LIFESTYLE"
 1930 MUSIKK MUSIKK MUSIKK
 2000 CASINO
 2115 POLITIET PÅ HILL STREET
 2210 ENGELSK FOTBALL
 2255 BEYOND 2000 (1)

MUSIKK OG VANS APART



ARD/BADN 1 PLUS

NORDIC CHANNEL

0405 05101012101110
 05000000 05101012101110
 05000000 05101012101110
 05000000 05101012101110
 05000000 05101012101110
 05000000 05101012101110

boxes be to avoid problems? The floor is carpeted (and no neighbors below).

2. Dickason shows a compound setup with the rear woofer back-to-back with the front, out of phase. Is there any advantage to this? I believe one would gain a little internal box volume with a shorter tube front-to-back.

3. Matching the woofer to the satellites, I can see two options, as I shall bi-amp. The first is using an AC Richter Scale as crossover and Equalizer. Looking at Dickason's chart on page 4, there is a bit of a hump with a Q_{TC} of 1. Will the Richter Scale let me flatten that out?

If my calculations are correct, I get an F_C of 28.3 and F_3 of 22.25. Have I made a mistake with these predictions?

The second option would be using the Basis kit described in a recent *Audio* magazine (April, 1990, p. 36) and a crossover kit from Old Colony. I am less inclined to do this because it looks more expensive, and because I'm not sure I have the necessary skill and knowledge to fit a power supply to a couple of crossovers and get the entire speaker system matched up. If I could find a way to overcome these drawbacks, would the second option have advantages over the first?

4. Whichever option I take, will I need to add impedance compensation for the

subwoofers? Does the use of electronic crossovers make that unnecessary?

I have one more set of questions. In the interests of cost and size, suppose I scaled down the above and used 12" woofers? I calculate the F_3 in the mid-30s. Would either option above allow me to lower and flatten F_3 , and still get clean bass?

If you can offer any advice about the matters I've touched on, or suggest further reading, I will be grateful.

PS) I listen exclusively to classical music, lately mostly chamber music.

Niels Winther Braroe
Charlestown, MA 02192

John Cockroft replies:

Unfortunately, your experience with the Madisound speaker isn't an isolated occurrence, though in most cases I believe you could expect better results. I had a similar experience with the Madisound 8152 8" woofer. I purchased one which had: F_{SA} , 41Hz, Q_T , 0.527. I didn't measure V_{AS} , as I was going to use it in a transmission line, where it doesn't matter. Published specs for this woofer are: F_{SA} , 32Hz \pm 2Hz, Q_{TS} , 0.35.

I could never get this speaker to sound good in anything. It sounded shallow and muddy. I eventually gave it to a high school friend to play with. Don't misunderstand me, I'm not down on Madisound. I think it's a great company. It's just that speakers aren't boxes of corn flakes.

There are many things which can go wrong when they try to make consistent speakers. Many times one error will cancel another error, and the speaker will become much like its brothers and sisters. Once in awhile everything seems to go wrong (as you and I know). This is life.

There are pitfalls in designing without measurement. These are often minimized by working with simpler systems, such as sealed boxes and my hybrid transmission lines and the aperiodic boxes (such as Dynaudio's Variovent). You may not come up with exactly what you wanted, but it will probably be something you can use. Vented and passive radiator systems and horns don't fare as well with casual treatment, as there are many things to balance. You can't balance very well if you don't know what it is you are balancing.

Apparently, your Zarathustra CD was in better shape than the one which drove Robert Spear (SB 3/90 p. 102) to the brink.

The VMPS 15" woofer looks like it would work fine for your Isobarik purposes. I came out with the same figures you mentioned. One word of caution: You said 6.1^3 (minus $1\frac{1}{4}^3$ for the tube). That should be *plus* $1\frac{1}{4}^3$. The 6.1^3 is net volume.

The box you describe would probably work well. I'd guess the 3" caster spacing would be a pretty good speaker spacing for a floor firing woofer. Other designs have used similar spacing with apparent success. I think the 1.24dB hump around 30Hz will not even be noticed. It will, no doubt, be swamped by standing waves in the room. The ear isn't very sensitive to low magnitude SPL changes at lower frequencies. (I'm not sure which ear I'm referring to when I say "the" ear, but I'm too old to worry about it.)

The Perfect Pitch

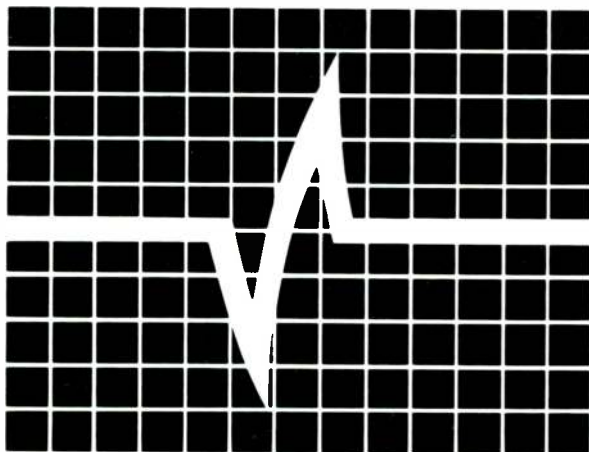

A ONE YEAR SUBSCRIPTION TO HI-FI NEWS & RECORD REVIEW COSTS £24.80 FOR SURFACE MAIL AND £42.50 FOR AIR MAIL

... SUBSCRIBE TODAY!

Please send me 12 monthly issues of Hi-Fi News & Record Review commencing with the next available issue.

- £24.80 Surface Mail
 £42.50 Air Mail

I enclose a cheque/International money order payable to Link House Magazines Ltd. or debit my credit card

- VISA ACCESS/MASTERCARD DINERS AMEX

Credit card no. _____ Expiry date: _____

Signature _____

(Please print in block capitals)

Name: _____

Address: _____

(HF02)

To: Hi-Fi News & Record Review, Subscription Department
Link House Magazines Ltd.
120-126 Lavender Avenue, Mitcham, Surrey CR4 3HP England

I understand that I am committed to one year's subscription and should I wish to cancel no refund will be made
Registered in England and Wales No 1341560

**HI-FI
NEWS
&
RECORD REVIEW**

Since that's what it's designed for, I'd assumed the Richter Scale would probably work well as a subwoofer crossover/equalizer. I am not familiar with the Basis kit you refer to. There are other, much less expensive ways to go. Marchand sells assembled XM-1 electronic boards for \$23.95 each, as advertised in *SB*.

All that is required for a crossover is two boards and two frequency modules (at \$1.45 each you could get a pair of 100, 125, and 200Hz modules and use the pair which sounds best). You will also need a $\pm 15V$ power supply. Marchand sells one, Old Colony Sound has them, and Jameco makes a nice regulated kit for less than \$20. I use the Marchand boards and a home brew power supply.

I believe the Isobarik configuration with the two speakers facing the same way allows a shorter tube, since the front speaker's magnet may extend a bit into the rear speaker's cone space. Make sure you leave enough room so the rear cone won't hit the front magnet in the long excursions subwoofers are apt to make.

There is a theoretical advantage to the back-to-back, out-of-phase version. There's supposed to be a cancellation of second-harmonic distortion because of the voice coils moving in opposite directions.

CAVEAT CORRESPONDENTS

Things that go bump in our round file:

1. "I'm thinking of building a 16-in, 8-out console in my basement. What tape recorder should I buy?"
2. "Is my Fisher Z-705 receiver worth updating? Where should I begin?"
3. "Although I forgot to enclose a stamped, self-addressed envelope, please answer the following nine questions based on my experiences building your inverted RIAA kit."
 4. "Please forward this (unstamped) letter to Ralph J. whose letter appeared in one of the 1970 issues—don't remember which."
 5. "I have a Milhous 10W integrated stereo amplifier and a Gesundheit turntable. Which of the following six cartridges would you recommend?"
 6. Queries with no stamped, self-addressed envelope or postal coupons enclosed.
 7. Letters without return addresses on them whose envelopes have strayed away somewhere.
 8. Illegible hand-written letters scrawled on odd scraps of paper. If you have no access to a typewriter, please try to be sure our typesetter doesn't lose his eyesight and his mind in deciphering your writing. (This is especially important if you want us to publish your classified ad.)

In a true push-pull system (where both speakers are radiating) this is probably true. I'm not sure this really happens in the case where one speaker is still in the womb (so to speak).

Using an electronic crossover allows you to ignore impedance compensating circuits (Zobel's) as most modern amplifiers can handle quite a range of impedances above the minimum.

If you wanted to use the 12" VMPS woofer, a box to give $Q = 0.707$ (based on published specs) with $F_C = F_3 = 37.3\text{Hz}$ would be about 2.4³ ft. net. This box is small enough to be stuffed with fiberfill pillow stuffing (or Acousta-Stuf) at about $\frac{3}{4}\text{lbs/ft}^3$. You could probably get by with a 4" layer of insulation grade fiberglass on all the walls of the larger box (if economy is a factor).

Remove any paper or plastic vapor barriers from

the fiberglass. Be sure to wear vinyl gloves when handling fiberglass. Glue it in place with dabs of white glue, or use something like box nails. Also put some fiberglass on the outside of the tunnel. Line the inside with $\frac{1}{2}$ " felt, or $\frac{1}{2}$ " cotton batting, or 1" fiberglass. Don't let it interfere with the cones or surrounds. Glue this well so it won't move around when the cones move.

Since you already have a power supply for the crossover, you could easily add a bass boost filter. If you're going to use a summed channel subwoofer you would only need one filter downstream of the resistors which are used to combine the channels. For a box close to $Q_{TC} = 0.707$ a 12dB peak should occur at $0.51 F_C$, for a response which will extend to about $0.49 F_C$. In your case, the filter serves as an infrasonic filter below 18Hz.



Peerless
HI-FI speaker

Reliable in supply and quality

CC-LINE

Peerless' new CC-line is for absolute connoisseurs. Music lovers who know how to appreciate the slight difference.

The CC-line, which consists of tweeters, midrange and woofers 6 1/2", 8" and 12", is an exclusive improvement to Peerless' standard line and the absolute top products Peerless has ever manufactured.

Peerless has introduced a specially developed magnet system with built-in short-circuiting ring, which eliminates AC magnetization of the pole piece and linearizes the impedance, thus reducing distortion substantially.



The CC-line is a genuinely peerless product. A guaranteed hi-tuned clarity of sound from Peerless.

For a catalog including the CC-line and standard line, please respond to reply number below.

PEERLESS OF AMERICA, INC.

800 W. Central Road
Mt. Prospect, IL 60056
708-394-9678

Fast Reply #KE666

HTA by CIZEK

NEW SUBWOOFER-

3dB DOWN AT 25 CYCLES!

NEW DESIGNER SERIES

SPEAKER SYSTEMS

FEATURING

SOLID RED WOOD CABINETS

WITH WHITE WASH

2-WAY/3-WAY

REQUEST OUR CATALOG

AND SPECIAL PROVISIONS

FOR FACTORY DIRECT SALES

NEW DRIVER CATALOG AVAILABLE

CUSTOM DRIVERS / SYSTEMS /

NETWORKS, ON REQUEST

HTA, INC.

1611 Crenshaw

Suite 142, Department SB1190

Torrance, CA 90501

(213) 539-2469

Fast Reply #KE643



ACOUSTIC MATERIALS FOR USE
IN SPEAKER CONSTRUCTION,
RECORDING STUDIOS,
LISTENING ROOMS.

PRODUCTS INCLUDE:

- SOUND ABSORBING
ACOUSTIC FOAM
- VIBRATION DAMPING
INTERLAYERS
- ACOUSTIC WALL PANELS

FOR MORE INFORMATION
CALL TOLL FREE AT

1-800-359-1036

SOUNDOWN CORP.

45 CONGRESS ST., SUITE 1
SALEM, MA 01970



Fast Reply #KE689

AREN'T YOU A FAMOUS AUTHOR?

Maybe you've never thought of yourself as an author, but that shouldn't stop you from telling your story. If you can write a letter, you can relate your account of how you solved a problem, improved a lackluster machine or speeded up a process. Maybe you needed a special tool or gadget that nobody makes and you made it yourself. Your ingenuity shouldn't go unrewarded. Write up your project, large or small, and send it along. On really large projects, write a short proposal first to make sure that we aren't about to publish a similar one. We pay \$50 per page minimum for articles! So warm up your word processor and share your adventures.

Your amplifier will seldom (if ever) be required to put out the extra 12dB, as there isn't much music around 18Hz. I would first try the system without the filter. It may be satisfactory. (See SB 3/90, p. 36 regarding Millard Johnson's Isobarik experience.)

I'm not familiar with the Dynaudio Twynn satellites (other than seeing ads for them), but I don't think speakers with a Q_{TS} of 0.74 are a good choice for serious music. I haven't heard them, but I believe one of the new speakers Joe D'Appolito designed might be just what you need. The 12" VMPS version of the subwoofer (with or without the filter) would be adequate for chamber music.

the minimum impedance above the basic resonant frequency is always larger than R_E , the voice coil DC resistance.

The proper way to model this effect is to include the voice coil inductance in your analysis. If you are interested only in low-frequency performance and voice coil inductance is not excessive, I would use R_E and *not* correct it for the measured minimum impedance.

KLIPSCHORNS REVISITED

I've been a subscriber to *Speaker Builder* almost from the beginning and decided I would tell you how much I enjoy the magazine, and how great it is to be able to exchange information, experience, and opinions. I'd also like to tell you that recently I've run a few classified ads in your magazine and the respondents have been very helpful.

I would like to share my experiences and opinions in this hobby which I've been involved in for the past 10 years.

I've been reading about the late Richard Heyser's work. We have lost one of the great minds in audio, but we were lucky he shared his interest in audio with us. His statement, "You out there, Golden Ear, you know you're right," is so true. It really does come down to the listening experience. Specs and theory are important when used properly, but so often they aren't. Heyser was one of the few who could relate measurements to the listening experience. As he said, "What we are trying to do right now is produce an illusion of a musical event in our minds."

I'd also like to comment about Gary Galo's statements in SB 5/89 on Klipsch products and the shortcomings of commercial horn systems. I don't know all the circumstances under which he has heard Klipsch systems, but I believe his statements do a disservice to Klipsch speakers and audiophiles. I own a pair of Belle Klipsch, which I bought in 1985 after listening to a pair. They gave the most

DOUBTING T/S

Speaker Builder published my article "Tweeter Q Problems" (5/89), and I have a doubt I hope you can help me resolve. I usually do my designs through simulations, using a SPICE-related program (ECA 2, Tatum Labs). Correct models are a must. The T/S models are specified using the DC resistance of the voice coil as R_E .

However, this is lower than the speakers' minimum resistance, since when the model was developed I used a crude VC model.

I've used a slightly modified value for R_E , in which its value is taken from the speaker's minimum impedance, when I don't have the full values for the VC supplied by the manufacturer. At this writing, only KEF has supplied it to me.

The other components— L_{MS} , C_{MS} , and R_{MS} are then calculated as usual from Q_M and Q_E , at F_S . Is that a valid approach?

Now, the critical question: How would you compare the ARIA 5 to the SWAN satellite, especially the dome X horn tweeters?

Jorge Omar Olivera
Campinas, Brazil

Joe D'Appolito replies:

The T/S model ignores voice coil inductance. When this inductance is included in the equivalent circuit,

realistic reproduction of a musical event I have ever heard. The next closest was a pair of JBL 250ti and Audio Research equipment. I've also heard Acoustat 2+2, Quad ESL USA, and Magnepan MGIII. All provided satisfying music, but I preferred the Klipschorns.

Why do I disagree with Mr. Galo? My experience tells me there are so many variables in musical reproduction anything could cause differing opinions, especially the listening room, speaker location and listener location—all adding up to the "system." I call it a system because these elements are so dependent on each other. Different types of speakers interact with the room differently, dipoles, wide/narrow dispersion (large, flat panel speakers) and controlled dispersion speakers (horns).

Such varied dispersion characteristics require different loudspeaker placements and wall absorption and diffusion treatments. I believe room treatment and proportions are almost as important as loudspeaker selection. It is probably one of the main reasons people disagree about the qualities of loudspeaker types. Small rooms, such as my 7 x 13 x 17-ft. listening area, make it difficult to get the best imaging and tonal balance out of loudspeakers.

I listened to the Klipschorn and also Klipsch Forte in a much larger room (approximately 10 x 16 x 25). The Klipschorns had great clarity, as if the wall behind the speakers had disappeared, replaced by the room in which the recording was made. The instrumental images, especially drums, were properly sized and had clarity and body. Vocals were also well-focused, and tonal balance was excellent. They showed excellent linearity and low harmonic and intermodulation distortion.

When I put the Klipsch speakers in my small listening room, clarity and imaging wasn't as good as what I heard at the dealer's. I tried fiberglass panels on the walls beside the speakers to kill early reflections. After nearly a year of experimenting, however, I realized it was the wrong approach. It was causing a dullness

SHOOT THOSE BEAUTIES

A clear, colorful slide of your favorite *Speaker Builder* project could be worth \$50—as well as the pleasure of sharing your workmanship with your fellow readers. We prefer "vertical" (the bottom of the photo on the short side of the slide) format on 35mm but 2x2s are equally acceptable. So fire up your cameras, site your device on a neutral or un-busy background, inside or outside, and send us the results. Mark your submission: "Editorial—SB Covers."

TRUST "YOUR" EARS

YOU know the sound of live music! Are you hearing ALL there is on your favorite record or disc?

ACOUSTICAL MAGIC, Flexible Borosilicate Ceramic coating will bring you a step closer to MUSICAL REALISM.

- Better dynamic contrasts.
- Increased sense of speaker speed.
- Finer resolution of low level detail.

HOW? Application of recommended three coats on the inside of cabinets will significantly reduce resonant distortions.

ACOUSTICAL MAGIC is also highly effective on turntables, tone-arms and cartridges.

Effective July 1, 1990

\$18.00 per quart \$60.00 per gallon
plus shipping

Available in 5 gallon containers at large discount.



ACOUSTICAL MAGIC COMPANY

INSULATION EXPERTS

1201 JAYNES DRIVE GRANTS PASS, OREGON 97527

(800) 654-4761

OFFICE HOURS: 9-9 PACIFIC TIME

Fast Reply #KE27

Specializing in Speaker & Crossover Design



**SCR metallized
polypropylene
capacitors**



VIETA woofers from Spain



**ACCUTON
ceramic concave
Dome Drivers**



FMS cables • Audioquest • Isoda Hybrid cables • Solen Coils • WBT
Edison Price Music Post
are just a few of the many lines we stock



*The Best Products
Knowledgeable Service
At The Right Price!*

**1828 W. Peoria
Phoenix, AZ 85029
(602) 944-1878**

Call or write for Free Catalog

Fast Reply #KE412

Speaker Builder / 6/90 81

VSA
SPEAKER WORKS



"The Cure for Speaker Headaches"

- Custom Grilles For B.I.C. Formula 6's
- Polypropylene Cones For Reconers - 8", 10", 12" & 15"
- Factory Service For ALTEC, ADVENT, B.I.C., JBL & RTR
- We buy blown speakers. CALL US.
- BUY • SELL • TRADE MARANTZ, MCINTOSH, Tube Equipment
- 22 Years Audio Experience

Call Us For Hard To Find Parts
1-800-526-8879
3115 S. Sheridan • Tulsa, OK 74145

Fast Reply #KE618

6000.6 phase correct

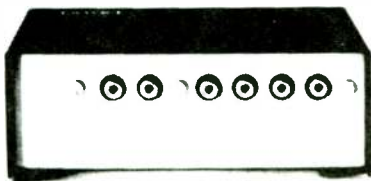

electronic crossover

The new 6000-6 is designed to improve your system by eliminating crossover errors and passing perfect square waves. A plug-in module allows convenient frequency change from 40-16,000Hz. Level controls on rear, 1% components used. Model 6000-6 \$195. PPD. Other models from \$16.25.

Free folder/reviews

ACE AUDIO CO.

532-5th St.
East Northport, NY 11731-2399

Fast Reply #KE53

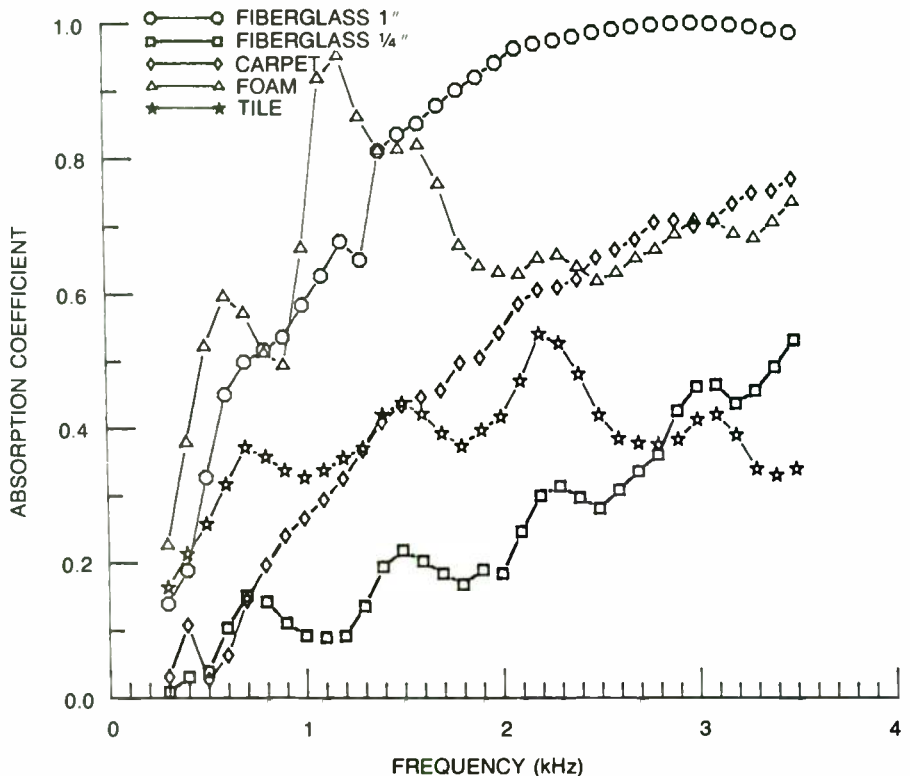

FIGURE 1: Materials' sound absorption capacity against frequency.

to the sound and imaging wasn't much improved.

I removed panels which were close to the speakers, and put them together to form a 6 x 9 area behind the speakers to help kill the slap echo and early reflections. Corner placement seems to help focus the bass by controlling the radiation angle and giving the most extended bass. I regained the tonal balance and imaging improved greatly. I'm now close to getting the sound I heard at the dealer's.

I plan on using some kind of diffusion on the walls, which I believe will get me closest to the sound of a large room. I could easily have blamed earlier performance problems on the speakers. We must, however, look at the speakers and room as a total system, as I was to learn.

Michael D. Beasley
Alcoa, TN 37701

A FEW LOOSE ENDS

I have read *Speaker Builder* now for more than 10 years, and your "Speaker System for CDs" (SB 4/90) is the first project I am going to build. I'm retired now, and must watch my spending, so I may wind the crossover coils. I have some questions about the article:

1. Are these coils of size 12, 14, or what? Do you have their resistances?
2. I assume resistors 2 and 20 shown for the MID are not used as the note says. Is this correct?

3. Are either the MID or tweeter "boxed-in" on the back side (within the primary enclosure)?

Thanks for the nice article.

E. Gene Bortmes
Tulsa, OK 74135

Philip Erhorn replies:

Thanks for your kind letter regarding my article. To answer your questions, I did not wind my crossover coils, but purchased them and the capacitors from my supplier, Zalytron Industries, listed at the end of the article.

The resistors shown in the crossover's midrange output were not needed with the Philips driver. With others they might be appropriate to keep relative efficiencies correct. The woofer contributes a lot of midrange response due to the rather high crossover point.

The midrange driver and the tweeter are "closed back" units, and require no further protection in the cabinet from the woofer.

The woofer I used is identical with the Zalytron TA305F. It has exceptional low bass response.

When you complete this system, please give me your reactions.

DATA, DATA, EVERYWHERE

I recently came across data taken more than 10 years ago measuring the absorption coefficient of materials tested in an acoustic impedance tube. Although the

data was taken a decade ago, it may still interest *SB* readers who are choosing box lining material. *Figure 1* plots the ability of a material to absorb sound against frequency. The larger the absorption coefficient the better.

The 1" fiberglass is similar to that used in suspended ceiling panels. The ¼" fiberglass is relatively dense and is surfaced with a commercial foam backed carpet designed to be glued to a subfloor. The foam is a 2" thick waffle pattern acoustic material used as wall treatment in many recording studios. The tile is typical ⅝" thick cellulose ceiling tile.

From the data, you can see to absorb low frequencies, you need a thick absorber. None of these materials does well at 300Hz, but at 1.2kHz, the 2" foam absorbs almost all sound but falls off at higher frequencies. The 1" fiberglass has a smoother response equalling the foam's performance at 1.4kHz, and becoming even better as the frequency rises.

Although the ½" carpet doesn't do much for the lower frequencies, it is better than the 2" foam above 2.3kHz. Tightly glued to the inside walls of a speaker cabinet, it does wonders deadening unwanted panel resonances without ap-

Why Your Magazine Doesn't Arrive

If you move and do not send us your new address in advance, your current issue is sent to your old address and may arrive after the Postal Service's six-month time limit on forwarding instructions has expired. If this happens, the Postal Service sends us a notice saying, in effect, they have forgotten where you now live, along with a bill for 30¢ to pay for this information. Meanwhile, they have trashed your magazine.

Since we have already paid for your destroyed copy, paid postage to attempt to deliver it to you and put a holding code in your computer record saying that we have no idea where you are, and further since we routinely act on the assumption that Murphy is overactive within most offices of the Postal Service, we send a first-class letter to your old address to determine whether you have, in fact, moved. We do this because from time to time some clerk mistakenly supposes a subscriber has moved and he or she has not. Then we write a nasty letter to the Postmaster suggesting the clerk is a vandal of sorts and how about paying for the magazine? So far, not one has sent any postage or even a repentant letter. Replies usually range from form to frowning to foaming.

So please inform us early when you move. Peel off your label, put it on a postcard, write in your new address and send it to us. We cannot afford to send you a duplicate, unfortunately. If your copy becomes a Postal Service casualty, the replacement copy will cost \$5.

BIG COVE RESEARCH



■ TECHNOLOGIE D'AVANT GARDE

NEW! T130K - 5V/7V313 - AUDIOM 7K - 10K/12K617

Great Variety in Inventory for Immediate Delivery
Studio, Auto and Custom Home Applications

■ Kits and Enclosures

Complete Line of FOCAL FRANCE and FOCAL USA Kits
ARIA Series: The FIVE - SEVEN - TEN

Enclosures: Oak or Walnut - Black or White Laquer

Coming Soon: All FOCAL 3-Way Systems by BCR

■ Crossovers

In Stock! Complete line of SCR polypropylene caps
Design / Analysis Services

■ The UnUsual Expertise, Advice, and Service!

BIG COVE RESEARCH 105 Catherine Dr., Owens Cross Roads, AL 35763

Phone: 205-881-6763 Kevin E. Davis !! NEW FAX #: 205-430-3961

881-8677 Hugh J. Christian, Jr. Ph.D.

Fast Reply HKE333

LISTEN UP !

We sell acoustical volume. We sell hysteretic dampening.

Your next project can be half the size or
can have twice the sensitivity any
can have extra bass extension combination

The addition of Marrs patented SuperStuff to your speaker will eliminate box talk and other spurious responses. It will enormously expand the front to back soundstage.

WILD CLAIMS? Maybe. But hear this: *We'll refund your entire purchase price for any reason. . .or for no reason at all !*

Invented by a Silicon Valley engineer, SuperStuff™ is patented in six countries here and abroad. Its behavior is totally passive, consisting solely of thermodynamic energy exchange with sound waves. Each SuperStuff package (about the size of a small salami) costs \$16.00 and contributes 4 liters or 250 cubic inches of extra acoustical volume. Hysteretic damping (which INCREASES with lower frequency) is inherent in the system.

Call.

(408) 629-8520



6809 Chateau Court, San Jose, CA., 95120

Fast Reply HKE389

Speaker Builder / 6/90 83

HIGH FIDELITY SPEAKER COMPONENTS

STOCKING THESE
POPULAR DRIVERS

AUDAX

DYNAUDIO ECLIPSE

ETON

FOTAL

morel

vifa

FERRITE/BOBBIN
LOW DCR
INDUCTORS

with 18, 16, or 14 gauge

MENISCUS

2442 28th St., S.W., Suite D
Wyoming, MI 49509

(616) 534-9121 FAX: (616) 534-7676

Fast Reply #KE568

preciably decreasing internal box volume. It is also considerably less messy than smearing roofing tar and sand inside your speaker box. Maybe a combination of 1/2" carpet with a 1-2" thickness of fiberglass is just the ticket for your tuned enclosure.

Robert A. Baals
Yorktown, VA 23692

24K INFORMATION

In your reply to a letter from reader RF Stonerock, Jr., in the 1/90 issue of *Speaker Builder*, you asked for the whereabouts of Gold Ribbon Concepts. As a friend of the principals of the company, I can provide you with that information.

Gold Ribbon Concepts still makes 30" vapor deposited planar dynamic drivers on a limited scale. The company now concentrates on custom installation of home entertainment and public address systems which do not utilize ribbons. The company's current name is Gold Ribbon Sound Cinema, rather than Gold Ribbon Concepts.

When Gold Ribbon Concepts pursued the esoteric speaker market, the company

CHOOSE THE "TEE" THAT BEST SUITS YOU



Please print in clear block capitals quantity and amount enclosed. Postpaid in US. Canada please add \$2.00 per tee. Overseas add \$4.00 per tee. Remit US \$ only. Please send me:

Audio Amateur logo: White on red TOTAL QTY.
___S ___M ___L ___XL

Speaker Builder logo: White on blue
___S ___M ___L ___XL

Speaker Builders Do It With Raw Drivers:
Red/white on black
___S ___M ___L ___XL

Glass Audio logo: Black on ecru
___S ___M ___L ___XL

Old Colony logo: White on green
___S ___M ___L ___XL

_____ x _____ = _____
TOTAL SHIRTS (\$12/1) (\$10/2+1) AMOUNT ENCLOSED

MC VISA CK/MO

NAME _____ MAGIC NO. _____

STREET & NO. _____

CITY _____ STATE _____ ZIP _____

MC/VISA _____ EXP. _____

Audio Amateur Publications, Inc.

PO Box 576, Dept. B90

Peterborough, NH 03458-0576

(603) 924-9464 FAX: (603) 924-9467

Answering machine for credit card orders only:
before 9:00 a.m., after 4:00 p.m. and weekends.
Have all information plus MC/VISA available.

HELP THE BLIND

The New Mexico Talking Book Library lends recorded books and magazines to people who cannot read regular printed material due to blindness or visual or physical handicap. We serve about 3,000 people with 80,000 items per year. We work in cooperation with the National Library Service for the Blind and Physically Handicapped, the US Postal Service, and volunteers.

We also lend cassette and record players and headphones. Until this year, the National Library Service provided us with headphones. This service suddenly stopped and we now depend on donations.

If you have any stereophonic or monaural headphones you are not using, our patrons will put them to good use. The Telephone Pioneers, an organization of veteran telephone workers, have volunteered to recondition donated headphones in need of repair.

The USPS will carry this equipment for free. In place of stamps on the parcel, write "Free Matter for the Blind and Physically Handicapped." Send donations to: New Mexico Talking Book Library, 325 Don Gaspar, Santa Fe, NM 87503.

NEW!



A MANUAL OF VENEERING by Paul Villiard

This book is a clear, well-written manual on the craft of veneering which explains how to turn out your own hardwood veneers beautifully and economically. Mr. Villiard shows you all the techniques of veneering: how to match veneers; how to glue, clamp, tape, and edge veneered panels; how to veneer curved panels; and how to inlay, finish, and repair veneers. Sixty-five photographs and drawings amplify the text, and 16 different veneered woods are shown in full color on the covers.

Veneering is an ancient and honorable craft, and when you select the wood yourself and do your own construction, you can be sure that the veneers you make will retain their beauty for years, even for generations.

Index, 174pp., 5 1/2" x 8 1/2", softbound.

BKD-4 \$4.95

Please add \$1.75 S/H for first book, 50¢ each addl.

OLD COLONY SOUND LAB

PO Box 243, Dept. B90, Peterborough, NH 03458
(603) 924-6371 / 924-6526 / FAX: (603) 924-9467

Answering machine for orders only: (603) 924-6371
before 9:00 a.m., after 4:00 p.m. and weekends.
Have all information plus MC/VISA available.

CALL OR WRITE FOR YOUR
FREE CATALOG TODAY!

was beset by many of the problems which typify small perfectionist audio companies. Chief among those problems was dependence on unreliable suppliers. Gold Ribbon Concepts could not meet demand, so the company wisely chose to curb demand by curtailing advertising for the ribbon, and concentrated on other products.

Gold Ribbons are still available—in fact, I have a new pair. The company also sells a complete assembled system including enclosure, two amps, electronic crossover, and active equalization. I understand Demian Martin, designer for Spectral Audio Associates, also markets a system using the Gold Ribbon, but it's not for sale in the US.

The Gold Ribbon is a remarkable transducer, but for the hobbyist it poses formidable demands. Suitable cabinets are very expensive and difficult to build, and the system really should be bi-amplified and actively equalized using the very best electronics. When everything's done right, a Gold Ribbon system will give anything in the world a run for the money, but it's not for everyone. Time, money, and a lot of technical expertise are required.

Daniel Sweeney
Burbank, CA 91054

MATERIALS ARE MATERIAL

I recently discovered the merits of using 10" diameter $\frac{5}{8}$ " thick cardboard tubes for enclosures which have been relatively free of resonances. The latest effort uses two B110Bs and a Morel MDT33 in a D'Appolito configuration, and the Linkwitz 100Hz-1.470kHz active crossover. The sub-woofers are two B200As in each 60-litre closed box with electronic equalization. The speakers are driven by home-built 100W MOSFET amplifiers.

The results are very good, but I would like to compare them with a similar system using a passive network before I decide on my ultimate system. I decided on the SWAN IV as this design embodies diffraction correction and I will more nearly be comparing like with like. However, there will be deviations due to the unavailability of certain materials and you did warn that seemingly trivial changes can be detrimental. So I'd appreciate your comments on the effect of the likely changes.

I will not be able to duplicate sandwicheing of the MDF/plywood veneer. I can use $\frac{3}{4}$ " mahogany veneered MDG made in New Zealand. I planned to line the tops, bottoms, and sides with bitumen pads $\frac{1}{4}$ " thick. The resulting internal volume will be the same, with the same external dimensions. There is a school of thought that the pads are more effective

Southeast Speaker Supply, Inc. Your Source for Speakers in the Southeast

Peerless Polydax Pro Audio
Phillips

We also feature our own full line of speakers.

Call us for:

Speakers Capacitors Ports
Grills Coils

Literature available on all products.

We offer a full line of automotive, home, commercial and professional equipment. All speakers are backed by a 1 year replacement warranty against manufacturers defect.

We offer computer-aided enclosure design free to our customers.

Southeast Speaker Supply, Inc.
P.O. Box 52-0637
Longwood, Florida 32752-0637

Orders
(800) 292-5559
FAX (407) 831-4490

Fast Reply #KE1340

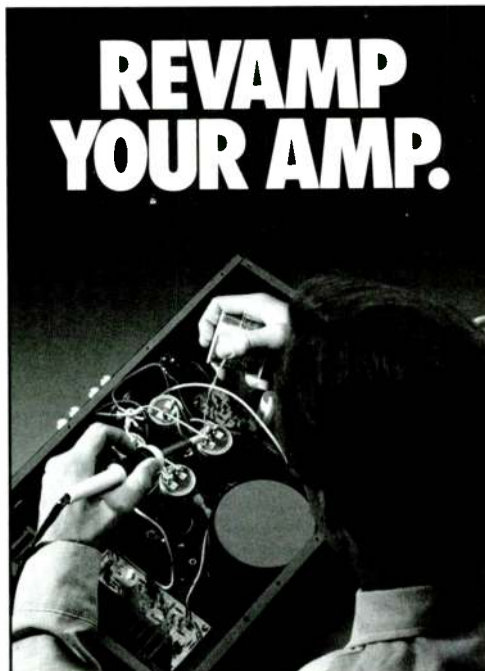

We make good amps great.

At Professional Mod Service, we take your Adcom, B&K, or Hafler amp and make the bass more powerful and the mids and highs clearer. By the time we're through, your amp will sound as good as amps costing *twice as much*.

How do we do it? We make real improvements, developed with factory engineers. We use nothing but premium materials. And our technicians are real pros with years of experience.

Pickup service.

Call us and we'll pick up your amp. Or send it to us with \$199.95 plus \$14.95 shipping. We'll revamp your amp, spec it out, and return it insured.

1-800-334-0295

Amex/Visa/MC/Discover

Professional Mod Service, Inc.

225 Oakes SW
Grand Rapids, MI 49503
616-451-3527 FAX 616-451-0709

Fast Reply #KE196

WE REPAIR SPEAKERS!

- ALTEC
- ADVENT
- CERWIN-VEGA
- AR
- JBL
- EV
- YAMAHA
- ... And many more



THE SPEAKER EXCHANGE
1242 E. Hillsborough Ave.
Tampa, Florida 33604
(813) 237-4800

"Speaker Specialists for over a decade"

Fast Reply #KE298

Mahogany Sound Acousta-Stuf

A SOUND ABSORPTION MATERIAL THAT ELIMINATES STANDING WAVES AND REFLECTIONS WITHIN THE SPEAKER ENCLOSURE TO FOCUS THE ACOUSTIC IMAGE IN THE LISTENER'S MIND.

A MULTI-DIRECTIONAL CRIMP IN EACH STRAND FORMS A COHESIVE MASS WITH A HIGH ABSORPTION COEFFICIENT OVER A WIDE FREQUENCY RANGE. USE IT IN SEALED, VENTED, APERIODIC, AND TRANSMISSION LINE SYSTEMS. IT'S ALSO GREAT FOR SPOT ABSORPTION PANELS AND BASS ATTENUATION TRAPS.

PRICE IS \$7.00 PER LB. PLUS \$1.00 PER LB. FOR SHIPPING (CANADIAN RESIDENTS MAKE THAT \$1.50 PER LB.) IN ALABAMA, ADD 4% SALES TAX. PLEASE PAY BY CHECK OR MONEY ORDER, NO C.O.D. OR CREDIT CARDS.

Speaker Kits

WE ARE PROUD TO INTRODUCE THREE NEW SPEAKER KITS COMPLETE WITH PRECUT OAK OR WALNUT VENEERED CABINETS BY WOODSTYLE. THESE KITS WILL BE HELPFUL TO THOSE WHO, FOR WHATEVER REASON, HAVE TROUBLE WITH THE WOODWORKING ASPECTS OF HOME CONSTRUCTION. THE LINE FEATURES A 12" PORTED SUB-WOOFER, A DUAL 6 1/2" SYMMETRICALLY ALIGNED APERIODIC FULL RANGE SYSTEM, AND A SMALL 5 1/4" APERIODIC BOOKSHELF SPEAKER. ALL OF THESE SPEAKERS USE ACOUSTA-STUF AS THE DAMPING MATERIAL. WRITE FOR MORE INFORMATION ON THESE NEW KITS.

Mahogany Sound

2480 Schillingers Rd. #488
Mobile, Alabama 36695
(205)-633-2054 After 5 PM CST

Fast Reply #KE73

on thinner panels, and should not be cemented onto them. Instead, they should be tacked at the corners and center to allow movement with respect to the MDF.

An alternative would be 3/4" MDF, with the pads replacing the sand/bitumen mixture of your earlier design. I would appreciate your views about which would offer lower and perhaps similar coloration to your SWAN IV. I do not like the 1" recess in the rear (for aesthetic reasons) but I note that this gives a similar depth to the original design, so it may be critical.

The SWAN IV photos seem to show all edges rounded, but the text only refers to the sides' tops and bottoms. In fact, the photo (SB 5/88 p. 40) shows a lip around the front panel. This cannot be right, and I assume this is a protective device during manufacture.

I plan to use the subwoofer during tests, but understand this must be changed to a system with comparable power handling capacity to derive the full benefits of the overall system. Unfortunately, the replacement 305 is not suitable as foam surrounds do not survive well in the tropics. A rubber surround is preferable. Similar cabinet material considerations will apply.

I do not plan any other changes. The speakers will be those recommended, although my Focals are not matched pairs. (When I purchased them the retailer said manufacturing tolerances were close enough so this was not essential. I must replace the Dacron filling with long-hair wool, as I do not have the former.)

I wonder how effective the bass cabinets' acoustic foam linings are. I would have thought the material would be relatively transparent at the frequencies I'm concerned about. Except for the internal bracing to shift resonances upwards, there was little one could do with respect to damping—short of concrete.

C.L.P. Carrington
Barbados

Joe D'Appolito replies:

Regarding your questions about cabinet construction and damping in the SWAN IV, the MDF/plywood sandwich construction was chosen so the home builder could produce sufficiently damped cabinets with readily available material. Production systems are made with 1" MDF, not commonly available at lumber yards.

The photos for the SWAN IV article were taken at different stages in the system's development and do not always agree with the published plans. At a minimum, all front edges of the cabinets should be rounded. Production systems are rounded on all edges. The front panel lip shown in one of the photos represents a very early design which was quickly abandoned.

Schools of thought on cabinet damping rarely define what they are trying to damp, and their ef-

Thin Bin

Mother Hubbard's cupboard was no doubt in worse condition than our file folders for SB's "TT&T" and "Craftsman's Corner" features, but we're about to get the "impending famine" warning light on our computer. Your handy tips, shortcuts and unique insights are all welcome, and SB pays \$7.50 minimum for them. (It's a great way to pay for your subscription.) Photos of your handiwork and an account of how and why you built your beautiful gear are also welcome. Payment for illustrated tips is \$15 and up, depending on length of copy and quality and number of photos.

fectiveness is uncertain. Two types of excess energy often need to be dissipated in loudspeaker systems, acoustic and mechanical. Not surprisingly, these forms of energy are dissipated by acoustical resistance and mechanical resistance.

Let's get rid of some common misunderstandings about cabinet vibration. Driver cone acceleration forces produce an equal and opposite force on the drive frame. Because the frame is usually tightly fastened to the cabinet, this reaction force is efficiently transmitted to the cabinet walls. When the forcing frequency corresponds to a cabinet resonance, a significant vibration results. Transmission of acoustic energy within the trapped air volume to the cabinet walls is inefficient, and rarely causes significant panel vibration in well-constructed enclosures. Standing waves within the enclosure can, however, influence the loudspeaker's acoustic response.

To rid mechanically induced panel vibration we first brace the panels to raise their resonant frequency. We then add panel damping, generally more effective at the higher frequency, to dissipate the remaining energy. To be effective, the damping material must be in contact with the vibrating panel. Bitumen pads are used extensively in the auto industry to damp sheet metal panels. In this application they are cemented to the sheet metal panels.

In our application they should also be cemented to the enclosure walls. Allowing them to sway in the breeze will absorb some acoustic energy before it reaches the cabinet walls and is converted to mechanical energy, but it will not damp the mechanical panel vibration. Firmly cementing bitumen to the walls will damp all vibration, regardless of its source.

We must be careful about acoustic energy damping within the enclosure volume. The SWAN IV Bass Module is a bass reflex design. Its low-frequency efficiency depends on a high box Q. Thus only the higher frequencies, which may bounce around inside and pass back out through the cone or ports, should be damped. This is done by lining the cabinet walls with foam or fiberglass.

Of your available materials for cabinet construc-

tion, I would use the 3/4" MDF. It should be adequate for the satellites. You may require more interior bracing for the Bass Modules. You'll have to experiment on that. The 10" Eclipse drivers, among those recommended for the Bass Modules, use a rubber surround. Dacron is commonly available in department and fabric stores as pillow stuffing, and you may be able to find it in Barbados.

BOXMODEL

continued from page 37

of about 12% of C. By changing to one 3" and one 4" tube in system A the air speed drops to about 8% of C. I usually settle for less than 10% as acceptable.

IV. CONCLUSION. With BOXMODEL it is easy to play the "what if" game because data can be entered and/or changed quickly and easily. Thus, you can almost effortlessly compare a wide range of driver and system possibilities before you decide on a particular design.

The program is also good for checking your system out against what the model predicts. For example, with a set of measured data, you could see the consequences of various loss distributions, or how measurement error would change response. You can also get a good idea of the cone excursion requirements of the system.

DYNACO A-25

continued from page 55

even flatter frequency response both on- and off-axis, and excellent high-frequency extension equal to the 25 TV-EW. Its high-frequency response is even more compatible with the D28-AF and the A-25's simple crossover. Using a ferrite magnet instead of an AlNiCo, the 25 F-EW is 1dB more sensitive than the older units, so the crossover's resistors might need to be modified. Alternately, I may eliminate the passive crossover

If you should have a TECHNICAL QUERY...

about an article appearing in this magazine, write it clearly, leaving space for a reply and referencing the magazine, the article and the page about which you are inquiring. Enclose a self-addressed stamped envelope and send these to *Speaker Builder*, PO Box 494, Peterborough, NH 03458.

If it's warranted, we will forward your query to the author or a Contributing Editor for a prompt reply.

NEW! Low Frequency Designer 1.0

a creative design tool by SpeakEasy

Super Features:

Acoustic modeler for:



Sealed HP



Vented /
Passive HP



Sealed /
Vented BP



Double
Vented BP



Series
Vented BP

- Calculate response and displacement for each type.
- Plot multiple curves over any frequency and magnitude range.
- Save system designs to disk and generate hardcopy on your printer.

More Super Features:

SYSTEM SYNTHESIS—give *Low Frequency Designer* a desired response and it will calculate a set of system parameters for you.

CURVE FITTING—*Low Frequency Designer* will iteratively change your system parameters to best fit your desired response.

CURVE FAMILIES—calculate a family of curves by varying a parameter over any range.

User Friendly:

- True graphical user interface with pop-up windows is quick and easy to use.
- Full HELP screens from ANYWHERE in the program, means you won't waste valuable time.

ALL THIS for only \$195 includes tax and shipping!

Requirements:

IBM PC or compatible / EGA graphics / Epson or HP compatible printer support.

Call or write for details or demo disk.

SpeakEasy

46 Cook Street / Newton, MA 02158
Phone or fax: 617-969-1460

More programs by SpeakEasy coming soon!

Fast Reply #K45

TARGET — B-TECH

WALL BRACKETS FOR SPEAKERS

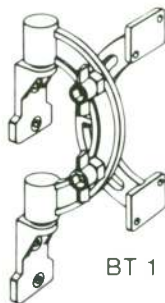

BT 1

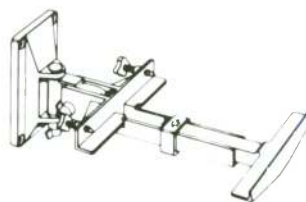

BT 3

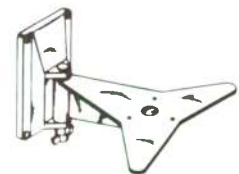

BT 4

For your free copy of our catalogue contact:

MAY AUDIO MARKETING INC.

P.O. Box 1048, Champlain, N.Y. 12919 - Tel.: (518) 298-4434
in Canada: (514) 651-5707

Fast Reply #K661

Speaker Builder / 6/90 87

Speaker Builder

THE LOUDSPEAKER JOURNAL

BACK ISSUES

1980

Realism Testing • Ambience Reproduction • Upgrade Mods for Small, Cheap Speakers • Diffraction and Cabinet Shape • Speaker Cables: Measurable and Audible Differences • A Three Enclosure System with Active Crossover and Delay (in 3 parts) • Electrostatic Speaker Construction Project (in 3 parts) • Double Chamber Enclosure: Deep Bass from an 8" Woofer • Corner Midrange Horn • Thiele/Small and Vented Speaker Design: Part I •

1981

A Testing Unit for Speaker Parameters • Variable-Volume Enclosure • Thiele/Small Theory (in 3 parts) • Easy to Make Enclosure Using Concrete Blocks • The Tractrix Horn: Good Dispersion Bass From an Old Design • Diffuser Port for Small Boxes • Mini-Speakers Made From PVC Tubes • Closed vs. Vented Box Efficiency • Interview with P.G.A.H. Voigt • Dual 8" Symmetrical Air Friction Enclosure • Thiele/Small Calculator Computations • Thiele/Small Parameters for Passive Radiators •

1982

Transmission Line Theory • Thiele/Small Sixth-Order Alignments • The Quad 63 • Table Saw Basics • AR-1 Modifications • Active Crossovers and Phase • Three Transmission Line Speakers • A Beginner's First Speaker • How Passive Networks Interact with Drivers • Horn Loaded Heil • Phase Correcting Active Crossover • Wind Your Own Inductors • Series and Parallel Networks • High Performance Corner Speaker • Using Zobel's to Compensate for Driver Characteristics •

1983

Building the Two-Way Dynaudio • A Crossover That Offsets Speaker Impedance • Using a Calculator for Box Design • Choosing a Calculator • A Simple Peak Power Indicator • A Small Horn Speaker • Audio Pulse Generator • How to Use Speaker Pads and Level Controls • An Easy-to-Build Voltmeter for Speaker Measuring • Nomograms for Easy Design Calculations • Interview with KEF's Raymond Cooke • Build a Simple Wattmeter • A New Type of Speaker Driver •

1984

Build an Aligned Satellite/Woofer System • BOXRESPONSE: A Program to Calculate Thiele/Small Parameters • Casting with Resins • A Phase Meter • An Interview with Ted Jordan • Building the Jordan-5 System • Self-Powered Peak Power Indicator • Closed Box Design Trade-offs • How to Build Ribbon Tweeters • Build a Dual Measurement Impedance Meter • A High-Power Satellite Speaker System • Build and Use a White/Pink Generator • Sound Pressure Level Nomographs •

1985

Compact Transmission Line Subwoofer • Bullock Crossovers, Passive and Active, three parts • Drive Attenuator, Computer-Designed • Curved Vertical Array • Sontek Powered Subwoofer • An Isobarik System • Modifying Strathairn's Ribbon • Ambience Systems • Experimental Transmission Line • Small Double-Chamber Reflex • Loose Walled Speaker • Modifying the Daline •

1986

The Edgar Midrange Horn • Sand-Filled Stands • Crossover Networks: Passive and Active • 5-Sided Boxes • A 2x4 Transmission Line • The Free-Volume Subwoofer • Notch Filters • Bi-Wiring the LS3/5A • A Push-Pull Constant Pressure System • Current and Power in Crossover Components • The Un-box (Egg) • Upgrade Speakerlab's S-6 Crossover • Measure Speakers with Step Response • A Gold Ribbon System • A Visit with Ken Kantor • A Tractrix Horn Design Program • Reviews: Audio Concepts "G;" Seven T.L. Midranges; Focal's Model 280; the Audio Source RTA-ONE •

1987

A Compact TL Woofer • Frequency Response and Loudspeaker Modeling (three parts) • A Manual Coil Winder • The Model-One Speaker • Designing a Listening Room • A Sixth-Order Vented Woofer • Tapered Pipe Experiments • Visiting Boston Acoustics • A Vented Compound System • The Octaline • Spreadsheets for Speaker Design • In Memoriam: Richard Heyser (two parts) • Using Non-Optimum Vented Boxes • Building Speaker Stands • Evaluating Driver Impedance Compensation • Tuning Bass-Reflex • Six Woofers Compared • Bullock on Passive Crossovers: Alternate Bandpass Types • Fast, Easy Filter Calculations • A Mobile Speaker • Modifying the Polk 10 •

1988

Electronic Turns Counter • Two-Way Design • Minimus-7 Mod • Dome/Midrange/Tweeter Array • Plotting Complex Impedances • A Driver Design Primer • A Cabinet Primer • Tuning Up Old Systems • Low-Cost AR-3 Upgrade • Electronic Time Delay • Enclosure Shapes and Volumes • Minimum-Phase Crossovers • Spot Sound Absorbers • How to Add a Subwoofer • The Swan IV System • Sub-Bass Power Boosting • The Unline: A Short TL • Active Filter Computer Design Program • Low-Cost Two-Way Ribbon • Amp-Speaker Interface Tester and Construction Plans • The QB₃ Vented Box is Best • A Pentagonal Box System • Keith Johnson Profile • Sheathed Conductor ESL • A Symmetrically Loaded System: Part I • Ceramic Enclosure • Inductance Measuring Technique • Polk 10 Mods •

1989

A Middle/Side Speaker • A Satellite/Woofer System • A T/S Driver Program • All About Cordless Drills • Symmetrically Loaded System, Part 2 • Adjusting Auditorium Acoustics • The Audio Laboratory Speaker System • A Passively Assisted Woofer • Digital Filter Tutorial • The Listening Arc Alignment • Small IC Power Amp & Crossover • Easy Surround Sound • Building Speaker Spikes • An Isobarik in a Thunderbird • Sheetrock Cabinetry • A Picket Speaker • Servo-Controlling AR-1 • Silent, Safe Muting System • Equalizing the Klipsch Cornwall • A Test Switcher • Visiting the Klipsch Kingdom • Rehab for Kitchen Music • Spreadsheet Design • A Subwoofer/Satellite System • Impedance Measurement as a Tool • Practical Passive Radiators • A Symmetrical Dual Transmission Line Parts 1 & 2 • The Microline • A Voice Coil Wheatstone Bridge • Tweeter Q Problems • A Dipole Subwoofer for the Quad • Adjusting Woofer Properties • Modifying Paradigm's 7se •

BACK ISSUES ORDER FORM

Please send:

- | | |
|--------------------------------------|--------------------------------------|
| <input type="checkbox"/> 1989 @ \$20 | <input type="checkbox"/> 1984 @ \$12 |
| <input type="checkbox"/> 1988 @ \$20 | <input type="checkbox"/> 1983 @ \$12 |
| <input type="checkbox"/> 1987 @ \$15 | <input type="checkbox"/> 1982 @ \$12 |
| <input type="checkbox"/> 1986 @ \$15 | <input type="checkbox"/> 1981 @ \$12 |
| <input type="checkbox"/> 1985 @ \$15 | <input type="checkbox"/> 1980 @ \$12 |

Check MO MC Visa

Books and magazines are not returnable.

Amount enclosed \$ _____

MAGIC NUMBER

UPS delivery add \$2 for the first two sets, each additional set 50¢.

Canada add \$4 postage per year. Please make checks payable to Audio Amateur Publications.

Checks in US \$ only.

NAME _____

STREET & NO _____

CITY _____

ST _____

ZIP _____

CARD # _____

EXPIRES _____

Speaker Builder Magazine PO Box 494, Peterborough, NH 03458-0494 USA

MC/Visa Phone Orders: (603) 924-9464; FAX: (603) 924-9467

Continued from page 87

and bi-amp, adding impedance compensation to the woofers. Neglecting the woofer's low-frequency resonance, its impedance peaks at 15Ω near the crossover point.

I've also considered a D'Appolito tower configuration (two 25 F-EWs flanking a D28-AF in a four cubic foot aperiodic box). That's a project I hope I'll soon get to. The increased woofer volume should improve bass response, and the multiple drivers will bring up acoustic efficiency. Just to whet my appetite, I ran the 25 F-EW's Thiele/Small parameters through Warren Merkel's Perfect Box CAD program (available from the Madisound bulletin board). In a 2 ft³-per-driver ported box, it predicts a -3dB point of 43Hz, and a -10dB point of 27Hz. With a little luck, an aperiodic box will shave off a few more hertz. With better imaging and the D28-AF's fine performance, I should have a system which will satisfy me for a long time to come.

Kit Report

continued from page 62

have. I rarely hear a loudspeaker which "disappears," allowing you to concentrate on the music.

Many reviewers, myself included, have probably overused the phrase "musical as well as accurate," but it best describes these speakers. This loudspeaker remains musically satisfying hour after hour, without any listening fatigue. The Sapphire IIs demand clean electronics, and are accurate enough to reveal any changes you might make in your system. I would have no problem using them to evaluate other components' sonic characteristics, particularly if a subwoofer were added to fill in the missing bass.

Comparisons

I connected them to Lorelei's system for a few days. We spent two evenings listening and comparing them to her Vandersteen 2CIs. Her Vandersteens are also bi-wired, so connecting her cables to the Sapphire IIs was easy. The Vandersteens are among the best dynamic loudspeakers for soundstage reproduction, re-creating a three-dimensional soundstage which reminds you of a dipole. They also have fairly good low-frequency extension. Their one objectionable characteristic is harshness, or grit, in the upper midrange/lower treble region. This problem is most noticeable on massed strings and choral passages.

They gave the Vandersteen soundstage a run for its money. They equalled the Vandersteen's imaging and depth capa-



Handcrafted speaker kits, assembled speaker systems, mono and stereo subwoofers – assembled or Kit – with or without powered amplifiers and cabinets from .3 cubic feet to 6.0 cubic feet. Systems for the beginner to the advanced audiophile, from bookshelf to our large 4–unit, 800 lb., 4–way system.

No automation for us. Each Kit, speaker system and cabinet is handcrafted to allow for the precise tolerances and finest quality only possible through the pride and craftsmanship that goes into each piece.

We also repair and recone speakers of any make, something an asser. bly line can't do at all. Our inventory of original manufacturer's parts (we can special order really esoteric parts) enables us to make our customer's speakers good as new. We'll even repair the scratches on the cabinet or replace the grill your cat sharpened it's claws on, if you wish. So, if you already have speakers you're really happy with, there's no need to replace them when a drunken guest decides to prove how many decibels a real macho man's eardrums can endure.

Send for our 1990, 14" x 20" catalog of handcrafted Kits, cabinets and complete speaker systems, \$5.00. Advanced Sound, Dept. SB, 711 E. Magnolia Ave., Knoxville, TN 37917-7636. (615) 637-6694 (Foreign & Canadian shipments please add \$1.00 for 1st class postage. US Currency Only)

ALUMINUM RACK AND CHASSIS BOXES

FEATURES:

DESIGNED FOR SMALL LOT PRODUCTION
EASY TO FABRICATE (DRILL OR PUNCH HOLES)
SHIPPED UNASSEMBLED (FLAT)
ALL MAIN PANELS ARE FLAT FOR EASY FABRICATION
FRONT AND REAR PANELS ARE CLEAR BRUSH ANODIZED
TOP AND BOTTOM PANELS ARE BLACK BRUSH ANODIZED
END PANELS ARE BLACK ANODIZED

CHASSIS BOXES

| MODEL# | WIDTH | DEPTH | HEIGHT | PRICE |
|--------|-------|-------|--------|----------|
| MC-1A | 4" | 3" | 2" | \$ 15.00 |
| MC-2A | 6" | 3" | 2" | 17.00 |
| MC-3A | 8" | 3" | 2" | 19.00 |
| MC-4A | 4" | 5" | 3" | 17.00 |
| MC-5A | 6" | 5" | 3" | 19.00 |
| MC-6A | 8" | 5" | 3" | 21.00 |
| MC-7A | 4" | 7" | 4" | 19.00 |
| MC-8A | 6" | 7" | 4" | 21.00 |
| MC-9A | 8" | 7" | 4" | 23.00 |

RACK BOXES

| MODEL | RU | DEPTH | PRICE |
|-------|-------|-------|----------|
| 1RU5 | 1.75" | 5" | \$ 29.40 |
| 1RU7 | 1.75" | 7" | 31.50 |
| 1RU10 | 1.75" | 10" | 33.60 |
| 2RU5 | 3.50" | 5" | 31.50 |
| 2RU7 | 3.50" | 7" | 33.60 |
| 2RU10 | 3.50" | 10" | 35.70 |
| 3RU5 | 5.25" | 5" | 39.90 |
| 3RU7 | 5.25" | 7" | 42.00 |
| 3RU10 | 5.25" | 10" | 44.10 |

ORDER DIRECT FROM THE FACTORY.
ON PREPAID ORDERS SHIPPED UPS
GROUND, SECOND DAY AIR \$10.00
NEXT DAY AIR \$20.00



CALL FOR COMPLETE CATALOG AND ENGINEERING DIMENSIONS.

WE ALSO STOCK CHASSIS, PUNCHES AND INSTANT LETTERING. CALL FOR CATALOG.

SESCOM, INC. · 2100 WARD DR. HENDERSON NV. 89015 U.S.A.

800-634-3457 (ORDERS ONLY) · 702-565-3400 (TECHNICAL HELP) · FAX 702-565-4828

Fast Reply NKE499

Speaker Builder / 6/90 89

RAMSDELL AUDIO

27" SUBWOOFER

MODEL SW2710:

6.3" Edgewound voice coil
 103dB/1W/1M (band limited)
 pink noise—32-150Hz in 15 ft.³ cabinet)
 Power Handling—500W RMS
 1000W Program

Polypropylene cone—Double Roll Cloth Surround
 52 lbs.

Fs 18.5Hz
 Qts .275
 Qes .293
 Qms 4.16
 No 4.0%
 Re 5.7Ω
 Le 3.0mH
 Xmax ±4mm
 Vas 1720 liters
 Piston Dia. 23.3"

\$1,250



**PO Box 76186
 St. Petersburg, FL 33734-6186
 (813) 823-8037**

NOW AVAILABLE: 27" Passive Radiator \$145

Fast Reply #KE163

Moving SALE-Expanding

NEW GOLD LINE TEST INSTRUMENTS -*WITH OMNI CONDENSER MIC

*30M8 Portable RTA, 30 band 1/3 octave; 25Hz-20kHz, 8 memories \$679
 "The least expensive & smallest 1/3 octave RTA; easy to use." CAR AUDIO
 *SPL120 digital SPL meter, measures 55-125dB, A, C & Flat in .1dB \$199
 TS1 1Hz-30kHz oscillator, frequency counter, line level dB meter \$329
 TS2 Above with 20Hz-20kHz digital impedance tester, .1-999 ohm \$449

| | Fs Hz | Vas | Qts | | OHM | WRMS | F.R. | \$/ea | QTY |
|----------------|------------|------|--------------------------------|--------------------------|-----|------|--------|-------|-----|
| EV | FORCE 10 | 65 | 1.5cf | 4 | 8 | 150 | 65-7k | \$ 89 | 2N* |
| | FORCE 12 | 55 | 3 | .44 | 8 | 150 | 55-7k | \$104 | 4N* |
| | EVM10 | 10 | 65 | 1.4 | 8 | 150 | 55-7k | \$129 | 2N* |
| GS | 4SC | 4" | Coax, Audax | Titanium Dome, Poly cone | 4 | 40 | 99-25k | \$ 29 | 66N |
| | 612 | 6.5 | 45 | 1 | 8 | 60 | 45-5k | \$ 23 | 28N |
| | 821 | 8" | 37 | 1.5 | 8 | 60 | 27-3k | \$ 26 | 18N |
| | 1060 | 10" | 21 | 6 | 8 | 200 | 25-5k | \$ 59 | 24N |
| JBL | 2226H | 15" | 40 | 6 | 8 | 600 | 30-2k | \$199 | 4D* |
| | 2235H | 15" | 20 | 16 | 8 | 300 | 20-1k | \$249 | 8N* |
| | 2245H | 18" | 20 | 29 | 8 | 600 | 20-1k | \$399 | 8N* |
| MOREL | MDT29 | 1.1" | Dome with ferrofluid | | 8 | 80 | 3-22k | \$ 25 | 16N |
| POLYDAX | HDM8ND | 3" | Ferrofluid sealed back mid | | 4 | 40 | 1-10k | \$ 6 | 44N |
| | HD10P25FSM | 4" | Fullrange/midrange | | 8 | 30 | 80-18k | \$ 11 | 21N |
| | HIF13F/8; | J/8; | JSM/4&8; | H/8 5.2" | 4/8 | 30 | 50-5k | \$ 9 | 48N |
| SEAS | 11FM | 4.5" | Midrange, Cast Frame | | 8 | 50 | 600-6k | \$ 25 | 58N |
| | 11FGX | 4.5" | Woofer, Cast Frame | 16oz Magnet | 4/8 | 50 | 45-6k | \$ 29 | 36N |
| | P17RC | 4.5" | Woofer, Cast Frame | poly cone | 4/8 | 60 | 40-4k | \$ 29 | 48N |
| VIFA | D25 | 1" | Mylar dome tweeter, ferrofluid | | 6 | 90 | 3-20k | \$ 12 | 88N |

N=NEW; D=DEMO; U=USED; *5 YR GRNTY

**4285 S. Broadway, Englewood CO
 303 789-5310; FAX 303 762-0527**



Fast reply #KE149

90 Speaker Builder / 6/90

bilities in every respect, and were free of the Vandersteen harshness. I believe the Sapphire IIs are more musically accurate than the Vandersteens—if you're willing to part with the 2CIs' low bass. Lorelei isn't, and says, "I really want to hear them with the Saturn subwoofers." If that combination delivers the goods in the low-end, I think Lorelei will be in the market for a new loudspeaker system.

Lorelei's listening chair is somewhat lower than my director's chair, and I believe they produced a better image in her room than mine, despite the fact her electronics and CD player are not as refined as mine. I also noticed an improvement in imaging sitting on a lower chair in my listening room, confirming Caldwell's views about optimum vertical position.

Conclusion

The Sapphire II is a refined audiophile loudspeaker which, within its frequency range, will give the best dynamic loudspeakers stiff competition. Any reader who doubts that a loudspeaker kit can compete with the finest factory-assembled products should think again. The Sapphire II is an outstanding kit, and an excellent way to learn about loudspeaker construction and design. Beginners and advanced builders should find this an educational, as well as a musically satisfying project. You may find, however, starting with this kit is a problem. This design is so refined and well-executed that building a better loudspeaker "from the ground up" will be difficult. I admit to being intimidated by Caldwell's expertise level which produced the crossover network. I have a lot of homework to do.

I love deep, clean, accurate low bass. The bass is the foundation of most music, and I wouldn't permanently install a system in my listening room without the bottom octaves intact. I have talked to Dzurko about reviewing the Saturn subwoofers. I have even conducted some preliminary experiments using my own transmission line woofers as subwoofers for the Sapphire II. The results have been impressive.

If the Sapphire II/Saturn combination delivers the low bass, with proper integration of the two loudspeakers, Audio Concepts has a full-range system to be reckoned with.

Software Report

continued from page 66

the entire length of the room, and allows you to ignore the front and/or side walls for the Boundary plot. If a wall is missing, as in an open door garage setup, for example, just ignore the relevant marker in the standing wave graph.

THE KLIPSCHORN THROAT REVISITED:

OR, OOOOPS

BY BRUCE EDGAR
Contributing Editor

FINAGLE'S FOURTH LAW: No matter what occurs, there is always someone who believes it happened according to his pet theory. (See "Pox Humana," p. 110.)

EDGAR'S COROLLARY: It is easy to be seduced by a simple mathematical result.

When I published the article on the Klipschorn constricted throat (*SB* 4/90) with an explanatory model, I believed I had achieved a significant breakthrough in horn design. As it turns out, however, the bandwidth extension associated with the Klipschorn constricted throat is a special case, not a general one.

After performing several controlled experiments, I have concluded that in general the constricted throat does not work as "advertised," and the measured responses are the same whether or not the throat constriction is in place.

THE EXPERIMENT. After the Klipschorn throat article appeared, my colleague Dave Rowe read it and analyzed the constricted throat on the basis of an acoustical model instead of the electromechanical model I used. He called me later and said, "Bruce, it won't work."

My immediate reaction was, "What do you mean? I have a measurement (that is, the Klipschorn result) which shows it works."

At that point, I had unwittingly fallen into the trap of Finagle's Fourth Law. Neither of us were willing to budge from our positions, but as scientists, we agreed to devise a controlled experiment to determine the truth.

The experimental apparatus consisted of a 100Hz quartersize straight exponential horn with easily removeable partitions which formed the constricted throat similar to that of a Klipschorn

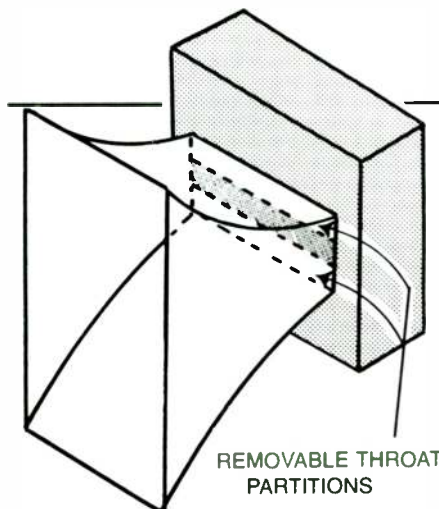

FIGURE 1: Sketch of the 100Hz quartersize exponential horn ($S_M = 346^2$ " $S_1 = 78^2$ " $L = 16$ "") used in the controlled experiment.

($S_1' = 3 \times 13$ "", $S_1 = 6 \times 13$ ""), as I've illustrated in *Fig. 1*. I also tried a 100Hz quartersize straight hyperbolic-exponential ($M = 0.6$) horn with a removable constricted throat ($S_1' = 5 \times 10$ "", $S_1 = 10 \times 10$ "").

I measured the near field spectrum response with a Spectrum Dynamics FFT analyzer, operating in an averaging mode. I used white noise as input to the amplifier. Keeping the drive levels and all other conditions the same, I performed a number of trials, with and without the throat partitions. I tried several 15"

drivers from my collection of speakers, including the Klipschorn K-33E, on both horns. For each driver, (*Fig. 2*) the responses with and without the throat partitions were indistinguishable.

DISCUSSION. If my constricted throat theory were valid, then we would have the two responses (with and without throat partitions) exhibit the classic constant gain-bandwidth characteristic. The response with the throat partitions would have a wider bandwidth but a lower amplitude level, compared to the case without the throat constriction. Instead, we see no differences.

There is some consolation for a horn builder who has built a bass horn with a constricted throat—he probably didn't harm the horn's response. So why isn't there any difference between a regular throat's responses and a constricted throat's?

The simplest answer is: a wave traveling down a waveguide (horn) isn't affected by an obstruction if its transverse protrusion is less than one-tenth of a wavelength. The partitions in my experiments were just on that condition's fringe. Therefore, the driver couldn't see any effects from the typical constricted throat.

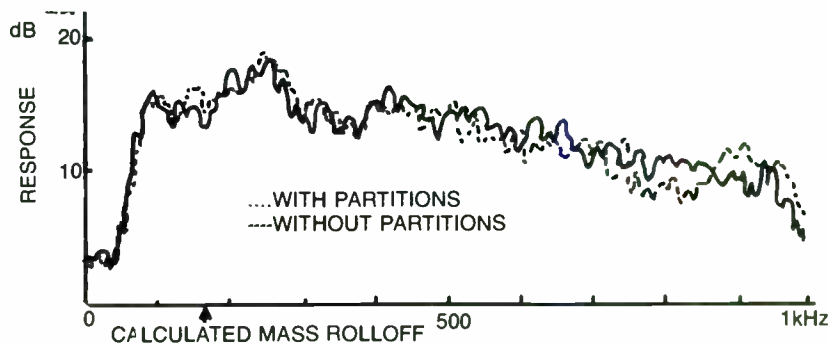

FIGURE 2: Response of the K-33E driver on the 100Hz horn with and without the throat partitions.

PINPOINTS

A sound foundation for all components of your system.

SPEAKERS

.....

EQUIPMENT RACKS

.....

TURNTABLES

.....

STANDS

Call, Write or FAX your order to
AUDIOPRISM
A Division of RF Limited

P.O. Box 1124
Issaquah, WA 98027
Tel: 206/392-0399
FAX: 206/392-8413

PinPoints have been designed to enhance the sound of your speakers through better coupling to the flooring eliminating unwanted distortion. Better coupling to the floor improves imaging, and bass resolution. Unlike other products that are simply placed under the speakers, PinPoints are designed to be permanently attached to the speaker. This is mechanically and sonically better than just placing the cones under the speakers. The PinPoint is a spike that has been threaded so that the rake angle can be adjusted to improve the vertical dispersion of the speaker. Each PinPoint is rated at 75 lbs, constant pressure. Threads are 1/4x20.

Select From Two Mounting Systems.

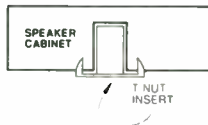

T-Nut Insert Kit Contains:

- 4 - PinPoints
- 8 - 1/4" Jom Nuts
- 4 - Threaded Inserts

\$8.00 suggested retail

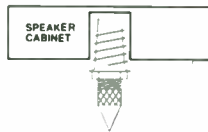

Threaded Spiral Insert Kit Contains:

- 4 - PinPoints
- 8 - 1/4" Jom Nuts
- 4 - Threaded Inserts
- 1 - 6mm Allen Wrench

\$11.00 suggested retail

Fast Reply #KE695

CAPE ACOUSTICS

100 RESERVE STREET
GLACE BAY, NOVA SCOTIA
CANADA B1A 6G4

MANUFACTURERS OF QUALITY
LOUDSPEAKERS

DISTRIBUTORS OF
SPEAKER KITS, WOOFERS

LOWEST PRICES
SEND FOR FREE BROCHURE

(902) 842-0110

Fast Reply #KE330

In *Figure 2*, the curves begin to diverge by several dB at 800-900Hz, where the 1½" partition height is approximately 10% of a wavelength. However, if a small obstruction (such as a bend) is repeated at intervals along the horn, there will then be reflections, which may have a harmful effect on the response. The reason the Klipschorn has a different response with and without the constricted throat, is due entirely to internal reflections from the bends along the path.

The throat partitions change the reflected wave pattern just enough to differ measured responses by several dB. Our Klipschorn result is a special case, and cannot be generalized to other applications.

Returning to my article, every formula up to Equations 7 and 8 is correct, because you can derive them from a complete electro-mechanical-acoustical model of the driver and horn. Equations 7 and 8, however, are based upon a wrong assumption of how the throat transformer works in an acoustical model—and, therefore, are invalid.

So how do you extend a horn's bandwidth? The answer is still the same: use a driver with a big magnet, a low Q_{ES} , and a high F_s on a horn with a small throat. There is an unusual bandwidth extension with the K-33E driver above the calculated mass rolloff of 167-300Hz, as in *Fig. 2*. This phenomenon may be due to stiffness control of the driver (Read "The Edgar Midrange Horn," *SB 1/86*), but it's difficult to predict extra bandwidth benefits for any given driver on a horn.

My experiments also brought home how bends seriously affect bandwidth. As you see in *Fig. 2*, the mass rolloff is fairly slow (only 6dB/octave). In my experience, however, the bends in a typical folded horn will introduce a 10-20dB/octave, or higher, rolloff. Following a good folding strategy, such as in my "Show Horn" article, (*SB 2/90*) is as important as choosing a good driver in extending the bandwidth.

CONCLUSIONS. I apologize to *SB* readers misled by my article (*SB 4/90*). Mistakes and later corrections lead to better understanding—a process in the evolution of science. Retracting an erroneous conclusion, however, has been a sobering experience.

So move over Sam Tellig, I now can sympathize with your Armor-All trials (*Stereophile 5/90*). Thanks to Dave Rowe for pointing out my mistake, and helping formulate an explanation. ▶

Tools, Tips & Techniques

BETTER LATE THAN NEVER

I recently constructed a pair of Audio Concepts Monitors. I bought the parts eight years ago, but have managed to procrastinate until a few months ago. I used the same basic construction techniques as described in *Speaker Builder* for the Swan IVs, except as noted below.

The corner construction details for the Swan IVs are similar to a table I built many years back. I was disappointed with the results. I'm not good with a rasp I guess. For the Compact Monitors, I used a sliding cut-odd table on my table saw to cut a 1/2" by 1/2" rabbet in place of the 45° bevel cuts. I resawn an oak board to 1/2", cut 1/2"-wide strips from the board and then glued the strips into the rabbets (Fig. 1).

These could then be rounded-over with a router, but I elected to leave them square for cosmetic reasons. I found it best to cut the oak pieces slightly bigger than the rabbet and sand them down. I think this method is easier, but you cannot achieve as large a radius when rounding over as with the Swan IV technique. A deeper rabbet would weaken the corner glue joint, although gluing in the strips should strengthen them.

I used yellow glue instead of epoxy for the strips. The yellow glue can be easily wiped up when it oozes out of the joint. I used plenty of strategically-placed bar clamps to hold all the strips in place while the glue dried.

For a grille cover, I used black waffle-pattern open-cell foam from Radio Shack. To avoid diffraction from metal or wooden standoffs, I cut narrow strips from the foam and used Goop to glue the strips to the back of the main piece of foam (Fig. 2). The Velcro strips which Radio Shack includes with the foam then hold the result to the cabinet. Goop works well in this application. Other adhesives I tried either wouldn't adhere or required an excessive amount of adhesive. For the finish I used Danish oil.

I commend Audio Concepts for their fine customer service. One of the push-on connectors on the crossover wires was soldered closed, and in trying to push it onto the tweeter terminal I snapped off the terminal. Audio Concepts replaced

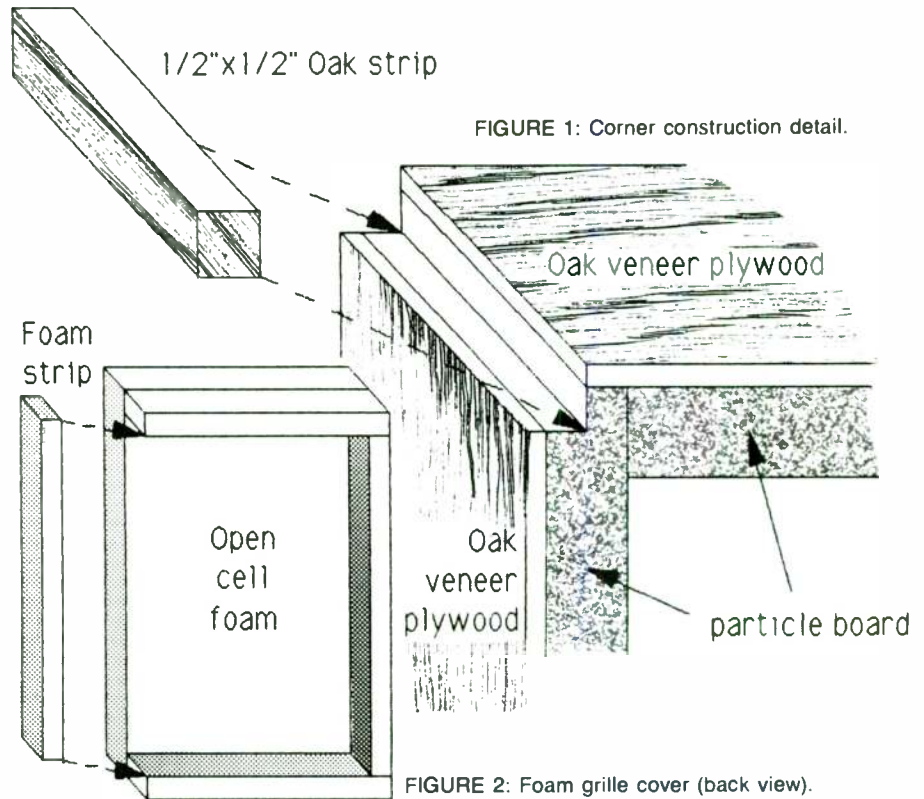

FIGURE 1: Corner construction detail.

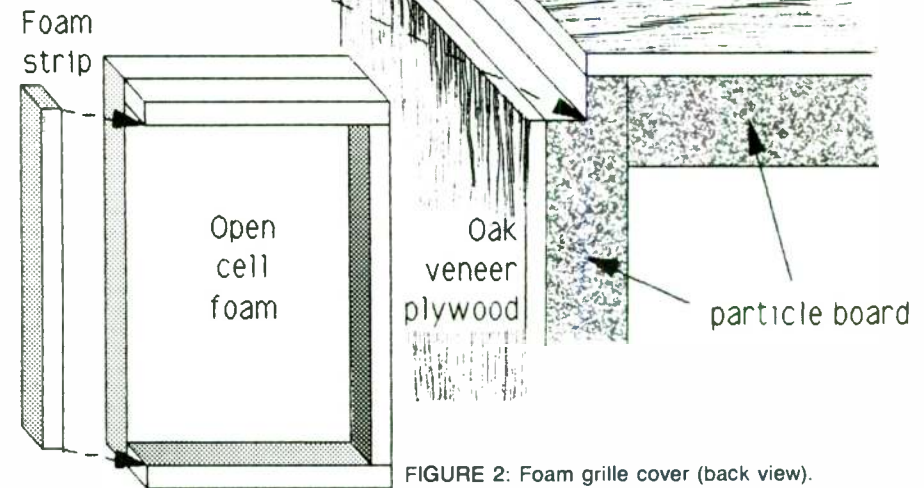

FIGURE 2: Foam grille cover (back view).

the tweeter, even though technically the warranty had expired. I'm sure other companies which advertise in *Speaker Builder* also provide good service to their customers, but AC has earned my loyalty and future business.

Thomas S. Downey
Brighton, MA 02135-1857

EASY TURNS COUNTER

I don't normally wind my own coils, but recently I needed some rather large inductances and decided the savings outweighed the time spent winding. What I really needed, though, was a turns counter. I once used a calculator to make an odometer for my bicycle and, remembering this, I realized it would work well in this application, as well.

To use my technique you'll need a

calculator which will allow you to punch "1 +" and then, by hitting the "=" key repetitively, automatically update the display each time. In this case, one (1) will be added to the total count displayed.

Carefully disassemble the calculator and connect a pair of wires across the "=" key switch, preferably somewhere on the circuit where it will not interfere with the "=" switch or otherwise damage the circuitry. To the other end of this pair of wires connect a reed (magnetic) switch. I recommend using a variable speed drill for winding; just tape a bar magnet to the chuck. Mount the reed switch close to the magnet, turn on the calculator and press "1 +." Now each time the magnet passes the reed switch the display will be updated by one.

Simple, and it's probably cheaper and less time-consuming to construct than the alternatives.

Karl Rabe
Jackson, MS 39216

GO VAN GOGH

I have an audiophile tip that might be helpful to many people.

As you know, all drivers fatigue. The paper cones of drivers lose some of their rigidity with continuing usage. I have a simple process to somewhat revive cone rigidity.

Use a can of high gloss or enamel paint and spray two or three coats onto the cone, letting each dry before applying the next. More coats may be applied for even more rigidity.

The most common application is reviving old or weather-beaten car speakers. I've used this method on many car speakers and the new sound is remarkably better. This technique is far cheaper than using special types of poly coatings. One can of paint does 40 or more 6" x 9" speakers—very cost effective. Use any color paint to give your cone a fancy look.

Andrew Steffek
Centereuch, NY 11720

RECYCLING MAGNETS

Anyone interested in experimenting with reverse-polarized magnets for Q_T modi-

fications (Richard Pierce, *SB* 4/90) may have problems in obtaining additional magnets. Blown speakers are an excellent source, but you must disassemble them from their pole plates.

I've found that most drivers use a heat-sensitive adhesive, usually a "super-glue," to hold them together, and can be readily taken apart with no damage to the magnet.

As the Curie point for ferrite magnets is at least 600°F, you can heat the whole speaker (or just break off the magnet structure) in an oven at 350°F without weakening the magnet's strength. After 20–25 minutes the adhesives break down. Wearing gloves (please) and exerting some pressure, the plates break free from the magnets fairly easily.

Some old Blaupunkt auto speakers fell apart using only a screwdriver. A Polydax needed the help of an arbor press, but a vise or hand-clamp would suffice. A Sparkomatic driver broke clean with a side force on the magnet relative to the plates. You must support the structure in a manner which applies force either away from or across the magnet to break the glue joint.

A recent experiment with some Polydax TX1125 RSN drivers was encouraging. A modest magnet which still attracted the present Polydax structure lowered the Q_T from 1.15 to 0.93. An oversize magnet which repels the struc-

ture further lowered the Q_T to 0.91, and was hardly worth the effort. Super-Glue works well to bond the extra magnet to the structure, but first clean both surfaces with solvent.

Matthew Honnert
Carol Stream, IL 60188

A GRAPHIC PROGRAM

Recently, I came across some useful information concerning graphics programming which I applied to a program I read in *SB* 4/86. Brian D. Smith's program calculates a tractrix horn's dimensions. The program is straightforward, and easy to implement. It tends, however, to run slowly when confronted with a horn which has a low cutoff frequency. Of course, compared to doing the calculations by hand it is an immense improvement.

My changes optimize the numerical calculations, allowing faster processing of information. Multiplication is much faster than division in BASIC, and multiplying a number by itself is more efficient than using exponentiation to square it.

I made only a few changes in the original program to allow easier conversion

Why Risk It ? Your time and money are valuable. Advanced Audio Products has done the homework and the groundwork, you do the woodwork and save. Computer-aided designs and quality parts ensure you great sound the first time.

AAP - Kit 1.8

Designed using MLSSA and XOPT. An 8" 2-way in a 1.5 ft³ cabinet, $f_3=35$ Hz, 89 dB, 100W.

Kit includes 2 Focal 8K415S 4 ohm woofers, 2 Focal T90K tweeters, all crossover parts, solid brass binding posts and complete cabinet plans.

Only \$299/pair !

Focal - Aria 5 Kit

Designed by Joe D'Appolito, dual 5" bass/midrange surround a T90K tweeter.

On *Stereophile* recommended list for 1990. This kit includes all drivers, Focal-made crossovers, cabinets and solid brass binding posts.

Only \$499/Pair !

Focal - Aria 10

Joe D'Appolito designed Bandpass 10" subwoofer. A perfect match for the Aria 5.

Bi-Amping to Aria 5 not required, passive crossover ensures true bandpass. Kit includes drivers, crossovers, cabinets, solid brass binding posts and how to roll-off your Aria 5s.

Only \$499/pair !

**Advanced Audio Products
1916 Place, Suite 1243
Seattle, WA 98102
(206) 527-3393**

Offering carefully engineered, quality Audio systems at do-it-yourself prices. We also carry a full line of Audiophile components and accessories. Call or write for more detailed information and prices.

to your specific application and programs you have developed around it. They are as follows:

```

130 THROAT = SQR(AREA1 * 0.31831)
REM 0.31831 = 1 / PI
150 B = SQR(PI * (A * A))
290 (A * A) * PI
310 ((A * A) * PI) / 8
440 YONE = SQR((R * R) * PI * 0.5
470 YTWO = SQR((R * R) * PI) * 0.5
490 PRODUCT = SQR((A * A) - (R * R))
530 DIST = SQR(((XONE - XTWO) *
(XONE - XTWO))
+ ((YONE - YTWO) * (YONE -
YTWO)))
590 AREA = (R * R) * PI
(PI references = 3.14159)

```

You may wonder why I did not change some of the division calculations to multiplication. Integer operations process data much faster than single- or double-precision decimal numbers, so I believed it was unnecessary to change them at this time. The REM line is just a reminder of what this number corresponds to.

The difference these few changes makes seems to make a case for optimizing code to increase performance. The other possible changes would be to convert single- and double-precision values to integers (possibly using an assembly language subroutine) for processing, and then convert them back for output to the printer or screen.

TABLE 1

PERFORMANCE COMPARISON

| F _c | 100Hz | 20Hz | 5Hz |
|----------------|--------|--------|---------|
| Original | 1' 20" | 7' 35" | 31' 17" |
| Optimized | 0' 20" | 1' 54" | 7' 54" |

I have included some performance times of horn calculations with and without the changes (Table 1). I hope this will be of use to people using Brian Smith's program to increase productivity.

Gregg S. Irwin
5837 Comstock #5
Whittier, CA 90601

If you already have a copy of Brian Smith's program, then you may wish to add the above modifications. Copies of the modification as well as the original program are available from Mr. Irwin whom you may contact at the above address.



LEAP

Loudspeaker Enclosure Analysis Program

NEW!

Graphics Features

- Semilog Graphs
- Absolute Scales
- Auto Scale Set
- Display 3 Designs
- Solid/Dot/Dash Line
- Fast Graphic Paging
- Disk Graph Storage
- EGA Color Graphs
- Cursor Measurements
- Harcopy Printout

Output Graphs

- Acou. On-Axis SPL
- Acou. On-Axis Phase
- Acou. Power SPL
- Acou. Power Phase
- Cone Excursion
- Group Delay
- Impedance Mag.
- Impedance Phase
- Current Mag.
- Current Phase

Advanced Analysis...Beyond the State of the Art!

Comprehensive true general system model/ Small-Large signal analysis/ Frequency dependent acoustic elements/ Multiple speakers and ports in box/ Full mutual coupling analysis/ Passive radiators/ Parasitic elements: Port loss, Box loss, Lining loss/ Any Power level/ Array Analysis/ Frequency dependent VC resistance/ VC temperature/ Cable resistance/ SPL at any Distance.

PROGRAM FEATURES: Unlimited Speaker, Cabinet, and Design Libraries/ Computer assisted parameter entry and checking/ Library Searches/ Metric or English Cabinet units/ Over 100 Speakers already in library from 3" to 30", JBL to Audax, Pro, Car, HI-FI/ ...Easy operation!

Computer System

PC/AT/386 and Compatibles
MS-DOS 2.x/3.x, 512K RAM
Math Coprocessor Suggested
Graphics: EGA/CGA/HGA

Only...\$199.00!

Free Demo Disks

AUDIO TEKNOLOGY INCORPORATED

5756 SW BRIDGEPORT RD., PORTLAND, OR 97224
Phone: 503-624-0405 FAX: 503-624-0194

Fast Reply #KE32

... from Euphonic Technology



... an affordable answer to the degrading effects of power line pollution! **AccuPower** can recover losses in transparency, detail, imaging and dynamics caused by RFI, EMI and equipment interactions ... our audio-optimized and patented* **AccuPower** Isolating Line Filter will restore all your audio and video components to their optimum level of performance!

Call or write for details.

EUPHONIC
technology



19 Danbury Road, Ridgefield, CT 06877
(203) 431-6434 • FAX (203) 431-3660

Model AP-4. \$549
* US Pat. No. 4,259,705

Classified Advertising

TRADE

DYNACO KIT BUILDERS—225,000 lb. buyout! Tubes, transistors, metal work, raw speakers, circuit boards, 200/200W amplifier kit, \$299; manuals, any, \$6. Shipping extra. Free parts list. **SOUND VALUES**, Box 551SB, Dublin, OH 43017. (614) 889-2117. 10-4. T2/91

WHALE COVE AUDIO is your source for the SWAN IV and for complete kits, empty enclosures, the PEDAL COUPLER, and Joe Curcio's new elegant rack mount version, the **Pedal Coupler II**. Box 356, Swan's Island, ME 04685. (207) 526-4343. T6/90

SPEAKER KITS, raw drivers, cabinets crossovers, available from **SPEAKER WORLD**, PO Box 14731, Fremont, CA 94539. Send for free catalog. (415) 490-5842. T2/91

LONG HAIR WOOL carded, cleaned for stuffing speakers, \$13.50/lb. including shipping. **J. EBBERT**, 431 Old Eagle School Rd., Strafford, PA 19087. (215) 687-3609. T6/90

MYLAR FILM. Dupont 1/4 mil type "T" Tensilized 25" width, 50 cents per running foot. Minimum order, \$10. **STATS, INC.**, 7501 Shady Grove, Fort Worth, TX 76180, (817) 498-3259. T6/90

PERFECT SPEAKER DESIGN SOFTWARE for PCs. Complete design system including; vertical radiation plots, active and passive crossover design, box alignments and more, \$10ppd. **ALTRON SYSTEMS**, PO Box 180064, Utica, MI 48318-0064. T6/90

THE FINAL LINK An audiophile grille cloth guaranteed to have no audible effect on loudspeaker performance. Peak measurable absorption is 0.4dB at 5000Hz. No measurable effect above 8000Hz. Available in black only, 36" x 92", \$20; 72" x 92", \$35. Check or money order. **ACOUSTIC TRANSPARENCY**, 5256 SW Dosch Rd., Portland, OR 97201. T6/90

D'APPOLITO ARIA 5 AND ARIA 7 cabinets, drivers, crossovers, etc. are available from **WHALE COVE AUDIO**, (207) 526-4343. T6/90

MAGNAVOX. Selected chip sets, \$80; CDB630, \$289; CDB582, \$159; CDB586 changer, \$210; CDB473, \$179; Isodrives, \$79; Navcom silencers, call; Audioquest, Straightwire, Mod Squad, Tweek, \$12.95; Reference, Sheffield, Dorian, DMP, Telarc CDs, \$12.99; Chesky, \$11.99; Fulton LP sets, 5/\$25. Free catalog. **DIGITAL SOUND**, 7634 Kolmar, Skokie, IL 60076, (312) 674-8024. T2/91

MYLAR FILM. 1/2 mil. genuine DuPont. 48" wide. \$1 per running foot. Also ESL transformers. **ROGER SANDERS**, R1, Box 125, Halfway, OR 97834, (503) 742-5023. T3/91



(616) 534-9121

MENISCUS

HIGH FIDELITY SPEAKER COMPONENTS

DYNAUDIO MOREL FOCAL ECLIPSE

2442 28th St., S.W., Suite D, Wyoming, MI 49509

C-64 VENTED BOX DESIGN SOFTWARE. Unique program with many features to speed your work. Enter driver parameters and calculate normally. OR compile a file of driver specs on floppy disk and recall them for calculation by pressing one button. OR enter your Vb and F3 requirements and let the computer search your files automatically for the best driver. Print your designs and/or store them on disk. Includes a short closed box routine and two box dimension routines. Calculates series resistance compensation. One disk stores over 600 drivers or 200 designs. With password protection, plus more features. On 5 1/4" floppy disk for Commodore 64 computers only, \$29.95. **SOUNDSTAGE ELECTRO-ACOUSTICS**, 10052 Babbitt Ave., Northridge, CA 91325. T1/91

EPIKITS ARE HERE! **EPIK Monitor Systems** is offering speaker kits that will allow the home builder to assemble satellites and subwoofer systems of uncompromised performance with hand tools only. Epikits feature state-of-the-art drivers, cabinet construction, crossover topology and computer calibrated response. **EPIK MONITOR SYSTEMS**, 1720 Lilac, Walnut Creek, CA 94595, (415) 930-9104. T6/90

SPEAKER DESIGN SOFTWARE for PC and Mac. **SpeakerCAD**: graphs predict performance, calculates woofer parameters, vents. **FILTERS**: calculates 1-6th-order electronic crossovers. **CROSSOVERS**: 1-4th-order all-pass, constant power networks. \$40 complete. **QUBIX**, 2302 5th NE, Salem, OR 97303, (503) 363-5143. T6/90

STATEMENT OF OWNERSHIP, MANAGEMENT AND CIRCULATION. (Required by 39 U.S.C. 3685) Date of Filing, Sept 30, 1989. Title of Publication, **SPEAKER BUILDER** Frequency of issue, Six times a year

Annual subscription price \$25 Location of the headquarters or general business offices of the publishers 305 Union St., Peterborough, NH 03458 Publisher Edward T Dell, Jr. PO Box 494, Peterborough, NH 03458; Managing Editor Stuart Norwood Owner, Edward T Dell, Jr., PO Box 494, Peterborough, NH 03458. Known bondholders, mortgagees, and other security holders owning 1 percent or more of total amount of bonds, mortgages or other securities None

| | Average # copies | |
|---------------------------------|---------------------------------------|-------------------------------------|
| | each issue during preceding 12 months | Single issue nearest to filing date |
| Total # copies printed | 14,524 | 13,975 |
| Newsdealer sales | 150 | 150 |
| Mail subscriptions | 7,801 | 8,946 |
| Total paid circulation | 7,951 | 9,096 |
| Free distribution complimentary | 85 | 89 |
| Total distribution | 8,036 | 9,185 |
| Office use, leftover | 6,488 | 4,790 |
| Return from news agents | 0 | 0 |
| Total | 14,524 | 13,975 |

I certify that the statements made by me above are correct and complete
 Publication No. 01997920 Karen Hebert, General Manager

CLASSIFIED ORDER FORM

PLEASE FILL OUT IN CLEAR BLOCK LETTERS OR TYPE. PLEASE SPELL OUT ENTIRE WORD.

| | | | | | | | | | |
|----|----|----|----|----|----|----|----|----|----|
| 1 | 2 | 3 | 4 | 5 | 6 | 7 | 8 | 9 | 10 |
| 11 | 12 | 13 | 14 | 15 | 16 | 17 | 18 | 19 | 20 |
| 21 | 22 | 23 | 24 | 25 | 26 | 27 | 28 | 29 | 30 |
| 31 | 32 | 33 | 34 | 35 | 36 | 37 | 38 | 39 | 40 |
| 41 | 42 | 43 | 44 | 45 | 46 | 47 | 48 | 49 | 50 |

Private For Sale Private Wanted Trade If Trade please indicate # of insertions. _____

Private ads are on a one time insertion basis. Must be resubmitted for renewal. Ads cannot be taken over the phone.

Definition of a word: A series of letters with a space before and after. Please remember to include your name, address and telephone number when making calculations. In order for Private For Sale and Want ads to be **free** you must be a current subscriber. Please include your Magic Number. **Ten dollar minimum charge for charge card orders and Trade ads.**

Any words over 50, 20¢ per word; Trade ads please charge at 70¢ per word and indicate number of insertions. Deduct 10% for a 4x contract in *Audio Amateur* and a 6x contract in *Speaker Builder*; deduct 5% for a 2x contract in *Glass Audio*. Payment **must** accompany ad.

Please charge to my MasterCard/Visa:

Check/Money Order enclosed

MAGIC NUMBER

CARD NUMBER _____ EXP. DATE _____

NAME _____

COMPANY _____

STREET ADDRESS _____

SIGNATURE _____

CITY _____ STATE _____ ZIP _____

FALCON ACOUSTICS is one of the largest independent manufacturers of crossover networks and speaker system accessories in the UK, supplying manufacturers, retailers and export. Your guarantee is the trust our manufacturing customers put in the quality and reliability of our networks. **Inductors:** Ferrite (up to 200W), air-cored and transformer; **Capacitors:** Reversible electrolytic 50V/100V, polyester, polycarbonate and polypropylene; **Networks:** choice of over 70 for different unit combinations; **Components & Accessories:** most except for the wood! Please send for details, \$2 air, \$1 surface, to our mail order retail outlet. **FALCON ELECTRONICS**, Tabor House, Norwich Rd., Mulbarton, Norfolk, England NR14 8JT. T6/90

PRO 400
AC/DC VOLTAGE
AC/DC CURRENT
DIODE TEST
LOGIC TEST
LED TEST GOOD/BAD
5 FREQUENCY RANGES
5 CAPACITANCE RANGES
LOW BATTERY WARNING
CONTINUITY TEST/BUZZER
TRANSISTOR CHECKER
20 MHz FREQ COUNTER

\$69.95
Stock No. 100022

30 DAY MONEY BACK GUARANTEE!

KELVIN Electronics
 (516) 349-7620 (800) 645-9212
 FAX (516) 349-7630 VISA M/C

MIT AUDIO CABLES, Van den Hul, Cardas, MAS Masterlink, OCOS, Magnan, including Teflon insulated hookup wire for rewiring components; Solen polypropylenes to 200uF! WonderCaps-solder-wire; Vishay & Resista resistors; largest selection of Holco resistors in North America; Music Posts & all types of audio connectors; RAM tubes; enclosure damping compounds; tone cones; NAVCOM isolators and sheets; spectrum analyzers, many parts and accessories. \$1 catalog (\$3 overseas). **MICHAEL PERCY**, Box 526, Inverness, CA 94937, (415) 669-7181. T6/90

WHY ARE YOU USING JUNK CHASSIS WIRE Try Music Metre OFC Teflon-coated pure copper chassis wire. 38 awg to 18 awg hear the improvement. **MUSIC METRE**, 249 North Bound Blvd., #701, Glendale, CA 91203, (818) 242-4535. T6/90

FOR SALE

VSP Labs straightwire preamplifier, excellent condition, microprocessor controlled design, \$450. Ed, (313) 663-8790.

48 Polydax HD9X8025A tweeters, used for few hours, like new, in original shipping boxes, \$4.50 each, for lot; 4 KEF B139 woofers, \$60 each; complete SWAN IV built by designers, \$1,900. Joe, 70 Chester St., Boston, MA 02134, (617) 254-0697, anytime.

Bose 901 Series 1 with stands and equalizer. Mint condition, \$395/pair. Pickup only. R. Whitaker, (703) 525-4293.

MERRILL MODIFICATIONS

For the AR turntables

Call

UNDERGROUND SOUND

2125 CENTRAL AVE., MEMPHIS, TN 38104
(901) 272-1275

Melos GK 1 + 1 preamp, adjustable phono loading, adjustable gain stage, high and low level CD inputs, separate power supply, recently retubed line stage, mute switch, tape loop, high end audiophile quality sound, new, \$1,500, asking \$850 or best offer. James, (904) 581-1787, 12-4 EST.

Vifa 20-05 tweeters with crossover plans for 17wj, pair, \$18. Mint condition. Ed Light, 2265 Westwood Bl., #415, Los Angeles, CA 90064.

Jordan module speakers. I have 4 pair of enclosures, drivers, and crossovers for anyone interested in building a Jordan system. Enclosures are floor standing oak or walnut. All at my cost, \$600 per pair. Marc McCalmont, RR2, Box 334A, Wilton, NH 03086, (603) 654-9826.

Complete set back issues of *Speaker Builder* 1980 to 1989 plus back issues *Audio Amateur* 1970, 1973 to 1975, 1983 and 1986, good condition, \$110 post-paid. A. Vangel, 4412 Wallace, St. Louis, MO 63116, (314) 481-0530.

PS Audio 4A preamp with external power supply. Acoustat 2 + 2 speakers with Medallion upgrades. Original owner. Make offer. Also have 1.5M and 5M Distech Blue interconnects; 8' MIT 650 speaker cable and a Yamaha moving coil preamp. (615) 875-7977, work or (615) 843-2049, after 6 p.m. EST.

Huge Western Electric 15B horns; Altecc Laguna cabinet; Altecc, JBL horns, drivers, Stentorian tweeter, Goodmans, Stephens, Radio Shack electrostats, Wharfedale, Jensen, E.V.. Send wants-trades. V. Vogt, 330 S.W. 43rd St., #247, Renton, WA 78055, (206) 251-5420, ext 247.

JBL 2235H subwoofer drivers, 15", fs = 20, Qts = .25, \$325/pr includes UPS; Cabasse 17NDM, \$125/pr; Cabasse 21M18, \$125/pr. All prices include UPS. Call Brad or leave message, (603) 891-4233.

Dahlquist DQ10s, black, with stands plus Randall Research mods, \$175 for the pair. Pick up only. John Carlblom, 2774 Doresta Rd., San Marino, CA 91108, (818) 441-1318.

Brand new Dynaudio D-28AF dome tweeter with factory rectangular face plate, \$60 pair; brand new SEAS 11-FM cone midrange, \$40 pair. Very smooth, very high quality. Louis Vannoni, PO Box 111, Redding Ridge, CT 06876, (203) 938-3542.

Large Alnico horseshoe magnets for building ribbon tweeters, \$5 to \$15 each; HP 400D AC VTVM, \$40; HP rackmount sinewave generator, \$50; Pickering XSV-3000, like new, \$35; pair Quads, best offer; assorted accelerometers. Mike Matsho, (618) 466-8476.

Huge filter capacitors: 110µF, 60V DC. Manufactured by MEPCO. Unused surplus, not salvaged! Limited supply, \$25 each. Pair of ETON 1" tweeters, new in boxes, \$60 pair; Crown D150, \$170; Dyna ST120, with beefed-up power supply, \$90. Jerry McNutt, 801 South Gay St., Auburn, AL 36830.

Dynaudio D-28 tweeters, \$19 each. Fred Janosky, (215) 693-6167.

(6) Toscanini CDs, \$6 each; Denon DP-2550 turntable with SME 3990-III arm, Shure V15 cartridge, \$450; Yamaha DSP-1 soundfield processor, \$495; dbx 124 4-channel dbx-II processor, \$150; Nakamichi 700-II three-head cassette recorder, \$495; used BASF C-90 chrome cassettes, \$10/dozen. Darroch, 1807 Elmcrest, Arlington, TX 76012.

Transformers, Triad S-142A for ESLs, \$49 each, plus shipping. 2 for \$85 plus shipping, or for greater efficiency with low power amps, 4 for \$165 plus shipping, this works great, I promise. Don Fagerstone, 955 S. Butler Way, Lakewood, CO 80226, (303) 986-9532.

Pair 15" Tannoy Monitor Gold, \$225. Terry, (503) 774-2149.

Carver CD player, Mark II, mint condition in original carton, low hours 4X oversampling, digital time lens feature, \$300, OBO, including shipping. Bob Fontaine, PO Box 158, Marlo Island, FL 33969.

Levinson LNC1 crossover, 100Hz, plug-in modules, very rare. Needs PLS 151 power supply, \$475; Altecc 811B horns with 9028B drivers, N1201-8A crossovers, 4148E 12" bass drivers, all mint condition, \$750; Lemo female connectors (board mount), \$15/pair. Jim, (408) 738-0559 (CA).

JBL N2400 crossovers, mint, \$40/pair; Electro-Voice 15TRXMKII 15" triaxials as new, \$195/pair; (1) EV SP15B coaxial, \$40; (2) Altecc-Lansing 9860A Active equalizers, perfect, \$100 each or \$170/pair. Horacio Vignale, (703) 578-4929.

4 pair Dynaudio 24W-75 woofers, \$70/pair; 1 pair Dynaudio D-21AF tweeters, \$40; Old Colony's Waldron Tube Crossover active L/P and H/P with power supply, excellent construction throughout, best offer over \$75 (no tubes); 1 pair Dynaudio D-52AF midrange domes, \$75; All drivers excellent condition with original shipping boxes. Paul, (619) 455-7590, 8-5, M-F only.

Bryston 2B amp, 50W at 8Ω, \$250; Heathkit AD-1702 electronic crossover, \$150; Sumiko Premiere LMX moving coil cartridge, \$45; Dynavector DV-67 step up transformer, \$45. Stanley H. Grycz, 2935 Crehore St., Lorain, OH 44052, (216) 288-9480.

Altec A7 theater speakers, pair, 921 woofers, 808 tweeters, 511B horns, 1kHz crossovers, all drivers and crossovers rebuilt, woofer cases solid, need cosmetics. Will deliver southern California, \$1,500 for all. Lee Hutchison, (805) 946-2109.

Rogers JR-149, \$300; Onkyo T-4055 FM tuner, \$75; Acoustat Spectra 22, oak, extra black covers, mint, \$1,000; Audio Control octave, mint, \$100; tweeters: MDT-32, \$100/pair; Techniques 5HH10 \$55/pair; Yamaha SR-50 surround processor, mint, \$175; Bogen C-100B PA amps, excellent, \$125, (cost \$300); Tektronics tube scope, \$150, (heavy, pick up). Steve, (203) 397-3888 CT, 7-10 p.m..

Back issues of *The Audio Amateur*, 1970-73, 1975, 1977-79, 1982, 1984-86, \$100. Richard Dolbow, 562 Susan Dr., King of Prussia, PA 19406, (215) 265-6649, evenings EST.

New CD players in factory-sealed cartons: Magnavox CDB 610, \$155; CDC 552 Carousel 5-disc changer, \$237, both with remote controls. Fred Janosky, (215) 693-6167.

Audax TW51A 4Ω tweeters, \$9.50/pair; HD20B25H2, 8", \$45/pair; TX1125JUN2CN9, 4 1/2" TPX mids, coils rub, \$9.5/pair; HD17B25H4, 6 1/2" woofers, \$45/pair; SEAS P14RCY 5 1/4" poly, unused (1), \$28; 21FWBX-DD 8" paper (1), \$25; Versatronics 5" poly D0130F-PP/8 (1), \$12. (703) 949-6727 (VA).

Audiophile Accessories

- DBP-2J (5) • Switch Box **\$69.95**
- DBP-2J (5) AU • Switch Box with Gold Jacks **\$89.95**
Selects among up to 5 inputs. When used with DBP-6 or -6MC, allows for selectable loading of cartridges. Alps level control available.
- DBP-10 • Phono Alignment Protractor **\$24.95**
Allows adjusting the lateral tracking error of a mounted cartridge to within 1/4 of a degree. Non-technical instructions and case included.
- DBP-16 • 12dB Input Attenuators (pair) **\$12.95**
- DBP-CK • Cramolin Audio Kit (contact treatment) **\$19.95**
- DBP-SC • Souther Record Clamp **\$15.00**

Other Accessories

Gold-plated phono plugs/jacks, banana plugs/jacks, spade lugs, Y adapters, custom cables, many other useful accessories.

Test Compact Discs

We carry almost every worthwhile test CD available, including 5 from the Japan Audio Society (tone bursts and stereo pink noise), 2 from Pierre Verany (1/3-octave warble tones), 3 from Denon (*Anechoic Orchestra*), and *Auditory Demonstrations*.

Electronic Components

We can create electronic crossovers from 6 to 36dB per octave, custom engineered for your application. 24 and 36dB are Linkwitz-Riley "In Phase" design. Models for Snell and Magnepan speakers available.

The renowned DB Systems preamps, power amps, tone controls, head amp, and phase inverter/bridging adapter are also available through dealers or direct.



DB Systems

Main Street, P.O. Box 460

Rindge Center, NH 03461

Phone (603) 899-5121

VISA/MasterCard accepted

Sell/swap: Dyna tube, tuners, preamps, power amps, tubes milspec, many types including power, large value high voltage caps, test equipment. Send SASE, Dennis Boyle, 2401 South Ervay, Studio 103, Dallas, TX 75215, (214) 428-3901.

Focal 7N313 7" mids, \$115/pair or trade for Focal 515 series or better 8" or 10" drivers. Clark Bendall, (219) 365-7308, Dec. 15 through Jan. 7, (317) 495-4231 otherwise.

Complete set of Dynaco A-10 speaker components, used but in perfect working order; (2) 6 1/2"; SEAS woofer/midbass drivers; (2) SEAS tweeters; (2) two-way crossovers, \$75 plus shipping. Mr. Willes, (800) 227-6121, weekdays.

ACTIVE ELECTRONIC CROSSOVERS

MODEL 120 CABINET & NEW 120-R "RACK AND PANEL" DESIGNS

Plug-in Butterworth (maximally flat) filters 6 db., 12 db., or 18 db. per octave slopes, any specified frequency. Model 120 instrument style case or 120-R "Rack and Panel" case with all terminations and regulated power supply.

Made in monaural or stereo bi-amp, tri-amp, or quad-amp with optional level controls, subsonic filters supplies with or without bass boost, and summers for "single woofer" systems. Also available, 500 Series filters, plug-in filters, regulated power supplies.

New catalog and price sheet. Free!

DeCoursey Eng. Lab.

11828 Jefferson Bl. Culver City, CA 90230
PHONE (213) 397-9668

(2) SAE A202 power amps 100w/channel, used, \$175 each; Ace Audio model 5000 electronic subwoofer crossover 200Hz 18dB, used, \$40; RG Dynamics X-15 Dynamic processor, used, \$75. Roger Daniels, Rt. 5, Box 612, La Grange, TX 78945, (409) 247-4260, before 9:00 p.m. CST.

Lowther corner enclosure, teak wood, mint condition, with driver. Anthony Lumkin, 31012 Camino Capistrano, San Juan Capistrano, CA 92675, (714) 661-8531.

Two pair Gold Ribbons 3.0 latest models, \$750/pair; Swan Pedal Coupler, \$125. Will trade ribbons for pair of B&K Sonata Monos. Carl, (916) 967-1065.

One JBL LE85 horn driver, excellent condition, best offer. David Adams, 2015 Paisley Dr., Arlington, TX 76015-2820.

Dynaco PAS preamp, unmodified, \$75; pair Madison 15258DVC 15" subwoofers, new, \$85; Technics SLJ2 turntable, \$50; Bell and Howell oscilloscope, \$40; pair Dahlia-Debra speakers, \$600. Phil, (408) 266-0543, after 7 p.m. PST or leave message.

SOTA SS vacuum clamp, SME III titanium arms, Grado/MCX used 8 hours; Monster Alpha Genesis 1000, 5 hours; Thorens TD-320, Shure V15YMR, 8 hours; Sony CDP-705ESD. All like new. Best offers. Sam Goda, 1815 N. Woodside St., Orange, CA 92665, (714) 637-3989.

Rare and unusual KEF model K-2 Celeste MK-2 two-way speakers made in 1966 in England. Solid wood construction, never abused, first class condition, woofer is oval shape, truly collector items. Good deal for the right person, cash price, \$200/pair. I pay shipping. Call Ed, (305) 891-2267.

(4) Radio Shack 40-1022 woofers, original version, new, \$16 each; (4) Audax TX2025RSC, new, \$25 each; (2) SEAS H400 tweeters, new, \$25 each; (2) Vifa D26TG05 tweeters, \$10 each; (2) Wood-style oak towers, new, \$100 each. Reasonable offers accepted. Al Vanneste, 45814 Kensington, Utica, MI 48317, (313) 739-0305, after 5 pm, EST.

WANTED

Circuit board or kit for Audio Research ST-70-C3 modification. Bill Swafford, 3121 Bell Dr., Boulder, CO 80301, (303) 449-0831.

Old Klipsch catalogs, JBL literature; Books: TM11-690, *Basic Theory and Applications of Transistors*, (Army Manual); *Throne of Merlin* (R.C. Schaller), D.R. Schaller, 6704 Schroeder Rd., Suite 6, Madison, WI 53711.

SWPTC 275 Tiger amplifier. Harold Berg, 9809 53rd Ave., College Park, MD20740.

Four 10K515 Focals, crossover for Aria 5, Richter Scale III. Chris (314) 993-1603 before 10 p.m. CST.

Two used Audax HD20 B25 H 8Ω. Stanley H. Grycx, 2935 Crehore St., Lorain, OH 44052, (216) 288-9480.

Circuit diagrams for tube crossover at 550Hz to 750Hz (premier grade parts) use for Apogee calipers and duettas signature series. Knowledge to form high-end clubs. Moktar BUD Ari, PML/1 BSP Seria 7082 Brunei Darussalam (Borneo).

Heil AMT tweeters. Broken or singles also wanted. Literature about the ESS Transar full-range speaker. Rod Baird, 1249-A Ninth Ave., San Francisco, CA 94122, (415) 681-7149.

Electrostatic speakers/parts/direct drive amps, Peerless output transformers, share tube schematics/modifications. Dennis Boyle, (214) 428-3901.

Fujitech A1033 integrated tube amp. with all papers. Harvey Otis Lewis, Rt. 1, Box 272, Stephens City, VA 22655, (703) 869-3066, after 6 pm.

TRANSDUCER ENGINEER

Established speaker manufacturer in California requires acoustic engineer with experience in tweeter design. Call Len at: (800) 727-2478.

Yamaha MX10000. Sam Goda, 1815 N. Woodside St., Orange, CA 92665, (714) 637-3989.

Power transformer for a Dynaco SLA 35 integrated amp and a single Dynaco Mark III stock in working condition. Robert Morrison, JG-15 U.W. Speech and Hearing Sciences Dept., Seattle, WA 98195, (206) 543-1575.

Information on high-pass crossover modification to Aria 5 to replace T90K with Accuton CII (4Ω?). No change in 5K013 crossover desired. P. Hessemer, 1355 Greenleaf, Chicago, IL 60626.

1-8 pairs of Distech Blue interconnect, especially 1-2 meter lengths; Audio Research RMV-3 rackmount ventilator; Phase Linear 500II, 700II, 400II amps; Crown and Bryston amps; Altec 416, 411, 515, woofers; older Altec and JBL furniture type speakers, such as Magnificent A7-500. David Rubenstein, (914) 688-5024.

Challenging and rewarding career offered by MTX, the fastest-growing, privately-held speaker manufacturer in the United States. Seeking qualified speaker design engineers, transducer development engineers, loudspeaker designers, and loudspeaker manufacturing management personnel. We offer a full benefits package, including medical coverage, 401K and profit-sharing programs. Salary commensurate with ability. Mail resume to MTX, One Mitek Plaza, Winslow, IL 61089, Human Resources Department. EOE

CLUBS

CONNECTICUT AUDIO SOCIETY is an active and growing club with activities covering many facets of audio—including construction, subjective testing, and tours of local manufacturers. New members are always welcome. For a copy of our current newsletter and an invitation to our next meeting, write to: Richard Thompson, 129 Newgate Rd., E. Granby, CT 06026, (203) 653-7873.

MEMPHIS AREA AUDIO SOCIETY being formed. Serious audiophiles contact J.J. McBride, 8181 Wind Valley Cove, Memphis, TN 38125, (901) 756-6831.

AUDIO SOCIETY OF MINNESOTA. Audiophiles, music lovers, scratch builders, record collectors, tube freaks, digital freaks—we've got 'em all! Monthly meeting, tours, audiophile concerts, special guests, etc. Now in our 12th consecutive year! Write ASM, PO Box 32293, Fridley, MN 55432.

AUDIOPHILES IN THE DAYTON/SPRINGFIELD, OHIO AREA: We are forming an audio club. Please contact me if you're interested in construction, modifications, testing, recording or just plain listening to music. Ken Beers, 1756 Hilt Rd., Yellow Springs, OH 45387, (513) 767-1457.

THE CATSKILL AND ADIRONDACK AUDIO SOCIETY invites you to our informal monthly meeting. Join our friendly group of audio enthusiasts as we discuss life, the universe and everything. No matter what your level of interest, experience, or preferences, you are welcome. Meetings are generally held once a month, on a weekday evening. Contact CAAS at 756-9894 (leave message), or write CAAS, PO Box 144, Hannacroix, NY 12087. See you there!

NEW JERSEY AUDIO SOCIETY meets monthly. Emphasis is on construction and modification of electronics and speakers. Dues includes monthly newsletter with high-end news, construction articles, analysis of commercial circuits, etc. Meetings are devoted to listening to records and CDs, comparing and A-B-ing equipment. New members welcome. Contact Bill Donnally, (201) 334-9412 or Bob Young, 116 Cleveland Ave., Colonia, NJ 07067, (201) 381-6269.

SOUTHEASTERN MICHIGAN WOOFER AND TWEETER MARCHING SOCIETY (SMWTMS), Detroit area audio construction club. Meetings every two months featuring serious lectures, design analyses, digital audio, A/B listening tests, equipment clinics, recording studio visits, and audio fun. The club journal is *LC, The SMWTMS Network*. Corresponding member's subscription available. Call (313) 477-6502 (days) or write David Carlstrom, SMWTMS, PO Box 721464, Berkley, MI 48072-0464.

In 1988, Madisound Speaker Components processed 20,000 orders.

VIFA
FOCAL
PHILIPS
EUROPA
MOREL
KEF
DYNAUDIO
MB QUART
AUDAX
PEERLESS
SOLEN
ETON
PERFECT LAY
SIDEWINDER
ELECTROVOICE
SLEDGEHAMMER

Doesn't your hobby deserve these fine product lines?

 Madisound Speaker Components
8608 University Green
Box 4283 Madison WI 53711
Phone: 608-831-3433
Fax: 608-831-3771

ELECTROSTATIC LOUDSPEAKER USERS GROUP is now a world-wide network for those interested in sharing valuable theory, design, construction, and parts source information. If you are interested in building, or have built, your own SOTA ESL we invite you to join our loose-knit organization. For information, send an SASE to: Barry Waldron, 1847 Country Club Dr., Placerville, CA 95667.

THE HI-FI CLUB of Cape Town in South Africa sends a monthly newsletter to its members and world-wide subscribers. To receive an evaluation copy of our current newsletter, write to: PO Box 18262, Wynberg 7824, South Africa. We'll be very pleased to hear from you.

THE COLORADO AUDIO SOCIETY is a group of audio enthusiasts dedicated to the pursuit of music and audiophile arts in the Rocky Mountain region. We offer a comprehensive annual journal, five bimonthly newsletters, plus participation in meetings and lectures. For more information, send SASE to: CAS, 4506 Osceola St., Denver, CO 80212, or call Art Tedeschi, (303) 477-5223.

ORGAN MUSIC ENTHUSIASTS: If live recordings of fine Theatre Organ Music are your thing, SFORZANDO has room for a few new members. We lend you the music on cassettes. All operation is via the mail. SFORZANDO, c/o E.A. Rawlings, 5411 Bocage St., Montreal, Canada H4J 1A2.

PACIFIC NORTHWEST AUDIO SOCIETY (PAS) consists of 60 audio enthusiasts meeting monthly, second Wednesdays, 7:30 to 9:30 p.m. at 4545 Island Crest Way, Mercer Island, Washington. Be our guest, write Box 435, Mercer Island, WA 98040 or call Bob McDonald, (206) 232-8130.

PIEDMONT AUDIO SOCIETY. Starting an audio club in the Raleigh-Durham-Chapel Hill area of North Carolina. Interested in designing, building, and modifying speakers and electronics (solid state and tube). Beginners and old hands both welcome. Kevin Carter, 9009 Langwood Drive, Raleigh, NC 27612, (919) 870-5528.

THE INLAND EMPIRE AUDIO SOCIETY our former name, has now been changed to the **SOUTHERN CALIFORNIA AUDIO SOCIETY (SCAS)**. Our effort is now inviting music lovers, audiophiles, hobbyists and other interested parties throughout the southland to join us in our pursuit for that elusive sonic perfection and truth at our meetings and seminars and through our official speaker. *The Reference* newsletter. For information write or call: Frank Manrique, President, 1219 Fulbright Ave., Redlands, CA 92373, (714) 793-9209.

THE ATLANTA AUDIO SOCIETY is dedicated to furnish pleasure and education for people with a common interest in fine music and audio equipment. Monthly meetings often feature guest speakers from the audio manufacturing and recording industry. Members receive a monthly newsletter. Call: Chuck Bruce, (404) 876-5659, or Denny Meeker, (404) 872-0428, or write: PO Box 361, Marietta, GA 30061.



PHILIPS
TWEETERS
MID-RANGES

Wholesale • Retail

The Speaker Factory

9141 Arbutuckle Drive
Gaithersburg, MD 20877-1428
301-840-0747

WASHINGTON AREA AUDIO SOCIETY Meetings are held every two weeks, on Fridays from 1900 hrs. to 2130 hrs. at the Charles Barrett Elementary School in the city of Alexandria, Va. Prospective members are welcome but must register in advance in order to be admitted to the meetings. No exceptions please. If interested please call Horace Vignale, (703) 578-4929.

THE WESTERN NEW YORK Audio Society (WNY Audio Society) is an active and growing audio club located in the Buffalo area. We issue a quarterly newsletter and hold meetings the first Tuesday of every month. Our meetings have attracted many local and distant manufacturers of audio related equipment. We are involved in all facets of audio—from building to purchasing at discount prices. For a copy of our current newsletter and information regarding our society, please write to M.A. Monaco, WNY Audio Society, PO Box 312, N. Tonawanda, NY 14120.



Advanced Akustik
Loudspeaker Technology Ltd.

DYNAUDIO • Speaker Kits • Cabinetry

4555 North Pershing Avenue • Suite 33•184
Stockton CA 95207 (209) 477-5045

THE BOSTON AUDIO SOCIETY invites you to join and receive the bimonthly *B.A.S. SPEAKER* with reviews, debates, scientific analyses, and summaries of lectures by major engineers. Read about Apogee, Nyal, Conrad-Johnson, dbx digital, Snell, music criticism and other topics. Rates on request. PO Box 211, Boston, MA 02126.

CHICAGO AREA ENTHUSIASTS WANTED for audio construction club. Call Tom, (312) 558-3377 or (708) 516-0170 evenings for details.

THE OREGON TRIODE SOCIETY is seeking men and women who are interested in good sound reproduction and the music it re-creates. We are 80+ members strong and meet bi-monthly in various locations in the Portland area. Our bi-monthly newsletter is *Positive Feedback*, a vital forum on audio and a host of related subjects. For information on our next meeting and newsletter, contact Richard Eggerston, 3623 S.E. Hawthorne, Portland, OR 97214, (503) 238-1957 or Ian Joel (503) 233-1079.

LONDON LIVE D.I.Y. HI FI CIRCLE has formed in London, England. We meet quarterly, with an open agenda of anything to do with any aspect of audio design and construction. For information contact Dick Bowman, (801) 520-6334.

Advertising Index

| FAST REPLY | PAGE |
|--------------------------------------|-----------|
| KE572 A & S SPEAKERS | 15 |
| KE66 ABILENE | 69 |
| KE53 ACE AUDIO CO. | 82 |
| KE27 ACOUSTICAL MAGIC CO. | 81 |
| KE1343 ADVANCED AUDIO PARTS | 94 |
| ADVANCED SOUND | 89 |
| AUDIO AMATEUR PUBLICATIONS | |
| BACK ISSUES | 88 |
| BOXES & BINDERS | 72 |
| ELEKTOR ELECTRONICS USA | 76-77 |
| T-SHIRTS | 84 |
| AUDIO CONCEPTS, INC. | |
| KE1344 BIG SALE | 33 |
| SAPPHIRE II | 71 |
| KE123 AUDIO CONTROL | 74 |
| KE695 AUDIO PRISM | 92 |
| KE32 AUDIO TEKNOLOGY | 95 |
| KE333 BIG COVE RESEARCH | 83 |
| KE330 CAPE ACOUSTICS | 92 |
| KE596 DLC DESIGN | 103 |
| KE283 DRA LABORATORIES | 29 |
| KE370 EQUALITY SCREW CO. | 105 |
| KE1107 ETON | Cover II |
| EUPHONIC TECHNOLOGY | 95 |
| FOCAL AMERICA | |
| KE147 ACCUTON | 57 |
| KE29 SUBWOOFERS | 9 |
| KE588 SRC CAPACITERS | 35 |
| KE149 GOLD SOUND | 90 |
| KE699 GREGENG | 75 |
| KE166 GRENIER CABINETS | 74 |
| KE551 HART PROFESSIONAL MARKETING | 59 |
| HI-FI NEWS | 78 |
| KE643 HTA | 80 |
| KE320 JOSEPHSON ENGINEERING | 19 |
| KE387 LRS ELECTRONICS | 66 |
| MADISOUND SPEAKER COMPONENTS | |
| KE20 FINEST INGREDIENTS | 13 |
| KE118 DYNADIO | 41 |
| KE73 MAHOGANY SOUND | 86 |
| KE389 MARRS DEVELOPMENT | 83 |
| KE661 MAY AUDIO MARKETING, INC. | 87 |
| KE568 MENISCUS | 84 |
| KE186 MITEK | 31 |
| KE142 MOREL ACOUSTICS | Cover IV |
| KE598 NEUTRIK USA, INC. | 43 |
| OLD COLONY SOUND LAB | |
| AUDIO GLOSSARY (HOLT) | 68 |
| BOOKS | 8, 46-48 |
| BULLOCK ON BOXES | 8 |
| CIRCUIT BOARDS | 49 |
| DOUBLE DISCOUNT CATALOG | 44-52 |
| KITS | 44-45 |
| MANUAL OF VENEERING | 84 |
| SOFTWARE | 50 |
| KE81 PARTS EXPRESS | Cover III |
| KE666 PEERLESS AMERICA | 79 |
| POLYDAX | |
| KE668 DISTRIBUTORS | 54 |
| PRESTIGE LINE | Pullout |
| KE196 PROFESSIONAL MOD SERVICE, INC | 85 |
| KE128 PYLE INDUSTRIES | 25 |
| KE163 RAMSDELL AUDIO | 90 |
| KE295 SCHUCK CONSULTING | 104 |
| KE499 SESCOM | 89 |
| SOLENT, INC. | |
| KE1342 DAVIS ACOUSTICS | 61 |
| KE1063 SPEAKER COMPONENTS | 37 |
| KE689 SOUNDOWN CORP. | 80 |
| KE1340 SOUTHEAST SPEAKER SUPPLY, INC | 85 |
| KE45 SpeakEasy | 87 |
| KE412 SPEAKERS, ETC. | 81 |
| KE298 SPEAKER EXCHANGE | 86 |
| KE618 SPEAKER WORKS | 82 |
| KE607 TRANSPARENT AUDIO MARKETING | 104 |
| KE544 TRUE IMAGE | 69 |
| VERSA-TRONICS, INC. | 65 |
| KE401 WATTERS SOUND WAVE, INC. | 5 |
| KE1131 ZALYTRON | 17 |



WANTED

AUDIO CLUB MEMBERS

(Good singing voice not required)

Learn about the latest equipment, techniques and recordings through group meetings, tours and newsletters. Ask questions. Share viewpoints and experiences. *Have fun!*

If there's no club in your area, why not start one? Our club ads are free up to 75 words (\$.20 per word thereafter). Copy must be provided by a designated officer of the club or society who will keep it current.

THOSE INTERESTED IN AUDIO and speaker building in the Knoxville-East Tennessee area please contact Bob Wright, 7344 Toxaway Dr., Knoxville, TN 37909-2452, (615) 691-1668 after 6 p.m.

TUBE AUDIO ENTHUSIASTS. Northern California club meets every other month. For next meeting announcement send a self-addressed, stamped #10 envelope to Tim Eding, PO Box 611662, San Jose, CA 95161.

WANT TO START OR JOIN CLUB IN CENTRAL ILLINOIS (Peoria, Bloomington, Champaign, Kankakee area). Speaker building and audio in general. Trade info and parts. (815) 657-8488 evenings or weekends.

Good News



INFINITY SYSTEMS, INC. has announced delivery of a new three-piece speaker system, the Infinitesimal Four, the first in a new line of Infinitesimal products. The system is the result of evolutionary engineering and development, going back to Infinity's \$50,000 IRS V Reference Standard speaker system and the MODULUS system.

The Infinitesimal Four consists of a pair of two-way satellites equipped with planar tweeter design, the EMIT-R™, and a 5¼" long throw woofer constructed with injection molded graphite (IMG) cone material. Housed in a Time Aligned and vented enclosure, the satellite has a frequency response of 100Hz-20kHz, ±3dB. Power handling is 10-80W per channel.

The tweeter delivers frequency and transient response through a design which allows the tweeter's moving mass to be a fraction of that of conventional dome tweeters. The benefit is clean frequency response and harmonic balance of the top end. The seamless transition from tweeter to woofer is accomplished by careful crossover design and Time Aligned mounting of the drivers. This also assures balance and imaging at all frequencies.

The satellites are matched with a cube shaped, powered 10" subwoofer also equipped with an IMG cone. The 100W

servo controlled subwoofer features a volume control, both high and low inputs, as well as a crossover circuit to blend smoothly with satellites. The subwoofer features switchable low-end cutoff points at 40Hz and 60Hz, allowing woofer response to be tailored to room and listening requirements. Finished in matte black, the Infinitesimal Four Satellites, are priced at \$419.95 and are available from audio specialist showrooms nationwide. The Infinitesimal servo subwoofer's suggested retail is \$629.95.

For further information or materials, please contact Richard Frank, Frank Marketing Associates, 8 Mohave Rd., Medfield, MA 02052, or call (508) 359-5977, FAX (508) 359-5343.

Fast Reply #KE146

Seattle-based **SOUNDINGS-ELECTROTEC** announces its appointment as North American import agents and distributors for Minim Ambisonic Surround Sound Decoders and Processors for the consumer hi-fi and professional recording markets.

Minim currently manufactures two decoders for the consumer market: the AD10 decoder, a high specification full-feature system including loudspeaker aspect ratio control, focus, and position (the listener may move forward or backward in the soundfield for more or less audience or

MOREL introduces a series of automotive loudspeakers. The MDT-204, MDT-205, MDT-206 tweeters, and CW-5 midbass. The tweeters emphasize mounting flexibility.

At least five mounting configurations are possible, from original locations as specified by the automobile manufacturer for flush and/or surface installations. Surface mounting may be in flat position or angles to 20° or 82°, with hardware supplied. Their compactness allows installation in door panels, rear or front shelves, or nearly any location.

Fashioned of highly-durable materials, the mini-tweeters are designed to withstand the rigors of automotive environments. The steel grille provides protection while enhancing the driver's modern look.

The designs use large diameter (1½") ferrofluid-cooled voice coils with soft domes, assuring high-power handling capability and wide dynamic range. With low resonant frequency points, these mini-tweeters have smooth sound quality, and are ideal for use with minimum phase shift 6dB crossovers, or a single film capacitor. All models have replaceable, self-centering dome coil assemblies.

The 5" automotive midbass driver, Model CW-5, features a double-magnet structure with a 3" voice coil, DPC (dampened polymer composite) cone, rubber surround, and removable grille.

For information contact, Morel Acoustics USA, 414 Harvard St., Brookline, MA 02146, (617) 277-6663.

Fast Reply #KE142

ambience). It also features stereo enhance for normal stereo recordings, variable from central mono image to a complete surround. The AD10 is priced at \$595.

The AD7 decoder, priced at \$325, is a simplified version of the AD10 and includes loudspeaker layout, focus, and stereo enhance controls.

For further information, please contact Nigel Branwell at Soundings-ElectroTec Inc., PO Box 10004, Winslow, WA 98110, (206) 842-7128, FAX (206) 842-5026.

Fast Reply #KE676

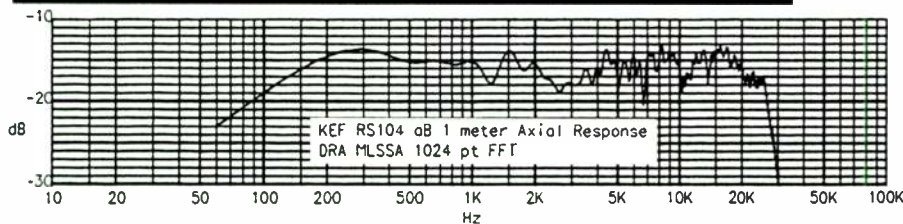

BKGRAPH, an audio data graphing utility, has recently been released. It accepts data from a wide variety of sources, such as design and simulation programs, measurement and analysis systems, and simple text files. It produces high-quality presentation- and publication-ready plots on a variety of media.

The system supports high-resolution color and laser plotters, and graphs simulation and measurement data together on one graph. It produces a universally-accepted format for all these systems.

BKGRAPH-generated plots meet industry standards for presentation of audio data, and replicate the style of plots produced by industry-standard graphic level recorders (such as the Bruel & Kjaer 2307 or the Neutrik 3302). The plots are 8" x 4", and their accuracy and resolution is limited only by the input data and the printer or plotter capabilities. It can use multiple color, and multi-pen plotters.

Plotting modes on the Y-axis are linear,

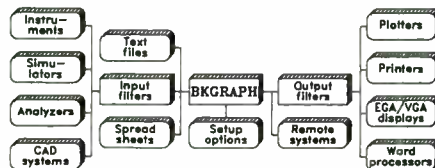

decibel, phase angle, and logarithmic, each available in six scale widths. The X-axis provides 10Hz-100kHz logarithmic frequency, and linear frequency or time, also in several ranges.

BKGRAPH is available for IBM PC/MS-DOS compatible systems on 5¼ and 3½" media. The software kit includes all the necessary executable programs, complete user and interface documentation, and several demonstration files. It is also available for UNIX systems.

The BKGRAPH single-user binary license is \$150. For input conversion filter prices and other options, contact Richard Pierce, 17 Sartelle St., Pepperell, MA 01463, or call (508) 433-9283.

TDL ELECTRONICS has developed the Studio 0.5, possibly the world's smallest transmission line loudspeaker. It provides exceptional bass performance, giving the illusion of a loudspeaker system many times larger. The design was tailored to the typical domestic environment.

TDL developed a miniature long throw bass unit for the new speaker. It uses Kapton, which allows an increase in the driver's Q , allowing it to more easily load the line. With smooth midrange transition, this driver is integrated with a metal dome tweeter via a simple crossover.

The speakers are ready for bi-wiring or for bi-amplifying. Bass and treble frequencies can be separately accessed using different interconnect leads. The treble and bass can be driven by a choice of amplifiers with different operating principles. Bridging the terminals (as supplied) allows for conventional single wire, single amplifier operation.

Custom stands are available. Constructed from square section steel, they allow for the insertion of spikes supplied with each unit. The use of stands is recommended, especially when the loudspeakers are on wooden floors. For information contact, TDL Electronics, 652 Glenbrook Rd., Stamford, CT 06906, (203) 324-7269.

Fast Reply #KE677

TRUE IMAGE announces availability of version 1.5 of **MacSpeakerz™**, a loudspeaker design application for the Macintosh™ computer. **MacSpeakerz** was written for the Macintosh and takes full advantage of its interface.

It calculates and displays the frequency response of any loudspeaker driver/box combination specified, and gives corresponding enclosure dimensions for that response. Dimensions are also displayed for vented enclosures. A library of loudspeaker drivers is provided and can be expanded to include new drivers. The application prints reports on finished speaker enclosures listing driver parameters, box parameters, enclosure dimensions, and frequency plots.

MacSpeakerz used the mathematical models of Thiele and Small for both vented and closed box systems. A bibliography of the engineering papers which first revealed the mathematical models is included in the technical references. You can run **MacSpeakerz** on any Macintosh computer with at least 512K memory and one 800K disk drive. Software and manual are available for \$145 from True Image. For information, contact True Image, 349 West Felicita Ave., Suite 122, Escondido, CA 92025, (619) 480-8961.

Fast Reply #KE544

File Edit Analysis Memory Vent Box

Fane Studio 15 Bass

| | V(B) | F(B) | Q(tc) | m |
|--|------|------|-------|---|
| | .68 | .0 | 1.00 | 1 |
| | 3.01 | .0 | .58 | 3 |
| | 1.81 | 45.0 | .68 | 5 |
| | 3.34 | 42.0 | .56 | 7 |
| | 4.78 | 45.0 | .51 | 9 |

| Driver Parameters | | Box Parameters | |
|-----------------------------|--------------|------------------------|---------------|
| Driver: Fane Studio 15 Bass | | Box Vol. (Cu Ft) | U(B) = 4.7834 |
| Free Air Resonance (Hz) | f(s) = 42 | Box Freq. (Hz) | F(B) = 45 |
| Total Driver Q | Q(tc) = .37 | Closed Box Q | Q(tc) = .51 |
| Equip. Volume (Cubic Ft.) | U(as) = 4.52 | Min. Vent Area S(v)MIN | = 56.6 |
| Max Thermal Power (Watts) | P(t) = 200 | Vent Area (Sq In) S(v) | = 50.3 |
| Nominal Diameter (Inches) | D = 15 | Vent Length (In) L(v) | = 8.205 |

Box Dimensions

Following are three different sets of dimensions which will give a box with internal volume: $V(B) = 5.71$ cubic feet

(Note that these are net internal dimensions in inches)

| | | | |
|-------------------------|-----------|-----------|-----------|
| Box 1 (1.62:1.00:0.620) | H = 34.75 | W = 21.45 | D = 13.30 |
| Box 2 (1.49:1.04:0.648) | H = 31.96 | W = 22.31 | D = 13.90 |
| Box 3 (1.25:1.00:0.800) | H = 26.81 | W = 21.45 | D = 17.16 |

FERROFLUIDICS CORPORATION has introduced a new series of audio-grade ferrofluids developed to withstand extreme temperatures while maintaining ultra-high stability. The APG 900 Series operates safely at voice coil temperatures of 200°C (392°F) for an extended time without significant evaporation. Voice coil operating temperatures are reduced when ferrofluid is used as a heat transfer medium.

As a result of the long-term thermal stability of APG 900 Series ferrofluids, transducer engineers developing high-efficiency speaker systems, such as those used for studio monitors, sound reinforcement, sirens, and voice warning devices, are now able to utilize ferrofluid as a design component.

The ferrofluids, which are offered in low to medium viscosity ranges, complement the current line of high viscosity ferrofluids used in tweeters and midrange drivers.

Application notes as well as performance differences between the various series of ferrofluids, are available. For further information contact, Customer Service, Ferrofluidics Corp., Customer Service, 40 Simon St., Nashua, NH 03061-2009, (603) 883-9800.

Fast Reply #KE117

ELECTRO-VOICE has recently implemented Kevlar™ fiber composite speaker cones into their EVX-180 woofers.

The ribbed Kevlar cone provides a high stiffness-to-weight ratio, giving the EVX-180 increased resistance to cone collapse and deformation, without sacrificing efficiency. A rubber mounting-flange gasket provides a reusable seal for front or rear mounting, completely surrounding the frame flange.

It provides excellent power capacity, linearity and excursion due to EV's exclusive HeatWick™ thermal engineering design, which "wicks" heat away from the speaker's voice coil, increasing power handling and long-term reliability.

A special frame extension and elongated pole piece provide a metal surface close to the voice coil, creating a heat-transfer path. The 100mm (four-inch) diameter voice coil is longer than conventional medium-efficiency woofers to give additional power handling, and eliminate dynamic-range power compression.

The EVX-180 also features a Flux Demodulation Device™ (FDD) which reduces distortion in the midband.

It offers 1kW continuous program power capacity for high output with low distortion. The woofer has a recommended frequency range of 20Hz-1.5kHz.

For information, contact Electro-Voice 600 Cecil St., Buchanan, MI 49107, (616) 695-6831, FAX (616) 695-1304.

Fast Reply #KE453

POLYDAX SPEAKER CORP., a subsidiary of Audax Industries, has developed a comprehensive line of loudspeaker components which have been introduced into the professional sound industry.

The most recent model is the PR 120. Engineered to meet exacting industry demands, this bullet tweeter uses a titanium diaphragm for better transient response, increased efficiency, and reliability.

The voice coil design employs a two-layer copper coil based on an aluminum former and is ferrofluid cooled. The PR 120 is rated at a sensitivity level of 104dB (1W/1M).

The competitively priced tweeter is designed for a wide application range, from



professional to high-end automotive installations. For information contact Polydax Speaker Corp., 10 Upton Dr., Wilmington, MA 01887, (508) 658-0700.

Fast Reply #KE668

SPEAK

Acoustic Simulation Software

- Design Revolutionary Loudspeaker Systems -

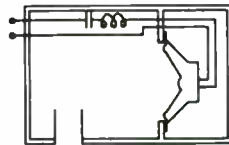

(A) 6th Order
(B) Vented
(C) Sealed

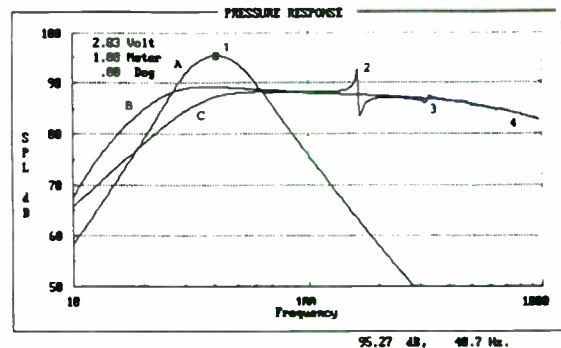

SPEAK output in iteration mode comparing 3 designs for the same driver. Note (1) cursor readout. (2), (3) Duct "organ pipe" resonances. (4) Rolloff due to v.c. inductance.

SPEAK gives the same results as conventional Thiele-Small based programs for simple designs. But, you can go far beyond.

Input Parameter Options
 Full driver specifications
 Front and rear enclosures
 Vents or passive radiators
 Passive crossover/equalizer
 Active filter, order 1-5
 Parametric equalizers
 Driver non-linearities
 Multi-way systems
 More...

Plotting Options
 Pressure Response
 Electrical (Z, V, I)
 Diaphragm displacement
 Off-axis Response
 More...

Requires
 IBM AT class compatible computer with coprocessor and EGA monitor.

Purchase.....395.00

Multi-User.....995.00

DLC DESIGN
 24166 Haggerty Rd.
 Farmington Hills, MI 48335
 (313) 477-7930

Fast Reply #KE586

UNCERTAINTIES IN CAPACITORS: GUESSWORK IN DESIGN

If soldering capacitors in parallel leaves you wondering if you're getting the best sound

MIT has a solution – THE MULTICAP™

Each individual MultiCap capacitor gives you 10 high-current precision capacitors in one compact optimized unit.

MultiCap is a patented process of unique physical and electrical properties providing superior transient and phase characteristics – critical elements for fast and accurate signal handling.

"MultiCap. The most advanced capacitor in the world."

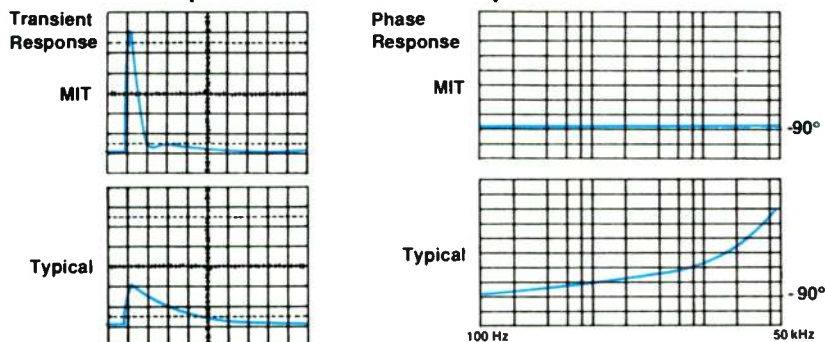

Our staff provides full technical support, documentation, and custom values for OEMs. Samples available.

Music Interface Technologies MIT

For more information, including a detailed white paper, please contact:

TRANSPARENT AUDIO MARKETING Rt. 202, Box 117, Hollis, Maine 04042 (207) 596-7151

Fast Reply #KE607

XOPT V3.0 : LOUDSPEAKER CROSSOVER DESIGN AND OPTIMIZATION PROGRAM

- * Easy to use pop-up menu driven program with graphics
- * Design optimized low, high or band pass crossover networks
- * Optimize the frequency response of a speaker system with up to 5 drivers and 33 interconnected crossover components on any axis or combination of up to 5 axes
- * Requires user input of magnitudes of driver frequency response in dB and impedance in Ohms at user specified frequencies
- * Calculates driver impedance phase from a model fit and frequency response phase using a Hilbert Transform
- * Uses relative locations of driver acoustic centers on the speaker front baffle for system crossover optimization
- * Used by many of today's top loudspeaker designers

Why settle for anything less than optimum crossover designs ?

Send check or money order for \$199.00 (US) to:

Peter Schuck

Peter L. Schuck Consulting

1705 Rodin Way, Orleans, Ontario, Canada K1C 4Y9
(613) 824-3822

For IBM PC, AT, PS/2 and compatibles including 80386's with 640K, Hercules, CGA, EGA or VGA graphics with or without a 80x87 math chip running DOS 2.0 or higher

Fast Reply #KE295

The **BOB WOOD ORGANIZATION** announced it has begun marketing the new home audio/video product **CABLEHIDER**, to put the finishing touches on installation of interconnect or speaker cables.

CABLEHIDER carries cables in two hidden slots behind the baseboard with entry and exit panels for easy access.

The baseboards are available in unfinished six-foot lengths in three of the most popular baseboard fronts, and are available in pine for a paint finish and in ash for staining. Oak is also available.

For more information call or write The Bob Wood Organization, 7 Treasure Cove, The Woodlands, TX 77381, (713) 363-4971.

Fast Reply #KE106

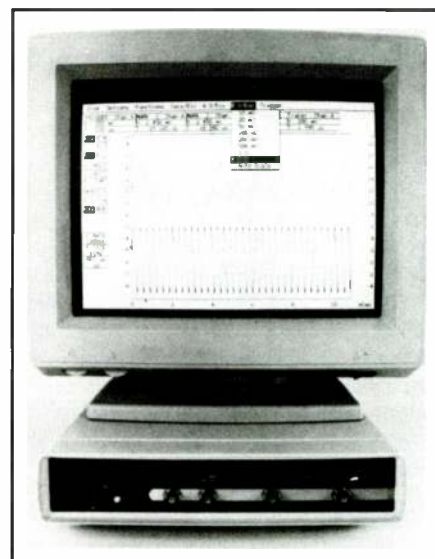

RAPID SYSTEMS has introduced the R380 PC-based Spectrum Analyzer and Digital Oscilloscope. The R380 has two 14-bit A/D channels with software selectable input signal gain ranges. Easy triggering allows setting the exact trigger level and conditions needed with easy on-screen tools, and an external trigger for remote control.

The hardware unit connects to a PC's serial port. Signal cursor and two dynamic markers allow for spot measurements of voltage, time difference, and frequency.

Applications include vibration analysis, acoustics, biological sciences, engineering and physics test systems, and teaching lab.

Product highlights offer two channel, 14-bit resolution, 85dB dynamic range, 100kHz sample rate; up to 8K point FFT; EGA, VGA, CGA, and Hercules compatible; 16K data buffer for each channel; and FFT and time domain averaging.

Available from Rapid Systems, 433 North 34th St., Seattle, WA 98103, (206) 547-8311, FAX (206) 548-0322.

Fast Reply #KE948

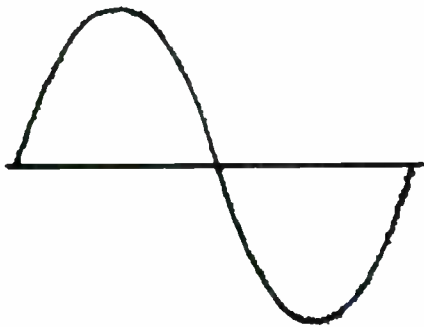

FIGURE 1: Digitized audio signal after feeding through a Digitrap filter.

Clean up your CD sound in seconds, re-discover the spaces around individual instruments, hear up to a 30-fold increase in signal detail.

SAGE AUDIO ELECTRONICS is now offering the CD Digitrap line of filters, a new filtration device based upon a passive "cyclic" filter block. When connected to a CD or DAT player the Digitrap provides up to 30dB reduction in the digital quantization noise, while passing the audio signal unaffected. This results in a 30dB increase in musical detail and resolution.

The Digitrap plugs into the audio output of a CD player, and the output from the Digitrap then feeds into your amplifier. It is compatible with all types of CD players.

Features and benefits include: gold-plated in/out connections, totally passive (no power required), top quality components, two filter blocks for stereo use, and lifetime performance guarantee.

The Digitrap 2 is available for \$110 (including airmail), and a catalog is offered for \$6 from Sage Audio Electronics, Construction House, Whitley St., Bingley, West Yorkshire BD16 4JH, England.

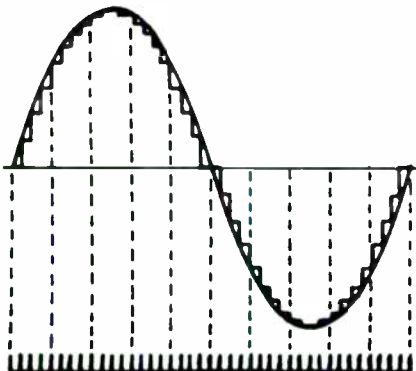

FIGURE 2: Replayed digitized audio signal from a CD player's output, including quantization noise.

ARE YOU MOVING?

Please!

Send us your *new* address 4 weeks in advance. Thank you.

The McNEILL loudspeaker makes use of loudspeaker principles and criteria for studio professionals. Measuring 20" x 11" x 12", the enclosure departs from conventional loudspeaker dimensions to improve stereo imaging and forward soundstaging.

Good linearity coupled with absence of coloration accounts for the Polydax 1" soft dome tweeter's reputation for reproducing quality natural sound. The heavy-duty 8" American-made woofer is mounted in an acoustic suspension enclosure with gradual low-frequency rolloff.

The enclosure is coated with a textured

jet black finish. All outside corners are rounded to ease diffraction effects. The standard grille is black, but any color or print may be ordered to match home interiors.

Frequency response is 34-22kHz, ± 3 dB, power requirements are 1-100W per channel, with sensitivity at 90dB. List price is \$319 per matched pair. A free brochure is available upon request. Contact McNeil Engineering and Manufacturing, 417 Temple Rd., Monaca, PA 15061-2843, (417) 375-9203.

Fast Reply #KE151

NEW



LITTLE GRIPPER END SPIN OUT!

PARTICLEBOARD HINGE SCREW

The "Little Gripper" is the answer to your small fastener problems in particleboard and MDF. With the wide spread use of these man made woods the right fastener that works each and every time is essential to your production requirement.

The "Little Gripper" with its wide spaced angled threads is especially designed for use with your hinge application in particleboard and MDF. Avoid the frustrating and time consuming problem of spin out, so common with sheet-metal screws in these man-made woods. USE THE RIGHT FASTENER—Use the "Little Gripper" by Equality Screw Co.

(CUT OUT AND SEND)

call or write
for your
FREE
sample

6 x 1/2 phillips flathead

6 x 5/8 phillips flathead

6 x 3/4 phillips flathead

SPECIALIZED FASTENERS for CABINETS & COUNTERTOPS



SCREW COMPANY INC.

P.O. BOX 1645, EL CAJON, CA 92022

1-800-854-2886 800-552-8844 (IN CALIFORNIA)

Fast Reply #KE370

Pox Humana

FINAGLE'S LAWS...

or why nothing in Research and Development happens the way it should

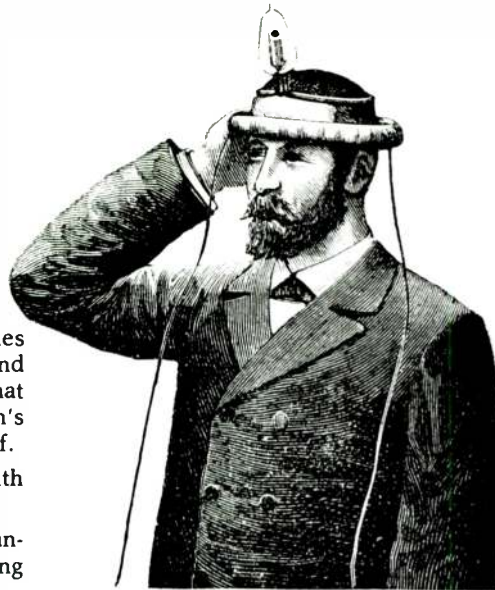

ON EXPERIMENTS

The first four laws are the only ones dignified by number. Note the beauty and simplicity of the First Law. Also note that the remaining three laws refer to man's reaction to Nature—not to Nature itself.

First Law: If anything can go wrong with an experiment, it will.

Second Law: No matter what result is anticipated, there is always someone willing to fake it.

Third Law: No matter what the result, there is always someone eager to misinterpret it.

Fourth Law: No matter what occurs, there is always someone who believes it happened according to his pet theory.

The Law of the Too Solid Goof:

In any collection of data, the figure that is most obviously correct—beyond all need of checking—is the mistake.

Corollary I—No one whom you ask for help will see it, either.

Corollary II—Everyone who stops by with unsought advice will see it immediately.

A further series of rules—or really advice to experimenters—has been formulated. They are a natural consequence of the first four laws reduced to day-to-day practice. Experiments must be reproducible—they should all fail in the same way.

First draw your curves—then plot the readings. Experience is directly proportional to equipment ruined.

A record of data is useful—it indicates you've been working.

To study a subject best, understand it thoroughly before you start.

In case of doubt, make it sound convincing.

Do not believe in miracles—rely on them.

Always leave room to add an explanation when it doesn't work. (This open door policy is also known as the Rule of the Way Out.)

HUMAN FOIBLES

The remaining rules outline the human problems that follow from the above. To some extent they represent man's reaction to Nature and, even more aptly, man's reaction to man.

Laws of Revision: (Often lumped into the Now They Tell Us Law)

First Law: Information necessitating a change of design will be conveyed to the designer after—and only after—the plans are complete.

Corollary I—In simple cases, where one obvious right way is opposed to one obvious wrong way, it is often wiser to choose the wrong way right off. This is one step ahead of choosing the right way, which turns out to be the wrong way, which has to become a right way.

Second Law: The more innocuous the revision appears to be at first, the further its influence will extend and more plans will have to be redrawn.

Third Law: If, when the completion of a

design is imminent, field dimensions are finally supplied as they actually are—instead of as they were meant to be—it is always simpler to start all over.

Fourth Law: Even if it is impossible to assemble a part incorrectly, still a way will be found to do it wrong.

Corollary I—It is usually impractical to worry beforehand about interferences—if you have none, someone will make one for you.

The Law of the Lost Inch:

In designing any type of construction, no overall dimension can be totalled correctly after 4 p.m. Friday.

Corollary I—Under the same conditions, if any minor dimensions are given to $\frac{1}{16}$ of an inch, they cannot be totalled at all.

Corollary II—The correct total will be self-evident at 9:01 Monday morning.

Deliveries that normally take one day will take five when you are waiting.

When adjusting (or drawing or computing, etc.) remember that the eye of the chief inspector (engineer, draftsman, etc.) is more accurate than the finest instrument.

After adding two weeks to a schedule for unexpected delays, add two more weeks for the unexpected unexpected delays.

In any problem, if you find yourself doing an unending amount of work, the answer may be obtained by inspection.

Finagle's Creed

Science is Truth—don't be misled by facts.

Finagle's Motto:

Smile—tomorrow it will be worse.

(Reprinted from *Oklahoma State Engineering Magazine*, April, 1962, p. 20.)



12" EMINENCE CAST FRAME

170W RMS, 80 oz. magnet. 40-4.5KHz response. #12-3760. Call for complete specs.



#SP-290-147

\$72⁹⁰
(1-3)

\$69⁵⁰
(4-up)

5" POLYDAX MIDRANGE

Poly cone midrange with rubber surround. 180-10KHz frequency response. #TX11.25JSN. Call for complete specs.



#SP-280-230

\$45⁸⁰
(1-9)

\$42⁹⁰
(10-up)

15" PIONEER SUBWOOFER

Dual voice coil. 100W RMS. 20-1.2KHz response. Call for complete specs.



#SP-290-190

\$54⁵⁰
(1-3)

\$49⁸⁰
(4-up)

8" POLYDAX MID/WOOFER

TPX cone with reverse rubber surround. 49-5KHz frequency response. #MTX20.25RSN. Call for complete specs.



#SP-290-035

\$45⁵⁰
(1-3)

\$39⁸⁰
(4-up)

18" EMINENCE CAST FRAME

200W RMS, 100 oz. magnet. 28-3.5KHz response. #18-1332. Call for complete specs.



#SP-290-230

\$128⁹⁰
(1-3)

\$124⁵⁰
(4-up)

POLYDAX TWEETER

Titanium composite dome. 1K-20KHz frequency response. #DTW100T25.FF6. Call for complete specs.



#SP-270-047

\$27⁵⁰
(1-9)

\$24⁸⁰
(10-up)

CALL TOLL FREE 1-800-338-0531

• 15 day money back guarantee • \$15.00 minimum order • We accept Mastercard, Visa, Discover, and C.O.D. orders. • 24 hour shipping • Shipping charge = UPS chart rate + \$1.00 (\$3.00 minimum charge) • Hours 8:30 am - 7:00 pm EST, Monday - Friday • Mail order customers, please call for shipping estimate on orders exceeding 5 lbs. Foreign customers please send \$5.00 U.S. funds for catalog postage.

340 E FIRST ST
DAYTON, OH
45402



DON'T FORGET



FREE CATALOG

more

high fidelity range



The MDM 85 is a mid range 75mm soft dome unit of extremely high standard, both from a design and technical viewpoint.

It incorporates the renowned Morel double magnet and Hexatech voice coil techniques, and results in a unit of above average sensitivity with extremely low distortion and high power handling capability.

With an output level of 96dB distortion in the area of 400-800Hz is slightly over 1% falling to 0.015% from 1KHz.

There are two different types available, one with a rear enclosure and one without (MDM 85NE). The type with the rear enclosure can be fitted into a cabinet as an integral unit.

The MDM 85NE without the rear enclosure can only be fitted into a system having a separate housing to enclose the unit. A volume of 0.7 litre is recommended for this housing, which is essential to prevent interaction with the bass unit compressions and expansions. This housing must be filled full with damping material, such as fibreglass or rock wool.

The Thiele small parameters are given for both types under specifications. The contribution of this unit to a suitably designed system will be evident in the clarity and detail given in the 500-5000Hz region.

Specification

| MDM 85 (with enclosure) | | Variations to specification for MDM 85NE (without enclosure) | |
|--|---------------------------|--|------------------|
| Overall Dimensions | Ø - 160mm x 113mm | Overall Dimensions | Ø - 160mm x 60mm |
| Nominal Power Handling | 300W | Frequency Response | 250-5000 |
| Transient Power 10ms | 1500W | Resonant Frequency | 170 |
| Voice Coil Diameter | 75mm (3") | Rmcc | 39. |
| | Hexatech Aluminium | Qms | 0. |
| Voice Coil Former | Aluminium | Qes | 1. |
| Frequency Response | 300-5000 Hz | Q/T | 0. |
| Resonant Frequency | 250 Hz | Vas | 0.7 li |
| Sensitivity | 92 dB (1W/1M) | Nett Weight | 1.05 |
| Nominal Impedance | 8 ohms | | |
| Harmonic Distortion for 96 dB SPL | <1% | | |
| Intermodulation Distortion for 96 dB SPL | <0.25% | | |
| Voice Coil Inductance @ 1 KHz | 0.2mh | | |
| Air Gap Width | 1.05mm | | |
| Air Gap Height | 3.0mm | | |
| Voice Coil Height | 6.0mm | | |
| Flux Density | 1.0T | | |
| Force Factor (BXL) | 4.6 WB/M | | |
| Rdc | 5.2 ohms | | |
| Rmcc | 37.90 | | |
| Qms | 0.29 | | |
| Qes | 2.66 | | |
| Q/T | 0.20 | | |
| Vas | 0.33 litre | | |
| Moving Mass including Air Load | 7.0 grams | | |
| Effective Dome Area | 63.50 cm ² | | |
| Dome Material | Chemically Treated Fabric | | |
| Nett Weight | 1.25 kg | | |

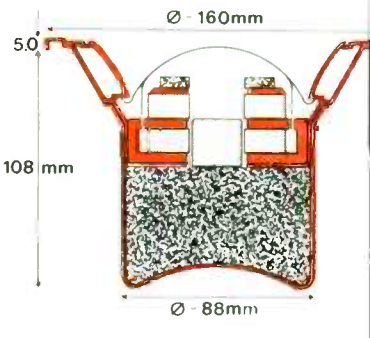

Specifications given are as after 24 hours of running.

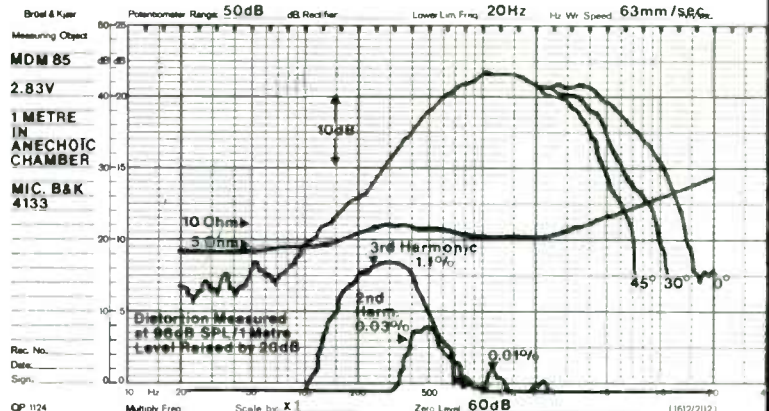

morel (u.k.) ltd.
 11 Foxtail Road,
 Nacton Rd (Ransomes)
 Industrial Estate,
 Ipswich, IP3 9RT
 England
 Tel: (0473) 719212
 Telex 987601 Morel G

morel acoustics USA
 414 Harvard Street
 Brookline, MA 02146
 Tel: (617) 277-6663
 FAX: (617) 277-2415

