

4/1981

SPEAKER BUILDER

US \$3.00

UK £1.25 | 15 Fr.

SAFE

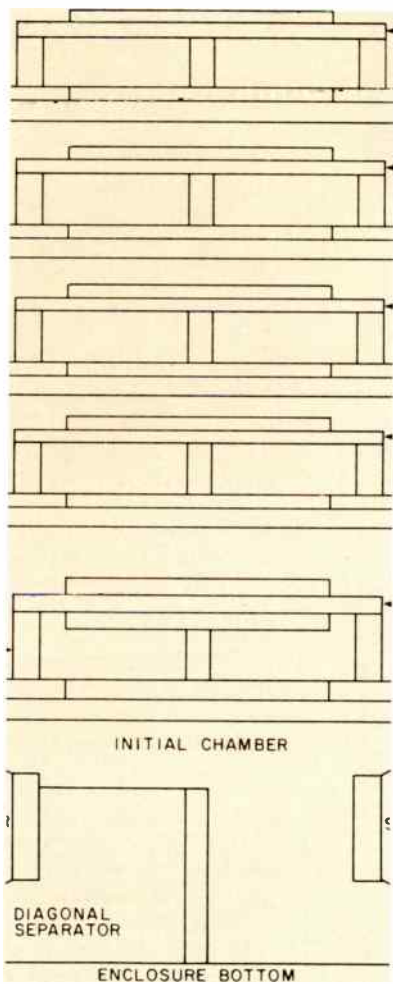

SYMMETRICAL
AIR FRICTION
ENCLOSURE



BUILDING FALCON'S MONITOR MINI



PASSIVE RADIATOR DESIGNER

VOIGT 2



EV Electro-Voice Component Speakers
of gullion speakers

A few good reasons to build your own system.

MODEL 30W BASS LOUDSPEAKER
 30in DIA
12TRXC Integrated 3-Way Component Speaker

Model 8HD Diffraction Horn
1824M Midrange Driver
 All-Weather Speaker

MUSICASTER II A
 All-Weather Speaker

Model T35A Horn Tweeter

CALL OR WRITE NOW!
 THESE PLUS MORE IN

free catalog

Sonix Co. DEPT. SB
 P.O. BOX 58
 INDIAN HILL AD
 MARYLAND 20640
 Phone (301) 753-6432

VISA master charge

Good News



Celestion Industries have a new offering dubbed the Ditton 100, a compact which is 13x8 1/4 x 7 3/4" using a 6 1/2" woofer and a 1" tweeter, crossed over at 2.3kHz. The frequency response is said to be 78Hz to 20kHz and weight a mere 9.5 lbs. Price is \$260 pair. For more information write to **Celestion**, Box 521, Holliston, MA 01746.



Heath is now offering a hand held capacitance meter with a range of .1pF to 199.9uF. The IT-2250 kit, priced at \$157.95, has a 3 1/2 digit display, auto ranging, and a way of measuring directly at cap leads to lessen error. Low voltage measures of small caps are possible as well. A battery eliminator is available for the unit also. Information from **Heath** at Benton Harbor, MI 49022, of course.

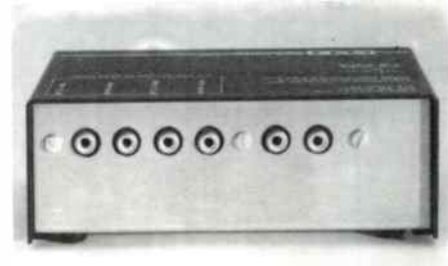

Phase coherency has become a prime question for audiophiles in recent years—a problem which particularly plagues filters. Crossovers are always filters of some sort whether passive or active in configuration. **Ace Audio** (532 5th St., East Northport, NY 11731-2399) has a new device, the Model 6000-6, which they claim is transient perfect. Slope is 6dB/octave, it has dual level controls, ±1% parts and is available in bi- or tri-amp version. Frequencies between 40 and 16kHz are set by plug-in modules. It comes only as a wired unit. Write **Ace** for more information.

If you have a line-of-sight relationship of no more than 100 miles to one of those TV transmitters that put out "the better" programming, **DynaComp Electronics** have a neat, simple dish antenna and amplifier that look as though they might be easy to build and install. The microwave system comes in kit form as well as assembled and although not a large undertaking, obviously requires painstaking work because of the frequencies involved. The plans cost \$9.95 and are refundable on purchase of the system, which is under \$300. Full details are available for the asking from DynaComp Electronics, PO Box 4148, Dept. SB, McCormick Ranch, Scottsdale AZ 85258.

THE ULTIMATE EQUALIZER

Your stereo system can only be equalized for one sound level if you have no compensation for the 'LOUDNESS EFFECT'; that psychoacoustic phenomenon by which our perception of low frequencies is diminished when reproduction levels are below the original or intended replay level. Most compensation methods are so inadequate they have prejudiced serious audiophiles against any control so labeled.

The ARTSTARR LC-40 corrects response to the latest accepted criteria over a dramatic 40 dB attenuation range. Operation is so free of coloration, you won't believe it's there... except for the full rich sound at all listening levels.

The LC-40 is a four inch cube in black, with a matte black legend on anodized aluminum. It costs \$159.00, shipped in the U.S., plus 4% in Virginia. A designer semi-kit is \$79.00. Write for FREE details, specifications and why serious enthusiasts find a manifold increase in stereo system usefulness.

ARTSTARR LC-40
 Loudness
 ARTSTARR LC-40

Yorktown, VA 23692-1247

ARTSTARR Associates, P.O. Box 1247

Artstarr Associates (P.O. Box 1247, Yorktown, VA 23892-1247) have a new loudness control for audio systems designated the LC-40. It utilizes the revised understanding audiophiles now have of the relationship of hearing acuity to frequency loudness. For years the old Fletcher-Munson curves of human ear sensitivity were accepted as accurate. Now we know they are not. Some preamps, notably the Apt Corporation offering, embody the new loudness contour. **Artstarr's** unit is an add-on function between preamp and power amp or within the tape loop. Full details from the manufacturer.



Audio Control is making a new simpler version of their equalizer with five bands of control. The unit is designed, according to the manufacturer, to adjust those specific parts of the spectrum which most often need adjustment for optimum speaker response. Most 5-band equalizers split the spectrum equally, but **Audio Control** considers those too wide to be very useful. Their D-520 also offers an 18dB/octave subsonic filter, slide pot controls. For full details write **Audio Control** at P.O. Box 3199, Lynnwood, WA 98036-0831.

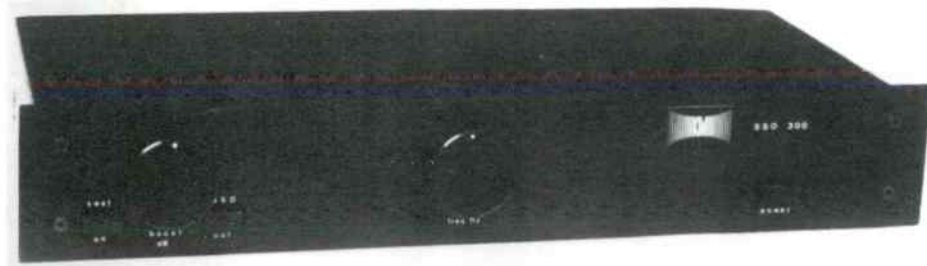

Gold Sound is the newest in the growing list of speaker kit companies in the U.S. Using drivers from SEAS, Audax, Foster, JVC, JBL and EV, their line includes 15 kits ranging from \$49 to \$769 in price. **Gold** also offers a line of sound reinforcement kits as well. Their Kit 8 with a JBL 8" woofer, a SEAS ferrofluid tweeter and JVC ribbon supertweeter is \$219. **Gold's** catalog is \$2, available by writing to P.O. Box 141, Englewood, CO 80110.

KM Laboratories (342 Madison Ave., NY, NY 10017) offer a device to "extend and tighten bass response of any loudspeaker system." The "Servo Sub Octavator" uses feedback control in the bass region to achieve its effects which the manufacturer claims is similar to motional feedback systems at far lower cost. The unit measures input, compares it to cone motion via a servo-loop, and uses feedback to correct any errors. The device connects to systems between preamp and power amp and controls the speaker via the ground lead only. The manufacturer offers full information on the Servo Sub Octavator.

KEF KITS



Now you can "build the best in confidence," as two of KEF's best-selling speaker systems—the Model 104aB and Cantata—are now available in kit form, enabling you to easily assemble a high quality speaker system at a considerable savings.

And, because they are kit versions of two of our best-selling speaker systems, you can actually audition the units at your KEF dealer *before* buying and assembling.

KEF speaker systems are designed and built using a Total System Design Concept, whereby each part is developed to compliment all others in the system so as to achieve the targeted performance.

The KEF Cantata kit consists of a bass unit, midrange unit, tweeter and an Acoustic Butterworth filter, and builds into an acoustic suspension loudspeaker system with a power handling capability of 100 watts.

The KEF Model 104aB kit consists of a bass-midrange unit, tweeter, Acoustic Butterworth filter section, plus an acoustic bass radiator to increase the bass response from such a modest-sized enclosure. The kit makes up into a bass reflex system with a power handling capability of 150 watts.

Both the kits include fuse units to protect the drive units, and contour controls to adjust the final acoustic output to suit the listening room.

Loudspeaker kit building has now been raised to a new level of ease and reproduction quality.

For more details and the name of your nearest KEF dealer where you can hear just how good our KEFKITS are *before* your purchase, write to us at the address below. Individual drive units and crossover networks are also available for your special custom requirements.

KEF Electronics, Ltd., c/o Intratec Department E, P.O. Box 17414, Dulles International Airport, Washington, DC 20041.

In Canada: Smyth Sound Equipment Ltd., Quebec.

KEF

SPEAKER BUILDER

MAGAZINE

EDWARD T. DELL, JR. *Editor/Publisher*
Contributing Editors ROBERT M. BULLOCK
 BRUCE C. EDGAR G. R. KOONCE
 W. MARSHALL LEACH NELSON PASS
 JUDITH CADIGAN *Associate Editor*
 KAREN HEBERT *Editor's Assistant*
 BETTE PAGE *Production*
 NANCY NUTTER *Circulation Director*
 TECHART ASSOCIATES *Drawings*

Editorial and Circulation Offices:
 P.O. Box 494
 Peterborough, New Hampshire 03458 U.S.A.

ADVERTISING REPRESENTATIVE

Robert H. Tucker
 316 St. James Place, Philadelphia, PA 19106
 Telephone (215) 627-5326

Speaker Builder is published four times a year by Edward T. Dell, Jr., P.O. Box 494, Peterborough, NH 03458. Copyright © 1980 by Edward T. Dell, Jr. All rights reserved. No part of this publication may be reprinted or otherwise reproduced without written permission of the publisher.

SUBSCRIPTION RATES

In the United States and Possessions
 One Year (four issues) \$10
 Two Years (eight issues) \$18

Elsewhere

Special Rates available on application in:
UNITED KINGDOM:

J.L. Lovegrove, Leazings, Leafield,
 Oxford, OX8 5PG, England

FRANCE:

Ainsco (France)
 17, rue Saint Louis-en-l'Île., 75004—Paris.
 Tel. 329-45-20.

ALL SUBSCRIPTIONS are for the whole year only. Each subscription begins with the first issue of the year and ends with the last issue of the year.

To subscribe, renew or change address in all areas outside the UK or France write to Circulation Department, P.O. Box 494, Peterborough, NH 03458. For subscriptions, renewals or changes of address in the UK or France write to addresses above. For gift subscriptions please include gift recipient's name and your own, with remittance. Gift card will be sent.

A NOTE TO CONTRIBUTORS:

We welcome contributions for possible publication in the form of manuscripts, photographs or drawings, and will be glad to consider them for publication. Please enclose a stamped, addressed return envelope with each submission. While we cannot accept responsibility for loss or damage, all material will be handled with care while in our possession. Receipt of all materials is acknowledged by postcard. Payment is on receipt of author's approved proof of materials. Contributions should be sent to Editor, *Speaker Builder*.

SPEAKER BUILDER MAGAZINE (US ISSN 0199-7920) is published four times a year at \$10 per year; \$18 for two years, by Edward T. Dell, Jr. at 5 Old Jaffrey Road, Peterborough, NH 03458 U.S.A. Second class postage paid at Peterborough, NH and pending at additional mailing offices. **POSTMASTER:** If undeliverable send PS form 3579 to P.O. Box 494, Peterborough, NH 03458.

MODEL 5000

Sub-woofer Electronic Crossover

100 Hz • 18 dB/octave



NEW precision crossover complete with subwoofer level control and bypass switch. Add a subwoofer to your speaker systems for accurate ultra low bass. (Custom frequencies available from 40-200 Hz). Kit \$97.00 PPD, wired \$161. PPD. **FREE CATALOG** from: ACE AUDIO CO., 532-5th St. E., Northport, NY 11731. (516) 757-8990.

Listen,



If you haven't heard the PPA-1, you haven't heard your moving-coil cartridge. Audition the Marcof PPA-1 Pre-preamplifier at fine audio dealers.

Marcof Electronics

7509 Big Bend Blvd.,
 Webster Groves, MO 63119

Do you own a tape deck?

Then write for our free brochure and current special offers

DIRECT-TO-TAPE RECORDINGS

- Natural Sound
- Talented Performers
- No compression, equalization or limiting
- Available on reels, [2/4 track, optional dolby or dbx II], cassettes and cartridges
- Duplicated at playing speed

BLANK RECORDING TAPES

- Top quality cassettes at super prices
- ASF and DIRECT II cassettes in special longer lengths [C-66/C-68 & C-96]
- AGFA open reel tapes—the best open reel tapes
- AMPEX video tapes

CUSTOM DUPLICATING

Direct-To-Tape Recording Co.

Dept. SB 14 Station Ave., Haddon Heights, N.J. 08035

SPEAKER BUILDER

- 7 Build a
Dual 8"
Symmetrical
Air Friction
Enclosure

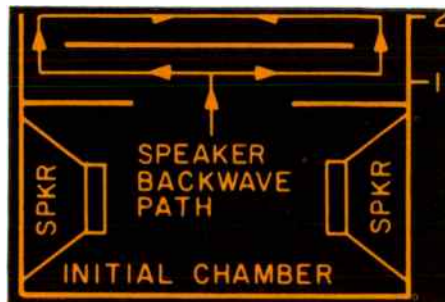

by George
Pappanikolaou

- 6 Editorial: Simplify, simplify
- 11 A Calculator Program for Thiele-Small
Parameter Computation

by G.R. Koonce

- 14 An Interview
with
Paul Voigt
Part II

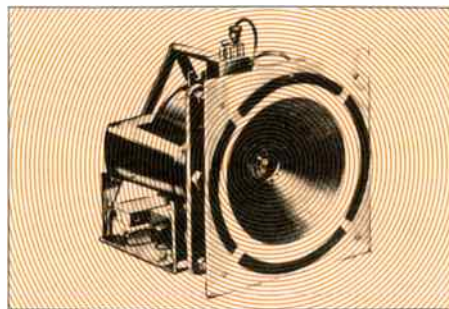

by Bruce Edgar

- 25 Finding f_p For Passive Radiator
Speakers

by G.R. Koonce

- 26 Loudspeaker Literature

by Hunter Kevil

- 39 Letters 43 Classified 43 Corrections 46 Ad Index

- 32 Building
the Falcon
Monitor Kit



by David Davenport
and
Mark Sabransky

About this issue

WHEN YOU DECIDE that a transmission line for the backwave ought to be long—then really make it long.

That's *George Papanikoalaou's* idea, anyway.

His patented design appears as our lead-off article this time (its smaller cousin is in the current issue of *Radio-Electronics*). The idea deserves our attention and should give us a new alternative transmission line.

Contributing editor G.R.

Koonce offers a program for your programmable calculator which takes the drudgery out of those Thiele/Small calculations (page 11). In addition he provides a handy way to design passive radiator devices on page 25.

Bruce Edgar's concluding installment of his interview with the late Paul Voigt begins on page 14. Voigt's adventures with the problems of loudspeaker driver and horn design are an invaluable glimpse of the very early days of audio and of the problems and tradeoffs designers still face today.

Hunter Kevil's survey of what's being written about loudspeakers (six months' worth), begins on page 26.

The kit report by Dave Davenport and Mark Sabransky (starting on page 32) examines a kit version of what is a near "cousin" of the LS3/5A monitor. The kit is made by Falcon, whose founder had years of work at KEF before setting out on his own. The LS3/5A is probably the most popular small monitor speaker available today. The original version, designed for the BBC, is available from Rogers and other licensees.

Next time, we'll be back with a whole range of new articles and ideas—SB's best year ever is coming up.

Milestones

MILESTONES ARE thought provoking stimulants and especially so when they come at year-end. This fourth issue of *Speaker Builder's* second year of publication marks such a milestone which has set me to thinking and evaluating where we are and more importantly, where I think we ought to be going.

I have had a number of helpful, thoughtful letters from some of you asking that we recognize a need some of you have to explore the ground-floor basics of this hobby of constructing loudspeakers. Your point is very well taken. This little essay is not only a policy statement, but it is also a call for more of your letters detailing what you would like to see in *SB's* pages that would help you become the sort of artisan you want to be.

But it is also a call to all our authors to respond to those needs with the sort of articles that tell the newcomer about the basics of this craft. I will be writing to those of you who have done articles for *SB* or who have expressed an interest in doing so, when we have compiled some reader responses to this call for material.

We are amazed and delighted with all the wonderful articles our authors have produced thus far. They are, in my opinion, some of the most innovative, and fresh pieces of writing about loudspeaker design and performance to be found anywhere. We have a lot more of it in our manuscript bins awaiting publication in 1982. G.R. Koonce has written an excellent series on measuring devices for speaker construction. Bruce Edgar will be back next year with a piece on table saw basics. If you've dreamed of putting a Heil air motion transformer into a horn loaded configuration—that is going to be possible in the 1982 series as well. Mike Lampton has built a big, no holds barred, three way system which you'll be hearing all about in the 1982 series, as well as a genuinely definitive article on crossover networking from Nelson Pass, of Threshold Corporation. There's a great deal in the works besides.

It is renewal time for many of you now. We are holding the line on prices this year and there will be no increase for 1982. If your renewal isn't in, please do it promptly, the first issue of 1982 is already in the works.

Speaker Builder's first two years have been something of the "milestone" type and we believe have set new benchmarks for audio publishing. But those two years are only the beginning and we are more than a little confident that the quality and content are on a steadily rising curve. We thank our authors and those of you who make *SB* what it is by subscribing, for making this new venture the exciting and valuable enterprise it has become.—*The Editor*

Build a Dual 8" Symmetrical Air Friction Enclosure

by GEORGE PAPPANIKOLAOU

MANY CONSIDER 8" woofers the closest possible thing to a perfect speaker. The cones are small enough to avoid the cone break-up which plagues larger speakers; at the same time, they are light enough to have good low frequency transient response. The only exception might be a 10" speaker with a very large voice coil, such as the JBL LE-10A. If you want more power handling capacity, you can use two or more 8" speakers.

Using two 8" speakers facilitates putting the SAFE into new or existing systems, since a separate speaker is available for each channel. Of course, you could use a speaker with two voice coils; but such speakers are difficult to find, expensive to buy, and offer no performance advantage over two 8" speakers. As with most vented enclosures, a woofer with a large magnet and voice coil is preferable since these two factors result in a speaker with a lower "Q," which usually gives a flatter impedance and frequency response curve.

The SAFE* is an improved version of the labyrinth design invented by Dr. Olney¹ in the early 1930's. In 1965 Professor Bailey^{2,3} improved on the original by using non-rectangular chambers and stuffing the enclosure with long-fiber wool instead of the material previously in use. He called his improvement a transmission line.

Until now labyrinth enclosures, and all variations thereof, have used acoustical material to line and/or stuff the enclosure. This increases air friction, which decreased the speaker backwave velocity and effectively lengthens the backwave path. In the process, efficiency and some transient response are lost. A stuffed enclosure's "Q" is also usually lower than optimum because of

the stuffing. The advantages are that the effective length is increased quite simply and the enclosure is fairly easy to construct, with no complicated modifications.

There are, however, other ways, as yet unexploited, of slowing down the speaker backwave. They include: 1) increasing the enclosure's internal surface area; 2) increasing the number of bends in the backwave's path; 3) increasing the angle of each bend; and 4) causing the backwave path to change its cross-sectional areas continuously as it travels through the enclosure. You can implement these suggestions by using

more, but smaller, chambers in series, with center and peripheral openings in each chamber.

The result will be better performance; the disadvantage is a more complicated type of construction requiring more enclosure material. However, this should not deter anyone who desires a good hi-fi system. This construction type has the advantage of greatly increased cabinet rigidity, which helps reduce distortion.

Refer to Fig. 6 which will explain how this embodiment of the SAFE operates. As you can see, two types of partition form a single middle chamber.

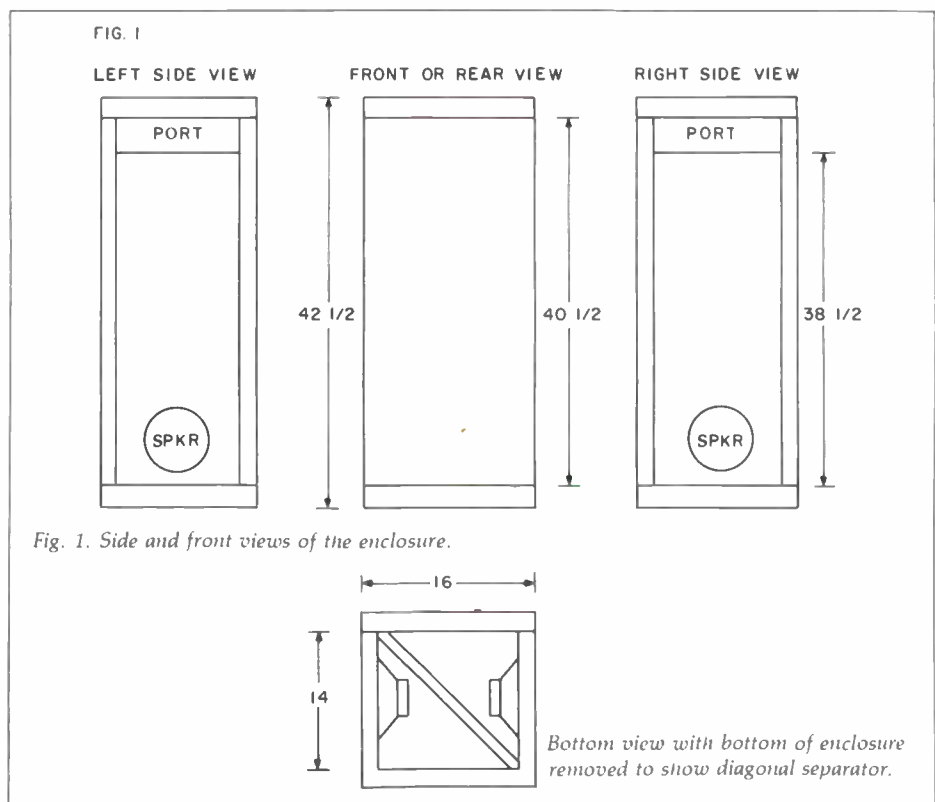

Fig. 1. Side and front views of the enclosure.

*U.S. Patent 4,168,761; other patents pending.

The "A" type partition is the larger, and has a square center opening. It is mounted perpendicular to the four sides of the enclosure on four partition mounting strips, as illustrated in Fig. 5, a cutaway front view of the enclosure. This A partition in effect reduces the cross-sectional area of the enclosure to the area of its center opening.

As Fig. 6 also shows, the "B" type partition is a flat square with sides $2\frac{3}{4}$ " shorter than the A partition's sides. The B partition is mounted parallel to and in the center of the A partition on eight mounting posts (only three of which show in the frontal view of Fig. 5). Each B partition has a square top plate attached to it for extra rigidity, and B-1 has a bottom plate as well; for clarity, these plates are not shown in Fig. 6.

The B partition provides an opening between its side edges and the enclosure sides; this is the middle chamber's peripheral opening, while the A partition's center opening is also the chamber's center opening. Both the center and peripheral openings have areas of about 64 sq. in., a little greater than the effective cone area of the two 8" speakers, which is about 50 sq. in.

Figure 2 shows the SAFE's simplified cutaway front view. The entire enclosure consists of an initial chamber, in which both speakers are located; a series of 10 identical middle chambers divided by a series of A and B-type partitions; and a final chamber which vents to the atmosphere. Figure 6 demonstrates that the entire backwave passes through the A partition's central opening, hits the center of the B partition, and scatters in all directions, as represented by the dotted circle.

Let us for the moment assume that the backwave breaks up into four portions—top, left side, bottom, and right side—and note that it changes direction by 90° , as represented by the four arcs marked with one, two, three, and four straight lines. When the backwave portions pass the B partitions edges and reach the enclosure sides (not shown in Fig. 6), they change direction by a further 90° and go through the peripheral opening. This action takes place in all the odd-numbered middle chambers shown in Fig. 2, and is reversed in the even-numbered chambers. The backwave path's cross-sectional area changes continually above and below an average value, due to the shape of the enclosure.

Figure 1 shows the outside of the enclosure, which has blank front and rear panels and an 8" speaker mounted at the bottom of each side panel. Above each speaker a port near the enclosure top vents to the atmosphere. The bottom view of the enclosure (with the bottom panel removed) shows a diagonal separator wedged between two

corners. This division of the initial chamber into two triangular parts ensures no large parallel surfaces can create standing waves.

In Fig. 3 we see how the partitions mount together to form partition assemblies. Note that:

1. The square center pieces cut out of partitions A-2 through A-5 are not discarded, but are centrally attached on top of partitions B-2 through B-5 to increase their rigidity.

2. The center pieces from partitions A-1 and A-6 are attached above and below partition B-1 for extra rigidity, which is particularly needed in the first middle chamber where the backwave is strongest.

3. A B partition centrally mounted on an A partition forms an assembly. Assemblies A-2/B-2 through A-5/B-5 each have eight mounting posts $1"$ square and $2"$ long. Assembly A-1/B-1's posts are $1"$ square and $2\frac{3}{4}"$ long.

4. Partition A-6 has no B partition, but is used by itself.

The series of five A/B assemblies plus partition A-6 is mounted in the square cross-section of the enclosure on six sets of partition mounting strips, four strips per set. Figure 4 shows the location of these strips, A-1 through A-6, to match the A partitions, on the four enclosure panels. The strips are

made of $\frac{1}{2}" \times \frac{3}{4}"$ material, $14"$ long for the side panels and $13"$ on the front and rear panels, and are mounted with the $\frac{3}{4}"$ side flat against the enclosure.

CONSTRUCTING YOUR SAFE

1. Assemble all parts and cut all parts to size.

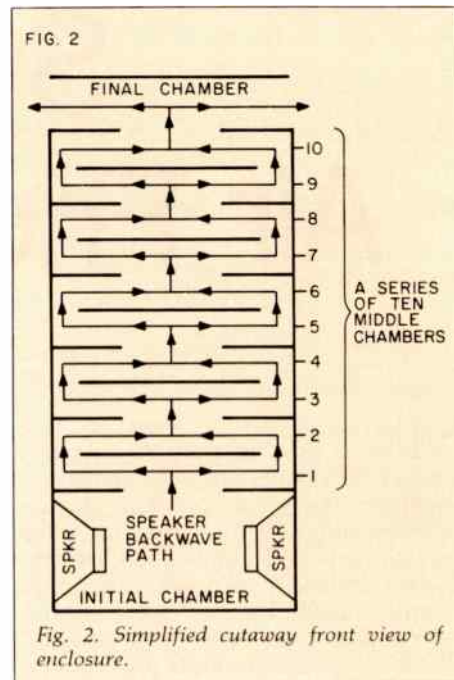

Fig. 2. Simplified cutaway front view of enclosure.

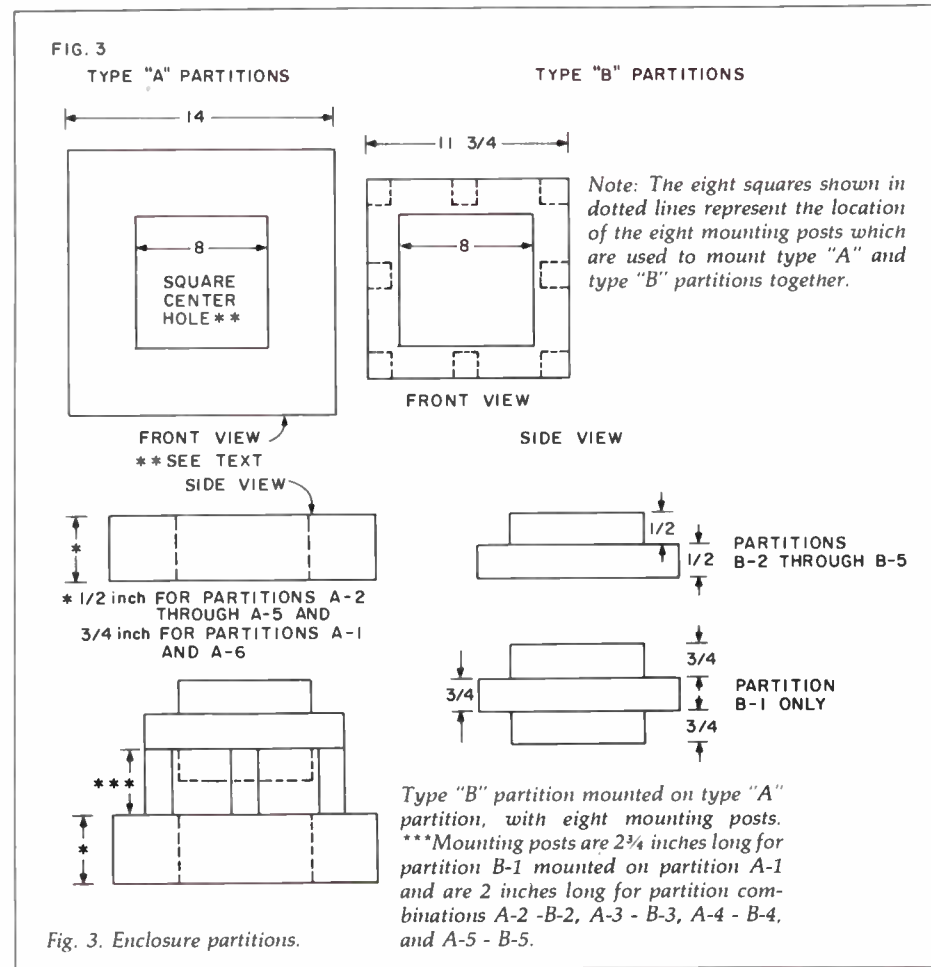

Fig. 3. Enclosure partitions.

2. Cut the two speaker mounting holes in the side panels according to the dimensions shown in Fig. 4, and drill the screw holes for mounting the speakers.
3. Install the four binding posts where desired and attach the four wires to them. Be sure to mark the wires and posts so you can identify them later and connect them with correct polarity.
4. Referring to Fig. 4, mark the inside surfaces of all four enclosure panels with guidelines for placing the partition mounting strips. Note that the distance between strips A-1 and A-2 is greater than that between the other sets of strips.
5. Take the 12 14" mounting strips and the two side panels. Hold each strip in turn, $\frac{3}{4}$ " side down, firmly in place on a line on one of the panels. Using a drill bit slightly smaller than the sheet metal screws you will later use to install the strips, drill a hole completely through strip and panel near each end of the strip. Put an identifying mark on each strip as you go, so you will have no trouble later in matching up strip and panel holes.
6. Repeat this procedure with the 12 13" mounting strips and the front and rear panels. Note that, whereas the side mounting strips run the full width of their panels, the front and rear strips

- are 3" shorter than their panel widths. Be sure to center the strips between the panel edges.
7. Using the next larger drill bit size, enlarge all the holes in the four panels. This will enable the sheet metal screws, when you insert them, to press the strips firmly against the panels.
8. Refer to Fig. 3. Glue the 8" square center sections cut out of partitions A-1 and A-6 firmly to the top and bottom of partition B-1, making sure you center each section on the partition. Glue the center sections from partitions A-2 through A-5 to the tops of partitions B-2 through B-5.
9. Still following Fig. 3, mount the B partitions on the A partitions with the mounting posts, remembering that the longer set of posts is for assembly A-1/B-1. Use $1\frac{1}{4}$ " screws and plenty of liquid glue.
10. Assemble the four sides of the enclosure with $1\frac{1}{2}$ " screws and liquid glue.
11. Glue the four A-1 partition mounting strips into position and insert $1\frac{1}{2}$ " screws through the previously drilled holes from outside the enclosure, through the sides and into the strips.
12. With the glue gun, put hot glue on the upper surfaces of the A-1 mounting strips. Lower the A-1/B-1 assembly, A-1 side underneath, from the top of the enclosure until it rests on the moun-

- ting strips, and hold it firmly in place until the glue sets.
13. Repeat steps 11 and 12 with the remaining sets of mounting strips and partition assemblies, ending with partition A-6 which will be positioned just below the vented port on the enclosure sides. Mount the enclosure top panel with $1\frac{1}{2}$ " screws and liquid glue.
14. Turn the enclosure upside down and look at Fig. 1. Carefully file down the $6\frac{1}{2}$ " side edges of the diagonal separator until you can wedge it into the enclosure as shown. Push it down until its bottom edge is level with the bottom edges of the enclosure panels.
15. Mount the enclosure bottom panel.
16. Reaching in through one of the speaker mounting holes, use the glue gun to attach the diagonal separator firmly to the bottom panel.
17. Connect the appropriate wires to both speakers, and mount them in the mounting holes. Use silicon rubber or a similar material between the speaker mounting flange and the enclosure side to ensure an airtight fit.

SOME PERFORMANCE NOTES

If you use a speaker such as the CTS 8W20C (which is no longer available) in your SAFE, the impedance curve, measured with both speakers connected in parallel, will show a single

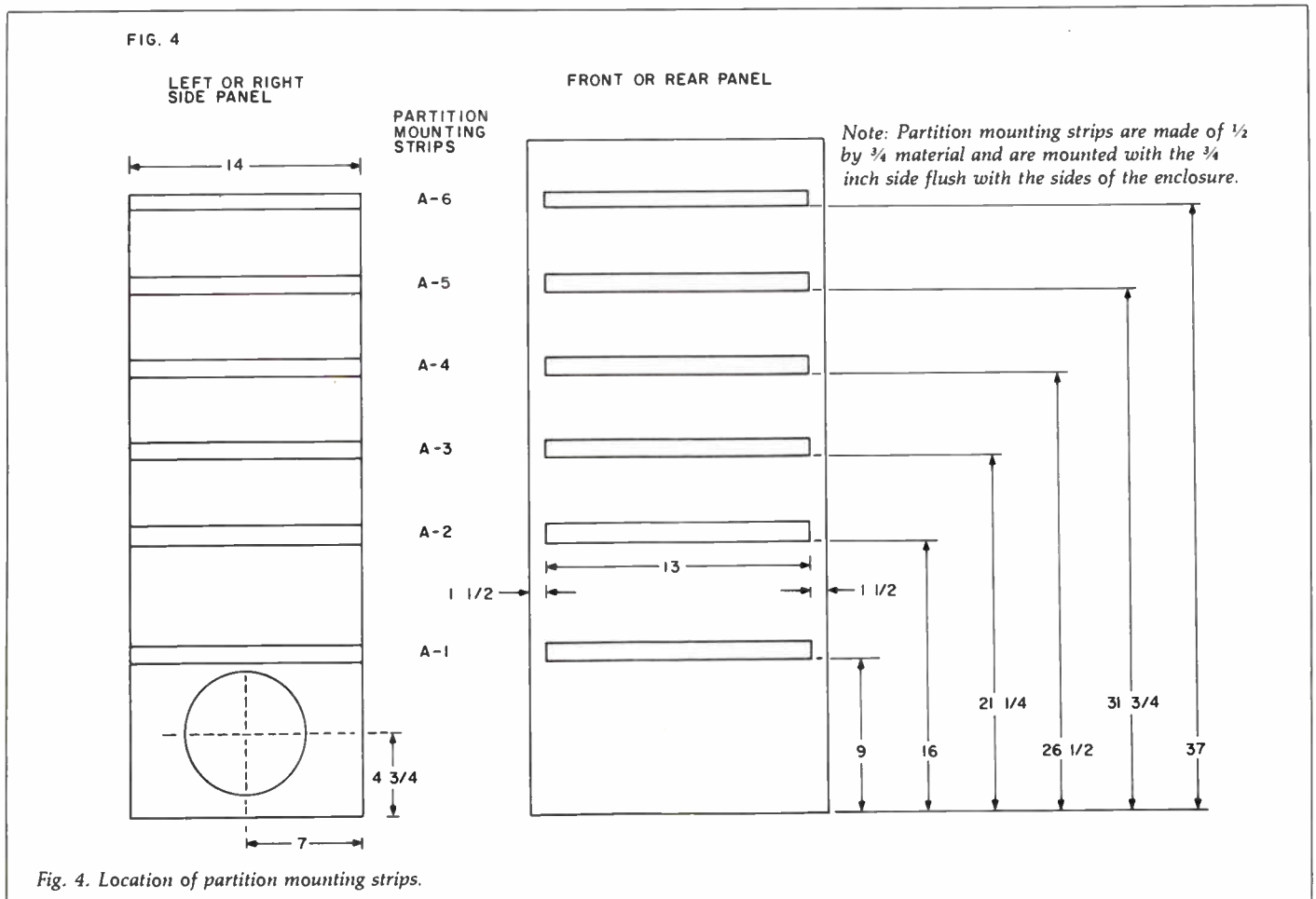

peak between 55 and 45Hz, depending on the particular characteristics of the individual speakers. Low frequency response will be useable down to about 30-25Hz, and transient response will be good. Efficiency will be relatively high.

With a speaker such as the Pyle Driver W8C300-F, you will also find small peaks at about 100Hz and 25Hz in the impedance curve, with low frequency output slightly less than that of the CTS. However, efficiency will be much greater because the Pyle has a 30 oz. magnet, as opposed to the CTS's 20 oz. magnet. Transient response will be about the same, or even possibly a little better, due to the Pyle's stiffer suspension. □

PARTS LIST

1" thick, heavy, dense chipboard (not plywood):
 2 pieces 14" x 38½" (left and right side panels).
 2 pieces 40½" x 16" (front and rear panels).
 2 pieces 16" x 16" (top and bottom panels).

¾" thick chipboard (as above):

1 piece 6½" x 19¾" (diagonal separator).
 2 pieces 14" x 14", with 8" x 8" squares cut out of the center of each (partitions A-1 and A-6). *Note:* the 8" square pieces will be mounted to the top and bottom of partition B-1 for added rigidity.
 1 piece 11¾" x 11¾" (partition B-1).

½" thick tempered pressboard, both sides finished:

4 pieces 14" x 14", with 8" square center opening (partitions A-2 through A-5). *Note:* the 8" square pieces will be mounted on top of partitions B-2 through B-5 for extra rigidity.

4 pieces 11¾" x 11¾" (partitions B-2 through B-5).

1" x 1" material (for partitions mounting posts):
 8 pieces 2¾" long, for mounting partition B-1 on A-1.

32 pieces 2" long, for mounting partitions B-2 through B-5 on A-2 through A-5.

½" x ¾" material (partition mounting strips):
 12 pieces 14" long, for use on left and right side panels.
 12 pieces 13" long, for front and rear panels.

Miscellaneous: 4 heavy duty, five-way binding posts. Since most of these posts are only ¾" long, I suggest you use them as follows:

(a) With a half-inch drill, drill half an inch into the inside surface of the 1" panel at the desired mounting location.

(b) Drill a hole slightly smaller than the diameter of the binding post screw from the center of the first hole through to the outside of the panel. Screw the binding post in place with a small nail through its wire hole and attach the washer and nut for extra insurance against speaker vibrations working the post loose. Solder the wire to the post's bottom terminal.

Insulated and stranded wire, at least #18, for connecting the speakers to the binding posts.

A hot glue gun and glue sticks.

A small tube of liquid glue.

A large tube of silicon rubber or any similar material, for an airtight seal in mounting the speakers.

Hardened sheet-metal screws, #12, 1½" long and 1¼" long. Use the 1½" screws for attaching the partition mounting strips to the enclosure sides and for assembling the enclosure itself. For putting the partition assemblies together use the 1¼" screws. In all instances use liquid glue along with the screws for really rigid construction.

NOTES: (a) This type of screw works better than wood screws, which are not hardened and can't take heavy-duty use without damage to the screw head.

(b) Use slotted-head screws, not the Phillips type.

(c) Pre-drill all screw holes, making sure they are small enough that the screws effectively seal the hole. To give the screw a better grip, make the hole which will be nearest the screw head after assembly a little larger by using the next size drill bit. [Or use a special screw-hole bit for the size you have chosen—Ed.]

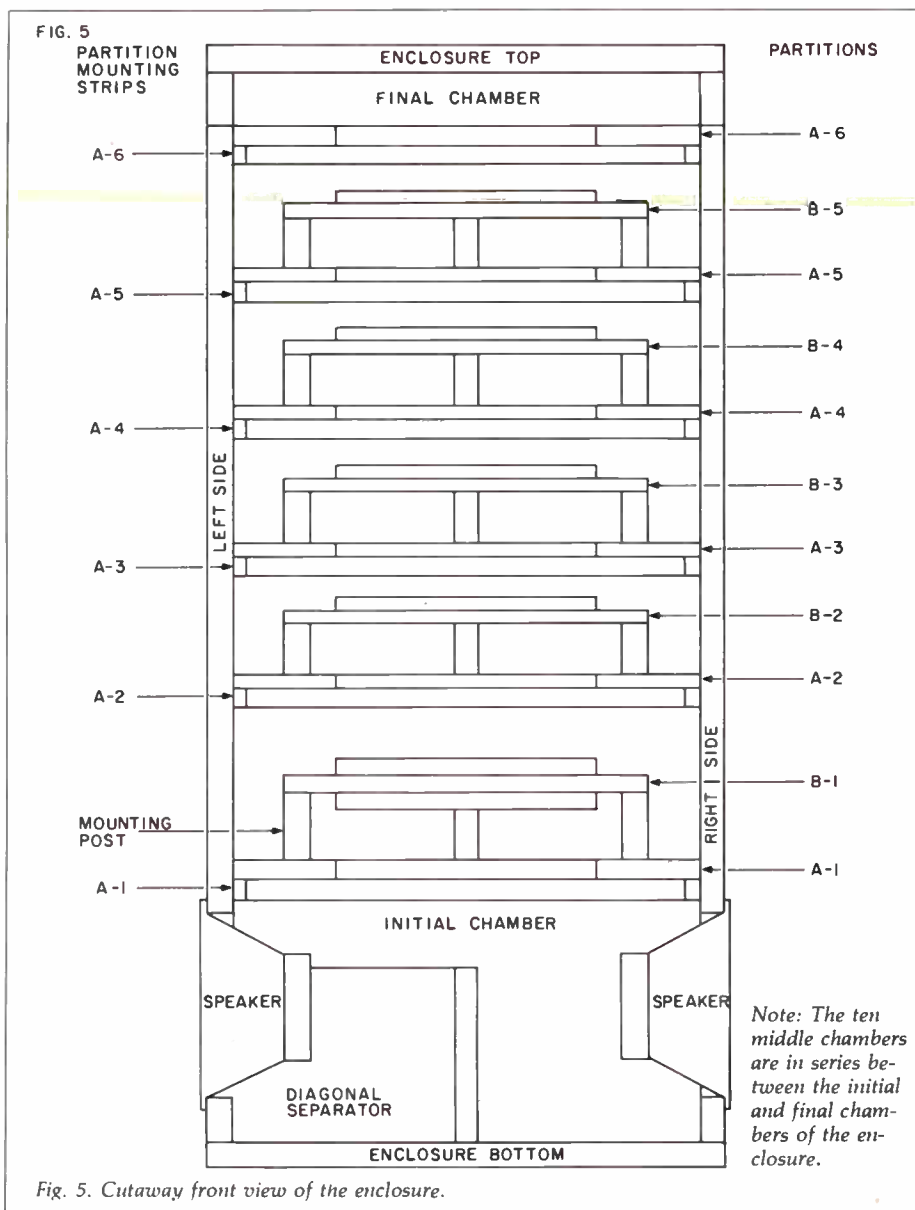

Fig. 5. Cutaway front view of the enclosure.

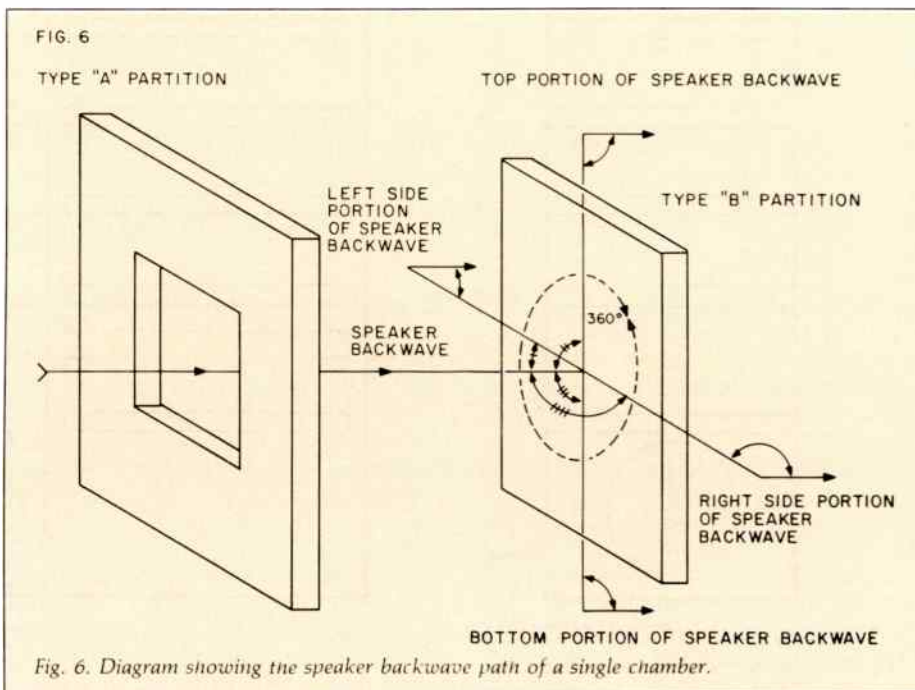

Fig. 6. Diagram showing the speaker backwave path of a single chamber.

A Calculator Program for Thiele-Small Parameter Computation

by G. R. KOONCE

I BUILD SPEAKER SYSTEMS as a hobby, so I measure the Thiele-Small (T/S) parameters on many drivers. If you have performed these tests manually, you know you must compute the R_x parameter during the tests. The calculation is simple, but if you make a mistake, all the test data taken from then on are incorrect and useless for the test segment involved.

I decided I wanted a quick, accurate way to compute R_x and reduce the other data as the test progressed to verify the results. So I treated myself to a Hewlett-Packard HP-34C continuous memory programmable calculator which could produce these computations. Once you have entered the program, the calculator will retain it even with the power off.

I don't intend to debate which programmable calculator is best or tell you how to minimize program length. This article describes the program I developed for the HP-34C calculator, how to use that program, and the definitions and equations associated with the program. I've included a test case to verify program entry. I hope these techniques and equations will be useful to those with other model manual and programmable calculators.

Several sources describe how to test a driver to establish its T/S parameters^{1,2,3}. I assume you are familiar with this testing, so will give just a quick summary for reference. I mount the driver on a baffle of the size I think such a driver's cabinet front might be, and connect it up with reasonably long test leads which will remain fixed throughout all the testing.

Resistance and impedance tests involving some computations are run on the driver while it's on the baffle. I then mount it in a vented or sealed test box for further testing and computa-

tions. I construct my test boxes so the baffle containing the driver becomes the front of the test box. This testing and the HP-34C program described here give me the three normal T/S parameters and approximate driver sound pressure level (SPL) at 1 meter for 1 watt input.

The program is listed in *Table I*, before keying it in, be sure to clear the entire program memory by pushing f CLEAR PRGM with the mode switch set to "program." *Table I* also lists the key codes for each step to aid in trouble-shooting if a problem develops. The program outputs, except for SPL, are all in "fixed" display format and shown to three decimal places; the SPL result is in decibels and rounded off to one decimal place. Remember with the HP-34C you can always push and hold "h Mant" to see all available digits in the display if you need more decimal places.

Now let's go through the use of the program along with the testing in detail. You've baffle mounted the driver and connected it up for testing. This section's terminology is fundamental T/S parameter definitions which I'll present later, along with all equations.

A) BAFFLE TESTS

Measure and record the DC resistance of the driver and test leads (R_e) in ohms. Find the test frequency (f_s) giving the driver its maximum impedance magnitude. The impedance at this frequency, called R_{MAX} , is nearly resistive. Go to the calculator:

Key in R_e , ohms; push Enter

Key in R_{MAX} , ohms; push Enter

Key in f_s , Hertz; push A

The calculator will display the value of test resistance R_x . Back to testing. Move the test frequency down from f_s ,

until you find the point where the speaker impedance magnitude equals R_x . Record this frequency as f_1 . Move the test frequency up past f_1 until speaker impedance magnitude again equals R_x , and record this frequency, f_2 . Back to the calculator to check up:

Key in f_1 , Hertz; push Enter

Key in f_2 , Hertz; push R/S

The calculator will now display $\sqrt{f_1 f_2}$ which should equal f_s . If they are not within ± 10 percent of each other you may have some problem in the testing.

Push R/S; the calculator displays: Q_{MS}

Push R/S; the calculator displays: Q_{ES}

Push R/S; the calculator displays: Q_{TS}

If you push R/S again, the calculator will display: ERROR 2—you have gone too far. This is no problem; just push CLX to clear the display. This completes baffle testing.

You have two options for the second test phase: closed or vented box testing. You need to do one or the other, but not both. I'll discuss them individually.

B) CLOSED BOX TESTING

The calculator program for closed box testing requires that you first run the baffle tests and computations. The results of the baffle tests will be properly stored even if you have shut off the calculator between test segments.

Mount the driver in an unlined closed test box of known net volume (V_B) and verify that the system is sealed; then repeat the test sequence run on the baffle. Find DC resistance, R_{ec} , if you changed any leads. Find f_c , the closed box equivalent of f_s , and R_{MAXc} . Go to the calculator:

Key in R_{ec} , ohms; push Enter

Key in R_{MAXc} , ohms; push Enter

Key in f_c , Hertz; push Enter

Key in V_B , (Feet)³; push B

Note that the net box volume is in cubic feet; I'll discuss later how to modify the program to work in metric volumes. The calculator will display R_{xc} . Go back to testing and find f_{1c} f_{2c} with the same definitions as in the baffle testing. On the calculator:

Key in f_{1c} , Hertz; push Enter

Key in f_{2c} , Hertz; push R/S

The calculator displays $\sqrt{f_{1c}f_{2c}}$ as a

check: it should match f_c .

Push R/S; the calculator displays: Q_{MC}

Push R/S; the calculator displays: Q_{EC}

Push R/S; the calculator displays: Q_{TC}

Push R/S; the calculator displays: V_{AS} in cubic feet

Push R/S; the calculator displays: SPL in dB

If you push R/S again, the calculator displays: ERROR 2. Pushing CLX will

clear the display. This ends the driver test sequence for a closed box.

C) VENTED BOX TESTING

The program for vented box testing also requires you to run the baffle tests and calculations first. The results of the baffle tests will be properly stored even if the calculator has been shut off between test sequences.

TABLE I PROGRAM LISTING

01	h LBL A	25, 13, 11	57	$f\sqrt{x}$	14, 3	113	\div	71
02	f FIX 3	14, 11, 3	58	R/S	74	114	R/S	74
03	STO 1	23, 1	59	RCL 5	24, 5	115	RCL 4	24, 4
04	g R↓	15, 22	60	$f\sqrt{x}$	14, 3	116	RCL 3	24, 3
05	$x = y$	21	61	RCL 3	24, 3	117	+	51
06	STO 2	23, 2	62	x	61	118	RCL 4	24, 4
07	\div	71	63	RCL 4	24, 4	119	RCL 3	24, 3
08	STO 3	23, 3	64	RCL 0	24, 0	120	-	41
09	$f\sqrt{x}$	14, 3	65	-	41	121	x	61
10	RCL 2	24, 2	66	\div	71	122	RCL 3	24, 3
11	x	61	67	STO 4	23, 4	123	RCL 5	24, 5
12	R/S	74	68	R/S	74	124	+	51
13	STO 2	23, 2	69	RCL 5	24, 5	125	x	61
14	$x = y$	21	70	1	1	126	RCL 3	24, 3
15	STO4	23, 4	71	-	41	127	RCL 5	24, 5
16	x	61	72	\div	71	128	-	41
17	$f\sqrt{x}$	14, 3	73	STO 0	23, 0	129	x	61
18	R/S	74	74	R/S	74	130	RCL 4	24, 4
19	RCL 3	24, 3	75	RCL 4	24, 4	131	RCL 5	24, 5
20	$f\sqrt{x}$	14, 3	76	RCL 5	24, 5	132	x	61
21	RCL 1	24, 1	77	\div	71	133	$g x^2$	15, 3
22	x	61	78	R/S	74	134	\div	71
23	RCL 2	24, 2	79	RCL 3	24, 3	135	RCL 0	24, 0
24	RCL 4	24, 4	80	RCL 0	24, 0	136	x	61
25	-	41	81	x	61	137	STO 3	23, 3
26	\div	71	82	RCL 1	24, 1	138	R/S	74
27	STO 4	23, 4	83	\div	71	139	h LBL 3	25, 13, 3
28	R/S	74	84	RCL 2	24, 2	140	RCL 1	24, 1
29	RCL 3	24, 3	85	\div	71	141	$g x^2$	15, 3
30	1	1	86	1	1	142	RCL 1	24, 1
31	-	41	87	-	41	143	x	61
32	\div	71	88	RCL fl	24, 14, 23	144	RCL 3	24, 3
33	STO 2	23, 2	89	x	61	145	x	61
34	R/S	74	90	STO 3	23, 3	146	RCL 2	24, 2
35	RCL 4	24, 4	91	R/S	74	147	\div	71
36	RCL 3	24, 3	92	GTO 3	22, 3	148	2	2
37	\div	71	93	h LBL 1	25, 13, 1	149	.	73
38	R/S	74	94	STO 0	23, 0	150	7	7
39	RCL .9	24, .9	95	g R↓	15, 22	151	EEX	33
40	h LBL B	25, 13, 12	96	$g x^2$	15, 3	152	CHS	32
41	STO f I	23, 14, 23	97	g R↓	15, 22	153	8	8
42	g R↓	15, 22	98	STO 4	23, 4	154	x	61
43	STO 3	23, 3	99	$g x^2$	15, 3	155	f LOG	14, 2
44	g R↓	15, 22	100	$x = y$	21	156	1	1
45	$x = y$	21	101	STO 5	23, 5	157	0	0
46	STO 4	23, 4	102	$g x^2$	15, 3	158	x	61
47	\div	71	103	+	51	159	1	1
48	STO 5	23, 5	104	f R↓	14, 22	160	1	1
49	$f\sqrt{x}$	14, 3	105	-	41	161	2	2
50	RCL 4	24, 4	106	$f\sqrt{x}$	14, 3	162	+	51
51	x	61	107	STO 3	23, 3	163	f FIX 1	14, 11, 1
52	R/S	74	108	R/S	74	164	R/S	74
53	STO 4	23, 4	109	RCL 4	24, 4	165	RCL .9	24, .9
54	$x = y$	21	110	RCL 5	24, 5	166	h RTN	25, 12
55	STO 0	23, 0	111	x	61			
56	x	61	112	RCL 3	24, 3			

Two options exist in the vented box tests, but only one of them is built into the program. The problem is that the frequency (f_m) representing the very bottom of the valley between the two peaks of a vented box impedance curve is difficult to locate exactly and only approximates the box tuned frequency (f_b); see Small³. A more accurate approach is to seal the box temporarily and measure f_c ; this option is built into the calculator program. If for some reason you cannot seal the box and driver, measure f_M and compute a synthetic f_c' for the program; you can do this manually with the HP-34C before starting to enter the vented box data.

$$f_c' = \sqrt{(f_H)^2 + (f_L)^2 - (f_M)^2}$$

The test procedure is as follows. With the driver mounted in an unlined vented test box of known net volume, temporary seal the box, verify it is airtight, and find the resonant frequency f_c . Unplug the port and put in the proper duct so f_M is about the same frequency as f_s , the baffle resonance. Install the duct outside the box so the net volume is unchanged. This tuning is approximate only and not critical. Move the test frequency below f_M to locate the frequency of the lower impedance peak f_L , then up to the second impedance peak frequency f_H . Go to the calculator:

- Key in f_L , Hertz; push Enter
- Key in f_H , Hertz; push Enter
- Key in f_c or f_c' ; Hertz; push Enter
- Key in V_B , cubic feet; push GSB 1

The calculator will display f_B ; if you used f_c' input, you should get back f_M . In any case f_B should be close to f_M .

- Push R/S; the calculator will display: f_{SB}
- Push R/S; the calculator will display: V_{AS} in Feet³
- Push R/S; the calculator will display: SPL in dB.

If you push R/S again the calculator will display: ERROR 2, which can be cleared by pushing CLX. This completes driver testing with a vented test box.

I have specified that the baffle test program must be run before you can run either of the test box programs. This is because the box test programs require the values of f_s and Q_{ES} developed in the baffle test program. If baffle data is available and you want to run box tests without rerunning the baffle tests, enter the required data and correct the display format as shown below:

- Key in f_s , Hertz; push STO 1
- Key in Q_{ES} ; push STO 2
- Push f FIX 3

DEFINITIONS AND EQUATIONS

Now let's look at the definitions and

TABLE II TEST SEQUENCE FOR HP-34C PROGRAM

Key in Following Data	Press Key(s)	The Display Should Show	Program Steps
None	f FIX 1	Sets up initial	display format
2	ENTER	2.0	None
18	ENTER	18.0	None
20	A	6.000	1-12
10	ENTER	10.000	None
40	R/S	20.000	13-18
None	R/S	2.000	19-28
None	R/S	.250	29-34
None	R/S	.222	35-38
None	R/S	ERROR 2	39
None	CLR X	.222	None
2	ENTER	2.000	None
8	ENTER	8.000	None
40	ENTER	40.000	None
3	B	4.000	40-52
20	ENTER	20.000	None
80	R/S	40.000	53-58
None	R/S	1.333	59-68
None	R/S	.444	69-74
None	R/S	.333	75-78
None	R/S	7.667	79-91
None	R/S	90.2 (105.7)*	92 & 139-164
None	R/S	ERROR 2	165
None	CLR X	90.2 (105.7)*	None
10	ENTER	10.0	None
50	ENTER	50.0	None
40	ENTER	40.0	None
1.5	GSB 1	31.6	93-108
None	R/S	15.8	109-114
None	R/S	8.1	115-138
None	R/S	90.4 (106.0)*	139-164

*Value in parenthesis obtained with metric modifications—not tested.

equations used in this program. Starting with baffle tests:

R_o = DC resistance of driver test set-up; ohms

R_{MAX} = magnitude of the speaker impedance at baffle resonance (f_s). It is very nearly resistive.

$$r_o = \frac{R_{MAX}}{R_e} \quad R_x = \sqrt{r_o} R_e$$

where R_x is the test resistance used to find f_1 and f_2 , the frequencies at which the speaker impedance magnitude equals R_x . Note that $f_1 < f_s < f_2$.

Q_{MS} = driver mechanical

$$Q = \frac{\sqrt{r_o} f_s}{f_2 - f_1}$$

Q_{ES} = driver electrical

$$Q = \frac{Q_{MS}}{r_o - 1}$$

Q_{TS} = driver total

$$Q = \frac{Q_{MS}}{r_o} = \frac{Q_{MS} \times Q_{ES}}{Q_{MS} + Q_{ES}}$$

The same definitions and equations apply to the closed box tests, but a subscript C is added:

$$r_{oc} = \frac{R_{MAXc}}{R_{ec}} \text{ where } R_{MAXc} \text{ occurs at } f_c$$

$$R_{xc} = \sqrt{r_{oc}} \times R_{ec} \text{ yielding } f_{1c} \text{ and } f_{2c}$$

Q_{MC} = closed box system mechanical

$$Q = \frac{\sqrt{r_{oc}} f_c}{f_{2c} - f_{1c}}$$

Q_{EC} = closed box system electrical

$$Q = \frac{Q_{MC}}{r_{oc} - 1}$$

Q_{TC} = closed box system total

$$Q = \frac{Q_{MC}}{r_{oc}} = \frac{Q_{MC} \times Q_{EC}}{Q_{MC} + Q_{EC}}$$

$$V_{AS} = V_B \left[\frac{f_c Q_{EC}}{f_s Q_{ES}} - 1 \right]$$

where V_B is the net closed test box

Continued on page 24

Part II

An Interview with

Paul Voigt

by BRUCE C. EDGAR

SB: *How big was your first tractrix horn?*

Voigt: My lab's first horn had a four foot square mouth and a four inch square throat, and was about five feet long with a monster magnet. Its frequency range peaked a little before its gradual low frequency cutoff, but now the sound was no longer "tinny," and the response went down to below 100Hz, being still useful at 50Hz.

My lab had a cathedral ceiling and left over from the radio set repairs who were the previous occupants, a platform onto which my monstrous loudspeaker could be raised. It provided the most perfect reproduced sound I had yet heard up to that time. In those days I did a lot of late work, so in the evenings, up to midnight when the B.B.C. dance music closed down, I had the pleasure of listening to reproduced live music, with no commercials, from London's leading hotels via the B.B.C.

This confirmed my belief that if a high average energy efficiency electricity-to-audio transducer could be produced, then not only would the energy response curve be smooth, but the audio effect would be very satisfying—assuming, of course, that the polar distribution diagram of the energy did not concentrate parts of the energy into compact beams with the listener located in an area of major concentration.

In my case, my four-foot-mouth horn speaker stood on a platform running across the room. The horn's axis was about nine feet above the floor; as I am only about 5'11" tall, my ears were about three and a half feet below axis level. The wall above the entrance door was about four feet from the horn mouth, along the axis. So any normal listening to which I was exposed was either reflected off that wall or may have come off the back of the diaphragm and been reflected in different ways.

SB: *When did your tractrix horns reach public notice?*

Voigt: As regards the word tractrix in connection with horns, that did not reach

readers of *The Gramophone* till the November, 1933, number which described a visit to the inventors' exhibition at which Voigt Patents, Ltd., had a stand (see Fig. 4).

SB: *How did you construct your cinema horns?*

Voigt: In the drawings I made for the carpenter, the forward flare part was four pieces of plywood bolted together on frames cut to the correct shape. The front was square, so the sections joined at an angle which from the front was 45° off the vertical. The front opening was four foot square while the assembly's rear opening was one foot square. To that could be bolted neck pieces of the length required for their input sources. Now the angle of the plywood pieces relative to each other was not 45° throughout, but varied along the length of the horn. So I figured out a jig to hold the wood at the appropriate shape; then by sawing vertically, the varying angle would come out automatically. But, the carpenter could not see the need for that at all. Obviously the angle was 45°, and he had been in the business for many years.

Well, when people know all the answers I do not waste time arguing with them: when I have alerted them I have done my bit. He learned the hard way that horns can look like 45° joints, but they are not. He had an awful job making it fit together.

The curves of those horns were based on the tractrix across the center section. This meant that across the diagonal the tangent would be longer, increasing toward the mouth where it would be 1.414 times the center line tangent. I made the horns square as a matter of woodworking convenience, and with serendipitous results; for if the discontinuity at the mouth at the centerline caused a reflection, that reflection would be ahead in time of the effect of the discontinuity at the corners of the mouth. With a circular mouth, all the effects of the mouth discontinuity get back at the same time.

Once I did have a circular tractrix horn made for outdoor use. The spun aluminum

flare measured three feet at the mouth, and the unit was housed in a cast aluminum box with a side door. The spun flare was, I think, in two parts. It sounded awfully "horny" compared with what I was used to with my wood horns, but there may have been other reasons.

That throat was circular, my wood horns were square. With the latter you might get vertical and horizontal "eigentones" affecting the load on the speaker, but they would spread. With the very strong circular casting, any eigentone would be radial with a concentration at the center. Since the casting was so strong the "give" would have been negligible and so the damping would have been small. With the wood horns, the inch-thick rear frame and plywood frame out forward would have lots of give and no doubt be able to absorb energy.

The question of give is important. Where a resonance builds up and a wall gives, energy is bound to be absorbed; and so the trouble will not get out of hand. The aluminum spun flare lacked the give of the slightly curved ply on the wood. In fact, with some horns, I had so much give and vibration at some low resonances that I had to reinforce the sides to get the response up to standard.

SB: *What developments led to the formation of Voigt Patents, Ltd.?*

Voigt: In the 1920's, while at Edison-Bell, I learned enough about magnets to design high-flux-density loudspeaker magnets properly. Those design principles were discussed in detail in my British Patent #331,209.

Excited field speakers, made under my patent by Edison-Bell, supplied with 40 to 50 watts excitation power gave a flux density of 16,000 to 17,000 gauss across a 2mm. gap. They were used for cinema work, high quality public address systems, etc. Edison-Bell "died" in the slump (1933), so I started my own business to keep the speaker alive? (See Fig. 5.)

SB: *How did you design your domestic corner horn? (Fig. 6)*

Voigt: The simplest way to visualize it is to imagine that my cinema square section horn, placed face down on the floor, is the bottom portion of a rather distorted pyramid. Then saw it into four parts by sawing vertically downwards from one corner to the opposite one. Now if you place one of the quarter sections into a corner of a room, the horn's performance will be unaffected. SB: How did the unusual reflector in the corner horn come about?

Voigt: The next design problem I faced was obtaining an even distribution around the room. I knew the low frequencies coming from the horn would diverge, while the higher tones would be projected more or less in a beam. The high frequency beam would tend to strike the lower concave section, and the more divergent lower frequencies would be reflected by the larger concave surface. So I aimed at a 30° reflection up and down, so as to cover persons sitting, standing, or, of course, anywhere in between. [Editor's note: Voigt received British Patent #404,037 in 1934 for this feature.]

SB: Why did you develop the $\lambda/4$ tapered pipe loudspeaker enclosure?

Voigt: In 1933-34 I was very much concerned with trying to increase the amount of bass you can get with a fairly small cone. That cone was already driving a short horn, but the system was inefficient below the horn cutoff. Several cubic feet of space were available in the cabinet below the horn; the problem was to find a way to augment the lowest frequencies within the available volume. The method I finally

adopted used a tapered folded pipe, rather like the neck of a horn, which exhausted near the floor. I named the system's bass department a bass chamber, but would certainly not have done so had I been aware of the impending introduction of what is now called the reflex cabinet, for that has a better right to be called a chamber than my more complex tapered folded pipe system!

In those days any kind of a resonance was considered taboo, so I refrained from

supplying any details. Its main purpose was to provide bass, and that I covered with the name bass chamber. [Editor's note: it even fooled Percy Wilson, technical editor of *The Gramophone*, who called it a Helmholtz chamber in his review⁵ of the Voigt corner horn.]

Actually it behaves like the neck part of a very low frequency horn which stops before the flare is fitted. Technically a quarter wavelength resonator will describe it. But



Fig. 5. Voigt (left) is taking a response curve on a recorder at Voigt Patents, Ltd. in the late 1930's. From *Wireless World*, July 21, 1933: "Mr. P.G.A.H. Voigt, for some time chief research engineer of Edison-Bell, Ltd., has acquired the stocks of Edison-Bell-Voigt moving coil loudspeakers and electrostatic microphones and has formed a company, Voigt Patents, Ltd., to carry on the manufacture of high grade electroacoustic devices."

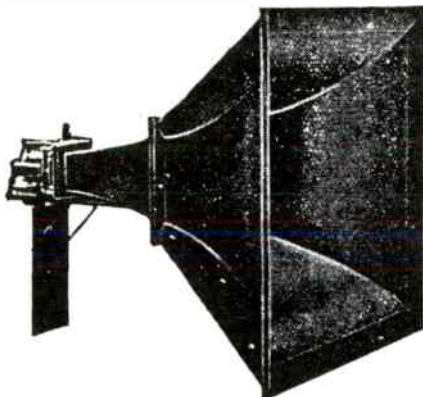

Fig. 4a. Voigt Cinema Horn!⁴

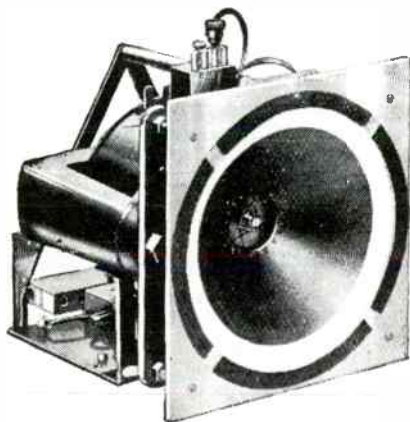

Fig. 4b. Voigt Excited Field Loudspeaker.

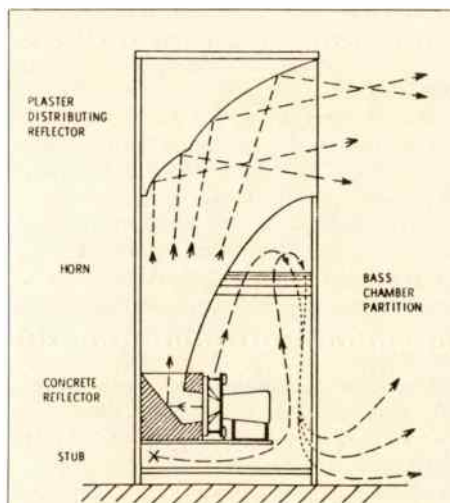

Fig. 6a. Cross-section of the Voigt Domestic Corner Horn. The horn portion had a response down to 100Hz, and the bass chamber used a $\lambda/4$ tapered pipe resonant at 50Hz to supply the bass!⁵



Fig. 6b. The corner in a living-room setting. Its base was two feet square, and its height was five feet. Peak production was reached in 1937 when Voigt's staff of nine was producing 12 corner horns a month. A corner horn with driver sold for £32 (unfinished wood) or £49 (luxury cabinet) in 1937.

since it exhausts at floor level in a corner it is feeding into an eighth of a sphere and so is well loaded and thereby highly damped. In addition, the floor and sides of the room act as a substitute flare, so the mouth reflection to be expected from a quarter wavelength pipe resonator is very much reduced. This widens the skirts of the response on each side of the peak, which itself is so much damped that there is no noticeable boominess. (See Fig. 7 for an explanation of the $\lambda/4$ tapered pipe enclosure.) [Editor's note: Voigt was granted British Patent #447,749 for this idea.]

SB: Did you have any problems with the corner horn response?

Voigt: I did have trouble with a bump with our domestic corner horns. By themselves they sounded fine, but when compared with the four-foot mouth straight horns that bump could easily be detected. I tried all kinds of things: thin ply for the back boards, saw slots, etc. Every batch of horns for a year or so included some experimental ideas.

In order to help put the problem on a proper footing, I started a year or so before the war developing a tone burst test of a simple kind. I made the burst last 100mS and the space 100mS by switching from a shaft at 5rps synchronized with the mains by gearing off a Baird scanning disc motor. (Baird was an early experimenter with television in England.) With this I could show quite clearly a hangover at about 120Hz. So at least I knew that our corner horns were not aperiodic around the horn limit frequency. By various experiments I could push the hangover frequency about, but not get rid of it. I never completed the total system or solved the problem; some problem we had with Hitler messed up further progress!

After the war I bought a double beam Cossor oscilloscope and was able to show that at the bump frequency the phase up and down the horn flare was substantially the same. This also occurs in a Helmholtz resonator, so my belief that there was some kind of a resonance was reconfirmed. It could be a cavity resonance. I did start some experiments for absorbing it electrically or mechanically, but was never able to finish them.

SB: How were your speaker diaphragms made?

Voigt: I used white paper as used by the draftsman on his drawing board; it was handy and available for the asking. I cut it to shape, bent the cone on the appropriate former, and glued the overlap seam with celluloid cement. Of the techniques developed between the paper makers and the mass-production speaker makers, I have no knowledge. I imagine the dies for forming the paper were not cheap.

Later, when we were making diaphragms for straight horn speakers for talkies, we sprayed the assembled diaphragm with mahogany coloured shellac using a hand-

operated gun sold for spraying anti-fly liquids; these were also readily obtainable.

In the early days, the frame around the diaphragms was made of wood, the outside being rectangular (almost square) while the opening (naturally) was round. The flexible surround was at first glued on chamois leather, but I changed that for two reasons: first it was not as elastic as I thought desirable; second, in some cinemas the mice ate it!

As things improved, we made the frames of die cast aluminum, and for surround I used a red material which I think was a form of crepe rubber. It came from the Malay States and was sold in England under the name "Linatex." An aluminum ring clamped the Linatex to the paper diaphragm. The mice showed no interest in that material, but like rubber materials in general it perished with time. It was affected by the atmosphere; in most cinemas, a life of four or five years was quite usual, but cinemas in seaside towns might get only half that. In the domestic corner horns of 1934 onwards a longer life was normal.

During the later '50's, when I lived in Toronto, I was introduced to a flexible plastic material about 0.4mm thick as I recall, made by DuPont under the name Fairprene M5550. It was not quite as elastic as Linatex, but for domestic work that is not as important as in a cinema. When we moved away from Ottawa about 18 years later, it showed no signs of perishing.

SB: When did you invent the twin cone diaphragm?

Voigt: I discovered the advantages of using a twin cone to improve the high frequencies in 1933, but it did not improve the high frequencies as much as did the later light coil feature. The twin cone was probably the most "borrowed" of any of my ideas. I licensed my twin cone patent for use in Wharfedale's and Goodman's loudspeakers, and they both paid their royalties faithfully.

Because the war spoiled the high quality sound business, I was granted an extension of the patent life. However, patents do not go on for ever, and I had no patents in other countries. What is the position today? Well, not a hifi shop in the world but has a few twin diaphragm loudspeakers in stock; and for every one in stock, how many hundreds are in use? So at least if Rice and Kellogg beat me by a few weeks for the moving coil loudspeaker, I contributed the twin diaphragm. [Editor's note: Voigt was granted British Patent #413,758 for the twin diaphragm in 1934.]

SB: How did you develop your Light Coil Twin (cone) version of the Voigt loudspeaker unit?

Voigt: While driving to Scotland in the late '30's, my mind returned to the field strength consequences. My main starting point was my 1929 cinema speaker design, which accomplished 16,000 gauss or a bit over in a 2mm. gap of 5mm. axial length. In Teslas,

16,000 gauss (the flux density at which iron shows signs of nearing saturation) is the same as 1600 milli Teslas. If you prefer to be strictly scientific and call it 1.6 Teslas and use that value after explaining to a customer how important it is to have the highest practical field strength, he would probably conclude you were nuts and think you were lying! And the above flux density I had accomplished with 40 watts DC magnetizing.

Now, the only "guidance" on the subject of speech coils I had come across was Olson's book⁶ in which he proved mathematically that the optimum mass for the

Continued on page 18

FIG. 7

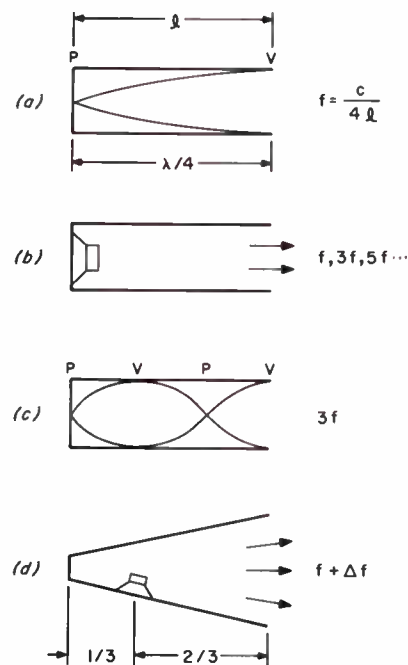
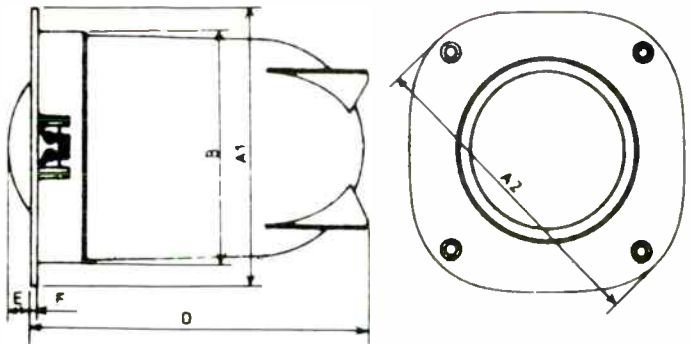

Fig. 7. The Voigt quarter wavelength bass loading enclosure relies on the fact that a $\lambda/4$ closed pipe resonates at the fundamental and odd harmonics. In (a) the fundamental standing wave has a pressure maximum (P) at the closed end and a velocity maximum (V) at the open end. A loudspeaker will be properly loaded if placed at the pressure maximum in (b), but will radiate at the fundamental and all the odd harmonics. At the third harmonic there are two pressure and velocity maximums as shown in (c). Voigt found that if he placed a driver unit one-third of the way down from the closed end (d), the speaker is near a pressure minimum of the third harmonic, reducing the third harmonic excitation. By also tapering the pipe, he was able to broaden the response about the fundamental to give an octave and a half of bass.

SEAS

QUALITY SPEAKERS FROM NORWAY

**ANNOUNCE A NEW 3" DOME
HIGH FIDELITY MIDRANGE
The H-204**



Featuring a vacuum-formed polyamide dome diaphragm with high internal damping, the new H-204 midrange employs a centrally located ferrite magnet in an efficient magnetic system which also provides mechanical damping of the diaphragm, resulting in an exceedingly uniform impedance characteristic. The loudspeaker is supplied with a molded back enclosure to provide optimum shape, volume and damping. Its exceptional performance is detailed below.

- A1: 134.6 mm
- A2: 151 mm
- B: ϕ 113 mm
- D: 166 mm
- E: 10 mm
- F: 3.5 mm



TECHNICAL DATA

Impedance	8 ohms	Voice coil height	3,0 mm
Recommended freq. range	400-4000 Hz	Air cap height	2,0 mm
Free air resonance	350 Hz	Voice coil resistance	6,4 ohms
Oper. pwr. (DIN 45500)	3,2W	Effective diaphragm area	55 cm
Characteristic sensitivity	91 dB	Moving mass	3,1 g
Nominal pwr. (DIN 45573)	80 W'	Air load mass in baffle	0,5 g
Force factor (B1 product)	4,7 Wb/m	Voice coil diameter	76,5 mm
Flux density	0,95 T	Weight	0,65 kg

1) Crossover frequency 500 Hz, 12dB/oct.

Brüel & Kjær
Copenhagen

Response curves recorded in anechoic room (free field, 4π -radiation)

Measuring Object:
H204 8 Ω
2V/0,5m
60x80cm baffle

Zero Lev: **60** Paper Sp: **3**
L.Lim.Fr.: **10** Rec.No:
Pot.: **50** Date: **81060**
Wr.Sp.: **100** Sign:
Rec: **RMS** Freq.Scale x

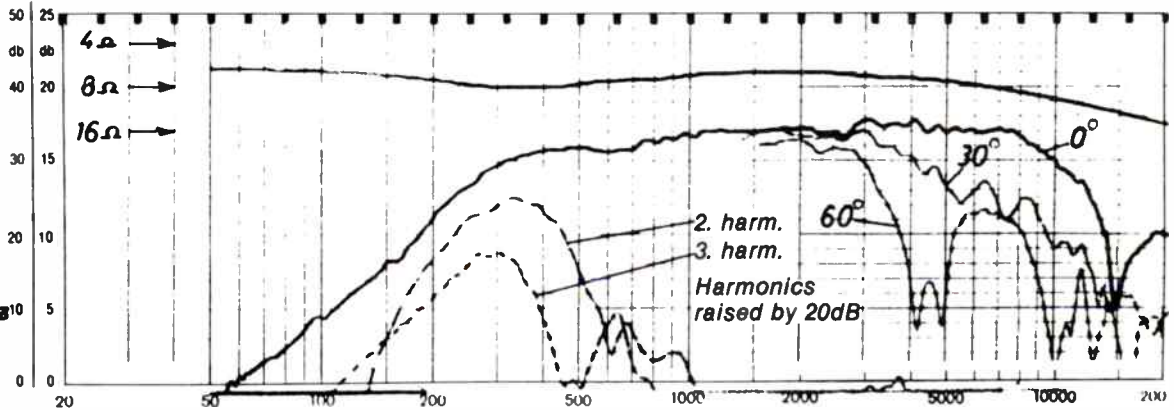

NOW AVAILABLE THROUGH THESE SEAS DISTRIBUTORS:

Classic Research & Engineering
5070 E. 22nd Street
Tucson, AZ 85711
(602) 747-8890

Speaker Supply Co.
5269-2 Buford Hwy.
Doraville, GA 30340
(404) 455-0571

SRC
3238 Towerwood Dr.
Dallas, TX 75234
(214) 243-4145

JC Electronics
2001 Springfield Ave.
Maplewood, NJ 07040
(201) 763-4970

The Speaker Works
Box 303
Canaan, NH 03741
(802) 295-1045

Just Speakers
233 Whitney St.
San Francisco, CA 94131
(415) 641-9228

Sound pressure
.4Pa/div.

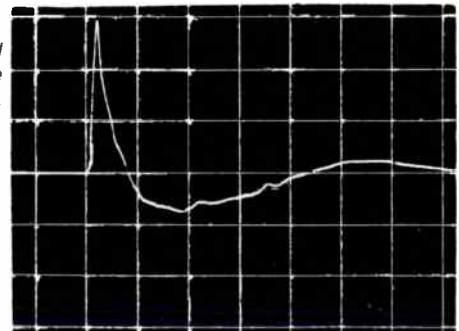

0.2 ms/div time →
Transient response to 4V step function at 1 meter.

SEAS

U.S.A. Sales, P.O. Box 64, Maple Glen, PA 19002
FABRIKKER A.S., Ryggeveien 96, Høyden, 1500 Moss, Norway

speech coil was that which made it equal to the mass of the diaphragm. That may have been correct relative to the assumptions on which his math was based. But I assumed high flux density was important. Anyway, my aluminum wire speech coil's mass was far less than that of my twin cone diaphragm (main cone 6" dia.), so I was already "guilty" of a major deviation from established ideas.

But, if I were to use coil weighing as much as the diaphragm, it would be impossible to squeeze it into a 2mm. gap. To increase the volume of the gap sufficiently for the "established" advice, the electromagnet would have to be increased tremendously. My 1929 design already required 8 lbs. of wire, took 40 watts, and weighed about 30 lbs.

SB: So what hypotheses did you reach?

Voigt: If I reduced the speech coil mass still more, it would cut the inertia of the moving parts, improving transient acceleration and high frequency response, though at the loss of average power. Would there really be a loss, and if there were, would it matter? The possibilities either way produced food for cogitation.

SB: How did you go about redesigning your speaker with these hypotheses?

Voigt: With a smaller mass of wires, I could reduce the speech coil from six layers to four, and the gap from 2mm. to 1½mm. That reduction would push the flux density up further into the saturation region, in practice by about 2000 gauss (about a 12 percent density gain).

With only four layers instead of six of the same gauge wire, the resistance would go down 66 percent. Now I had two alternatives. Change the output transformer from a secondary for 30Ω to one for 20Ω. Then the voltage would go down by about 12 percent and the current up by about 12 percent. One disadvantage would be changing the transformer; were there others?

With two-thirds the turns, the ampere-turns were down by two-thirds because of the reduced number of turns and up by about 12 percent because of the increased current—i.e. only down to 80 percent considering those two factors alone. But hold it! There is a third factor. With the narrower gap, the flux density will go up; but by how much? Sitting at the wheel of a moving car, I could only guesstimate. Getting into the iron saturation region, how much would the flux density in the gap go up when that gap was reduced from 2mm. to 1½mm.? If the rest of the magnetic circuit was a perfect conductor of magnetism, one could expect the 25 percent gap reduction to give an approximate 33 percent increase in flux density. Suppose, since the iron was going into saturation at the pole tips, which were nowhere near perfect, that one-third of the above increase would be

available in practice, then the third factor would provide a 10 percent boost. Eighty percent plus one tenth is 88%!

SB: So what were the ramifications of these "guesstimates"?

Voigt: First, that with a coil mass reduction to 66 percent, the force would obviously also go down by 66 percent. This is correct, but not final. If the reduction of mass is obtained by reducing the wire length, charging the input transformer alone helps to counteract the situation and reduces the efficiency drop to 20 percent. On the good side, the reduction of the coil mass has reduced the inertia loss by 33 percent.

I did not mention before that, instead of changing the transformer to suit the reduced resistance load, a change in wire gauge can match the load to the existing transformer. In either case, the mass reduction makes possible a reduction of the gap width, in turn enabling an increase in flux density—by how much is guesswork until you can measure it from a live sample. The limits are easy to imagine but are probably fairy tales.

Suppose you had a magic wand that eliminated the resistance of iron to carrying magnetic flux, then reducing the gap width by a quarter would allow the flux density to increase by a third. We had already a force reduction to 80 percent before considering the beneficial effect of increased flux. The 80 percent relative difference, multiplied by four-thirds, is 107 percent of the original force. In practice such a magic wand does not operate in the saturation region, but it works much better at lower flux densities.

The other imaginary limit is lower. Suppose the iron circuit refuses to carry more flux, then there is no increase, and the above 80 percent figure holds good. Thus, until practical measurements are made with real hardware, reducing the coil mass will produce a force somewhere between 80 and 107 percent of the original. So cogitation showed treble loss could be reduced and transient acceleration improved with no major reduction, and possibly even an increase, in electromagnetic force.

The idea that for good results coil mass should equal diaphragm mass seemed OK to me if you could not "juggle" with the flux density; but I could. Lab measurements showed that reducing the gap to 1½mm. produced a flux density gain of about 2000 gauss—a gain of 1 in 8 over the previous density of slightly over 16,000 gauss.

SB: With what result?

Voigt: The result? I deliberately developed a "light coil twin" variation of the Voigt loudspeaker. I knew I was deviating further from the established concept than before, and my title made clear that I was doing it deliberately.

As a practical result, extreme high frequencies were so much better that for AM radio reception we had to put whistle frequency filters into the circuit to cut out the heterodyne beat frequency between adja-

cent wavelength transmitters. For gramophone use one could cut out the filter, and in the daytime it could be switched in when receiving the B.B.C.

My light coil twin corner horn speaker was submitted for review and received favorable reports, e.g., in *Wireless World*, March 9, 1939. [Editor's note: After W.W. II Voigt consolidated many of his arguments for a low mass speech coil and diaphragm in British Patent #667,170 and U.S. Patent #2,615,995.]

SB: Tell us about your early experiments with stereo.

Voigt: A few years before the war, I lectured to the Radio Society of Great Britain on sound reproduction and demonstrated with a pair of my corner horns side by side to give 180° distribution. The climax of that lecture was the reproduction of a small orchestra playing live in another room. Initially I connected the two small speakers in parallel, as would be correct for mono reproduction. Then I separated them by about six feet, the distance between the two mikes, and separated their circuits. As far as I know, that was the first demonstration to a British audience of two-channel reproduction. *Wireless World* reported on the meeting in its issue of April 10, 1936.

It is a pity that they call two-channel reproduction "stereo" these days. It is *not* stereo. Real stereo needs not only headphones but mike placing which has in mind that the listener will be wearing headphones.

However, in my stereo demonstrations I was following the lead of Blumlein, who in 1931 invented the stereo record groove (British Patent #394,325). His brilliant idea is now incorporated in every regular stereo record made. I regarded Blumlein as head and shoulders above myself in ability. Had he not been killed during the war in a plane accident while developing a radar system, we would have had many more ideas from him.

SB: How did your association with Lowther begin?

Voigt: I first met the young O. P. Lowther at RadiOlympia in 1934. It was his ambition to market the best possible radiogramophone, which naturally needed the best possible speaker. This meeting developed into a very friendly alliance with the Lowther Mfg. Co. Their excellent tuners and amplifiers, together with Voigt speakers, made up the Lowther-Voigt Radiogram, which set a very high standard of performance?

SB: Describe the research developments of the late '30's.

Voigt: In those days I had set a tone burst test system and was experimenting with permanent magnets. However, I could not obtain magnets which provided the flux density obtainable with my excited field units. I had hoped a unit being made in time for the 1939 annual RadiOlympia exhibition would do the trick. It was so late in

coming that they had to deliver it direct to the address where we and Lowther had rented space near the Olympia building. When we compared it to one of our excited field units, it sounded poor, and we removed it from view. When I measured the flux density it was not up to standard in spite of the large dimension of the magnetic overcoat.

On Sunday, a few days after the exhibition opened, Prime Minister Chamberlain announced that Hitler's forces had invaded Poland and Britain was at war with Germany. That altered everything. On Monday everything was being dismantled. I could not resume my tone burst tests as the noise might be mistaken for some enemy action. Our sales collapsed.

SB: What did you do during World War II?
Voigt: With the help of my wife, who did the drafting and bookkeeping chores, we kept Voigt Patents alive doing maintenance work on our cinema horns. This work was deemed necessary for keeping up Home Front morale. The Admiralty did give us some research money, which surprised us because of my German parents—they could be quite sticky about such matters.

SB: Tell us about your postwar research efforts.

Voigt: In 1939, when Hitler walked into Poland, Britain had sterner tasks on hand and speaker research stopped in its tracks. By the time the war was in its last stages, newer magnetic materials, known variously at Ticonal, Alcomax, and Alnico V, had proved their worth and were able to provide a magnetomotive force far exceeding that obtainable with 40-50 watts of electrical excitation. When research could be resumed, it was with these newer materials in mind.

This time I concentrated on producing a PM unit with the magnetic material in the center. As a matter of policy, I retained the old stylus as far as possible. I thought it might eventually be practical to convert existing excited-field speakers to PM, thus enabling Voigt speaker owners to bring their speakers up to date at minimum expense.

Our policy on diaphragms had been similar, and when the twin cone came out in 1933 they were mounted so as to make them interchangeable with earlier single cones. When we introduced the light coil twin in 1938 that too was interchangeable. As it required a gap of 1½mm., we made liners which could be fitted to existing magnets. With these the flux density went up to the 18,000-19,000 gauss region?

SB: What was the relationship between your and Lowther's PM loudspeaker research and developments?

Voigt: In the postwar period Mr. Chave, Mr. Lowther's former chief technician who now owned the firm, shared my opinion that the excited-field speaker would be regarded as obsolete and therefore we needed a PM version. He pushed on with experiments on a version using the magnetic ma-

OLD COLONY PARTS

P.O. Box 243, Peterborough, NH 03458

CAPACITORS

Metallized polypropylene capacitors non-inductive, epoxy packages, copper leads and high quality attachments. Low dielectric absorption. All are rated as ±20% tolerance but most are within ±10%. Values listed. A-Axial leads; R-Radial leads. Total order **Old Colony Parts** discounts apply.

VALUES AVAILABLE

	630 Volt	400 Volt	250 Volt	160 Volt
μF	.001	.0015	.022	.1
.001	.0015	.033	.15	
.0022	.0033	.047	.22	
.0047	.0047	.068	.33	
.01	.0068	.1	1.0	
.1	.01	.22	2.2	
	.022	4.7		
	.033	10.0		
	.047			
	.068			
	.1			
	.47			

GOLD PLATED CONNECTORS

Our connectors and associated hardware are 23.9K gold plated (0.000020" gold). This is a plate of the highest quality, and has been chosen for its suitability in electronic contact applications.

PHONO PLUG

A shielded (gold plated brass handle) plug that mates well with our gold plated phono jack as well as the gold plated phono jacks commonly and now on high quality equipment.

PHONO JACK A

A jack that mounts from the rear of the panel (up to 3/4" thick) in a hole of 3/8" diameter. The design allows the hex brass body to be firmly held, while the external nut is completely tightened. This results in an installation that is free from the loosening problems commonly encountered in panel mount phono jacks. All hardware is supplied in gold plate to insure optimum grounding continuity.

PHONO JACK B

Conventional front-of-panel mount with washer, lug, and nut mounting on rear of panel. Requires 1/4" hole. All hardware gold plated.

NYLON INSULATORS

Sold in sets of ten, each insulator consists of a nylon step washer and flat washer.

3/8" SIZE: Large insulator for our phono jack described above, and other 3/8" connectors. Requires 1/2" mounting hole.

1/4" SIZE: Can be used on phono jacks from H.H. Smith, Keystone and Switchcraft (350IFP). This insulator fits our older gold plated phono jack. Also useful for the insulation of metal banana jacks (H.H. Smith # 101, # 109; Pomona # 3267; E.F. Johnson # 108-0740-001.)

PRECISION METAL FILM RESISTORS:

Meet Specs for: MIL R10509 RN55, MIL 55182 RNR55

Tolerance: ≤ 1%

Max. Power: 0.35 W @ 70°C, derated linearly to 0 W @ 165°C.

Max. Voltage: 250 V

Temperature Coefficient: 50 ppm/°C

Current Noise: ≤ .05 uV/v to 10k

≤ .1 uV/v to 100k

≤ .25 uV/v to 1M

DIMENSIONS:

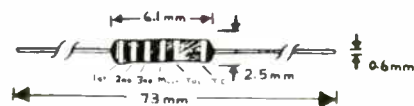

VALUES:

For those of you unfamiliar in working with 1% metal film resistors, we might note that the values given are on the MIL-BELL scale. These are usually within 1% to 1½% of the corresponding IEC E24 values commonly used in domestic equipment. This gives a consistently much tighter tolerance to the specified value than a 5% or even 2% carbon film resistor. At the same time metal films provide less than half the noise, and much greater temperature, time and load stability, and better linearity than carbon film or composition types.

VALUES AVAILABLE

10	100	1 k	10 k	100k
20	110	1.1 k	11 k	110k
27.4	121	1.21k	12.1k	121k
30.1	130	1.3 k	13 k	130k
39.2	150	1.5 k	15 k	150k
47.5	162	1.62k	16.2k	162k
68.1	182	1.82k	18.2k	178k
75	200	2 k	20 k	200k
82.5	221	2.21k	22.1k	221k
90.9	249	2.43k	24.3k	243k
	274	2.74k	27.4k	274k
	301	3.01k	30.1k	301k
	332	3.32k	33.2k	332k
	365	3.65k	36.5k	365k
	392	3.92k	39.2k	392k
	432	4.32k	43.2k	432k
	475	4.75k	47.5k	475k
	511	5.11k	51.1k	511k
	562	5.62k	56.2k	562k
	619	6.19k	61.9k	619k
	681	6.81k	68.1k	681k
	750	7.5 k	75 k	750k
	825	8.25k	82.5k	825k
	909	9.09k	90.9k	909k

1 MEG

Send a stamped #10 self-addressed envelope to **Old Colony Parts**, Box 243, Peterborough, NH 03458 for full details and price list.

terial externally, while I carried on with my experiments using an internal magnet block. At my suggestion we worked independently and did not compare notes till completion.

The outcome of his work was the Lowther PM series (British Patent #618,802 and #628,432); the outcome of mine was reviewed in *Wireless World*, March, 1949. I subsequently improved the design still further, but it is no longer in production as my company became dormant some years after I emigrated to Canada. (See Fig. 8.)

The diaphragms used on the early Lowther PM speakers were supplied by my company, so the speakers were in more ways than one a true Lowther-Voigt combination and were sold as such. The diaphragms used by Lowther's even now differ but little from the genuine Voigt diaphragms of the '30's and '40's. The reason is simple.

When my health started giving trouble in 1946-47, I realized I could no longer supervise the manufacture of handmade diaphragms. I would have to subcontract this work and we would continue only the final test and inspection. I lent all the special tools and jigs needed to the subcontracting firm, and taught them all the special techniques involved. That subcontracting firm was the Lowther Manufacturing Co.; and so when I am credited with being responsible for the PM-2, this is partly correct. But Mr. Chave is responsible for the transition from the Voigt-excited field to the Lowther PM. His work has merit, and it would not be proper for me to accept all of the credit.³ [Editor's note: Part of the confusion between Lowther and Voigt was inadvertently started by George Augspurger's article on horn loudspeakers⁷ in which he gave Voigt credit for the Lowther PM speaker. See also the letter by Chave⁸ with a different opinion on the subject.]

SB: *What went wrong with your health in 1946?*

Voigt: Briefly, in the later '40's after the war, I began to experience sensations of pressure in my left chest. They were fatigue related and slowed me down. If I walked past the stands slowly at an exhibition, no one noticed. But at a restaurant I could not follow the head waiter to my table in a normal fashion, and it was extremely noticeable.

I consulted a series of medical doctors who applied the standard tests. They could find no reason for my trouble and assured me there was nothing physically wrong with me; they eventually tried to convince me that I was imagining it all! Finally I found an osteopath who diagnosed the problem as a malformation of the spine. A spinal brace was made for me which initially produced daily improvement.

SB: *Why did you decide to move to Canada in 1950?*

Voigt: The war had reduced my firm to a

Continued on page 22

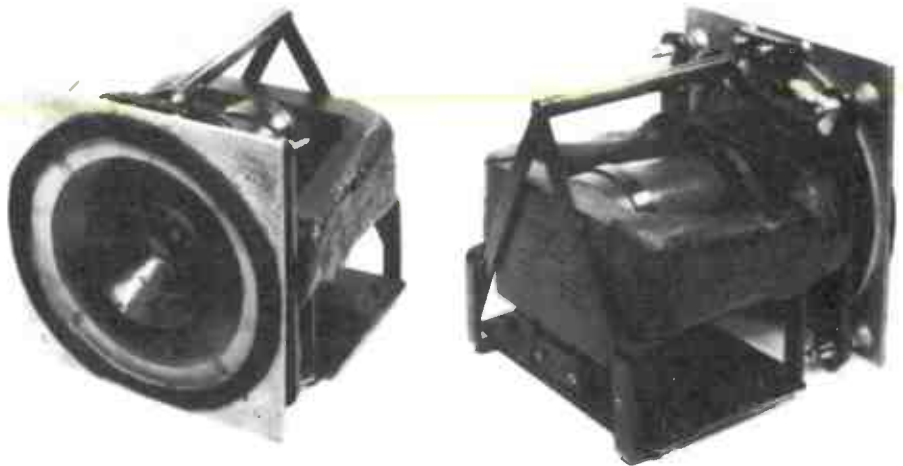

Fig. 8. Light coil twin diaphragm Voigt PM loudspeaker of 1949. The permanent magnet consisted of a large center block of Ticonal with the magnetic return paths supplied by the two large side limbs. The unit weighed about 30 lbs. and cost \$37!⁶



Fig. 9. Paul Voigt, taken about 1970 in Canada.

Old Colony KITS

POLICY: OLD COLONY SOUND LAB is a service agency for readers of *The Audio Amateur* and *Speaker Builder* magazines. It attempts to provide circuit boards and the basic, or hard to find, parts for construction projects which have appeared in the magazine. **Old Colony assumes that the constructor will use the *Audio Amateur* or *Speaker Builder* magazine article as the guide for building his unit.** Kits, with noted exceptions, are not priced to include article reprints or construction instructions. Old Colony kits, with stated exceptions, do not provide metal work, cabinets, line cords and the like. We suggest that before purchase amateurs secure and evaluate the articles, which give details on each unit. Kits vary widely in complexity and required construction skills. A very few can be assembled by the beginner. If you are just starting in audio, get some experience building Heath or Dyna kits before tackling an Old Colony kit, or locate an experienced friend to help in case of difficulties.

CROSSOVERS ELECTRONIC

For both electronic crossovers: crossover points and R_1 , R_2 , C_1 , C_2 MUST be taken from Fig. 3, p. 11, Issue 2, 1972, TAA. No other values can be supplied.

KC-4A: ELECTRONIC CROSSOVER, KIT A. [2:72] Electronically divide the signal before the amplifier. Requires one amp for bass; a second for treble (or one stereo amp per channel). Lowers distortion and dramatically increases power capability. Single channel, two-way. Values of R_1 , R_2 , C_1 , C_2 must be specified with order. All parts and C-4 circuit board. Includes new LF351 ICs. Each **\$8.00**

KC-4B: ELECTRONIC CROSSOVER, KIT B. [2:72] Single channel, three-way. Values of R_1 , R_2 , C_1 , C_2 , must be specified with order. All parts and C-4 circuit board. Includes new LF351 ICs. Each **\$11.00**

KK-6L: WALDRON TUBE CROSSOVER: Low pass. Single channel, 18dB/octave, Butterworth, [3:79] includes Bourns 3-gang plastic pot, level control, Mullard tubes, board, and three frequency range determining capacitors. Specify ONE frequency range per kit please. (Hz.): 19-210; 43-465; 88-960; 190-2100; 430-4650; 880-9600; 1900-21,000. Single channel. Each **\$43.00**

KK-6-H: WALDRON TUBE CROSSOVER: High pass. Single channel, 18dB/octave, Butterworth, [3:79] includes Bourns 3-gang plastic pot, level control, Mullard tubes and 3 frequency determining capacitors. Please specify one of the frequencies above. No other can be supplied. Each **\$45.00**

KK-6-S Switch Option. 6-pole, 5-pos. rotary switch, shorting, for up to five frequency choices per single channel. Each **\$8.00**
When ordered with two kits above, Each **\$7.00**

KK-7: WALDRON TUBE CROSSOVER POWER SUPPLY. [3:79] All parts, including board, transformer, fuse, semiconductors, line cord, capacitors. Will power four tube x-over boards (8 tubes), one stereo bi-amped circuit. Each **\$88.00**

PASSIVE

KF-7: CROSSOVER FOR WEBB TLS. [1:75] Passive four-way crossover, in pairs, assembled. Components are included for both STC and Celestion tweeters. Made by Falcon of England. Pair **\$87.50**

FILTERS & Speaker Saver

KF-6: 30Hz RUMBLE FILTER. [4:75] Rolls off system response at 18dB/octave below 30Hz to eliminate rumble and garbage on discs below 30Hz. Cuts speaker distortion and wasted amplifier power. Two channel universal filter card supplied with WJ-3 (F-6) circuit board and all basic parts, 1% metal film resistors and 5% MKM capacitors for operation as an 18dB/octave 30Hz rumble filter. 30Hz, 0dB gain only. Kit may be adapted as two- or three-way single channel crossover with added capacitors and resistors. Each **\$19.75**

KH-2A: SPEAKER SAVER. [3:77] Protects speakers from destructive transient signals by quick shutdown of amplifier output. This basic two-channel kit includes board and all board-mounted components for control circuitry and power supply. It features turn-on and off protection and fast opto-coupler circuitry that prevents transients from damaging your system. 4PDT relay and socket included. Each **\$35.00**

KH-2B: OUTPUT FAULT OPTION. If the amplifier goes into self-destruct mode, this added feature cuts off drive to output devices quickly. Additional board mounted components for speaker protection in case of amplifier failure. Each **\$6.75**

KH-2C: COMPLETE SPEAKER SAVER WITH OUTPUT FAULT OPTION. Each **\$40.00**

KK-8: COMPLEX C. Signal compression in a repeatable format for tape recording or signal transmission. Two channel board with all parts to compress signal, including 1% polycarbonate capacitors and large tantalums. [3:79] Each **\$45.00**

KK-9: COMPLEX E. Signal expansion in tape replay mode or after transmission via limited phone lines. Two channel expansion board with all parts including precision Rs & Cs, [3:79] Each **\$35.00**

SYSTEM ACCESSORIES

KH-8: MORREY SUPER BUFFER. [4:77] All parts & board for two channel output buffer to isolate tape outputs in your preamp from distortion originating in a turned-off tape recorder. Many uses for this versatile matchmaker. Each **\$14.00**

KF-1: BILATERAL CLIPPING INDICATOR. [3:75] Single channel, all parts and board for any power amp up to 250W per channel. (Does not work well with Leach Amp). Powered by amp's single or dual polarity power supply. Each **\$5.50**
Two kits, as above **\$8.25**

KK-14A: MacARTHUR LED POWER METER. [4:79] Two channel, two sided board and all parts except switches, knobs, and Mtg, clips for LEDs. LEDs are included. No chassis or panel. Each **\$110.00**

KK-14B: MacARTHUR LED POWER METER. [4:79] As above but complete with all parts except chassis or panel. Each **\$137.50**

KL-2: WHITE-DYNAMIC RANGE & CLIPPING INDICATOR. [1:80] One channel, including board, with 12 indicators for preamp or crossover output. Requires $\pm 15V$ power supply @ 63 mils. Single channel. Each **\$49.00**

Two channels. **\$95.00**
Four channels. **\$180.00**

BENCH AIDS & Test Equipment

KH-7: GLOECKLER PRECISION 101dB ATTENUATOR. [4:77] As basic to measuring as a good meter, and more accurate than most. All parts except chassis and input/output jacks to build author's prototype including all switches and loads. Resistors are MF 1% and 2% types. Each **\$50.00**

KB-8: INVERSE RIAA KIT. Six precision components to shape your audio signal generator's output to the response curve of a recorded disc. Checks phono preamp inputs. Each **\$5.75**

KL-3C: INVERSE RIAA NETWORK. [1:80] Revised, precise, deluxe network. Two channels, 1% polystyrene capacitors and metal film resistors, gold jacks, cast aluminum box, solder lugs and alternate 600 ohm or 900 ohm R_2/C_2 components. Each **\$35.00**

KL-3R: INVERSE RIAA. [1:80] Resistor/capacitor package complete. Stereo R_2/C_2 alternates. Each **\$25.00**

KL-3H: INVERSE RIAA. [1:80] Box, terminals, gold jacks, and all hardware, (No resistors or caps) in KL-3C. Each **\$13.50**

KF-4: MORREY'S MOD KIT FOR HEATH IG-18 (IG 5818) SINE-SQUARE AUDIO GENERATOR. [4:75] Includes two boards and all added parts needed to modify the Heath unit to distortion levels of parts per million range. Replacement sine-wave attenuator resistors not included. Each **\$35.00**

KG-2: WHITE NOISE/PINK FILTER [3:76] All parts, circuit board, IC sockets, 1% resistors, $\pm 5\%$ capacitors. No batteries, power supply or filter switch. Each **\$22.00**

KJ-7: VTVM BATTERY REPLACEMENT KIT. [4:78] All parts to replace your VTVM's battery with a regulated supply. Each **\$7.50**

KJ-6: CAPACITOR CHECKER. [4:78] All parts to build an accurate meter for measuring capacitance, leakage, and insulation. Check phono & speaker lead capacitance effects. Includes all parts with $4\frac{1}{2}''$ D'Arsonval meter. Each **\$68.00**

KK-3: THE WARBLER OSCILLATOR. [1:79] For checking room response and speaker performance without anechoic chamber. All parts and board. Each **\$56.00**

KL-6 MASTEL TIMERLESS TONE BURST GENERATOR. [2:80] Highly valuable and useful device for testing speakers and room response. All parts with circuit board. No power supply. Each **\$19.00**

NEW KIT: SBK-A1: LINKWITZ CROSSOVER/FILTER. *Speaker Builder's* [4:80] first kit, including all parts and board for one channel of the three-way crossover/filter/delay. 24dB/octave at 100Hz and 1.5kHz and 12dB/octave below 30Hz, with delayed woofer turn-on. Board is $5\frac{1}{2} \times 8\frac{1}{2}$. Requires $\pm 15V$ supply, not supplied. Use the Sulzer supply KL-4A with KL-4B or KL-4C.

Per channel **\$64.00**
Two channels **\$120.00**
SBK Board only Each **\$14.00**

ORDERING INFORMATION

Prices, except as noted, are prepaid in the USA and insured. We prefer to ship via UPS, which requires a street address. If you cannot receive UPS delivery, please include an extra \$2 for insured service via Parcel Post. We cannot accept responsibility for safety or delivery of uninsured Parcel Post shipments. PLEASE ADD \$1 service charge for all orders under \$10

CHARGE CARD
TELEPHONE ORDER SERVICE

MON. THROUGH FRI. 9AM-4PM
(603) 924-6526

MasterCharge/Visa Cards Welcome

OLD COLONY Box 243 Peterborough NH 03458

P.G.A.H. VOIGT: PART II

Continued from page 20

skeleton basis. I could see no chance of recovery unless I could build up sufficient export trade, since British purchase tax and rationing of materials tended to reduce our British sales till they were of no consequence. In April, 1950, my wife and I crossed the Atlantic, leaving Voigt Patents, Ltd., running on a skeleton basis in London, England. Our purpose was to build up export sales of my corner horn loudspeaker on this continent specifically, to make sure that I did not have all my eggs in one basket.

My wife had spent a year or so in Toronto somewhere around 1926, so for her it was not a blind shot and she had friends there. I had one helpful audio contact there, and another in New York. From a general point of view, Toronto is within 600 miles of one-third of the population of this continent, and from a personal point of view I felt it would be more satisfying to operate from a part of the British dominions than from the United States. Not only had they come in late for both world wars, but British radio journals at the time had not overlooked inventor Armstrong's suicide because of legal patent troubles.

SB: *What happened to the Canadian venture?*

Voigt: Default by a company I thought I could trust upset the financial situation, and an almost total failure of communications ensured my Canadian venture's doom. The company ran on its own momentum into the mid 1950's, but without substantial export trade it would not and did not survive.

I have two important things to be thankful for. Had the Canadian venture succeeded, without doubt I would have overtaxed my strength and long ago become the late Mr. Voigt. Instead, I am now 79 and in better shape than when I left England in 1950.

SB: *What was your last development in loudspeaker design?*

Voigt: The week before we sailed in April, 1950, I applied for something for ensuring that the spacing between the inner and outer poles of the PM speaker magnet would automatically be accurate upon assembly.

SB: *What did you do after the failure of Voigt Patents, Ltd.?*

Voigt: I had various activities such as teaching electronics, consulting, etc. At one time I worked in the laboratory of a firm which made office dictation machines that recorded on tape. This gave me the opportunity to gain first-hand experience in tape recording research—hardly hifi, but instructive all the same. I was very surprised at the distortion figures for slow tape speeds.

Unsuspected tape distortion may well explain why so many records do not satisfy the ear when heard over really first-class equipment. The highs are there, and the

lows, and the mid-range, but they leave you dissatisfied. The sound of live music contains a satisfying richness which many records lack.

In my opinion, freedom from distortion is even more important than a wide frequency range. I regard a distortion-free system with a range of 40-10,000Hz as better than one which distorts appreciably, even though its range may be two octaves wider and run from 20-20,000Hz. The target, of course, is full range without any distortion?

During periods of rest, and in between jobs, I started to think about the basic nature of gravity, electricity, etc. which were more than enough to keep me out of mischief.¹⁰

In 1960 I was employed by the Canadian Federal Government in radio regulations (anti-interference section). I found very satisfactory the time I spent in the lab, developing test techniques, apparatus for direction finding, etc. This gave me a better understanding of the relationship between electricity and magnetism and the electromagnetic wave, and so on. In 1970 I retired to a country dwelling in Brighton, Ont. with more time to concentrate on the riddles of the fundamentals of nature.

SB: *Where did you meet Paul Klipsch?*

Voigt: At the 1974 Audio Engineering Society meeting in New York, someone asked whether I or Paul Klipsch was first with corner horns. As I was about to answer, the fellow with the mobile mike went over to someone in the audience section and I was saved from replying, for he told the audience that when he was applying for his patent my work was among that brought up against him. Klipsch himself was speaking.

From there I picked up and filled in details. I told the audience that, after reading his first horn paper, I had sent him



Imagine...
an acoustic gramophone with a horn mouth area of 16 sq. ft. . . . Imagine one in which the horn length is 12 feet or so! Imagine how fine it would sound in your own room...
Imagine your wife's remarks!
Then write to us for details of how to get even better results as well as the approval of the ladies.
Our big corner horn occupies less than 2 ft. x 2 ft. floor space, yet it is even better than the huge horn indicated above.

Illustrated above:
Cabinet Type Corner Horn. Price, "in the white," with O.C. Unit. £32.5.0 ex Works
Also available: H.C. Type Horn with O.C. Unit. £17.15.0 ex Works
Complete Lowcher/Voigt Equipments at from under £40.0.0

VOIGT PATENTS LTD
THE COURTS, SILVERDALE, SYDENHAM, LONDON, S.E.26
Sydenham 6666
Regd Office: 22, Castle St., E.C.1

a copy of our literature as I thought it would interest him. However, not knowing his address, I sent it to the organization that published his paper. It was never acknowledged, so I did not know if it had ever reached him, or whether he was very busy or simply impolite. He replied that he had no recollection of receiving it, and so a question which had been in my mind for 30 years had been favorably answered. After the meeting he invited us all to lunch and later to his hotel room to see some of his slides—very interesting. So Klipsch is no longer just a name to me.

[*Editor's note:* Klipsch told me he later tried to find out the exact claims held against him, but the details could not be found in his patent papers. At that 1974 AES meeting Paul Voigt was made an honorary member of the Audio Engineering Society "in recognition of his pioneering achievements in the pickup, recording, and reproduction of sound."¹¹]

SB: *Can you review the progress of your*

PLEASE STOP USING VOIGT SPEAKERS ON BAFFLES

With a baffle, the loading of the air on the diaphragm is a maximum for wavelengths so small that the sound is thrown off as a beam. With increasing wavelengths the loading becomes lighter and lighter. A properly designed horn presents a uniform load over its working scale and therefore permits CORRECT MATCHING.

Since only the ideal case interests us, we have CONCENTRATED ALL ALONG on the development of horn loaded speakers. Transients, etc., have been improved by adopting a magnetic field of much higher intensity than is desirable on a baffle speaker. This also prevents boominess in the bass.

Make a point of hearing a Voigt Speaker, and judge it for yourself. **The 1937 Propaganda Tours are now being planned.** For details write or phone.

THE COURTS · SILVERDALE · LONDON S.E.26
Telephone: Sydenham 6666.
Registered Office: 22, Castle Street, E.C.1

VOIGT PATENTS LTD

Why aluminium?

The effectiveness of a moving coil magnet/valve system is, roughly speaking
Dynamic Impedance
Static-Dynamic Impedance.
This should be kept as uniform and as high as possible.
At high frequencies, the dynamic impedance (due to back E.M.F. caused by cutting the flux when the coil is set into motion by the current in it) is normally low, because in the first place the inertia of the conductor prevents it from attaining the necessary velocity. Therefore the conductor should be made of a material having the highest
conductivity Ratio.
Density
This ratio for silver, copper, and aluminium is in the proportion of 5.8, 6.3, and 11.5 respectively.
The reason why the vibrating conductor in VOIGT speakers has always been aluminium will now be obvious.
Voigt Speakers are the result of DESIGN

VOIGT PATENTS LTD.
THE COURTS SILVERDALE LONDON S.E.26
Telephone Sydenham 6666
Regd Office 22 Castle Street E.C.1

VOIGT PATENTS LTD

Fig. 10. A sampling of advertisements for Voigt Patents, Ltd. Voigt wrote all his own ads and never repeated an ad once it had been published. These ads appeared in The Gramophone in 1937.

Voigt speakers from the '30's to the '50's?
 Voigt: The 1929 cinema speaker had a flux density of 16,000 gauss across a 2mm. gap with 40-50 watts field excitation. The axial length of the gap was about 5mm. In the later '30's, for our light coil twin diaphragm as used in the domestic corner horn, the gap was reduced to 1½mm., which improved the flux to 18,000-19,000 gauss with the same excitation. At the end of the '40's, with a new speech coil design I could go down to a 1mm. gap. By then we had a permanent magnet, but I had to design a 20,000 ampere-turn magnetizer for it. By 1950 the flux density was 22,000-23,000 gauss in prototypes. It never went into production because of the failure of Voigt Patents, Ltd.

SB: *Have you any advice for testing loudspeakers?*

Voigt: The final test should be your ear test. Some people are concerned with organ pedal tones, some with clarity or edginess of cymbals and triangles; but the real test of a speaker system is male speech. If that sounds boxy, boomy, or unnatural in any way, something is very wrong somewhere. It may be in the studio or mike; but if the same kind of unnaturalness persists on all program material the trouble is usually in the speaker or enclosure.¹²

And one thing: occasionally go to a live concert in a hall with no public address

system gear, just to keep your ideas in line!³

"That wise old owl P.G.A.H. Voigt, One all-important point has toigt: When speakers sound like ailing mouses, What they need's a good dose of Gausses."
 Anon, *Hi Fi News*, 1964

Errata to Part 1: Figure 2a should read moving armature loud-speaker instead of "moving coil loudspeaker."

REFERENCES

1. Voigt, P.G.A.H., A Controversial Idea from England, *Audio Engineering*, 24, pp. 40-41, Oct. 1950.
2. Rice, C.W. and E.W. Kellogg, Notes on the Development of a New Type of Hornless Loudspeaker, *Trans. A.I.E.E.*, 44, pp. 461-480, 1925.
3. Voigt, P.G.A.H., Letter to Editor, *Radio-Electronics*, 30, pp. 16, 20, 22, Mar. 1959.
4. _____, All About the Reflex Enclosure, *Radio Electronics* 30, p. 38, Feb. 1959.
5. Wilson, P., Cabinets for Speakers—II, *Gramophone*, 14, p. 334, Jan. 1937.
6. Olson, H.F., *Acoustical Engineering*, D. Van Nostrand, N.Y., 1940, p. 128.
7. Augspurger, G.L., Horn-Type Speaker Systems, *Radio-Electronics*, 26, p. 82-86, May 1955.
8. Chave, D.M., Letter to Editor, *Radio-Electronics*, 26, p. 16, July 1955.
9. Voigt, P.G.A.H., Text of Address to British Sound Recording Assn., Sept. 21, 1957, *Gramophone Record Review*, p. 966-967, Oct. 1957.
10. _____, Velocity of Electromagnetic Waves and the Expanding Universe, *Proc. I.E.E.* (London), Electronics and Power, (March) p. 109, 1965.
11. 49th A.E.S. Convention, *J.A.E.S.*, 22, p. 712, 1974.
12. Voigt, P.G.A.H., A Box for Your Speaker, *Radio-Electronics*, 30, p. 51, Jan. 1959.
13. _____, All About the Reflex, *Radio-Electronics*, 30, p. 82, Nov. 1959.
14. The Voigt Loudspeaker, *Gramophone*, 10, p. 298, Dec. 1933.
15. Voigt Loudspeaker, *Wireless World*, 33, p. 274, Sept. 29, 1933.
15. Wilson, P. and G.L. Wilson, Horn Theory and the Phonograph, *J. Audio Engineering Soc.*, 23, pp. 194-199, 1975.

Continued on page 24

HAVE YOU HEARD?

Have you heard that Voigt Speakers are sometimes taken on propaganda tours, in order to give enthusiasts an opportunity of hearing them under domestic conditions? We have carried out several tours, and are planning further tours for the Spring.



The demonstrations take place at points preferably thirty miles apart, in the homes of those who, in exchange for an evening's demonstration, are prepared to accommodate our engineer for the night, and to permit us to invite about six other visitors.

We shall be pleased to make comparison tests against your equipment, and to play over your own records.

Talk it over with your friends this Christmas and then write to us if you are interested, mentioning whether you wish to be VISITOR or HOST. If the latter, please give approximate dimensions of the demonstration room and distance to nearest garage (A.C. mains required).



With the Compliments of the Season
 THE COURTS · SILVERDALE · LONDON · S.E.28
 Tel: Sydenham 6666

Road D.8.r. 22, Castle Street, E.C.1

SAVE \$\$\$ WITH THIS SPECIAL SELECTION OF FINE DRIVERS!
 ORDER NOW QUANTITIES ARE LIMITED
 FOR COMPLETE CATALOG SEND \$2
 REFUNDABLE UPON PURCHASE

TWEETERS

Audax HD12X9D25HR High Efficiency 1" Dome **\$13.00**
 SEAS H225 ¾" Ferrofluid Dome **\$14.00**
 SEAS H211 1" Ferrofluid Dome **\$16.50**

MIDRANGE

SEAS 11FM 4½" Doped Cone **\$18.50**

BASS

SEAS 25FEW 10" Cast 1½"VC **\$24.50**
 (Dynaco replacement)
 Audax HD24B45 10" Bextrene 2"VC **\$49.00**
 Audax HD20B25J2C12 8" Bextrene 1"VC **\$24.50**
 Audax HD21B37R2C12 8" Cast Bextrene 1½"VC **\$50.00**

BASS-MIDS

Audax HIF13J 5¼" PVC Surround 4 ohm **\$15.75**
 Audax HIF17J 6½" PVC Surround **\$16.00**
 Audax HD17B25J2C12 6½" Bextrene **\$22.25**

MISC.

8.0 MF 250V 10%T Mylar Caps **\$1.50**
 Sand Cast Power Resistors to 10 Ohm 5 or 10 watt **\$.80**
 Bituminous Felt Pads 8.5"x10.5"x½" **\$3.00**



THE SPEAKER WORKS

Box 303

Canaan, N.H. 03741

(802-295-1045)

AUDAX

SEAS

P.G.A.H. VOIGT: PART II

Continued from page 23

Voigt Domestic Loudspeaker, *Wireless World*, 35, p. 561, Dec. 29, 1934.

16. Voigt Permanent-Magnet Loudspeaker, *Wireless World*, 55, p. 103, March 1949.

Other Works by P.G.A.H. Voigt on Audio

1. Voigt, P.G.A.H., Comments on "Faithful Reproduction by Broadcast" by P.P. Eckersly, *Wireless World*, p. 290, May 28, 1924.

2. _____, Discussion of "Some Acoustic and Telephone Measurements" by Harbottle, I.E.E., 71, p. 632, 1932.

3. _____, *Sound Reproduction*, Proc. Brit. Kin. Soc., #7, Jan. 4, 1932.

4. _____, How Near Are We to Perfect Sound Reproduction, Proc. Brit. Kin. Soc., #30, Nov. 26, 1934.

5. _____, Sound Distribution in PA Work, *Wireless World*, 38, p. 293, Mar. 20, 1936.

6. _____, Collaborating with the Architect, *Wireless World*, 40, p. 118, Feb. 5, 1937.

7. _____, Getting the Best From Records, *Wireless World*, 46, p. 141, Feb.; p. 177, Mar.; p. 210, Apr.; p. 240, May, 1940.

8. _____, Sound Reproduction, *J. Brit. Inst. Radio Engr.*, 1, p. 74, June 1940.

9. _____, Some Design Considerations on Pickups, *Audio Engr.*, 36, p. 64, 1952.

10. _____, Future Sound and TV Developments, *Trade Builder (Canada)*, 28, p. 46, June 1951.

11. _____, All About the Reflex Enclosure, *Radio-Electronics*, 30, p. 38-40, Feb.; p. 24, 26, 82, 83, 88, 90, 93, 94, Apr.; p. 56-58, May; p. 55-58, June; p. 76, 80-82, July; p. 39-41, Aug.; p. 72-75, Sept.; p. 28, 50-52, Oct.; p. 78-82, Nov., 1959.

12. _____, How I Was Nearly the Inventor of the Moving Coil Loudspeaker, *Electron (Canada)*, 10, p. 47, May 1973.

Reference Works on Paul Voigt

1. Beckett, L., Lowther and Voigt (letter), *Radio-Electronics*, 26, p. 10, Dec. 1955.

2. Briggs, G.A., Briggs Speaks Up (Letter), *Radio-Electronics*, 27, p. 14, Jan. 1956.

3. Hartley, H.A., Voigt and Lowther (Letter), *Radio-Electronics*, 27, p. 14, Jan. 1956.

4. Wilson, P., Paul Voigt and Edison-Bell, *Gramophone*, 43, p. 269-270, Nov.; p. 326-327, Dec. 1965.

5. Paul Voigt's Contributions to Audio, *British Kinematography, Sound and Television*, 52, p. 316-327, Oct., 1970.

Acknowledgements

I thank the following people for their support in putting together this interview: Mrs. Voigt for her generosity in loaning me original photographs and papers from Paul Voigt's files; Prof. Geoffrey Wilson for copies of Voigt's letters to his father, Percy Wilson, and for many conversations; Dr. Robert Edgar, Debe Arsenych, Karen Olds, and Celine Walker for tracking down many of the old references; Joe Paul for the fine photo-copying and retouching; and Yvonne Owens for retyping many of Voigt's old letters.

The Interviewer

Dr. Bruce C. Edgar is a Space Scientist for the Aerospace Corporation and is a Contributing Editor for *Speaker Builder* in the areas of horn design and the history of loudspeakers.

A CALCULATOR PROGRAM FOR THIELE-SMALL PARAMETER COMPUTATION

Continued from page 13

volume after allowing for driver volume losses, etc. V_{AS} is the air volume with the same acoustic compliance as the driver suspension under test, and will be in the same units as used for V_B . The SPL equation and definition will be given after the vented box equations.

For vented test boxes, f_L is the frequency of the lower impedance peak, f_H the frequency of the valley bottom between peaks, and f_M the frequency of the upper impedance peak. Note that $f_L < f_M < f_H$.

$$f_B = \sqrt{(f_L)^2 + (f_H)^2 - (f_C)^2}$$

where f_B is the frequency to which the vented box is tuned and f_C is the resonant frequency of the driver-box combination when the vent is plugged to produce a sealed box. Note $f_B \cong f_M$.

$$f_{SB} = \frac{f_H f_L}{f_B}$$

where f_{SB} is the resonant frequency of the driver in the test box; it should be about equal to f_S .

$$V_{AS} = V_B \frac{(f_H - f_B)(f_H + f_B)(f_B - f_L)(f_B + f_L)}{(f_H f_L)^2}$$

where V_{AS} will again have the same units as used for V_B .

The SPL is computed by the same equations for either test box type. The reference efficiency (η_o) for the driver is computed from:

$$\eta_o \cong 2.7 \times 10^{-8} f_S^3 \frac{V_{AS}}{Q_{ES}}$$

where V_{AS} is in cubic feet.

This can be converted to SPL at 1 meter for 1 watt input for 2π steradian freefield radiation—see Small! This approximates the SPL produced in the reverberant field of a typical room. The equation is:

$$\text{SPL } 112 + 10 \text{ Log}_{10} \eta_o$$

Numerous measurements on finished cabinets with warble tones and an inexpensive SPL meter have given me results within ± 1.5 dB of the computed SPL. A driver's SPL value is useful for grouping drivers of similar efficiencies when putting together a system. You can run T/S parameter tests on open-back midrange drivers to establish their SPL for matching with a woofer.

Note that the only equation in the program that is sensitive to the measurement units for V_B is the equation for SPL. If you want to work with volumes in cubic meters, change the

2.7×10^{-8} constant in calculator steps 148 to 153 to the constant 9.6×10^{-7} . So to change the program to use V_B in cubic meters:

Program Step	Change from:	To:
148	2	9
149	.	.
150	7	6
151	EXP	EXP
152	CHS	CHS
153	8	7

It takes a lot of time to key in 160+ program steps, so the possibility of error is high. Table II shows a test sequence to help you verify that your program is working correctly. It lists what data to key in, what key(s) to push, and what you should see in the display. Also shown are the program steps involved in the computation to help locate the difficulty. The parameters in the test sequence do not represent a real driver; I made them up for convenience. □

REFERENCES

1. D. B. Weems, *How to Design, Build and Test Complete Speaker Systems*, Tab Books No. 1064, 1978.
2. R. H. Small, "Closed-Box Loudspeaker Systems," *Journal of the Audio Engineering Society*, Vol. 20, Dec. 1972, p. 798; Vol. 21, Jan./Feb. 1973, p. 11.
3. R. H. Small, "Vented-Box Loudspeaker Systems," *Journal of the Audio Engineering Society*, Vol. 21, June 1973, p. 363; July/Aug. 1973, p. 439; Sept. 1973, p. 549; Oct. 1973, p. 635.

Muses and Music

Since the music moves you—the muse is almost surely able to do so as well. The writer's muse, that is. Put pen to paper or better yet, typewriter ribbon to paper with a clear, orderly account to your adventure in speaker construction, or any related field of endeavor or leading to good listening. Send it along with a stamped, return envelope. We pay modestly for articles, so if your muse moves you, write us about it and we'll answer promptly with suggestions and saying whether or not we have such an article, whether one is already in preparation, or whether we are interested. Some of our best articles come from people who have never before written for periodicals. And if your muse is as silent as a tomb, don't let that stop you. Write anyway and let's see what develops. We have a nice sheet of suggestions for authors which we will send to nearly anybody who asks for it.

Finding fp for Passive Radiator Speakers

by G. R. KOONCE

DESIGNING PASSIVE RADIATOR speaker systems, as described by R. H. Small¹, requires that you know the Thiele-Small parameters for the driver and also parameters for the passive radiator unit. Several articles cover measuring driver Thiele-Small parameters^{2,3,4}. This article presents a technique for measuring the passive radiator unit parameters, based on a variation of Weem's technique² for tuning a reflex enclosure before installing the driver. An advantage of this technique is that it can be performed on normal drivers to verify the procedure is working properly.

We can find the passive radiator unit's resonant frequency (fp) by mounting the unit on a baffle to supply air mass loading and then driving it by holding the cone side of a small driver against the back of the frame where the magnet assembly would normally be placed. When the resonant frequency is reached the passive radiator cone motion will greatly increase; we can establish fp just by looking at the cone.

Establishing the passive radiator suspension's compliance is the problem. Compliance is most conveniently specified as a volume of air with the same acoustic compliance as the passive radiator suspension, or V_{AP}. We can arrive at V_{AP} by finding the resonant frequency in a sealed box of known volume.

Mount the passive radiator unit in a test box of known net volume (V_B), sealed except for a hole approximately 3/8" in diameter. Drive the system with a small driver placed tightly against this hole. At the resonant frequency of

the closed box-passive radiator system (fc) the audio output will increase to a peak.

Working with 10 inch drivers and passive radiator units, I found this peak is difficult to locate by ear or by watching the cone motion; but it shows up clearly on a sound pressure level meter. Then V_{AP} can be computed from:

$$V_{AP} \cong V_B \left[\left(\frac{f_c}{f_p} \right)^2 - 1 \right]$$

TABLE I

Test of 10" Driver:

Parameters by conventional means:

f_s = 23.3Hz
Q_{TS} = .312
V_{AS} = 7.39 FT³

Results for Test Procedure Developed Here:*

TEST BOX

V _B = 2.84FT ³	V _{AS} = 7.94FT ³	7.4% error
V _B = 2.03FT ³	V _{AS} = 7.54FT ³	2.1% error

% error = $\frac{\text{Indicated } V_{AS} - \text{Actual } V_{AS}}{\text{Actual } V_{AS}} \times 100\%$

Test of two 10" passive radiator units (catalog data—fp = 25 - 30Hz)

	Unit #1	Unit #2
fp	21.8Hz	25.3Hz
test box V _B = 2.86FT ³	V _{AP} = 9.71FT ³	8.27FT ³
test box V _B = 2.05FT ³	V _{AP} = 9.08FT ³	7.60FT ³
Average	V _{AP} = 9.40FT ³	7.94FT ³
% Spread	6.7%	8.4%

% Spread = $\frac{\text{bigger result} - \text{smaller result}}{\text{average result}} \times 100\%$

* Actual f_s for the driver used as magnet structure prevents f_s measurement technique used for passive radiator units.

This equation is subject to error if the air mass loading on the driver alters between finding fp and finding fc. I try to minimize this error by making the test baffle used when I measure fp the same size as the front of the test box used when I measure fc.

Table I shows the results of this technique on a 10 inch driver that had been measured by conventional means. I tried two different test box volumes; the measured V_{AS} values are within some 7 percent of the results obtained by normal Thiele-Small parameter techniques.

Also shown in Table I are the results obtained on two 10 inch passive radiator units via the technique described. Again I used two different test box volumes, and the "spread" in V_{AP} results is about 8 percent.

This technique, therefore, only gives approximate parameters; but they are significantly accurate to allow you to design your passive radiator enclosure.

REFERENCES

1. R.H. Small, "Passive-Radiator Loudspeaker Systems," *Journal of the Audio Engineering Society*, Volume 22, p. 592 (Oct. 1974); p. 683 (Nov. 1974).
2. D.B. Weems, "How to Design, Build, and Test Complete Speaker Systems," Tab Book No. 1064, 1978.
3. R.H. Small, "Closed-Box Loudspeaker Systems," *Journal of the Audio Engineering Society*, Volume 20, p. 798 (Dec. 1972); Volume 21 p. 11 (Jan/Feb. 1973).
4. R.H. Small, "Vented-Box Loudspeaker Systems," *Journal of the Audio Engineering Society*, Volume 21, p. 363 (June 1973); p. 439 (July/Aug. 1973); p. 549 (Sept. 1973); p. 635 (Oct. 1973).

Loudspeaker Literature

JANUARY-JUNE 1981

(1) THEORETICAL AND GENERAL

Beers, George L. and H. Belar. *Frequency-modulation distortion in loudspeakers*. *Journal of the Audio Engineering Society* 29:5 (May 1981), pp. 320-326. 7 refs. A landmark paper on the subject, reprinted from the April 1943 issue of the *Proceedings of the IRE* and introduced by Paul Klipsch.

Bruneau, A.M. *Rayonnement d'un haut-parleur à diaphragme conique*. (in French: "Radiation from a loudspeaker with a conical diaphragm"). *Acustica* 48:2 (May 1981), pp. 86-96. 9 refs. "A study is made of the sound field created by a loudspeaker cone, with or without a rigid planar baffle and radiating from one or two faces. Using Helmholtz-Huyghen's integral equation, a point-value of radiation impedance enables the sound pressure to be approximately deduced from the supposedly known value of the velocity of the vibrating surface."

Bücklein, Roland. *The audibility of frequency-response irregularities*. *Journal of the Audio Engineering Society* 29:3 (March 1981), pp. 126-131. 6 refs. One of the conclusions advanced is that "Peaks in the frequency response are far more audible than equivalent valleys or dips."

Eargle, John. *Sound Recording*. Second edition. Van Nostrand, 1980. Standard book no. 0,4422 2557 1. \$21.95. Chapter 6 deals with "Monitor loudspeakers and the monitoring environment," (pp. 139-171. 12 refs); it is an excellent short discussion of the problems. Chapter 1, "Physical aspects of sound" (pp. 1-33, 5 refs), will also be of interest for its treatment of room acoustics.

Guglielmo, C., E. Campia, M. Milanese. *An interactive multicriteria computer program for the synthesis of loudspeaker systems*. *Audio Engineering Society Preprint no. 1736*.

Inoue, T. *Shape and size design of finite plane baffle—Theory of a developed doublet model*. *Part I. Acustica* 46:3 (Nov. 1980), pp. 318-324. 5 refs. Theory for estimating the axial response of an arbitrarily shaped plane baffle.

Lee, Richard. *Is linear phase worthwhile?* *Audio Engineering Society Preprint no. 1732*. The author is with Rank HiFi. Phase distortions larger than those of real speakers are inaudible with music signals, but minimum-phase speakers do present improved stereo and depth panoramas. Guidelines for the design of minimum-phase speakers are given.

Lipshitz, Stanley P., Mark Pocock, and John Vanderkooy. *Preliminary results on the audibility of midrange phase distortion in audio systems*. *Audio Engineering Society Preprint no. 1714*. 48 refs. There are four preliminary conclusions: "Even quite small midrange phase nonlinearities can be audible on suitably chosen signals; audibility is far greater on headphones than on loudspeakers; simple acoustic signals generated anechoically display clear phase audibility on headphones; on normal music or speech signals phase distortion appears not to be generally audible, although we have heard it with 99 percent confidence on some recorded vocal material." A very interesting paper with an excellent list of references.

Motegi, A., K. Okao, and M. Ohkawa. *A method of evaluation for reproduced sound fields*

using a cross-power spectrum. *Audio Engineering Society Preprint no. 1734*. The authors are with Toshiba Corp.

Ramachandra Reddy, C.V., N. Ganesan, and B.V.A. Rao. *Response of clamped sandwich panels with viscoelastic cone under random acoustic excitation*. *Journal of Sound and Vibration* 75:4 (April 22, 1981), pp. 481-494. 23 refs.

Rodgers, C.A. Puddle. *Pinna transformations and sound reproduction*. *Journal of the Audio Engineering Society* 29:4 (April 1981), pp. 226-234. 20 refs. "When a loudspeaker system is misaligned, poorly designed, or incorrectly positioned, the resultant frequency response can mimic a pinna transformation creating contradictory localization cues."

Rossing, T.D. *Physics and psychophysics of high-fidelity sound. III The components of a sound-reproducing system: amplifiers and loudspeakers*. *Physics Teacher* 18:6 (Sept. 1980), pp. 426-435. 14 refs.

Suzuki, Hideo and Jiri Tichy. *Sound radiation from convex and concave domes in an infinite baffle*. *Journal of the Acoustical Society of America* 69:1 (Jan. 1981), pp. 41-49. 17 refs. The least-square error method was used to compare convex and concave radiators with respect to pressure response, radiation impedance, and directivity patterns.

(2) LOUDSPEAKER DRIVER UNITS

Bank, Graham and Gordon T. Hathaway. *A three-dimensional interferometric vibrational mode display*. *Journal of the Audio Engineering Society* 29:5 (May 1981), pp. 314-319. 4 refs. The authors are with Rola Celestion Ltd. A method for obtaining a three-dimensional representation of a vibrating speaker diaphragm. The technique, which is said to be an improvement over the laser-holography method of Rank Wharfedale, is also described in the *New Scientist* 88:1223 (16 October 1980), "Quick-draw lasers beat speaker problems," p. 162.

Fox, Barry. *Audio Patents. Hi-Fi News and Record Review* 26:4 (April 1981), p. 47. In British patent application no. 2,032,222. Pioneer reveals a diaphragm material of rolled PVC and graphite, which gives superior performance to aluminum, titanium, and beryllium at a lower cost.

Gander, Mark R. *Moving-coil loudspeaker topology as an indicator of linear excursion capability*. *Journal of the Audio Engineering Society* 29:1-2 (Jan.-Feb. 1981), pp. 10-26. 20 refs. The author is with JBL. Discussion of the causes of non-linearity and of the means to predict linearity.

Melillo, Louis and K. Raj. *Ferrofluids as a means of controlling woofer design parameters*. *Journal of the Audio Engineering Society* 29:3 (March 1981), pp. 132-139. 6 refs. The authors are with Ferrofluidics Corp. A technique to control Q_m , the mechanical damping factor.

Roth, W. *A hi-fi loudspeaker with a novel transducer systems*. *Funkschau* 52:3 (Feb. 1, 1980), pp. 78-80. 3 refs. (in German.) "Describes a newly produced transducer for dynamic loudspeakers which uses the flexural vibrations of metal segments with a fully specified curvature which, when subjected to a

force at one end alter their curvature, being subjected to periodic compression and tensile stresses which propagate sound waves. Its design is such that Doppler distortions are eliminated." (Electrical and electronics abstracts, no. 41305, Sept. 1980).

Royalance, David, Paul McElroy and Frederick McGarry. *Viscoelastic properties of paper*. *Fibre Science Technology* 13:6 (Nov. 1980), pp. 411-421. 9 refs. According to *Engineering Index*, "The paper presents experimental data concerning the viscoelastic properties of loudspeaker paper. Paper specimens of the type commonly used in high-fidelity loudspeaker cones have been subjected to dynamic viscoelastic characterization using a Rheovibron Viscoelastomer. The paper exhibited a broad, relatively weak transition."

Shindo, T. and O. Yashima. *Effect of the voice coil and the surround on the vibration and the sound pressure response of the cone of a loudspeaker*. *Journal of the Acoustical Society of Japan* 36:7 (July 1980), pp. 366-373. 4 refs. (in Japanese) The authors are with Mitsubishi Electric Corp.

Stefanides, E.J. *Adhesive bonding simplifies speaker assembly*. *Design News* 36:40 (December 22, 1980).

(no author given.) *Acrylic system used by stereo speaker/wood beam makers*. *Adhesives Age* 23:4 (April 1980), pp. 36-38. Pyle Industries uses a second-generation two-part acrylic adhesive to attach the magnet assembly to the basket. This replaces an epoxy that required heat-curing, and had a pot life of only 12 minutes.

(3) CROSSOVER NETWORKS PASSIVE AND ACTIVE

Aatre, V.K. *Network theory and filter design*. Wiley, 1981. 432 pp. \$18.95. Standard book no. 0 4702 6934 0.

Antoniazzi, P. and A. Hennigan. *Dual-slope filters optimize speaker's crossover response*. *Electronics* 53:13 (June 5, 1980), pp. 134-135. 10 refs. A method for avoiding the notch at the crossover frequency when second-order filters are summed in phase; responses are staggered so that the cut-off frequency of the first RC network is half that of the second.

Atiya, F.S., A.M. Soliman, and T.N. Saadawi. *Universal second-order filter using single op-amp*. *Wireless World* 87:1544 (May 1981), pp. 79-82. 8 refs. "Design equation for hybrid I.C. filters."

Duncan, Ben. *A versatile active crossover; part 1*. *Hi-Fi News* 26:2 (Feb. 1981), pp. 51-53, 55, 59. No refs. (Part 2, March, pp. 63-65, 68-69; part 3, April 1981, pp. 48-49, 51; part 4, May 1981, p. 37). Construction article for a three-way fourth-order Butterworth crossover, using the NE5534. Part 1 discusses filter design generally; part 2 gives the schematic and construction information; part 3 discusses equalization of drivers and an LED bar graph display of levels; part 4 gives the printed circuit pattern for the optional peak program meter. An English supplier of pcb's and ready-made units is given on p. 49 of part 3. A letter from Stanley Lipshitz, published on p. 41 of the July issue, corrects an error regarding damping factors of the B4 alignment, and gives the resistor values necessary to change the design to the

perhaps better sounding Linkwitz alignment.

Gill, William. *Easy-to-use BASIC program analyses transient response*. *EDN* 26:4 (Feb. 18, 1981) pp. 133-136. No refs. "Computerizing the state-variable model of a system's transfer function makes finding the system's transient response easier. It works especially well in the design of active filters." BASIC program written for a TRS-80 Level II.

Greiner, R.A. and Mark Allie. *Manipulating the response of the multiway loudspeaker crossovers*. Audio Engineering Society Preprint no. 1761. 12 refs. "The use of tactics such as introducing time delay, modifying crossover filter parameters, adjusting crossover frequencies, and inverting the polarity of some drivers in order to improve the amplitude and phase response of crossover systems is reviewed in this paper. It is shown that improvements indicated solely by study of the steady-state frequency domain results show clearly that some tactics can be quite misleading. Time-domain results, such as inversion of the polarity of some drivers, will cause transient-response catastrophes which should be avoided. The use of time delay obtained through physical offsetting of drivers is shown to have a strong effect on transient response as well as frequency and phase response of multiway loudspeakers; and time delay can improve the expected response from some selected crossover configurations." The use of time delay and overlapping response can produce interesting results in a second-order Butterworth crossover connected in phase.

Greiner, R.A. *Toneburst testing on selected electronic crossover networks*. Audio Engineering Society Preprint no. 1762. 8 refs. This paper should be read in conjunction with preprint no. 1761. Cf. D.C. Hamill, "Transient response of audio filters," *Wireless World* August 1981, pp. 59-64. 10 refs.

Harms, W.F. *Crossover network compensation values*. *Hi-Fi News* 26:3 (March 1981), p. 45. A

note of caution concerning C.J. Brain's "simple, effective crossover network" of the December 1980 *Hi-Fi News* (pp. 105, 107).

Lipshitz, Stanley P. and John Vanderkooy. *A family of linear-phase crossover networks of high slope derived by time delay*. Audio Engineering Society Preprint no. 1801. One of the most important papers yet from this productive team; excellent set of references. See John Murphy and Jim Ford, "Comment: an exciting crossover development," in *Modern Recording and Music* 6:11 (August 1981), p. 76.

Moschytz, G.S. and P. Horn. *Active filter design handbook for use with programmable pocket calculators and minicomputers*. Wiley-Interscience, 1981. \$49.50. Standard book no. 0 4712 7850 5. 296 pp.

Read, David C. *More on active crossover networks*. *Wireless World* 87:1543 (April 1981), pp. 41-43, 54. No refs. Modifications to author's design published in the Nov. 1974 *Wireless World*. An equalized system built around the Quad ESL.

Thomas, Alan A. *Filter design with voltage controlled voltage sources*. *Wireless World* 87:1545 (June 1981), pp. 79-81. 1 ref. "Independent frequency, gain, and damping for simplified variable filter design;" a class of second-order filters.

Tsychiya, H., T. Omura, et al. *Reducing the current distortion of network inductors for loudspeakers*. *Mitsubishi Denki Giho* 54:3 (March 1980), pp. 33-36. 4 refs. (in Japanese).

Williams, Arthur B. *Electronic filter design handbook*. McGraw-Hill, 1981. \$32.50. Standard book no. 0 0707 0430 9. This is a very useful book, designed to help non-specialist engineers design practical filters without use of high mathematics. Though loudspeakers are not mentioned, and the problem of correct summing of two or more filters is not discussed, this is an important reference, dealing with basic theory, the several filter types, the time and amplitude domains, selection of passive

components and of op amps, and an introduction to digital filters. The last chapter consists of 116 pages of normalized filter design tables.

Williamson, Reginald. *An audio window*. *Hi-Fi News* 26:1 (Jan. 1981), pp. 49-51, reprinted in *Audio Amateur* 11:2 (2/80), pp. 19-22, 26, 28, 29, for a fourth-order bandpass filter, which could easily be adapted to crossover use.

Young, C. Gilbert, editor. *Active filters, 1970-April 1980*, (Citations from the Engineering Index data base). 127 abstracts, covering theory, design construction, and use of active filters. Available from National Technical Information Services, 5285 Prt. Royal Rd., Springfield, VA 22161. 703-487-4650.

(4) CABINETS

Beer, Doug. *Waferboard—a modern construction material*. *Engineering Journal* 63:6 (Dec. 1980), pp. 12-15. No refs. Primarily discusses the CAE Flaker, but does explain what waferboard and its "refinement" strandboard (a plywood substitute) are.

Birchak, J. and D. Rader. *Damping of mechanical vibrations and acoustic waves*. *Shock and Vibration Digest* 12:10 (Oct. 1980), pp. 11-30. A classified survey of recent literature; 261 references. Engineering Index no. 045628.

Cummings, A. *Stiffness control of low-frequency acoustic transmission through the walls of rectangular ducts*. *Journal of Sound and Vibration* 74:3 (Feb. 8, 1981), pp. 351-380. 12 refs. May be helpful for use of very stiff materials for speaker enclosures.

Hand, A.J. *Power screwdriving—best way to do all your fastening jobs*. *Popular Science* 218:5 (May 1981), pp. 57-58, 60, 65.

Julien, Y. and T. Takagami. *Vibration de poutres et de plaques recouvertes en partie de matériaux absorbants*. (in French) ("Vibrations of beams and plates partially covered by damping materials"). *Acustica* 47:4 (March 1981), pp. 304-313. 11 refs. Study of constrained-layer

ROWLAND RESEARCH SV-3 ELECTRONIC CROSSOVER

State variable, third order (18 db/ octave), electronic crossover with your choice of x-over frequency. Available in semi-kit or fully assembled form with black anodized rack mount chassis. Optional 18 db/ octave Subsonic filter can be inserted into lowpass output. Battery and AC models available.

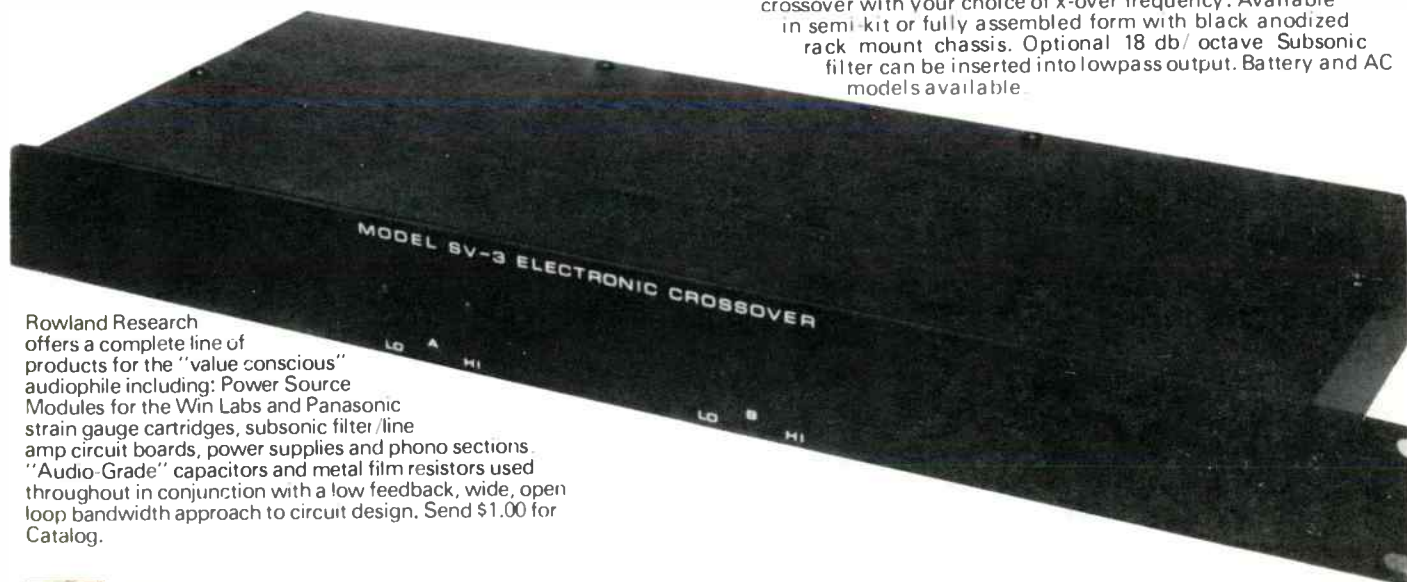

Rowland Research offers a complete line of products for the "value conscious" audiophile including: Power Source Modules for the Win Labs and Panasonic strain gauge cartridges, subsonic filter/line amp circuit boards, power supplies and phono sections. "Audio-Grade" capacitors and metal film resistors used throughout in conjunction with a low feedback, wide, open loop bandwidth approach to circuit design. Send \$1.00 for Catalog.

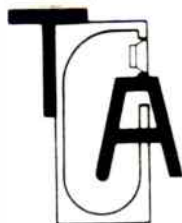

Transcendental Audio

6796 ARBUTUS ST. DEPT # 1, ARVADA, COLO. 80004 303-420-7356

"Innovative Components and Designs in High-end Audio"

9-5 M-F, 10-3 SAT.

AUDIO AMATEUR MAGAZINE'S PREVIOUS POSSIBILITIES

1970 "Price, Time and Value" surveys nine years of the fortunes of used equipment. An all silicon, complementary output, 20W per channel amplifier, fail-safe overload protected by Reg. Williamson. A high efficiency bookshelf speaker by Peter J. Baxandall. How to update and improve your Dynaco PAT-4 preamp. A visit to the Heath Co.

1971 A superb, simple, high quality preamplifier by Reg. Williamson; A 4 + 4 microphone mixer, using four ICs in a compact chassis, with eight inputs and two-channel output. A four channel decoder for adding a new dimension to listening: cost to build: \$12.50. Two four-channel encoders, one with microphone preamps, to put four signals on two tape tracks. Three voltage/current regulated power supplies for better power amp performance.

1972 A nine octave graphic equalizer with slide pots by Reg Williamson. A 10 1/2" reel tape transport, a full-range electrostatic loudspeaker and a 900 watt tube amplifier for driving the electrostatic panels directly. A high quality op amp preamp, Heath AR15/AR1500 modifications. A new type A + B, low cost 35W power amp, electronic crossovers for bi- and tri-amplifier operation. All about microphones, and tuning bass speakers for lowest distortion.

1973 Construction: Five transmission line speakers: 8" to 24" drivers, peak reading level meter, dynamic hiss filter, tone arm, disc washer, electrostatic amplifier II, and customized Dyna Mark II and Advent 101 Dolby. How to photograph sound, power doubling, microphones, Jung on IC op amps, Williamson on matching and phono equalization, and much more.

1974 A perfectionist's modification of the Dynaco PAS tube preamp, a mid/high range horn speaker, a wall-mounted speaker system, an IC preamp/console mixer by Dick Kunc, a family of regulated current limited power supplies, a switch & jack panel for home audio, grounding fundamentals, low-level phono/tape preamp with adjustable response, an IC checker, a lab type $\pm 15V$ regulated supply. A series on op amps by Walt Jung and kit reports on an electret microphone and a Class A headphone amplifier.

1975 The superb Webb transmission line speaker construction article, how to test loudspeakers, a test bench set of filters, a variable frequency equalizer, building and testing Ampzilla, a power amp clipping indicator, a compact tower omni speaker, controls for two systems in three rooms. A visit to Audio Research Corp., an ultra low distortion oscillator, all about filters by Walt Jung, a universal filter for either audio garbage or crossover applications. An electrostatic speaker and complete schematics for Audio Research Corp.'s SP-3A-1 preamp, Heath's XO-1 and the Marantz electronic crossovers.

1976 Three mixers by Ed Gately, a vacuum system for cleaning discs, a 60W per channel amp for electrostatic speakers, a silent phono base, a perfectionist's tonearm, re-mods for Dyna's PAS preamp, Jung on active filters, a white noise generator/pink filter, A-Z tape recorder set-up procedures by Craig Stark, modifying the Rabco SL-8E, a high efficiency speaker system for Altec's 604-8G, uses for the Signetics Compador IC, modifying Heath's IM (tube) analyzer, simple mods for Dyna's Stereo 70 amp, a tall mike stand. Kit reports: the Ace preamp, Heath's 200W per channel amp, Aries synthesizer, Heath's IO-4550 oscilloscope.

1977 Walt Jung's landmark series on slewing induced distortion, a wood/paper/epoxy horn, Reg Williamson's Super Quadpod, experiments with passive radiator speakers, a high efficiency electrostatic speaker with matching low-power direct-drive amplifier, modifying the AR turntable for other arms, do-it-yourself Heil air motion loudspeakers, a \$10 Yagi FM antenna, Ed Gately's 16-in/two out micromixer, the speaker saver: complete stereo system protection. Audio Research modifies the Dyna Stereo 70: the super output buffer, a 101dB precision attenuator.

1978 Modular equipment packaging, A PAT-5 preamp modification, a radio system for Hospitals, supply regulation for Dyna's Mark III amp, B.J. Webb on phono interfacing and record cleaning, a 24" common bass woofer, a TV sound extractor, modifying the Formula 4 tonearm, a phono disc storage cabinet, Jung on IC audio performance and noise control, a visit to Peter Walker's Quad factory, a small horn enclosure, an audio activated power switch, the Nelson Pass 40W class A amplifier, a thermal primer, a capacitor tester, recording with crossed cardioids. Kit reports: Heath IC 1272 audio generator, Heath's IM5258 harmonic distortion analyzer, Hafler preamp, Dynaco's octave equalizer, West Side Electronics pink noise generator.

1979 A space-age IC preamp by Lampton-Zukauckas; a scientific evaluation of listening tests. A room testing oscillator, a do-it-yourself version of the Advent mike preamp, three preamp construction projects compared, basic issues or record manufacture, a primer on soldering, a variable frequency tube-type electronic crossover, a re-modification of Dynaco's PAT-5 preamp. A noise reduction system for amateurs, Williamson's 40W power amp, a LED power meter, and an interview with Peter Baxandall. Kit reports included: The Integrex Dolby, Heath's audio load, IG1275 sweep generator and their Technician's training course. Classic circuitry included a 1936 GE console, the Marantz 8B, Dynaco PAS-3 and Audio Research SP-6.

1980 A family of regulated power amp power supplies, dynamic range and clipping indicator, Precise, Inverse RIAA Network, Interview Peter Baxandall Pt. II, Golden ears? Power supply regulator for Op Amp preamps, Timerless tone burst generator, Filters outside the audio band, Intensity Stereo primer, Upgrading FM tuners, Choosing & installing an FM antenna, Passively equalized phono preamp. Soldering practice, Modifying the Hafler DH-101 preamp, Analog phase meter, Audio equipment rack, AD7110 Digital attenuator, Capacitor Dielectric absorption, Tube RIAA equalization. Reviews: Hafler DH-200, SWPTC Tigersaurus 210A, Heath AP-1615 preamp, Logical Systems 318 Silencer, Heath AA-1600 power amp, Heath AD-1701 Output indicator.

damping techniques that do not entirely cover the surface to be damped.

Kaiser, Jo-Ann. Resinator avoids emissions problems. *Wood and Wood Products* 86:2 (Feb. 1981), pp. 30-31. "The paper describes a dry finishing system that features a process called resination which seals sanded particleboard and medium-density fiberboard substrates." (Engineering Index no. 053837)

Lees, Al. Choosing plywood; what you should know to buy wisely. *Popular Science* 218:1 (June 1981), pp. 130-131.

Mathew, J. and R.J. Alfrsdson. The reflection of acoustical transients from fibrous absorptive surfaces. *Journal of Sound and Vibration* 75:4 (April 22, 1981), pp. 459-473. 17 refs. "An investigation into the reflection of acoustical transients from a surface of fiberglass has been carried out, with an electrical spark used as the transient measure. The fiberglass was backed by chipboard."

Pizzurro, Joseph. The acoustics of plastic foam. *Machine Design* 53:1 (Jan. 8, 1981), pp. 135-139. No refs. The author is with Scott Paper Co., Foam Division. "Foams can be designed so that they either transmit or attenuate sound, and they can be made highly selective with regard to the frequencies they pass or absorb." Reticulated foams have reproducible properties and "can be tuned to various frequencies."

Silken, Howard. Carbide blades—do you need the high-priced types the pros use? *Popular Science* 217:6 (Dec. 1980), pp. 114-115. Includes a list of manufacturers.

Warring, R.H. Balsa—a possibility for enclosures. *Noise and Vibration Control Worldwide* 11:9 (Nov.-Dec. 1980), pp. 356-358. Balsa shows a mean transmission loss of 19dB in the frequency range 100 to 3,000Hz; the use of lead increases sound absorption.

Wicks, Harry. Portable drill accessories. *Popular Mechanics* 155:3 (March 1981), p. 148. Some very handy accessories when using hundreds of screws in a loudspeaker enclosure.

(5) MEASUREMENTS, TEST EQUIPMENT AND SPEAKER EVALUATION

Baxandall, Peter J. A low-distortion acoustic measurement oscillator using semiconductor junctions as variable-tuning elements. *Journal of the Audio Engineering Society* 28:12 (Dec. 1980), pp. 874-878. 1 ref. An accurate, stable oscillator with low distortion and noise, and with autosweep and warbler facilities. The two equal-amplitude outputs are in phase quadrature, so the oscillator can be used in a tracking-filter system.

Bullock, Robert M., III. How you can determine design parameters for your loudspeaker. *Speaker Builder* 1/81, pp. 12, 14, 16-18. 11 refs. A very useful summary of procedures.

Davies, J.C., J. McIntosh, K.A. Mulholland. The generation of short-duration acoustic signals. *Journal of Sound and Vibration* 76:1 (May 8, 1981), pp. 77-82. 6 refs. Use of a loudspeaker as a source of reliable, repeatable pulses for acoustic testing is investigated; a suitably 'deconvoluted' KEF midrange was found to give satisfactory experimental results.

Guzina, Blazo and Husnija Kurtovic. A contribution to the objective investigation of the frequency-response characteristics of the multiway loudspeaker cabinet system. *Audio Engineering Society Preprint no. 1728. Determination of the frequency response of the JBL 4343.*

Koonce, G.R. A quick-opening, variable-volume test box. *Speaker Builder* 1/81, pp. 10-11. No refs.

Linsley Hood, John L. Wien-bridge oscillator with low harmonic distortions. *Wireless World* 87:1544 (May 1981), pp. 51-53. 6 refs. "New way of using Wien network to give 0.001 percent THD."

Lipshitz, Stanley P. and John Vanderkooy. The great debate; subjective evaluation. *Audio Engineering Society Preprint no. 1563. The vexing problem of subjective evaluation or testing as seen by two applied mathematicians. Recommended.*

The Audio Amateur, P.O. Box 176, Peterborough NH 03458, USA

- | | | |
|--|---|-------------------------------------|
| <input type="checkbox"/> The four 1980 issues @ \$14 | <input type="checkbox"/> The four 1974 issues @ \$8 | <input type="checkbox"/> |
| <input type="checkbox"/> The four 1979 issues @ \$12 | <input type="checkbox"/> The four 1973 issues @ \$8 | <input type="checkbox"/> |
| <input type="checkbox"/> The four 1978 issues @ \$12 | <input type="checkbox"/> The four 1972 issues @ \$8 | <input checked="" type="checkbox"/> |
| <input type="checkbox"/> The four 1977 issues @ \$10 | <input type="checkbox"/> The four 1971 issues @ \$6 | <input type="checkbox"/> |
| <input type="checkbox"/> The four 1976 issues @ \$10 | <input type="checkbox"/> The four 1970 issues @ \$6 | <input type="checkbox"/> |
| <input type="checkbox"/> The four 1975 issues @ \$8 | <input type="checkbox"/> Send back issues UPS @ \$1 extra | <input type="checkbox"/> |

NAME _____

STREET & No. _____

CITY _____ STATE _____ ZIP _____

☎ Telephone: (603) 924-6526 (M-F, 9-4 EST)

Please allow up to six weeks for delivery of first copies of your magazine.

Long, Robert. *Loudspeaker testing and the listening world.* *High Fidelity* 31:6 (June 1981), pp. 18-19. High Fidelity's new computer-assisted speaker testing procedures.

Moir, James. 'Just detectable' distortion levels. *Wireless World* 87:1541 (Feb. 1981), pp. 32-34, 38. 7 refs. Attempts to derive "a practical criterion for assessing audio equipment." See comments in the May issue, pp. 56-57, on suitability of THD measurements for reliable assessment.

Muller, Bernhard and David Carlstrom. *The sorcerer's apprentice: a swept function generator, part 1.* *Audio Amateur* 12:2 (2/81), pp. 21-24, 26-31, 45. No refs. Designed for testing loudspeakers, using warble tones, tone bursts, and sine waves. Part II is in 12:3 (3/81), pp. 14-17, 9; no refs.

Netta, T. *Free-field measurements for a loudspeaker system in a normal room.* *Journal of the Acoustical Society of Japan* 36:6 (June 1980), pp. 297-303. 7 refs. (in Japanese). The author is with Toshiba Research-Development Center. "Frequency responses, directional characteristics, phase characteristics, and group delay characteristics are studied. Two methods for reducing reflected waves are investigated." (Electrical & Electronic Abstracts.)

Saffran, Richard. *Build a widget box to measure loudspeaker parameters.* *Speaker Builder* 1/81, pp. 7-9, 21. No refs.

Toole, Floyd E. *Speaker listening tests: a scientific approach.* *Audio Scene Canada* 17:3 (March 1980), pp. 52-54, 56, 61. No refs.

Trendell, E.G. *Comments on 'shaped-tone-burst testing.'* *Journal of the Audio Engineering Society* 29:1-2 (Jan.-Feb. 1981), pp. 53-54. No refs. Comments on S. Linkwitz' article in *JAES* 28:4 (April '80), pp. 250-258.

Ziegahn, Karl-Friedrich. *HiFi-Tests leichter verstaendlich.* ("Hi-Fi testing made easier to understand"). Part 3, *Boxen* ("speaker systems"), and Part 4, *Lautsprecherboxen* ("loudspeaker systems"), in *HiFi Stereophonie*

20:3 (March 1981), pp. 315-6, and 20:4 (April 1981), pp. 449-451. Part 3 is a very brief technical introduction to speakers; part 4 briefly describes *HiFi Stereophonie's* procedures for comparative listening, giving a list of paired contrasting terms used and gives advice to speaker buyers.

(6) INTERFACE OF SPEAKER, CABLE, AND AMPLIFIER

(no author given). *Radio Shack Model 42-3019 Sound-Level Meter.* *Radio Electronics* 52:6 (June 1981), pp. 34-35. Review of the improved version of Radio Shack's \$40 SPL meter.

Hirseh, F. *Loudspeaker fuse.* *Elektron* (Canterbury, U.K.) Vol. 6 (July-Aug. 1980), pp. 7, 78-79. No refs. A protection circuit using relays.

Klingelberg, Arndt. *Lautsprecherkabel, da capo al fine.* ("Loudspeaker cables, da capo al fine"). *Hi-Fi Stereophonie* 20:4 (April 1981), pp. 440, 442, 444, 446-7. No refs. Ordinary cables up to 5 meters long are completely satisfactory.

(no author given). *Loudspeaker fuse.* *Elektron* (Canterbury, U.K.) Vol. 6 (July-Aug. 1980), pp. 7, 23. A glass resistor is connected in the negative-feedback loop of the amplifier, reducing its series resistance close to zero.

(no author given). *Loudspeaker protection module.* *Electronics Today International* (London) 9:7 (July 1980), pp. 95-97. No refs. A comprehensive protection circuit that permits removing all amplifier coupling capacitors.

(7) INTERFACE OF SPEAKER AND ROOM

Borenius, Juhani. *On loudspeaker response in sound control rooms.* *Journal of the Audio Engineering Society* 29:4 (April 1981), pp. 258-261. 6 refs.

Everest, F. Alton. *Guideposts in the use of acoustical materials.* *Recording Engineer-*

Producer 12:1 (Feb. 1981), pp. 36, 38, 40, 42. 18 refs. Good source of information; excellent list of references.

Fahy, F.J. and C. Schotied. *A note on the interaction between a Helmholtz resonator and an acoustic mode of an enclosure.* *Journal of Sound and Vibration* 72:3 (Oct. 8, 1980), pp. 365-378. 8 refs.

Hirata, Y. and H. Nakajima. *Optimum reverberation times of monitor rooms and listening rooms.* Audio Engineering Society Preprint no. 1730.

Hojan, Edward. *Analysis of the configuration of the acoustic field of loudspeaker systems excited with a sinusoidal signal.* *Archives of Acoustics* 5:1 (1980), pp. 47-58. 8 refs. "Discusses the accuracy of the approximation of the acoustic pressure distribution radiated by loudspeaker systems with the pressure distribution radiated by a flat circular membrane." (Engineering Index no. 041889)

ITT Research Institute (Robert. A. Hedeen). *Compendium of materials for noise control.* Contract no. 210-77-00-63 for U.S. Dept. of Health, Education, and Welfare, National Institute for occupational safety and health. Published by U.S. Government Printing Office, May 1980. 380 pp. Bibliography, pp. 115-141. DHEW (NIOSH) Publication No. 80-116. \$8. Update of the first edition, published in 1975. The NIOSH Technical Report is essential for all concerned with noise and sound control. There are more than 200 pp. of data tables on absorptive materials of all kinds, useful for room treatment and inside speaker cabinets.

Owens-Corning Fiberglas Corp. *Noise control manual; guidelines for problem-solving in the industrial/commercial acoustical environment.* Second edition, 1981. 40 pp. No refs. Available from: Owens-Corning Fiberglas Corp., Attn: Inquiry Dept., Fiberglas Tower, Toledo, Ohio 43659.

Rettinger, Michael. *Angled control-room-window sound diffraction phenomena; a practical*

DYNAMIC ACOUSTICS OFFERS PARTS N' KITS TOO

Resulting from the successful development and introduction of our unconventional and exciting loudspeaker line, we can offer the hobbyist as well as the professional a plethora of high quality components at reasonable prices.

Close tolerance Mylar and non-polar electrolytic capacitors, ferrite bobbin core chokes (inductors), advanced circuit designs, level controls, L.E.D.'s, kits, unusual drivers including polypropylene, and more lead the list. A \$2.00 investment secures a catalog and complete speaker literature as well as future updates.

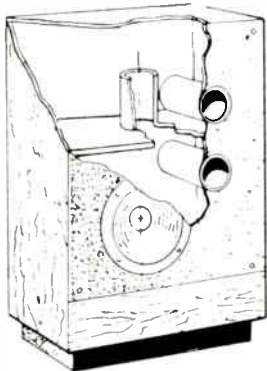

Model 3000 Helmholtz Dual Port Resonator

As to our loudspeakers, our model 3000 Helmholtz dual port resonator is an industry first and the only commercially available unit of its type (see *Speaker Builder* 3/80). It functions with an advanced-designed 8" bass speaker and newly developed 1" soft dome tweeter. Output is measured 89dB at 27Hz not varying more than ± 2 dB from 30-20,000 Hz!

CBS laboratories impressively reviewed this unit in the July, 1980, *High Fidelity*. They stated "its output in both—tests indicate an excellent dynamic range—tests confirm Dynamic's claim of extended low frequency output—bound to please a great many listeners—a harbinger of other interesting products from this young company."

For a limited time only you can purchase the incredible 3000 or other models directly from us at a special price and receive, free of charge, a year's subscription (or renewal) to *Speaker Builder*!

Don't delay. Write to us now for complete details and catalogs. You'll be glad you did.

Enclosed is \$2.00 Please send complete info to:

NAME _____
 ADDRESS _____
 CITY _____
 STATE _____ ZIP _____



CIRCUIT BOARDS

Old Colony Circuit Boards are made of top quality epoxy glass, 2 oz. copper, reflowed solder coated material for ease of constructing projects which have appeared in Audio Amateur and Speaker Builder magazines. The builder needs the original article (indicated by the date in brackets, i.e. 3:79 for articles in TAA and SB 4:80 for those in Speaker Builder) to construct the projects.

- C-4: ELECTRONIC CROSSOVER (DG-13R) New 2x3½" board takes 8 pin DIPs, Ten eyelets for variable components. Parts layout included. [2:72] Each **\$4.50**
- D-1: HERMEYER ELECTROSTATIC AMPLIFIER II. [3:73] Two sided with shields and gold plated fingers. Each **\$7.50**
Pair **\$14.00**
- F-1: BILATERAL CLIPPING INDICATOR. (CB-1) 2x2½" [3:75] Single channel. Each **\$3.00** Pair **\$5.00**
- F-6: JUNG 30Hz FILTER/CROSSOVER (WJ-3) 3x3" [4:75] High pass or universal filter or crossover. Each **\$5.50**
- G-2: PETZOLD WHITE NOISE GENERATOR & PINK FILTER. (JP-1) 2½x3½" [3:76] Each **\$5.00**
- H-2: JUNG SPEAKER SAVER. (WJ-4) 3¼x5¼" [3:77] Each **\$7.00**
- H-3: HERMEYER ELECTROSTATIC AMP BOARDS. (ESA-3) Set of three boards with plug-in edges for one channel. [3:77] Set **\$19.00**
- J-6: SCHROEDER CAPACITOR CHECKER. (CT-10) [4:78] 3¼x6" Each **\$7.25**
- J-7: CARLSTROM/MULLER VTVM ADAPTER. (CM-1) [4:78] 1¼x2½" Each **\$4.25**
- K-3: CRAWFORD WARBLER 3¼x3¼" [1:79] Each **\$6.00**
- K-6: TUBE CROSSOVER. 2x4½" [3:79] Two needed per 2-way channel. Each **\$4.25** Four **\$13.00**
- K-7: TUBE X-OVER POWER SUPPLY. 5x5½" [3:79] Each **\$7.00**
- K-12: MacARTHUR LED POWER METER. 5½x8¼" [4:79] Two sided, two channel. Each **\$16.00**
- L-2: WHITE LED OVERLOAD & PEAK METER. 3x6" [1:80] One channel Each **\$10.50**
- L-5: WILLIAMSON BANDPASS FILTER. 3¼x4" [2:80] (RWAW479) Two channel 24dB/octave Sallen & Key circuit. Each **\$6.50**
- L-6: MASTEL TONE BURST GENERATOR. 3½x6½" [2:80]. Each **\$8.50**
- L-9: MASTEL PHASE METER 6¼x2¼" [4:80] **\$8.00**
- SBK-A1: LINKWITZ CROSSOVER BOARD ±4:80 5½x8½" Each **\$14.00**

ORDER BLANK:

Old Colony Sound Lab

PO Box 243, Dept. SB, Peterborough NH 03458

To order from Old Colony Sound, please write each board's number below with quantity of each and price. Total the amounts and remit by check, money order, or MasterCard, or Visa/BankAmericard. All prices are postpaid in the 50 states. **\$10 minimum order on credit cards.** Canadians please add 10%, other countries 15% for postage. All overseas remittances must be in U.S. funds. **Please use clear block capitals.**

Name _____

Street & No. _____

Town _____

State _____ ZIP _____

No. Bds.	Price
... Board No.	\$.....
... Board No.	\$.....
... Board No.	\$.....
... Board No.	\$.....
Total \$.....	

Please add \$1 service charge to all charge card orders under \$10.

solution using convex Laxon plastic panels. *Recording Engineer-Producer* 12:2 (April 1981), pp. 58, 60. No refs.

Rezviakova, Z.N. *Correction of the frequency response in the listening room.* (in French) *Radio Television* (Prague) no. 5 (1980), pp. 14-27. 16 refs. "A detailed analysis of the problems connected with the correction of the amplitude-frequency response of sound-monitoring systems in listening rooms." (Physics Abstracts)

Rosenhouse, G. *Analysis of acoustic tiles.* *Acustica* 47:3 (Feb. 1981), pp. 199-213. 21 refs. "A design principle that considers sound transmission or absorption by locally reacting surfaces in terms of efficiency is presented."

(8) HORNS

Edgar, Bruce C. *The Tractrix horn contour.* *Speaker Builder* 2/81, pp. 9-12, 14-15. 20 refs. Discusses Paul Voigt's tractrix horn; good set of references.

Kergomard, J. *Ondes quasi-stationnaires dans les pavillons avec pertes visco-thermiques aux parois; calcul de l'impédance.* (in French) ("Quasi-stationary waves in horns with visco-thermal losses at the walls, calculated from the impedance"). *Acustica* 48:1 (April 1981), pp. 31-43. 20 refs.

Rettinger, Michael. *Reproducing electronic music in the control room.* 15:3 (March 1981), pp. 41-43. 4 refs. "A real advance in sound recording and reproduction can be made by extending the reproducible low-frequency range of the program." A 10-foot-long ceiling mounted horn is proposed. See the critical response by J. Robert Ashley in the June issue, pp. 6, 8.

Salava, Tomas. *Measurements of the input impedance of loudspeaker horns.* *Journal of the Audio Engineering Society* 29:6 (June 1981), pp. 416-420. 12 refs.

(9) METHODS OF BAFFLING WOOFERS

Bullock, Robert M., III. *Fine points of vented speaker design.* *Speaker Builder* 2/81, pp. 18-25, 31, 35, 7 refs.

Clarke, Thomas L. *Augmented passive-radiator loudspeaker systems, Part I.* *Journal of the Audio Engineering Society* 29:6 (June 1981), pp. 394-404. 13 refs. "The augmented passive-radiator loudspeaker system is a natural extension of both the vented box and the drone-cone systems. Additional radiation associated with the augmented passive radiator provides an additional degree of freedom, which permits the duplication of any vented-box or drone-alignment as well as the realization of new alignments having improved low-frequency performance."

Darlington, R.W. *Electronic control of sub-bass loudspeakers.* *New Electronics* 13:4 (July 8, 1980), p. 6.

Feldman, Len. *Big bass from small speakers.* *Radio-Electronics* 52:4 (April 1981), pp. 75-77. No refs. KLH's dynamic equalization technique developed by D. von Recklinghausen.

(A team of KEF engineers). *Loudspeakers—the bottom-end equation.* *Hi-Fi News and Record Review* 26:4 (April 1981) pp. 44-45, 47. No refs. The first of two articles extracted from KEFTOPICS Vol. 3, no. 4, "High efficiency with small enclosures?" The second part will be found in the May issue, pp. 44-45, 49; 1 ref. A very helpful discussion of the "trade-offs" among sensitivity, cabinet volume, damping, magnet strength, and cut-off frequency in the low bass region.

Koonce, G.R. *A diffuser port for small boxes.* *Speaker Builder* 2/81, pp. 16-17, 35. 1 ref.

Leach, W. Marshall, Jr. *Active equalization of closed-box loudspeaker systems.* *Journal of the Audio Engineering Society* 29:6 (June 1981), pp. 405-407. 3 refs. Given a sealed-box system with Q less than 1.3, an active equalizer can give an overall fourth-order Butterworth response. For a box with Q of 0.707, the equalizer lowers the cut-off point by a factor of 1.85.

Margolis, Garry and Richard H. Small. *Personal calculator programs for approximate vented-*

box and closed-box loudspeaker system design. *Journal of the Audio Engineering Society* 29:6 (June 1981) 421-441. 6 refs. A group of calculator programs to help select enclosure volume, given woofer parameters. Approximate frequency response, ripple, displacement-limited power rating, and vent dimensions are computed. The programs are suitable for the H-P 67, 97, and 41C calculators.

Schaeffer, John W. (letter to Speaker Builder mailbox.) *Speaker Builder* 1/81, p. 33, 34, 36. Interesting discussion of sealed vs. vented enclosures.

(10) PROFESSIONAL SOUND SYSTEMS

Electro-Voice, Inc. *The PA Bible, Addition number seven, crossovers and biamping.* Pp. 4. No refs. See the first *Loudspeaker Literature*, section 10, for the basic guide and the earlier additions.

Electro-Voice, Inc. *The PA Bible; addition number eight, microphone techniques.* Pp. 6. 11 refs.

Maloney, Patrick. *Sound reinforcement for Barry Manilow.* *Recording Engineer-Producer* 12:3 (June 1981), pp. 74, 76, 78, 80-87. No refs. An interview with David Morgan, Manilow's sound man during the tour of summer and autumn 1980.

(11) CONSTRUCTION PROJECTS

Hayward, Tom. *The Phase Concept Model VII.* *Speaker Builder* 1/81, pp. 28-29, 32. No refs. Construction article for a four-way system.

Manrique, Frank J. (letter to Speaker Builder mailbox.) *Speaker Builder* 1/81, pp. 30-32. No refs. Design of a B2 sealed enclosure for a KEF B139 woofer.

Martin, D.R. *Thick as a brick; an easy acoustic-suspension project.* *Speaker Builder* 2/81, pp. 7-8. No refs. Construction project using a cement block as enclosure for a 6" full-range speaker with whizzer cone.

Withey, John. *Domesticating hi-fi loudspeakers.* *Hi-Fi News and Record Review* 26:2 (Feb. 1981), pp. 65-66, 69. 1 ref. A design for a two-way speaker using the KEF B200 and T27 drivers. The bass unit is loaded by a resistively damped tapered pipe with a fundamental resonance of 40Hz. The design is intended to fit attractively into a room full of furniture as much as to give good sound. See some interesting comments on the folded tapered enclosure by Ralph West in the May issue, p. 41.

(12) STEREO, AMBIENCE, AND SURROUND SOUND

Atkinson, John. *The stereo image.* *Hi-Fi News and Record Review* 26:5 (May 1981), pp. 30-31, 33. No refs. The first of two parts explaining 'how a loudspeaker pair can produce stereo.' The concluding part is in the June issue pp. 29-31, 33.

Cohen, Joel M. *A new image enhancement technique for stereo reproduction.* *Audio Engineering Society Preprint* no. 1746. "A new system for unlimiting and clarifying the sonic image in stereo loudspeaker reproduction is described." The author is with Sound Concepts, Inc.

(13) HEADPHONES

Feldman, Len. *New breakthrough in headphone design.* *Radio-Electronics* 52:6 (June 1981), pp. 51-53. Sony's new featherweight MDR series.

Stock, Garry. *The new featherweight headphones.* *Audio* 65:5 (May 1981), pp. 30-32.

(14) MISCELLANEOUS AND UNCLASSIFIABLE

Aldous, Donald. *Paul G.A.H. Voigt.* *Audio* 65:6 (June 1981), p. 12. Obituary of Paul Voigt.

Beranek, Leo L. and John W. Kopec. *Wallace C. Sabine, acoustical consultant.* *Journal of the Acoustical Society of America* 69:1 (Jan. 1981),

pp. 1-16. 14 refs. Article based on recent discovery of 22 of Sabine's correspondence files.

Bras, Pieter G.W. *Meeting feature. BAS Speaker* 9:2 (Nov. 1980), pp. 16-20. Jon Dahlquist talks about his DQM-7 and DQM-9 speakers at the October meeting of the Boston Audio Society. Among other things, Mr. Dahlquist made the controversial statement that dynamic loudspeakers cannot reproduce transients.

Fox, Barry. *Audio Patents. Hi-Fi News and Record Review* 26:3 (March 1981) pp. 44, 47. British patent application no. 2,024,563 by IMF and M. Gerzon treats a method of arranging drivers in a multiple-unit speaker system symmetrically around a reference point; this is claimed to give better results than staggering the units on a baffle or using time delay. British patent applications no. 2,009,669 by Karlheinz Lipschutz relates how extra coils in a bass driver can be used to center the diaphragm electronically, thus compensating for the resistive force of the cabinet air. (See also 'Loudspeaker Design proposal' in *Electronics Today International* 9:1 (Jan. 1980), pp. 95-97.) British patent application no. 2,029,668 concerns a dome tweeter with a diaphragm of a mixture of polyamide resin and a plasticizer.

Ginsberg, Gerald L. *A user's guide to selecting electronic components*. Wiley-Interscience, 1981. \$27.50. Standard book no. 0 4710 8308 9. Pp. 256. "A guide to information collected from over 4,000 articles and catalogs, to help in the selection of the basic components for electronic circuits."

Gregoire, B.F. *Featured speaker—Paul Klipsch. BAS Speaker* 9:3 (Dec. 1980), pp. 8-11. Many quotable remarks from Mr. Klipsch at the November 9 meeting of the Boston Audio Society.

Gregoire, B.F. *Meeting feature—Peter Snell. BAS Speaker* 9:1 (October 1980), pp. 21-22. No refs. Snell's presentation to the September meeting of the Boston Audio Society.

Henricksen, Clifford A. *Unearthing the mysteries of the Leslie cabinets. Recording Engineer-Producer* 12:2 (April 1981), pp. 130, 132, 134, 136, 138-143. No refs. The Leslie is a musical instrument speaker, not one for hi-fi use.

Hertz, Bent F. *100 years with stereo—the beginning. Audio Engineering Society Preprint no. 1724* (German Text only). The invention of stereo goes back to the first Electrical World Exhibition in Paris, August 1881, where Clement Ader demonstrated his *Stereoscopic* binaural telephone system. Listeners were able to listen to performances taking place at the Paris Opéra three km away. A report of the demonstration from the December 3rd 1881 issue of *Scientific American* is reprinted in the May 1981 issue of the *Journal of the Audio Engineering Society*, pp. 368-372. Mr. Hertz is with the Danish Broadcasting Company.

Mitchell, Peter W. *Meeting feature—Joel Cohen. BAS Speaker* 9:3 (December 1980), pp. 12-14. Mr. Cohen talked about the Sound Concepts IR 2100 image restitution device at the November 23rd Boston Audio Society meeting.

Stock, Gary. *KLH's Daniel von Recklinghausen. Audio* 65:2 (Feb. 1981), pp. 20-22, 24. Interview with the noted speaker engineer. V. addendum in May issue, p. 16.

Whyte, Bert. *Behind the scenes. Audio* 65:5, (May 1981), pp. 85-86, 88. Speakers heard at the Consumer Electronics Show, including models from Shahnian, Acoustat, B&W, VMPS, KEF and JBL.

Wilson, Geoffrey L. *In memoriam. Journal of the Audio Engineering Society* 29:4 (April 1981), p. 308. Obituary for Paul Voigt.

(no author given.) *Cumulative index: Journal of the Audio Engineering Society, 1953-1980; Volumes 1-28. Completely revised with author and subject indexes. 88 pp. \$7.50 for members, \$9.00 for others from: Audio Engineering Society, Inc., 60 East 42nd Street, New York, N.Y. 10165.*

(no author given.) *Paul Voigt (1901-80). Hi-Fi News and Record Review* 26:4 (April 1981), pp. 25.

NOTES: The last installment of *Loudspeaker Literature* (issue 2/81, p. 26) was mistakenly labelled July-August 1980; in fact it covers the period of July-December 1980. The Audio Engineering Society preprints mentioned can be ordered for \$2 each (\$1.50 to members) from the Society at 60 East 45th Street, New York, N.Y. 10165.

STATEMENT OF OWNERSHIP, MANAGEMENT AND CIRCULATION (Required by 39 U.S.C. 3685) Date of Filing Sept. 25, 1981. Title of Publication SPEAKER BUILDER frequency of issue Four times a year.

Annual subscription price \$10.00. Location of the headquarters or general business offices of the publishers Old Jaffrey Road, Peterborough NH. Publisher Edward T. Dell, Jr., Old Jaffrey Road, Peterborough NH 03458, Editor same. Owner Edward T. Dell, Jr., Carol Carr Dell, Old Jaffrey Road, Peterborough, NH. Known bondholders, Mortgagees, and other security holders owning 1 percent or more of total amount of bonds, mortgages or other securities None.

	Average # copies	Single issue
	each issue during preceding 12 mths	nearest to filing date
Total # copies printed	12,000	12,000
Paid Circulation		
Newsdealer sales	71	72
Mail Subscriptions	5,333	5,269
Total paid circulation	5,404	5,341
Free Distribution		
complimentary	111	119
Total Distribution	5,515	5,460
Office use, leftover	6,485	6,540
Return from news agents	0	0
Total	12,000	12,000

I certify that the statements made by me above are correct and complete.
Publication No. 01997920 Edward T. Dell, Jr., Editor

T.A.'s cylindrical "Un-box" design provides maximum rigidity while minimizing internal standing waves

The Jordan 50mm Module:
The lowmass, wideband midrange/tweeter from England that is fast becoming a legend among speaker hobbyists.

"Un-boxes also available for T.A.'s polystyrene subwoofers! Send \$1.00 for 36 page catalog. \$2.00 for the 26 page Jordan Manual on loudspeaker theory.

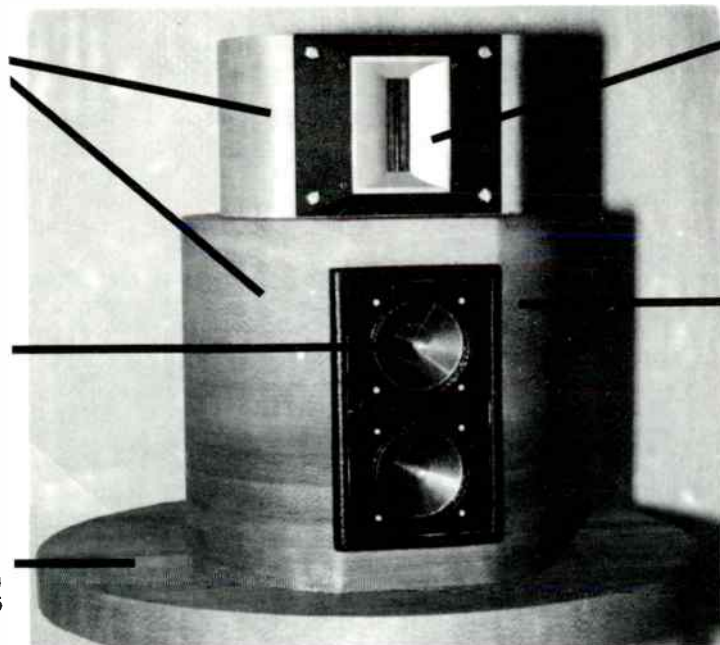

JVC's "Dyna-flat" ribbon tweeter provides unparalleled high frequency accuracy even at five times the price!

These "minimum diffraction" cylinders allow full exploitation of Jordan's incredible imaging capability.

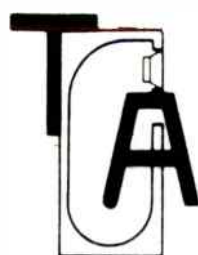

Transcendental Audio

6796 ARBUTUS ST. DEPT # 1, ARVADA, COLO. 80004 303-420-7356

"Innovative Components and Designs in High-end Audio" 9-5 M-F, 10-3 SAT.

Building the Falcon Monitor Kit

by DAVID W. DAVENPORT

EVERY SO OFTEN I get the opportunity to build a fine device from a kit; I have fun, achieve a sense of accomplishment, and save money as well. Such was my good fortune with the Falcon Acoustics' "Monitor Quality Compact (SIM LS3/5A)." The quality of the finished project will appeal to anyone; however, the kit should be of special interest to the inexperienced builder because of its construction simplicity.

Figure 1 shows and lists the contents of the kit which comes double-packed in corrugated cardboard boxes with nylon strapping. The tuning pipe is optional and not included in the kit. After many hours of listening I have concluded that its use does not improve the sound. Those items not included in the kit but required are listed. Two items we do not see very much in the States, but which are quite popular in England, are BAF wadding and bituminous felt pads. BAF stands for Bonded Acetate Fiber, a resilient textile material, used in stuffing pillows or quilts. It is nominally 1" thick and comes in rolls 24" wide. Bituminous felt pads are nominally 1/2" x 8 1/2" x 10 1/2" felt slabs impregnated with a slightly sticky, oily, viscous liquid (probably an oil based adhesive). They are quite inert and dense, weighing about one pound, and acting somewhat like a soggy overcoat.

CONSTRUCTION

Construction of the enclosures is straightforward, requiring little wood-working skill, only some care to obtain straight, square cuts to ensure an airtight fit. I will describe how I built my pair of enclosures which you can duplicate while waiting for your kit to arrive.

The only power tools I used were a

saber saw and an electric drill. If you plan to build speaker systems and don't own a variable speed, reversible electric drill, I strongly advise buying one. A pair of small speakers, such as these, have over one hundred screws in them. I bought my drill several years ago after driving over two hundred screws by hand into the first of a pair of large speakers I was building. My arm felt like it was in training for the national wrist wrestling championship. One word of caution, though: do not use the drill for mounting the loudspeakers—the inevitable slip will—well, I'll leave it to your imagination!

1. For a pair of enclosures you will need four panels each of 1/2" x 7" x 7 1/2"; 1/2" x 7" x 11"; and 1/2" x 6 1/2" x 11". (See Fig. 2.)

2. Cut a strip 11" x 48", then cut two of each of the above panels out of it. Mark each of the above panels as belonging to one speaker. Repeat for the second speaker. I make straight cuts in plywood by clamping a straight board to the plywood to act as a guide for the base of my saber saw.

3. Fit your panels together like a house of cards forming the enclosures. If you are not happy with the fit correct it now.

4. Draw lines on the insides of the top, bottom and side panels parallel to, and 1" from, the front edge.

5. Likewise draw lines on the side panels 1/2" from the back edge, and on the top and bottom panels 1/2" in from the back and side edges.

6. Cut the battens to length and glue them in place inside the lines. (I used yellow liquid woodworking glue.) Keep the battens from moving with a couple of brads or clamps while you drill screw pilot holes through the panels into the battens. Use a #6 x 7/8" screw about every two inches.

7. Again, place the panels together and check the fit.

8. Working one edge at a time, glue and screw the sides to the top and bottom. Use brads or clamps to hold the edges while drilling.

9. Lay the enclosure face down on a table and glue the back in place. Use a square and adjust the enclosure so that the top and side form a right angle. Nail a couple of brads through the back panel to hold this angle while drilling the pilot holes through it and while driving the screws. Figure 3 shows the assembled panels.

10. Trim the edges flush with the panels with a plane or rasp and sandpaper. Fill any large gaps that might cause an air leak with wood fillers. If you plan to veneer the enclosure, it is not really necessary to fill the screw holes and small gaps along the edges as shown in Fig. 4; however, sand the enclosures to remove any burrs and provide a smooth surface for the veneer.

11. Spray the inside faces of the panels around the front with flat black spray paint.

12. Solder about 8" of #18 gauge wire to each terminal of your terminal strip and mount it through the back panel, about 2" from the bottom.

13. Fill the terminal strip holes with silicone caulking.

External cosmetics are your option. I have had good luck with a paper-backed type veneer marketed by several manufacturers. The veneer is flexible, available in a variety of woods and many sizes. I have used rolls ranging from 12" x 18" to 24" x 96" for veneering different speakers that I have built. It is also available in 1" or 2" wide tape-like rolls for edge finishing, but I normally cut edge pieces from scraps left over from the panels. It may be cut with a sharp knife or scissors

Items Included with Kit	quantity
item	
KEF B110-SP1003	2
KEF T27-SP1032	2
Falcon #23 crossover	2
BAF wadding	1 yard
Bituminous felt	8 panels
Baffle	2
Gasket for B110	approx. 40"
Grillecloth	2
(specify D2-Brown, D3-Gray, or D9-Black)	

Items Not Included with Kit	
1/2" birch plywood	2' x 4'
1/2" square beech battens	16'
#6 x 3/8" flathead wood screws	150
Black felt fabric	1/3 yard
3/4" brads and flathead nails	small box of each
Flat black spray paint	1 can
#18 gauge wire	10'
Terminal strips	2
Veneer	2' x 4'
Finish	small can
Adhesive (silicone sealer, small container of each: rubber cement, white or yellow woodworking glue, asphalt or roofing cement).	



and will not split unless mistreated. Application is easy:

14. Spread a thin coat of white (or yellow) glue over the entire panel with a piece of cardboard used as a spatula. Allow to get tacky.

15. Cut a piece of veneer about 1/4" larger than the panel, and lay it in place. Weight it and allow the glue to dry for a couple of hours. You can do two opposite panels at the same time.

16. Lay a single-edged razor blade flat on the panel edge and run it along carefully trimming off the overhang. Touch up the veneer edge with fine sandpaper on a sanding block.

17. The edges of the panels are a bit more tricky. As with the panel faces, cut your veneer pieces about 1/4" wider and longer than the edges.

18. Glue and apply the veneer to all four edges at the same time. Don't let the glue dry.

19. While the glue is still tacky you can cut your miter joint. At each corner of the enclosure there is a double thickness of veneer where the strips overlap. Place the edge of a single edge razor blade at a 45° angle at the corner and lightly tap with a hammer, cutting through both layers of veneer. Remove the two ends you have cut off; the veneer edge strips will mate to form a perfect joint.

20. Allow the glue to dry and trim off the excess overhang.

The materials you use to finish the enclosures will, of course, depend on the type of wood chosen for the veneer and character of finish desired. I chose walnut and, wanting a matte oil finish,

ORDERING INFORMATION

Falcon Electronics
Tabor House
Norwich Road
Mulbarton, Norwich
Norfolk NR14 8JT
England

A catalog of speaker kits, crossover networks, loudspeaker units, and miscellaneous components is available from Falcon by sending \$2.00. The kit featured in this article is listed as "Monitor Quality Compact (sim. LS3/5A)." Prices listed in the catalog include 15% VAT (Value Added Tax) and should be divided by 1.15 for items to be shipped to the USA.

The monitor kit was £68.70 (79÷1.15). Additionally, there was an export packing charge of £2.50, insurance of £1.20, surface mail of £10.45 and £.17 for notification of dispatch (a copy of the sales receipt sent by air mail when the kit is shipped). This gives you a nice, warm feeling that your kit is on the way, since the kit will take the proverbial slow boat. It took eleven weeks from the day I mailed my order until I received the kit.

There are many different ways to pay for the kit, but considering that Falcon's prices may change and the exchange and postal rates will change, the simplest and surest way is to include your MasterCard number with the order and let Falcon bill you.

The total charge from Falcon was £83.02 which transferred to \$200.00 at the exchange rate on the day my MasterCard bill cleared. [Note: The Pound

Sterling rate is now about \$1.80 and fluctuating daily. Check with your bank when you order for the current exchange rate.—Ed.] When the kit reaches the US, it will fall into the hands of a friendly Customs inspector who will: determine the import duty due (\$11.80 for my kit), attach a form stating the amount due, and give it to the US Postal Service for delivery. The postman will deliver your kit and collect the duty plus \$2.50 for the inspection by the U.S. Customs Service. [Whether they inspect it or not they charge.—Ed.] It's all so simple—really no different from mail ordering and charging your MasterCard within the US.

I have corresponded with Falcon several times and they have been very cooperative and prompt in answering my questions. However, if at any time you write to Falcon and expect a reply by return mail, remember to include a self-addressed, stamped envelope or, in lieu of stamps, a couple of international mail coupons.

Falcon Acoustics Ltd. is the manufacturing and parent company, with Falcon Electronics a mail-order retail outlet subsidiary. Nightingale Acoustics Ltd. is a speaker system manufacturing subsidiary.

I used Watcò Danish Oil Finish (available from the Woodworkers Stores, 21801 Industrial Blvd., Rogers, MN 55374. They carry other finishes and are also a source for the flexible veneer but only in large sheets. Try your local lumber yard for smaller sizes.)

This is about as far as you can go without the kit, although you could start on the grille.

BAFFLE AND GRILLE

21. Cut out the center of the remaining $6\frac{1}{2}'' \times 11''$ panel $\frac{5}{8}''$ from the outer edge.

22. Trim this frame two thicknesses of grillecloth (about $\frac{1}{8}''$) smaller than the front opening into which it will fit. If measured correctly the finished grille should make a friction tight fit in the enclosure. (It is better to be a little small than large here; if it is too small you can always hold it in place with Velcro.)

23. Sand the frame smooth and spray with flat black paint.

24. Lay the grillecloth on a table with the frame on top, wrap the edges of the cloth back over the frame and staple about $\frac{1}{2}''$ intervals.

25. Check the fit of the kit's baffle and trim it if necessary.

26. Four screw holes around the periphery of the baffle's tweeter hole will

not be used. Plug them thoroughly with wood filler.

27. The screws supplied with the T27 driver are meant to be screwed into the baffle, but the baffle is drilled to accept bolts. Plan to use the bolts supplied with the B110 for the T27; however, this means you must enlarge the tweeter mounting holes in the baffle.

28. The front baffle should be removable to provide access to the drivers and crossover; therefore, it must be fitted with a gasket. Run a heavy bead of silicone caulking cement around the front battens on the surface that mates with the baffle.

29. Wrap the baffle in plastic food wrap and press it firmly in place so as to displace the silicone caulking and form a gasket. Leave the baffle in place until the silicone has set.

30. Remove the plastic wrap and, using the screw holes in the baffle as guides, drill pilot holes in the battens.

31. Remove the baffle from the enclosure and spray it with flat black paint.

32. Cut the bituminous felt to fit inside the battens on all the interior panels except the front baffle.

33. Glue them in place. Falcon advises gluing with a bituminized roofing compound applied with a brush; however, I had trouble getting a small quantity of this type of adhesive so I

used an adhesive intended for laying asphalt floor tiles. It seems to be holding well.

34. Secure each felt pad with six or eight $\frac{3}{4}''$ flat-head nails.

PUTTING IT ALL TOGETHER

No, your eyes don't deceive you—the B110 is rear-mounted on the baffle. This is part of the LS3/5A design, and the woofer is the Rogers LS3/5A is mounted identically. I don't know why this is so, as it is common practice to front mount speakers as the instructions supplied by KEF with the B110 specify. It seems to me that rear mounting the speaker would cause two problems: diffraction from the edge of the hole, and worsening of the phase characteristics due to increasing the distance between the planes of radiation. If anyone knows why the B110 is rear mounted, I would be interested in knowing the reason. In any event, such is the design Falcon produced and I built.

As you are now ready to mount the speakers, one word of caution is in order. Both speakers have very strong magnets that can cause screwdrivers to do strange things, so be careful. I always place my hand palm down over the screw and slide the screwdriver between my fingers. Oh yes—if you for-

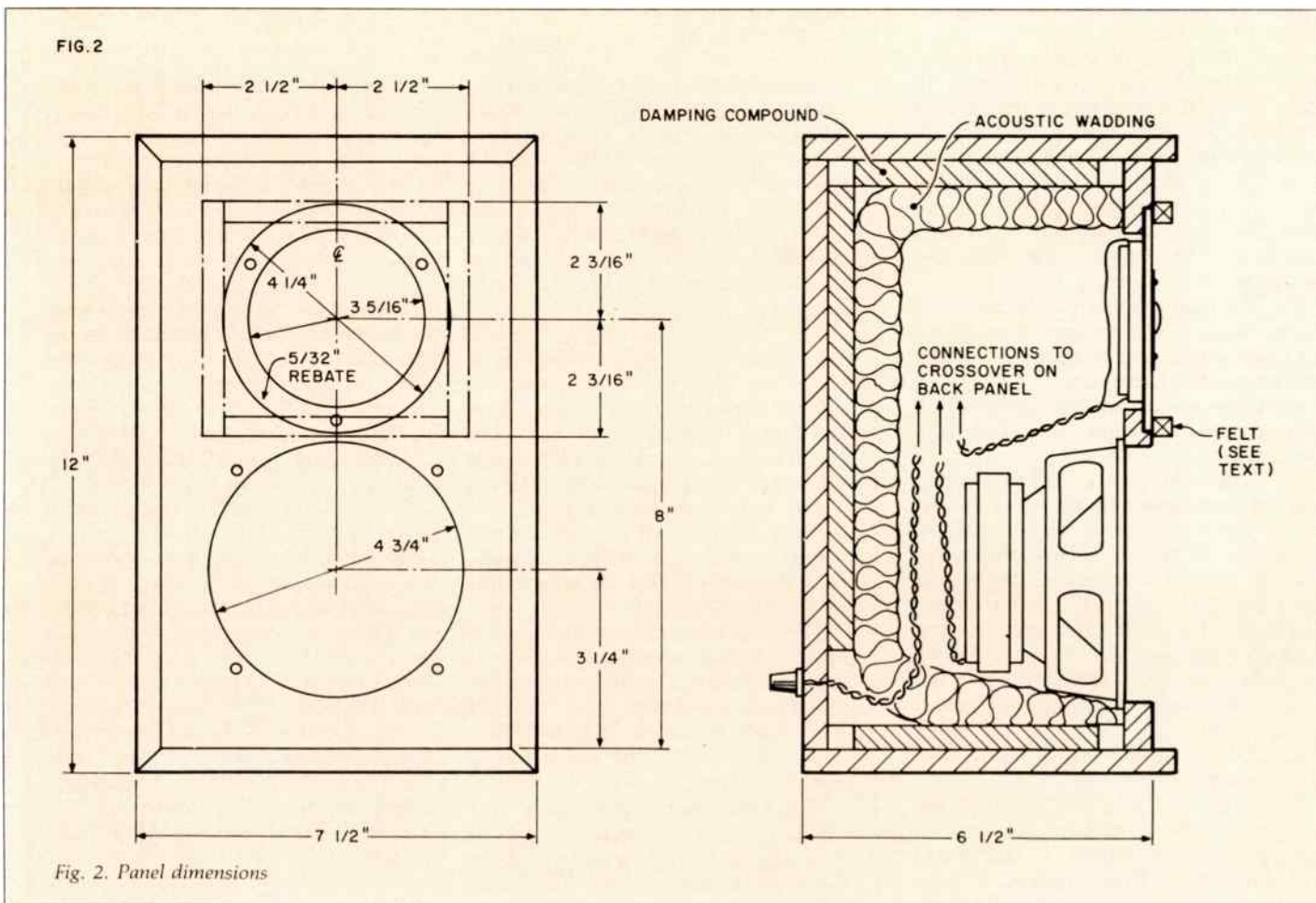

Fig. 2. Panel dimensions

got—your watch is now magnetized.

35. Gasket material that fits on the lip of the frame of the B110 is supplied with the kit. Cut the gasket to length and press it in place on the speaker.

36. Run a bead of gasket cement or silicone caulking along the gasket and sit the speaker in place on the baffle.

37. Don't use the bolts supplied with the B110 (save them for the T27). Instead, use 10/24 x 1" flat-head bolts through the baffle with nuts and lock washers behind the speaker. Don't over-tighten.

38. Cover the bolts, nuts, and holes behind the speaker with silicone caulking. Inspect for air leaks.

39. The T27 is front mounted, and the baffle is rebated for a flush fit. As with the B110, I did not use the gasket at KEF supplied with the speaker. Instead, I ran a bead of gasket cement around the rebated area and pressed the T27 in place.

40. Secure with the bolts supplied with the B110 and use lock washers and nuts behind. Don't over-tighten.

Now is the time to install the felt diffraction ring around the tweeter. It will protect the dome from getting squashed when you lay the baffle face down to wire it. Felt is not supplied with the kit, and Falcon suggests that you use under-carpet felt. The only under-carpet felt that I had was a ratty jute

material, so I chose instead to make the ring out of layers of cloth felt.

41. Cut 3/8" wide felt strips and glue them on top of one another with rubber cement. Use enough strips to make the ring thick enough to contact the grillecloth. Glue the rings in place on the baffle with rubber cement.

CROSSOVER NETWORK

Falcon has included their assembled #23 crossover network in the kit. As Fig. 5 illustrates it is not a trivial

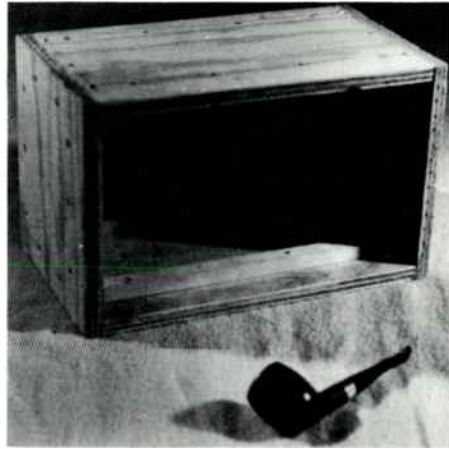

Fig. 3. Assembled panels.

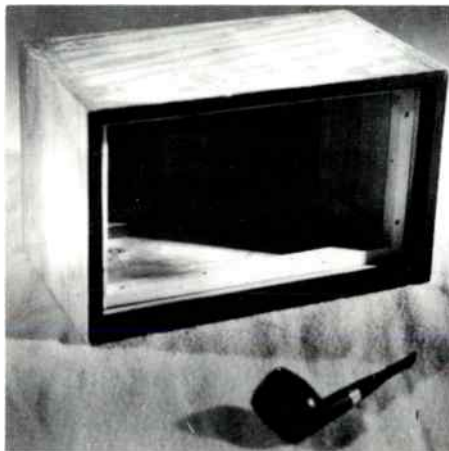

Fig. 4. Enclosure ready for venterring.

TABLE 1

No. of 100Ω parallel resistors	Equivalent parallel resistance	Resultant resistance of R ₁
0	—	5.6Ω
1	100Ω	5.30Ω
2	50Ω	5.04Ω
3	33.33Ω	4.79Ω
4	25Ω	4.58Ω
5	20Ω	4.37Ω
6	16.67Ω	4.19Ω
7	14.29Ω	4.02Ω
8	12.5Ω	3.87Ω

FIG. 5

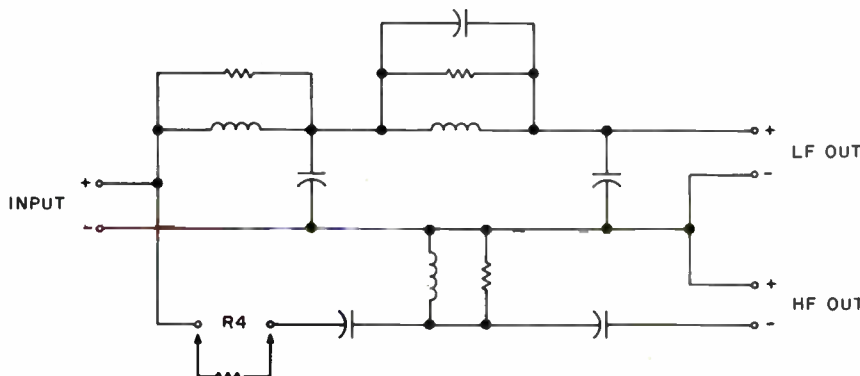

Fig. 5. Crossover network schematic. See text for values, which are proprietary to the kit designer, but are also very difficult to duplicate accurately by traditional value designations.

NOT FOR LOVERS OF BOXES

If you are planning to build a speaker system, please don't make it a conventional box speaker. We publish an informative 20 page book that will show you how to build non-diffractive time aligned speaker enclosures and kits that have only the highest quality drivers used in the right combinations—including crossover networks. Secrets of decoupled driver mounting, how to use "hot" modeling clay to eliminate resonances, and the tubular midrange are revealed. Do you like transmission line enclosures? We design them narrow and deep because they sound better. Have you ever heard our horn loaded subwoofer that weighs 200 lbs.? Or our DQ-10 mods that include new drivers, new caps, time alignment and anti-diffraction material. What about the amazing modified Panasonic Ribbon tweeter that beats anything at 3 times the price? It's all in the **Speaker Bible**—Send \$2 to:

New York Audio Laboratories, Inc.,
33 North Riverside Avenue
Croton-on-Hudson, NY 10520
(914) 271-5147.

WE ACCEPT VISA AND MASTERCARD



crossover. Top quality components are used throughout; the capacitors are polyester with some polycarbonate in the HF section.

The system is based upon a BBC design modified by Falcon. Although the low pass section appears to be the same as that used in the Rogers LS3/5A, it incorporates higher power handling and tighter tolerance components with lower DC resistance giving better damping in the bass. The high pass section is quite different from the Rogers; the tapped HF inductor/transformer has been eliminated and resistors used to attenuate the T27. It is similar to, but not the same as, that used in the KEF DIN 13-Sp 1017.

I have not included component values with the schematic because some of the components have been selected for other than their nominal values, and there are "virtual" components present (1). Care must be taken in selecting components to ensure the correct Q in the tuned circuits. Also, from time to time Falcon may update the circuit (they have since I received mine).

To obtain replacement parts from

Falcon, it is necessary only to quote the reference on the board, i.e. L1 or C2. Where composite capacitors are involved a matched pair will be supplied.

Solder joints on the crossover should be closely inspected, as this area was the source of the only minor defect that I found in the kit. I had to re-solder two joints that had fractured, due to, I suspect, stresses on the leads of the physically large capacitors incurred during shipment. A dab of silicone cement under the capacitors during assembly would prevent such damage. The inductors were well secured with plastic cable straps, and their solder joints were not damaged.

Shelving resistor, R_4 , attenuates the signal to the tweeter. Its value should be chosen to provide the best balance during listening tests. Falcon included two resistors in the kit, a 3.9Ω 5 watt which it recommends as the usual value, and a 5.6Ω 5 watt as an alternative. You can develop intermediate values by paralleling the 5.6Ω resistor with a number of 100Ω $\frac{1}{4}$ watt resistors as listed in Table 1. To ease changing the value of R_4 during listening tests, I brought its connection

points to an external terminal strip as shown in Fig. 6.

42. Refer to Fig. 7 and wire the components using #18 gauge wire. Ignore the note referring to the aB tweeter section in the instruction sheet provided by Falcon. The polarity of the T27 was not marked, but a tiny piece of paper supplied with the screws indicated that the blue wire of the T27 was (+).

43. Mount the crossover to the inside of the rear panel with four #6 x 1" wood screws. Don't over-tighten.

44. Cut pieces of BAF wadding to cover the inside of the top, bottom, side and back panels. Use a single layer; do not stuff the enclosure.

45. Finally, install the baffle and grille. Connect your speakers to your system, put on your favorite record, and lie back to enjoy the fruits of your labor.

DEVIATIONS

The speakers I built deviated from the drawing supplied by Falcon in two particulars:

1. I used $\frac{1}{2}$ " pine plywood and $\frac{1}{2}$ " x $\frac{1}{16}$ " pine battens. Falcon specified $\frac{1}{2}$ "

Falcon Monitor Listening Test

by Mark Sabransky

Dave Davenport asked me to write this section on our listening tests since I should have a less biased opinion of his speakers.

Our listening room is 12 by 18 feet with the speakers placed on the shorter wall, 2 feet above the floor and 12 inches from the wall. We listened from various parts of the room, but mainly from a center position approximately 12 feet from the speakers. I consider the room to be of average acoustic liveness, having such things as carpeting, couches, and drapes as absorbers.

Now, for the toughest part of this article: describing the sound of Falcon's speakers. I dislike using descriptive words and phrases like those in *The Absolute Sound* and their peers, so I won't. After extended listening with a variety of program material I cannot honestly say I heard any particular characteristic or peculiarity about the speakers. Of course I was expecting good sound considering the components and was not disappointed. I experienced no listener fatigue and in general consider the speakers to be very natural and neutral in their sound.

Now for the actual comparison listening. I was fortunate to be able to borrow a pair of Rogers LS3/5A's for our comparison testing. They were manufactured by Swisstone, serial numbers F09983A and F09983B.

Everyone has doubtless heard or read of the importance of speaker placement—yet I, like many others I am sure, do very little experimenting with placement. Most of us are constrained by room dimensions, furniture locations, or less than understanding people with whom we share our living quarters. Of the disparities I noticed (minor as they were) probably the greatest one was created by speaker placement. Without going into the detail of our many placements I will say that we decided on a diagonally opposed stacked setup as having the least amount of placement induced differences.

In general, the two distinctions I heard between the speakers were minor and their detection required extremely critical listening. The first variation I noticed is in definition or clarity: the Rogers are slightly but audibly better. The midrange (especially male vocals) is more natural sounding and seems to have more high frequency content, i.e. the upper midrange is clearer, and I could hear more detail and clarity in the higher frequencies—especially apparent with cymbals. Another way to put it would be that Dave's speakers had a warmer midrange.

I'd like to comment on the use of the perforated metal grill on the

Rogers tweeter. I think that this allows some attenuation of the tweeter without having to insert resistance into the crossover network. The Falcon crossover allows the user to insert various resistors into the network to attenuate the tweeter. This may explain some of the differences in the high frequency clarity and detail. A 3.9Ω resistor was used during most of the listening, however we did experiment with different values, and found that while the balance of the sound was affected, the character was not.

The other difference was in presence. The Rogers had a sound image that seemed more forward or at least in the plane of the speakers whereas the Falcons had a trace of hollowness. The sound image seemed somewhat recessed and distant, but not in a spatial or ambient sense (i.e. the ambience was not inherent in the program source).

We experimented with felt rings around the tweeters, and like Stamler (*SB* 1/1980) found that it did improve imaging. However, this change did not seem to have any effect on the high end or the hollowness in the midrange as it did for Stamler. Possibly the imaging improvement was not as dramatic in our case because of variations in crossover and cabinet design.

Since the major distinction in construction or componentry between the two speakers is in the crossover, I suspect that it is responsible for the differences I heard. This is backed up by listening tests with speakers I built using the same drivers and crossover but different cabinet material and damping and with the B110 flush mounted on the baffle board. With these modifications in construction, I still heard basically the same thing—a slight lack of definition or clarity and a recessed, hollow sound image. Being totally unscientific, I used my ear to subjectively determine that the Rogers cross-over at a lower frequency, letting the tweeter handle more of the midrange. I believe this is why I heard less warmth in the midrange compared to Dave's (and my) speakers.

Those are the only dissimilarities I feel confident talking about.

I think it is also important to note that Dave has a bi-amped system crossing over at 140Hz via an electronic crossover to stereo subwoofers—so I obviously could not compare the low bass response of the speakers.

Again, I'd like to emphasize that these differences required concentration to hear—if I let my mind wander in the least, I had trouble distinguishing between the Rogers and the Falcon. □

birch plywood and 1/2" square battens. After I built the speakers, I learned from an article in *Hi-Fi Answers* (2) that the BBC has closely specified birch plywood and beech battens for the LS3/5A as their tests have shown other woods to cause a clearly audible coloration due to interaction with a resonance of the B110 chassis.

2. Falcon specifies the felt diffraction rings to be 3/8" square. My ring is 3/8" wide by 5/8" high and touches the grille cloth. Prakel² reports that if the felt does not contact the grillcloth a glitch will occur at 5.5kHz, and that without a grille the speaker will exhibit a deep trough at 4kHz with a plateau from 6kHz upward.

COMPARED WITH ROGERS

I inspected a Rogers LS3/5A and noted the following differences between it and my speakers:

1. The speakers I built measure 12" x 7 1/2" x 7", while the Rogers measure 12" x 7 1/2" x 6 3/8".

2. I used 1/2" pine plywood and 1/2" by 1/16" pine battens. Rogers used 1/2" hardwood plywood (birch?) and 3/4" square hardwood battens (beech?).

3. In my speakers all panels are damped with bituminous felt. The top, bottom, and sides in the Rogers are damped with one layer of Bostic sound deadening pads. The back panel is not damped.

4. I have a single layer of BAF wadding on each panel, while the Rogers has a single layer of 3/4" anechoic foam on each panel.

5. My tweeter is a stock KEF T27. The tweeter in the Rogers is fitted with a perforated metal grille.

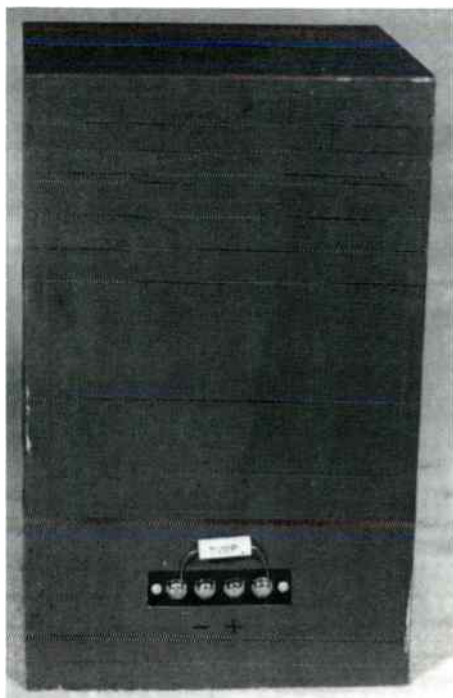
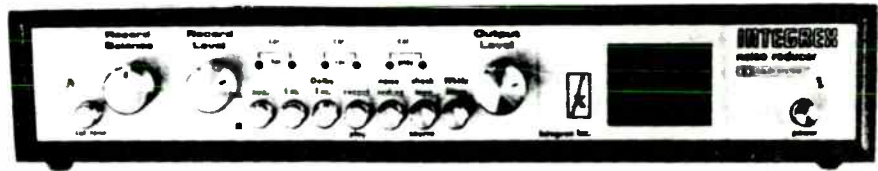

Fig. 6. Rear of speaker, showing R_a.

DOLBY® DECODERS for FM and TAPES



Has the quality of Dolbyized® FM broadcasting disappointed you? If your station is really trying to bring you good sound, the lack of proper decoding makes accurate levels and balance impossible, and minimizes the potential for noise reduction. An Integrex decoder lets you hear what you've been missing because of the compromises in the system intended to make Dolby® -encoded programming "compatible" for most listeners.

The \$99.50 Model DFM decoder easily connects to any tuner, or in the tape monitor loop of a receiver, and includes de-emphasis correction. If you wish to Dolbyize® your tapes as well, the newly revised and far more versatile encode/decode kit is \$137.* Also available built, on special order. Complete details, including test reports, are available on request.

*Add \$3 for UPS; \$6 for parcel post, APOs and Canada. Pennsylvania residents add 6% sales tax.

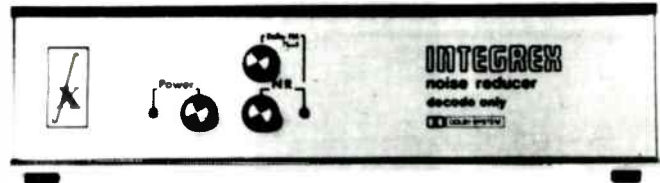

INTEGREX SB, INC.

® Trademark of Dolby Labs Inc.
DEALER INQUIRIES INVITED

P. O. Box 747 Havertown, Pa. 19083

KING SPEAKER SYSTEMS

I carry what I believe are the world's highest quality Raw Frame Drivers and Components and sell them at very low prices.



Dalesford and Polydax (Bextrene Drivers)
Peerless (Polypropylene and Dome Tweeters)
Pyle Passive Radiators and Piezo Electric Tweeters
J.V.C. and Foster Extraordinary Ribbon Tweeters
J.B.L. and Altec High End Components
12dB per octave X-Overs and parts

Please write for free catalogue: 34 Harvard Street,
Arlington, MA 02174

6. The crossover in my speaker is mounted on the back panel. The crossover in the Rogers, which is behind the tweeter, is mounted with standoffs on the front panel (remember those four holes that you had to fill?)

7. The circuitry of the high frequency sections of the crossovers are different.

8. While the grille on the Rogers was similar to mine, it differed in construction details.

9. One difference that I expected to see and was surprised not to find was in the woofers. I thought that the Rogers LS3/5A used KEF B110 Spec 1057; however, the one that I inspected had a standard KEF B110 Spec 1003, the same as supplied with the Falcon kit.

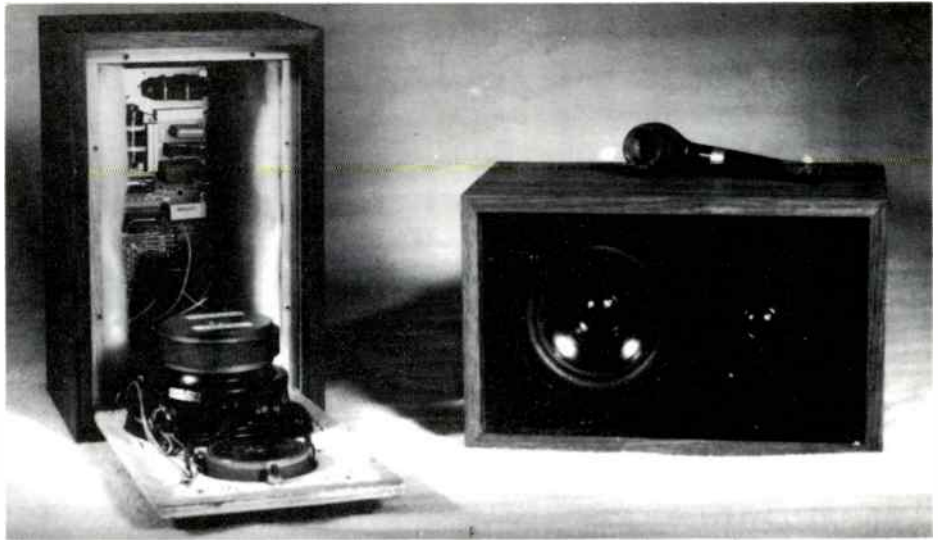

Fig. 7. Finished speakers with BAF wadding removed from top, bottom, and rear to show crossover.

THE SECOND TIME

As one always does a few things differently the second time, if I were to build another pair of these speakers, I would:

1. Use birch plywood and beech batens.
2. Install rubber grommets in the B110 mounting holes to provide acoustic isolation.
3. Glue on a piece of felt fabric instead of veneering the bottom. This should protect the finish of whatever

the speaker sits on and perhaps provide a little acoustic isolation.

4. Copy the beautiful job that Rogers did with the grille: cut the frame as described above, except use 1/4" plywood. Apply a strip of 1/8" thick, 1/2" wide foam weatherstripping around the front face of the frame. Attach the fabric as described above. Staple a strip of Velcro around the back of the grille and mating strip of Velcro on the baffle. The foam and

Velcro make up for the difference in the thickness of the wood, while the weatherstripping provides a smooth, tight-fitting grillecloth.

5. Falcon now offers an "aB version" of the Monitor Quality Compact kit. It differs from their standard kit only in that the crossover supplied is Falcon's 23aB. The 23aB uses the same low pass section as the 23, but with an acoustic Butterworth high pass section. I have

Continued on page 42



Loudspeaker Components



HORNS • WOOFERS • MIDS • TWEETERS

AT TREMENDOUS OEM SAVINGS. ALTEC, ELECTRO-VOICE, PHILIPS-AMPEREX, PEERLESS, POLYDAX, ISOPHON, AND MANY OTHERS. HUGE SELECTION OF X-OVER COMPONENTS. LARGE INVENTORY FOR IMMEDIATE DELIVERY. GOOD SELECTION OF MUSICAL INSTRUMENT LOUDSPEAKERS. CATALOG CONTAINS VALUABLE X-OVER INFORMATION, AND TECHNICAL DATA ON SPEAKERS. SEND \$1⁰⁰ TO: SRC AUDIO DEPT. SB



3238 Towerwood Dr. Dallas, TX 75234

ENCLOSED IS \$1.00, PLEASE SEND CATALOG

name _____

address _____

city _____

state _____ zip code _____

BUILDERS AHoy

WHILE WE HAVE MANY fine manuscripts in hand for future publication in these pages—we need your contributions too. How about those offerings for our *Craftsman's Corner, Tools, Tips & Techniques*? We also need accounts of your construction adventures with specific projects. Why not plan to take pictures (black and white preferred) and make notes when you're building that next project—or kit. Write it up just as you would a letter to a friend. Send it along to us and we'll give it every consideration. We pay for articles, so you might have a nest egg for that next project you want to try, as well. We have a nice sheet of suggestions for authors which you may have just by asking for it. □

HORN KUDOS

I READ MR. EDGAR'S ARTICLE in *SB 3/80* about his corner midrange horn with great interest. The size, cost, frequency response and power handling ability of his design are quite appropriate for low cost speech reinforcement. I wish all of the direct radiator column arrays being used in similar public auditoriums would be replaced with horns such as these; my PTA attendance would surely improve as a result. He has produced a good, sound design and avoided most of the common pitfalls of folded horn designs.

Properly designed horns offer superior dynamic range, transient response, and freedom from distortion compared with direct radiators (especially for bass). Because of that, I expect their popularity to grow in the near future. As the dynamic range, transient response and distortion characteristics of the program sources are improving (i.e., audiophile disks, noise reduction encoding systems, and, eventually, digital disks), the disadvantages of direct radiator loudspeakers are becoming obvious. Because all of these factors are related to the total loudspeaker system size, the best direct radiator systems are now getting large enough that bass horns are becoming competitive in size. Bass horns always were competitive in terms of cost per unit of clean acoustic power output.

My reason for writing this letter is to correct some widespread misconceptions about horns that have surfaced once again in this article, and to help any of your readers who are interested in designing horn systems for themselves put the whole design process on a sound basis. To that end I would like to recommend the following technical papers to everyone interested in horn design. They are the best I have found in a fairly exhaustive search of the literature:

Victor Brociner. "The Why and How of Horn Loudspeakers." *Audio March* and *June 1971*. This is the clearest and at the same time the soundest description I have

seen of what horns are all about and how they work. It is not very mathematical.

Kyono Morita, et al. "Acoustic Radiation of Horn Loudspeakers..." *Journal, Audio Engineering Society*, July/Aug. 1980. Via mathematical simulations of several tweeter horn varieties, plots are presented of wavefront shapes inside straight horns.

Paul W. Klipsch. "Modulation Distortion in Loudspeakers." *Journal, Acoustical Engineering Society*, 17, p. 194, 1969; "Modulation Distortion in Loudspeakers: Part II." *Journal, Acoustical Engineering Society*, 18, p. 29, 1970; "Modulation Distortion in Loudspeakers: Part III." *Journal, Acoustical Engineering Society*, 18, p. 29, 1972. These three papers present a mathematical foundation for describing modulation distortion in both direct radiator and horn loudspeakers. They also include photographs of spectrograph displays of distortion produced by both types of loudspeakers in all frequency ranges (woofers, midrange, and tweeter). These three papers, and many more, are available from Klipsch and Associates, in Hope, Arkansas, for a nominal fee.

In addition, let me warn that the Dinsdale articles mentioned by Mr. Edgar contain more than their share of misconceptions about horns. The primary problem with these is their failure to base the horn design on the driver's parameters, or vice versa. The matter is too complex to analyze fully here, but the throat size must be chosen as a function of the driver's moving mass, diaphragm area, B_1 product, and voice coil resistance. The horn length and cutoff frequency also enter into the throat size selection somewhat.

For high fidelity use a bass horn using a direct radiator type cone driver will give excellent results. I think, however, that a midrange horn using a cone-diaphragm driver is not likely to provide the high quality results necessary for high fidelity use. That type of driver has several deficiencies that are hard to work around for this application. (1) They have too much moving mass to provide flat response up high enough for a tweeter to take over. (2) Their cones are not strong enough to work with the required throat pressures. (3) The diameters of their cones are large enough to cause sharp response irregularities within the pass band just because of the diameter of the air chamber between the cone and the throat (even assuming perfectly rigid piston action of the cone).

Radial standing waves form in this chamber that sap the energy you are trying to radiate out the throat. The wavelength of the lowest frequency standing wave is in the vicinity of 1.64 times the radius of that chamber. Therefore, to keep the resulting sharp trough above 6000Hz, say, would require keeping the radius of that chamber below about 1.3 inches.

(4) If a sealed chamber is used behind the cone, it will produce severe response troughs and peaks at frequencies whose wavelengths are four times the distance from the diaphragm to the chamber walls. Thus, the walls of a rear chamber must be within a half an inch of the cone in order to put these problems above 6000Hz.

I hasten to add that these considerations have prevented me from even trying to use a cone driver with a midrange horn, so I have no idea how easily these theoretical problems may be overcome. It appears to me that the way to make a midrange horn for high fidelity use is to select a commercial midrange compression driver, use the throat area recommended by the manufacturer, and construct your horn out of wood, plaster, cement, or plastic, etc.

Unfortunately, in the case of bass horns I do not know of any driver manufacturer who will advise you what throat area to use, so you are on your own. To cope with these factors experimentally, I would recommend selecting a driver for a bass horn with the highest possible ratio of $(B_1)^2/R$ (30 to 40 is typical). Get the lowest moving mass possible, and sufficiently high compliance so that the free air resonance of the driver is about an octave below the horn's cutoff frequency, assuming that the rear of the speaker will be enclosed in a sealed box. On the other hand, if the rear of the driver is not to be enclosed, then select a driver with a free air resonance higher than the horn's cutoff frequency: the horn throat provides additional mass loading to the driver, and so will move the resonant frequency lower.

A typical bass driver will require a throat area of about 60 percent of the diaphragm area. (The "area of the diaphragm" is usually defined as the area of a circle whose radius is midway between the inner and outer radii of the surround. Typical values are 140 square inches for a 15 inch driver and 85 for a 12. Dinsdale's use of the actual surface area of the cone will not work in any of the standard formulas, because they were all developed under the assumption that the diaphragm is a flat circular disk.)

After building and assembling the horn, measure the frequency of the major low frequency impedance peak, and adjust the volume of the sealed rear chamber to bring it close to the cutoff frequency of the horn. If the frequency of the peak is too low, reduce the volume. If the peak's frequency is too high, build a larger rear chamber. After that is taken care of, measure the low end frequency response. If a significant output peak occurs at the frequency where the impedance peaks, the $(B_1)^2/R$ (braking factor) of the driver is too low for the throat area you used. The best alternatives at this point are to live with it if it is not too bad, replace the driver with one with a higher braking factor, or build a new horn with a

IMPROVE YOUR COST/PERFORMANCE RATIO 3 DB*
PUT YOUR MONEY WHERE IT REALLY COUNTS. IN QUALITY
COMPONENTS AND A HIGH PERFORMANCE DESIGN.
BUY A PHOENIX SYSTEMS KIT.

FOR SALE:

PARAMETRIC EQUALIZER KIT	P-94-S	\$ 99.00
ANALOG DELAY LINE KIT (MONO)	P-25-DL	\$150.00
(STEREO)	P-25-SDL	\$250.00
TAPE NOISE REDUCTION KIT	P-518-S	\$ 65.00
HP/LPF (-12db/OCT)	P-91-S	\$ 15.00
SAD-4096 ASR	P-4096	\$ 45.00

PRICE INCLUDES SHIPPING

SEND FOR SPECS/CATALOG

PHOENIX SYSTEMS/91 ELM ST./MANCHESTER, CT 06040
(203) 643-4484

*3DB FIGURE BASED ON APPROXIMATE DOUBLING OF DB\$ (DOLLAR POWER)

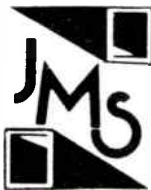

**you can
build a
better
speaker
system**

FOR CATALOGUE SEND 25¢
WITH NAME, ADDRESS, ZIP

TO: **JMS SYSTEMS**

RR #1 Box 172
CARM. ILL. 62821

Mailbox

larger throat area. However, if there is no peak at that frequency, and if the output continues to rise with increasing frequency for the next octave, the driver's braking factor is too high and the low frequency output is suffering. That is easy to fix. Add a small resistance in series with the voice coil. Be sure the resistor can take the required power.

The second major factor in the design of horn loudspeakers is the moving mass of the diaphragm, voice coil, and dust cap. The attempts of Mr. Dinsdale and his readers to make high quality midrange horns using cone loudspeakers are probably doomed to failure by the high mass and low strength of the cones, and by the difficulty of making the front air chamber small enough to pass the higher frequencies. Any attempt to compensate for the excessive mass by using a smaller throat area usually increases the effective volume of that chamber, further increasing the high end rolloff. But if your driver needs more mass, you can always cement a ring of solder securely to the joint where the dust cap meets the cone.

Now back to Mr. Edgar's article. High throat pressures do not in any way require the use of a stiff suspension as Mr. Edgar suggests. Indeed, since the high pressures always act to push or pull the diaphragm back toward its relaxed center position, LESS suspension stiffness (more compliance) is required, not more. This is directly analogous to an acoustic suspension system, where the suspension is very compliant and a large part of the system's stiffness is provided by the small volume of enclosed air.

Mr. Edgar follows Mr. Dinsdale's lead in being overenthusiastic in making the diaphragm and throat large in order to avoid throat overload distortion. The formulas for harmonic distortion in a horn throat have been well known for at least 45 years, and everyone seems to have been terribly aware of that source of distortion. The formula and graphs for distortion given in Dinsdale's article are sound, but the use of them is not. When deciding how large a throat is to be in order to keep harmonic distortion below a specified limit when reproducing speech or music at a specific power level, the spectral content of the source must be kept in mind (just as it is when specifying the power handling capacity of a loudspeaker). The spectral content of these sources is approximately constant from 400 to 1000Hz and then reduces by a factor of 10 for every doubling of frequency above 1000Hz (Beranek).

Using that fact, the average distortion in a midrange horn with a one square inch throat, when producing an acoustic output of one watt of program material, reaches a 0.5 percent peak around 1000Hz, and averages about 0.4% over the entire pass band. Remember that one (1) watt acoustic output produces about 102dB SPL in a "typical" listening room. This horn with a one square inch throat produces less distortion at that loudness level than a direct radiator would. If you find that hard to believe, just listen to the prodigious amounts of clean undisturbed power the

Klipschorn produces, using a midrange horn with a throat area of less than one half square inch.

In bass horns with 15-inch drivers, the throats often have areas in the order of 80 square inches. In view of the low resulting power per area, the widespread concern over throat-pressure-induced distortion in bass horns would be laughable if it were not so widespread. For the 100Hz cutoff Mr. Edgar used, a small direct radiator type of cone loudspeaker is proper. Its mass and size, however, will inevitably cause high frequency rolloff above a couple thousand Hz. It is difficult to make any horn cover than about forty octaves.

Mr. Edgar is correct in surmising that a stiff cone is required for low distortion in horns. That is a major reason why high quality midrange horns use specially designed compression drivers with very small, stiff, lightweight diaphragms made of plastic or metal. The result is much less distortion than a direct radiator would have.

Mr. Edgar's article and project were excellent. I am looking forward to seeing more material of that quality.

ROBERT J. FEESER
Kernersville, NC 27284

Mr. Edgar replies:

I thank Mr. Feeser for his compliments on the midrange horn article (SB, 3/80 p. 15). His other comments deserve attention by all would be horn builders. I was aware of some of the pitfalls in Dinsdale's *Wireless World* horn articles, however, I used them because they serve as a fairly recent source of design parameters. With the horn literature spreading over half a century, it is a problem to cite references that are available to readers today.

However, recently two papers, published as A.E.S. preprints,¹ ± give very readable formats for horn design. Keele's—horn design follows the traditional method of fixing the throat area to give maximum mid-band efficiency, which is essentially the same approach as stated by Mr. Feeser's letter. But Keele states at the end of his paper that "constraint of this parameter (i.e. throat size) removes one valuable degree of design freedom."

In a companion paper Small ± showed in a study of direct radiators for use in horns that maximum efficiency implies minimum bandwidth. In Small's analysis the maximum efficiency occurs at unity coupling. But if we accept a tradeoff in efficiency, we can extend the upper frequency response near to its practical limit. This tradeoff is determined by the ratio of the throat area to the driver area. In one example to achieve a horn response of 50-500Hz, the ratio of throat to driver was calculated to be 0.22. The drawback to Small's analysis is that he ignores the diaphragm-throat coupling volume which, as Mr. Feeser correctly points out, will limit the high frequency response.

Clearly from Mr. Feeser's letter, my reply, and the references, there is some latitude in assigning the optimum throat area. The most important factor in this area is the driver and its parameters. Once it is selected, the horn design and construction can proceed to achieve the desired result, whether it be p.a. or hifi applications.

REFERENCES

1. Keele, D. B., Low frequency horn design using Thiele-Small driver parameters, *A.E.S. preprint #1250*, 1977.
2. Small, R. H., Suitability of low frequency drivers for horn-load loudspeaker systems, *A.E.S. preprint #1251*, 1977.

HORN HOW-TO

THANKS SO MUCH for your *SB* article (3/80, p. 15). I am inexperienced in speaker designing, and do not have the resources or training necessary for good designs.

Due to this, I have several questions which I hope you can find the time to answer:

1. Is it necessary that the speaker have a free air resonance of 90Hz? Would equal results be obtained from a guitar speaker with a free air resonance of 45Hz—e.g. the Eminence 10" guitar speaker (EM-40-G-8) on page 73 of the 1981 McGee catalog?

2. I would like to use a speaker with a larger magnet and greater power handling capacity. Would this increased output result in an overload on the speaker or the horn?

3. Will this horn perform well if it is not placed in a corner? I would like to use it as part of a free standing P.A. without the benefit of either a wall or corner.

I do have one suggestion about your fine article. In the future, though it may be boring to some, would you include your mathematical computations? It would help many of us who are trying to comprehend the mechanics of horn design.

PETER BLOCH
Eugene, OR 97405

Mr. Edgar replies:

Thank you for the compliments on the corner horn article (*SB* 3/80). To answer your questions:

1. A horn enclosure will restrict the bandwidth response of a cone driver. The upper corner frequency where the driver mass limits the high frequency response given by $2fs/Qts^2$. Good drivers for horns usually have $Q's$ in the range .2-.3. So a speaker with a 90Hz resonance will have a better high frequency response than the Eminence speaker with a 45Hz resonance, assuming the $Q's$ are comparable for both speakers. Assuming a Q_s of .25 for the Eminence speaker, one finds an upper rolloff frequency of 360Hz which is too low for PA. I would recommend putting the Eminence speaker in a box of convenient size and using it as a direct radiation rather than a horn. (The Eminence speaker does on the surface seem to possess the qualities for a bass horn driver, so I would not dismiss it entirely for horn use.) Of course now I have sacrificed the efficiency of a horn for bandwidth response in a closed box.

2. Recently I ran across a replacement for the discontinued Radio Shack 10" guitar speaker. Fane America markets a Crescendo 10/60E 10" speaker which has a 60 watt power rating, a 90Hz resonance, and a higher than normal flux density. Unfortunately they did not supply any Thiele-Small parameters. This speaker should satisfy your magnet-power requirements.

3. The corner mid-range horn (*SB* 3/80) is designed to work in a corner or against a wall. For a free-standing horn with 120Hz

BUILDER PURISTS

The audio industry was founded by dedicated builder purists like you, seeking new and novel approaches to sound reproduction.

We started that way over fifty years ago and still maintain that same dedication to the ideal of utmost quality, a fact which is reflected in the products we manufacture; including raw drivers for the builder. We invite you to write or call to learn more about our products:

DRIVERS: 7" Dual voice coil midrange/tweeter
10" Dual voice coil full range
18" Parallel wound voice coil subwoofer with heat sink
24" Parallel wound voice coil ultra-woofer with heat sink

FEATURES: All-polymer cones
High speed magnetic suspension
Equalized Flux Magnetic structures
Sand-cast aluminum frames
100% hand fabrication
200% quality control

ACCESSORIES: 3-way passive crossover
TF-1 natural fiber cellulose damping material
Terminals and binding posts

ALSO NOW AVAILABLE: We are your **only** source for the ultimate **speaker wire. . . REFERENCE CABLE**



Write for free brochures, specs, cabinet recommendations and prices.

Hartley Products Corp., Box 316B, Ramsey, NJ 07446
(201) 327-4443

British Components and designs for the high quality speaker builder!

Our range runs from transmission lines to a system similar in all essential respects to the LS3/5A. **Audiogram** have twice recommended our Webb kit alongside the KEF R105 and the Linn Isobarik (issues 12/78 and 12/79 refer).

All our systems are comparable in performance with the best similar commercial types and usually better—we do not confuse things by handling radio/T.V., group, disco, PA or junk designs or components. Full catalogue, data and export rates \$5.00 air mail. Stockists of **Crimson Elektrik** amplifier modules.

Badger Sound Services Ltd.

46 Wood Street
Lytham St. Annes, FY8 1QG Lancashire,
ENGLAND



READER'S CHOICE

In these inflation fighting days we look for ways to keep our operating costs down. One means is finding other sources of income from our operations which reduce overhead and keep the inevitable price increases in subscription rates to a minimum. We are approached from time to time by various firms asking if we would make your name available for direct mail promotions of their products. For many years we have refused all such requests, knowing that many of you would prefer that we do so.

Recently we have had letters, quite unsolicited, from several readers suggesting that if we wished to make their names available to those vendors whom we consider might be of some interest to them, they would have no objection to rental of our list for such purposes.

We have decided to change our policy about mailing list rental and will consider such proposals in the future. We will restrict rentals to reputable firms whose products we consider to be of interest to you. We also exercise strict control on any unauthorized use of our lists by secondary sales of the information to other users.

If you feel strongly that you do not wish your name to be included in such rentals we are able to lock your name and address record out of rental use availability on our computer. All you need to do is drop a postcard to us at *SB*, Circulation Dept., P.O. Box 494, Peterborough, NH 03458. Thanks.

YOU PROBABLY HAVE NEVER HEARD THE FULL POTENTIAL OF STEREO PHONIC REPRODUCTION



You may have wondered why all the sound from your stereo seems to come from the space between your speakers when you know that speakers project sound in all directions. In a conventional stereo system, the speakers act as sonic barriers to the stereo image. They actually become obvious sources for the sounds that were originally recorded beyond the angle that they enclose.

The IR2100 Image Restoration Control can effectively remove this barrier and allow your stereo to reproduce the full breadth and depth of the original performance. The IR2100 is also uniquely adjustable from the listening position for a wide range of speaker locations and source material, so you can easily tune it to get the most out of your stereo and your recordings. The impact of the IR2100 will be to expand your stereo sound stage and give greater localization of the individual instruments and voices while restoring the original open feeling of a live performance.

For complete information write to Sound Concepts c/o Box 135, Brookline, MA 02146 or call (617) 566-0110.



FIDELITY IN SPATIAL REPRODUCTION

Mailbox

mouth-expansion rate cutoff, you would have to extend the horn until you reached a mouth size of 1000 sq. inches. For a smaller free standing horn, I suggest building a straight Tractrix horn for an expansion rate for 200Hz as given in Fig. 4 of my Tractrix horn paper (*SB* 2/81). That would give a horn length of approximately 14 inches and mouth size of approximately 370 square inches.

Additional Comments

The corner mid range article was written before I knew about Keele's design paper on horns (Ref. 1). The throat size is smaller than what you would calculate for maximum efficiency. However you can sacrifice efficiency for wider band width by going to smaller throat sizes. As constructed the corner horn performs well in rooms, but I was lucky that the combination worked out satisfactorily for PA applications, because the design was chosen on the basis of intuition and not on the basis of any analytical design a la Keele.

REFERENCES

1. Keele, D.B., "Low frequency horn design using Thiele/Small driver parameters," A.E.S. preprint #1250, 1977.
2. Fane America, 6708 Varietal, Canoga Park, CA 91303.

PORTUGAL'S SPEAKER BUILDERS ALERT

I WOULD LIKE TO FIND some people from my

country who subscribe to any one of your magazines in order to exchange experiences and opinions on the subject of audio reproduction.

ARMANDO S. CERQUEIRA
R. Maestro Antonio Taborda 13-1°
1200 Lisbon, Portugal

BUILDER'S REPORT: THE FALCON MONITOR QUALITY COMPACT KIT (Similar to LS3/5A)

Continued from page 38

not had the opportunity to hear one; however, Falcon claims a significant improvement, and for the slight increase of cost (£5) I think I would try it.

I really can't say that I would front mount the B110, except perhaps as an experiment to satisfy my curiosity. I have listened to a system using the Falcon #23 crossover, a T27 and a B110 front mounted in an enclosure of similar size to mine. Sound localization, particularly off-axis, seemed slightly superior; however, there were differences in the character of the sound, and it is impossible to say if they were caused by front mounting the B110 or other factors.

REFERENCES

1. Hughes, B. Letter to the editor, *Speaker Builder* 3/80, 42-43.
2. Prakel, D. BBC's home service, *Hi-Fi Answers*, Aug/79.

SPEAKER BUILDER BINDERS

Rich blue, heavy vinyl binders imprinted in white with *Speaker Builder's* logo. Spaces for twelve issues on loose wires will store your valuable *SB* data in a readily accessible format.

Each **\$7.00**
Two binders, ea. **6.50**
Three or more, ea. **6.00**

Ppd. in USA. Outside USA please add \$2. per binder for shipping

ORDER BLANK
Speaker Builder
PO Box 494, Peterborough NH 03458

Send _____ binder(s) @ \$ _____ ea.

Total \$ _____ check; M.O.; MCard; Visa

Charge card no. _____

Charge card expiration date _____

Signature _____

Name _____

Street & No. _____

Town _____ St. _____ Zip _____

Old Colony's BARGAIN BASEMENT BONANZA

A once-in-a-lifetime purchase allows Old Colony to offer readers some unusual value in electronic parts. All are brand new devices. Quantities are strictly limited and are offered on a first-come, first-served basis.

TRANSISTORS

BT-TIP29C-T1 to-220 NPN, .1 amp 100V **Ea. \$.70**
BT-40361 Solid State to-5 NPN **Ea. \$.80**
BT-40406 RCA to-5 PNP **Ea. \$.90**

QUALITY CAPACITORS

BC-1 TRW, 5µF/200V ±20% Polypropylene units. 1 3/4 x 3/4". **Pair \$19.00**
BC-3 Sangamo 500R 5700 @ 30VDC Electrolytic Low ESR. Insulated can. **Pair \$16.50**
BC-6 Rubycon Photoflash 600µF, 360V. 3 3/4 x 1" dia. **Ea. \$4.00 Two for \$6.50**

UNUSED SURPLUS

BC-4 1500µF/80V Mallory Electrolytic. **Ea. \$2.50**
BC-5 2500µF/80VDC, 105V Surge Electrolytic. **Ea. \$3.50**

Send all orders to
OLD COLONY SOUND LAB
BOX 243 PETERBOROUGH NH 03458
M/C or VISA Charge Orders: (603) 924-6526—9-4 M-F.

Classified Advertising

PRIVATE CLASSIFIED ADVERTISING SPACE up to 50 words in length is open to Speaker Builder's subscribers without charge for personal, non-commercial sales and for seeking information or assistance. The publishers reserve the right to omit any ad. Any words beyond 50 are 15 cents per word. Please type or neatly print ad copy on a separate sheet or card with your full name and address.

TRADE CLASSIFIED ADVERTISING RATES: 25 cents per word including name, address, and zip code—prepaid only. 10% discount for four insertions. Speaker Builder cannot accept responsibility for the claims of either the buyer or the seller.

TRADE

GET THE BEST FROM YOUR SPEAKERS with the finest electronics. AudioWorld is the high end connection for those who want the best sounding system for their money. We have competitive prices on whatever you are interested in. **AUDIOWORLD**, Box 6202B, Grand Rapids, MI 49506. (616) 451-3868. T4/81

CATALOG OF HARD to find speaker cabinet hardware, crossover parts, tweeters, midranges, woofers, cabinet plans, grille cloth, etc. Over 300 Hi-Fi and Pro Audio items. For your copy send \$1.00 to **UNIVERSAL SOUND**, 2253 Ringling Blvd., Sarasota, FL 33577. T4/81

LOOKING FOR a speaker to compliment your SOTA electronics? The Jordan 50mm. module forms the nucleus of a coherent, high resolving, accurate imaging system. The audio amateur can construct a superb, flexible loudspeaker using the Jordan module for a fraction of the cost of comparable commercial systems. If your reference is live music, this could be your system. We also have Audax, Dalesford, JVC and Foster ribbons, SEAS, highest quality crossover components, Falcon crossovers, cabinets and much more. Catalogue \$1.00, Jordan manual \$2.00. **AUDIO CONCEPTS**, 1919 S. 19th St., La Crosse, WI 54601. T2/82

This publication is available in microform.

University Microfilms International

300 North Zeeb Road Dept. P.R.
Ann Arbor, Mi. 48106 U.S.A.

30-32 Mortimer Street Dept. P.R.
London WIN 7RA England

TRANSDUCER TECHNOLOGY & DESIGN

offers continuous hi-power handling speakers

12" 2 1/2" VC 80 oz. magnet 200 watts.....	\$ 75.00
12" 3" VC 106 oz. magnet 200 watts.....	\$125.00
15" 3" VC 95 oz. magnet 300 watts.....	\$150.00
18" 3" VC 120 oz. magnet 350 watts.....	\$175.00
18" 3" VC 120 oz. magnet 500 watts.....	\$225.00

Above models available with foam rubber, cloth and conventional annulus, ribbed and smooth cones.

Specify requirements.

18" models have die cast aluminum magnets.

Send for information

TRANSDUCER TECHNOLOGY & DESIGN
Box 2336 GPO Dept. TTD Brooklyn, NY 11202

POLYDAX - SEAS - PHILIPS PEERLESS - BECKER - AUDAX AMPEREX - EV - MOTOROLA

- COMPLETE LINES IN STOCK
- DOME TWEETERS, DOME MID-RANGES, AND BEXTRENE CONE WOOFERS
- KITS AVAILABLE
- EXTENSIVE LIBRARY OF PLANS
- FREE TECHNICAL AND DESIGN ASSISTANCE
- WRITE FOR FREE CATALOG

Speaker Supply Co.
Post Office Box 48362
Atlanta, Georgia 30362
404/455-0572

Classified

FINALLY, A LINE of raw drivers that are efficient, well built, linear, fast, handle vast power, and are affordable. We stock the entire DYNAUDIO line. All drivers are rated at better than 1000 watts pulsed. The incredible D28 tweeter can be crossed over at 2.5K 6dB/oct. and handle 300 watts DIN! Truly SOTA dynamic loudspeakers. And our prices and services are the best. See our other ad for our other products. Catalogue \$1. **AUDIO CONCEPTS**, 1919S. 19th St., LaCrosse, WI 54601. T4/81

NEW GOLD PLATED PHONO JACK. Rear mount, gold plated, solid brass jack w/gold plated ground flag and hardware, \$1.75 ea. Will interchange with Audio Research SP3A-1's phono jacks. Gold plated solid brass shielded phono plugs, \$2.00 ea. Send stamped self addressed envelope for flyer and order form. Minimum order \$10.00. **OLD COLONY PARTS**, PO Box 243, Peterborough, NH 03458.

"IN PHASE" 24dB/8ve electronic crossover minimizes irregularity in radiation pattern through crossover region. 0.0008% distortion, 5 year warranty. Single frequency (specify) with power supply: \$490.00. Standard version 100Hz: \$420. **DB SYSTEMS**, Box 347K, Jaffrey, NH 03452. TTF

TRANSCENDENTAL AUDIO'S new catalog features: 1. Precision Step Attenuators—available for solid state or tube units, assembled or in kit form from Tech Labs and Alps. 2. Polypropylene and Polystyrene caps from 20pF to 10uF—160 volts to 600 volts. 3. Hafler Preamp and Power Amp Modification Kits, a very cost effective improvement to an already excellent product. 4. Dahlquist DQ-10 Mod Kits—"audio grade" capacitor updates with or without the JVC "Dyna-flat" tweeter. 5. Dynaudio Raw Drivers—from the 3/4" ferro-fluid super tweeter to the 2" soft dome midrange right up to the 12" magnesium frame woofer. Each one of these ultra high quality Danish drivers can handle 1 kilowatt for 10 milliseconds! 6. Low DCR Air Core Inductors—custom wound to your specs with #16 or #12 gauge wire. Wholesale inquiries invited. 7. Polystyrene Cone Woofers—from Great America Industries that fit the Thiele B4 alignment. Available with or without our cylindrical "Unbox" subwoofer enclosures. Send \$1.00 for our 36 page catalog, \$2.00 for the 26 page Jordan Manual on loudspeaker theory. **TRANSCENDENTAL AUDIO**, 6796 Arbutus Street, Dept. #1, Arvada, CO 80004. (303) 420-7356 9-5:30 mountain time. T4/81



Audax and Philips Loudspeakers
 — in stock
 — competitive prices
 — competent service

Suppliers to the Audio community of air core inductors, audio grade capacitors, Falcon crossovers, JVC and Foster tweeters.

Madisound Speaker Components
 431 West Gorham, Box 4283
 Madison, Wisconsin 53711 (608) 256-7337

OPEN REEL TAPES from studio masters. Philips, Argo, Telefunken, Vanguard, Unicorn. Catalogue \$1.00. **BARCLAY-CROCKER**, Room 1470-L, 11 Broadway, NYC 10004. TTF

CROSSOVER COMPONENTS and accessories for the speaker hobbyist. Low prices. Send for free flyer. **UNIVERSAL AUDIO**, Box 712, Providence, RI 02901. T1/82

SPEAKER CABINETS—factory close out of rich walnut vinyl laminated cabinets constructed of 3/4" particle board. Shipped assembled with grill frames. Speaker openings can be cut to your specifications. Measurements 24x13x13. Only \$19.95. **FABER**, 1625 Kelley St., Santa Rosa, CA 94501. T4/81

RAW SPEAKERS and Kits. Specializing in plastic cone drivers and high end auto systems. Brands include Audax, Becker, Dynaudio, Dalesford, JVC, Philips, Jordan-Watts, Falcon-Acoustics, SEAS and Peerless. Free price list. **A&S SPEAKERS**, P.O. Box 7022-B, Denver, CO 80207. (303) 399-8609. T4/81

GOLD PLATED phono jacks \$1.20 plugs 90¢ ea., \$1.00 handling. Also custom 1% capacitors, 0.5% resistors. Details SASE. **REFERENCE AUDIO**, Box 368M, Rindge, NH 03461. T1/82

LONG HAIR WOOL carded-cleaned for stuffing speakers. \$10.00/lb. including shipping. **J. EBBERT**, 431 Old Eagle School Rd., Stratford, PA 19087. (215) 687-3609 TTF



ACOUSTIC TEST INSTRUMENTS
 USE TO ADJUST EQUALIZERS, OPTIMIZE SPEAKER PLACEMENT, ETC.

Complete Test Set	\$399
Calibrated Sound Level Meter	\$169
Fractional Octave Pink Noise Generator	\$299
Handbook on Acoustic Testing	\$6

Free broch. HALL ENGINEERING Dept B4
 P O Box 506 Martinsville NJ 08836
 (201) 647-0377

SAVE 50%. Build your own speaker system. Write: **McGEE RADIO ELECTRONICS**, 1901 McGee Street, Kansas City, MO 64108. T4/83

RAW SPEAKERS AND CROSSOVER PARTS. Send 20¢ stamp. **MENISCUS SYSTEMS**, 3275 Gladiola, Wyoming, MI 49509. T2/82

WE ARE ONE OF the largest independent manufacturers of crossover networks and speaker system accessories in the U.K., supplying manufacturers, retailers and export. We have a growing number of outlets in the U.S.A. and Canada. Your guarantee is the trust our manufacturing customers put in the quality and reliability of our networks. If you have supply problems, please send for details: \$2 bill Air, \$1 bill Surface, to our mail order retail outlet: **FALCON ELECTRONICS**, Tabor House, Norwich Road, Mulbarton, Norfolk, England. T2/84

GOLD PLATED BANANAS. DBP-9AU, eight solderless (set screw) plugs for up to 12 gauge wire, \$11.95. DBP-9H, four red and four black bakelite plug handles, \$5.50. DBP-9J, 5-way dual binding post rated 30 amperes at 1000 volts, AU plated hardware included, package of two, \$14.95. DBP-8, 12 gauge speaker wire, \$43.95 for 100 feet. Include \$2.50 handling charge for orders under \$45. **DB SYSTEMS**, P.O. Box 347G, Jaffrey, NH 03452. T3/82

RAW FRAME SPEAKERS—All Types—All Sizes. Philips C.T.S. Peerless, Polydax, Dealer pricing. **APOLLO ELECTRONICS**, 1437 Santa Monica Mall, Santa Monica, CA 90401. (213) 393-0794. Mon.-Sat. Stuart. T2/82

METAL FILM RESISTORS, RN55, 0.35 watt, 107 values from 10 ohms to 1 Meg., 25¢ ea., 10 per value/\$1.80, 50 per value/\$7.50. Send stamped self addressed envelope for list of values and order form. New gold plated brass rear mount phono jack, \$1.75 ea. Gold plated shielded RCA type phono plugs, \$2.00 ea. Minimum order \$10.00, quantity discounts available. **OLD COLONY PARTS**, Dept. SB, PO Box 243, Peterborough, NH 03458.

AUDAX 10" BEXTRENE cone drivers for Sanders ESL/T.L. woofer system. Performance equal to KEF B-139, at about 1/2 the price. \$66 each post paid. **R. SANDERS**, 1578 Austin St., Atwater, CA 95301. T4/81

CROSSOVERS COILS CAPACITORS
SPEAKER CABINETS & KITS
 Send \$1.00 for Brochure
KUSTOMIZED SPEAKER SYSTEMS
 260-A Glenn Circle
 Powell, Tennessee 37849

SPEAKER KITS. Catalog of home, car and sound reinforcement kits, over 100 raw drivers available, Thiele data, JBL, EV, Audax, Peerless, Foster and JVC ribbons, more. \$2 refundable. **GOLD SOUND**, PO Box 141SB, Englewood, CA 80151. T4/81

JAPANESE RAW SPEAKERS, tweeters, supertweeters, speaker cables. Also cartridges, tonearms, transformers, accessories. All manufacturers lowest prices. **INTERSONICS**, PO Box 113, Toyohashi 440, Japan. T3/82

TESLA TWEETER: At last, a very efficient 8 ohm 40 watt round horn tweeter. Designed and produced by **TESLA ELECTRIC** Company. None finer for under \$40.00. Free brochure, 1029 Marles Drive, Santa Ana, CA 92706. T4/81

OUR FREE CLASSIFIEDS

SPACE IN OUR classified columns is open to subscribers for finding equipment or for selling equipment. This is a personal service. If your ad is for profit, it must appear in the regular Trade classified section, at 25¢ per word.

NEW LIMIT: Because of our new technology we now have more room in the classified section and we're increasing the number of words in private ads to 50 (rather than 40) as before. If your private ad is over 50 words, please send along a check with your text for 15¢ per word over the 50 limit. Number and street count as one word as do Zip codes with the state abbreviation.

PLEASE help us by typing or printing your ad on a separate piece of paper or card—including your name and address exactly as you want it to appear.

YOUR AD will not be repeated unless you re-submit it for subsequent issues. If we receive your ad too late for one issue, it will appear in the next one. Private ads are not acknowledged unless you send us an addressed postcard for the purpose.

ADDRESS all classifieds to "Classified Department." It helps. Please make full use of this service. Your offerings of equipment will delight others who are searching for them. Readers are welcome to use these pages to search for information about equipment.

ACTIVE ELECTRONIC CROSSOVERS

Plug-in Butterworth (maximally flat) filters in 6dB, 12dB, or 18dB per octave attenuation, any frequency specified. Filters flat beyond 100kHz.

Complete crossover in attractive metal cabinet with all terminations and regulated power supply.

STEREO BI-AMP \$139

Tri-amp, quad-amp, and monoaural types available at comparable prices. Other available features: summer for "single woofer" systems, Subsonic noise elimination filters supplied with or without bass boost, level controls.

FOR OEM'S AND HOME ASSEMBLERS

500 Series dual filters and/or plug-in filters, regulated power supplies.

FREE CATALOG & PRICE SHEET

Write to:

DeCoursey ENGINEERING LABORATORY

11828 Jefferson Bl., Culver City, CA 90230
Phone: (213) 397-9668

AUDIO CLUBS

Space in this section is available to audio clubs and societies everywhere free of charge to aid the work of the organization. Copy must be provided by a designated officer of the club or society who will be responsible for keeping it current. Send notices marked *Audio Clubs* in care of the magazine.

PACIFIC NORTHWEST AUDIO SOCIETY (PAS) consists of 50 audio enthusiasts meeting monthly, second Wednesdays, 7:30 to 9:30 PM at 4545 Island Crest Way, Mercer Island, WA. Be our guest, write Box 435 Mercer Island WA 98040 or call Bob McDonald (206) 232-8130.

SERIOUS AUDIOPHILES interested in a central Colorado group (Denver, Boulder, Ft. Collins, Greeley area) contact James S. Upton, 2631 17th Ave, Greeley, CO 80631.

AUDIO SOCIETY WANTED in the Sacramento CA area. Serious audiophiles and dedicated audio amateurs please contact Barry Waldron, 1847 Country Club Drive, Placerville, CA 95667.

and now
FOR SOMETHING COMPLETELY DIFFERENT
offers
5mF 10% 400V metallized polypropylene caps. less than .05%DF \$7.00 ea. ppd.:
J.C. mini monitor, 5 inch polypropylene woofer, ribbon tweeter, polypropylene crossover—\$125.00 ea. ppd.
and now
FOR SOMETHING COMPLETELY DIFFERENT
3016 N.E. Oregon St.
Portland, Oregon 97232

THE BOSTON AUDIO SOCIETY INVITES you to join and receive the monthly B.A.S. SPEAKER with reviews, debates, scientific analyses, summaries of lectures by major engineers. The BAS was the first to publish info on TIM, effects of capacitors, tonearm damping, tuner IM dist., Holman's and Carver's designs, etc. Sample issue \$1. sub, \$12/yr. P.O. Box 7, Boston, MA 02215.

AUDIO SOCIETY WANTED in the Fort Wayne, Indiana area—for serious audiophiles only—contact: J. D. Reynolds, Jr., 703 Nordale Drive, Fort Wayne, IN 46804. Phone (219) 432-1294.

SAINT LOUIS AUDIO SOCIETY meets monthly for discussion and equipment audition. For information sheet send a stamped, self-addressed envelope to SLAS, 7435 Cornell, Saint Louis, MO 63130.

DO YOU LIKE CLASSICAL MUSIC AND AUDIO EQUIPMENT? Would you like to form a small society mixing music listening with audio equipment discussions? If you live in Nassau or Suffolk County New York in the vicinity of Plainview, contact: Alex Soave, 192 Central Park Road, Plainview, NY 11803. (516) 935-1704.

THE AUDIO SOCIETY OF HONOLULU holds meetings once a month and invites you to join. Membership is just \$10 a year and includes a subscription to our newsletter, *The AudioFile*. Call (808) 941-1060 for information about specific meeting times.

Southeastern Michigan Woofer and Tweeter Marching Society

Detriot area audio construction club.

CONTACT: DAVE CARLSTROM 10155 Lincoln^h
Huntington Woods, Michigan 48070 313-54-48453

MINNESOTA AUDIO SOCIETY Monthly programs—Newsletter—Special events, yearly equipment sale. Write: P.O. Box 3341, Traffic Station, Minneapolis, MN 55402.

A CLUB FOR FM AND TV DXers, offering antenna equipment and technique discussions, plus updates from FCC on new station data. Monthly publication "VHF—UHF Digest"; annual convention in August. For more info: Worldwide TV-FM DX Association, PO Box 97, Calumet City, IL 60409.

PRIVATE

FOR SALE: Sheffield classic direct discs, extra copies each only played three times, very clean, but jackets have some ballpoint writing. Prices include UPS and insurance. Vol. II, S-10, \$400; Vol. III, Lab-1, \$400. Dan Shanefield, 119 Jefferson Rd., Princeton, NJ 08540. (609) 924-9450 evenings.

WANTED: Two University Sound (Altec) T-50 Midrange Drivers to fit Cobreflex horns. Howard White, 1029 Marles Drive, Santa Ana, CA 92706.

WANTED: Older, "raw" speakers 12-8" full range coaxials, triaxials only: Norelco like AD5200M, AD4800M (stamped "made in Holland"). Old Univ. like #312, #UC-123, Mustang #M-12T, Spherocon tweeters #T-203. Old Jensen #SG300, #SG223, #SG88. Trusonic (Stephens) 12-8" coaxials, tweeters, #5KT, #RT-1. JBL #LE8T, tweeters #077. Wharfedale 12-10-8", tweeters #3. Singles ok. No cabinets. James Jelinek, 495 W. Citrus, Colton, CA 92324. Call collect (714) 792-0220.

AUDIOPHILE ACCESSORIES

- DBP-2J SWITCH BOX.....\$43.95, AU (gold jacks).....\$52.95
Selects between up to 4 phono inputs. Used with DBP-6 or 6MC, allows for selectable loading of cartridges.
- DBP-6 PHONO EQUALIZATION KIT.....\$32.95
Allows adjusting the input capacitance of the phono input of every preamp and receiver with low loss Polystyrene Capacitors.
- DBP-6MC RESISTIVE LOADING KIT.....\$32.95
Allows adjusting load resistance from 10 to 200 Ohms for moving coil cartridges. Gold plated phono plugs in both kits.
- DBP-8 SPEAKER WIRE 12 ga., in 3, 6, 9 meter and bulk.
DBP-9AU BANANA PLUGS Eight gold plated, solderless.....\$11.95
DBP-9J GOLD PLATED DUAL BANANA JACKS 2pk.....\$14.95
DBP-10 PHONO ALIGNMENT PROTRACTOR.....\$21.95
Allows adjusting the lateral tracking error of a mounted cartridge to within 1/4 of one degree. Non-technical instructions and case included.
- DBP-11 or 11MC loading switch boxes.....\$79.95
- DBP-12 AUDIO CABLE 10 meter (33 ft).....\$65.95
Low capacitance (400pF) stereo interconnect cable, terminated with rugged gold plated phono connectors. Custom lengths available.
- DBP-13J GOLD PLATED PHONO JACKS (1/4") 8 pk.....\$11.95
DBP-13JR GOLD PLATED PHONO JACKS (3/8") 8pk.....\$14.95
DBP-13P GOLD PLATED PHONO PLUGS 8 pk.....\$9.95
DBP-14 GOLD PLATED DUAL BANANA JACKS 2 pk.....\$14.95
DBP-CK CRAMOLIN AUDIO KIT contact treatment.....\$11.95
ELECTRONIC CROSSOVERS...6, 12, 18, 24dB.....Inquire
At your dealer or direct. Orders under \$45, add \$2.50 Handling.

DB SYSTEMS

Box 347A Jaffrey, NH 03452 (603) 899-5121

FOR SALE: 5 pairs of new Jordan 50mm. modules. Serialized and in original boxes. Design data included, \$135. per pair (regularly \$180 per pair). NAD 4020 FM tuner, 1 yr. old in original containers, \$95. Russ Bleakley, (916) 367-2528.

FOR SALE: 2 Symmetry x-overs ACS IA (new in sealed cartons) \$925. both or \$500. each. Pair MAC 60's sequentially serial numbered. Carefully maintained and up to factory specs. Mint. \$700. Patrick Hunter, 550 Baker #6, San Francisco, CA 94117. (415) 921-0870.

FOR SALE: Speaker drivers—prices include shipping: SEAS 33FWKA, 13", \$85; SEAS 21FWBX-DD 8", \$35; SEAS H107 dome tweeters, \$13.; SEAS 13FGMB 5 1/4" midrange, \$18.; Peerless KJ20DMR dome midrange, \$20; Peerless TP 165F 6 1/2" polypropylene cone, \$20; Peerless 5 1/4" polypropylene cone, \$16; Pyle W69C290F 6x9 woofer, \$27; Becker 908A278 8", \$18.; Metal grilles for Peerless 5 1/4" woofers, \$5; Polydax HD17HR37 6 1/2" open-back midranges, \$40. Also, Koss ESP 9 headphones, factory overhaul, \$65; Dynaco Mark VI, new tubes \$600 pr. (no shipping); Signet TK7E, needs new stylus \$50. All drivers new; some have solder marks made during test. Steve Fritz, (805) 969-1977 between 2-7 PST.

FOR SALE: JBL 136A 15" woofers w/new cones \$125. each. ESS-Heil air motion transformer tweeter units \$75. each. Altec 604-C 15" duplex spkrs. w/crossovers \$320. pair. E-V T-350 tweeter horns all w/new diaphragms \$70. each. 4 for \$260. Contact T. Young, 171 Moreland Ave., Waterbury, CT 06705.

BUY SPEAKERS WHOLESALE

WRITE FOR
McGEE'S ELECTRONIC AND
SPEAKER CATALOG

1801 MCGEE STREET
KANSAS CITY, MISSOURI 64109

build your own speaker system
PHONE 1 816 942 5022

Classified

WANTED: Tannoy speakers all models. Arnold Wabnick, 5502-14 Avenue Apt. F-5, Brooklyn, NY 11219. (212) 438-5714 evenings.

FOR SALE: Double pair Bose 901 with selected equalizer-impressive in large room \$500. S. Janows, 2950 N. Oakley Ave., Chicago, IL 60618.

FOR SALE: New pairs: KEF B110, T-27, Falcon LS3-5A crossover, \$170. KEF SP1017 crossover new \$20. Cabinets: 1.5 cu. ft walnut vinyl (large Advent) mint, packing, \$50 pr. Audax HD20B25H4 plus passive radiator plus 6th order equalizer \$125. pair. Drivers, caps, inductors, SASE for list. Realistic SLM mint \$30. Tom Sutkowski, Box 96, Canton, CT 06019. (203) 693-6067.

**High-End Audio
DISCOUNTED!**

THE VERY BEST IN HIGH-END EQUIPMENT: ADCOM, ATRIA, AR, BOSE, DBX, DENON, HAFER, HARMON-KARDON, INFINITY, JBL, JVC, MITSUBISHI, NAD, NIKKO, ORSONIC, SAE, SONY, THORENS AND OVER 100 MORE HIGH-END BRANDS!

FOR PRODUCT INFORMATION & DETAILS PHONE:

(914)258-4077

SOUND SHED HI-FI

MERRITS ISLAND ROAD, PINE ISLAND, NEW YORK 10969

ORDERS ONLY CALL TOLL FREE

800-431-3122

9 A.M. to 9 P.M. Monday - Friday, 9 A.M. to 4 P.M. Saturdays

FOR SALE: 15 pounds ads and speaker construction articles, mostly '50's to '70's, \$25. Eleven issues British HiFi Annual, same years, hundreds illustrated priced listings in each, \$30. the lot. Pair Stephens Trusonic full range 8" \$30. Variable mixing network with diagram and directions for Stephens satellite system \$15. Pair Celestion tweeters, from 1300Hz, unused \$30. Alex Shaw, La Jolla, CA (714) 454-8661.

FOR SALE: SEAS 33F-WKA 13" woofers, brand-new unmolested, same units as used in Dahlquist and Rogers subwoofers, \$60.00 each plus UPS shipping. Enclosure designs provided with purchase if needed. David Barnett, 8523 Linda Lane, Little Rock, AR 72207 (501) 225-4736 evenings and weekends.

FOR SALE: Two for one tape recorder sale. Two superb portables: a Nakamichi 350 cassette recorder w/battery carrying case and a Uher 4000 record-S reel-to-reel w/AC pack. Both for \$400. plus shipping. Roger Beinsh, (603) 279-4102 evenings.

FOR SALE: High quality polycarbonate film caps, radial leads, metal body with glass and seals, 2.0mFd. @ 200V., new, 5 for \$12 ppd, 10 for \$20. Dick Nelson, 3470 Travis Ave., Simi Valley, CA 93063. (805) 526-7066.

FOR SALE: Ampex F-44 fine line series reel-to-reel tape deck. All new tubes, mint. cond. \$125. Tektronix time base plug in for 5000 series scopes model 5B42 delayed sweep. Cost \$650 sell for \$350. Advent receiver model 300 \$125. William Rathyen, 137 Rodney Ave., Somerset, NJ 08873. (201) 249-2535.

WANTED: Dyna A-25 speakers and Magnaplanar feet. Rich Davidson, 501 Paige Loop W, Los Alamos, NM 87544. (505) 672-1094 evenings.

WANTED: Dynaco MK III tube cages must be good cond. PC boards for ST-70 MK III's and PAS preferably blank and new, face and knobs for PAS-3, must be mint or new, 45RPM adaptor for Linn, Audio Amateur issues 72, 73, 74. Nick Palladino, #2095 33 Village Road North, Brooklyn, NY 11223. (212) 996-2252.

FOR SALE: ARC SP-4A, mint, reasonable; (4) 8045G triodes new in box, \$50 all; Phase Linear 700 (early model), one channel out, other good, make offer; will consider trading SP-4A for mint SP-6A or mint Marantz 7C. Joel Estes, (817) 244-2356; 3101 W Normandale #1043, Ft. Worth, TX 76116 call weekends.

FOR SALE: McIntosh MX-113 Tuner-Pre \$380; SAE 3000 pre & 2200 pwr both \$490; 30 pre & 31B pwr \$290; Sony: FX6C Dolby "C" deck \$295; PS-X600 Biotracer \$285; IMA port. radio AM/FM/SW/PSB/Weath/Police /CB & all TV chans, (\$229 list) \$40 incl. AC cord/Rappaport Pre-1 \$200/Phase III metal box mini, sim ADS 200C \$70/pr. Wm. Gabriele, 1334 Chapel St, New Haven, CT 06511. (203) 777-1476.

WANTED: Bruel & Kjaer used 1", 1/2" or 1/4" free field microphones or info where can be obtained. John Koval, 11521 Cielo Pl., Santa Ana, CA 92705. (714) 838-6555.

FOR SALE: Hartley 220 MSG's, 10" full range drivers, factory matched pair. Unused, \$220. Joe Dappolito, 9 W. Knoll Rd., Andover, MA 01810. (617) 470-1346.

FOR SALE: Two Symmetry ACS-1A active x-overs \$795, each new (still in sealed cartons) both \$905, or \$475 each. Two MAC-60's sequentially serial numbered, carefully maintained & up to factory specs with KT-88's and Allegro 12AX7B's gold plated "hot" tubes \$695. P.W. Hunter, 550 Baker St., #6, San Francisco, CA 94117. (415) 921-0870.

MOGAMI

Complete line of world renown high definition audio cables now available in U.S. Mogami is a world leader in the research and manufacturing of advanced audio and video cables.

TONEARM-INTERCONNECT-SPEAKER-MICROPHONE-
GOLD PLATED PLUGS & CHASSIS JACKS

MOGAMI PRODUCTS DIV.

P.O. BOX 2027

CULVER CITY, CALIF. 90230 (213) 836-4288.

FOR SALE: Peerless K010DT 1" dome tweeters, \$8. each. Peerless K040MRF 4" sealed midranges, \$10. each. Philips 10" woofers qts .32, Fs 32Hz. Used in top quality systems ie Snell, Mariah, and Sequerra. Larry Hunsicker, home (914) 586-3161, work, (914) 586-3295.

FOR SALE: Oaktron 10" woofer, all parameters measured, suitable for sub-woofer in approx. 5 ft. box, \$49. ppd. Tom Nousaine, 1584 Chantclair, Wixom, MI 48096. (313) 223-9105 or (313) 669-9302 eves.

McIntosh MC240 amplifier, \$200; large transformer for Leach 250 watt amplifier, \$80. each. Capacitors for Leach amp, 13,000 mFd. 4/\$36.00. Hewlett Packard 200AB audio signal generator, \$45. Kent Siegenthaler, 11805 102 Pl. N.E., Kirkland, WN 98033. (206) 823-2165.

WANTED: Karlson "clam" speaker enclosure plans or will consider purchasing boxes. Also need plans for RCA theatre horns. Contact Tom Young, 171 Moreland Ave., Waterbury, CT 06705. (203) 575-9786.

ADVERTISING INDEX

Ace Audio	4
Audio Control	Cover IV
Audio Horizons	46
Badger Sound	41
dB Systems	45
DeCoursey Labs	45
Direct-To-Tape	4
Dynamic Acoustics	29
Hall Engineering	44
Hartley Products Co.	41
Integrex	37
JMS Systems	40
KEF Electronics	3
King Speaker Systems	37
Customized Speaker Systems	44
Madisound	44
Marcof Electronics	4
Marshall Electronics	46
McGee	45
New York Audio Labs	35
Old Colony Bargains	42
Old Colony Books	Cover III
Old Colony Circuit Boards	30
Old Colony Kits	21
Old Colony Parts	19
Phoenix Systems	40
SEAS	17
Something Different	45
Sonix	2
Sound Concepts	42
Sound Shed Hi-Fi	46
Speaker Builder Binders	42
Speaker Supply	43
Speakerworks	23
SRC Audio	38
Transcendental Audio	27, 31
Transducer Technology & Design	43
University Microfilms Int'l	43

AUDIO HORIZONS

P.O. BOX 10973
ST. LOUIS, MISSOURI 63135

Issue #5 is now available. It contains reviews of the ACM Linn platter assembly, the CART-A-LIGN alignment protractor, the JMAS moving-coil cartridge, LAST record treatment, the ACM, LEVINSON "Silver", and MENDOTA interconnecting cables, the MAGNEPAR Ultrac 1 pickup arm, the MARCOF PPA-2 headamp, the ORSONIC DS-250 disc stabilizer, the SUMO "Nine" power amp, and the WIN LABS SDC-10 turntable. Issue #5 also features a survey of 9 turntable mats, and another survey of 19 speaker cables.

Subscription rates to AUDIO HORIZONS for four (4) issues are: U.S.A. - \$20 (FIRST CLASS MAIL); Canada and Mexico: \$22 (FIRST CLASS MAIL); and outside North America: \$24 (AIR MAIL). PLEASE REMIT IN U.S. FUNDS ONLY. Sample copies of all issues are available for \$6.00 each (U.S.A., Canada, and Mexico), and \$7.50 each (outside North America).

HOWARD W. SAMS

S-5 AUDIO CYCLOPEDIA, [2nd Ed.] by *Dr. Howard M. Tremaine*. Twenty-five sections covering everything from basic theory to solid state. A complete audio reference library in itself, the most comprehensive and authoritative work on audio available. Covers every aspect of the audio art—from the basic principles of sound to the latest in solid-state equipment. 3,650 entries, 1,760pp., hardbound. Each \$39.95

S-11 HOW TO BUILD SPEAKER ENCLOSURES, by *Alexis Badmaieff and Don Davis*. The "whys" and "hows" of speaker enclosures. Drawings and instructions cover infinite baffle, bass reflex, and horn types plus combinations. 144pp., softbound. Each \$4.95

S-12 IC OP AMP COOKBOOK by *Walter G. Jung*. [2nd Ed.] The revised bestselling, authoritative, best introduction to practical op amp usage available. By TAA's op amp columnist and author. 480 pp., softbound. Each \$14.95

S-14 ACTIVE FILTER COOKBOOK by *Don Lancaster*. A practical, user-centered volume with everything you need to build your own active filters. Explains the various types and how to select the best for your circuit. 240pp., softbound. Each \$14.95



DOVER BOOKS

D-1 REPRODUCTION OF SOUND, *B Edgar Villchur*. An elegantly simple 92-page paperback primer on the subject by the man who invented the bookshelf speaker. Loan or give it to friends who want to build a system as good as yours. Each \$2.00

D-3 MUSIC, PHYSICS AND ENGINEERING by *Harry F. Olson*. A thorough introduction to the physical characteristics of sound and the relationship of sound to musical instruments by the former head of staff at RCA's lab for acoustical and electromechanical research at Princeton, NJ. A classic by one of the giants in the audio field. Good, easy to read chapters on acoustics, mikes and recording, recording and playback systems, as well as an electronic music chapter. 2nd. Ed. (1967) 460pp., softbound. Each \$6.00

The PENGUINS

P-2 A NEW DICTIONARY OF ELECTRONICS by *R.V. Young*. This remarkably compact reference covers electronics from A-Battery to Z-parameters with succinct, concise definitions and illustrations. A quick reference completely revised and updated with lots of added charts and reference data. 618pp., softbound. Each \$4.95

P-3 A NEW DICTIONARY OF MUSIC (THIRD ED., 1973; FIRST PUB. 1958) by *Arthur Jacobs*. Alphabetically arranged entries covering composers, individual musical works, orchestras, performers, conductors, musical instruments, and technical terms. 458pp., softbound. Each \$3.95

SCELBI

SC-1 SCELBI'S SECRET GUIDE TO COMPUTERS by *Russell Walter*. An absolutely first rate beginner's book about computers. Explanations about computers that anyone with an IQ over 95 can understand. Written with wit, humor and a secret phone number to call if all else fails. 100 pp. 8½x11, paperbound. Each \$5.95

SC-2 UNDERSTANDING MICROCOMPUTERS AND SMALL COMPUTER SYSTEMS by *Nat Wadsworth*. A clear, comprehensive introduction to microcomputers with excellent images for visualizing what a computer does and how it does it. Includes a comprehensive glossary and a good chapter on how to choose a system. 306 pp., 5½x8½, paperbound. Each \$9.95

TAB BOOKS

T-3 THE BUILD-IT BOOK OF MINIATURE TEST AND MEASUREMENT INSTRUMENTS by *Robert Haviland* is a general electronic constructor's manual as well as a source for test instrument usage, design, and construction. An interesting and different sourcebook. 238pp., softbound. Each \$4.95

T-4 HOW TO DESIGN, BUILD AND TEST SPEAKER SYSTEMS by *David Weems*. A cookbook approach to speaker design with some 21 tests for performance. Individual drivers are specified for actual building projects. Weems likes closed box and reflex enclosures but is skeptical of transmission lines. 336pp. Softbound. Each \$7.95

HAYDEN BOOKS

H-8 BUILD YOUR OWN HIGH-QUALITY, LOW-COST TEST EQUIPMENT by *M.J. Salvati*. Especially written for the do-it-yourself craftsman who wants to build his own one-of-a-kind test gear especially tailored for highest performance. A wealth of circuitry including a \$40 harmonic distortion analyzer, a DC voltmeter, a breadboard electronic load, and much more. 140pp., softbound. Each \$7.25

H-10 HI-FI LOUDSPEAKERS AND ENCLOSURES by *Abraham Cohen*. [2nd Edition]. Speaker theory covers how and why of drivers, enclosures and rooms. Brief discussions of measuring and building are included along with advice on placement of stereo speakers. 438pp. Softbound. Each \$11.60

FONTANA BOOKS

FT-1 INTRODUCING AMATEUR ELECTRONICS by *Ian Sinclair* is a primer of both elementary theory and basic construction techniques. For beginners who want a survey to introduce them to the field. Tools, simple theory, circuits, component descriptions, measurements, and much more. 88pp., softbound. Each \$4.50

FT-2 HAND TOOLS FOR THE ELECTRONICS WORKSHOP by *Harry T. Kitchen*. An excellent basic introduction to tooling the amateur's workbench for electronics construction. Good chapters on cutting, measuring, drilling, tapping, and soldering. 124pp., softbound. Each \$4.95

McGRAW-HILL

MH-1 HANDBOOK FOR ELECTRONICS ENGINEERING TECHNICIANS by *M. Kaufman and A.H. Seidman*. A comprehensive compendium of electronic facts. Component selection, circuit analysis, power supplies, IC uses and characteristics, op amps, transistors, batteries and tubes. A one-volume encyclopedia on how components work and how to choose the best of them for your application intelligently. 740pp., softbound. Each \$26.00

WILEY BOOKS

W-1 HIGH PERFORMANCE LOUDSPEAKERS (2ND ED.), by *Martin Colloms*. Highly praised sourcebook on loudspeaker theory and construction by a top-notch English authority. 245pp. Hardbound. Each \$27.95

NEWNES CONSTRUCTOR'S GUIDES

H-1 ELECTRONIC DIAGRAMS by *Morris A Colwell*. A beginner's introduction to electronic diagrams of all sorts: schematics, block, layout, and circuit board. Symbols, interconnections, circuit elements, representational conventions are all explained. Basic symbolic language for the electronics enthusiast. 112pp., softbound. Each \$7.50

H-4 SIMPLE CIRCUIT BUILDING by *P. C. Graham*. A beginner's approach for simple circuits to step-by-step guidance from the very elementary circuit through increasingly complex circuitry. Circuit board layouts, logic modules, ICs, power supplies, AC amps, and more. A good way to cut your teeth on building if you have no previous experience in electronics. 128pp., softbound. Each \$6.95

ORDER BLANK:

Old Colony Sound Lab
PO Box 243
Peterborough NH 03458

To order from Old Colony Sound, please write each book's number below with quantity of each and price. Total the amounts and remit by check, money order, or MasterCard, or Visa/BankAmericard. Please add 50¢ for postage on the first book; 25¢ per additional book. \$10 minimum order on credit cards. Canadians please add 10% for postage. All remittances must be in U.S. funds. Please use clear block capitals.

Name _____
Street & No. _____
Town _____
State _____ ZIP _____

No. Bks.	Price
.... Book No.	\$.....
.... Book No.	\$.....
.... Book No.	\$.....
.... Book No.	\$.....
Postage	\$.....
Total \$.....	

Please add \$1 service charge to all charge card orders under \$10.

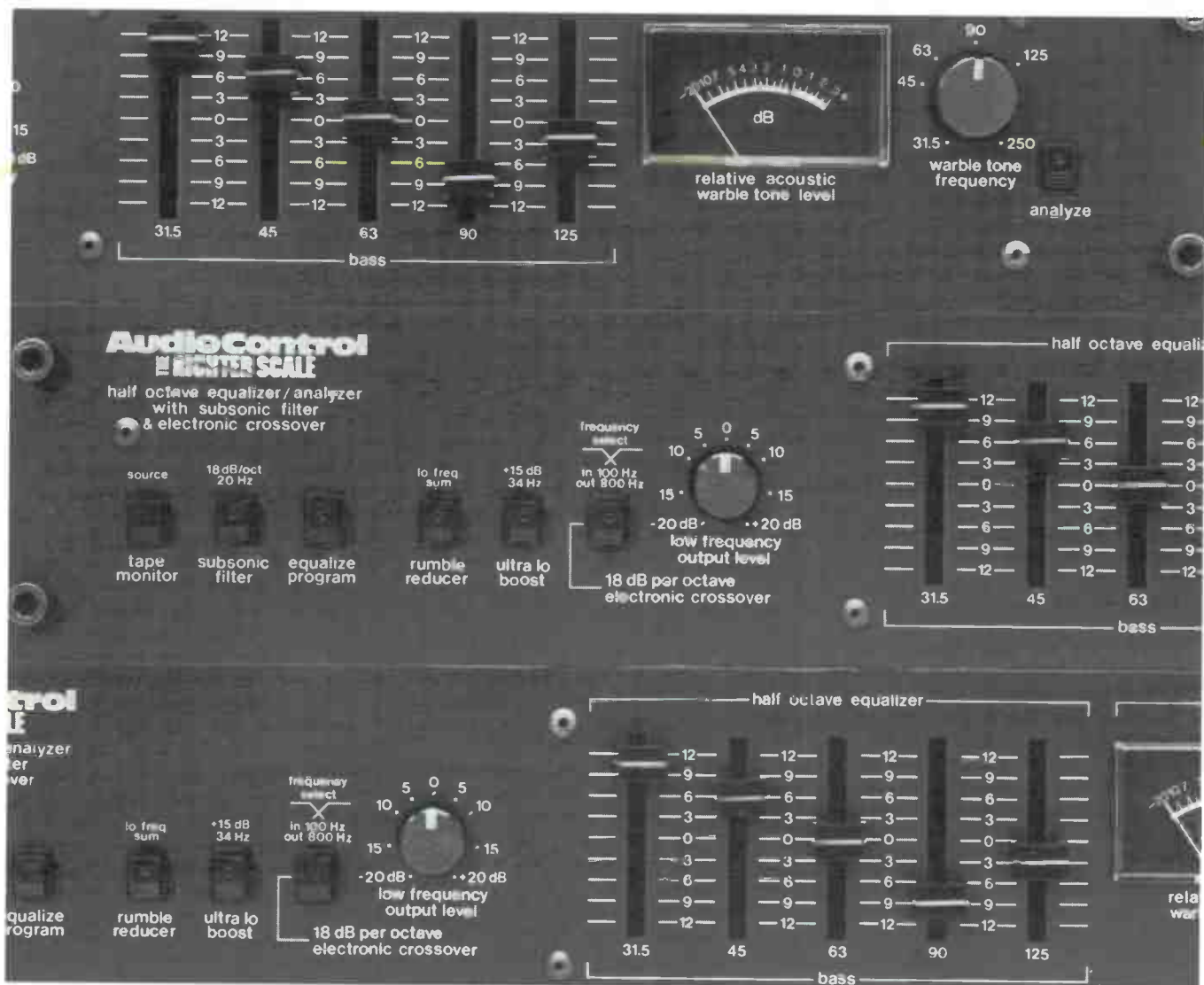

NEW HOPE FOR UNDERSIZED BOTTOM ENDS.

 The Richter Scale™ is the world's first half-octave bass equalizer with built-in electronic crossover, Rumble Reduction Circuit, 18dB/octave Subsonic Filter, Ultra-Low Bass Boost circuit, sweepable Warble Tone Generator and Measurement Microphone. All in a unit just 14" x 2.5" x 6."

For precise equalization the Richter Scale employs a half-octave Warble Tone, the same type of test source used by B&K for calibration of its precision microphones under 150Hz. The stereo output tone is read with an Audio Control phantom-powered condenser Measurement microphone and a special damped ballistics dB meter.

The Richter Scale's Rumble Reduction circuit mono's bass under 200Hz to cancel vertical record components and tonearm resonances.

The 18dB Tchebechev subsonic filter is down 24dB at 10Hz.

An Ultra-Low Bass Boost



shown: D-11 octave/analyzer, R/S, D-10 octave

circuit adds +15dB at 36Hz, seemingly an overabundance of EQ, but in reality barely compensation for the cumulative loss from microphones, analog tape, and mastering, not to mention wimpy woofers.

The electronic crossover is a special asymmetrical design with 18dB/octave roll-off of bass and 6dB/octave roll-off of treble. In addition to 100Hz subwoofer and 800Hz 3-way crossover points, the unit is dealer modifiable to any other custom crossover point. A recent Stereo Review evaluation observed less than ±.25dB deviation from flatness across the whole audio spectrum.

Overall distortion was found to be .003% compared to our modest .015% published spec.

How much?

\$249.

For either a half-octave equalizer/analyzer or electronic crossover alone, a stunning price.

Write us for more information.

And then enlarge someone's bottom end soon.

AudioControl

6520 212th SW Lynnwood, WA 98106