

2/1981

SPEAKER BUILDER

US \$3.00

UK £1.25 | 15 Fr.

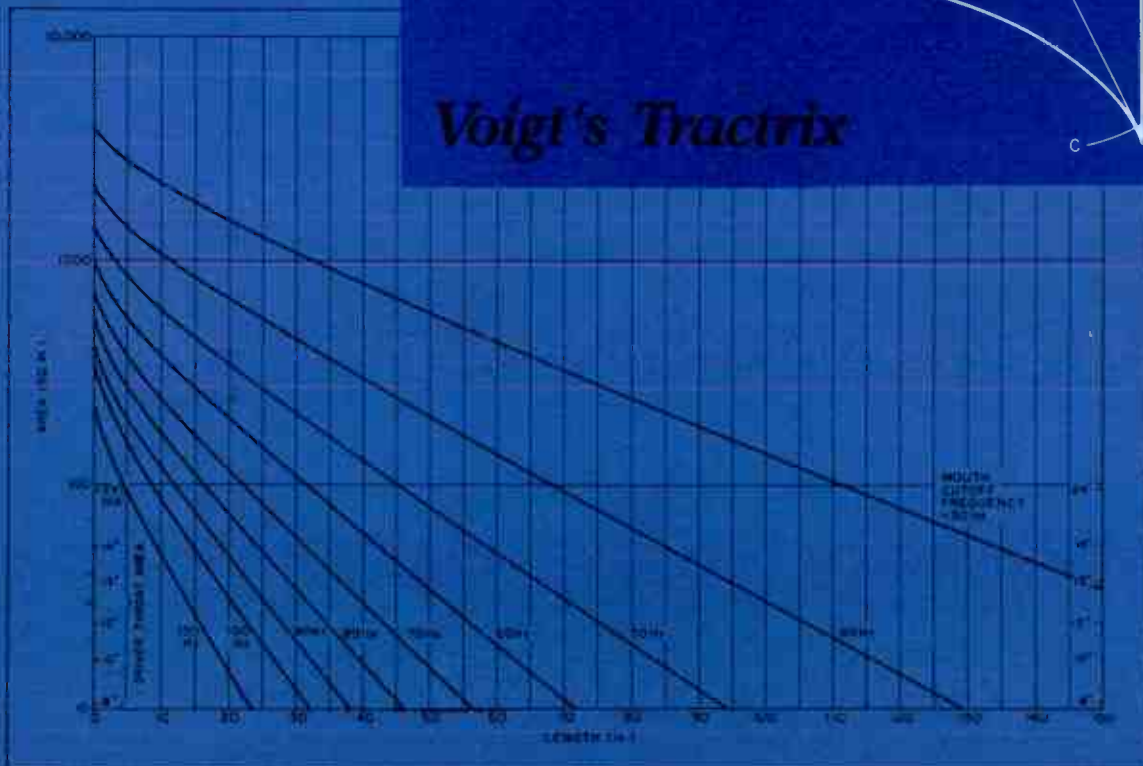
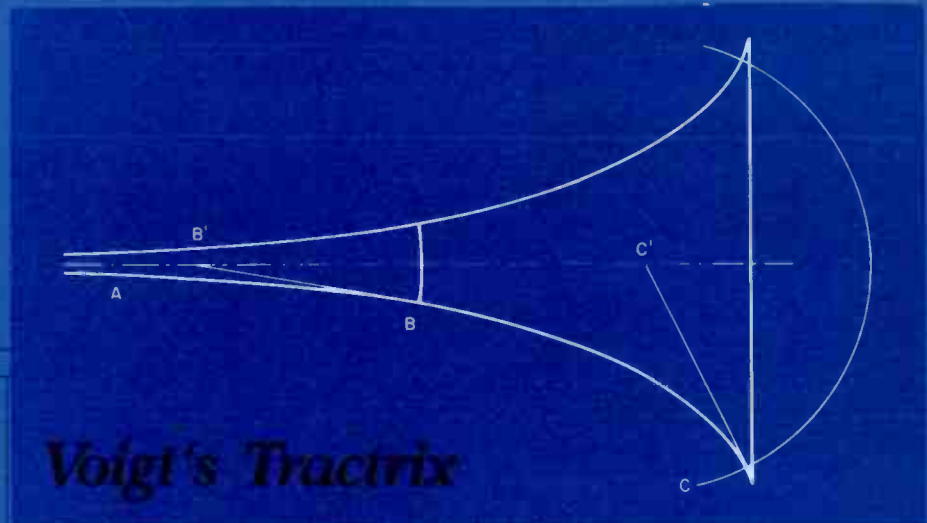

Listen,



If you haven't heard the PPA-1, you haven't heard your moving-coil cartridge. Audition the Marcof PPA-1 Pre-preamplifier at fine audio dealers.

Marcof Electronics

7509 Big Bend Blvd.,
Webster Groves, MO 63119

IMPROVE YOUR COST/PERFORMANCE RATIO 3 DB*
PUT YOUR MONEY WHERE IT REALLY COUNTS, IN QUALITY
COMPONENTS AND A HIGH PERFORMANCE DESIGN.
BUY A PHOENIX SYSTEMS KIT.

FOR SALE:

PARAMETRIC EQUALIZER KIT

ANALOG DELAY LINE KIT (MONO)

(STEREO)

TAPE NOISE REDUCTION KIT

HP/LPF (-12db/OCT)

SAD-4096 ASR

PRICE INCLUDES SHIPPING

P-94-S \$ 99.00

P-25-DL \$150.00

P-25-SDL \$250.00

P-518-S \$ 65.00

P-91-S \$ 15.00

P-4096 \$ 45.00

SEND FOR SPECS/CATALOG

PHOENIX SYSTEMS/91 ELM ST./MANCHESTER, CT 06040

(203) 643-4484

*3DB FIGURE BASED ON APPROXIMATE DOUBLING OF DBS (DOLLAR POWER)

Good News



The giant **Radio Shack** organization has a kit speaker offering, three-way with a passive crossover and a claimed 45Hz to 22kHz response as well as a 60Hz system resonance. Plans for a suitable enclosure are included in the under \$80 price. For that you get a 12" woofer with 20 oz. magnet, a 5 1/4 cone midrange with 5.3 oz. magnet and a soft dome tweeter. Crossover frequencies are at two and seven kilohertz. Your local dealer has details. Ask about #40-3025. Further data by writing Radio Shack, P.O. Box 2625, Ft. Worth TX 76101.

For a long while US speaker builders looked longingly at an English line of rugged drivers sold under the name of **Fano**. It is good news that Pignose Industries is now appointed U.S.A. distributor for this impressive line of drivers. Their ruggedness is aimed to serve music performers and the music industry but those qualities could be very useful in home systems as well. The line includes horns, cone drivers, and electronic crossovers. Ask for a brochure on their "Specialist Series" and any special interest you may have, by writing to Fane-America, 16134 Covello St., Van Nuys CA 91406.

Tiny speakers continue to appear in the marketplace. **American Acoustics Labs** has a 14 1/2x9x9 that sports a 5" woofer and a one inch soft dome tweeter. The acoustic suspension system also sports a rear firing 6" passive radiator with 16 oz. magnet on the woofer and a 10 oz. on the tweeter. The IM-96 is designed to work in a bookshelf or on a stand. The price is \$239. per pair. Information from 629 W. Cermak Rd., Chicago IL 60616.

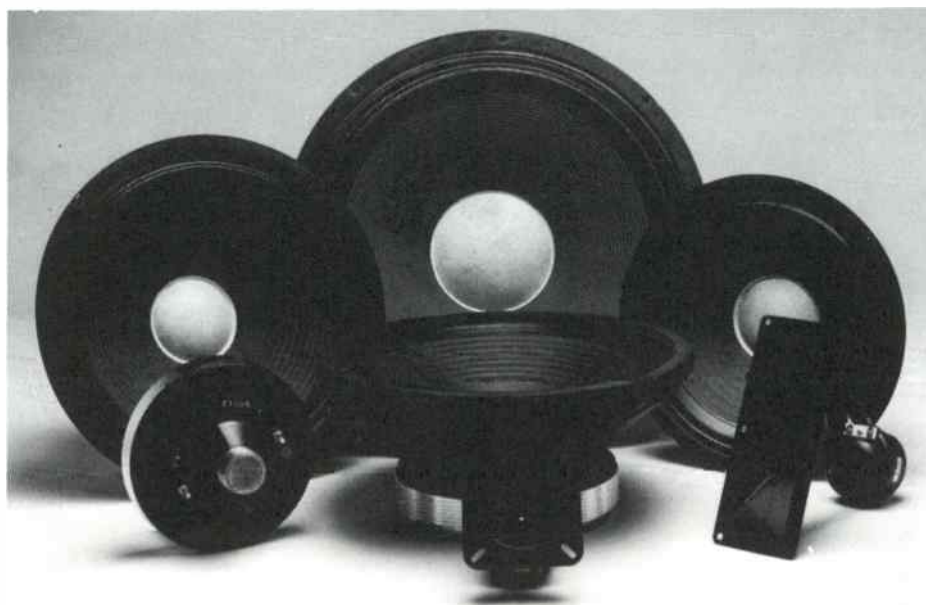



Everyone, it seems, is finally discovering the virtues of electronic crossovers. **Electro-Voice** is adding the XEQ-2 crossover/equalizer to its line of professional music sound systems. A two-way design, it is available crossed over at either 500 or 800Hz, or with a module for building three ranges of crossover points into the device. It can be operated "flat" or with a continuously variable equalization control for frequencies above 5kHz. Low frequency time delay is also available, adjustable between 0-2 milliseconds. User net on the unit is \$349.95. Details are available by writing to the company at Dept. 38SB, 600 Cecil St., Buchanan MI 49107.

For a look at what can be done—and is—with tiny speakers in minimum enclosures you could do worse than ask for **Visonik's** new brochure on its David speakers. As the name implies, the David line proposes to challenge the larger goliaths of the speaker field. If their response curves indicate anything about how these devices sound, they are worth a listen. Visonik is located at 701 Heinz Ave., Berkeley CA 94710.

Jon Dahlquist is one of the audio industry's remarkable figures—and all the more so because he cares about honesty and quality. His speakers have garnered an enviable amount of acclaim and interest among dedicated audiophiles. He has written a short pamphlet dealing with the basic terms of reference about loudspeakers. It is certainly a welcome offering from someone of Dahlquist's standing. It should be helpful to anyone trying to comparatively evaluate speakers. The nicest thing about the pamphlet is the absence of any selling hype about the Dahlquist line. In any case, the five-page "Hearing and Believing: A Guide to Loudspeakers for the Music Listener" is free for the asking by writing Dahlquist, Inc., 601 Old Willets Path, Dept. SB, Hauppauge NY 11787.

The people who make the large costly **Beveridge** electrostatics tell us that in response to "the marketplace...crying out for a sound system that satisfies the discerning ear..." they have a smaller version of the cylindrical Beveridge which sells for just under \$3k per pair, and stands only 63" high. The System 4, as it is called, was introduced at the Winter CES. Claimed performance specs include a ± 3 dB from 33Hz to 20kHz and SPL of 106dB at 3.3 meters in a 13'x26' room. They are electrostatic above 200Hz with a woofer covering the 33-200Hz area and require a minimum of 50W per channel, 300W maximum. For more information address your query to Harold Beveridge Inc., 505 E. Montecito St., Santa Barbara CA 93103.

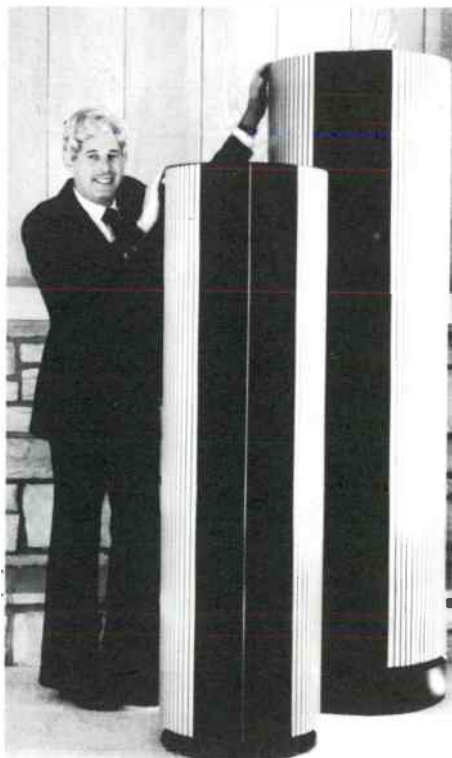

KEF KITS



Now you can "build the best in confidence," as two of KEF's best-selling speaker systems—the Model 104aB and Cantata—are now available in kit form, enabling you to easily assemble a high quality speaker system at a considerable savings. And, because they are kit versions of two of our best-selling speaker systems, you can actually audition the units at your KEF dealer *before* buying and assembling.

KEF speaker systems are designed and built using a Total System Design Concept, whereby each part is developed to complement all others in the system so as to achieve the targeted performance.

The KEF Cantata kit consists of a bass unit, midrange unit, tweeter and an Acoustic Butterworth filter, and builds into an acoustic suspension loudspeaker system with a power handling capability of 100 watts.

The KEF Model 104aB kit consists of a bass-midrange unit, tweeter, Acoustic Butterworth filter section, plus an acoustic bass radiator to increase the bass response from such a modest-sized enclosure. The kit makes up into a bass reflex system with a power handling capability of 150 watts.

Both the kits include fuse units to protect the drive units, and contour controls to adjust the final acoustic output to suit the listening room.

Loudspeaker kit building has now been raised to a new level of ease and reproduction quality.

For more details and the name of your nearest KEF dealer where you can hear just how good our KEFKITS are *before* your purchase, write to us at the address below. Individual drive units and crossover networks are also available for your special custom requirements.

KEF Electronics, Ltd., c/o Intratec Department E, P.O. Box 17414, Dulles International Airport, Washington, DC 20041.

In Canada: Smyth Sound Equipment Ltd., Quebec.

KEF

Do you own a tape deck?

Then write for our free brochure and current special offers

Direct-To-Tape Recordings

- Natural Sound
- Talented Performers
- No compression, equalization or limiting
- Available on reels, [2/4 track, optional dolby or dbx II], cassettes and cartridges
- Duplicated at playing speed

Blank Recording Tapes

- Top quality cassettes at super prices
- ASF and DIRECT II cassettes in special longer lengths [C-66/C-68 & C-96]
- AGFA open reel tapes—the best open reel tapes
- AMPEX video tapes

Custom Duplicating

Direct-To-Tape Recording Co. Dept. SB
14 Station Ave., Haddon Heights, N.J. 08035

BUILDER PURISTS

The audio industry was founded by dedicated builder purists like you, seeking new and novel approaches to sound reproduction.

We started that way over fifty years ago and still maintain that same dedication to the ideal of utmost quality, a fact which is reflected in the products we manufacture; including raw drivers for the builder. We invite you to write or call to learn more about our products:

DRIVERS: 7" Dual voice coil midrange/tweeter
10" Dual voice coil full range
18" Parallel wound voice coil subwoofer with heat sink
24" Parallel wound voice coil ultra-woofer with heat sink

FEATURES: All-polymer cones
High speed magnetic suspension
Equalized Flux Magnetic structures
Sand-cast aluminum frames
100% hand fabrication
200% quality control

ACCESSORIES: 3-way passive crossover
TF-1 natural fiber cellulose damping material
Terminals and binding posts

ALSO NOW AVAILABLE: We are your **only** source for the ultimate **speaker wire. . . REFERENCE CABLE**



Write for free brochures, specs, cabinet recommendations and prices.

Hartley Products Corp., Box 316B, Ramsey, NJ 07446
(201) 327-4443

VOLUME 2, NUMBER 2

MAY 1981

SPEAKER BUILDER

MAGAZINE

EDWARD T. DELL, JR. *Editor/Publisher*
NELSON PASS *Contributing Editor*
W. MARSHALL LEACH *Contributing Editor*
JUDITH CADIGAN *Associate Editor*
KAREN HEBERT *Editor's Assistant*
BETTE PAGE *Production*
NANCY NUTTER *Circulation Director*
TECHART ASSOCIATES *Drawings*

Editorial and Circulation Offices:

P.O. Box 494

Peterborough, New Hampshire 03458 U.S.A.

ADVERTISING REPRESENTATIVE

Robert H. Tucker

316 St. James Place, Philadelphia, PA 19106

Telephone (215) 627-5326

Speaker Builder is published four times a year by Edward T. Dell, Jr., P.O. Box 494, Peterborough, NH 03458. Copyright © 1980 by Edward T. Dell, Jr. All rights reserved. No part of this publication may be reprinted or otherwise reproduced without written permission of the publisher.

SUBSCRIPTION RATES

In the United States and Possessions

One Year (four issues) \$10

Two Years (eight issues) \$18

Elsewhere

Special Rates available on application in:
UNITED KINGDOM:

J.L. Lovegrove, Leazings, Leafield,
Oxford, OX8 5PG, England.

FRANCE:

Ainsco (France)

17, rue Saint Louis-en-l'Île, 75004—Paris.
Tel. 329-45-20.

ALL SUBSCRIPTIONS are for the whole year only. Each subscription begins with the first issue of the year and ends with the last issue of the year.

To subscribe, renew or change address in all areas outside the UK or France write to Circulation Department, P.O. Box 494, Peterborough, NH 03458. For subscriptions, renewals or changes of address in the UK or France write to addresses above. For gift subscriptions please include gift recipient's name and your own, with remittance. Gift card will be sent.

A NOTE TO CONTRIBUTORS:

We welcome contributions for possible publication in the form of manuscripts, photographs or drawings, and will be glad to consider them for publication. Please enclose a stamped, addressed return envelope with each submission. While we cannot accept responsibility for loss or damage, all material will be handled with care while in our possession. Receipt of all materials is acknowledged by postcard. Payment is on receipt of author's approved proof of materials. Contributions should be sent to Editor, *Speaker Builder*.

SPEAKER BUILDER MAGAZINE (US ISSN 0199-7920) is published four times a year at \$10 per year; \$18 for two years, by Edward T. Dell, Jr. at 5 Old Jaffrey Road, Peterborough, NH 03458 U.S.A. Second class postage paid at Peterborough, NH and pending at additional mailing offices.

POSTMASTER: If undeliverable send PS form 3579 to P.O. Box 494, Peterborough, NH 03458.

SPEAKER BUILDER

7 **Thick as a
Brick: Easy
Enclosures**

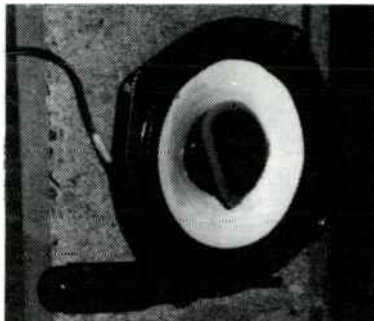

by D. R. Martin

2 **Good News: From the world of loudspeakers**

6 **Editorial: Digital and Speakers**

9 **The Tractrix
Horn Contour**

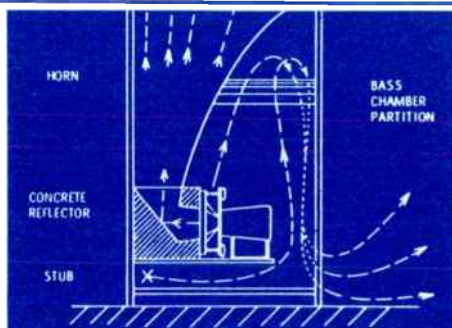

by Bruce C. Edgar

26 **Loudspeaker Literature**

by Hunter Kevil

18 **Thiele, Small and Vented Loudspeaker Design Part III
Fine Points of Speaker Design**

by Robert M. Bullock, III

32 **Mailbox**

35 **Classified**

32 **Corrections**

38 **Ad Index**

16 **The Diffuser
Port For
Small Boxes**

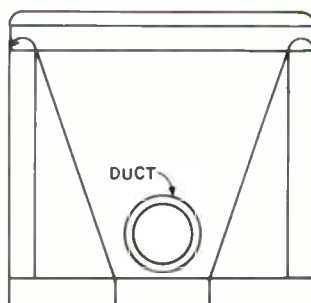

by G. R. Koonce

Digital and Speakers

About this issue

D. R. Martin's leadoff article this time is just the sort of project I look for as an editor. An experienced author, Martin had a practical need for extension speakers and wedded the need to a good idea he saw in a do-it-yourself publication in England. Concrete enclosures aren't new—but the idea is still primary to good sound reproduction.

I'm sure there are other variations possible too.

Let's hear about them.

Bruce Edgar's Tractrix horn piece, page 9, is a bittersweet monument to the memory of Paul G.A.H. Voigt who died February 9, 1981. Voigt began to experiment with horns in the 1920's and missed being the primary holder of the patent on the moving coil speaker by a matter of weeks. Edgar's piece is a fine introduction to the Tractrix. Fortunately for us all, Edgar is preparing materials for an interview with Voigt which will appear in an upcoming issue. G.R. Koonce gives us another of his excellent and continuing pieces this time, on a special kind of port for tiny cabinets on page 16.

And Robert Bullock is back with Part III of his excellent continuing series on Thiele and Small, this time with some very practical suggestions on building techniques. Hunter Kevil gives us four months of 1980's rich harvest of speaker-related articles—even to particle board characteristics and glue surveys.

Next time we will return to some of our smaller features and your offerings to Tools, Tips & Techniques, Craftsman's Corner, and more books in review.

Digital calls up images of the new style of making sound recordings and of the new TV discs just making their appearance. But other, smaller omens appear on our horizon here at *Speaker Builder*. We have just corrected proof on our first article containing a programmable calculator program—and taken delivery on a new computer of our own for doing circulation fulfillment, business and inventory tasks. That sort of digital points in a different direction for those of us who care about good sound.

Although computers are becoming a commonplace in business today, we think the programmable calculator and the micro-computer are going to figure more and more prominently in our effort to build better loudspeaker systems. In planning for the founding and growth of *Speaker Builder* we had visions of lots of pieces on specific projects involving cabinet size, cutting guides and crossover specs.

The announcement of *Speaker Builder's* birth, however brought the editor an amazing amount of mail from would-be authors who were already hard at work on converting speaker theory into hardware—experimental to be sure—but they were chin deep into extrapolations of Thiele/Small theory. The sawdust and sandpaper were always the ultimate goal to be sure. But the matter of searching out an ideal design was what was on the minds of those who wrote to me about articles. It was as though Thiele and Small had promulgated an announcement of what the geography of a new country might look like if anyone was willing to make the voyage and then proceed to the actual mapping of the countryside.

The loudspeaker cartography project has been well begun in *SB's* pages by Bullock, Saffran, Koonce and others. And more is to come.

This little treatise is by way of an invitation to all readers of *Speaker Builder* to begin thinking in terms of the programmable calculator (probably the TI-59 or the HP-41) or about one of the smaller computers. The chief candidates appear to be the Radio Shack, the Apple, and Heath's H-89 or H-19 with the H-8. The language will doubtless be some form of Basic.

For perspective let's dream a little about what might be possible. With some form of mass storage we might just begin to really analyze those rooms in which we listen and also to evaluate comprehensively how our particular speaker systems behave in those rooms. We will be considering some form of program exchange among readers if that is of interest. We are thinking seriously of arranging for a "meeting place" on one of the computer nets where *Speaker Builder* readers may meet and interchange ideas. We can receive your mail in that way and you can transmit yours to us.

For those who want a quick, simple introduction to computers, I know of nothing better than Russell Walter's *Scelbi's Secret Guide to Computers* (Scelbi, \$5.95) or Nat Wadsworth's more advanced *Understanding Microcomputers* (Scelbi, \$9.95). (Available from Old Colony.) More reviews will be forthcoming.

We welcome your input on these ideas. We welcome your articles, ideas, programs and suggestions. Within ten years I doubt whether anyone with a serious interest in a scientific subject will be without a computer of some sort. That ought to be good news for good sound.

Thick as a Brick:

An easy acoustic suspension project

by D. R. MARTIN

BEING A FREELANCE MUSIC CRITIC has certain advantages—free concert tickets, free records, opportunities to visit with prominent musicians, getting paid for something you'd spend time on anyway.

The disadvantage is—that pay isn't much.

So, when I wanted to put a pair of extension speakers in my workroom, my enforced frugality forbade me from spending much on a good commercial design, and my persnikety taste in audio foreclosed on cheap little shoeboxes. Better nothing at all than money down the tubes.

I'd pretty much given up daydreaming about a nice pair of extensions, when I saw an article in the March '79 issue of *Hi-Fi News* [Printed Word Ltd., 527 Madison Ave., Suite 1217, NY, NY 10022], which suggested an inexpensive and potentially pleasurable way to scratch my itch: Brick block speakers using four-inch full ranges, capped with particle board on either end. It sounded like something even I could put together, so out I went in search of hollow bricks. Well, there may be lots of them in Great Britain, but they're nonexistent in Minnesota.

A friend of mine named David Markle was intrigued by the idea. He's been designing, building and selling speaker systems in the Twin Cities for almost 20 years, mainly to professional musicians, artists and wealthy clients; I use a pair of his two-way passive radiator design as my main system and find them to be very accurate and musical, not to mention cost-effective. (The best-sounding speakers I've ever heard at \$400 of 1979 dollars.) He mulled over the idea for a few weeks and came

up with something undoubtedly superior to the *Hi-Fi News* design.

Instead of a hollow brick enclosure, David provided a cement block with the central member chiseled away to accommodate the driver. Instead of a four-inch, he went with a good quality six-inch, modified by him for smoother response. It can be put together in a few one-hour sessions, and the sound—still to the amazement of my

while they don't do anything terribly well, neither do they do anything poorly. They are quite competent, they don't irritate: The treble is clean, with a hint of grain. The upper midrange I find almost punchy, especially in piano; the lower midrange is nondescript but honest. So too the upper bass. The lower bass, naturally, is left mostly to the imagination; proper placement and/or bass boost are called

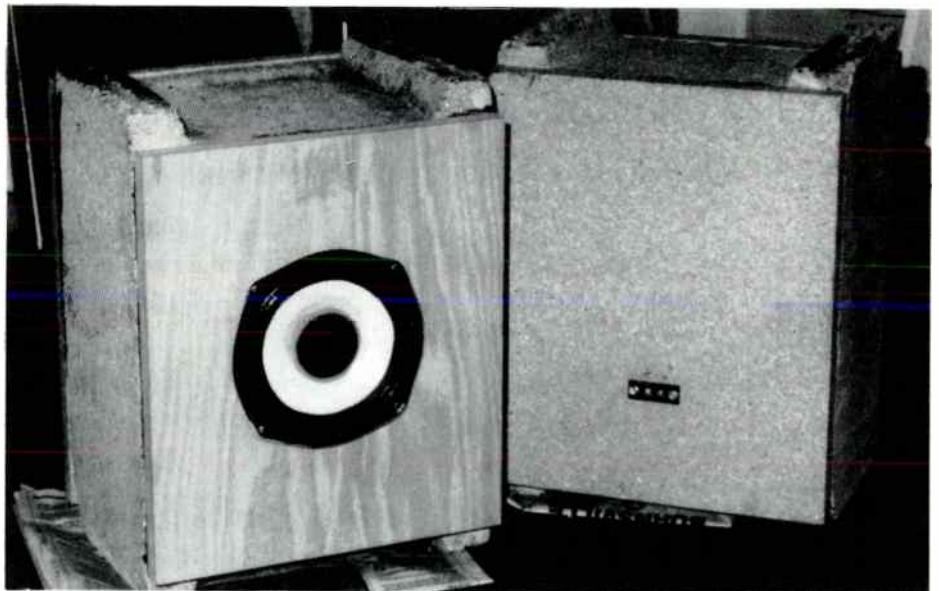

Photo 1. The author's finished pair of extension speakers use a 6" driver mounted in a concrete block.

wife and myself—is certainly high-fidelity. I don't think there's a question of these speakers sounding better than systems costing over four times as much. (Though some commercial designs might make me eat those words.) In the rock-bottom speaker category, though, they do a remarkable job.

I'd describe the sound by saying that

for. All of which makes for a perfectly decent system for kitchen, basement, kids' room or impoverished undergrad's digs. Only two things can be said against them: They are heavy for their size, 60 pounds. And they won't win beauty contests.

David explains their success this way: "Apparently there are two reasons for the surprisingly good

sound of these units. First, the unusually solid enclosure is unlikely to add those delayed resonances which have been shown to be a major problem of speaker design, though not often avoided through testing. Second, the fairly high resonant frequency of the driver (near 100Hz) prevents large cone excursions and thus reduces the amount of modulation distortion at moderate listening levels. A highly compliant full range driver with sealed box enclosure might be rather harsh sounding."

At the time I built them the cost of materials for both units was about \$45.

INSTRUCTIONS

1. Preparation of Drivers. In my case, the units supplied were Misco (Minneapolis Speaker Co.) JC6CDs, six-inch full ranges rated at 55 Hz to 17kHz, power handling to 15 watts RMS (though I use them with my Hafler amp to no ill effect). David modified the drivers by doping the cone with his proprietary doping compound. He says PVA or carefully applied neoprene will work well; a less effective substitute would be ordinary rubber cement. Then damp the edge of the cones just within the edge of the suspension with a $\frac{3}{8}$ inch wide, $\frac{1}{16}$ inch thick roll PVC foam strip adhesived on one side. Damp the edge of the whizzer cone with a low density $\frac{1}{4}$ inch square foam strip, attached with a nonhardening cement. (See Photo 2.) Solder ten inch lengths of 16 ga. stranded wire to terminals.

2. Preparation of blocks. Wearing goggles or safety glasses, chisel away enough of supporting member on one side to accommodate driver's magnet. Wire brush edges of blocks, to smooth out irregularities. Seal interior of block with masonry paint, tung oil or any finish that will hold and prevent decrepitation of the concrete. This step is important for long-term reliability, as a driver with an aluminum voice coil former (such as the Misco) may otherwise be affected by the alkalinity.

3. Preparation of front panels. Cut a $5\frac{3}{4}$ " hole in center of panels. Rout around the hole, so that the driver can be installed flush to the panel surface, $\frac{1}{4}$ inch deep. At the bottom of the rout, install roll foam strip as gasket. (See Photo 3.)

4. Preparation of back panels. Drill holes, centered four inches from bottom, for terminals.

5. On the side of the blocks opposite the chiseled member, apply a generous bead of construction mastic (such as

H.B. Fuller Pow'r Grip) to the edge of the block, allowing no gaps in coverage. Lay the back panels on a floor—a flat floor, as the block will slide on wet mastic—and carefully lower the mastic coated sides onto the panels, centering them. Let dry 24 hours.

6. Install terminal strips through holes in back panels with suitable sheet metal screws, caulking generously around the wires as they enter the interior of the blocks.

7. Glue front panels to blocks in same manner as step 5.

8. Fill interior with fiberglass, making sure that none of it will touch the cones; with fibers aligned along axis of speaker motion.

9. Twist terminal leads and driver leads together, solder them and wrap connections with masking tape.

10. Drill pilot holes in routed surface in front panel and firmly install drivers with suitable sheet metal screws.

APPLICATION

I've found that the best way to get somewhat adequate bass from the Miscos is to place them on the floor close to the wall, tilted upward at 8-10 degrees. The treble and midrange seem to take care of themselves. I've also found that using good cable—even something as good as Fulton Brown—helps make the most out of these items.

VARIATIONS

First, I see no reason why another good noncompliant full range other than the Misco couldn't be used; where a bigger block is used, adventurous souls might even try an eight inch. Also, those disinclined to modify the driver could put it in plain, and modify later if desired. Cosmetically speaking, the speaker can be painted; a grill can be made to fit the front.

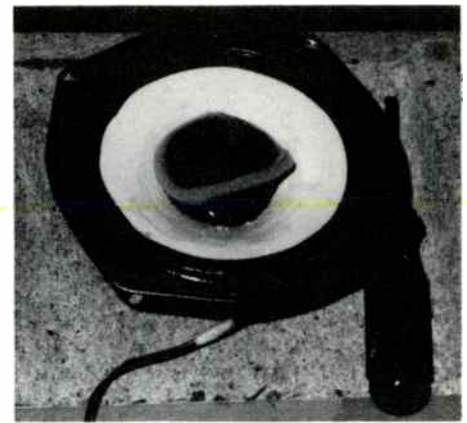
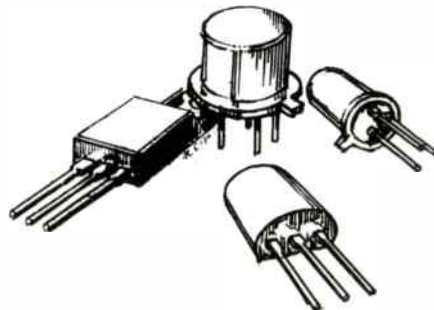

Photo 2. Preparing the speaker for use in the enclosure involves cones and whizzer alteration.

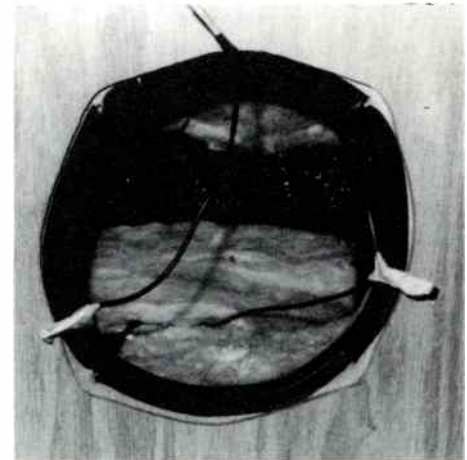

Photo 3. The speaker panel is routed $\frac{1}{4}$ " deep to mount the driver flush.

PARTS LIST

- 2 six inch full range drivers with whizzer cone, fairly noncompliant
- 2 large cement or cinder blocks. terminal strips with 12 inch stranded 16 ga. wire installed
- 4 particle board panels cut to fit front and back of blocks. bonded strand fiberglass sufficient to fill interior of blocks. roll foam strip, adhesive one side, for gasketing drivers.
- 1 tube construction mastic. small amount of caulk (Moretite will work fine).
- 1 can masonry paint or tung oil. masking tape.

Builders wishing to secure JC6CDs can order them from Hi-Fi Sound Electronics, 1226 Harmon Place, Minneapolis MN 55403. Price per unit (as of winter '81) is \$16.95 plus \$1.50 shipping (and \$.68 sales tax if ordering in Minnesota).

The Tractrix Horn Contour

by BRUCE C. EDGAR

Introduction

IN HIS 1974 article for *Wireless World* on horn loudspeakers, Dinsdale¹ introduced the present generation of speaker builders to the tractrix horn contour. The tractrix curve, he claimed, combined the excellent low frequency characteristics of the exponential curve with the spherical wave propagation characteristics of the conical horn.

"Well," you may ask, "if the tractrix contour was so great, why has it been ignored for the last 40 years?"

The principal reason for the tractrix contour's relative obscurity is probably the complexity of its mathematical expression. A non-mathematician would have great difficulty using it, and even those skilled with programmable calculators may shy away from it.

Before the advent of the digital computer, engineers did much of their nuts and bolts design work with a simple aid: the design curve or chart. Back in 1938, Sanial² assembled a series of design curves for the exponential horn. In the same manner, we will evolve some tractrix horn design contours so you can design your own tractrix horns without too much difficulty.

Some History and Theory

Webster³ assumed in his 1919 pioneer paper on horns that the wavefronts in an exponential horn are plane (no curvature). Hanna and Šlepian⁴ later realized that the plane wave assumption was not valid at low frequencies. In 1934, Wilson⁵ proposed a modified exponential horn in which the wavefronts made a gradual transition from plane to spherical waves.

Independent of all the theoretical analysis on how horns work, a 24 year old British inventor, P.G.A.H. Voigt started in 1926 to design a moving coil loudspeaker.⁶ He argued that a loudspeaker should be as efficient as possible and that this goal could only be approached by using the maximum practical field strength in the magnet. Using an 80 lb. iron electromagnet driving a 6" diaphragm, he found that the test results were very disappointing. The sound was very "tinny." He reasoned that since the diaphragm radius at low frequencies was a small fraction of a wavelength, the air, instead of resisting the diaphragm, was "escaping" sideways and did not load the speaker.

Voigt saw clearly that attaching something as simple as a straight pipe to the diaphragm would not do. When a wavefront sees a discontinuity at the end of the pipe, a reflection of the wave occurs which travels back to the diaphragm and tends to make the pipe resonate much like an organ pipe. Voigt reasoned that the pipe should be expanded very slightly near the diaphragm, and as the wavefront moved away from the diaphragm the tapering angle could be increased gradually. He also recognized that the wavefront at the wall will try to follow it and simultaneously be slowed due to friction. These two processes naturally produce a rounded wavefront since its center would be least affected by the wall.

If the pipe's tapering angle is increased until the taper is at 90° in relation to the axis, the wavefront becomes a hemisphere which matches nicely the outside air's tendency for spherical expansion of wavefronts from a source.

Voigt, in a letter to the author (7 Jan. 1981), says:

"As I drew out this curve to

make the smoothest possible transition from the nearly parallel taper near the diaphragm to a 90° angle to the axis, I wondered if I had re-invented the standard exponential curve mentioned in some advertisements (this being the mid-1920's). When I plotted the latter I found that at the throat where the taper was very slight, the difference was negligible. As the mouth was approached, however, the taper increased faster than the exponential, and the 90° angle was reached quite soon so that it seemed shorter (see Fig. 1). Later I learned from our draftsman that the curve was known in the mechanical world and that its name was a Tractrix."

In July 1926 Voigt applied for a patent on the tractrix horn contour and British patent #278,098 was granted to him in 1927. In the early 1930's Voigt⁶ introduced a commercial horn utilizing the tractrix contour and an electrodynamic driver of his own design. The horn was 4 ft. long with a mouth opening 4 ft. square. The field coil (remember, this was before the days of good permanent magnets) required 40 watts DC, but the horn efficiency was so outstanding it required only 4 watts to fill an auditorium. The horn's response was good down to 100 Hz with some response still audible at 50 Hz (letter from Voigt, 7 Jan. 1981). Many of these tractrix horns were used in British cinemas through World War II.

In 1934 Voigt introduced his corner horn^{7,8} for domestic use which was an adaptation of his commercial tractrix horn. The speaker (see Fig. 2) featured a 4 ft. square mouth and a tapered

quarter wave length pipe which supplied the bass response below 100 Hz. A contemporary critic, Percy Wilson^{9,10} commended the Voigt horn for its fine sound, but could not understand why the tractrix contour was better than the modified exponential contour which Wilson championed. After Voigt's pioneering work in the twenties and thirties, Jensen and Lambert¹¹ examined the tractrix horn in 1954 and concluded after much mathematical analysis that the design was a valid alternative to the exponential horn. However they did not mention Voigt's work. No one picked up on the research, and it remained dormant until the Dinsdale review in 1974. So the amateur speaker builder has plenty of room to experiment with the tractrix horn.

Tractrix Horn Contour

Figure 3 shows how a spherical wavefront propagates down a tractrix circular horn. The spherical wavefront has a constant radius arm (B'B = C'C) such that the radius arm is always tangent to the wall of the horn. This fact can be used to graphically generate a tractrix curve, as shown by Dinsdale¹, but I found this procedure too error-prone, although doing one curve by hand is fun. For serious design work it is best to work from the tractrix mathematical expression as derived in the appendix.

The tractrix curve is given by:

$$x = a \cdot \ln \left(\frac{a + \sqrt{a^2 - r^2}}{r} \right) - \sqrt{a^2 - r^2}$$

where x = distance along the axis measured from the mouth,

a = radius of the mouth,

r = radius of the horn at point x

This expression is somewhat awkward to use because we cannot plug in a value for x and compute r as we can for an exponential horn. However, near the throat ($a \gg r$) tractrix expression reduces to

$$r = 2 a e^{-\left(1 + \frac{x}{a}\right)}$$

which shows the exponential characteristic near the throat necessary for good low frequency transmission.

The mouth size determines the horn's low frequency cutoff. The cutoff condition is given by $\lambda = 2\pi a$, where λ = wavelength. The cutoff frequency is then:

$$f = \frac{c}{2\pi a}$$

where c = velocity of sound (13500 in/sec).

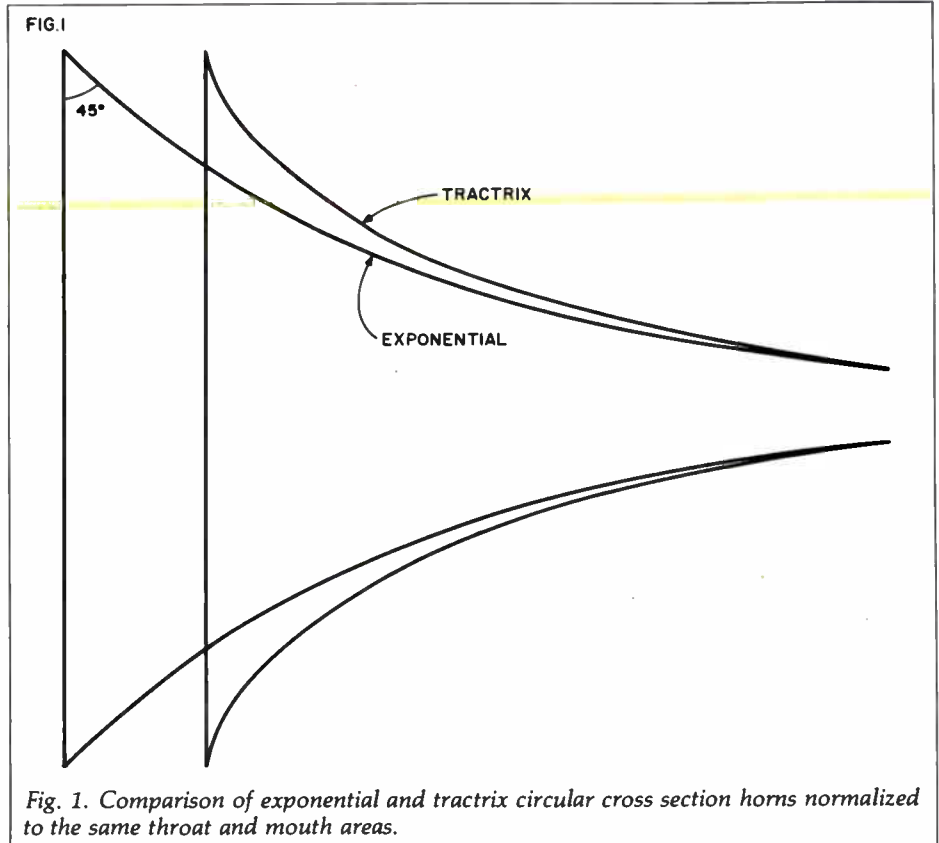

Fig. 1. Comparison of exponential and tractrix circular cross section horns normalized to the same throat and mouth areas.

Since the tractrix formula is for a circular cross-section horn and we usually construct rectangular cross-section horns, we have to convert the radius information to area by the familiar formula for the area of a circle:

$$A = \pi r^2,$$

which is good for free standing horns. For wall position horns, we divide the area by 4; for corner horns, by 8.

Some error is involved in translating the circular cross-section to rectangular because in the latter the tangent to the corner is longer than that to the sides. Voigt argues that if you make the shorter tangent in a square horn the tractrix tangent, you end up with an area of $4/\pi = 1.27$ times that of the

Continued on page 12

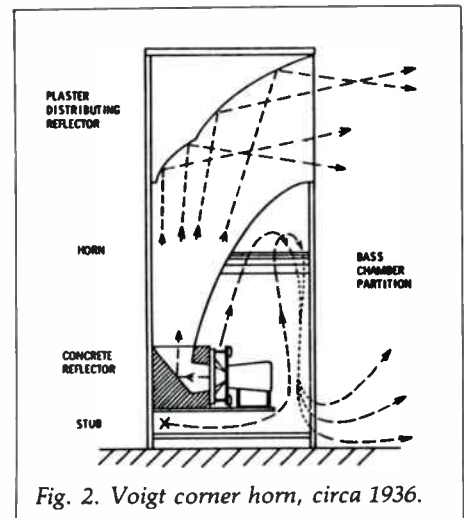

Fig. 2. Voigt corner horn, circa 1936.

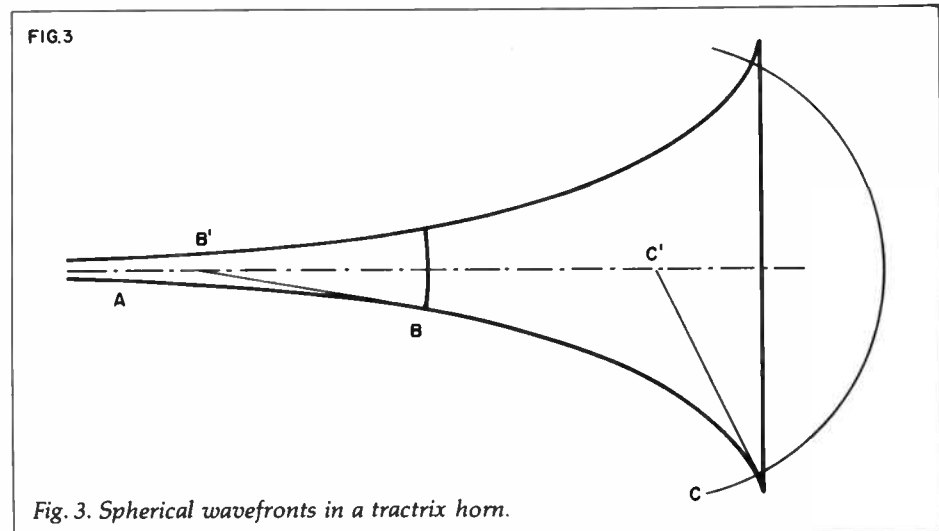

Fig. 3. Spherical wavefronts in a tractrix horn.

FIG. 4

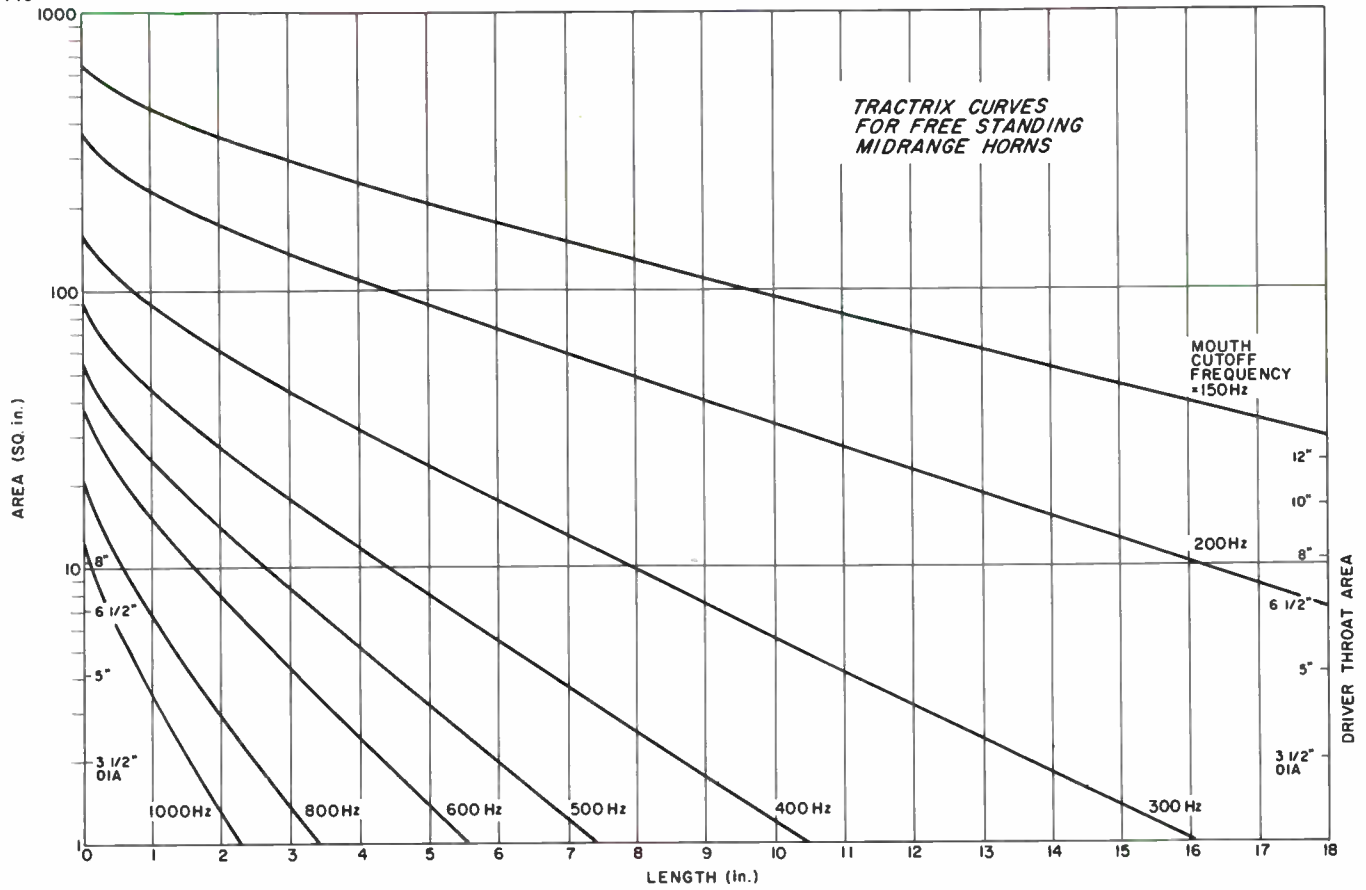

Fig. 4. Tractrix area expansion for midrange horns (free standing) with low frequency cutoffs from 150Hz to 1kHz.

FIG. 5

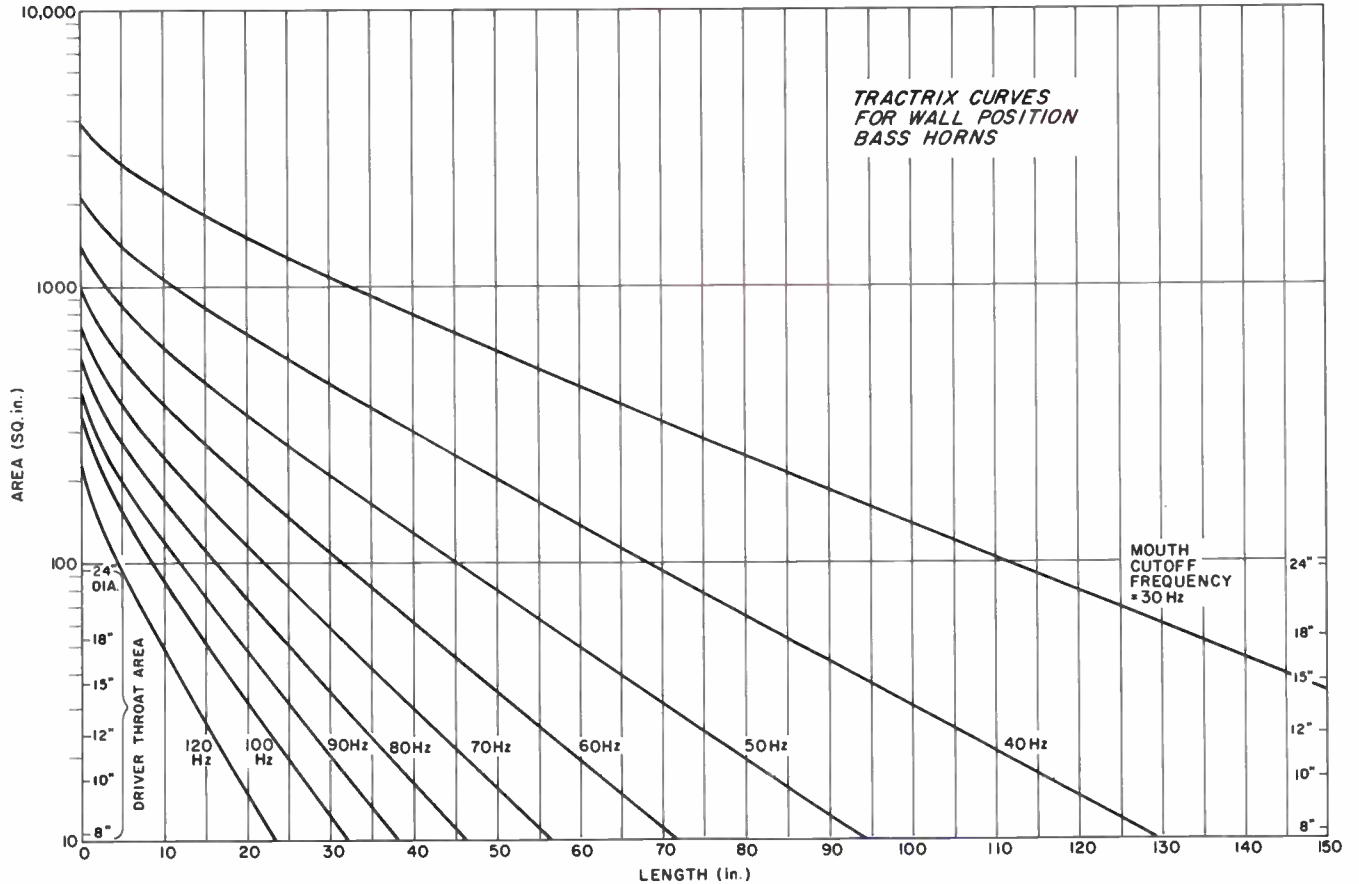

Fig. 5. Tractrix area expansion for bass horns (wall position) with low frequency cutoffs from 30Hz to 120Hz.

corresponding (circular) tractrix horn. "If the area is made equal to the corresponding tractrix, the tangent to the sides will be short, a defect which is partly compensated for by the excess length of the tangent to the corners."¹²

Design Curves

In Figs. 4, 5, and 6 we plot the tractrix area expansion as a function of length from the mouth for free standing horns (150Hz-1000Hz), wall position horns (30Hz-120Hz), and corner horns (30Hz-120Hz), respectively. To use these charts, simply select the desired cutoff frequency and pull out the area values every 2" to 5" (depending on the total length) down to the desired throat size. We have marked the throat areas for several speaker sizes as recommended by Dinsdale! However, these throat sizes were based on geometrical considerations (throat to piston area ratio of 0.33) and ignore the driver parameters which is the other half of the design problem. The reader is referred to the horn design papers of Keele;³ Small;⁴ and Leach;¹⁵ which deal with the selection of throat size for maximum bandwidth or maximum efficiency. Generally, for maximum bandwidth of a horn, one uses throat to driver ratios of 0.50 to 0.30; for maximum efficiency

Continued on page 14



Fig. 7. Spherical-wave midrange horn with direct radiator woofer used in Germany in the early 1950's.

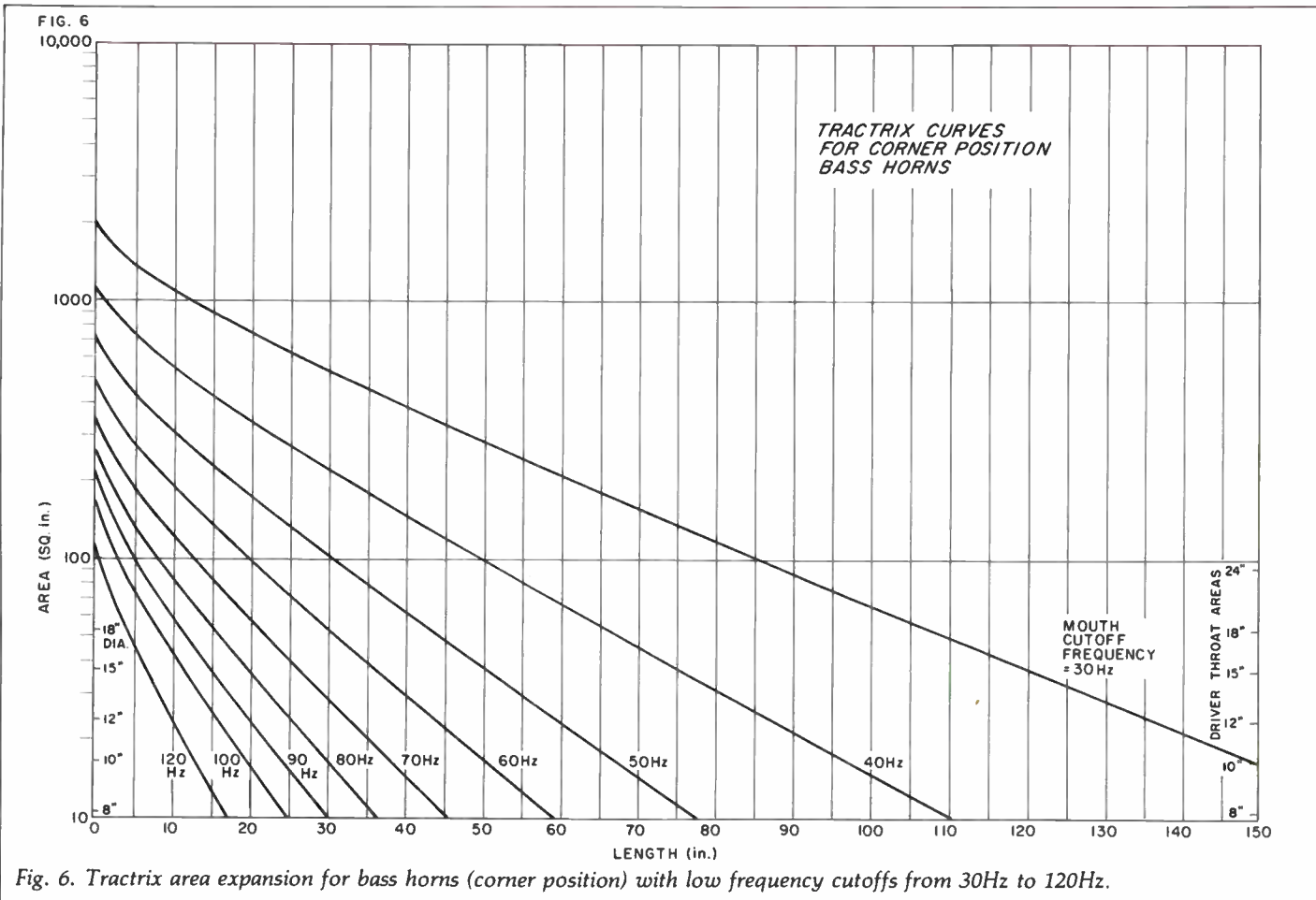



HOW TO DESIGN THIS INTO YOUR NEXT SPEAKER.

This is the graphic for our consumer and regular trade advertising and might seem a little glossy for you hard-core speaker builders but the point is still this: Your speakers should kick butt.

And after you get through with flux density calculations, Theile formulas, crossover nomographs, vent cutting, damping, cutting, sawing, screwing and wiring, the best way to make sure your speakers kick butt is with an equalizer.

We make the only five-band EQ in the world with three octave bass bands: 36, 60 and 120 with "Q"'s around 2.9. (We throw in a wider band at 1K and a sizzler at 15.5, too.)

We also include something no builder of speaker systems should ever be without: An 18dB/octave Tchebechev subsonic filter.

And the 520B Equalizer costs just \$119.

On the other end of the spectrum (excuse the pun) is our C-101. An octave equalizer with built-in Realtime Spectrum Analyzer, built-in Pink Noise Source and phantom-powered Measurement Mike.

All for just \$549.

We don't even have to tell you what use that combination can be to the speaker designer/builder. And it also has the 18dB/octave subsonic filter and a special Rumble Reduction circuit which mono's bass under 200Hz to cut audible low-end crud.

We also make just the Analyzer portion of the C-101 with pink noise and mike for \$399. And the equalizer only for \$249. We sell our line through over 600 reputable hi-fi dealers across America. If you're resourceful enough to enjoy Speaker

Builder, you'll have no trouble ferreting out your local Audio Control dealer.

It's worth it to get speakers that truly kick butt.



AudioControl

6520 212th SW, Lynnwood, WA 98036 in the Heart of the Northwest Rainforest.

one uses ratios of 0.50 to 0.70.

Do not reduce the size of the mouth too much from the values of the charts. In his examples of tractrix horn design Dinsdale¹ terminates his horns just before the 90° flare is reached, resulting in a mouth area reduction of 70 percent. Lambert¹¹ in his analytic study of the tractrix horn indicates that the true cutoff occurs at the 80 percent point. Keele's study of optimum mouth size¹⁶ shows that, depending on the solid radiation angle of the horn, the mouth reduction ranges between 70 and 80 percent. Probably in most cases the mouth size is determined by the folding geometry and "what fits." However, do not go below the 70-80 percent reduction factor. If you do, the resultant speaker in the case of a bass horn will become more an acoustical labyrinth and less a true horn.

Another attractive feature of tractrix horns is the 90° flare at the mouth. Keele¹⁷ found that beaming effects found in mid-range conical horns can be minimized by doubling the flare at the mouth. The effect of additional flare is to make these conical horns look very much like a tractrix horn. The tractrix's reduced length compared to conical and exponential horns of the same frequency range gives it the advantage of being smaller than other horn contours.

Commercial Tractrix Horns

I recently ran across an example of tractrix horns (referred to as spherical-wave horns) in a book edited by Richardson.¹⁸

Figure 7 shows a mid-range spherical-wave horn with a direct radiator woofer; it probably has a low

frequency cutoff around 300-400Hz. The interesting square cross-section construction should suggest some construction techniques to you. Figures 8a and 8b show front and back views of a full range horn cluster, German-built for large cinemas in the early 1950's. Comparing the mouth size to the person standing, a rough calculation gives

a lower cutoff of 25Hz for the bass horn.

Summary

I hope the tractrix design curves will stimulate constructor interest in designing and building tractrix horns. The shorter length and lack of beaming

Appendix: Tractrix Derivation

THE TRACTRIX EXPRESSION can easily be derived by anyone with a knowledge of first year calculus, but in the literature^{1,9,19} you will find several different equations all purporting to be the tractrix expression.

Any point along a tractrix circular horn (Fig. 9) you can draw a tangent line from the horn wall to the X-axis which defines the radius of the spherical acoustic wave. From the triangle relations, the slope at (x, r) must be:

$$\frac{dr}{dx} = -\frac{r}{\sqrt{a^2-r^2}}$$

$$\text{Integrating, we find } \int \frac{\sqrt{a^2-r^2}}{r} dr = - \int dx$$

$$\text{or } x = a \cdot \ln \left(\frac{a + \sqrt{a^2-r^2}}{r} \right) - \sqrt{a^2-r^2}$$

We used the above expression, which is equivalent to Dinsdale's¹ tractrix expression if $a = \lambda/2\pi$ is substituted. Noting that:

$$\frac{a + \sqrt{a^2-r^2}}{a - \sqrt{a^2-r^2}} = \frac{a + \sqrt{a^2-r^2}}{a - \sqrt{a^2-r^2}} \cdot \frac{a + \sqrt{a^2-r^2}}{a + \sqrt{a^2-r^2}} = \frac{(a + \sqrt{a^2-r^2})^2}{r}$$

we arrive at the expression used by Baldock¹⁹ and Wilson⁹:

$$x = \frac{a}{2} \ln \left(\frac{a + \sqrt{a^2-r^2}}{a - \sqrt{a^2-r^2}} \right) - \sqrt{a^2-r^2}$$

According to Lockwood²⁰ the tractrix curve was generated by Leibniz in 1690, but Huygens first solved it analytically and gave the curve its name.

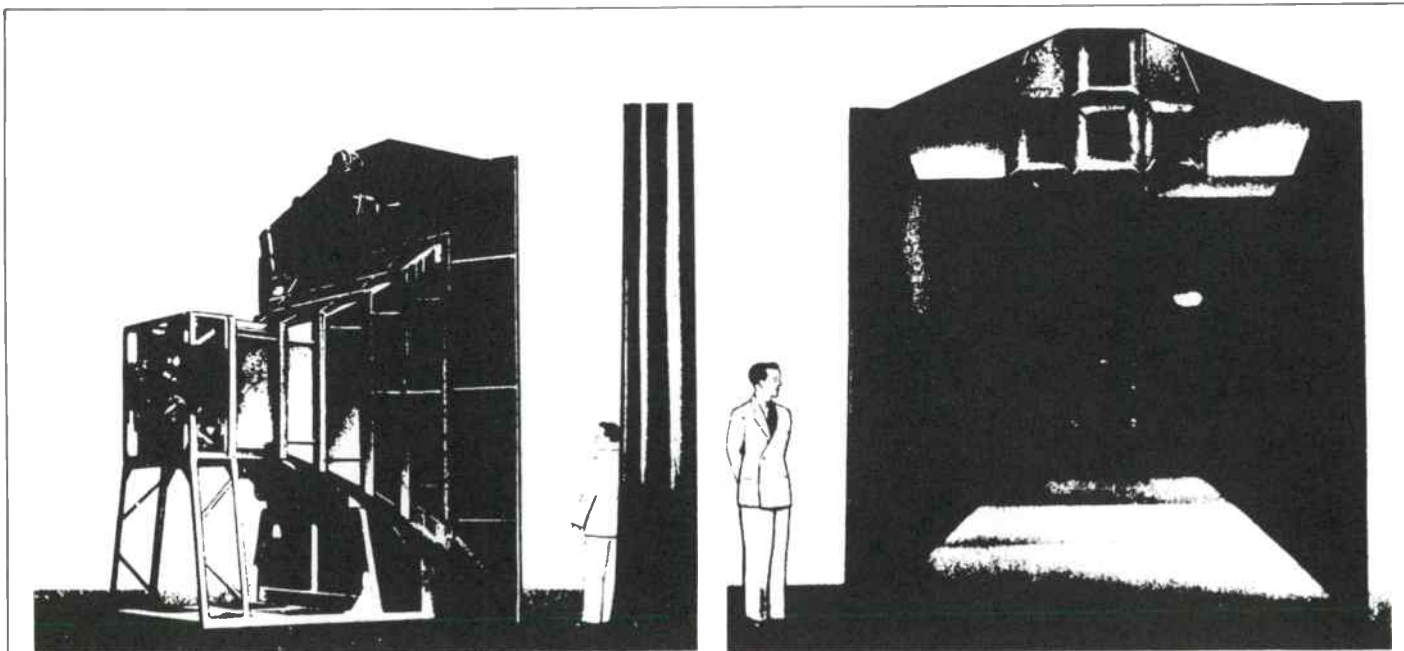

Fig. 8. Spherical-wave bass and midrange horn combination used in German cinemas in the early 1950's.

effects found in tractrix horns compared to the traditional exponential horns are two features with much to recommend them. I am currently working on several tractrix horn designs which I will write about in future issues of *Speaker Builder*. □

Acknowledgements

The author acknowledges the help of Paul Voigt in clarifying many of the points in the development of tractrix horns. In particular, he wrote me a long letter about my initial tractrix paper in January 1981, just before his untimely death, congratulating me on "the tremendous amount of library research" and at the same time upbraiding me for glossing over some historical dates. So I dedicate this article to the late Paul Voigt, a grand old gentleman which I had the pleasure of knowing during the past year. I also thank Geoffrey Wilson for many helpful comments.

The Author

Dr. Bruce C. Edgar is a space scientist for The Aerospace Corporation, El Segundo, California. His hobbies include woodworking, horn design and construction, and bicycling.

REFERENCES

- Dinsdale, J., "Horn Loud Speaker Design," *Wireless World*, 80, 19-24 (Mar), 133-138 (May), 186-190 (June), 1974.
- Sanial, A.J., "Graphs For Exponential Horn Design," *RCA Review*, 3, 97-104, 1938.
- Webster, A.G., "Acoustical Impedance, and the Theory of Horns and of the Phonograph," *Proc. Nat. Acad. Sci.*, 5, 275-282, 1919, reprinted in *J. Audio Eng. Soc.*, 25, 24-28, 1977.
- Hanna, C.R., and J. Slepian, "The Function and Design of Horns for Loudspeakers," *Trans. A.I.E.E.*, 43, 393-404, 1924, reprinted in *J. Audio Eng. Soc.*, 25, 573-585, 1977.
- Wilson, P., "Technical Talk," *The Gramophone*, 11, p. 455-456 (April) p. 492-493 (May), 12, p. 30-31 (June), 1934.
- The Voigt Loudspeaker, *The Gramophone*, 10, 289 (Dec.), 1933.
- Wilson, P., "Technical Talk, *The Gramophone*, 14, 354, 1937.
- Wilson, P., and G. L. Wilson, "Horn Theory and the Phonograph," *J. Audio Eng. Soc.*, 23, 194-199, 1975.
- Wilson, P., "Tractrix Horns," *The Gramophone*, 12, 119-120, 1935.
- Wilson, P., "The Voigt Domestic Speaker," *The Gramophone*, 12, 510, 1935.
- Lambert, R.F., "Acoustical Studies of the Tractrix Horn, I," *J. Acous. Soc. Am.*, 26, 1024-1028, 1954. Jensen, A.O. and R. F. Lambert, Acoustical Studies of the Tractrix Horn, II, *J. Acous. Soc. Am.*, 26, 1029-1033, 1954.
- Voigt, P.G.A.H., British Patent #278,098, "Improvement in Horns for Acoustic Instruments," 1927.
- Keele, D.B., "Low Frequency Horn Design using Thiele-Small Driver Parameters," *A.E.S.*, preprint #1250, 1977.
- Small, R. H., "Suitability of Low Frequency Drivers for Horn loaded Loudspeaker Systems," *A.E.S.*, preprint #1251, 1977.
- Leach, W.M., "On the Specification of Moving Coil Drivers for Low-frequency Horn-loaded Loudspeakers," *J. Audio Engr. Soc.*, 27, 950-959, 1979.
- Keele, D.B., "Optimum Horn Mouth Size," *Audio Engineering Society preprint #933*, 1973.
- Keele, D.B., "What's So Sacred about Exponential Horns?"; *Audio Engineering Society preprint #1038*, 1975.
- Richardson, E.G., ed., *Technical Aspects of Sound*, D. Van Nostrand, N.Y., 1953, p. 364-367.
- Baldock, Rex, "Horn Acoustics," *HiFi News & Record Review*, 11, (April) 1176-1195, 1967.
- Lockwood, E.G., *A Book of Curves*, Cambridge Univ. Press, Cambridge, 1961, p. 119-124.

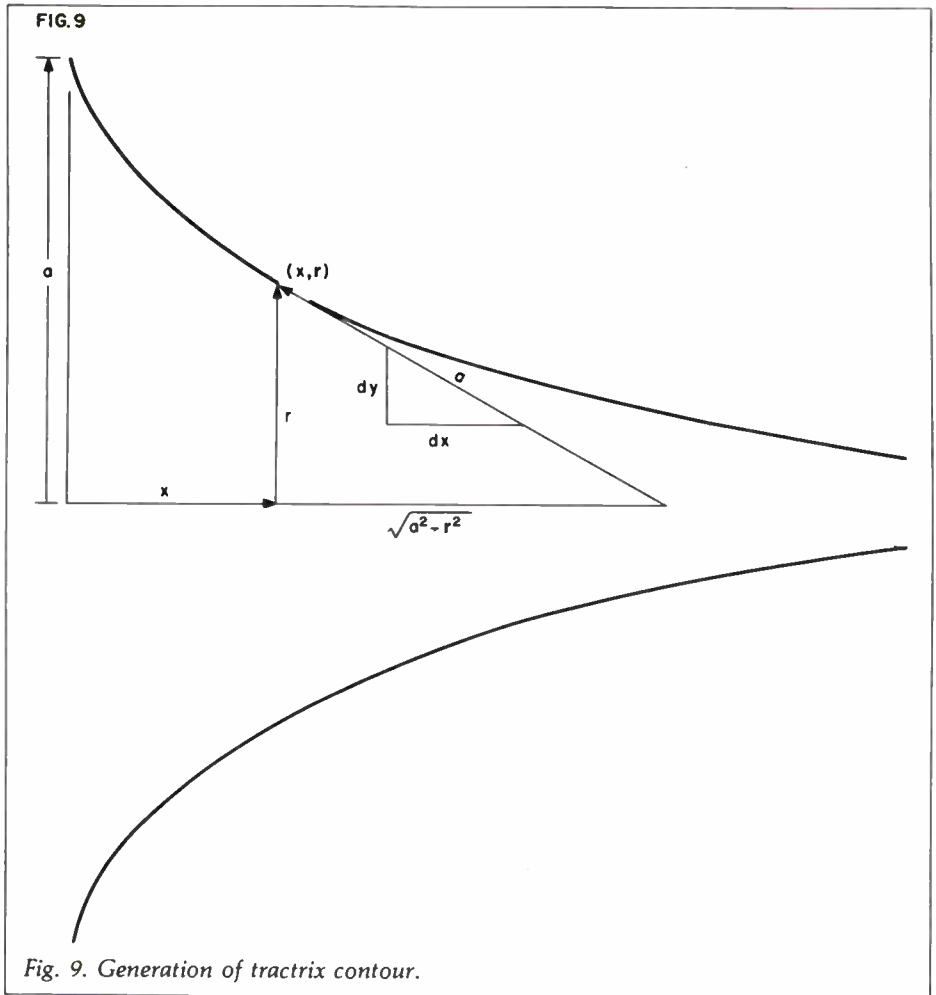

Fig. 9. Generation of tractrix contour.

Literature

Continued from page 30

major modifications to the crossover.

McKenzie, Angus. *FM Radio. Hi-Fi News* 25:10 (Oct. 1980), p. 69. Discussion of car stereo, including placement of speakers; installation in the doors is much preferred to installation in the rear.

Preis, D. *IEEE Transactions on Acoustics, Speech, and Signal Processing* 28:6 (Dec. 1980), p. 769. Review of Martin Colloms, *High-performance loudspeakers* (Halsted Press, 1980, 2nd ed.). "A superb job"; "a sensible well written compendium of information for the non-specialist"; "written at a level understandable to junior or senior engineering students".

von Recklinghausen, Daniel R. *Dynamic equalization for loudspeakers. Journal of the Audio Engineering Society* 28:11 (Nov. 1980), pp. 770-774. 3 refs. The author is with KLH Research & Development Corp. A method to obtain the flattest possible low-frequency response at a given power input level, up to the large-signal limit of the driver. This system is used in KLH's Computer Controlled speakers.

Whyte, Bert. *Behind the scenes. Audio* 64:10 (Oct. 1980), pp. 6, 10, 12, 14, 16, 121. No refs. Review of new loudspeakers by IMF, B & W, Meridian, KEF, Fulton, Cerwin-Vega, ADS, and VMPS-Itone heard at the Summer Consumer Electronics Show.

Whyte, Bert. *Behind the scenes. Audio* 64:12 (Dec. 1980), pp. 112-118. Report on the design of the B & W 801 speaker.

(No author given). *Annual equipment directory. Audio* 64:10 (Oct. 1980) pp. 67-102 list commercially available loudspeakers, with price and other information. Headphones are listed pp. 118-120. Manufacturers' addresses are given pp. 158-164.

(No author given). *IEC issues two new standards on loudspeaker requirements. Journal of the Acoustical Society of America* 68:5 (Nov. 1980), p. 154.

(No author given). *Sixth annual car stereo directory. Audio* 64:7 (July 1980), pp. 28-48. Speakers are listed on pp. 35-42; specifications and prices are given. Addresses of the manufacturers are given on p. 28.

A Diffuser Port for Small Boxes

by G. R. KOONCE

ONE DIFFICULTY IN building small reflex utility cabinets is finding enough length in which to position the duct. *Table 1* gives data for just two of many drivers which have posed this problem for me.

The table shows Thiele-Small parameters for the drivers, along with the net enclosure volume and tuning frequency for vented box enclosures. I have computed the minimum duct area values for peak displacements of 0.2" and to maintain duct air velocity at less than 5 percent of the velocity of sound (see Small¹). *Table 1* also shows expected duct lengths for the duct diameters indicated which have already been pushed down below "minimum." Compare these duct lengths with the inside enclosure dimensions and the problem is obvious: 10" ducts in 8" boxes.

Using multiple smaller diameter ducts does not help, as what establishes the tuning is the length to total area ratio. Duct area is already below the recommended minimum so I hate to reduce it any farther. I have also found tuning these small boxes is critical, so the tuning duct should be accessible for length changes without opening the enclosure. And these small enclosures are apt to be set on desks or work benches, so the acoustic environment behind the cabinet is unpredictable. This, coupled with these units high port radiating frequencies, makes front port radiation the desired goal.

One approach I have used successfully on several small speaker boxes is to bring the round duct out underneath the enclosure and couple it to the enclosure front. *Figure 1A* shows the bottom of such a cabinet before duct installation. I call it the "dif-

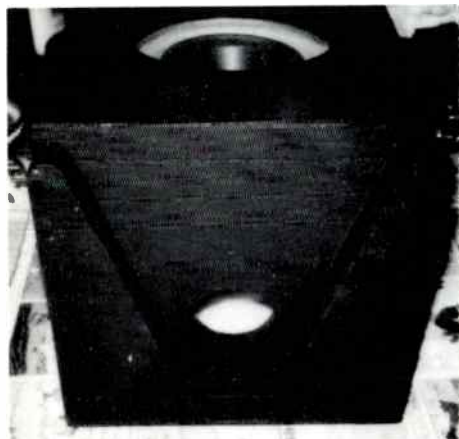
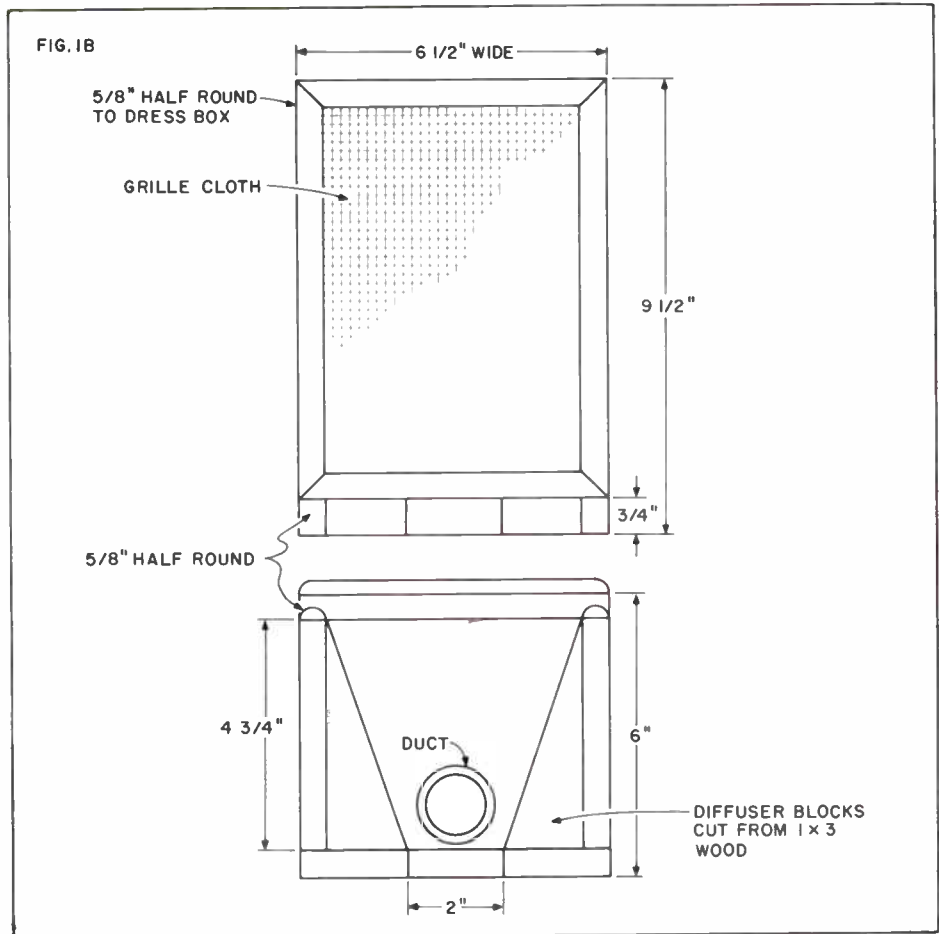

Fig. 1A. Bottom view of diffuser on port.



fuser port" because of the diffuser section (please don't call it a horn load), between the duct and the front radiation port. *Figure 1B* gives my prototype's size and construction detail.

The advantages of this design approach are:

- 1) The tuning duct now runs along the cabinet's longest dimension, its height.
- 2) The diffuser length along the bottom of the cabinet reduces the duct length within.
- 3) One can remove the duct from outside the cabinet for tuning.
- 4) High frequency radiation "sneaking" out through the duct is reduced by the 90° bend and because the duct is now at a right angle to the driver cone motion.
- 5) The grille which protects the driver does not cover the duct, preventing resistive port loading and the potential rattle problem associated with grille cloth over high velocity ports. *Figure 2* shows this clearly on a finished enclosure.
- 6) The small duct's high air velocity is

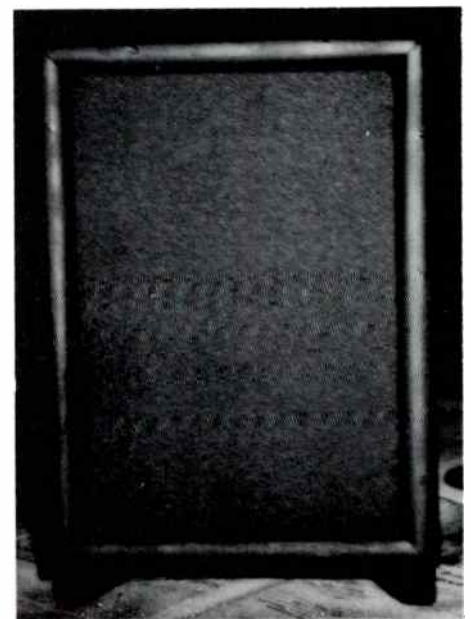

Fig. 2. Finished cabinet with diffuser port.

reduced somewhat before being discharged at the cabinet face.

7) The port radiation is right down at the enclosure-to-surface interface, maximizing the output.

Like everything in the real world, this approach also has some disadvantages. It somewhat increases cabinet height, but this is offset by a decrease in total enclosure volume due to less duct inside the cabinet. I normally make the diffuser out of 3/4" (nominal 1") wood, so the height penalty is slight.

Another disadvantage is that computing duct length is now very difficult. The portion of the duct inside the enclosure will be

Continued on page 35



Fig. 3A. Use of contoured front board in front of diffuser.

FIG. 3B

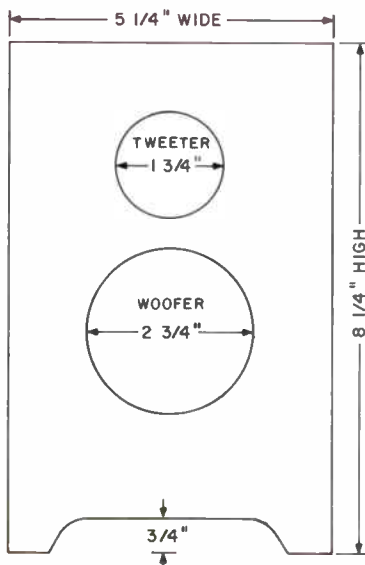

Fig. 3B. Front and bottom dimensions of the diffuser ported box. The trim on the grille is 1/8" half round wood. The box is constructed of 1/2" particle board. The diffuser blocks on the bottom are 1"x3" stock.

TABLE I DATA FOR SMALL DRIVERS

Driver Size	5 1/4" Full Range 16oz. Mag.	5" Full Range 16oz. Mag.
T/S Parameters		
fs	63.4Hz	58.1Hz
QES	0.304	0.230
VAS	0.240 ft. ³	0.280 ft. ³
Vented Box Design		
Net Volume VB	0.118 ft. ³	0.062 ft. ³
Tuned Freq. fB	77.8Hz	91.6Hz
Port Duct Design		
Minimum Area—SVmin	4.41 in. ²	2.37 in. ²
Minimum Dia.—dmin	2.4 in.	1.74 in.
Peak Displacement-x	0.2 in.	0.2 in.
Duct Actual Dia.	2.0 in.	1.4 in.
Computed Length	10.4 in.	7.0 in.
Box Shape		
Gross Volume	0.151 ft. ³	0.080 ft. ³
Inside: Height	8.35 in.	5.75 in.
Width	6.25 in.	5.5 in.
Depth	5.0 in.	4.4 in.

OLD COLONY PARTS

P.O. Box 243, Peterborough, NH 03458

PRECISION METAL FILM RESISTORS:

Meet Specs for: MIL R10509 RN55, MIL 55182 RNR55

Tolerance: $\leq 1\%$
 Max. Power: 0.35 W @ 70°C, derated linearly to 0 W @ 165°C.
 Max. Voltage: 250 V
 Temperature Coefficient: 50 ppm/°C
 Current Noise: $\leq .05 \mu\text{V}/\text{V}$ to 10k
 $\leq .1 \mu\text{V}/\text{V}$ to 100k
 $\leq .25 \mu\text{V}/\text{V}$ to 1M

DIMENSIONS:

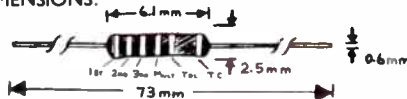

VALUES:

For those of you unfamiliar in working with 1% metal film resistors, we might note that the values given are on the MIL-BELL scale. These are usually within 1% to 1 1/2% of the corresponding IEC E24 values commonly used in domestic equipment. This gives a consistently much tighter tolerance to the specified value than a 5% or even 2% carbon film resistor. At the same time metal films provide less than half the noise, and much greater temperature, time and load stability, and better linearity than carbon film or composition types.

VALUES AVAILABLE

10	100	1 k	10 k	100k
20	110	1.1 k	11 k	110k
27.4	121	1.21k	12.1k	121k
30.1	130	1.3 k	13 k	130k
39.2	150	1.5 k	15 k	150k
47.5	162	1.62k	16.2k	162k
68.1	182	1.82k	18.2k	178k
75	200	2 k	20 k	200k
82.5	221	2.21k	22.1k	221k
90.9	249	2.43k	24.3k	243k
	274	2.74k	27.4k	274k
	301	3.01k	30.1k	301k
	332	3.32k	33.2k	332k
	365	3.65k	36.5k	365k
	392	3.92k	39.2k	392k
	432	4.32k	43.2k	432k
	475	4.75k	47.5k	475k
	511	5.11k	51.1k	511k
	562	5.62k	56.2k	562k
	619	6.19k	61.9k	619k
	681	6.81k	68.1k	681k
	750	7.5 k	75 k	750k
	825	8.25k	82.5k	825k
	909	9.09k	90.9k	909k

I MEG

GOLD PLATED CONNECTORS

Our connectors and associated hardware are 23 9K gold plated (0.000020" gold) This is a plate of the highest quality, and has been chosen for its suitability in electronic contact applications.

PHONO PLUG

A shielded (gold plated brass handle) plug that mates well with our gold plated phono jack as well as the gold plated phono jacks commonly and now on high quality equipment

PHONO JACK A

A jack that mounts from the rear of the panel (up to 1/4" thick) in a hole of 1/8" diameter. The design allows the hex brass body to be firmly held, while the external nut is completely tightened. This results in an installation that is free from the loosening problems commonly encountered in panel mount phono jacks. All hardware is supplied in gold plate to insure optimum grounding continuity

PHONO JACK B

Conventional front-of-panel mount with washer, lug, and nut mounting on rear of panel. Requires 1/4" hole. All hardware gold plated

NYLON INSULATORS

Sold in sets of ten, each insulator consists of a nylon step washer and flat washer.

1/8" SIZE—Large insulator for our phono jack described above, and other 1/8" connectors. Requires 1/2" mounting hole

1/4" SIZE—Can be used on phono jacks from H.H. Smith, Keystone and Switchcraft (3501FP). This insulator fits our older gold plated phono jack. Also useful for the insulation of metal banana jacks (H.H. Smith #101, #109, Pomona #3267, E.F. Johnson #108-0740-001.)

ORDERING INFORMATION

PRICING IS AVAILABLE ON THE CURRENT ORDER FORM.

Minimum order is \$10.00. Please order on the form provided. It helps us to process your order smoothly and without errors. We reserve the right to return any order not placed on the current order form, or under the \$10.00 minimum. Orders on MasterCard or Visa are welcome by mail.

We ship all orders by First Class Mail or UPS. Usual delivery time should be 2-3 weeks. Please include appropriate additional funds for special handling (UPS Blue Label etc.). OVERSEAS ORDERS should add 10% to their total order to cover extra shipping charges. If you pay by personal check, please allow an additional 10 days for the check to clear.

ALL PRICES ARE SUBJECT TO CHANGE WITHOUT NOTICE

Send a stamped #10 self addressed enveloped to Old Colony Parts, Box 243, Peterborough, NH 03458 for full details and price list.

OLD COLONY PARTS

P.O. Box 243, Peterborough, NH 03458

Successor to Component Systems of Indianapolis, Indiana 46227

Fine Points of Vented Speaker Design

by ROBERT M. BULLOCK III

IN MY EARLIER ARTICLES^{1,2} I described Thiele-Small alignments, how we use them to design optimal vented loudspeakers, and how to find the parameters needed to carry out the design. Now let us turn to the practical matters of construction and adjustment.

I do not intend to give detailed construction plans for specific systems. Instead I will discuss those factors which Thiele and Small regard as important, and give you some tips on avoiding the mistakes I have made in the course of building more vented systems than I care to admit. (I have had this compulsion for several years now.) I hope to follow this article with others giving detailed construction plans for particular systems that have worked out well for me.

The material on system adjustment is crucial for obtaining the best sounding system. It will allow you to determine how closely your completed system fits the intended alignment, and what to do if it does not. The vagaries of system parameter values make a need for corrections almost certain.

STARTING POINT: THE DRIVER

I assume you are starting with a driver whose parameters R_E , f_s , Q_{ES} , Q_{MS} , Q_{TS} , V_{AS} you know. A quick glance at the alignment tables in my first article in this series shows that the Q_{TS} parameter must be between .2 and .65. This does not mean you cannot build vented systems using drivers with higher or lower total Q ; but the vast majority of high quality drivers fall into this range. If you are interested in alignments using Q 's outside this range, let the editor know and I will gladly supply them.

There are two other reasons for staying within this range. For drivers with Q_{TS} much higher than .65, the response ripple will exceed 1dB and by my arbitrary

definition will no longer be flat. In addition, the system transient response deteriorates with increasing Q and becomes significant with very high Q 's. Further, a high Q driver requires an extremely large enclosure: for example, a Peerless K080T-WF 8" driver ($Q_{TS} = .66$) would require a box volume in excess of 10 cu. ft. Finally, the extremely low predicted cutoff frequency of high Q systems could well require cone excursions beyond the driver's capabilities.

On the other hand, extremely low Q drivers can yield very good results, but very few drivers have Q 's below .2. The SRC Audio catalog³ lists parameters on 49 drivers; only two have Q 's less than .2, and when we take amplifier-crossover-connecting lead resistance into account, the effective Q of even these will probably exceed .2.

When selecting a driver for your system keep in mind the fact that relative box size increases with total Q . For example, one of my KEF B139's has $Q_{TS} = .35$ and requires about a 2.6 cu. ft. box, while a Dalesford 12" woofer with $Q_{TS} = .27$ needs only a 2.3 cu. ft. box. Thus, a 10" driver (the B139) can require a larger box than a 12" if its Q is larger.

One other consideration is very important in selecting a driver for a vented box. *It must have no route for air to leak through.* Such a leak will act as an additional vent, and the Thiele-Small models may not apply to a system using such a driver. I have encountered this problem with the Audax drivers HD13B12 and HD17B37. Both are otherwise excellent, but air will leak through their porous dust caps. I closed the leaks by spreading rubber glue over the dust cap; however, do not lightly undertake such a modification, since it can alter the driver parameters and characteristic sound. The results for these two drivers were

quite good, I thought. Without the modification, however, neither performed very well in the apparently correct alignment. I think both coaxial and cloth surround drivers might be especially prone to this air leak problem.

Of course, many other factors go into selecting a driver and apply to its use in any type of system. I have concen-

TABLE 1:
SAMPLE SYSTEM PARAMETERS,
VOLUMES AND RESONANCES

Driver Parameters			
	B139	HD17B37	
R_E	6.9Ω	6.5Ω	
f_s	24.2Hz	40.4Hz	
Q_{MS}	6.91	3.81	
Q_{ES}	.343	.277	
V_{AS}	8500 in. ³	1200 in. ³	
System Parameters			
Crossover Resistance	.0Ω	.27Ω	
Amplifier R_g	.28Ω	.28Ω	
Cable resistance	.12Ω	.15Ω	
Q'_{ES}	.363	.307	
Q_T	.345	.284	
Target Alignment (*)			
Q_L	7	7	
Q_T	.345	.28	
h	1.1549	1.4029	
α	1.8832	3.4295	
f_3/f_s	1.2980	1.7165	
System Dimensions			
$V_B (=V_{AS}/\alpha)$	4514 in. ³	305 in. ³	
$f_B (=hf_s)$	28.0Hz	56.7Hz	
$f_3 (=f_3/f_s)f_s$	31.4Hz	69.4Hz	

*The B139 target alignment was interpolated from the tables, for $Q_T = .345$, while for the other system, Q_T was rounded to the nearest table value. The latter should be quite adequate.

trated on those properties important for vented systems. For other factors, I refer you to Colloms' excellent book⁴.

THE ALIGNMENT

With the driver selected and its parameters known, you are ready to choose an alignment. Before doing this, remember to account for amplifier damping and crossover-connecting lead resistance as described in my first article. This will give a modified, slightly larger, value of Q_{TS} than we obtain from the driver alone; I will denote it by Q_T . Thus $Q_{TS} = Q_{ES}Q_{MS}/(Q_{ES} + Q_{MS})$, but $Q_T = Q'_{ES}Q_{MS}/(Q_{MS} + Q'_{ES})$.

To illustrate the procedures I will use two systems I have built: a subwoofer using a B139, and a bass-midrange system using an Audax HD17B37 modified as described above. Table 1 lists the parameters for these drivers. The B139 is an oval driver of 10" nominal diameter with a construction optimized so it behaves in a strict piston fashion up to about 500Hz; Colloms⁴ describes its structure in detail. The Audax unit has a die cast aluminum frame and a bextrene cone with a nominal 6.5" diameter.

Before you can choose the alignment, you must know one more parameter: the leakage loss number Q_L . As I said in the first article, you'll have to guess this number for initial design

purposes. Once you've built the system you can measure the actual value of Q_L and adjust the alignment to account for it. According to Small, most systems have a Q_L of about 7, so this will be our assumed value if we have no additional information. Table 1 lists the $Q_L = 7$ alignment parameters and the resulting enclosure volume V_B , vent frequency f_B , and cutoff frequency f_3 for the two sample drivers. I suggest that you construct a similar table for your system. I will refer to the numbers Q_L , Q_T , h , α as the target alignment because your job will be to design and build a system to hit them.

THE ENCLOSURE

When designing the enclosure, remember its *net* internal volume must be V_B . This means the gross internal volume should be V_B plus the volume occupied by the driver, vent tube, and any bracing. For example, the B139 system's net internal volume should be 4514 cu. in. The driver will occupy about 40 cu. in., the vent tube 70, and internal bracing 110, so the box should have a gross volume of $4514 + 40 + 70 + 110 = 4730$ cu. in. rounding off to the nearest ten.

The volume occupied by the driver can only be roughly approximated; for reasons discussed below, it is better to overestimate. You can estimate the vent tube volume accurately once you

have decided on a tube diameter and length, which will be covered in the next section. You then find its volume from the formula $V = \pi R^2 L$, where R is the outside radius of the tube and L is the length of the tube minus the wall thickness of the enclosure.

The bracing volume will also be a rough estimate, so overestimate to be safe. I made a mistake here when building my first system: I estimated the total gross volume very accurately and built my enclosure using this figure. When it came time to adjust the system I found that I had to substantially *increase* the internal volume, which couldn't be done.

My advice is to generously oversize the box initially: by 25 percent if you have room, but certainly no less than 10 percent. My first system is about 10 percent too small because of this mistake. I'll write about enclosure sizing in future articles.

When deciding on box dimensions, keep in mind that the cabinet must house a vent tube, and so must have sufficient depth in some dimension. This is usually a problem only with a small low resonance driver. For example, consider the vent requirements of the HD17B37. If you use a 1.5" diameter tube, it will have to be about 7" long. If you wish to mount the tube in the front baffle, the box will have to be 9" deep at least. But using a 1" diam-

MODULAR ACOUSTICS OFFERS

Resulting from the successful development and introduction of our unconventional and exciting loudspeaker line, we can offer the hobbyist as well as the professional a plethora of high quality components at reasonable prices.

Close tolerance Mylar and non-polar electrolytic capacitors, ferrite bobbin core chokes (inductors), advanced circuit designs, level controls, L.E.D.'s, kits, unusual drivers including polypropylene, and more lead the list. A \$2.00 investment secures a catalog and complete speaker literature as well as future updates.

PARTS N' KITS TOO

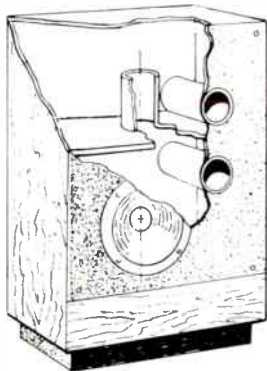

Model 3000 Helmholtz
Dual Port Resonator

As to our loudspeakers, our model 3000 Helmholtz dual port resonator is an industry first and the **only** commercially available unit of its type (see **Speaker Builder** 3/80). It functions with an advanced-designed 8" bass speaker and newly developed 1" soft dome tweeter. Output is measured 89dB at 27Hz not varying more than ± 2 dB from 30-20,000 Hz!

CBS laboratories impressively reviewed this unit in the July, 1980, **High Fidelity**. They stated "its output in both—tests indicate an excellent dynamic range—tests confirm Modular's claim of extended low frequency output—bound to please a great many listeners—a harbinger of other interesting products from this young company."

For a limited time only you can purchase the incredible model 3000 directly from us at a special price and receive, free of charge, a year's subscription (or renewal) to **Speaker Builder**!

Don't delay. Write to us now for complete details and catalogs. You'll be glad you did.

MODULAR ACOUSTICS™

20986 Corsair Boulevard • Hayward, California 94545 • (415) 887-8555

OUR CONCERN IS A SOUND COMPANY

Enclosed is \$2.00 Please send complete info to:

NAME _____
ADDRESS _____
CITY _____
STATE _____ ZIP _____

eter tube, you can reduce the cabinet depth to less than 4".

The enclosure's single most important requirement is that it contains no air passages except for the vent. I cannot emphasize this point enough; the slightest cabinet leak at a point other than the vent can significantly alter the response. For this reason, when building the box, use generous amounts of glue in the joints to make them airtight. In addition, glue battens the length of all joints. This will not only improve air integrity, but will increase the cabinet's rigidity and thus reduce panel resonances.

The point where electrical connections go through the cabinet wall is another source of potential air leakage, so check carefully that it is airtight. I use banana jacks, which are hollow, so I caulk the inside tip of each jack to seal it. I also mount the jacks in a ring of caulking.

If you build your cabinets with one removable panel, as I do, you must be very sure that it can be drawn down airtight. I make the baffle removable so I can easily install a new one if I want to alter driver and vent positions. To anchor it, I screw and glue a 3/4" continuous wood lip around the inside of the box opening so that the baffle is supported at each perimeter point. I attach the baffle to the lip with round head stove bolts and tee nuts at intervals of not more than 6". Between the baffle and the lip I apply 1/2"x3/8" foam weatherstripping around the whole perimeter. I coat the stove bolts with vaseline and draw down the bolts until the weatherstripping is completely compressed. At this point I am fairly confident that the baffle panel will not leak. This procedure is not absolutely required, I describe it to emphasize the importance of eliminating air leaks.

Once when I was adjusting one of my systems, my measurements showed I was way off the desired alignment, which I knew from previous measurements was not so. Checking the enclosure revealed two baffle board bolts inserted but not drawn down. After I tightened them, the system was right on target. The culprit was an air leak other than the vent.

Another common air leak source is the seal between the driver and the baffle. Probably caulking is best used in this joint, but I usually rely on foam weatherstripping drawn down tightly. You should also caulk the joint between the vent and cabinet wall.

For matters of appropriate cabinet materials, sizing, and bracing, I refer you to other sources. Colloms' book has some useful information. I use particle board (super shelf is best when 3/4" material is needed) because it is inexpensive and has some desirable acoustic properties. I use butt joints since they are the easiest to make, but apply

screws and glue copiously to assure a rigid joint. One of my B139 cabinets contains about 60 1.5"x 8 wood screws and a tube of Liquid Nails, which is especially good for those of us not expert at joinery. I usually finish the cabinets by veneering.

If the driver you plan to use has a light cone, locating the vent opening some distance from the driver will minimize driver-vent interaction.

THE VENT

You can use three types of vent. If you pick one with a circular cross-section, then this formula gives the required length:

$$L_v = (c^2/4\pi)R^2/(f_b^2V_B) - kR \quad (1a)$$

where c is the speed of sound in air, R is the radius of the vent tube, f_b is the desired box resonant frequency, V_B is the box volume and k is a correction factor depending on the type of vent. If you wish to use a vent with other than a circular cross section, simply replace R in the above formula by $\sqrt{S_v/\pi}$ where S_v is its cross sectional area. If we use units of inches and seconds and the speed of sound at 70.5°F, formula (1a) becomes

$$L_v = 1.463 \times 10^7 R^2 / (f_b^2 V_B) - kR \quad (1b)$$

If you prefer to use the speed of sound at 68°F, then the constant becomes 1.450×10^7 .

The correction factor k is determined by the flanging of the vent. Each flanged end contributes .85 to k and each unflanged end .613. So there are three possibilities: $k = 1.7$, $k = 1.463$, $k = 1.226$. In practice, two ends flanged means a simple hole in the enclosure wall, one flanged end is a tube in the enclosure wall flush with the wall on one end, and both ends flanged is a tube through the wall extending beyond it on both sides. This last configuration is rather impractical, so I will not consider it further.

For a simple hole in the wall, the wall thickness t fixes the tube length and you must determine the hole radius. Solving (1) for R gives

$$R = 5.8 \times 10^{-8} f_b^2 V_B + \quad (2)$$

$$\sqrt{(5.81 \times 10^{-8} f_b^2 V_B)^2 + 6.84 \times 10^{-8} f_b^2 V_B t}$$

This type of vent is often unsatisfactory because it results in a small hole which generates audible wind noise.

By far the most popular type of vent is a tube mounted flush with the outer box wall extending into the interior, i.e., one end flanged. For such a vent, the tube length L_v is:

$$L_v = 1.463 \times 10^7 R^2 / (f_b^2 V_B) - 1.463R \quad (3)$$

As you see, a larger vent radius requires a longer tube. For a given system, the maximum allowable vent length must obviously be somewhat shorter than the box dimension parallel

to the tube; so the vent radius is indirectly limited by the box dimensions. My B139 system was designed to have a 14" cabinet depth and was made from 3/4" particle board. A 4" diameter vent would have had to be about 14" long, leaving only a 3/4" space at the tube end for air movement. I considered this quite inadequate and used a 3" vent tube instead, whose length allowed ample room for unrestricted air flow. As a rough guide, I think you should allow at least one tube radius of air space beyond the tube end.

Vent stock is usually available only in selected diameters. PVC pipe, which I use because it can be easily cut and finished, comes in the following diameters: 1/2", 3/4", 1", 1.5", 2", 3", 4". You can design a vent of some other diameter by using multiple tubes. Generally, tubes of diameters d_1 and d_2 used together will behave as a single tube with diameter d given by

$$d = \sqrt{d_1^2 + d_2^2} \quad (4)$$

For example, a 1" and 2" tube will act together as a 2.25" tube, while 1.5" and 2" tubes will act as a 2.5" tube.

According to Small, a vent tube should not be much longer than its diameter, since it may then selectively amplify wind noise. I have used a 13" long, 3" diameter tube in one of my systems without any audible problems.

Another factor to keep in mind is that you may have to change the vent length when adjusting the system. I

TABLE 2:
CABINET AND VENT DIMENSIONS,
VENT AIR SPEED DATA

	B139	HD17B37
Enclosure Dimensions		
Wall thickness	.75"	.75"
Inside height	27 1/16"	11"
Inside width	12 1/16"	7 9/16"
Inside depth	14 1/16"	6 9/16"
Gross int. volume	4750 in. ³ *	560 in. ³ *
Internal Volumes		
Driver volume	40 in. ³	25 in. ³
Bracing volume	110 in. ³	50 in. ³
Vent volume	70 in. ³	15 in. ³
Net internal volume	4530 in. ³	470 in. ³
Design volume	4514 in. ³	350 in. ³
Temporary filling	10 in. ³	120 in. ³
Vent Wind Speed Data		
η_0	.00512	.0044
Driver power rating	50W	30W
M . N .	.11	.19
More probable M.N.	.075	.14
Vent Dimensions		
R (inside vent radius)	1 1/2"	1 1/16"
L_v (from formula (3))	7 1/8"	5.14

*Includes volume of baffle hole since drivers are front mounted.

force-fit my vent tubes into a hole in the baffle and caulk the seam. It is easy to knock the tube out and replace it with a different length if necessary. PVC pipe is relatively inexpensive and easily cut to size with a hacksaw, so vent tube changes are not difficult.

The final factor to consider is whether the vent diameter is large enough for tube air speeds to stay low enough to remain inaudible. Small recommends keeping these speeds below 5 percent of the speed of sound, while Thiele suggests 10 percent. Thiele gives a formula for calculating the Mach number of the tube speed, i.e., fraction of the speed of sound, as

$$M.N. = 13.7\sqrt{W}/(f_b R^2) \quad (5)$$

where W is the maximum acoustic power output of the driver, R is the vent radius in inches and f_b is the box resonant frequency. The difficulty with this formula is arriving at a reasonable value for W . At the low frequencies where vent response is significant, the driver acoustic power is probably limited by the cone's ability to move sufficient air, rather than by the voice coil's ability to dissipate heat. But it is hard to quantify the former, so I will use the latter which is usually larger.

The driver reference efficiency can be calculated from parameters as

$$\eta_o = 1.56 \times 10^{-11} f_s^3 V_{AS} / Q_{ES} \quad (6)$$

if V_{AS} is given in cubic inches. W can then be calculated as the product of η_o and the advertised power handling ability of the driver. For the B139, $\eta_o = .00512$ and it is rated at 50 watts, so $W = .255$ acoustic watts. Using a 3" vent tube gives a Mach number of .110 for the recommended 28Hz box resonant frequency. This is higher than either recommendation, but for the low frequencies involved the value for W is probably too optimistic. For example, $W = .2$ will give a wind speed within Thiele's limit and would produce 105dB in a typical listening environment. As I mentioned earlier, I use a 3" diameter in this system and have never been able to distinguish any wind noises.

Table 2 lists the relevant vent data for the two sample systems, which will give you some idea of the numbers I have used and found acceptable.

SAMPLE SYSTEMS

Table 2 also contains all the dimensions of the two sample systems as I constructed them. Since the B139 system was to serve as a subwoofer, I selected its height to place a high frequency system at ear level when set on top. The width chosen fits the available space in my listening room. Notice how close the actual net box volume is to the design value. This is what caused trouble in the system adjustment stage.

The HD17B37 system's height allows a dome tweeter to be mounted directly above the low frequency driver. The use of 3/4" particle board for this cabinet is a bit ridiculous, but I wanted to make use of available materials. Half-inch cabinet walls would have been more appropriate. Because of my experience with the B139 cabinet, I oversized this one about 35 percent and reduced it to design size by stuffing it with books.

SYSTEM IMPEDANCE MEASUREMENTS

The completed system is now ready for fine tuning and adjustment, which will require making impedance measurements. For this reason, the box should contain no acoustical lining or filling and any passive crossover should be bypassed.

Figure 1 shows the frequency-

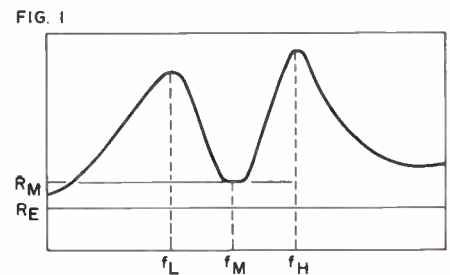

Fig. 1. Shape of impedance curve for a vented box system.

LAZER AUDIO is fast becoming the one source for high end speaker builders. This is why:

- 1) Prompt delivery of high performance drivers—Jordan, Decca, Audax and others.
- 2) A range of kits to satisfy any musical requirement, including transmission line woofer systems that open up the wonderful world of ultra deep bass; semi-cylindrical satellites which will overwhelm you with super-clean undistorted sound from 150Hz up.
- 3) Ancillary items to complete your system: high quality crossover parts, elegant brushed aluminum speaker stands, a handsome component rack, and more.

Build your dream system for one half the cost elsewhere. Send \$1.00 now for brochure!

LAZER AUDIO P. O. BOX 943
UNION CITY, CA 94587



impedance curve of a vented system. An impedance minimum of R_M ohms occurs at the frequency f_M . This frequency is the actual box resonance, so if the system is on target, $f_M = f_B$. Above and below f_M there are two frequencies f_H and f_L at which the impedance is a maximum. You will have to measure these four quantities, probably several times, using the vented box technique for finding V_{AS} that I described in my second article and which I urge you to consult for best results. Briefly, hook the system to one of the impedance measuring setups described there and adjust the signal frequency until a minimum impedance is found. Record the frequency as f_M and the corresponding impedance reading as R_M . Then sweep above and below f_M , locate the frequencies f_H and f_L where the impedance is a maximum and record them.

ADJUSTMENT PROCEDURES

The method for system adjustment is quite thoroughly described by Small. What follows is a particular adjustment sequence which I have devised by trial and error in the course of building

TABLE 3:
MEASUREMENTS AND NEW TARGETS
FOR SAMPLE SYSTEMS

	B139	HD17B37
Original Driver Data		
f_S	24.2Hz	40.4Hz
Q_{MS}	6.91	3.81
Q_{ES}	.343	.277
Q_T	.345	.284
Original Target		
Q_L	7	7
Q_T	.345	.28
h	1.1549	1.4029
α	1.8832	3.4295
System Measurements		
R_M	7.9	8.3
f_L	13.5Hz	21.9Hz
f_M	26.7Hz	54.1Hz
f_H	46.3Hz	97.1Hz
Modified Driver Parameters		
f_{SB}	23.4 Hz	39.3 Hz
Q_{MSB}	7.15	3.92
Q_{ESB}	.355	.285
Q_{Tb}	.357	.292
Actual System Parameters		
h_A	1.1410	1.3766
α_A	1.9433	3.5185
Q_{LA}	11.33	4.858
New Target Alignment		
Q_L	10	5
Q_T	.357	.29
h	1.1002	1.3957
α	1.7206	3.0364
f_3/f_5	1.2016	1.6889

about six systems. The key is to have an enclosure whose volume can be increased as well as decreased.

So far, you have designed the system to realize the target alignment $Q_L = 7$, Q_T , h, α . $Q_L = 7$ was a guess and you must now find its actual value Q_{LA} for your system. Further, the driver parameters f_S , Q_{ES} , Q_{MS} , Q_{ES} , Q_T you used for construction were measured in free air. Now that the driver is operating in an enclosure, they may have new values, which I will denote by f_{SB} , Q_{ESB} , Q_{MSB} , Q_{Tb} . The first step in adjustment is to find the actual loss Q , Q_{LA} , and the modified driver parameter values.

To do this, first take a set of measurements f_M , R_M , f_L , f_H on your system. Then, calculate

$$\begin{aligned} f_{SB} &= (f_L f_H) / f_M \\ Q_{Tb} &= (f_S / f_{SB}) Q_T \\ Q_{MSB} &= (f_S / f_{SB}) Q_{MS} \\ Q_{ESB} &= (f_S / f_{SB}) Q_{ES} \end{aligned}$$

I have listed a measurement set for each sample system in Table 3, together with the modified driver parameters calculated from the formulas.

In order to find the actual loss Q_{LA} , you first must find the actual h and α parameter, denoted h_A , α_A , from

$$h_A = f_M / f_{SB}$$

$$\alpha_A = (f_H^2 - f_M^2)(f_M^2 - f_L^2) / (f_H^2 f_L^2)$$

Then

$$Q_{LA} = (h_A / \alpha_A) (1 / (Q_{ESB}(r_O - 1)) - 1 / Q_{MSB})^*$$

where $r_O = R_M / R_E$.

The number Q_{LA} is the actual leakage loss of your system and the higher its value the less air leakage there is. If $Q_{LA} < 3$, then you had better do some detective work to locate air leak sources and plug them up. If you can't get $Q_{LA} \geq 3$, then the theory on which the design procedures are based does not apply and the best you can do is to design by trial and error.

I have twice designed systems where Q_{LA} was low and in each case have found driver air leaks to be the culprit. The sample HD17B system had $Q_{LA} = 2.7$ when I first put it together; then I discovered the porous dust cap. As the above figures indicate, I managed to get it up close to 5.

You too should try for a Q_{LA} of at least 5; but in case the best you can do is 3, I have included a $Q_L = 3$ alignment table as Table 5. Table 6 lists alignments for $Q_L = 15$ in case you have a very tight system. If you somehow get an even higher Q_L , you can use this table, since it probably won't be much larger than 15.

Using the actual loss Q_{LA} and the

* Q_{LA} is really the total box loss including leakage, absorption, and port losses, but the latter two are usually small enough to be ignored. See Small? for more on this.

modified driver Q , Q_{Tb} , find a new target alignment from the tables. For the B139 system, the original was $Q_L = 7$, $Q_T = .345$, h = 1.1549, $\alpha = 1.8832$; but $Q_{LA} = 11.3$, $Q_{Tb} = .357$, so the new target alignment is $Q_L = 10$, $Q_T = .357$, h = 1.1002, $\alpha = 1.7206$. Notice that I have rounded Q_{LA} from 11.3 to 10. You could interpolate between the $Q_L = 10$ and $Q_L = 15$ tables, but it is not necessary. I did interpolate the h and α values to be consistent with the way I calculated the initial target. For the HD17B system, my original target was $Q_L = 7$, $Q_T = .28$, h = 1.4029, $\alpha = 3.4295$, but the new one is $Q_L = 5$, $Q_T = .29$, h = 1.3957, $\alpha = 3.0364$ because of the actual Q values. Table 3 summarizes this data for the two sample systems.

FINAL ADJUSTMENT

Now the problem boils down to adjusting the system to hit the new targets. You know the current values of h and α , which were calculated above as h_A , α_A . If these agree with the new values then you are not only done, but lucky besides. If they are not the same, first adjust the system volume to correct α , then install a new vent tube to adjust h.

The box volume must be increased if $\alpha_A >$ target α and decreased if $\alpha_A <$ target α . To estimate the necessary volume change you can calculate $V_{ASB} = V_B \cdot \alpha_A$, where V_B is the current box volume and α_A is the current box α . This gives a modified value of the driver volume compliance, from which a new box volume V_{BT} is calculated using $V_{BT} = V_{ASB} / \text{target } \alpha$. The approximate volume change then should be $V_{BT} - V_B$.

For example, the current box volume of the B139 system is $V_B = 4514$ cu. in. and $\alpha_A = 1.9433$. So the modified driver volume compliance is $V_{ASB} = (4514)(1.9433) = 8772$ cu. in., some 272 cu. in. larger than the initial design value. This means the target box volume is $V_{BT} = 8772 / 1.7206 = 5098$ cu. in. and the required volume change is $V_{BT} - V_B = 5098 - 4514 = 584$ cu. in.; i.e., the box volume must be increased by 584 cu. in. Recall that the total available volume in this system is 4560 cu. in. This means I can't hit the target alignment. The best I can do is get an $\alpha_A = 8772 / 4560 = 1.9237$; hence there will be an error of about 12 percent in the actual α parameter for this system. The moral is: oversize the box!

When we look at the HD17B system, the situation is better. Here, $\alpha_A = 3.5185$ and target $\alpha = 3.0364$. This means the box volume needs to be increased. Again, $V_{ASB} = V_B \cdot \alpha_A = 350(3.5185) = 1232$ cu. in., $V_{BT} = 1232 / 3.0364 = 406$ cu. in. So the approximate volume increase is $V_{BT} - V_B = 56$ cu. in. Since this box is sufficient-

ly oversized, we can remove filling to obtain the required volume change.

As a third example, consider a system with $V_B = 500$ cu. in., $\alpha_A = 1.5$ and target $\alpha = 1.8$, so that the volume must be decreased. First, $V_{ASB} = 500(1.5) = 750$, so the target volume is $V_{BT} = 750/1.8 = 417$ cu. in. and the required change is $V_{BT} - V_B = 417 - 500 = -63$ cu. in., i.e., a volume decrease.

After the volume change, measure the new values of f_L , f_M , f_H and compute α_A again. Repeat until the value is as close to the target as you can get it. Then replace whatever temporary filling is left with something more permanent, such as additional bracing.

To adjust the resonance, calculate the current $h_A = f_M/f_{SB}$, where $f_{SB} = (f_L f_H)/f_M$. If h_A agrees with the target h , your system is adjusted; if not, design and install a new vent, using the now current box volume V_{BT} and the target resonant frequency $f_{BT} = f_{SB} \cdot h$ in formula (3) to find the length of the tube. Cut one somewhat longer; after installing it, take another set of measurements and calculate h_A . If it is not on target ($h_A \approx h$), it should be lower than required so you can shorten the tube a little at a time until $h_A \approx h$. The adjustment is then completed. Final values for the two sample systems are given in Table 4.

You may be wondering how close

you need to be to the target parameters in order to consider your system adjusted. I try to get h_A within 2 percent of h and α_A within 4 percent of α . This goal is warranted not by my test equipment but by my hope of minimizing the error accumulated throughout design and construction, by being as accurate as possible at each step.

I lack the facilities to check actual response, but have programmed Small's model to produce computer generated response curves from parameters. Figures 2 through 15 were obtained in this way and show how parameter errors alter response. This will help you decide for yourself how much error you are willing to tolerate.

RESPONSE CURVES

Figure 2 shows the target response (2) of the B139 system compared with the model predicted response using the actual system parameters (1). The primary cause of the slight peak is the box being too small, i.e., α being too large.

The same two curves are shown in Fig. 3 for the HD17B system. Again, the slight peak in the actual response is due to the box being a bit on the small side.

I recently built a vented system with $Q_T = .38$, $f_{SB} = 34$ and $Q_L = 9$. Figure 4 shows the on target response of this system (1), the response with Q_T 5 per-

TABLE 4:
FINAL ALIGNMENT VALUES

	B139	HD17B37
Final Measurements		
f_L	13.4Hz	22.9Hz
f_M	26.3Hz	55.0Hz
f_H	46.1	93.6Hz
R_M	7.9	8.3
Final Calculated Parameters		
f_{SB}	23.5Hz	39.0Hz
h_A	1.1197	1.14113
α_A	1.9239	3.1219
Q_{LA}	11.2	5.6
Errors		
h	+1.8%	+1.1%
α	+11.8%	+2.8%

FIG. 2

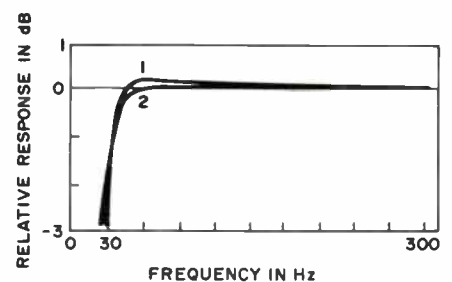

Fig. 2. 1 is the actual B139 system response and 2 is the target response.

HORNS • WOOFERS • MIDS • TWEETERS

AT TREMENDOUS OEM SAVINGS. ALTEC, ELECTRO-VOICE, PHILIPS-AMPEREX, PEERLESS, POLYDAX, ISOPHON, AND MANY OTHERS. HUGE SELECTION OF X-OVER COMPONENTS. LARGE INVENTORY FOR IMMEDIATE DELIVERY. GOOD SELECTION OF MUSICAL INSTRUMENT LOUDSPEAKERS. CATALOG CONTAINS VALUABLE X-OVER INFORMATION, AND TECHNICAL DATA ON SPEAKERS. SEND \$1.00 TO: SRC AUDIO DEPT.



3238 Towerwood Dr. Dallas, TX 75234

ENCLOSED IS \$1.00, PLEASE SEND CATALOG

name _____

address _____

city _____

state _____ zip code _____

cent too large (2) and with Q_T 5 percent too small. Thus it seems that a 5 percent error in Q_T translates to a .5dB dip or peak in response.

Figure 5 shows the results of a 10 percent error in h for this same system, and Fig. 6 displays the effects of a 20 percent error in α . Notice that an er-

ror in α alters the response much less than one in h . This state of affairs is desirable because $\alpha = V_{AS}/V_B$ and neither of these volume parameters can be measured with great precision. V_{AS} is particularly difficult to get with any accuracy because it varies not only with atmospheric conditions but with

time. Figure 7 shows this same system with errors in both h and α , while Fig. 8 shows the consequences of an incorrect value of Q_L .

To give you an even better feeling for error effects, I have included similar curves for a system with $Q_T = .20$ in Fig. 9 through 11 and one with

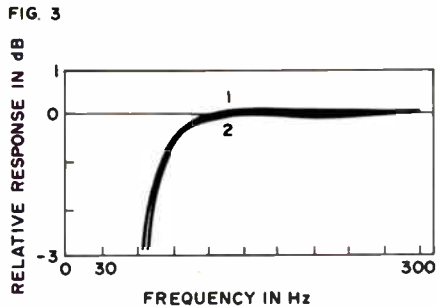

Fig. 3. 1 is the actual HD17B response and 2 is the target response.

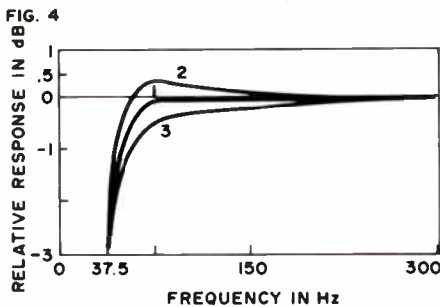

Fig. 4. Curve 1 is the target for $Q_T = .38$, $Q_L = 10$; curve 2 is for a Q_T which is 5.25% too large; curve 3 is for a Q_T which is 5.25% too small.

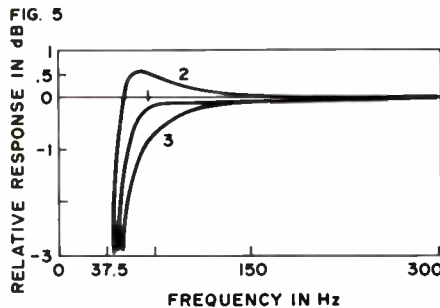

Fig. 5. Curve 1 is the target for $Q_T = .38$; $Q_L = 10$; curve 2 is for an h which is 10% too large; curve 3 is for an h which is 10% too small.

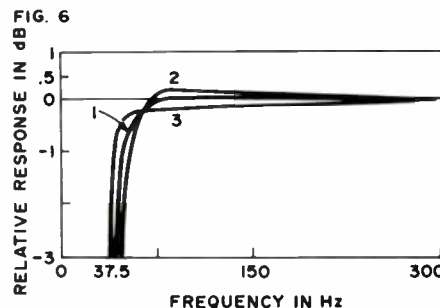

Fig. 6. Curve 1 is the target for $Q_T = 10$; $Q_T = .38$; curve 2 is for an α which is 20% too large; curve 3 is for an α which is 20% too small.

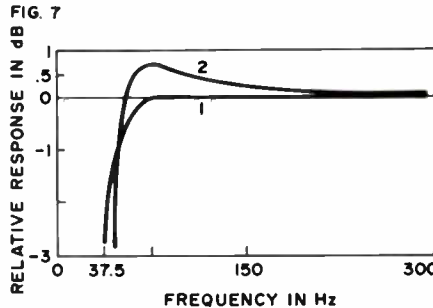

Fig. 7. Curve 1 is the target for $Q_T = .38$, $Q_L = 10$; curve 2 is the response when h is 10% too large and α is 20% too large.

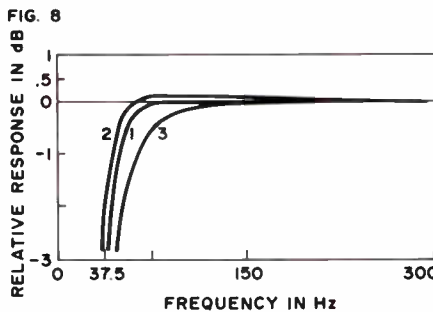

Fig. 8. Curve 1 is the on target response with $Q_T = .38$, $Q_L = 10$; curve 2 is for $Q_L = 15$; curve 3 is for $Q_L = 3$.

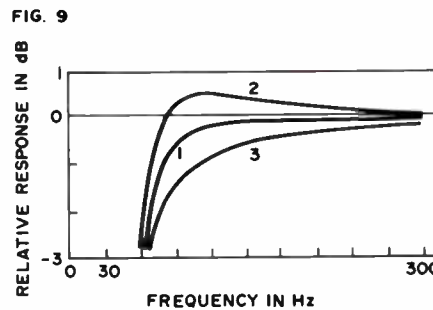

Fig. 9. Curve 1 is the target response for $Q_L = 7$; $Q_T = .20$. Curve 2 results from a +10% error in Q_T and curve 3 results from a -10% in the same parameter.

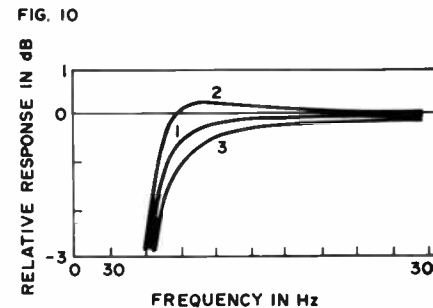

Fig. 10. Curve 1 is the target response for $Q_L = 7$, $Q_T = .20$. Curve 2 results from a +10% error in h and curve 3 from a -10% error in the same parameter.

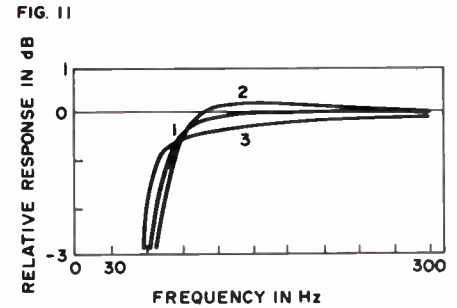

Fig. 11. Curve 1 is the target response for $Q_L = 7$, $Q_T = .20$. Curve 2 results from a +20% error in α and curve 3 from a -20% error in the same parameter.

TABLE 5
SMALL ALIGNMENTS for $Q_L = 3$

Q_{TS}	h	α	f_3/f_s	Ripple (dB)
.2000	2.1694	7.0552	2.7548	
.2100	2.0666	6.3041	2.6125	
.2200	1.9733	5.6531	2.4824	
.2300	1.8881	5.0851	2.3630	
.2400	1.8100	4.5866	2.2528	
.2500	1.7381	4.1467	2.1508	
.2600	1.6719	3.7566	2.0559	
.2700	1.6105	3.4090	1.9674	
.2800	1.5536	3.0980	1.8845	
.2900	1.5006	2.8186	1.8065	
.3000	1.4512	2.5666	1.7331	
.3100	1.4050	2.3386	1.6636	
.3200	1.3617	2.1217	1.5978	
.3300	1.3210	1.9432	1.5351	
.3400	1.2828	1.7712	1.4754	
.3500	1.2467	1.6136	1.4183	
.3600	1.2127	1.4690	1.3636	
.3700	1.1806	1.3360	1.3110	
.3800	1.1501	1.2133	1.2605	
.3900	1.1213	1.0999	1.2118	
.4000	1.0939	.9949	1.1649	
.4100	1.0679	.8974	1.1198	
.4200	1.0431	.8069	1.0763	
.4300	1.0195	.7225	1.0346	
.4400	.9970	.6439	.9947	-
.4500	.9744	.5726	.9572	-
.4600	.9515	.5093	.9222	-
.4700	.9286	.4533	.8898	-
.4800	.9059	.4040	.8597	-
.4900	.8837	.3605	.8318	-
.5000	.8621	.3223	.8060	.01
.5100	.8412	.2885	.7822	.02
.5200	.8212	.2586	.7601	.02
.5300	.8021	.2321	.7397	.03
.5400	.7838	.2084	.7208	.05
.5500	.7664	.1872	.7033	.06
.5600	.7499	.1681	.6871	.08
.5700	.7341	.1508	.6720	.10
.5800	.7192	.1350	.6579	.12
.5900	.7049	.1205	.6447	.14
.6000	.6913	.1072	.6324	.17
.6100	.6784	.0948	.6209	.20
.6200	.6661	.0832	.6101	.23
.6300	.6543	.0723	.5999	.26
.6400	.6430	.0621	.5903	.29
.6500	.6322	.0524	.5812	.32

$Q_T = .65$ in Fig. 12 through 15. I used a value of $f_s = 25\text{Hz}$ for these figures. Thus, you can now see how the errors affect response not only for medium Q alignments but also for extreme Q values.

The $Q_T = .65$ response is a Chebyshev alignment and you can see quite clearly the "ripple" of about .75dB. If you compare this Chebyshev response curve with others you may have seen, the ripple here seems to be overly concentrated at lower frequencies. This is because the frequency axis is displayed linearly rather than logarithmically.

PERFORMANCE QUALITY

These comments on quality are purely subjective, so take them with the appropriate amount of salt. I own a well-known acoustic suspension system of approximately the same size as the HD17B. In comparing the two, my wife and I decided the commercial

Continued on page 31

TABLE 6
SMALL ALIGNMENTS for $Q_L = 15$
Ripple (dB)

Q_{Ts}	h	α	f_3/f_s	Ripple (dB)
.2000	1.8640	8.0331	2.4512	
.2100	1.7784	7.1822	2.3225	
.2200	1.7007	6.4446	2.2045	
.2300	1.6299	5.8010	2.0960	
.2400	1.5652	5.2361	1.9956	
.2500	1.5058	4.7375	1.9023	
.2600	1.4512	4.2952	1.8153	
.2700	1.4007	3.9011	1.7338	
.2800	1.3540	3.5484	1.6571	
.2900	1.3106	3.2314	1.5846	
.3000	1.2703	2.9455	1.5159	
.3100	1.2327	2.6867	1.4504	
.3200	1.1976	2.4517	1.3880	
.3300	1.1648	2.2376	1.3281	
.3400	1.1341	2.0420	1.2705	
.3500	1.1052	1.8629	1.2151	
.3600	1.0781	1.6983	1.1615	
.3700	1.0526	1.5468	1.1099	
.3800	1.0286	1.4070	1.0602	
.3900	1.0059	1.2777	1.0125	
.4000	.9840	1.1591	.9675	-
.4100	.9615	1.0535	.9262	-
.4200	.9390	.9604	.8884	-
.4300	.9167	.8787	.8539	-
.4400	.8951	.8074	.8226	.01
.4500	.8744	.7453	.7942	.02
.4600	.8547	.6911	.7684	.03
.4700	.8361	.6439	.7451	.05
.4800	.8187	.6027	.7239	.07
.4900	.8025	.5666	.7047	.09
.5000	.7873	.5348	.6873	.12
.5100	.7732	.5068	.6714	.16
.5200	.7601	.4820	.6569	.20
.5300	.7479	.4599	.6437	.24
.5400	.7366	.4402	.6315	.29
.5500	.7260	.4225	.6204	.34
.5600	.7162	.4065	.6101	.39
.5700	.7070	.3921	.6006	.45
.5800	.6984	.3789	.5919	.51
.5900	.6903	.3670	.5838	.57
.6000	.6828	.3560	.5762	.63
.6100	.6757	.3459	.5692	.70
.6200	.6690	.3366	.5626	.77
.6300	.6627	.3281	.5565	.83
.6400	.6567	.3201	.5508	.90
.6500	.6511	.3127	.5454	.97

DOLBY® DECODERS for FM and TAPES

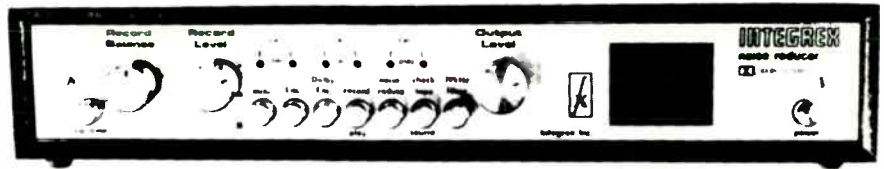

Has the quality of Dolbyized® FM broadcasting disappointed you? If your station is really trying to bring you good sound, the lack of proper decoding makes accurate levels and balance impossible, and minimizes the potential for noise reduction. An Integrex decoder lets you hear what you've been missing because of the compromises in the system intended to make Dolby®-encoded programming "compatible" for most listeners.

The \$99.50 Model DFM decoder easily connects to any tuner, or in the tape monitor loop of a receiver, and includes de-emphasis correction. If you wish to Dolbyize® your tapes as well, the newly revised and far more versatile encode/decode kit is \$137.* Also available built, on special order. Complete details, including test reports, are available on request.

*Add \$3 for UPS, \$4 for parcel post, APOs and Canada. Pennsylvania residents add 6% sales tax.

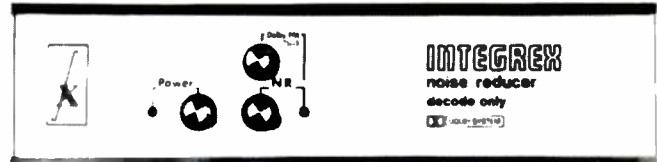

INTEGREX, SB, INC.

P. O. Box 747 Havertown, Pa. 19083

® Trademark of Dolby Labs Inc.
DEALER INQUIRIES INVITED

POLYDAX - PHILIPS PEERLESS - BECKER - AUDAX AMPEREX - EV - MOTOROLA

- COMPLETE LINES IN STOCK
- DOME TWEETERS, DOME MID-RANGES, AND BEXTRENE CONE WOOFERS
- KITS AVAILABLE
- EXTENSIVE LIBRARY OF PLANS
- FREE TECHNICAL AND DESIGN ASSISTANCE
- WRITE FOR FREE CATALOG

Speaker Supply Co.
Post Office Box 48362
Atlanta, Georgia 30362

Loudspeaker Literature

JULY-AUGUST 1980

(1) THEORETICAL AND GENERAL

Atkinson, John. *Listening tests and absolute phase. Hi-Fi News* 25:11 (Nov. 1980), pp. 85, 87, 89. 22 refs. *Hi-Fi News* staff conducted tests to determine whether absolute phase is audibly detectable. Some listeners, notably one with perfect pitch, could reliably detect a change in pulse trains when phase was reversed; others could not. Tests on musical material were inconclusive. See the entry under Ivor Humphreys in section 11.

Avid Corp. *Method of and means for loudspeaker sound wave distribution*. U.S. patent No. 4,214,645. *Official Gazette of the U.S. Patent & Trademark Office*, July 29, 1980, pp. 1678-9. Avid's grille frame to reduce diffraction.

Maloney, Pat. *Time alignment of sound-reinforcement equipment. Recording Engineer-Producer* 11:6 (Dec. 1980), pp. 52, 54, 56, 60-63. No refs. An interesting article, not least for the history of some famous Altec systems.

Oie, S., and others. *Sound radiation from a concave radiator in an infinite baffle. Acustica* 46:3 (Nov. 1980), pp. 268-275. 4 refs. An improved method for computer prediction of response from cones and horns.

Platte, H.J. and K. Genuit. *Can an electro-acoustical transmission depending on loudspeaker reproduction be an accurate reproduction of the original sound? NTG Fachberichte Vol. 72* (1980), pp. 51-58. (in German) 7 refs. Derives mathematical expressions to define accurate transmission; considers properties of the human ear and the question of the number of speakers.

Riggs, Michael. *The state of the speaker art (for now). High Fidelity* 30:10 (Oct. 1980), pp. 43-46. Simplified discussion of some recent design goals, such as correct "phase," minimizing diffraction at cabinet edges, uniformity of dispersion with frequency, low-mass and sandwich diaphragms, and computer simulation of loudspeaker performance.

Suzuki, Hideo, and others. *On the perception of phase distortion. Journal of the Audio Engineering Society* 28:9 (Sept. 1980), pp. 570-574. 10 refs. The authors are with Mitsubishi & Electric Corp. "For music signals the quantity of phase distortion used in our experiments was not enough to be detected by any subject. It will be our future goal to find out the permissible level of phase distortion for music sources." R

Vilchur, Edgar, and Roy F. Allison. *The audibility of Doppler distortion in loudspeakers. Journal of the Acoustical Society of America* 68:6 (Dec. 1980), pp. 1561-1569. 16 refs. "The theoretical analysis indicates that for any practical cone velocity Doppler distortion will be less audible by an order of magnitude than the flutter of a 15-ips tape machine that meets the NAB standard. The experimental results provided confirming evidence that it is inaudible."

(2) LOUDSPEAKER DRIVER UNITS

Chrétien, Gérard. *Le tweeter absolu? Le transducteur ionique Klein-Magnat. ("The absolute tweeter? the Klein-Magnat ionic transducer")*. *L'Audiophile* No. 18 (Dec. 1980), pp. 7-13. (in French) No refs. A refined and superior version of the Ionophone. The basic principle is unchanged (LF amplitude modulation of a VHF voltage strong enough to provoke ionization of air, the LF modulations creating directly proportional temperature, and hence sound pressure, varia-

tions); but the quartz crystal and RF radiation have disappeared. The high frequency is 27MHz, and the average temperature of the plasma is 1,200 to 1,500 deg. C. Frequency response is flat from 3 to 200kHz, with a sensitivity of 114dB for 1 watt at one meter. Oscillograms of tone bursts up to 100kHz are what one would expect of an approximation to a point source with a massless diaphragm. Patent rights have been bought by the West German firm Magnat, which is to use the tweeter in systems to be introduced in autumn 1981. The inventor, Siegfried Klein, was for 20 years head of the plasma physics lab of the French Atomic Energy Commission.

Cochet, Yves. *De nouveaux types de membranes pour haut-parleurs de médium. ("New types of diaphragm for midrange drivers")*. *L'Audiophile* No. 17 (Oct. 1980), pp. 64-67. (in French) No refs. Description of the new Siare 12 VR 12-cm midrange with a phenolic-impregnated woven glass fiber diaphragm and aluminum wire for the voice coil. Oscillograms show that the speaker responds to a square wave without loss of level; an identical speaker with a paper cone and copper voice coil wire responded to the square wave at a significantly lower amplitude.

Fox, Barry. *Audio patents. Hi-Fi News* 25:9 (Sept. 1980), p. 57. (Mr. Fox has dropped the pseudonym Adrian Hope.) British patent application No. 2,023,373 for Alan Hill's Plasmatronics driver. "Although the ideas are doubtless feasible it all sounds rather eccentric for domestic hi-fi reproduction." The device produces ozone, a dangerous gas.

Fox, Barry. *Audio patents. Hi-Fi News* 25:11 (Nov. 1980), p. 81. In British patent application No. 2,022,362, Mitsubishi claims a 20dB reduction in distortion if the iron pole piece of a driver is coated with a ferromagnetic material of very fine crystalline structure. Suitable materials are pure iron, nickel-iron alloys, low-carbon steel & c. The coating, it is claimed, will make the permeability of the pole piece linear, and therefore that of the hysteresis loop as well.

Murray, Fancher M., and H. M. Durbin. *Three-dimensional diaphragm suspensions for compression drivers. Journal of the Audio Engineering Society* 28:10 (Oct. 1980), pp. 720-725. 3 refs. The authors are with JBL. A new surround shape used in the new JBL 2441 compression driver.

Shindo, Takeo, and others. *Effect of voice coil and surround on vibration and sound-pressure response of loudspeaker cones. Journal of the Audio Engineering Society* 28:7-8 (July-Aug. 1980), pp. 490-498. 6 refs. "The finite-element method is used to calculate the changes in eigenfrequencies, the shapes of the normal modes, and the displacements due to forced vibration of the conical cone resulting from the attachment of the voice coil and the outer surround."

Stock, Gary. *Alternative speaker technologies. Audio* 64:8 (Aug. 1980), pp. 32-36. No refs. On p. 36 there is a list of works dealing with electrostatic, planar-dynamic, ribbon, piezoelectric, and "exotic" loudspeakers.

van der Pauw, Leo J. *The trapping of acoustical energy by a conical membrane and its implications for loudspeaker cones. Journal of the Acoustical Society of America* 68:4 (Oct. 1980), pp. 1163-1168. 14 refs. The author is with Philips Research Labs. "in a relatively wide frequency range, typically from 2-10kHz, the driving-point admittance has a non-vanishing real part (...). It appears that the supplied energy is accumulated and trapped in the

cone in a ring-shaped area with frequency-dependent radius."

Walker, Peter J. *New developments in electrostatic loudspeakers. Journal of the Audio Engineering Society* 28:11 (Nov. 1980), pp. 795-799. 8 refs. the author is the founder of Acoustical Manufacturing Co., Ltd. A new electrostatic speaker with annular elements and delay.

Yamamoto, Takeo, and others. *High-fidelity loudspeakers with boronized titanium diaphragms. Journal of the Audio Engineering Society* 28:12 (Dec. 1980), pp. 868-873. 6 refs. The author are with Pioneer Electric. A new process of boronizing titanium diaphragms is described; improved performance over titanium diaphragms is claimed.

(No author given.) *Hi-fi firm makes a strong case for flimsy film. New Scientist* 87:1216 (28 Aug. 1980), p. 651. PSB Electronics (Leeds, England) has developed a new driver using a thin polyester diaphragm with an aluminum track deposited on a photographically prepared pattern. In the presence of an audio signal, the aluminum tracks sets up a variable magnetic field; this interacts with the static field from magnets at both sides of the diaphragm.

(3) CROSSOVER NETWORKS PASSIVE AND ACTIVE

Borys, Andrzej. *On intermodulation and harmonic distortion in single-amplifier active filters. Journal of the Audio Engineering Society* 28:10 (Oct. 1980), pp. 706-712. 9 refs.

Brain, C.J. *A simple, effective crossover network. Hi-Fi News* 25:12 (Dec. 1980), p. 105, 107. No refs. Compensation of drivers so they present a resistive load to the amplifier; the values of the compensation components are cleverly chosen so they can be part of a quasi-second-order network. A practical example of a network integrating a Jordan-Watts module and the Coles 4001G at 7kHz is given.

Bruton, Leonard T. *RC active circuits, theory and design. Prentice-Hall*, 1980. \$29.95. Standard book No. 0 1375 3467 1. An undergraduate text.

Chen, Wai-Kai. *Active network and feedback amplifier theory. 1980. \$27.50* Standard book No. 0 0701 0779 3. "intended as a text for one-semester graduate courses requiring only an understanding of basic circuits and simple matrix algebra."

Cochet, Yves. *Application des condensateurs à l'audio; 2—les condensateurs électrolytiques. ("Audio applications of capacitors; part 2, electrolytic capacitors")*. *L'Audiophile* No. 17 (Oct. 1980), pp. 47-53. No refs. (in French) Continues the article by Yves Neveu cited in Loudspeaker Lit April June 1980, section 3.

Fink, Dennis G. *Time offset and crossover design. Journal of the Audio Engineering Society* 28:9 (Sept 1980), pp. 601-611. 9 refs. The author is with UREI. "The magnitude response of a crossover/speaker system can vary as a function of time offset and crossover order, and there are delay networks that can compensate for these effects."

Garde, Peter. *All-pass crossover systems. Journal of the Audio Engineering Society* 28:9 (Sept. 1980), pp. 575-584. 17 refs. "Response characteristics are given for all-pass crossover systems up to ninth order, and the importance of a systems approach to crossover-network design is emphasized."

Harms, W.F. *Series or parallel? Hi-Fi News* 25:12 (Dec. 1980), p. 103. No refs. Parallel crossover networks are to be preferred to series ones, because current loads and DC resistance are

smaller, and because component variations in a series network will affect both bass and treble, unlike in parallel networks, where the sections are independent.

Ho, C.F. *Synthesis of active r.c. all-pass networks. International Journal of Electrical Engineering Education*. Vol. 17 (July 1980), pp. 265-270. Second order filters.

Horowitz, Paul, and Winfield Hill. *The art of electronics*. Cambridge University Press, 1980. \$25. Standard book No. 0 5212 3151 5. pp. 25-35 and 148-162 form an excellent short introduction to active filters.

Huelsman, Lawrence P., and P.E. Allen, *Introduction to the theory and design of active filters*. McGraw-Hill 1980. \$25.95. Standard book No. 0 0703 0854 3. "appropriate for senior- and graduate-level active network synthesis courses."

Lindquist, Claude S. *Active network design with signal filtering applications*. Steward and Sons, 1980. \$21.95. Standard book No. 0 9171 4401 5. Textbook incorporating original research.

Marec, Guy. *Mise au point des filtres séparation passifs; 2—point de vue d'un puriste*. ("Clarifying passive dividing filters, 2—a purist's approach"). *L'Audiophile* No. 18 (Dec. 1980) pp. 15-23. (in French) No refs. Continuation of an earlier article (see Loudspeaker Lit, April-June 1980, section 3). A very sophisticated and complex network of 28 elements is designed for the three-way system described in Nos. 8, 9, and 11 of *L'Audiophile* by Yves Neveu.

Murphy, John, and Jim Ford. *An overview of crossovers. Modern Recording and Music* 5:11 (Aug. 1980), pp. 68-72. No refs. Part two is in the Sept. issue, pp. 74-77. 3 refs. The first part treats bandwidth and power limits of drivers, the benefits of multi-amplification, and frequency selection for electronic crossovers. The second part discusses summing error with 12dB per octave filters; 18dB per octave Butterworth filters are recommended for all but the most critical monitoring systems, where constant voltage filters with flat amplitude & phase response should be used.

Protheroe, David W. *Simple active filters for equalizers. Wireless World* 86:1536 (Sept. 1980), pp. 77-78. 10 refs. Designs using simulated inductors to give filters having any desired values of centre frequency, Q, and gain.

(4) CABINETS

Leissa, A. W. *The relative complexities of plate and shell vibration. The Shock and Vibrating Bulletin* 50 (Sept. 1980), Part 3, pp. 1-9. 19 refs. Very useful for curved and particularly cylindrical speaker cabinets. Cf. Sundarajan, C., *An approximate solution for the fundamental frequency of plates. Journal of Applied Mechanics, Trans. of the ASME* 45:4 (Dec. 1978), pp. 936-38 (reviewed in *Applied Mechanics Reviews* 33:1 (Jan. 1980), No. 262, p. 38).

Lightsey, George R., ed. *The role of chemical engineering in utilizing the nation's forest resources*. American Institute of Chemical Engineers, AICHE Symposium series, No. 195, Vol. 76, 1980. Two papers are of interest.

1) Hunt, Michael, O. and others. *Hardwood structural particleboard for industrial-commercial roof decking*. pp. 43-56. Tables on pp. 55-56 gives mechanical parameters, notably high values of modulus of elasticity.

2) Harpole, George B. *Cost of manufacturing structural flakeboard panel products*. pp. 57-67. p. 63 for mechanical properties of this board.

Purcell, W. Ernest. *Materials for noise and vibration control. Sound and Vibration* 14:7 (July 1980), pp. 8-32. No refs. Discusses materials for sound absorption, sound barriers, vibration damping, and vibration isolation. The section on damping materials, pp. 25-27, is relevant for panel resonance. Use in conjunction with *Buyers guide to materials for noise and vibration control*, pp. 4-5 of the same issue.

Smay, V. Elaine. *The glue revolution is changing the way we put it all together. Popular Science* 217:2 (Aug. 1980), pp. 62-65, 106-107. 7 refs. The second part will be found in the Sept. issue, pp. 56-64, 146-149. 3 refs. A good survey of the newest uses of epoxies, silicones, cyanoacrylates,

British Components and designs for the high quality speaker builder!

Our range runs from transmission lines to a system similar in all essential respects to the LS3/5A. **Audiogram** have twice recommended our Webb kit alongside the KEF R105 and the Linn Isobarik (issues 12/78 and 12/79 refer).

All our systems are comparable in performance with the best similar commercial types and usually better—we do not confuse things by handling radio/T.V., group, disco, PA or junk designs or components. Full catalogue, data and export rates \$5.00 air mail. Stockists of **Crimson Elektrik** amplifier modules.

Badger Sound Services Ltd.

46 Wood Street
Lytham St. Annes, FY8 1QG Lancashire,
ENGLAND



IF YOUR MUSIC LISTENING REQUIREMENTS DEMAND PHASE COHERENT, ACCURACY OF REPRODUCTION WITH VERY HIGH SIGNAL RESOLVING ABILITY, DEEP, TIGHT AND ARTICULATE BASS, WITH HIGH SPL CAPABILITY FOR TODAY AND TOMORROW'S WIDE DYNAMIC RANGE RECORDINGS, CHECK OUT OUR LINE OF DRIVERS, DESIGNS, AND PARTS INCLUDING AUDIO-GRADE CAPACITORS. DESIGN AND MOD ASSISTANCE AVAILABLE.

REFRESHING SONIC PURITY NOW AVAILABLE

Use Ted Jordan/TA designs with the Jordan 50mm Module intended for building linear line source arrays that radiate coherent cylindrical wave fronts and do most of the work in your dream system. Speaker signal tracing, high resolving at all usable realistic SPL's is now here in a satellite size you can almost hide at a cost that makes sense.

Send for the Jordan Manual, a 26-page text book on sound and speaker design and a catalog of drivers, crossover parts, application notes, biamping and subsonic filter kits, audio-grade capacitors for your electronics projects, mods and crossovers. Both for \$3.00.

Transcendental Audio

INNOVATIVE COMPONENTS AND DESIGNS IN HIGH-END AUDIO
6796 ARBUTUS STREET, ARVADA, COLORADO 80004 - 303-420-7356

MODEL 5000

Subwoofer Electronic Crossover

100 Hz • 18 dB/octave

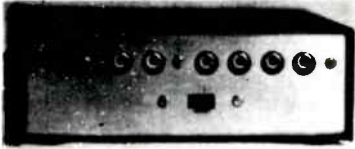

NEW precision crossover complete with subwoofer level control and bypass switch. Add a subwoofer to your speaker systems for accurate ultra-low bass. (Custom frequencies available from 40-200 Hz). Kit \$87.50 PPD, wired \$145 PPD. FREE CATALOG from ACE AUDIO CO., 532-5th St. E. Northport, NY 11731. (516) 757-8990.

WHAT'S YOUR AQ?*



* Audiophile Quotient. Find out by taking the AQ test in the next issue of *BIASED*. Also in that issue, Asak cartridge updates, a look at digital, and the return of the Fubar Award.

For a four issue subscription, send one dollar to:

Audiophile Systems, Ltd.,
Dept. A, 6842 Hawthorn Park Dr.,
Indianapolis, Indiana 46220.

Literature

anaerobics, and "yellow glue" (Tite-Bond). Dow's Urethane Bond and Duro Depend may be useful in controlling panel resonance.

Wicks, Harry. *Using a sabre saw*. *Popular Mechanics* 154:6 (Dec. 1980), p. 28. This article is continued in the January 1981 (p. 110) issue, and concluded in Feb. 1981 (p. 150).

Vinogradov, B.D., and V.V. Chernoberevskii. *Damping of tubes by a constrained coating*. *Soviet Physics—Acoustics* 26:4 (July-Aug. 1980), pp. 328-330.

Zeinettinova, R.Z., and others. *Vibration damping of tubes by vibration-absorbing coatings*. *Soviet Physics—Acoustics* 26:4 (July-Aug. 1980), pp. 312-315. 5 refs.

(No author given). *Wood bonding. Part 2. Lumber, particleboard, and fiberboard bonding*. (Citations from the Engineering Index data base). A world-wide literature search, covering the years 1970 to 1979, giving 174 abstracts; gives recommended procedures for bonding wood, except for plywood bonding, which is excluded. Available from National Technical Information Service, 5285 Port Royal Road, Springfield, VA 22161 for \$30. NTIS order number PB 80-804438.

(5) MEASUREMENTS, TEST EQUIPMENT, AND SPEAKER EVALUATION

Baxandall, Peter J. *A low-distortion acoustic measurement oscillator using semiconductor junctions as variable-tuning elements*. *Journal of the Audio Engineering Society* 28:12 (Dec. 1980), pp. 874-878. 1 ref. An accurate, stable oscillator with low noise and distortion, and with warble and autosweep facilities. There are equal-amplitude outputs in phase quadrature, so the oscillator can be used in a tracking-filter system.

Borwick, John. *If we can hear it, we can measure it*. *db* 14:7 (July 1980), pp. 49-52. No refs. Results of listening tests given at 65th AES Convention (London, Feb. 1980); objective and subjective testing at KEF factory.

Christophorou, Jason. *Low-frequency loudspeaker measurements with an accelerometer*. *Journal of the Audio Engineering Society* 28:11 (Nov. 1980), pp. 809-816. 9 refs.

Fasbender, J., and D. Günzel. *Ein Messsystem für rechnergestützte Impulsmessungen in der Akustik*. ("An experimental system for computer-assisted impulse measurements in acoustics") *Acustica* 45:3 (July 1980), pp. 151-165 (in German). A technique for measuring the complex transfer function of a loudspeaker or room. Sophisticated pulse signals are used to give adequate signal-to-noise ratio.

Hirsch, Julian D. *Technical talk: double-blind equipment comparison*. *Stereo Review* 45:1 (July 1980), pp. 31-32. Use of ABX Comparator for speakers and amplifiers.

Moir, James. *Measuring loudspeaker responses*. *Hi-Fi News* 25:10 (Oct. 1980), pp. 71-73. Discussion of the causes of irregularities in frequency-response curves and the disadvantages of anechoic rooms and pulse testing. Mr. Moir tests speakers for *Hi-Fi News* in the open air, at least two meters above a grassy surface, using pink noise.

Thompson, J.K. and D.R. Tree. *Leakage error in fast Fourier analysis*. *Journal of Sound and Vibration* 71:4 (Aug. 1980), pp. 531-544. 4 refs.

(6) INTERFACE OF SPEAKER, CABLE AND AMPLIFIER

Allison, Roy. *Loudspeaker power requirements*. *Stereo Review* 45:2 (Aug. 1980), pp. 62-65. No refs.

Holman, Tomlinson. *The amplifier/loudspeaker interface*. *Hi-Fi News* 25-12 (Dec. 1980), pp. 77, 79. No refs. Properties of amplifiers that are significant for powering real loudspeaker loads.

Mitchell, Peter W. *The uneasy symbiosis*. *High Fidelity* 30:10 (Oct. 1980), pp. 49-53. Informative discussion, at popular level, of the operation of an amplifier output stage when connected to a speaker. Good discussion of the effects of speaker reac-

tance and "the arithmetic of impedance". Sheds no light on the problem of speaker cables.

Otala, Matti, and Jorma Lammasniemi. *Intermodulation at the amplifier-loudspeaker interface; Part 1: analysis of one source of audible difference between amplifiers*. *Wireless World* 86:1538 (Nov. 1980), pp. 45-47. 7 ref. "Intermodulation occurs between an amplified signal and a delayed version returned from a loudspeaker through a feedback loop, when open-loop output impedance is high compared to speaker impedance." "Part 2: causes, how to avoid it; measurements on four types of amplifier circuit" will be found in the December 1980 issue, pp. 42-44, 55. 5 refs.

(7) SPEAKER AND ROOM INTERFACE

Altieri, Gustavo. *Conditionnement acoustique de la salle d'écoute; l'isolement—fondements*. ("Acoustics and acoustical treatment of the listening room; preventing sound transmission—fundamentals") *L'Audiophile* No. 17 (Oct. 1980), pp. 69-75 (in French). No refs. Continues earlier articles (see *Loudspeaker Lit.*, April-June 1980, section 7).

Altieri, Gustavo. *L'isolement de la salle d'écoute, critères pratiques*. ("Isolation of the listening room: practical considerations") *L'Audiophile* No. 18 (Dec. 1980), pp. 79-83. Continuation of the previous entry.

Marcoux, Pierre. *Réalisation d'un auditorium*. (*Building a listening room*) *L'Audiophile* No. 17 (Oct. 1980), pp. 92-99 (in French). No refs. An interesting and unconventional approach to designing a listening room from a producer for Canadian television who built his own house.

Messenger, Paul. *Subjective sounds: the final component*. *Hi-Fi News* 25:10 (Oct. 1980), p. 61. Analysis of Messenger's listening room using the Ivie IE-30A spectrum analyzer.

Mitchell, Peter. *Loudspeaker placement*. *Stereo Review* 45:2 (Aug. 1980), pp. 56-61. No refs. "How to use your listening room's absorptions, reflections, standing waves, boundary reinforcements, and cancellations to determine optimum loudspeaker placement." Valuable advice.

(8) HORNS

Morita, Shigeru, and others. *Aboustic radiation of a horn loudspeaker by the finite-element method—a consideration of the acoustic characteristic of horns*. *Journal of the Audio Engineering Society* 28:7-8 (July-Aug. 1980), pp. 482-488. 4 refs.

(9) METHODS OF BAFFLING WOOFERS

Alard, Michel. *Optimalisation d'un bass-reflex; 2ème partie: application*. (*Optimizing bass reflex designs; Part 2, applications*) *L'Audiophile* No. 17 (Oct. 1980), pp. 26-37 (in French). No refs. This continues the No. 14 (see *Loudspeaker Lit.* for Jan.-Mar. 1980, section 9). In an interesting departure from the cookbook approach, M. Alard proposes to regard the reflex principle as an aid to greater linearity of dynamic response, not to deeper bass response. Thus he advises tuning the box to higher than usual frequencies, and using a vent with a large cross-sectional area, to maximize radiating area. The Audax PR 38 15" woofer chosen as a practical example. The optimum enclosure volume is 232 liters; the enclosure greatly resembles the Onken woofer.

Bullock, Robert M., III. *Thiele, Small, and vented loudspeaker design: Part 1. Speaker Builder* 1:4 (1980), pp. 7-13, 30. 9 refs.

Klipsch & Associates. *Low-frequency folded exponential horn loudspeaker apparatus with bifurcated sound path*. U.S. patent No. 4, 210, 233. *Official Gazette of the U.S. Patent & Trademark Office*, July 1, 1980, p. 132. A bass horn with one fold.

White Jeffrey N., and R. J. Newman. *Constructing loudspeaker systems with predictable performance*. *Recording Engineer-Producer* 11:4 (Aug. 1980), pp. 62, 64, 68, 70-75. 7 refs. The authors are with Electro-Voice Corp. Helpful for using drivers that don't fit into Thiele's alignments and for determining vent dimensions.

(10) PROFESSIONAL SOUND SYSTEMS

Borwick, John. *A classical speaker situation*. *db*
Continued on page 30

Old Colony KITS

POLICY: OLD COLONY SOUND LAB is a service agency for readers of *The Audio Amateur* and *Speaker Builder* magazines. It attempts to provide circuit boards and the basic, or hard to find, parts for construction projects which have appeared in the magazine. **Old Colony assumes that the constructor will use the *Audio Amateur* or *Speaker Builder* magazine article as the guide for building his unit.** Kits, with noted exceptions, are not priced to include article reprints or construction instructions. Old Colony kits, with stated exceptions, do not provide metal work, cabinets, line cords and the like. We suggest that before purchase amateurs secure and evaluate the articles, which give details on each unit. Kits vary widely in complexity and required construction skills. A very few can be assembled by the beginner. If you are just starting in audio, get some experience building Heath or Dyna kits before tackling an Old Colony kit, or locate an experienced friend to help in case of difficulties.

CROSSOVERS ELECTRONIC

For both electronic crossovers: crossover points and R_1, R_2, C_1, C_2 MUST be taken from Fig. 3, p. 11, Issue 2, 1972, TAA. No other values can be supplied

KC-4A: ELECTRONIC CROSSOVER, KIT A. [2:72] Electronically divide the signal before the amplifier. Requires one amp for bass; a second for treble (or one stereo amp per channel). Lowers distortion and dramatically increases power capability. Single channel, two-way. Values of R_1, R_2, C_1, C_2 must be specified with order. All parts and C-4 circuit board. Includes new LF351 ICs. Each \$8.00

KC-4B: ELECTRONIC CROSSOVER, KIT B. [2:72] Single channel, three-way. Values of R_1, R_2, C_1, C_2 , must be specified with order. All parts and C-4 circuit board. Includes new LF351 ICs. Each \$11.00

KK-6L: WALDRON TUBE CROSSOVER: Low pass. Single channel, 18dB/octave, Butterworth, [3:79] includes Bourns 3-gang plastic pot, level control, Mullard tubes, board, and three frequency range determining capacitors. Specify ONE frequency range per kit please. (Hz.). 19-210; 43-465; 88-960; 190-2100; 430-4650; 880-9600; 1900-21,000. Single channel. Each \$43.00

KK-6H: WALDRON TUBE CROSSOVER: High pass. Single channel, 18dB/octave, Butterworth, [3:79] includes Bourns 3-gang plastic pot, level control, Mullard tubes and 3 frequency determining capacitors. Please specify one of the frequencies above. No other can be supplied. Each \$45.00

KK-6-S Switch Option. 6-pole, 5-pos. rotary switch, shorting, for up to five frequency choices per single channel. Each \$8.00
When ordered with two kits above, Each \$7.00

KK-7: WALDRON TUBE CROSSOVER POWER SUPPLY. [3:79] All parts, including board, transformer, fuse, semiconductors, line cord, capacitors. Will power four tube x-over boards (8 tubes), one stereo bi-amped circuit. Each \$88.00

PASSIVE

KF-7: CROSSOVER FOR WEBB TLS. [1:75] Passive four-way crossover, in pairs, assembled. Components are included for both STC and Celestion tweeters. Made by Falcon of England. Pair \$76.00

FILTERS & Speaker Saver

KF-6: 30Hz RUMBLE FILTER. [4:75] Rolls off system response at 18dB/octave below 30Hz to eliminate rumble and garbage on discs below 30Hz. Cuts speaker distortion and wasted amplifier power. Two channel universal filter card supplied with WJ-3 (F-6) circuit board and all basic parts, 1% metal film resistors and 5% MKM capacitors for operation as an 18dB/octave 30Hz rumble filter. 30Hz, 0dB gain only. Kit may be adapted as two- or three-way single channel crossover with added capacitors and resistors. Each \$19.75

KH-2A: SPEAKER SAVER. [3:77] Protects speakers from destructive transient signals by quick shutdown of amplifier output. This basic two-channel kit includes board and all board-mounted components for control circuitry and power supply. It features turn-on and off protection and fast opto-coupler circuitry that prevents transients from damaging your system. 4PDT relay and socket included. Each \$35.00

KH-2B: OUTPUT FAULT OPTION. If the amplifier goes into self-destruct mode, this added feature cuts off drive to output devices quickly. Additional board mounted components for speaker protection in case of amplifier failure. Each \$6.75

KH-2C: COMPLETE SPEAKER SAVER WITH OUTPUT FAULT OPTION. Each \$40.00

KK-8: COMPEX C. Signal compression in a repeatable format for tape recording or signal transmission. Two channel board with all parts to compress signal, including 1% polycarbonate capacitors and large tantalums. [3:79] Each \$45.00

KK-9: COMPEX E. Signal expansion in tape replay mode or after transmission via limited phone lines. Two channel expansion board with all parts including precision Rs & Cs, [3:79] Each \$35.00

SYSTEM ACCESSORIES

KH-8: MORREY SUPER BUFFER. [4:77] All parts & board for two channel output buffer to isolate tape outputs in your preamp from distortion originating in a turned-off tape recorder. Many uses for this versatile matchmaker. Each \$14.00

KF-1: BILATERAL CLIPPING INDICATOR. [3:75] Single channel, all parts and board for any power amp up to 250W per channel. (Does not work well with Leach Amp). Powered by amp's single or dual polarity power supply. Each \$5.50
Two kits, as above \$8.25

KK-14A: MacARTHUR LED POWER METER. [4:79] Two channel, two sided board and all parts except switches, knobs, and Mtg, clips for LEDs. LEDs are included. No chassis or panel. Each \$110.00

KK-14B: MacARTHUR LED POWER METER. [4:79] As above but complete with all parts except chassis or panel. Each \$137.50

KL-2: WHITE DYNAMIC RANGE & CLIPPING INDICATOR. [1:80] One channel, including board, with 12 indicators for preamp or crossover output. Requires $\pm 15V$ power supply @ 63 mils. Single channel. Each \$49.00

Two channels. \$95.00
Four channels. \$180.00

BENCH AIDS & Test Equipment

KH-7: GLOECKLER PRECISION 101dB ATTENUATOR. [4:77] As basic to measuring as a good meter, and more accurate than most. All parts except chassis and input/output jacks to build author's prototype including all switches and loads. Resistors are MF 1% and 2% types. Each \$50.00

KB-8: INVERSE RIAA KIT. Six precision components to shape your audio signal generator's output to the response curve of a recorded disc. Checks phono preamp inputs. Each \$5.75

KL-3C: INVERSE RIAA NETWORK. [1:80] Revised, precise, deluxe network. Two channels, 1% polystyrene capacitors and metal film resistors, gold jacks, cast aluminum box, solder lugs and alternate 600 ohm or 900 ohm r_1'/C_2' components. Each \$35.00

KL-3R: INVERSE RIAA. [1:80] Resistor/capacitor package complete. Stereo R_2'/C_2' alternates. Each \$25.00

KL-3H: INVERSE RIAA. [1:80] Box, terminals, gold jacks, and all hardware, (No resistors or caps) in KL-3C. Each \$13.50

KF-4: MORREY'S MOD KIT FOR HEATH IG-18 (IG 5818) SINE-SQUARE AUDIO GENERATOR. [4:75] Includes two boards and all added parts needed to modify the Heath unit to distortion levels of parts per million range. Replacement sine-wave attenuator resistors not included. Each \$35.00

KG-2: WHITE NOISE/PINK FILTER [3:76] All parts, circuit board, IC sockets, 1% resistors, $\pm 5\%$ capacitors. No batteries, power supply or filter switch. Each \$22.00

KJ-7: VTVM BATTERY REPLACEMENT KIT. [4:78] All parts to replace your VTVM's battery with a regulated supply. Each \$7.50

KJ-6: CAPACITOR CHECKER. [4:78] All parts to build an accurate meter for measuring capacitance, leakage, and insulation. Check phono & speaker lead capacitance effects. Includes all parts with $4\frac{1}{2}''$ D'Arsonval meter. Each \$68.00

KK-3: THE WARBLER OSCILLATOR. [1:79] For checking room response and speaker performance without anechoic chamber. All parts and board. Each \$56.00

KL-6 MASTEL TIMERLESS TONE BURST GENERATOR. [2:80] Highly valuable and useful device for testing speakers and room response. All parts with circuit board. No power supply. Each \$19.00

NEW KIT: SBK-A1: LINKWITZ CROSSOVER/FILTER. *Speaker Builder's* [4:80] first kit, including all parts and board for one channel of the three-way crossover/filter/delay. 24dB/octave at 100Hz and 1.5kHz and 12dB/octave below 30Hz, with delayed woofer turn-on. Board is $5\frac{1}{2} \times 8\frac{1}{2}$. Requires $\pm 15V$ supply, not supplied. Use the Sulzer supply KL-4A with KL-4B or KL-4C.

Per channel \$64.00
Two channels \$120.00
SBK Board only Each \$14.00

ORDERING INFORMATION

Prices, except as noted, are prepaid in the USA and insured. We prefer to ship via UPS, which requires a street address. If you cannot receive UPS delivery, please include an extra \$2 for insured service via Parcel Post. We cannot accept responsibility for safety or delivery of uninsured Parcel Post shipments PLEASE ADD \$1 service charge for all orders under \$10

CHARGE CARD
TELEPHONE ORDER SERVICE

MON THROUGH FRI 9AM-4PM
(603) 924-6526

MasterCharge/Visa Cards Welcome

OLD COLONY Box 243 Peterborough NH 03458

Build Your Own Speakers!

low DCR inductors
metal film resistors
electrolytic NP
film capacitors
driver components



10mFd 50V NP cap.	\$ 1.00
16mFd 50V NP cap.	1.29
1mH inductor air	2.99
3.5mH inductor PIC	5.99
4½" 8ohmMid/potCov.	10.00
10" 8ohm Woofer 50W	13.95
1½" Horn Super Tweeter	3.95

Partial List/Much More!

Free Catalog & Price Sheet

Write to:

PHASE MATRIX GROUP
Box 101
Bethlehem, CT 06751
(203) 266-5585

MINIMUM ORDER \$10.00

All orders add \$1.00 Postage and Handling

YOU PROBABLY HAVE NEVER HEARD THE FULL POTENTIAL OF STEREOPHONIC REPRODUCTION



You may have wondered why all the sound from your stereo seems to come from the space between your speakers when you know that speakers project sound in all directions. In a conventional stereo system, the speakers act as sonic barriers to the stereo image. They actually become obvious sources for the sounds that were originally recorded beyond the angle that they enclose.

The IR2100 Image Restoration Control can effectively remove this barrier and allow your stereo to reproduce the full breadth and depth of the original performance. The IR2100 is also uniquely adjustable from the listening position for a wide range of speaker locations and source material, so you can easily tune it to get the most out of your stereo and your recordings. The impact of the IR2100 will be to expand your stereo sound stage and give greater localization of the individual instruments and voices while restoring the original open feeling of a live performance.

For complete information write to Sound Concepts c/o Box 135, Brookline, MA 02146 or call (617) 566-0110.



**FIDELITY IN
SPATIAL REPRODUCTION**

Literature

Continued from page 28

14:12 (Dec. 1980), pp. 27-29. No refs. The use of 18 Quad 405 amplifiers and 36 KEF 105.2 speakers to reproduce the organ part, which was being played from a remote location, during a live performance of Berlioz's *Te Deum*.

Crabbe, John. *Berlioz and the phantom organ*. *Hi-Fi News* 25:11 (Nov. 1980), pp. 96-97, 99. Use of KEF 105.2 speakers and strapped Quad 405 amps to reproduce the organ part, played at a remote location, in a concert performance of Berlioz's *Te Deum* in Edinburgh, September 1980.

Davis, Don and Chips Davis. *The LEDE concept for the control of acoustic & psychoacoustic parameters in recording control rooms*. *Journal of the Audio Engineering Society* 28:9 (Sept. 1980), pp. 585-595. 30 refs.

Fierstein, Alan. *Acoustical troubleshooting*. *db* 14:10 (Oct. 1980), pp. 36-40. How to analyze the acoustical properties of a room using a variety of tests, including time-delay spectrometry.

Munro, Andy. *Developments in recording and monitoring acoustics*. *Studio Sound and Broadcast Engineering* 22:10 (Oct. 1980), pp. 50-52, 54. Discusses control of early reflections by use of time-delay spectrometry, live end-dead end, time alignment, and equalization.

Neve, Rupert. *Basic studio acoustics and design*. *Studio Sound and Broadcast Engineering* 22:10 (Oct. 1980), pp. 44-46, 48.

Rettinger, Michael. *Bass traps*. *Recording Engineer-Producer* 11:4 (Aug. 1980), pp. 46, 48, 50-51. 1 ref.

(11) CONSTRUCTION PROJECTS

Edgar, Bruce C. *A corner mid-range horn*. *Speaker Builder* 1:3 (1980), pp. 15-19. 9 refs. For PA use.

Harcourt, R.I. *An acoustically small loudspeaker*. *Wireless World* 86:1537 (Oct. 1980), pp. 65-67, 73. 6 refs. A curious 3½-way, active-network design. Attention is paid to cavity and panel resonance, and to diffraction. The second part of the article is in the November issue, pp. 72-76, 1 ref.

Humphreys, Ivor. *A simple phase-inversion box*. *Hi-Fi News* 25:11 (Nov. 1980), pp. 91, 93. A construction project using CMOS switches. See the entry under John Atkinson in section 1.

Linkwitz, Siegfried. *A three-enclosure loudspeaker system with active delay and crossover: part 2*. *Speaker Builder* 1:3 (1980), pp. 9-14. 9 refs. The concluding part of this article is in *Speaker Builder* 1:4 (1980), pp. 14-19, 22-24, 30. 6 refs.

Marsh, Richard N. *The double-chamber speaker enclosure*. *Speaker Builder* 1:3 (1980), pp. 7-8. No refs. Derives from George L. Augspurger's article of the same title in *Electronics World*, Dec. 1961, pp. 41-43, 72-73.

Neves, John, and others. *Build a digital audio delay line*. *Popular Electronics* 18:3 (Sept. 1980), pp. 68-70, 73-75. No refs.

Roberts, John. *A low-cost analog audio delay line*. *Popular Electronics* 18:1 (July 1980), pp. 53-57. No refs. Uses a bucket-brigade device and "comparison". The concluding part of the article is in the August issue, pp. 83-86. A complete kit of parts is available at a cost of \$250.

Sanders, Roger R. *An electrostatic speaker system, part II*. *Speaker Builder* 1:3 (1980), pp. 20-25, 27. No refs. The concluding part of the article, dealing with the woofer, a KEF B 139 in a transmission-line enclosure, is found in issue 4, 1980, pp. 26, 28-30. No refs.

Stock, Gary. *Build this high-performance minispeaker system*. *Radio Electronics* 51:12 (Dec. 1980) pp. 52-54, 105. No refs. Uses a doped 4½" Pioneer midrange and a 2¼" Peerless tweeter in a 7½" x 4¾" x 3 aluminum Bud box. An interesting project.

(12) STEREO AMBIENCE AND SURROUND SOUND

Bose Corp. *Varying loudspeaker spatial characteristics*. U.S. patent No. 4, 218, 583. *Official Gazette of*

the U.S. Patent & Trademark Office, Aug. 19, 1980, p. 1066. "Apparatus for controlling the perceived image of a sound signal radiated by a loudspeaker system".

Carver, Robert W. *Dimensional sound producing apparatus & method*. U.S. patent No. 4, 218, 585. *Official Gazette of the U.S. Patent & Trademark Office*, August 19, 1980, pp. 1067-8. "A dimensionalized audio-signal producing apparatus", known commercially as the Sonic Hologram.

Hope, Adrian. *Audio Patents*. *Hi-Fi News* 25:8 (August 1980), p. 73. British patent No. 1,553,630 has been granted to Sony for a scheme to expand stereo spread and improve localization from a pair of speakers by increasingly reducing separation and adding phase shift as frequency increases above 300Hz. Yoshiro Nakamatsu has filed European patent application No. 0,005,037 for floating a moving coil on an invisible, intangible suspension, such as a uniform flow of air or a magnetic repulsion field.

Kates, James R. *Optimum loudspeaker directional patterns*. *Journal of the Audio Engineering Society* 28:11 (Nov. 1980), pp. 787-793. 10 refs. Using a mathematical model of human auditory localization, the author concludes that "loudspeakers should typically have 3dB bandwidths of from 30 to 90 degrees, and should be angled in toward listening area so that the loudspeaker axes are aimed at the opposite ends of the desired listening area."

(13) HEADPHONES

(14) MISCELLANEOUS AND UNCLASSIFIABLE

Browne, Bob and Gary Stock. *Profile: Paul Klipsch—Arkansas Speaker Maker*. *Audio* 64:8 (Aug. 1980), pp. 27-30. No refs.

Chrétien, Gérard. *L'enceinte Triangle, ou comment un passionné devient constructeur*. (*The Triangle Speaker, or how an enthusiast can become a manufacturer*). *L'Audiophile* No. 18 (Dec. 1980), pp. 25-31 (in French). No refs. Interview with Renaud de Vergnette, whose Triangle speaker is interesting largely because the midrange and tweeter satellite is in the shape of a truncated pyramid and constructed of plaster used in dental surgery.

Crabbe, John. *Editorial comment*. *Hi-Fi News* 25:8 (August 1980), p. 47. While the best of current British speakers can barely reproduce levels of approximately 100dB in a domestic living room (100dB being the maximum likely to be encountered in the concert hall), this is not the case in even slightly larger rooms. It was reluctantly concluded, after the experience of a demonstration in which KEF 105's had to be replaced with Tannoy GRF's, that the three extra decibels at the top of the dynamic range are audibly significant.

Crabbe, John. *Editorial comment*. *Hi-Fi News* 25:12 (Dec. 1980), p. 67. Continuing his editorial of August 1980, Mr. Crabbe welcomes the greater dynamic range of digital recordings, despite the many problems created. An example of the latter was seen in a simple recording of a solo snare drum, which though "not especially startling" when played back in a hotel room, required 800 watts of amplifier power to achieve the original sound level.

Fox, Barry. *Audio patents*. *Hi-Fi News* 25:10 (Oct. 1980), p. 67. British patent No. 1,559,190 granted to Sony for its "digital" speaker of compressed-air driven horns.

Mahul, Jacques. *Les dernières améliorations du système Onken-Mahul*. (*Recent improvements in the Onken-Mahul system*). *L'Audiophile* No. 18 (Dec. 1980), pp. 55-57 (in French). No refs. In *L'Audiophile* No. 2 Jean Hiraga published a constructional article for the celebrated Onken woofer enclosure using an Altec 416-8A 15" woofer. In the tenth issue Jacques Mahul described a midrange and tweeter system suitable in efficiency and quality for mating with the Onken. It used the Audax HD17 HR37 6½" midrange and the Fostex T925 horn in a third order compensated passive network. Many improvements to this basic system have since been reported. The latest involve doping the surround of the midrange and

Continued on page 15

SOME FINE POINTS OF VENTED SPEAKER DESIGN

Continued from page 25

system sounded somewhat less boxy. I later acquired active crossovers and we now can't distinguish between the two systems.

As for the B139 system, it will put out lower frequencies than most speakers I have heard, but it has two problems. First, the power handling capability is not the best. For example, even at normal volume levels the cannon shots in Telarc's recording of the *1812 Overture* will bottom the driver. On the other hand, it does quite a good job on organ music, which doesn't contain such high energy passages.

A more serious problem is the system's extreme sensitivity to subsonic interference. Even with the best recordings, during silent passages you can hear the cone flapping back and forth. This problem is common in vented systems and makes for a muddy sounding bass. I think the B139's high cone mass aggravates the situation.

I have cured this problem by going to a sixth order alignment, as opposed to the fourth order alignments we have been using. Not only is subsonic interference eliminated, but the loudspeaker bandwidth is significantly extended. My sixth order B139 system sounds clean and goes very, very low. It is still poor in terms of power handling, but it reproduces notes so low that you feel as much as you hear them. I plan to report on these alignments in a later article. In the meantime, I advise you to have a good subsonic filter in your system when using a vented loudspeaker with a low cutoff frequency. The Williamson Bandpass Filter kit offered by Old Colony should do an excellent job. [See also the Jung 30Hz filter.—Ed.]

ACOUSTIC LINING OR FILLING

Thiele claims that a properly aligned vent system requires no lining or filling to smooth its response; in fact, such material will tend to depress the low frequency output and somewhat defeat the vent function. My own experience confirms this.

However, if the system is crossed over at a sufficiently high frequency, you need material to absorb rear radiation and damp standing waves. This should only be placed close to the cabinet walls, not stretching across the middle. A 1/2-1" thick lining on all walls but the baffle is the most that is usually recommended.

I originally lined the B139 cabinets, but the response was the same without it, so they now function with bare walls. I think lining was unnecessary in this system because it is crossed over to

FIG. 12

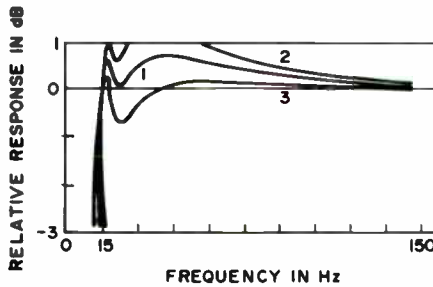

Fig. 12. Curve 1 is the target response for $Q_L = 7$, $Q_T = .65$. Curve 2 results from a +10% error in Q_T and curve 3 from a -10% error in the same parameter.

FIG. 13

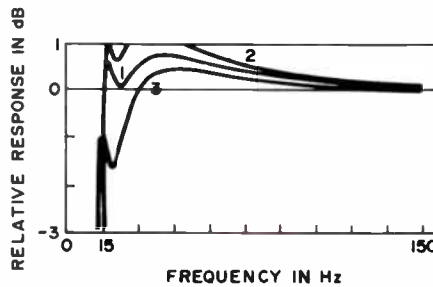

Fig. 13. Curve 1 is the target response for $Q_L = 7$, $Q_T = .65$. Curve 2 results from a +10% error in h and curve 3 from a -10% error in the same parameter.

FIG. 14

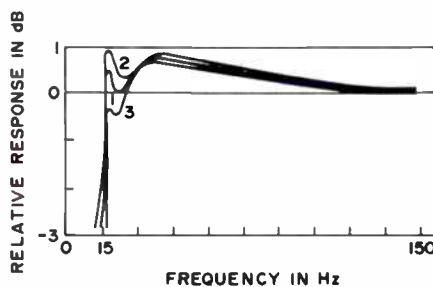

Fig. 14. Curve 1 is the target response for $Q_L = 7$, $Q_T = .65$. Curve 2 results from a -20% error in α and curve 3 from a +20% error in the same parameter.

FIG. 15

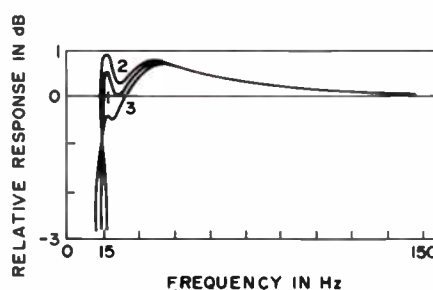

Fig. 15. Curve 1 is the target response for $Q_L = 7$, $Q_T = .65$. Curve 2 results from $Q_L = 10$ and curve 3 from $Q_L = 5$.

a separate enclosure at 150Hz and so never sees the higher frequencies that would excite panel resonances, create standing waves, etc.

On the other hand, the HD17B system is crossed over to a tweeter at

Continued on page 35

CIRCUIT BOARDS

Old Colony Circuit Boards are made of top quality epoxy glass, 2 oz. copper, reflowed solder coated material for ease of constructing projects which have appeared in *Audio Amateur* and *Speaker Builder* magazines. The builder needs the original article (indicated by the date in brackets, i.e. 3:79 for articles in *TAA* and *SB* 4:80 for those in *Speaker Builder*) to construct the projects.

- C-4: ELECTRONIC CROSSOVER (DG-13R) New 2x3 1/2" board takes 8 pin DIPs, Ten eyelets for variable components. Parts layout included. [2:72] Each \$4.50
- D-1: HERMEYER ELECTROSTATIC AMPLIFIER II. [3:73] Two sided with shields and gold plated fingers. Each \$7.50
Pair \$14.00
- F-1: BILATERAL CLIPPING INDICATOR. (CB-1) 2x2 1/2" [3:75] Single channel. Each \$3.00 Pair \$5.00
- F-6: JUNG 30Hz FILTER/CROSSOVER (WJ-3) 3x3" [4:75] High pass or universal filter or crossover. Each \$5.50
- G-2: PETZOLD WHITE NOISE GENERATOR & PINK FILTER. (JP-1) 2 1/2 x 3 1/2" [3:76] Each \$5.00
- H-2: JUNG SPEAKER SAVER. (WJ-4) 3 1/2 x 5 1/4" [3:77] Each \$7.00
- H-3: HERMEYER ELECTROSTATIC AMP BOARDS. (ESA-3) Set of three boards with plug-in edges for one channel. [3:77] Set \$19.00
- J-6: SCHROEDER CAPACITOR CHECKER. (CT-10) [4:78] 3 1/4 x 6" Each \$7.25
- J-7: CARLSTROM/MULLER VTVM ADAPTER. (CM-1) [4:78] 1 1/4 x 2 1/2" Each \$4.25
- K-3: CRAWFORD WARBLER 3 1/4 x 3 3/4" [1:79] Each \$6.00
- K-6: TUBE CROSSOVER. 2x4 1/2" [3:79] Two needed per 2-way channel. Each \$4.25 Four \$13.00
- K-7: TUBE X-OVER POWER SUPPLY. 5x5 1/2" [3:79] Each \$7.00
- K-12: MacARTHUR LED POWER METER. 5 1/2 x 8 1/4" [4:79] Two sided, two channel. Each \$16.00
- L-2: WHITE LED OVERLOAD & PEAK METER. 3x6" [1:80] One channel Each \$10.50
- L-5: WILLIAMSON BANDPASS FILTER. 3 3/8 x 4" [2:80] (RWAW479) Two channel 24dB/octave Sallen & Key circuit. Each \$6.50
- L-6: MASTEL TONE BURST GENERATOR. 3 1/2 x 6 1/4" [2:80]. Each \$8.50
- L-9: MASTEL PHASE METER 6 1/2 x 2 1/4" [4/80] \$8.00
- SBK-A1: LINKWITZ CROSSOVER BOARD ± 4:80 5 1/2 x 8 1/2" Each \$17.00

ORDER BLANK:

Old Colony Sound Lab

PO Box 243, Dept. SB, Peterborough NH 03458

To order from Old Colony Sound, please write each board's number below with quantity of each and price. Total the amounts and remit by check, money order, or MasterCard, or Visa/BankAmericard. All prices are postpaid in the 50 states. \$10 minimum order on credit cards. Canadians please add 10%, other countries 15% for postage. All overseas remittances must be in U.S. funds. Please use clear block capitals.

Name _____

Street & No. _____

Town _____

State _____ ZIP _____

No. Bds.	Board No.	Price
.....	\$
.....	\$
.....	\$
.....	\$
.....	\$
		Total \$

Please add \$1 service charge to all charge card orders under \$10.

SPEAKER BOILER BINDERS

Rich blue, heavy vinyl binders imprinted in white with *Speaker Builder's* logo. Spaces for twelve issues on loose wires will store your valuable *SB* data in a readily accessible format.

Each **\$7.00**
Two binders, ea. **6.50**
Three or more, ea. **6.00**

Ppd. in USA. Outside USA please add \$2. per binder for shipping

ORDER BLANK

Speaker Builder
PO Box 494, Peterborough NH 03458

Send _____ binder(s) @ \$ _____ ea.

Total \$ _____ check; M.O.; MCard; Visa

Charge card no. _____

Charge card expiration date _____

Signature _____

Name _____

Street & No. _____

Town _____ St. _____ Zip _____

BUILDERS AHOY

WHILE WE HAVE MANY fine manuscripts in hand for future publication in these pages—we need your contributions too. How about those offerings for our *Craftsman's Corner, Tools, Tips & Techniques*? We also need accounts of your construction adventures with specific projects. Why not plan to take pictures (black and white preferred) and make notes when you're building that next project—or kit. Write it up just as you would a letter to a friend. Send it along to us and we'll give it every consideration. We pay for articles, so you might have a nest egg for that next project you want to try, as well. We have a nice sheet of suggestions for authors which you may have just by asking for it.

HAYWARD CLUE

Anyone interested in Tom Hayward's offer of at-cost drivers for his *Craftsman's Corner* project appearing in *SB* 1/81 (p. 28ff.) may contact him by writing Phase Concepts Ltd., 3875 Omaha Dr., Norcross, GA 30071 or calling (404) 923-1127.

LINKWITZ QUERY

RE: 3/1980 PART 2 by Siegfried Linkwitz. *Figure 13* shows a second section of 3kHz high pass as being +6dB, but the voltage graph *Fig. 21* does not support this and the author gives us no clues as to why in the text. The 3kHz x-over amplitude response schematic has also been omitted from *Fig. 13*. The compensation for flat tweeters output is in the input stage.

The answer to this would be interesting, as I believe I have read several times that the output of the T27 is "hot" compared to polymer cone units.

I also agree completely with author Linkwitz's contentions in the first column of page 14 concerning SPL measurements for flat output don't seem to be supported in practice, (lest we forget Fletcher-Munson et al).

I have been experimenting for a year and a half with third octave pink noise record and SPL meter to obtain that elusive flat acoustic output with my system. I have approached it very closely on several occasions, say $\pm 3\text{dB}$ 30-16kHz at the listening position. But do you know what? It sounded awful and no where near realism. Good (very good) sound, yes, but far removed from that elusive orchestra "in the room" quality. I almost threw the SPL meter out until I realized it is *only* a guide under our very much less than laboratory conditions of measurement, and began to realize that *my ears* are the final most important guide.

This method does take considerable listening time and serious thought, however, as I feel we are very easily psychoacoustically fooled into tolerating some terribly un-realistic sound, as, with extended listing to one acoustic blend we are unable

SB Mailbox

to make a comparison to the truth at that moment. We can probably note immediately the difference between a very bad sound and a "good" one, but not so easily between the "good" and the perfection we seek.

Many average audiophiles are seldom subjected to honest live performance sounds. How many know Sinatra's actual personal timbre? Do we glean this from T.V., records of our same system, or even only through large hall P.A. systems?

I have tried near field, far field, and room reverberant SPL measurements, and flatness does *not* work with my room, system and ears. Extraneous object peaks and general trends, yes.

I have a system which is somewhat unusual. I use 15" woofers in separate cabinets from the upper bass, mid, treble units. My woofers use motional impedance feedback with a servo control amp to augment the acoustic suspension alignment to a very much lower cutoff frequency than Linkwitz and others.

My most unusual approach is that I have completely remoted the crossover, feedback and control units to my equipment rack position. This is an all-passive crossover system with only the feedback being active. This allows complete flexibility of design experimentation, network tailoring and switching control from the listening position for instant comparison.

As an additional note, I do enjoy *SB* very much, when it concerns itself with subject matter of a newer, more technical nature, giving insight into some of the newer highly experimental crossover and system schemes. I feel articles for the neophyte builder who wants to put 2 or 3 in specified drivers in a box with a mail order filter, are better left to *Popular Electronics*.

I would be interested in articles and reprints on the following: Completely phase coherent crossovers, tailoring a driver's impedance curve, systems with a "flat" impedance across band, passive electrical delay, taming the average "wild" drivers, pseudo 2nd order networks—from 1st order, the (Speakerlab) Nestornic 2 bass driver system, and factual information on phasing multi driver networks.

I'd also like to know the sonic result of, as example, a 27.03Hz f_3 cutoff of a 5" driver as per Stamler 1/80 pg. 22 (I guess my 15" drivers are just too big) and how to really, easily blend with attenuation, drivers of different efficiency at the crossover points.

In addition, I'd like to know why Mr. Linkwitz needs to sum the center channel woofer outputs to prevent vertical rumble from coloring the sound when he has a whopping +23dB boost at 9.7 hertz. I run anywhere from +20 to +36dB boost at 20-25Hz *but* it cuts off drastically below that frequency. He is boosting right smack

EV Electro-Voice® a gulton company **Component Speakers**

A few good reasons to build your own system.



SP15A
15 inch Speaker



12TRXC
12 inch Speaker



MODEL 30W
BASS LOUDSPEAKER



SP12C
12 inch Speaker



Model 8HD
Diffraction Horn



1824M
Midrange Driver



SP8C
8 inch Speaker



All-Weather Speaker



MUSICASTER II



Model T35A
Horn Tweeter



free catalog

CALL OF WRITE NOW!
THESE PLUS MORE IN

Sonix Co.

DEPT. SB
P.O. BOX 58
INDIAN HEAD
MARYLAND 20640
Phone (301) 753-6432



in the pickup-tone arm resonance zone where he might already have a possible 10dB boost (or at least some boost).

FRANK B. HORNER
Allenhurst, NJ 07711

Mr. Linkwitz replies

HERE IS A RESPONSE to questions raised by readers and some further explanations of related circuit details.

Referring to Fig. 13 (p. 11, 3/80): the tweeter section has a gain of +6dB when the output pot is set to its maximum and 0dB when to the minimum. This should be compared to a fixed gain of +4.2dB (61.9k/38.3k) for the midrange channel. Thus the signal level at the T27 terminals could be set 4.2dB below the B110 terminal voltage, should a particular T27 be that much "hotter," than the B110.

The woofer channel provides equalization for a flat response to 25Hz (-3dB) determined by the poles at 19.5Hz and 9.7Hz. Without this equalization the acoustic output from the two B139's would fall off at 12dB/octave rate below 54.5Hz where they have their motional resonance in the specified enclosure of Fig. 4. Thus to extend the frequency range by an octave requires 24dB amplifier boost at 12dB/octave rate.

Below 25Hz the acoustic output falls off at 12dB/octave which is normal for a totally closed box and for transient reasons more desirable than a faster cutoff rate.

The cancellation of vertical rumble from the turntable comes for free in the summing scheme for the center channel. The left and right channel outputs from the cartridge are out-of-phase for vertical modulation and therefore cancel at the summing junction of the op-amp. As with any system that has an extended low frequency response, care has to be taken to isolate the turntable from structure and airborne low frequency vibrations to avoid feedback coloration of the sound.

BULLOCK QUERIED

I AM IMPRESSED with Robert Bullock's inclusion of a very complete set of vented box alignments in his [SB, 4/80] articles. The information is much appreciated by those of us who must design with only the aid of dog eared AES Journals and hand held calculators.

However, I believe Mr. Bullock has given erroneous information in one of his worked examples when he gives the V_{AS} of an Audax HD17B37 as 1200 in.³.

D. B. Keele, in his paper "Low Frequency Horn Design using Thiele-Small Parameters" defines V_{AS} equal to $(P_o)(C^2)(C_{MS})(S_D^2)$ where P_o = the density of air (1.21 kg/m³), C = the velocity of sound in air (343 m/sec, C_{MS} = the compliance of the driver suspension, and S_D = the effective surface area of the speaker cone.

Audax gives a value of 1.69×10^{-3} mN⁻¹ for the C_{MS} and .0124m² for S_D of the HD17B37. Plugging these values into Keele's formula yields a V_{AS} of 2263 in.³. If Mr. Bullock is confident of his calculations I would appreciate his response as I am currently working on a box design for this driver.

CHARLES WIENS
Eugene, OR 97401

P.S. D. B. Keele's paper is available as a AES Preprint from the 57th Audio Engineering Society Convention in Los Angeles, May 10-13, 1977. Address is—Audio Engineering Society, Room 449, 60 E. 42nd St., New York, NY 10017.

Mr. Bullock replies:

I'M GLAD YOU LIKE the tables and I hope they ease the way for you.

Your inquiry about the V_{AS} parameter of the HD17B driver can be phrased in a more general way: Do the manufacturers' spec sheets provide reliable data for the design of vented systems? It has been my experience that the answer is usually "no." On the other hand, the values I used in the article cannot be expected to be accurate for the samples you have. I have determined the parameters of some sixteen drivers in the last few years and in most cases their values

vary significantly from spec sheet values and there is also large variation from sample to sample of a given model.

The major reason for the variation seems to be that the C_{MS} parameter is quite difficult to control in production. The driver resonant frequency f_s , mechanical mass M_{MS} and compliance are related by:

$$(2\pi f_s)^2 = 1/(C_{MS}M_{MS}). \quad (1)$$

For a particular driver model M_{MS} is usually consistent from sample to sample but C_{MS} is not. Thus f_s can vary quite a bit. To get an idea of production tolerances, my spec sheet for the Audax HD17B gives $f_s = 30 \pm 30$ Hz, $M_{MS} = 15.47 \times 10^{-3}$ and $C_{MS} = 1.8 \times 10^{-3}$. So, in production f_s can show a variation of 6Hz or 22% taking the smaller values as a base. Assuming the mass is constant for two samples formula 1 shows that a 50% compliance variation is possible. The driver Q parameters will also change since

$$Q_{MS} = 1/(2\pi f_s R_{AS} C_{AS}) \quad \text{and}$$

ALIGNED ENCLOSURES™

With the availability of high quality drivers, crossover networks and the technical information required for Thiele-Small alignments, the home speaker builder can build better speakers for a lot less than he can buy in a store. The major problem confronting the home speaker builder involves the difficulty involved in making or buying the proper enclosures. We feel that in general, the area of speaker enclosure design has been badly neglected. Most speaker enclosures are designed for convenience, marketing considerations, advertising pictures and wife pacification.

Gizmo Audio Development has done something about this problem. We manufacture superior quality walnut veneer enclosures that are intended to maximize the performance of your drivers instead of strangling them. Our cabinets are completely finished and are designed for Audax and KEF dynamic drivers and JVC and Technics ribbon drivers. They are designed to be nonresonant and nondiffractive and are not boxes.

Gizmo Audio Development has calculated the proper enclosure dimensions for a given set of alignments and drivers and uses them to construct triangular, tubular and pyramidal shapes for infinite baffle and ported enclosures and special transmission lines. All of our enclosures are MODULAR so you can mix and match your drivers while keeping each driver in an optimally designed enclosure. This gives you the additional and essential benefit of driver time alignment (we supply time alignment information). For the first time you can build true state of the art systems without problems of complex cabinetmaking.

Our SPEAKER BIBLE is a provocative treatise on speaker enclosure design which will assist you in the design of nonstrangulating driver enclosures.

For owners of the Dahlquist DQ-10 we have a spectacular modification kit that includes new midbass drivers, ribbon tweeters, a complete set of die cut felt padding for top and front of cabinet and new time alignment placement specifications.

We stock a full line of Audax, KEF, JVC and Technics drivers and precision proprietary crossovers designed for them. For our catalogue and SPEAKER BIBLE send \$1.00 to

GIZMO AUDIO DEVELOPMENT

239 CENTRAL PARK WEST, NEW YORK, NEW YORK 10024

Mailbox

$$Q_{ES} = 2\pi f_s R_E M_{MS} / B^2$$

C_{MS} not only varies quite a bit in production but is also hard to measure accurately. In this regard let me quote B. J. Bailey, AES reprint No. 1299(B-4), Nov. '77:

"The compliance is found to be ill-behaved in two main ways. First, typical suspensions suffer from hysteresis and creep which makes static measurements...variable (and tedious), but not to a sufficient extent to explain the magnitude of the systematic errors. It was found that the static compliance is usually greater than the dynamic value, and by as much as 50% for some drivers (30% is more usual)...The second problem area with C_{MS} (from now on we mean dynamic compliance) is that it is displacement dependent...We need, then, a small-signal electro-mechanical way of measuring dynamic C_{MS} , at the mean position of operation of the cone."

Audax uses a "Scale method" to calculate C_{MS} and this sounds like a static measurement to me. The method I use is dynamic. Even so, the discrepancy between my value and Audax's can be explained almost completely by formula 1.

The HD17B sample I used for the article had $f_s = 40.4\text{Hz}$, while Audax gives a value of 30Hz. This shift in resonance frequency could be explained by a compliance which is $(30/40.4)^2 = .55$ times the spec sheet

compliance of 1.8×10^{-3} . This would give $C_{MS} = .99 \times 10^{-3}$ for my sample. This translates into $V_{AS} = 1325 \text{ in.}^3$ which is within 10% of the value I determined.

In my opinion the spec sheet parameter values are not accurate enough to use for design. For the best design, the driver parameters of the actual units you will should be determined. The second part of my series for SB gives a detailed account of how to do it. I would strongly urge that you hold off designing your system until you can determine actual driver parameters.

SPEAKER EFFICIENCY

AFTER RECEIVING THE 3/80 issue of SB I was pleased to see Max Knittel and Rod Rees' letter on speaker efficiency. They make a very neat mathematical explanation of the term reference efficiency and arrive at the same conclusions that I did in my 14 July 1980 letter.

Supporting evidence has also been presented by Leonard Feldman in an article based on data provided by KEF which is entitled "Designing Small Speaker Systems" in *Radio-Electronics* (July, 1980). The pertinent part of the article is Fig. 10 and the associated text explanation.

In sum, to gain efficiency in a direct radiator speaker system one must use a more efficient driver.

ALAN C. SMITH
APO New York 09162

TL'S AND WOOL

OUR HEARTY CONGRATULATIONS and thanks

to Roger Sanders for his fine article (SB 4/80) on the transmission line woofer section of his electrostatic system. Aside from the generally superior performance of a TL woofer (extension into the wonderful world of very deep bass, significantly improved transient response, and less distortion), Mr. Sanders raises another highly important asset of this design theory which is often ignored: "...T.L.s will have a lot of deep bass because it will not be masked by a midbass peak." It seems sad that many potential speaker buyers are conditioned to accept that midbass peak as normal and even natural.

We must take exception, however, to the statement "There is little question that natural long fiber wool is best..." for stuffing the line. We at Lazer Audio (specialists in TL design) have experimented with a wide range of damping materials and have settled on a long, linear synthetic fiber because it offers better efficiency and does not require moth proofing, yet does an effective job of filtering out the higher frequencies. This material may be available to builders depending on the interest we receive.

We also must question Mr. Sanders' notion that it is the damping material which slows down the sound waves enough so that their phase is shifted by 180 degrees by the time they reach the port. By our experience, it seems to us that the phase relationship of the port to the front of the cone is almost totally determined by the length of the line, although the damping material does have some effect. But this discussion could employ volumes and still remain

TUBES STILL SOUND THE BEST



CLASSIC
CIRCUITRY

DYNACO



BUILT
LIKE A
BATTLESHIP

We bought the factory's entire stock of one of the greatest amplifiers of all time

FAMOUS **DYNACO** MARK VI KIT

The rugged reliability and superior sound of America's finest mono tube amplifier by the company whose name is synonymous with excellence in transformer design, and world renowned for perfectionist value.

Still in original cartons, with factory warranty. Original 1978 price was \$549.00 kit, \$749.00 assembled.

NOW ONLY \$295 AS A KIT
SHIPPED COLLECT

Jeff Goldman

SYN-FIN Dept. SB 1400 Welsh Road, North Wales, PA 19454

120 watts continuous into 4, 8 or 16 ohms at less than 1% IM distortion. Distortion drops sharply at lower power levels. Hum and noise 95 dB down. Frequency response +0, -1dB, 10 Hz to 40 kHz @ 1 watt. Full output from 1.6 volts into 50K ohms XLR or phono input, with alternative low filter. Front panel speaker fuse and large meter which is switched for bias adjustment or 3 ranges of output level. 19" rack mount x 10 1/2" x 9" high. 55 lbs.

CALL FOR QUANTITY PRICES.
215-641-2333

unresolved. We have some other comments on Mr. Sanders' design but they are of specialized nature and probably of interest to only a few whose correspondence we welcome.

GUY W. WENTWORTH
Lazer Audio

This publication is available in microform.

University Microfilms International

300 North Zeeb Road Dept. PR
Ann Arbor, Mi. 48106 U.S.A.

30-32 Mortimer Street Dept. P.R.
London WIN 7RA England

THE DIFFUSER PORT FOR SMALL BOXES

Continued from page 17

shorter than the duct originally computed, so I start with the longest duct I can fit into the enclosure and tune them individually. In addition, the cabinet must in use be set on something firm, such as board, to preserve tuning. Units without such a board are great for demonstrating vented box tuning to disbelievers, as when the unit is lifted up the bass response disappears.

I design the diffuser to have the same area across the duct centerline as the duct area. From there the diffuser spreads out to the cabinet's full front width. I have found nothing to be critical in this regard. Figures 1A and 1B show where I use half-round molding to dress the cabinet sides at the diffuser output.

Figures 3A and 3B show the approach of contouring the front board to cover the diffuser output; this produces no adverse effects. The unit looks like an early console radio, but you'll realize its true size if you note the woofer is a 3" driver!

REFERENCES

1. R. H. Small, "Vented-Box Loudspeaker Systems," *Journal of the Audio Engineering Society*, Vol. 21, June through October, 1973.

SOME FINE POINTS OF VENTED SPEAKER DESIGN

Continued from page 31

3000Hz in the same cabinet. I found an acoustic lining very effective in eliminating a slightly harsh sound, which I took to be the interference or rear radiation.

I have no suggestions about what material is most effective. I used polyester fiber-fill my wife had on hand. The idea is to use a material relatively transparent to low frequencies, but opaque to higher ones. I wish

someone would study the effectiveness of various readily available materials.

CROSSOVERS

None of the variables in this complicated area have much to do with the type of loudspeaker loading. For some good discussions of the problem I recommend Colloms' book, an article by Linkwitz⁵ and another by Leach⁶. If you use a passive crossover, don't forget to include the resistance of the series inductors in your calculations of Q_T .

The B139 sample system is crossed over at 150Hz using third order Butterworth active crossovers. The crossover point is low enough to keep it out of the frequency band to which the ear is most sensitive and high enough so that both drivers work well within their passbands at crossover.

The HD17B was originally crossed over at 3000Hz using a passive quasi-second order network, a type of constant voltage crossover. Again, the crossover frequency was chosen to keep it out of the crucial midband range. I later modified this system for an active crossover and the performance improvement was substantial.

FUTURE ARTICLES

The Thiele-Small alignment tables I have included in these articles utilize only two types of filter response. For Q_T smaller than about .4 the alignments are quasi-Butterworth and for larger Q 's they are Chebyshev. In a future article I will discuss the pros and cons of various other fourth order alignments and provide tables.

I also plan to cover sixth order alignments with tables. In this regard, if you design a fourth order system with Q_T less than .38 you may want to oversize the enclosure by an additional 15 percent (for about a 45 percent total overvolume). By keeping temporary filling in your completed system, you can later modify it to a sixth order alignment without designing a new box.

REFERENCES

1. R.M. Bullock, "Thiele, Small and Vented Loudspeaker Design," *Speaker Builder*, (4/1980, p. 7).
2. R.M. Bullock, "How You Can Determine Design Parameters for Your Loudspeaker," *Speaker Builder*, (1/81, p. 12).
3. Catalog of SRC Audio. Available from the company.
4. M. Colloms, *High Performance Loudspeakers*, 2nd. ed., Halsted Press, New York, 1980.
5. S. Linkwitz, "A Three-Enclosure Loudspeaker System—Parts 1,2,3," *Speaker Builder*, Issues 2, 3 & 4 1980.
6. M. Leach, "Loudspeaker Driver Phase Response: The Neglected Factor in Crossover Network Design," *JAES*, Vol. 28, pp. 410-421, 1980.
7. R. Small, "Vented-Box Loudspeaker Systems. Part I: Small-Signal Analysis," *JAES*, Vol. 21, pp. 363-371, 1973.

Old Colony's

BARGAIN BASEMENT BONANZA

A once-in-a-lifetime purchase allows Old Colony to offer readers some unusual value in electronic parts. All are brand new devices. Quantities are strictly limited and are offered on a first-come, first-served basis.

BB-2 ELECTROLYTIC FILTER CAPACITOR: 3,300uF @ 60V, (70V surge), Sangamo insulated. No hdwe. Ea. \$2.00; Four for \$7.00.

BB-4 SLIDE POT: Mono, 10k linear. Travel 2".
Close Out Five for \$3.00; Ten for \$5.00.

BB-5 DYNACO PAT-5 HIGH LEVEL PREAMP: One pair of boards, all parts soldered in place including socketed FET IC's, mounted on U-brackets. Very limited quantities. Pair \$20.00.

BB-7 PAT-5 High level boards with all parts, original non-FET version. Brackets supplied. Limited quantities. Pair \$7.00.

QUALITY CAPACITORS

BC-1 TRW, 5uF/200V ±20% Polypropylene units. 1 3/4 x 3/4". Pair \$19.00

BC-3 Sangamo 500R 5700 @ 30VDC Electrolytic Low ESR. Insulated can. Pair \$16.50

UNUSED SURPLUS

BC-4 1500uF/80V Mallory Electrolytic. Each \$2.50

BC-5 2500uF/80VDC, 105V Surge Electrolytic. Each \$3.50

Send all orders to

OLD COLONY SOUND LAB

BOX 243 PETERBOROUGH NH 03458

M/C or VISA Charge Orders: (603) 924-8528—9-4 M-F.

Books by

Briggs

B-1 AERIAL HANDBOOK. A Layman's Guide to Antennas. (2nd Edition) 176pp. by Briggs and R.S. Roberts on the principles of receiving aeriels with details on building indoor, outdoor types as well as boosters and single frequency attenuators. Q & As included. Softbound. Each \$5.50

B-2 ABOUT YOUR HEARING. A thorough investigation into how we hear and how to care for ears. Correlates effects of age, noise effects, deafness, hearing aids. A valuable work on caring for the most vital part of your audio system. 176pp. Softbound. \$5.50

B-3 AUDIO BIOGRAPHIES. Briggs' personal reminiscences about, coupled with dozens of autobiographies by, the people he met during his forty years of audio research and experiment. Briggs and many of his "guests" write in a vital, personal style, which illuminates the human side of audio. 344pp. Hardbound. Each \$8.95

B-4 CABINET HANDBOOK. A 112-pg. guide for the audiophile on design, woodworking, veneering and polishing of speaker cabinets. Deals with principles of everything from horns to bookshelf types. Sections on guitars and room treatment as well. Softbound. Each \$6.95

ORDER BLANK: sb-22
Old Colony Sound Lab, PO Box 243, Peterborough NH 03458

To order from Old Colony Sound, please write each book's number below with quantity of each and price. Total the amounts and remit by check, money order, or MasterCard, or Visa/BankAmericard. Please add 50¢ for postage on the first book; 25¢ per additional book. \$10 minimum order on credit cards. Canadians please add 10% for postage. All remittances must be in U.S. funds. Please use clear block capitals.

Name	_____
Street & No.	_____
Town	_____ State _____ ZIP _____
No. Bks.	_____ Price _____
... Book No.	\$
... Book No.	\$
... Book No.	\$
... Book No.	\$
... Book No.	\$
Postage	_____
	Total \$

Please add \$1 service charge to all charge card orders under \$10.

Classified Advertising

PRIVATE CLASSIFIED ADVERTISING SPACE up to 50 words in length is open to *Speaker Builder's* subscribers without charge for personal, non-commercial sales and for seeking information or assistance. The publishers reserve the right to omit any ad. Any words beyond 50 are 15 cents per word. Please type or neatly print ad copy on a separate sheet or card with your full name and address.

TRADE CLASSIFIED ADVERTISING RATES: 25 cents per word including name, address, and zip code—prepaid only. 10% discount for four insertions. Speaker Builder cannot accept responsibility for the claims of either the buyer or the seller.

TRADE

STOP THE AGONY! Get yourself a set of Custom High Quality Speakers. For Ultra unique speaker design book send \$3.50 to: **WOOD "N" THINGS WORKSHOP**, PO Box 1043, Binghamton, NY 13902. T2/81

AUDAX 10" BEXTRENE cone drivers for Sanders ESL/T.L. woofer system. Performance equal to KEF B-139, at about half the price. \$66 each post paid. **R. SANDERS**, 1578 Austin St., Atwater, CA 95301. T4/81

ACTIVE ELECTRONIC CROSSOVERS

Plug-in Butterworth (maximally flat) filters in 6dB, 12dB, or 18dB per octave attenuation, any frequency specified. Filters flat beyond 100kHz.

Complete crossover in attractive metal cabinet with all terminations and regulated power supply.

STEREO BI-AMP \$139

Tri-amp, quad-amp, and monoaural types available at comparable prices. Other available features: summer for "single woofer" systems. Subsonic noise elimination filters supplied with or without bass boost, level controls.

FOR OEM'S AND HOME ASSEMBLERS

500 Series dual filters and/or plug-in filters, regulated power supplies.

FREE CATALOG & PRICE SHEET

Write to:

DeCoursey ENGINEERING LABORATORY

11828 Jefferson Bl., Culver City, CA 90230
Phone: (213) 397-9668

and now
FOR SOMETHING COMPLETELY DIFFERENT
offers
5mF 10% 400V metallized polypropylene caps, less than .05% DF \$7.00 ea. ppd.
J.C. mini monitor, 5 inch polypropylene woofer, ribbon tweeter, polypropylene crossover—\$125.00 ea. ppd.
and now
FOR SOMETHING COMPLETELY DIFFERENT
3016 N.E. Oregon St
Portland, Oregon 97232

SPEAKER CABINETS—factory close out of rich walnut vinyl laminated cabinets constructed of 3/4" particle board. Shipped assembled with grill frames. Speaker openings can be cut to your specifications. Measurements 24x13x13. Only \$19.95. **FABER**, 1625 Kelley St., Santa Rosa, CA 94501. T4/81

MIDRANGE/HIGH-FREQUENCY HORN. 800Hz crossover. Non-ringing material, consistent 40°x90° dispersion. \$28.00 each. Quantity pricing available. **EDC**, P.O. Box 1201, Lexington, NC 27292. T2/81

CROSSOVER COMPONENTS and accessories for the speaker hobbyist. Low prices. Send for free flyer. **UNIVERSAL AUDIO**, Box 712, Providence, RI 02901. T1/82

GOLD PLATED phono jacks \$1.20 plugs 90¢ ea., \$1.00 handling. Also custom 1% capacitors, 0.5% resistors. Details SASE. **REFERENCE AUDIO**, Box 368M, Rindge, NH 03461. T1/82

LONG HAIR WOOL carded-cleaned for stuffing speakers. \$8.75/lb. including shipping. **J. EBBERT**, 770 Holly Rd., Wayne, PA 19087. (215) 687-3609 TTF

LOOKING FOR a speaker to compliment your SOTA electronics? The Jordan 50mm. module forms the nucleus of a coherent, high resolving, accurate imaging system. The audio amateur can construct a superb, flexible loudspeaker using the Jordan module for a fraction of the cost of comparable commercial systems. If your reference is live music, this could be your system. We also have Audax, Dalesford, JVC and Foster ribbons, SEAS, highest quality crossover components, Falcon crossovers, cabinets and much more. Catalogue \$1.00, Jordan manual \$2.00. **AUDIO CONCEPTS**, 1919 S. 19th St., La Crosse, WI 54601. T2/82

RAW SPEAKERS and kits. Specializing in plastic cone drivers and high end auto systems. Our brands include Audax, Becker, Philips, Foster, Jordan, Jordan-Watts, SEAS, Dalesford, Falcon Acoustics and Peerless. Free price list. **A&S SPEAKERS**, 2371 Dahlia St., Denver, CO 80207. T2/81

AUDIOPHILE ACCESSORIES

- DBP-2J SWITCH BOX**.....39.95 AU (gold jacks).....47.95
Selects between up to 4 phono inputs. Used with DBP-6 or 6MC, allows for selectable loading of cartridges.
- DBP-6 PHONO EQUALIZATION KIT**.....29.95
Allows adjusting the input capacitance of the phono input of every preamp and receiver with low loss Polystyrene Capacitors.
- DBP-6MC RESISTIVE LOADING KIT**.....29.95
Allows adjusting load resistance from 10 to 200 Ohms for for moving coil cartridges. Gold plated phono plugs in both kits.
- DBP-8 SPEAKER WIRE** 12 ga., in 3, 6, and 9 meter...Inquire.
- DBP-9AU BANANA PLUGS** Eight gold plated, solderless....10.80
- DBP-10 PHONO ALIGNMENT PROTRACTOR**.....19.95
Allows adjusting the lateral tracking error of a mounted cartridge to within 1/4 of one degree. Non-technical instructions and case included.
- DBP-11 CAPACITANCE LOADING SWITCH BOX**.....79.95
- DBP-12 AUDIO CABLE** 10 meter (33 ft).....59.95
Low capacitance (400pF) stereo interconnect cable, terminated with rugged gold plated phono connectors.
- DBP-13J GOLD PLATED PHONO JACKS (1/4")** 8 pk....10.80
- DBP-13P GOLD PLATED PHONO PLUGS** 8 pack7.20
- ELECTRONIC CROSSOVERS**...6, 12, 18dB, 24dB.....Inquire
At your dealer or direct. Orders under \$45, add \$2.00 Handling.

DB SYSTEMS

Box 347Q Jaffrey, NH 03452 (603) 899-5121
Dealer inquiries invited. Overseas distributors in Benelux, W. Germany, Scandinavia, Japan, Hong Kong, Singapore, Taiwan, France.

"IN PHASE" 24dB/8ve electronic crossover minimizes irregularity in radiation pattern through crossover region. 0.0008% distortion, 5 year warranty. Single frequency (specify) with power supply: \$442.00. **DB SYSTEMS**, Box 347K, Jaffrey, NH 03452. TTF

OPEN REEL TAPES from studio masters. Philips, Argo, Telefunken, Vanguard, Unicorn. Catalogue \$1.00. **BARCLAY-CROCKER**, Room 1470-L, 11 Broadway, NYC 10004. TTF

High-End Audio DISCOUNTED!

THE VERY BEST IN HIGH-END EQUIPMENT: ACCOM, AMIA, AA, BOBE, DBX, DENON, HAFER, HARMON-KARDON, INFINITY, JBL, JVC, MITSUBISHI, NAD, NIKKO, OMBRONIC, SAE, SOHY, THORENS and OVER 100 MORE HIGH-END BRANDS!

FOR PRODUCT INFORMATION & DETAILS PHONE:

(914) 258-4077

SOUND SHED HI-FI

MERRITS ISLAND ROAD, PINE ISLAND, NEW YORK 10980

ORDERS ONLY CALL TOLL FREE 800-431-3122

9 A.M. to 9 P.M. Monday-Friday, 9 A.M. to 4 P.M. Saturdays

HIGH PERFORMANCE LOUDSPEAKERS factory direct. LS/35A and other equivalents. European drivers, speaker enclosures, kits, finished systems. Speaker reps needed. Box 18009 Seattle, WA 98118 and Box 12242, Jacksonville, FL 32209. T2/81

DYNACO AF-6, FM-5, FM-3, FM-1 FANS; Scott LT-110 Fans: PLL Stereo Demodulator is assembled and tested and features the KB4437 (Separation: 45dB, THD: 0.04%) with pilot canceller circuit for greatly improved sound quality. Send for free info. **VSM AUDIO**, PO Box 114, Maspeth, NY 11378. T3/81

ACOUSTIC TEST INSTRUMENTS

- SLM-201 Calibrated Sound Level Meter...\$169
ATG-301 Fractional Octave
Pink Noise Source\$299
ATS-401 Complete Acoustic Test Set\$399

Free brochure:

HALL ENGINEERING

Dept. B-1, P.O. Box 506, Martinsville NJ 08836

AUTHORITATIVE INFORMATIVE & FAST ...

Twice a month, by first class mail, Peter Mitchell gives you the very latest news about the audio world: hardware, software, engineering developments and marketing moves by companies big and small. Peter gets around to Tokyo, Hong Kong, Taipei, Las Vegas, Chicago and to the technical sessions at the AES engineering meetings. His news is hot, his text is in lay language, and altogether a fine, informative, non-commercial insider's view of what's going on in audio.

For \$20 a year (less than 84¢ an issue) you receive first-hand, technically sound news and explanations of what is happening in new equipment offerings. And with that you also get free classifieds for trading, selling and finding equipment. Send \$1 & stamped addressed envelope for sample issue or send check or money order for \$20.

Mystic Valley Audio News,

P.O. Box 337, Dept. SB-1, Peterborough, NH 03458 USA

SPEAKER DRIVERS CUSTOM-built to your specs. Reasonable prices. Any quantity. EDC, P.O. Box 1201, Lexington, NC 27292.

T2/81

GET THE BEST FROM YOUR SPEAKERS with the finest electronics. AudioWorld is the high end connection for those who want the best sounding system for their money. We have competitive prices on whatever you are interested in. **AUDIOWORLD**, Box 6202B, Grand Rapids, MI 49506. (616) 451-3868.

T4/81

SPEAKER: THE IMPOSSIBLE DREAM? Make your own "supercable" from ordinary lamp cord for only pennies per foot?! We didn't believe it either, but our computer and ears say it works, and better than those high-priced commercial brands. Our electrical engineer shows you how with step-by-step illustrated instructions, plus a lengthy technical discussion as to why this ultra low-resistance, low-inductance (and safe) cable design sounds so good. \$4.00 to **ROSSWOOD DESIGN GROUP**, Dept. S2, P.O. Box 7691, S.F., CA 94120.

T2/81

METAL FILM RESISTORS, RN55, 0.35 watt, 107 values from 10 ohms to 1 Meg., 25¢ ea., 10 per value/\$1.80, 50 per value/\$7.50. Send stamped self addressed envelope for list of values and order form. New gold plated brass rear mount phono jack, \$1.75 ea. Gold plated shielded RCA type phono plugs, \$2.00 ea. Minimum order \$10.00, quantity discounts available. **OLD COLONY PARTS**, Dept. SB, PO Box 243, Peterborough, NH 03458.

NEW GOLD PLATED PHONO JACK. Rear mount, gold plated, solid brass jack w/gold plated ground flag and hardware, \$1.75 ea. Will interchange with Audio Research SP3A-1's phono jacks. Gold plated solid brass shielded phono plugs, \$2.00 ea. Send stamped self addressed envelope for flyer and order form. Minimum order \$10.00. **OLD COLONY PARTS**, PO Box 243, Peterborough, NH 03458.

CATALOG OF HARD to find speaker cabinet hardware, crossover parts, tweeters, midranges, woofers, cabinet plans, grille cloth, etc. Over 300 Hi-Fi and Pro Audio items. For your copy send \$1.00 to **UNIVERSAL SOUND**, 2253 Ringling Blvd., Sarasota, FL 33577. T4/81

10 GOOD REASONS TO READ TA'S NEW CATALOG. 1. Step Attenuator Volume controls by Alps and Tech Labs for highest accuracy and perfect tracking. The deluxe model has silver contacts, 1% MF resistors as a semi-kit. 2. Rowland Research electronic crossover boards with 18dB/octave slopes and optional 20dB gain so it will replace the high level section of your preamp. A subsonic filter board. 3. Rowland RIAA phono preamp section boards one with passive equalization. Strain Gage cartridge boards for WIN Labs and Panasonic. Until you have heard the WIN through this board you have not heard the WIN. All for highest signal resolving detail. 4. All above boards come as semi-kits stuffed and tested. Regulated power supply module and rack mount chassis available or available as assembled unit. 5. New 8" polypropylene cone driver that delivers amazingly tight and articulate deep and mid bass in our reflex push-pull alignment that is -3dB at 30Hz and non-resonant. Similar alignment for Dynaudio driver by SEN Labs -3dB at 26Hz. 6. Dalesford 5" and 6 1/2" drivers too for woofers, midbass, and midrange. 7. Jordan 50mm Modules for phase coherency and transient speed like electrostatics that do most of the work in your dream system. 8. JVC and Foster polymer ribbon super tweeters for detail, extended highs, and "air." 9. Unbox cylindrical semi-kit enclosures for woofer alignments and Jordan Modules. 10. Crossover parts and kits using air core inductors wound with #12 and #16 wire. Dealer inquiries invited. Polypropylene and styrene caps. Mod kits for Hafler amp and preamp and the Dahlquist DQ-10. Jordan Manual text on sound and loudspeaker design \$2.50. TA catalog, \$1.50. **TRANSCENDENTAL AUDIO**, 6796 Arbutus St., Arvada, CO 80004. 9-5 Mountain time 10-3 Sat. (303) 420-7356. T2/81

RAW FRAME SPEAKERS—All Types—All Sizes. Philips C.T.S. Peerless, Polydax, Dealer pricing. **APOLLO ELECTRONICS**, 1437 Santa Monica Mall, Santa Monica, CA 90401. (213) 393-0794. Mon.-Sat. Stuart.

T2/82

SAVE 50%. Build your own speaker system. Write: **McGEE RADIO ELECTRONICS**, 1901 McGee Street, Kansas City, MO 64108. T4/83

**CROSSOVERS COILS CAPACITORS
SPEAKER CABINETS & KITS**
Send \$1.00 for Brochure
KUSTOMIZED SPEAKER SYSTEMS
260-A Glenn Circle
Powell, Tennessee 37849

AUDIO CLUBS

Space in this section is available to audio clubs and societies everywhere free of charge to aid the work of the organization. Copy must be provided by a designated officer of the club or society who will be responsible for keeping it current. Send notices marked Audio Clubs in care of the magazine.

SERIOUS AUDIOPHILES interested in a central Colorado group (Denver, Boulder, Ft. Collins, Greeley area) contact James S. Upton, 2631 17th Ave, Greeley, CO 80631.

Southeastern Michigan Woofer and Tweeter Marching Society

Detroit area audio construction club.

CONTACT: DAVE CARLSTROM 10155 Lincoln
Huntington Woods, Michigan 48070 313-54-48453

Invaluable, Indispensable Additions To Your Audio Bookshelf By

WALT Jung

AA-1. SLEWING INDUCED DISTORTION IN AUDIO AMPLIFIERS by Walter G. Jung, Mark I. Stephens, and Craig Todd is available as a 32-page booklet. About this landmark series, which appeared in the four 1977 issues of The Audio Amateur, Peter Mitchell says: "...clearly the most important work in audio electronics in several years..." Each \$4.00

S-12. IC OP AMP COOKBOOK. Second Edition. A new, 480 pp., updated and revised, compendium on understanding and using integrated circuit operational amplifiers. Voltage and current regulators, signal processing, log and analog converters, amplifier techniques, Comparators, integrators and differentiators, signal generators, and a wide variety of other useful applications. Schematics give buildable parts values. Softbound. Each \$14.95

S-16 AUDIO IC OP AMP APPLICATIONS. A new thoroughly updated and larger edition of Jung's earlier work on op amps for audio use. The book includes a general introduction to op amps, the special factors the user must consider in using op amps for audio, building blocks for audio uses, and dozens of practical and buildable circuits. Second Edition. 208 pp., softbound. Each \$7.95

H-9 IC ARRAY COOKBOOK. The newest circuit packaging idea now explained. IC arrays give the builder super-matched transistors and diodes for excellent results in amplifiers, oscillators, and many other applications. A practical handbook, full of usable, useful data. 200 pp., softbound. Each \$9.95

Old Colony, Box 243, Dept. SB, Peterborough, NH 03458

Send me Walt's books:

___ SID Preprint at \$4.00 _____
___ copies Cookbook at \$14.95 ea. _____
___ copies Audio IC's at \$7.95 ea. _____
___ copies IC Timers at \$9.95 ea. _____
___ copies IC Array at \$7.95 ea. _____

Total _____

Name _____

Street & No. _____

Town _____ State _____ Zip _____

Please add \$04 for first book; 25¢ per additional book for postage.

AUDIO HORIZONS

P.O. BOX 10973
St. Louis, Missouri 63135

Issue #4 is now available. It contains reviews of CRAMOLIN contact cleaner, the DYNAVECTOR DV-100R and DV-100D moving-coil cartridges, the LINN Itok LVII pickup arm, the MARCOF "Glass Mat" platter plate, the HAFLER DM 200, MICHAELSON & AUSTIN TVA-1, SUMO "Power", and SUMO "Power" power amplifiers, the MICRO SEIKI BL-91 and ORACLE turntables, the MUSICAL FIDELITY bb-1 and POWERLIGHT MC-4 pre-amplifiers, the SAEC SS-300 platter plate, and the SPECTRA Disc Cushion. Issue #4 also features a survey of interconnecting cables with reviews of cables from AGI, AUDIO CRAFT, AUDIONICS, AUDIO NOTE, AUDIO TECHNICA, BELDEN, DISC WASHER, FULTON, MELCO, MITCH COTTER, NEUMANN, PETERSON, SAEC, SOUND CONNECTIONS, SOLAR TRADING, SUPLEX, and ZEPHYR.

Subscription rates to AUDIO HORIZONS™ for four (4) issues are U.S. \$16 (\$20 by FIRST CLASS MAIL); Canada and Mexico \$18 (\$22 by FIRST CLASS MAIL); and outside North America \$24 (AIR MAIL). PLEASE REMIT IN U.S. FUNDS ONLY. Sample copies of all issues of AUDIO HORIZONS are available for \$5.50 each (U.S., Canada, and Mexico), and \$7.00 each (outside North America).

Classified

DO YOU LIKE CLASSICAL MUSIC AND AUDIO EQUIPMENT? Would you like to form a small society mixing music listening with audio equipment discussions? If you live in Nassau or Suffolk County New York in the vicinity of Plainview, contact: Alex Soave, 192 Central Park Road, Plainview, NY 11803. (516) 935-1704.

FT. WORTH AREA AUDIO SOCIETY being formed. Would like a diversified group (women welcome), for information send a stamped, self-addressed envelope to Richard P. Machos, 6201 Onyx Drive North, Ft. Worth, TX 76118.

AUDIO SOCIETY WANTED in the Sacramento to CA area. Serious audiophiles and dedicated audio amateurs please contact Barry Waldron, 8811 Little Oaks Way, Stockton, CA 95207. (209) 478-9310.

AUDIO SOCIETY WANTED in the Fort Wayne, Indiana area—for serious audiophiles only—contact: J. D. Reynolds, Jr., 703 Nordale Drive, Fort Wayne, IN 46804. Phone (219) 432-1294.

SAINT LOUIS AUDIO SOCIETY meets monthly for discussion and equipment audition. For information sheet send a stamped, self-addressed envelope to SLAS, 7435 Cornell, Saint Louis, MO 63130.

MINNESOTA AUDIO SOCIETY Monthly programs—Newsletter—Special events, yearly equipment sale. Write: P.O. Box 3341, Traffic Station, Minneapolis, MN 55402.

A CLUB FOR FM AND TV DXers, offering antenna equipment and technique discussions, plus updates from FCC on new station data. Monthly publication "VHF—UHF Digest"; annual convention in August. For more info: Worldwide TV-FM DX Association, PO Box 97, Calumet City, IL 60409.

PACIFIC NORTHWEST AUDIO SOCIETY (PAS) consists of 50 audio enthusiasts meeting monthly, second Wednesday, 7:30 to 9:30 PM at 4545 Island Crest Way, Mercer Island, WA. Be our guest, write Box 435 Mercer Island WA 98040 or call Bob McDonald (206) 232-8130.



Complete line of world renown high definition audio cables now available in U.S. Mogami is a world leader in the research and manufacturing of advanced audio and video cables.

TONEARM-INTERCONNECT-SPEAKER-MICROPHONE.
GOLD PLATED PLUGS & CHASSIS JACKS
MOGAMI PRODUCTS DIV.
P.O. BOX 2027
CULVER CITY, CALIF. 90230 (213) 836-4288.

THE BOSTON AUDIO SOCIETY INVITES you to join and receive the monthly B.A.S. SPEAKER with reviews, debates, scientific analyses, summaries of lectures by major engineers. The BAS was the first to publish info on TIM, effects of capacitors, tonearm damping, tuner IM dist., Holman's and Carver's designs, etc. Sample issue \$1. sub, \$12/yr. P.O. Box 7, Boston, MA 02215.



Audax and Philips Loudspeakers
— in stock
— competitive prices
— competent service

Suppliers to the audio community of air core inductors, audio grade capacitors, Falcon crossovers, JVC and Foster tweeters.

Madisound Speaker Components
431 West Gorham, Box 4283
Madison, Wisconsin 53711 (608) 256-7337

PRIVATE

FOR SALE: Marantz 3250 preamplifier—new—factory sealed. Retail \$350—sell \$230 or offer. Marantz 2240 20w/channel quadraxial adaptor amplifier. Used—excellent \$100 or offer. **WANTED:** Marantz 150 stereo tuner—state condition and price. Andrew P. Craig, 1312 North 3rd St., Oskaloosa, IA 52577. (515) 673-3505 after 7pm CST.

FOR SALE: Dynaco PAS3X pre-amp, good to very good condition. Dynaco Stereo 70 amp, fair condition. Both unmodified. \$200 plus shipping for both. S.B. Owens, 713 1/2 Washington Ave., Princeton, WV 24740.

WANTED: Will pay fee for proven design of ultimate speaker system, for personal use, hi power handling, musical, "specs" well, really moves air in 4000 ft³ room, \$1,000-\$1,500 each less crossovers, more available if required. Jack Katzen, 38 Bruce Park Dr., Greenwich, CT 06830.

FOR SALE: Hafler DH-200 power transformer (part number 464002). 88VAC center tapped. Use it for a new project or in parallel with Hafler amp for improved bass. \$25. Don (513) 435-7155 eves.

WANTED: Back issues of *Wireless World* reel-to-reel tape deck, electronics condition insignificant. A Polaroid of the unit would be helpful. I can't offer much for either item, but if you are looking for someone one to take them off your hands, contact: T. Mishler, 2438 Kentucky Ave., Flint, MI 48506.

FOR SALE: Heathkit IG-5218 sine-square wave audio generator, \$65. 1B-3128 impedance bridge, \$100. Both assembled, little use. **WANTED:** "Acoustics" by Leo Beranek. Call Al at (612) 388-4683.

FOR SALE: Capacitors, super quality military grade, metallized polycarbonate, 2mfd. @ 200V, 1.6"x0.6" dia., axial leads, hermetically sealed, metal body, new, \$2. each. Same, 400V, 2.1"x1" dia., \$3. each. Also mylar 5mFd, 300V, 2.3"x0.9", axial, new, \$2. each. Quantities limited. Minimum order \$10; add \$2 shipping. Dick Nelson, 3470 Travis Ave., Simi Valley, CA 93063. (805) 526-7066.

FOR SALE: Pair J.B. Lansing speaker systems in floor cabinets, 15" LE15A woofer, LE85 high frequency horn with 500 cycle custom crossover, \$250 for pair. C. Hansen, 10 Chestnut St., Chatham, NJ 07928. (201) 635-6277.

FOR SALE: AR 12" woofer for AR3, \$20; mid range driver for AR3, \$15; two tweeters for AR3, \$10 each. Plus shipping. Don (513) 435-7155 eves.

FOR SALE: Quad Electrostatic loudspeakers, recently checked and OK-ed by Quad dealer. \$850/pr; Quad 405 amplifier \$500 or best offer; Dyna Stereo 70 and PAS II preamp both for \$50. David Stensby, 2118 Kendall Ave., Madison, WI 53705. (608) 238-0675.

WANTED: College student needs Dynaco PAT-5, ST-120 and SCA-50, as cheap as possible. They don't have to be in working condition. Ron Lias, P.O. Box 9604, Denver, CO 80209.

FOR SALE: Fried monitor system—model C improved satellite's and model T stereo transmission line subwoofer. See SB #4 for pictures and details or call. Offers open. Dynaco 416w/c-100 mint never mounted factory built, \$675. Yamaha C-4 preamp mint w/packing, warranty, \$375. Nick (212) 996-9719.

FOR SALE: Braun L300 3 way speakers, under warranty, \$340/pr. Ace model 5000 electronic subwoofer crossover, \$100. Advent 300 receiver \$175. Dave Powell, 2918 Barmettler St., Raleigh, NC 27607. (919) 832-2284.

WANTED: Does anyone know where I can purchase 1/4" felt in large pieces? I would like to use it to cut down diffraction in a way similar to what A.R. and other companies do. Possibly some other SB reader could help me. Bill Grindberg, 1618 So. 17th St., Moorhead, MN 56560.

WANTED: Vestigal tonearm for transcribers Saturn or machinist who can repair broken arm or will see unit with broken tonearm for \$150. Glynn Wilson, 844 Cle-mont Dr., NE #3, Atlanta, GA 30306. (404) 873-2265.

ADVERTISING INDEX

Ace Audio	28
Audio Amateur	Overcover 4
Audio Control	13
Audio Horizons	37
Audiophile Systems	28
Badger Sound	27
Briggs Books	35
CBS Test Records	Overcover 2
dB Systems	36
DeCoursey Labs	36
Fane America	40
Gizmo	33
Goldman	34
Hall Engineering	36
Hartley Products Co.	4
Integrex	25
Jung Books	37
KEF Electronics	3
Kustomized Speaker Systems	37
Lazer Audio	21
Madisound	38
Marcof Electronics	2
Marshall Electronics	38
Modular Acoustics	19
Mystic Valley Audio News	37
Old Colony Bargains	35
Old Colony Binders	32
Old Colony Books	Overcover 3
Old Colony Circuit Boards	31
Old Colony Kits	29
Old Colony Parts	17
Phase Matrix	30
Phoenix Systems	2
Something Different	36
Sonix	32
Soundbox	39
Sound Concepts	30
Sound Shed Hi-Fi	36
Speaker Supply	25
SRC Audio	23
Transcendental Audio	27



SOUNDbox

Soundbox offers you speaker parts and accessories similar to, and more often than not identical, parts used by the major speaker companies. We all buy from the same handful of manufacturers (OEM). The latest computer technology and

the series of equations developed by Thiele (Têl) and Small enable Soundbox to offer some of the most advanced designs and plans available today, and they are free with the appropriate woofers.

WOOFERS — Thiele Parameters, Butyl Rubber suspensions, Split Aluminum voice coils, Polymer-Cellulose cones, Dual Voice Coil Sub-Woofers, Musical Instrument Speakers. **MID-RANGES** — Cone Drivers, Horn Drivers, Ferrofluid voice coils, Aluminum voice coils. **TWEETERS** — Ultra wide band Ribbon Tweeters, Horn Tweeters, Domes, Ferrofluid, Peizos. **X-OVER PARTS** — Printed Circuit Boards, Air Core Coils, Capacitors, L-Pads.

PLANS— "Air Suspension", "Thiele Alligned" Ported systems, "Non-Corner" Folded Bass

Horns (E.V. Eliminator and University Classic). And lots of info to improve the system you have now for pennies.

Send \$1 for catalog

SOUNDbox

Edneyville Acres, Route 1, Hendersonville, N.C. 28739

OUR CLAIM TO FANE

Fantastic Raw Frame Speakers!

We at FANE have been waiting for the right time to tell you folks in the colonies about our line of instrument loudspeakers, and in the next few months we will! Until then, you'll just have to rely on the word of some of our friends who've used us.

ROLLING STONES THE WHO FLEETWOOD MAC
PINK FLOYD CHET ATKINS MOODY BLUES
RUSH RICK WAKEMAN MANFRED MANN



Exclusive American distribution through FaneAmerica, 16134 Covello St., Van Nuys, CA 91406 OEM sales handled by SANO Corp., Roselle, NJ 07203