

SOUND & COMMUNICATIONS

Volume 38 Number 3

March 27, 1992

THE CHURCH OF THE NINETIES

With seven-thousand seats, a 200-member choir, theatrical presentations, conferences and videotaping, the Chapel Hill Harvester Church wanted flexibility and excellence. Bob Ditzler supervised the project, with sound design by American Audio. Participants felt that they were designing a technical system that would be the prototype of the "church of the nineties."**29**

TODAY'S WORSHIP CENTERS

A good diplomat, demonstrator, tactician and businessman — that's what it takes to work in the worship center business. "Churches are getting more serious on hearing the Word," says one observer. There are all kinds of options. This article investigates some of them.**21**



IN THIS ISSUE

• Determining Sound Quality

You've heard of the quality circle. Taking quality seriously, circles of acousticians are now developing new methods of insuring sound quality. **60**

• CD Changers

The CD changer runs the gamut from a three-disc carousel to three-hundred-disc magazine configurations. Mike Klasco surveys the market. **56**

• Integrated Synagogue Sound

Congregation Keneseth Israel was behaving like a giant radio receiver. RF interference, a hodgepodge of equipment, and woeful intelligibility were hampering communications and services. **39**



DEFINING MULTIMEDIA

The communications industry has changed forever. Myriad sources, myriad transmission systems all flow seamlessly through the data pipeline. Products interact; contractors counteract. And whatever happened to pure audio? **50**

THE MOVEABLE CHURCH

When the Cardinal comes to visit he needs to hear and be heard. The Monte Brothers have designed a sound system that travels with Cardinal O'Connor. **44**



167007

MARK GANDER
PRES
BEAR SOUND & COMMUNICATION
21000 W WINFIELD RD
TOPANGA CA 90290

Microphones

for

ALM™ 16

Electret Condenser Podium Microphone

△ The ALM™ 16 microphone offers a unique combination of features which ideally suit it to virtually any lectern, podium, rostrum, or similar application. A wide frequency response is subtly tailored for natural voice reproduction with optimum articulation. Off-axis rejection is carefully engineered for effective suppression of feedback and effects of reverberation. △ For positioning, the arm consists of an 18" length of flexible tubing with the two flexible ends permitting a nearly infinite choice of microphone positions, while preserving a neat and clean appearance.

every

application.

ACM™ 1

Miniature Unidirectional Microphone

△ The ACM™ 1 is a very small, unidirectional condenser microphone designed primarily to be suspended over choirs, instrumental ensembles, or stage areas for sound reinforcement and/or recording. △ The small size allows one or more ACM 1 mics to be hung or "flown" in virtually any application with no distraction or sight-line obstruction. It can also be easily concealed in scenery or props when desired. △ The very uniform, cardioid polar response is highly effective in suppressing feedback and unwanted sound as well as minimizing undesirable coloration of off-axis sources. A subtly rising high frequency response characteristic is incorporated into the design to compensate for the high frequency roll-off inherent in this kind of pick up.

ASM™ 1

Unidirectional Microphone

△ Specifically designed for low profile, surface mounted microphone applications. The ASM™ 1 consists of a wide range unidirectional condenser capsule, so mounted in its rugged housing that it becomes part of the acoustical boundary when placed on a flat reflective surface. △ The excellent performance, low profile, and rugged construction of the ASM 1 make it an ideal choice for many applications such as footlight areas for stage productions, on conference tables or TV news desks, on church altars, as a "plant" microphone on walls or ceilings of sets, and in any number of related situations. For instrumental music applications it may be mounted to the side of a grand piano lid, used in front of or inside kick drums, or in front of instrument amps.

PEAVEY

ARCHITECTURAL ACOUSTICS ®

Peavey Architectural Acoustics. A company dedicated to supplying the market with the best "permanent installation" sound products available, both in quality and price. From zone amplifiers, receivers, mixers, speakers, and microphones to accessories. All the products you need to meet your sound contractor needs whether it be for churches, offices,



retail outlets, gymnasiums, schools, auditoriums, grocery stores, or factories. For more information call/write:
Peavey Electronics Corporation • 711 A Street, P.O. Box 2898,
Mendham, MS 39302-2898 • (601) 483-5376 • Telex 504115 • FAX (601) 484-4278

WEST PENN WIRE FIBER OPTIC CABLES FOR CCTV SIGNAL AND DATA TRANSMISSION



WPW
WEST PENN WIRE

West Penn Wire offers a complete line of fiber optic cables for CCTV signal and data transmission installations.

Their rugged construction resists mechanical damage even under the demanding conditions of rigorous installation and use.

Optical properties are assured by a quality control system that includes a 100% attenuation testing of all finished cables.

Choose from these standard types:

- Simplex
- Duplex
- Multi Fiber Distribution
- Multi Fiber Breakout

All cables are available in either PVC (Riser Type) or Plenum type.

Multi Fiber Breakout cables are available with an outdoor and/or direct burial jacket. Consult your dealer or the West Penn factory for price and delivery.

And, of course, all of our fiber optic cable is backed by the dependable quality, outstanding service, competitive pricing and complete engineering and technical assistance that you expect from an industry leader like West Penn Wire.

To place an order, or for more information, call **800-245-4964** (in PA, call 800-222-8883) or write:

West Penn Wire
P.O. Box 762
2833 West Chestnut Street
Washington, PA 15301



Circle 202 on Reader Response Card

LETTER FROM THE EDITOR

JBL Helps the Residential Market Grow Up

One day past deadline, and 37,000 feet above Kansas, we're thinking about JBL as we fly home from a visit to JBL headquarters in Northridge, California where we've seen a way of dealing with high end residential media systems that may make sense.

In the pages of this magazine, and through the other properties of Testa Communications, we've long been calling for more rational manufacturing, distribution, training and marketing of home entertainment product. JBL may have found the way.

As a primary player in the professional movie theater business, JBL Pro's cachet is being used to market a new product of the JBL Consumer Products Division, the residential arm of the company. When Tom Jacoby, president of JBL Consumer Products (who spearheaded the new project), announced the development of a home media system on CES-TV News during the Consumer Electronics Show in January, he emphasized the connection between the two JBLs.

And the Consumer division has obviously taken some hints from the professional arm of the business, and is using them in conjunction with their own experience in the home market. It behooves the industry to watch how well these tactics work — or don't work:

- Optimizing speaker design for specific applications.
- Shipping directly to the installation site.
- Assuring minimal downtime.
- Using computer based test equipment for room evaluation.
- Considering the room as part of the whole system.
- Providing serious technical training to installers.
- Backing up its product with certification.
- Using an assembly line manned by

highly trained people.

- Manufacturing components that are rugged and travel well.
- Providing consultation on design work and cabinetry.
- Calibration of electronic settings with an end-user lockout.

And what's the product? JBL's Synthesis is a new series of home media systems, of which the first (and so far only) model, the Synthesis One, is a turnkey system consisting of speakers, surround decoder, amplifiers, signal processing, and video projector to be made available to no more than 25 selected dealers, with showrooms, who have completed JBL training. Retailing for \$47,000 (without installation or source electronics), this is obviously high end.

The system has been optimized for both music and video by essentially providing two speaker systems in one. One configuration — for "theater" — makes use of horns front and center, modified dipole side speakers, and two subwoofers. The "music" mode uses polypropylene cone drivers and a titanium dome tweeter. The consumer chooses one mode or another, and the correct system parts are automatically engaged sequentially. Appropriate electronic elements are also switched automatically. The system is THX licensed, with Dolby Pro Logic.

The Synthesis One dealer is equipped with a customized MLSSA program to test and design the room. JBL retains the right to certify that room, and will not ship product until it has done so. This presumably maintains the parameters built into the design of the new speakers.

The product is shipped to the customers' site through JBL's Fort Wayne warehouse facility; the installer is notified by the trucker (already on line); and the system is installed. After that, the installer and JBL guarantee for the life of the war-

(continued on page 55)

SOUND COMMUNICATIONS

Publisher/Editorial Director
Vincent P. Testa

Editor-in-Chief
Judith Morrison

Technical Editor
Mike Klasco

Associate Editor
Steve Jacobs

Research Assistant
Kathleen Coppola O'Connor

Contributors
Wes Alderson, Maria M. Conforti, Bob Ditzler, L. Richard Feld, Stephen Minozzi, Steven J. Orfield, Robert Pelepako, James Young

Technical Council
Dr. Mort Aitshuler

Professor Audiology, Hahnemann University, Chief of Audiology, V.A. Hospital, Phila, PA

C. Leroy James

Rees Associates, Inc.
Richard N. Jamieson

Jamieson and Associates, Inc.
Russell Johnson

Artec Consultants, Inc.
Joel Lewitz

Lewitz and Associates
Daniel Queen

Daniel Queen Associates
Jon Sank

Cross Country Consultants
Neil Shaw

Paul Veneklasen Associates
William R. Thornton

Phd, PE

Art Director
Joyce Dolce

Artists

Alicia Celli, Janice Pupelis, Scott Schlemmer, Colleen Warenik

Production Manager
Michelle Montoya

Typography

Christina Buckley

Diane Catanzaro

Circulation Director

Arturo Lizarraga

Advertising Manager

John Carr

Classified Ad Manager

Santiago Quinones

Traffic Manager

Ron Perone

Director of Sales and Marketing
Nancy Davis

Editorial and Sales Office
Sound & Communications
25 Willowdale Avenue
Port Washington, New York 11050
(516) 767-2500
FAX: (516) 767-9335



Sound & Communications • DJ Times
Post • Producers Quarterly
Sound & Communications Blue Book
The Music & Sound Retailer • The Retailer Red Book
The Music & Sound Buyer's Guide
CES-TV News • NAB-TV News • NAMM-TV News
NSCA-TV News • CROSSTALK/AES-TV News

BACKBOX:

Choice of seven.

SPEAKER:

Choice of eleven.

BAFFLE:

Choice of nine.

TRANSFORMER:

Choice of five.



With 3450 standard assemblies, Quam gives you custom-designed flexibility with off-the-shelf delivery.

When we say Quam offers a broad line of 8" assemblies, we don't mean a few speakers with a lot of baffles. We mean 11 different speakers, with nine baffles, to suit virtually any application. Add any of seven backboxes and five transformers (and more of each coming), and you have more than 3450 combinations to choose from.

You specify it the way you want, and you receive it when you

want. All the components are in inventory ... 70,000 pieces! You order and we assemble and ship within 24 hours. No waiting.

Our broad commercial sound accessories line is a change from the days when Quam concentrated exclusively on speakers. And we'll continue to change, adding innovative, high-quality products that help make you more profitable.

What will never change is our tradition of quality and service.

Make Quam your Sound Decision. Call or write now for your free Commercial Sound Products catalog, and we'll add you to our mailing list for catalog updates and product announcements as they occur.

Quam: The Sound Decision



QUAM-NICHOLS COMPANY • 234 E. Marquette Road • Chicago, Illinois 60637 • (312) 488-5800

Circle 208 on Reader Response Card

CONTENTS

Volume 38 Number 3

March 27, 1992



21



29



60

FEATURES

- 21 TODAY'S WORSHIP CENTER**
By Maria M. Conforti
The tricky business of worship centers is expounded upon by some of the major participants in the industry.
- 29 CHAPEL HILL HARVESTER CHURCH**
By Bob Ditzler
The new Cathedral of the Holy Spirit holds 7,000 people and, with the diverse combination of worship and the arts, needed a flexible sound system.
- 39 SYNAGOGUE SOUND**
By L. Richard Feld
A Pennsylvania Reform Congregation had some serious sound problems. The solution included integrating signal processing and other high-tech improvements.
- 50 THE MULTIMEDIA MARKET**
By Judith Morrison
Multimedia is a term that means many things to many people. What is it? Where's the market? And how can you get involved?
- 56 CD CHANGERS FOR COMMERCIAL APPLICATIONS**
By Mike Klasco
An in-depth look at the different types of changers available on the market from both consumer and professional realms.

DEPARTMENTS

- 4 LETTER FROM THE EDITOR**
- 9 NEWSLETTER**
- 12 THE ANSWERMAN:
VIBRATION ISOLATION SYSTEMS**
- 16 TRADE SHOWS: NSCA EXPO '92**
By Judith Morrison
- 44 FIRST PERSON:
THE MOVEABLE CHURCH**
By Stephen Minozzi and Robert Pelepako
- 60 THEORY AND APPLICATIONS: SOUND
QUALITY PSYCHOACOUSTICS**
By Steven J. Orfield
- 66 NEWS FROM AROUND THE INDUSTRY**
- 70 PEOPLE**
- 70 CALENDAR**
- 71 PRODUCTS**
- 75 LITERATURE**
- 76 AD INDEX**
- 76 MARKETPLACE**
- 78 PRODUCT CHECK:
SOUND MASKING SYSTEMS**

Why More Congregations Put Their Faith In Shure Microphones.

No one can match Shure's record for delivering great sound and dependability at an affordable price.

It's a reputation we've been building for better than half a century in churches around the world.

Whether you need a microphone for the altar, the pulpit, the choir, vocal soloists, or the activity halls, you'll find a Shure product that answers the call.

It could be the SM102 miniature choir microphone, the premier member of our growing MicroFlex™ line of condenser



microphones. Or a selection from the Shure L Series, the most reliable, trouble-free wireless systems ever created.

Find out why Shure microphones have such a faithful following. Send for your free copy of our product catalog and educational booklet, "Microphone Selection and

Application for Church Sound Systems." Write Shure Brothers Inc., Dept. 1563-CP, 222 Hartrey Ave., Evanston, IL 60202-3696. Or call 1-800-25-SHURE. The Sound of the Professionals...Worldwide.



SHURE

"THE RIGHT TOOL FOR THE JOB"

There's no substitute for the right tool.

So when it comes to equalization, look to Rane for a superlative arsenal of equipment designed

exclusively for commercial applications.

A recognized leader in equalizer technology, Rane offers an extensive line of commercial equalizer designs, from the standard-setting GE 30 dual-mode graphic to the compact FME 15 HR-format graphic to the programmable MPE series. All are safety agency exempt and fitted with a full compliment of connector hardware to meet your specific needs.

Every Rane equalizer offers the same proven reliability and uncompromising studio grade sonic quality, regardless of price.

So you can choose with confidence

from a variety of models to

satisfy a wide range of

budget and format requirements.

Whatever your job, we've got the right tool.

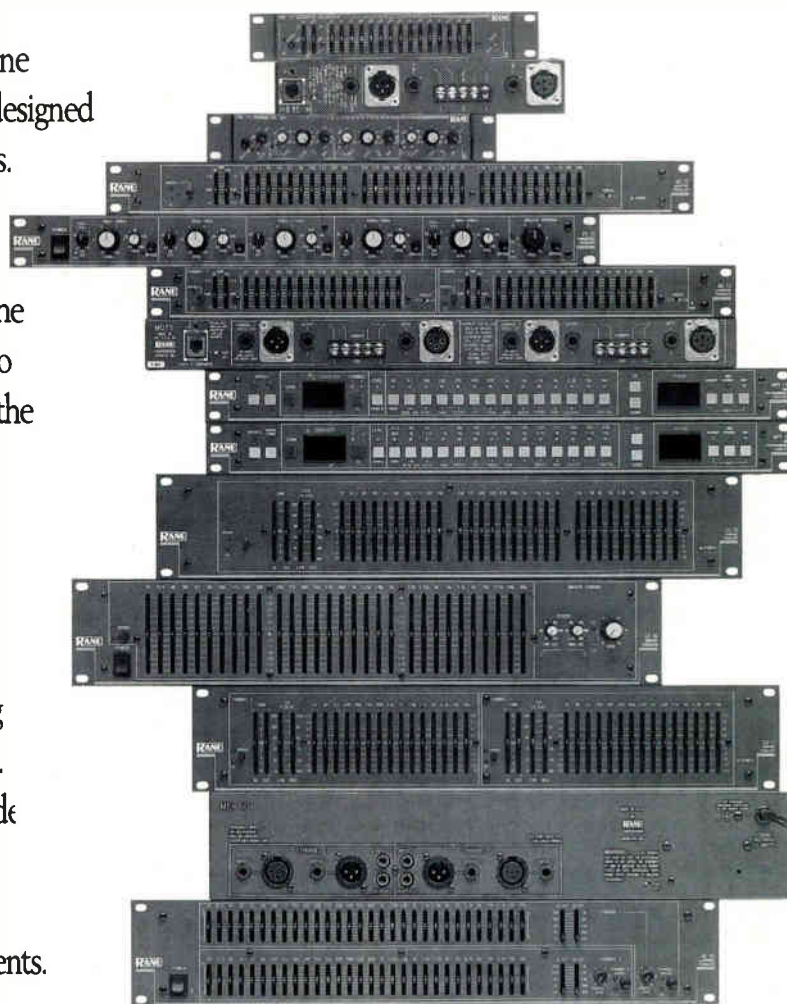

RANE CORPORATION 10802-47th Ave. W., Mukilteo, WA 98275. (206) 355-6000

Circle 209 on Reader Response Card

NEWSLETTER

GAUSS DISTRIBUTION RESTRUCTURED

Distribution of all Gauss speaker products in the U.S. is now being handled by Altec Lansing's direct network of distribution sales managers. In the past, Gauss speaker products had been marketed through independent representatives. According to Jim Williams, president of Gauss, "A shared distribution plans . . . enables Gauss products to reach selective channels of distribution never before attained." Added Paul Hugo, sales and marketing director of Gauss, "Altec's distribution sales managers will ensure coordinated attention and technical support on a continuing basis." Altec Lansing and Gauss are both operating companies of Mark IV Audio, which also includes Electro-Voice, Dynacord, Klark-Teknik, Vega, DDA, Midas, University Sound, and Electro Sound.

GROUP ONE LTD. FORMED

Group One, Ltd., specializing in the representation of "high technology manufacturers," has been formed by industry veterans Jack Kelly and Chris Fichera. Kelly, founder and former president of Klark-Teknik Electronics, Inc., serves in the same capacity with Group One. Fichera, a recording engineer and former DDA product specialist with Klark-Teknik, directs his energies on nationwide customer contact for Group One. Group One has been appointed as National Marketing Specialists for DDA/KTE's recording console group. Group One supplements the efforts of the local rep force. In addition Group One represents Uptown Automation in the retrofit market, and serves as the exclusive importer and distributor for DynaudioAcoustics monitor loudspeakers, and Milab microphones. The company is headquartered in Farmingdale, New York, with an additional office in Marina Del Rey, California.

NEW SOFTWARE UPGRADE

Renkus-Heinz has announced Version 1.2, a major upgrade of EASE, the acoustical analysis and system design software program Renkus-Heinz markets for ADA of Berlin, Germany. Version 1.2 reportedly incorporates a simplified method of room modeling plus new energy and intelligibility mapping features. In addition, the company has reported that the beta testing of Ease Jr has been completed and is scheduled for immediate delivery.

ANCHOR AUDIO SELLS PORTA-COM

Anchor Audio, Inc. has announced the sale of its Porta-Com line to Glendale-based Portland Instrument. Porta-Com is an "economically priced" intercom system used by school athletic and drama departments, along with churches and institutions.

PARRY STARTS COMPANY

Will Parry, who was for many years with Maryland Sound, has formed a new design, consulting and contracting company, Signal Perfection Ltd. Based in Columbia, Maryland, the new company is specializing in international multimedia and "smart building" projects.

SAMSON TECHNOLOGIES PRODUCT

Samson Technologies has entered the mixer market with the Model 2242 portable mixer. Preliminary specs give a suggested list price of \$1049.95 for the 22 channel input, four band equalizer model. Delivery is expected by the end of the second quarter of 1992.

IVIE BUYS QSC LINE

QSC Audio Products has sold its entire Series Two line of contractor products to Ivie Technologies, Inc. The sale includes the exclusive license to manufacture the line, which consists of a music and paging system and two amplifiers. Ivie Technologies will take delivery of all existing inventory that QSC warehouses.

DCC GROUP ELECTS OFFICERS

The DCC Group of America, a new trade organization of electronics manufacturers, record companies and others has elected officers. Michael Aguilar of Panasonic/Technics has been elected chair person. Other officers include Geoff Holmes of Time Warner, Ron Parrish of Tandy, Gary Rockhold of PolyGram, Bud O'Shea, EMI, Randy Miller of MCA.

NEWSLETTER

The Board of Directors consists of Christian Jorg, BMG; Bob Garcia, Sharp Electronics; Frans Schmetz and Emiel Petrone, Philips; Ken Furst, Denon, and Mike Grubbs, Tandy.

MUZAK EXPANDS DBS

Muzak has announced that it has signed a deal with Microspace, a division of Capitol Broadcasting, to lease transponder space on the Hughes SBS-6 Ku-band satellite that will more than double Muzak's satellite broadcast capacity. Muzak initiated its commercial Direct Broadcast Satellite service in 1989 with six channels, and now services over 25,000 DBS subscribers. Transponder space on SBS-6 will be used for marketing messages and an expanded array of music formats targeted to retail environments.

A.R.T. NEWS

Applied Research and Technology is increasing its manufacturing capacity by over 50 percent. The expansion includes an increase in manufacturing and engineering facilities, new personnel, and new automated assembly and test equipment. In other news, A.R.T. has been cited for the second consecutive year as one of Rochester, New York's Top 100 fastest growing privately owned businesses. The list is compiled by the accounting firm KMPG Peat Marwick.

WHJW MOVES

Wrightson, Johnson, Haddon & Williams has expanded its operation into new facilities at 13714 Gamma Road, Dallas, Texas 75244. The acoustical, sound and audio/visual/video consulting firm has also announced the addition of Gary T. White as an associate.

FCC CHAIRMAN AT N.A.B.

Federal Communications Commission Chairman Alfred C. Sikes has been confirmed as the keynote speaker at the Broadcasters' Law & Regulation Conference luncheon, April 14, during the National Association of Broadcasters' convention in Las Vegas. The Law and Regulation conference is a new feature of the convention.

SPARS DAW CONFERENCE

The Society of Professional Audio Recording Services plans its Digital Audio Workstation Conference this year for May 16 and 17 in Los Angeles. The weekend technical conference is hosted in conjunction with leading manufacturers of DAW's. A primary focus of this conference will be the DAW interface with the video postproduction industry. Manufacturers giving presentations and offering hands-on demonstrations are Akai, AMS, Digidesign, New England Digital, Otari, Roland, Solid State Logic, Sonic Solutions, Studer/Dyaxis, and Waveframe.

LEAP 4.1 DEVELOPED

Audio Teknology Incorporated has announced the Loudspeaker Enclosure Analysis Program (LEAP) version 4.1. The new program is a complete 20 Hz to 20 kHz multi-way design program capable of doing accurate nonlinear modeling of low-end driver response. In addition, the company has announced a new cost-effective acoustic and electrical measurement system for loudspeaker, the LMS (Loudspeaker Measurement System).

DJ EXPO SESSIONS FINALIZED

The 1992 International DJ Expo/West, May 4 through 7 at the Sheraton Universal in Los Angeles will feature over 20 panels covering the DJ and dance music industries. Six workshops will also be presented. Topics include: Dance Club Design Trends; Shopping for DJ Equipment; and Mobile Lighting. Workshops include CD Mixing and Karaoke.

SUMMER CES OPEN TO PUBLIC

The 1992 International Summer Consumer Electronics Show will open its doors to the public for the last two days of the show. Held over four days — May 28 through May 31 — at McCormick Place in Chicago, CES will be open to the trade only for the first two days. Approximately 100,000 consumers are expected by CES, with over 1,000 exhibitors. The Consumer Electronics Group of the EIA, which sponsors the show, is planning special dealer promotions to encourage the public to attend.

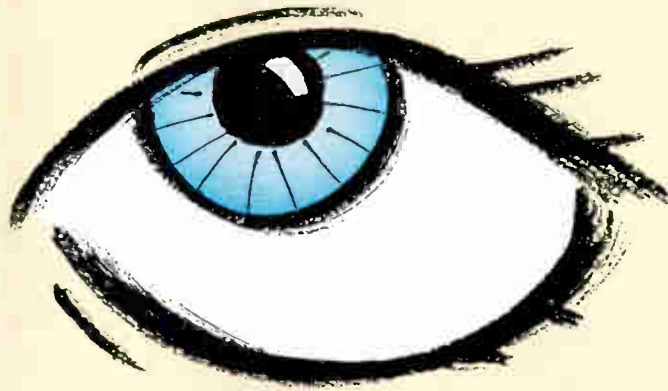
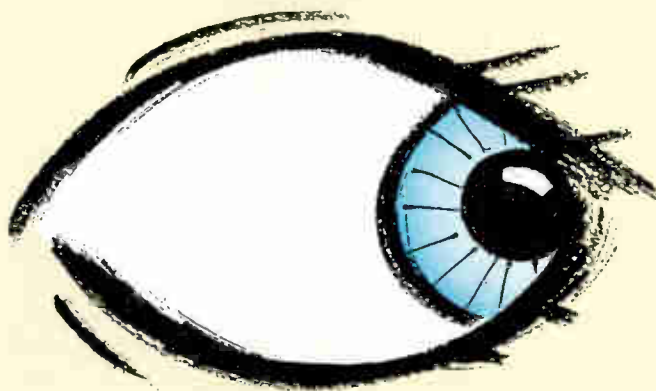
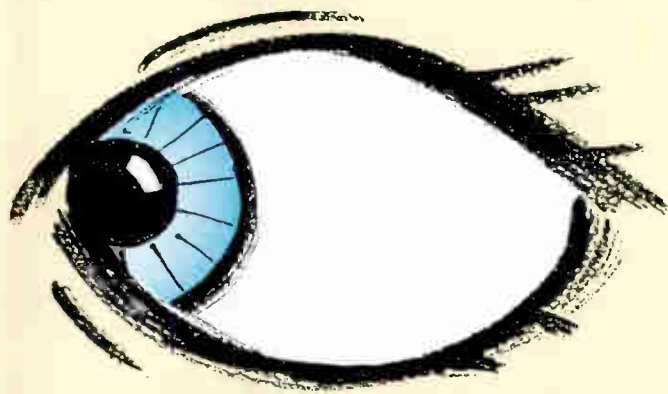
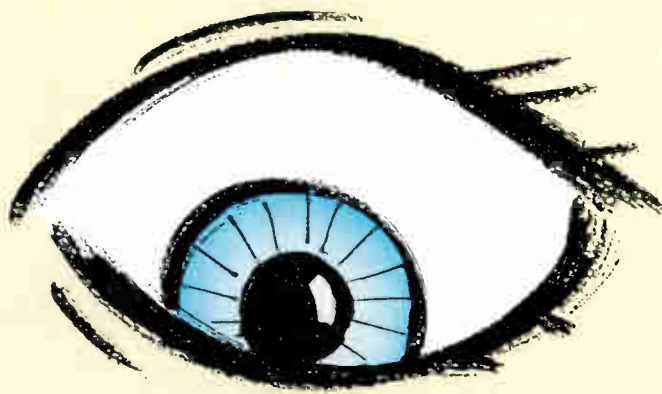

Now you've seen everything.

Aiphone introduces the world's first multi-directional video entry system.
The Video Sentry PanTilt.



Scans five times more viewing area than typical fixed systems. Without the distortion of extreme wide-angle cameras.

Aiphone does it again! Now with fingertip control, you can easily scan the entire entry space—left, right, up, down, all-around.

So no one can hide in the shadows. And no one is too small, or too tall, to be greeted by the new Video Sentry PanTilt.

Everything off two wires.

PanTilt directional commands, picture, sound—all on two wires. It's ingenious. And with only two wires, installation's a snap.

Multi-directional control pad

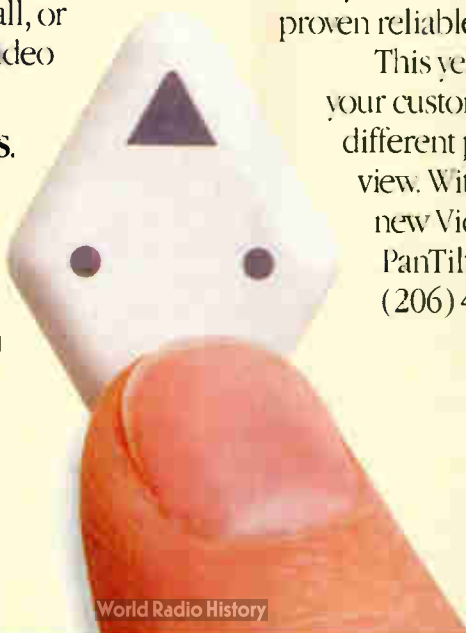

Multi-directional door camera

The quality that is Aiphone

The Video Sentry PanTilt is made by Aiphone. So even with all its innovative technology, you know it's been proven reliable.

This year, give your customers a different point of view. With the new Video Sentry PanTilt. From Aiphone. Call us at (206) 455-0510.



Inside monitor features backlight and PanTilt control buttons

AIPHONE

Communication systems for business, home & industry.

Sight • Sound • Security

Circle 212 on Reader Response Card

Everything You Wanted To Know (and more!!!) on Vibration Isolation Systems

Dear Answerman,

In the January 29, 1992 issue of *Sound & Communications* a reader inquired about turntable acoustic feedback problems in dance club systems. Your advice was fine, but the products you recommended provide only a partial solution.

After grappling with this problem for many years, I am happy to report that a 100-percent permanent solution is at hand, and what a difference it makes! Not only does it eliminate skipping on heavy bass notes, but it cleans up the muddy bass on those notes not strong enough to jar the turntable.

All it takes is a 55 pound piece of lead on four custom-made counter-wound springs under each turntable. We make the bases up as we need them. If anyone wants them, they're available at \$250 each. It's not cheap but it's a real solution to a real problem. The last place we used them was in a control room built right over a subwoofer consisting of eight 18-inch bass drivers in a bass reflex enclosure. To my knowledge, there are no other remedies available to overcome the effects of strong bass vibrations. Before undertaking to do it ourselves, we tried everything available plus experiments with water, oil, sand and rubber. The only fun part was when we solved the problem for the first time, using marble. Lead became a less fragile and cheaper alternative, so that's how it stands. If anyone out there has another method which actually works, let me know and we'll use yours.

**Alexander Rosner
Rosner Custom Sound, Inc.
Long Island City, New York**

Dear Alex,

Truly workable home remedies for severe cases of turntable feedback are few

and far between. Your approach should be excellent, although the Answerman would like to discuss the secrets of achieving high levels of feedback isolation in detail. Bouncy floors, cruise ships, aerobic studios, enormous subwoofers have all caused havoc and sleepless nights for many sound contractors trying to achieve stable sound reproduction, without feedback and skipping. Last month I discussed remedial measures to treat the typical situations. The more serious problems are the most insidious and the cause of great grief, yet even the worst of these is solvable. So this month we will look at what it takes to deal with the worst of the problems.

ANSWERMAN

Perhaps the most research on vibration isolation systems has been done on heating ventilation air conditioning (HVAC) units on the top of buildings and on laboratory isolation tables for electron microscopes and laser interferometers (laser measuring devices). A well-engineered HVAC isolation system would typically consist of an extremely rigid base, highly compliant springs, and viscous elastic dampening material above and below the spring. What is the purpose of each element?

The Base

The rigid base has a number of functions. The roofs of most buildings often have a good deal of flex to them and so do the floors that DJ consoles are built on.

The rigid base must provide a stable platform for the turntable. Another critical factor is mass. In vibration isolation tables for instrumentation (electron microscopes, CD or record mastering equipment), maximum rigidity for the *minimum* possible mass are important and honeycomb sandwich construction is typical. Just the opposite approach is needed for vibrating motors, where a high mass inertia base is used so that the motor vibration will be inadequate to excite the heavily sprung structure. At first glance, the turntables would seem to be more closely analogous to siltation to sensitive equipment on the rigid lightweight base, but in actual practice the opposite is true. If a highly sprung but low mass base has a turntable placed on it, every time the turntable controls or tonearm are touched it will bounce. This is an impossible situation for a DJ. Alex's approach of using a 50 pound lead base is a sensible solution, as the force of the DJ operating the turntable controls is insignificant to excite the massive sprung weight.

Springs

The suspension must be more compliant (springy) than the bouncy floor you intend to isolate the turntables from. So if the floor flex has a resonance of 4 Hz, then your suspension must have its resonance peak below this point. If the floor has a lower resonance frequency than the springs, then your suspension system is too stiff and will not be effective, passing the flex (deflection) onto the turntables. Springs are more effective in expansion than in compression, so if you can hang your base down from the console top deck, then things will work better (the AR and Thorens turntables used this approach for their internal suspensions).

Large springs are important in achieving

You just lost your last reason not to own a TEF[®]

Introducing RTA Software from TEF

TEF 20—The measurement platform.

You've come to know TEF as the powerful measurement platform. Now, with RTA software, the TEF 20 becomes the one tool you can use everyday.

RTA—the TEF way—your way.

Choose 1, 1/2, 1/3, 1/6 and even 1/12 octave band measurements. View data in 3, 6 or 12 dB per division increments. Store up to six sets of data in memory, then perform overlays or compare your measure-

ments to a standard using the difference mode.

Sound Synergy.

The TEF 20, Sound Lab[®] and RTA software are powerful

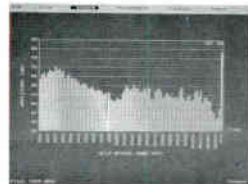

allies for analyzing sound. Equalize a room using RTA in 1/3 octave mode, switch to 1/12 for parametric equalization, then use TEF Sound Lab to do an ETC or NC measure-

ment. TEF 20 and RTA software—all the power and performance you need in one easy to use package.

For more information and your free demo disk, call 1-800-833-8575.

Tef Systems. Sound intelligence at your fingertips.

**TEF²⁰
system**

Techron Division, Crown, International
P.O. Box 1000 / Elkhart, IN 46515-1000
Phone: 219-294-8300
Fax: 219-294-8329

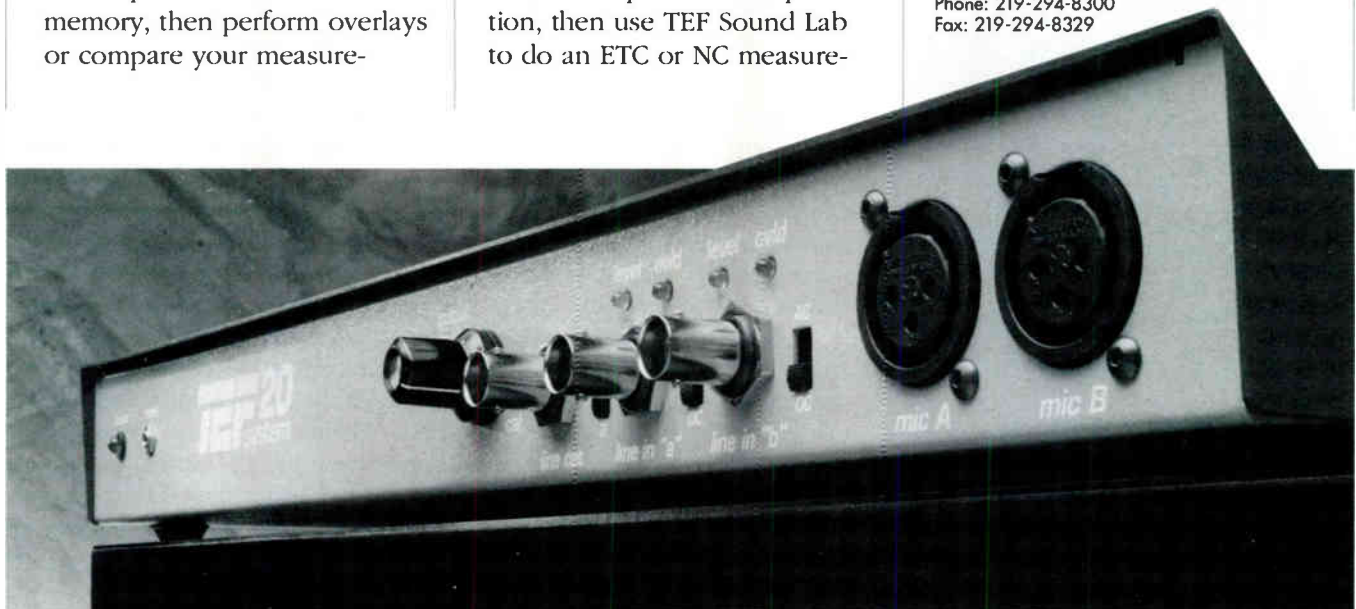

Distributed outside of North America by Amcron, a division of Crown International. TEF is a registered trademark of Techron Division, Crown International. The Trademark SOUND LAB is licensed under United States Trademark Registration No. 1,424,678.

Install the Very Best...Specify Frazier CAT™ 40

- Dual horn. Point Source Alignment
- Coherent phase & time domains
- Smooth 90°X90° Speech pattern
- Full band width 65Hz - 17kHz

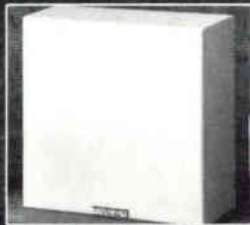

New Decorator white

Coincident Aligned Transducers

Frazier Demo
NSCA '92
Anaheim Hilton
Palisades Room
4th Floor



State of the art 2'X2' alternate to ceiling Co-Axes



Mounting Bracket

When you specify and install FRAZIER CAT™ 40's you've done your *very best!* Our CAT™ design establishes point source accuracy and signal alignment. Smooth, controlled energy ... excellent gain before feedback ... for reverberent spaces ... That's the CAT™ 40.

FRAZIER

Route 3, Box 319 • Morrilton, Arkansas 72110
(501)727-5543
Toll Free 1-800-422-7757
FAX (501)727-5402



Circle 268 on Reader Response Card

a low enough resonant frequency, but as the spring height gets larger, you must also use springs of larger diameter — or lateral stability will be a problem. The springs must be loaded optimally: too heavy and the springs will bottom out, too lightly loaded and they will not provide isolation and the resonant frequency will be too high. Watch out for interaction between

BOUNCY FLOORS, CRUISE SHIPS, AEROBIC STUDIOS, ENORMOUS SUBWOOFERS HAVE ALL CAUSED HAVOC AND SLEEPLESS NIGHTS FOR MANY SOUND CONTRACTORS.

the turntable's internal suspension system and the external suspension system. If your isolation system is well designed, then the turntable's suspension is really vestigial and should be bypassed. Springs are resonant at their natural frequency and amplify rather than attenuate isolation. One potential problem is when the turntable's internal springs and the external isolation system's springs both have overlapping resonance frequencies. This is like having two parametric equalizers in series, both turned to the same frequency band — look out!

Dampening

The limitation of springs is that while they are effective above their resonant frequency, much higher frequencies simply pass through the spring steel. Therefore good isolation mount design calls for energy absorbing resistive damping isolation, ideally located above and below the spring. This can take the form of neoprene grommets, isolation matting, isolation feet (like the Allsop NAVCOM feet mentioned last month). While the limited excursion capacity of the high loss material restricts effectiveness of the isolation at extremely low frequencies, the energy above 20 Hz is greatly attenuated. Where does the

energy below 20 Hz come from? Certainly not from your subwoofers, but how about the dancers hobbling around on flexing floors or on a cruise ship from the engine and the sea?

New Developments

Will this art be lost now that CDs are replacing vinyl? Apparently not, as I have just finished testing a CD player that essential has a miniature version of the above suspension system built into its transport. The Stanton CD-22, a dual transport disco CD player, uses silicon rubber grommets above and below high excursion springs that suspend the CD mechanisms. No amount of jumping or pounding on the control console could get this player to skip.

JUST THE OPPOSITE APPROACH IS NEEDED FOR VIBRATING MOTORS, WHERE A HIGH MASS INERTIA BASE IS USED.

Even more robust is Sony's new mini-disc (MD) system displayed in New York last spring, and at the Japan Audio show last October. A shock-memory system using a digital buffer memory holds four seconds of music. If the transport is jugged and mistracks, it remembers where on the CD it lost its footing, waits until the transport settles down, and goes back to where it left off. If all this happens in less than the four seconds grace period of the buffer memory, you'll never know the system has worked its magic. While the Sony mini-disc is not compatible with conventional CDs (which DJs are not too happy about using anyway), Fisher introduced the identical approach in a portable, joggable CD player at the CES in January. Buffer memories are already used by some pro CD players for faster start up (such as the Tascam CD-701), so I would expect this foolproof tracking technique to become more common in the near future. ■

A photograph of Paula Abdul on stage. She is wearing a dark, long-sleeved outfit and has her signature high ponytail. She is holding a microphone in her right hand and a single red rose in her left hand, which she is offering to a fan's hand reaching up from the bottom right. The background is dark with some blurred stage lights.

GUESS WHICH WIRELESS PAULA'S USING.

With 11 trucks, 9 buses, 9 musicians, 8 dancers, 2 stilt walkers and hundreds of support personnel on the road for her spectacular "Under My Spell" tour, Paula Abdul is using only one kind of wireless. Samson UHF.

SAMSON[®]
WE ARE THE WIRELESS FUTURE[®]

APRIL CALENDAR: MAKING PLANS FOR EXPO '92

By Judith Morrison

April in Anaheim. That's the time and the place for the 1992 Contractors' Conference and Expo sponsored by the National Sound and Communications Association.

This year's Expo is filling out as the most ambitious ever, with 390 exhibitors signed on at press time, and over 5,000 attendees expected.

The NSCA Expo has always been more ambitious and designed to be more useful than a mundane equipment market. Once again, the educational sessions are qualified, quantified, and extended over extra days beyond the convention.

Expo dates are April 27 through 29. Education session dates are April 25 through 28.

All this takes place in the Anaheim Convention Center, and in the NSCA headquarters hotel — the Anaheim Hilton.

A consortium of manufacturers' reps once again is supporting the Contractors Caper, planned for 6:30 PM on April 26 (that's the night before the show begins). Traditionally, the Caper is a networking opportunity par excellence, convivial, informal and lively.

Added to the roster this season is the Women in Electronics Wine and Cheese Party, scheduled for Monday, April 27 at 6:30 PM. Sponsored by NSCA and free to industry women, this event is planned to foster networking and information for the industry's most visible minority.

Judith Morrison is the Editor in Chief of Sound & Communications magazine.

And again, West Penn Wire has scheduled its Appreciation Party for the second night of the show, Tuesday, April 28.

Serious business is conducted during NSCA. The business meeting of the association takes place on April 27 at 8 a.m., and it behooves association members to make the early morning meeting, to keep up with the doings of the association.

The awards schedule of the NSCA has been expanded. This year, the board of directors has planned both Service awards and Tommy awards for distinguished contributions to the industry. The Service awards will be presented to three reps, three manufacturers, two past board members, and six past presidents of NSCA. Tommy (named for Thomas Edison) awards will include: The Innovation Award, Milestone Award, and Exemplary Contribution Award. All Tommies go to individuals, not companies. (If you'd like to make suggestions for nominations, contact NSCA board member Barry Glick at Comtex Inc., 201-896-3333.)

Elections take place for NSCA members this April. Jay Johnson, outgoing president, is expected to welcome Jack Toerner as the new president. Toerner, of course, has been Expo Chairman for the last couple of years and has worked mightily to increase the usefulness of the association for its members. (Per Haugen is expected to be Expo Chairman next year.)

The keynote speaker is Gail Wenows, a speaker and entertainer, with a presentation on "team work, how it works, why it works, and what happens when the team dissolves." That's at 9 AM on April 27.

For the record, these are the specifics of the NSCA convention. Dates: April 27 through 29. Hours: 10 — 6 Monday and Tuesday, 9 — 2 Wednesday. Convention hotels: Anaheim Hilton, Marriott, Inn at

the Park, Jolly Roger. Venue: Anaheim Convention Center, Orange County, California. Educational sessions: Anaheim Hilton. Write or call NSCA for further information — 10400 Roberts Road, Palos Hills, Illinois 60465, 800-446-NSCA.

Be there. And as long as you're there, you may want to take in the tour of the Anaheim Stadium the afternoon of the 29th. Hosted by Craig Janssen, project design consultant, and supported by Maryland Sound Industries, the two-hour tour starts at the press box, and includes complete demos of the Stadium's sound equipment. Participants include Dave Liester, project manager installation; Mike Stahl, MSI West; Clay Barclay and Verne Searer, Crown; Art Chase and Mark Lee, AMX; Gary Hardesty, JBL; Kenton Forsythe, EAW.

As far as the educational sessions go, we at Sound & Communications have some biases. Mike Klasco, our technical editor, is planning a session on 'Loudspeakers — All You Want To Know.' No one will dispute that Mike's knowledge of speakers is intense, deep, encyclopedic and both technical and historical, and we're expecting to learn from his presentation. (He's also a pretty good speaker.) That's at 10:30 AM on Monday, April 27.

Likewise, Don Davis, who frequently writes for this magazine and of course is well known for his teaching expertise at Syn-Aud-Con, is planning a session on "Equalization, Synchronization and Mesmerization." The content is described as "Preparing a sound system for equalization and synchronization. Learn to avoid and correct customer mesmerization."

A session that is especially in tune with the times is the "Hearing Impaired Audio System and The American's with Disabilities Act" presentation scheduled

for Tuesday April 28. Manufacturers of audio systems for the hearing impaired will cover the Act itself, the market, the equipment, and the contractor's niche. As the Act enters its fourth month, this session should be unusually timely.

More time is being apportioned this year to technical sessions — 90 percent versus 10 percent for "sales and business." (The mix in previous years was 70 percent — 30 percent.) The new ratio has been established as a direct result of the comments of attendees during previous years. ("We *do* listen," says Expo Chairman Jack Toerner.)

Note to all: Be aware of a new rule this year: All non-members must pay to get in to Expo. That includes reps who are manning exhibit booths. The message from NSCA is clear: Join the Association.



We at Sound & Communications will all be doing our usual double duty at NSCA, covering the Expo as reporters for this magazine, and producing NSCA-TV News, the daily news program about the convention. We're working now on preparing the crews and reporters who will be around

the floor asking the questions you want the answers too. The show will be transmitted into convention hotel rooms, so you can see what's happening before you reach the floor. And of course we'll be on monitors at the exhibit hall. It's been our experience that a television news show is a welcome



CAL SWITCH

CALIFORNIA SWITCH AND SIGNAL, INC.

**YOUR #1 SOURCE
FOR:**

Switchcraft®

Audio Connectors, Adapters, Jack Panels,
Patch Cords, Plugs, Switches

Off the Shelf Delivery

Competitive Pricing

Just in Time Delivery

Value Added Services

Assembly, Engraving, Modification

[800] CAL-SWCH

[310] 538-9830

[213] 770-2330

[818] 761-5226

[714] 525-6606

[619] 231-6740

[415] 621-7386

[408] 279-8848

[510] 452-1009

[916] 448-6370

[209] 441-1752

Circle 257 on Reader Response Card

World Radio History

addition to the informational mix to any convention, and especially at NSCA which is small and friendly — but serious business. It's a truism that within the general electronics industry, the most favorable comments on conventions refer to NSCA. It's the convention with the least hype and the most business proportionately of any of the related meets of this market.

So we'll see you in Anaheim. We'll be there. And we welcome any suggestions you have for our television coverage and our post show coverage for this magazine. ■

NSCA CALENDAR

Saturday, April 25

- 1:15 PM Basic Sound Design and Estimating
- 1:15 PM Advanced Sound Design and

- 1:00 PM Estimating
- 1:00 PM MATV System Design

Sunday, April 26

- 8:00 AM Basic Sound Design and Estimating (continued)
- 8:00 AM Advanced Sound Design and Estimating (continued)
- 8:00 AM MATV System Design (continued)
- 6:30 PM Contractors' Caper

Monday, April 27

- 8:00 AM Annual Business Meeting for NSCA members.
- 9:00 AM Keynote Speech (Gail Wenows)
- 10:30 AM Equalization, Synchronization & Mesmerization
- 10:30 AM Using Effective Demos to Increase Sales

- 10:30 AM Business Music in the Marketplace
- 10:30 AM Everything You Always Wanted to Know about Loudspeakers.
- 11:45 AM Women in the Marketplace
- 6:30 PM Industry Women's Wine and Cheese Party

Tuesday, April 28

- 8:00 AM Room Acoustics
- 8:00 AM How To Better Communication with Consultants
- 8:00 AM Hearing Impaired Audio Systems and The Americans with Disabilities Act
- 8:00 AM CCTV Design Course Certification
- 10:15 AM Acoustical Treatment of Problem Areas

CARVER
PROFESSIONAL
P.O. BOX 1237, LYNNWOOD, WA 98046 • TOLL-FREE 1-800-443-CAVR, FAX (206) 778-9453

THE NEW LIGHT HEAVYWEIGHTS

PM-120 (2x60 watts)
PM-300 (2x150 watts)
PM-600 (2x300 watts)
PM-900 (2x450 watts)
PM-1200 (2x600 watts)

- 10:15 AM Mastering Computer Interfacing to Large-Screen Presentation Displays.
 10:15 AM Microphones I.
 10:15 AM Fiber Optics and The Communications Contractor
 11:15 AM Microphones II.

Wednesday, April 29

2:00 PM Tour of Anaheim Stadium

(Contact NSCA for details and any costs involved.)

FOR MEN (ONLY?)

New Educational Session Scheduled at NSCA

A new educational session at NSCA Expo is especially designed for men. "Women in the Marketplace," scheduled for Monday April 27 at 11:45 AM, will focus on the male-female business mix and how it can enhance projects — and profits.

The session is specifically geared toward working profitably in the sound and communications business. Moderated by Miriam Evaslin of ProTec Electronics, session participants include several women working successfully in sound and communications businesses — from contracting through manufacturing.

Topics include the unexpected and financial benefits of hiring women, along with successful case histories.

Participants include Maryann Kofski, Telex; Mary Hanna, Hanna Associates; Lucy Getgen, Electronic Construction Design; Marianne King, GMK Security Systems; Dale Rubinkam, Pennsylvania Sound Management; Evelin Perry, Carolina Sound and Communications, Judy Morrison, Sound & Communications.

The organizers are vocal in expressing the business aspects of the general topic. This session isn't about feminism; it's about making money in hard times. ■

JUST YOUR EVERYDAY VIRTUALLY INDESTRUCTIBLE MIXERS.

When you've been making mixers for over 20 years, you learn how to build them rugged and reliable enough to handle just about anything. And then some.

Years ago, the value and versatility of TASCAM studio mixers led sound reinforcement engineers to use them in sites far removed from the quiet and controlled recording environment for which they were originally designed.

Our studio heritage has always required us to make quieter mixers with more headroom and higher output. And, to meet the demands of real-world applications, we also make our mixers more rugged and roadable.

Like the M-200 Series. Available in 8, 16 and 24 input versions, with 4-buss plus stereo outputs for applications requiring multiple mixes or sub-groups. Starting at just \$1,199* for the rackable M-208.

The rack-ready M-1016 (\$1,299*) and M-1024 (\$1,899*) are both 2-buss boards with phantom power. The M-1016 has 8 mono and 4 stereo inputs. The M-1024, 16 mono and 4 stereo inputs.

The 6 input/4 output M-106 (\$699*) is ideal for multi-image, boardroom or other applications that require versatile and rackable mic and line mixing.

And, for economy applications, the M-06 (\$369*) and M-06ST (\$499*) provide flexible stereo buss mixing in either 6 mono or 6 stereo input versions, with CD quality specs.

For more information, call or write TASCAM, the company whose Industrial Strength product line also includes cassette decks and CD players.



TASCAM®



© 1991 TEAC America, Inc., 7733 Telegraph Road, Montebello, CA 90640. 213/726-0303. *Suggested retail price.

Circle 220 on Reader Response Card



S



M



L



XL

One S1520S System fits all.

This is the one. The one with the new speaker. The one with digital processing. The first one of its kind. It's the YST S1520S speaker system. And it's not at all what you're used to.

First things first, let's talk YST. It stands for Yamaha Active Servo Technology. It allows us to make some unorthodox cabinet tunings in the S1520S speakers. What you end up with is tight low-frequency output. And range that extends much lower than other speakers this size (all the way down to 50 Hz.).

To all this we've added state-of-the-art digital processing. It's the C20 Digital System Controller. And it makes



the system easily programmable. You can adjust and store EQ, delay, crossover, time/phase alignments, security

parameters and a lot more. So you can customize the sound to whatever situation you get into. Whether it's a picnic for the company big-wig or a convention for a thousand of them.

The system also includes the Y20. It's the heart and soul of YST. The Y20 monitors back EMF. While it electronically synthesizes parameters for the woofer. The result is more precise woofer control with less distortion and less acoustic interaction between the drivers.

The Y20 also gives you the ability to use any professional power amplifier you want. And because it's designed to fit right into the amp rack, there's no need for



added sense wires to the speakers. And calibrating it is a simple set-it and forget-it procedure.

Now back to that YST speaker. It's got a 15" high power, high sensitivity woofer with a carbon fiber impregnated cone. And the system is available with an interchangeable, medium format horn in 60 or 105 degree versions.



There is no other system like the YST S1520S. It's the one that's digital. It's the one system that fits all. It's the one that's available from selected Yamaha dealers and contractors.

YAMAHA®

© 1991 Yamaha Corporation of America, Professional Audio Products, P.O. Box 6600, Buena Park, California 90622-6600, (714) 522-9011.

Circle 203 on Reader Response Card

The Worship Center

Today's Trends and Techniques

BY MARIA M. CONFORTI

Sound contracting for houses of worship is a tricky business these days.

"A lot of people are scared, I guess, to spend the money," says Joe Mezzafonte, president of Applied Sound and Communications in Mineola, New York. "We're finding that it takes them a little bit longer to decide." While Mezzafonte notices a downshift in the New York tri-state-area market and attributes it to the economy, he points out that houses of worship still have a need for quality sound systems.

Middle America's word on the church market differed from Mezzafonte's. "Business has increased, due to several factors," says Tim Vear, applications engineer, Shure Brothers. "One [reason] is, there's a fair amount of new construction and new churches going up around the country that necessitates systems. There's also an increased awareness in the general population about sound quality . . . both for speech and for music. This has created demand for a lot of retrofit and upgrade of older systems that may have been in place for 20 or 30 years."

"We sometimes see some very large work being done," says Bob Ancha, Ancha Electronics of Rolling Meadows, Illinois. "In fact, we're working on completing a quarter-of-a-million-dollar sound system

Maria M. Conforti is a freelance writer in the New York area who was previously the Assistant Editor of Sound & Communications and The Music and Sound Retailer.

An Ancha Electronics install in a classroom in the West Expansion of the Willow Creek Community Church.



comprising about seven sound systems at the Willow Creek Community Church in South Barrington, Illinois. The budget was still tight, but they were still insistent on very high-quality components for that project . . . The system for the Willow Creek Community church is in a brand-new facility [the West Expansion], which has effectively doubled the [church's] space. So we're finding some new churches as well as retrofit [business]."

Equipment is getting more sophisticated for unattended systems as well as for full-blown performance PA systems, says Vear. "The operator-run systems are becoming very large in some cases — 32-input consoles, multiple-monitor systems, and sophisticated delay and signal processing,"

Vear states. "Even the simple turn-it-on-let-it-run systems are getting more complex, although it's sort of behind the scenes — automatic mixers; programmed equalizers and so forth — in order that the things that the sound system has to do are done automatically and are not under the direct control of the operator. . . . There's probably more business going on in the operator-based systems, to go along with very expanded music productions that a lot of churches are doing these days. They'll have orchestras and visiting artists with taped accompaniment. The [automatic] systems are for more liturgical-based churches."

"Systems are going from the old fashioned distributed system to a system

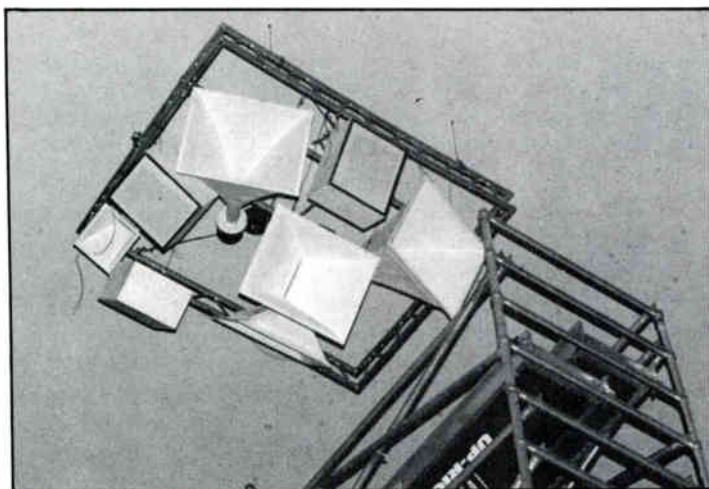

Cluster at St. Nicholas of Tolentine Church in Jamaica, New York installed by Applied Sound & Communications.

design consisting of a central cluster," says Mezzafonte. "More and more churches have accepted the central cluster concept, as compared to a distributed system. Before, there was an objection to having this mass of speakers hanging high from above the church."

On the other hand, according to Ancha, central cluster systems have always been the vogue, "unless there are some extenuating circumstances where the reverberation is so large you need pewback speakers or speakers under each pew," he states. "You always need a cluster in a church, but sometimes due to budgetary restraints, you may not be able to afford putting a ring of satellite clusters out. Sometimes it's not needed, either. Certainly a cluster is considered the normal way to go in practically 95 percent of the church jobs we do."

One-button sound systems and switchable EQs are the order of the day at Atlanta, Georgia's Davis Audio, reports Greg Davis, head of sales. Davis Audio frequently installs subwoofers in houses of worship, as well as distributed speaker systems.

Streamlining is the name of the game in other equipment news. "We've been trying to establish our HR format into [church system] applications, which will allow a relatively small facility to enjoy the features of large-sized and expensive consoles without committing to 24 or more channels," says Larry Winter, VP/sales and marketing at Rane. "There's an advantage to having an equipment room that can be secured; there's been a history of problems that really nag the installer: They install a system and get it all set up, and then the local band will come in and tweak the board and the EQ, and the next thing you know, they've got a service call

to get the thing back on-line again."

"When you do a church job, it's no longer a question of 'Do you want a wireless microphone?' it's 'How many wireless microphones do you want?'" says Ken Reichel, VP/marketing, Audio-Technica US Inc. "That's become a standard item. Having huge, ugly microphones mounted on goosenecks on pulpits is obviously a thing of the past. Our UniPoint has become almost generic in terms of technology."

"Churches are getting more serious on hearing the Word in a much more intelligible manner, so it's very important to have a quality amplifier that has little or no coloration and distortion," states Gerry Barclay, marketing services coordinator for Crown. "The IQ System 2000 [is] finding its way into the larger churches and some of the small churches. We're finding software to be coming available in churches, so they can view on a computer screen what their amplifiers are doing so they don't have to keep running to the back of the church to check the status. . . . Once the installation is done, the [sound system operator] could turn out to be a teenage boy. . . . So we're trying to make the software simple enough that once it is set, even a teenager can comprehend how to run the sound system for the church."

"We're working with clients that are very sophisticated in their ministry efforts. As a result, they're very knowledgeable about what they want, and they themselves are driving the quality issue, whereas years ago we were the ones who were stressing the quality. Now the tables are practically turned," Ancha says.

"The customer has no idea what he's getting," Davis counterpoints. "The main thing they're concerned about is, 'Can I

Major Brand Sound Products Available From ADI Include:



Over 70 Locations in North America:

ARIZONA Phoenix North Phoenix CALIFORNIA Anaheim Carson Cerritos Irwindale N. Hollywood Riverside San Diego COLORADO Denver CONNECTICUT Cromwell Milford FLORIDA Boynton Beach Clearwater Jacksonville Miami Airport N. Miami Beach Orlando Tampa GEORGIA Atlanta Doraville HAWAII Waipahu ILLINOIS Elk Grove Village Morton Grove LOUISIANA New Orleans MARYLAND Gaithersburg Owings Mills MASSACHUSETTS Allston MICHIGAN Detroit North Detroit MINNESOTA Minneapolis NEW JERSEY Fairfield Pennsauken So. Plainfield NEW MEXICO Albuquerque	NEW YORK Albany Bohemia Brooklyn Buffalo Lynbrook/Valley Stream Ozone Park Plainview Staten Island Yonkers NORTH CAROLINA Charlotte Greensboro OHIO Cincinnati Columbus Oakwood OKLAHOMA Oklahoma City OREGON Portland PENNSYLVANIA Pittsburgh Plymouth Mtg. Philadelphia (See Pennsauken, NJ) RHODE ISLAND Warwick SOUTH CAROLINA Columbia TENNESSEE Nashville Memphis TEXAS Dallas Houston San Antonio UTAH Salt Lake City VIRGINIA Alexandria Norfolk Richmond WASHINGTON Kent Kirkland WISCONSIN Milwaukee AND 6 LOCATIONS IN CANADA
--	--

To reach the center near you, call
1-800-233-6261

The service people.
ADISM
A SUBSIDIARY OF PITTMAY CORP.



NOW YOU CAN GET MAJOR BRAND SOUND PRODUCTS AT A LOCATION NEAR YOU!

TOA. Atlas/Soundolier. Bogen. University. Paso. Shure. Furman. Aphex. Pro Co. These are just some of the brands you'll find at ADI's 70 locations across the U.S. Plus residential systems for home theater and multi-room audio.

You'll also find the nation's largest stock of CCTV, intercom, access control and other low voltage systems. All computer linked for total accessibility. And backed by 16 systems specialists and hundreds of sales experts.

ADI is just for you, the contractor. We sell wholesale to the trade only. You get credit

terms if you qualify. Plus technical training and support.

Find out what a difference convenience makes at ADI. Call or visit the ADI convenience center near you today.

**To reach the ADI convenience center near you, call:
1-800-233-6261.**

The service people.
ADISM
A SUBSIDIARY OF PITTSWAY CORP.

Circle 214 on Reader Response Card

World Radio History



South Exterior of the Willow Creek Community Church in South Barrington, Illinois.

push a button so it will work?" "

"It depends on which denomination you're working with," Mezzafonte says. "As a whole, most of them still don't have the 'sound person' to work a mixing board or control the sound system."

Ignorance about sound systems on the part of church personnel frequently leads to problems during services. "The main problem we see in churches is the operator changes the EQ system for an improvement in music playback, and that, of course, sacrifices the sound quality for

voice," Davis says, adding that installation of a digital equalizer compensates for both. Reichel points out that some people have problems when mixing wireless mic elements. For instance, when a cardioid element is on the pulpit, and the minister uses an omnidirectional lavalier, the system goes into feedback when he walks away from the pulpit. However, Reichel further states that members of churches that focus on contemporary music often have both the equipment and the knowledge level of a recording studio.

"Churches have to be very cost-conscious," Winter notes. "They want to put in something that works; they don't necessarily want to cut corners. Our approach has been to try to encourage installation of a system that can grow with the facility. . . . When equipment comes with enough different inputs, including terminal strips, there's a place that can cut down some costs so that the installer doesn't have to buy and then spend the labor to install XLRs on the existing cables. When equipment can be installed with minimal labor and minimal ancillary equipment, then the whole bid price comes down and we're all more likely to do more business."

"Getting new business requires a lot of research and leg work to get a feel for the market," Vear says. "The church-sound

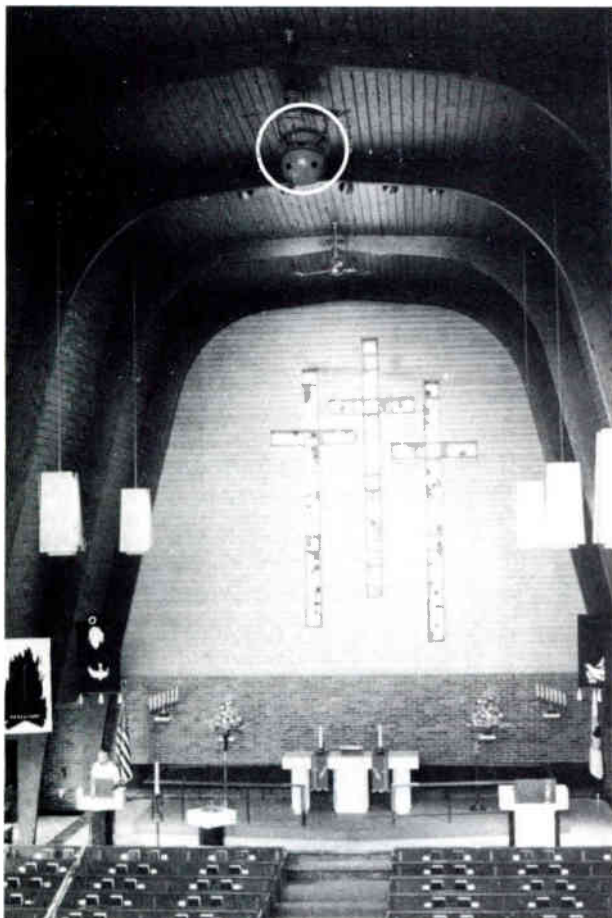

"...excellent voice clarity and beautiful music reproduction."

Pastor Don F. Thomas

The Prince of Peace Lutheran Church, Ida, MI, has used a Sand colored Soundsphere #2212-1 loudspeaker for a few years. Pastor Don F. Thomas has been delighted with the improvements. He stated "there is no comparison between the former system and what we have now. The single Soundsphere loudspeaker produces excellent voice clarity and beautiful music reproduction. It also achieves very even sound distribution in my church. With it, we now do a lot more speaking by church members with wireless mikes from various areas of the church with good results. Even special programs done with children are now clearly heard in the church."

This Soundsphere installation was done by Monroe Sound in Monroe, MI. They have also installed Soundsphere loudspeakers in many other local churches, gyms, and auditoriums. A representative of Monroe Sound stated that, "Soundsphere speakers are a quick and easy installation. My employees can finish more jobs in a shorter time period resulting in improved cost efficiency for the church and for the company."

Write or call direct for further information.

SOUNDSPHERE A PRODUCT OF
SONIC SYSTEMS, INC.

737 Canal Street • Bldg 23B • Stamford, CT 06902 • USA • Tel (203) 356-1136

industry tends to be very word-of-mouth oriented. That is, the contractor who's installed some good sound system becomes known, and people call him when they need a sound system. People who have been doing it for a while and have been doing it well tend to have an ongoing customer base, and new people who are trying to get into this market find it more difficult. You've got to cultivate the business.

"In many cases the decisions are dictated by committees of people, not individuals, and the committee may or may not value some of the fine points of the installation, particularly when they cause higher cost," Vear continues. "So you fight a constant battle of giving people the system that will do what they want, and to give them a high value system that

Ancha's Activity Center install-in-progress at Willow Creek.



allows you to make a living in installing. . . The contractor who will succeed in this business has to be a very good diplomat. Patience is a primary virtue, because these things can get dragged on for months or even years from initial contact to final installation. There has to be a lot of hand-holding, instruction, and education that goes on in some of these things, so it requires a full-service approach to that market. And service, of course, after the installation. In many cases, if they're upgrading to a sophisticated system, you're

going to have to train the people to operate it in an ongoing fashion. You have a long-term customer when you install a system in a church, typically, and you have to be prepared to deal with that."

Attend the worship service of a prospective client, advises Reichel. "I would guess that probably that's only done in less than 50 percent of the cases," he estimates. "Many of the proposals that cross my desk make one shudder, in that it's obvious that they don't know how the service works and what goes on. . . I

How To Reach 22 Million Hard-Of-Hearing Americans...Sennheiser Infrared.

The Perfect Solution for Providing an Assistive Listening System While Complying with the ADA.



Cinemas and Live Theatres
Retirement Communities



Houses of Worship
Municipal and Legislative Facilities



SENNHEISER

Sennheiser Electronic Corporation 6 Vista Drive, P.O. Box 987, Old Lyme, CT 06371 (203) 434-9190, Fax (203) 434-1759
Manufacturing Plant: D-3002 Wedemark, Germany AudioLink® is a trademark of the National Captioning Institute, Inc. SEC, Inc. SE-4R 11/91

know many contractors who go out and do a demonstration of a system in the church facility before the people actually buy the system; that's very convincing."

Many of the proposals that cross my desk make one shudder, in that it's obvious that they don't know how the service works and what goes on.

"If the minister is a pulpit-pounder, then you by all means would recommend when they install a Unipoint that they use an 8416 shock mount built into the pulpit to elimi-

Cluster installation by Applied Sound & Communications at St. Louis de Montfort Church in Sound Beach, New York.

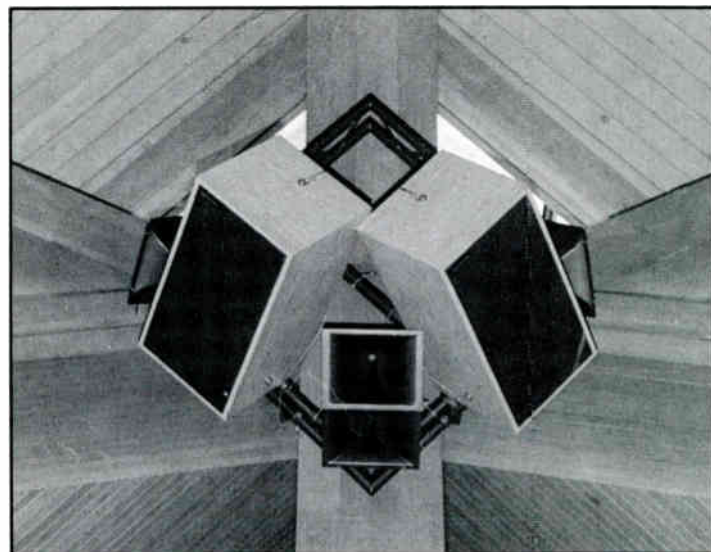

nate the noise, as opposed to bolting it down to the pulpit and the guy coming back three weeks later and saying, 'This is the noisiest microphone system I've ever heard,' " Reichel explains. "Same thing with P-pops. . . . If you've got a mic-swallower, you better put a pop filter on there, or the congregation is not going to be happy. The worst case is the roving mic, which is located down front. That's for when the children get up to do a pro-

gram, or Aunt Tilly is presented the Church Lady of the Year Award. Whatever the case may be, it's strictly a handheld microphone that's there [for such purposes]. Whatever you do on that, A: it needs to be low in handling noise; and B: you've got to put a pop filter on it, because lay people don't know how to use it. So you anticipate those problems and use the right microphone in the right location.

"If most ministers had their wish, they wouldn't want to see anything: They don't want to see speakers, they don't want to see microphones, they don't want to see anything," Reichel continues. "So the minister reads an ad and says 'I want one of those plate mics so nobody will see the microphone on the pulpit.' So you put a plate mic there, and the first thing he does is flop the Bible on top of it, and then he flips the pages of the Bible, and then wonders why the people are out in the congregation wiping the blood out of their ears. That's why you go to the service to see how the guy [preaches]."

Interviewing the minister is nice to get a feel for what a church wants, but clergy often are not technically oriented. "By attending a service, a good contractor can come up with a range and say 'Do you want this thing to really be complete? Do you want an outreach program where you can send the service to people at home via telephone lines? Do you want sound systems in your cry room and nursery where people there can hear your service? Do you want a complete hearing-assist system for numbers of people?' There's all kinds of options, and you can price it according to what they feel they want and can afford," Reichel says. ■



We are pleased to announce our new AB-CLOCK CARILLON AND CLOCK CHIME SYSTEM

In response to your enquiries regarding our Digital Audio Repeaters' use in carillon and clock chime systems, we have taken our largest selling repeater, the AB-100 AudioBrick, added a clock, a lot more memory, and some special firmware to create our newest product, the AB-Clock. It's features include:

- Each AB-Clock is a complete audio playback system (except for amplifier and speakers).
- Any sound that can be recorded (voices, music, sound effects, etc.) can be digitized and put into an AB-Clock.
- The length of sounds is virtually unlimited.
- Up to 255 different sounds can be stored.
- Bandwidths to 15 KHz, dynamic range 72 dB.
- Clock can chime on each quarter, half and full hour, and toll on full hours.
- Up to 60 special shows and times each day.
- External inputs can select and play a sound for alarms or to start unscheduled shows.
- All configuration is done through easy menus using virtually any computer or terminal.
- Schedules can be set for 8 days a week.
- Lithium battery to protect from power failures.
- Automatically adjusts for clock drift.
- Easy to adjust clock for daylight savings time
- Status output can give remote 'running' indication or pulse once each minute to run 'regulator' style remote clock faces.
- Volume, bass and treble controls.
- Balanced and single ended line level outputs.
- 5" wide x 12" long x 2-1/2" tall case.
- Includes UL listed wallmount power supply.

GILDERFLUKE & COMPANY • 820 THOMPSON AVENUE #35 • GLENDALE, CALIFORNIA 91201
800/776-5972 • 818/546-1618 • FAX 818/546-1619

YOUR AUDIO PROBLEM SOLVER...



ADVANTAGE ONE is an 8-input mic/line mixer with HPF, notch filters, output EQ and limiter.



ADVANTAGE EX is an 8-input *expander*, which can provide limitless inputs to the system.



ADVANTAGE AG II is an 8-channel *auto gate*, which provides all automatic mixer functions.



ADVANTAGE RC is a 4-channel *remote control*, which provides level and mute functions.



ADVANTAGE AM is an 8x3 *auxiliary mixer*, which can provide limitless send/zone outputs.



ADVANTAGE EQ is an 8-channel, 3-band *equalizer*, which provides EQ for inputs or outputs.

ADVANTAGE SYSTEM ONE

From a simple 8-channel mixer...to a 64-input automatic mixer with priority, logic outputs, remote control, 3-band EQ, and multiple zone outputs...ADVANTAGE SYSTEM ONE gives you a creative and powerful tool. SYSTEM ONE modules may be used together, alone, or with other audio products to solve an incredibly wide range of audio system installation problems.

advantage  AMERICAN
SOUND
CRAFTSMANSHIP

Call us toll-free at 1-800-826-1457 for product & applications information.

Biamp Systems, 14270 N.W. Science Park Drive, Portland, Oregon 97229

Circle 211 on Reader Response Card

World Radio History

Opportunities

op·por·tu·ni·ty \dɒp'ət-ɪ/ˈɒɹnə-tē\ 1. a favorable or advantageous combination of circumstances 2. a chance for advancement or progress.

Whether your next project is new or retrofit, custom install or commercial—*Aura•Style* in-wall loudspeakers offer you new opportunities for easy installation and customer satisfaction.

Unique mounting clamps and separate system components allow you to install the bezel and grille first, then wait until project completion to mount the actual loudspeaker. No more worrying about construction dust, paint or vandals damaging your high fidelity loudspeakers.

Full-range system includes:

- 6" and 8" dia. models
- unique transformer mounting posts for constant voltage use
- attractive grilles that may be painted or wallpapered
- selection of accessories.

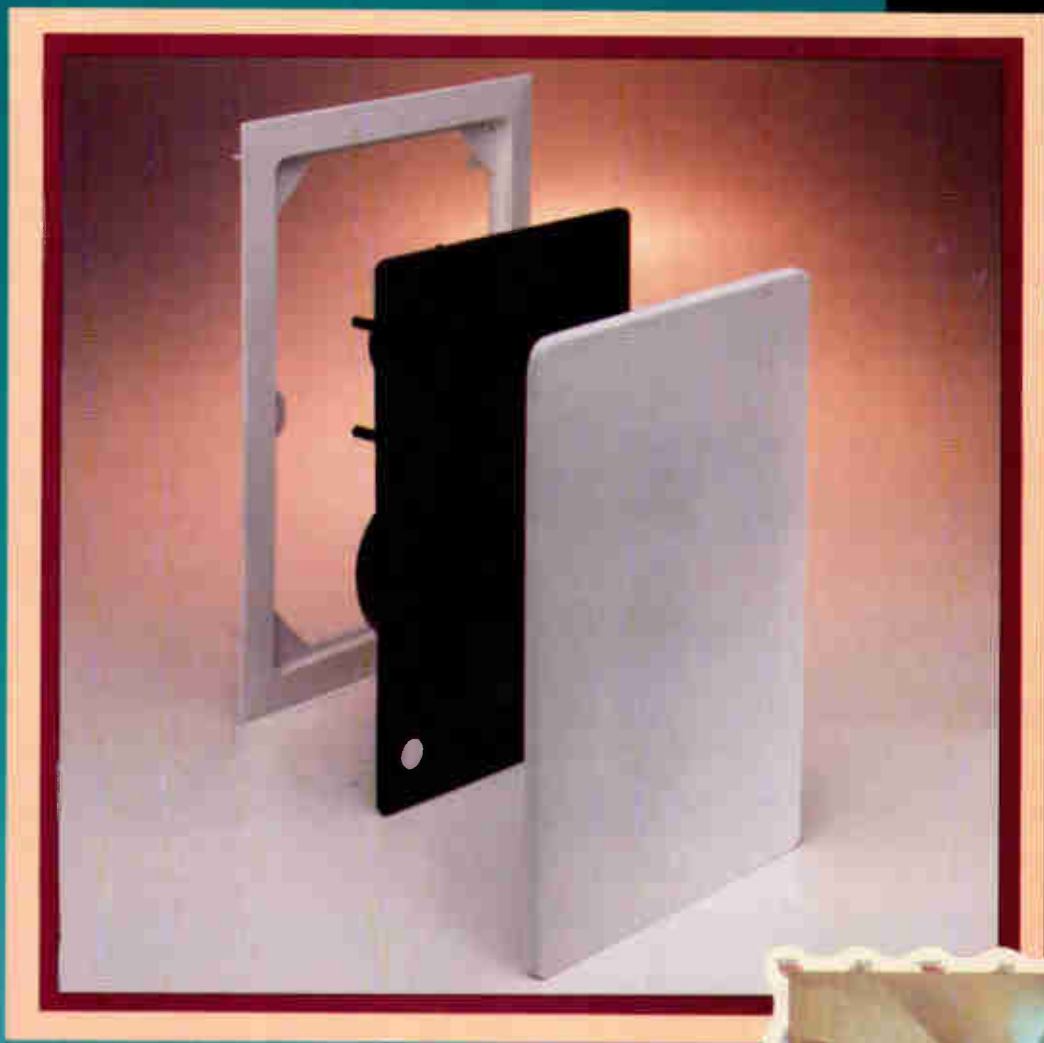

ATLAS / SOUNDOLIER

ATAPCO SECURITY & COMMUNICATIONS GROUP
1859 INTERTECH DRIVE FENTON, MO 63026 U.S.A.
TELEPHONE: (314) 349-3110 FAX: (314) 349-1251

Aura • Style IN-WALL LOUDSPEAKERS

*"an intimate part of the atmosphere,
but not the surroundings"*

Circle 213 on Reader Response Card

World Radio History

Chapel Hill Harvester Church

The “Church for the Nineties”

BY BOB DITZLER

(Contributing Writers: Becky Moses, Alicia Ditzler, Chapel Hill Harvester Church; Jim Young, Gwyn Edwards, American Audio.)

When the pastors of Atlanta’s Chapel Hill Harvester Church announced plans to build the 7,000 seat Cathedral of the Holy Spirit, we knew immediately that we were being handed a chance to design a technical system that would become a prototype for the church of the nineties.

In order to understand why, you’d have to know a little about the Cathedral and its goals for ministry. First of all, it’s not your average church by the side of the road. Its racially integrated congregation, which normally filled the old 3,000-seat sanctuary three times on Sunday, is involved in literally dozens of ministries and projects, including international conferences, musical productions and television broadcasts.

The facilities, therefore, would have to be designed to be extremely flexible. Nationally renowned for its diverse combination of worship and the arts, the Cathedral needed to be able to accommodate an unusually wide variety of musical styles, from Gregorian chants to classical orchestral pieces to country, contemporary Christian and black gospel.

Bob Ditzler is the Technical Coordinator and Production Manager for the Cathedral of the Holy Spirit at Chapel Hill Harvester Church.



Atlanta’s Chapel Hill Harvester Church.

Additionally, we had to plan around a 200-member choir, 50-piece orchestra, and the Cathedral singers, a specialized group singing on stage in front of the choir during all services.

And that’s just the musical end of things. Chapel Hill also produces original plays, musicals, and special events in the Cathedral which require theatrical lighting and sound. This aspect presented a real challenge because lighting for theatrical productions differs radically from lighting

for television. Since we also tape our services for television, we had to plan for both aspects of production.

Another factor we had to consider was special conferences, which we hold at least once a year. These conferences require special translation systems so that guests from Latin America and Europe can hear the services in their own language. These conferences, and frequently even regular Sunday services, also feature video presentations requiring a state-of-the-art projection system — one more thing to add to the specialized list of requirements.

Needless to say, we knew from the beginning that planning the technical system to fit the needs of this church was going to be an enormous challenge. And fortunately, the people working on this took it as a positive one — one that would make this local church a greater resource to our own community and around the world.

And this is where I come into the picture. As an involved member in the church and a salesman in the field of broadcast television equipment and sound reinforcement, I made a sales call to my own church. The information I received was disturbing at the least. The architect for the Cathedral had estimated \$100,000 for sound and lighting. I knew this wasn’t even close to what would be needed for this project.

My strong recommendation was that they hire someone to oversee the technical

Sound Design at Chapel Hill Harvester Church

BY JAMES YOUNG

Remarkable needs demand remarkable solutions. The broad scope of a project such as the sound design for Chapel Hill Harvester's Cathedral of the Holy Spirit in Atlanta included many elements of design requiring such solutions. The success of a project this size depends on excellent communication between builder and consultant, as well as a thorough understanding of the expected results.

We were fortunate to work with a group that expected systems excellence as the norm. Headed by technical coordinator Bob Ditzler, the church staff at Chapel Hill knew almost exactly what they wanted from their sound system and acoustics, and were willing to allow us the freedom

We find that central point cluster designs are often rejected as a possible solution in a room intended for musical performance.

to explore design techniques that are at the leading edge of technology. However, when Bishop Earl Paulk stated his desire for the sound to be natural, clear, and dynamic for both music and speech, the challenge became evident. Providing those requirements in a room with three million cubic feet of volume is no small task.

Performance requirements and features were quickly established with the groups that would be using the system, from both the technical side and the performance side. We had to consider the acoustical situation and how the room response would affect the audience's perception of speech and music. Even with thorough treatment of the room to control unwanted echoes and provide reasonable diffusion, the sound system requirements were still impossible to satisfy with a conventional

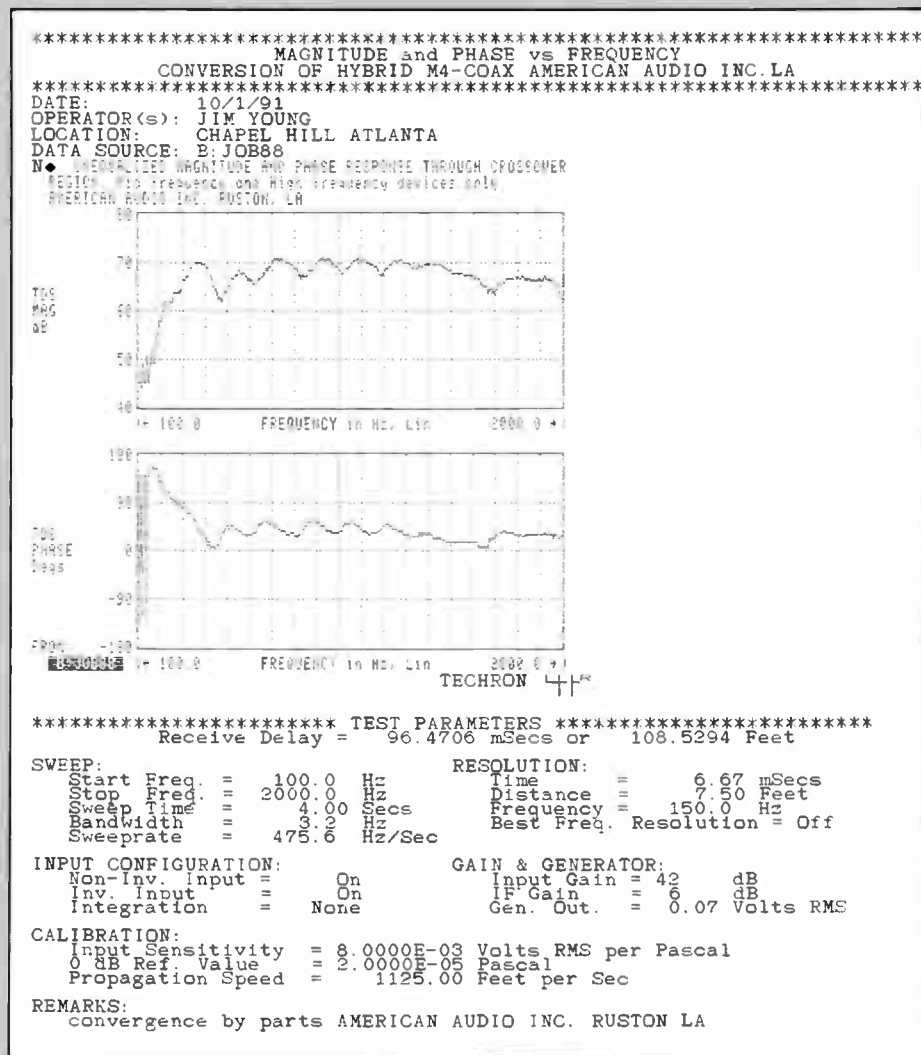

A TEF printout of device operation through the crossover region.

arrangement for a two- or three-way speaker system. We recommended to Bob a three-way central cluster comprised of Electro-Voice and Community devices arranged coaxially.

Even when sound pressure levels are hovering around 112 dB during music programs, the system distortion is almost imperceptible.

We find that central point cluster designs are often rejected as a possible solution in a room intended for musical performance. The perceived limitation cited most often is limited sound pressure level. With the new smaller 2-inch exit neodymium high frequency drivers and effective mani-

fold mounting arrangements available, very loud and low distortion high frequency levels can be achieved while maintaining a single point speaker array.

When these devices are mounted in the throat of a large high output mid frequency horn, such as Community's M-4, and the complete device is arranged into a point source array, the results are astounding. Some care is required in the selection and positioning of the coaxially-mounted high frequency device, and convergence must be done with a Techtron TEF or equivalent analyzer. The two-way horn arrangement discussed here will operate well from about 225 Hz to near 20 kHz. (See the TEF printout of device operation through the crossover region.)

Arrangement of a good low frequency device is all that is required to make this a compact arrangement that packs a clean, strong punch. The TEF magnitude and phase plot shown was taken from devices

James Young is the President of American Audio, Inc. in Ruston, Louisiana.

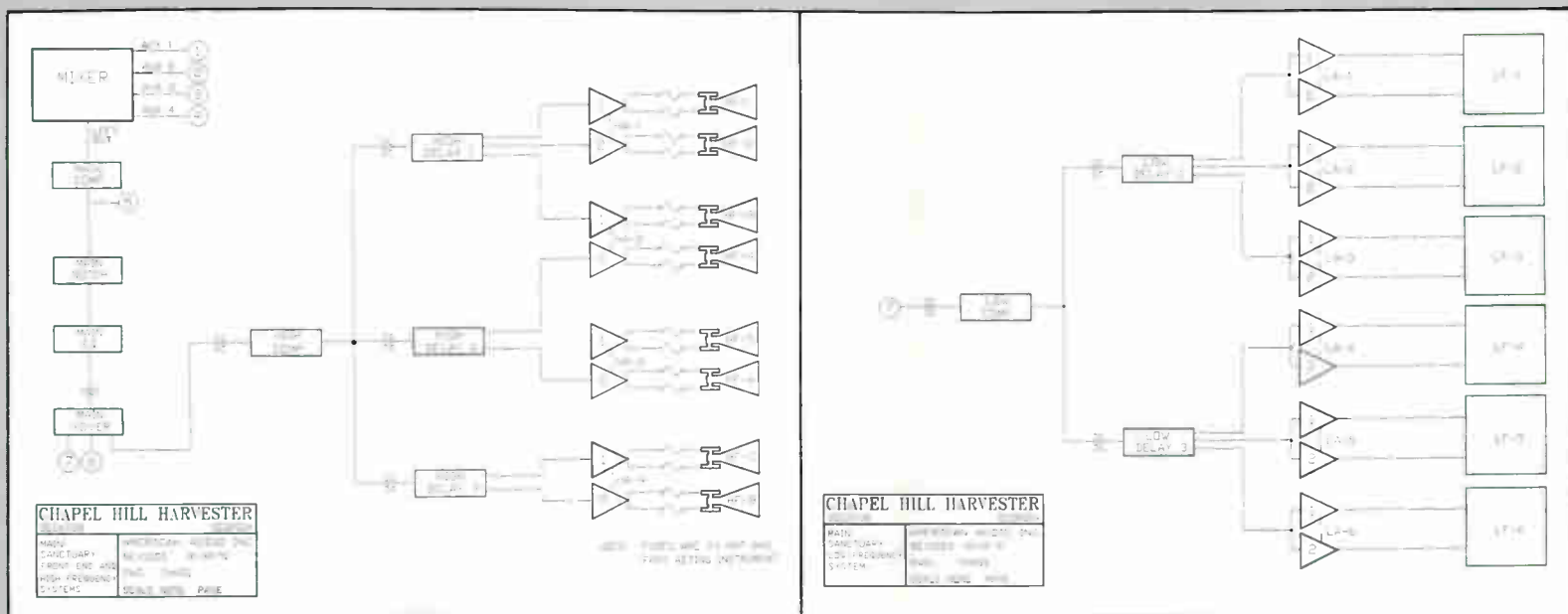

Main Sanctuary front end and high frequency systems. (left) Main Sanctuary low frequency system. (right)

installed in Chapel Hill Harvester's Cathedral of the Holy Spirit.

One comment that we get from this type of application is that even when sound pressure levels are hovering around 112 dB during music programs, the system distortion is almost imperceptible. The result is clear, loud music with dynamics that do not create discomfort to the listener.

The acoustical treatments planned for

the Cathedral were not completed on Opening Day. This resulted in reflected patterns that are detrimental to clear perception in parts of the Cathedral. We expect the owner to install the remaining materials as funds are allocated for this purpose.

As a result of our research in large coaxially mounted horns, many demanding users are now enjoying substantially

improved clarity and dynamic range than was previously possible. Several other organizations using this design are Bellevue Baptist Church in Memphis, Tennessee; the Southern Baptist Convention; Busch Stadium; and the Cincinnati Music Hall. Also, several companies have begun production of large coaxially mounted horns based on our design. ■

The Word is proclaimed in many ways!
The messages from the pulpit, the choir,
the special productions are powerful!

*But... are the messages
being heard?*

We invite you to take a closer look at the
Com-Tech Series amplifiers from Crown.
Designed for ultimate satisfaction.



GUARANTEED EXCELLENCE

Features include: • Crystal clear sound & reliability • Circuitry engineered to prevent overloads & overheating • Grounded bridge circuitry that allows the amp to drive high output levels into massive loads with minimal distortion • Constant 70 volt output capacity - requires no expensive set-up transformers • 3-Year No-Fault Warranty, and much more at affordable prices.

 **crown**[®]
Crown International, Inc.

P.O. Box 1000 • Elkhart, IN 46515-1000 • 800-535-6289 • (219) 294-8000 • FAX (219) 294-8329

Circle 256 on Reader Response Card



The Cathedral of the Holy Spirit holds 7,000 people.

part of this project — someone who would make sure that the technical systems would support the needs of the ministry. (And I would love to help recommend and sell them the equipment!) Little did I know that they would ask me to take that responsibility. Little did I know that I would accept!

Once started, I felt that my role would be that of gathering information from all affected departments in the church — television, worship and arts, tape duplication and most importantly, Senior Pastor Bishop Earl Paulk. Then, I would need to put together a team consisting of consultants and members of the television staff who could best identify the ministries' needs.

In the Atlanta area, I was familiar with all of the major dealers and manufacturing reps for the equipment we needed. I hoped to find a consultant to design the cluster and associated electronics for the sound system with whom the church staff and I could work in spec'ing the front end equipment, i.e., splitter, mixing boards, effects, mics, etc.

At this point, I invited a few of the major sound and acoustical designers and several sound contractors to give us their presentations. At the same time, the builder informed me that he was bringing in his sound and acoustical experts, a group from Ruston, Louisiana called American Audio. The company's president, Jim Young, arrived in Atlanta for a meeting. After his presentation, I was impressed enough to set up a personal meeting with him and arrange to see what he had done in rooms similar to ours.

Jim told me that he and his associates were working on a new technology in speaker systems that they called the "HiQ

The house mixing board is a 12-foot-long DDA 60-channel Q Series console.



Coax Concept," and that they would be able to let me hear the first one in a few months. Because of the delay, I kept working with my other, more typical sound contractors in designing the system.

Finally, American Audio had their special system installed at Bellevue Baptist Church in Memphis, Tennessee. Although the system had not been completely tweaked, it had unbelievable clarity with the punch of a rock 'n' roll sound system. The low end did seem to roar some, but I found out later that this was because of acoustical design (not specified by American Audio), which we could fix in our own room. I immediately issued a design contract to Jim Young and American Audio for the sound and acoustics.

In our room at the Cathedral of the Holy Spirit, the house and monitor mix positions are located in a double tier audio booth at the center of the first balcony. The church technical staff and I debated long and hard about this positioning. Our reasons for doing it were that we couldn't find a place on stage where it wouldn't stand out like a sore thumb. The main reason for close proximity to the stage was for communication between stage person-

nel and the audio person. We felt we could overcome this with our intercom system located at the worship leader's position, and by using floor directors on both sides of the platform. (Later, the worship leader designated one person on stage to be responsible for communicating the sound

needs of the stage, so we added an intercom station at his seat.)

The monitor mixing board is a 40-channel Q-Series DDA with mute groups. In addition to the Yamaha REV-7 reverb, each of the six stage mixes are powered with three Crown CT-1600s and compressed with two Klark-Teknik DN-504bs. The outputs to the monitor amplifiers are patchable to any of 19 monitor jacks located on the platform via a "speakon" locking patch bay. To maintain precise pattern coverage and reduce unwanted reflections, the choir system uses all horn-loaded components. This was very necessary in order to provide the choir monitor level needed without "washing" the orchestra or side walls. The choir cluster consists of two Community VB-664 dual 15-inch cabinets and two E-V HP-6040 horns with two DH-1A drivers each. The electronics are comprised of a dbx 160 RT compressor, a Klark-Teknik DN-405B notch filter, Memory equalizer, and DC-24 crossover. The amps are a Crown CT-800 and a CT-1600. In addition to the monitor board, both house audio and the recording board can be patched into the monitor system for situations like

rehearsals and recording sessions.

The house mixing board is a custom-made 12-foot-long 60-channel Q-Series DDA with group mutes. The house mix also feeds the presbytery foldback system

The architect for the Cathedral had estimated \$100,000 for sound and lighting. I knew this wasn't even close to what would be needed for this project.

via two E-V HP-6040 horns with DH-1A drivers located in the catwalk. These speakers serve as a "fill" type system for

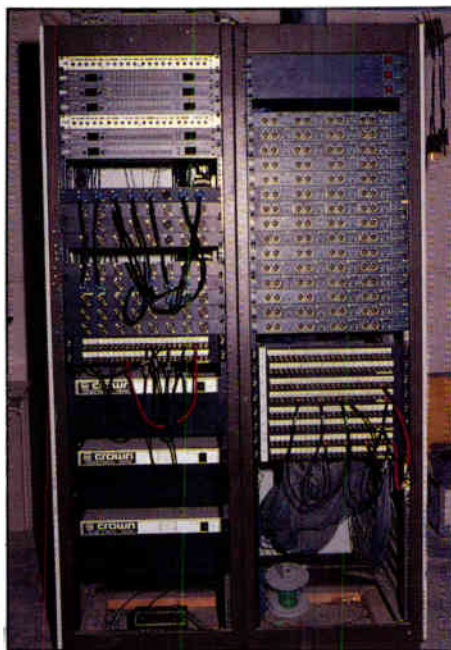

The splitter and monitor rack.

our worship leaders and visiting VIPs. House audio can also be used as the source for monitors and television via the patch system if needed.

House electronics are quite extensive and flexible to handle the multitude of tasks required. All EQs are one-third octave memory units with over 100 presets. Crossovers are also digital with built-in limiters for each band and multiple presets. Each speaker is fed by its own digital alignment delay and equalizer and amplifier for redundancy in case of any partial system failure.

Television and television audio are located in temporary facilities behind the stage area. No upgrades were made to the current equipment, which consists of four Sony BVP-30 and three Ikegami HL-79 broadcast cameras, and utilizes 1-inch, 3/4-inch and Betacam formats.

Features Like These Are Usually Found Only In Larger Mixing Consoles.

Mic/Line switching for optimal level adjustment.

High-gain (84dB Channel input to program output) ensures full output with low level or distant mics. Optional Precision input transformers are available.

Better than 130dBu Equivalent Input Noise.

10-Segment LED meters for quick, accurate visual monitoring of all signals.

Switchable Phantom Power for Condenser Mics

Three-band EQ with sweepable mid frequency center.

Separate Mono Output level

Rear-panel channel insert points on separate jacks.

Headphone Out w/ Level control

Switchable Meter Functions

2 Aux sends per channel greatly increase flexibility when interfacing signal processing units.

Utilizes the same mic preamp chip found in top recording consoles to provide exceptional, low-noise performance.

Transformer Isolated +24dBm 600 ohm Balanced XLR Stereo Program Outputs w/ Left and Right Master Controls.

Our MM-508 Offers Them In Just Three Rack Spaces.

ASHLY

100 Fernwood Avenue, Rochester, NY 14621 • Toll Free: 800-828-6308 • 716-544-5191 • FAX: 716-266-4589

The TV audio mixing console is a Ramsa WR-S852 with four of its optional WU-S82 sub-input modules that expand the board to 64 inputs in their standard frame. The mix from this location feeds all video and audio tape machines via D/As and the routing system. During the week, it is used as a 16-track recording facility to produce albums and tracks for live productions.

The 52 mic jacks on the platform and 12 AKG C747 choir mics can be patched into any of 60 channels of the splitter via 'ADC' type patch bays. The splitter consists of 15 BSS Audio MSR-604 splitters. The MSR-604 contains four channels of active microphone signal distribution. The splitter provides four output channels for every input. Each channel can independently be selected for 48 volt phantom power and also features a switchable +4 dB or +14 dB gain for maximum headroom. The system is powered with two MSR-602s with a third for backup. The splitter feeds the house mix, monitor mix and television mix with one spare channel for other options such as a recording truck.

The patching/routing system contains 33 24x24 punch type jack fields. In addition

Both house audio and the recording board can be patched into the monitor system.

to the areas described above, we also brought out most input/output options from the back of each board, and all out-board equipment to the patch bay. A 20x10 audio-follow-video routing switcher is also incorporated for routing audio and video tape machines to all mix locations and video to the projection system.

After each amp channel output, there are custom built fuse box panels (the most helpful and professional ones I know of). Each driver in the system has its own fuse for extra protection. These are grouped by frequency sections so if a midrange driver appears to go out, we go to the mid-

range fuse panel, remove a bad fuse and replace it with a spare found in the same holder.

Redundancy and protection are vital to our system since we sometimes operate near 100 dB for concerts and special events. Also, visiting mixers who aren't used to the clarity of this type of system tend to push it until they begin to hear distortion or see clipping (about 113 dB) as they may do on their own system.

The projection system consists of one Barco 1500S, which projects the main 21-foot x 15.75-foot image on a screen directly above the top row of the choir. The

I was impressed enough to set up a personal meeting with him.

choir can look forward at another 16-foot x 12-foot screen facing toward the stage which uses a Sony VPH-1041Q projector. The second balcony and upper galleries also use three of the same Sony projectors as the choir. We also plan to add two 60-inch rear screen monitors to enhance visibility to the lower gallery areas.

As I mentioned earlier, the builder brought in his expert on lighting at the same time we met Jim Young of American Audio. Unfortunately, the results were not the same and we chose to contract our own lighting consultant. Jerry Horstmann, who has designed studios at CNN, CBN, and CBS, designed our lighting package.

It had unbelievable clarity with the punch of a rock 'n' roll sound system.

The lighting system is actually three systems: architectural, theatrical, and television, with all systems provided by one manufacturer, Strand Lighting. We are able to address all dimmers independently with the Strand Light Board M computer console. With this capability, the architectural

lights and the theatrical lights can be used for lighting effects during live productions (and trust me, these effects are great!). The system is capable of supporting 392 2.4-thousand watt dimmers, 46 6-thousand watt dimmers, and 10 10-thousand watt dimmers.

There was some debate whether we should try to wire the splitter or rent a snake for the conference.

The amazing part of this whole project was that we installed the whole audio system (except the cluster), moved the television control rooms, installed the projector system and ran the conduit for the lighting system in only five months, using two full-time employees working during the week and a crew of volunteers working nights and weekends when possible. American Audio provided us with the design specifications, and had installed the sound cluster several months earlier.

Each speaker is fed by its own digital alignment delay and equalizer and amplifier for redundancy in case of any partial system failure.

An additional push was needed to have all systems up and running prior to a Worship and Arts Conference the first week of October. In effect, we had one Sunday service to tweak the system and assure that the basics were working. The main mix board would handle the house, monitor, and television mixes for the time being. There was some debate whether we should try to wire the splitter or rent a snake for the conference. We opted to wire the stage mic jacks into the splitter



Light dimmers for the church are able to be addressed independently through a Strand system.

The Television audio facilities.

via the patching system and the house mix snake only. At this point, we were *really* out of time, so we gerry-rigged some old snakes the day before the first service. Since that time, we've completed all but a few areas in the sound and television systems.

The lighting system and acoustical treatments for the room are to be completed as funds become available. We were able to acoustically treat the balcony face and

The job of coordinating this project has taken four years to date, and will probably be another year before all the specified systems are finished. Then, we can start upgrading! The total equipment cost was

\$730,000. The church staff and I had a great time installing the systems, but I think that next time we'll let the system installation boys handle it and we'll go to Disney World! ■

We doubled the amount of conduit from the mix position to the stage, and pulled extra snakes just in case.

first balcony wall, but the larger gallery walls have caused some problems and will be the next area to be treated.

I knew going into the project that we would not be able to get every thing we needed at once, so my goal was to make sure that the infrastructure to build on was in place. For example, we doubled the amount of conduit from the mix position to the stage, and pulled extra snakes just in case. The lighting system, when completed, will never have to add to the distribution. Each spare drop home-runs to a slot in the dimmer rack. You just have to add a dimmer and a lighting instrument and you're ready to go.

Hearing Assistance + Worship Space =



No sound system for worship is complete without a Williams hearing assistance system. Only Williams offers high quality FM and Infrared systems to suit any worship space. Our systems also meet ADA requirements for theaters, cinemas, conference rooms, auditoriums, and arenas. For complete specifications, call today.

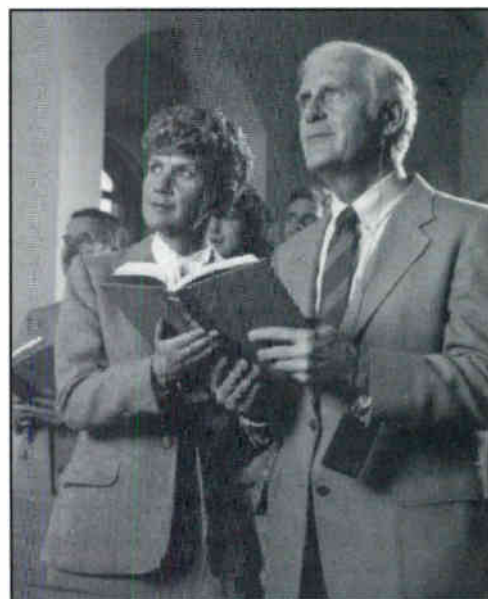

- 3 Year Warranty
- Over 15 years experience
- Full Product Line
- Made in USA

A hearing assistance system makes a wonderful memorial gift or youth project!

Call Toll-Free: 1-800-328-6190

Circle 270 on Reader Response Card

Have your cake...

You can have it both ways with System One.

Most audio test sets fall into one of two categories...

There are the specialty testers, like tape recorder test sets, video/audio monitors or pricey short interval test systems. Then there are conventional general purpose audio testers, which can do basic testing but lack the capability to fill today's specialized testing needs.

Investing large amounts in specialty systems that don't also meet your day-to-day audio testing needs is both expensive and frustrating.

SYSTEM ONE solves the problem by providing both high performance general purpose audio testing and innovative specialty testing functions. Basic SYSTEM ONE configurations are priced competitively, yet can grow with your needs to include these advanced functions:

FASTest – Test any audio channel in 2 seconds or less

MLS – Quasi-anechoic measurements of loudspeakers

FM – Automated Stereo Proofs

TV BTSC – Automated Stereo Proofs

DUAL DOMAIN TESTING – Direct digital domain testing of digital audio and interfaces.

TAPE TESTING – Complete magnetic tape recorder and media testing.

SPECTRUM ANALYSIS – Audio FFT analysis

EBU 0.33 – Short interval testing



and eat it too.

With System One, you can have it both ways!

**Audio
precision**

P.O. Box 2209, Beaverton, OR 97075
503/627-0832 1-800/231-7350
FAX: 503/641-8906, TELEX: 283957 AUDIO UR



INTERNATIONAL DISTRIBUTORS Australia: IRT (02) 439 3744 Austria: Eastern Europe: ELSINCO elektron GmbH 222 812 17 51 Belgium: Trans European Music NV, +02 466.50.10 Canada: GERF Electro Acoustics Ltd., (416) 868 0528 China: Hong Kong: ACE (HK) (852) 424-0387 Denmark: AudioNord Danmark npn 86 57 15 11 Finland: Genelec OY, 77 13311 France: ETS Mesureur (t) 45 89 66 41 Germany: RTW GmbH 221 70 91 30 Holland: Trans European Music, +03408 70717 Israel: Dan-El Technologies Ltd 3-544 1466 Italy: Medea S.r.l. 2 4840 1780 Japan: TOYO Corporation 3 (5688) 6800 Korea: Myoung Corporation 2 784 9942 New Zealand: Audio & Video Wholesalers, Ltd 71 73 414 Norway: Lydconsult (09) 19 03 81 Portugal: Acutron ELA: 1 941 40 87 Singapore & Malaysia: TME Systems PTE Ltd 298 2608 Spain: Telco Electronics, S.A. 531 7101 Sweden: Tal & Ton AB 31 80 36 20 Switzerland: Dr. W.A. Gunther AG, 01/910 41 41 Taiwan: Litz Technologies Ltd 2 758 3179 U.K.: SSE Marketing Ltd 71 387 1262

Circle 207 on Reader Response Card

World Radio History

Synagogue Sound

Integrated Signal Processing at a Pennsylvania Congregation

BY L. RICHARD FELD

Reform Congregation Keneseth Israel, located in Elkins Park, Pennsylvania, had some serious sound problems: a hodgepodge of old equipment, chronic radio frequency interference, and very poor intelligibility.

The solution, installed in the summer of 1991, includes integrated signal processing, a room-combining system, new loudspeakers, new power amplifiers and an automatic ambient-dependent leveler, as well as recording for broadcast and tape: improvements that no one can see. But several of the congregants have noticed the system's only user-accessible controls: small but handsome wall plates, each with the words "Sound System" and a few clearly labeled, rocker-style, lighted push buttons.

The synagogue's primary reason for shopping for a new system was its radio frequency interference (RFI) problems. High-impedance devices and improperly terminated inputs had turned Keneseth Israel's system into a giant radio receiver. A new system was imperative, not only to stop the CB interference but also to deliver the comprehension (intelligibility, naturalness and directional realism) that state-of-the-art audio could provide.

It is interesting to note here that we at Tekcon Corporation were the *only* sound contracting firm willing to guarantee, in writing, that our installation would be RF-free. For whatever reason, the other firms would not make that assurance.

L. Richard Feld, formerly president of Tekcon Corporation, is currently with Clair Brothers Audio Systems, Inc.



Keneseth Israel is one of the oldest Reform congregations in North America.

The first phase of the design was to attend services and interview the principal parties to the system. Keneseth Israel had a "wish list;" together, we trimmed it to match their budget. They clearly understood the need for and desired automated live mixing, as well as high-quality manual mixing for recording and broadcast; and the system had to be operational before the High Holidays in September.

So our design team went to work, and fast. The team consisted of Don Pacitti, our job supervisor and Autocad whiz; Armand Pascetta, our resident electronics genius; the ubiquitous Jesse Klapholz for acoustical work; and me, to push and prod.

Because it was quite evident to me that we would indeed be awarded this project if we could satisfy the congregation's needs within their budget, and meet the time constraints, we broke our own company rule, that no serious system design work be initiated until a client commitment was received. In this case we did prepare preliminary "blueline" drawings detailing many of the unique features that would be in our final design. Obviously, our efforts were rewarded with the sale.

EXPANDABLE, FLEXIBLE SOUND

Keneseth Israel, established in 1847, is one of the oldest Reform Jewish congregations in North America. In its present home, built in 1956, a fan-shaped sanctuary radiates from the 50-foot-wide bima, the raised platform from which the service is conducted. During the High Holidays and other occasions when overflow seating is required, the rear full-wall folds back, opening onto a passage area. The air-wall on the opposite side of the passage area also folds back, opening onto a 112 x 60-foot multi-purpose auditorium, meeting room and social hall. When the combined spaces are filled with seating, the distance from the bima to the back row is 140 feet. The Sanctuary can seat over 800 people; and when opened completely to the auditorium, it can seat 2,200 people.

To operate the system, a staff member simply inserts a key into the lock on the "Sound System" control plate at the rear of the Sanctuary and pushes the "System Power" button, which activates an Atlas

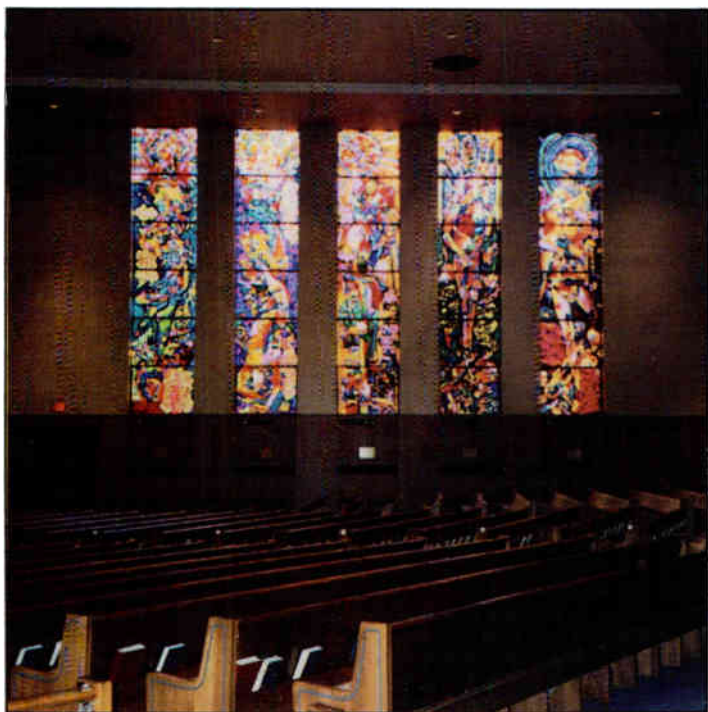

Suspended above cloth panels in the 30-foot ceiling, four horns cover the fan-shaped sanctuary of Reform Congregation Keneseth Israel.

SACR-191 sequential power unit. Then he presses "Sanctuary," or "Passage," or "Auditorium," or "Lobby," or any combination, all of which activate and configure the system. A similar panel is located backstage in the auditorium for those occasions when operations are local to the auditorium, and a redundant master control panel is in the sound room overlooking the Sanctuary.

Keneseh Israel's "front-end" includes IRP System 41 automatic microphone mixers, automatic gain controls, signal delays, equalizers, notch filters, distribution amplifiers, and a matrix mixer: a total of 39 modules in four mainframes. Additional signal delays, power amplifiers, monitor panels and a customized FSR logic-switching system complete the package. The processed signals go through 37 speakers, ranging from a ceiling cluster of four horn-loaded devices to a pair of small, side-fill JBL Control 1 speakers at the front of the Sanctuary.

DIRECTIONAL REALISM

The ceiling cluster, which is mechanically time-aligned, has two Community Light & Sound PC264 60-degree pattern control horns with JBL 2450 2-inch compression drivers, and two Community M80 mid-bass horns with JBL 2123, 10-inch cone speakers, all hidden within the 30-foot ceiling and playing through framed cloth openings.

The careful application of fiberglass absorption is quite effective at shading the

very forward rows of pews in the Sanctuary for better coverage balance and gain before feedback. But the width of the bima complicates matters, as the Rabbi's lectern is at far bima right and the Cantor's is at far bima left. The two lecterns are 35 feet apart!

We broke our own company rule, that no serious system design work be initiated until a client commitment was received.

In order to achieve adequate front fill and to maintain directional realism, we cross-feed and cross-delay the left and right fill speakers. Dedicated electronics control the mix, delay and equalization to these two speakers only. A listener at front congregation right hears the reinforced and delayed voice of the Rabbi and the unreinforced voice of the Cantor. The converse is true of a congregant seated at front left. He perceives the sound as coming from its original source, rather than from the loudspeaker.

The signal path to the ceiling cluster goes from Shure SM99 mics at the Rabbi's and Cantor's lecterns, and from the ark, the choir and the organ, through an IRP DJ-4114 Voice-Matic automatic mic mixer

and DJ-4115 Voice-Matic master. There are input connector locations for additional participants. The auto-matic mixers mute the inactive mics, minimizing ambient noise and maximizing gain-before-feedback. A DJ-4109 Level-Matic automatic gain control lifts the soft voices and lowers the loud ones. It is the ultimate test

EQUIPMENT LIST

The four System 41 mainframes at Reform Congregation Keneseth Israel contain 39 signal processing modules:

- 10 DJ-4114 Voice-Matic® Microphone Mixers
- 4 DJ-4115 Voice-Matic® Master
- 5 DJ-4109 Level-Matic® Automatic Gain Control
- 6 DJ-4132 Digital Delays
- 4 DJ-4107 9-band TEQ® Equalizers
- 1 DJ-4117 29-band TEQ® Equalizer
- 4 DJ-4106 Notch Filters
- 3 DJ-4104 Distribution Amplifiers
- 1 DJ-4126 Matrix-Mixer
- 1 DJ-4128 Remote Matrix Controller

Additional equipment includes:

- 2 Community PC264 60-degree Pattern Control Horns
- 2 Community M80 MidBass Horns
- 2 JBL 2450 2S Compression Drivers
- 2 JBL 2202 12 MidBass Loudspeakers
- 26 JBL 8140 Coax Speakers in the Auditorium
- 26 Soundolier HT329 70V Transformers for same
- 2 JBL Control 1™ Front Fill Loudspeakers
- 3 JBL Control 1™ Monitors for Bima and Choir
- 6 Crown ComTech 200 Amplifiers
- 1 Symetrix A220 Power Amplifier for Control Room
- 1 Custom TRS ¼ inch Normalled Patch Bay System
- 1 Custom Combining System for Auditorium Sound
- 1 Custom Power-up Power-down System
- 2 Symetrix 571 Ambient Noise Control
- 3 Symetrix 571 Slave Units 4 E.V. 635 Microphones
- 1 Tascam M216 Recording Mix Console
- 1 Tascam 122B II Three Head Cassette Recorder
- 2 JBL Control 5™ Control Monitors for Sound Booth
- 2 JBL MTC-51 Wall Mount Brackets
- 3 Shure SM99 Lectern Microphones
- 1 Soundolier 100-72 Steel Electronics Rack
- 1 Fostex MS Microphone for Broadcast
- 2 Deltalab ADM315 Digital Delays
- 2 TOA MP932 Monitor Panels
- 2 TOA A901A Mixer Amplifiers

of the system when a soft-spoken, mic-shy congregant is comfortably heard, even when off-mic by over 18 inches.

The signal then routes through a DJ-4104 distribution amplifier, a DJ-4117

A redundant master control panel is in the sound room overlooking the Sanctuary.

29-band transversal equalizer, a Symetrix SPC571 SPL computer (which automatically raises or lowers the gain within a 10 dB window in response to background noise-level changes), and through a Rane AC22 crossover and Crown CT200 amplifier to the cluster.

A fiberglass wall surrounds the speakers and absorbs reflections.



The feeds to the corridor and auditorium speakers go through 9-band transversal equalizers (DJ-4107), notch filters (DJ-4106), Symetrix noise-sensing controllers, a DJ-4104 distribution amplifier, and the DJ-4126 matrix mixer with its DJ-4128 controller. These loudspeakers and delays are configured from the control panel in the Sanctuary rear.

The auditorium sound system has a separate pushbutton wall control: "Room A," "Room B," "Passage," "Lobby,"

"Local Room B," and "System Power." Room A is the portion of the auditorium (about two-thirds of it) between the stage and a folding wall; Room B is the rest of the space. Meetings can be conducted in Room B while another activity takes place in Room A. The Room B user simply presses "Local Room B," which activates the local speakers only, with no delay.

Folding open the wall combines Rooms A and B, and pushing the appropriate switches combines their sound. Room A,

SOUND STRATEGY

Cluster Modules... A Totally New Concept

Unique Multi-angled cabinets are ideal for close coupled arrays; simplify installation; provide full size performance in a space saving, cost effective design; offer you a choice...

Choose Between The:

Sub compact CM 61 (only 9.25" X 18" X 7") 80 to 20 kHz, 111dB output SPL performance.

Compact CM 81 (only 11.5" X 21.6" X 9.75") 70 to 17 kHz, 116 dB output SPL performance

Choose Horn Orientation:

for wide angle vertical or horizontal coverage (the horns rotate 90°)

Choose The Finish:

Black Carpet, Paint, Natural (unfinished) or Weather Resistant

Choose Connector Type:

Terminal Strip or Neutrik Connector

Choose Mounting Method:

Tripod Stand, Omnimount Hardware or Custom Arrays.



th RENKUS-HEINZ

For Full Technical Details, or Further Information - Contact:

17191 Armstrong Avenue Tel 714/250-0166
Irvine, California 92714 Fax 714/250-1035

Circle 258 on Reader Response Card

Room B and the corridor each has an ambient sensing mic at the ceiling. Their combined feed enters a second Symetrix SPL computer. Sound originating in the Sanctuary goes through DJ-4132 digital delays on its way to the ceiling speakers (JBL 8140's) in the auditorium and corridor. Sound originating in the auditorium "Local Room B" bypasses the delays, and the remote switching actuates this bypass.

AUDIO FOR EVERYONE

The people seated on the bima always complained that they could not hear the Rabbi and Cantor. Now they have a monitor on each side of the ark, yet hidden from the congregation. The people in the choir had difficulty hearing the organ and now they have a monitor that brings them only the organ music from a mic located in the organ loft. There are feeds to a

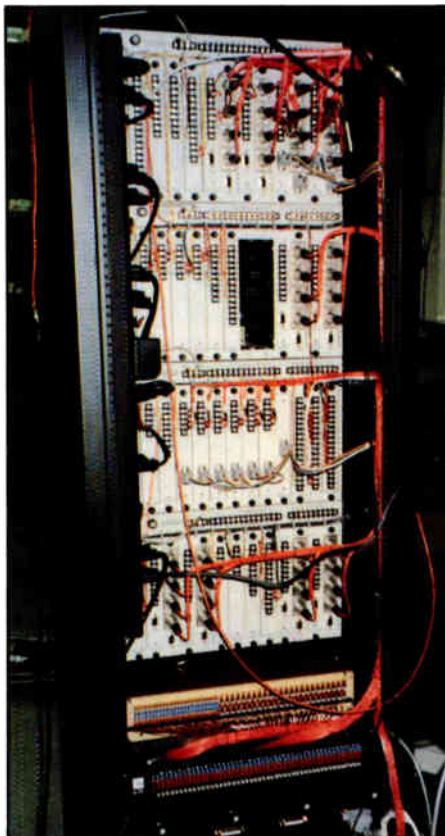

Open at the shop and locked at the site, the four IRP mainframes contain 39 signal-processing modules. The rear view shows the modules and the wiring during assembly.

Sennheiser infrared system for the hearing-impaired, to cassette recorders, and to a radio transmitter when it is used for live broadcast. A rooftop antenna sends the service to a nearby radio station. The

The Room B user simply presses "Local Room B," which activates the local speakers only, with no delay.

radio transmitter, recorders and equipment racks are in a second-floor control room that overlooks the Sanctuary.

On the control-room wall is a duplicate of the pushbutton arrays in the Sanctuary and auditorium. We wanted to make these

POWER CONTROL AND DISTRIBUTION



A NEW NAME IN PERFORMANCE.
A DECADE OF QUALITY.

- LINE CONDITIONING
- VOLTAGE REGULATION
- POWER SEQUENCING
- AC POWER DISTRIBUTION
- REMOTE CONTROL ACTIVATION
- ISOLATION TRANSFORMERS

FOR FREE INFORMATION, PLEASE CONTACT:



7320 Ashcroft #104
Houston, Texas 77081

Phone: (713) 772-1404
Fax: (713) 772-9124

LOOK WHAT ^{else} QUAM HAS FOR YOU!



VANDAL RESISTANT INTERCOM STATIONS

Part No. C1SI/SE3GVP

- Interface with standard intercom amplifiers
- Built-in speaker-microphone and acoustic coupler
- 11-gauge carbon steel construction
- Flush or Surface Mount
- Baked epoxy mar-proof finish over heavy zinc plating
- Tamper-proof speaker mounting
- Heavy-duty tamper-proof call switch
- Standard 3-gang electrical box mount

Ask for FREE Tech Spec TS-46

Quam-Nichols Company

234 East Marquette Road, Chicago, Illinois 60637
Phone: 1 312 488-5800 • FAX: 312 488-6944

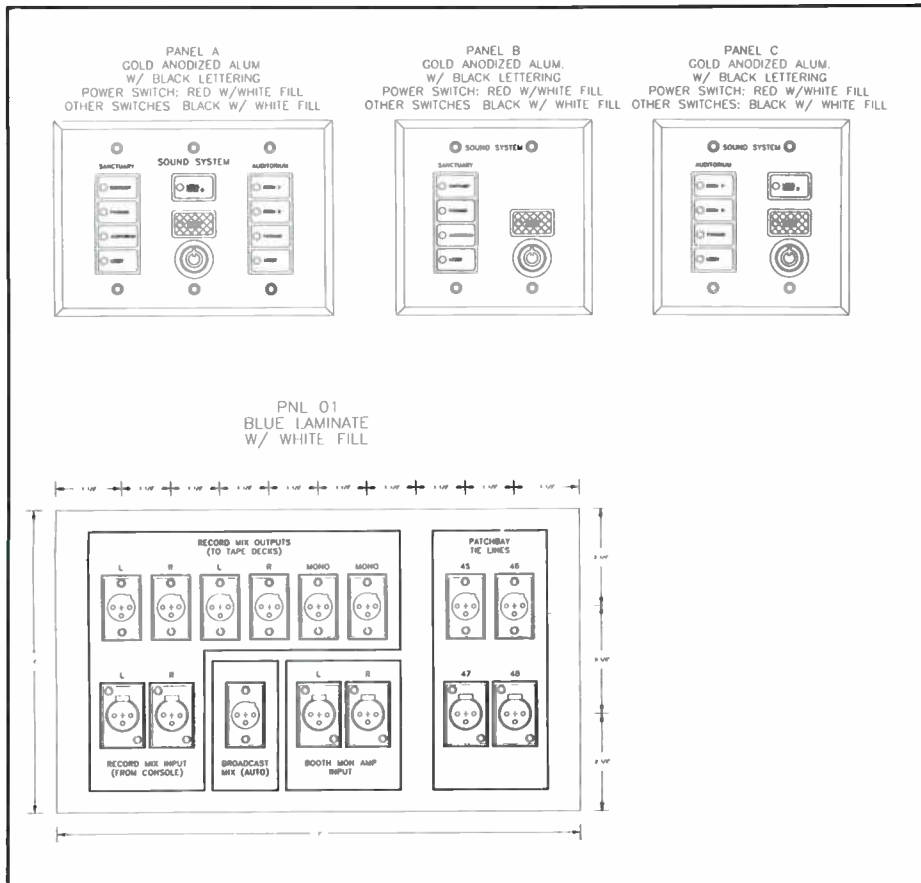

Sound system panels.

panels attractive, as they are virtually the only visible parts of the system. They are all anodized, brass-colored, heavy aluminum plates with a brushed finish. The rocker switches have LED indicators. The lettering and engraving are tasteful.

No one can see a transparent sound system. But our handsome panels will, we hope, remind the congregants that it's there.

The people in the choir have a monitor that brings them only the organ music from a mic located in the organ loft.

IN OPERATION

Installation was completed early enough to allow for system use during a few regular Friday evening and Saturday morning services. Even before any serious tweaking and balancing were accomplished, it was evident that we had a winner. The first observation was the incredible "reach" that our pulpit and lectern microphones

were delivering. One synagogue official commented that he had never before heard a certain part of the service, because it was performed by a congregant with a very small voice.

Before the start of the High Holidays, we completed final system balancing and tuning. The few punch-list items were completed and we were ready to go. Synagogue officials kept asking if

The radio transmitter, recorders and equipment racks are in a second-floor control room that overlooks the Sanctuary.

everything would be okay, and we assured them that it would.

To make a long story short, save for some "real time" adjustments, the system worked flawlessly and sounded wonderful. Many unsolicited compliments from various congregants as well as our own observations assured us that we had accomplished our goals. ■

NEW TO THE U.S.

Optim Audio
The Source For

WHARFEDALE

Known worldwide for Quality and Innovation.

FORCE Series

hi performance professional loudspeakers. Directional Arrayable Powerful Live Sound



PROGRAMMES Series

commercial Loudspeakers for superior paging and foreground music



WHITELEY

Integrated amplifiers TeliPager telephone interconnects for public address

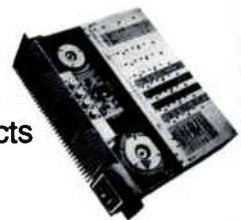

SOALIST

Sound Operated Automatic Level and Impedance Speaker Testing Amplifier

DESIGN/PLANNING

We are looking for key dealers wishing to share the success of fine products.

CALL US

1-800-989-0802

733 Canal St., Stamford, CT. 06902

Circle 274 on Reader Response Card

March 1992 43

THE MOVEABLE CHURCH: MONITORING THE CARDINAL'S SOUND

By Stephen Minozzi and Robert Pelepako

Cardinal O'Connor often travels throughout the Archdiocese of New York, to visit with the people of its 413 parishes.

These meetings usually occur in large auditoriums not readily equipped with sound systems that are capable of accommodating a visit from the Cardinal.

His Eminence appreciates the ability to speak "intimately," to large audiences, and also enjoys the freedom of mobility that is provided by the use of a wireless lavalier microphone.

Wireless microphones are also required in the aisles, in order to support a dialogue between the Cardinal and his audience.

Since the average auditorium does not need this type of sound reinforcement for routine events, and the availability of effective sound reinforcement plays such a major role in the success of these meetings, a temporary sound system is usually required for the Cardinal's visit.

Monte Bros. Inc. maintains a portable sound system that is always available to Cardinal O'Connor, wherever it is necessary to provide this caliber of performance.

THE SETUP

An "on-site" format is established to locate wireless microphones wherever they are required. Low "Q" Titan series speakers, powered with Biamp MOSFET



John Cardinal O'Connor, Archbishop of New York.

amplifiers, surround the listening areas to provide what we call "subjective reference monitoring" (SRM).

Gemini series speakers, with independent audio feeds, supply the pradella with additional sound reinforcement of the wireless microphones in the aisles.

The main electronics console is discretely positioned for optimal visual contact with all of the wireless microphone locations.

One cassette deck is prepared to record the Cardinal, and another cassette deck is prepared to simultaneously record the entire event.

Multiple balanced audio outputs from distribution amplifiers are prepared to accommodate the news media, including the possibility of a live broadcast.

A White model 140 sound analyzer is

connected to one of the media distribution amplifiers, and will provide a "real time" profile of the voice, while visually monitoring any output signals to the media.

The performance of the sound system is normalized to the ambience of the auditorium by means of digital equalization.

EQUALIZATION TECHNIQUES

Since each portable sound system installation contains the same equipment and usually accommodates the parameters of a formatted floor plan, the variable, in almost all situations, is the "ambience" of each particular room.

Equalization is the common denominator that normalizes the performance of this sound system to the acoustics of these rooms.

Two Audio-Technica AT-859/O microphones are connected to Lectrosonics H-185 wireless transmitters and placed on a double microphone stand in the center of the listening area.

They simultaneously talk to a White model 140 one-third octave sound analyzer, and a White model 200 one-sixth octave sound analyzer.

A White model 4710BL digital equalizer is used to normalize the Titan series speakers to a flat frequency response, from 160 Hz to 4 kHz, with the "pink noise voicing" from a White model 200 sound analyzer.

When a "flat" response from 160 Hz to 4 kHz is simultaneously attained at one-third octave measurements (± 2 dB), on the White model 140 sound analyzer, and at one-sixth octave measurements (± 2 dB), on the White model 200 sound analyzer, the wireless test microphones

Stephen Minozzi and Robert Pelepako are directors of Monte Bros. Inc. in Dobbs Ferry, New York.



Cardinal O'Connor uses a wireless lavalier microphone and additional wireless microphones in the aisles for a dialogue with his audience.

are repositioned to multiple locations in the listening areas, in order to verify the "relative consistency" of the sound system.

This relative consistency in all listening areas is the result of a well tuned, distributed sound system that utilizes low Q speakers.

Listening tests are conducted at all wireless microphone locations in order to verify a satisfactory caliber of performance.

In most situations, wireless microphones must perform in the vicinity of multiple speaker systems in an ambient room, without acoustic feedback or phase cancellation.

Cardinal O'Connor has an excellent public speaking voice, with a significant dynamic range, and he must be permitted to speak conversationally or emphatically, without reservation.

In order to achieve this capability, we calibrate an ambient profile of the room at one-third octave RT-60 measurements, from 160 Hz to 5 kHz, with a White model 200 sound analyzer.

A Lectrosonics M-119 omnidirectional lavalier microphone on a Lectrosonics M-185 wireless transmitter is used with random and dynamic speech at various volume levels throughout the room, until acoustic feedback can be digitally identified with a Goldline TS1RMX1 frequency counter.

These feedback frequencies are compared with the RT-60 profile, and concurring frequencies are relatively attenuated with the one-sixth octave White 4710BL digital equalizer.

The flat equalization has now been fine tuned to the ambience of this particular room, therefore providing the ability to significantly increase the sensitivity of these wireless microphones to accommodate intimate speech, without ring modes

or acoustic feedback.

Since the White 4710BL digital equalizer has multiple memory storage capability, the repetition of this entire equalization process is eliminated in rooms that are frequently visited by Cardinal O'Connor.

The dB levels of each of the one-sixth octave frequencies are also stored in our main computer, and can be assigned to additional White 4710BL equalizers, in order to accommodate situations that may involve the installation of multiple sound systems in different locations, for consecutive use by His Eminence on the same day.

Subjective Reference Monitoring: "SRM"

We developed the concept of subjective reference monitoring as a result of providing portable sound systems for Cardinal O'Connor.

Not only did his eminence feel comfortable during these events, but others also commented on the sense of intimacy provided by this environment.

Subjective reference monitoring is the ability of the person who is speaking through a sound reinforcement system to clearly hear the direct results of the speaker system in the room.

This reduces the distortion caused by a person changing the tone of his voice to accommodate the effect of reinforced sound that is audibly perceived from the rear of a directional sound system.

Subjective reference monitoring is both possible and effective when the person who is speaking through the sound system is capable of hearing the "on axis" effect of the speaker system, and is satisfied with what is heard.

This effect has been successfully installed in many churches of the archdiocese of New York, including St. Joseph's Seminary Chapel, which is often visited by Cardinal O'Connor to celebrate archdiocesan events.

Stop pounding headaches!



When they pound the podium or lectern, install the AT8416 shock mount and dramatically reduce the noise. Two wide rubber rings isolate either the supplied 5/8"-27 mounting stud, or any XLR-type connector to "float" the entire microphone, minimizing transmitted noise and low-frequency resonances.

Single-hole mounting insures a neat, professional installation. The AT8416 is easy to install and usually permits higher gain-before-feedback than conventional solid mountings.

The AT8416 is designed for light-weight microphones like the popular UniPoint® AT837 and AT857 series, including all Quick Mount models.

Ask your A-T representative for details today.



audio-technica®

1221 Commerce Dr., Stow, OH 44224
(216) 686-2600 • Fax (216) 686-0719
In Canada call: (800) 258-8552

THE 2nd ANNUAL
INTERNATIONAL
DJ WEST
expo
RETURNS TO

LOS ANGELES, CALIFORNIA

Monday — Thursday, May 4, 5, 6, & 7, 1992
Sheraton Universal Hotel

Any questions about the workshops or other events — just call the DJ Times hotline (516) 767-2500 or FAX (516) 767-9335

Return this form below before April 13, 1992, and your badge and tickets will be waiting for you at the Pre-Registration desk at Sheraton Universal Hotel.

Discount Hotel Reservations available through the Sheraton Universal Hotel, with 1992 International DJ Expo/West affiliation.

I am a . . .

- Club DJ
- Mobile DJ
- Radio DJ
- Radio PD/MD
- Sound Contractor/Installer
- Lighting Installer/Designer
- Club Owner/Manager
- Architect/Designer
- Audio Equipment Dealer/Distributor
- Lighting Equipment Dealer/Distributor
- Record Tape, CD Retailer/Distributor
- Record Company
- Independent Promoter/Manager Agent
- Artist
- Media
- Manufacturer's Rep
- Other

YES! Register me now for the 1992 DJ EXPO/West in Los Angeles (on May 4, 5, 6, & 7, 1992)

<input type="checkbox"/> EXHIBITS ONLY Before Feb 25.....Free (Tues, Wed, Thurs)	After Feb 25.....\$25.00	XXX
<input type="checkbox"/> DAILY PASS (includes all special events)	Monday\$125.00 (9 Sessions & 3 Workshops. There are no exhibits today) Tuesday\$100.00 (Exhibits, 6 Sessions & 1 Workshop) Wednesday\$100.00 (Exhibits, 6 Sessions & 1 Workshop) Thursday\$75.00 (Exhibits, 3 Sessions & 1 Workshop)	
<input type="checkbox"/> FULL EXPO PASS (4 Days) (includes sessions, workshops, exhibits and all special events)	Register by Feb 25....\$135.00 Register by April 13....\$175.00	
On-Site Registration (\$225.00)	TOTAL	\$ _____

Make Check Payable to: 1992 International DJ Expo/West
25 Willowdale, Ave., Port Washington, NY 11050
(516) 767-2500 Fax: (516) 767-9335

- Check or money order enclosed. US funds only, please.
- Charge my MasterCard/VISA account

Card Number _____ Expires Day _____

Signature — required for charge orders

NAME _____

TITLE _____

COMPANY _____

ADDRESS _____

CITY _____ STATE _____

COUNTRY _____ POSTAL ZIP _____

Daytime telephone _____ (include country and city code if outside the USA)

FAX number _____ (include country and city code if outside the USA)

Please photocopy for your files or if you need additional forms.

An RT-60 ambient room profile calibrated at one-third-octave frequencies.

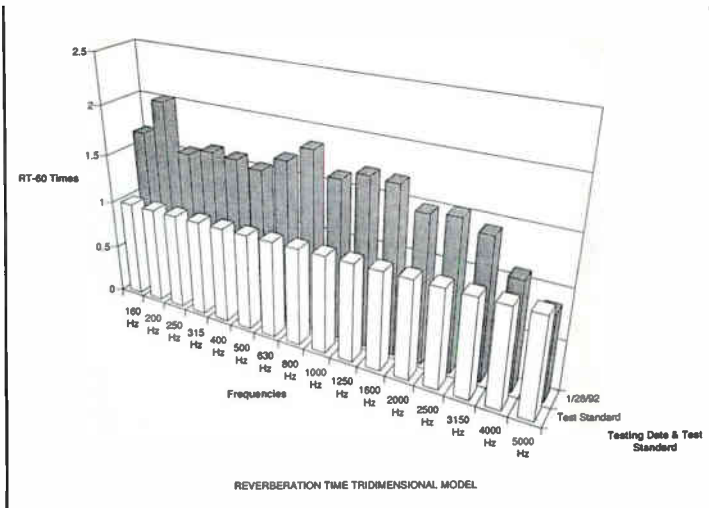

On one occasion, Cardinal O'Connor was scheduled to dedicate the Katerie Residence, a 16-story nursing home located at 87th street on the west side of Manhattan.

In the first floor lobby, the Cardinal used a Lectrosonics diversity wireless microphone to talk to the portable sound system we installed in the Chapel and the adjacent auditorium, on the fifteenth floor; which also supplied audio to the closed circuit TV system in the patients' rooms, to enable the dedication in the main lobby and the celebration of the liturgy in the Chapel to be heard by everyone in the building.

Immediately following this event, His Eminence was scheduled to dedicate the Incarnation Children's Center at 173rd Street on the east side of Manhattan, while additional ceremonies continued at the Katerie Residence.

Both the Katerie Residence and the Incarnation Children's Center were outfitted with portable sound systems of equal caliber on the previous evening, and were ready to accommodate these events with the usual menu of amenities.

However, since the ceremonies were to continue at the Katerie Residence, while the Cardinal was proceeding with a police escort to the Incarnation Children's Center, we had to negotiate a faster police escort to the Children's Center, in order to engineer the sound system for that dedication.

THE REWARDS

The new digital equalizers and other technological developments, such as multi-channel diversity wireless microphone systems, have been so successful that the budget for these sound system rentals has not increased since 1986.

Concepts, such as SRM, that have been developed while providing portable sound systems for Cardinal O'Connor, have been successfully used in the design of sound systems in St. Francis of Assisi Cathedral

in Metuchen, New Jersey; the Lafayette Federated Church in Lafayette, New Jersey; the Westchester Reform Temple in Scarsdale, New York; Temple Israel of New Rochelle, New York; St. Francis Friary in Andover, Massachusetts; Our Lady Queen of Martyrs Church in Centerport, New York; Holy Rosary Church in Staten Island, New York; St. Brigit's Church in Stamford, Connecticut.; the World Apostolate of Fatima in Washington, New Jersey; the Asbury United Methodist Church in Tuckahoe, New York, and hundreds of other Churches and Temples in the tri-state metropolitan area. ■

Portable sound system equipment list:

- 2 AUDIO-TECHNICA AT-859/O TEST MICROPHONES
- 6 AUDIO-TECHNICA AT-857-QM MICROPHONES
- 4 AUDIO-TECHNICA AT-859 MICROPHONES
- 2 APHEX 120 DISTRIBUTION AMPLIFIER
- 2 APHEX 612 GATES
- 2 BIAMP RACKMAX 16 CHANNEL MIXERS
- 6 BIAMP T-1000 AMPLIFIERS
- 1 BIAMP D-60-EQ AMPLIFIER
- 1 GOLD LINE TS1RMX1 FREQUENCY COUNTER
- 1 LECTROSONICS PRO 4 CHANNEL DIVERSITY ASSEMBLY (4 RECEIVERS)
- 1 LECTROSONICS DR-185 RECEIVER
- 5 LECTROSONICS M-185 WIRELESS MICROPHONE TRANSMITTERS
- 5 LECTROSONICS H-185 WIRELESS MICROPHONE TRANSMITTERS
- 5 LECTROSONICS M-119 WIRELESS LAVALIER MICROPHONES
- 2 NIKKO ND-750 RACK MOUNT CASSETTE DECKS
- 2 SHURE FP-16 DISTRIBUTION AMPLIFIERS
- 2 GEMINI SERIES SPEAKERS
- 12 TITAN SERIES SPEAKERS
- 12 SPEAKER STANDS
- 2 WHITE 4710BL DIGITAL EQUALIZERS
- 1 WHITE 4240A EQUALIZER
- 1 WHITE MODEL 200 SOUND ANALYZER
- 1 WHITE MODEL 140 SOUND ANALYZER

"With the BBE® system, it sounded cleaner, crisper, brighter, & simply put . . . BETTER!"

DJ Times Magazine



"BBE is the most inexpensive way to stand out from the competition. BBE is easy to use and will make your music so exciting, you'll be booked solid!"

DJ Times Magazine

BBE Sound Inc. Huntington Beach, CA
(714) 897-6766

ASK YOUR DEALER FOR A DEMO TODAY

Circle 287 on Reader Response Card

Phantom in a tube!

Now your phantom-powered condenser microphones work with almost any input. Simply put the new CP8508 supply in series with the microphone line, plug it into 120V AC power, and Voila!

The CP8508 powers a single microphone, providing 24V phantom power easily and quickly. It's perfect for upgrading a system that lacks a built-in phantom power supply. Or, if you have several microphones to install, use our CP8506 4-channel 48V supply. Either way, you'll have the power you need where you need it, at minimum cost.

You can trust Audio-Technica to solve your toughest microphone problems. Ask your A-T representative for more details today.



audio-technica®

1221 Commerce Dr., Stow, OH 44224
(216) 686-2600 • Fax (216) 686-0719
In Canada call: (800) 258-8552

Transparent Behavior and the Multimedia Market

Can We Catch up to the Technology?

BY JUDITH MORRISON

Multimedia. It's a term that's tired before it's born. Bandied about for the last ten years, multimedia is only now coalescing into the concept that we'll use and re-use for the rest of our professional and non-professional lives. It's, after all, not the concept that's tired — only the term. Multiple mediums — that is, print, television, radio, audio, computer, and almost any other technology you can think of on whatever kind of transmission system you want — tape, disc, space, ground, wire, glass — are coming together in new products and new systems that will make a difference in delivery of information and in the information's format itself.

What's driving the market? High definition television has had something to do with popularizing it. But the mother of multimedia is no doubt the silicon chip. The development of the compact disc, of digital audio and video have furthered the development of formats that work together.

Standards beware. The standards that have evolved don't mean necessarily that product will follow. Witness DAT; witness the still-born CD-Video. And so on.

But of three recent conventions that we — and perhaps you — attended, multimedia stands out as a concept that is making inroads in places where it's least

expected. We're not talking here about the MultiMedia Show. We're talking CES; we're talking NAMM; and of course we're talking Infocomm.

Some years ago, when a high ranking member of the Testa Communications team suggested to the Consumer Electronics Show that John Sculley the C.E.O. of Apple Computers be the keynote speaker, nothing happened. Apple wasn't ready. Consumer electronics wasn't ready. Now the time has changed, and in fact John Sculley was the keynote speaker at the winter CES in January. His speech formally announced the coming distribution of low-end Macintosh through consumer electronics channels. And Sculley pronounced the age of multimedia as here. "Digital" is the key word — allowing the mixing of media through transparent channels.

When Apple mounted Bose speakers on its computers' sides a few years ago, well yes we all paid note. But that's only the beginning, we all realize. Audio and full video can in fact work with an Apple, given the time and technology.

And compression. Compression of information is at the heart of this matter, with varying methods vying for supremacy and specificity within certain product categories. MPEG seems to be the standard that will be paid attention to. However, we're on to proposals for MPEG II. Nothing stands still in this business. The advanced Research Consortium has in fact

fiddled with MPEG I to allow high definition television using this standard and has submitted its own proposals for MPEG II.

And no matter what the format, not everything talks to each other. SMPTE is hard at work trying to produce standardizations that will allow interformat capability for whatever will turn up in the laboratory and in the marketplace.

And where is that marketplace? That's what everyone would like to know. And there's no reason for it not to exist through a distribution network of sound contractors and electronic systems designers.

How about the B.E.S.T. audio and Stewart Filmscreen setup seen at the last NSCA? That was certainly a marriage of audio and video. But it's also multimedia. In addition, computer control of zones of audio and video within a multifaceted media-equipped establishment is an affirmation of the concept of multimedia.

At the Consumer Electronics Show, the best place to see multimedia displays was the home theater section of the Mirage Hotel where there was a world of CD-ROM controllers, Faroudja line doublers, Square D home automation, Niles programmed outlet strips, Fosgate THX surround product, the new Frox system integrating a world of media including an NSM disc changer, and in general an interactive world of tomorrow.

And Sonance made it all easier to install with a new line of gadgets that include automatic source selectors, bridging

Judith Morrison is the Editor in Chief of Sound & Communications magazine.



Square D's Elan Series networks existing residential equipment.

adaptors, and line level converters.

But that wasn't all. On the main floor of CES, Pioneer showed its broadcast market videodisc recorder (32 minutes of full video on a \$1200 disc). CD recorders were shown by Marantz (\$7,000) and others. Denon exhibited DV-I (Digital Video-Interactive), yet another new format of media integration via computer. DV-I is being positioned as an alternative (accommodating full motion video and other enhancements) to CD-I (CD-Interactive), for which Philips, the marketer of CD-I machines, announced new software titles during CES. The Kodak Photo CD format introduced last year will now allow sound, text and graphics to be recorded along with photographic images onto Photo CD discs. Photo CD is compatible with CD-I. (The Photo CD Access Developer's Toolkit is available from Kodak.)

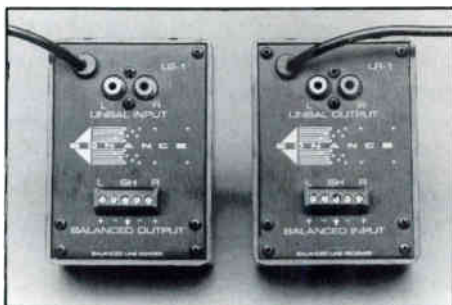

Sonance unbalanced/balanced line converters.

And NSM and Gefen double dutied with a residential system for CD changer and program.

Take the NSM changer for instance. Marketed here by Euroson, the German designed CD jukebox now formats using any software designed for it. While the NSM's currently work on CD only, video may be in the cards within two years (not videodisc).

Karaoke as a matter of fact is one of the prime fuelers of multimedia, at least from the Japanese manufacturers. Laserdisc, CD-Interactive, DV-I, CD-Graphics, Commodore's CDTV, and CD-Video are some of the formats making themselves serviceable to karaoke, and they've all been somewhere on the CES floor (from Pioneer, Philips, JVC, Denon and others).

The new 16 x 9 TV tube was in evidence, making itself ready for the advent of high definition television. Thomson and Philips, both European companies, showed the new screen size for the consumer market.

Pioneer Electronics Technology showed lighted garden speakers in free-standing cabinets produced in three different colors.

AT&T introduced its new Videophone, using a compression format from Compression Labs.

(In other Compression Labs news, shortly after CES, a consortium made up of Compression Labs, Philips and Thomson announced a new digital HDTV format to be included in the current testing that will eventually produce a U.S. standard sanctioned by the FCC.

The THX camp was in evidence at CES. The Lucasfilm-owned THX imprimatur for quality sound for audio and video software, spearheaded by Tomlinson Holman, has gained a number of adherents in the past few years, including JBL under its Fosgate marque. This CES, Rane joined the camp with intentions of producing an equalizer approved by THX. The multichannel Home THX Equalizer is a new product category for THX, and Rane, a newly signed licensee, will be the first to produce the product.

And Technics introduced its second THX system for the home, including gold plated input jacks, a six-channel amplifier, four optical digital inputs with processing through MASH one-bit DACs. The system has six audio, six video and two microphone inputs. Speakers have been downsized.

Much of the talk in and around the CES show concerned DCC, the new digital compact cassette format by Philips. Table

**FREE
INFORMATION**

Use
the
Reader
Response
Cards in this
issue to find
out more about
companies
that
interest
you.

Super screen!

New AT8104a metal pop filter slips over any UniPoint® microphone, then locks permanently in place.

Add the external foam windscreens to reduce wind noise in outdoor applications, and further control pops from even the closest talkers.

The AT8104a insures secure, noise-free performance. Ask your A-T representative for more details today.

 **audio-technica®**

1221 Commerce Dr., Stow, OH 44224
(216) 686-2600 • Fax (216) 686-0719
In Canada call: (800) 258-8552

AT8104A/Ms audio-technica



Kodak Photo CD system will work with sound, text and graphics.

or the computer.

Infocomm, which started life as the audio-visual show, has in the past few years become a prime marketplace for multimedia equipment. As the presentation market has become more complex

top models were shown by Philips and Technics. A personal stereo prototype was shown by Panasonic. And the DCC Group, an industry promotional group, met and elected officers.

While DCC is, for the foreseeable future an audio-only format, its use of digital compression brings it into the forefront of a central issue in the multimedia arena.

At NAMM, we were also treated to recordable CD via Carver and Marantz Professional. And Yamaha reduced the price of its professional disc recorder to a little under \$14,000.

New media held out promises of multimedia. Notewriter made a new merchandising option of buying rather than leasing the kiosk holding the hardware. (This produces customized sheet music via computer.)

Alesis expanded on its ADAT system which uses S-VHS tape, showing a keyboard/controller and a console that provides a complete digital studio audio system at a low price point. The original ADAT is now promised for delivery around the time you read this.

Not to be outdone, Tascam was rumored to be showing to key dealers an eight track digital format, reportedly using eight millimeter tape.

NAMM exhibitor Biamp Systems offers a mixer marketed directly for "multimedia applications." The Advantage PM602 is a rackmount audio mixer with four stereo line inputs and two mono mic/line inputs, providing control of audio signals from vtr's, audio tape recorders, CD players, as well as inputs from microphones and auxiliary mixers.

Crown's IQ 1.4 software for the Apple

Sharp Electronics XG-2000 LCD Projector.



Macintosh, for use with the Crown IQ System 2000 includes full color graphics, security levels and scene sequencing. Multiple scenes can be run as a series for repeatable system configuration.

Hardware and software joined forces as Fostex, Atari, C-Lab, Steinberg/Jones and Dr. T's debuted the Musician's Automated Studio System using the tape recorder as a "true MIDI peripheral." The tape functions are controlled from a computer keypad or mouse. All transport functions can be accessed from either the tape machine

and as the distribution chain for these products has become more problematic (A-V dealers have been especially hard hit by economic hard times), we have, over the past few years seen more consultants, more contractors and audio manufacturers at this convention.

The education and corporate communities have been at the forefront of using multimedia — and Infocomm makes clear that multimedia includes teleconferencing, video production, and other categories that were once isolated and are now



Musician's Automated Studio System by Fostex, Atari and several software companies.

joined.

For companies such as Barco, in fact, this is the biggest convention of the year. Barco's introductions spanned the presentation category, with the launch of a new line of rear screen digitally controlled projection systems, the Retro 800 Series; a

Pioneer video cubes.

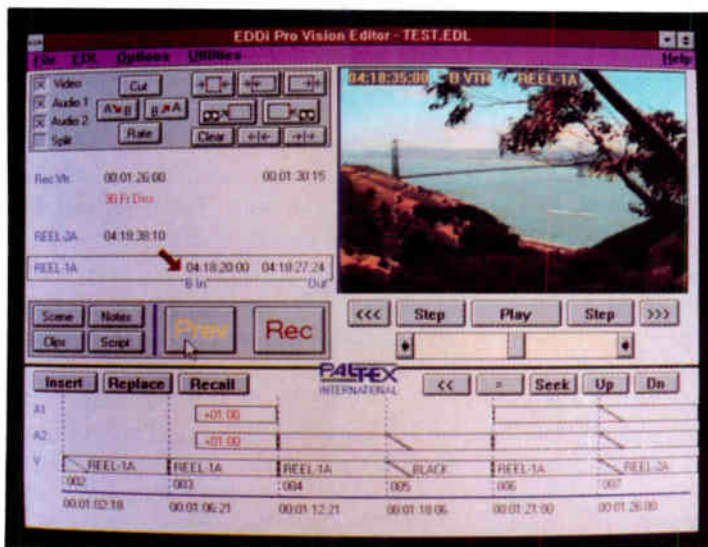
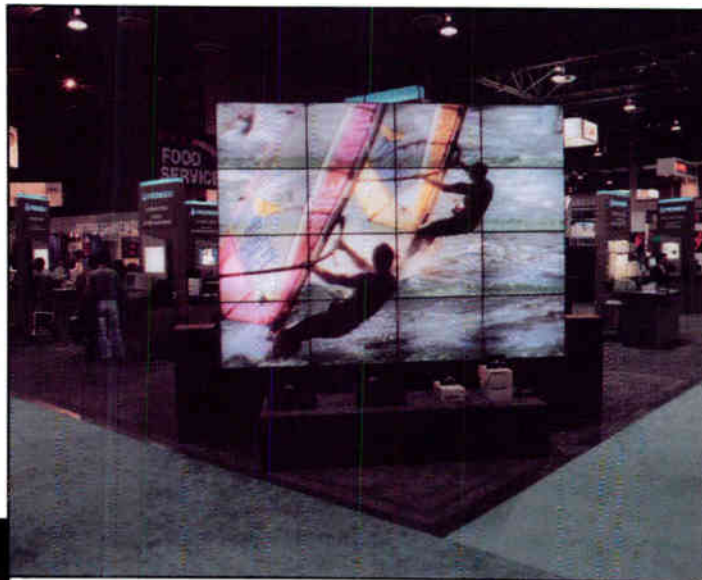

EDDi desktop video system introduced by Paltex.

Electrosonic opened a new U.S. Leisure Systems Division to expand the company's activities in museums and theme parks. RGB Spectrum showed its MediaWall providing direct digital interface to a computer. The system consists of an adapter card for the Macintosh, a satellite control unit with special effects hardware, an array of stackable RGB monitors or projectors.

And Peirce-Phelps had one of the best demonstrations on the Infocomm floor — a live videoconference from its booth to headquarters in Pennsylvania. This was the company's first showing of its new cooperative deal with PictureTel.

The end of the cold war is adding to the multimedia show, as traditional government suppliers of high technology are turning their attention to the commercial sector. Hughes Aircraft has several divisions doing just that. The company's SRS technology was incorporated into some Sony consumer television set speakers a couple of years ago. At this CES Hughes exhibited home loudspeakers under its own name for the first time. And at Info-

light valve projector using three active matrix LCD panels; an HDTV-compatible large screen projector with nine-inch CRT technology; and a host of other products.

Infocomm was the place where one could see companies previously pigeon-holed spreading their wings. Paltex, a manufacturer of professional video and broadcast post production systems, interestingly chose Infocomm as the venue for the introduction of EDDi, a desktop video production center working within Microsoft Windows. EDDi is a complete system allowing the user to freely switch among the videotape editor, video switcher, character generator, audio mixer, and scene management system, along with Windows-based programs such as paint systems. The product's Vision Video Overlay system captures full motion, real time video on the user's PC display, and the SceneManager is a video key-frame database system.

Similarly, a company well-known in the custom installed residential media room market, Audio Design Associates, exhi-

bited for the first time at this Infocomm — showing the System Titanus Board Room Media Center working off the ADA bus and allowing intricate systems, which can include security and lighting control, to be operated from a single keypad.

Other old friends expanded their media horizons during Infocomm. Harman Video introduced the company's first data rate projection monitors. Audio-Technica showed its new teleconferencing product.



Technics Model SC-TH200 THX system.

How To Mic Your Piano!

Cducer

CP SERIES

Preferred By More Professionals

Models also available for:
Guitar, Harp, Bass, Violin,
Mandolin and Dulcimer.



Contact Your Dealer or
Call 800 C-T AUDIO

Circle 286 on Reader Response Card

MAXIMUM STORAGE



SDR



RKV

Raxxess

The ultimate in storage . . . sturdy, fully enclosed sliding drawers in two or three space versions (lock optional), and the RAK-VAULT, 3 or 4 space units for secured storage of otherwise loose items (lock standard). More rack solutions from RAXXESS. CALL, FAX or WRITE for our full-line brochure.

P.O. Box 417, Riverside Station
Paterson, NJ 07544-0417
(201) 523-1425 • FAX (201) 523-1658

Circle 290 on Reader Response Card



Barco Retro Graphics Series.

comm (which Hughes exhibited at last year), the company's light valve LCD projectors were shown to great interest.

AVL introduced its "Integrated Multimedia Workstation." The DVideo Workstation includes a computer, playback and capture boards, CD ROM, 500 MB of on line Winchester disk, DAT backup and two color monitors. AVL also supplies the DV Kiosk, a turnkey operation with the DVCR playback device, touch screen, enclosure and signage.

The major electronics manufacturers active in both the consumer and professional ends of the business are making major pushes into the multimedia and presentation markets. Pioneer's Multimedia Systems Division and Display Systems Division both provide products of

interest to the multimedia community. The Display Systems Division showed the mobile Vehicle Cube incorporating 16 permanently shockmounted video projection cubes and a multi-video processor along with a three-quarter-inch vtr, a laserdisk player and a video switcher. The company has also introduced the Spot Speaker, a unidirectional speaker designed to focus sound into a specific area, for use in lecture halls or exhibits.

Sony introduced two multiscan projection systems with a new video decoder and a redesigned high resolution aspherical color corrected lens. The company also showed new monitors and a new camera.

Among the products on display from Mitsubishi was a new color video printer with composite, analog RGB, S-video, and Centronics parallel interfaces.

Sanyo officially announced its entry into the industrial video marketplace — a market the company is choosing to call G.A.P. for "Graphics, Animation and Presentation." Products were for both

(continued on page 64)

Audio-Visual Contracting: The New "Big Bang"

Are You Missing Out on Crossover Sales During the Evolution of this Market Niche?

By Wes Alderson

Ten years ago the vast majority of audio visual equipment sales was made through A/V distributors and dealers. These businesses stocked the equipment and sold it to end users, including schools, government and corporate entities.

In many cases these end users had an

in-house technician who accomplished the installation of the equipment. In those days the installation was relatively simple and straightforward. Frequently such an installation consisted of just drapes, screen and a slide projector.

Technological advance has had a tremen-

dous impact on the Audio-Visual Industry. There has been a melding together of portions of the Computer Industry, micro-processor-based control systems, signal routing and sound, as well as more traditional audio-visual devices. Video Teleconferencing has entered a new era. So has nearly every facet of the audio-visual market.

With due respect to the "in-house tech" at the school, the government facility and the corporate client, the typical audio-visual system has evolved in complexity and sophistication to the point where this tech can no longer install it. These complex systems require the professional design, installation and service performed by a qualified engineering consultant and/or a design-build electronic systems contractor.

On one hand, audio-visual manufacturers are becoming increasingly aware of this irresistible trend away from box sales and toward professional design and installation. Many of these manufacturers such as AMX, Navitar and Bose are advising their sales representatives to seek and interact with the engineering consultants and design-build contractors. Other manufacturers are having trouble perceiving the trend and are therefore unable to react to it. These manufacturers are losing market share.

On the other hand, there is no shortage of good, qualified engineering consultants or design-build contractors. In many cases, distributors that were formerly box houses are developing design-build capabilities to move with the trend toward professional design. The only problem, as is usually the case in a rapidly-evolving market, is finding a method of putting the manufacturers, consultants and contractors together. One excellent method of accomplishing this is to rely on those select manufacturers' representatives who specialize in doing exactly that. Lists of such manufacturers' representatives are available.

A faster method of putting the contractors, consultants and manufacturers together is to find or create a trade show which caters to the rapid evolution of the

Professional Audio Visual Design Market Niche. Such a trade show already exists! It is the annual NSCA Expo. NSCA is the acronym for National Sound and Communications Association. The NSCA consists of several thousand electronic systems contractors, consultants and manufacturers from various corners of the United States. The more prominent contractors and engineering consultants are already involved in a variety of related disciplines that include both audio visual and sound. Therefore, they are perfect examples of the business entities that we must look for to maintain pace with the evolution.

The trend, the rapid evolution we have been discussing (away from box sales and toward professional design), points directly at this NSCA Expo. This is the trade show where you will find the concentration of manufacturers, consultants and contractors with which you need to interact.

The NSCA Expo does not consist of merely exhibits of new products and technology. The Expo highlights excellent classes, workshops and seminars for beginning, intermediate and advanced electronic systems contractors. At the 1992 NSCA Expo, additional emphasis will be placed on audio-visual classes.

The professionally-designed audio-visual systems evolution is about to become another *Big Bang!* This big bang can contribute significantly to the growth of your business. Whether the nature of your business is manufacturing, design, sales or installation of audio-visual equipment, we urge you to become involved in the 11th Annual NSCA Expo. Whether your goal is to stay ahead of competition or catch up to competition, this Expo will help you do it. The Expo will be held at the Anaheim Convention Center in California April 25-29, 1992.

For information on the 1992 NSCA Expo or a membership application, contact: NSCA, 10400 Roberts Road #D, Palos Hills, IL 60465. Phone: 708-598-7070. Fax: 708-598-4888. ■

Wes Alderson is President of WesTech Marketing, a manufacturers' representative organization in Culver City, California.

EDITOR'S LETTER

(continued from page 4)

ranty (five years) that no part of the system will be down for over 48 hours.

The JBL consumer system shows the impact of other acquisitions of Harman International (the parent company of JBL). Fosgate (acquired last year) has been the basis for the surround decoder. Harman Video provides the projection television for Synthesis One (its new data grade projector shown at Infocomm in February). Some of the electronics are being manufactured at DOD (another Harman company); some at Harman Electronics (which makes audio systems for Ford and Chrysler). The speakers, produced on site in Northridge, will be on an assembly line used for pro equipment, manned, we're told, by the most experienced labor at JBL.

This is a hearty endeavor, giving the residential customer a way to shop, a way to see and hear the product, and a way to trust the dealer/installer. Dealers are currently being signed on by Eli Harary, who has joined the company from Paris Audio. And while the project has been in the works for two years, it seems to us that the commercial/acoustic factors in the design and testing bear the imprimatur of Dr. Floyd Toole, who joined the company last fall from NRC.

It also seems to us that the JBL Synthesis One is a product to watch on all fronts — design, manufacturing methods, distribution and marketing. As a high-end product it can fuel the marketing of more mainstream consumer products. And as a high-end consumer product, it has obvious spillover potential into boardrooms and other commercial applications.

Best regards,

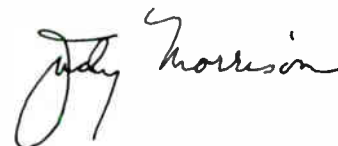

Judith Morrison
Editor in Chief

CD Changers for Commercial Applications

Many Choices for Hardware and Software

BY MIKE KLASCO

Record changers and jukeboxes have been around for over 50 years. There have also been many efforts at perfecting tape changers and these have come and gone; there have been very few tape changer success stories. Briefly, Sony had an open reel changer about 20 years ago, but pulled this from the market quickly. Staar, the Belgian co-inventor with Philips of the compact cassette, had developed a cassette changer mechanism which was briefly marketed by many manufacturers about 15 years ago, but resulted in a lot of service problems, and this to promptly disappeared. Panasonic offered a circular tray cassette changer patterned after slide projectors. Benjamin Electronics until just a few years ago sold sound contractors a tape player based on a later generation of the Staar cassette changer with some success. Pentagon, the tape duplication equipment people, offered another background music tape player that consisted of four discrete single transport cassette mechanisms in one housing.

Even with the mechanical bugs worked out, the compact cassette is not the best of mediums for commercial use. The mechanism, due to the inherent design of the transport and head assembly, is prone to unstable head alignment. The various

bias and equalization settings of the recorder/players rarely match the optimum characteristics of the tape being used, not to mention the effects of head wear and lack of head cleaning. And all this results in problematic response errors that are magnified by the Dolby noise reduction system. Compounding these problems are Dolby's rigorous licensing requirements which generally resulted in background/foreground hardware manufacturers leaving out the complementary Dolby noise reduction in their playback units.

In the early 1980s the compact disc arrived on the scene. With the playing time limited to only a little over an hour, it did not appear to be any sort of solution to the problems of commercial music systems. Denon introduced a modified CD player that played for eight hours, but in mono and with restricted bandwidth and dynamic range. This never took off in the U.S. due to a combination of Denon's inability to attract any program material for this format, the limited audio performance, and the introduction of low priced standard format CD changers. CDs are the ideal medium for changer operation; they have inherently tight tolerance, their surface is smooth with nothing to get caught in the mechanism (unlike the cassette with the tape just waiting to get snagged!) and the operation is intrinsically simpler and parts count lower than any sort of tape changer. In the consumer market two formats using

the standard compact disc have emerged: the carousel and the magazine changer.

CAROUSEL CHANGERS

Carousel units hold anywhere from six CDs down to only three (in the case of Sansui's cute robot changer), although five CDs is the most common. Some units are top loading, others build the carousel onto a tray that slides out the front for loading discs. Some carousel changers cannot have any of the CDs removed while a CD is being played and this should be determined if continuous music is required for your application.

One carousel player, the Kenwood DP-R4430, has CCRS, a unique feature which would be useful for commercial applications. CCRS automatically adjusts the output level so differences in the levels of CDs are compensated for. Although long gone, dbx/ADC had a single play CD player with dbx compression circuitry that helped control the wide dynamic range of CDs, which is ideal for background/foreground music applications.

The Technics SL-PD807 five disc carousel changer uses a digital servo laser positioner which prevents mistracking on dirty, off-center, or sub-standard discs. This digital servo laser is more useful than you might expect.

I have been using a sophisticated CD analyzer system from Optical Disc Corporation. This computer-based analyzer

Mike Klasco is the Technical Editor of Sound & Communications magazine.



The Technics SL-PD807 five-disc carousel changer.



The Carver PSD-36b — a 10-CD-magazine player.

reports CD tracking and signal processing errors such as tracking focus, bit errors, error concealments, and errors in concealments. I was surprised to find that there are large differences in performance between players, especially in the areas of tracking scratched or otherwise funky discs and tracking in high vibration conditions. Apparently the cheapest CD changers (both carousel and magazine styles) have been subjected to the most severe cost cutting and I strongly suggest that the "loss leader" consumer changer models be avoided in commercial installations.

MAGAZINE FORMAT CHANGERS

The magazine format units hold from 10 CDs down to six CDs. Preprogrammed selections can usually be stored in the changer's memory for a group of selec-

tions within a magazine. This format usually does not allow changing the magazine without interrupting the music, although there are exceptions. Nakamichi's CD Player2 holds 6 CDs + 1 and offers some of the performance benefits of single play units including the ability to change magazines without interrupting the music, as well as performance enhancements such as a built-in disc stabilizer. A disc stabilizer aids the player when operating in a high vibration environment.

Another unusual magazine changer which can provide uninterrupted music is Pioneer's PD-TM1 which holds three six-disc magazines for a total 18 discs — about 20 hours before the music repeats. At \$510 list price, the PD-TM1 will find many applications including modest installations such as doctor's offices and small retail stores. For commercial pay-for-play ap-

plications, Pioneer's Laser Entertainment group offers jukebox versions of this concept (and we will cover this later in this report).

Sony's CDP-C90ES has a 10 disc capacity and a comprehensive memory system for custom programming. A link mode is offered similar to the Tascam CD301 single disc player mentioned last month. Two Sony changers have a capacity of 20 discs and one machine's magazine can be switched out while the other is in play.

All of these changers are consumer models, and generally you are unlikely to find any rackmount models. One solution to rackmounting is a rack tray. A more serious problem will be the long term reliability of these units in continuous duty operation. It would be prudent to replace these consumer changers every two years as part of a preventive maintenance pro-

SOUNDSPHERE LOUDSPEAKER HITS HOME RUN IN CINCINNATI ...

If you didn't register for The NSCA Trade Show at the Hyatt Regency Cincinnati, you missed hearing a single Soundsphere #168 loudspeaker providing background music to four levels of the large atrium. This includes the lounge bar where music in the evening, emitting from the speaker, provides piano-bar type ambience.

Richard Carlson, the Hyatt general manager stated, "The Soundsphere speaker in the four-story atrium lobby of the Hyatt Regency Cincinnati has really enhanced the hotel's atmosphere. The system is clean and crisp in quality, and is a pleasant addition to our Sun-garden Lounge, our restaurant Findlay's and all the public areas into which it reaches."

The baseball theme of banners and the large Cincinnati Reds cap is continued in the permanent "Home run," a floating White #168 Soundsphere loudspeaker. Allen Volz of Industrial Communications and Sound, the contractor, mentioned that "it was a very easy and simple installation."

Many other hotel, mall and office building atriums have Soundsphere loudspeakers to solve the problem of even distribution of voice page and background music in these highly reverberant environments. In many instances they are color coordinated to the design scheme of the location.

There are 5 different models of Soundsphere loudspeakers to help you solve problems in difficult environments. Call us to assist with your next challenging situation.



SOUNDSPHERE A PRODUCT OF
SONIC SYSTEMS, INC.
737 Canal Street • Bldg 23B • Stamford, CT 06902 • USA • Tel (203) 356-1136

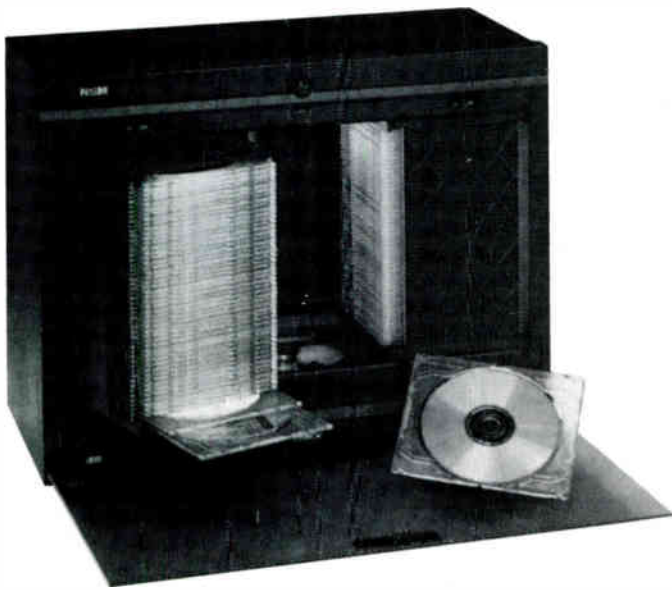

The NSM CD 2100 CD juke box stores 100 discs in two 50-disc magazines.

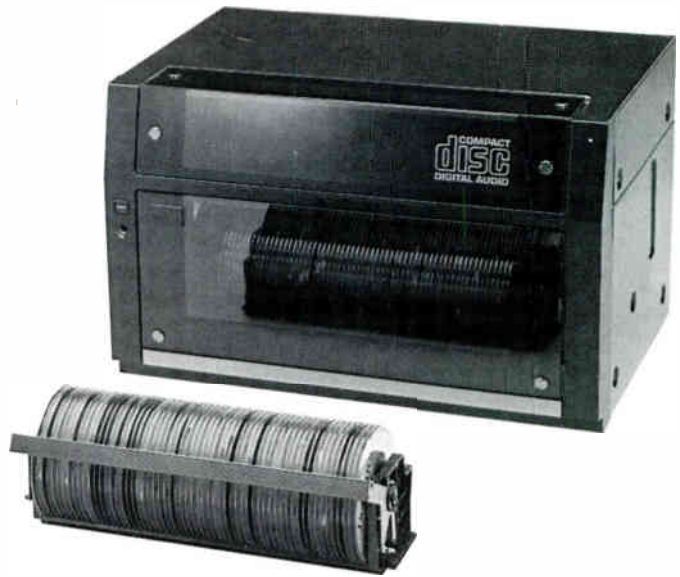

The Sony CDK-006 60-disc CD juke box.

gram. One exception to lack of rackmounting is the Carver PSD-36b, a 10 CD magazine player. Carver is intentionally marketing their 'Pro-Source' line of hi-fi gear toward pro audio dealers. At \$800 list price it is more likely that care has been taken to design and build a unit with good long term reliability.

COMBO LASERDISC/ CD PLAIERS

A number of multi-format laser disc/CD players are on the market, including a few that use a CD carousel changer. Perhaps for home use these consumer models are acceptable, but my experience is that these products are the worst of all worlds and not adequate for commercial applications. Mechanical noise, performance, and reliability all suffer in this unhappy marriage of uncomplementary technologies, a match that could only be born from the minds in a marketing department. Recently, a few commercial-grade

karaoke/combo units have been introduced that may be decent, but I have not yet heard any field reports.

CD JUKEBOXES

For most audio engineers, a jukebox is equivalent to a junkbox. Forty five rpm single play phonograph disks were pressed of recycled vinyl from LPs that did not sell (even the labels of these LPs were chopped up and recycled). That is why the upscale record firms boasted that their LPs were virgin vinyl, but the 45 rpm singles were noisy. The jukebox changer mechanisms were rough on the records, as they required high tracking forces to avoid skipping and feedback since boomy speakers were built into the juke box. But all this is history as CD jukeboxes now bring pristine quality to this format.

The first CD Jukebox that I encountered was in the mid 1980s from Nikko, a Japanese hi-fi company that was attempting to find a niche in the sound contracting

market. Nikko was too small to survive in the cut-throat consumer hi-fi market and never successfully established itself in the U.S. prosound business. During the brief existence of Nikko's CD Jukebox, library software that ran on IBM compatibles was introduced. But Nikko is long gone from our shores.

Today, the most popular CD juke boxes are made by NSM of Germany and imported by EuroSon. The NSM 2100 was their first CD jukebox, although NSM has been in the phonograph jukebox business for over 30 years. The NSM2100 disc jukebox stores 100 discs in two 50 disc magazines and can play any one disc randomly. Additional magazines of 50 discs can be used for storage. There is a 3 to 5 second access time between discs. The NSM 2100 is used in many systems distributed by Gefen Systems, Audioaccess, Frox, Niles, Alva Systems, Bos Systems and MKO. EuroSon's positioning of the changer mechanism as a generic component of these different companies' systems has been successful; with over 20,000 units in the field. At the CES show last January EuroSon reduced the retail price of the NSM 2100 from \$4,500 down to \$3,250. EuroSon also announced at the CES the CD 3101 FPS, which aside from the 100 disc mechanism, uses a single play CD transport to minimize the wait between selections. Microprocessor controlled, the 3101 FPS allows preprogramming up to 99 lists of up to 99 selections each. The Scan mode plays sample bits as it goes until a selection is made while the random mode selects music on its own. Program play lists can be generated and stored into the system's memory. The 3101 FPS lists at \$4000.

Visual-Pager for Churches, Auditoriums and Restaurants

The **VISUAL-PAGER** system quickly pages an individual from a waiting room, restaurant or a large audience without disturbance. **VISUAL-PAGER** by Microframe Corp. is used in hundreds of churches all over America for quietly paging mothers to the nursery when needed. Send for a free brochure today describing easy installation. Discount to qualified system installers.

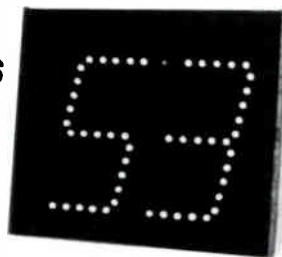

Visual-Pager Systems from \$398
2, 3, and 4 Digit versions available

FREE Brochure "B4" - CALL TOLL FREE 1-800-635-3811

Microframe Corp., P.O. Box 1700, Broken Arrow, OK 74013

B5

Circle 285 on Reader Response Card



Rowe International's LaserStar CD 100.

Gefen offers the NSM CD 2100 CD changer with a manual control unit. The NSM 2100 is also available for computer controlled systems (without the manual controller). Additionally, Gefen can also supply Sony's 60 disc CD changer. A recent development from Gefen Systems is "Touch The Music" for bars, hotels, music stores and home systems. The user



Pioneer's CJ-V99 CD juke box.

selects a CD by touching the track he wishes to hear on a touch screen overlay on the computer's monitor. To hear a complete CD, simply touch all the tracks. Or the system can run randomly by selecting from any six music styles. Hardware includes the NSM 2100 CD jukebox, a Macintosh computer with touch screen overlay and Gefen software package, as well as scanning, typing and cataloging the update floppy diskette. Retail price is \$12,500 and Gefen has prepared a dealer program.

Frox is offering a computer-controlled system which integrates the NSM-2100 jukebox CD changer as part of a total home theater entertainment package with video projector, surround sound, and multi-room control.

Two other of the OEM users of the
(continued on page 65)

The Secret is out!
RCI Systems...more than
just great plates & panels.

Broadcast ■ Audio ■ Video



301-984-1800 ■ FAX 301-984-6175
5615 FISHERS LANE, ROCKVILLE, MD 20852

RCI
SYSTEMS INC

RACOM MODEL 1700X MULTI-LINE PAGING CONCENTRATOR



Racom Model 1700X

The Racom Model 1700X MPC MULTI-LINE PAGING CONCENTRATOR can be used anywhere audio has to be concentrated from multiple inputs to a single output.

This version of our popular 1700X records audio or pages simultaneously from up to five sources. The 1700X will concentrate these audio sources and play them sequentially on a common output.

FEATURES:

- 19" Rack Mount
- Up to 5 inputs, 1 output
- Playback activates transistor switch
- 24 Minutes storage time

ALSO AVAILABLE:

- Feed-Back Eliminator
- Telephone Record Then Page
- Multi-Line Digital Announcers for sports, concerts, and any other entertainment information.

**CUSTOM CONFIGURATIONS AVAILABLE
PLEASE CALL WITH YOUR APPLICATION**

RACOM
PRODUCTS INCORPORATED

5504 State Road
Cleveland, OH 44134-7330 • (216) 351-1755
800-RACOM-OH FAX (216) 351-0392

Circle 279 on Reader Response Card

SOUND QUALITY: A NEW PARADIGM IN PSYCHOACOUSTICS; PART ONE

By Steven J. Orfield

Sound Quality, informally defined as the psychoacoustic study of the listener's positive and negative responses to sound, is an interesting case of acoustical practice crossing many disciplines.

While the tendency within science over the recent past has clearly been toward specialization, a more current paradigm within many of the specialties has been toward a more integrated general view of problems from the point of reference of many disciplines rather than one.

This interest in multiple points of reference with regard to a given problem has been very clear within the fields of acoustics, audio engineering, audiology, physiology and psychology. While most of these fields have been insistent on their origins in physics, they are now becoming increasingly convinced about the utility of resolving many of their problems within the social sciences, and more specifically, with the field of the psychology of perception. This move from the traditional sciences to the social sciences has long been predicted and is now well underway.

While the judgment of acoustic phenomena has generally been based on the analysis of the source, it is now moving inexorably toward analysis of the receiver —

Steven J. Orfield is President of Orfield Associates, Inc.



Sound Quality Jury

Sound Quality Editing

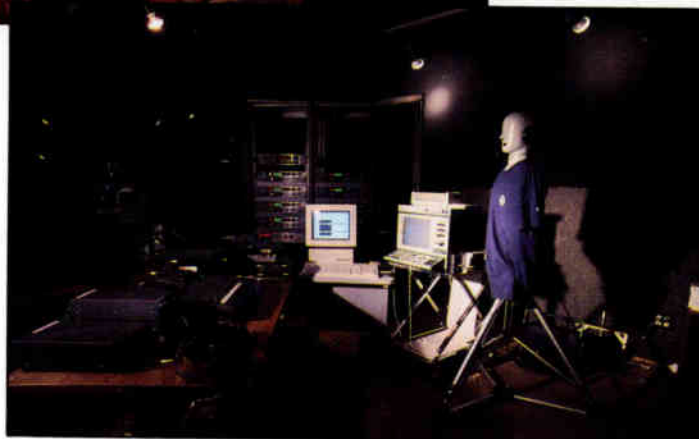

or listener response. This article is not a research overview, but is rather a brief introduction to the concept of sound quality. It is not specifically oriented to the audio field but rather deals with basic acoustical sound quality concepts.

THE FIELD OF SOUND QUALITY

Sound Quality is an emerging field that is currently most strongly applied in one industry, automobiles, and this serves as a partial basis for its discussion. From the design of the Miata sports car or a Ford

Taurus sedan to the increasingly sophisticated audio systems being installed in cars, the question of how the listener perceives sound has become central to automotive design. Recently, Ford Motor Company gave its highest annual employee honor to the developer of a sound quality program for that manufacturer.

In general, sound quality suggests these types of questions:

- How pleasant does the product sound?
- Does the sound suggest power?
- Does the sound seem appropriate for

Sound Intensity Mapping



Modal Analysis Testing

is the issue of the 'natural response' of a product. While many products produce 'positive' sound qualities as part of their inherent operation, in some cases, the ideal sound quality of a product may have to be synthesized, as the product itself cannot be 'tuned' to produce this sound. An example in vehicles may be the installation of a concealed audio generator to provide or enhance the overall sound quality of the vehicle. This is an interesting case in point especially when the near and far field requirements for sound quality are substantially different.

SOUND QUALITY METRICS

Psychoacoustics has long supported the development of metrics and calculations to describe the individual's response to acoustic sources. Some of the better known among these are environmental acoustics metrics, such as Ldn, Noise Pollution Level and Effective Perceived Noise Level. In the audio and architectural acoustics fields, there is the articulation index, AL%cons, and some of the more sophisticated quality descriptors of rooms, such as lateral fraction and C and U values. Bridging to the field of audiology are calculations such as Speech Transmission Index.

Of particular interest to the sound quality community is the work of Zwicker and Fastl, most recently incorporated into their 1990 work, *Psychoacoustics, Facts and Models*. In this classic work, Professors Zwicker and Fastl expose a long history of work in attempting to define specific characterizations of sound, such as loudness, sharpness, pleasantness, fluctuation strength, roughness and subjective duration. There is now work ongoing to develop methods of sound quality analysis, using these calculational tools as an adjunct to quantitative jury experiments. (Further information will be available in the continuation of this series.)

THE SOUND QUALITY PROGRAM

In the actual applications engineering of a product, sound quality is generally a multi-

the product?

- Does the product sound expensive?
- Does the product sound annoying or peculiar?

The intent of the acoustical staff and the allied market researchers in the sound quality field is to characterize various parameters of listener response to products and to then optimize the acoustical performance of the specific product in accordance with these positive and negative response parameters.

It is interesting to note that these user preference parameters are often well correlated with very limited market segments. For example, the sports car enthusiast buying a new Porsche generally wants the car to sound powerful and responsive. He may even identify the sound quality as 'sounding like a Porsche' if he has had previous experience with this car.

The same set of qualities may well be described by a more typical driver as rough and unpleasant. Thus, sound quality has a clear interest in the expectation of the product purchaser and other potential users.

Another issue with considerable bearing on sound quality is that of environmental impact. Whether the product is a subwoofer installed in a typical condominium or a lawnmower in a residential neighbor-

hood, the strongest sound quality response may be from someone other than the product owner or user, and this response is generally characterized by annoyance. Therefore, a product may need to have two levels of sound quality performance: in the near field (close to the user) it should produce a sound that meets the user's expectations, and in the far field it should produce a sound that has little or no negative response from other listeners. There are many products which are in need of this double sound quality definition.

THE QUESTION OF HOW THE LISTENER PERCEIVES SOUND HAS BECOME CENTRAL TO AUTOMOTIVE DESIGN.

An additional issue in describing the designed sound quality of a product may be the time or place of use. The 'sports car' sound may be suitable for the open highway but far less suitable on a residential street at night. As a result, there may be some rationale in developing 'adjustable' sound quality devices, such as active electronic mufflers.

Another issue in the sound quality field

step program from inception to completion. SQ programs generally include the steps outlined in Table One.

TABLE ONE	
Sound Quality Standards Development	
<ul style="list-style-type: none"> • Product listening and market discussion • Market research • Binaural Recording of current and competitive products • Playback to a listening jury • Calculation of sound quality parameters • Editing of sound to reduce annoyance and increase positive sound quality based on jury response and calculations • Playback to a listening jury of alternative solutions for validation. 	
Sound Quality Initial Measurement	
<ul style="list-style-type: none"> • Playback and measurement of above recordings • Application of alternative analyses of time and frequency-based components • Characterization of acoustical performance at all points of operation (speed, cycles, etc.) 	
Sound Quality Localization Measurement	
<ul style="list-style-type: none"> • Sound Intensity measurement based on measurement findings and targets for reduction in sound components • Sound Intensity measurement of components of the product under test, often with product covers removed • Sound Intensity mapping of sound power over engineering diagrams of product surfaces 	
Sound Quality Modal Measurement	
<ul style="list-style-type: none"> • Modal Analysis measurement based on measurement findings and targets for reduction in sound components 	
Sound Quality Prototype Development	
<ul style="list-style-type: none"> • Production of an operational prototype based on sound quality standards and measurements 	
Sound Quality Jury Presentation	
<ul style="list-style-type: none"> • Binaural recording of prototype • Presentation of recordings to jury • Presentation of actual product to jury • Market research on prototype 	

A hypothetical case may serve to illustrate the process. A washing machine manufacturer may be interested in evaluating the sound quality of one of their products, with the fact in mind that washers are considered noisy. A number of questions may follow:

- *Is our washer louder than other competitive products?*
- *How much louder than the background noise level is the washer? (background level in area of use)*
- *Is it important that the washer provide any noise level as a cue to the fact that it is operating?*
- *Are some cycles on the washer more annoying than others?*
- *Does the washer need to have a higher sound quality definition due to its increasing use in kitchens and upstairs areas?*
- *Should the washer only run at certain times of the day? (i.e., does it have a timer?)*

Given this information, the manufacturer would normally want to validate the consumer response with some type of focus or quantitative jury session. This may begin with consumer discussions first, in order to determine if the consumer has any strongly expressed feelings about the noise of the washer. (Since market research experts often consider focus groups to be quite unreliable, this step is increasingly left out.)

After this step, recordings are often made of the product under test and of directly competitive products. These recordings are often played back to the acoustical staff to develop some initial opinions of comparative sound quality, and measurements of overall noise level are often taken at this time. Also, some sound quality calculations may be made at this time to attempt to predefine the problem areas of the recordings.

Next, consumers are generally assembled into a listening jury representing the demographics of typical product users. They are presented with a number of recordings of washers, comparing the overall response to each product and comparing the cycle-by-cycle sound quality ratings of the individual products. (Sometimes, this consumer jury is also presented with visual stimuli, such as a video of a washer running.)

Based on the results of jury testing, the recordings are transferred to a digital editing system in order that changes can

be made in the product to reduce negative sound qualities and to enhance positive ones.

The jury is again assembled, and closely spaced presentations of alternative edited sections are presented for quantitative rating. After a series of these jury rating sessions have been completed, a sound quality standard is then assembled as a design goal.

Once negative sound qualities for the washer are determined, testing must be completed to locate the source of those qualities, and this is generally done via the use of sound intensity measurement and contour mapping. Each face of the product is generally mapped under operating conditions, and these data are then plotted over engineering drawings of the product in order to locate the source of the specific noise components producing the offending sound qualities. This will often result in quick identification of the specific components which can then be redesigned in order to reduce the offending noise.

In some cases, the offending noise is a result of the resonance of specific component parts, such as pulleys, shafts, etc. In those cases, a second stage of analysis is often undertaken, and that is order and modal analysis. Via this analysis, the contribution of a single structural item can be analyzed, and the 'ring' or resonance of this component can be changed via changes in materials, material density, stiffening, etc.

Finally, many new analysis tools are coming on line, including non-stationary signal analysis tools, such as the wavelet transform.

After these efforts, measurements are continually made to detect variations in the noise components of interest which have resulted from the change. Once the product begins to approximate the sound quality definition, then recordings are often repeated along with quantitative jury testing.

In the case of a washer or similar complex product, the full schedule of sound quality procedures may span from between a few months to design cycles of years.

SOUND QUALITY — AREAS OF INTEREST

Currently, there are very few firms in the United States with full sound quality programs capable of analysis, jury work, product diagnosis and product alteration. The concept is currently being applied principally to consumer product design by manufacturers, but its potential is far broader.

Other areas of involvement that are promising are architectural acoustics, audio product design and systems engineering, hearing aid design and testing, environmental noise evaluation, and medical diagnosis.

THE SOUND QUALITY WORKING GROUP

Since sound quality is new to most inter-

ested acoustical professionals, it is difficult to find information on firms involved in the field and providing outside consulting assistance. With this in mind, Orfield Associates recently formed the Sound Quality Working Group, an organization of specific firms who are interested in supplying products for sound quality evaluation and services, such as seminars, training and support services. In addition to Orfield Associates, this group includes Bruel & Kjaer Instruments, supplier of acoustic test instrumentation, TEAC Industrial Recorders, suppliers of precision acoustic DAT recorders, Yamaha Professional Audio, supplier of audio processing components, and Sennheiser, supplier of headsets. In addition to these members, National Instruments is providing support

for the development of sound quality software and interfaces to accept data from analyzers and download to PCs for calculation and analysis.

The first three of these manufacturers have previously joined sponsored research into the development of binaural recording systems (see Sound & Communications; Sept., Oct. 1990) and the fourth has just introduced a new line of headsets targeted toward the binaural listening environment. (All of these manufacturers will be providing their products through their normal sales representatives.) After much discussion and preplanning, the Sound Quality Working Group held its initial meeting in Minneapolis on January 23, 1992, and a Sound Quality User Group is now being organized for interested users and potential users of this technology. ■

**1992
SYN-AUD-CON'S
20th YEAR OF SERVICE
TO THE AUDIO INDUSTRY**

To Celebrate SYN-AUD-CON'S 20th Year . . .

**3-Day Audio Engineering Seminars—\$550
The Farm—S. Indiana**

**May 21-23, 1992
June 18-20, 1992
July 16-18, 1992
August 20-22, 1992
September 17-19, 1992
October 15-17, 1992**

**3-Day Workshop—\$600
Binaural Auralization & Precision Equalization**

**Instructors: Dr. Wolfgang Ahnert, Berlin
Dr. Eugene Patronis, Georgia Tech**

**The Farm & Medora, IN
May 15-17, 1992**

LIKE TO KNOW MORE ABOUT SYN-AUD-CON?
Fax, call or write for a complimentary Syn-Aud-Con
Newsletter as well as our 1992 schedule and brochure.
A subscription to our quarterly Newsletter is \$35/year.

**Syn-Aud-Con
12370 W. Co. Rd. 100 North
Norman, IN 47264
Ph: 812-995-8212
Fax: 812-995-2110**

MULTIMEDIA

(continued from page 54)

NTSC and High Definition. The High Definition line consists of a video projector and still frame storage system. Other products included a high definition still picture file system and a half-inch CCD "color graphics" camera.

Sharp Electronics has been in the forefront of developing LCD products for the multimedia presentation market. At Infocomm, among a slew of products, Sharp showed a video presentation scanner that connects to video projectors and TV monitors and allows documents, full color



Sanyo color graphics camera.

photographs and three-dimensional objects to be presented to a large audience. The company's "multimedia capable" QA-1050 computer projection panel features 185,000 colors and full motion capability. The panel uses a 640 x 480 dot 10.4-inch-thin film transistor color LCD with an active matrix system. The display time is 30 frames per

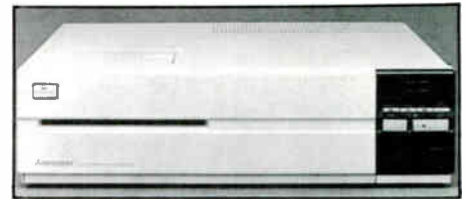

Mitsubishi color video printer.

second.

LCD monitors are growing in size. Sharp showed at both CES and Infocomm an 8.6-inch flat panel LCD color monitor with a resolution of greater than 400 TV lines.

Infocomm has also become a place to see a hint of the future. And that was most evident in the Interactive Media Presentation Center of the Future, a cooperative display organized by Extron Electronics. A working model of a presentation center and classroom center, software and hardware was integrated and networked with video switching options emphasized. Parti-



Sony VPH-1271Q projection system.

cipants included AMX (control system), Barco, Chisholm (for the ColorWriter, a pen based color writing peripheral that attracted great attention at the 1991 Infocomm), Extron (for video routing), GE (the Video Visualizer), MacroMind software, Mitsubishi (data displays), Paragon furniture, Presentation Electronics computer remote controls, Selectech Air-Mouse Remote Control, Sharp (LCD panels), Videomedia (V-Lan).

What does all this mean? Essentially it means that there are new opportunities for the individualist, the creator, the innovator and the businessman. Technology has out-paced applications. What Sanyo chooses to call G.A.P., what Pioneer chooses to call both multimedia and display, what Apple chooses to call simply Digital has developed into an interactive world of participating products and people who will create a new virtual reality for the next generation. The challenge is in spearheading the market towards the next century. ■

Get the most out of your NSCA Show in Anaheim



APRIL 27 — 29, 1992

The only daily news coverage at the show. See it ON THE AIR, EVERY HOUR, in your HOTEL ROOM. See it on LARGE SCREEN MONITORS at the convention center.

NSCA-TV NEWS is your:

- Daily Planner
- New Technology Information Source
- Medium for Full Coverage of the People and Products Important to your Business.

EXHIBITORS

Get that extra visibility for your 3 most important business days in 1992.

CALL NOW (516) 767-2500

TV Advertising Manager: ADAM PACE
Editorial Director: Judith Morrison

NSCA-TV NEWS is written and edited by **SOUND & COMMUNICATIONS**. It is produced by Testa Communications and is no way associated with the National Sound & Communications Association.

CD CHANGERS

(continued from page 59)

NSM mechanism that contractors may find useful are Audioaccess and Alva. The Audioaccess system is computer controlled and is finding application in high-end and commercial jobs. The Alva system is intended for disco/club use and allows crossfading between selections under DJ control.

Rowe International, an established record jukebox manufacturer, builds its own components from the ground up. Rowe's LaserStar CD-100 looks like a real jukebox because it is. Unlike most of the changer/controller modules described in this section, the LaserStar is a self-contained sound system, including 250

The user selects a CD by touching the track he wishes to hear on a touch screen overlay on the computer's monitor.

watt (125 x 2) amplifier, graphic equalizer and built-in speakers. Feedback, a problem with conventional phonograph jukeboxes with integral speakers, is far less of a problem with CDs. A title display shows 12 of the original CD jackets at a time to aid customer program selection. The LaserStar can be programmed to play randomly, to play pre-determined selections, entire CD albums, or by customer selection. The LaserStar, like its precursor jukeboxes, is pay for play, and accepts coins and bills.

Rowe's CD-51 is a down-sized version of the LaserStar CD-100, with the same features and amplification, but with a disc capacity of 51 discs. Rowe also offers the WallStar, a remote selection system that can be connected to any of their CD jukeboxes. Rowe distributes its products through music and games operators.

DataBeat, a British firm affiliated with the Julianas Group, offers a 120 CD jukebox based on two Sony 60 CD mechanisms and a common controller. Operation can be random, pre-programmed, or by DJ. Even when selections are by micro-processor control, the transitions are cross-faded (the ability to avoid "dead-air" is due to the use of two separate changers

rather than a single larger capacity unit). Aside from the two changers and controller, software for controlling and programming the music library and a personal computer are included in the \$18,000 list price.

Sony offers the CDK-006 60 disc CD Jukebox with a capacity of 60 discs, although this unit is distributed essentially as a sub-system to manufacturers who package it with a controller, such as Gefen and DataBeat.

Nikkodo specializes in karaoke systems, especially CD sound/graphics. Nikkodo's CD players will work with any CD, but when special AVZ CDs are used (called "Audio-Visual-Zone" by Nikkodo, but actually conforming to the CD+G standard), the words to the music appear on the video monitor. If a camera, laser disc or video source is used, the text can be superimposed onto the image. Nikkodo's changer system consists of the CD-100M master controller and the CD-100A changer. The combination of controller and changer retails for \$4,800. The controller can be interfaced to three of the changers for 300 disc capacity. A speed control (for key changer or beat matching) allows 10 percent variation. Wireless remote control is included with the controller. The CD-100A changer has a single magazine rack that holds 100 discs.

Nikkodo also offers the CD-A150II, a 150 disc capacity changer, various laser disc video players, key changers (pitch shifters), karaoke software programs and other stuff for karaoke installations.

Feedback, a problem with conventional phonograph jukeboxes with integral speakers, is far less of a problem with CDs.

Until recently, the most automation you could expect out of a Laserdisc system would be for it to be able to play both sides. Pioneer Laser Entertainment's LC-V300 Laser Karaoke Autochanger manages to store and play up to 72 laser discs with a single mechanism, and up to 4 autochangers can be connected together to the CO-V300 Autochanger Commander. Sound contractors should use caution

here, as continuously sitting through 288 laser karaoke discs (8,064 songs) can be hazardous to your health. The approximate retail of the LC-V300 is \$13,000.

Pioneer sells the mother of all jukeboxes, a 300 disc system, in Japan, but as yet has not formalized plans to market it in the U.S.

Pioneer has already introduced two more modest coin operated CD jukeboxes that are ideal for commercial sound systems such as bars, restaurants, bowling centers, and other background and foreground music applications. The CJ-V99 and CJ-V77 have built-in power amplifiers for driving their 4-way internal speakers as well as external speakers. Both systems are equipped with Pioneer Laser Entertainment's new CD autochanger that con-

Until recently, the most automation you could expect out of a Laserdisc system would be for it to be able to play both sides.

tains three six-disc magazines for an initial capacity of 18 discs, but up to two additional autochangers can be added for a maximum capacity of 54 discs. When no selections have been made by customers, the jukeboxes can automatically play music from designated CDs or from an external source. Pioneer's Optimizer disc programming mechanism minimizes delay time between selections. The jukeboxes are PC compatible, allowing operators to audit selections and determine top hits and unprofitable songs. Retail prices for the jukeboxes range from \$4,500 to \$5,700, depending on model and number of additional CD autochangers used.

The big question of music software, that is, the use of copyrighted program material in public spaces, has been covered by Pioneer. Through an exclusive contract with Diamond Time, Ltd., international music clearing house (i.e., like ASCAP and BMI) music packages featuring current hits, "evergreens," and holiday favorites are available.

We are preparing a report on dealing with clearing houses for using CDs and other program material in your installations. Look for it in an upcoming issue. ■

NEWS FROM AROUND THE INDUSTRY

Carter in Northridge; Streamlining in Redwood City



Left to right: Rosalynn Carter, Jane Harman, Dr. Sidney Harman, former President Carter.

Carter Visits Harman

The Harman/JBL International headquarters was the site of a visit by former President Jimmy Carter and his wife Rosalynn. The couple toured the 500,000 square foot design and manufacturing center along with Harman/JBL Chairman and founder Dr. Sidney Harman, who served in the Carter administration as Undersecretary of Commerce. Carter addressed 1500 employees of Harman/JBL in Northridge, California. Among his comments, Carter stated that his personal sound system in Plains, Georgia is a Harman/JBL system.

Ampex Recording Media "Streamlines"

Ampex Recording Media Corporation has eliminated 224 positions throughout the company and at all levels. The Opelika manufacturing facility will eliminate 191 positions; the remainder will come from the Redwood City headquarters and the company's sales office. Thomas J. Wheeler, president of the corporation, said that the move was part of the efforts begun during 1991 that emphasized quality and productivity as major goals. "Ampex has successfully reorganized and refocused itself as a leading supplier of the new media products."

Cal Switch Honored

California Switch & Signal was named "Distributor of the Decade" by Switchcraft, Inc. William C. Jones, president of Switchcraft, and Keith A. Bandolik, vice president and general manager — components division, made the presentation. Accepting the award and the framed proclamation certificate for Cal Switch were Herbert M. Poncher, president, and Robert A. Andrade, executive vice president and founders of the firm. In making the presentation, Jones said, "Our growth and the Cal Switch growth have been mutually beneficial and we look for this relationship to continue to be advantageous for both parties."



Left to right: Keith Bandolik, Herbert M. Poncher, William C. Jones, Robert A. Andrade.

Ben W. Lowell Dies

Ben W. Lowell, industrialist, engineer and a pioneer in the sound and communications industry, died at age 75 after a lengthy illness. In 1947, Lowell founded Lowell Manufacturing Company, using the concept of sound from the ceiling. He held numerous design patents on loudspeaker baffles and enclosures. The company remains under family ownership.

Audio-Technica Installs

Audio-Technica has announced the delivery of product for several installations. Alex Rosner of Rosner Custom Sound is using Audio-Technica wireless lavalier systems and miniature cardioid condenser UniPoint microphones at St. Stephens Episcopal Church in Port Washington, New York. The pair of AT853a's were suspended from two chandeliers. The six antennas for the wireless lavalier systems were attached to wooden planks and mounted in the ceiling. Rosner also used A-T wireless handheld microphone systems and two ATW-T31 wireless systems at the Regency Hotel Ballroom in New York. A Urei 562 notch filter was employed to eliminate two resonant peaks in the ballroom.

Bert Schultz of Sound Systems, Inc. in St. Louis has installed Audio-Technica microphones in the City Council Chambers of Crestwood City Hall.

Harry Wenger Dies

Harry Wenger, founder of the Wenger Corporation, died on January 26, 1992 at the age of 85. The Wenger Corporation began as the Wenger Music Equipment Company in 1946 in the founder's basement in Owatonna, Minnesota. It now occupies more than 250,000 square feet and manufactures standard equipment for music educators in addition to professional platforms, acoustical shells and Showmobiles.



Harry Wenger

Disney World Adds Wireless

Walt Disney World recently purchased 24 Vega UHF wireless microphone systems for use in convention services. The systems were purchased from Audio Services Corporation of Orlando. Joe Guzzi, general manager of ASC-Orlando, noted that the units are the first Vega UHF wireless systems to be used by Disney's convention services. Coordinating the frequencies of the units was complicated because Disney already uses more than 370 wireless units on their property. For flexibility, all of the new systems include both Vega bodypack transmitters and handheld transmitters fitted with Electro-Voice N/D857 microphone elements. ASC constructed custom racks, on wheels, in order to make the systems easily transportable.

The American Intercom Market: Directions

By Jun Matsumoto

Editor's Note: From time to time, Sound & Communications publishes the comments of manufacturers concerning a market segment and market directions of the company. Aiphone's recent World Convention prompted these comments from Jun Matsumoto, president of Aiphone Corp.

For all their manufacturing prowess, the Japanese still have a thing or two to learn about foreign marketplaces. Luckily, they're listening.

I recently attended the Aiphone Company's first world convention in Nagoya, Japan. The company, which is the largest manufacturer of audio and video intercom systems in Japan, invited distributors from 20 countries to tell Aiphone how it can improve the research and development of equipment for their individual markets.

The goal, of course, is to increase sales. Aiphone now sells 70 percent of the intercoms Japan exports. While its share of the overseas market share is large, it's dwarfed by domestic sales. Fully 85 percent of Aiphone's sales are in Japan, with overseas markets together comprising only 15 percent, a third of that from the United States.

While the company continues to dominate Japanese sales with a 40 percent market share, it has set its sights on tripling its overseas sales. While some European countries, notably France and Belgium, have seen sales skyrocket over the past few years, the United States is by far the largest potential market.

So what does it take to increase sales in this country? We requested that Aiphone President Shusaku Ichikawa have more research done on what Americans want, then get those products on the market sooner. In the past, Aiphone largely developed products for its domestic market, then evaluated their saleability overseas. We think that process

needs to be reversed.

As with other technologies, product life cycles continue to shorten, forcing manufacturers to continually upgrade their offerings. Aiphone, of course, has been an acknowledged leader in the intercom field, often being the first to introduce new technology, such as the recent debut of the Video Sentry PanTilt. (The PanTilt is the first door station to incorporate a panning and tilting CCD camera. Audio, visual, and power are all transmitted over a single pair of wires.) Aiphone also has prided itself with having the lowest factory defect rate and the highest long-term reliability of any manufacturer.

Although highly successful, Aiphone is hardly another Japanese conglomerate. The company was founded by Toshio Ichikawa as Tokai Onkyo Denki Kenkyujo (Tokai Audio Electronics Laboratory) in 1948 and still had only a handful of employees when it was renamed Aiphone Co., Ltd. in 1959. Aiphone now has \$130 million in sales, 750 employees, numerous branch sales offices, one main factory and two others through a subsidiary. Ichikawa is now chairman while his son, Shusaku Ichikawa, is president. Aiphone stock wasn't publicly traded in Japan until 1990.

In 1991, Aiphone expanded its Toyota City plant to facilitate a shift in the company's focus from basic intercom equipment to video intercom systems and home automation systems. It now produces 200,000 pieces per month.

Aiphone has only one company operating independently outside Japan, and that's Aiphone Corp. of Bellevue, Washington. Harry Quanz, vice president of marketing for the company, assists me in developing a game plan for increasing sales in the U.S. market.

That game plan, in large part, consists of aggressively pursuing the residential market, which up until



Aiphone First World Convention. Jun Matsumoto is second from right.

recently played a back seat to commercial sales. Consider this: of the seven trade shows we attended in 1991, the largest number of leads were generated by the National Association of Home Builders Show in Atlanta, followed by the International Security Conference East in New York and the National Sound & Communications Association show in Cincinnati. That tells us a lot about where the action is. So do sales of demonstration kits, which involve a working model of one of our several

audio and video access control systems. Sales of kits jumped nearly six-fold from 1989 to 1991, indicating an upswing in interest by dealers selling residential systems.

While Aiphone has every intention of maintaining its strong role as a high end supplier of commercial equipment, look for a new push into residential markets, where practically every doorbell in America is a candidate for an audio or video door station.

NSCA WORKSHOPS • EXHIBITS
EDUCATION & MORE...

EXPO  **'92**

**ANAHEIM CALIFORNIA
CONVENTION CENTER
APRIL 27th, 28th, & 29th**

April 1992

S	M	T	W	T	F	S
			1	2	3	4
5	6	7	8	9	10	11
12	13	14	15	16	17	18
19	20	21	22	23	24	25
26	27	28	29	30		

MARK YOUR CALENDAR

Phone: 800-446-NSCA



Left to right: Bill Richards and Dave Henderson of The Henderson Company; Steve Woolley, Ramsa national sales & marketing manager; Carla Campbell, Ramsa eastern regional sales manager.

Henderson Rep of the Year

The Henderson Company has been named 1991 Rep of the Year by Ramsa/Panasonic. David Henderson, principal, has been a Ramsa rep since 1979. He and Bill Richards formed The Henderson Company in May, 1991 to serve New England and upstate New York.

Fight to Protect Rep Position

The Council of Manufacturers Representatives Associations has voted unanimously to commit support to further the efforts to battle "power retailers" such as Wal-mart who are attempting to force manufacturers to terminate their relationships with manufacturers representatives and brokers. CMRA voted unanimously to support the recently formed Coalition of Americans to Save the Economy (CASE). Working coalitions have been formed around the country, many in direct response to Wal-mart's announced decision to force manufacturers to cease dealing with manufacturers representatives and brokers.

Bartech Associates Appointed

Brand-Rex Company has appointed Bartech Associates as its representative in southern California. Six Bartech sales people service the region, which includes the five counties of greater Los Angeles. Bartech Associates is wholly owned by Barcel Wire and Cable Corp.

Anniversary Celebrated

The Peter E. Schmitt Company of Leonia, New Jersey has celebrated its 65th anniversary in the New York metro territory. Among the company's longstanding relationships is a 60 year history representing Shure Brothers. Two staff members have been added to the Schmitt Company: George Xouris specializes in contracting and consultants; Bart Bucsko is an inside technical specialist.

Wheelock Products UL Listed

All Wheelock Voice Paging and Telephone Alerting Products which are connectable to the public telephone network have been U.L. 1459 listed, in accordance with the provisions of the 1990 National Electrical Code, Section 800-51. Some 25 Wheelock products manufactured since July of 1991 will bear the appropriate U.L. marking.

Tannoy in Central Assembly of God

Several loudspeakers and subwoofers from the Tannoy Contractor Series have been delivered to the new Central Assembly of God Church in Springfield, Missouri. The church is a fan-shaped auditorium with a seating capacity of 2,500. Milam Audio of Pekin, Illinois served as acoustic design consultants for the project and designers of the sound reinforcement system, installed by Central Assembly of God sound engineer Brian Roggow. Milam Audio's principal design consultant John Westra said, "Our intention was

to provide a high gain-before-feedback system with high intelligibility and articulation, and precise stereo imaging."

The main system consists of 12 CPA 12 loudspeakers deployed as two groups of six speakers each. One group covers the main floor while the second group covers the balcony. Each group of six is concealed behind shrouded, arced soffits protruding from the ceiling. The CPA 12s are positioned at 16-foot intervals along the circumference of the arc. Radiating outward, they are alternately staggered in a left-right configuration. A pair of Tannoy CPA 15.2 subwoofers is located in special reson-

ating chambers. Two additional CPA 12s hidden in the ceiling serve as monitors for the choir loft.

Acoustic Sciences Expands in Europe

Acoustic Sciences Corporation has expanded its European factory production and distribution. Sound and Music of Lucca, Italy continues to distribute home acoustic products. A new corporation has been formed, Acoustic Applications, that will take over manufacturing for home acoustics and add ASC's pro recording studio and commercial acoustic products.



The projection room is the main routing and distribution point of the Compaq Conference Center.

Routing System in Compaq Conference Center

The Compaq Computer Corporation's new Houston conference center, for which its designer—installer, Pran, Inc., won an award at the Infocomm convention in February, includes a 50 x 20 audio and video routing system by Dynair to connect the AV sources located in the center's projection room with meeting rooms, the board room, and the auditorium. Among the sources used are tape machines, cable television, observation cameras, NTSC, and audio. Destinations within the center include three video projectors,

tape machines, television monitors, and the sound system. The system is configured for 20 x 20 audio/video and 50 x 40 two-level audio.

John Whitcomb, senior vice president of Pran, said, "We wanted a true matrix for the headquarters." The sources and specified functions of the router can be operated from each room with an AMX handheld control. A "User-Allow" software function enables the AV technician to preassign control and routing of any machine to any area. The AMX communicates to the router via an RS-232 communications line. The system can also be configured using a Compaq 386/25 personal computer.

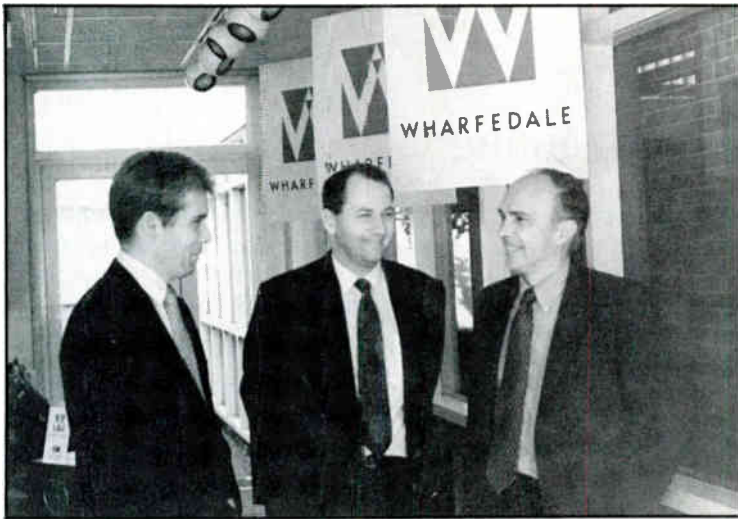

At Wharfedale headquarters in England, left to right: Steve Halsall, product group manager, Wharfedale; Michael Wood, marketing director, Wharfedale; Daniel Gravereaux, president Optim Audio.

Optim Audio Agreements with Wharfedale, Whiteley

Daniel Gravereaux, president of Optim Audio, Inc., has announced an agreement in principle with Wharfedale Loudspeakers, Ltd. naming Optim as the "premier distributor/importer of Wharfedale's commercial loudspeaker systems." Wharfedale Loudspeakers, Ltd. was founded in 1932 by Gilbert A. Briggs, and is now owned by Wharfedale p.l.c., whose principal subsidiaries include Fane Acoustics, McKenzie Acoustics, Fanfare Electronics, Cambridge Audio and Linx. Optim Audio, Inc. was founded in August 1991 by Daniel Gravereaux and Irving Joel. Optim Audio, Inc. represents Wharfedale Loudspeakers, Ltd. exclusively in the U.S.A. to import, market, stock, distribute and repair products from Wharfedale's Commercial Products Division. This currently includes the Force 9 performance loudspeaker series, as well as the Programme Series for background and foreground music installations.

In addition, Optim Audio has been named distributor/importer of Whiteley Electronics Limited Public Address product lines. Whiteley was founded in 1926 by Alfred H. Whiteley. The company is currently designing and manufacturing the "world's largest distributed public address system" for the English Channel Tunnel, covering the service tunnel and terminals at Coquelles, France and Folkstone, England.

Indiana Convention Sound

Altec Lansing has announced that The Indiana Convention Center and Hoosier Dome, the United States Military Academy at West Point, the University of Southern California, and East Carolina University, have all recently installed sound equipment by Altec Lansing. The new main speaker cluster of the Indiana Convention Center includes 14 Altec 299 drivers mounted on Altec MR542 horns, and four Altec 299 drivers mounted on Altec MR642 horns. Twenty-two satellite clusters and several extended clusters contain 77 Altec 288 drivers on Altec MR542 horns and 40 515 woofers in 817 cabinets.

Airports Choose IED

Among the airports installing equipment from Innovative Electronic Designs are Birmingham Municipal Airport, Tampa International Airport, Terminal One at Los Angeles International Airport, and the Detroit Metropolitan Airport.

Consultant Brad Weber of Newcomb and Boyd directed the Birmingham installation of the 500ACS Announcement Control System. Installation was serviced by Electronic Engineers. All voice announcements and pre-recorded messages are microprocessor controlled, with the IED Model 596 Monitor/Test System providing full diagnostics of all electronic components and speaker circuits.

The Tampa Airport also received a 500ACS system, under the direction of consultant Chris Purdy of Tilden, Lebnitz and Cooper, with installation by Baytown Sound.

Neil Shaw of Veneklasen and Associates directed the installation at LAX, with installation by Acromedia. And consultant Dave Hill of Multi Communications Systems directed the installation at Detroit Metropolitan Airport.

New England Digital Names Sascom

New England Digital has named SASCOM Marketing Group as its representative in the eastern Canadian provinces. The company maintains offices in Montreal and Toronto.

REP NEWS Community Reps

Community Light & Sound has added two rep firms: Dick Bellew Sales, Inc. and Brian Trankle Associates. Dick Bellew Sales, located in Dallas, covers Arkansas, Louisiana, Oklahoma and Texas. Trankle and Associates, of Belmont, California, covers northern California and northern Nevada.

In other news from Community: Representative of the Year awards went to both K/M Ltd. and Cordial/Riley Marketing. "Most Improved Territory" also resulted in a tie — between the Vector Corporation and Starin Marketing.

Perma Power Appointments

Perma Power Electronics has appointed Mid States Technologies as a distributor for its line of power protection products. Mid States Technologies is located in Columbus, Ohio.

Reps Recognized by Allsop

Allsop, Inc.'s Consumer Electronics Division has recognized the following reps: Representative of the Year Award — LK & Associates; Best Sales Award — Jennings-Limauro Associates; Allsop Award — Spike Spiegel.



Left to right, back: Dan and Ken Rancilio; front: Chuck Rancilio, Chuck Smith.

Burle Appoints Rancilio

Burle Industries, Inc. Security Products Division has appointed Rancilio Associates, Inc. to represent video surveillance products in Missouri, Iowa and southern Illinois. In addition to working with dealers, distributors, contractors and installers, Rancilio will be working with architects, engineers and consultants in designing BURLE products into projects.

Apogee Electronics Representation

Apogee Electronics has appointed Charlie Day of The European Office as the company's exclusive European representative. Day's home office is in Bedfordshire, U.K. In addition, Apogee Electronic's has added three representatives in the U.S. to sell at the company's pro audio products. Newly named reps are Steven Strassberg Associates, Manhasset Hills, New York; Wind Over the Earth, Boulder, Colorado; and Audio Images, Seattle, Washington.

Rep Honors from Gentner

The John B. Anthony Company has received three awards from Gentner Teleconferencing Systems: Outstanding Sales Award, Teleconferencing Representative of the Year Award, and Outstanding Salesman Award (Mike Oltz).

In addition, Starin Marketing received the Excellence in Communication Award; and William Ray & Associates was named Representative Firm with the Greatest Potential for Growth.

PEOPLE

Wilkens at Community; Pioneer Appoints Young

Wilkens Joins Community

Douglas Wilkens has been appointed Community's director of sales and marketing. Wilkens is responsible for Community's domestic sales operations, including the management of its field sales force and independent sales representatives. He is also assisting in the development of strategic planning and other marketing concerns.

Wilkens has held positions with contractor/supplier Peirce-Phelps, Inc., University Sound and Electro-Voice.



Wilkens

Young Joins Pioneer Laser

Steve Young has joined Pioneer Laser Entertainment as vice president of national sales for the Karaoke Division. Young supervises the division's six regional sales offices in New York, Atlanta, Chicago, Dallas, San Francisco and Los Angeles. He is also responsible for local and national account development.

Previously, Young held positions with Pioneer Electronics (USA), Inc.

President of Dukane

Charles N. Clark, Sr. has assumed the responsibilities of Corporate President and Chief Operating Officer formerly held by J. McWilliams Stone, Jr. Stone has retained his responsibilities as Chairman of the Board and Chief Executive Officer. Clark joined Dukane in 1987 as President of the Microbiotics division and has also held positions with Siciaky Brothers and Milacron.

Shirley at Shure

Shure Brothers Incorporated has appointed Alan B. Shirley to its newly created position of Manager, Technical Markets and Strategic Planning. In the position Shirley is managing the marketing departments for sound contracting, broadcast, communications, and music industry markets. Shirley rejoins Shure after completing his Masters of Management degree (M.B.A.) at the J.L. Kellogg Graduate School of Management, Northwestern University.

Shirley was previously Product Line Manager, Wired Microphones at Shure and worked for Electro-Voice in several marketing management assignments.



Shirley

Lone Star Appointments

Lone Star Communications, Inc., a Rauland-Borg Corporation sound communications distributor for north-central Texas has announced the sales staff addition of two Sales Consultants. Al Daniels is developing school systems and Doug Derby is selling hospital nurse call systems. Ron Krause has also joined Lone Star as a Project Engineer.

Aiphone Appoints DeRoche

Aiphone Corp. has appointed Loran DeRoche to the position of comptroller. DeRoche is responsible for overseeing the finances of the company. His duties include managing the payroll, general budgets and accounts payable and receivable.

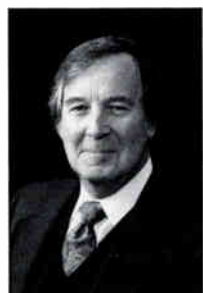

DeRoche

VP at Ampex

Ampex Recording Media Corporation has appointed Ernst L. Ranft to the position of Vice President of Operations. In his position, Ranft is based at the company's Opelika, Alabama manufacturing facility.

Marketing at Sony

The Sony Professional Tape Division, a division of Sony Recording Media of America, has announced the promotion of Kenneth F. Wiedeman from Director of Sales and Marketing to Vice President, Sales and Marketing, and the naming of Joseph E. Tibensky to the position of Director of Marketing.

In his new position, Wiedeman oversees the operation of the Sony Professional Tape Division, including its strategic marketing and planning, the coordination of sales, marketing and operational staffs and the service and distribution of Sony professional tape products.

Tibensky is responsible for the implementation of short and mid-term strategic marketing, advertising and sales planning for the division.

Lackey at Int'l Space Optics

International Space Optics, S.A., manufacturer of Rainbow CCTV lenses has appointed Daniel E. Lackey National Sales Manager. Lackey is responsible for managing the efforts of regional sales managers and handling O.E.M. and house accounts.



Lackey

Previously, Lackey was Rainbow's Midwestern Regional Sales Manager, and has held positions with Ikegami and Desert Hills.

CALENDAR

Upcoming Events

APRIL

COMDEX: Chicago, Illinois. Contact: (617) 449-8600. April 6-9.

NAB (National Association of Broadcasters): Las Vegas, Nevada. Contact: (202) 429-5350. April 13-16.

Basics of Telecommunications: Boston, Massachusetts. Contact: (800) 422-4636 ext. 115. April 22-24.

NSCA (National Sound and Communications Association): Anaheim, California. Contact: (800) 446-NSCA. April 27-29.

MAY

International DJ Expo/West: Los Angeles, California. Contact: (516) 767-2500. May 4-7.

Society for Imaging Science/Technology: East Rutherford, New Jersey. May 10-14.

International Communications Association (ICA): Atlanta, Georgia. Contact: (214) 716-4143. May 17-21.

Summer Consumer Electronics Show: Chicago, Illinois. Contact: (202) 457-8700. May 29-June 2.

JUNE

ShowTech '92: Berlin, Germany. Contact: (030) 3038-0. June 2-4.

International Conference on Consumer Electronics (ICCE): Rosemont, Illinois. Contact: (716) 392-3862. June 2-5.

Showbiz Expo: Los Angeles, California. Contact: (213) 668-1811. June 20-22.

Image World: Chicago, Illinois. Contact: (914) 328-9157. June 22-26.

JULY

Satellite Dealers Association: New Orleans, Louisiana. Contact: (317) 653-8262. July 8-11.

PRODUCTS

Bose Means Business; Mixing Advantage

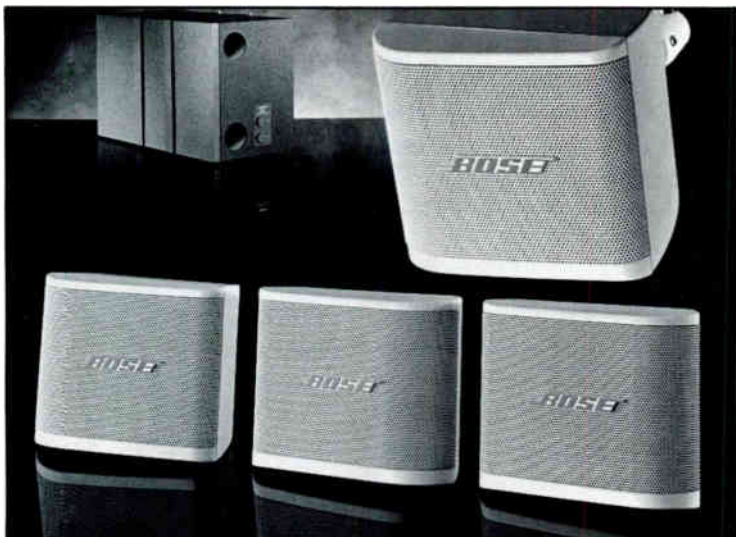

Business Music System

Bose Corporation has introduced the FreeSpace business music system designed to blend into the decor of retail stores, spas and restaurants.

The system includes four cube speakers and an Acoustimass bass module which can be placed or suspended. The four small speaker enclosures provide dispersion of mid and high frequencies. The cubes come in black or white and can be painted.

Circle 1 on Reader Response Card

Multimedia Mixer

The Advantage PM602 is a rack-mount audio mixer, from Biamp, designed for multimedia presentations. With four stereo line inputs and two mono mic/line inputs, the PM602 is meant for applications such as conference rooms, universities, exhibition halls and corporate training facilities.



The unit provides control of audio signals from video tape recorders, audio tape recorders and compact disc players, as well as inputs from microphones and auxiliary mixers.

Circle 2 on Reader Response Card

"Fatboy" Loudspeaker

Community's N-Series FB "Fatboy" loudspeaker is a nearfield system that implements a 3-way "wavefront-coherent" design incorporating a subwoofer unit.

Housed in a black-carpeted trapezoidal enclosure measuring 26 1/2-inches (H) x 18 1/4-inches (W) x 14 1/2-inches (D) with a 22 1/2 degree cabinet pitch, the speaker feature steel edges with integral rigging points and a built-in stand adaptor.

Circle 3 on Reader Response Card



MIDI Machine Control

Fostex Corporation of America has introduced a MIDI machine con-

trolled system. The MTC-1/B claims to be the first product available with MIDI Machine Control (MMC) MIDI interface protocols recently announced by the MIDI Manufacturers of America and the Japanese MIDI Standards Committee. Present owners of R8/MTC-1 recorder packages can upgrade with no charge to the MTC-1/B.

Circle 4 on Reader Response Card

Miniature Condensers

Audio-Technica has introduced its AT845R/RW and AT847R/RW miniature condenser permanent installation UniPoint microphones for teleconferencing, boardrooms, surveillance and special sound reinforcement or recording applications.

The AT845R/RW and AT847R/RW are designed to mount in tabletop,



podium, desk or ceiling applications. The UniPoint element, contained in an XLR-sized housing, slips into a predrilled tabletop opening. Omnidirectional or unidirectional patterns are available as are choices of finish.

Circle 5 on Reader Response Card

else
LOOK WHAT QUAM HAS FOR YOU!

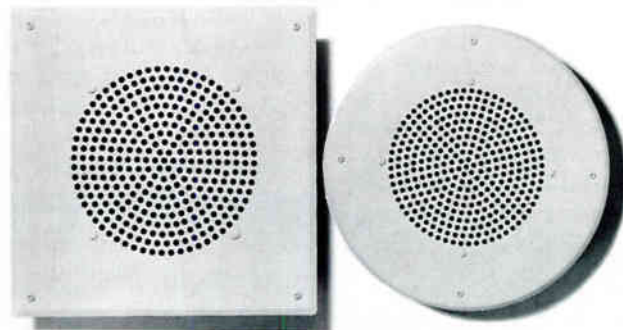

VANDAL-PROOF BAFFLES FOR 8" LOUSPEAKERS
Part No. BS8VP/BR8VP

- Fit Quam square security enclosures plus most popular recessed enclosures
- Carbon steel grille and acoustically transparent 23 gauge steel speaker screen
- Tamper-proof hardware and interior security screen
- Virtually chip and scratch-proof

Ask for FREE Tech Spec TS-44

Quam-Nichols Company

234 East Marquette Road, Chicago, Illinois 60637
Phone: 1 312 488-5800 • FAX: 312 488-6944

Circle 281 on Reader Response Card

March 1992 71



Modular Exciter

Aphex Systems has introduced modular versions of its Aural Exciter. The modules are designed to install in one input module space in the rear of TOA 900 series, University 9000 series, Gemco and Peavey MA series power amplifiers, taking its power from the amplifier.

Both models feature a jumper-selectable bass boost. The model 510B connects to the amplifier's preamp OUT and amp IN jacks on the rear with a phono cord and processes the audio output. The model 520B is a single-channel muting input card. Its RC-type phono jack takes any line level unbalanced input.

Circle 6 on Reader Response Card

Fifth Generation Amp

Bryston has introduced its 4BNPB, 250-watt-per-channel professional stereo amplifier; the fifth generation of the company's 4B series. The redesign includes multiple filter capacitors, a new input design with a proprietary buffer circuit and clipping indicators. The unit also includes a solid-state soft-start circuit.

Circle 7 on Reader Response Card

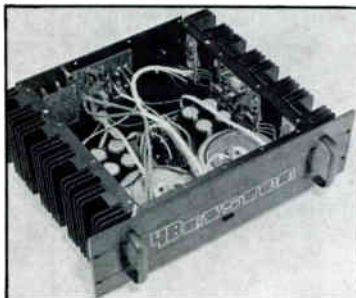

Equalizer/Analyzer

BSS is introducing its FCS-926 dual equalizer analyzer. The unit, which can be configured as two separate channels of programmable six-band parametric equalization, can work as a stereo-linked pair or as a

single mono 12-band parametric equalizer. Included is BSS' Varicurve system of EQ processing and control elements.

Circle 8 on Reader Response Card

Solid State Switcher

Protech Audio Corporation has introduced the model 72590 solid-state switcher. The switcher allows complex systems to be created and features four built-in switch programs including lockout, last-on, all-call and individual closure features. The switcher is linkable to allow for larger system fabrication.

Circle 9 on Reader Response Card



Iris-Type CCD

Ikegami Electronics (U.S.A.), Inc. has introduced its ICD-30 series 1/3-inch black and white camera. The ICD-30 will accept both auto-iris and fixed- and manual-iris lenses. The unit has in excess of 1,050 automatic electronic adjustment steps and is line locked with phase adjustment for system applications.

Circle 10 on Reader Response Card



Forward and Reverse

Gyrr, a division of Odetics, has introduced the TLC1800-TDS time-lapse recorder. Features include a built-in forward and reverse time-date-search to allow the user to search to the exact time and date when viewing video tape, 12 recorder/playback speeds and compatibility with all VHS-recorded formats.

Circle 11 on Reader Response Card



DSP Processing

White Instruments has released its digital signal processing device, the DSP 5000. Features include delay up to 680 milliseconds, parametric equalization with the 'Q' adjustable from .2 to 100 and up to four-way crossover outputs with a greater than 100 dB dynamic range.

Circle 12 on Reader Response Card

Ready Access Paging

The Whiteley TeliPager has been introduced to the American market. The TeliPager is designed to universally interface with public address systems, voice alarms and other industrial control systems. It provides ready access from telephone to public address system. The system's random access memory section uses the store and forward technique for paging.

Circle 13 on Reader Response Card



Signal Processing

JBL has introduced a line of electronic signal processing devices. The M Series Electronics line includes two variable crossovers, a noise gate and a gating compressor/limiter.

The model M644 4-channel noise gate offers four independent noise gates on a single rack unit. The M712 2-channel gating compressor/limiter offers user control of Threshold, Ratio, Attack and Release and a gate with variable threshold for each channel.

Circle 14 on Reader Response Card



VCR Cabinet

The Winsted Corporation has introduced a locking VCR cabinet. Equipped with a see-through plexiglas door, the tamper-proof cabinet allows for viewing of the VCR. The top and front of the cabinet are hinged. The back is vented to allow for air flow. The cabinet is constructed of steel plate with a reinforced steel door. Cable ports in the back allow for power and camera wiring.

Circle 15 on Reader Response Card



Security Products

Burle Security Products introduced several products at February's ISC West in Las Vegas. The TC1914 is a monochrome video monitor that features a 14-inch display tube and is rackmountable. The TC3990 is a high resolution timelapse recorder. In addition, Burle is introducing variations on the Allegiant micro-processor-based switcher/control system.

Circle 16 on Reader Response Card





Digital Loudspeaker Processor

Celestion Industries has introduced the Celestion DLP, a digital processor designed to enhance the performance of the SL600 and SL600Si compact monitors. The DLP employs digital signal processing to correct time-domain errors and claims improvements of image definition, detail and transparency.

Circle 17 on Reader Response Card



Residential In-Walls

MTX has introduced three in-wall loudspeakers to its home loudspeaker line. The series is comprised of three models including a 5 1/4-inch two-way, a 6 1/2-inch two-way and an 8-inch two-way. The models feature polypropylene woofers, soft dome tweeters and 12 dB/octave crossovers. The speakers are designed to resist moisture, dust and temperature changes for its applications, and feature the WallVise mounting system for installation.

Circle 18 on Reader Response Card

Mobile Monitor

The Mobile Monitor from Uni-Screen is a self-contained portable projection unit that features a seven-foot diagonal rear projection screen and a 750 lumen Runco projector enclosed in an oak cabinet with built-in speakers.

The projector is mounted in a drawer riding on positive traction guides and retracts and locks while the unit is being moved. The unit is designed for presentations, teleconferencing and home entertainment.

Circle 19 on Reader Response Card



Coax Import

The Wharfedale Force 9 series loudspeaker has been introduced. The loudspeaker has an SMS coaxial driver with a 12-inch silicon paper cone and a 1-inch formed titanium compression driver sharing a common magnet. The speakers are designed for live performance in theaters, night clubs, ballrooms, arenas, stadiums and churches.

Circle 20 on Reader Response Card



Wireless Headset

Shure Brothers Incorporated has announced its WCM16 Wireless Headworn Condenser Microphone designed for use by vocalists, exercise instructors and production crews.

Produced for Shure by Countryman Associates, the WCM16's features include: adjustable, concealed headband; hypercardioid polar pattern; a pop filter; and an attached cable with a Switchcraft TA4F connector for direct input to the Shure L11 body-pack transmitter.

Circle 21 on Reader Response Card



Monitor Console

The Spirit Monitor is an addition to the Spirit line of consoles from Soundcraft. The Spirit Monitor is a 24-channel console with eight monitor outputs designed for on-stage monitoring applications. Each of the monitor outputs has talkback routing, variable high-pass filter and a 6 dB DIM facility for feedback control.

Circle 22 on Reader Response Card

Audio Subsystem

The VAM2020 series audio subsystem from Notifier functions as a part of an AM2020 fire alarm control panel. Manual or automatic alarm signals generated by the AM2020 are used to generate audio evacuation signals or messages that are distributed throughout the building.

Circle 23 on Reader Response Card

Video Fader

ESE has introduced the ES-233 video fader. The fade-to-black system uses a digital attenuator. Fade operation is triggered by a front panel UP/DOWN switch or an external momentary contact closure or logic pulse to ground.

Circle 24 on Reader Response Card



Linkage.

LED signs that network.

From high-traffic retail settings to industrial communication, LaBelle offers a network that can work alone or with existing audio systems to help any business broadcast information better, faster and to larger audiences than ever before.

Find out how selling LED networks will increase your profits.

Call 1-800-558-9526.

LaBelle
Display Sciences Group

Circle 282 on Reader Response Card



Digital Equalizers

Yamaha Corporation of America has debuted the DEQ5 and DEQ5E digital equalizers. The DEQ5 is either a dual-channel, one-third octave graphic equalizer or a six-band parametric equalizer.

Programming is done on a 240 x 64 LCD screen that graphically displays the EQ curve and provides a text display of utility menus and parameters.

The DEQ5E offers the capabilities of the DEQ5 but lacks front-panel programming controls and displays and is intended to be programmed by the DEQ5.

Circle 25 on Reader Response Card

Message Repeater

Mackenzie has introduced the DMR-Px, an addition to the company's line of message repeaters. The unit is designed for use in arcades, amusement parks, airport zone control, car rental agencies and public service announcements.

Messages are stored in EPROM memory. The DMX-Px converts the digitized sound to analog and plays it through the P.A. system.

Circle 26 on Reader Response Card

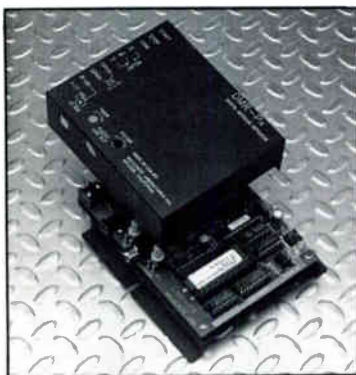

Three Phase UPSs

Square D Company has introduced the Topaz Series Three line of uninterruptible power supplies (UPSs) to provide on-line protection for mid-range computers. The line is designed for input/output devices for critical-load applications including telecommunications/PBXs, health-care equipment, process controls and CAD/CAM/CAE workstations.

Circle 27 on Reader Response Card

Commercial System

Marsh Products, a division of Spectrum companies, has introduced the Series 400 an audio system. Each master is capable of up to four channels that can be used for two-way or monitor speakers. When not being used for intercoms the indoor-outdoor remote stations can be used for background music or paging. In addition, the "Smart" amplifier and logic circuitry regulates voice levels and ambient noise automatically.

Circle 28 on Reader Response Card



Self-Contained Access

Northern Computers has released the Northern Omnilock, a self-contained single door access control system that's designed to replace existing door knobsets with no wiring. The Northern Omnilock and its handheld infrared printer form a system that offers 250 events, holiday scheduling, and access level control.

Circle 29 on Reader Response Card

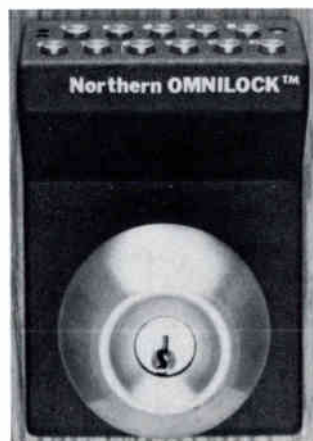

Portable Amp

Electro Force Corp. has introduced the 800-SR-4 power amp. The unit delivers 400 watts rms per channel into 4-ohm speakers with an additional 100 watts per channel headroom. With 8-ohm speakers it delivers 275 watts rms per channel.

Circle 30 on Reader Response Card

Electronic Enclosures

A line of product enclosures is being offered by Equipto Electronics. The line has been designed to offer RFI attenuation at frequencies below 1 GHz. The cabinet offers in excess of 120 dB of attenuation at lower frequencies and approaches 50 dB of attenuation at 1 GHz. The shielded cabinet meets Mil-Std 810D for shock and vibration Mil-Std 901 for shock and can be hardened to meet seismic through Zone 4.

Circle 31 on Reader Response Card

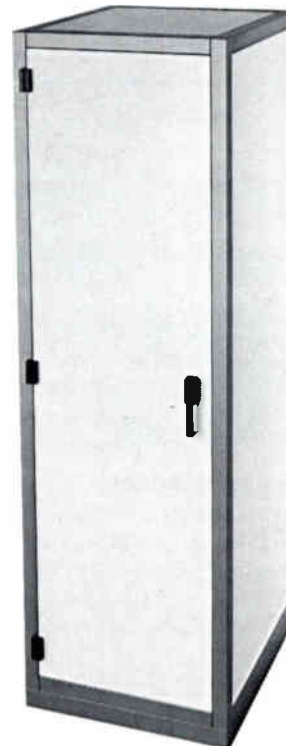

MIDI Automation

Mackie Designs has announced an add-on controller board designed to provide full-fader automation plus muting for the 16 inputs, four stereo

aux returns and main outputs of the CR-1604 mixer. The unit is installed inside the CR-1604 chassis via ribbon cables and can be controlled by MIDI hardware or software.

Circle 32 on Reader Response Card



Monitor Speaker

Bond ElectroAcoustics has introduced a monitor speaker for multiple uses. Bond Monitors allow for tripod mounting and are actively cooled. Features include the capability that allows a user choice of four interchangeable horns for the compression driver. Granite or marble cabinetry are options.

Circle 33 on Reader Response Card



Telephone Access

DoorKing is introducing its Model 1814 Telephone Access System. The 1814 has been upgraded with an electronic directory display. The display provides 1/2-inch alphanumeric characters that the company claims won't fade out in sun light. The 1814 uses a single-line display and includes programmable entry codes, hands-free operation, remote programming programmable talk tin and multiple entry systems on the same phone line.

Circle 34 on Reader Response Card

LITERATURE

Security Library; Fiberoptic Products

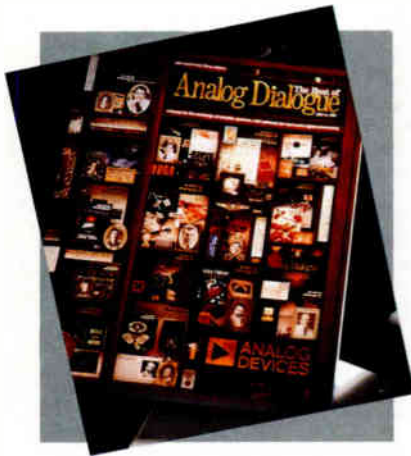

Security and Surveillance

American Fibertek, Inc. has introduced a product catalog that offers fiberoptic products designed specifically for the security and surveillance industry. Included is American Fibertek's full line.

Circle 35 on Reader Response Card

Security Library

Burle Supply, Inc. has released a two-volume Security Library containing information on video surveillance and access control products. The compiled information and a one-year subscription service that will continually update the information, is available.

Volume I includes Burle's Security Products Catalog in loose leaf form. Volume II is the Burle Security Products Design Guide which contains architectural and engineering specifications, product guides, the Security Dimension Newsletter and demonstration software.

Circle 36 on Reader Response Card

Channel Recorder

Astro-Med's eight-to-32 channel recorder is described in an illustrated 12-page four-color brochure. The brochure contains various full-size,

unretouched chart samples of the MT95K2 which offers 64 event and 34 annotation channels, built-in monitor, signal conditioning, 3.5-inch floppy disk drive, 120 megabyte internal hard drive, 32 megabytes RAM and chart speeds up to 500 mm/second.

Circle 37 on Reader Response Card



Collection By Request

Analog Devices has released a 224-page collection of material from its technical and applications journal, Analog Dialogue. The collection, entitled The Best of Analog Dialogue, features articles from the 25-year history of the journal. The compendium features application articles, tutorials and 'problem-solving' products that have been judged by readers and staff to be the most useful and helpful.

Circle 38 on Reader Response Card

Menlo Scientific, Ltd.

Acoustical Consulting and design services for sound contractors

Contact Michael Klasco

Menlo Scientific, Ltd.
39 Menlo Place
Berkeley, California 94707

(510) 528-1277

FAX (510) 526-8087

AD INDEX

Company	Page	RS #
ADI	22/23	214
Aiphone Communication Systems	11	212
Ashly Audio	33	254
Atlas/Soundolier	28	213
Audio Logic	CIII	215
Audio Precision	38	207
Audio Technica	47,49,51	—
BBE Sound	49	287
Biamp/Advantage	27	211
Cal Switch	17	257
Carver Corporation	18	253
Cord Lox	77	232
Crown International	31	256
CT-Audio	54	286
DJ Expo	48	—
Frazier	14	268
Gilderfluke & Company	26	269
JBL Professional	CIV	—
Kelvin Electronics	77	238
LaBelle Industries	73	282
Mellotone	77	237
Menlo Scientific	75	252
Microframe	58	285
Modular Audio Products	77	235
Music Supply Company	77	231
Nikkodo, USA	77	233
NSCA	67	276
Opamp Labs	77	234
Optim Audio	43	274
Peavey-Architectural Acoustics	CII	205
Qualitone	77	230
Quam-Nichols	54,2, 208,280,	
	71	281
Racom	59	279
Rane Corporation	8	209
Raxxess Metalsmiths	54	290
RCI Systems	59	283
Renkus-Heinz	41	258
Samson Technologies	15	201
Seamtech	77	236
Sennheiser Electronics	25	255
Shure Brothers	7	204
Sonic Systems/Soundsphere	24,57	250,251
Tascam	19	220
Techron	13	210
West Penn Wire	3	202
Whitenton/Juice Goose	42	277
Williams Sound	37	270
Yamaha Pro Audio	20	203

FREE INFORMATION

Use the Reader Service Card opposite page 34. Just circle the RS# of products that interest you. Detach, and Mail!

HELP WANTED

AUDIO/VIDEO SYSTEMS DESIGN CONSULTANT

Audiovisual/acoustical consulting firm in midtown Manhattan (NY) seeks consultant with a minimum of 5 years experience in the design and implementation of audiovisual, video and television systems for corporate and institutional clients. Technical experience should include audio, video, television studio, remote controls, teleconferencing, basebuilding systems and architectural coordination. The firm has exciting projects worldwide, good benefits and advancements opportunities. Excellent writing and presentation skills are required. Fax resume and cover letter to: Shen Milsom & Wilke, Inc. 212-725-0864.

FOR SALE

Sound & Communication Systems Sales
Equipment salesperson needed for international music co. for NYC & L.I. territories. Salary + commis + excel benefit pkg. Prefer person exp'd working w/electrical contractors. Please fax or mail resume to:
MUZAK
25-34 Jackson Avenue, LIC NY 11101
Fax 718-392-2663

NOTICE OF PUBLIC SALE

On Thursday, April 30, 1992, at the warehouse facility located at Suite 100, 501 Industrial in Richardson, Texas, a public sale will be held at 10:00 a.m., local time, to sell for cash or prior approved credit the audio, visual gear generally described below, said property being held to secure obligations arising under a security agreement between First Gibraltar Bank, FSB, as secured party, and Kimball Audio-Video, Inc., as debtor. The property will be sold in units, parcels or bulk as First Gibraltar Bank, FSB, may designate at the sale. First Gibraltar Bank, FSB, reserves to bid at this sale and to withdraw items from sale. All sales will be "as is".

The property to be sold includes the following: (1) video equipment, including 1/2" and 3/4" video cassette players and recorders, monitors, laser disc players, video projectors, cameras, switchers, dimmers and lighting fixtures, projection screens, sync generators, time base correctors and distribution amplifiers; (2) audio equipment, including microphones, stands, amplifiers, mixers, tape recorders, noise reduction units, headsets, equalizers, compressors and speakers; (3) computer equipment, including personal computers, keyboards, printers, scanners, data projectors, overhead panels, software and monitors; (4) film and slide equipment, including film and slide projectors, lenses, sequencers, dissolve units, projection screens and multi-image computers; and (5) accessories and furnishings, including cables, interface equipment, carts, lamps, tables, chairs, copy machines, test equipment, typewriters, equipment racks and travel cases.

For a complete list of the property being sold, for an appointment to view the property, or for additional information regarding the property or the public sale, contact Bob Ramsey at First Gibraltar Bank, FSB, telephone number (214) 444-5179.

SALES ENGINEER

For company involved in the design, sale and installation of sound reinforcement and communications systems. Will contact customers and design sound reinforcement system to fit their needs. Will manage the installation of projects according to specifications. Promote the incorporation of audiovisual equipment into public school system construction specifications. Provide technical services to clients. B.S. in Electrical Engineering, 2 years in job offered or 2 years as Electrical Estimator/Project Manager. Will supervise 2 employees. 40-hour week, 8:30 AM-5:00 PM. \$500 per week. Send resume to: Job Service of Florida, 105 East Broward Boulevard, Ft. Lauderdale, Florida 33301 ATTN: Job Order No. FL0560994

WANTED:

MANUFACTURER'S REPRESENTATIVES

Power Protection Products mfr is seeking independent sales reps to represent our line in the security & audio/visual markets.

Please send resume to:

Kalglo Electronics Co., Inc.
Dept SC
6584 Ruch Road
Bethlehem, PA 18017

EQUIPMENT FINANCING

- ◆ No Down Payment
- ◆ True Lease or \$1.00 Buyout
- ◆ Fixed Rates, Long Terms
- ◆ No Financial Statements Required
- ◆ New or Used Equipment
- ◆ for Transactions Under \$50,000

AMERICOM
LEASING, INC.

To apply or request information contact
John McMendes

(713) 680-8822

Circle 239 on Reader Response Card

GET RESULTS

Put a Market Place ad to work for you.

For rates and information —

Call:
(516) 767-2500

MARKETPLACE

One Stop!

Great Prices
Great Service

EVERY DAY SINCE 1958!

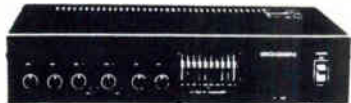

Qualitone

FREE! 164 pg. Dealer/
Contractor Catalog.
800-431-2490

896 Locust Street Box 214 Mount Vernon, New York 10552

Circle 230 on Reader Response Card



THE
ORIGINATORS OF KARAOKE
HARDWARE/SOFTWARE
ACCESSORIES
AMERICA'S #1 KARAOKE



ITT FINANCING



1-800-NIKKODO

Circle 233 on Reader Response Card

The Source for the
Latest Information on
Models, Prices, Specs.

The Music & Sound Buyer's Guide

ORDER YOUR COPY NOW!

For each copy send \$7.95 plus
\$2.00 postage and handling.

THE MUSIC & SOUND
BUYER'S GUIDE

25 Willowdale Avenue
Port Washington, NY 11050

INSTALLERS!



• 3 SIZES
• All Steel Construction
• Carry like a briefcase

PUSH-PULL RODS Get cable through impos-
sible places. Extends 45'. Light weight. Flexible



SPEAKER & TILE
SUPPORTS
SPEAKER
ENCLOSURES



ALL STEEL LIGHT WEIGHT but STRONG for all
4" and 8" SPEAKERS in ALL types of CEILING
U.L. LISTED FREE SAMPLES



The Audio Serviceman's Right
Arm. Check the complete sound
system from MIC to SPEAKER
TESTSET TS-1A ... and much, much more.

CALL OR WRITE FOR CATALOG
MUSIC SUPPLY CO., INC.
809 North Madison • Dallas, TX 75208
ALL 50 STATES 1-800-527-1522
FAX 214-946-9155 Local 214-946-8450

800-527-1522

Circle 231 on Reader Response Card

Free Catalog & Audio/Video Applications

Routing Switchers (SI-A/V)
(24, 16, 12, 8, 4, 2 stations)

Mic, EQ, Line,
Tape, Phono,
Disc, Trans.,
Video, ACN,
Pwr. Supp.

Press Boxes
1-in/18-out
Video/Audio
2-in/24-out Audio

Video & Audio Dist. Amps.
RGB-Sync Dist. Amps.

OPAMP LABS INC (213) 934-3566
1033 N Sycamore Av LOS ANGELES CA. 90038

Circle 234 on Reader Response Card

RIP-TIE
Velcro® Cable Wraps

FAST
EASY
TIDY

Sum Tech 800-348-7600
P.O. Box 77394 San Francisco, CA 94107

Circle 236 on Reader Response Card

AC/DC VOLTAGE
AC/DC CURRENT
DIODE TEST LOGIC TEST
LED TEST GOOD/BAD
5 FREQ RANGES
5 CAPACITANCE RANGES
LOW BATTERY Warning
CONTINUITY TEST/BUZZER
TRANSISTOR CHECKER
20 MHZ FREQ COUNTER

PRO 400

\$69.95

Stock No. 890092

2 YEAR WARRANTY
PARTS & LABOR

KELVIN Electronics
(516) 756-1750 1(800) 645-9212
FAX (516) 756-1763 VISA M/C

Circle 238 on Reader Response Card

TOP CASH PAID FOR VACUUM
TUBE AUDIO EQUIPMENT.
Especially Western Electric, Marantz,
McIntosh, Altech, JBL, Pannoy, etc.
Pls. Call Collect
(908) 249-3738

Cord Fox

VELCRO CORD-TIES



- Over 20 Standard Designs
- 18 Colors Available
- Custom Printing
- Can Build to Your Specs!

Toleeto Fasteners International

170 Mace St. E-6 (619) 426-3725
Chula Vista, CA 92011 FAX (619) 422-2084

Circle 232 on Reader Response Card

FREE 56-PG CATALOG

Complete line of audio
modules and accessories for all engineered
sound & broadcast applications

MODULAR AUDIO PRODUCTS
1-800-333-7697 • 516-345-3100 • FAX 516-345-3106
DIV. OF MODULAR DEVICES INC. • 1 RONE RD. • SHIRLEY NY 11967

Circle 235 on Reader Response Card

FLAME RESISTANT ACOUSTIC GRILLE FABRICS

Meeting Fire Code Safety Standards.

ALL FABRICS INVENTORIED AND
AVAILABLE FOR IMMEDIATE SHIPMENT

CALL OR WRITE FOR YOUR
FREE SAMPLE FOLDER AND PRICE SHEET

MELLOTONE®

Mills: Post Office Box 145 • 108-East Church Street
Blacksburg, SC 29702 • (803) 839-6341
Fax (803) 839-2911

Circle 237 on Reader Response Card

PRODUCT CHECK:

SOUND MASKING SYSTEMS FOR OFFICES

Products used most frequently in office installations . . .

... NOW IN PROGRESS

PRODUCTS

	FIRST PLACE	SECOND PLACE	THIRD PLACE
Noise Generators	ATLAS/SOUNDOLIER	DUKANE	WHITE
Processors	ATLAS/SOUNDOLIER	DUKANE	YAMAHA
● Graphic Equalizers ●	RANE	WHITE	ATLAS/SOUNDOLIER
Amplifiers	TOA	QSC	ALTEC LANSING
Loudspeakers	ATLAS/SOUNDOLIER	DUKANE	JBL
Mounting Hardware	ATLAS/SOUNDOLIER	JBL	DUKANE

* indicates tie

... IN LAST SIX MONTHS

PRODUCTS

	FIRST PLACE	SECOND PLACE	THIRD PLACE
Noise Generators	ATLAS/SOUNDOLIER	DUKANE	WHITE
Processors	ATLAS/SOUNDOLIER	DUKANE	YAMAHA
● Graphic Equalizers ●	RANE	ATLAS/SOUNDOLIER	WHITE
Amplifiers	TOA	QSC	ALTEC LANSING
Loudspeakers	ATLAS/SOUNDOLIER	DUKANE	QUAM-NICHOLS
Mounting Hardware	ATLAS/SOUNDOLIER	DUKANE	JBL

* indicates tie

SURVEY METHODOLOGY

1. The sampling pool for the survey consists of sound and communications contractors from Sound & Communications' subscription list. Only contractors within the United States and Canada are called.
2. In a telephone survey, contractors/installers selected at random are asked to identify what brand they used for various products in installations completed in the past six months and those in progress. A different type of installation is highlighted each month.
3. On completion of the survey, results are tabulated and the product brands are ranked on a scale from one to three, with number one having the most votes. Separate rankings are made for installations occurring in the past six months and for those in progress.
4. An asterisk (*) denotes a tie for that ranking.

Copyright © 1992 SOUND & COMMUNICATIONS PUBLISHING, INC. Reprint of any part of contents without permission forbidden. Titles Registered in the U.S. Patent Office. Sound & Communications (U.S. P.S. 943-140) (ISSN #0038-1845) is published monthly by Sound & Communications Publications, Inc., 25 Willowdale Avenue, Port Washington, N.Y. 11050. 516-767-2500. President, Vincent P. Testa. Subscription rates: U.S.—1 year \$15.00, 3 years \$37.50. All other countries—1 year \$25.00, 3 years \$67.50. Subscriptions outside of U.S. must be paid in American currency. Second-class postage paid at Port Washington, NY and at additional mailing office. POSTMASTER: Send address changes to Sound & Communications, 25 Willowdale Avenue, Port Washington, NY 11050.



Audio Logic Commitment to Quality

At Audio Logic we believe that quality isn't defined with a fancy logo or a price tag. Instead, it is a commitment in purpose and policy through every step of the manufacturing and testing process. And we back up that commitment with a two year warranty on every product. In a professional sound system, each unit in the audio path is critical to performance and reliability. In the same way, every electronic component in an Audio Logic processor is equally

critical. That's why we at Audio Logic insist on 1% resistors and capacitors, when other manufacturers settle for 3% or 5% tolerances. The difference is hardly perceptible, unless it happens to affect your system. Commitment to quality. It's the Audio Logic guarantee. Because your commitment to performance and reliability in the systems you build for your customers can only be as good as ours. And that makes your choice simple logic...Audio Logic.



5639 SO. RILEY LANE • SALT LAKE CITY
UTAH 84107 • 801-268-8400 • FAX 801-262-4965

©1991 DOD ELECTRONICS CORPORATION
Circle 215 on Reader Response Card

Behind Every Virtuoso, There's Years Of Practice.



Europa

Virtuosity takes practice. And almost two decades of practice have gone into producing the definitive front-of-house console: Soundcraft's *Europa*. The best circuit designs, like our patented padless mic amp and active pan pot. Balanced sends, returns, inserts; fully-parametric EQ and a noise gate on every module. The list goes on.

But the secret of *Europa* isn't just ours — it's yours. We asked professionals working in every area of live sound what they wanted in an FOH console. And we designed *Europa* with you in mind.

It's designed to withstand the rigors of the road. The frame is immensely strong, built to prevent twisting. Handles run the length of the console to make it easy to lift. Multiway connectors are recessed to reduce strain, mounted to resist damage.

The smallest detail has been scrutinized. The knobs, for example, combining "grippability" with style so ingeniously, we patented them too. No dual concentric controls on the entire console — you won't tweak the wrong thing. All switches are illuminated or associated with LEDs.

Europa combines superb design and audio quality with value for money. Without compromise. A full eight groups plus mono and stereo buses, twelve aux sends, matrix sections with external inputs for additional submixes and eight stereo inputs are standard. Full VCA facilities with non-destructive soloing and multiple assignment. You can even continue a soundcheck while playing a CD to the audience. And fade the entire console on one fader. If you've always wanted something on a live sound console, it's probably on the *Europa*. You asked for it; we put it there.

Now you need to listen to *Europa*. Try it out. Experience a level of sound quality that you'd usually associate with a digital studio. Hear why *Europa* is in a class of its own — virtuoso class.

Europa. Between us, we've designed the best.

Soundcraft

Soundcraft USA/JBL Professional,
8500 Balboa Boulevard, Northridge, CA 91329

■ A Harman International Company