

SOUND & COMMUNICATIONS

FOR CONTRACTORS, SYSTEM MANAGERS, AND SPECIFIERS

APRIL 1986

TV NEWS

High Rise Safety Systems

SGND2MBAL5000 .CA0 01 000MAY86
MARK GANDER
JBL INCORPORATED
8500 BALBOA BLVD
NORTHBRIDGE CA 91329

**Distributed Sound System Design
ISDN: Tying America Together Bit By Bit
The Disco System at the Palladium**



NEW WAVE DESIGN

Blocking the Incoherent Wave

Cast into the throat of every **TransPlanar™ HP horn**, unique beamwidth control vanes represent a revolutionary advance in constant-directivity design. Until now, two-inch-throat designs were compromised by on-axis dropout. Intrigued with this curious problem, EV engineers applied principles of geometric optics to isolate the incoherent waveform responsible for this phenomenon. Instead of coursing down the horn in an organized fashion, this offending wave reflects off the walls of a two-inch throat, shadowing direct output and causing a loss in level. Ray analysis was used to predict this occurrence and determine the exact configuration of slotted waveguides which block the cancelling wave and eliminate on-axis dropout.

Acting together with an optimum diffraction slot, the beamwidth control vanes also eliminate both horizontal and vertical beaming in the very highest octave. Other two-inch-throat designs exhibit narrowing of the coverage angle above 10,000 Hz. But the new HP horn maintains uniform dispersion to 20,000 Hz!

When Electro-Voice invented the constant-directivity horn in 1972, we really started something. Now we're making waves again... introducing second-generation CD design with the most uniform beamwidth control in the industry. To learn more about the new HP horn or the high-performance DH-1 and DH-2 two-inch-exit drivers designed especially for them, contact Pro Sound Marketing at Electro-Voice, 600 Cecil St., Buchanan, MI 49107. **We'll be glad to tell you why when the competition beams, we just smile.**



EV **Electro-Voice®**
SOUND IN ACTION™

See us at Booth #73

Circle 219 on Reader Response Card

World Radio History



Toa/Files



Date
First Quarter 1986

Installation

Expanded the **Toa 900 Series Music & Paging System** in the downtown shopping center. Management office now has the six-channel mixer power amp, and the center's entire system now contains eight of the 900 Series' different modules.

Comments

This was a typical high-quality Toa installation, which means I don't expect to make any service calls. Customer is pleased with the sound quality and easy operation of the 900 Series, and I'm pleased with the 900 Series' flexibility, availability, and profitability.

Future Prospects

We discussed the expansion made possible by the 900 Series' modularity, which accommodates their future needs. Contact mall management next week & explain how simple it is to expand system to warehouse and employee lounges.

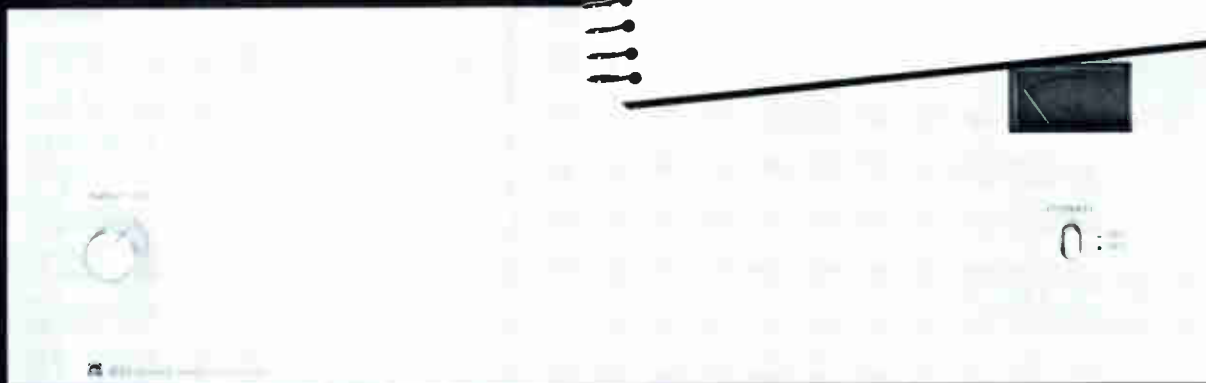
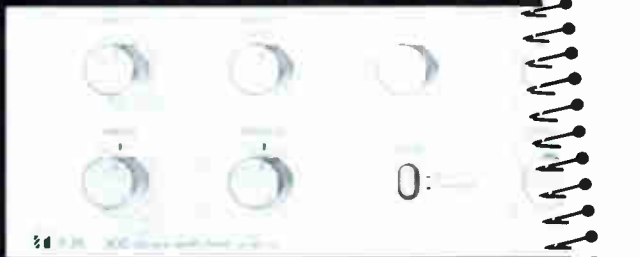

Install Confidence.



Toa Electronics, Inc.
Commercial/Engineered Sound Division
See us at Booth 5

480 Carlton Court
South San Francisco
California 94080
(415) 588-2538

Toa Canada: (403) 489-5511 Edmonton, or (416) 624-2317 Toronto ■ Toa U.K.: (0277) 233882 Essex ■ Toa Europe: (040) 811127 Hamburg

FSR inc.

LEADERS IN:

- Hotel Ballroom Combining Systems
- Digital Boardroom Control Systems
- Teleconferencing Equipment
- Remote Control Modules For All Audio Visual Equipment
- Deluxe Conference Room Floor Boxes
- Custom Panels
- Custom Engineering
- Audio & Video Switching Units
- Infrared Control Equipment

See us at Booth 8

FSR inc.
creators of innovative
products for AV systems

220 Little Falls Road
Cedar Grove, NJ 07009
201/783-3966 ■ 201/239-0988

Circle 225 on Reader Response Card

IDEAS & VIEWPOINTS

Standards, Surveys, & Shows

by Chris Foreman

The so-called "integrated services digital network," (ISDN) as described by Sandy Kyriash in her article this month, may seem far-away and unimportant if your main business is sound contracting. So what are we doing covering it in *Sound & Communications*?

Well, we are a sound and *communications* magazine. Thus sound may be our primary editorial focus, but we must also cover other communications subjects. Of course, "communications" is an incredibly broad subject. So, how do we decide which sub-topics to cover?

It's not easy but we do our best to choose those subjects that will be of general interest to our readers (based on our reader surveys and your letters). And, we do our best to choose topics that represent important changes in the overall communications business. ISDN is one of those topics.

Why is ISDN important to the sound contractor? I have two answers to that. The first answer is that ISDN will affect everyone in any kind of business because it will affect the way you communicate. Even if all you sell is industrial paging systems, ISDN will affect your business because the telephones your customers use to access your paging system will, eventually, be all digital. Many of them are already; ISDN will simply speed the process.

My second answer to why ISDN is important to the sound contractor is "I don't really know." Before you laugh too loud, let me say I'd probably give the same answer to a question like "why is it important for us to go to the moon?" The point is, it's not easy to judge the impact of a major event like ISDN until after the fact.

One thing I'm certain of. ISDN will be a major event. And, while the entire ISDN won't happen overnight, some of the network is already in place. The future begins today, and that's why we're reporting on it today.

THE SOUND CONTRACTING SURVEY

A new *Sound & Communications*/NSCA contractor survey, compiled by Charles Dietz Associates, is being finished as I write this in late March. The survey covered a lot of ground and should help contractors see where they fit in our industry. The survey was mailed to *Sound & Communications* contractor subscribers and to all NSCA members. If you didn't get one, you probably aren't in one or the other of these categories (and you should be in *both!*).

Full results of the survey will be mailed only to those contractors who returned the survey and requested a copy of the results. A summary, however, will be published in the May issue of *Sound & Communications* and in the May issue of the NSCA Newsletter. Look for it!

THE NSCA EXPO

Like most trade organizations, the NSCA has its problems. (I still can't get on their mailing list after asking for two years.) On the other hand, I think they are doing a great job of identifying and working on industry issues and the regional NSCA shows are, in my opinion, a great idea (and apparently a real success). I hope eventually the NSCA will have the clout to pull us together as an industry and get us to do things that are already common in other industries (like statistical reporting).

In May, it'll be NSCA convention time again. In fact, a lot of you may be reading this at NSCA. If so, I hope that you will come to the *Sound & Communications* panel discussion on "Expanding Our Markets" and I hope you enjoy our NSCA-TV News. See you there.

Introducing

HEXCOLUMNS™

DIRECTIONAL SOUND COLUMNS

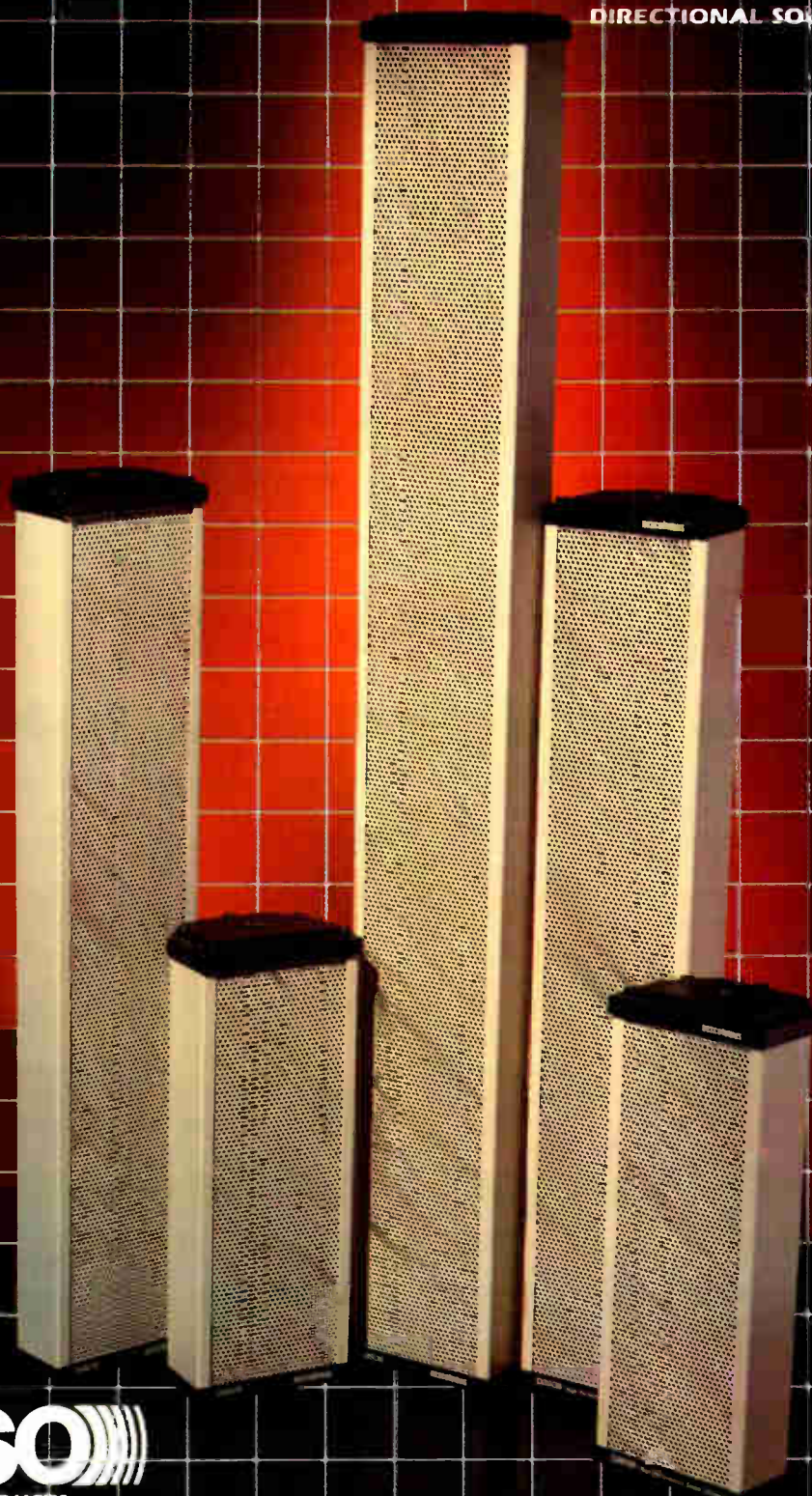

pasos
SOUND PRODUCTS

For more information please contact:
Paso Sound Products, Inc.
14 First St. — Pelham, NY 10803
914-738-4800 Telex No. 646783

See us at NSCA Booth 96
See us at EDS Booth G9

Circle 268 on Reader Response Card

WHEN MANUFACTURERS MERGE

by Iver I. Rose

When you think about corporate mergers and acquisitions, you might think of big fish eating little fish. And this predatory image accurately reflects firms which buy companies and then resell them for a quick profit.

However, both sound and communication contractors and manufacturers describe the recent mergers and acquisitions in their industry as more cooperative than predatory. While you will hear a variety of opinions on the long-range effects that these mergers and acquisitions have on the sound and communications industry,

Most industry sources report that recent acquisitions and mergers improved the companies which were acquired.

most industry sources report that recent acquisitions and mergers improved the companies which were acquired.

Altec Lansing, Gulton, & Mark IV

In July, 1985, Electro-Voice's parent company Gulton Industries acquired the assets and business of bankrupt Altec-Lansing. Bob Pabst, vice president of

the Gulton audio sector and president of Gulton's EV division, said the acquisition benefited Altec-Lansing by "injecting capital and more efficient management practices." According to Pabst, "our contributions will allow Altec to restore itself to worldwide preeminence in fixed-installation sound."

Pabst cites improvements in Altec-Lansing's repair service and dealer education. When Gulton acquired Altec-Lansing, Pabst said, the company had a two-month backlog of equipment for repair. Within a few months, efficient management reduced the repair turnaround time to two weeks.

As for dealer training, Pabst said, "The Altec-Lansing that people remember as being famous for its seminars and training is back after an absence of a couple of years." He added that Altec-Lansing ended a four-year absence from AES conventions when it exhibited at the recent AES convention in Montreux, Switzerland. Pabst also noted the resurgence of educational programs citing the company's recent educational seminars in California, New Jersey and Florida and visits to Altec-Lansing distributors in Europe and the Far East.

According to Pabst, Altec-Lansing's customer service has also improved since the acquisition. "We still have the Altec-Lansing direct sales force in the United States. That was one of the

great assets of the the company we acquired. The Altec-Lansing contractor has been remarkably loyal, sticking with the company through years of quality and delivery problems. Now that loyalty has paid off. The contractor sees better delivery, product quality and company responsiveness."

Mel Wierenga, president of Ascom, a contracting company, confirmed Pabst's statements. "It was a plus for us that Gulton acquired Altec-Lansing. Now a regional manager drops in to talk with us about products. We didn't have that when Altec-Lansing was in its financial straits. Also, delivery and repair speed has improved," Wierenga said.

Bob Ancha, Jr., vice president of Ancha Electronics, also agreed that the acquisition by Gulton has strengthened Altec-Lansing. "Gulton has a very strong management and its EV division is one of the premier sound reinforcement manufacturers. What Gulton has done is nothing short of a miracle, bringing Altec back with more financing and more engineering. Altec-Lansing has been reinvigorated," he said.

While the contractors have responded positively to the new management of Altec-Lansing, Pabst said he feels that some customers might fear the Altec-Lansing lines will merge with EV lines and lose their identity. He pointed out that when EV acquired the Tap-

co product lines in the 1970s, EV integrated the Tapco products with its lines then eliminated the Tapco name. But Pabst said Gulton did not acquire Altec-Lansing for this purpose. Gulton intends to continue and strengthen the Altec-Lansing reputation as a leader in the professional sound market.

Now, less than a year after the Gulton acquisition of Altec-Lansing, Gulton is in turn being acquired by Mark IV Industries. The Gulton board of directors has recommended that shareholders accept Mark IV's offer of \$34 per share. (The stock had traded around \$22 before Mark IV started buying it.)

"The Mark IV acquisition will have little if any effect on the way we do business, except in that they might be interested in more aggressive growth for the audio divisions," Pabst said.

Ancha said, "I don't think Mark IV will have any effect on Altec-Lansing or EV."

But Wierenga said, "Perhaps Mark IV will strip the company and leave an empty shell. I'm concerned that might happen, but I have no way of knowing what Mark IV will do."

Biamp, Klark-Teknik, & the Cetecs

In August, 1985, the sound reinforcement industry saw another acquisition with Leupold and Stevens, a manufacturer of optical products, buying the

Maybe we should give away our products. And sell our service.

The thought has occurred to us more than once. Not that Quam products aren't worth the money. They are. We build some of the best-made, most innovatively-designed loudspeakers, baffles, backboxes and accessories in the industry. But we know you can buy adequate product elsewhere.

What you can't buy elsewhere is our service. Beginning with a factory inventory of 70,000 catalog items, with same-day factory assembly of 3450 different loudspeaker, baffle and transformer combinations. And shipment of your order within 24 hours—without exception and without backorders—so you can have the Quam products you need, when you need them.

We manufacture and stock not only a dozen different 8" models, but the hard-to-find loudspeakers as well. With Quam, you have a wide choice of speaker sizes and configurations—from 2" and 5" intercom speakers to 3" outdoor

speakers to 12" coaxial foreground speakers—that are standard items ready to ship, not specials that make you wait.

Exceptional quality—and quality control—is another Quam service. No guesswork. No costly testing time or call-back problem. Power ratings for every Quam speaker are established in accordance with EIA RS-426 Standard for Loudspeaker Power Ratings.

And, wherever you are, there's a Quam representative close by, knowledgeable and helpful. This national capability is worth something, too.

It's hard to put a price on this kind of complete service, so we'll continue to give it away to the sound contractors who buy our products. They know what a bargain they're getting!

The Quam: Sound Decision since 1930.

See us at Booth 32



QUAM-NICHOLS COMPANY • 234 EAST MARQUETTE ROAD, CHICAGO, ILLINOIS 60637 • (312) 488-5800

Circle 236 on Reader Response Card

assets of Biamp Systems.

Don Waggoner, president of Biamp Systems, said the company had been privately owned and had been losing money before Leupold and Stevens acquired it. He said these losses had not reduced product reliability, increased repair time, or disrupted communications with dealers. However, he added, the capital supplied by Leupold and Stevens has allowed Biamp Systems to improve training of its independent sales reps and to develop new products.

For Klark-Teknik who this year purchased Darden Davis Associated Ltd., a British-based manufacturer of audio consoles, the acquisition permitted Klark-Teknik to expand its name into a new product market.

"This move increases Klark-Teknik's product range and brings us into the mixing console industry, where we can use our technical expertise and distribu-

tion network to a very good effect," Philip Clarke, chairman and managing director of Klark-Teknik, said.

The decision to expand to the mixing console industry was made two years ago, when Klark-Teknik decided it was ready to expand its products offered around the world besides those in signal processing. Jack Kelly, U.S. president of Klark-Teknik, explained, "It took well over a year just to find a company with which we were satisfied. The individuals involved at DDA shared the same philosophy as we at K-T do, both in engineering and commercial."

DDA will continue to operate from Ilseworth, England under the DDA banner. Plans have already been made for engineers from the two companies to begin collaborations. "This will begin to bring the expertise in mixing consoles together with that of Klark-

Teknik," said Kelly. For the time being, products already manufactured by DDA will bear the DDA name.

The company does see prospects for success for both parties as a result of this acquisition. Though DDA has become a wholly-owned subsidiary of Klark-Teknik, some products will continue to be released under the DDA name, Kelly reports. Those products designed through the combined efforts of both engineering staffs will be brand-named according to the market segment. According to Kelly, "There really aren't any hard and fast rules as to which is used. It really depends on what market we are dealing with and what it calls for."

Another example of companies which were acquired and brought under one corporate umbrella is the Cetec Corporation. In recent years, the Cetec Corpora-

tion acquired the Vega, Gauss, Raymer, and Ivie audio companies. Cetec Vice President Dick Drake said that while his firm now manufactures only commercial and professional audio products, its management would buy a consumer audio company if they could do so profitably.

What does it all mean?

One industry insider said that the current mergers and acquisitions in the sound reinforcement industry indicate a reversal from the trend of the last 15 years which saw a sound and communications industry that nourished smaller, specialized equipment manufacturers. The insider predicts that most of these small, specialized companies will eventually merge with larger corporations. So, by the year 2000, there will be only four or five full-line manufacturers which will

(continued on page 78)



Now Available in Wood Veneer Finish

There oughta be a law!

The way our new high tech CG Series blew away the competition makes you wonder how they got away with it for so long. Two and three-way systems, Stage Monitor and Sub-Woofer.

**THE COMMUNITY CS SERIES
OF LOUDSPEAKERS
BIG GUNS FOR LITTLE MONEY
CALL TODAY FOR MORE AMMO**

Community

See us at Booth 39
Community Light & Sound, Inc.
333 East 5th Street
Chester, PA 19013

(215) 876-3400

Circle 270 on Reader Response Card

WEST PENN WIRE

WE CURE COMMUNICATIONS WIRING HEADACHES!



There is more to wire than just the installation. There are very important terminations to the equipment. You want to make them quick and efficient.

That's why, when it comes to connecting wire, you need **WEST PENN'S - "PERFECT STRIPE"™ - Multi-conductor and the "PERFECT PAIR"™ -**

West Penn's unique double extrusion method makes the stripes an actual part of the insulation.

See us at Booth 38

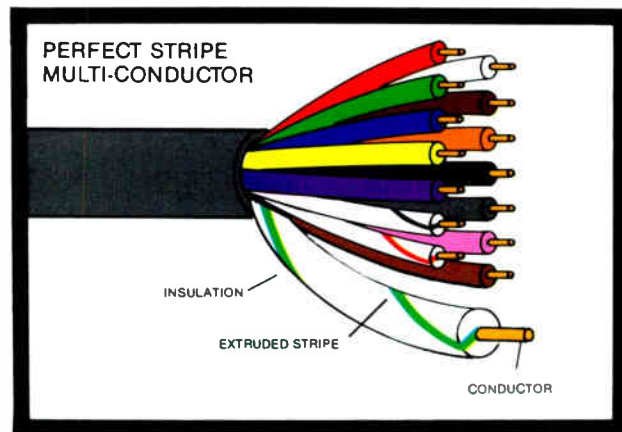
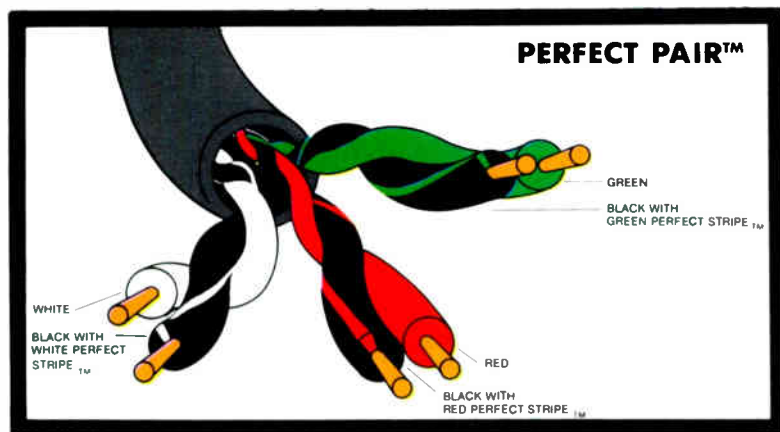

Conductors 13 and above have PERFECT STRIPE™

Circle 249 on Reader Response Card

For Quality and Service 10 Stocking Locations

So call us today - 800-245-4964. You'll find we're just what the doctor ordered.

WPW WEST PENN WIRE CORP.

Call our Hot Lines - 800-245-4964 - in Penna - 800-222-8883

World Radio History

LATE BREAKING NEWS:

AKG ACOUSTICS INC. ACQUIRES URSA MAJOR AS NEW DIGITAL PRODUCTS DIVISION

AKG Acoustics Inc. of Stamford, CT, has acquired all assets and trademarks of Ursa Major of Boston, MA, thus formally establishing a new Digital Products Division with AKG Acoustics, it was announced by S. Richard Ravich, AKG vice president and general manager, and Christopher Moore, Ursa Major president. In addition to the extensive R&D activities undertaken by parent company AKG Acoustics of Vienna, Austria, the new Boston-based facility will become AKG's second R&D center for digital product development. AKG Acoustics' Stamford facility will handle all U.S. sales and marketing, export, and administration for the new division. All products for the new Digital Products Division, to remain in Boston, will be released under the AKG name. Moore, the newly appointed executive vice president of the division, will be in charge of all future projects and will head the product development team maintaining the current staff. Ravich said: "The establishment of this new U.S. subsidiary will enable AKG to better respond to the demands of the U.S. market, and without being affected by international monetary fluctuations." Two new products introduced under the AKG name at the recent National Association of Broadcasters Convention were the MSP 126 stereo processor and the ADR 68K reverb, which represents the first product in a new generation of digital reverb/effects processors.

COMMUNITY AND WHELEN ENGINEERING SIGN NEW LOUDSPEAKER AGREEMENT

While it had been reported that Community Light & Sound was near agreement with Whelen Engineering on a merger last year, negotiations to that end eventually fell through. However, the two companies continued other negotiations and have finally announced an agreement concerning loudspeakers and loudspeaker systems for high-powered emergency public address and siren warning systems. Under the terms of the new agreement, Community has granted Whelen exclusive rights to certain present and future loudspeaker products, including the highly successful WS3000 horn developed by Community. In return, Whelen has granted Community exclusive manufacturing rights to other products covered by the agreement. Whelen and Community entered this agreement in lieu of their previous merger plans according to a Community spokesperson, because they felt it would better serve the interests of both parties.

DOLBY ANNOUNCES SPECTRAL RECORDING SAID TO REVOLUTIONIZE INDUSTRY

At a press conference at the MGM screening room in New York this month, Dolby debuted its spectral recording process, Dolby SR, which will revitalize analog recording and transmission technology. At a cost of \$750 per module, the SR card provides a dynamic range that exceeds any 16-bit digital system. In a sampling of recordings that incorporated the SR process, no noise could be heard—even in one sample of a sixth generation voice announcement. Beyond SR's obvious ramifications to the analog/digital issue are: audiophile quality in optical and magnetic cinema systems; increasing the use of 7½ ips cassette and cartridge formats; reducing noise, hums, buzzes, and crosstalk in land lines, broadcast links, and teleconferencing systems.

MOTOROLA TO SUPPLY FIRST 800 MHZ CELLULAR SYSTEM IN CHINA

Motorola Inc. has been selected to supply the People's Republic of China (PRC) with its first 800 MHz cellular radiotelephone system. The system, to be installed and implemented in Beijing, China's capital, will be a TACS (Total Access Communications System) similar to the type adopted in the United Kingdom. The contract is valued in excess of \$3.7 million. The installation of cellular telephone systems represents another significant step in the rapid modernization of communications facilities throughout the PRC, said an official of the Beijing Telecommunications Administration. These systems

will form an important part of the PRC's developing infrastructure and will ensure more efficient telecommunications services to new industrial and commercial enterprises. Sound installation in the PRC has grown equally in recent years, with high quality, high powered systems of prime importance in reaching the vast population. Some of the theaters recently constructed in PRC have no rear walls, with additional seating available on an adjacent hill, similar to New York's Saratoga Performing Arts Center.

WASHBURN LAUNCHES SOUNDTECH LINE OF REINFORCEMENT EQUIPMENT

Washburn International has launched the new SoundTech sound reinforcement line from its existing B.F.E. (formerly B.F.I.) facilities in Elkhart, IN. The line will also feature high-end recording consoles manufactured in Europe to SoundTech design specifications by L.E.M., said to be Europe's largest pro audio manufacturer. According to Keith Brawley, Western regional manager for SoundTech, who came to Washburn a year ago from Sunn Electronics: "The recent upheaval in the sound reinforcement market created a tremendous opportunity for us to introduce new competitive, innovative products. Under the direction of national sales manager Gerry Schrader, the company will market mixers, powered mixers, power amplifiers, loudspeaker enclosures, optimized keyboard monitors with Electro-Voice components and recording consoles with up to 32 x 8 configurations.

DRAGON DIVISION OF HARRIS TO DISTRIBUTE MOTOROLA PIEZO VOICE PAGING

The Dragon Division of Harris Communications has been awarded the distribution contract for Motorola piezo voice paging systems. P-TEC/5 paging loudspeakers use a thin ceramic plate, cut by an exclusive process developed by Motorola.

U.S. AND WEST GERMAN TESTING LABS SIGN MUTUAL COOPERATION PACT

ETL Testing Laboratories Inc. of Cortland, NY, and TUV Rheinland of Cologne, West Germany, have signed a major international testing agreement providing for TUV Rheinland to supply its clients with access to the ETL product labeling and listing program recognized throughout the U.S. The agreement will also provide ETL's clients with access, through TUV Rheinland, to the German Government's GS mark, required by law there and recognized throughout Europe. According to James W. Tucker, president of ETL, "This agreement will greatly increase ETL's ability to support U.S. clients in their international marketing efforts." He added that without this type of product safety approvals, it is virtually impossible for U.S. manufacturers to market their product in Europe. ETL signed a similar agreement last year with a Japanese firm.

SOUND & COMMUNICATIONS PRESENTS CLOSED-CIRCUIT TV COVERAGE OF NSCA

The publisher and editors of Sound & Communications magazine will produce NSCA-TV News, a three-day, one-hour, daily television program covering up-to-the-minute highlights of the National Sound & Communications Association (NSCA) Expo in Las Vegas. The program will air repeatedly all day through the Sahara Hotel's cable television system so that NSCA attendees can watch morning or evening briefings at their leisure. The program will additionally be shown on the exhibit floor on large-screen televisions. Publisher Vincent P. Testa said the program is being produced by Sound & Communications magazine as part of a series of projects to re-establish a leadership role for the 31-year-old magazine. "When we sat down to decide what to do for the NSCA Convention, the thought of sponsoring another breakfast or of throwing a party seemed a bit superficial, particularly in light of the year we have spent seriously redesigning the magazine and redirecting its editorial. Today we believe we are addressing the real needs and interests of today's sound contractor, systems manager and specifier," he said. The TV show is a way of giving those professionals who attend the Expo in Las Vegas a thorough, on-going report of the show's events, new product introductions, workshops, and seminars.

Part Two: The Designing of... **DISTRIBUTED SOUND SYSTEMS**

by Jesse Klapholz

In many situations, it is obvious when a distributed loudspeaker system is appropriate, for example in a low-ceilinged office. But, when the sound contractor is called upon to solve a customer's communications problem, there are times when deciding to "go distributed" is not necessarily cut and dried. In these cases, the performance requirements and the acoustical characteristics of the space or spaces need to be quantified and analyzed to determine the type of system to be installed. Then the choice between a cluster or clusters, distributed, or a combination of the two can be made. And the decision of what kind of speaker, how many, and where they should be located can be resolved.

The design process, when applied to the real world, is inevitably combined with aesthetic and budgetary considerations. Often, the aesthetic and budgetary factors dictate the system approach and design. In these cases, it is equally important to understand the design criteria in order to predict the system's performance. Nobody wants to install a system that does not work. The customer wants to know, beforehand of course, the bottom line in performance. The three (four, for a reinforcement system) following questions are the electroacoustical bottom line:

- 1) Is the system loud enough?
- 2) Can everybody hear?
- 3) Can everybody understand?
- 4) Will the system feedback?

The purpose of this article is to pre-

sent a brief overview of the electroacoustic and psychoacoustic considerations of distributed sound system design.

The design process, when applied to the real world, is inevitably combined with aesthetic and budgetary considerations.

Central versus Distributed

As just mentioned, the first step in the design of a sound system is to decide whether its basis shall be a distributed system or a central cluster. The architectural and acoustical characteristics must be quantified to start our evaluation procedure. If the room is already in use, the parameters in question may be directly measured.

Otherwise, they may be calculated using the appropriate equations.

The room constant, reverberation, and ambient noise level are the first three basic parameters of concern. The room constant (R) is the product of the room's surface area (S), and average surface's absorption coefficient (a), divided by a constant of 1-a. This may be calculated from a directly-measured reverberation time or from tables of absorption coefficients and the blueprints of the room. The ambient noise level is usually specified as a single number or NC. Now that these parameters have been established, we shall use them to ascertain how many sources are necessary. (Figure 1)

The ambient noise level should be low enough so that any listener may be provided with at least a 25 dB signal-to-noise ratio. If this criteria cannot be met, unintelligibility is guaranteed. Excessive reverberation may also impede upon the understanding of speech. The following formula serves as a rough indicator of unintelligibility if the number M is less than 20 dB:

$$M = 10 \log (QR/r^{2n})$$

where,

Q = directivity factory of a loudspeaker or the room-source combination

R = the room constant as described above

r = the distance from the loudspeaker (or talker if there is no system) to the listener

n = number of loudspeakers (for no sound system $n = 1$)

This formula shows that if M is lower than 20 dB, it can be increased by increasing Q or R . If the room constant cannot be modified and the Q of the loudspeaker or the room cannot be increased, then a distributed system of n loudspeakers should be installed yielding a decreased r such that the product of nr^2 is decreased. It should be noted that in some cases adding a single loudspeaker in a reverberant room may make an unnoticeable improvement, since the ratio of Q/r may not change appreciably. This is one of the easiest mistakes to make in sound system design.

Once it has been determined that a distributed system is necessary—either because of the room acoustics, sight-lines, low ceiling, aesthetics, budget, etc.—the task of determining what kind, how many, and where is next on the design agenda.

What kind? How many? Where?

Distributed systems may take several forms including overhead distributed, pew back, and distributed-column, or distributed-horn systems. We are concerned here with overhead distributed systems since most spaces naturally lend themselves to this application. An object of the distributed system is to ensure that every listener is in the direct field which is even in regards to its loudspeaker coverage. The kind of loudspeaker selected will depend on the required bandwidth and SPL requirements. Putting aside this decision for the moment, let us take a look at how many and where.

Distributed systems are typically designed using square or hexagonal speaker patterns with varying amounts of overlap from none or edge-to-edge; minimum; to maximum or center-to-center. There are six possible coverage-pattern combinations and they are shown in Figures 2 and 3. Traditionally, loudspeaker coverage design uses the "cone method" where an included-angle of coverage is laid out, with reference to the loudspeaker's axis, and is based upon the -6 dB points from polar plot information. At ear level, the -6 dB point of the loudspeaker will actually be lower due to the inverse square law. Therefore, the -6 dB point should be calculated for ear height, or a point in a plane parallel to the floor.

Many designers use -6 dB as a level

criteria for the overlap point between adjacent loudspeakers. This means that they are expecting two incoherent sounds to sum as if they were coherent or in-phase with each other. This is obviously not going to happen with such widely spaced sources. Therefore, a higher density of loudspeaker coverage should be used, closer to the -3 dB point. A word of caution: depending on reverberant energy to help smooth loudness variations in areas between loudspeakers is not a plausible assumption.

In 1981, Rex Sinclair of Altec Lansing, presented a new method of designing distributed loudspeaker systems. Sinclair's method simplifies the decision of loudspeaker density and actual layout. The Altec design technique uses a set of overlay transparencies, one for each combination of pattern and amount of overlap for coverage circles scaled to a one-inch radius. Each transparency specifies the speaker density as a number of speakers per coverage circle. All a designer has to do is select a loudspeaker. A scaling factor is then applied to the room plan, and the



Omnidirectional loudspeakers, such as the Soundsphere 110 above, have been successfully used in distributed sound system applications. In distributed systems, omnidirectional loudspeakers provide uniform coverage and smooth frequency response at every point in the direct field. In addition, when high-ceilings are a consideration, fewer speakers are necessary for complete coverage, hence reducing installation time and labor and hardware costs.

transparency is manipulated around the scaled plan, determining speaker placement. The method is easy, reliable, and gives answers in real-time.

Most installations have ceilings that are parallel to the floor. Flush-mounting loudspeakers in these rooms means a constant ear-to-loudspeaker at each on-axis location. However, in installa-

tions where the ceiling heights vary within the space or the ceiling is sloped in relation to the floor, there are further complications. When loudspeakers cannot be suspended from the ceiling in order to maintain a constant floor-to-loudspeaker height, two approaches have been used: variable density and variable loudness. Here there are cost versus performance trade-offs to be considered. Furthermore, the room acoustics, for example if there is excessive reverberation, may preclude one from simply turning up those speakers which are further away.

Many times deciding how many speakers and where they should be located ends up being an ergonomic matter which can be decided empirically; or worse yet by a decorator's matter. Both the scientific and empiric approach are acceptable and have been proven to be equally effective; that is when the respective technique is used in the appropriate situation. Nonetheless, when the decision is made as to how many and where, it still has to be decided as to—what kind.

Most loudspeakers used for distributed systems are direct-radiator cone-types, some with either a *whizzer* element or high-frequency unit, available in four-, eight-, 12-, or 15-inch sizes (the exception is the BES planar-type). These loudspeakers typically have half-space reference efficiencies between .5 percent and 2 percent and power capacities between several watts to several hundred watts. Frequency response ranges can vary from full fidelity to voice-only bandwidths.

The intended application will narrow down the possibilities somewhat; for example, if voice only is required four- or eight-inch loudspeakers will suffice. However, if high-level music will be reproduced with a bigger/wider-bandwidth, 12- or 15-inch speakers should be chosen. While the application will indicate in most instances the type of loudspeaker, the power requirements dictated by the room-constant and ear-to-speaker distance may modify our initial choice.

Since smooth loudspeaker coverage is one of the objectives, the loudspeaker's coverage pattern should also be considered. As long as loudspeakers have been around, they have been analogized to a rigid piston in an infinite baffle. Figure 4 shows what happens to the dispersion and Q of a piston/loudspeaker as the frequency is increased in proportion to the speaker

diameter. This is the main reason that eight-inch speakers use a high-frequency element—they try to maintain even coverage through a wide bandwidth. Nevertheless, this shows why four-inch loudspeakers, provided they can deliver the required level, work nicely for speech systems. Using the -6 dB points, most loudspeakers' nominal dispersion falls between 60 to 120 degrees.

The topic of loudspeaker dispersion brings up an interesting, as well as controversial, subject—directional versus omnidirectional loudspeakers. Even if real-world loudspeakers truly approximated rigid pistons in an infinite baffle, they still would not have a Q of 2 throughout their used frequency range. In fact, even a four-inch loudspeaker narrows to 30 degrees at 6 kHz (measured at its -3 dB points). Conventional cone-type loudspeakers have on-axis and off-axis characteristics; with omnidirectional loudspeakers a listener is always "on-axis." Using omnidirectional loudspeakers makes life easier since our tools can simply be a protractor and the inverse square law. There is a detailed mathematical exposition concerning the use of omnis in overhead distributed systems by William Lobb available from Sonic Systems in Stamford, CT.

In addition to the sound pressure level uniformity and frequency response at any given point in the

direct field, it is also important to know what happens in the reverberant field. Conventional cone-type loudspeakers inherently do not have smooth power response; that means that the total power they transfer to the space changes as a function of frequency and direction, along with the Q. On the other hand, omnidirectional loudspeakers virtually maintain the same Q over a wide band of frequencies, and therefore, maintain a constant power output characteristic as a function of frequency and direction. The frequency response of the reverberant field is important for two reasons: A) in reinforcement situations it is the reverberant field that the microphone will "see," therefore, if the response is uniform and flat the gain-before-feedback can be optimized, predicted with greater accuracy, and be more stable with changing microphone positions; B) the reverberant field also contributes to our overall psychoacoustic assessment of the quality of the sound presentation.

Omnidirectional loudspeakers are not always omni—it is simply a matter of direction versus bandwidth. Any omnidirectional loudspeaker is only omnidirectional over a specific frequency range. In overhead distributed systems, we are generally concerned with loudspeakers that will be flush mounted in ceilings, and consequently what we call half-space radiation or a Q of 2. Many loudspeakers have a Q of

2 over some frequency range, so the idea is to match up the desired operating frequency with a loudspeaker that maintains a Q of 2 in that range. If a conventional loudspeaker that has a Q of 2 can be used, it usually can reduce loudspeaker costs.

Let us return to the four questions we raised in the beginning of this review. We have discussed loudspeaker coverage which is the primary factor answering: Can everybody hear? We talked about the acoustics of the space, how to determine if a distributed system was needed, and NC-criteria, all of which help answer the question: Can everybody understand? The concepts of smooth power response, and the geometrical relationships of the source, microphone, loudspeaker, and listener contribute to answering that important question: Will the system feedback? Now let us examine, in more detail, the matter of: Is the system loud enough?

How loud is loud enough?

In our daily engineering, we routinely use the term dB-SPL. As we can recall from our textbook days, the decibel (dB) is not a measurement unit of quantity itself. The dB is a manageable method of comparing ratios between a reference and some level above it in three whole numbers or less. Psychoacoustically, the dB works for us since it uses a logarithm-based system that matches our perceptual response to external stimuli. We use the dB freely to represent differences in sound pressure, voltage, current, and power. Using the dB to represent the level of a sound is just that—level.

Figure 1a ACCEPTABLE NC LEVELS FOR VARIOUS ACTIVITIES

Activity	Suggested Range of Noise Criteria
Sleeping, Resting, and Relaxing Suburban & rural: Homes, apartments, hotels, hospitals, etc. Urban: Homes, apartments, hotels, hospitals, etc.	NC-20 to NC-25 NC-25 to NC-30
Excellent Listening Conditions Required Concert halls, recording studios, etc.	NC-15 to NC-20
Very Good Listening Conditions Required Auditoriums, theaters Large meeting and conference rooms	NC-20 to NC-25 NC-25 to NC-30
Good Listening Conditions Required Private offices, school classrooms, small conference rooms, libraries, television listening	NC-30 to NC-35
Fair Listening Conditions Required Large offices, restaurants, retail shops and stores, etc.	NC-35 to NC-40
Moderately Fair Listening Conditions Required Lobbies, cafeterias, drafting rooms, business machine areas	NC-40 to NC-45
Acceptable Working Conditions with Minimum Speech Interference Industrial areas, garages, laundries	NC-45 to NC-55

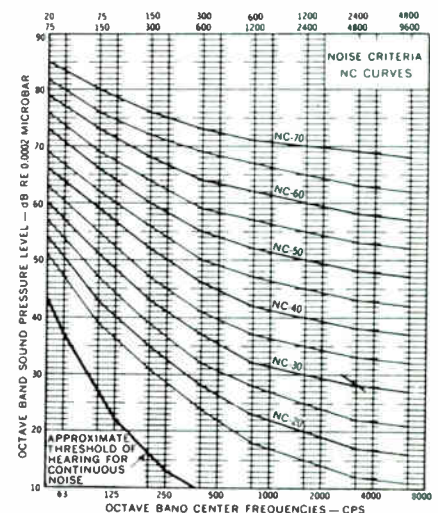

Figure 1b



Toa/Files

Date
First Quarter 1986

Installation
Installed Toa's new **HS Speakers** in the new church, with their existing 900 Series sound system. This new loudspeaker series really suits medium-size churches that want clear, transparent vocal reinforcement.

Comments
HS speakers are easy to handle, with their built-in mounting hardware for ceiling suspension and input terminals for full-range or bi-amp operation. We painted the two-way speakers to blend with the architectural design; they'll be used for sermons and the choir. I explained to the church elders that the congregation will hear every word, without distortion. After all, Toa has 50 years' experience in commercial sound.

Future Prospects
Church elder asked why I prefer Toa—told him Toa systems are reliable, durable, and they provide quality sound (but I didn't mention the Toa profitability that I've come to expect!).

Propose three-way speakers for youth music program next week.



Install Confidence.



Toa Electronics, Inc.
Commercial/Engineered Sound Division
See us at Booth 5

480 Carlton Court
South San Francisco
California 94080
(415) 588-2538

Toa Canada: (403) 489-5511 Edmonton, or (416) 624-2317 Toronto ■ Toa U.K.: (0277) 233882 Essex ■ Toa Europe: (040) 811127 Hamburg

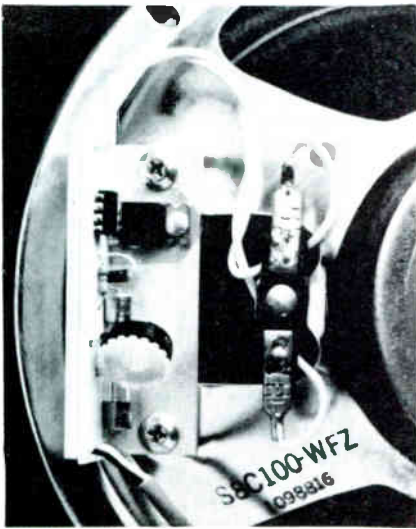

The J.W. Davis SBA (Signal Biased Amplifier) Distributed Sound System consists of power supply and speaker-mounted amplifier modules. Operation with system balance and control is implemented either by the SBA-PM master's volume control or by individual gain controls on the SBA-R remote speaker units. The system can be expanded without changing existing equipment. To add paging horns, it is necessary to increase the DC power supply with additional SBA-P power supply units (not shown). This system also permits the use of lower fidelity speakers in some cases.

We are also interested in loudness. Loudness is a subjective term and this is why the well-known Fletcher-Munson curves, as illustrated in Figure 5, were developed. To specify loudness in scientific terms we use the Phon. Notice that at only around 1 kHz do the SPL and Phon correspond, otherwise the Phon changes with both frequency and level. While we are dealing in subjective terms, the equal-loudness curves have proven themselves over time to be fairly representa-

tive providing good correlation between individuals.

These curves are not "preferred house curves" and should not be interpolated for equalization purposes. The information displayed by these curves simply tells how much power will be needed in a system to attain specified subjective loudness levels. For example, if we are designing a foreground music system to be operated with moderate level, the system will need to produce a level 6 dB higher at 100 Hz

and 10 kHz in reference to the 1 kHz level. Often this is the cause of overload in the amplifiers and saturation in the transformers of many distributed systems.

Most spaces that we design distributed systems for are office spaces and the like with low reverberation times. In these situations, the reverberant energy does not add a great amount of level and we concern ourselves mostly with the direct sound field and inverse square law calculations. As an aside, this puts a greater constraint on the uniformity of coverage. However, in situations where we are depending on a distributed system to overcome high reverberant energy effects, the room constant which was discussed earlier comes into play.

To determine the electrical power required for a loudspeaker in a room the parameters of desired peak sound pressure level in the room, its volume, its reverberation time, and the efficiency of the loudspeakers are all related by the following equations:

$$W = \frac{0.028V \times 10^{(SPL-74)/10}}{TE \times 10^6}$$

where T = reverberation time

E = loudspeaker efficiency in percent

SOUND SOLUTIONS

EXPECT MORE FROM STENTOFON

... More selection.

In addition to a full line of intercom systems, we also offer the complete line of teleCOURIER pocket-paging systems.

... More quality.

Our product quality is not only built-in, it's also tested-out... more thoroughly than any other manufacturer. This superior quality lets you offer the ultimate in performance-proven intercom and paging systems.



... More services.

Internal communications is not a side-line with Stentofon. It's our

only business. As such, you can expect more back-up services in design, engineering, parts, sales and installation expertise.

... More profitable sales.

With more selection, quality and service from our business, you can expect more profitable sales in your business. That's the bottom-line reason for making Stentofon your top-line choice.

Call or write, today.

See us at NSCA Booths T and U.

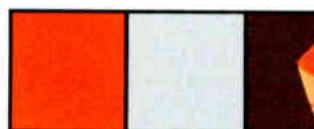

All desk stations available in choice of Designer Orange, Neutral Gray or Walnut Brown colors.



STENTOFON®
We've got the answers.

Stentofon Communications Inc.
6012 Parretta Drive
Kansas City, MO 64120
(816) 231-7200

Circle 242 on Reader Response Card
World Radio History

THE SECRET'S OUT.

(Announcing a technological advance in voice paging loudspeakers.)

OUR P-TEC/5™ TECHNOLOGY STORY.

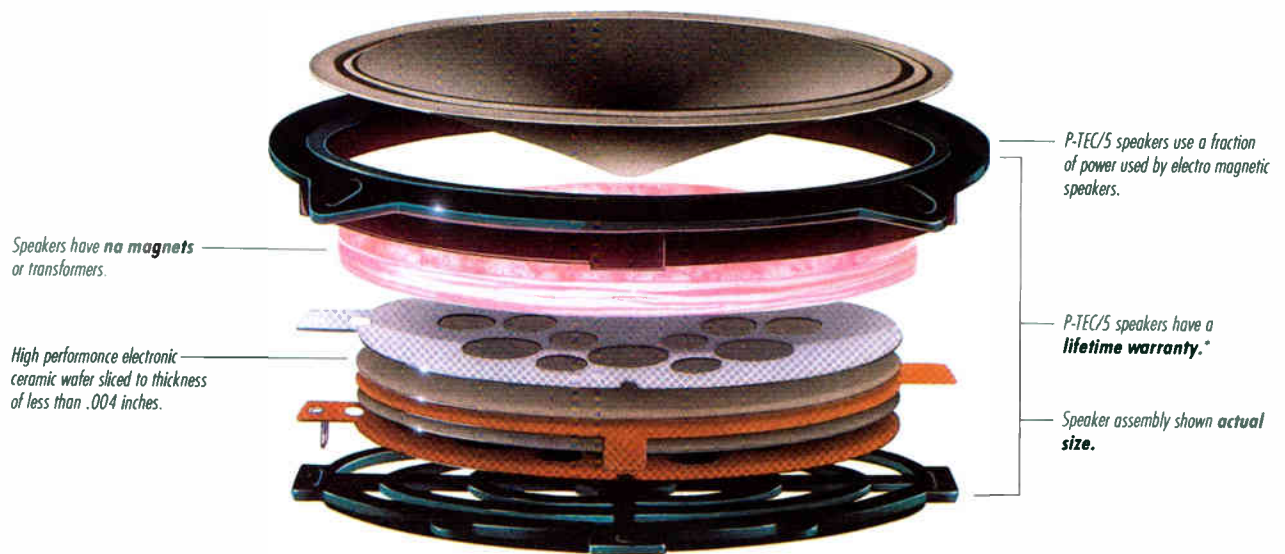

Now it's possible to utilize piezo technology for sound systems. Previously used only for high frequencies, piezo technology has entered the voice paging range as the result of a technological breakthrough by Motorola researchers.

A patented process slices a unique high performance electronic ceramic to a thinness of .0038 inches. A unique baffle design was created by our Harris engineers to house the speaker assembly.



The result.

A totally unique new line of lightweight voice paging loudspeakers called P-TEC/5.

P-TEC/5 speakers outperform, use less power, have no magnets or transformers, are moisture resistant and have an unprecedented lifetime warranty.* P-TEC/5 loudspeakers use only a fraction of the power to create the same sound level as existing electromagnetic speakers. A smaller amplifier is needed to drive paging for the same size building—so cost efficiencies are

multiplied throughout a paging system. Less electricity is used and the units are easier to maintain.

Installation is easier too.

Weighing less than 6 ounces,

P-TEC/5 speakers install without cutting, drilling or the need for special grids. Two insert wires built into the baffle simply puncture the ceiling tile by gently pushing against the face of the baffle.

Retaining clips then create their own counter tension which holds the speaker in place. After removing the clips, a gentle tug will pull the baffle back out without damaging the tile—so it can be relocated easily if necessary.

Harris/Dracon engineers have been pioneering new product development for the telecommunications industry for almost 30 years. Our line of voice paging products encompasses the wide and diversified needs

of every size company from the smallest to the largest most sophisticated multi-featured, multi-location paging system. We are most proud of the efficiencies and advancements that P-TEC/5 now offers to the voice paging marketplace.

For more information, contact any major telecommunications or sound distributor.

We're HARRIS CORPORATION Dracon Division in Camarillo, CA. 805/987-9511. Telex 182327.



*after 1 year, warranty does not cover labor or shipping.

FOR YOUR INFORMATION,
OUR NAME IS
HARRIS
HARRIS

TOGETHER HARRIS AND MOTOROLA RE-INVENTED THE LOUDSPEAKER.

Because of an agreement between HARRIS CORPORATION Dracon Division and Motorola, Inc., piezo patented technology for voice paging applications is only available through Harris/Dracon in the U.S., Canada and Mexico. The exclusive baffle design is a trademark of the Dracon Division. Motorola® is a registered trademark of Motorola, Inc.

OUR P-TEC/5TM INSTALLATION STORY.

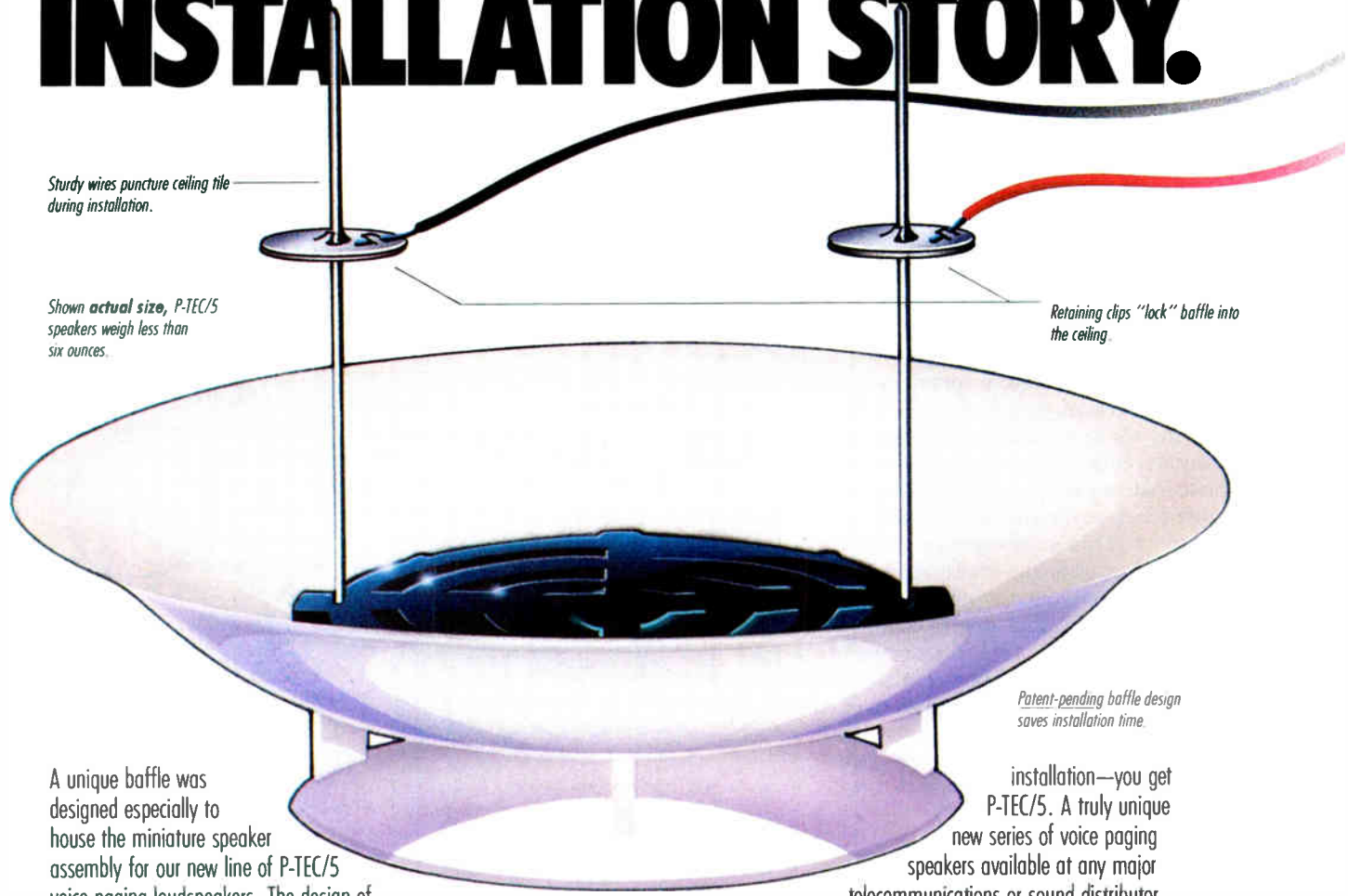

Sturdy wires puncture ceiling tile during installation.

Shown actual size, P-TEC/5 speakers weigh less than six ounces.

Retaining clips "lock" baffle into the ceiling.

Patent-pending baffle design saves installation time.

A unique baffle was designed especially to house the miniature speaker assembly for our new line of P-TEC/5 voice paging loudspeakers. The design of this baffle revolutionizes the installation of your loudspeaker network. It is so simple and so easy to install—it makes you wonder why loudspeaker installation was ever done any other way.

A gentle push on the face of the baffle causes the two installation poles to

This unique installation process not only saves time and materials, it makes mistakes a thing of the past. (The tiny puncture holes are so small, no one will notice.)

Even with metal or plaster ceilings, installation is simpler than with traditional loudspeaker baffles.

installation—you get P-TEC/5. A truly unique new series of voice paging speakers available at any major telecommunications or sound distributor. We're HARRIS CORPORATION Dracon Division in Camarillo, CA. 805/987-9511. Telex 182327.

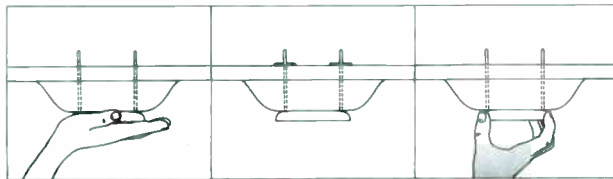

Insert wires puncture ceiling tile. Retaining clips "lock" speaker into ceiling.

Remove clips, pull downward to release.

puncture the ceiling tile while the retaining clips create a counter tension that "locks" the baffle into the ceiling. To relocate, simply remove the retaining clips and tug firmly in a downward motion and the baffle releases itself.

loudspeakers use a fraction of the power to create the same sound level as existing electromagnetic speakers.

When you combine breakthrough technology with low cost, mistake-proof

P-TEC/5 speakers outperform, use less power, have no magnets or transformers, are moisture resistant and have an unprecedented lifetime warranty.* P-TEC/5



*after 1 year, warranty does not cover labor or shipping.



See us at Booth Q

TOGETHER HARRIS AND MOTOROLA RE-INVENTED THE LOUDSPEAKER.

Because of an agreement between HARRIS CORPORATION Dracon Division and Motorola, Inc., piezo patented technology for voice paging applications is only available through Harris/Dracon in the U.S., Canada and Mexico. The exclusive baffle design is a trademark of the Dracon Division. Motorola® is a registered trademark of Motorola, Inc.

V = volume of the room

SPL = sound pressure level

Figure 6 shows the relationship between room size, electrical power input, and expected sound pressure levels for loudspeakers with 2 percent efficiency. This number was chosen since most loudspeakers used in distributed systems typically have half-space reference efficiencies between 5 percent and 2 percent, and a nominal rating of 2 percent is fairly representative. Implicit in this graph are three assumptions:

- That the reverberation time of the room is optimum for its volume as shown in **Figure 7**.
- That the speaker layout provides uniform coverage.
- That the shape of the room is not highly irregular.

Notice that we use the loudspeaker's reference efficiency, rather than its axial sensitivity. This is done so that the total power output of the loudspeaker is what we measure, not its output on axis. Loudspeakers with lower axial sensitivity and lower Q number can actually have a higher output power into a space than a higher Q loudspeaker with a higher on-axis sensitivity.

Constant-Voltage Systems

Constant voltage amplifiers are just that—constant voltage—the power output is constant as the load changes. Today, everybody is using solid-state power amplifiers, the specification of amplifier size is simple—just add up the transformer taps. Once the power input requirements at each speaker location have been established, and the transformer losses factored, a transformer with the appropriate tap is selected.

In addition to the ease of specifying the power amplifier's size, with constant voltage systems the current is low, smaller gauge speaker wire can be used and/or longer speaker lines can be run—both affording money and engineering savings.

The most common constant-voltage power amplifiers in use are 70.7-volt and 25-volt output types. Most of the time we use 70.7-volt systems for their higher output capabilities. But low-power systems using the 25-volt line can offer economic advantages. There are two *stumbling blocks* that are the effect of older techniques applied in cur-

rent technology; they are from the older constant-impedance system and tube amplifiers. In both of these systems, the amplifier(s) had to be loaded to specified impedances in order to operate properly and deliver the appropriate power. This does not apply with constant-voltage systems. With a constant-voltage amplifier the output power is determined by the input signal level and the gain of the amplifier. This makes life easy. In constant-voltage systems the only precaution is not to exceed the power amplifier rating by the total sum of transformer taps connected to its output.

Psychoacoustic Considerations

Progressively, more *background*

music systems installed today are becoming *foreground* music systems. As this is the case, more of the psychoacoustic criteria of reinforcement systems are applicable to all types of music systems. The most often used buzz words under this heading are adequate speech intelligibility, naturalness, proportionately low room reverberation, and no flutter and echo. Intelligibility will be the end product of combining each parameter of the design and is equally applicable to music-only systems. Naturalness is partially achieved by providing for good intelligibility and applying, to a scaled-down degree, the criteria of selecting a studio monitor system to distributed system compo-

Figure 2

Methods of Square Overlap

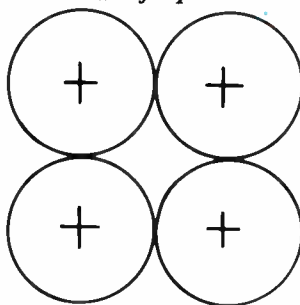

a) Edge to Edge

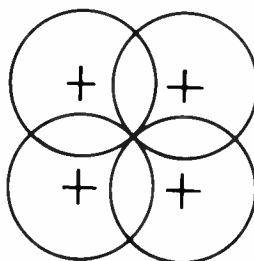

b) Minimum

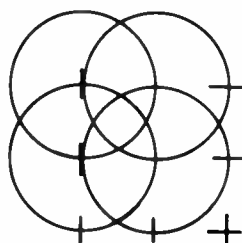

c) Center to Center

Figure 3

Methods of Hexagonal Overlap

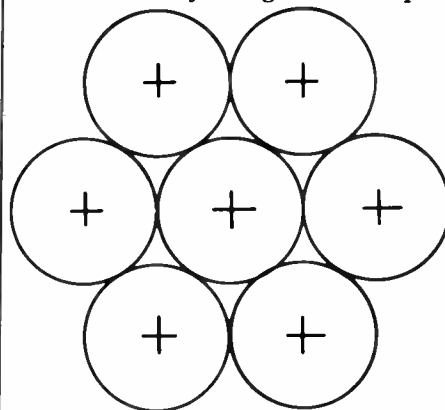

a) Edge to Edge

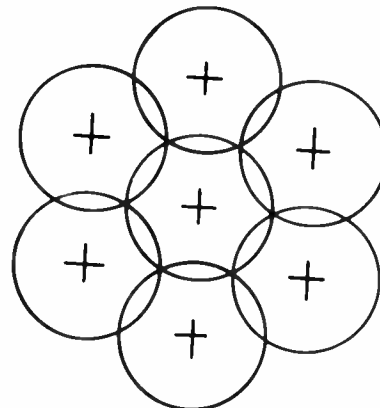

b) Minimum

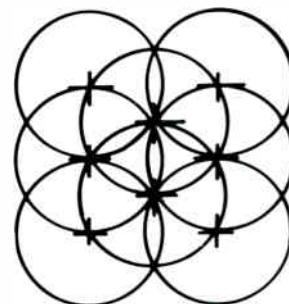

c) Center to Center

The world doesn't stand still. Every day brings new professional demands, and to keep up, you need the best: the new BPE 41, 42 and 43 series from Philips.



INDUSTRIAL STRENGTH MICROPHONES

Philips is the only company with a complete line of 11 *backplate electret* condenser mics designed specifically for sound reinforcement. From concert hall to noisy factory floor,

our durable and reliable BPE series handles it all. What's your need? Name it and we'll meet it.

The BPE specs stand firm:

134 dB SPL, frequency response up to 20,000 Hz (depending on choice of pattern), phantom power from 9 to 52 volts and trouble-free construction (our gooseneck mics won't creak unless your

voice does). Best of all, the BPE series is the most advanced electret condenser technology available anywhere at a cost less than many dynamics!

The world doesn't stand still. And, neither do we.

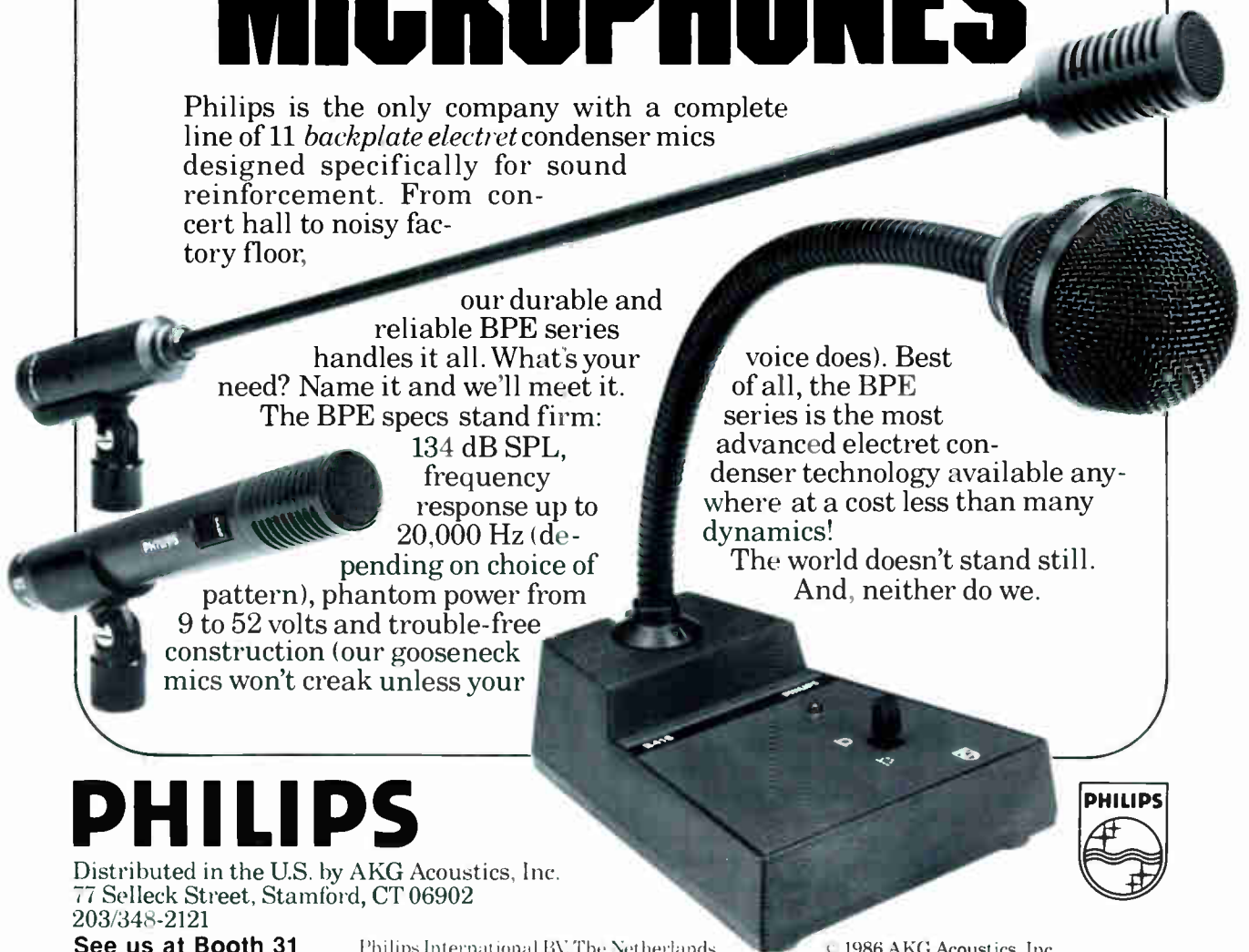

PHILIPS

Distributed in the U.S. by AKG Acoustics, Inc.
77 Selleck Street, Stamford, CT 06902
203/348-2121

See us at Booth 31

Philips International BV, The Netherlands

© 1986 AKG Acoustics, Inc.



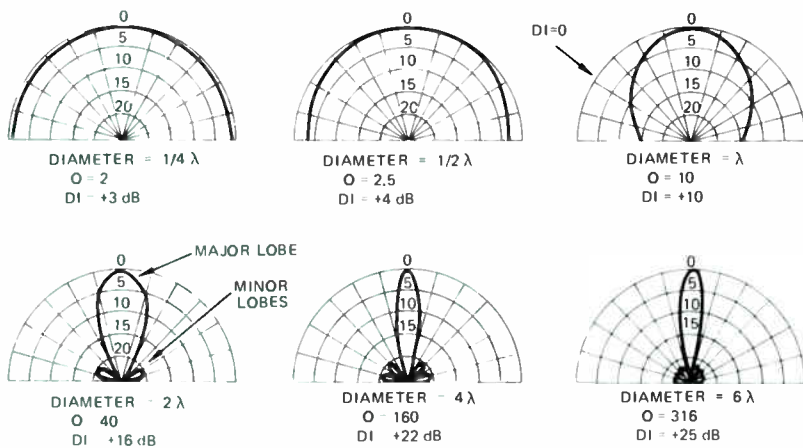

Figure 4 Directional Characteristics of a Circular-Piston Source Mounted in an Infinite Baffle as a Function of Diameter and λ

ment selection. In reinforcement systems, attention must be paid to the direction and transit-time of the source versus reinforced sound in order to ensure realism.

Now that we have designed and installed the system it is time for the mystical equalization process. Ever

since Bell Labs introduced wave filters to telecommunications during the 1920s, we have been subjected to reading endless encyclopedias on the *art*. Later, starting in 1965, Dr. C.P. Boner quantified the concept of the gain of a sound system and pioneered narrow-band equalization. His

Figure 5:

Equal loudness curves after Fletcher and Munson.

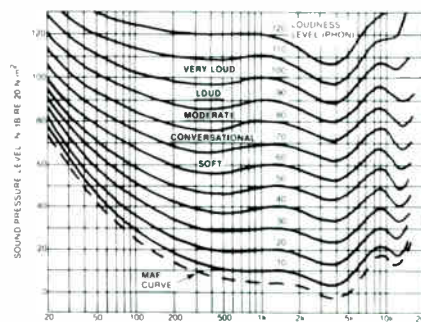

methods were as much an art as a science—unfortunately a dying art. Shortly after the introduction of narrow-band equalization, a new *better mousetrap* was introduced—third-octave equalization.

Third-octave equalization caught on almost overnight because filters were not built on the job and the tuning time was reduced from days to a matter of minutes. Equalization is used routinely today—sometimes too routinely. To add yet another paragraph to the never ending *book* on equalization, is a comment concerning on-axis versus off-axis loudspeaker equalization. If a cone-type loudspeaker's included angle of dispersion narrows with increase in frequency within its operating bandpass, then its response will change with respect to position. If one attempts to equalize such a device for flat power response, on-axis response will have an accentuated high-frequency response. Likewise, if one equalizes for a desired response on-axis, it will not respond the same off-axis. That's right, it is a no win situation. Another plus for omnidirectional loudspeakers.

Since the early days of distributing sound in department stores, the soundman's job was to enable the communication of voice and musical messages to take place over large areas. The advent of solid-state electronics, and newer materials technologies providing higher-quality loudspeakers, have given us better hardware to keep up with the quality level of related technologies. Even though the hardware is continually refined and economized, most principles of distributed sound system design have been around for quite some time.

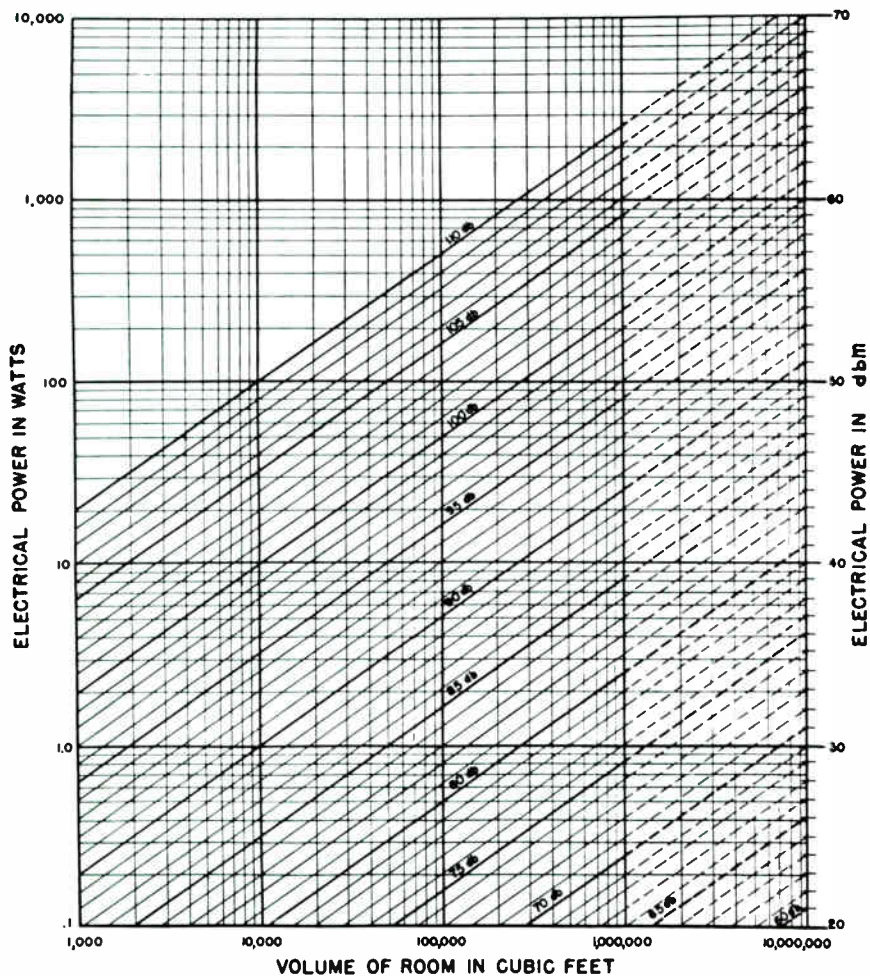

Figure 6: Desirable reverberation time vs. volume of room (mid-band)



**FROM A PORTABLE,
SELF-CONTAINED VOCAL PA TO
LARGE CUSTOM SYSTEMS,
FOSTEX PRODUCTS AND
COMPONENTS DELIVER.**

See us at Booth 47

- MICROPHONES • SPEAKER SYSTEMS • LOUDSPEAKER COMPONENTS
- HEADPHONES • AMPLIFIERS • MIXERS • RECORDERS • SYNCHRONIZERS



FOSTEX RP TECHNOLOGY

If you work with sound, you owe it to yourself and your clients to audition these remarkable transducers. To date, they have received over twenty international patents.

Fostex
PRO SOUND DIVISION

15431 Blackburn Ave.
Norwalk, CA 90650
(213) 921-1112

Circle 223 on Reader Response Card

World Radio History

New at NSCA in Las Vegas



**ON•THE•AIR...24 Hours a Day...Everyday...at the
National Sound & Communications Expo on April 29 - May 2**
IN•THE•HOTEL ROOMS and
ON•THE•EXHIBIT FLOOR

NSCA-TV NEWS WILL BROADCAST:

- ★ New Products
- ★ The Latest in Technology & Design
- ★ Interviews with Manufacturers
- ★ Workshop & Seminar Reports

Produced by the Publisher and Editors of *Sound & Communications* magazine.

DON'T MISS IT! AN INDUSTRY FIRST!
BY THE INDUSTRY'S BEST!

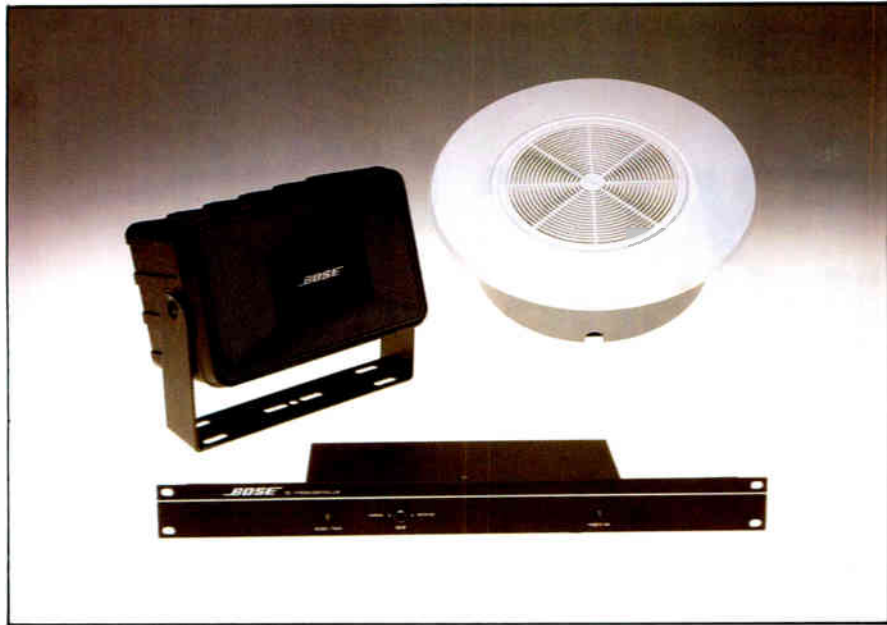

The Bose 102™ Commercial Sound System allows a choice of a surface-mount loudspeaker (left) or a flush-mount loudspeaker (right). The 102™ System Controller provides full-bandwidth active equalization.

One thing is clear from a look at the past, no matter how many generations of technological revolutions we have gone through, we have not designed a replacement for the venerable distributed sound system. A sure bet is that we will be designing distributed sound systems for generations to come. Knowing all the options will certainly help us all do our jobs better and more efficiently.

BIBLIOGRAPHY

"Acoustics," L.L. Beranek, McGraw

Hill, 1954.

"Manual of Sound Systems," Western Electric Company, 1941.

"JBL Sound System Design Reference Manual," 1982.

"The Design of Distributed Sound Systems from Uniformity of Coverage and Other Sound-field Considerations," Rex Sinclair, JAES, Vol. 30, #12, 1982.

"Electrical and Signal Processing Requirements for Loudspeakers," Mark Engbretson, AB Systems Tech Note, 1984.

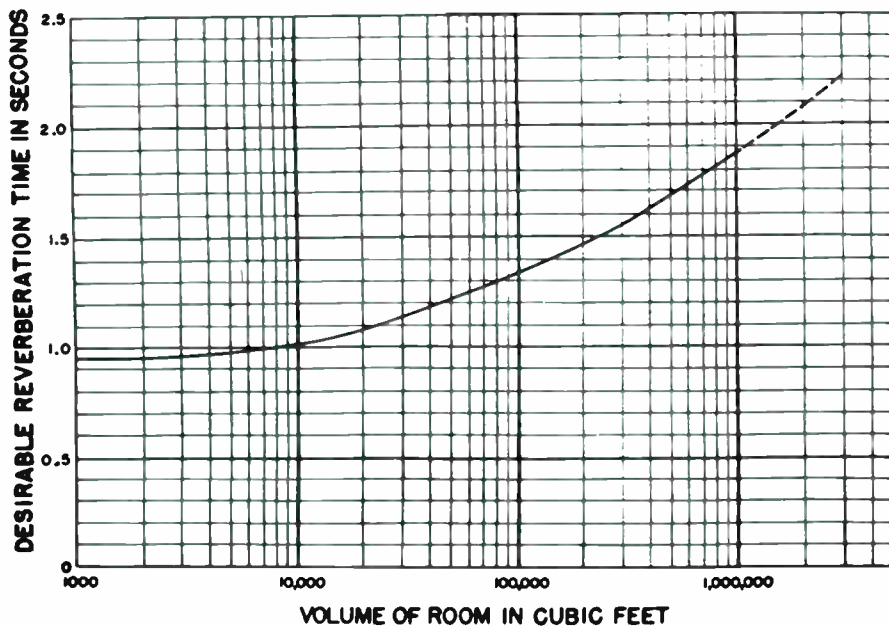
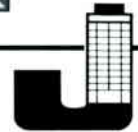

Figure 7: Sound pressure level produced by loudspeakers of 2% efficiency indoors.

Intercom • Security

Door Entry Systems for Apartment Buildings & Town-Houses

• Door Alarm Systems



JERON

electronic systems, inc.

3554 N. Clark St., Chicago, IL 60657
(312) 528-4020

TOLL FREE: 800-621-1903

See us at Booth 14
Nurse Call Systems

for Hospitals,
Nursing Homes,
Elderly Housing

• Doctors' In-Out Registers
• Clinic Call/Room Status



Circle 229 on Reader Response Card

Life Safety for High-Rise Buildings

by Barry McKinnon

The scene is a downtown high rise, somewhere in a major metropolitan center, crowded offices, people bustling about with their attention focused on the business at hand. Smoke issues from a storage room on the thirty-fifth floor and sets off a smoke detector and the fire alarm goes off. But rather than looking like a remake of the "*Towering Inferno*," the workers look up from their work at the sound of the alarm and listen for specific evacuation instructions over the life safety sound system incorporated into the fire alarm system. For the workers, this alarm is like any of the regular fire drills they participate in each month. These people work in a type of building which is becoming more commonplace, a building equipped with a comprehensive life protection system comprising a part of an overall building management and security system.

As the cost of public liability insurance escalates, the need for life safety systems has become more apparent. Many building owners have been made aware of potential dangers of fires in high rise structures after some of the major disasters in the past years. Up to that point, fire alarm systems in high rise buildings were a lot like insurance, you hoped that you never needed them and would never know how effective they were until disaster struck. Sadly, it has been discovered that a simple alarm is inadequate in conveying information to people in a panic situation. The insurance companies realized this fact as well and responded the only way they could, by raising the cost of insurance for public liability coverage in response to a change in their statistical forecasts.

In an effort to improve the tenants' odds of surviving a high rise building fire, the insurance companies, fire alarm companies, and various safety

and government organizations investigated methods of improving the safety of high rise structures. As a result, products, systems, regulations, and incentives for life safety systems have all come about in the past few years.

Early in these investigations, it was found that the only effective method of evacuating people from a building and ensuring they move *away* from dangerous areas, rather than inadvertently moving toward them, was to issue voice instructions instead of complicated combinations of tones, bells, whistles, and noises. In panic situations people are generally too preoccupied to count how many beeps or rings they have heard. A human voice directing their movements can cut through to the center of the brain that controls reflex, thereby negating the need to think about each action.

The life safety sound system is part of an overall building control system in most cases, usually because of the complexity of the supervisory system that keeps track of the system itself. The theory being that the larger and more complex the system the building requires, the more likely it is that it will require a life safety system as well. As a result control systems for most life safety systems are made by fire alarm and building control companies such as Edwards, Simplex, Honeywell, and Johnson Controls, and are incorporated into an alarm *system* of detectors, pull boxes, fire phones, and sounding devices.

While the actual regulations governing the life safety portion of an alarm system may vary from area to area, typical regulations would read as follows:

1) "Voice communication systems are required when the vertical distance between the floor of the top story and grade exceed 36 meters (110

feet), or in buildings containing a floor area or part of a floor area located above the third story designed or intended as a group B occupancy for patients in bed or infirmed persons; the system shall consist of:

- (a) a two-way communication system at acceptable locations on each floor area, with connections to the central alarm and control facility and to the mechanical control center, and
 - (b) loudspeakers operated from the central alarm and control facility which are designed and located so as to be heard in all parts of the building except for elevator cars.
- 2) The system shall include provision for silencing the fire alarm devices when the loudspeakers are in use, but only after the devices have operated initially for not less than one minute.
- 3) Voice communication systems shall conform to ULC-S524-1978, "Standard for the Installation of Fire Alarm Systems and Emergency Voice Communication Systems." (From the National Building Code of Canada.)

As one would expect of any area so heavily governed by regulations, the products used in fire alarm/life safety systems are also covered by more stringent standards. Everything used in life safety systems must be UL approved for the application, from the speakers and enclosures to the wire that connects them. As a result, there are many manufacturers that specialize in these products such as: loudspeakers that must meet specifications involving high temperature operation, flame retardancy, moisture proofing, sound pressure levels and response; wire and cable that must have high insulation breakdown temperature, non-flamma-

(Right) Atlas speakers mounted on Soundolier enclosures were installed on every floor of the Georgia-Pacific Building (below).

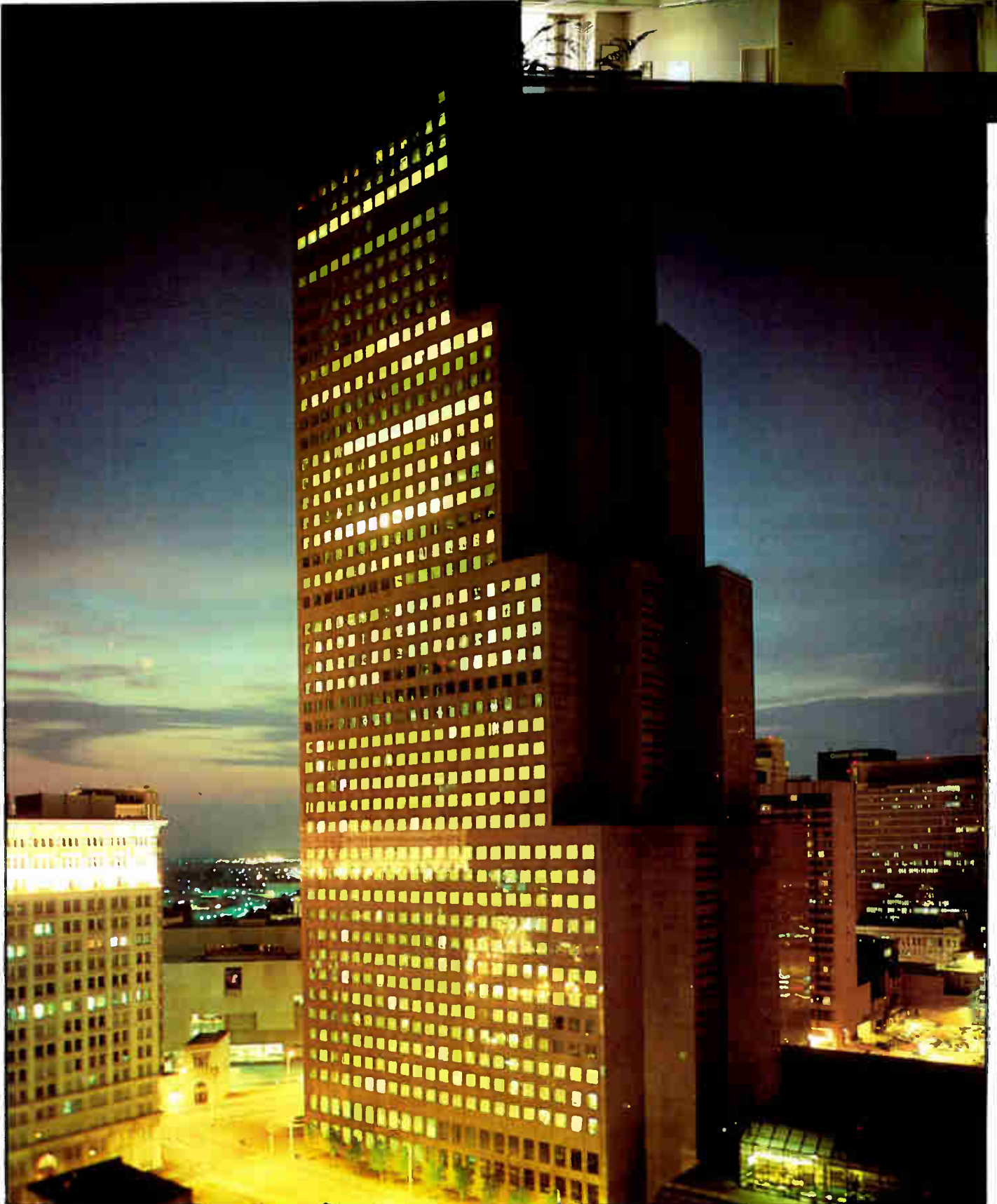

bility, must not emit noxious vapors when burning, minimum change of resistance when exposed to high temperatures, etc; rugged steel enclosures, designed to be vandal resistant, temperature and environment resistant to ensure the function of the loudspeaker when required.

300 V at 105 degrees C, and the IEEE 383/UL 70,000 BTU flame test. Details of these specifications would be available from the agencies concerned.

If the product specifications are strict, so are the requirements of the overall installation. Redundancy and failsafe operation of the system are the

The building will be around for at least 50 years, the extra cost of the fire control system and life safety equipment will be more than paid off by the reduction in insurance premiums alone.

These stringent requirements have led companies such as Atlas Sound, Soundolier, Quam-Nichols, Oaktron, and University Sound and others to produce loudspeakers for the life safety systems market. Specialty cable manufacturers produce cables for this market in an array of configurations, meeting stringent UL specifications; UL Subject 13 and Subject 1424, as well as specifications by other agencies such as the NEC article 725 covering insulation rating of

key factors in equipment specification. Unlike many sound systems where a failure may only be a nuisance, a failure in a system of this type could cost lives. Full redundancy is common, with automatic switchovers and backup power supplies the standard. The primary rule followed during the design phase of a life safety system is Murphy's law, *if it can go wrong, it will!* All the weak points in the system are located and doubled so that any one failure will not make the system

inoperative. The net result is a system with an equipment list that rivals or exceeds some touring sound systems.

These systems are also self supervisory. All speaker lines are continually monitored for continuity. In some cases where the life safety system is part of a security system, loudspeakers can be used as microphones to pick up sounds of unauthorized activity or for intrusion detection. Amplifiers are monitored for failure and are automatically switched out of the system base on various operation tests.

As many of the really elaborate fire control systems are part of a complete building management system, including functions such as security, temperature, lighting, ventilation, electrical consumption etc. The control system itself is often a highly specialized device designed and built for the requirements of specific buildings. Often large computer systems are tied to these consoles with software engineered for control of a specific building. This is not the sort of work that every sound contractor gets involved in, except perhaps as a subcontractor to a large company such as Honeywell or Johnson Controls. The tremendous power of the international or national resources of companies like these design and engineer the complex systems. While most of the hardware design for this type of system is done at the company's local or regional level, the control software is usually designed and written at some central point by the company's computer experts.

An example of a system of this type is the Georgia Pacific Center in Atlanta, GA. The building is owned by a joint venture consisting of Georgia-Pacific Corporation and Metropolitan Life Insurance Company, and is managed by Taylor & Mathis, an Atlanta-based real estate development/management company. The building itself, a 52 story, 1.3-million-square-foot structure, has office space, conference facilities, a computer center, health club, and a restaurant and is located in the center of Atlanta's business district. Over 3,000 people work in the building placing a heavy responsibility on the life safety system.

According to Roger Cissa of Taylor & Mathis, the decision to include a very elaborate fire control and life safety system was based on a number of factors. With the involvement of Metropolitan Life, a keen awareness of the safety aspect led to the inclusion of this

EKTACOM G



Many call it the world's best direct-select intercom. This premium quality system has been proven in thousands of installations. Six to 1,000 key masters; all light annunciation; solid gold switch contacts; 4" speakers; 45 ohm, balanced lines; plug-in 25 pair cables; in and out volume controls; solid state T/L muting and compression; desk, flush or rack mounting; UL Listed power supplies. Many options including central and group paging; parallel call from one remote to multiple masters; master-to-master annunciation; 11 watt RMS output. The G is used by all branches of the Government from Walter Reed Hospital to the USS Enterprise. Two year Factory warranty.

See us at Booth H

F B FISHER BERKELEY CORPORATION

5800 Christie Ave., Emeryville, CA 94608 (415) 655-9696

You should know more about EKTACOM G! Write Today!

"QSC Customers Are Buying More Than A Product; They're Also Buying Our Support."

Barry Andrews
President,
QSC Audio.

"What if it breaks?" That's an ugly question, but an unavoidable one for anybody who buys a pro audio product. At QSC, we won't leave you high and dry if you have a problem with one of our amplifiers. We pride ourselves on the reputation we've earned for quick and courteous service.

We offer a 3-year warranty on our Series Three amps

and a 2-year warranty on our Series One. For QSC, anticipating problems before they occur is a part of effective design. Through careful engineering, we've been able to make service easy for our customers, our dealers and ourselves. Protection from real-world hazards is built right into QSC amplifiers. Take the patented Output Averaging Circuit™ used in our top-of-the-line Series Three and more economical Series One. It provides complete protection from short circuits



without compromising the amplifier's performance. Both the input and output stages of QSC amplifiers are fully isolated against overdrive, RF burnout or unstable loads. Even your speakers are protected against destruction caused by DC fault. The modular design of our Series Three amplifiers makes service easy in the event that something does go wrong. Each channel is built into its own front-removal module, which can be easily taken out for service. Modules are connected to the mainframe by means of a locking gold-plated connector on a flexible cable—an interface that stands up to rough handling. For QSC, service means a lot more than just fixing things. It means listening. We listen to your problems as well as your praise. And we've incorporated that real-world experience into the design and service of every product we make. For more information contact: QSC Audio Products, 1926 Placentia Avenue, Costa Mesa, CA 92627, (714) 645-2540.



QSC Quality
Service
Commitment

Circle 237 on Reader Response Card

See us at Booth 22



World Radio History

QSC AUDIO STEREO AMPLIFIER
MODEL 1400

type of system early in the project's design. The benefits that resulted were many. Not only does the increased safety of the building provide an effective sales tool for attracting tenants, but it also makes it faster and easier to

management system. From the protected control center in the basement, fire alarm systems, voice communication, fire phone systems, CCTV security systems and complete environment control are supervised by human

by RCA, with all the cameras, monitors, switching and components installed by Johnson Controls.

The Soundolier Fire Phone system's control center is located in the basement, in a protected area to allow the fire chief to direct fire fighters throughout the building by using data supplied by the environment management system. There are special outlets on each floor, in each stairwell, to allow firefighters to plug their handset in and receive instructions. The pressurized stairwells provide a safe corridor for the firemen to work through. This two-way communication provides efficient control of the fire while reducing the risk to the firemen.

The life safety system consists of Atlas APF-15 loudspeakers mounted in Soundolier enclosures installed on every floor. Each floor is a separate zone with speakers located above the ceiling plenum or wall or surface mounted. The loudspeakers are driven by McMartin amplifiers, 100-watt and 200-watt amplifiers, the larger ones being used for the larger floors. There are two amplifiers per floor, including the parking garage, with automatic switchover in the event of

(continued on page 76)

As many of the really elaborate fire control systems are part of a complete building management system, including security, temperature, lighting, ventilation, electrical consumption, etc.

obtain occupancy permits from the municipal government, and the public liability insurance costs are significantly reduced.

The building will be around for at least 50 years, the extra cost of the fire control system and life safety equipment will be more than paid off by the reduction in insurance premiums alone. But more effective yet is the cost savings provided by the environmental control by computer which will pay itself off in a few years, Cissa said.

The life safety portion of the system is impressive, as is the overall building

operators 24-hours-a-day, seven-days-a-week. Johnson Controls' Atlanta office was responsible for the massive installation which operates with the building's built-in safety features such as steel beams covered in heat and fire retardant foam, smoke and heat detectors, pressurized stairwells, the conduit for speaker and sensing wire running in the concrete slab for maximum protection from heat and damage, sprinkler systems, Halon extinguishers in the computer facilities, and water pumps in the basement.

The security CCTV system is built

ONE SOUNDSPHERE DOES 1,300 SEAT GYM!



The gymnasium of Our Lady Queen of Heaven has a single Soundsphere #2715 in the room center. With the bleachers pulled into position for basketball games, the space holds approximately 1,300 people. When the contractor, Howard Trotter of Sylvan Sound, visited the site months after installation, someone asked what had been the largest group of people in the gym for an event. The response was that after special decoration, the space had been used for a Midnight Mass which was attended by more than 2,500 people. The one #2715 Soundsphere delivered quality music and crisp voice announcements for the entire congregation. The same speaker also plays popular and rock music for the heavy sound at student sock hops.

Howard Trotter has recently installed Soundspheres in many school gyms and auditoriums. He reports very favorable comments from the staffs of Westlake, LA High School, DeRidder, LA High School and St. Philip of Neri Church in Kinder, LA. Howard has used Soundsphere dual reflectored speakers #2212 and #2715 in numerous installations where one Soundsphere can effectively operate as a single source. Mr. Trotter is also very enthusiastic about the ease of installation of all Soundsphere loudspeakers.

See us at Booth 124

Write or call direct for further information.

SOUNDSPHERE

A PRODUCT OF
SONIC SYSTEMS, INC.

737 Canal Street • Bldg 23B • Stamford, CT 06902 • USA • Tel (203) 356-1136



Toa/Files

Date
Second Quarter 1986

Installation

Sold Toa's new 500 Series Mixer/Power Amplifier to the seafood restaurant on the wharf. This table-top unit is perfect for places that want Toa quality at an economical price—and no service calls.

Comments

The 500 Series Mixer/Power Amp accepts any high level signal source, & it has all the features & controls the client needs. I told client that this all-in-one paging/music system is backed by Toa's 50 years in commercial sound.

Future Prospects

The 500 Series consists of 30 watt, 60 watt, and 120 watt power configurations, so it can go in larger restaurants, cafeterias, waiting rooms, health spas—contact all locations that require economy and clarity from a reliable commercial sound system.

*see
steakhouse
next
week*



Install Confidence.



Toa Electronics, Inc.
Commercial/Engineered Sound Division
See us at Booth 5

480 Carlton Court
South San Francisco
California 94080
(415) 588-2538

Toa Canada: (403) 489-5511 Edmonton, or (416) 624-2317 Toronto ■ Toa U.K.: (0277) 233882 Essex ■ Toa Europe: (040) 811127 Hamburg

Need a reliable, portable, professional PA system?

You could carry this...

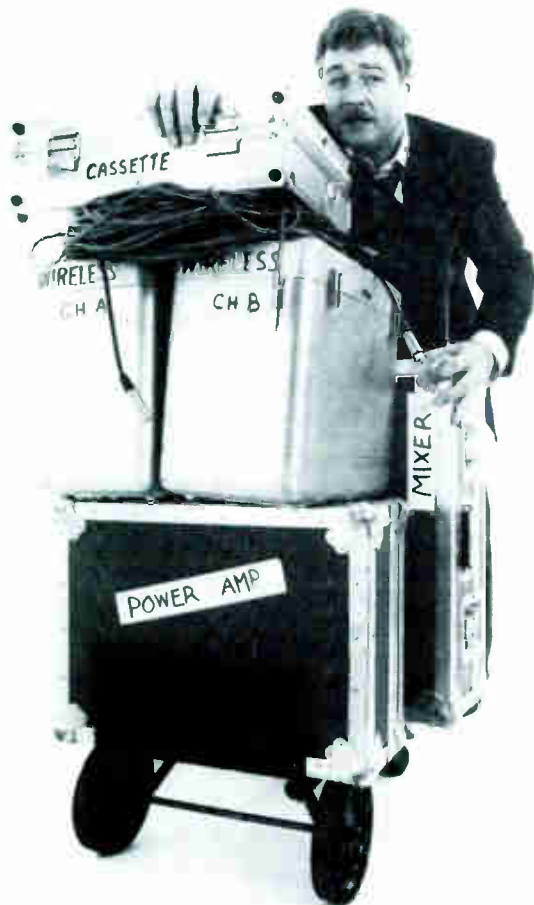

Or this...



THE PANASONIC WX-801C/A

- A complete sound reinforcement system for A/V and sales presentations, meetings, hearings, conferences, trade shows, & other exhibits
- Freedom of motion with simultaneous use of up to 2 wireless mics plus conventional hard-wired mic input
- Record or play back with built-in cassette deck
- Built-in amplifier and speaker—no wiring or setup
- Carry and use it anywhere. Operate on batteries or AC

The WX-801C/A is a professional quality PA system with wireless mic, cassette deck, mixer, amp and speaker. Easily carried in one hand, it will operate for over 4 hours on internal batteries so you can be heard at outdoor meetings or anywhere AC power is not available. For larger portable or fixed installations, it can be used in conjunction with an external amplifier/speaker system. It employs a sophisticated dual-diversity VHF wireless mic system to eliminate fades and dropouts, with a compander to avoid hiss and distortion.

If you're looking for a portable, flexible PA system, the WX-801C/A is the clear choice. Available from your Panasonic Professional Audio or Video Dealer, or contact:

Panasonic Industrial Company
Professional Audio Systems
6550 Katella Avenue/Cypress, CA 90630
(714) 895-7200



Panasonic
Industrial Company

See us at Booth 152

Circle 238 on Reader Response Card

World Radio History

TELEPHONE ALERT

Life Safety for High-Rise Buildings

by Art Meindink
Tellabs Inc.

The American public has always been extremely safety conscious. Since the advent of consumer protectionism, OSHA, and the legislation of certain public safety issues, this concern has become increasingly apparent.

This sense of concern for public safety has been escalated by media coverage of recent events that focuses on dramatic disasters such as chemical spills, radioactive contamination, floods, earthquakes, tornados, and

high-rise building fires. Many of these incidents share common elements such as tragic loss of life and the need for mass evacuation. Collectively, they have increased public awareness of the dangers posed to people in the course

(Right) The Tellabs Alerting System was designed to be activated from the control panel located near the Marriott Marquis' (below) PBX.

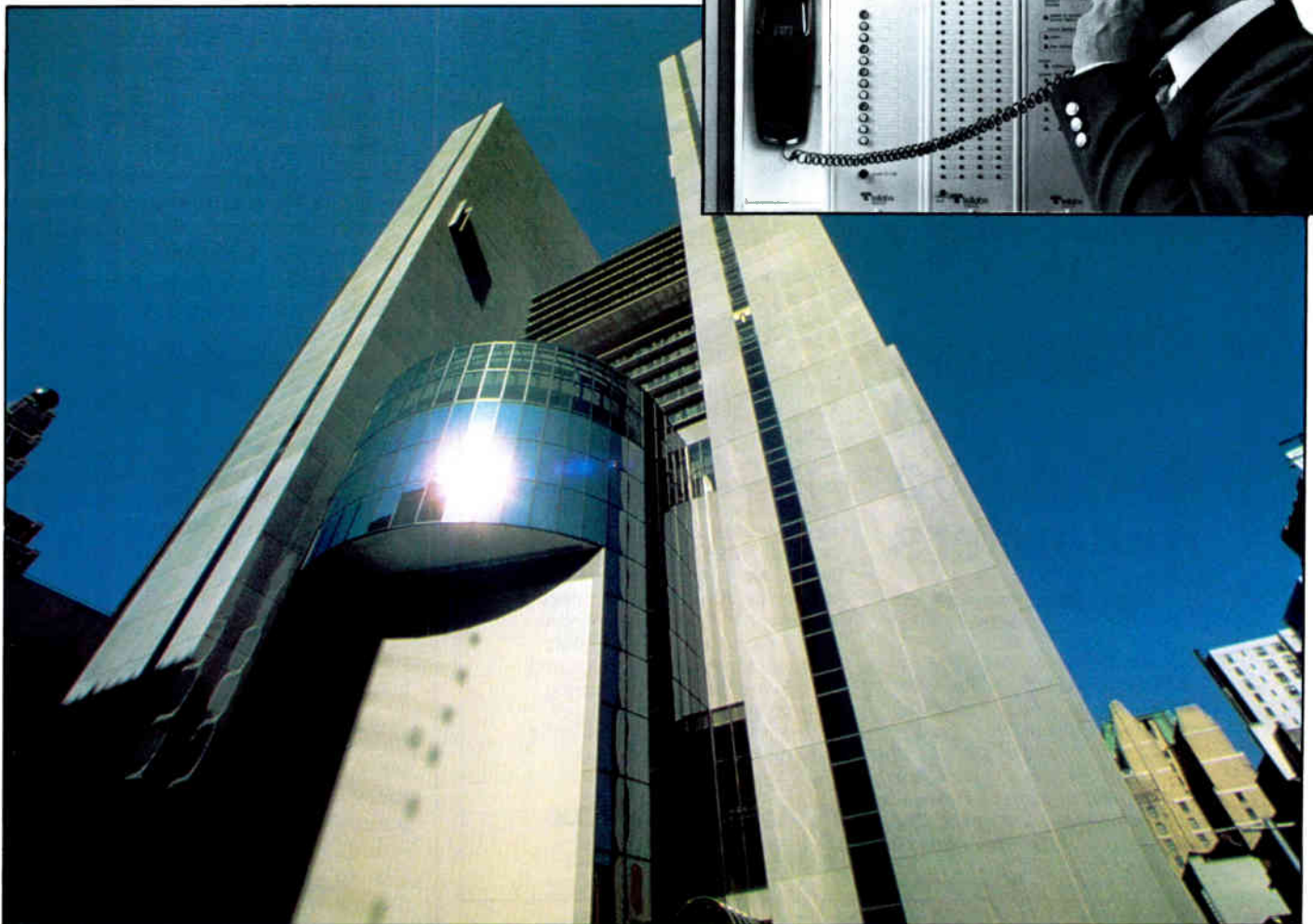

of daily life. In view of the public's increased safety consciousness, the demand for enhanced public safety measures is greater than ever.

One area of concern focuses on fire safety in high-rise office buildings and hotels. State, county, and city governments address these concerns through preparation and enforcement of building codes. These codes address actual building structures, detection equipment (heat and smoke detectors), and evacuation procedures. Only new construction is covered by code, since many building codes would require extensive structural or wiring changes to existing buildings.

Building codes for evacuation procedures focus in particular on use of public address amplifiers and speakers specially designed to meet UL 864 re-

quirements for voice evacuation systems. These systems usually cover hallways, elevator areas, stairwells, and common areas. They typically do not cover individual rooms due to the expense of additional speakers and amplifiers.

The New York Marriott Marquis in Times Square incorporates all of the building code requirements for life safety, but during the planning stages of the hotel, the designers wanted to go even further with regard to guest safety. They wanted to send alerting or evacuation messages directly to each room.

Although the public address system could have been expanded to provide one speaker in each of the 1,700 rooms, the Marriott Marquis officials wanted to research all potential alter-

natives. The search led to Tellabs, Inc., of Lisle, IL. Tellabs manufactures a telephone-based alerting system that can be added to any new or existing telephone system. It is capable of ringing all telephones in the hotel simultaneously and broadcasting a pre-recorded or live verbal message by phone to all who answer.

The Tellabs 293 Conference and Alerting system is designed to be activated from a control panel located near the hotel's PBX. A Marriott Marquis official can use pushbutton controls to ring all telephones in the hotel, or a selected zone of telephones. As telephones are answered, listeners are connected to either a continuous-loop recorded message or a live evacuation message (the choice is the system operator's). The same message can be sent simultaneously through the hotel's loudspeaker paging system. This provides complete coverage to corridors, and common areas, as well as to each individual guest and meeting room.

Since the required message may vary from area to area in the hotel, the ability to activate individual zones (similar to paging system zones) is built into the system. This allows the message to be tailored to the needs of each area's particular situation. In the case of the New York Marriott Marquis's system, 11 distinct zones were incorporated into the design. The alerting function at the Marriott Marquis is activated from a Tellabs 930 control panel, which includes a telephone handset for sending live messages, pushbuttons for activation of individual zones, prerecorded message capability, answer status indicators (LEDs), and an alarm panel to report any system failures.

The Tellabs 293 Conference and Alerting System also provides "answer status" for each telephone being alerted. As each telephone is answered, an associated status lamp is illuminated at the control panel. This allows the operator to quickly determine who has (and who has not) received the message.

In the case of the New York Marriott Marquis, 1,700 room status lamps would be cumbersome to scan, so a printer was incorporated instead. In this case, the Tellabs equipment scans all lines in the alerting zone or zones. As the lines are answered, their status is typed onto a permanent record. The printer is located near the alerting system control panel. When the system is activated an emergency



38 Revox Industrial and A/V Audio Recorders

Thirty-eight? Where are the other thirty-five?

No need to show them. They all look pretty much the same as the three basic transports shown: PR99 MKII, PR99 Playback Only, and B77 MKII. But, with all our special versions, modifications, and options, you can order a Revox to fill virtually any application. The "menu" includes:

- Auto-reverse 4-track playback for background music
- Auto repeat for loop play
- Alternate recorder control for logging
- Voice activated start
- Any two adjacent speeds from 15/16 to 15 ips

Other choices include balanced or unbalanced in/out, rack mount or cabinet, consoles, transport cases, monitor panels, vari-speed—the list goes on! PR99 MKII models also feature real time counter, autolocate, zero locate, and loop functions. And all three transports offer a die-cast chassis, full logic controls, servo capstan motor, and solid Swiss-German engineering.

If you need audio recording of any kind, give us a call. If we don't have what you need, we'll get cracking on #39.

STUDER REVOX
Studer Revox America

1425 Elm Hill Pike, Nashville, TN 37210 (615) 254-5651

Circle 243 on Reader Response Card

message is transmitted by phone and safety personnel receive constant printer updates showing which rooms have answered their phones.

Ease of installation and maintenance were also of prime concern to the New York Marriott Marquis. Since the Tellabs 293 System is designed to be plugged into standard telephone company connecting blocks, installation consists of simply mounting prewired racks, plugging in connectorized cables, and connecting power, and peripheral equipment. The system uses the same wires that the telephone system uses. No additional wires to individual stations are required. That makes this kind of alerting equipment ideal for retrofit into existing buildings.

As stated earlier, most building codes apply to new construction only. Retrofit of large public address systems into existing buildings may not be financially, or even physically, possible. A telephone alerting system can be used for these applications because it uses existing telephone lines. Now buildings that cannot be retrofitted with a "voice evacuation system" can economically install a telephone alerting system.

The System is modular in design and uses prewired shelves for expansion. It features unlimited expandability, so it can handle any number of stations. It can even be expanded after initial installation. Supervisory modules are included in the system to monitor amplifiers, circuit continuity, and power. Any failure of the 293 results in an alarm at the control panel. Since the New York Marriott Marquis system is to be used primarily for voice evacuation, the hotel required that it have U.L. approval. All components of the Tellabs 293 meet the requirements of UL 864.

The New York Marriott Marquis installed the Tellabs 293 Conference and Alerting System in time for their grand opening in the Fall of 1985. Since then, many representatives of other hotels have expressed interest in systems for their facilities. In addition, proposals for similar systems have been requested by chemical plants, refineries, prisons, school dormitories, and shopping centers.

SUBSCRIBE

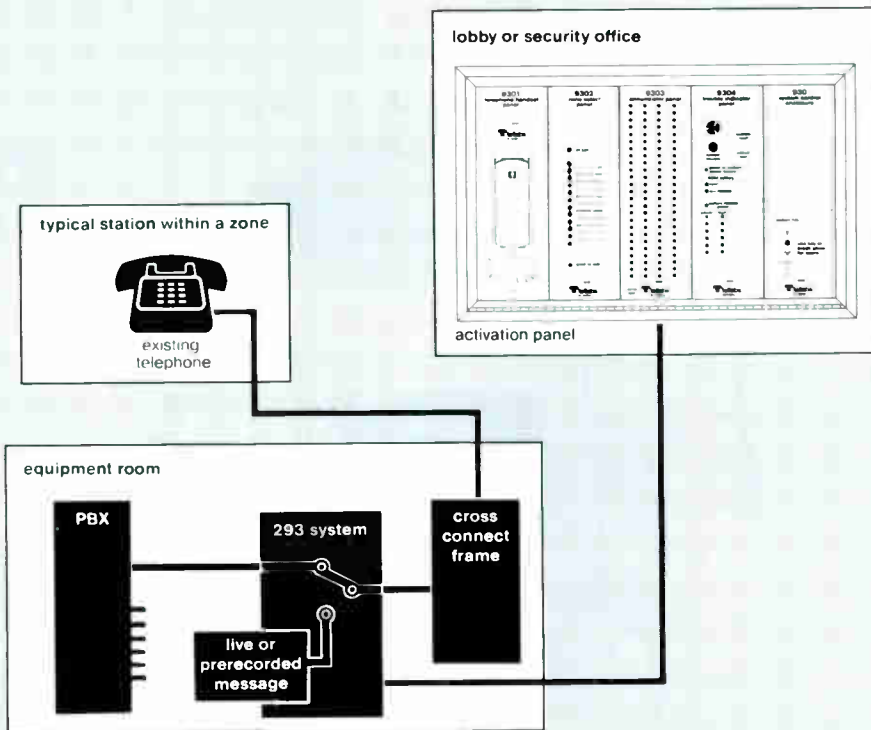

© 1986 Sennheiser Electronic Corporation (N.Y.)

“I’d rather spend my money on a Sennheiser than spend my time making excuses.”

See us at Booth 80

SENNHEISER[®]

Sennheiser Electronic Corporation (N.Y.)
48 West 38th Street New York, N.Y. 10018 • (212) 944-9440
Manufacturing Plant: D-3002 Wedemark, West Germany

Circle 239 on Reader Response Card

Tying America Together Bit by Bit

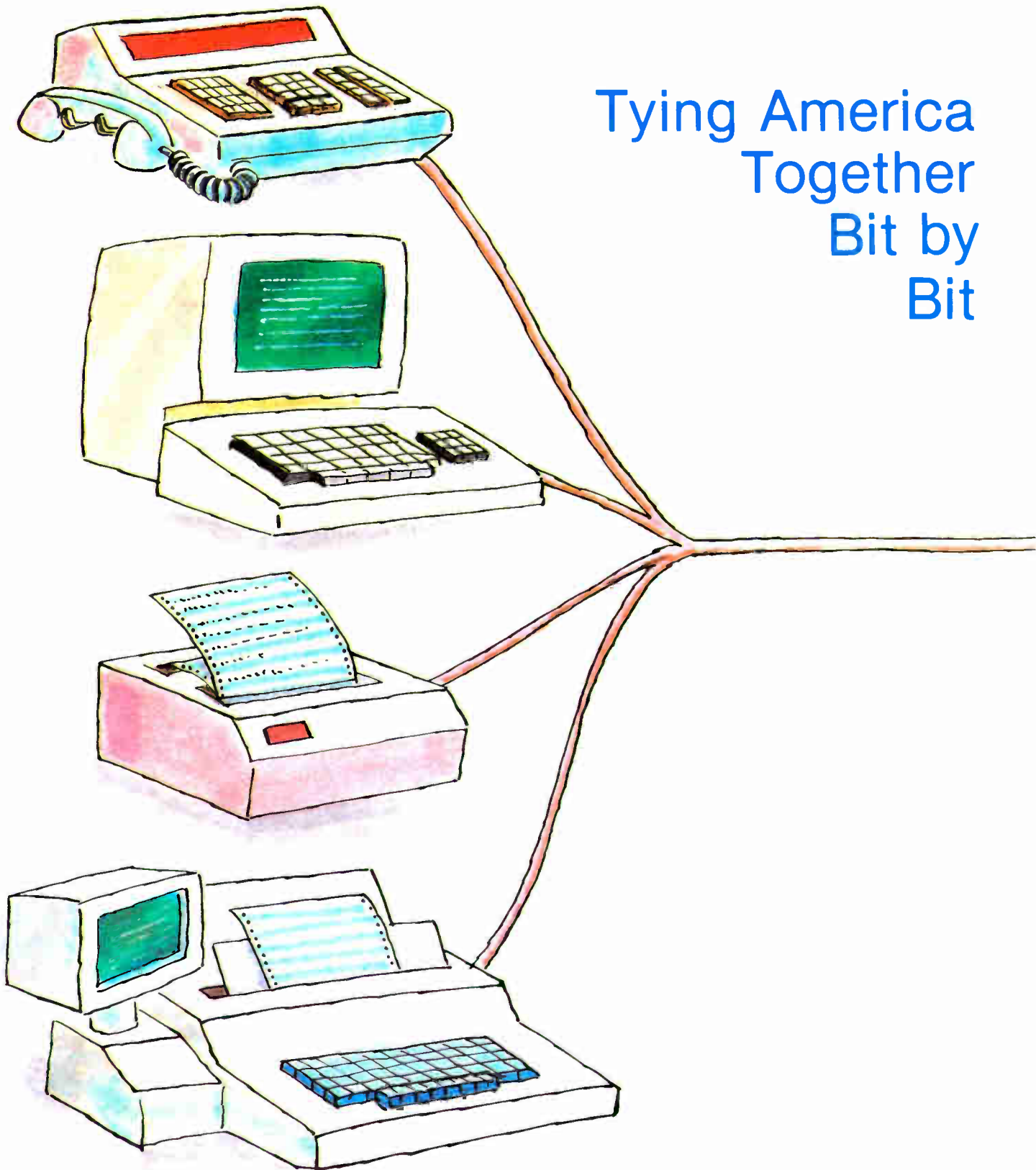

ISDN

by Sandy Kyrish

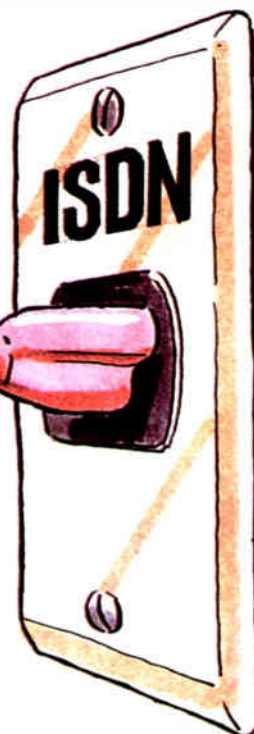

ISDN is a great idea whose time has come but will still have to wait awhile. Everybody has heard something about ISDN, a nationwide digital network merging voice, data, facsimile and image transmission. Few ideas could make more sense, be more necessary, take so long and cost so much money.

ISDN stands for Integrated Services Digital Network. ISDN is actually a still-evolving set of standards for end-to-end digital information transfers. Its purpose is to allow different forms of electronic communication to travel along the same digital paths, just as all electrical appliances plug into a standard wall outlet. Devices including telephones, computers, and televisions will all use the same interface to an ISDN.

The existing telephone network is the logical backbone for an ISDN, since local exchanges and long distance routes have already been intricately established. But turning the phone

network into a digital central nervous system will not be easy. The network is a mostly-analog assembly of instruments, switches, and lines representing a current investment of over \$120 billion. Many geographical areas have modern digital telephone switches, but some telephone exchanges still use the mechanical step-by-step switching device that was invented by an undertaker in 1891.

This article discusses the structure and advantages of an ISDN and illustrates some of the difficulties of converting to an all-digital network. It's difficult to resist writing about "how it's going to be," but be warned that a *true* ISDN is at least a decade away.

In 1984, the International Telegraph and Telephone Consultative Committee (or CCITT) released its first recommendations of standards for an all-digital communications network. The CCITT defined an ISDN by three features:

digital end-to-end channels under customer control, provision of a broad scope of services using interleaved bit streams, and multipurpose standard user interfaces.

The growth of private, point-to-

panies needing high-speed, high volume data transfers generally lease or purchase private digital connections. Companies wanting video teleconferencing must arrange and pay for the installation of special equip-

unit will be the "B channel," equivalent to 64 kilobits per second (kb/s).

The B channel is the digital equivalent of a standard voice-grade line. Here is the equation. The telephone company allocates 4 kHz for a voice line (which explains why telephone voices have no real timbre). The digital sampling of an analog waveform is done at twice the highest frequency of the waveform, to ensure fidelity. The digital sampling rate of an analog voice line is then 8 kHz. Since an 8-bit word is assigned to each sample, the digital rate becomes 8 bits times 8,000 cycles per second, or 64 kilobits per second.

A second channel has also been established, called the D channel. The D channel is 16 kb/s, and it serves as the signalling channel for one or several B channels. The D channel sends packet-switched signalling information between the ends of the transmission path. It can be used to set up transmission links, or to carry information about multiplexed signals traveling on the B channels.

Two main service offerings have been defined. "Basic access" provides a customer with two B channels and a D signalling channel, for a total of 144 kb/s of channel capacity. Basic access can be brought into most homes and offices over the presently-installed twisted-pair cabling. One of the main features of an ISDN is that channels can be shared among users, as long as the information transmitted doesn't exceed the carrying capacity of the circuit.

"Primary access," for larger corporate customers, provides one D channel and 23 B channels for a total of 1.544 mb/s. Many will recognize primary access as the American-standard T-1 channel. T-1 is already commonly used for digital voice, data and compressed video trunking. Since all digital transmissions will travel over the same paths, a company can carry voice, data, and facsimile emanating from different sources at the same time over the primary access channel.

The ISDN will offer many inherent advantages as a communications system. Customers will be able to specify transmission rates on demand. For example, a company using a primary access circuit (or T-1) could easily and actively decide when to tie up the whole channel with compressed video and when to use it to provide variable rates of speed for data transmission. Data transmission rates will rise

THE ISDN WILL OFFER MANY INHERENT ADVANTAGES AS A COMMUNICATIONS SYSTEM. FOR EXAMPLE, CUSTOMERS WILL BE ABLE TO SPECIFY TRANSMISSION RATES ON DEMAND.

point digital transmission facilities had been underscoring the need for an ISDN for several years. The telephone network and computer users have obviously been at odds since the first modem was invented. The telephone network had been built to accommodate analog voice transmission in an era that hadn't even imagined computers. Turning a binary output into a modulated waveform and back again, naturally causes a limitation in the speed and reliability of data transfers.

To bypass the analog network, com-

ment and lines. Facsimile transmission over a telephone line takes forever. And the average consumer is left wishing that his or her modem could do more than 1200 baud and not tie up the home telephone line. With so much technology available, the obvious next step is to tie it all together.

An ISDN will provide common signal paths for all digital transmissions. The concept is simple. Rather than thinking of channels in increments of kilohertz, signal paths will be expressed in bits per second. The basic channel

RELENTLESS.

Choose the system that just won't quit.

Reliability is critical in a door monitor system.

Which is precisely why our A-1000 series door monitor is becoming the industry's system of choice.

Quality is one reason. We use only LEDs in our monitors and stations, for example, and build every panel out of rugged anodized aluminum.

Flexibility's the other. We offer you a full range of options, from

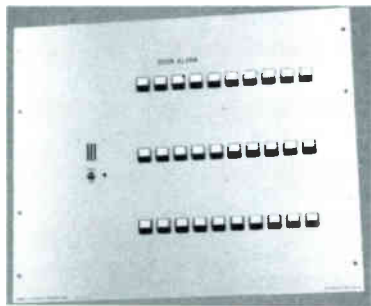

remote zone control with or without timers to tamper-proof systems for locking statuses to preset conditions. So you can configure just the right system for applications ranging from building entranc-

ces to interior doors and cabinets.

All of which makes our A-1000 door monitor a system that just won't quit. For details, write or call today.

See us at Booth 9

CORNELL

ELECTRONIC PRODUCTS, INC.

4911 W. Good Hope Rd./P.O. Box 23411/Milwaukee, WI 53223/(414) 351-4660

Circle 213 on Reader Response Card

dramatically above even the new 2400-baud mark, as modems will no longer be required.

The telephone network will become a giant computer network. Videotex will become more economically feasible, since customers can access information as easily as they now make a phone call. Digital PBXs can be used as cost-efficient gateways to external CPUs and databases, and to local and wide area networks. An underestimated benefit to corporate customers is that very high speed facsimile transmission will provide a real alternative to costly overnight delivery services.

Long distance calls (for both voice and data) will have faster set-up times and more efficient routing. Packet-switched call information will race ahead of the voice channel, automatically determining the cleanest, most efficient path for the call. And, of course, a caller can intersperse his or her conversation with computer data, facsimile, or even image transmission.

Digital switching already provides custom calling features to certain metropolitan residents. For example, most citizens in Austin, TX, have access to selective call rejection, automatic recall of missed calls, auto-redial of busy numbers and distinctive ringing for certain incoming calls. The services do not have to be subscribed; consumers can activate any feature with the Touch-Tone keypad.

But the features only react to telephone calls originating from another local, digital switch. That's the catch to ISDN—the whole thing has to be digital to work. If a business can send digital end-to-end data from New York to Cleveland but not from New York to El Paso, then there is no ISDN at all. The customer still must know when to use the modem.

Converting the nation to an ISDN requires digitizing all four parts of the telephone network: the transmission lines, the switches, the local loops, and the instruments. Although ISDN is usually thought of in terms of digital trunks and satellite links, all components are equally important in making the end-to-end connection.

AT&T and other major long distance carriers are already replacing long distance transmission lines with fiber optic technology and digital microwave. But the process is slow and extremely expensive. AT&T has begun linking major cities by fiber and microwave; however, the company estimates that this project will cost \$2

The SOUND ENHANCER

Fire Retardant
ABS Plastic

Vibration Free
Construction

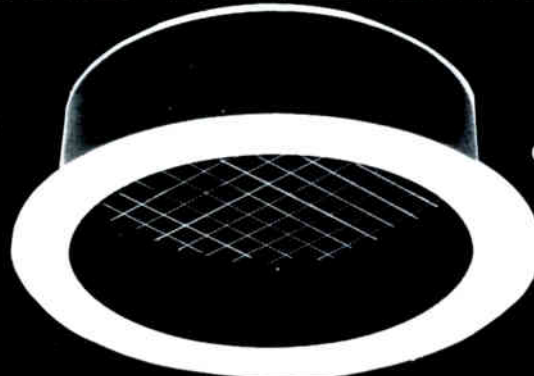

ALSO AVAILABLE AS SPEAKER AND LINE TRANS. ASSEMBLIES

Designed To Complement
The Decor
Of Any Room



A Recessed
Sound Chamber
For Any
8" Speaker

SPECO Circle 277 on Reader Response Card

1172 ROUTE 109, P.O. BOX 624, LINDENHURST, N.Y. 11757
516-957-8700 • TOLL FREE 800-645-5516
TELEX: 96-7754 SPECO LNST • FAX: 957-9142

SEE THE SOUND ENHANCER AT THE EDS SHOW BOOTHS L1 & L3

The inside sells better when the outside looks good.

Choose from 11 attractive styles—sloping fronts, low profiles, uprights. In the sizes you need most. Made of rugged metal or metal/plastic combinations. Available in 7 contemporary colors or your custom match.

Learn how TEN-TEC enclosures can make your sales look better. Send for our free catalog. Call toll free or write:

1-800-231-8842



TEN-TEC
Dept. J12 Sevierville, TN 37862

Circle 246 on Reader Response Card

Presenting the system you helped us design: The Bose® 102™ Commercial Sound System.

Don't miss
Bose's Modeler™
system (new
Sound System
Software!)
April 30,
Las Vegas
NSCA
Booth #26

Full bandwidth
frequency
response and
high SPL output
capability

Factory-
assembled system:
enclosure, driver,
transformer and
level switch

Designed to meet
U.L. standard
#1480

5-year
transferrable
warranty

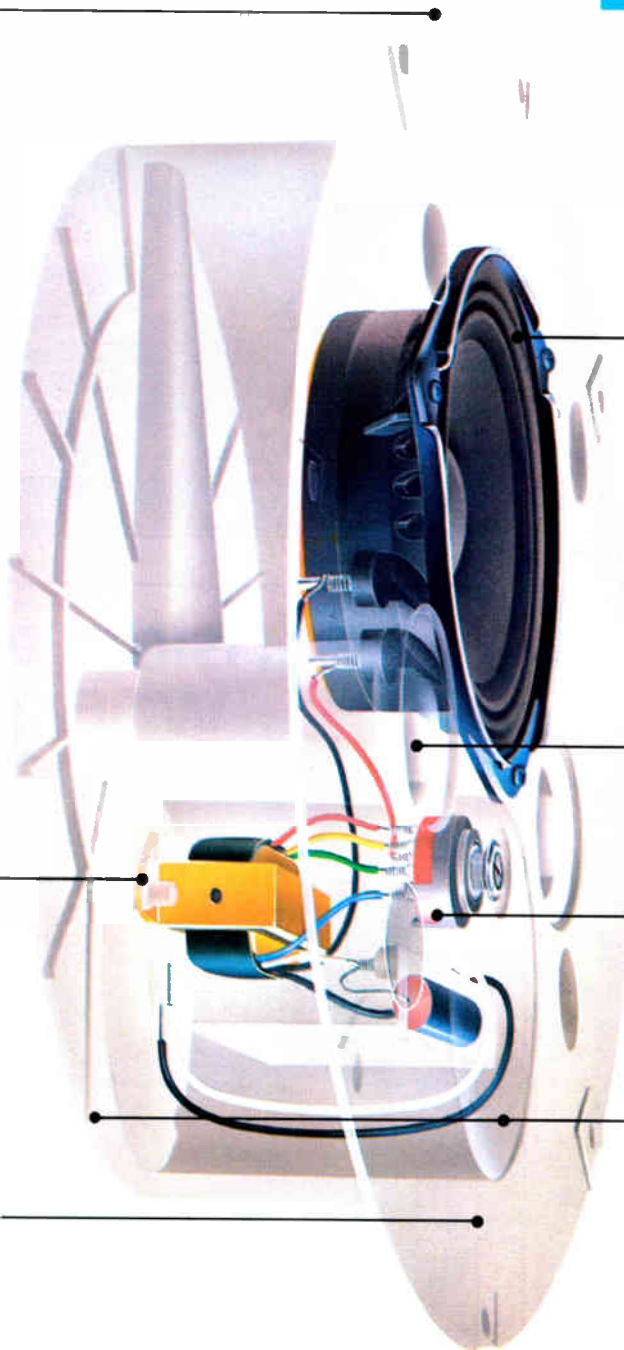

High-efficiency,
wide-dispersion
4½" helical voice
coil Bose full-range
driver

Dual-port,
bass-reflex
design for
efficient bass
reproduction

Prewired
5-position level
switch

Front and rear
wiring access
plates

Factory-installed
transformer

Requires only
3½" wall or
ceiling depth and
retrofits into
existing cans

The design of the Bose 102 Commercial Sound System began with our question: "What do you want in an installed sound system?"

In short, you wanted a system with full bandwidth response, high SPL capability, wide dispersion and high reliability. Furthermore, you wanted that system to be flexible, easy to install and competitively priced.

For the past year we worked with more than 25 sound contractors and acoustical consultants, reviewing prototypes and blueprints, and refining the system. Now, thanks to you, it's right.

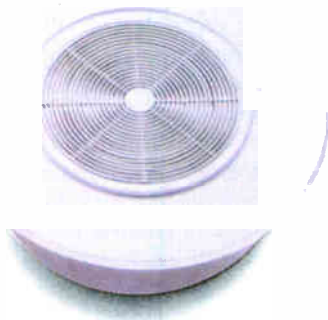

102 Flush-Mount Speaker with optional 102 Snap-on Grille.

The 102 System offers you two compatible loudspeaker configurations, the 102 Flush-Mount Speaker (above and left), and the 102 Surface-Mount Speaker (below). Both are available in 8 watt and 25 watt models with 70 or 100 volt transformers, plus an 8 ohm non-transformer model for small systems.



102 Surface-Mount Speaker.

The 102 Surface-Mount Speaker has the same performance characteristics as the 102 Flush-Mount Speaker and includes the factory-installed line transformer and level switch, but is housed in a contemporary surface-mount enclosure with a black metal grille. Optional brackets give you a variety of mounting options.

Our systems approach saves you time and money.

Since the components in the 102 System are compatible, you no longer have to pore over endless data sheets looking for system components. Simply choose the correct number of 102 Flush-Mount and Surface-Mount speakers for your application.



102 System Controller.

The 102 System Controller provides two independent channels of full bandwidth equalization for music, allowing stereo or two-zone mono operation.

The full-bandwidth channels feature balanced, differential inputs with sensitivity switches that can be set at 100 mv or 1 volt. The 102 System Controller comes with a two-year transferrable warranty.

Exclusive Opti-Voice™ System.

The 102 System Controller's Opti-Voice™ circuitry automatically reduces the volume of the music during voice-over operation, then gradually restores the music level after the voice message has ended.

Opti-Voice™ circuitry also provides custom band-limiting equalization for maximum voice intelligibility and minimal microphone proximity effect and handling noise. A compressor compensates for varying input levels by raising soft voice signals and lowering loud voice signals. As a result, each voice broadcast over the system will sound consistently smooth and intelligible.

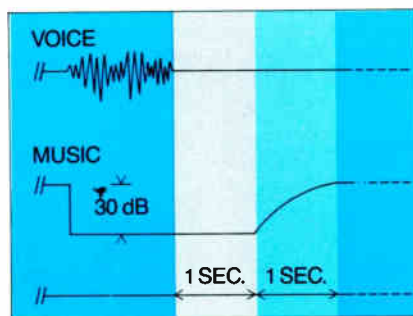

Timing Diagram for Opti-Voice™ System.

Automatic voice channel gain feature.

A recessed adjustment screw on the rear panel of the 102 System Controller controls the voice-channel gain. When a 3:1 compression ratio is reached, the LED flashes, allowing you to quickly set the proper voice-channel gain—regardless of the strength of the input signal.



Rear panel control for voice-channel gain.

Broader dispersion.

The broader dispersion of the Bose 4½" driver over conventional 8" drivers means you can specify fewer units per system. This results in lower cost for your customer and less labor for you.

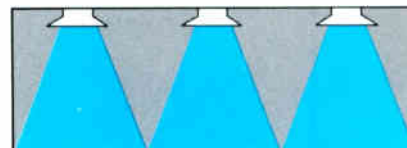

102™ LOUDSPEAKER SYSTEM

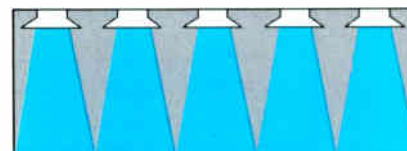

8" COAXIAL SPEAKER

Comparison of 102 system and 8" coaxial speaker dispersion characteristics at 2 kHz.

Recommended applications:

- Restaurants/lounges/nightclubs
- Hotels
- Airport/train and bus terminals
- Conference rooms
- Hospitals and schools
- Commercial buildings and offices
- Outdoor and environmental applications
- Recreational facilities
- Entertainment and sporting complexes

Regardless of the application, you'll find the new Bose 102 Commercial Sound System provides a significant improvement in installed sound system performance. However, that's not surprising, considering that you were an integral part of its design.

For more information on the 102 Commercial Sound System, call the Professional Products Division at Bose Corporation:

- USA: (617) 879-7330
- Canada: (416) 881-2331
- Europe: 2993-66661
- Japan: 3-499-0901
- Australia: 2-684-1022

Bose Corporation, The Mountain, Framingham, MA 01701

See us at Booth 26

BOSE
Better sound through research.

Circle 210 on Reader Response Card

FANE EUROPE'S #1 LOUDSPEAKER MANUFACTURER



5/35 SPECIALIST



SPECIALIST MONITOR 150

Find out for yourself why for over 2 decades FANE has been Europe's Favorite Speaker. FANE offers a variety of 5", 8" and 12" Loudspeakers to fit all of your sound system needs; From a distributed sound system to a large concert array.

FANE
AMERICA-LIMITED

A DIVISION OF IMC

P.O. BOX 2344 FORT WORTH, TEXAS 76113-2344
PHONE (817) 336 5114

Please send me more information on Fane Loudspeakers

Name _____

Address _____

City _____ State _____ Zip _____

Circle 280 on Reader Response Card

VARIETY, VERSATILITY and VALUE...we've got you covered.

TekTone's line of quality products provide more choices for today's busy world. From security, intercom and entertainment systems for the home, to large multi-dwelling inter-communications systems, TekTone is your one stop source.



Come see us at
NSCA Expo '86,
Sahara Hotel, Las
Vegas, Nevada
April 29, 30 and
May 1, Booth "K".

Featuring TekTone's IR-104A apartment station, EK-804A AM/FM radio-intercom and the VM-102A video intercom system.

TekTone

Sound & Signal Mfg., Inc.
1331 S. Killian Dr. Lake Park, FL. 33403
(305) 844-2383 TLX 513438 TEKSTONE WPB
toll free order desk (800) 327-8466

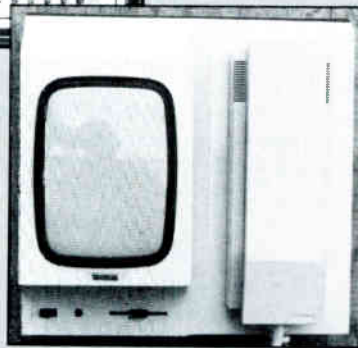

Circle 244 on Reader Response Card

billion and take at least six years. Smaller cities can expect to wait much longer.

Bell Operating Companies are also replacing analog telephone switches with digital ones. Regulatory and financial constraints, however, often determine the progress of this task. Telephone equipment is normally depreciated over cycles as long as 40 years, and telephone companies do not always replace equipment just because something better comes along.

Local loops, or the wires connecting a home or business to the telephone switch, feature the toughest collection of motley technologies. The twisted-pair cabling may pass through one or several loading coils, may be spliced in several areas and consist of varying gauges of wire. None of this is conducive to digital transmission, but immediately replacing local loops would be a hopelessly labor-intensive task.

Echo-cancelling devices will enable 80 percent of existing metropolitan homes to use their present local loops for digital transmissions. Eventually, the local loop may use fiber optics, coaxial, or perhaps radio links. Although it has been speculated that telephone and cable companies could join forces to use coaxial cable loops, cable company distribution schemes don't always work well for high-volume, real-time duplex traffic.

Telephone instruments are steadily going digital in the business environment. The device which translates analog waveforms into digital pulses is called codec (short for coder-decoder), and in a telephone it can be reduced to a single chip. Companies that lease or buy their own digital PBXs normally use digital telephones. Smaller businesses will have to purchase new telephones.

Digital telephones have not been introduced to the mass consumer market, but they may be less costly than current telephones because they can eliminate mechanical items such as ringers and carbon microphones. Naturally, the cost of replacing an analog telephone will fall on the consumer. If current trends are any guide, consumers looking for a cheap digital telephone will probably get a flimsy device which will sound just as bad as today's \$10 phones.

Back in the office, telephones and computers will increasingly merge into workstations. Telephone-industry companies including Rolm have introduced combination voice-data ter-

minals for use by executives. An ISDN will be a natural encouragement to develop devices which can plug into a standard interface and immediately provide a full range of voice, data, and image capabilities to the user. These devices will be customized for executives, secretaries, middle managers, and other employees. Home devices should follow.

But in a free market society, products and services aren't normally introduced without indication of market demand. And as in the invention of the telephone itself, people often don't realize they "need" a product until it has been offered to them. Implementation of ISDN is hampered by a sort of chicken and egg problem—digital networking doesn't really pay off until it's completely end to end, but there must be an economic incentive to bring digital connections to all points. Visualizing a future and creating it are not the same thing.

The American ISDN will begin as a network of the most profitable customer centers. The ISDN backbone will naturally evolve from metropolitan areas outward, similar to the original development of the long distance

network. ISDN is helped by a phenomenon called "digital synergy," which means that each new piece of digital hardware makes the implementation of the next piece more cost-effective.

Of course, divestiture means that even if long distance carriers bring digital connections to a city, the local phone company may not have a digital switch ready for ISDN connections. Most of the country is still served by independent telephone companies, and the seven regional Bell companies act separately of each other when providing local service. Although all telephone companies are migrating to digital switching, chances are that any area still using rotary telephones will be far down on the list for ISDN implementation.

Technologically, an all-digital network is an attainable goal. Practically, an ISDN will be an efficient and necessary national communications pipeline. Purchase new communications equipment with ISDN standards firmly in mind. Make sure that new wiring runs will accommodate future ISDN interfaces. Plan for the future, but don't expect it tomorrow.

THE RESULTS ARE IN!

Look for the results
of the NSCA/Sound &
Communications'
Contracting Survey in
the May issue of the:

★ NSCA Newsletter

★ Sound & Communications

NADY 501 VHF WIRELESS. AFFORDABLE, AND EASY TO USE.

The Nady 501 VHF Wireless System is the perfect wireless for most stages, churches and studios. List price is under \$900.



And we designed the 501 with the speaker or entertainer in mind — you don't have to be a sound engineer to set it up and use it.

The 501 VHF is available with a good-looking handheld microphone/transmitter or a bullet-proof lavalier microphone transmitter. A lightweight, portable AC or DC-powered receiver completes the system.

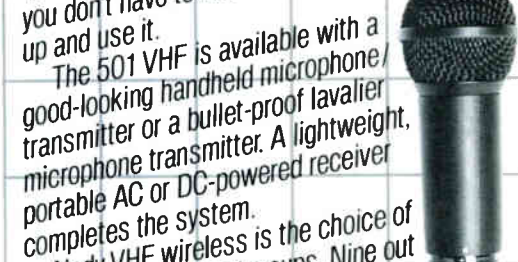

Nady VHF wireless is the choice of today's major musical groups. Nine out of ten (based on Billboard Magazine's 1985 Talent Almanac) use our wireless microphone and instrument systems.

There are reasons for this. Nady Wireless is road-proven dependable. With audio quality that measures up to these artists' demanding standards. (Try a side-by-side comparison yourself — Nady Wireless always sounds best.)

Send for the specs on our affordable 501 VHF Wireless System, or ask your Nady rep for a demonstration. You'll like what you see — and hear.

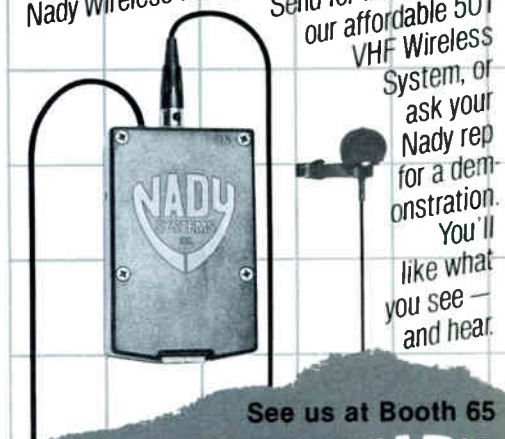

See us at Booth 65

Nady Systems, Inc.
1145 65th St.,
Oakland CA 94608
415/652-2411



Installation Profile



Photos by David Schelrman

(Top) Power amplification for the system is by Hafler and Carver. In excess of 15,000 watts is available. (Bottom) The DJ booth is the audio control center housing turntables, cue system, and special effects processing.

The Disco System at THE PALLADIUM

by David Scheirman
Concert Sound Consultants

In the ever-changing field of dance music clubs, trends that develop in New York City often become industry standards. New sound system designs and operating techniques first tried out in the Big Apple have a way of eventually filtering out to London, Tokyo, and the rest of the world.

In New York City today, a small handful of dance clubs currently represent the active 'scene'. Some of Manhattan's

clubs have become internationally famous, such as Studio 54, Regine's, and the Paradise Garage.

Some of New York's most recent sound system installations include the Red Parrot, Limelight, Visage, The Saint's, and newcomer The Palladium. The Red Parrot is a small club which relies on groups of JBL 4520 enclosures to cover the dance floor. Four JBL 2395 horns with lenses are installed

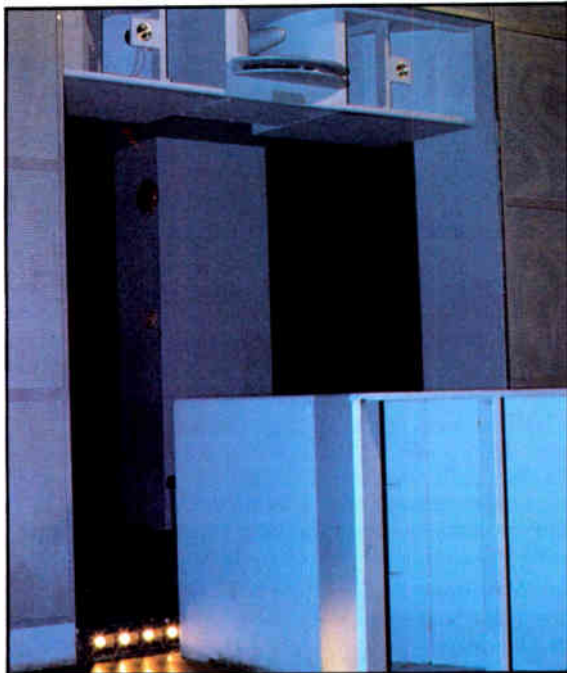

Six of Richard Long's Levan bass horns are located on the dance floor.



According to Palladium Production Stage Manager Paul Mathiesen the club's crowd looks for bass/mid/high variations, because "it's the sound that brings the dancers out on the floor."

above the primary activity area.

A nationally-franchised dance club, the Limelight currently uses a large number of JBL 4520 'scoop' enclosures for the low end. A multitude of eight-inch loudspeakers are used for the midrange power band. The system was installed by Discospec, a Canadian firm.

At Visage, Harris Audio of Florida recently installed four Meyer Sound UPA-1A enclosures above the dance floor. UREI Model 6500 amplifiers power the system.

And The Saint's features a custom-designed system by Entertech. Eighteen-inch speakers are used for the system's bottom end (L18-851 RCF drivers). The midrange power band is driven through Phillips cone drivers, as is the top end: a total of 192 cone tweeters are installed.

But the city's latest dance music club is the Palladium. Built into an older multi-story theater building, this live-wire venue is rapidly becoming the place of media events, dance parties, and other entertainment happenings. A \$20 cover charge and drinks that are priced at \$5 and up help to act as a socio-economic high-pass filter.

"When it comes to a sound system,

reliability is the number one factor," the Palladium's Production Stage Manager Paul Mathiesen said. "We just cannot afford for the system to ever go down."

Mathiesen explained that the club's sound system has to straddle the fence

"At a club like the Palladium, it is imperative to have a very concentrated sound on the dance floor."

—Richard Long

between 'bulletproof' reliability and user creativity. "Every night we have a different dance-music mixer at the controls," he said. "Each of these people is known for his own sound and style of playing to the crowd. They all need to get different things from the sound system."

Mathiesen said that he felt the Palladium's crowd looks for bass/

mid/high variations; different tonal characteristics are applied to the system for desired effects. "A successful sound system in a place like this must have all the bass the D.J. wants, have plenty of mids to fill it in, and then put out the sizzling highs that the dancers want. That sound is what brings them out on the floor."

The Palladium features a horn-loaded, custom-designed sound system conceived by Richard Long of RLA International, Ltd. of Long Island City, New York. Long, who also counts the high-energy system at the Paradise Garage and the original Studio 54 system among his credits, has installed dance music club systems on five out of seven continents. In the past decade alone, his systems have gone into facilities located in over 16 countries, including Egypt, Spain, Venezuela, and Malaysia. Upcoming projects include systems for Iceland and Thailand.

"At a club like the Palladium, it is imperative to have a very concentrated sound on the dance floor," Long said. "With the crowd in here, we have measured an average sound pressure level of 118 dB, C-weighted, with peaks of up to 132 dB. We get more

No moving parts—no maintenance required

Solid-state, Natural Voice Digital Message Repeater

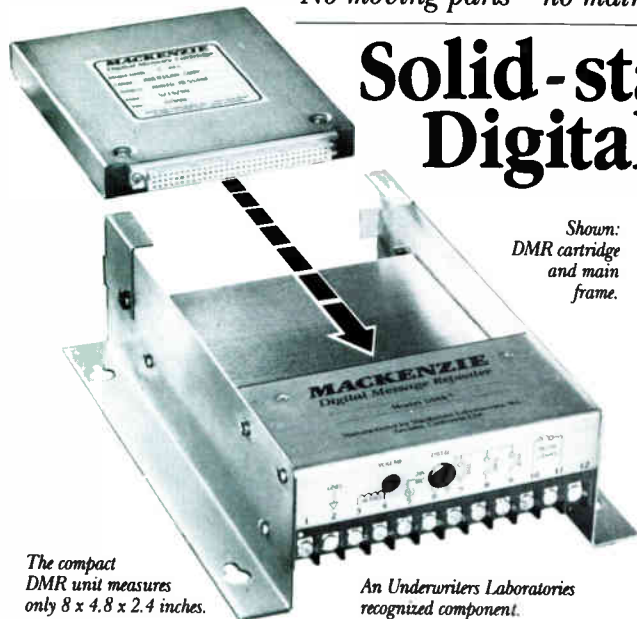

*Shown:
DMR cartridge
and main
frame.*

*The compact
DMR unit measures
only 8 x 4.8 x 2.4 inches.*

*An Underwriters Laboratories
recognized component.*

MacKenzie's Digital Message Repeater (DMR) is ideal for:

- | | |
|--|---|
| <input type="checkbox"/> Fire alarm messages | <input type="checkbox"/> "Watch your step" messages |
| <input type="checkbox"/> Voice evacuation | <input type="checkbox"/> Rental car return instructions |
| <input type="checkbox"/> Fireman's return | <input type="checkbox"/> Sound effects |
| <input type="checkbox"/> "Code Blue" | <input type="checkbox"/> Dark rides |
| <input type="checkbox"/> Parking warnings | <input type="checkbox"/> Exhibits and displays |

MacKenzie's Digital Message Repeater is a revolutionary concept in repetitive sound. *No maintenance* is required because our all-solid-state DMR has *no moving parts*.

The DMR uses EPROM memory cartridges to store digitized recordings of human voices, music or sound effects. Upon demand, the digitized information is reconverted to analog and played to an audio output. The sound is *completely natural*—just like a conventional tape recording—and the audio quality is excellent. Messages are permanently stored and may be played repeatedly without loss of sound quality.

The DMR consists of the message cartridge and the controller main frame. The complete unit is very compact—only 8 x 4.8 x 2.4 inches. Standard message length is up to 60 seconds; longer message time is available. Models are available for multi-message random access. The DMR is an Underwriters Laboratories recognized component.

For more information about the DMR—including our new DMR record-play unit—call MacKenzie Laboratories toll-free at (800) 423-4147.

See us at Booth 117

MACKENZIE MacKenzie Laboratories, Inc.

5507 Peck Road □ Arcadia, California 91006 USA □ (818) 579-0440

Circle 230 on Reader Response Card

The AT853 UniPoint™ Condenser Cardioid

**It's been
hung,
planted,
buried,
strapped,
stood up,
clamped,
taped,
and swung...
all in the name
of better,
less visible
sound.**

The AT853 condenser cardioid is a remarkable microphone. Smaller than your little finger, yet with flat response from 30 to 20,000 Hz, and an effective cardioid pattern, even at the lowest frequencies.

The AT853 is so light (1/2-ounce) it can hang on its own 25-foot cord above a choir or orchestra. The ingenious wire adapter permits pointing it exactly where it's needed without support cables or stays, making the AT853 even less visible.

It also includes a neat stand adapter to instantly convert the AT853 into a desk or floor stand model. Or simply hide it in the bushes, behind props, or wherever superb sound is

needed with minimum visibility.

The AT853 is operated by a single 1.5V "N"

battery or phantom power. The power module also has a low-frequency rolloff option to solve rumble and room noise problems.

The AT853 is one of a family



of six UniPoint ultra-miniature condenser microphones. Each with special features to solve the toughest sound pickup problems, plus professional reliability. And all from the innovators at Audio-Technica.

The AT853 may be hard to see, but it's great to listen to. Arrange for a hands-on test today.

See us at Booth 34



audio-technica®

Audio-Technica U.S., Inc., 1221 Commerce Dr., Stow, OH 44224
(216) 686-2600

Circle 208 on Reader Response Card

World Radio History

INPUT DEVICES: TURNTABLES, CASSETTE AND REEL-TO-REEL TAPE, COMPACT DISC, PA MIXER, VCR AUDIO FEEDS, MICS

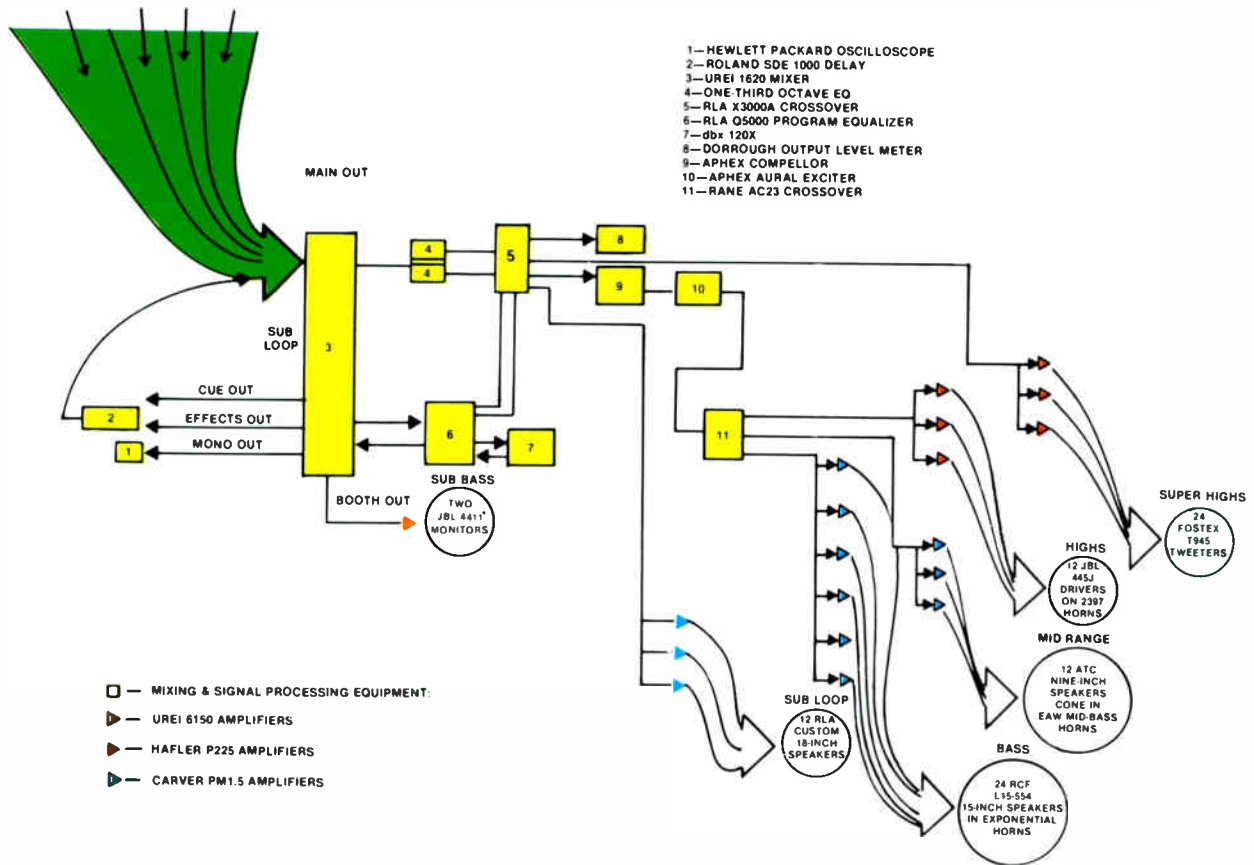

Signal path flow chart of the sound system at the Palladium in New York City.

than 110 dB, 1 watt/1 meter, from each large bass horn.”

Richard Long’s Levan bass horns house 18-inch priority-designed, custom-made loudspeakers. A total of six of these massive units are located on the dance floor. “I’ve always been fascinated with horn design,” Long said. “I built my first Klipschhorn in 1955. We have chosen Eastern Acoustic Works to manufacture the Levans. EAW’s Kenton Forsythe has been an ideal collaborator.”

The Levans, in addition to functioning as subwoofers, do double duty as informal staging platforms. During the course of a typical evening, both male and female dancers from among the crowd jockey for position atop the enclosures.

The Palladium’s main dance floor sound system comprises 12 custom-built, full-bandwidth enclosures, each housing three separate modules. These units are installed against the side walls, facing the dance floor. Each unit is a four-way device.

RCF 15-inch loudspeakers are housed in each side-mounted horn section, and 10-inch ATC loudspeakers are loaded into special EAW-built



Custom-built, compact enclosures consisting of three separate modules were installed.

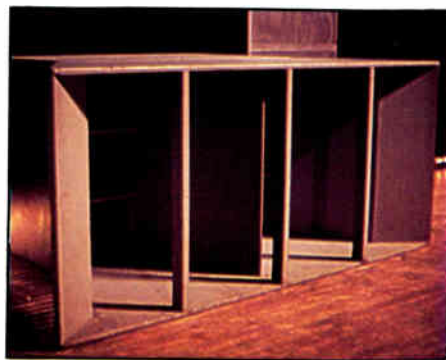

RLA’s Levan sub bass horns house a pair of 18-inch loudspeakers.

mid-bass horns. JBL 2445 compression drivers are mounted on the classic JBL 2397 horn (now discontinued). Fostex tweeters complete the package.

“Having the ability to separately control the sub-bass and tweeters levels as differentiated from the full-bandwidth main music system is an important part of this type of installation,” explained Long. “Different crowd densities and various program material each take an adjustment.”

To that end, RLA International, Ltd. has designed and assembled special active crossovers (the X3000A). A five-band program equalizer (the RLA Q5000) was used as well (Figure 4). These compact units (one rack space each) are located in the master control console used by visiting D.J.’s, along with turntables, cue amplifier and special effects signal processing.

“Sometimes, system operators use the X3000A crossover to boost the subwoofers to intensify sound pressure levels,” Long said. The unit offers up to 16 dB of boost (or cut) for program tailoring of the sub bass and tweeter outputs.

In addition, the Palladium’s system is equipped with equalization devices

from Rane (model GE30) and JBL/UREI (model 5549). More than 15,000 watts of power amplification are available from Hafler and Carver products.

"My system design philosophy is based upon years of devoting myself to the dance music club scene," Long said. "Such systems require sonic excellence coupled with totally reliable hardware. Above all, the system must be cost-effective. A large club will spend upwards of \$150,000 for a sound system. If the individual components are not priced right, they can end up with an expensive system that doesn't quite do the job."

Long's choice of hardware rests ultimately upon sound. "This is a very specialized field. Many manufacturers do not offer things in their product lines that we can use," he said. "Sometimes, older components actually work better than the latest designs. For instance, the JBL 2397 horn offers very uniform, wide coverage with 140 degree dispersion in the horizontal axis. It suits our needs perfectly. Yet, it is no longer commercially available."

Long pointed out that bass and mid-bass frequencies are crucial to the success of a dance music club system. "It

has taken many years to finalize the design for my systems' lower power bands," he explained. "The EAW-built Levan bass horns are very precise, using a hyperbolic flare. The first 24-inches of the bass horn throat are absolutely critical for the proper reproduction of the intended frequencies. In the full-bandwidth units, the 40-250 Hz frequency range is handled by RCF L 15-554 speakers in EAW-built bent exponential horns. The 250-1,200 Hz bandpass utilizes EAW's MR-101 mid-bass horns. A system like this is no better than the sum of its parts. So I use good parts."

"Many people come to a place like the Palladium to lose themselves in the music," Mathiesen said. "The sound has to envelop them, move them, offer non-stop excitement all night long. The music pace put out by the D.J.s, the lighting effects, and the crowd itself, all come together to form a certain experience. The actual production systems, including the sound and lights, are the backbone of our efforts. The system here has to sound *right*, and always work."

The dance music club scene offers a unique proving ground for pro sound hardware. System components are

constantly being pushed to their limits. "We haven't lost a single loudspeaker component at the Palladium since its opening several months ago," Long noted. "I have had to swap out one or two power amplifiers, however. This is some of the most intense use that sound systems will ever get. Each system that I do incorporates all that I have learned in the past 15 years. We're up to 462 installations and still counting. When we find hardware that works, we stick with it."

That attitude perhaps will help to explain why Richard Long's system at the Palladium in Manhattan is attracting visitors from all over the globe. "People considering new clubs in Hong Kong or London stop in here first," Long said. "This sound system is somewhat of a reference standard."

Disco may be dead, but dance music clubs are thriving. The New York scene is operating at a frantic pace, and major new rooms are scheduled for Chicago, San Francisco, and Miami. Each new club that is built requires a reliable, good-sounding system. Audio designers and installation contractors may find the booming dance club scene to be a healthy profit center for 1986.

Throughout the world Atlas Sound is synonymous with original design, consistent quality, ready availability and customer satisfaction.

signal devices and notification appliances for safety and security consultants



environment resistant loudspeakers for sound communication specialists



microphone stands and accessories for performers

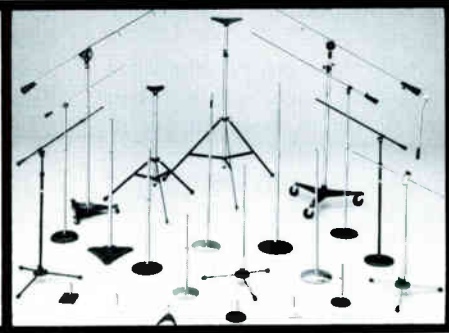

Join the professionals who specify, sell and use . . .



ATLAS SOUND

DIVISION OF AMERICAN TRADING AND PRODUCTION CORPORATION
10 POMEROY ROAD, PARSIPPANY, NEW JERSEY 07054
See us at Booth 3

TELEPHONE: 201 887-7800

92

PRODUCTS IN REVIEW

TALK-A-PHONE'S INTERCOM FOR HEALTH FACILITIES

Talk-A-Phone Company has announced its latest model of the Chief Master Intercom System. Designed for communications between hospital personnel throughout a facility or between facilities up to a distance of 20 miles apart, Masters can call and carry on conversations with any other sub-stations, selectively or privately.



With "non-private" Masters, a person can respond at a distance without operating controls. When connected "privately," other stations cannot listen in. A system may be started with a single Master and sub-station and added to as necessary. Talk-A-Phone Chief Intercoms are available in 12, 20, 30, and 40 capacity models along with Staff Units, Sub-Stations, and accessories.

Circle 61 on Reader Response Card

NEW BOGEN AMPS FEATURE SMALLER SIZE

Bogen, A Lear Siegler Company, has announced two new power amplifiers, the BPA-60 and BPA-125, said to be smaller, lighter, and more economical than their predecessors. Both deliver clean, undistorted power to public address systems, communications consoles and all other systems that require amplification, according to Bogen.

These solid-state power amplifiers deliver full rated power with less than 2 percent distortion from 50 Hz to 15,000 Hz. The BPA-60, rated 60 watts rms, and the BPA-125, rated at 125 watts rms, operate on 120 VAC, 60 Hz, and are convertible for use with 48 VDC battery backup.

Frequency response is -2 dB, from 20 Hz to 20 kHz with output regulation better than 2 dB, from no load to full load, and hum and noise 85 dB below rated output.

The front panel incorporates an illuminated on/off power switch and the



rear panel has an input-level control, a circuit breaker reset and a lo-cut filter switch (-10 dB attenuation at 100 Hz). A three-wired grounded, unswitched auxiliary receptacle is provided. Both models feature protection against overloads and excessive temperatures, using transient protection diodes, an electrical circuit breaker and a 105 degree thermostat.

Circle 62 on Reader Response Card

ENVIRONMENTAL SOUND OFFERS NEW ES SERIES

Environmental Sound has introduced the ES Series of speakers that can be installed in the wall or on the ceiling.

Two versions are available: the ES-802 houses an eight-inch, polypropylene low-frequency driver and a three-quarter-inch dome tweeter with magnetic fluid; ES-502 houses a five-inch polypropylene low-frequency driver and a three-quarter-inch dome tweeter with magnetic fluid.

Environmental Sound is also offering an exclusive variety of grille colors for architectural and interior decorators.

Circle 63 on Reader Response Card

CETEC GAUSS DEBUTS COAX REINFORCEMENT SYSTEM

Executive Audio has introduced the new Cetec Gauss sound reinforcement system, featuring a 12-inch coaxial loudspeaker, at the Musik Messe Frankfurt 1986. The new system uses a totally new coaxial speaker developed by Gauss.

The new coax system will deliver 80 to 15,000 Hz with a sensitivity of 103 dB. Crossover is at 1,600 Hz. Although the new system boasts such high sensitivity, the enclosure is compact measuring 16-inches high by 23 5/8-inches wide by 16-inches deep. As with all Gauss systems, the enclosure is protected with a special carpet woven exclusively for Gauss by Ozite.™ This carpet is denser than

normal Ozite to provide better resistance to tearing. The backing is thinner to provide better wrapping on the cabinets.

The coaxial loudspeaker features Gauss' triple spider construction which offers active centering and prevents hang up and lead break off. A dual-magnet assembly provides a higher flux density for a higher signal. Voice coils are precision edge-wound directly onto an aluminum center former for better heat dissipation, allowing the high sensitivity of the system.

Circle 64 on Reader Response Card



SHURE'S COST COMPETITIVE UNIDIRECTIONAL MIC

Shure Brothers Inc. has announced the introduction of the Shure 587SB-LC, a cost competitive, unidirectional dynamic microphone. Sandy Schroeder, Shure's marketing manager for sound reinforcement products, said, "The 587SB-LC is designed to provide users with an exceptional value. Its cartridge has been designed to provide the best performance per dollar in its class. The 587SB-LC is perfectly suited to any application which requires a quality unidirectional microphone—musical performance, general sound reinforcement, recording, or broadcasting."

The 587SB-LC's features include a smooth, wide-range frequency response with Shure's trademark mid-range presence boost for clarity and brilliance. The microphone's shock mount is extremely effective, surrounding the cartridge with high-density rubber for ruggedness and low noise. The built-in spherical pop filter is constructed for durability and effectiveness in controlling explosive breath sounds and wind noise. The 587SB-LC also features a lockable on-off switch.

User net price is \$90.

Circle 72 on Reader Response Card

Odds Are 17,000 to One...



Oaktron's Life-Safety speaker, HT8H. Built of fire-proof or retardant materials. Tested and operated at over 400°F.

... OAKTRON Has What You Need

Maybe you need Oaktron's new high-temperature fire-retardant speaker, developed for life-safety fire-warning systems where reliable communications are vital—built and tested for temperatures up to 400°F.

But whatever you're looking for, odds are over 17,000 to one Oaktron has what you need.

Over the last 27 years, Oaktron has made over 17,000 different sizes, models, or configurations of loud-speakers—to some of the toughest specifications in the sound field. From Hi-Fi to mini-alarms, for submarines or lunar modules, Oaktron has the experience and the expertise to make the speaker you need.

The odds are 17,000 to one.

Ask for Oaktron catalogs of over 185 models now in stock and ready to ship.

Or, send us your specs—the odds are 17,000 to one we can produce.

See us at Booth 133

YOUR SOUND PROBLEM IS OUR SOUND
OAKTRON
INDUSTRIES, INC.

OAKTRON NATIONAL SALES
1000 30TH STREET, MONROE, WISCONSIN 53566
TELEPHONE (608) 328-5560

PRODUCT

(continued from page 50)

two new broadband indoor distribution amplifiers designed for CATV and SMATV signal distribution systems which use a cable drop as a signal source.

Both models, the BIDA 300-50, with 50 to 300 MHz bandpass, and the BIDA 450-50 with 50 to 450 MHz bandpass, are configured for one-way operation. Optional field-

installable modules are available for the addition of two-way capability with either a passive or active subchannel return path.

BIDA amplifiers are ideal for critical signal distribution applications requiring high gain since both have a flat operating gain of 51 dB. Gain can be adjusted down to 41 dB with the unit's variable attenuator. These amplifiers exceed FCC specifications for both conducted and radiated interference

at full output level. For applications where input signal levels are too high or where greater cable equalization is necessary, the BIDAs can be configured, by using plug-in attenuators and cable slope equalizers, to meet particular system requirements.

All controls and indicators are externally accessible. These include two -30 dB backmatched test points, gain and slope controls, LED pilot light, and fuse.

Circle 65 on Reader Response Card

Performance you'll appreciate, sight unseen.

Astatic's 827 electret condenser microphone offers a low profile while providing high quality sound reproduction. These ultra thin 13" or 17" gooseneck mics stay well hidden; ideal for applications where close miking is required to produce additional system gain.

Among the "out-of-sight" features of the 827 are:

- controlled low frequency roll-off
- cardioid pattern
- permanently charged diaphragm
- built-in circuitry for phantom power
- high impact construction
- long lasting black finish
- miniature windscreen provided
- TWO YEAR WARRANTY

Not seeing the 827 is believing! But you can hear the difference that Astatic makes in a microphone. Call or write for the name of your nearest dealer. Dealer inquiries welcome.

See us at Booth 81



ASTATIC
Astatic Corporation
Commercial Sound Division, P.O. Box 120 • Conneaut, OH 44030-0210
(216) 593-1111
In Canada: Canadian Astatic, LTD. 1220 Ellesmere Rd., Unit 2 •
Scarborough, Ontario M1P 2X5
(416) 293-2222

Circle 206 on Reader Response Card



NEW MINIATURE VIDEO CAMERA FROM SIEDLE

A new miniature video camera for low light applications is now available from Siedle Intercom/USA.

The Siedle CAM-1, utilizing Saticon tube technology, has auto-iris and features quick-start operation, going from full off to full picture in 1.5 seconds. It is the standard camera used in the new Siedle video intercom system. Standard features include an 11 mm, fixed focus f.18 lens, automatic gain control, and automatic beam control.

The entire camera, with lens, has dimensions of only one 1 x 2 x 3-7/8 inches. An optional 5.5 mm wide angle lens, with a 70 degree field of view, is also available. With the wide angle lens, the camera can be used for elevator security systems or other applications in extremely confined spaces. An optional bayonet mount is also available.

The camera operates on 6-12 VDC at 150 mA with 1V P-P and 75 ohms. Horizontal resolution is 400 lines and minimum illumination is 5 lux.

Circle 66 on Reader Response Card

(continued on page 64)

Sound & Communications

FLY FIRST CLASS FLY TURBOSOUND

If your clients are as demanding as the engineers at Carnegie Hall, the Apollo Theater, the Grand Ole Opry and the National Convention Center of Japan, you should audition the speakers permanently installed in these and other top clubs and concert halls from New York to Nashville to Kyoto: Turbosound.

PRE-ENGINEERED

To make your job easier, we design certified, load-rated flying and angling points as an integral element of every Turbosound full-range enclosure. And the innovations we've put inside our pre-engineered speaker modules will cut your planning and installation time significantly. The patented* TurboMid™ device, for example, enables our proprietary 10" driver to reproduce a seamless midrange from 250–3700 Hz. Its unique internal geometry creates a much higher 'Q' factor than conventional horns of equivalent frontal area. Tighter directivity greatly reduces interaction problems in multiple unit arrays, so planning an installation often involves nothing more complicated than laying coverage patterns over a set of blueprints.

COMPACT AND EFFICIENT

Because neither you nor your customers should have to compromise sightlines to get full frequency response, every Turbosound full-range enclosure employs both the TurboMid device and the patented* TurboBass™ device. Our high-velocity partial horn-loading technique enhances cone control and produces high levels of bass projection from astonishingly compact enclosures.



Integral mounting points accept optional flying rings.

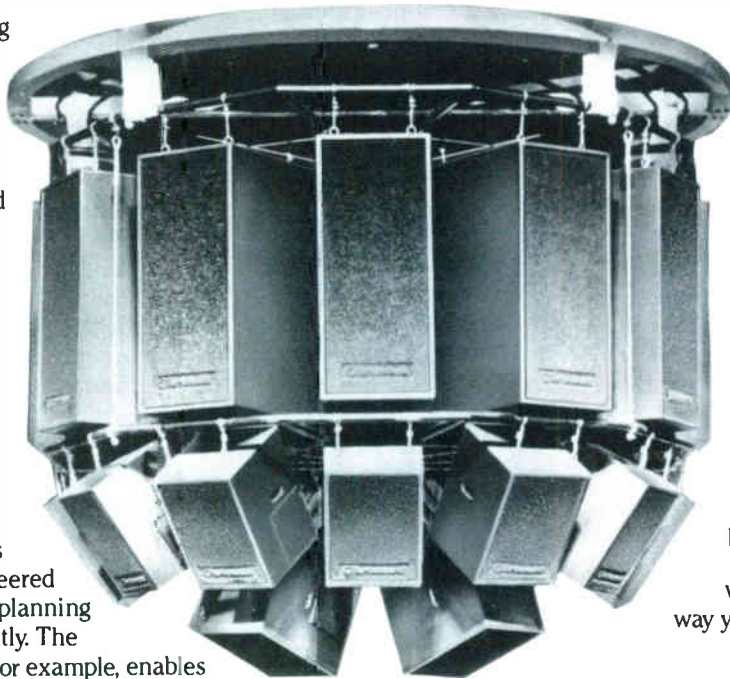

UNPRECEDENTED DESIGN, UNCOMPROMISING EXECUTION

We're equally demanding in the execution of our radically original designs. We use only the highest quality Finnish birch ply because we consider cabinetry an essential element of audio engineering. Virtually all of the drive units in these finely tuned acoustic structures are built exclusively to our specifications. When it comes to creating completely professional sound reinforcement systems, we recognize only one way to go — first class. If that's the way you feel about your work, call Dan Abelson at 212-460-9940.

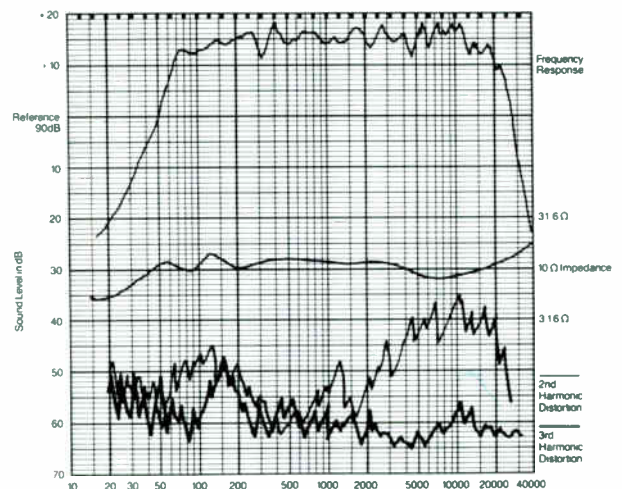

Turbosound speaker modules like the TMS-2A charted above achieve low distortion levels and naturally correct, transparent sound without the need for unreliable, artificial compensating electronics. Linear dynamic response, phase coherency and optimized impedance curves enable our enclosures to reproduce transients with unflinching accuracy.



Only Turbosound is Turbosound.™
Turbosound

See us at Booth 23

A member of the Turbosound Group of Companies • London • New York

Circle 248 on Reader Response Card

*TurboMid™ and TurboBass™ devices are covered worldwide by Principle Patents, not simple design patents. The concepts embodied in these designs are, therefore, entirely unique. See Turbosound literature for full information.
Turbosound, Inc. 611 Broadway *841 New York, New York 10012 (212) 464-9940 Telex 230199 IMC ABELSON — US Turbosound Sales Ltd. 202-208 New North Road, London N1 7BL (01) 226-0099 Telex 265612 IMC SALES — UK

Worldwide distributors: *Australia*: Creative Audio Pty Ltd Melbourne Tel (03) 354-3987 *Austria*: Audiosales Moedling Tel (2236) 888145 *Canada*: Beliste Acoustique Inc. Quebec Tel (514) 691-2584
China: Wo Kee Engineering Ltd Hong Kong Tel (51) 249073/5 *Denmark*: Per Meistrup Productions Karlshunde Tel (02) 151300 *France*: Regiscene Paris Tel (01) 374-5836 *Greece*: Alpha Sound Athens Tel (01) 363-8317
Holland: Ampco Holland b v Utrecht Tel (30) 433134 *Hong Kong*: Tom Lee Music Co Ltd Hong Kong Tel (34) 722-1098 *Indonesia*: PT Auwindo Marten Prima Jakarta Tel (01) 323029/320704 *Israel*: Barkai Ltd Ramat-Gan Tel (03) 735178/732044
Italy: Audio Link Parma (0521) 598723/1 *Milan*: (02) 285-0334 *Japan*: Matsuda Trading Co. Tokyo Tel: (03) 295-4731 *Korea*: Bando Pro Audio Inc. Seoul Tel (02) 546-5491
Malaysia: Atlas Hi Fi Sdn Bhd Kuala Lumpur (03) 432104 432077 *Norway*: Nordtek Equipment a/s, Oslo Tel (02) 231590 *Singapore*: Atlas Sound (Pte) Ltd Singapore Tel 220-4484 *Spain*: Lexon s a Barcelona Tel: (03) 203-4804
Sweden: Inter Music a b Skovde Tel (500) 85260 *Switzerland*: Studio M + M Schonenwerd Tel: (64) 115722 *Thailand*: Bangkok Cine/Graphic Center Bangkok Tel (2) 314-3570 *UK*: Turbosound Sales Ltd London Tel (01) 226-0099
USA: Turbosound Inc New York Tel (212) 460-9940 *W. Germany*: Adam Hall GmbH Ursingen Tel: (6081) 16031

a closer look

by gary d. davis

CERWIN-VEGA'S V-31C SPEAKER SYSTEM

Cerwin-Vega, Inc. has introduced the V-31C, a two-way, full-range, compact, high-performance speaker system. The V-31C incorporates a 15-inch woofer and high-frequency compression driver with horn.

Cerwin-Vega's 15-inch 153EV cone driver is front-horn loaded and operates in a vented enclosure optimally tuned to 50 Hz. The 153EV low-frequency driver features a die cast aluminum frame and a three-inch high-power voice-coil.

At higher frequencies, the JMH-1 one-inch throat compression driver operates from the crossover at 1 kHz to beyond 15 kHz. It utilizes an aluminum diaphragm with elastomer surround and edgewound aluminum wire voice-coil.

The new constant coverage 90 x 40 degree horn provides optimum loading characteristics for the JMH-1 driver with wide, controlled dispersion over the entire operating bandwidth.

The JMH-1 is unconditionally protected against inadvertent overpowering by a self-resetting circuit breaker in the crossover. In addition, the crossover provides a three-position equalizer to accommodate most performing environments.

The enclosure is heavily braced premium plywood finished in durable indoor/outdoor carpet and fitted with recessed handles for ease of portability.

The V-31C is designed such that the acoustic centers of the driver components are located in a single plane to ensure that sound energy is propagated as a single wavefront, without "smearing" over a period of time. Reproduction of percussive and other transient sounds are well-defined, while music and dialogue take on greater realism.

Cerwin-Vega said its concept of expandable sound systems using full-range single cabinets and add-on components allows the user to accommodate many application needs. The V-31C is designed to integrate with other C-V components to extend bass response and/or increase high-

frequency throw or dispersion, according to the company.

Manufacturer's suggested retail price for the V-31C is \$600.



Comment: After reading the information Cerwin-Vega provided on its V-31C speaker system, I wondered how well a circuit breaker could protect the HF driver. So, I talked to Mark Silverman of Cerwin-Vega who told me there was actually a frequency-weighted sensing circuit that integrates average power over about 30 seconds, and trips a relay as required to protect the driver. This approach avoids false triggering or chatter, and provides a positive measure of protection. The sensing circuit itself is high impedance, so it does not have any audible effect on the signal. At such time as it "decides" the relay should trip, then the signal power is used to activate the relay...at that point, it doesn't matter that the signal power is being diverted. The breaker circuit resets automatically.

The crossover's three-position equalizer is not simply a high frequency level control, but instead provides a choice of broad boost characteristics rising above 4 kHz. (Remember that the HF driver crossover is 1.2 kHz, so this comes in the middle of that driver's range.) I inquired about the

HF driver's elastomer surround and learned that it is a silicon rubber compound which has several advantages: it is not subject to shattering, as are pleated metal surrounds; it helps damp reflected vibration from the driver frame back to the diaphragm; and it is dimensionally stable at high temperatures. As a result, the HF driver, with a relatively small 1.75-inch voice coil, has a 50 watt EIA power spec.

The V-31C represents yet another example of today's trend toward compact, high-output loudspeaker systems. This trend has been accelerated by the higher costs of truck transportation, smaller cars, higher real estate (and warehouse) costs, and the relatively low cost per watt of modern power amplifiers. In this case, the V-31C is rated at 150 watts power handling (EIA spec), and exhibits 105 dB/1 watt/1 meter sensitivity. If it performs as claimed, it bears a closer look for a variety of keyboard and general sound reinforcement applications.

Circle 11 on Reader Response Card

ROSS FEATURES PC6130 POWERED MIXER

Ross has introduced a six-channel, 130 watt powered mixer—the PC6130—which Ross said is "out in front of the competition in performance and price value." The new mixer features six input channels with three-band graphic EQ, built in reverb, monitor send, and effects send with high and low impedance inputs. The PC6130 has an output power of 130 watts RMS. The output section of the PC6130's mixing console also features a full 10-band graphic EQ with 12 dB cut or boost. There is a master level control and a master reverb control. Also on the PC6130's output section is a monitor send and an effects loop with master level send. The PC6130 features a full patchbay section including mixer line out, monitor line out, power amp in, effects loop, and speaker outputs. The built in reverb in the PC6130 is a three-spring

Accutronics-type reverb. The suggested retail for the Ross PC6130 is \$529.95.

Comment: Ross, a division of International Music Company, has a growing line of moderately priced sound reinforcement equipment. The PC6130 is claimed to step "out in front of the competition in performance..." so I wanted to find out how this might be so. James Suttle, a Ross technician, filled in some technical details that, frankly, left me wondering about the claim.

The unit is spec'd at 120 watts "RMS" into 4 ohms at 0.1 percent distortion; that's not necessarily THD... they don't differentiate on the spec. By "RMS," we assume Ross means "continuous average sine wave" power. The unit has high and low impedance inputs, although no actual input impedances are specified. Also, while the low impedance inputs are XLR type, they are not balanced, so there is a distinct possibility of grounding problems and hum. Signal-to-noise ratios for the low and high Z inputs are spec'd at 63 dB and 70 dB respectively. (They use the term "dBu," which is not an appropriate unit to specify a S/N ratio.) No equivalent input noise spec was available. The unit has a 10 volt unbalanced line output, both 0 dBu and -10 dBu effects send outputs, and 0 dBu effects, reverb expansion and aux



inputs. While the original release described a three-spring reverb, the unit apparently uses a two-spring unit with a maximum two second decay time. Dimensions are 5.25 x 19.5 x 14.25 inches.

It is my guess, based on the available specifications and the general lack of other desired specs, that this unit is more for "musical instrument" applications and must be very carefully scrutinized before it is considered in more demanding applications. The lack of balanced inputs, the use of inappropriate values in specifications, and the absence of detailed noise and distortion specs makes me wary. Of course if you're a curious sound contractor, you may well wish to field and bench check the Ross PC6130, and perhaps find it is a good-sounding unit for a very good price; we're only reviewing the available information.

Circle 12 on Reader Response Card

IED'S SMART ELECTRONICS SOLVES COMPLEX AUDIO DISTRIBUTION PROBLEMS

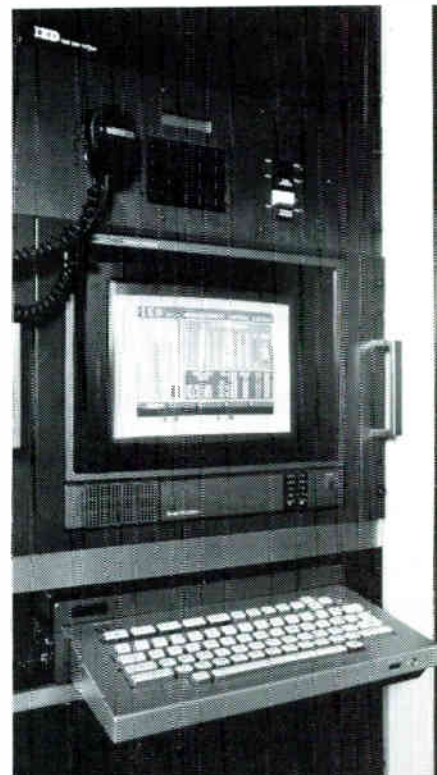

Innovative Electronic Designs Inc.

is the leader in the industry using digital logic and a **MICROCOMPUTER** with **NON-VOLATILE MASS STORAGE** to control all phases of audio system operation.

Typical IED systems are installed at LAX International Air Terminal, the Hoosier Dome in Indianapolis, and Ocean Center in Florida.

IED also has designed and manufactures the **only AUTOMATIC MIXER** in the industry using "**SMART ELECTRONICS**", plus a full line of **BUILDING BLOCK** audio distribution cards.

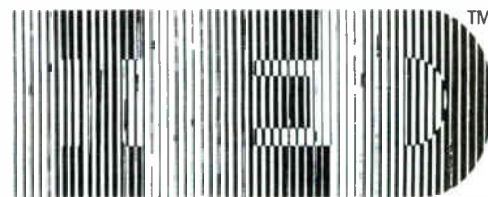

To become an **AUTHORIZED IED CONTRACTOR**

Contact Tom Roseberry
Innovative Electronic Designs Inc.
9701 Taylorsville Road
Louisville, KY 40299
(502) 267-7436

Circle 227 on Reader Response Card

SOUND & COMMUNICATIONS

CLASSIFIEDS GET RESULTS

For rates and information, please call
(516) 334-7880, or write to:
Classifieds, *Sound & Communications*,
220 Westbury Ave., Carle Place, NY 11514

PORTABLE LECTERN ADDED TO AMPLICOLUMN® LINE

Paso Sound Products has announced the addition of the new CA 160/L portable sound lectern to the company's Amplicolumn® series of Packaged Sound Systems.®

A complete portable PA and sound system for sound reinforcement indoors and outdoors, the lectern consists of a 10 watt RMS amplifier built into Paso's sound column, collapsible floor stand for the column, unidirectional low impedance dynamic microphone with on/off and volume control and antishock support, a removable lectern, and connecting cables. An auxiliary input permits playback from a program source and a contour switch permits tone control. The entire system can be set up and knocked down in minutes. All components, including the optional AC power supply, can be packed into the system's custom-designed carry case with shoulder strap. The CA 160/L may be powered from 10 internal D batteries,



external 12 VDC supply, or optional AC supply.

The system delivers sound over a 10,000-square-foot area.

Circle 69 on Reader Response Card

DASA DEBUTS D-4800 DIRECTORY DIALER

DASA Corporation has introduc-

ed the D-4800 Directory Dialer™. Unlike standard speed dialers, which store names and numbers, D-4800 directories include information such as extension, customer account number, personal information, secretary's name, PBX access, and function codes.

The D-4800 offers users automatic dialing from a directory of up to 800 entries. It is fully compatible with most telephone systems including single-line, standard keysets, electronic keysets, and PBXs.

D-4800 is available in two models, with capacities of 400 or 800 entries. Prices range from \$425 to \$495.

Circle 70 on Reader Response Card

AUTH COMPANY DEBUTS FIRE ALARM PANEL

The Auth Company has introduced the AFC-400, a microprocessor-controlled, U.L. listed, multi-zone fire alarm panel (MFACP). Operation is

SEE US AT THE EDS SHOW BOOTHS L1 & L3

ENGINEERING EXCELLENCE

NOW AVAILABLE AT AFFORDABLE PRICES.
THE COMPLETE LINE OF SPECO BACKGROUND/FOREGROUND SYSTEMS.
DESIGNED AND CONSTRUCTED WITH UNCOMPROMISED QUALITY.
AVAILABLE FOR IMMEDIATE DELIVERY FROM STOCK.

A Totally Sound Company

SPECO

8" Speakers, Speaker Assemblies – With Grilles
Transformers, Sound Columns, Wall Baffles,
Wall Baffle Assemblies, Line Transformers,
Ceiling Grilles, L-Pads, PA Horns, PA Amplifiers,
All-Weather Polypropylene Speakers, Enclosed
Mini-Speakers With Built-In Line Transformers,
Intercoms, Test Instruments

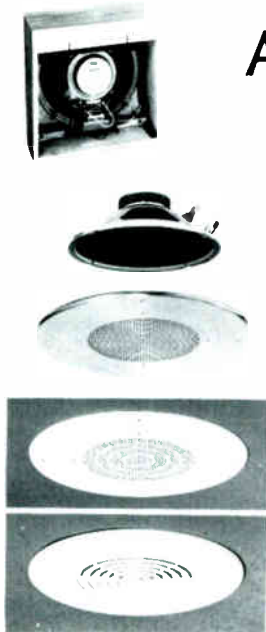

NEW YORK STATE
516-957-8700

FAX
516-957-9142

SPECO Division
Components Specialties, Inc.
1172 Route 109 • P.O. Box 624
Lindenhurst, N.Y. 11757

TELEX
96-7754 SPECO LNST

OUT OF STATE
800-645-5516

Circle 276 on Reader Response Card

Designed For Results!

THE SR-SERIES



If results are your bottom line in mixers, then we invite you to put our SR Series through its paces. Only then do we feel you will be convinced that AHB offers the features you have been looking for, at a price you can afford.

Stateside Savvy

One reason is because the SR Series Mixers were designed here in the "States" by our own R and D department, allowing us to incorporate features from customer input, into its Development . . . and Producing a Mixer for the Perfectionist in all of us.

The Results

Features such as 4 aux sends, 4 band E.Q., long throw faders, multi-source peak indicators on input channels and primary mix buses, stereo

and mono outputs, and external power supply with 48 volt phantom power are all provided as standard on all SR models.

Pro Performance

For 4 Track Recording and more demanding Sound Reinforcement situations, 16 and 24 input models are available with 4 submaster/group outputs as well as the addition of channel mute and E.Q. bypass switching on all input channels.

The Bottom Line

For more detailed information on the AHB SR SERIES of mixers, Call or Write Today. Give yourself "The Edge" with the Mixer That Achieves Recognition . . . Through Your Results!

AHB

Mixing **ART** With **SCIENCE**

Allen & Heath Brenell (USA) Ltd.

Five Connair Road
Orange, Ct. 06477 / (203)795-3594

Allen & Heath Brenell Ltd.

69 Ship Street, Brighton, BN1 1AE England
Telephone: (0273) 24928/ Telex 878235

Canadian Distributor: Heint Electronics Inc. / 1-416-727-1951

Circle 20 on Reader Service Card

controlled by program software stored in EPROM, affording greater flexibility and ease of installation, according to the company.

The AFC-400 is of modular construction and may be expanded from the basic 4 to 20 class A/B detection zones and from 2 to 6 class A/B signal circuits. This expansion is readily made with additional SDM-2 or NDM-2 plug-in detection modules and/or relays.

The SDM-2 is a two-zone, smoke

detection module for up to 30 compatible two-wire ionization, photoelectric, or combination of smoke detectors per zone including any number of shorting type devices such as pull stations, heat detectors, waterflow switches, etc.

For economy and lower standby current, the NDM-2, two-zone, non-smoke detection module is available which accommodates all shorting type devices other than two-wire smoke detectors. They are especially recommended for use with four-wire smoke

detectors.

Both the SDM-2 and NDM-2 are equipped with a set of 3A, form C relay contact outputs.

The signal circuits are 24 VDC (FWR), up to 8 amps class A/B, for compatible, polarized, 24VDC bells, horns, strobes, lights, etc.

The AFC-400 also features the following built-in functions: march time, pre-alarm and floor-above and floor-below signaling, as well as reverse polarity and local energy alarm transmit capability.

Circle 71 on Reader Response Card

PROCESSOR-CONTROLLED SYSTEMS BY RENKUS HEINZ

Renkus-Heinz has introduced a complete series of processor-controlled systems and support devices to complement its existing Smart catalog.

The new MR-1 and LR-2M Arena System is capable of producing 140+ dB continuous SPL and the Smart processor controlled amplifiers, which incorporate both oscillation and clip protection, thus making all Smart Systems fail-safe, according to the company.

Also included in the line are the new LR-1 single 18-inch Subwoofer and the new W-1 Wedge Monitor. Both of these items are compact, yet exhibit the same performance characteristics of the larger parent enclosures.

Renkus-Heinz has also introduced an all-new concept in processor-controlled systems at Winter NAMM. The new product, RH-1, is a sophisticated stand-alone processor designed to be used with passively controlled systems. The processor can be used with any manufacturer's enclosures and is switchable to accommodate drivers of various sizes and efficiencies. The controller protects against thermal failure and overexcursion, and has built-in automatic loudness compensation, equalization and time coherency.

Circle 73 on Reader Response Card

(continued on page 64)

SUBSCRIBE



Ashly is not the only company that makes power amplifiers and signal processing equipment. We do, however, work very hard at being the best. We utilize only the highest quality electronic components, and our mechanical construction is legendary. Our computer-assisted test systems assure reliability and allow us to offer our extended warranty program on each and every product. When the situation calls for nothing less than the best, you can depend on Ashly.

ASHLY

See us at
Booth 61

MAKERS OF FINE AUDIO PRODUCTS SINCE 1972

POWER AMPS • INSTRUMENT PRE-AMPS

NOISE GATES • COMPRESSOR/LIMITERS • PARAMETRIC EQUALIZERS

GRAPHIC EQUALIZERS • ELECTRONIC CROSSOVERS

FOR INFORMATION CONTACT:

ASHLY AUDIO, INC.
100 FERNWOOD AVENUE
ROCHESTER, NY 14621
TOLL FREE: 1-800-828-6308
IN NYS (716) 544-5191

IN CANADA CONTACT:
GERRAUDIO DISTRIBUTION, INC.
363 ADELAIDE STREET EAST
TORONTO, CANADA M5A 1N3
(416) 361-1667

Circle 283 on Reader Response Card

When You Have to Get it Right the First Time—Reach for HME.

There are very sound reasons why professionals reach for HME when the show goes on.

Dependability. HME knows the vital need in your business for reliable equipment. We think we build the best wireless microphones, as well as the best wireless intercoms and cabled intercoms available anywhere. They're rugged, built from top quality components, and assembled with HME's Pride in Excellence.

Performance. You'll please the most demanding performers with an audio quality that's second to

none. Dynamic range and immunity to interference are unsurpassed.

Service after the sale. No one reacts like HME in the event you need assistance. Now we have direct telephone lines to Customer Service—the people with the answers. Should your system ever require repair we'll turn it around faster than anyone in the business.

Call us today for all the details. See why more professional sound engineers rely on HME when performance is on the line.



See us at Booth 67

h m e
HM ELECTRONICS, INC.

HME manufactures:
Wireless microphones
Wireless Intercoms
Cabled Intercoms

9675 Business Park Avenue, San Diego, CA 92131, U.S.A.
Phone (619) 578-8300 Telex: 350-771

PIERCE-PHELPS OPENS BRANCH

Pierce-Phelps of Philadelphia, PA, has opened a video systems branch office in Pittsburgh. Bob Earl, formerly manager of the Pittsburgh office of Brenner Cine-Spund of Washington, DC, will head the new office.

According to Frank Brady, general manager of Pierce-Phelps' video division, the company's decision to enter the Pittsburgh market was influenced by the major professional video supplier and contractor in the city, Electromedia, going out of business. Also, Brady said, video equipment manufacturers had suggested that Pierce-Phelps cover the Pittsburgh area.

The new Pittsburgh office will serve industrial, educational, and broadcasting clients. Brady said the city's recent resurgence as a business center makes it an attractive market. "It was a dying steel town," he said. "Now it's really picking up with high-tech industry and new corporate headquarters."

Pierce-Phelps, which celebrates its 60th anniversary this year, has been in the video systems business for 25 years. The company also handles audio and teleconferencing equipment.

Bob Earl's 23 years of media industry experience includes executive positions with Electromedia in Pittsburgh, with the MPEC division of WRS Motion Picture Labs in Pittsburgh, and with the ASCOR Division of Berkey Technical in New York.

Mead Joins McKinney

Thomas J. Mead has been named AV Communications specialist at Lloyd F. McKinney Associates of Hayward, CA, it was announced by Dick Bowman, director of sales and marketing.

In his new position, Mead will be calling on architects, and electrical and acoustical consultants.

Mead joined Lloyd F. McKinney in the Fall of 1985. He was formerly with Caribbean Exhibits Inc. in San Juan, Puerto Rico.



Six Flags' Power Plant is located on Baltimore Harbor.

Despite Delays SOUND "ON" at POWER PLANT

Electrosonic Systems of Minneapolis, MN, Triad Productions of Des Moines, IA, and Maryland Sound Systems of Baltimore, MD, installed the sound system at the new Six Flags Power Plant Entertainment Complex in Baltimore, MD. Landmark Entertainment of Los Angeles, CA, managed the project.

The Entertainment Complex, located in a renovated power plant building on the shores of Baltimore Harbor, features automated multi-media shows with robots as the main characters. Martin Collins, who worked on Disney's EPCOT Center, designed the audio system and worked on-site to implement its installation and operation. Electrosonic Systems installed the low-level audio equipment; Triad Productions installed the control systems, and Maryland Sound Systems installed the high-level audio equipment.

Delays in the building's renovation created difficulties for the sound contractors, according to Bill Synhorst of Triad Productions.

"The building was in a very rough state," said Synhorst. "We had to work in hard hats and construction boots. Since the elevators weren't run-

ning, we had to carry equipment up five flights of stairs. The air conditioning and ventilation systems still weren't installed. Dust quickly covered equipment and the temperature in the building approached 100 degrees. Some rooms had no electricity. The conditions were adverse, but the people we worked with made up for it and seeing the shows come together made it all worthwhile."

QSC Audio Products amplifiers were chosen for the system because the amps' front-to-back ventilation system allowed them to be stacked closer together.

Other products used in the system, according to William Parry of Maryland Sound Industries, were Innovative Electronic Design control modules, Tascam 16-channel reel-to-reel tape decks, Tascam MS-16 cassette decks, Shure microphones, Meyer Sound equalizers, Klark-Teknik equalizers, Yamaha mixing consoles, ClearCom intercom systems, TAD high-frequency drivers, JBL studio monitors, mid-range and low-frequency drivers, Bose 102 full-range ceiling speakers, and Soundolier C803 speakers for background music.

Aegis Technologies
Aiphone Corp.
AKG Acoustics
Altec Lansing
ART
Atlas Sound Div.
Ashly Audio Inc.
Audio-Technica U.S. Inc.
Bogen Communications
Cetec Vega
Community Light & Sound
Conquest Sound
Cornell Electronic Products
Crown International
J.W. Davis
dbx
DIS•USA
DOD Electronics
Dukane Corp.
Electro-Voice Inc.
Environmental Sound
Fisher Berkeley Corp.
Four Jay Industries
F.S.R. Inc.
Galaxy Audio
Grommes Precision
JBL Professional
Jeron Electronic Systems
Klark Teknik Electronics
Knowles
LCA Sales
Lee Dan Communications
Mackenzie Labs
Nady Systems
NEI
Neutrik Products
Numark Electronic Corp.
Oaktron Industries
OWI Inc.
Panasonic/Video Systems
Paso Sound Products
Rane Corp.
Rowe Customusic
RTS Systems Inc.
Sennheiser Electronic
Shure Brothers Inc.
Sonic Systems Inc.
Soundolier
SPECO
Tape A Thon Corp.
TASCAM
TCE Electronics Group
Tektone Sound Signal
Telex Communications
TOA Electronics
White Instruments
Yamaha International Corp.
Yesco

SOUND & COMMUNICATIONS

**regularly features advertising
and product information
from manufacturers of
this caliber, the companies
you deal with and the
products you need.**

Use the enclosed rapid
response cards for fast
information on any
of the companies
featured in this issue.

SOUND & COMMUNICATIONS

**It's Not Just a Magazine,
It's An Industry.**

PRODUCT

(continued from page 60)

DELTACOM DEBUTS INSTITUTION INTERCOM

Delta Communications Co. has introduced a compact intercom system for use in schools, businesses, and retirement complexes.

It features dual channel intercom/program capability, with "Color-Flo" instructions on its control panel.

The console has an AM-FM radio/cassette, announcement microphone/handset, and pre-announce chime. The unit is shipped factory assembled.

Features include one-button general announce with program automute,

choice of privacy and room call-in, remote microphone input, and high level selective paging. Selector panels



are color-coded push buttons with matching colored instructions on the control panel.

The program amplifier has an output capability of 120 watts. The intercom section provides up to 10 watts of amplified communications to one or more loudspeakers.

The selector panels are provided with plug-in connectors for attaching the room speaker lines.

Up to 78 rooms can be served by this small compact console. Larger installations can be served by the addition of a second cabinet.

Circle 67 on Reader Response Card

VALCOM INTRODUCES LINE STATUS MONITOR SYSTEM

Valcom has introduced the Line Status Monitor System which is said to eliminate the need for key telephone equipment by using your telephone system's built-in group pickup and call

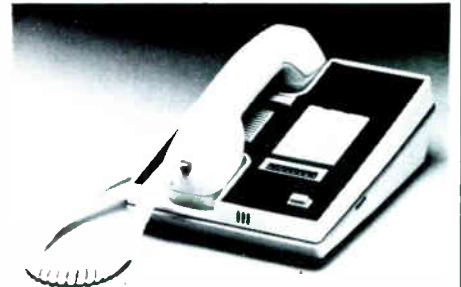

pickup features. The Line Status Monitor System is used with both Centrex and PABX telephone systems.

This telephone functions as both a standard single line extension and a monitor for the status of up to eight stations.

A MDF transmitter unit is required to power the Line Status Monitor Telephones. One MDF transmitter can sense off-hook or ringing conditions on eight station numbers.

Circle 68 on Reader Response Card

SPECO'S RECTANGULAR ABS PLASTIC PA HORN

Speco has announced the addition to its product line of the SPC-60RP, 60 watt rectangular ABS Plastic PA Horn.

SPC-60RP is a high powered 5-inch x 8-inch horn. It is constructed of white ABS plastic and comes with stainless steel hardware and is completely weatherproof. The horn has a frequency response of 200-15,000 Hz and an impedance of 8 ohms.

Circle 80 on Reader Response Card

State-of-the-watt performance



The SA2500. Uncompromising performance and reliability for professional sound applications.

Rated at 280 watts per channel (8 ohm load), and 450 watts per channel (4 ohm load) FTC, 20 Hz - 20 kHz, the SA2500 packs enough punch to handle a wide variety of professional sound applications ranging from background music systems to sound reinforcement.

Featuring advanced, super linear, ultra-high speed DC coupled bipolar technology, the SA2500 offers high-power output with extremely low distortion characteristics, even with impedances as low as 2 ohms.

For quiet and reliable operation, the SA2500 features a forced-air cooling system with thermostatically controlled fan.

DC and thermal protection, turn-on delay circuit and 16-amp magnetic circuit breaker power switch ensure safe and dependable performance, even under the most demanding operating conditions.

Specifications and advertising hyperbole can't fully describe the SA2500's advanced design and unmatched performance. That's why we encourage you to compare it yourself. When you do, you'll agree that the SA2500 is definitely state-of-the-watt.

Suggested retail price, \$1249.95.



See us at
Booth 53

Numark Electronics Corp.
503 Newfield Avenue, Raritan Center,
Edison NJ 08837 Tel: (201) 225-3222
Telex: 287-249 Edin Fax: (201) 287-2155

Circle 232 on Reader Response Card

"The result is magic."

Richard Long, President, RLA International, Ltd.

Richard Long is right at home in select company. From New York to Cairo. From London to Kuala Lumpur—Long builds the disco systems that make every night special at Regines, Club Area, Chippendales, the Paradise Garage, Studio 54 and countless other international night spots. He's used to the best. That's why Richard Long has made the BBE™ 202R a vital part of the

voice coil characteristics, reflected impedance from the environment, crossover impedance anomalies, and the mechanical properties of dynamic speakers. The relationships among the fundamental frequencies, their leading harmonics and between the leading harmonics themselves become distorted in both amplitude and time. The result? Muddiness, poor imaging and pinched, colorized sound that lacks the presence and punch of the real thing.

controls let you boost low frequencies and regulate the amount of high frequency amplitude correction to suit your needs.

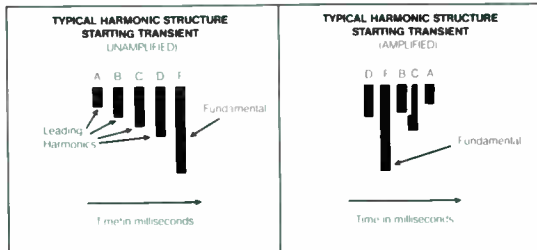

systems he designs and installs. "I use BBE in either the loop of the mixer or at the output stage. It makes the sound of recordings and other source material far more dynamic and exciting."

BBE is also right at home in select company. Even the finest audio components can be undermined by that all-important interface between amplifier and speaker. That's where phase and "overhang" distortion develop, due to

the original source, BBE restores the natural harmonic balances that were present in the live performance. How? First it divides the audio spectrum into three bandwidths. Then it applies phase correction across the full spectrum and dynamic high frequency amplitude compensation as required. BBE's continual sampling of the mid/high frequency relationship allows this correction to take place automatically. Convenient front-panel

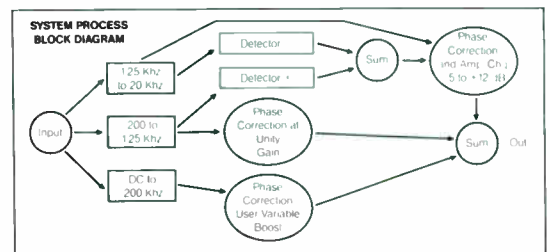

The BBE 202R is easy to install with either standard XLR or 1/4" connections, balanced or unbalanced. And because the BBE process does *not* involve any special encoding or decoding, the 202R can be used on any audio signal and in any sound system. Whether the installation is a crowded club or a cavernous cathedral, indoors or out, professionals like Richard Long depend on the BBE difference. Shouldn't you?

To find out what the BBE 202R can do for your sound, contact your professional sound dealer.

Or write to us at Barcus-Berry Electronics, 5500 Bolsa Avenue, Huntington Beach, CA 92649, or call 1-714-897-6766.



BBE™ All the sound you've never heard.
Barcus-Berry Electronics, Inc.

DATE	EVENT/COMMENT	LOCATION	CONTACT
April 22-23	SMATV/MATV/CATV/TVRO Technical Seminar sponsored by Blonder-Tongue and Enjay Associates.	Tampa Airport Hilton Tampa, FL	Sharon Leight (201) 679-4000
April 23-24	Duncan Audio Visual Exhibition of A/V and video equipment.	Holiday Inn Airport Rochester, NY	Duncan Audio Visual (716) 342-4500
April 28-29	Sound Engineering Seminar Two day seminar in audio and acoustics by Synergetic Audio Concepts.	Aladdin Hotel Las Vegas, NV	Syn-Aud-Con (714) 728-0245
April 28-May 1	Electronics Distribution Show and Conference A major showcase for electronic components, test equipment, and accessories.	Las Vegas Hilton Hotel Las Vegas, NV	Laurence Kauffman (312) 648-1140
April 28-May 1	Contractor's Expo and Conference for contractors, suppliers, engineers, and technicians sponsored by the National Sound and Communications Association.	Las Vegas, NV	NSCA (312) 593-8360
May 7-9	Studio Designers Workshop On control room technology.	Tele-Image Studios Dallas, TX	Syn-Aud-Con (714) 728-0245
May 12-16	L.A. Professional Video Show Exhibits & seminars on video equipment & technology.	Long Beach Convention Center Long Beach, CA	Ann Bisgyer (800) 248-KIPI in NY (914) 328-9157
May 13-16	Teleconferencing '86 10th annual conference on audio, graphic, video, & computer systems.	University of Wisconsin Madison, WI	ITCA (703) 556-6115
May 20-22	1986 Eastern Telecommunications Showcase Seminars & exhibits.	Georgia World Congress Center Atlanta, GA	USTSA (202) 872-1200
June 9-13	23rd Annual Conference & Technical Exhibition For healthcare telecommunications.	Clarion Hotel St. Louis, MO	Nancy Montenegro American Society for Hospital Engineering (312) 280-6139
June 12-13	Centrex: Strategic Directions Market & technology outlook.	Key Bridge Marriot Hotel Arlington, VA	Cross Info. Co. (303) 444-7799
June 14-17	International Music & Sound Expo Seminars & exhibits.	Chicago, IL	NAMM (619) 438-8001
June 16-19	National Computer Conference Seminars & exhibits.	Las Vegas, NV	AFIPS (703) 620-8900

REVO- LUTION

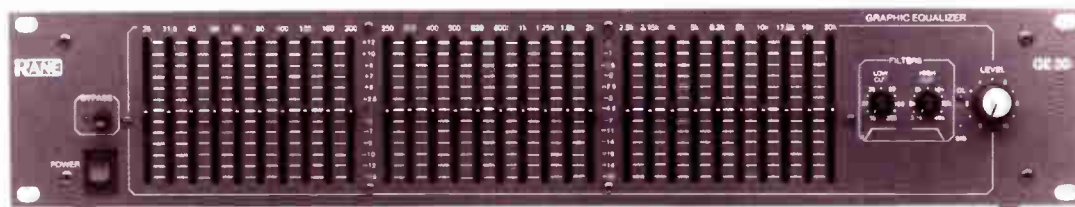

Prepare yourself. Graphic equalizers as you have known them are obsolete. Because Rane just rewrote the rules.

Introducing the GE 30, Rane's astonishing new Commercial Grade True 1/3-Octave graphic equalizer. The GE 30 is a new functional concept which allows one single model to provide all the capabilities that previously required two separate models.

It's the first graphic equalizer ever to let you switch from a +12/-15dB boost-cut mode to a 0/-20dB cut-only mode by simply pushing a button on the back. The first with 60mm sliders, for maximized resolution in a 3.5" format. And the first with a

Circle 263 on Reader Response Card

user-switchable active direct-coupled or transformer-coupled complimentary balanced output configuration as a standard feature.

Using 2nd generation Constant-Q filters (developed by Rane), it provides all the proven advantages of constant bandwidth performance with even less overall ripple.

There's more, too, like built-in RFI filters and both 3-pin and barrier strip input/output terminations.

Check out the GE 30. After the revolution, it'll be your way of life.

Rane Corporation, 6510 216th Southwest
Mountlake Terrace, WA 98043. 206/774-7309.



See us at Booth 59



Panduit Publishes Telephone Industry Wiring Products Catalog

A new, 32-page catalog from Panduit Corp., Electrical Group, describes the company's full line of wiring products for the telephone and interconnect industries.

The illustrated catalog lists Panduit® cable ties for indoor and outdoor applications, cable clamps, lashing ties, and stainless steel ties, along with mounting and marking accessories and installation tools.

Installation procedures are il-

lustrated and typical applications shown for the various products. In addition, complete tabular product listings are provided, giving part numbers, product dimensions, color availability, and packaging quantities.

Circle 55 on Reader Response Card

Speco's Commercial Sound & Security Products Catalog

The latest Speco Division Commercial Sound and Security Products catalog is now available. This catalog features the complete commercial

sound product line plus available products Speco has recently added to their line.

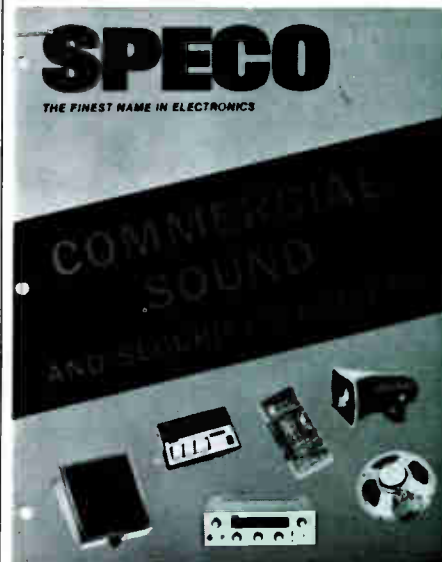

Circle 54 on Reader Response Card

More Ceiling Speaker For Your Money

In a day when the average consumer has a high tech sound system in their car as well as in their home, most industrial sound system companies seem to have forgotten how to make a ceiling speaker that's dependable and sounds good, yet still affordable.

For people who don't think that's very sensible, EAW introduces the RCF L12/CX2.

RCF is one of the largest professional loudspeaker manufacturers in the world, selling more pro speakers in Europe last year than anyone else.

This success is due to the simple fact that RCF has been making high performance loudspeakers that are built right and priced right for over 30 years.

One reason RCF can make such superior loudspeakers is that RCF recently completed one of the world's most advanced speaker production facilities, complete with automated fabrication machinery and high tech computer aided design facilities.

All of this experience in craftsmanship, engineering and high technology is clearly evident in the L12/CX2 high output coaxial speaker system.

The L12CX2's high frequency driver's mylar film diaphragm and space age magnetic damping fluid cooled voice coil provide exceptionally smooth response to beyond 15,000 Hz while virtually eliminating costly field failures. (After you've installed a speaker in the ceiling you don't want to have to go back to fix it.)

The L12CX2's true coaxial design



EAW / RCF L12/CX2 300mm (12-in) Coax Ceiling Speaker

enables wider coverage through the entire operating band than any competitive system. And with greater than 120 dB SPL at 1 meter maximum output, the L12/CX2 is clearly in a class by itself.

And when you listen to the L12CX2 you get the feeling that you just hung a studio monitor in the ceiling, only it gets much louder than most monitor systems.

But the most interesting thing about the EAW/RCF L12CX2 is its price. The retail price for this clearly superior performance is less than \$180.

So instead of spending more money for less performance, contact EAW for the location of your nearest dealer, and get more ceiling speaker for your money.



59 Fountain St. • Framingham, MA 01701
(617) 620-1478

See us at Booth 136

Circle 217 on Reader Response Card

Catalog of Training Support Resources by abc TeleTraining

abc TeleTraining, Inc. has released a new 36-page training catalog with detailed outlines on basic workshops in telecommunications and 35 easy-to-read training manuals.

Three new training manuals are included in the catalog, "A basic guide to 1A2 key telephone installation," "Principles of traffic and network design," and "Spanish translation of Telecabulary."

The catalog also describes new on-site training courses in the marketing of network services, and the fundamentals of stored program control.

Circle 53 on Reader Response Card

New Brochure Details Electrovert Wiring Products

A new 12-page brochure of the Electrovert line of wire/cable harnessing, marking and accessory devices has been published.

Products included are: wiring duct; sleeve type and clip-on PVC markers; grommet strip; coaxial and telephone cable clips; P-clips; spiroband; cradleclips; and cable ties. Complete and detailed information on applications, materials, specifications, properties, dimensions and ordering data are included for each product.

Circle 52 on Reader Response Card

Acoustical Designing in Architecture

Knudsen, Vern O., and Cyril Harris, *Acoustical Designing in Architecture* (First edition 1950; reprinted by the American Institute of Physics, 1980) vii + 408 pp., paperback, \$15.

Basic books, fundamental books, classic books—there aren't very many in acoustics, but this is one. If your work touches on reverberation, noise control, speech intelligibility, or the behavior of sound in venues of public assembly, you need this book. Further, you will profit from re-reading it (or part of it) from time to time. The American Institute of Physics has republished it in a paperback edition for the Acoustical Society of America, which distributes it.

Architectural acoustics is the study of the behavior of sound, whether indoors or outdoors. The sound itself

surprise after installation by asking, "What's that room doing to my wonderful loudspeakers?" In fact, good architectural acoustics can conceal certain sound system faults. It is true, however, that the wise designer or contractor is able to foresee acoustical troubles.

Acoustical Designing in Architecture was written for architects, builders, and others who need practical understanding of the fundamental principles of acoustics, and specific applications information for a variety of venues. This is in the tradition of Wallace Clement Sabine, who first developed the concept of reverberation; all his publications, until the last part of his career, appeared in architectural and builder's trade magazines. Oddly enough, when this book was written the sound contracting industry as we know

percent of us have a threshold hearing acuity 45 dB more sensitive than the average? Ten percent of us have low-level hearing 12 dB more sensitive than the average. Those who look at Fletcher and Munson's bottom curve and think that nothing below that ever matters would do well to think again. A chapter is also devoted to the characteristics of speech and music, in both amplitude and frequency.

Chapter 4 shows the physical behavior of sound when reflected and diffracted. To the authors' credit little time is wasted with the phonon, the sound ray, and its specular or mirror-like reflections. Many other books spend too much time on this idea which is intuitively apparent: sound behaves like light. It is one of the least useful descriptors of sound behavior in real architectural spaces. Diffraction effects around corners, through apertures, and in "shadow" zones behind objects, which are shown in detail in this book, offer much more to the reader.

Chapter 5, on open-air theaters, has a few pages on Greco-Roman amphitheaters, and then turns to the behavior of sound outdoors, across temperature gradients, and interacting with the ground. Figure 5.8 shows graphically the maximum distance outdoors unamplified speech may be projected by professional talkers (actors, orators), under ideal conditions: no wind (beyond that generated by the talker), and no intruding noise. Additional curves show the effect of wind. And modern practice in reflective shells is discussed at some length.

The next two chapters focus on sound absorption, first as may be mounted on an interior surface, and then in special constructions: free-hanging, in slotted concrete blocks, and rotatable panels used to vary a room's absorptivity. Thank goodness there are almost no physics here and no acoustic impedance or adiabatic conversion efficiency equations. Many materials are shown (some no longer manufactured) and the often overlooked importance of mounting technique is driven home most effectively.

Any reinforcement sound system contractor or designer must understand architectural acoustics, because his client is interested in the sound he hears, not in the sound as it leaves the loudspeaker grille.

may originate from talkers or musicians; it may originate from mechanical systems such as air conditioning ducts, or from automobile or aircraft traffic outside; or it may originate from loudspeakers. Any reinforcement sound system contractor or designer must understand architectural acoustics, because his client is interested in the sound he hears, not in the sound as it leaves the loudspeaker grille. Manufacturer's anechoic chamber measurements of the sound equipment's performance (or their fantasies about its performance) are only starting points, and the contractor or the designer is obliged to know how the equipment—all of it—will interact with the room in which it is used.

Only the naive will assume architectural effects always to be negative. Only the naive cover every unpleasant

it today did not exist. Yet the book is ideally suited to sound contractors.

The book's approach is practical, with numerous examples, and only two or three mathematical expressions requiring high mathematical ability beyond the high school level.

The first three chapters form the introduction to sound and hearing. Unlike most such opening chapters, they are not scrapbooks of physical equations which never again appear in the book. They are, rather, conceptual in nature and develop ideas that are referred to throughout the book. The notions of sound power, intensity, and pressure are related to each other and to the practice of acoustics. A chapter on hearing devotes most of its attention to hearing loss, and the ordinary variations in hearing ability within any population. Did you know that one

The next two chapters form the heart of the book, the material we ordinarily think of when the subject is acoustical designing.

A chapter on the principles of room acoustics looks at varieties of sound behavior in a room: the growth of sound, the decay of sound, the distribution of sound in single enclosures and in coupled enclosures (as for instance between a stage house and auditorium in a theater), and the normal modes of rectangular rooms. There is plenty of theory here, and plenty of formulas, for those who want them. The authors have carefully explained the idea each equation has to teach us, so those who can't or don't want to deal with mathematics can benefit from a close study.

A chapter on the acoustical design of rooms puts to work the fundamental ideas developed in the book. The shape of the room is dealt with at length, and its size, ordinarily thought of in acoustics as volume per seat. Specific problems are identified, as well as ideal criteria. Reverberation control is covered, as amount of reverberation, decay over time, and decay over frequency. Scale model testing is described (Although much

work has been done on this subject since the book was published, these few pages serve as an introduction.), as well as testing the completed room.

Especially important in this chapter is a lengthy section on articulation testing. It is insufficiently appreciated today that all intelligibility prediction techniques are ultimately empirical, and based on word lists read out to, and copied by, listening juries.

Four chapters cover noise control. An introductory chapter presents criteria and standards. A chapter on airborne noise gives much practical information on outdoor noise and flanking path noise indoors as well as partition constructions that reduce inter-room noise. A chapter on noise transmitted through building structures shows floating floors, pipe lagging, and the like. A chapter on HVAC noise outlines the benefits from lining the interiors of air ducts, and the introduction of silencers and the like.

Chapter 14 is devoted to sound amplification. These 11 pages have little to teach those in the sound and communications industry.

The final six chapters of the book are each assigned one type of building

in which acoustics are especially important, and each looks at room design and noise control for that type structure. Auditoriums are treated here, as are school buildings and commercial and public buildings.

The book ends with three useful appendices. The first includes tables of absorption coefficients, and the second has a table of noise isolation characteristics. The final appendix has a very brief list of unit conversion factors and physical constants used throughout the book.

This new edition has about 10 percent fewer pages than the Wiley edition owned by your reviewer. And a few hopelessly outdated illustrations have been deleted, for example one in the chapter on sound amplification originally printed "courtesy Western Electric." A few illustrations have been updated, such as one of a sound level meter. With these exceptions the new edition includes every word in the previous editions, reset with more text per page. Footnotes at the bottom of many pages were added in 1980, explaining changes in SI units, standards, and such since the original publication in 1950. There are also
(continued on page 78)



COMBINING ART AND TECHNOLOGY



In the business of professional audio, new products and ideas are being applied to expand the boundaries of creativity.

ART products are being used creatively in a growing number of studios, commercial installations, touring companies and broadcast/post-production facilities. This is the result of our dedication to the professional

audio industry - providing quality high technology performance.

When you're in a demanding audio situation, keep in mind that ART products are designed to help you achieve superior results with ease and reliability.

ART brings talent and technology together to produce excellence in audio.

We remain devoted to the art of professional audio...today and tomorrow.



Applied Research & Technology Inc.
215 Tremont Street
Rochester, New York 14608
(716) 436-2720

• DR1 DIGITAL REVERB • D1A DIGITAL REVERB • DR2a DIGITAL REVERB • 1500 DIGITAL DELAY • 1/3 OCTAVE EQUALIZER • 2/3 OCTAVE EQUALIZER • PITCH TRANSPOSER PACKAGE



Marshall Introduces Line of Pro Audio Speaker Cables

Marshall Electronics Inc. has announced a new line of superflexible, heavy-duty speaker cables. New Sound Runner II is designed for use with professional and consumer audio systems. These speaker cables feature high-density copper multi-strands in four powerful configurations: 10-awg, 12-awg, 16-awg, and 18-awg; superflexible glossy black PVC jacket with positive conductor markings; and low signal loss performance. List prices for Sound Runner II are 10-awg .69/foot; 12-awg .49/foot; 16-awg .22/foot; 18-awg .24/foot.

Sound Runner II 10-awg Power Speaker Cable features 238 high-density copper strands in a two-conductor format. The 18-awg Sound Runner II is designed with a stabilized, round, glossy black PVC jacket for easy construction of custom interconnects.

Circle 57 on Reader Response Card



Penny & Giles Introduces Quadrant Faders & Controllers

Penny & Giles has announced a new line of quadrant fader/quadrant controllers.

Quadrant faders are used in the audio, and now more particularly, the video industries, for selection and con-

trol of sound and picture channels.

They feature a standard hybrid track (conductive plastic on wire) giving infinite resolution and long life. An operating level mounted in plastic bearings gives smooth operation through an angle of 90 degrees.

The quadrant fader/quadrant controllers can be supplied either as single units or as dual sets (back-to-back), and can incorporate microswitches at the lever "start" position.

Circle 58 on Reader Response Card

New Automatic Wire Stripper & Kit from GC Electronics

GC Electronics has introduced the Coax Automatic Wire Stripper and the GC Automatic Wire stripper kit.

The Coax Automatic Wire Stripper features a fully automatic delayed action mechanism which prevents the wire from being crushed. It can handle three sizes of coax cable: RG58, RG59, and RG62. This coax stripper is also plenum capable.

The GC Automatic Wire Stripper Kit comes complete with the multi-

wire Automatic Wire Stripper, which can handle 8 thru 22 gauge wire, along with two replacement blades for use with telephone line cord, station wire, and coax cable.

Circle 59 on Reader Response Card

Complete Line of Bulk Erasers From Benjamin International

Benjamin International, Inc. has announced a complete line of bulk erasers for audio, video tapes and cassettes, and computer tapes, and floppy discs. This line includes both AC powered units and cordless permanent magnet tapes.

Two types of permanent magnet erasers are manufactured by Benjamin. The smaller unit is specifically designed for micro-cassettes. The larger model handles both micro and standard cassettes. The hand-held AC powered models are recommended for all audio and video cassettes as well as for floppy discs.

Circle 60 on Reader Response Card

SMART SPEAKERS...

ENVIRONMENTAL SOUND has developed a new class of loudspeaker technology engineered primarily for **SOUND CONTRACTING, CONSULTING, and ARCHITECTURAL FIRMS**.

If you haven't already heard, introduce yourself to the **PROFESSIONAL DROP CEILING MONITOR** and **ES SERIES**. Innovative versatility allowing numerous applications as well as to shape the future state-of-the-art loudspeaker and to improve cost effectiveness from installation to sound quality. **ENVIRONMENTAL SOUND** has heard what the sound contractor needs!

The **PRO DROP CEILING MONITOR** and **ES SERIES** represent a brilliant achievement required for today's technology that until now has been overlooked and neglected.



FOR SOUND THINKERS.

"For Those Who Listen"

ENVIRONMENTAL SOUND[®]
31220 LaBaya Dr. #110, Westlake Village, CA 91362 (818) 706-0228.

SEE US AT NSCA BOOTH #90

World Radio History Circle 220 on Reader Response Card

FACES AND PLACES

Com Dev Names VerMeulen VP, Sales

Com Dev, Inc. has announced that John D. VerMeulen has taken the position of vice president—sales and service. In this role, VerMeulen will have responsibility for managing all sales functions as well as the customer support operations, which includes technical support and customer training.

VerMeulen comes to Com Dev from UTCC sales and sales management positions, most recently as vice president—national accounts. A 1965 graduate of Hope College, in Holland MI, with a BS in Business Administration, John was with GTE Automatic Electric for six years prior to joining UTCC.

Jeron Names Charczuk National Sales Manager

Jeron Electronic Systems, Inc. has appointed John R. Charczuk its national sales manager.

Jerome Chesnul, president of Jeron said, "Our customers will be pleased with John's thorough knowledge of the various products we manufacture. He has a degree in electronic engineering and has several years of experience in this industry." John was previously national sales manager at The Auth Company.

"I'm enthused to be working with a company whose broad range of products makes it a unique source to its customers," said John Charczuk. "I'll be working closely with Jeron's sales representatives throughout the United States. We'll be emphasizing customer services and sales assistance to distributors."

ADC Names Griffin to Technical Support Position

ADC Telecommunications, Inc. has named John Griffin technical support manager. In his new position, Griffin is responsible for worldwide technical

support of ADC's sales force, products, and customers.

Prior to joining ADC Telecommunications, Inc., Griffin was with Northwestern Bell Telephone Company for 13 years. He held a variety of positions at Northwestern Bell's Omaha, NE, and Minneapolis, MN, locations, including central office supervisor, staff manager and central office engineering manager. Most recently, Griffin was manager, switching operations at Northwestern Bell's Minneapolis operation.

Griffin holds an MBA and a BSME degree, both from the University of Minnesota, Minneapolis.



JOHN GRIFFIN



KEVIN LYONS

NEC Telephones Promotes Byrnes, Hires Lyons

NEC Telephones, Inc. has announced the promotion of Roger J. Byrne to vice president of east region operations and the hiring of Kevin Lyons as product manager.

As vice president, Byrne will be responsible for managing all east region activities pertaining to the sales and marketing of the company's telecommunications product line.

Byrne, who has over 25 years of experience in the telecommunications industry, began his career with New York Telephone. In 1980, he joined NEC Telephones as a systems PBX manager, and in 1982, was promoted to director of east region operations.

Lyons, who was named product manager, will be responsible for preparing sales and marketing materials for the Electra™ Information Management System (IMS). He will also be involved in new product development.

Before joining NECTEL, Lyons was a product manager for Executone, Inc. He also held sales management positions with Private Telephone Technologies and Coradian Corp.

APPLICATION FOR MEMBERSHIP

National Sound and Communication Association
501 West Algonquin Road
Arlington Heights, Illinois 60005-4411
(312) 593-8360



We are: _____ Contractors _____ Representatives
_____ Manufacturers _____ Consultants

We were sponsored by: _____

Company Name: _____ (Please type)

Street Address: _____

City: _____ State: _____ Zip: _____

Area Code: (_____) _____

Your Name: _____ Title: _____

Dues For: Contractors \$100.00
Representative Sponsor \$125.00
Manufacturer Sponsor \$250.00
Consultant Sponsor \$125.00

My Check for \$ _____ is enclosed. Check No. _____ Dated: _____

_____ Please Invoice me for \$ _____

Signature: _____ Dated: _____

**Please complete the application and mail it to NSCA.
Make checks payable to:
National Sound and Communications Association**

REP NEWS

Four **dbx Professional Products Division** sales representative organizations were honored recently for sales achievement in 1985, announced **Stan Peters**, vice president for marketing and sales.

The top award, "**Sales Representative of the Year**," was presented to **David Henderson**, president **Professional Audio Associates Inc.**, of Burlington, MA.

"**Outstanding Achievement**" awards were presented to three firms. The presentations were made to **Ted Bennett** of **Sphere Associates**, Reston, VA; **William Ray** of **William J. Ray & Associates**, Atlanta, GA; and **Larry Peterson** of **LP Marketing**, Oakland, CA.

In other news, **AMH Sales** of Phoenix, AZ, has been appointed a manufacturer's representative for the dbx Professional Products Division, according to Peters.

AMH Sales' **Alan Hyatt** and **Harry Warman** will share account responsibilities for dbx professional product sales in Arizona, Utah, New Mexico, Colorado, Wyoming, and parts of Texas, Nevada, Idaho, and Montana.

Bogen has appointed **SRT Marketing** as its sales representative throughout UTP #13, the state of Florida. According to **Carl C. Dorwaldt**, Bogen's vice president, marketing, "We know that our distributors in this territory will be as pleased as we are to have this strong company representing Bogen."

SRT's president, **Troy Gunnin**, and outside salesperson **Scott Gunnin** are located in SRT's administrative center in Tampa, FL. **Harold Scott** of Winter Springs, FL, handles outside sales in the Orlando area and his counterpart for the southern part of Florida is **Herbert Desser** of Hollywood, FL.

TekTone Sound & Signal Mfg., Inc. has added three representatives for its product line. **Lichtenauer & Assoc.** of Antioch, CA, will cover the areas of northern California and Nevada; **Westech Marketing** with offices in Culver City, CA, and Phoenix, AZ, will cover Arizona and southern California and Nevada; **Alarmtronics** of Edina, MN, will cover Michigan (upper peninsula) and

Wisconsin.

Pete Finney of the Indianapolis-based **PRO Marketing Systems, Inc.**, was named **Community Light & Sound's Sales Rep of the Year** at Community's annual sales meeting and awards banquet.

Hosted by Community President **Bruce Howze**, Executive VP **John Wiggins**, and National Sales Manager **John Strand**, the event was held just prior to the opening of the NAMM Winter Market in Anaheim, CA. In

addition to the sales rep of the year award, other awards went to **Metro Rep Sales, Inc.**, of Freehold, NJ, for more than 10 years of continued service, and to **Key Marketing** of Plymouth, MI, for seven years of service.

To have your rep news listed, please send your information to: **Rep News, Sound & Communications**, 220 Westbury Ave., Carle Place, NY 11514.

SCAMP®

the self-contained audio masking package with the 6-year guarantee

Now SCAMP — the world leader in speech privacy — is better than ever. So much so, that we've increased the guarantee to 6 years — the industry's longest. Output stability is enhanced with added power supply regulation. Switch selection for mineral fiber or glass fiber ceilings. 12 position output adjustment in 1½dB steps, 16VAC input power.

For complete details write or call today. Also ask about Insul-Art Satellite and Centrallite soundmasking systems and our other acoustical products.



See us at
Booth 115

Insul-Art® ACOUSTICS CORPORATION

107 Allen Boulevard, Farmingdale, NY 11735
800-526-0908 • In New York State (516) 694-0002

World Radio History

An Atrium Industries Inc. Company

FREE!

**New
1986
Installer
Catalog-
88 Pages,
Full Line...**



- Connectors and Adaptors in stock plus exclusive Connector Locator Service*
- Hi quality bulk cable featuring Mogami Superflexible and Ultraminature
- Custom Cable Assembly and Repair Department plus
- Tools and Accessories

For professional installers of Electronics Systems of every kind.

Ask about our 5% discount for your first catalog order... celebrating our 20th Year.

CALL TODAY! 800-522-7377;

in NY 212-585-1645 for catalog, price list, engineering assistance and quotes. All FREE without obligation!

The One-Stop Installer Shop.
Our 20th Year!



BI-TRONICS, INC.

Box 125, Tuckahoe, NY 10707

Circle 211 on Reader Response Card

IMPEDANCE METER

Model RZ-1



Stop guessing at impedance parameters— Save time and money on 25 or 70 watt speaker system installation, repairs, or any other audio system impedance matching requirement.

Write for free literature with 40 money and time-saving application notes.

The RZ-1 is easy to use— connect unknown Z to meter, select range, and read impedance directly. Full frequency range— 5 Hz to 20 kHz.

- Range—00.1 ohms to 1.20 megaohms
- Internal industry frequency standard—1 kHz
- Auxiliary frequency input—5 Hz to 20 kHz
- Three-digit display
- Portable— Battery powered
- Processor time—1 conversion/second

\$389.00

Vegas Valley Group
3694 E. Tompkins
Las Vegas, NV 89121
(702) 458-7991

Circle 205 on Reader Response Card

AD INDEX

RS#	Company	Page	NSCA Booth #
201	AHB	59	
	AKG	23	31
203	Altec Lansing	III	15
282	ART	70	136
204	ASC	80	
283	Ashly Audio	60	61
206	Astatic	54	81
207	Atlas Sound	51	3
208	Audio Technica	49	34
209	Barcus Berry Electronics	65	
211	Bitronics	74	
210	Bose	38, 39	26
269	Bozak	81	123
212	Cetec Vega	77	44
270	Community Light & Sound	10	39
214	Conquest Sound	75	33
213	Cornell Electronics	40	9
216	Delta Com	80	
217	Eastern Acoustic Works	68	136
234	Eddcor	79	105
219	Electro-Voice	II	73
220	Environmental Sound	71	90
272	ESG	76	145
280	Fane	44	
222	Fisher Berkeley	30	H
223	Fostex	25	47
224	Four Jay	78	J
225	FSR	6	8
253	Harris Corp.	19, 20, 21	Q
261	HM Electronics	61	67
227	IED	57	E
228	Insul-Art	73	115
229	Jeron	27	14
230	MacKenzie	48	117
231	Nady	45	65
262	NSCA	72	
232	Numark	64	53
271	Oaktron	53	133
218	OWI	79	110
238	Panasonic Industrial	34	152
268	Paso	7	96
236	Quam Nichols	9	32
237	QSC	31	22
263	Rane	67	59
239	Sennheiser	37	80
240	Shure Brothers	IV	A
241	Sonic Systems	32	124
277, 276	Speco	41, 58	
242	Stentofon	18	U
243	Studer Revox	36	
244	TekTone	44	K
245	Telex	5	25
246	Ten-Tec	41	
	TOA	3, 17, 33	5
248	Turbosound	55	23
264	Vegas Valley	74	
249	West Penn Wire	11	38
250	White Instruments	78	36

(continued from page 64)

WICOM'S PHONE FOR HANDS FREE USE

Wicom has introduced a complete lightweight telephone with the convenience of a cordless phone, but with none of the problems associated with cordless technology. Called Walk 'N



Talk, the new telephone clips onto a belt, fits into a shirt pocket, or sits on a desk allowing the user to talk hands free. The unit comes complete with a lightweight stereo headset with flexible microphone arm, allowing it to be

used while moving about freely. It can be used for outgoing calls, or to take incoming calls, and is supplied with 15 feet of line cord and a standard telephone jack to plug directly into any telephone wall socket.

The complete telephone, the size of a cigarette pack, includes an on/off switch, a built-in ringer, last-number redial, hold button, full range volume control, tone or pulse dialing, red LED and belt clip.

Circle 13 on Reader Response Card

CERWIN-VEGA'S COMPACT THREE-WAY SYSTEM

Cerwin-Vega has introduced its most powerful compact single cabinet system, the V-35C, for PA. The three-way system features an 18-inch bass driver and is also suitable for keyboards, side-fill, and monitoring applications. A midrange compression driver with a constant-coverage horn and a high-efficiency horn super tweeter complete the system.

Bass frequencies are provided by an 18-inch cone driver, front horn loaded and operating in a vented enclosure optimally tuned to 50 Hz. The speaker

features a precision diecast aluminum frame and high-power (30 W EIA) three-inch voice coil.

Midrange frequencies are provided by Cerwin-Vega's JMH-1, one-inch throat compression driver operating from the crossover at 1.2 kHz to 5 kHz, which utilizes an aluminum diaphragm with elastomer surround and edgewound copper-clad aluminum-wire voice coil. Beryllium-copper lead-in wires will not fatigue with repeated flexure and eliminate a potential source of failure, said Cerwin-Vega.

The new constant-coverage 90 X 40-degree mid-frequency horn provides optimum loading characteristics for the JMH-1 driver with wide, controlled dispersion over the entire operating bandwidth.

High frequencies are reproduced by Cerwin-Vega's H-25 compression driver and integral horn (5 kHz-15 kHz). The H-25 features an oversize barium ferrite magnet driving a lightweight one-inch phenolic dome and aluminum wire voice-coil assembly.

Circle 14 on Reader Response Card

(continued from page 77)

OVER 5000 WIRING PRODUCTS FOR THE SOUND SPECIALIST

Conquest:

Conquest Sound is the leading manufacturer of audio wiring products. Since 1975, Conquest has provided excellence in product design, quality, service and pricing. From small music stores to many of the largest sound contractors, network and local T.V. stations, recording studios and touring groups, professionals world wide have depended on Conquest for quality products and quick service.

PRODUCT RANGE:

From the simplest of guitar cables to complicated multi-line systems, Conquest offers the widest selection available.



We manufacture over 2000 wiring products and distribute another 3000 wiring related products covering the audio field alone. Our Home and Industrial Division manufactures and distributes another 250 wiring related products.

MATERIALS:

Names like "Belden" and "Switchcraft" make up the bulk of our product line. Over one million feet of wire is in stock, from single conductor to 37 pair. We also stock over 110 different "Switchcraft" connectors, adaptors and plugs, all at prices that can't be matched.

GUARANTEE:

All products manufactured by Conquest carry a 5 year guarantee.

The next time your needs call for audio wiring products, give us a call. We are sure you will appreciate the difference fast service and friendly people make.

Send for our 32 page catalog or call: 1 (800) 323/7671
In Illinois, Alaska or Hawaii call: 1 (312) 429-1770 COLLECT

Conquest Sound • 15524 South 70th Court • Orland Park, Illinois 60462
See us at Booth 33

Circle 214 on Reader Response Card

MOVING?

Please attach your Sound & Communications mailing label or print your address exactly as it appears on the label.

NEW ADDRESS

NAME (Please Print)

COMPANY

ADDRESS APT NO.

CITY STATE ZIP

Return to:
Circulation Dept.
Sound & Communications
220 Westbury Avenue
Carle Place, NY 11514

PAGING

(continued from page 32)

an amplifier failure. There are a total of 106 amplifiers in the installation for a total audio power of 31,600 watts. All aspects of the signal chain are redundant as well, including preamps, to ensure failsafe reliability. Speaker lines are monitored continuously; if a speaker shows as non-operational the back up amp is switched in, if it is still non-functional an alarm goes off to make the operator aware of an open line.

The concern for safety does not stop with the hardware though, there are two fire drills per month. "The tenants are very co-operative in this. Their security is enhanced by knowing they can get out without panic," Cissa said.

Because of the building control systems' complexity, Johnson Controls spends 40 hours training new employees in the engineering maintenance group in the use of the equipment. This is followed by a two week period of on the job training with an experienced operator used to supplement his knowledge.

Life safety systems such as this are becoming more commonplace. Several other major corporate offices in Atlanta now also have systems of this type. Awareness of what can be done to protect human life will move this type of system into the standard equipment list of new buildings throughout North America.

For more information on manufacturers of life safety systems, see the Sound & Communications Bluebook. Also, look for a new issue of the Bluebook—coming in August 1986.

SOUND & COMMUNICATIONS

CLASSIFIEDS GET RESULTS

For rates and information, please call
(516) 334-7880



THE HIGH QUALITY, ALL-TERRAIN, WEATHER-RESISTANT, OUTDOOR SPEAKER SYSTEM.

The New Soundscape™ ATS-360.™

The new Soundscape ATS-360 outdoor speaker system will put high-quality sound wherever you need it. Typical applications include pool and lakeside recreation areas, hotel atrium and lobby gardens, church walkways, theme parks, zoological gardens, business exterior walkways, parks, and residential porches and patios.

The unique, inverted 360° direct-radiating speaker design totally eliminates trapped-water problems and the integral metal screen basket won't deteriorate like other products which use cheap foam materials as moisture and pest barriers. Because our exclusive design doesn't require internal "reflectors" either, there's nothing to get in the way of the outstanding sound quality.

An attractive low-profile design, the ATS case is made from a tough polyethelene plastic and includes impregnated ultra-violet ray inhibitors — to resist color fading. Once you've installed them in the ground they will withstand not only the weather, but the ravages of landscape trimmers and tools, too. The standard case colors are Foliage Green and Bark Brown, and custom colors are available. The ATS-360 is covered by a full five year limited warranty.

Contact us now for technical data and low, competitive prices.



Circle 272 on Reader Response Card

ELECTRONIC SYSTEMS GROUP, INC.

4405 VINELAND RD., SUITE C-8
ORLANDO, FLORIDA 32811 305-423-2363

See us at Booth 145

© 1986 ESG, Inc.

(continued from page 75)

JERON SECURITY SYSTEM REDUCES FALSE ALARMS

The SC-500 Alarm Communicator System manufactured by Jeron Electronic Systems, Inc. is for installation in buildings with apartments and condos, or offices where it is desired to create economical security systems with individual tenant control as well as alarm annunciation at a master panel conveniently located for building personnel. The two-way voice communication feature is a means of reducing "burning toast" false alarms to fire or police departments.

An Alarm Control Panel is installed in each tenant unit with contact switches and a smoke detector connected to the terminals. It has a keypad with four digit Off code that is simple for the tenant to use and is field programmable by the installer. The tenant depresses a single button to active On (Leave or Stay mode) and a single button activates the 'panic' Instant Alarm. Direct audio connection with the master panel is established during an alarm condition.

Jeron Alarm Communicator Master Panel is an annunciator with LED in-

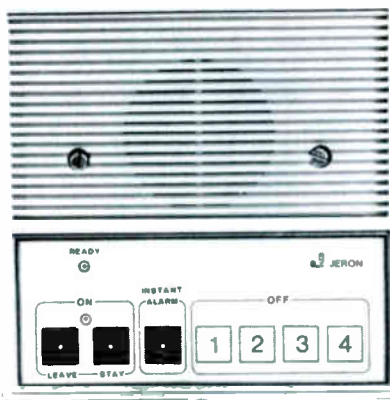

dicators that activate to pinpoint the location of an alarm and an audible tone alerts the guiding personnel. The the handset may be used to listen-in and appropriate action may be taken.

Circle 15 on Reader Response Card

LEADER INTRODUCES AN AM STEREO SIGNAL GENERATOR

Leader Instruments Corporation has announced the introduction of a new AM Stereo Synthesized Signal Generator, Model LSG-245.

"We have developed an affordable test instrument for the most popular

AM stereo system today — Motorola's C-Quam® system," said Robert B. Sparkes, Leader's director of marketing. "The LSG-245 provides the versatility to be used over the entire AM band, as well as at the IF, in addition to providing a wide variety of modulation and output conditions. It's the perfect signal source for sensitivity, separation, selectivity, distortion, and other tests on today's AM stereo receivers."

To facilitate set up, all parameters are entered by front panel pushbuttons and verified by LED displays. In addition, up to 100 sets of user defined test conditions (consisting of frequency, output, and modulation) can be easily stored and recalled enabling measurements to be made rapidly and without error.

Circle 16 on Reader Response Card

ELECTRO-ACOUSTIC ASSEMBLY FROM ATLAS

Atlas Sound has introduced the QVT and RVT Series of electro-acoustic assemblies combining decorative baffles for wall or ceiling installation

(continued on page 79)

The clear choice...

ORATOR III Wireless microphone system

Combines ease of operation with high performance at an affordable price. Its new audio processor provides very high signal-to-noise ratio and wide dynamic range. Operation is clean and clear up to 1000 feet, line of sight.

FEATURING:

TO-93 bodypack transmitter

Long battery life (up to 10 hours on a 9-V alkaline battery).

Power on/off switch

Recessed.

Mic level control

Screwdriver adjustment.

Mic on/off switch

Silent "no pop" operation.

Miniature XLR mic connector

Allows use of most lavalier mics.

Extra rugged case

High-impact Cyclolac.



106X mic
Other lavalier
mics are available.

Terminal strip
Line-level output.

XLR connector
Switchable mic-level and line-level audio outputs (internal switch).

RO-95 receiver
Easy to set up.

Rugged steel case

REAR VIEW

LED indicators

Transmitter on, audio overload, and power. For fast, simple setup.

Power switch

Also available is the TO-92A hand-held transmitter. The ORATOR III operates on a clear VHF high-band frequency. It is rugged and dependable, and is manufactured in the United States by ...

Cetec Vega

... the world's leader in wireless mics

9900 Baldwin Place
El Monte, California 91731
(818) 442-0782 TWX: 910-587-3539

See us at Booth 44

Circle 239 on Reader Response Card

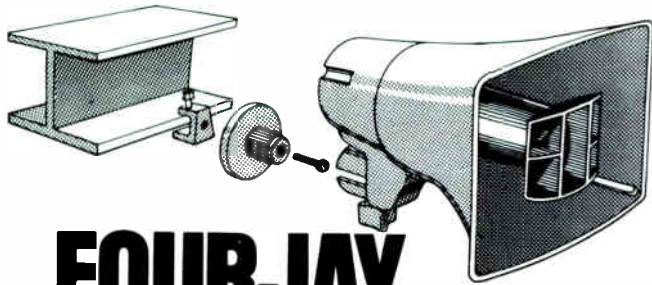

FOURJAY Cuts Installation Costs

You'll save time and money when you choose a Fourjay Paging Speaker. It practically installs itself. And you can depend on it for quality...

- Nearly unbreakable mounting base made of Lexan®.
- Long hook-up cable for hard wiring assures weatherability.
- Unique speaker design disperses high frequencies equally.
- Enclosed transformer with selectable taps.

Each Fourjay Paging Speaker is tested for optimum talk-back sensitivity to assure performance in intercom applications. With a Fourjay Speaker, you'll improve quality and cut installation costs dramatically.

LEXAN® is a GE trademark



FOURJAY INDUSTRIES INC.

3400 Stop Eight Road, Dayton, Ohio 45414
Phone: (513) 890-6444

See us at Booth J

Circle 224 on Reader Response Card

Moderately Priced & Clearly In A Class By Itself!

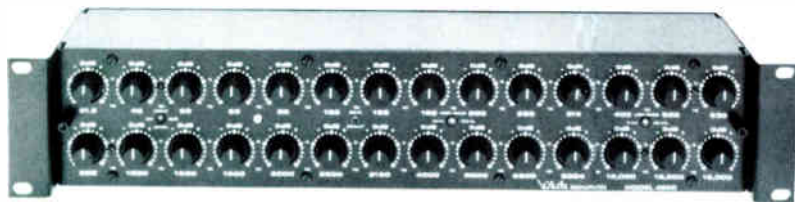

R-C ACTIVE • One-Third Octave 4500 GRAPHIC EQUALIZER

The Model 4500 was developed in response to hundreds of dealer, consultant and end-user requests for a moderately priced, full featured, one-third octave equalizer with the quality and innovations that the White Instruments name stands for.

FEATURES:

- 28 One-Third Octave Filters, 31.5 Hz - 16 kHz. Boost or Cut 10 dB. Detented Control Centers.
- Continuously Variable High & Low-Pass Filters.
- Three Independently Buffered Outputs For TRI-AMP Operation.
- Adjustable LED Peak Indicator.
- Socket Mounted ICs. Equalizer May Be Serviced WITHOUT Removing It From The Rack Or Disturbing Its Settings.
- Highest Filter Calibration Standards In The Industry.
- Security Cover Furnished.

OPTIONS:

- Plug-In BI-AMP And TRI-AMP Crossover Networks.
- Plug-In Input and Output Transformers.
- Plug-In Pink Noise Generators For Speech Privacy Systems.



P.O. Box 698, Austin, TX 78767
Telex: 776409 WHITE INST AUS
(512) 892-0752

See us at Booth 36

For further information write or call.

Circle 250 on Reader Response Card

BOOK REVIEW

(continued from page 70)

constant references to more recent books which have become standard handbooks in acoustics.

The best handbook on architectural acoustics overall is *Acoustical Designing in Architecture*. That it is 36 years old almost does not matter, because it deals with concepts, not tips and techniques which change every few years. Concepts, however, have changed very little since the first publication of this book.

★ ★ ★

Acoustical Designing in Architecture may be purchased only from the Acoustical Society of America, 335 East 45th St., New York, NY 10017. It costs \$15 postpaid if payment accompanies the order, and there is a discount for orders of five or more copies.

SALES & MARKETING

(continued from page 10)

make everything from consumer to professional audio equipment. A sound contractor in the year 2000 would then deal exclusively in the complete product line of one manufacturer.

But Bud Rebedeau, NSCA executive secretary, doubts further centralization in the industry would eliminate the small, specialized producers. "With four major speaker lines, you wouldn't have the variety you have now. Only the high selling speakers could make it. The little niches in demand wouldn't be filled. Because there are some products large corporations just can't produce properly, there will always be room for manufacturers that can fill the small niches."

SOUND & COMMUNICATIONS

CLASSIFIEDS GET RESULTS

For rates and
information,
please call
(516) 334-7880

(continued from page 77)

with the frequency-shaped sound distribution and high power output handling capability of the compression-driver voice/tone products.

The UL-listed loudspeaker assemblies comply with the 1985 safety and performance standards for voice alarm communications and notification appliances for protective signalling. Suitable for application in retrofit and new construction projects, the assemblies fit standard four-inch electrical blackboxes.

The seven-inch (QVT Series) and seven-inch circular (RVT Series) steel grille are finished in baked white enamel to provide unobtrusive appearance when located in the public areas of hotels, shopping malls, transportation terminals, condominium hallways, or governmental buildings.

Circle 18 on Reader Response Card

EV XEQ-3 CROSSOVER WITH LINKWITZ-RILEY FILTERS

Electro-Voice has introduced its XEQ-3 crossover which features Linkwitz-Riley Filters and variable time delay.

According to Jim Long, EV's pro sound marketing services manager, the Electro-Voice XEQ-3 electronic crossover/equalizer uses precise filtering and accurate speaker system compensation to optimize performance in high-quality, professional sound systems. "The XEQ-3 incorporates fourth-order Linkwitz-Riley frequency dividing networks," Long said, "which offer two unique advantages over conventional, third-order Butterworth filters: greater out-of-passband attenuation (24 dB per octave) for better driver protection; and, zero lobing error for smoother overall frequency response."

The XEQ-3 also features variable time-delay equalizers on each output which compensate for different speaker mounting positions and phase responses to provide in-phase acoustic summing at the crossover frequencies.

Each output has an EQ section controlled by a plug-in module. The low EQ can be used as an infrasonic filter or for "step-down" operation of EV's TL bass speaker systems. The mid EQ and high EQ are designed to provide constant-directivity horn and driver equalization. Other features include a

(continued on page 81)

NEED

HEADPHONE AMPS



See us at Booth 105

Call
EDCOR
800 854-0259
800 523-2824 CA
714 863-1529

EDCOR 16782 Hale Ave. Irvine, CA 92714

Circle 234 on Reader Response Card

OWI

Think Small, Think Quick.

B A P - 1 0 0



See us at Booth 110

5W, 10W or 15W) and an input line voltage of 70.7V, nothing extra is necessary beside a screwdriver or possibly, a power drill. Needless to say, this aluminum die-cast model comes complete with a bracket and hardware. OWI also makes available the BAP-25 (with a 25V line).

Exercise sound judgement — investigate the BAP-100, BAP-25 and OWI's complete mini-speaker line, including the weatherized, outdoor BAW-50. The quicker the better.

Designed For Background/Foreground Music.
OWI INCORPORATED 1160 Mahalo Place., Compton, CA 90220, (213) 638-4732

Circle 218 on Reader Response Card

TUBE•TRAPS

CONTROL BASS ACOUSTICS



THE ONLY ACOUSTICAL TREATMENT SYSTEM

- Broadband, Effective 400 Hz. Thru 40 Hz
- Corrects Low End Phase Distortion
- Damps Standing Wave Room Resonances
- Reduces Room Resonance "Q" Response By 4
- EQ's Low End RT-60 Decay Constants
- Packs 15 Sabines Absorption Into Each 3' Tube
- Midrange, Adjustable Diffusion
- Light Weight, Sturdy and Very Portable
- Versatile, Pressure Zone Bass Trap or GOBO

1-800-ASC-TUBE

ASC ACOUSTIC SCIENCES CORPORATION

P.O. BOX 11156 EUGENE, OREGON 97440

Circle 204 on Reader Response Card

DELTA COM 2600 School & Institutional Intercom Systems



- Solid State/Modular Design
- Dual-Channel Capability
- Two-Channel Telecom Option
- Selective Time-Tone Option
- Includes AM-FM Cassette
- Lightweight — Small Size
- No Hidden Extras—Completely Factory-Assembled

U.L. LISTED

DELTA COMMUNICATIONS, INC.
7852 78th Avenue SW
Tacoma, WA 98498
(206) 582-2201

Dealer Inquiries Welcome

Circle 216 on Reader Response Card

Oaktron Mourns William Rollins

William L. Rollins, president of the loudspeaker manufacturing firm Oaktron Industries, Inc. of Monroe, WS, was killed in an automobile accident in Beloit, WS, on March 13. He was 77. Mr. Rollins, an industry leader, was known for his contributions to loudspeaker design, his dynamic personality, and a life-long love of music.

Jerry Disch, an Oaktron salesman, said of Mr. Rollins: "The margin between honest and dishonest, good and evil, has grown a bit tougher with Bill's passing. But because of his positive influence on people, that margin is wider today than it would have been without him."

An innovator in the loudspeaker industry, Mr. Rollins developed higher-strength speaker lead wire. Oaktron was the first manufacturer to produce an aluminum voice coil.

Mr. Rollins, the son of Mormon homesteaders, grew up on his parents' ranch in Lymon, WY. Starting at the age of five, he sang in school musical productions. In 1929, Mr. Rollins moved to Chicago to study voice. For the next four years, he toured the country with several professional singing groups.

It was on one such tour that Mr. Rollins discovered the Monroe, WS, area where he would later found Oaktron Industries. In 1930, he sang at the Green County Fair as a member of the Scotch Highlander Band. He liked the area so much that he later chose it as the base of Oaktron Industries.

In 1933, after a dispute with a booker, Mr. Rollins took an assembly line job with Utah Radio Products of Chicago. He then worked with several other Chicago-based companies related to the loudspeaker industry. In 1936, at Ariston Manufacturing Co., Mr. Rollins developed a new speaker lead wire that lasted 10 times as long as previous wires.

During Mr. Rollins's 16-year tenure with Crescent Industries of Chicago, that company grew from 10 to 1,500 employees.



In 1954, Mr. Rollins founded Oaktron Industries with a staff of four. Now a major employer in Monroe, WS, Oaktron has manufactured a wide variety of loudspeakers, including those used in Boeing 747 aircraft, nuclear submarine conning towers, and lunar spacecraft.

Mr. Rollins served as the president of the American Loudspeaker Manufacturers Association in the 1970s. Long an advocate of protecting American manufacturers from foreign competition, Mr. Rollins is credited with coining the phrase, "Buy American, the job you save may be your own." Mr. Rollins attributed Oaktron's success to producing specialized speakers for areas of the market overlooked by foreign speaker manufacturers.

Mr. Rollins never lost his love for music. During Christmas season, he would often sing carols to his employees over the intercom at Oaktron headquarters. In 1978, he recorded an album *I Love Life*, which reflected his optimistic outlook.

Mr. Rollins is survived by his wife, Margaret, and their daughter, Mabel Copley. Ms. Copley was elected president of Oaktron at a March 7 board of directors meeting. She said, "Oaktron's longstanding tradition of supplying quality and service to the industry will continue."

Sound & Communications

(continued on page 79)

level display for optimizing dynamic range, and a level control, polarity reverse switch, and mute switch for each output. The XEQ-3 mounts in one EIA rack space and is supplied with a smoked acrylic front cover to prevent uninvited control adjustment. The XEQ-3 is available at a pro user net price of \$695.

Circle 17 on Reader Response Card

BOZAK FEATURES INDOOR/OUTDOOR SPEAKER

Bozak, Inc. is offering a professional speaker system designed to provide broad coverage. According to Bozak, its usage is not limited by physical obstructions which prevent large clusters or vertical units from being used. Broad horizontal coverage is assured in low-ceiling structures, indoors or outdoors. Stage applications are possible, since the low profile and wide pattern enable a variety of installation possibilities.

The same peak-free response delivered by the Bozak CM-209-18 vertical system is incorporated into the CM-209-16CH. Thus, freedom from feedback without additional electronic

devices is characteristic of these speaker systems. The patented aluminum cone designs and carefully selected transducer assemblies enable continuous outdoor usage unaffected by the elements. A uniform polar pattern is produced by four short vertical arrays arranged in an arc. Each array is a two-way system comprised of an aluminum Curvilinear® design cone low-frequency driver, and three aluminum cone Bozak high frequency units.

The enclosure is constructed of weather-proof plywood and water-proof adhesives, and is finished in lacquer enamels. The grille is made of heavy gauge perforated steel for maximum protection.

Circle 19 on Reader Response Card

RAYMER ADDS PRODUCTS INTERCONNECT LINE

Cetec Raymer has announced the addition of three new products to its expanding line of interconnect accessories designed for interfacing of telephone systems to voice paging equipment.

Model TSA Telephone Station Access paging adaptor allows station access from a PABX, or Centrex CU, to a paging amplifier. Phone line powered, Model TSA connects via standard modular jack to a dedicated station line in place of a telephone instrument.

Model TAP Trunk Access Paging adaptor provides access to a paging system from Centrex CO, PABX or PBX, using rotary or tone instruments. Operates on 120 VAC, 50/60 Hz.

Model TRG Telephone Tone Ringing Generator produces bell-like warble tone in cadence with ringing voltage present on the phone line. No other power source required. Connecting TRG output to an input of a paging system allows speakers to serve as ringing source in place of mechanical ringers.

Circle 20 on Reader Response Card

**SUBSCRIBE
TODAY**
by using the
enclosed
Subscription Card

Bozak®

MONITOR SYSTEMS

- EXCELLENT DETAIL
- HIGH POWER CAPACITY
- SPUN ALUMINUM CONES
- PEAK FREE RESPONSE

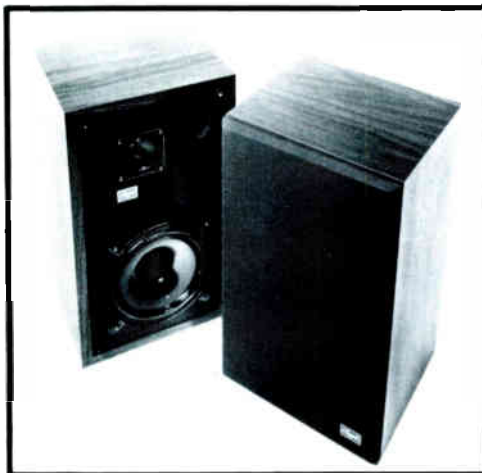

- STAGE
- STUDIO
- FOREGROUND
- BACKGROUND

Call for complete info on
Bozak Monitor Systems

326 South St., New Britain, CT
Phone: (203) 225-0555
Telex: 955439 INTL DIV

Bozak® INC.

Circle 269 on Reader Response Card

CLASSIFIEDS

RJ31X JACKS & CORDS
WIRE & CABLE
UL-PLENUM-FIRE
"B" CONNECTORS, TIE WRAPS
DRIVE RINGS & PINS
ARROW STAPLERS
FASTENERS
CALL TOLL FREE

cabletronix

800-431-WIRE (USA)
800-642-WIRE (NY)

Circle 271 on Reader Response Card

TIME SAVERS

- PUSH-PULL RODS Get Cable through tight places
- TEST SET. For the Audio Serviceman
- EASY KARY™ Wire Reel Holders 3 sizes
- SPEAKER SUPPORT TRUSS (T Bar Bridge)
Prevent ceiling sag. Speed Installation
- SPEAKER GRILLES For 8" Speakers
- EXTENSION CORDS 3 ft. and 10 ft. U.L. Listed

CALL WRITE - 30 DAY FREE TRIAL
Tex. Call Collect (214) 946-8450, All Other 1-800-527-1522

INSTALLATION & SERVICE AIDS

Circle 272 on Reader Response Card



SESCOM, INC.
1111 Las Vegas Blvd. North
Las Vegas, NV 89101 U.S.A.

"the audio source" FOR ALL OF YOUR AUDIO NEEDS
CALL OR SEND FOR A COPY OF OUR CATALOG
CATALOG REQUESTS & ORDERS: (800)834-3457
OTHER BUSINESS: (702)384-0993 TWX (910)397-8998

Circle 273 on Reader Response Card

Franklin TIME SYSTEMS



- COMPLETE**
- TIME SYSTEMS
 - MASTER CLOCKS
ELECTRONIC
 - PROGRAMMERS
ELECTRONIC
 - CLOCKS ANALOG, DIGITAL
SYNCHRONOUS 110 VAC AND
BATTERY QUARTZ CRYSTAL



TERRITORIES AVAILABLE
FOR DEALERS AND REPS.

Phone 215/355-7942
Franklin INSTRUMENT CO., INC.
TIME SYSTEMS DIVISION
P.O. Box 2949, Warminster, PA 18974

Circle 274 on Reader Response Card

POSITION AVAILABLE

Expanding metropolitan N.Y. area based electronics company seeking experienced Sales Managers, National and Regional. Must be experienced selling professional and consumer electronics to music, professional and audio accounts. Heavy travel. All replies confidential. Send resume with salary history to:
Sound & Communications
Box 1N
220 Westbury Ave.
Carle Place, NY 11514

Circle 275 on Reader Response Card

**Background Music for
SCA-CATV-Telephone
BGM INTERNATIONAL**
A Division of
F. T. C. BREWER COMPANY
P.O. Box 8057
Pensacola, Florida 32505
904 433-7932

Circle 276 on Reader Response Card

Current Cable Company, Inc.

1801 W. Diversey Parkway
Chicago, IL 60614
Suppliers of quality sound, intercom
and telephone cable.

For Prompt service call Toll Free
1-800-821-2432

In Illinois: 312-472-7790

Circle 277 on Reader Response Card



Electrical Wire & Cable
Lorum Street, Tewksbury, Mass 01876

Tel: (617) 851-4541

Manufacturers of quality sound & communications cable.
Stock & price list mailed on request

Circle 278 on Reader Response Card

FREE 32pg Catalog & 50 Audio/Video Applic.

Stereo Mono Pwr Amplifier
PWR SUPP EQ
PHONO, MIC, TRANS, ACR, TAPE VIDEO, LINE OSC
8-in 2-out 12-in 4-out 16-in 4-out
Video & Audio Dist Amps, TV Audio & Recd Prod Consoles

OPAMP LABS INC (213) 934-3566
1033 N Sycamore Av LOS ANGELES CA, 90038

Circle 279 on Reader Response Card

REGIONAL SALES MANAGERS Commercial & Pro Audio

- Eastern U.S.
- Central U.S.
- Western U.S.

As the result of increasing demand for our innovative products, Panasonic Industrial Company is undergoing accelerated growth in major U.S. markets. This has created key opportunities for dynamic Regional Sales Managers in select areas.

OPENINGS EXIST IN THE EASTERN, CENTRAL AND WESTERN TERRITORIES FOR RESULTS-ORIENTED PROFESSIONALS

You will work with our manufacturers rep organizations, recording and broadcast dealers, sound reinforcement, sound contractors, and MI distributors, while assuming the responsibilities of sales administration. Oversee and conduct effective product demonstrations and instruct potential users, dealers and reps. Must be capable of integrating audio and video sales.

Qualified professionals will have a proven record of achievement in professional audio sales and sales administration, encompassing directing independent manufacturer representative organizations and selling to dealers.

These positions command excellent compensation packages along with the opportunity to make a significant impact within a major market territory. For immediate consideration, please forward resume, including salary history and territory of interest, in confidence, to: Panasonic Industrial Company, Personnel Dept., Attn: PAW, 6550 Katella, Cypress, CA 90630.

Panasonic® Industrial Company

Circle 210 on Reader Response Card

CLASSIFIEDS

- Regular Classified—\$52 per column inch.
- Marketplace Display—
25 percent off rate card (up to 1/3 page).

Classified listings are accepted up to the
25th of the month preceeding publication.

Name _____
Address _____
City/State/Zip _____
Telephone _____
Credit Card # _____

Check Heading You Want

- SERVICES MISCELLANEOUS
- FOR SALE SITUATIONS WANTED
- FOR RENT HELP WANTED
- BUSINESS OPPORTUNITIES

Please send copy & payment to:
Sound & Communications Classifieds
220 Westbury Avenue Carle Place, NY 11514
TELEPHONE: (516) 334-7880



THE FUTURE IS... SOUND



Altec Lansing manufactures audio equipment using a total concept for fixed installations. We interact with sound design professionals to produce superior systems with the flexibility to meet the most complex specifications. The Professional Sound Contractors who are members of our worldwide sales and installation network transform our concepts into reality. Acoustical Consultants, Sound Design Engineers and Sound Contractors the world over have worked together to design and install Altec Lansing sound systems. They've specified Altec Lansing because of our uncompromised quality and dependability. From stadiums, convention centers and warning systems to theaters, churches and teleconferencing suites, professionals whose reputations depend on every installation have made us the premier supplier to our industry. Fixed installations are our only business. We've dedicated our 50 years of expertise in support of the Professional Sound Contractors and Consultants who rely on Altec Lansing equipment to meet the most exacting standards of audio reproduction. As a result, our systems have been selected for many of the most sophisticated installations in the world. We're proud of our image as a leader in our industry. And we realize much of the credit for our recognition is a reflection of the confidence sound system professionals have had in our products. Together we've built a sound foundation for the future.

Altec Lansing Takes The Words, The Emotions, The Music Of Man And Projects Them To Mankind.



a **gulton** company See us at Booth #15

Circle 203 on Reader Response Card

The world's first ^{and best selling} unidirectional surface-mounted condenser mic.

Clean and simple.



No carpet strips or plastic baffles needed. Until now, all surface-mounted mics have been omnidirectional. Trying to add directionality has required a lot of busy work. The new SM91 brings the big advantages of unidirectionality to boundary effect microphones by incorporating a condenser cartridge with a half-cardioid pattern that isolates the speaker from surrounding noises.

The new smoothie. The sleek SM91 delivers wide-band, smooth response throughout the audio spectrum, while greatly reducing the problems of feedback, low-frequency noise and phase cancellation.

Low visibility, high versatility. The SM91 is an excellent mic for meetings and conference rooms. It also does a great job of isolating a vocalist or instrument

in musical applications. And it's the ideal mic for live theater.

A preamp ahead of its time.

The ultra-low noise preamplifier provides switch-selectable flat or low-cut response, excellent signal-to-noise ratio and a high output clipping level. A low-frequency cutoff filter minimizes low-end rumble—especially on large surfaces.

If you're going omni. Our new SM90 is identical in appearance to the SM91 and just as rugged.

For more information or a demonstration, call or write Shure Brothers, Inc., 222 Hartrey Ave., Evanston, IL 60202.

(312) 866-2553. **SHURE®** BREAKING SOUND BARRIERS

See us at Booth A