

SOUND & COMMUNICATIONS

FOR CONTRACTORS, SYSTEM MANAGERS, AND SPECIFIERS

FEBRUARY 1986

ICIA '86
NATA & '85
Convention Reviews

BROADCAST WHAT'S IN IT FOR YOU?

SGND2MBAL5000 • AAO 01 000MAY86*
MARK GANDER
JBL INCORPORATED
8500 BALBDA BLVD
NORTHRIDGE CA 91329

Mail
Technology
How to be a SHARP salesman



NEW WAVE DESIGN

Blocking the Incoherent Wave

Cast into the throat of every **TransPlanar™ HP horn**, unique beamwidth control vanes represent a revolutionary advance in constant-directivity design. Until now, two-inch-throat designs were compromised by on-axis dropout. Intrigued with this curious problem, EV engineers applied principles of geometric optics to isolate the incoherent waveform responsible for this phenomenon. Instead of coursing down the horn in an organized fashion, this offending wave reflects off the walls of a two-inch throat, shadowing direct output and causing a loss in level. Ray analysis was used to predict this occurrence and determine the exact configuration of slotted waveguides which block the cancelling wave and eliminate on-axis dropout.

Acting together with an optimum diffraction slot, the beamwidth control vanes also eliminate both horizontal and vertical beaming in the very highest octave. Other two-inch-throat designs exhibit narrowing of the coverage angle above 10,000 Hz. But the new HP horn maintains uniform dispersion to 20,000 Hz!

When Electro-Voice invented the constant-directivity horn in 1972, we really started something. Now we're making waves again . . . introducing second-generation CD design with the most uniform beamwidth control in the industry. To learn more about the new HP horn or the high-performance DH-1 and DH-2 two-inch-exit drivers designed especially for them, contact Pro Sound Marketing at Electro-Voice, 600 Cecil St., Buchanan, MI 49107. **We'll be glad to tell you why when the competition beams, we just smile.**

Reader Service #236



EV Electro-Voice®
SOUND IN ACTION™

ONLY ONE INTERCOM SYSTEM IS BUILT TO 911 EMERGENCY STANDARDS.

When it comes to public safety, communications can be the difference between life and death. That's why more and more major cities—Miami, Baltimore and Rochester, to name a few—have chosen the speed and reliability of Ring's advanced emergency 911 communications systems. The same performance available to you in Ring-Master™ intercom systems, designed for the widest variety of applications in business, institutions and government.

Ring's advanced microprocessor-based design allows you to integrate hands-free intercom, public-address, security and fire

alarm—even remote access and other control functions—into a single, highly-efficient, flexible system.



**Ring-Master
Desk/Surface-Mounted Station**

One that incorporates more than three dozen advanced features to help save time and money, while dramatically increasing productivity throughout any facility—including built-in links to telephone systems, radio and voice paging systems.

Whether you're modernizing an

existing facility or building a new one, let Ring show you how to economically combine maximum flexibility with maximum efficiency.

Return the coupon for more information. Or better yet, give Ring a ring.

CALL TOLL FREE 1-800-645-9690



230 Community Drive
Great Neck, New York 11021
Call Toll-Free 800-645-9690;
in NY Metro Area, 516-487-0250;
Other offices in California, Canada and Mexico
•Ring-Master™ Tridex™ All-Electronic Intercoms
•Automatic Call-Distribution Systems
•911/Emergency ACD•Ring 3000 School System
•Scanpager™

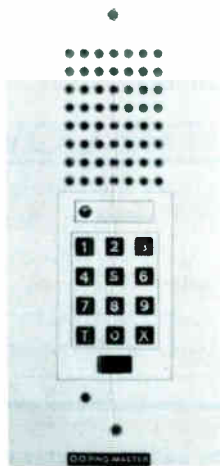

**Ring Flush-Mounted
Wall Station.**

Reader Service #252

I'd like to know more about Ring's advanced, versatile communications systems.

Name _____
 Title _____
 Company _____
 Address _____
 City _____ State _____ Zip _____
 Telephone (____) _____
 Applications _____

Ring Group of North America
230 Community Drive, Great Neck, NY 11021
© 1985 Ring Group of North America, a wholly-owned subsidiary of Scanvest Ring A/S S&C 286

SOUND & COMMUNICATIONS

FEBRUARY 1986

Volume 32 #2

FEATURES

BROADCAST BOOM

14

Broadcast consultant, Jim McDonald, reports on the developments in the broadcast industry during the 1980s. AM stereo, digital audio, LPTV, and stereo TV are among the new advances which, combined with the FCC's new regulation posture, have opened up a whole new area of business for the contractor in the local market.

INTERCOM TECHNOLOGY OUTLOOK

20

Four intercom manufacturers discuss the state of intercom technology today and what they see in the future for this area of the sound and communications industry. Draw your own conclusions.

VOICE MAIL

28

Writer Greg Prince's look at the emerging voice mail market demonstrates how a sophisticated message system can save large and small businesses substantial time and money. This translates to profits for the right contractors.

COLUMNS

IDEAS & VIEWPOINTS

6

This month Sound & Communications has a guest editorial by Ron Rosen who makes a strong stance in defense of the microprocessor.

SALES & MARKETING

10

Are salespeople born or made? Tom Giacobello discusses both types of salespeople and offers guidelines for maximizing your sales potential.

THEORY & APPLICATION

12

Bruce Bartlett of Crown International takes a look at the evolution and application of directional boundary microphones.

CONVENTION REVIEW

32

In December it was NATA's Convention & Showcase, in January it was ICIA's Commtex International. A wrap up of both conventions are reviewed here by *Sound & Communications*.

DEPARTMENTS

NEWSLETTER 8

PRODUCTS IN REVIEW 35

A CLOSER LOOK BY GARY D. DAVIS . 36

SUPPLIES/SUPPORT/SERVICES 39

FACES AND PLACES 40

REP NEWS 41

AD INDEX 42

DATAFILE 44

BOOK REVIEW BY TED UZZLE 45

DATEBOOK 47

CLASSIFIEDS 50

ON THE COVER

On February's cover is the broadcast studio at WHLI-AM stereo in Hempstead, NY. AM-stereo is just one of the recent developments in broadcasting which may offer new opportunities to the sound contractor. (See story page 14.) Photo by Doug Hanewinkel.

combining **SOUND MERCHANDISING & MODERN COMMUNICATIONS**

FOUNDED 1955

© **SOUND & COMMUNICATIONS PUBLISHING, INC.**, 1986. Reprint of any part of contents without permission forbidden. Titles Registered in the U.S. Patent Office. Sound & Communications (U.S. P.S. 943-140) is published monthly by Sound & Communications Publications, Inc., 220 Westbury Ave., Carle Place, N.Y. 11514. 516-334-7880. President, Vincent P. Testa. Subscription rates: U.S.—3 years \$37.50, 1 year \$15.00. Canada and Mexico—3 years \$48.00, 1 year \$18.00. Foreign and South America—1 year \$25.00. Second Class postage paid at New York, NY and at additional mailing office. Postmaster: If undeliverable notify on Form 3579 address correction.

STAFF

Editorial Director

CHRIS FOREMAN

Managing Editor

NANCY PETERSON

Senior Editor

ELLIOT LUBER

Editorial Assistant

MARY PAT O'CALLAGHAN

Consulting Editor

JEROME J. BROOKMAN

Contributing Editor

GARY D. DAVIS

Contributors

**BRUCE BARTLETT
ROBERT S. FISHER
TOM GIACOBNELLO
JIM McDONALD
JIM MORRISON
GREG PRINCE
RONALD J. ROSEN
ROBERT T. SHIPLEY
JIM SMALL
TED UZZLE**

Production Manager

SUSAN POWER

Art Director

KARLA TONNING

Production

**BONNIE BRENNAN
BETH CHARNEY
BILL-LEE ITHIER
WILLIAM MONCURE
KAREN WENNISCH**

Illustrator

STUART WEISS

Typesetting

**GEORGE PROPER
DAVID SCHMIDT**

Circulation Director

DENISE RIGOPOULOS

National Advertising Sales Manager

CLIFFORD CAPONE

West Coast Sales Manager

JAY S. MARTIN

President/Publisher

VINCENT P. TESTA

Editorial And Sales Offices

**Sound & Communications
220 Westbury Avenue
Carle Place, New York 11514
(516) 334-7880**

Advertising/West Coast

**15532 Cohasset St.
Van Nuys, CA 91406
(818) 904-9669**

Circulation audited by

Verified Audit Circulation Corp.

VERIFIED
AUDIT CIRCULATION

TESTA
COMMUNICATIONS
INC.

Sound & Communications • Music & Sound Output
The Music & Sound Buyer's Guide • Post
CES-TV News • NAMM-TV News • The Daily
The Music & Sound Electronics Retailer
Home Entertainment Magazine

Professional VHF Wireless for \$**900** Under



Rock and Roll or Rock of Ages—the pulpit or the Palladium... Whether you need a dynamic handheld for the stage or a miniature lapel mike for your church, Telex has an affordable single antenna wireless mike system that will fit your needs.

Telex FMR-50 systems have most of the high performance features of the more expensive top-of-the-line wireless microphones and provide a much clearer, stronger and better-sounding signal than competitive units.

All-important dynamic range is greatly enhanced because of the system's unique COMPANDER circuit. A special circuit at the transmitter takes the full dynamic range of the audio, compresses it to RF transmission limits, then restores it to its full strength at the receiver. The result is a full dynamic range with greatly improved signal-to-noise ratio.

Because it operates on high band VHF frequencies there is no danger of picking up interference from low band channels such as CB, cordless telephones, garage door openers and electric toys. And, Telex offers a FREE computerized service to assure the selection of an interference-free frequency based on known channel allocations in each operating area.

To read more about why this improved technology transmits a high quality signal over longer distances, write to: Telex Communications, Inc., 9600 Aldrich Ave. So., Minneapolis, MN 55420.

For quick information, call toll free

800-328-3771

or in Minnesota call (612) 887-5550.

TELEX[®]

TELEX COMMUNICATIONS, INC.

9600 Aldrich Ave. So. Minneapolis, MN 55420

IED'S
SMART ELECTRONICS
SOLVES
COMPLEX AUDIO
DISTRIBUTION
PROBLEMS

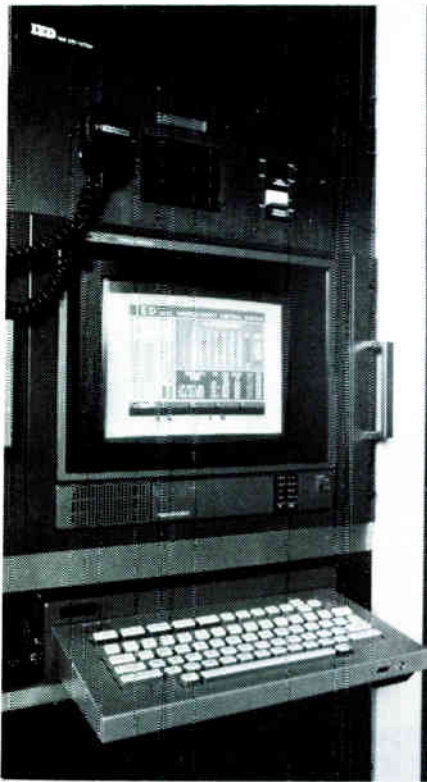

Innovative Electronic Designs Inc.

is the leader in the industry using digital logic and a **MICROCOMPUTER** with **NON-VOLATILE MASS STORAGE** to control all phases of audio system operation

Typical IED systems are installed at LAX International Air Terminal, the Hoosier Dome in Indianapolis, and Ocean Center in Florida.

IED also has designed and manufactures the **only AUTOMATIC MIXER** in the industry using "**SMART ELECTRONICS**", plus a full line of **BUILDING BLOCK** audio distribution cards.

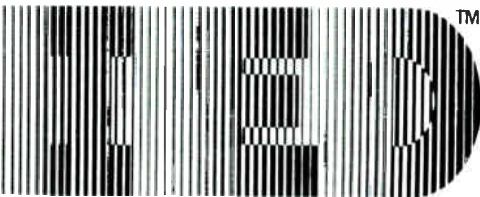

To become an

AUTHORIZED IED CONTRACTOR

Contact Tom Roseberry
Innovative Electronic Designs Inc.
9701 Taylorsville Road
Louisville, KY 40299
(502) 267-7436

IDEAS & VIEWPOINTS

Guest Editorial

IN DEFENSE OF THE MICROPROCESSOR

*Ronald J. Rosen
Manager, Engineered Systems Division
New England Sound & Communications, Inc.*

Since health care communications is an important part of our market here in Central Massachusetts, I read with interest your article, "Monitoring The Nurse-Patient Communications Market," which appeared in the December issue.

I found this to be an excellent article which published the view-point of several different manufacturers in order to be as objective as possible. I feel compelled to comment however on the statements made by Kelsey Page, sales manager for Crest Products regarding microprocessor-based nurse call systems.

Quoting Mr. Page, "Who needs all that stuff?" Beats me, certainly not anyone who is satisfied with 30-year-old electro-mechanical technology. You state that smaller facilities generally don't need two-way voice communications, and prefer responses to be in person. True, some facilities choose to operate in that fashion—albeit a small minority—so don't use the audio, walk if you must and if you have the excess staff to dispatch on every simple patient request. If the system has audio, when either state regulation or a change in administration mandates two-way communication the customer is not facing a major expense in removing the visual-only system. Tight budget or not, most contractors would agree that with the exception of an I.C.U., C.C.U., or Code System, we do the customer a disservice by recommending a visual-only nurse call system.

"If you have a computer related system and the central brain goes out, you're out of luck," Page said. He further pontificates that any glitch or electrical surge could make the system dysfunctional, and if one is to find oneself in Bohonk, Kansas, chances of finding someone out there to service the system are slim.

Kansas has come a long way since Dorothy got whisked away to the Land of Oz. Only in the town of Bohonk will you find an electronic technician in bib overalls that watches a black-and-white T.V., winds a mechanical watch and listens to 8-track tapes in his 1950 Terraplane.

The technician that carried relays and switches now carries the correct board assemblies when servicing a microprocessor-based system. Troubleshooting is often simplified with on-board diagnostics and board level servicing. If an electrical surge makes the system dysfunctional, better seek a new manufacturer with better regulation on their power supply.

Forgive me, Mr. Page, I am not really picking on you, only on that type of antediluvian thinking that impedes our industry growth. I am not a newcomer in this business and have installed many electro-mechanical systems as early as 1963. The new generation hospital communication systems do away with the troublesome mechanical switches and frame relays, the membrane touchpad eliminates severe damage to the master station when liquids are spilled—(Ask any nurse, it happens often enough.)—conserves valuable space, and in general "does more—costs less."

Computers and microprocessors are here to stay. They are a part of our daily lives and perform wondrous tasks in our televisions, calculators, watches, autos, dishwashers, and microwave ovens.

(continued on page 49)



Total communications control that's easy-to-use, easy-to-install, easy-to-maintain and impossible-to-beat.

NEW COMMUNITEL 2[®] **Administrative Communication System**

Now administrators in schools and other facilities can get information faster, issue instructions instantly, control emergencies more effectively. Bogen's COMMUNITEL 2 system gives them two-way voice communication with each other and with all staff members.

Heart of the system is a card cage containing plug-in microprocessor circuit cards which control all operations.

Modular design lets you start with just the facilities needed now, expand later if requirements grow. Up to 50 administrative and 400 staff stations can be included in a system.

Multiple conversation paths permit simultaneous conversations. Advanced technology makes COMMUNITEL 2 fast, versatile, dependable.

Emergency calls take priority over routine calls. They

are announced by a distinctive tone signal and the word "HELP" appearing on all digital displays, along with the number of the station originating the call.

Callback review. Administrators also can use their displays to review unanswered calls in the system's memory, return them in any order or automatically, in sequence.

Field-programmable features include architectural dialing (no directory needed), interconnect to outside telephone lines, emergency paging, six-zone paging, alarm signalling, executive priority (interrupt or join a conversation), and many more. You assign them to the desired phones.

Built-in diagnostic software simplifies maintenance. For more details on these state-of-the-art, cost-effective, COMMUNITEL 2 systems, call or write the one to watch in communications:

 **BOGEN[®]**
A LEAR SIEGLER COMPANY
P.O. Box 500, Paramus, NJ 07653
(201) 343-5700

Reader Service #256

World Radio History

SONY HIRES AWAY STUDER DIGITAL EXPERT ROGER LAGADEC

Dr. Roger Lagadec, one of the world's leading digital audio researchers and director of product development for Willi Studer, AG of Regensdorf, Switzerland for the past six years, a co-author of the Digital Audio Stationary Head (DASH) format specifications, has left Studer to assume the position of general manager, technical management for Sony Communication Products Group, it was announced by group senior general manager Shiro Koriyama. Lagadec, who worked closely with Sony and Matsushita on the DASH digital format negotiations, will be responsible for forming engineering strategy, developing industry relationships, standardization, and some direct research and development concerning pro audio and video related products. A spokesman said the change will not affect the company's production schedule or long-term goals.

JBL TO DISTRIBUTE SOUNDCRAFT PRODUCTS IN U.S.

Soundcraft Electronics Limited, a British-based manufacturer of audio consoles, has appointed JBL Professional to become the exclusive U.S. and Mexico distributor of Soundcraft products, effective January. According to a joint statement from Soundcraft chairman and managing director Philip Dudderidge and JBL president Ron Means, Soundcraft U.S.A. will be a separate division within JBL Professional. Under the direction of Means, the statement said, Soundcraft will continue to operate from its current Santa Monica offices. Wayne Freeman will remain with Soundcraft U.S.A., to head sales and marketing efforts.

TANDBERG REORGANIZATION RESULTS IN U.S. MANAGEMENT AND NEW PRODUCTS

Tandberg of America, Inc. has been reorganized as Tandberg Audio, a new company. This reorganization is the most significant event in Tandberg's 54-year history, as it brings American management and marketing skills together with the European company's engineering and production capabilities. Tandberg will maintain its R&D and production facilities in Oslo, Norway, all operations will be directed by the Armonk, NY office. One benefit of the reorganization is the expansion of the existing line of high fidelity products. Four new products were introduced at the January Consumer Electronics Show. Among them was its first CD player and a high current/high power stereo amplifier. In related news, Stanley Wulc has been named chairman and CEO of Tandberg Audio.

SALARY LEVELS IN TELECOM INDUSTRY HIGHEST IN WEST AND MOUNTAIN

Overall telecommunications salary levels are averaging highest for technical and engineering personnel in the West and Mountain regions of the country, and the lowest in the Southwest, according to a survey released by the NATA's Human Resources Council. The survey report entitled Compensation and Benefits Practices, 1985: A Survey of the Telecommunications Equipment Industry. Technical and Engineering Personnel, details wages and benefit levels for nationwide field technicians, bench technicians, and engineers. The largest single source for salary increases for the year ending May 31, 1985 was merit increases. The increases were largest in the smallest firms and smallest in the largest firms. Generally all firms paid all or almost all of their employees' insurance premiums for health, income

disability, or life insurance benefits. Copies of the report are available through NATA, 2000 M St., Suite 550, Washington, D.C. 20036; (202) 296-9800.

STUDY REPORTS HEALTHY MARKET FOR COMPUTER EQUIPMENT IN HOSPITALS

In response to new Medicare reimbursement procedures and increasing financial pressures, hospitals are trying to cut costs and increase services. One way they are doing this is through computerizing their operations. A new Frost & Sullivan study forecasts total sales for all information processing products and services to hospitals in 1990 will reach \$6.7 billion, a healthy increase over 1984's \$2.2 billion market. This expansion is expected to include not only financial and administrative areas, but also delivery of care. This 282-page study not only forecasts the market through 1990 but also describes the types of hospitals by size, legal structure, and financial structure that make up the market for hospital technology products.

UHER TO MORE ACTIVELY MARKET TO SOUND CONTRACTORS AND PRO SOUND

Uher of America, having reestablished itself in the U.S. a year and a half ago, plans to more actively market its products to sound contractors, AV customers, law enforcement organizations, the educational market and to other industrial, governmental and commercial users. Heading the offices in suburban Los Angeles are John A. Belgiorno, president and George A. Rose, vice president of marketing. "We have been in pro sound in the past. Our expansion is with additional high quality audio recording equipment to meet the needs of the professional," according to Belgiorno.

NEW REGIONAL NATA SHOW SLATED FOR SAN FRANCISCO, CA, IN JUNE 1986

The North American Telecommunications Association announced that it will conduct a new regional trade show in San Francisco, CA, from June 25 through 27, 1986, at the Moscone Center. The show will be called NATA-West, and will concentrate on bringing together telecommunications and data buyers from the states of California, Oregon, Nevada, and Washington. "Like the past annual showcases, NATA-West will make new strides in both wholesale and retail distribution of telecommunications, data, and computer products, including the means of connecting all these technologies," said Ed Spievack, NATA president. He reported that attendance at NATA's annual showcase has increased by 14 to 22 percent in each year over the past five years. "We expect this growth experience at San Francisco and, on that performance, project that 8,000 people will register for the NATA-West in June." NATA-West will focus users on the means of connecting technologies to accelerate growing trends towards office automation.

NUMARK ELECTRONICS EXPANDS AND MOVES WEST COAST OFFICE

Numark Electronics Corporation has moved its West Coast office and warehouse to a new and larger facility, according to Paul Friedman, national sales manager. The new address is Numark Electronics Corp., 4486 Runway St. P.O. Box 3180, Simi Valley, CA 93063. Headquarters remain at Raritan Center in Edison, NJ.

A SALESMAN IS BORN

by Tom Giacobello

Trainee: "Gee, isn't that Les Getum a sharp sales person?"

S/M: "Yeah, like a cat—good reflexes. She knows when to close."

Trainee: "But how does she do it?"

S/M: "Harumpf. Well, that's what you'll be learning. Then you can make the big bucks!"

All too often, this is a common scene in sales offices across the country. The trainee has done everything he or she was told to do: the prescribed number of prospecting calls were made; the exact number of qualifying appointments were set; and the right number of follow-up calls and demonstrations

greater sales results. Perhaps, just working harder *isn't* the only answer.

Trainee: "But coach, if it's all in the numbers, I should be Number One in the office."

S/M: "Sometimes, Workalot, you have to face the fact that there are *born salespeople* in this world. But maybe you can become one, if you work hard enough."

One answer to the trainee's question, "How does she do it?", can be found in the seminars, video tapes, book, pamphlets, hints, tips, and legends that abound in the sales lexicon. But another answer appears more obvious and apparent; in fact it came from the trainee's observation—"Les Getum is a sharp salesperson."

Sharp is the one characteristic we often attribute to a successful salesperson. Yet, we attempt to explain what *sharp* is with vague catch-all descriptions that still leave our trainee mystified on how Getum does it. We'll say she is sharp because: she's always on the prowl for a hot new prospect; she smells a sale; she pounces on a buying signal; she is a tiger during a presentation and a real bear when something or someone doesn't measure up to the prospect's specs. Young Workalot knows that simply performing as a functionary and working with intensity won't always qualify one for "Sharp Blood." Over some time, working hard will result in a degree of success. But if we eavesdrop on Getum, the office Sharpie, after a sale is made, we'll learn

what it was she looks for and capitalize on what facilitated her closing of the deal.

Beyond the proposal, the bottom line, the features and benefits, the bells, the whistles, and the social interaction, here are a few notes Workalot might have taken during just such a debriefing of Getum:

a) You have to *make a friend*—somehow, somehow, you and the prospect have to join forces. A small emotional surge or feeling of comfort will often mark this key moment.

b) Learn to *steal with your eyes*—that office decoration, Phi Beta Kappa Key, or framed fingerpainting by a three year old proudly displayed could point the way to the prospect's motivation for buying.

c) Look for a *change in facial muscles*—relaxing, smiling, lessening tension in the forehead or eyebrows, increased eye contact.

d) Look for *positive body language*—unfolding arms, opening clenched hands, unfolding legs, turning to face you more, a nod of the head, a knowing smile, the pen thrown down on the table in an accepting fashion.

e) Look for *unusual or thinking movements*—scratching the head, rubbing the chin, fussing with clothing, taking deep breaths, raising the eyebrows, tugging at an earlobe.

f) Look for a *change in attitude*—the prospect becomes friendly, becomes confused, begins laughing, becomes unsettled or nervous.

g) *Be watchful if the prospect re-examines the proposal,*

the sample, the order pad, the application.

h) Most often, the office Getum simply listens to the prospect who, if properly prompted, is happy to *share that other condition* for the sale.

Getum is revealing how to read the prospect and know when to go for the order of commitment. We can call this "street smarts" or a good sense of timing. The debate continues over whether this is a skill which can be learned and put into practice or an innate talent which has its roots in the intuition, background, and interpersonal skills the salesperson has developed.

Our trainee may be blessed with this innate talent or may need to spend many a gruelling post-sales session perfecting this skill with a manager/mentor attempting to figure out what was done right, exactly when and how it can be perfected in the future. However the birth of a salesperson occurs, it must be well noted that it occurs after the die has been cast and the commitment is made to be a success. From that moment on, whether an innate talent or an acquired skill, those sales techniques will develop the accolades *successful* and *sharp*. For Workalot to take heart, he need only remain committed to staying on the path to success. If studying Getum, the office Sharpie, is to prove of any value to Workalot, it will come from Workalot's own ability to generate questions.

Good luck, young Workalot, and most of all, remember to have fun.

"However the birth of a salesperson occurs, it must be well noted that it occurs after the die has been cast and the commitment is made to be a success."

were given that the manager and the book said would spell sales and success. Yet, the trainee can see Getum making less prospecting and sales calls and achieving

it's a whole new sound



the FD150 dual-channel
300-watt power amplifier

FOR *Rauland*
DISTRIBUTORS
ONLY

RAULAND-BORG CORPORATION • 3535 West Addison Street, Chicago, IL 60618-4289 • (312) 267-1300

In Canada: RAULAND-BORG (CANADA) INC • 6535 MILL CREEK DRIVE, UNIT 5, MISSISSAUGA, ONTARIO, CANADA L5N 2M2 • (416) 821-2225

DIRECTIONAL BOUNDARY MICS

by Bruce Bartlett
Crown International

The directional boundary microphone is a low-profile, cardioid or supercardioid microphone designed to be used on surfaces. It solves many sound-pickup problems, and has the additional advantage of being nearly invisible in use.

Here we'll explore the background and applications of this new tool, and describe an example of the technology. A directional boundary microphone may be the problem-solver you've been looking for.

Background

How did the need for such a microphone arise? A microphone placed near a hard reflective surface, such as a stage floor, picks up delayed sound reflections from the surface, as well as direct sound from the sound source. The direct and delayed sound waves combine at the microphone, where they interfere with each other. The resulting phase cancellations cause a series of peaks and dips in the frequency response—an unnatural, colored tonal quality.

Reinforcement of a stage play is a good example of the phase-interference effect. Footlight microphones mounted above the stage floor often reproduce a hollow, colored tone quality which varies as the actors move.

A solution to this problem was discovered in the early 1960s at Electro-Voice and Shure Brothers. If a microphone is placed on a floor, phase cancellations move very high in frequency, leaving a smooth response over

most of the audible band. The EV "Mic Mouse," a foam housing, was developed to mount a microphone horizontally next to a stage floor. The Shure S55P Low-Profile Microphone Stand has the same function.

Directional microphones (cardioids) can be placed near the floor with little loss in directivity, and so provide more gain-before-feedback than surface-mounted omnis. Consequently, floor-mounted cardioid mics have become accepted for reinforcement of stage plays.

Three problems remain, however. Most directional microphones are large in diameter compared to audio wavelengths, so phase cancellations still occur at high frequencies. The result is a dull sound. Second, some large-diaphragm microphones suffer from off-axis coloration. Third, conventional floor-mounted mics can be damaged by being stepped on or kicked.

Enter The Directional Boundary Microphone

Recently, miniature mic capsules have solved these

problems. In the new directional boundary microphone, the mic capsule is small enough to ensure phase coherency up to the highest frequencies in the audible spectrum, resulting in a wide, smooth frequency response free of phase interference. And since the capsule is small, the polar pattern is constant at all frequencies across a broad pickup angle. A microphone designed specifically for surface-mounting can be made to withstand being stepped on.

Currently, microphones of this type are made by Shure Brothers Inc. and Crown International. Here we will describe the Crown PCC™.160 microphone as an example of the technology.

Crown International applied its years of experience with boundary microphones (PZMs) in developing a surface-mounted microphone using a subminiature, supercardioid mic capsule. The product was dubbed the PCC-160 Phase Coherent Cardioid™.

Like the Pressure Zone

Microphone® (PZM®), the PCC-160 is designed to be used on a relatively large boundary surface.

Unlike the PZM, which picks up sound equally from anywhere around it, the PCC emphasizes sounds from the front and rejects sounds from the rear. The PCC's directional polar pattern also improves gain-before-feedback and reduces pickup of room acoustics and background noise. Surface-mounting creates a "half-supercardioid" polar pattern and increases directivity 3 dB.

The supercardioid pattern (Figure 1) was chosen because it provides more gain-before-feedback than a cardioid pattern, all else being equal.

Because the microphone capsule is placed on a boundary, direct and reflected sounds arrive at the diaphragm in-phase. This coherent addition of direct and reflected waves provides several benefits: microphone sensitivity increases 6 dB; signal-to-noise ratio increases 6 dB; and

(continued on page 48)

Figure 1

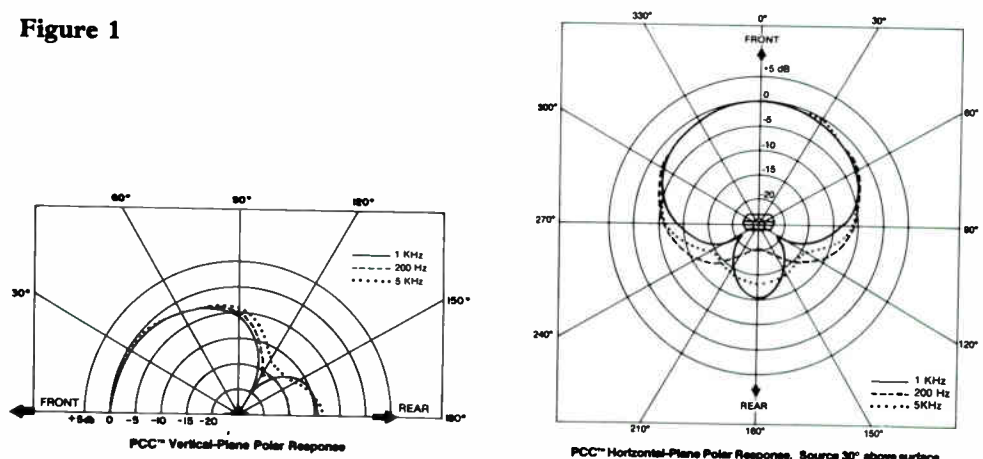

REVO- LUTION

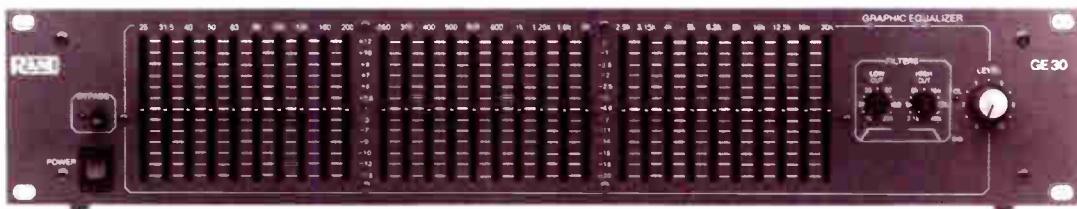

Prepare yourself. Graphic equalizers as you have known them are obsolete. Because Rane just rewrote the rules.

Introducing the GE 30, Rane's astonishing new Commercial Grade True 1/3-Octave graphic equalizer. The GE 30 is a new functional concept which allows one single model to provide all the capabilities that previously required two separate models.

It's the first graphic equalizer ever to let you switch from a +12/-15dB boost-cut mode to a 0/-20dB cut-only mode by simply pushing a button on the back. The first with 60mm sliders, for maximized resolution in a 3.5" format. And the first with a

user-switchable active direct-coupled or transformer-coupled complimentary balanced output configuration as a standard feature.

Using 2nd generation Constant-Q filters (developed by Rane), it provides all the proven advantages of constant bandwidth performance with even less overall ripple.

There's more, too, like built-in RFI filters and both 3-pin and barrier strip input/output terminations.

Check out the GE 30. After the revolution, it'll be your way of life.

Rane Corporation, 6510 216th Southwest
Mountlake Terrace, WA 98043. 206/774-7309.



Reader Service #251

World Radio History

BROADCAST BOOM

MTS, Digital Audio, & AM Stereo Spark Local Upgrade Market

by Jim McDonald
The Wind River Group,
Broadcast Consultants



Production facilities at KUSA-TV in Denver, CO, an ABC affiliate which broadcasts in stereo.

In what may become known as a decade of turbulence, the 1980s have seen massive changes in the technology and economics of American broadcasting. FCC technical and operational deregulation, multichannel TV sound, digital audio, AM stereo, FCC Docket 80-90, and LPTV (Low Power Television) have wrought many adjustments, some painful and some profitable for the industry—and for many equipment suppliers.

What do these changes mean to the industry? What do they mean to listeners and viewers—and what do they mean to suppliers of equipment and services? An overview of broadcasting's upheavals is certainly now in order as most of these changes have impact on the sound business.

FCC Deregulation

As government agencies sought to cut costs during the late Seventies, the FCC found several ways of reducing its involvement in the industry it was charged with managing. Historically, the FCC has exerted virtually total control over the broadcast industry, requiring much manpower and mountains of paperwork. In its efforts to

save money, the FCC allowed staff to dwindle, reduced paperwork requirements and decided to break tradition by allowing the industry's competitive pressures to regulate large areas of broadcasting—hence, deregulation.

FCC deregulation of the industry had several immediate effects. Maintenance, operating and program logging were no longer required. More commercials could be run per hour. And most recently, licensed operator, remote control, monitoring and audio "proof of performance" requirements were relaxed. At first glance, these last few changes would appear destructive to the technical quality of broadcast operations and indeed, in a few cases, they were. What was less known about deregulation was that the *FCC in no way relaxed the technical performance requirements*; deregulation affected only the *manner* in which the standards were to be maintained. Several large fines were levied against stations whose compliance had slipped and the industry was put on notice to prohibit deregulation from degrading technical quality.

One of the most profound effects of FCC deregulation has been to reduce

the number of fulltime staff engineering personnel at many operations. Indeed, many small rural stations have no engineer at all! Rather, the management pays a consultant to visit the station once or twice a month to inspect, adjust or repair the equipment as necessary. Of the 9,300 radio stations on the air in the U.S. today, about 50 percent are in smaller markets and may be in this position.

What does this mean to an equipment supplier? In attempting to get along without an engineer, the station will often look to local sources of supply for some of its audio equipment; vendors may be sought who will provide installation, warranty protection, and service. Consumer audio equipment which can be used for broadcast is the most likely candidate for vendor service; high-end cassette equipment. Manual turntables, audio amplifiers and speakers for monitor use and—most recently, compact disk (CD) players—are all candidates for delivery and/or installation by local sound equipment suppliers.

Multichannel TV Sound

In less than two years Multichannel



Engineer at KUSA doing production for a stereo TV broadcast.

TV Sound (MTS) has had an enormous impact on well over 200 TV stations and is now available in broadcast form to over half the viewers in America. Often called Stereo TV, there is much more to this technology than stereo. According to the FCC's March 1984 order, stations may transmit an aural carrier containing not only a stereo (L-R) subcarrier at 31.468 kHz, but may also use additional subcarriers within the aural baseband. The de facto standard for such subcarriers has become a second audio program (SAP) which is frequency modulated on a 78.67 kHz subcarrier and a professional use channel which is modulated on a 102.27 kHz subcarrier. The stereo and SAP subcarriers are locked to the horizontal scanning rate to eliminate any beat notes in these programs.

The audio in both the stereo and SAP channel is heavily compressed at the transmitter and correspondingly expanded in the viewer's set. Frequency response of the stereo channel is 50 to 15,000 Hz and that of the second audio program is 50 to 10,000 Hz. With the compansion and the methods of modulation, distortion and noise are extremely low and TV audio is now capable of two separate programs, one in mono and one in stereo, both of which are of superb quality by broadcast standards.

Because most television stations are generally staffed with skilled person-

nel and new MTS broadcast equipment—because it is uniquely broadcast-oriented—is not sold through normal audio distribution channels, such stations do not represent fertile ground for contractor business. The SAP channel, because it is often more costly and difficult to install at a station, is enjoying limited growth and is still of little interest to many stations.

Bars, restaurants, and other public places where TV sporting events and other stereo programming may be watched by groups of people are an entirely different story. NBC, the network pioneer of broadcast stereo, used the 1985 All-Star Baseball Contest for its kick off stereo broadcast and are continuing to emphasize stereo coverage of games. According to an NBC staff engineer, games are easy to produce in stereo and they sound rewarding to the viewer because of the crowd ambience. With a well-placed component MTS television receiver and a good reinforcement system, Saturday and Sunday afternoons at the local watering hole could become something of a bonanza for the barkeep—and a nice little project for the installer of the equipment.

Digital Audio

Dramatic technical developments have occurred in this field within the past three years. Costs are coming down but still remain higher than

most local broadcast station budgets permit. CD players represent the bulk of the local station business; some stations are using digital processing or delay equipment but it is frequently provided by manufacturers or broadcast equipment distributors.

An interesting recent development in digital audio is the "digital cart" machine. Designed to replace the standard NAB cartridge machine, the new generation device uses either formatted floppy or Winchester drives to record digitized audio. Costs are coming down; the most knotty problem is economical storage as one minute of digitized broadcast quality stereo audio requires about 20 megabytes. Manufacturers are experimenting with various approaches to this requirement, so the technology is yet far from being standardized. Gotham Audio, Compusonics Corporation, Microprobe, and Broadcast Electronics, Inc. are among those actively seeking this market. As costs come down and equipment becomes standardized, digital audio will certainly find its way into more broadcast facilities.

AM Stereo

AM stereo, long the dream of many of the industry's old timers, has become a bad joke in the business. Thanks to the FCC's tragic 1981 failure to take the initiative in establishing any technical requirements for an AM stereo system,



WDHA (above) in Dover, NJ, was one of the nation's first FM radio stations to go stereo in 1961. Now, sister station WMTR, an AM station, broadcasts in stereo.

at least five manufacturers fought it out in the marketplace with the result being two incompatible systems (Motorola's C-Quam and the Kahn system) offered to broadcasters and receiver manufacturers. While both systems are compatible with existing mono receivers, neither system's receivers can deliver stereo from the other's transmissions.

In silent testimony to the confusion, most broadcasters have simply stood by and watched the system developers spend money; thus, only 10 percent of the nation's 4,500 licensed AM stations have converted to stereo. While the Motorola system has a numerical advantage among broadcast licensees and receiver manufacturers, the Kahn people are convinced and working hard to prove that theirs is the better system. Until the market becomes better defined, it may be a treacherous place to do business.

FCC Docket 80-90

This FCC action produced in 1985 the possible construction of about 700

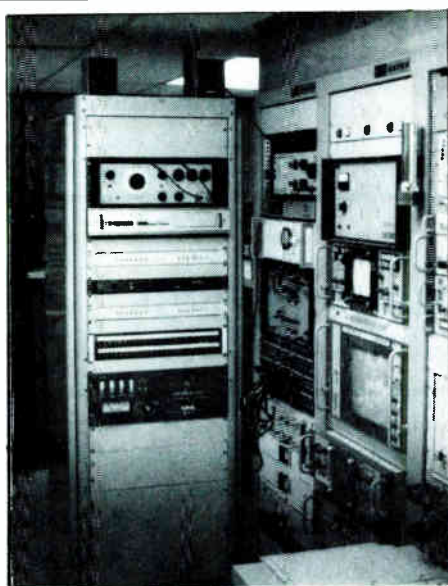

KUSA's stereo processing rack for television broadcast.

new FM stations. The operative term here is *possible* because the new station assignments were predicated on existing stations which had not installed the maximum permissible facilities

under the FM Table of Assignments. Thus, if the FCC assignment had called for 100 kW with an antenna height of 3,000 feet, the station owner might have licensed only 40 kW on a 450-foot tower. If so, some areas of coverage were left open and this action allowed other stations to apply for coverage in these areas. If the new application is granted, the original station would lose its right to upgrade at a later date to the higher power or antenna height. The results have been twofold: applications are being prepared for the new assignments and, at the same time, many existing stations are scrambling to upgrade. The net result? Over the next few years, FCC Docket 80-90 may produce as many as 700 actions which may either be new facilities or upgraded older ones. Studio equipment will be needed in the new stations; the upgraded stations will largely confine their efforts to the transmitting plants. Docket 80-90 has a down side; some of the 700 locations are not well enough populated to require any more radio

A Closer Look at Stereo TV

OXFORD, ENGLAND—After years of talk and planning, stereo television has finally emerged as one of America's major consumer stories. By the end of 1985, it is anticipated that 250 U.S. television stations were broadcasting stereo programs. Stereo TV receivers were one of the Christmas season's big sellers—and those who have equipped their homes with the stereo sets will tell you that television has become a whole new entertainment experience.

While the stereo sets themselves are quite inexpensive, implementation of the massive engineering works required to distribute and transmit stereo television signals across the country have cost millions of dollars. Moreover, the new system was slow to get off the ground, with the receiver manufacturers hesitating to build stereo sets until there were stereo broadcasts, and the broadcasters hesitating to transmit stereo programs when there were no sets to receive them.

Credit for breaking the deadlock must go to NBC. With their 1985/86 season, NBC became America's first television network to broadcast extensively in stereo, leading the way for prime-time stereo television across the states.

The network's "Skypass" satellite system carries high fidelity stereo sound to all affiliates, who must then equip their station with special transmitters to beam these signals to the home.

But before any of this, the programs must first be produced with stereo soundtracks. And, although Hollywood has been producing stereo films for years, television soundtrack production requires new techniques and different equipment.

The complicated sound processing necessary to create and match the stereo sound with the TV picture is highly specialized. The audio control consoles used for this work can cost as much as a quarter of a million dollars apiece. Looking every bit as sophisticated as a space shuttle command bridge, these consoles are at the very heart of stereo television sound. Only a handful of manufacturers produce the advanced equipment needed to do this work efficiently. Among these are Harrison, Neve, Sony, Studer Revox, Soundcraft, and Solid State Logic. Here we will focus on the latter.

In 1982, the Oxford-based manufacturer Solid State Logic (SSL) introduced the SSL Stereo Video System, the first computer-assisted audio con-

sole designed specifically for stereo television soundtrack production. The SSL System allows the television audio engineer precise control over as many as 128 different sound sources simultaneously, adjusting the tone, loudness and stereo position of each individually.

While it is still early days for stereo television in the United States, leading industry observers are convinced that the trend will accelerate. Allan Schlosser, communication director of the Electronics Industries Association (EIA) in Washington, D.C., said, "Stereo is here to stay. Once consumers are exposed to the new technology, they accept it, especially for sports and music events. Stereo TV isn't a fad, but an exciting new technology that adds a lot to home entertainment."

"Around the world, producers and broadcasters are demanding new standards in television audio. The SSL Stereo Video System allows them to produce these complex soundtracks without inflating their production budgets. Judging by our order book, the world industry's commitment to stereo television is strong and permanent," said Antony David, SSL's international sales manager. —Doug Dickey

than they already have. Undoubtedly, some of them will stay silent.

Low Power Television

This relatively new broadcast service is an outgrowth of TV translators,

companies, and applications which were technically unsound. The FCC's LPTV Branch has little choice but to review each and every application for its merit; this has taken an enormous amount of time. Most of these applica-

years.

How may suppliers enter the broadcast market?

There are several ways. Broadcasters have for years purchased much equipment from its manufacturer or one of the relatively few broadcast equipment distributors. As the fortunes of distributors change, territories sometimes become available for new ones. Experienced communications distributors who set up a broadcast operation may be welcomed by a manufacturer whose southeast distributor just went bankrupt. As many manufacturers sell direct, some form of price and territory protection is essential in the distributor agreement.

On the selling side, most broadcast sales are negotiated, so marketing and business techniques vary from the bid/spec market. *Caution:* Broadcasters require 24-hour service and parts availability. Most existing suppliers meet this requirement with a pocket pager which rotates among a few experienced employees who can drop by the stock room and ship the parts immediately, offer telephone assistance or who can travel to the site on fairly short notice. *Around-the-clock*

Broadcasters require 24-hour service and parts availability.

which have been in use since the 1950s to provide television service to small communities not otherwise served. When the FCC decided to allow local program origination over translator type equipment a new broadcast market was opened which many thought had incredible potential. Two years ago, it was expected to be a bonanza. By last Fall, it seemed as though the bottom had fallen out. What had happened?

When the FCC opened the applications process, some 22,000 applications flooded the commission's offices. Most of the applications were copies of other applications, applications filed by nonexistent or undercapitalized

tions have now been cleared away and the commission is now granting a few. Since then, FCC procedures have been changed to minimize "junk" applications and this year, the LPTV process is expected to start moving again.

As new applications will have been tendered under the new filing rules, it is likely that more of them will be successful. In most cases, the new facility will require a small production TV studio, complete with cameras, video switchers, special effects generators, audio production gear, microphones, cabling, monitors, input equipment and accessory items. It is estimated that there may be as many as 3,000 such installations over the next 10

Don't miss out on the action!



School system updating

From **schools** to **retirement complexes** the Telecor microprocessor controlled communications system bridges the generation gap!

Priced to compete in the modern age, Telecor offers standard advanced features, not add-ons at extra cost!

Programmable from each console, program selection and distribution, **zone paging** and emergency announcements are under fingertip control. Multiple class changes are initiated by multi-channel built-in **clock** programs to eight separate areas.

Call answer, hold and recall via telephone handset or built-in microphone. Architectural dialing with six levels of incoming **priority!**

Over **1000 station** capacity and up to 32 master consoles means that no job is too big!

Call us!
We mean business!

EDCON

USA-BCE/EDCOM Inc. 755 Center Street Lewiston NY 14092-0506 (716) 754-7130
Canada-Barrie Comm. Eq. Ltd. 1585A Britannia Rd. E. Mississauga Ont. L4W 2M4 (416) 678-0801

service is a must in the broadcast market.

To market equipment or services within the broadcast industry, one needs information. Who are the principals at the stations? Where are the manufacturers? What are industry trends? Industry news?

The most likely source of information of this dynamic and rapidly changing industry, its stations, services and equipment manufacturers is the National Association of Broadcasters (NAB). The NAB is the nation's largest association of broadcast executives, stations, and representatives of allied fields. Some 40,000 broadcast personnel gather each year at its convention. The NAB maintains one of the largest information centers covering the broadcast industry. Additionally, there are numerous other industry-specific periodicals and directories.

Contact local broadcasters. If you are located in a metropolitan area, it is likely the station will have readily available engineering personnel, eliminating the need for outside services. Parts and components are a different story. If prices are attractive, there is no reason the station cannot purchase a post production console, microphone, or tape transport from a local firm.

Outside your community, there may be even more business. Many rural broadcasters are hard pressed to find qualified personnel to install or service facilities. Work in broadcast studios is not normally subject to FCC regulation; what is important is that the installation meet FCC standards of performance when operating. The technical standards for all types of broadcast stations are detailed in Title 47, Code of Federal Regulations, Parts 73 and 74. A useful paperbound book containing these rules is available from the Government Printing Office or a nearby GPO bookstore. Stations must meet the standards and procedures outlined in this book; they are not difficult for any high quality audio installation to meet.

Marketing to broadcasters is much like marketing anyplace else; the mechanics and expectations of the industry must be understood before success can be achieved.

*National Association of Broadcasters,
1771 N St. NW, Washington, D.C.
20036; (202)293-3570*

MOVING?

Please attach your Sound & Communications mailing label or print your address exactly as it appears on the label.

NEW ADDRESS

NAME _____ (Please Print)

COMPANY _____

ADDRESS _____ APT. NO. _____

CITY _____ STATE _____ ZIP _____

Return to:
Circulation Dept.
Sound & Communications
220 Westbury Avenue
Carle Place, NY 11514

The Wireless Intercom System designed for your specific needs

The Cetec Vega O System fulfills the demanding applications of motion picture, broadcasting and stage production communications. Sound and camera crew cuing, stunt coordination, sound program monitoring, etc. can be achieved easily without running cables.

Features

- Can interface with wired intercom systems such as RTS, Clear-Com, David Clark, four wire, etc.
- Operates simplex or duplex with up to 6 walking units plus 1 plug-in unit (at the base station, which can include a wired-intercom interface).
- Operates in the VHF high band, 150 to 216 MHz, for minimal interference.
- Usable with commonly available headsets (electret or magnetic).



 **Cetec Vega**

Division of Cetec Corporation

P.O. Box 5348, El Monte, CA 91734. (818) 442-0782. TWX: 910-587-3539

World Radio History

Reader Service #234

INTERCOM ■ ■

TECHNOLOGY ■

The Microprocessor Influence

by **Jim Morrison,**
National Sales Manager,
Aiphone Corporation.

Intercom Technology

Internal intercommunication changed little from the 1930s until well into the 1960s. Almost all systems had what we would call today, old-fashioned lever switches. They were bulky and were powered by vacuum tubes which resulted in high maintenance and certainly less features than we have come to expect.

Then reliable, fast response, noise free switching was designed, which allowed dependable and economical, full duplex intercom or meaning one person no longer had to control the conversation by pressing a talk/listen switch. Rather, once a party was called, both parties could then converse hands free. This led to further innovations but even then, in the early 1970s, a common internal intercom with 10 stations might require 20, 25, or even 30 conductors between stations so wiring was both expensive, cumbersome, and a potential source of problems.

But with the advent of the microprocessor-based intercom system, the entire intercom industry was revolutionized.

Essentially the microprocessor allowed multiple functions on an intercom system to be conducted on either one or two twisted pairs of wire. Immediately, installations became simpler and of course the cost of wire

was much much less. But most important the microprocessor, being high technology, allowed built-in multiple functions to operate one or two pairs of twisted wire and opened up the internal intercom industry as a direct competitor with the interconnect telephone companies which were featuring intercoms and which were becoming so prevalent throughout the United States. A good microprocessor-based internal intercom system can have 10, 20, 30, and more functions built in. Most commonly such a system has a central exchange unit with each intercom station having a "Home

Run" back to that central exchange unit. However, there are now systems on the market with the microprocessor based in each intercom station. So, instead of a home run from each station, a person can start with two stations add a third and fourth, and keep running them in loop fashion with no central exchange unit. In comparing one of Aiphone's older basic multiple wire systems to one of our new microprocessor-based systems with many many more features and functions and actual greater reliability, the older unit is more expensive than the microproc-

(continued on page 24)

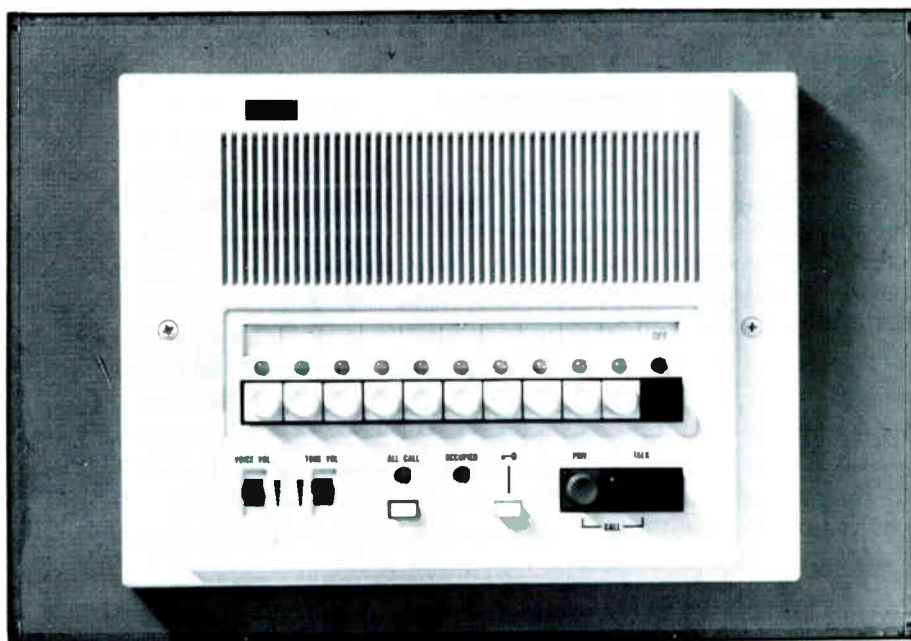

Aiphone's LAF Intercom with privacy and talk switches and volume control.

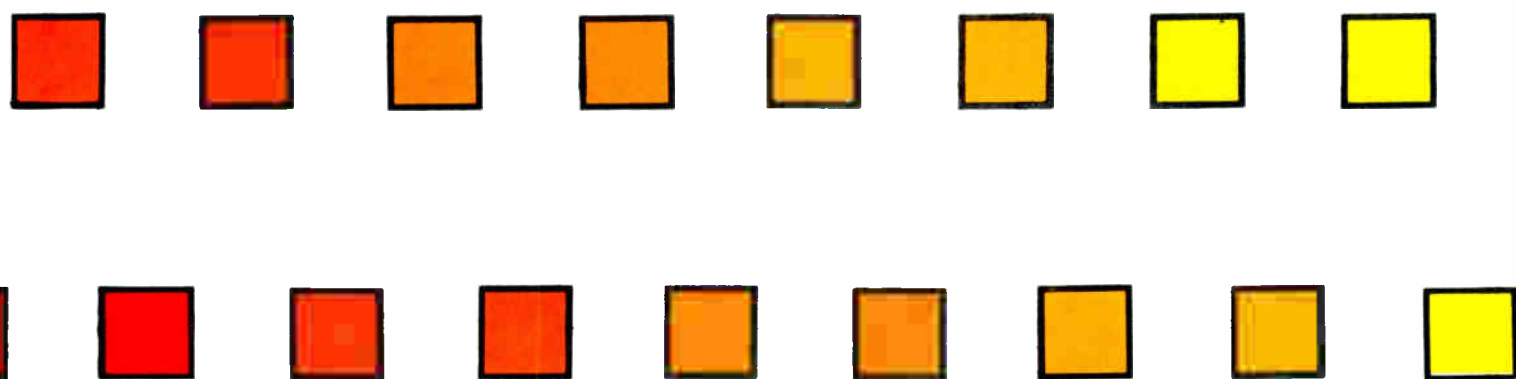

Growing Technology May Redefine "Intercom"

by Jim Small, Chief Engineer, Ring Group of North America, Internal Communications Division.

intercom *n*: intercommunication system
intercommunication system *n*: a two-way communication system with microphone and loudspeaker at each station for localized use

The intercom of yesteryear and the intercom of today are worlds apart in technology. Yet, dissimilar as they are, they still accomplish their original purpose: to serve as instruments for internal communications. But, the technological icing on the cake is the real story.

Today's intercom technology has pushed the old, mechanical cross-bar connections out, and brought in "state-of-the-art," all-electronic systems. So-



Prototype of automatic dialer with incoming call message identification.

phisticated duplex systems, such as the Ring-Master™ and those of many of our competitors, are packed with a host of special features and interfaces

not dreamed of a decade ago.

In fact, the capabilities of today's intercom systems have advanced so far as to rewrite the old definitions. Today's intercoms act as **internal control mechanisms** in a variety of applications, and in general, serve as communication lifelines for companies and organizations.

First and foremost, even as intercom manufacturers try to differentiate their product from telephones, intercoms are often used in telephone-like capacities. End users have come to rely heavily upon them for all internal voice communications; without the need to tie up CO lines, or the need to place phone calls on interminable



Ring's Scanpager™ on site radio pocket pager.

hold.

Intercom conversations, just like phone hookups, can be held in a number of flexible ways: in simultaneous conference with scores of other inter-
(continued on page 24)



Scanpager's Maxi Operator Station can send messages to as many as 100,000 receivers.

New Applications and Lower Costs

by Robert T. Shipley,
Vice President Engineering;
and Robert S. Fisher,
President, Fisher Berkeley
Corporation.

The Intercom Market

There are basically two types of intercoms: direct select and digital. The direct select type uses one key (switch) for each location to be called. Conversations may be two-way. Usually a talk-listen switch is operated by the originating party, but automatic (vox) operation is offered in some cases.

The digital type of intercom uses a key pad similar to a Touch Tone telephone key pad, and by central or distributed logic selects the station to be called. Once the station is selected, most digital systems use an automatic (vox) talk-listen circuit so that opera-

the outside caller on hold.)

A major factor in the volume of sales of intercom systems is that while interconnect telephone systems are universally sold by aggressive and active sales people, intercom equipment is rarely *actively* sold, but rather is sold only when a customer asks for it.

The market has therefore been reduced from what it once was, but has now stabilized and is even showing some growth. Users are now more often special users. Some examples include jails and prisons; new car dealers; water and sewage treatment plants; many kinds of security applications (often in conjunction with a video system); military barracks; hospital radiology, surgery, warehouse, and laboratory applications; post offices; commercial boats and ships; fast food outlets; gasoline stations; processing plants; manufac-



Ektacom's L Series of Intercom.

can be programmed quickly and easily in the field—are the wave of the future.

The actual cost of hardware is also a major item in the market. A major influx of Asian intercom products at very low prices has been a factor here. These products are often not as well made as domestic products, but their quality is frequently as good as the end-user is willing to pay for. For example, the user is unwilling to pay for a system with a 20-year expected life—a much shorter life span is perfectly acceptable if the initial cost is one-half or less. Domestic manufacturers, faced with higher labor rates, have responded in two ways: (1) by going off shore themselves, or (2) by developing other means of reducing costs (other than labor costs). Such other means including engineering into their products custom integrated circuits which have very high capital costs to the manufacturer, but permit programmable systems which greatly reduce the dealer's inventory, installation time, and give the dealer features not available elsewhere.

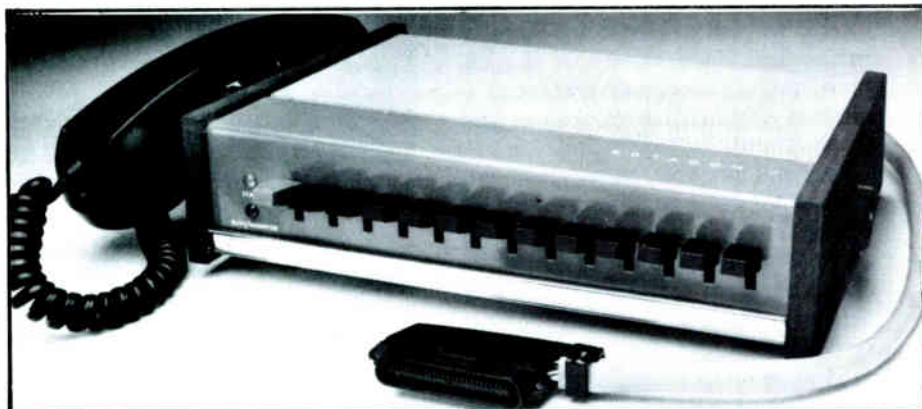

Fisher Berkeley's Ektacom Series "J" intercom.

tion is hands-free. Some digital systems are offered with manual talk-listen functions.

Prior to availability of interconnect telephones, the major market for intercom systems was offices and other commercial installations. However, all interconnect telephones are available now with "built-in" intercom: accordingly the number of office users who buy a separate ("second channel") intercom has diminished substantially. (It is interesting to note that almost all office users who actually have a separate, second channel intercom system in conjunction with their telephone systems, find the intercom indispensable. It is much faster, reduces call-backs significantly, and allows the user to get needed information immediately and without putting

turing facilities; and, of course, offices. Other specialty applications include apartment houses.

Market Pressures

The market is driving manufacturers to lower installation costs. Labor for installation is generally higher in cost than the hardware. The manufacturer that can reduce these costs has an edge.

Another market force presses for more features in fewer products: dealers do not want to stock as many products as they once did because the size of the market does not justify huge inventories. Products, therefore, that will meet the needs of many and varied applications are more attractive to the dealer because his inventory costs will go down. Programmable systems—that

Manufacturers Directions

In addition to the development of special, custom integrated circuits, manufacturers are also using more multiplexing where both audio signals and data are transmitted on the same conductor. This reduces installation time; it also reduces the cost of the wire for a given system.

Where the volume can be developed to justify it, manufacturers are going to more sophisticated manufacturing techniques including automatic insertion of components into printed circuit boards; automatic soldering of the boards and automatic testing. The use of surface mounted integrated circuits is also being looked at since it reduces significantly the number of holes that have to be drilled into a printed circuit board.

(continued on page 26)

Microprocessors Allow Software-Only Upgrades

by **Kenneth T. James**
Vice President, Sales & Marketing
Rauland-Borg Corporation

Intercoms today totally benefit the end user because they cost less and do more. These benefits can be attributed to the microprocessor-controlled technology we have today. For example, our new system that was introduced last year, the Telecenter IV, offers the end user the ability to specially program the intercom and telephone system with the features that suit his needs. There is no expansion necessary since multiple voice paths are already included.

Until the 1960s, we were still making tube intercoms. Then in the mid sixties came solid state technology. In the mid-seventies we got integrated circuit design, which was followed in the late seventies/early eighties with microprocessor-controlled intercom systems. To give you an idea of the

rapid growth of intercom technology, we introduced our first microprocessor-based intercom in 1979, the Telecenter III, which offered one talk path and serviced 100 stations. Today, our newest Telecenter (IV) has 16 talk paths and can serve up to 500 stations. The Telecenter IV offers more features and costs less!

Microprocessor-based intercom systems cost at least 50 percent less than systems of comparable capacity did 10 years ago.

Looking Into The Future

As far as what the future holds, it is difficult to predict given the continued rapid movement of technology. What appears impossible now can easily become do-able in six months to one year.

The Editors of Sound & Communications...are

always looking for qualified contributors who wish to write for the publication on a freelance basis.

If you are involved in the Sound & Communications industries, and would like to write for the magazine bearing their name, please write to the editor at the below address and outline your experience and particular interests.

Thousands may share your interests, and we're willing to share them with our readers.

The Editor

Sound & Communications
220 Westbury Ave.,
Carle Place, NY 11514
(516) 334-7880.



10 ways to solve your most common microphone problems.

- Input Overload** **A15AS** Microphone Attenuator—inserts 15, 20 or 25 dB loss to prevent overload.
- Phasing** **A15PRS** Switchable Phase Reverser for balanced lines.
- Low-Frequency Noise** **A15HP** High Pass Filter—reduces low-frequency noise and proximity effect.
- High-Frequency Noise** **A15LP** Low Pass Filter—reduces objectionable high-frequency noise.
- Lack of Presence** **A15PA** Presence Adapter—adds intelligibility and brilliance.
- Excessive Sibilance** **A15RS** Response Shaper—sibilance filtering, plus flattened response.
- Adapting Line Level to Mic Input** **A15LA** Line Input Adapter—converts balanced low-impedance mic input to line level input.
- Matching/Bridging/Isolating** **A15BT** Bridging Transformer—matches balanced or unbalanced devices of different impedances.
- Troubleshooting** **A15TG** Tone Generator—700 Hz signal helps check levels, connections, mixer inputs, and cables.
- Microphone Impedance Matching** **A95** and **A97** Series Line Transformers—make it possible to connect low impedance lines to mid and high impedance inputs (or vice-versa).

Shure Brothers Inc., 222 Hartrey Ave., Evanston, IL 60204. (512) 866-2555.

SHURE®

THE SOUND OF THE PROFESSIONALS®... WORLDWIDE

AIPHONE CORP.

(continued from page 20)

essor-based system when you consider the difference in cost of wiring and installation.

Microprocessor-controlled systems can have multi-talk paths, multiple trunks, hands free reply, lamp memory, privacy, privacy override, low release, paging, paging with talk back, zone page, all page, desk page, all call, background music, conference call, call transfer, camp on busy, temporary privacy, secretary transfer, absence memory, memory call back, call holding, telephone interconnect, urgent brake-in signal, paging with call back, monitoring, pocket paging interface, and more.

So today's intercom system is a completely different one from that offered on the market just a very few years ago. We had gone many decades with few changes and now, in just a few years, the entire market has been revolutionized by the microprocessor concept. We feel that while microprocessors today certainly do not sell in the volume of regular types of intercoms, it will only be a matter of a few years

until practically all intercommunication systems will be microprocessor systems and priced no higher, and probably less return than standard electronic types of intercoms.

Video Intercom

Along with microprocessor technology came the video intercom concept. While audio communication is acceptable in many instances, visual identification is becoming a necessity because of security demands. Now Aiphone offers the first modular video system which can be matched with several of our intercoms, including microprocessors. This allows a visual display, an intercom with the option of using both together or separately.

In the Future

What is the future? Total visual and audible interconnected microprocessor based and at a price equal to or lower than what we found acceptable for systems that would be considered completely out of date today. But even this concept is not the ultimate today. The addition of a security panel to the audio/visual intercom is available to monitor fire, alert police, or a selection

of needed options.

The office, factory, home or any facility will enjoy the benefits of technology unknown a few years ago. Literally, from one or more small, inexpensive stations, one will be able, (in fact, can today), to see and converse with remote stations and have at your finger tips complete security and memory capability.

RING GROUP OF N.A.

(continued from page 21)

com users; connected to remote company facilities a mile or an ocean apart (on leased line); via "hoot and holler" circuits, allowing any number of participants in different locations, including cities and countries, to be constantly tied together in party-line type arrangement; and by phone interfaces to wireless on-site paging systems, to wide area paging systems and to cellular telephones.

Current technology has allowed the development of intercom voice and message storage systems; voice synthesis systems (for playback of encoded voice messages); interfaces to CRT for retrieval of non-voice messages and computer/data input interfaces. On the hardware side, executive intercom stations which offer a visual advisory of a caller's identity (prior to the start of a conversation) are making their way into the marketplace. Automatic dialers, the intercom equivalent of direct station selection units, are now being offered by a few manufacturers.

Software-based systems offer a wide range of features including sectoring, all-call and group call, on-site or remote reprogramming of station numbers, program and alarm channels, automatic busy call-back, automatic call redirection, speed dialing, priority dialing, secretary transfer, all-call and memory backup for power outages.

The sophistication of the applications being developed for today's intercoms seems only limited by the conceptualization of that application. That's why a variety of our customers have interfaced their systems to be capable of *remotely*: controlling the heating and cooling of their plants and buildings; activating alarm systems, entry latch mechanisms and video and snapshot surveillance cameras; switching lighting (as well as dimming func-

(continued on page 26)

7000 SERIES INTERCOM INDUSTRIAL — INSTITUTIONAL

Dial Access

Zone or All
Call Paging

Modular
Expansion
to 899 units



Rack with Electronics

Schools

Dormitories

Hospitals

Special
Applications

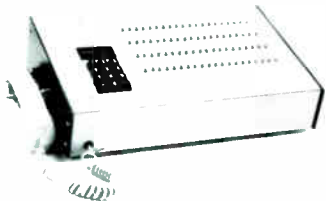

Master with Annunciator

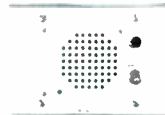

Room
Station

Cornell Electronic Products, Inc.

4911 W. Good Hope Road

P.O. Box 23411

Milwaukee, Wisconsin 53223

(414) 351-4660

Reader Service #243

Aegis Technologies
Aiphone Corp.
AKG Acoustics
Altec Lansing
ART
Atlas Sound Div.
Ashly Audio Inc.
Audio-Technica U.S. Inc.
Bogen Communications
Cetec Vega
Community Light & Sound
Conquest Sound
Cornell Electronic Products
Crown International
J.W. Davis
dbx
DIS•USA
DOD Electronics
Dukane Corp.
Electro-Voice Inc.
Environmental Sound
Fisher Berkeley Corp.
Four Jay Industries
F.S.R. Inc.
Galaxy Audio
Grommes Precision
JBL Professional
Jeron Electronic Systems
Klark Teknik Electronics
Knowles
LCA Sales
Lee Dan Communications
Mackenzie Labs
Nady Systems
NEI
Neutrik Products
Numark Electronic Corp.
Oaktron Industries
OWI Inc.
Panasonic/Video Systems
Paso Sound Products
Rane Corp.
Rowe Customusic
RTS Systems Inc.
Sennheiser Electronic
Shure Brothers Inc.
Sonic Systems Inc.
Soundolier
SPECO
Tape A Thon Corp.
TASCAM
TCE Electronics Group
Tektone Sound Signal
Telex Communications
TOA Electronics
White Instruments
Yamaha International Corp.
Yesco

SOUND & ***COMMUNICATIONS***

**regularly features advertising
and product information
from manufacturers of
this caliber, the companies
you deal with and the
products you need.**

**Use the enclosed rapid
response cards for fast
information on any
of the companies
featured in this issue.**

SOUND & ***COMMUNICATIONS***

**It's Not Just a Magazine,
It's An Industry.**

RING GROUP OF N.A.

(continued from page 24)

tions) on and off; opening and shutting water valves, and controlling their rate of flow; activate and access computer systems for data entry and manipulation.

As those of us in the communications and sound industry have seen, intercom use, technology and applications have leap-frogged since their introduction. With superchip technology advancing in the laboratories, it's only a matter of time for even greater internal...external...and all types of communication systems.

Some interim developments I expect include improvements and cost reduction in cabling, allowing today's two, four, and six wire runs to be replaced by fiber optics and/or by radio transmissions. I also expect intercoms to become simpler to operate with an increasing variety of features and applications, and technical capabilities still undreamed of today.

I predict that within the next 25 years, *intercoms as we have come to know them, will be obsolete!* Equally doomed to obsolescence will be the

pager...and even the telephone. Instead, I believe an all-in-one communications product will come to market; akin to the "communicator" that Star Trek fans have seen "demonstrated" for the past two decades.

With continuing advances in cellular and computer technologies, it will be commonplace for an executive to reach for his or her credit-card sized communicator, and either by means of touch or voice activation, call up the party they need to speak with, in the next room...at home...on a plane...or possibly on the moon! With equal ability to reach someone on or off premises, technology itself will have rewritten the definition of intercom—and forever change the way people keep in touch.

FISHER BERKELEY CORP.

(continued from page 22)

Fisher Berkeley's Offerings

Fisher Berkeley, makers of the Ektacom brand of intercom equipment, offers both direct select and digital select equipment.

The latest system, called the S Series, is a two station only line which

is programmable in order to allow the dealer to do almost anything any user might need. However, the dealer does not have to add optional hardware or apply home made modifications to the equipment: instead all that is required is opening the master unit and pressing a few DIP switches similar to those used in garage door opener electronics (as well as many other places).

The Ektacom L Series is a digital select system with automatic switching (often called "duplex") but with distributed logic so that there is no large central switching mechanism as is most often found in digital equipment. The "L" is also multiplexed so that there is only a single, three-pair cable that loops from station to station, "daisy chain" style.

The Ektacom G is Fisher Berkeley's major direct select offering with literally dozens of different stations and a large number of options, mostly factory installed. This system can be delivered with up to 1,000 station capacity. Even the smallest "G," however, has all of the options and includes several switch contacts that make or break when a station is called: this allows for great flexibility.

ONE SOUNDSPHERE DOES 1,300 SEAT GYM!

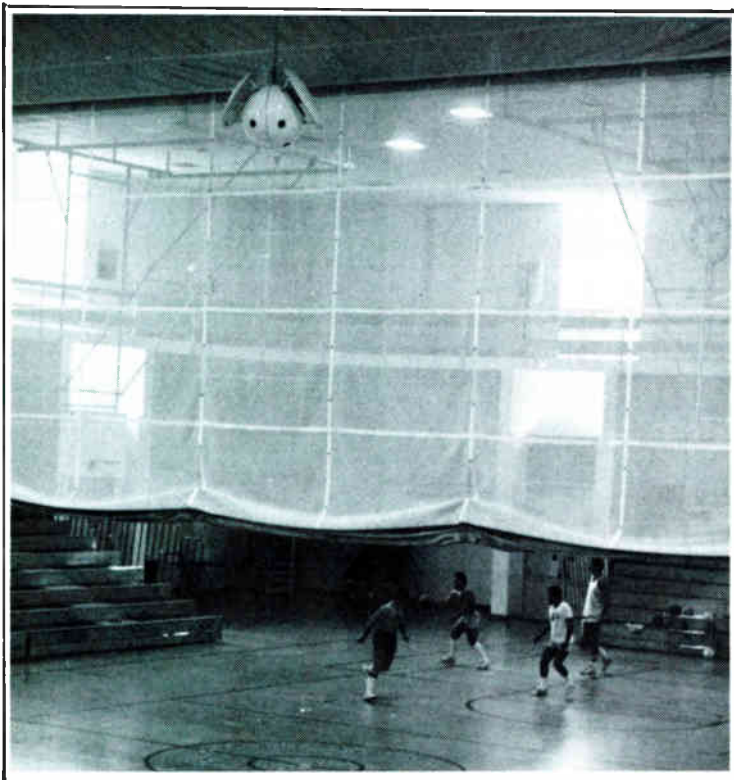

The gymnasium of Our Lady Queen of Heaven has a single Soundsphere #2715 in the room center. With the bleachers pulled into position for basketball games, the space holds approximately 1,300 people. When the contractor, Howard Trotter of Sylvan Sound, visited the site months after installation, someone asked what had been the largest group of people in the gym for an event. The response was that after special decoration, the space had been used for a Midnight Mass which was attended by more than 2,500 people. The one #2715 Soundsphere delivered quality music and crisp voice announcements for the entire congregation. The same speaker also plays popular and rock music for the heavy sound at student sock hops.

Howard Trotter has recently installed Soundspheres in many school gyms and auditoriums. He reports very favorable comments from the staffs of Westlake, LA High School, DeRidder, LA High School and St. Philip of Neri Church in Kinder, LA. Howard has used Soundsphere dual reflectored speakers #2212 and #2715 in numerous installations where one Soundsphere can effectively operate as a single source. Mr. Trotter is also very enthusiastic about the ease of installation of all Soundsphere loudspeakers.

Write or call direct for further information.

SOUNDSPHERE

A PRODUCT OF
SONIC SYSTEMS, INC.

737 Canal Street • Bldg 23B • Stamford, CT 06902 • USA • Tel (203) 356-1136

Corrections

*A typographical error in the Gary Davis' review of the Bogen 31-Band Hi-Tek™ Equalizer in the December issue apparently has caused some confusion. It should have read:

"According to Bill Dunn, engineer for Bogen, the Q of the individual "tank circuits" (or whatever they use per filter band) was carefully calculated to provide minimal inter-band ripple while still providing good control over individual bands. The result is no more than 1.5 dB of ripple at maximum control settings. This was achieved with a Q of 2.5, as contrasted with the typical Q of 5 or 6 for other graphic EQs..."

*Harry Whittelsey, president of Executone Long Island, was flattered when recently quoted as president of Executone, Inc. But, of course, William O'Connor holds that title for the company now known as Contel Executone, and is additionally executive vice president of Continental Telecom Corp.

SOUND & COMMUNICATIONS CLASSIFIEDS GET RESULTS

If you're looking for new employees, new business or just trying to sell some used equipment, then *Sound & Communications* classifieds are for you. More qualified readers look through *Sound & Communications* classifieds than any magazine in this industry.

For rates and information, please call (516) 334-7880, or write to:
Classifieds, *Sound & Communications*,
220 Westbury Ave., Carle Place, NY 11514

mobile d.j. system

MOBILE MUSIC MEANS MONEY

Here's the PPD pre-pak mobile system. Everything is included. Travel is easy since the carpet covered cases have pro 'roadie' hardware. Transport only four pieces. Set up in 15 minutes. Breakdown in less.

Use the MDJS19 as the nucleus of a premier club system. The pre-pak dramatically reduces custom booth carpentry costs. The speakers are ready to fly. Add two speakers, an amp, and DMS212C Subwoofers for maximum SPL.

**Suggested Retail MOJS19 —
\$4,339.00**

If economy is critical, use the PPD MDJS17 System. The same quality throughout with the less expensive DM1750RM Mixer, UD925 Microphone, and compact DMS310C 10" three-way speakers.

**Suggested Retail MDJS17 —
\$3,869.00**



FEATURES

- 15 space 19" Rack and Console
- DMS312C Speakers (12" three way design)
- DM1900 Mixer (5 Inputs, EQ)
- EQ250 Octave EQ and SA220 125W/Ch. Amp
- Two TT2400 Direct Drive DJ Turntables with Stanton 680 EL Cartridge
- Studio quality UD940 Mic with Gooseneck

For more information on PPD Mobile DJ Systems, please call or write Paul Friedman, National Sales Manager.

PPD

GO WITH THE PRO

Numark ELECTRONICS CORP.

General Offices: 503 Raritan Center, Edison, NJ 08837
Telephone: (201) 225-3222 Telex: 287-249 Fax: (201) 287-2155

West Coast Branch: 7850 Alabama Ave., Canoga Park, CA. 91304
Telephone: (818) 346-8222 Telex: 287-313

VOICE MAIL

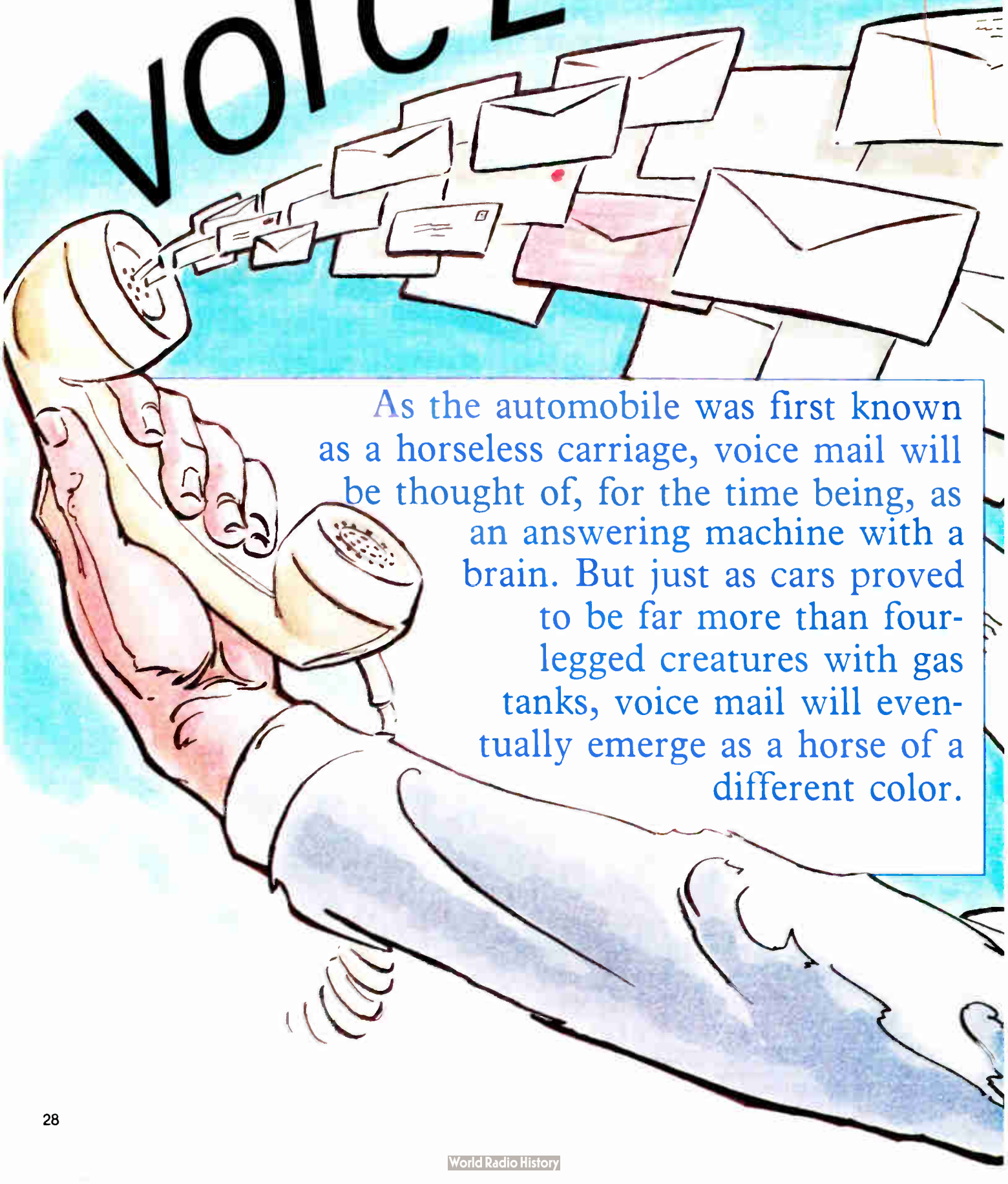

As the automobile was first known as a horseless carriage, voice mail will be thought of, for the time being, as an answering machine with a brain. But just as cars proved to be far more than four-legged creatures with gas tanks, voice mail will eventually emerge as a horse of a different color.

IL

by Greg Prince

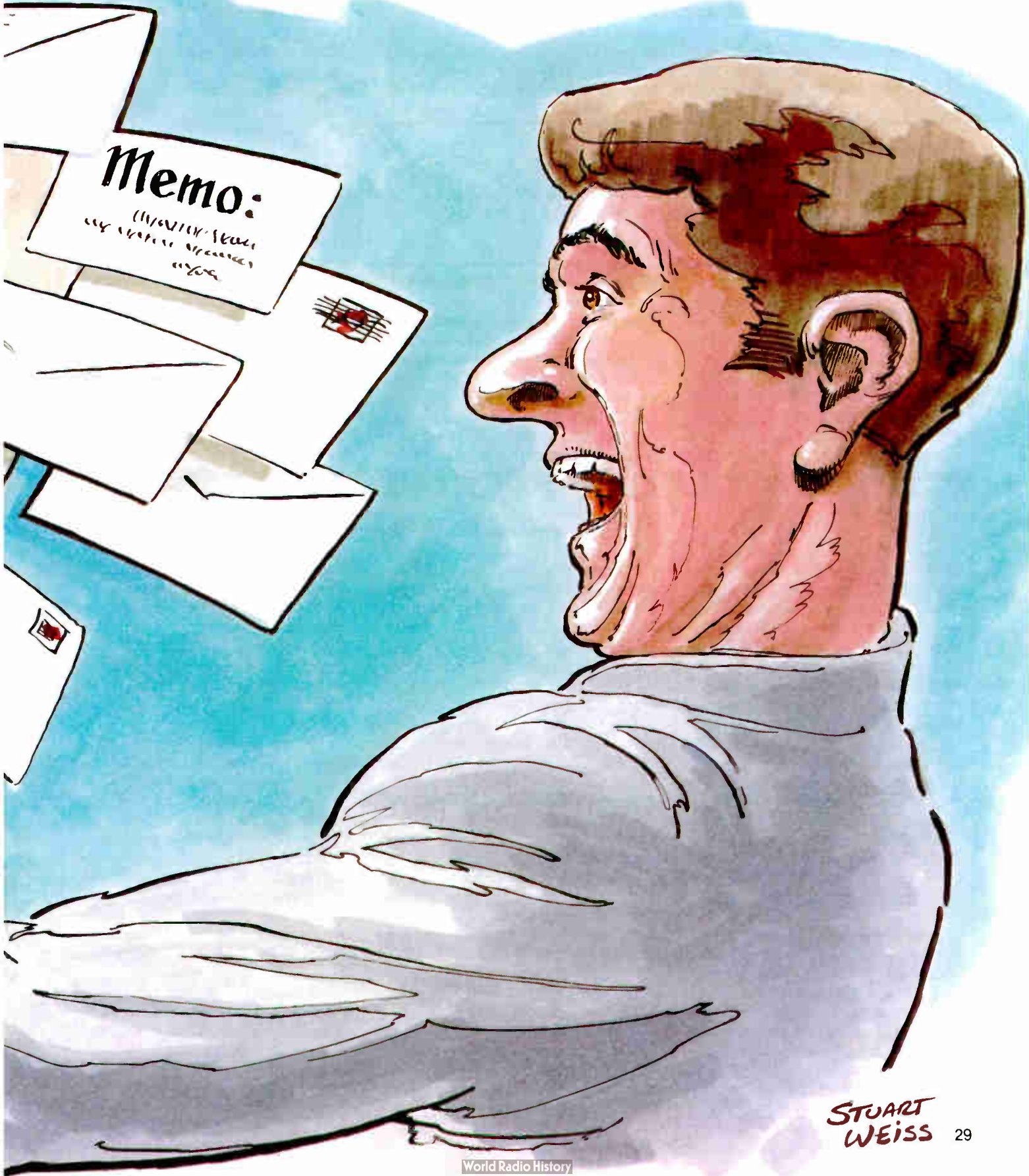

STUART
WEISS

Whatever the hue, you can bet voice mail is on the fast track. Industry experts are predicting total sales of systems will reach a \$1 billion payoff by the dawn of the next decade. With figures like that being bandied about, companies that are turning this technology into dollars are adamant that the future is now.

Voice mail (also known as voice messaging) picks up where the telephone answering machine leaves off. Or, more accurately, picks up what

claim of \$1 billion by 1990 is justified, just be considering what voice mail can mean and does mean to essential areas of business like multiple-unit orders and the ultimate telephone cost reduction."

Genesis' voice mail products are specifically designed for small-and medium-sized businesses and offices. Pfeiffer pointed out that applications are not limited to any type of business, or business alone. "It would seem best suited for the general business en-

Voice Mail Picks Up Where the Telephone Answering Machine Leaves Off.

those call recorders miss altogether!

Three out of every four telephone calls in business today are not answered by the person for whom they are intended, according to figures provided by Rolm Corporation, an IBM subsidiary. Instead, these calls are answered by secretaries, message centers and sometimes, by no one at all. Voice messaging provides an easy-to-use, cost-effective alternative to an unpleasant game that has come to be known as "telephone tag."

Designed to reduce the number of wasted telephone calls and allow more efficient communication to a number of people at one time, voice messaging is said to make a direct impact on business communication. When one phone call can be made and information passed on via a voice message, time is saved, productivity increased, and frustration eased. When a voice message is sent simultaneously to a number of people, time-consuming memo writing is reduced.

The need for voice messaging systems is not considered to be limited to offices of a particular size. Both small and large businesses can benefit from the use of voice mail. And, in special cases, so can personal phone use.

"Definitely, the time has come for voice mail to be considered a vital part of doing business in the 1980s," Genesis Electronics Corporation's Product Marketing Manager Geoff Pfeiffer said. "The major thing is the inability of manufacturers and distributors out there to get in touch with individual end users. It is this inability, and the solution voice mail provides, that is bringing wider acceptance of the technology as a normal everyday use. The

environment, but it has definite uses in government, education, anywhere you have a lot of telephoning and people who are not always around."

If voice mail is not yet a household word, according to Pfeiffer, it's because not everybody in the house has quite grasped the concept of voice messaging. "Typically, the end user has a problem understanding voice mail initially," Pfeiffer said. "It's very conceptual. You can't see and feel its uses immediately."

The essence of voice mail is in its name. Features like electronically transmitted oral memos and customized messages distinguish it from both answering machines and human operators. Users check their voice "mailboxes," by punching a code into their telephones. Little time is wasted sending an urgent message or getting in touch with the hard-to-reach people.

There are two basic ways to hook up to a voice mail system. Some companies, usually through local telephone distributors, install actual hardware in an office. Other firms offer voice messaging via subscription, meaning the end user's only equipment is a Touch-tone™ phone.

Rolm and Genesis are two of the companies which deliver their systems through installed hardware. Last July, Rolm announced expanded capacity for its PhoneMail system on the CBX II 9000. With that expansion, PhoneMail can meet the needs of as many as 8,000 users with up to 128 channels. The expanded capacity was achieved by connecting up to eight 16-channel nodes in a single system. This distributed architecture offers Rolm CBX II 9000 customers increased reliability

and flexibility. The company's configurations now range from four to 128 channels, providing voice messaging and telephone answering for 40 to 8,000 users, at a cost of less than \$1 per user per day.

Rolm Vice President Anthony Carollo cited the expansion as an indication of the systems' versatility. "We believe Rolm now provides the broadest range of voice messaging product configurations in the market and meets the needs of both small establishments and large enterprises," he said.

The IBM subsidiary offers two versions of PhoneMail: one is integrated with the Rolm CBX and the other interfaced to non-Rolm PBX or Centrex systems. First marketed in December 1982, PhoneMail is a computer-controlled voice messaging system that stores and forwards voice messages, enabling users to communicate when both parties are not available at the same time. Callers can leave voice messages that are digitized and stored on hard disks. Customers can retrieve these messages at any time, send replies through the PhoneMail system, forward the messages to their colleagues, or save them for later action simply by pressing pushbutton keys. The system guides callers through their options with oral prompts.

Rolm points proudly to users such as the large Denver law firm of Holme Roberts & Owen as evidence that PhoneMail is a system people can adapt to quickly. The system was implemented in the firm's offices in early 1984. Lawyers, paralegals, secretaries, and administrative staff exchange voice messages through the system when simultaneous conversation is not possible.

How quickly do lawyers adapt to a system which goes beyond established patterns of communication? Bob Gregory, directory of administration with Holme Roberts & Owen, said that "lawyers have been educated to make decisions based on precedent. As a result, one does not expect them to openly embrace new technology." But embrace it they have—the firm's PhoneMail system now has 318 users and some of the attorneys' clients have ordered the system as well.

Similarly, Genesis can tell tales of customers who have grown accustomed to CINDI (Central Information Dispatch). Ryerson Steel purchased CINDIs for its Chicago, Boston, and Pittsburgh offices. According to LDB, Minneapolis-based distribu-

tor, the sale wore a price tag of about \$400,000. The steelmaker will initially install six CINDI model 880-D voice mail systems before the end of the year, each supporting up to 412 users at a single location. The systems will be primarily used by Ryerson's external sales force.

"Already our personnel are discovering many ways voice mail can improve their productivity," Roger Wininski, Ryerson telecom manager said. "With CINDI, our salespeople can request information and pick it up later—without having to wait on the line for the contact to be hunted down. Our customers are really the ones who will benefit from the voice mail system."

LDB Sales Engineer Skip Sponsel noted the distributor's custom training sessions will allow Ryerson personnel to enjoy all of the benefits of the Genesis system immediately. "During the training sessions, we examine the user's telecommunications problems and frustrations and then demonstrate how CINDI solves most of their headaches without a long learning curve. In one day, we can train up to 60 people—from clerk to president."

Another leading provider of voice mail systems is Massachusetts-based Commterm, active in the voice mail field since 1978. Its EVX (Electronic Voice Exchange) features pre-recorded greetings to callers, adding to or rerouting of messages, delivery and broadcast to multiple extensions and erase, replay and store functions. In the office market, Commterm makes the EVX available on a stand alone basis that provides fully featured voice messaging. When integrated with a PBX or Centrex telephone system, the EVX also provides telephone answering as well as voice messaging features.

To secure distribution channels, Commterm has developed a variety of distribution relationships and alliances with regional Bell Operating Companies (BOCs), including Southwestern Bell and Bell South.

While Rolm, Genesis, Commterm, and companies like Octel (with its Aspen voice message system) deliver their voice mail service with actual installed service, others in the voice messaging business bring their voice mail to customers over the phone.

Async Corporation is an Atlanta-based voice messaging service bureau that caters to people who want to use voice messaging without worrying about the large capital outlay it takes to install a system in an office. "We are

providing just the service," explained Async Vice President of Marketing Jack Brantley. "We do it on a term basis, usually monthly. The typical price is \$30 per month per user per mailbox, meaning if somebody wants to set up 10 mailboxes, to leave specific messages for 10 different clients, it would cost \$300 for that person."

Brantley said Async is usually in the position of introducing voice mail technology to clients who were previously unfamiliar with it. "The most common misconception is the voice messaging is a glorified answering machine," he said. "I like to think of it more as something of a memo center, where you don't have to deal with a thousand pink message slips to get something across."

Async's customers are advised to start using voice messaging on an internal basis only. "There has always been some resistance to leaving detailed messages, whether you're giving them to a human being or a machine," Brantley explained. "So by using it for just internal communications at first, everybody gets used to it. Then you can try it out with your best customers and eventually you see that they get used to it. There's so much more to it than just being an answering machine.

If one person in a company needs approval on a project, for example, he or she can leave a message in a voice mailbox asking for it. The person who gives the approval can answer by immediately sending the asker a message in their box, or even better, the person giving approval can just leave the approval as the initial message, as opposed to: 'Sorry, I'm not in...' Everybody gets used to it pretty quickly."

Advanced Voice Systems offers voice mail in a similar fashion and Marc Cohen, company president, also finds education is a big part of any sale. "It's still something of a missionary sale because you're bringing the product to people who have never seen such a thing before," Cohen said.

Neither Brantley or Cohen said they believed their services will replace answering machines altogether. "I think voice mail helps answering machines in a way because it gets people used to leaving detailed messages," Brantley said. "They said the dictaphone would replace the secretary too," Cohen added.

Cohen said personal and home use might not be far off. "Typewriters started as strictly an office product," he noted.

APPLICATION FOR MEMBERSHIP



National Sound and Communication Association
501 West Algonquin Road
Arlington Heights, Illinois 60005-4411
(312) 593-8360

We are: _____ **Contractors** _____ **Representatives**
_____ **Manufacturers** _____ **Consultants**

We were sponsored by: _____

Company Name: _____
(Please type)

Street Address: _____

City: _____ State: _____ Zip: _____

Area Code:(_____) _____ - _____

Your Name: _____ Title: _____

Dues For: Contractors	\$100.00
Representative Sponsor	\$125.00
Manufacturer Sponsor	\$250.00
Consultant Sponsor	\$125.00

My Check for \$ _____ is enclosed. Check No. _____ Dated: _____

_____ Please invoice me for \$ _____

Signature: _____ Dated: _____

Please complete the application and mail it to NSCA.
Make checks payable to:
National Sound and Communications Association

Reader Service #239

CONVENTION REVIEW

by Nancy Peterson

ICIA '86/COMMTEX INTERNATIONAL and NATA SHOWCASE

Last January 18-20 the International Communications Industries Association (the ICIA, formerly NAVA) in co-sponsorship with the Association for Educational Communications & Technology (AECT) held its ICIA '86/Commtext International trade show and conventions in Las Vegas, NV.

"We consider the show a very big success," Jerome Raymond, convention general chairman said. "We had excellent attendance. And in the year to come, we're looking forward to instituting new programs to benefit our members, as well as plan a very successful show for next year in Atlanta."

Although this year's show was shortened by one day, the sponsoring associations lengthened the open hours so that members would have ample time to see the exhibits and talk to the manufacturers. The shorter format seemed not to have affected attendance.

According to Bobbie Hunt, director of information and membership services at the ICIA, the show had over 10,000 attendees and 365 exhibitors. The ICIA boasts that "it is the largest trade show in the world of its kind."

Yet, Hunt said, next year's ICIA/Commtext International in Atlanta, GA, is scheduled for late February because it conflicts with the Consumer Electronics Show and the Superbowl.

"CES was scheduled on the same days in another city," Hunt said. "We felt we had to move the show or put a burden on our exhibitors who show at both."

"The following year we'll be pretty much back on track. Although we will be scheduling the show closer to the

flucting with the Superbowl," Hunt said.

On the opening day of the show, J. Philip Stack, president of Sony Communications Products Company, addressed association members. In his speech, Stack traced the growth of video from the early days of improvised professional broadcast equipment to the specialized business and education systems of today. He also took a look at present and future technologies and how they will affect the coming generations of business communications.

On the education program of this year's ICIA/Commtext International were six programs and seminars covering sales, management and "state-of-the-art topics" planned by the association's Professional Education Training (PET) Committee.

On January 12-16, prior to the opening of the ICIA/Commtext International, the PET Committee sponsored the Institute for Professional Development, a "highly-acclaimed" sales program whose schedule this year covered *Preparing the New Salesperson, Developing Your Business Plan, Basic Video Technology and Sales, and Rental Management*.

In addition, CTS certified seminars held during the show included *Sales and Promotion Techniques, Using Computers for Inventory Control, Credit and Collection Techniques, and Computer Projection*.

And finally, 1985 ICIA President George Bacon's term ended and Jerome Raymond was named 1986 ICIA president. Raymond, this year's

convention general chairman, is president of Willoughby's V.I.P. Division in New York, NY. In his volunteer capacity he will serve as Regional Director and Chairman of the Membership Committee.

NATA 85 Annual Convention and Exhibition Showcase

Last December 3-6, the North American Telecommunications Association (NATA) held its Annual Convention and Exhibition Showcase at the Infomart in Dallas, TX. According to NATA's Convention Department in Washington, D.C., the 1985 convention saw 7,098 attendees visit 544 booths representing some 177 companies. "This was the largest convention so far," a NATA spokesperson said. "But then every year it has been getting larger and larger."

The trade show of the interconnect industry, NATA85 brought together the buyers and sellers of telecommunications and data equipment for four days of seminars, speeches, award presentations, and new product announcements.

Among the educational seminars were: *Improving Productivity: "The Human Factor,"* moderated by George Floridis of RCA's Service Company; *Strategic Planning for the Small Contractor* moderated by Richard Long; *How Do Mergers and Acquisitions Affect you?* with Edwin Spievak, president of NATA, moderating; and *Trade Secrets: Successful Interconnect Selling* moderated by Terry Janocko, president, Sales Media, Inc.

And again this year, was "The Harry Newton Extravaganza" featuring the

publisher of *Teleconnect* magazine, Harry Newton.

Speakers at the convention included Rep. Richard A. Gephardt, D-MO.; Rep. Matthew Rinaldo, R-N.J., a senior Republican on the House Telecommunications Subcommittee; and a keynote address by Tom F. Carter, the founder of competition in the telecommunications industry.

The Eighth Annual Tom F. Carter Award went to John W. Hinkle, president of the Fisk Division of Centel Business Systems. Hinkle is a long-time NATA board member and a past president of the Texas Interconnect Association. This year there were two recipients of the Third Annual President's Distinguished Service Award; the late W.A. Jarvis Sr., and Fredrick K. Shaftman. Jarvis was the founder of the Jarvis Corporation, a major east coast interconnect company located in Richmond, VA. Shaftman is president and chief executive office of Universal Communication Systems Inc., a Roanoke, VA-based interconnect company.

Recently NATA announced that it will be sponsoring a new regional trade show in the west in June of this year.

Scheduled for the Moscone Center in San Francisco, CA, the show will bring together telecommunication and data communication buyers from California, Oregon, Nevada, and Washington.

According to NATA, they are predicting a registration of some 8,000 industry members at the new regional show. These figures are based on the successful attendance growth of NATA's annual showcase which has seen an increase of 14 to 22 percent in each year over the past five years.

NATA86 is scheduled for November 5-7 1986 in St. Louis, MO.

FOR MORE INFORMATION

International Communications Industries Association, 3150 Spring St., Fairfax, VA 22031-2399; (703) 273-7200

* * *

North American Telecommunications Association, 2000 M St., NW, Washington, D.C. 20036; (202) 296-9800

The Editors of Sound & Communications...are always looking for qualified contributors who wish to write for the publication on a freelance basis.

If you are involved in the Sound & Communications industries, and would like to write for the magazine bearing their name, please write to the editor at the below address and outline your experience and particular interests.

Thousands may share your interests, and we're willing to share them with our readers.

The Editor
Sound & Communications
220 Westbury Ave.,
Carle Place, NY 11514
(516) 334-7880.

SOUND SOLUTIONS

EXPECT MORE FROM STENTOFON

... More selection.

In addition to a full line of intercom systems, we also offer the complete line of teleCOURIER pocket-paging systems.

... More quality.

Our product quality is not only built-in, it's also tested-out... more thoroughly than any other manufacturer. This superior quality lets you offer the ultimate in performance-proven intercom and paging systems.



... More services.

Internal communications is not a side-line with Stentofon. It's our

only business. As such, you can expect more back-up services in design, engineering, parts, sales and installation expertise.

... More profitable sales.

With more selection, quality and service from our business, you can expect more profitable sales in your business. That's the bottom-line reason for making Stentofon your top-line choice.

Call or write, today.

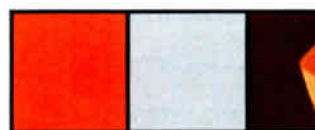

All desk stations available in choice of Designer Orange, Neutral Gray or Walnut Brown colors.



STENTOFON®
We've got the answers.

Stentofon Communications Inc.
6012 Parretta Drive
Kansas City, MO 64120
(816) 231-7200

National Sound and Communications Association



Harold Lander, President

Here's the
ONLY
working vacation
worth closing
up shop for!

If You're a **REAL** Contractor
You've **GOTTA** Be Here!



National Sound and
Communications
Association

Don't Miss the Fourth Annual

NSCA CONTRACTORS EXPO • WORKSHOPS • EXHIBITS • AND MORE '86

April 29, 30 & May 1, 1986 Las Vegas, Nevada

Register now, or you'll miss the most important
Contractor Conference and Expo of the year!



National Sound and
Communications
Association

For Information
Package Phone

312/593-8360

Free Shuttle to Electronic
Distribution Show



NSCA CONTRACTORS EXPO • WORKSHOPS • EXHIBITS • AND MORE '86

_____ Company Name

_____ Address

_____ City, State, Zip

_____ Telephone

Contractor Representative Manufacturer Consultant
 Trade Press Other

Expo Registrations: FREE
***WORKSHOP REGISTRATIONS:** Member Companies: \$75/person 3 days; \$30 1 day
 *Non-Member Contractors: Add \$100.00 per company (which may be applied to membership dues).

My check for \$ _____ is enclosed to pay for _____ conference registrants.
 (Make checks payable to NSCA Contractors Expo.)

NSCA Member Non-Member

NSCA CONTRACTORS EXPO
 501 W. Algonquin Road
 Arlington Heights, Illinois 60005

PRODUCTS IN REVIEW

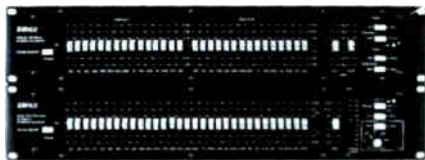

ASHLY AUDIO OFFERS NEW LINE OF GRAPHIC EQs

Ashly Audio has introduced a new series of Graphic Equalizers.

Precision Wein-Bridge filters and newly designed summing amplifiers combine to provide accurate response, low noise, negligible distortion, and complete immunity to magnetic fields. All units exhibit constant "Q" response with no broadening near the "flat" setting. High slew-rate circuitry throughout the signal path results in clean, quiet, transparent sound. The faders used are a custom manufactured metal-shaft type, with molded saddle knobs.

Ashly's "T-Beam" front panel construction eliminates interconnections between the faders and the filters resulting in a very rugged and rigid front panel.

Three models are currently being offered. The GQ215 features two channels of 15 band two-third octave equalization and a switchable high pass filter. The GQ131 is a single-channel 31 band model, while the GQ231 features two channels of one-third octave. Both the GQ131 and GQ231 offer tunable high-pass filter circuits. Each model in the line features switch-selectable cut or boost of either 6 dB or 15 dB.

□ Contact: Bob French, Ashly Audio, Inc., 100 Fernwood Ave., Rochester, NY 14621; (716) 544-5191.

Reader Service #5

SONY EXPANDS MINIATURE LAVALIER MIC LINE

Sony Professional Audio Division has introduced a fourth microphone to expand a miniature lavalier series that already includes the world's smallest high performance mic, the ECM-77.

The new ECM-44 will join the ECM-77, ECM-66, and ECM-55 introduced earlier this year. Sony's lowest priced lavalier, the ECM-44 is a general application mic, with omni-

directional pickup and an 8.5 mm capsule diameter.

According to Sony, all four microphones are engineered to combine miniaturization and attractive styling with the highest level of audio performance. The mics are intended for applications where unobtrusive or concealed pickup is necessary or for miking dialog or musical instruments.

The ECM-44 offers a reliable, cost-effective alternative to the general pur-



pose ECM-55 for less demanding applications. Designed for omni-directional pickup, the ECM-44 provides frequency response from 40 to 15,000 Hz, and a small 8.5-millimeter diameter capsule. It is available with either XLR connector or a pigtail at the output. In the pigtail version, the ECM-44's cost and performance make it especially suitable for OEM applications.

□ Contact: Sony Communications Product Company, Sony Drive, Park Ridge, NJ 07656; (201) 930-6432.

Reader Service #6

FANE INTRODUCES NEW COMPRESSION DRIVER

A new compression driver has been introduced by Fane Professional Products Division. The driver features a two-inch throat entry. (This model, designated the MD4100, was announced in 1984 and is now in production and ready for shipment to the American dealers.)

The MD4100 has an RMS power rating of 100 wats and operates smoothly over the range of 800 to 17,000 Hz with an average sensitivity of 100 dB. This unit employs a field



replaceable four-inch Titanium diaphragm assembly and incorporates the standard four-bolt mounting attachment. There is an optional support bracket, model # MB1, available for the MD4100.

□ Contact: Fane America, P.O. Box 2344, Fort Worth, TX 76113; (817) 336-5114.

Reader Service #7



ENVIRONMENTAL CCTV CAMERA FROM G.E.

General Electric Company's closed-circuit television division has introduced a new series of self-contained, pressurized housing, environmental television cameras. The 4TE50E series of television cameras are designed for industrial use in operating environments which may be unusually harsh; however, require continued, reliable performance in monitoring a critical function.

The camera and lens combination are contained in a sealed cylindrical housing which is purged and pressurized with dry nitrogen to keep moisture, dust, oily deposits, and condensation from appearing on the window, therefore defrosters or window

(continued on page 37)

PRODUCTS IN REVIEW

a closer look

by gary d. davis

HARRISON SERIES 10 CONSOLE WITH DIGITIZED CONTROLS

At the 79th Audio Engineering Society Convention, held in New York in October of last year, Harrison Systems, Inc. debuted its new Series 10 console. The system is noteworthy in that every operator control is digitized and serves as an input device for a network of computers. The computers, in turn, effect changes to the analog audio signal through the use of DCAs (digitally-controlled amplifiers). For this reason, all functions of the console—not only faders and mutes, but also EQ, pan, routing, and dynamics processing—may be automated.

Company president Dave Harrison describes the Series 10 as “the first console system to be designed and built with total integration of micro-processor technology.” Each Series 10 module “strip” houses two high-speed CMOS processors which control that module’s analog audio signal-processing circuitry. The module computers are serviced in groups of 16 by local automation slave processors which, in turn, communicate with a separate, rack-mounted host computer for automation functions. Automation data is stored on a 20 megabyte hard disk, and the automation of control functions is said to be sufficiently fast to reset the entire console in less than one video frame (1/30 second).

Each individual Series 10 module controls two separate audio paths, switched by means of a pair of pushbuttons located directly above a motorized fader; the two paths may be operated separately (a double input channel) or as a tracking stereo pair. Equalization, pan, auxiliary sends and dynamics processing (compression and gating) are all controlled by a set of five rotary controls on each strip. These controls are “assignable”—that is, the function of a given control is not fixed. The same knob that at one moment controls an EQ section may become a pan control at the push of a button. This design reduces the number of controls on the module face, and is said to enhance the speed

of operation.

All other console functions are addressed from a central control panel which is divided into two sections. The “Shared Facilities” section controls individual modules, one at a time, allowing determination of module signal flow, routing assignments, and grouping. The “Global Facilities” section, on the other hand, affects the entire console at once. It is used to select different modes for the metering, muting and solo functions, as well as providing master control of the

leap for this talented designer.

With the Series 10, Harrison Systems, Inc. has taken by the horns an idea that has been charging through the console manufacturing community of late—the concept of the assignable (or “virtual”) console. While assignability and automation of operator controls offers numerous potential advantages, it also raises serious and complex questions of ergonomics and sonic quality. These questions, coupled with the significant costs involved in the research and

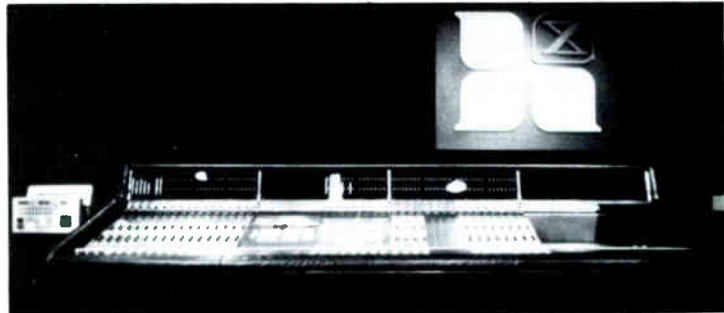

automation (including 32 external events triggers).

The Series 10 makes extensive use of LEDs for operator feedback. In addition to 40-segment bargraph meters (which can be assigned to be peak or VU reading), each strip incorporates LED displays of routing, along with a four-character alphanumeric labeling panel. The function and settings of the assignable controls are also indicated by LEDs, and the central control panel includes larger alphanumeric panels for display of automation, assignment and labeling information.

Comment: Over the years, Dave Harrison has been responsible for several innovations in console design, chiefly in the areas of architecture and operational control. He is generally credited as the designer of the first in-line console, a custom unit produced for Johnny Cash when Harrison was under contract to MCI. (Other console designers also were pursuing the concept at the same time, however.) The Series 10 represents another major

design process, have resulted in an understandably cautious attitude on the part of most manufacturers. The decision to develop and market this console could therefore be seen as a brave move, but Harrison has carefully hedged their bet.

The Series 10 represents a clever compromise between the seductions of computer technology and the real concerns of working audio professionals. For example, the use of distributed multi-processing architecture should enhance reliability, since the system is not dependent upon a single central computer for its operation. Furthermore, Harrison has opted for operational features and displays that mimic those of a conventional console, so operators may find that they can use the Series 10 in a relatively short period of time. (Harrison has stated, in fact, that they have intentionally downplayed the apparent presence of the computer system, and the system does not use a CRT for operator feedback.)

(continued on page 49)

(continued from page 35)

fans are not required. Proven reliable circuitry is used and a number of one-inch vidicons and intensified image tubes are available for any lighting condition from bright sunlight down to moonlight. A wide selection of fixed focal length, zoom, and automatic iris lenses are available to provide the viewing coverage needed. Automatic compensation adjusts for changes in scene illumination.

□ Contact: General Electric Company, Closed Circuit Television, 316 E. 9th St., Owensboro, KY 42301; (502) 685-6200.

Reader Service #8



HME ADDS LOUDSPEAKER INTERCOM TO 700 SERIES

HM Electronics, Inc. (HME) has introduced the RL742, a two-channel rack-mounted loudspeaker intercom station. The RL742 is compatible with all HME 700 Series products, as well as other popular three wire intercom systems. The RL742 features simultaneous talk/listen via a headset or handset. An automatic loudspeaker mute function mutes the loudspeaker when headphones are connected, or when the button is depressed on the push-to-talk microphone.

Phantom power can be supplied to electret microphones via an internal switch for use with lightweight electret headsets.

The RL742, for theater, broadcast, and sound reinforcement, takes up two rack spaces in a standard 19-inch rack. It is now available at a professional net price of \$260.

□ Contact: HM Electronics, Inc., 9675 Business Park Ave., San Diego, CA 92131; (619) 578-8300.

Reader Service #9

SHURE ANNOUNCES FP32 COMPACT STEREO MIXER

Shure Brothers Inc. has announced the introduction of the FP32 Stereo Field Production Mixer. According to Shure, the FP32 was created in re-



sponse to the increasingly sophisticated demands of broadcast audio field production and growing popularity of stereo broadcasts.

"The FP32s design was inspired by our hugely successful FP31 Mixer, introduced in 1983," said John F. Phelan, Shure's professional products marketing manager. "As the FP31 grew in popularity, we received many requests for a stereo version—an extremely compact, rugged mixer with full stereo capability. With the introduction of stereo television broadcasts, the need for such a mixer has become critical, and the FP32 is the ideal answer."

Features include two transformer-

isolated outputs (one for each stereo channel) and three transformer-isolated input channels, each of which includes a level control, center-detented stereo pan pot, and a switch permitting mic- or line-level operation. The mixer's stereo capability is further enhanced by a concentric clutched stereo master gain control.

The FP32's professional user's net price is \$1,200.

□ Contact: Shure Brothers Inc., Customer Services Department, 222 Hartrey Ave., Evanston, IL 60202-3696; (312) 866-2532.

Reader Service #10

MISCO INTRODUCES WATERPROOF SPEAKERS

Misco has announced two new four-inch waterproof speakers for paging, background music, and voice communications.

The JC5WP, constructed of a vinyl-

SMART SPEAKERS...

ENVIRONMENTAL SOUND® has developed a new class of loudspeaker technology engineered primarily for **SOUND CONTRACTING, CONSULTING, and ARCHITECTURAL FIRMS.**

If you haven't already heard, introduce yourself to the **PROFESSIONAL DROP CEILING MONITOR and ES SERIES.** Innovative versatility allowing numerous applications so as to shape the future state-of-the-art loudspeaker and to improve cost effectiveness from installation to sound quality. **ENVIRONMENTAL SOUND®** has heard what the sound contractor needs!

The **PRO DROP CEILING MONITOR and ES SERIES** represent a brilliant achievement required for today's technology that until now has been overlooked and neglected.



FOR SOUND THINKERS.



"For Those Who Listen"

ENVIRONMENTAL SOUND®
31220 LaBaya Dr. #110, Westlake Village, CA 91362 (818) 706-0228

SEE US AT NSCA BOOTH #90

Reader Service #261

impregnated cloth cone to withstand actual immersion in water, is a full range speaker and will fit standard four-inch baffles. It is suited for lockerooms, pool areas, saunas, outdoor shopping malls, patio or lounge areas as well as marine applications. Sensitivity is 95 dB, 1W/1M. The JC5WP comes with or without pre-mounted transformer.

The JC5WI, a four-inch voice communication speaker, is also completely immersible and will withstand tough environments according to Misco. Its high sensitivity (102 dB, 1W/1M), broad dispersion, and low frequency, ambient noise filter can be used for two-way voice communications, paging, and menu board installations. It may also be used as a substitute for many paging and intercom horns. Talk-back (microphone) sensitivity is excellent. The JC5WI has a flexible mounting hole configuration to make it easily adaptable to job requirements.

Contact: Misco/Minneapolis

Speaker Company, 3806 Grand Ave., Minneapolis, MN 55409; (612) 825-1010.

Reader Service #11

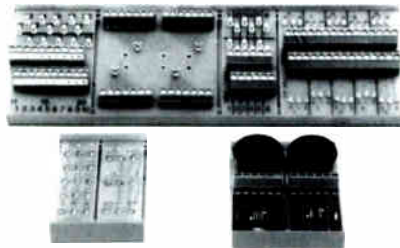

RACK INTERCONNECT CARDS FROM FSR, INC.

A new series of interconnect cards is now available from FSR, Inc. The small, track-mounted cards, are available for rack demarcation; audio wiring; power supply distribution; and transformer cards.

Priced from \$8, these cards provide

organization, convenience, and diversity to an equipment rack.

Contact: FSR, Inc., 40 Commerce Road, Cedar Grove, NJ 07009; (201) 783-3966.

Reader Service #12

AIPHONE DEBUTS GOOSENECK MICROPHONE

Aiphone Corporation has introduced a new, professional-quality low impedance electret condenser gooseneck microphone for use with all of its open-voice systems.

The slim, chrome-finished design features a one-half-inch diameter unidirectional ECM with a frequency response of 70 to 20,000 Hz. The ultra-slim gooseneck measures only 9/32 of an inch in diameter.

Total length of the GM-12F gooseneck microphone is 13 3/16 inches,



with 7.5 feet of cable and a black urethane foam shield provided.

Contact: Aiphone Corp., P.O. Box 90075, Bellevue, WA 98009; (206) 455-0510.

Reader Service #13

HIGH NOISE PROBLEM? ADCO Intercoms are the solution

We design intercoms specifically for high noise area use—to deliver clear, penetrating voice communication under the most difficult conditions. In factory production areas, machine shops, steel mills and foundries, loading areas, etc.

Intercom housing is a heavy-duty aluminum casting... fully sealed against dust and dirt, corrosion-proof, weatherproof for use indoors or out. All transistorized for dependability. Effective range is from a few feet to several miles.

Each unit both transmits and receives, so only one is required per station. Installation is simple, practical: plug each intercom into power source, make ordinary 2-wire connection between units.

Full range of models includes compatibility with existing sound-power telephone systems. Request complete catalog.



Reader Service #262

ATKINSON DYNAMICS

A Division of
Guy F Atkinson Company

10 West Orange Avenue
Department R
South San Francisco,
CA 94080

Phone (415) 583-9845



HANDS FREE TALK-BACK PAGING SYSTEMS BY VIKING

Viking Electronics has introduced a low cost hands free talk-back paging amplifier for shipping, city desk, warehouse, service desk, or anywhere

(continued on page 42)



New Paging Control for Centrex and PBX Systems Debuts

Tone Commander has introduced the PCU 8 Paging Control Unit which connects directly to unused line keys on a Centracom console or key telephone, or can be accessed via CO or PBX station loops. Eight zones of paging with all call can be selected with tone or rotary dialing.

The PCU 8 uses external amplifiers or amplified speakers. It includes a background music input, volume controls, dial tone, and paging alert tone. Paging disconnect is initiated by a built-in voice detect (VOX) circuit, loop detector, or an adjustable timeout. The compact PCU 8 wall mounts in the telephone equipment room.

Contact: Tone Commander, 4320 150th Ave. NE, Redmond, WA 98502; (800) 524-0024.

Reader Service #1

Competitively Priced Equipment Rack from CWY

CWY Electronics has introduced a 72-inch high equipment rack priced up to 25 percent below competitive racks.

The RR72 rack provides 70 inches of panel space with 40 rail spaces. Panel rails are drilled and tapped for 10-32 screws on EIA-Retma rack spacing of one-half-inch to 1.25 inches. The RR72 rack is constructed of 11-gauge formed steel and features a standard ASA 61 gray baked enamel finish. A number of rack accessories are available, including a shelf for mounting equipment not having an attached rack mount panel, a series of blank panels, a punched panel for mounting of "F" and "BNC" connectors, a rail support bracket to add

rear support to rack-mounted equipment and a roll base for convenient moving of the rack.

Contact: CWY Electronics, P.O. Box 4519, Lafayette, IN 47903; (317) 448-1611.

Reader Service #2

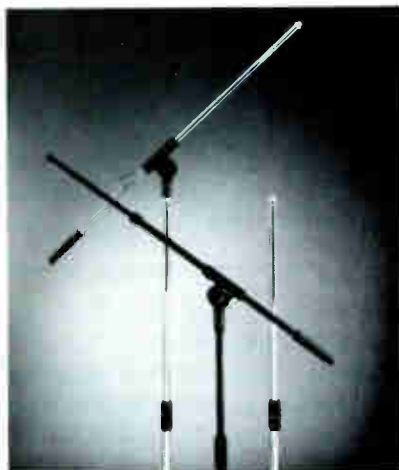

ATUS™ Mic Stands and Booms Premiere at NAMM Market

"ATUS" is not only the designation of a new series of microphone stands and booms, but a new name in professional sound, as well. Both—the brand name and the product line—made their first appearance at Anaheim, CA, at the National Association of Music Merchants Winter Market last January at the Audio-Technica exhibit.

The microphone stands and related products make up three categories: floor stands; boom assemblies; and combinations: floor stands with booms.

Because the products are made to Audio-Technica specifications by a West German manufacturer, they will be marketed under the name ATUS, rather than Audio-Technica. Even so, according to A-T national sales manager Mark Taylor, "they will be distributed exclusively by Audio-Technica and will offer design features not found in any other line."

The two floor stands in the line extend from 35 inches to 62-inches in height, but the Model AS500-C (\$49.50, professional net) is chrome-plated, while the AS500-B (also \$49.50, professional net) is matte-black, overall.

The two ATUS boom assemblies (both of which are \$28, professional

net) extend from 16.5 inches to 32 inches. The Model AB500-C is chrome-plated, while the AB500-B is finished in matte-black. The angle adjustment device on ATUS booms, it is claimed by A-T, is the most advanced design available, permitting easy, reliable settings.

The two floor stand/boom combinations include the Model ASB450-C, a full-size (35 to 62.5 inches), chrome-plated stand with a 33-inch single-section boom (\$70.00, professional net); and the model ASB510-B, a low profile stand (12.5 to 24.5 inches), finished in matte-black, suggested for use with drum miking and other low-level uses. Pro net is \$65.

Contact: Audio-Technica, 1221 Commerce Dr., Stow, OH, 42244; (216) 686-2600.

Reader Service #3



Belden Introduces Conformable High Temperature Coax Cable

Belden Electronic Wire and Cable offers high-temperature coaxial cable with a copper-tin composite shield in 50- and 75-ohm versions. Part numbers 9307 and 9308 are miniature cables with a .084-inch outside shield diameter. Both cables are ideal substitutes for semi-rigid, copper-sheathed coaxial cable in applications where compact electronic packaging and tight bending radii are required.

Belden's conformable coax is lightweight and flexible, able to be formed by hand without the need for forming tools. Connectorization is straightforward since conformable coaxial cables are compatible with most non-crimp connectors.

Contact: Pat Mikesell, Marketing Communications, Belden Electronic Wire and Cable, P.O. Box 1980, Richmond, IN 47375; (317) 983-5200.

Reader Service #4

FACES AND PLACES

J.W. Davis & Company Elects Charles A. Griffiths President

Charles A. Griffiths has been elected president and chief operating officer of J.W. Davis & Company. Griffiths previously had served as controller since 1981, and vice president-finance since 1984.

Griffiths received a B.S. degree in Business Administration from Michigan Technological University, and did graduate work at Ball State University.

M.H. Earp continues his position as chairman and chief executive officer.



CHARLES A. GRIFFITHS



GEORGE F. CURRIE

Sony Promotes Currie To President Pro Audio Division

Sony Corporation of America has promoted George F. Currie to president, Sony Professional Audio Division, it was announced by Neil Vander Dussen, president.

"As vice president in charge of Professional Audio Division, George Currie has expanded our marketing and sales organization and broadened our customer support capability," said Vander Dussen. "We look forward to the pro audio group continuing to grow under his leadership."

Currie joined Sony in 1973 and was appointed vice president, Sony Professional Audio Division in 1983. Previously, he held regional management positions in the company's Communications Products Company.

Strand Appointed National Sales Manager at Community

Community Light & Sound, Inc. has announced that John Strand has become the company's national sales manager effective as of January 1, 1986. Strand, who entered Community's sales force in 1984 as a regional

sales manager, will replace Thomas Walter, who resigned the post to pursue other interests.

Strand graduated from the University of Wisconsin in 1980 with a B.S. in electrical engineering. Shortly thereafter, he was employed as an applications engineer for Bose pro products, and then went on to a sales position at Klipsch and Associates before joining forces with Community. One of his first priorities in his new capacity will be coordinating the sales efforts of Community's new CS Series of loudspeaker systems.

Altec Lansing Appoints Rusch VP, Engineering

Edward Rusch has been appointed vice president of engineering at Altec Lansing Corporation, announced F. Davis Merrey, Jr., president of Altec. In his new position, he is responsible for the electronic and acoustical research laboratories at the company.

Rusch has more than 20 years experience at engineering and engineering administration for audio manufacturers, at Shure Brothers, Inc., and then at Peavey Electronic Corp. He has developed several patented designs, and his work has been the subject of a number of engineering papers.



EDWARD RUSCH



ROBB RICE

Bogen Appoints Rice Telecommunications Manager

Bogen, A Lear Siegler Company, has expanded its telecommunications sales staff with the addition of Robb Rice as telecommunications products manager, Carl C. Dorwaldt, vice president of marketing, announced.

Rice comes to Bogen following three years with Harris Corporation's Lanier Business Products, Atlanta,

GA. There he sold electronic key systems and PBXs and later became a telecommunications buyer.

Kurtz Named New Regional Manager At Speco

Mel Hulkower, vice president/sales at Speco, has announced the addition of Bruce Kurtz to the executive sales staff.

Kurtz will be a regional manager for Speco covering specific territories throughout the country. He will be working with manufacturer reps, calling on and servicing key accounts.



BRUCE KURTZ



BRUCE MARKET

Yamaha Adds Video To New National Sales Manager's Duties

Yamaha Electronics Corporation has announced that Bruce Market has been named to the newly created post of national sales manager for the company's expanding line of video products. Market joined Yamaha in 1983 and adds video responsibilities to the position he holds as national sales manager for Concert Systems, Yamaha's line of one-brand audio systems.

Market's experience combines sales and marketing for both audio and video products and the fit is a natural extension of his duties at Yamaha, said Steve Girod, Yamaha's national manager of marketing and sales. "Since we first entered the video business, Bruce has been a resource for us," Girod said. "The new title acknowledges what he has been doing for close to a year."

Market joined Yamaha from Fisher Corporation where he had been national sales manager for TV, NSM for portable high fidelity, key accounts manager, and directory of sales training.

REP NEWS

Charlie Winkler, marketing director of the Audio-Technica professional products division, has resigned to form a professional sound products sales representative firm, **Charlie Winkler & Associates**, it was announced. He will work out of Uniontown, OH, calling on dealers and distributors in Ohio, Pennsylvania, and West Virginia.

"My seven-plus Audio-Technica years have given me an opportunity to participate directly in the development of one of the industry's fastest-growing product lines," Winkler said. "It has been rewarding but, now that the line has been established, I'm eager for a new challenge. I've long felt there is a need for another sound products rep firm in this area, and I hope to fill that need."

David Moore, sales manager of **Paso Sound Products**, has announced the appointment of **Dimension Point IX Marketing** as the company's representative within UTP territories 21A, 22, and 23 including Texas, Oklahoma, Arkansas, and Louisiana.

The appointment, which became effective December 1, 1985, gives the firm full responsibility for sales of all Elvox Intercom, Paso Packaged Sound Systems, Commercial Sound Products, and Professional Sound Products.

The representative firm headed by **Terry Green** in Dallas, TX, and **Phil Canavespe** in Houston, TX, brings extensive sound and communication experience to the region.

Basel Marketing Corp (BMC) has appointed several independent sales representative firms to assist in its plan which offers all the services a retailer needs to get into and stay in the cellular telephone business. Joining the BMC team are **Bernard Carter Associates**, North Hollywood, CA (So. CA, NV and AZ); **Al Moskau & Associates**, Dallas, TX (TX, OK, AK, and LA); **Ron Fisher Sales, Inc.**, Overland Park, KS (NB, KS, IA, MO); **Stan Axelrod Associates, Inc.**, Englewood, NJ (No. NJ, Metro and Long Island, NY); **North Delta Sales Corp.**, Mt Laurel, NJ (E. PA, So. NJ, MD, DC, and DE); **Silverman Sayre Services**, Miami FL (FL), and **Omega U.S.**, Honolulu.

A perfect marriage of

NEW



lightweight comfort and heavy-duty protection.

Telex PH Series marries these two advantages to exceed even the toughest industrial requirements!

- Dynamic receivers resist mechanical shock, moisture and temperature extremes.
- Impact resistant earphone cups.
- Soft polyurethane cushion covers are resistant to temperature and ultra-violet extremes.
- Long-life superflex cable with strain relief.
- Vinyl covered, stainless steel split headband.
- Stainless steel adjustable yoke assemblies.
- Field replaceable dynamic mike and earphone elements save time and money.

Tough PH Series designed for user comfort

- Perfect clamping pressure for day-long use.
- Soft foam pads on headband and earcups.
- Washable nylon earphone socks.
- Headband has air vents to keep head cool.
- Clothing clip.
- Mike boom rotates for right or left side useage.

Ask about our wide variety of models

- Dual/single sided.
- Dynamic/carbon mikes.
- Binaural/monaural earphones.
- With/without in-line push-to-talk switch.



Single side models available.

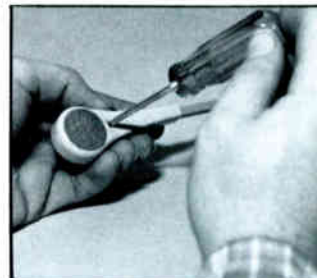

Dynamic models have economical, field replaceable mike elements

TELEX®

TELEX COMMUNICATIONS, INC.

9600 Aldrich Ave So., Minneapolis, MN 55420 U.S.A., Telephone: 612-887-5550, 884-4051, telex: 29-7053

Call Toll Free in U.S. 800-328-3771 • In Minnesota Call (612) 887-5550

AD INDEX

RS#	Company	Page
232	Altec Lansing	III
262	Atkinson Dynamics	38
256	Bogen	7
234	Cetec Vega	19
243	Cornell	24
235	Edcom	18
253	Edcor	43
236	Electro-Voice	II
261	Environmental Sound	37
255	Hammond	45
237	IED	6
238	Numark	27
239	NSCA	31
251	Rane	11
266	Rauland Borg	13
252	Ring	3
240, 258	Shure	23, IV
241	Sonic Systems	26
242	Stentofon	33
254	Talk-A-Phone	42
257, 201	Telex	5, 41

(continued from page 38)

quick answers are needed.

Model HF-2WB is compatible with 1A2, electronics key, "No KSU" multi-line, and single line telephones. Model HF-2WB can serve a 25 to 100-foot work radius and power up to three 8 ohm paging horns. The unit operates on any unused truck line (providing "1-button" access) and generates talk battery for 1A2, or "Non KSU" telephones.

The HF-2WB System costs \$96 and includes a one year warranty.

□ Contact: Rosemary Olson, Customer Service Department, P.O. Box 362 Hudson, WI 54016; (715) 386-8861.

Reader Service #14

NEW ULTRA-HIGH-CURRENT MOSFET STEREO AMP

Soundcraftsmen's continuing research into advanced amplifier technology has resulted in the Ultra-High-

Current "Phase-Control-Regulation®" (PCR) power amplifier, the model PM860. Combining PCR technology with Power Mosfet output circuitry, Soundcraftsmen engineers have produced an amplifier offering clear performance advantages.

The PM860 will continue to operate at maximum power output even when speaker impedances drop below 1 ohm. Soundcraftsmen said it is well-known that some of the most highly-regarded loudspeaker systems available exhibit impedance curves which drop as low as 1 ohm at certain frequencies, resulting in severe amplifier clipping and triggering protective circuitry in conventional amplifiers.

Current-limiting is eliminated entirely in the PM860, completely avoiding the sonic degradation typical of this type of commonly used output stage protection circuitry.

The PM860 is matched to a 70 volt line without the need for a matching transformer, when mono bridged us-

Automatic hands-free communication between Menu Board and Window Order Taker

TALK-A-PHONE

Fast food drive-up intercoms



TAP-1R Single Station Master



TAP-4R Four-Station Master

Rugged and dependable with exceptional intelligibility

Neither Master nor Sub uses controls with TALK-A-PHONE Fast Food Drive-up Intercoms. Background noises are suppressed to provide exceptional intelligibility even in noisy locations. Talk-A-Phone Intercoms can be used with customer's new or existing vehicle detector.

TALK-A-PHONE CO.
5013 NORTH KEDZIE AVE. • CHICAGO, IL 60625
(312) 539-1100 DEPT. SC

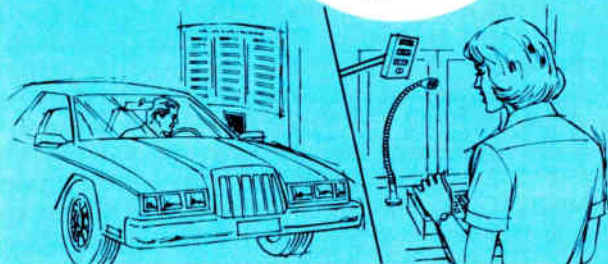

Reader Service #254

ing an optional adapter.

□ Contact: Soundcraftsmen, 2200 S. Ritchey, Santa Ana, CA 92705; (714) 556-6191

Reader Service #15



CERWIN-VEGA IMPROVES V-43 FULL RANGE SYSTEM

Cerwin-Vega has announced an improved version of its V-43 portable sound reinforcement speaker system. The V-43 is a high-quality music playback speaker system, for high-power keyboard monitoring and high-intensity stage and side-fill monitoring. The V-43 is a full-range, all horn-loaded three-way speaker system capable of high performance without biamplification. The system uses a compact single throat folded bass horn (40 Hz to 300 Hz) which uses a three-inch voice-coil, 18-inch, 400 W (EIA) driver and low-level equalization to achieve free-standing power response into the 40 Hz region.

The midrange (300 Hz to 3 kHz) is reproduced by a wooden two-inch throat exponential/hyperbolic horn powered by C-V's ultra-low distortion M-161, 150W (EIA), nodally driven 4.5-inch phenolic dome compression driver. The large-throat driver/horn design allows the unit to generate extremely high sound pressures with just a fraction of the distortion exhibited by competing systems. The exceptional sensitivity (107dB/1W/1M), power capacity, and bandwidth of the M-161 replaces "power hungry" midbass cone drivers without costly biamping.

High frequencies are reproduced by

a H-25 compression driver and integral horn (3 Hz to 20 Hz). The H-25 features an oversized barium ferrite magnet driving a lightweight one-inch phenolic dome and aluminum wire voice-coil assembly. The tweeter is unconditionally protected from inadvertent overpowering by a self-resetting circuit breaker.

Manufacturer's suggested retail price is \$1,500 each.

□ Contact: Cerwin-Vega, 12250 Montague St., Arleta, CA 91331; (818) 896-0777.

Reader Service #16

AUDIX ANNOUNCES MOSFET "POWERBLOCS" MODULE

Audix has announced the launch of a range of power amplifiers introducing the latest generation of MOSFET power devices.

MOSFET "Powerblocs," developed by Audix engineers, are an entirely new, compact and efficient 60

watt module which can be fitted in parallel into any Audix Power Amplifier to provide a wide range of outputs. This allows an amplifier chassis to be fitted with an individual or a combination of 60 watt Powerblocs to provide 100 volt line outputs of 60, 120, 180, or 240 watts RMS.

The Audix Power Amplifiers are the first in a line of new introductions. The MPA Series MOSFET Modular Amplifiers, a series of Mains or 24 volt DC Powered Slave Amplifiers, are available now. The successful Audix 'Wenden' series—a high quality modular mixer/amplifier range, incorporating MOSFET Powerblocs, were available as of January. As of Spring 1986, the versatile and low cost Audix 'Newport' integrated mixer/ amplifier range will also be available.

□ Contact: Audix Limited, Wenden, Saffron Walden, Essex CB11 4LG England; (0799) 40888.

Reader Service #17

NEED
MIXER AMPS

Call
EDCOR
800 854-0259
800 523-2824 CA
714 863-1529

EDCOR 16782 Hale Ave. Irvine, CA 92714

Reader Service #253

Closed Circuit Television

Short Form Catalog



GENERAL ELECTRIC

New Short Form Catalog On General Electric CCTV

General Electric Company's closed-circuit television has available a new short form catalog describing the line of cameras and accessories available for a complete CCTV installation.

The catalog also includes the new pressurized housing environmental camera. The camera and lens combination are contained in a sealed cylindrical housing which is purged and pressurized with dry nitrogen to keep moisture, dust, oily deposits, and corrosive atmospheres out of the housing. The dry nitrogen prevents condensation from appearing on the window, therefore defrosters or window fans are not required.

The recently introduced Lite Gard camera has automatic circuitry to ignore bright lights and produce clear, detailed pictures in otherwise obscured shadow areas.

Also featured is a video multiplexer enabling the simultaneous transmission of up to 16 separate camera signals in real time over one transmission path.

Contact: General Electric Company, Closed-Circuit Television, 316 East 9th St., Owensboro, KY 42301; (502) 685-6200.

New Intercom Concepts Brochure From Stentofon

A new, 10-page, full-color brochure entitled "Internal Communications Solutions" is available from Stentofon Communications, Inc. The brochure addresses the concept of total communications efficiency as it relates to the needs of business, professional,

and institutional organizations. It also presents the most advanced designs and capabilities of modern intercom equipment. Such equipment features Stentofon's new line of teleCourier pocket pagers and new system of message storage, which enables the status of absent employees to be transmitted in voice reply from their intercom station or in visual display at a switchboard locations.

Contact: Stentofon Communications Inc., 6012 Parretta Dr., Kansas City, MO 64120; (816) 231-7200.



Argos

600 So Sycamore St. Genoa, Illinois 60135

Argos Introduces New Sound Product Catalog

Argos Sound, manufacturer of sound products, has recently completed its revised general catalog. The new 12-page catalog (SC-86) contains information on the Argos line of sound columns, speaker/baffle systems, standard baffles, packaged sound systems and outdoor speaker/baffles. Included in the free catalog is detailed information on the Argos foreground speaker and the outdoor eaves speaker.

Contact: Argos Sound, 600 S. Sycamore St., Genoa, IL 60135; (815) 784-5118.

Brochure Describes Aiphone Retail Intercom Line

Intercom systems for retail applications are explained in a new color brochure now available from Aiphone Corporation.

The company's four most popular

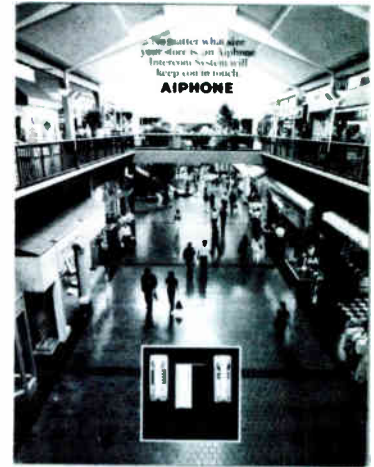

retail intercoms are featured in the six-page brochure. The four include the latest in communications and paging systems designed for department stores, discount stores, supermarkets, garden and home improvement centers, specialty stores, and small to mid-sized shops.

The sophisticated features, accessories, power and wiring requirements, and dimensions of each product are explained in clear, easy-to-understand terms. Full-color photographs show each Aiphone system in a realistic in-store setting.

Contact: Aiphone Corp., P.O. Box 90075, Bellevue, WA 98009; 1-800-692-0200; in WA, call (206) 455-0510.

Zero Corp Offers Catalog on Cabinets, Cases, & Enclosures

Zero Corporation, a designer and manufacturer of cabinets, cases, enclosures, and accessories for electronic, electro-mechanical and instrumentation equipment, has just released a new, 280-page catalog describing nearly 30 standard product lines offered by the company. These include a broad range of deep drawn aluminum boxes; carrying cases, instrument enclosures, military cases and cabinets, chassis slides and accessories; blowers and cooling systems; and rotational molded transit cases.

The new catalog also includes design ideas and engineering data, color selection charts, complete mechanical and military specifications.

Contact: C.K. Dixon, Zero Corporation, 777 Front St., P.O. Box 509, Burbank, CA 91503; (818) 846-4191.

by Ted Uzzle

Building Your Own Loudspeaker

Badmaieff, Alex, and Don Davis, *How to Build Loudspeaker Enclosures* (Howard W. Sams. & Co., 18th printing, 1985). 144 p., \$6.95.

Weems, David B., *Designing, Building, & Testing Your Own Speaker System* (Tab Books, Inc., second edition, 1984). 190 p., \$10.95.

Loudspeaker Enclosure Design and Construction (Fane Acoustics, Ltd., 286 Bradford Rd., West Yorkshire WF17 5PW, England, n.d.), 54 p., \$6.95.

Leo Beranek showed a remarkably shrewd and accurate understanding of the loudspeaker hobbyist when he remarked many years ago, in his book *Acoustics*, "...if one selects his own components, builds his own enclosure, and is convinced he has made a wise choice of design, then his own loudspeaker sounds better to him than does anyone else's loudspeaker."

This is probably the best reason for building your own loudspeaker today. Decades ago, you could save money buying the components and constructing your own cabinetry, but this is no longer true. Modern high fidelity loudspeaker systems sound very good, and, since the Japanese manufacturers entered the scene, have very low price tags. These manufacturers control their prices by mass-producing the loudspeaker systems, and by not hiring a large technical sales staff to assist the hobbyist who needs help in constructing the cabinet.

The loudspeaker builder is not completely without help, however, as there are a number of excellent books available which explain the performance of components and show ways to design and build cabinets. The classic is *How to Build Speaker Enclosures* by Alex Badmaieff and Don Davis, now in its 18th printing, with a newly designed cover. There's hardly a page in this book without an illustration, and many pages are devoted principally to photographs, construction drawings, network schematics, and the like. It's hard to imagine many audio professionals today who do not have a

worn copy on their shelves.

The opening chapter reviews the basic enclosure types, and describes the trade-offs each offers. A large number of photographs show the various types integrated into living room decor, a not insignificant consideration for many loudspeaker builders. The second chapter covers components:

how they work, and their various performance capabilities. This book is too old to show the more modern, and more theoretical, work of Small and Thiele. These two Australian researchers published their work in the United States only after *How to Build Speaker Enclosures* achieved status as a classic on the subject. This is not

We Stock

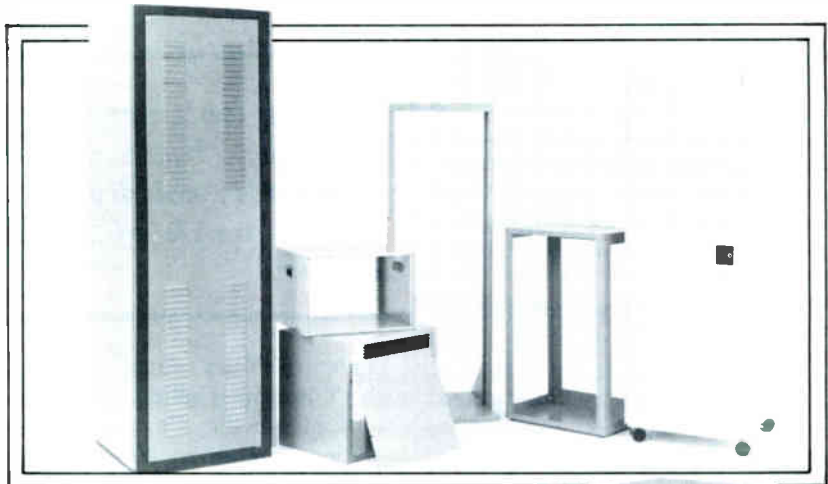

COMMERCIAL SOUND PRODUCTS

In stock now! A complete line of enclosure products for the commercial sound contractor. Racks, cases, cabinets, baffles, a wide range of mounting accessories and a complete line of audio transformers.

Send for our FREE catalog.



**HAMMOND
MANUFACTURING**

Hammond Manufacturing Co. Inc.
1690 Walden Ave.,
Buffalo, N.Y. 14225

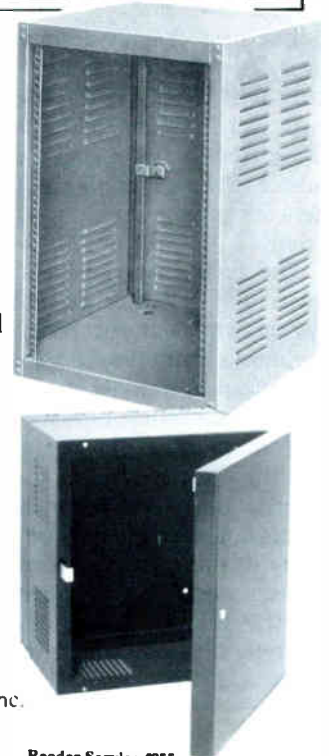

Reader Service #255

necessarily a fault, however; not very many loudspeaker hobbyists have the mathematical capability to use that research. The principal beneficiaries of the new research seem to be the manufacturing companies, who employ graduate engineers and who can use it for computer modeling and reduced "cut and listen" design.

The next four chapters cover specific enclosure types, starting with one we don't see much anymore: the infinite baffle. This type is a natural for the loudspeaker hobbyist; it's big enough to reward building it right in the home where it is to be used. It is relatively forgiving of design errors, compared to other types. Best of all, it tends to give a controlled, accurate bass, unlike vented cabinets designed for a bumped-up bass, which sound impressive at the stereo shop, but which begin to sound flabby and tubby after listening for a time.

Next come classic bass reflex designs, based on the Novak alignments and tested by measuring the changes in impedance over frequency. There is also a section on ducted ports, contributed to the book by Novak himself. The following chapter deals with bass horn designs, from the Klipsch systems to the Altec Lansing Voice of the Theatre types.

Chapter Six shows a number of hybrid designs which combine these characteristic: a bass horn with a vented back chamber, a bass reflex cabinet with a horn on the port, a Karlson enclosure, the labyrinth, and so on.

The next chapter deals with crossover networks, considering selection of crossover frequency with special reference to component performance, and the effects of slope rates on performance. Practical methods of selecting network components are described briefly.

The final chapter covers measurement of the finished loudspeaker system, and here the book shows its age most. Many simple and affordable measurement techniques have been introduced since the original publication of *How to Build Speaker Enclosures*, and these are not shown. Overall, the severest criticism that can be directed at this book is that, because of its age, many of the components used in the projects are no longer manufactured, and this hampers its usefulness to the hobbyist who itches to get right down to the construction of a loudspeaker

system. For an understanding of how loudspeakers work, it is hard to fault.

* * *

The author of *Designing, Building and Testing Your Own Speaker System*, David B. Weems, also wrote *Raising Goats: The Backyard Dairy Alternative*. Inside the former book, however, we find an up-to-date treatment of loudspeaker system design. While there isn't much theory, the author introduces and uses the symbols and nomenclature of modern design. The opening discussion on how a speaker works includes impedance, resonance, dispersion, efficiency, compliance, and damping, and the other basic ideas that will be used throughout the book. The next two chapters, on enclosures, describe briefly the different types of enclosures and mechanical considerations for building them. The following two chapters give theory and sample designs for closed box and ported box loudspeakers.

"There isn't very much theory, but what's present is solidly based on the work of Neville Thiele."

There isn't very much theory, but what's present is solidly based on the work of Neville Thiele. Numerical solutions are given through nomographs and data tables. All the designs shown are based around Radio Shack components.

Another chapter gives design solutions for musical instrument loudspeakers, including the stage monitors. Then comes a chapter on crossover networks, from the simplest bypass capacitor to much more complex three-way networks, as well as simple contour networks. Everything in this discussion is aimed toward the hobbyist builder, as it should be, but there is very little general discussion about networks and the many different options open to the designer (different configurations, slope rates, and the like).

The final chapters are devoted to choosing the design that will meet the individual hi-fi listener's requirements, and then testing the finished loudspeaker system (which is addressed at further length in the appen-

dix). The book winds up with more projects and then appendices of useful formulas and charts, and a computer program for cabinet design, flow-charted and with a program listing for Tandy TRS-80 computer.

Weems' book is less useful than that of Badmaieff and Davis if you want an understanding of how high fidelity loudspeakers work, but it is more useful to the builder who wants to jump right into a project. It also includes more of the important recent work of Small and Thiele.

* * *

Once upon a time all the manufacturers of loudspeaker components published books with detailed designs and construction examples for systems using their components. Today, unfortunately, these have become rather rare, and one of the best *Loudspeaker Enclosure Design and Construction* is published by Fane Acoustics, in England. Exactly two dozen designs are shown, clearly illustrated in plan and perspective drawings. Performance of these systems is demonstrated throughout with strip chart recordings of the response that results from the cabinets with Fane loudspeaker components inside.

The strength of this book lies in its resolute orientation toward musical applications: bands, discos, and the like. It's a wise choice, because as home high fidelity hobbyists have been tempted by the low price and high quality of factory-assembled systems, young musicians who need loudspeakers for keyboards, vocals, electric guitars, and similar applications, still face high prices for loudspeakers that will play very loud. It seems that bands that practice in garages have noticed the woodworking tools in the garages.

Fane's *Loudspeaker Enclosure Design and Construction* covers simple bass reflex cabinets and high frequency horn enclosures. Then it goes on to multi-way systems, multi-driver systems, slope front stage monitors, and bass horns that are straight, folded, and W-bin types. An opening chapter describes system selection and use for different applications, bass reflex design theory, and the mechanical construction of cabinets.

The authors and draftsmen at Fane Acoustics are to be complimented on the clarity and practicality of their book, and its suitability for its intended readers.

DATE	EVENT/COMMENT	LOCATION	CONTACT
February 24-26	Cost Effective Telecommunications Management —Controlling voice & data costs in a deregulated environment.	Sheraton Centre Towers New York, NY	Center for Advanced Professional Education (714) 261-0240
February 25-27	NTCA Expo '86 For America's independent cooperative and commercial telephone systems.	Disneyland Hotel Exhibit Hall Anaheim, CA.	Susan Coughlin (202) 298-2343
March 4-7	International Conference of the Audio Engineering Society.	Montreux, Switzerland	AES (212) 661-2355 (212) 661-8528
March 5-7	Cost Effective Telecommunications Management —Controlling voice & data costs in a deregulated environment.	Sheraton Plaza La Reina Los Angeles, CA	Center for Advanced Professional Education (714) 261-0240
March 11-13	Southcon/86 Electronics exhibition & convention.	Orange County Convention Center Orlando, FL	J. Fossler (213) 772-2965
March 26-27	Sound Engineering Seminar Two day seminar in audio and acoustics by Synergetic Audio Concepts.	Red Lion/Jantzen Beach Portland, OR	Syn-Aud-Con (714) 728-0245
April 2-3	Sound Engineering Seminar Two day seminar in audio and acoustics by Synergetic Audio Concepts.	Holiday Inn Downtown Vancouver, B.C. Canada	Syn-Aud-Con (714) 728-0245
April 3-10	ERA's 27th Marketing & Management Conference.	Vienna, Austria	ERA (312) 649-1333
April 13-16	National Association of Broadcasters annual convention.	Dallas, TX	NAB (314) 721-7717
April 15-17	International Security Conference Sound, Signal, & Security.	Los Angeles, CA	ISC (213) 826-6070
April 28-May 1	Electronics Distribution Show and Conference A major showcase for electronic components, test equipment, and accessories.	Las Vegas Hilton Hotel Las Vegas, NV	Laurence Kauffman (312) 648-1140
April 28-May 1	Contractor's Expo and Conference for contractors, suppliers, engineers, and technicians sponsored by the National Sound and Communications Association.	Las Vegas, NV	Bob Barba (313) 254-5290 NSCA (312) 593-8360

THEORY & APPLICATION

(continued from page 12)

phase cancellations are prevented. Clarity and reach are also enhanced.

The PCC-160 is intended for professional applications on stage floors, lecterns, conference tables, and news desks—wherever improved gain-before-feedback and articulation are considerations.

Its electret condenser capsule provides a uniform, wide-range frequency response for high-fidelity sound reproduction (Figure 2).

Electronics are self-contained within the microphone housing. A three-way "bass tilt" switch allows the user to tailor the low-end re-

sponse for particular applications (Figure 2). RFI suppression is included. Self-noise is low, and sensitivity is very high to help override mixer noise in distant-miking applications. Output impedance is 150 ohms, balanced.

The PCC-160 can be phantom powered directly from the console or other remote power source providing 12 to 48 volts. (Crown makes an AC-powered model PH-4 supply for powering up to four PCCs. Also available is a single-channel battery supply, Crown model PH-1.)

Capable of withstanding up to 120 dB SPL without distorting, the PCC-160 is designed not to overload in its intended speech applica-

tions. For example, a stage actor near the PCC can yell without breaking up the microphone.

Due to its low profile and dark finish, the microphone becomes almost invisible in use. A side-mounted connector complements the form factor of the PCC-160, allowing the unit to be placed effectively at the stage edge, at the top of a lectern or in other tight spots.

The heavy-gauge, all-steel body protects the unit from accidental abuse. Permanent mounting is enabled by screw holes in the base. An optional windscreen (Crown model WS-1) is available for outdoor use.

PZM vs. PCC

Is a PCC a "directional PZM?" Not really. The diaphragm of a PZM is parallel with the boundary (a patented feature); the diaphragm of a PCC is perpendicular to the boundary. Still, the PCC gains many the same benefits from surface-mounting as does the PZM.

The PCC-160 is not a replacement for the PZM. Each microphone has its own applications. The PCC is the microphone of choice when you need to increase gain-before-feedback or reduce pickup of leakage and room acoustics. PZMs are preferred when you need a uniform hemispherical pickup, a shapable polar pattern, corner mounting, 150 dB SPL capability, or a flat response down to 20 Hz.

Note that PZMs can be made directional by adding large vertical boundaries next to the mic capsule. These boundaries are usually made of clear plexiglass to make them less conspicuous. The PCC obtains its forward directionality from the mic capsule, rather than from additional boundaries.

Application Suggestions

The PCC-160 is designed for use on a surface or

boundary such as a stage floor, news desk, lectern top, etc. As with any boundary microphone, the PCC's low-frequency response depends on the size of the boundary. The published response curve is measured on an "infinite" boundary such as a floor. If the PCC is used on a table or lectern, the low-frequency response shelves down compared to the published curve. Specifically, the response shelves down 6 dB at and below the frequency $F = 188/D$, where D equals the boundary dimension in feet.

On the bottom of the microphone is a bass-tilt switch which allows the user to tailor the low-end response for particular applications. In general, the FLAT position is used. Use the CUT position to reduce room rumble and air-handler noise. Use the BOOST position to compensate for low-frequency losses when the PCC is placed on small boundaries such as lectern shelf-tops.

The PCC "aims" along the plane on which it is mounted. In other words, the main pickup axis is parallel with the plane. The included angle of acceptance is about 120 degrees horizontal and 45 degrees vertical.

Specific Applications

News desks: The PCC can eliminate lavalier microphones in news-desk applications. It disappears on camera. Again, the PCC should be placed on an unobstructed surface if possible. Set the BASS TILT switch so that the PCC's tone quality matches that of lavalier microphones.

Conference tables: Try one PCC between every two participants, about arm's length away, with all mics feeding an automatic microphone mixer. The sound will be very clear, with good rejection of room acoustics.

Figure 2

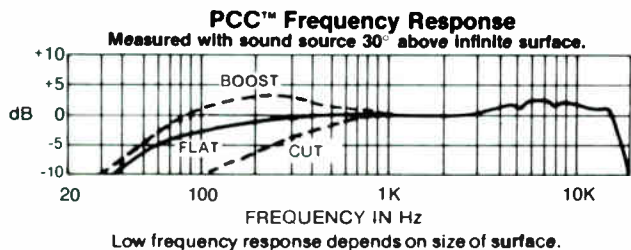

Figure 3: Microphone Setup at Bethel College.

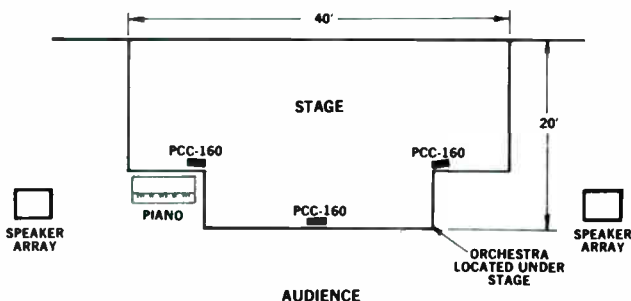
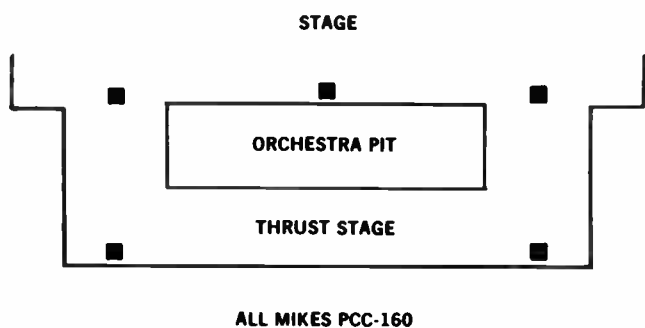

Figure 4: Microphone setup at Lakeshore High School.



Lecterns, pulpits, altar tables: Cavities built into lecterns will degrade the PCC's frequency response and polar pattern, so place the PCC on an open surface, out of cavities. Many lecterns have a small shelf on top where the PCC can be placed. Since the shelf is a small boundary, the low-frequency response will be reduced unless you set the BASS TILT switch to the BOOST position.

Drama, musicals, opera: Try one to three PCCs evenly spaced across the front edge of the stage, about one foot from the edge. To reduce feedback, use the smallest number of microphones that adequately pick up everyone on stage. You may be surprised at how well two, or even one, PCC will cover a large stage area.

The farther you can place the PCCs behind the sound-reinforcement speakers, the

greater the gain-before-feedback. For maximum clarity and gain, turn up only the microphone nearest the person talking.

The PCC will sharply reject sounds from the audience and orchestra pit. Rejection is best at 135 degrees and 225 degrees off-axis.

The microphone is relatively insensitive to floor vibrations, and will pick up footsteps mainly through the air (acoustically) rather than through its housing.

Application Examples

PCCs greatly improved the sound reinforcement in a gymnasium/auditorium at Bethel College in Mishawaka, IN. The microphones picked up a stage production of an original musical, "Joseph."

As shown in **Figure 3** three PCCs were strategically located on 20-foot x 40-foot stage. The gym was 100-feet deep by 70-feet wide, with cement block

walls and a hardwood floor.

All three mics were "open" or "on" simultaneously. Although this procedure decreases gain-before-feedback compared to muting unused mics, the gain was sufficient. There was no need to ride the microphone faders.

The PCC-160 has a supercardioid pickup pattern with a small rear lobe, and maximum sound rejections (null) at 135 degrees off-axis. The sound engineer used this knowledge to advantage when aiming the mics. When the rear of the microphone was aimed at the piano, the PCC picked it up slightly. But after rotating the mic to "null out," the piano became inaudible through the reinforcement speakers.

As in any theater sound system, actors who didn't project were harder to hear. Additional microphones (PZMs) might be suspended

to reinforce rear-stage dialog in future productions.

According to the sound engineer, past setups have always had problems, but the PCCs provided the best sound in years. The reinforced sound was quite intelligible despite the gym's cavernous acoustics.

Ken Kuespert, a freelance sound engineer, tried PCCs for a recent stage production of *Brigadoon* at Lakeshore High School in Stevensville, MI. Five PCCs were placed as shown in **Figure 4** three across the front of the main stage and two on the thrust stage.

Ken rode gain on the microphones. As a result, he often had *gain to spare*—practically unheard of in stage miking. The tone quality was natural; the foot noise was minimal. Some of the actors did not project, and the reproduced sound was louder than the live sound of these actors.

IDEAS & VIEWPOINTS

(continued from page 6)

I distinctly remember the howls of protest when transistorized amplifiers were first introduced, from the manufacturers who didn't make one. If microprocessor-based nurse call systems are such a problem, perhaps someone could explain why the U.S. Government mandates that type of system for all new V.A. hospital installations in their revised specification.

I submit that perhaps it would be better to go back to the drawing board than to stand on the sidewalk watching the cars go by and yelling, "Get A Horse!"

Editor's Note: We accepted Mr. Rosen's Editorial Comment because of its strong stand on microprocessor-based technology. Not only is it pertinent to our industry, which is experiencing the influence of the microprocessor; but it is pertinent to this issue which takes a look at intercom technology today.

Sound & Communications will continue to offer this space to qualified Spokesmen. Write to: Editor, Sound & Communications, 220 Westbury Ave., Carle Place, NY 11514

A CLOSER LOOK

(continued from page 36)

For these and other reasons, the Series 10 stands a good chance in the professional market, particularly if it sounds as good as it looks. I heard a limited demonstration at a recent trade show and paid particular attention to the quality of the digitally attenuated faders; with both program and test tones, both slow and fast fades produced no audible steps or artifacts. . . just a smooth, natural fade. Of importance to the sound and communications industry is the console's ability to recall a preset console configuration—complete with all the EQ, pan and dynamics settings. This could be of major benefit to theater sound engineers in coping with complex scene changes. . . or multiple, overlapping shows in a single venue. Similar advantages are suggested in broadcast television and film/video postproduction. In music recording and reinforcement, the creative potential of a totally-automated console such as this one may take years of experimentation to realize.

The Series 10 is, nonetheless, a

decidedly "high-tech" product: the necessarily brief description provided here tells only a small part of the story. While the console is not likely to be specified for many installations in the near future, the technology it represents is certainly here to stay. For this reason alone, the Series 10 definitely merits a closer look.

Contact: Harrison Systems, Inc., P.O. Box 22964, Nashville, TN 37202; (615) 834-1184.

SOUND & COMMUNICATIONS

CLASSIFIEDS GET RESULTS

For rates and information, please call
(516) 334-7880

CLASSIFIEDS

RJ31X JACKS & CORDS
WIRE & CABLE
UL-PLENUM-FIRE
"B" CONNECTORS, TIE WRAPS
DRIVE RINGS & PINS
ARROW STAPLERS
FASTENERS
CALL TOLL FREE

cabletronix

800-431-WIRE (USA)
800-042-WIRE (NY)

Reader Service #203
TIME SAVERS

- PUSH-PULL RODS Get Cable through tight places
- TEST-SET, For the Audio Serviceman
- EASY-KARY™ Wire Reel Holders 3 sizes
- SPEAKER SUPPORT TRUSS (T-Bar Bridge) Prevent ceiling sag Speed Installation
- SPEAKER GRILLES For 8" Speakers
- EXTENSION CORDS 3 ft and 10 ft U.L. Listed

CALL - WRITE - 30 DAY FREE TRIAL
Tax. Call Collect (214)946-8450, All Other 1-800-527-1522

INSTALLATION & SERVICE AIOS

Reader Service #290

MUSIC SUPPLY CO. - SC
808 N. MADISON

DALLAS TEXAS 75208

Business Opportunities

Twenty-year-old Sound, Communications, & Signal Co. Has several major franchises. Average yearly sales \$400,000, can be expanded complete buy-OUT or manage option. Send inquiries to: Box 2622, Youngstown, OH 44507.

Reader Service #202

NATIONAL SALES MANAGER

Soundolier, a leader in the commercial sound industry, is seeking an experienced National Sales Manager to assume immediate responsibility for their manufacturing "reps" organization and for all sales administration activities including customer service and order entry.

The ideal candidate will possess successful sales and sales management experience in the commercial sound industry. Well developed negotiating skills, and the ability to interface with engineers on a technical basis are essential. Position requires 25% travel and is based in St. Louis, Missouri.

We offer an excellent compensation package, a comprehensive benefits program, advancement opportunities and a high degree of stability. For prompt consideration, forward detailed resume and salary history, in confidence, to: Sales Director, Soundolier, 1859 Intertech Drive, Fenton, MO 63026. Equal Opportunity Employer M/F/H.

SOUNDOLIER

Reader Service #204

UNIPRISE WATERTOWN, CT.
CORP



FLEX ARMS
(GOOSENECKS)
For Microphones

SALES DIRECTOR
Stanley Hirsch
15 Hickory Dr. Roslyn, N.Y.
516-621-6987

Reader Service #272

Background Music for
SCA-CATV-Telephone
BGM INTERNATIONAL
A Division of
F. T. C. BREWER COMPANY
P.O. Box 8057
Pensacola, Florida 32505
904 433-7932

Reader Service #294

Current Cable Company, Inc.

1801 W. Diversey Parkway
Chicago, IL 60614
Suppliers of quality sound, intercom and telephone cable.

For Prompt service call Toll Free

1-800-821-2432

In Illinois: 312-472-7790

Reader Service #291



Lorun Street, Townsend, Mass. 01876

Tel: (617) 851-4549

Manufacturers of quality sound & communications cable.
Stock & price list mailed on request

Reader Service #296

FREE 32pg Catalog & 50 Audio/Video Applic.



OPAMP LABS INC (213) 934-3588
1033 N Sycamore Av LOS ANGELES CA, 90038

Reader Service #295

HELP WANTED? HIGH TECH SALES, MARKETING, MANAGEMENT, CANDIDATES

3100 execs listed in consumer electronics industry guide, complete with resumes.

WHO'S WHO IN CONSUMER ELECTRONICS contains names, numbers, biographies of high tech professionals working in audio, video, telecommunications, computers, software, satellite TV, cellular, prerecorded video, magnetic & optical media, and more, all cross-referenced by position and product category.

WHO'S WHO is the indispensable high-tech headhunting tool.

Return in 10 days for full refund if you don't agree.

Name _____
Address _____
City _____
State _____ Zip _____
 MC Visa AMEX
Exp _____ Bill Me Check enclosed
Signature _____

\$100 each plus \$4 shipping. Send your order to: Who's Who in Consumer Electronics, 76 Court St., Brooklyn Heights, New York 11201. Volume discounts available to corporate accounts

Reader Service #300

CLASSIFIEDS

- Regular Classified—\$52 per column inch.
- Marketplace Display—25 percent off rate card (up to 1/3 page).

Classified listings are accepted up to the 25th of the month preceding publication.

Name _____
Address _____
City/State/Zip _____
Telephone _____
Credit Card # _____

Check Heading You Want

- SERVICES MISCELLANEOUS
- FOR SALE SITUATIONS WANTED
- FOR RENT HELP WANTED
- BUSINESS OPPORTUNITIES

Please send copy & payment to:
Sound & Communications Classifieds
220 Westbury Avenue Carle Place, NY 11514
TELEPHONE: (516) 334-7880



THE FUTURE IS... SOUND

Sound is present everywhere we go, in everything we do. And the pacesetter for audio reproduction is Altec Lansing, a company whose strength has always been found in its ability to anticipate and meet customers needs. We're committed to sound systems designed and built exclusively for fixed installations. It is this commitment that's made us the choice of professional sound contractors who demand uncompromised quality and dependability coupled with the most extensive factory support available. Altec Lansing emerged as a company single-minded in its resolve to serve a specific industry by combining a reputation for innovation based on solid engineering and our unique total system concept. Not involved in consumer, portable or patchwork multiple vendor systems, we've molded 50 years of expertise into performance. This enables us to stand alone as the premier supplier for the fixed installation market. Our total dedication to this market and to our worldwide dealer network is now backed by Gulston Industries, our new parent company, and a mandate to continue building a sound future as the preeminent force in our field.



**Altec Lansing Takes The Words,
The Emotions, The Music Of Man And
Projects Them To Mankind.**



a **gulston** company



legislation



deliberation



observation



information



conversation



inspiration

The Shure Automatic Microphone System... wherever microphones and people gather.

AT&T World Headquarters. The Pentagon. Bally Casino. St. Peter's Cathedral. Alberta (Canada) Provincial Courts. Ft. Wayne City Council. Wherever speech-related multi-mic systems are needed, the Shure Automatic Microphone System (AMS) provides the perfect solution. It combines microphone, mixer and logic technology in a totally integrated package.

The AMS System turns on and off automatically with the sound source—smoothly, quickly and quietly. Unlike other multi-mic systems, set-up is quick and simple with no need for complicated readjustment after the initial installation. Add-on options include the AMS 880 Video Switcher

Interface. It's these features that make the Shure AMS the number one choice for multi-mic applications—from security monitoring to churches, courtrooms, conference rooms, legislative chambers and broadcast studios.

Shure's Automatic Microphone System—the right mic, wherever microphones and people gather.



SHURE

For more information, write or call Shure Brothers Inc., 222 Hartrey Ave., Evanston, IL 60204, (312) 866-2553.

THE SOUND OF THE PROFESSIONALS...WORLDWIDE