

# SOUND & COMMUNICATIONS

**IBMA  
SPECIAL ISSUE**

COVERING TELECOMMUNICATIONS  
AND ELECTRO-ACOUSTICS

JULY 1985

## BACKGROUND & FOREGROUND MUSIC — a sophisticated industry



**RETAIL STORE SOUND  
ELECTRONIC PHONE SYSTEMS  
LOUDSPEAKER CLUSTER DESIGN**

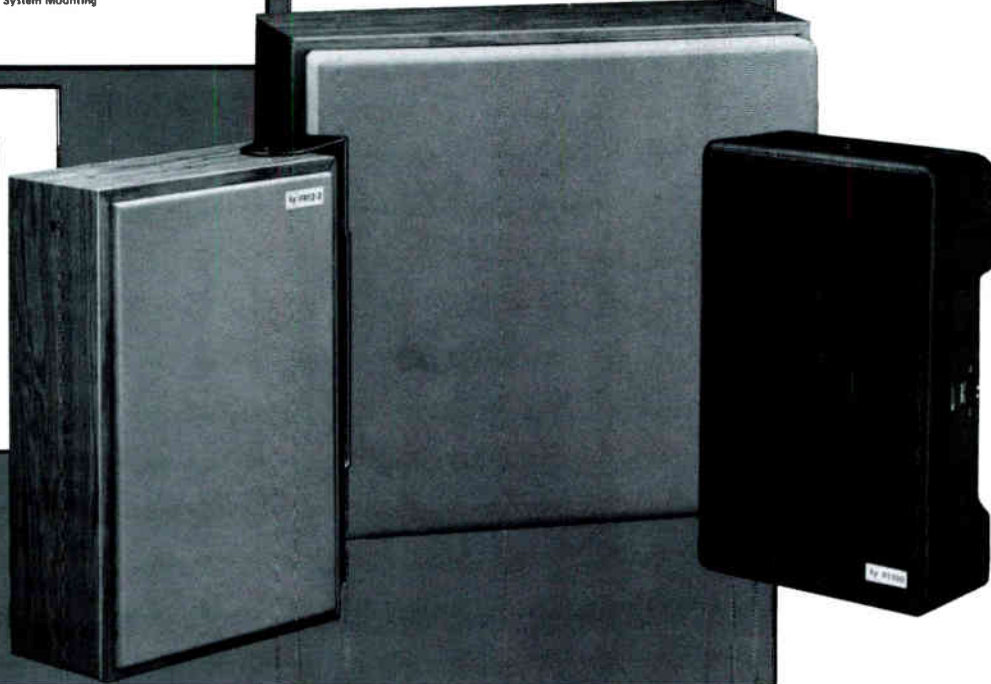
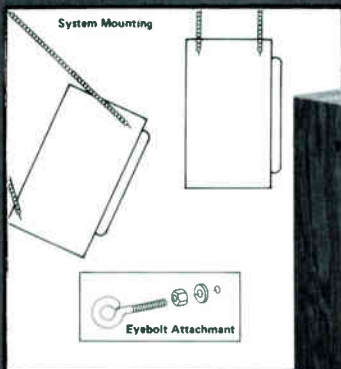
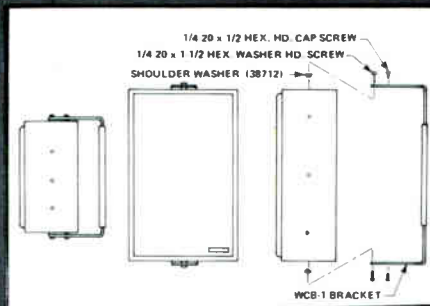
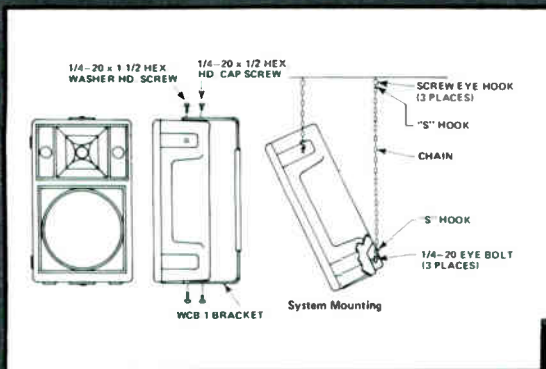

# Great Sound In Small Packages

## Contractor-Friendly Speaker Systems from EV

We went into the field to find what you wanted most: a wide-angle speaker system that works like a component array, but installs with ease and looks great anywhere. Then we designed our new FR15-2, FR12-2 and PI100 speaker systems to make your job easier.

All systems are factory-fitted with threaded inserts to facilitate suspension. And, with an optional telescoping bracket, the FR12-2 and PI100 can also be wall or ceiling mounted in six versatile positions. For constant-voltage operation, an optional TK60 line



TK60 TRANSFORMER KIT

transformer kit replaces the normal direct input panel.

The FR15-2 and FR12-2 have oak-grained, vinyl-covered enclosures, for use indoors.

The PI100's one-piece molded polyethylene enclosure is tough enough to go outdoors.

All three new units are two-way, full-range systems featuring EV's own constant-directivity design which radiates sound over well-defined coverage zones: 90° x 40° for the FR15-2; 100° x 100° for the FR12-2 and PI100. They're all substantially more sensitive (96/97 dB, 1W/1m) and more rugged (100/200 watts long-term average power capacity) than most competing systems.

The FR15-2, FR12-2 and PI100 speaker systems from Electro-Voice. Outstanding performers that install with ease and look as great as they listen. Let us tell you more. Contact Jim Long, Director of Marketing/Professional Sound Reinforcement, Electro-Voice, Inc., 600 Cecil St., Buchanan, Michigan 49107.



Reader Service #201

# TOA Defines "Quality"

It's not easy to do. But after 50 years of successfully dealing with concepts like system flexibility — reliability — power — and sophistication, we wound up with a proven track record of **quality**.

Our 900 Series of commercial sound and background music systems offer overload and short circuit protection. They incorporate a range of features that allow quick, clean, flexible installation and years of maintenance-free operation. TOA takes for granted the fundamentals of "good merchandise." That's because ours is **quality** merchandise.

Accordingly, TOA provides **everything** you need. Eight different Powered Mixers and Power Amps. 22 input modules with so many connector configurations, you can select from 46 module choices. Power Amps that double as integrated amplifiers. Choose your wattage — anywhere from 10 watts to 240 watts RMS. Choose your inputs — 2? 4? 6? Choose your outputs — transformer-coupled and balanced, or transformerless-direct? XLR or RCA, phone jack or terminal strip?

We give you tone signal generators. Mic Pre-Amps/Mixer Pre-Amps with bass and treble EQ controls. A dozen features that make your job faster, easier, and more profitable. Features that will acquaint your customer with quality.

## You Get What You Pay For

When purchasing the quality of TOA's 900 Series, your customer acquires the very best commercial sound system that money can buy.

So what does the customer get when paying for quality? Not just flexibility and outstanding specifications (0.1% THD, signal-to-noise of 108dB at max gain, 20-20kHz frequency response), but characteristics that cannot be measured in numbers: warmth, clarity, transparency, and definition.

You need more than specifications to define **quality**.

You need TOA.

©1984  
TOA Electronics, Inc.



TOA Electronics, Inc., 480 Carlton Court, South San Francisco, California 94080 (415) 588-2538  
In Canada: TOA Electronics, Inc., 10712-181 Street, Edmonton, Alberta T5S 1K8 (403) 489-5511

World Radio History

# **SOUND & COMMUNICATIONS**

**JULY 1985**

**Volume 31 #7**

## FEATURES

- ELECTRONIC TELEPHONE SYSTEMS: GOING DIGITAL** 16  
Jeffrey Schwartz examines the state of the market of electronic phone systems, which like much of the technology today, are going digital.
- BACKGROUND/FOREGROUND MUSIC—A SOPHISTICATED MARKET** 20  
What is going on in the background/foreground music industry? Views from insiders, legal battles, and what's new in the marketplace are all discussed.
- THE EVOLUTION OF LOUDSPEAKER CLUSTER DESIGN** 29  
S&C writer, Barry McKinnon, takes an interesting look at the evolution of loudspeaker cluster design—how it came to be and where it's headed. Included is the sound system design in McMahon Stadium in Calgary, Canada which was by John Taves of Raines, Finlayson, Barrett & Partners who used JBL's Central Array Design program.
- INSTALLATION PROFILE: CLOTHES STORE SOUND** 36  
A new section for Sound & Communications, this feature profiles a professional sound installation which was done in a clothing store in New York City. Retail stores could be a whole new market for the sound contractor.

## COLUMNS

- IDEAS & VIEWPOINTS** 6  
"If you want to make a good living, sell things people need. If you want to get rich, sell things people want!"
- COMPUTERS & DIGITAL AUDIO** 11  
Keith Bose discusses telecommunications-computer options for the small and medium size business.
- THEORY & APPLICATION** 14  
Tape noise reduction is covered by Jim Brown who concentrates on dbx and Dolby noise reduction systems.

## DEPARTMENTS

- NEWSLETTER** ..... 8
- DATAFILE** ..... 34
- BOOK REVIEW BY TED UZZLE** ..... 35
- PRODUCT IN REVIEW** ..... 40
- A CLOSER LOOK BY GARY DAVIS** ..... 41
- FACES AND PLACES** ..... 44
- REP NEWS** ..... 45
- SUPPLIES/SUPPORT/SERVICES** ..... 46
- DATEBOOK** ..... 48
- CLASSIFIEDS** ..... 50

## ON THE COVER

Our cover photo shows a foreground music system in the new Rusty Pelican restaurant in Seattle, WA. Yesco provides the programming for the California-based chain of 19-restaurants. The sound system is designed by Seawind Sound Company of Brea, CA. Photo by Jim Fagiolo.

combining **SOUND MERCHANDISING & MODERN COMMUNICATIONS**

FOUNDED 1955

© **SOUND & COMMUNICATIONS PUBLISHING, INC.**, 1985. Reprint of any part of contents without permission forbidden. Titles Registered in the U.S. Patent Office. Sound & Communications (U.S. P.S. 943-140) is published monthly by Sound & Communications Publications, Inc., 220 Westbury Ave., Carle Place, N.Y. 11514. 516-334-7880. President, Vincent P. Testa; Vice President, Paul G. Gallo. Subscription rates: U.S.—3 years \$37.50, 1 year \$15.00. Canada and Mexico—3 years \$48.00, 1 year \$18.00. Foreign and South America—1 year \$25.00. Second Class postage paid at New York, NY and at additional mailing office. Postmaster: If undeliverable notify on Form 3579 address correction.

## STAFF

Editorial Director  
**CHRIS FOREMAN**

Managing Editor  
**ELLIOT LUBER**

Assistant Editor  
**NANCY PETERSON**

Consulting Editor  
**JEROME J. BROOKMAN**

Contributing Editor  
**GARY DAVIS**

Contributors  
**KEITH BOSE**  
**JIM BROWN**  
**BARRY MCKINNON**  
**JEFFREY SCHWARTZ**  
**TED UZZLE**

Art Director  
**JAKE UZO**

Production  
**DEBORAH M. CASSANO**  
**LORI KATZ**  
**WILLIAM MONCURE**

Typesetting  
**GEORGE PROPER**  
**ARTHUR VIDRO**

Circulation Director  
**BUNNY FRIED**

National Advertising Sales Manager  
**CLIFFORD CAPONE**

West Coast Sales Manager  
**JAY S. MARTIN**

Vice President/Associate Publisher  
**PAUL G. GALLO**

President/Publisher  
**VINCENT P. TESTA**

Editorial And Sales Offices  
**Sound & Communications**  
220 Westbury Avenue  
Carle Place, New York 11514  
(516) 334-7880

Advertising/West Coast  
15532 Cohasset St.  
Van Nuys, CA 91406  
(818) 904-9669

Circulation audited by  
Verified Audit Circulation Corp.

**VERIFIED**  
AUDIT CIRCULATION

**TESTA**  
COMMUNICATIONS  
INC.

Sound & Communications • Music & Sound Output  
Pro Sound News • The Music & Sound Buyer's Guide  
CES-TV News • NAMM-TV News • The Daily  
The Music & Sound Electronics Retailer  
Home Entertainment Magazine

# Not just another microphone.

# Independent testing proves the TE10 is better!

Recently, Telex engaged Dr. Eugene Patronis, Jr., professor of Physics, Georgia Institute of Technology, to test the TE10 condenser microphone against the Electro Voice BK-1, Audio Technica ATM31R and the Shure SM87. Tests were conducted with complete objectivity without the presence of any Telex personnel. It is of further interest that the competitors' microphones were purchased randomly "off the shelf", and all had Pro Net prices that were considerably higher than the Telex TE10.

### Telex ranks superior

Dr. Patronis tested the mikes by a wide variety of performance criteria and, overall, Telex ranked as a superior value. Telex fared especially well in the areas of **linearity**, **distortion** and **frequency response**. Here, Telex was either first or second in terms of performance. Put the TE10 to your own tests and you'll agree—this is a superior condenser microphone at an exceptional price.

### A mike with studio precision—built to take road abuse

Even though the TE10 has all of the precision and sensitivity of expensive and fragile studio mikes, it's as rugged as they come. The condenser element resists temperature and humidity extremes and is protected from handling abuse by the exclusive Tri-Flex™ shock isolation system.

If you would like to learn more about the TE10, call or write to: Telex Communications, Inc., 9600 Aldrich Ave. So., Minneapolis, MN 55420.

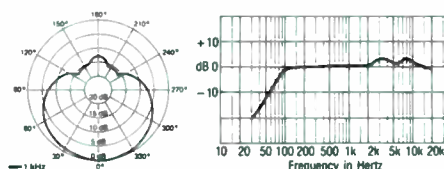

For quick information, call Toll Free

**800-328-3771**

or in Minnesota call (612) 887-5550.

# TELEX®



## CONFERENCE COMMUNICATION SYSTEMS

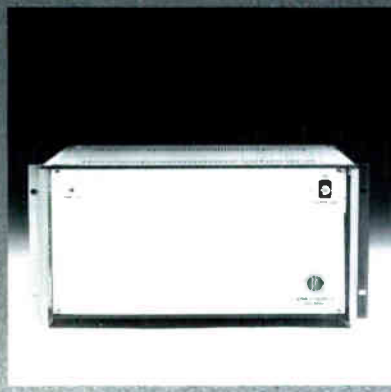
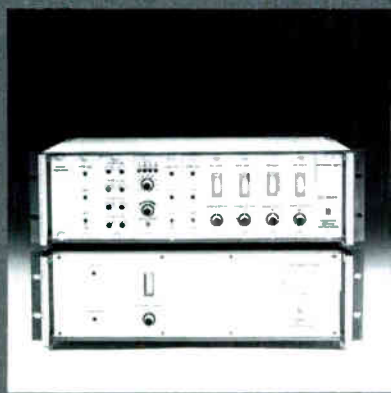

In this rapidly shrinking world, the necessity for highly sophisticated conference communication systems is becoming increasingly important. In business, industry and government.

We are proud to offer computerized conference microphone systems and simultaneous interpretation technology from the best in the world. DIS-USA.



DANISH INTERPRETATION SYSTEMS

2831 15th St. N.W.  
Washington, D.C. 20009  
(202) 387-7900 Telex: 64394

Reader Service #204

## IDEAS & VIEWPOINTS

# CUSTOMER WANTS OUTWEIGH NEEDS

by Chris Foreman

Last month, while in Washington, DC, to visit a client, I saw an unusual street vendor. A man and woman were selling the long distance services of one of the newer OCCs! Everyone who signed up got a free six-pack of Pepsi. Not very different from walking into a Sears store and signing up for their credit card (except Sears gives away their Pepsi in liter bottles).

That street corner was a dramatic statement about the condition of our (partly) deregulated telecommunications business. I read a combination of things there. First, long distance has become enough of a commodity to be sold on street corners. Second, the apparent value of this service, at least in the minds of the vendors, is low enough that a free Pepsi offer is enough to attract new customers away from other vendors. Third, the business is truly in the midst of amazing change and vendors are likely to try almost any tactic to sell their services.

Finally, this scene reinforced something I've believed for a long time and that is that the typical *residential* long-distance customer is not well informed about their choices and has little idea of how to go about choosing a long-distance vendor. The long-distance street vendor sold their service on the basis of lower price and free Pepsi. No one talked about audio quality, satellite delays (which I find unacceptable), the cost of access telephone calls or any of a group of other important factors.

### Deciding Factors

The point of all this is that the street scene in Washington got me to wondering about how well most *business* customers do in choosing telecommunications hardware and transmission services. My guess is that the Fortune 500 companies, and anyone else large enough to have a dedicated telecommunications manager, do a good job of choosing, provided they know what it is their companies need. Those small companies, lucky enough to be called on by a good interconnect, have probably made well-informed choices. A lot of other companies may be out in the cold. Telecommunications as a commodity is just too new, and people must know their true *needs*.

### If you want to get rich...

Background and foreground music is one of the few things in our business that customers *truly want*. Many communications products, especially PA systems, are things people *need* but don't really *want*. The significance of this is in a famous sales saying: "If you want to make a good living, sell things people need. If you want to get rich, sell things people *want*!" I don't know how many people have gotten rich selling background music, but I haven't seen too many contractors with Muzak franchises who weren't doing well.

The background music market didn't exist until the background music pioneers got their psychological studies together and persuaded the public that their product was something the public needed. Soon, they persuaded a good part of the business world that background music was something they actually *wanted* for their businesses. What happened here is that these people actually *created* a new market and that impresses me very much.

### Going Strong

The background and foreground music markets seem to be strong and stable. Some new things are beginning to affect the background and foreground music business. One of those is directly connected to the telecommunications business

(continued on page 49)

Introducing

# *the handjers*

UNIDIRECTIONAL DYNAMIC MICROPHONES



**pasO**  
SOUND PRODUCTS

For more information please contact:  
Paso Sound Products, Inc.  
14 First Street — Pelham, New York 10803  
Phone 914-738-4800 Telex No. 646783  
Reader Service #205

## NATA ENCOURAGES DATA COMMUNICATIONS INDUSTRY COOPERATION

The 650-member North American Telecommunications Associates (NATA) has announced a series of programs designed to better promote synergy between computer and communications companies, as their technologies continue to merge in the interconnect industry. Programs include promotion of the NATA '85 trade show to the data industries with a special hotline for booth-space reservations, special mailings to NATA-member companies with a continuing education program, and inclusion of computer-related topics in the '85 convention seminars. Said NATA President Edwin B. Spievack, "Faced with intensifying competition, computer manufacturers are desperately looking for new markets, just as telecommunications equipment vendors are looking for new products...It's a perfect fit."

## MOUNTAIN BELL SELECTS COMPUTER CHAIN TO SELL CENTRON SWITCHING

MicroAge Computer Stores has signed an agreement with Mountain Bell (B.O.C.) to act as agents in selling Mountain Bell services in its operating area. The agreement currently includes seven states: Arizona, New Mexico, Colorado, Wyoming, Montana, Idaho, and Utah. MicroAge reports that it has the potential to expand into the U.S. West areas. MicroAge is providing Centron, an enhanced central office-based switching that offers users from two lines to hundreds PBX-type sophistication.

## REPORT SEES PBX MARKET GROWTH SLOW DUE TO SATURATION

According to a newly published Frost & Sullivan report, the PBX market will increase from today's installed base of 244,500 systems by an average of five percent, reaching 378,000 systems by 1993. In spite of current success and popularity of PBX's, the report sites that the market is nearing saturation, which will limit sales. Future sales will be predominantly replacements, and manufacturers will increasingly rely on sales of ancillary systems such as applications processors and proprietary station equipment to sustain sales levels. Replacement sales will climb to \$6.5 million in 1993, up from \$3 million in 1985, according to Frost & Sullivan.

## IAAM PRESIDENT WARNS OF TAX BILL'S IMPACT ON PUBLIC ASSEMBLY FACILITIES

Cliff Wallace, president of the International Association of Auditorium Managers (IAAM), and president and manager of the Louisiana Superdome, warned that elimination of business related entertainment tax deductions "would be disastrous for both public facility operators and owners" who derive as much as half their revenues from tickets to sporting and theater events sold to large corporations and small companies for business entertainment. Loss of revenue there could have an effect on sound and communications installers as facilities would be less likely to invest in new equipment.

## MUZAK AND YESCO EXTEND COOPERATIVE VENTURE FOR ON-PREMISE MUSIC

Muzak, the world's leading supplier of environmental music, and Yesco, the company that pioneered "foreground" music in 1968, have signed a long-term agreement calling for Yesco to provide programming in a variety of formats for Muzak's Tones<sup>tm</sup> foreground on-premise music product line. Yesco will provide original artist music in formats such as rock, country/western, jazz, classical and ethnic music. Muzak, a unit of Group W (Westinghouse Broadcasting and Cable Inc.) serves more than 130,000 subscribers worldwide.



#### AUDIO-TECHNICA REPORTS MARKETING AND SALES PERSONNEL ADDITIONS

As part of an expansion of the marketing and sales departments at Audio-Technica's pro division, Charlie Winkler has been promoted to manager, marketing and sales. He was previously national sales manager. Greg Silsby has been named marketing manager. He was previously market development manager at Electro-Voice Inc. President Jon R. Kelly made the announcement. Don Kirkendall, director of marketing communications, also announced that Rock Wehrmann has been named to the newly created position of assistant advertising manager. He previously ran an independent audio/video consulting company.

#### TELECOM PLUS INTERNATIONAL ACQUIRES COMPATH NATIONAL

Telecom Plus International, said to be the nation's largest independent telecommunications company has announced completion of its acquisition of Compath National, said to be the second largest, for a total of 5 million common shares of Telecom Plus stock. Compath is comprised of five wholly-owned non-regulated subsidiaries of Alltel Corporation, CP National Corporation, and Pacific Telecom Inc.

#### FIRST NATIONWIDE PAGING NETWORK USING FM SUBCARRIERS FORMED

With the appointment of Richard N. Thompson as chairman and chief executive officer, Spantel Corporation is on its way to become the first nationwide paging network to use FM radio station subcarriers. Some 160 FM stations are already part of the network, out of a targeted 350. The system is designed to provide a quality low-cost paging network, providing voice and printed page communication to subscribers anywhere in the U.S. or participating country.

#### FCC RULING SEEN AS SETBACK TO WOULD-BE PAY PHONE SUBSIDIARIES

A recent ruling by the FCC will allow AT&T and BOCs to continue to offer coin-operated pay phones through their telephone company operations, not through separate subsidiaries as requested by competitors, according to NATA. Tonka Tools and Southern Merchandise Corp. had urged the FCC to treat pay phones like CPE, requiring telcos to market equipment apart from regulated network services. But the FCC refused, in the latest assault on Computer II guidelines. In late April, the FCC similarly refused to preempt discriminatory state regulation limiting expansion of pay phone competition.

**\*\*\*LATE BREAKING NEWS\*\*\*LATE BREAKING NEWS\*\*\*LATE BREAKING NEWS\*\*\*LATE BREAKING NEWS**

#### GULTON INDUSTRIES' PURCHASE OF ALTEC EXPECTED TO BE FINALIZED JULY 15

On July 1, U.S. Bankruptcy Court for the Central District of California approved the sale of Altec Inc, assets and business, clearing the final barrier to the expected purchase by Gulton Industries, parent company of Electro-Voice. The deal is expected to be completed by July 15. According to Robert Pabst, vice president in charge of the audio sector of Gulton, Altec will now become a wholly owned subsidiary of Gulton called Altec Lansing. Dave Merrey, vice president of operations at Electro-Voice, will become president of Altec Lansing and will relocate to Altec's headquarters in Oklahoma City, OK, while Gary Rilling continues to head-up marketing. Pabst stressed that Altec will be a separate operating division of Gulton, and that it will carry out its own marketing and product strategies.

*Time-Master  
keeps the music going in time  
with the business.  
Without changing tapes!*



We know busy people have better things to do than change tapes. And, because background music is critical to any business, we've developed our new Time-Master on-premise unit that sets the pace for business automatically. With pre-programmed, time-controlled, musical programs and announcements. □ Nothing could be easier or more reliable. Once programmed, the Time-Master turns itself on, runs continuously, changes tapes without time gaps, and shuts itself off at the end of the day. □ Operators can intermix relaxing background music with upbeat tempos; even program pre-re-

corded promotional announcements between musical tapes. Our unique endless loop tape cartridges allow playback of six different cartridges, each containing up to 10 hours of music, providing a total of 60 hours with no repeats. □ If your customers are busy business people, recommend Time-Master. The *only* background music system in the business that changes tapes *automatically!*

**CPC-180**  
**CUSTOMUSIC**  
SOUND SYSTEMS THAT STAND ALONE

To find out more, contact Customusic®, Rowe International Inc., 75 Troy Hills Rd., Whippany, NJ 07981. 201-887-0400. □ Rowe International, Subsidiary of Triangle Industries, 75 Troy Hills Rd., Whippany, NJ 07981-3608. (201) 887-0400.

Reader Service #206

# SOUND & COMMUNICATIONS

## IS NOT JUST A MAGAZINE... IT'S AN INDUSTRY.

*Subscribe Now!*



YES! I WANT TO STAY ON TOP OF THE INDUSTRY BY RECEIVING A COPY OF **SOUND & COMMUNICATIONS EVERY MONTH**  NEW  RENEWAL

1 Year \$15.00  3 Years \$37.50 (Savings \$7.50)  
 Payment Enclosed  Bill My Credit Card  Visa  MC  AE  
 (Foreign: Add \$5) Card # \_\_\_\_\_ Expires: \_\_\_\_\_

Signature \_\_\_\_\_  
 Name \_\_\_\_\_  
 Company \_\_\_\_\_  
 Address \_\_\_\_\_  
 City \_\_\_\_\_ State \_\_\_\_\_

- |  |   |   |
|--|---|---|
| <p>① Are you a subscriber to Sound &amp; Communications?<br/> <input type="checkbox"/> Yes <input type="checkbox"/> No</p> <p>② Primary Job Function (only one):<br/> <input type="checkbox"/> Management/Owner<br/> <input type="checkbox"/> Engineering/Technical Mgt<br/> <input type="checkbox"/> Sales/Marketing<br/> <input type="checkbox"/> In-House Maintenance/Service<br/> <input type="checkbox"/> Field Installation/Maintenance<br/> <input type="checkbox"/> Consultant<br/> <input type="checkbox"/> Advertising/Promotion<br/> <input type="checkbox"/> Other _____</p> | <p>③ Primary business of company (only one):<br/> <input type="checkbox"/> Contractor—Engineered Sound/Acoustical<br/> <input type="checkbox"/> Contractor—Interconnect/Intercom<br/> <input type="checkbox"/> Contractor—Fire/Alarm/Safety<br/> <input type="checkbox"/> Electrical Contractor<br/> <input type="checkbox"/> Pro Audio/Studio/Reinforcement<br/> <input type="checkbox"/> Architect/Designer<br/> <input type="checkbox"/> Engineering/Acoustical Consulting<br/> <input type="checkbox"/> Maintenance/Service<br/> <input type="checkbox"/> Dealer/Distributor/Rep<br/> <input type="checkbox"/> Manufacturer<br/> <input type="checkbox"/> Other _____</p> | <p>④ Your purchasing authority is:<br/> <input type="checkbox"/> Final approval/Buyer<br/> <input type="checkbox"/> Recommend/Specifier<br/> <input type="checkbox"/> No Direct Authority/User</p> <p>⑤ Intensity of your product need:<br/> <input type="checkbox"/> Have salesman call<br/> <input type="checkbox"/> Need within 3-6 months<br/> <input type="checkbox"/> Future projects</p> <p>⑥ Number of employees at your company:<br/> <input type="checkbox"/> 1-3 <input type="checkbox"/> 4-10 <input type="checkbox"/> 11-25<br/> <input type="checkbox"/> 26-100 <input type="checkbox"/> over 100</p> |
|--|---|---|

YES! I WANT TO STAY ON TOP OF THE INDUSTRY BY RECEIVING A COPY OF **SOUND & COMMUNICATIONS EVERY MONTH**  NEW  RENEWAL

1 Year \$15.00  3 Years \$37.50 (Savings \$7.50)  
 Payment Enclosed  Bill My Credit Card  Visa  MC  AE  
 (Foreign: Add \$5) Card # \_\_\_\_\_ Expires: \_\_\_\_\_

Signature \_\_\_\_\_  
 Name \_\_\_\_\_  
 Company \_\_\_\_\_  
 Address \_\_\_\_\_  
 City \_\_\_\_\_ State \_\_\_\_\_

- |  |   |   |
|--|---|---|
| <p>① Are you a subscriber to Sound &amp; Communications?<br/> <input type="checkbox"/> Yes <input type="checkbox"/> No</p> <p>② Primary Job Function (only one):<br/> <input type="checkbox"/> Management/Owner<br/> <input type="checkbox"/> Engineering/Technical Mgt<br/> <input type="checkbox"/> Sales/Marketing<br/> <input type="checkbox"/> In-House Maintenance/Service<br/> <input type="checkbox"/> Field Installation/Maintenance<br/> <input type="checkbox"/> Consultant<br/> <input type="checkbox"/> Advertising/Promotion<br/> <input type="checkbox"/> Other _____</p> | <p>③ Primary business of company (only one):<br/> <input type="checkbox"/> Contractor—Engineered Sound/Acoustical<br/> <input type="checkbox"/> Contractor—Interconnect/Intercom<br/> <input type="checkbox"/> Contractor—Fire/Alarm/Safety<br/> <input type="checkbox"/> Electrical Contractor<br/> <input type="checkbox"/> Pro Audio/Studio/Reinforcement<br/> <input type="checkbox"/> Architect/Designer<br/> <input type="checkbox"/> Engineering/Acoustical Consulting<br/> <input type="checkbox"/> Maintenance/Service<br/> <input type="checkbox"/> Dealer/Distributor/Rep<br/> <input type="checkbox"/> Manufacturer<br/> <input type="checkbox"/> Other _____</p> | <p>④ Your purchasing authority is:<br/> <input type="checkbox"/> Final approval/Buyer<br/> <input type="checkbox"/> Recommend/Specifier<br/> <input type="checkbox"/> No Direct Authority/User</p> <p>⑤ Intensity of your product need:<br/> <input type="checkbox"/> Have salesman call<br/> <input type="checkbox"/> Need within 3-6 months<br/> <input type="checkbox"/> Future projects</p> <p>⑥ Number of employees at your company:<br/> <input type="checkbox"/> 1-3 <input type="checkbox"/> 4-10 <input type="checkbox"/> 11-25<br/> <input type="checkbox"/> 26-100 <input type="checkbox"/> over 100</p> |
|--|---|---|

# **SOUND & COMMUNICATIONS IS NOT JUST A MAGAZINE... IT'S AN INDUSTRY.**



NO POSTAGE  
NECESSARY  
IF MAILED  
IN THE  
UNITED STATES

**BUSINESS REPLY MAIL**  
First Class Permit No. 155 Carle Place, N.Y.

**POSTAGE WILL BE PAID BY ADDRESSEE**

**SOUND & COMMUNICATIONS MAGAZINE**  
**220 Westbury Ave.**  
**Carle Place, New York 11514**

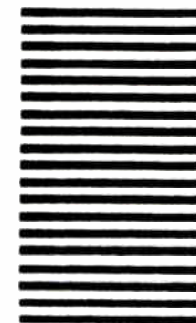

NO POSTAGE  
NECESSARY  
IF MAILED  
IN THE  
UNITED STATES

**BUSINESS REPLY MAIL**  
First Class Permit No. 155 Carle Place, N.Y.

**POSTAGE WILL BE PAID BY ADDRESSEE**

**SOUND & COMMUNICATIONS MAGAZINE**  
**220 Westbury Ave.**  
**Carle Place, New York 11514**



## COMPUTERS FOR SMALL BUSINESS

by Keith Bose

**D**ealers and installers of sound and communication systems who are looking for opportunities in closely associated fields, now have an opportunity to get into telecommunication-computer systems. It is not a new field. The big boys such as banks have been talking to their computers over the telephone for years. What is new is that technology is now on the shelf that lets any *small business* have its own computer tie-ins.

The oldest way that computers are hooked together is by leasing a line from appropriate telephone companies. This is often expensive, especially when the line does not have to be continuously open for use.

The newest way is to send data by a simple telephone call. A computer can send a complete inventory across the country for a few dollars... the cost of a long-winded conversation.

A business telecommunication system can consist of a desk model central computer and a series of desk model, lap held, or pocket sized computers which would all be tied together by customized programming.

The real opportunity lies in the ability to customize the entire set-up to meet the requirements of an individual client.

Personal computers began to make use of telecommunication almost from the beginning. Computer enthusiasts use over-the-counter equipment to set up "bulletin boards" that receive and store information that can be used by others who have the proper password. The idea is that any central computer can store information and process it in conjunction with other computers.

Among the first commercial users to seize upon telecommunication were journalists who needed to send words to a central place for publishing. The small lap computer makes it possible for a writer to carry a



Access by Melard Technologies.

computer in a brief case to places where action is taking place. The computer is programmed to act as a word processor. The story is written by word processing, then sent as a complete text by using the nearest telephone.

The actual process by which a telephone conversation is sent over wire has been unchanged for over a century. Basically, during a conversation the two telephones are connected by an equivalent series circuit containing a 48-volt battery. The mouthpiece modulates the DC current in accordance with sound waves from the voice. Getting computer data over a telephone requires the use of a tone that is modulated by the digital data from the computer.

Telecommunication is a two-way process. One computer sends two standard tones; the other sends a different standard set of two tones. The sending process consists of modulating tones and the receiving process is demodulating. The circuitry that does this is called a

computer use binary data, that is, a number system made up only of 1s and 0s. Computers talk to each other with one computer in the "answer" mode and the other in the "originate" mode. In the originate mode, a "1" bit is represented by a 2,225 Hz tone and a "0" bit is a 2,025 Hz tone. The computer in the answer mode will use 1,270 Hz for a "1" and 1,070 for "0." This is the frequency shift keying (FSK) standard known as the "Bell 103."

The speed at which the 0 and 1 frequency shifts are sent is known as "baud," or bits per second. There are two standard rates for the ordinary telephone line, 300 and 1,200. A special high quality line can take 9,600 baud, but this high rate is usually reserved for use when two computers are connected directly together for "up loading" and "down loading" data. The important thing here is that the higher baud rates use less time to transmit data, hence the telephone call will be cheaper. On the other hand, the

higher rate increases chances of garbled data if there is a certain amount of noise on the line.

Most desk size computers require the use of an external modem. Just about all of the super-portables have some kind of built-in modem. The modem connects directly to the telephone line through the standard jack.

There is another trick, however, that dates back to the days when the Bell monopoly owned all the phones and screwed the wires into a mysterious black box on the wall. The trick is to have the modem generate audible tones with a small speaker and pick up the signals from the other computer with a small microphone. The speaker is then placed next to a telephone mouthpiece and the microphone next to the telephone earpiece. This is called "acoustic coupling." It is going out of fashion, but the advantage is that it always works, even when the telephone jack is behind a 500-pound piece of furniture, or if the telephone is still hooked to the wall with one of Ma Bell's indestructible connections.

Any computer can be part of a telecommunication network, but it is the newest small lap and pocket portables that have captured imagination.

One reason is that the portable can be used wherever there is a telephone. Osborne was among the first to come out with a portable, but at over 25 pounds, it was a piece of baggage. The four-pound Tandy 100 broke through the weight barrier. A step-up in computing power is the Tandy 200 that weighs in at four-and-a-half pounds.

The Hewlett-Packard Portable is in the Mercedes class of the portables. Although it weighs in around nine pounds, this brief case computer is more powerful than many desk sizes, and is compatible with the IBM PC class of machines. As

with all of the miniature portables, the Hewlett-Packard uses a liquid crystal display (LCD) rather than the familiar cathode ray tube (CRT). The liquid crystal display is the kind used to display the numerals on digital watches. Watching these displays can be tricky because they do not generate their own light, but act upon reflected ambient light. Tipping and turning the display will bring the characters into contrast.

All of these devices are standard computers that can be programmed or loaded with commercial software. Such machines can be intimidating, and there is no indication that the average person longs to be a computer nerd. Most business uses of telecommunication do not need a standard computer at one end. A computer can be adapted to a single use for simple push-button manipulation.

Melard Technologies is a quiet newcomer to the frenetic computer industry. It manufactures a hand-held, pocket-size

telecommunication computer called Access, that can be permanently programmed for a specific use. Although the tiny keyboard can be used for word processing, the real intent of Access is to provide a means for people on the road to have access to telecommunication facilities.

Access is powered with a small battery and has all programming built in. The user is presented with menus that allow data to be retrieved, stored, sent, and received. The main storage device is a cartridge that holds up to 64 K and plugs into one corner of the unit. The cartridges take the place of disk drives and disks in conventional personal computers. The basic model of Access provides such extras as built-in personal time alarm, but the real intent is that the unit will be customized so to be used by anyone who is not interested in computer gimmickry, but can profit from telecommunication. Access connects to any tele-

phone with a set of cups that fit over the mouth and earpiece.

Melard's president, Ali Sherrif-Emami, expects personal telecommunication to catch on for more and more business applications. "Any special application that uses at least 100 Access units can afford custom programming that will allow simple push-button control that a child can use."

Personalized telecommunication leads to the logical step that data can be sent over standard radio channels. The cellular telephone is one example. Law enforcement and health care personnel can tap into their own "main frame" computers or dedicated computers for special information, or may periodically "up-load" or "down-load" their pocket computers from remote locations by radio or telephone. Many businesses already have their own radio links.

The makers of Access have also demonstrated another useful trick. The little computer

can be made to read the familiar bar codes found on supermarket and other consumer product packages. A small wand extends from a short cord

The wand plugs into the same port that the telephone cups plug into. The results of loading the computer with bar code data may be sent over the phone to another computer.

The sale of computers to hobbyists and other consumers is finally leveling off. Marketing experts believe that the real place for a computer is still where it always has been, as a business tool. The same experts say that telecommunication is the next big growth area.

But the big secret is that most computer sales to business are not over the counter retail transactions. Most sales to businesses are made by "value added retailers." The added value is in customized programming or even special hardware. In telecommunication, this area is wide open.



ZX-50-D  
for buildings with  
up to 50 residents

**\$645**

*Built-in resident directory.*



*Installation Is A Snap!*

## More Than Competitive.

**Identifone will win you more bids and let you provide a superior product at a lower cost.**

Identifone entry phone makes you more than competitive by being a sound alternative to the standard hard-wire intercom. That's because Identifone doesn't need to have wires run to each resident's unit—it works over the regular telephone and phone lines. Just plug Identifone into its own phone line and you're ready to go. And, Identifone is far less expensive to use in most size buildings than a standard intercom. Installations usually take less than a single day.

Identifone has features intercoms just don't have—such as a built-in

multi-code digital lock for residents to enter the building without a key and also off-premise phone dialing to call numbers such as police, fire, paramedics, rental recordings, real estate sales offices, and property management companies. Models range from 50 to 1000 unit resident capacity.

For more information on how Identifone makes you more than competitive, call or write: **Aegis Technologies, Inc.** P.O. Box 1716, 1709 La Costa Meadows Drive, San Marcos, CA 92069 (619) 471-0469

# IDENTIFONE

*The Original Telephone Entry System*

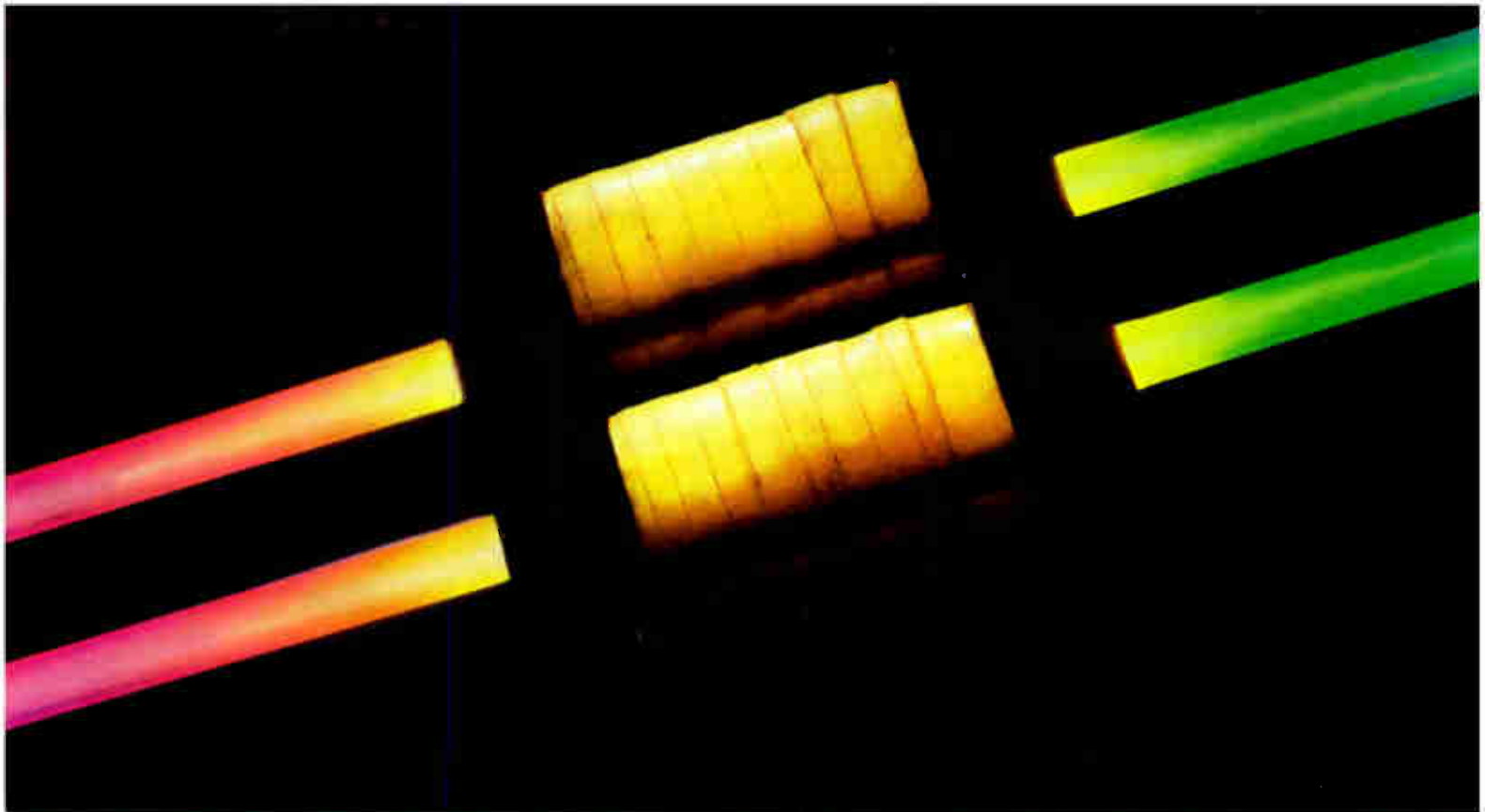

*Our painstaking vacuum and coil-winding technology increases efficiency and eliminates acoustical "buzz."*

## OUR SCIENTISTS HAD TO OPERATE IN A VACUUM TO GIVE YOU A NEW QUALITY OF SOUND.

The quality of any sound system begins at its source. Precision in the power supply is vital to capturing and maintaining the fullness and subtlety of amplified sound. The need for that exactness is why we insist on operating in a vacuum rather than depending on outside sources.

A vacuum tank, to be precise. An environment in which our transformer is created with an air expulsion process. Where air pockets are purged from multi-layers of the transformer's high grade core laminations, and the core made airtight with a special impregnating sealant.

This process gives us impeccable control of transformer function and quality. Which gives you the assurance of the most efficient transfer of power possible, and an end to the acoustical "buzz" that so often fights sound purity.

To a lot of manufacturers the lowly transformer is far down on the list of priorities. For us, every element in the sound system relies on the exacting performance of every other element, and must be painstakingly attended to.

Whether you're driving your studio monitors in a demanding final mix, or powering a massive sound reinforcement array, you'll find our technology giving outstanding clarity to your work in products from our new Model 6230 and 6260 amplifiers to our broad line of signal processing equipment. To find out which system is designed to meet your needs, contact your authorized JBL/UREI professional products dealer today.

JBL Incorporated,  
8500 Balboa Boulevard,  
P.O. Box 2200,  
Northridge, CA 91329  
U.S.A.



UREI  
ELECTRONIC  
PRODUCTS

JBL harman international JBL INCORPORATED 1984

Reader Service #208



## TAPE NOISE REDUCTION SYSTEMS

by Jim Brown

**G**enuine noise reduction systems are forms of compansion systems. A companding noise reduction system consists of some form of compression of program audio going onto the tape followed by precisely matched expansion coming off of the tape. When this compression and expansion are perfectly matched, the dynamic range of the program material is not changed by the process.

The simplest example of a classic compansion system is the dbx system. The dbx system offers 30 dB of noise reduction and a 5 dB improvement in dynamic range at the expense of somewhat greater audibility, particularly with inferior recorders. It operates by the compression going onto the tape in what is called a "dB linear" fashion, using a 2:1 compression ratio. This means that a 10 dB change in program level is compressed to a 5 dB level change on tape, and later expanded back to a 10 dB level

*When this compression and expansion are perfectly matched, the dynamic range of the program material is not changed by the process.*

change coming off the tape.

The dbx system is not level sensitive and requires no level calibration. It does the same thing at all levels—compresses 2:1 going onto tape and expanding 2:1 coming off tape. As such, it is very simple to use and offers the possibility of excellent performance with good tape recorders and other signal

paths.

A system closely related to the dbx system but using even more (3:1) compression and expansion is used on the National Public Radio Satellite circuit, turning a very noisy (on the order of 35 dB) but very flat frequency response into one with nearly 100 dB dynamic range.

The shortcomings of the dbx system are related to its strengths. Because of its high compression-expansion ratio, any defects in the frequency response of the path inside the dbx loop are multiplied by the expansion ratio. A 2 dB frequency response peak such as one that occurs with a typical tape recorder equalization error becomes a 4 dB peak with dbx. In addition, the frequency response error causes mismatching of the expansion to the compression. The result is "pumping" of the program material and tape hiss. Piano, flute, and bass notes can come out with "fur" around them. Excessive noise in the tape path causes the dbx system to mistrack as well. dbx was used for noise reduction in the early stages of videotape stereo simulcasting; and suffered serious problems with crosstalk into the audio channels of video components. It's never enjoyed widespread use in video systems, primarily for that reason.

The Dolby system is a more conservatively designed system and operates in a more genuine fashion to accomplish less noise reduction but with less audibility. It was the first to be developed and is the one most commonly used in the video industry. It is the most gentle of the systems, providing 10 dB of noise reduction in the low and middle frequencies, rising to 15 dB at the high end of the audio spectrum.

The Dolby system operates by compressing only the lower level portions of the program material, pulling them up out

of the noise in a precise manner when recording the signal on tape. Then when the tape is played back, the quieter parts that have been recorded with compression are played back with precisely matched expansion to compensate. This works well because the ear is less sensitive to compression at lower sound levels. Loud parts of the program are not operated on by Dolby.

In order to make the processing even less audible, the Dolby A system splits the frequency spectrum into four frequency bands, each of which is processed separately. In that way, compression that is happening in one part of the spectrum does not "pump" the level in another.

The Dolby B system (the original consumer system, and the one used in VHS cassette recorders) does not do band splitting in the same sense as the Dolby A (professional and film) system. The Dolby B system operates only upon the high frequency portion of the audio spectrum, offering 10 dB of noise reduction (which is nearly all hiss). This is a very simple and quite effective (as well as cost effective) system. It also requires good level calibration for most effective use. Unlike the dbx system, which sounds just awful (very harsh and compressed) if played back without a decoder, undecoded Type B Dolby doesn't sound all that bad—just a bit on the bright side and a bit "pumpy" on the high end. Undecoded Dolby A isn't that awful either, especially when you listen to the lousy processing on broadcast transmitters.

There are two types of dbx noise reduction as well. The most commonly used in studios is the Type I system, which operates much as described above. Pre-emphasis and de-emphasis are used to get the last ounce of noise reduction available, as is careful high and

low frequency bandpass filtering in the detector circuit which controls the compression and expansion. The bandpass filtering makes sure that excessive subsonic and super-sonic noise components cannot contribute to the control signal fed to the detector circuit. Even though, the full audio bandwidth is processed through the audio signal path.

dbx II, or consumer dbx, does all of the things that dbx I does, but uses somewhat different pre-emphasis and uses a more limited bandwidth for the control signal. Type II limits the control bandwidth at 100 to 10,000 Hz hoping to minimize mistracking problems caused by turntable rumble, record scratch, broadcast cart machines, and limited telephone line frequency response. Tapes made on dbx I and dbx II systems are not interchangeable.

When a copy is made of a recording, it is said to have gone through a generation. In magnetic recording, considerable loss of audio quality results from each generation.

Each time the number of generations is doubled, the signal to noise ratio degrades by 3 dB if the copying medium is equal to the original medium. For example, if a recording has a signal to noise ratio of 60 dB and is copied onto a 60 dB medium, the copy (called the second generation) will be 57 dB. The next dub (the third generation) from that new copy will be 55 dB, the next 54 dB, etc. The loss of noise performance is less with each additional generation.

When copies are made onto a medium much superior to that of the original, as when audio is transferred to a synchronized analog or digital audio tape, the signal to noise ratio of the original will not be further degraded audibly until many generations of that new medium have degraded its quality to that of the original.



When copies are made onto an inferior medium, the quality degrades to the signal to noise ratio of the inferior medium.

Each generation adds its own distortion to the distortion of the original in the same proportion as with signal to noise ratio. If the original has 1 percent distortion, the second generation will have 1.4 percent. By the fourth generation, the distortion will be up to 2 percent.

Most recorders do not have perfectly flat frequency response. A specification of  $\pm 1$  dB is very good for an audio recorder, and  $\pm 2$  dB is typical for the audio tracks of a good video recorder. If all the recorders involved in the copy have the same shape of frequency response curve, the frequency re-

sponse of the  $\pm 1$  dB machine can quickly degrade to  $\pm 4$  dB with only four generations, and the video machine with the first copy. By then, it can sound pretty bad.

Fast (flutter) and slow (wow) speed variations of the recorder show up as momentary pitch changes, low frequency distortion, and additional noise (scrape flutter). These distortions can add as severely as the frequency response errors in the worst cases.

The magnetic recording process has been characterized by a non-linear phase characteristic that significantly distorts the time response (and thus the waveform of the audio). These effects are usually additive as in the case of frequency response. The result is that voices and

music sound "un-natural," and "un-lifelike."

Earlier audio engineers knew that phase response distortions were audible, but an intermediate uneducated generation of audio engineers grew up ignorant of this. Modern research is proving the first group correct. The reason is that improved technology (mics, speakers, recorders) and techniques (better microphone placement, mixing and processing) have made accurate phase response possible in all steps of the recording process.

Each time the video signal is passed through a frame synchronizer or time base corrector it is delayed by one or more frames (approximately 33 ms). If this happens several times along the way from mas-

ter to user copy, lip sync will be degraded to an unpleasant degree. The solution is to delay the audio using a digital audio signal delay appropriate to the video delay involved.

While not much is known about the exact nature of the distortions produced by various digital techniques, it is generally acknowledged by audio engineers that significant distortions are produced which are audible in high quality systems and with good program material. The exact nature of these distortions and how they combine in copying is not clearly understood, but communications theory predicts that each analog to digital conversion can be expected to increase these distortions in ways similar to analog distortions.

# SOUNDSPHERE JOINS THE PEPSI GENERATION

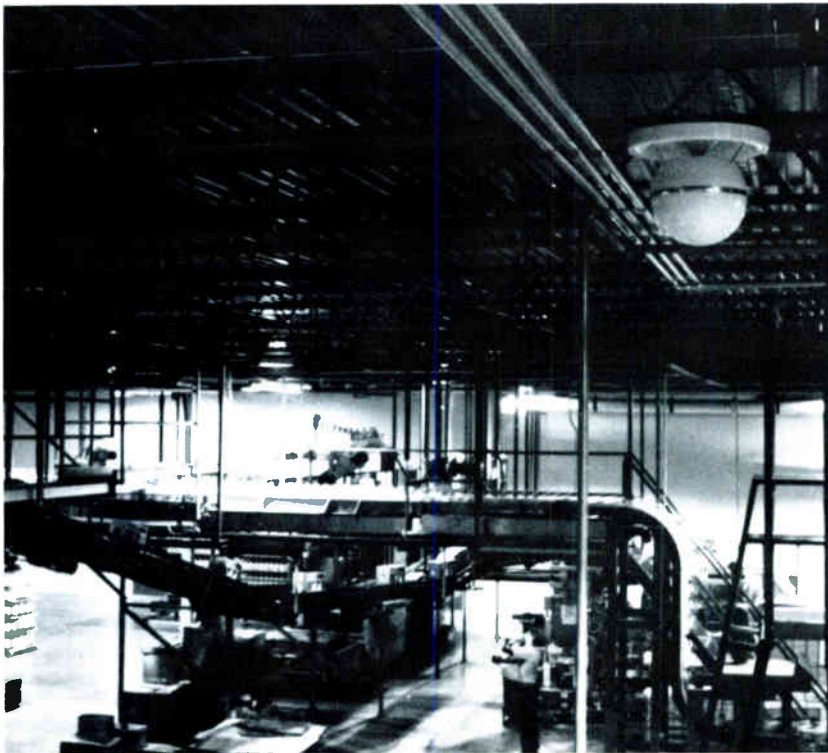

The whirl of machinery and constantly beeping lift trucks at the CPF Inc. Pepsi bottling facility in Ayer, MA, create a high ambient noise level. Paired with the usual hard wall, floor and carton surfaces, the location is a challenge to any loudspeaker. Originally done with horn speakers, the management of the facility decided to install 13 Soundsphere #110's after a live demonstration by the contractor, COMLINK. The result was improved voice announcement in the cavernous building, including the new storage facility addition.

**YOU'LL BE HEARING MORE FROM US!**

*Write for further information or call direct.*

**SOUNDSPHERE** A PRODUCT OF  
**SONIC SYSTEMS, INC.**

737 CANAL ST. BLDG 23B • STAMFORD, CT 06902 USA • (203) 356-1136

# Going Digital

## ELECTRONIC PHONE SYSTEMS

by Jeffrey Schwartz

The electronic telephone world is going digital. That's what telecommunications specialists are saying about the world of electronic key and PBX telephone systems. Digital systems are said to be cheaper, easier to install and maintain, and more efficient.

Advances in very large scale integration (VLSI) circuitry have resulted in the reduction of the price of the micro-chip and it can now handle more functions. While the technology for transmitting voice and data via digital transmission systems exists, it is only utilized by very large organizations.

However, there has been tremendous growth in the area of digital switching systems and it is said that in little time that all PBX systems will be all digital.

The growth of digital PBXs has been so evident that Systems Technology Forum in Burke, VA, held three-day courses in New York, Washington, D.C., and San Francisco, CA, to describe the systems, how they work, and how they can be integrated within private and public networks. The course was designed to explain the features of standard



*V Band Systems Valent Telephone is a 10, 20, or 30-button fully electronic key telephone featuring four pair "light line" cabling designed to replace call director.*



*Executone's Equity III is the newest in the Equity line of small key systems. Technology for the larger Encore line provided the Equity III design, for three lines and eight phones to five/12.*

and advanced PBXs. Topics that were addressed ranged from the components of voice systems to PBX selection and vendor selection. The course was taught by Ivan Jacobson, a vice president with Bank of America in San Francisco, CA. He led a project to select and implement over 200 digital PBXs for Bank of America to replace its existing Centrex and AT&T PBXs.

Since the breakup of the Bell System, as well as the rapid changes in digital telecommunications technology, consultants recommend that a potential user carefully evaluate a company and its product line to see that the user's business needs can be met economically. "It's a whole new ball game now that Ma Bell has broken up," said James Morgan, president of JH Morgan Consultants of Morristown, NJ, "and not all of these telecommunications companies are going to survive. A user has to evaluate a company carefully. This can be done by calling other users to see how service is. The potential user has to verify that everything a salesman says is correct. This includes checking the financial status of a company and assuring that it

*“While digital transmission is gaining acceptance among large corporations, it is still in an evolutionary stage in terms of cost-effectiveness.”*



*Walker's Reliant 50 is a full-featured communications system that doesn't require elaborate user training. The system has a capacity of 20 CO lines, 50 stations and 30 access codes/speed dialing numbers.*



*Businesscom Plus for small businesses allows one to five lines and up to 12 extensions. The microprocessor-controlled key telephone system is expandable to other Businesscom lines up to 24/64.*



The Data Star Key system from TIE Communications can digitally transmit voice and data simultaneously.

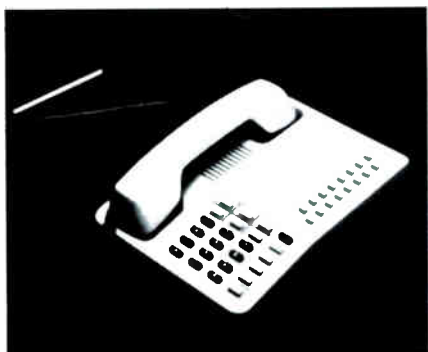

Trillium Telephone Systems' Talkio 616 Electronic Key System provides features to up to six lines and 16 extensions.



Siemens Saturn is a DYAD Digital Telephone PABX system, available in three configurations.



Teltone's Cascade 30 Digital Key Telephone System has a modular, port-oriented architecture.

has the capital to upgrade its system. It takes a lot of time but it's important."

Bob Fish, manager of technical sales support for Network Equipment Technologies in San Francisco, CA noted that with the divestiture of the Bell System, there is no current effective standard. "Companies should follow the American National Standard Institute (ANSI) and stay within those requirements so that they know their equipment won't become obsolete," said Fish. He explained that new products should be easy to maintain and operate and a user should choose a system to handle the business needs. "You shouldn't install new technology just because it is there. What you should look for is price, reliability, and the ability to upgrade a system."

While digital transmission is gaining acceptance among large corporations, it is still in an evolutionary stage in terms of cost-effectiveness. "Everyone I talked to in the past year-and-a-half is positive about the digital environment," said Fish. "The concern is when it will be cost effective. The cost economics are there. We see the movement in large corporations but they're not moving as fast as they could." He explained that T-1 is the first link in digital transmission systems. T-1 uses a digital pulse mode with a transmission link of 1.544 megabits per second. A T-1 is a group of 24 lines together on a single circuit. The user pays one access charge for 24 conversations.

"T-1 is super cost-effective," said Fish. "We (at Network Equipment Technologies) can get 47 voice conversations on one circuit and by the end of the year we expect to get 90. That's tremendous savings." Sophisticated T-1 processors are used in very large organizations where there is a large amount of voice, data, and switching traffic. Network Equipment Technology's systems can handle 32 T-1 lines. "That's a lot of horse power," said Fish. "We're the only company who can go from one T carrier to 32 T carriers on a single switch. Furthermore, they are easy to install and they are upward compatible."

Another attribute of digital transmission is its ability to send data without the use of modems or other forms of outboard gear. According to Morgan, few users are switching to this system for data transmission, but the potential is there. Nevertheless, he said he sees digital transmission as a way of the future. As for PBX systems,

Morgan also believes that they will all become digital. "Just like all transmission will become digital, there is no doubt that PBX systems will all become digital," said Morgan. "We are rapidly going into the all digital world. I think this is good. The quality is equal to or better than the old systems. For data, the error rate is much better when you go to a digital system."

Siemens in Boca Raton, FL, reported that it has noted a trend toward the digital voice transmission market. The company recently introduced its Dyad digital PBXs designed to operate with the Siemens' Saturn PBX switching system. The Dyad telephones connect to the Saturn system with single pair wire and is interfaced to the switch with a single port connection on a digital line card. This line card can also be used to connect Saturn's Data Communication Interface (DCI). This is designed to allow one type of line card for connection of voice and or data terminal devices.

---

***While PBX transmission and switching systems are at the forefront of digital technology, electronic key systems have not been left out in the cold.***

---

The Dyad telephones are available in 10, 18, and 26 button configurations. All buttons on the phones are programmable which can be utilized for additional lines or for the use of the system's features. Any of Saturn's call handling features can be accessed by pushing a button on a Dyad phone.

Manufacturers of electronic key and PBX telephone systems for smaller companies question the cost-effectiveness of digital transmission systems. Trillium Telephone Systems Inc. in Ontario, Canada manufactures digital telephone systems with analog voice control. "The digital aspect of our systems is the control aspect," said Noel Cheeseman, product manager for Trillium. "The voice is still analog technology as most systems are. Right

now, it's not cost-effective to have a digital voice system with smaller systems. It's not cost-effective for systems 10 lines and under."

Trillium's system utilizes digital signalling. The microprocessor is in the KSU (Key Service Unit), which controls the entire system. According to Cheeseman, the systems are easy to install. "Most people are having installers put our systems in," he said. "People are afraid of playing with their wires. Installers don't have to be specially qualified."

Most PBX systems that have been designed in the past seven years are operated by digital switching systems, according to Joe Enzor, director of PBX Product Line Development for ITT in Raleigh, NC. Most companies are putting their research dollars into digital technology because it is cheaper, and he believes that within two years the cost of analog systems will be more expensive than digital because fewer research dollars will be spent on cost-improvement for analog systems. "All research dollars are spent on reducing the cost of digital technology," said Enzor. "The cost-effectiveness will be there to support that, whether it is at the desk or the switching system. As long as what is delivered to the customer is cheaper, that's what really matters. From a performance quality standpoint, the use of digital bit streams is clearly an advantage. Digital sampling takes care of the quality of the voice." He maintained, however, that the attractiveness of digital technology is not so much that it promises improved features, as the fact that it will provide cost improvements.

While PBX transmission and switching systems are at the forefront of digital technology, electronic key systems have not been left out in the cold.

Teletone Corporation in Kirkland, WA, has been marketing its Cascade 30 for over one year. This key telephone system operates with a digital switch and analog voice. Ray Sala, project manager for Teletone explained that the Cascade 30 system features data carrier technology.

"It superimposes up to 9.6 kilobits of information over a voice circuit without affecting the voice in any way," said Sala. "It is comparable with data transmission systems and compatible with other PBX and key systems." He reported that Teletone

has 60,000 data carrier channels in service around the country. The key system here is software-driven and all station attributes are carried in the KSU instead of the telephone set. This is designed to allow the user to unplug the station set without replacing the program.

While there is still question as to when digital voice transmission will be cost-effective for smaller businesses, the concept is presently on the market. TIE Communications in Shelton, CT, recently introduced its Data Star Key, a totally digital key telephone system, both in the switching system and the voice system.

Data Star Key offers voice and data

features which include user-programming of the multi-functional line keys, 11 dedicated keys for single button feature access and the capability of transmitting data at 19.2 Kbs. It also offers the capability for modular expansion from two to 18 incoming lines with up to 96 extensions. Businesses who use the Data Star equipment can later expand to a larger PBX system. The Data Star PBX has been on the market for one year.

To date, the company says that more than 500 of these systems have been sold and other companies are carefully watching the concept of digital voice transmission systems in small business applications.

# SOUND SHAPERS

By  
**ROSS**  
SYSTEMS

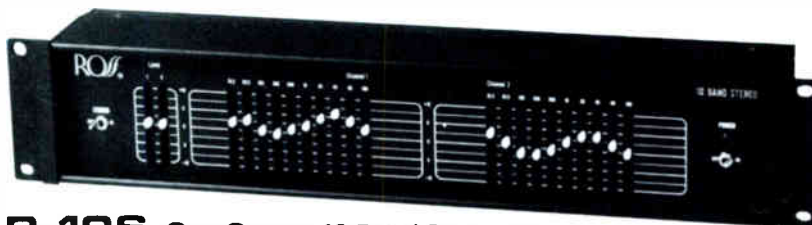

**R-10S** -One Octave 10 Band Stereo Graphic **\$189.95**



**R-15S** -2/3 Octave 15 Band Stereo Graphic **\$199.95**



**R-31M** -1/3 Octave 31 Band Mono Graphic **\$199.95**

Ross presents the "Sound Shaper Series." Three precision equalizers which give you total control of your sound reinforcement needs.

**"The Quality Line at an Affordable Price"**



P.O. Box 2344 FORT WORTH, TEXAS 76113 (817) 336-5114  
A DIVISION OF INTERNATIONAL MUSIC CO.

# **Background/Foreground Music A Sophisticated Market**



*By Jerome J. Brookman*

The background music business is booming these days, according to many parties interviewed in a random survey by *Sound & Communications*. And the parallel success by the foreground industry has created an interesting synergy, as music libraries sign up many new clients for hybrid background/foreground applications for new classes of customers.

The price of all this excitement has, and continues to be, rising licensing fees by ASCAP and BMI, which have both increased incrementally since 1982.

The brief survey among the supplying music libraries revealed that the "product" has undergone a major shift; background music is no longer

“elevator” music, as several officials observed; and foreground music has moved closer to background music in a mix of tunes and arrangement as dictated by the location.

One background library official commented that the difference between the background music and foreground music was the volume level it was played in. Still, as one respondent commented, “turn up the amp for foreground, down turn the amp for background.” The point being that the two forms of music presentation have coalesced, for the improvement of both.

A sales official remarked that the earlier “heavy metal” sound of foreground has been refined. There is a sense within the precincts of the industry that music is no longer “something to be played and not listened to” but a sales enhancement for .

Examples abound on the “marriage of background and foreground music programming.” Boutiques, for example, have bought five-hour tapes which combine the two music forms. The tunes have ranged from orchestral to combo to vocal. Clubs and discos have paced their music offerings with background and foreground selections, from ethnic through break-dancing. What companies report is music customized for the individual application.

What brought on the changes in direction of music offerings? All respondents agreed, it was the *location* making demands for *more sophisticated* presentations.

Moreover, it has been the location that has removed the terms background music and foreground music, as separate deals, and is dictating a mix of tunes and arrangements that are more reflective of today’s lifestyle.

Customer lists have grown at an almost geometric progression. One library reported that his dealerships had grown almost 50 percent in less than one year. The counter to that gain, was the revelation that some dealers in the south and southeast, were witnessing a jarring trend—cancellations of music services, were almost equal to the number of new locations opened.

The industry has been attempting to get a handle on the number of locations subscribing to a music service. The difficulty lies in the fact that there are thousands of operators who are not members of a trade association—national or local—nor are they licensed

by ASCAP or BMI. It’s been a problem that the licensing bureaus have been fighting all their business lives. They’ve pursued legal actions in the courts right up through the U.S. Supreme Court, attempting to bring into line, the fringe operator.

However, some figures do exist. The International Background Music Association (IBMA) members serve 43,000 end users. While Muzak, as of December 1984 said its franchisers were serving 121,000 end users.

The wild guessing on the broadcast field of subscribers to background/

foreground music settles on a bit over 250,000 locations being served by an operator .

And the popular pricing for this service—a recurring income for the sound contractor, audio system dealer, whatever—is at a starting price of \$27 per month for a five-hour tape, through \$50 per month, with the average seemingly \$38 per account. One respondent to the survey, a sales manager, observed that pricing today was on a “regional basis,” and that his pricing ran from \$28 per account/month to over \$50 per account/month.

## Copyrights Enforced

While music licensing firms recently grabbed major media attention by winning huge retroactive fees from television stations, their ability to enforce copyrights in the more numerous installed sound systems has traditionally been more of “an honor system.” But along with new sophistication in sound service delivery and custom programming, has come new sophistication in the detection and enforcement of license fees.

A federal magistrate recently awarded BMI and ASCAP fees frozen for the duration of the Buffalo Broadcasters’ case, which the licensing firms won on appeal. Though legal fights continue, the firms may see as much as \$80 million in back fees, according to published reports. But those headline grabbing sums stem from an industry with only 785 television stations which are required by law to supply video logs to the FCC, making discovery a clerical task. In this industry, firms were historically limited to making random inspections, listening for their music in business offices, restaurants, clubs, and factories, leaving copyright enforcement largely up to voluntary compliance or the honor system.

But the same type of computer technologies which have created leaps in the communications industries, including new methods of music transmission and new levels of program selectivity, have also given the companies new power to find freeloaders.

“It’s much more of a science these days,” said Robert W. Warner, assistant vice president of licensing for BMI. “I’m sure in the old days we were forced to do random checks, but today it’s a scientifically designed

process involving many research materials, computer networks and between 50 and 60 regional representatives, all linked to our central data bases, so that they can instantly determine if a user is or is not licensed.

“Last year we took 300 people to federal court for unauthorized use of our music. We don’t distinguish between background music and any other types of music, because any violation of our copyrights is illegal. We have taken as many as 500 people to court in a single year,” he said.

L. Barry Knittel, director of national sales, general licensing for ASCAP, said, “We have had control over operations to a great extent. Since 1974 or 1975 we’ve been modernizing our general licensing efforts to include entire industries and not just the major users. For example, while I’m not naive enough to say we have everybody, I would safely estimate that 99.9 percent of all background and foreground systems are now licensed, and the other percent of a percent is currently being addressed by our legal department.”

Knittel said that ASCAP currently has over 100,000 licensees, a figure which is greatly increased when licensees with multiple facilities such as large retail store chains are taken into consideration.

He said lists such as liquor license applicants, entertainment facility fliers and advertisements, yellow page directories, new mall openings, etc. all provide local ASCAP representatives with likely music users. And a new locked-box payment accounting system allows local representatives to check payment records hours old. —*Elliot Luber*

## ‘INNOVATIONS ‘85’ 1985 I.B.M.A. AGENDA

Sunday Aug. 4	Monday Aug. 5	Tuesday Aug. 6	Wednesday Aug. 7
	8:00 AM Continental Breakfast	8:00 AM Continental Breakfast	8:00 AM Continental Breakfast
	8:30 Welcome & Intro by Steve Jones	8:30 Report from Nominating Comm. Steve Jones	8:30 Sales Seminar By Dan Hart
	8:45 Appointment of Nominating Comm. By Steve Jones	9:00 Keynote Speaker Dr. James Melton	10:30 Coffee Break In Mfg. Exhibit Area
3:00 PM Board of Directors Meeting	9:00 Management Assoc. By Steve Jones	10:30 Coffee Break in Mfg. Exhibit Area	11:15 Sales Seminar continued
6:00 PM Cocktail Party Hosted by Mfgs.	9:30 Discussion by members on Mgmt. Assoc. by Steve Jones	11:30 Dr. Melton continued	12:15 PM Adjournment
	10:00 Coffee Break in Mfg. Exhibit Area	12:15 PM Adjournment	12:30 Board of Directors Meeting
	11:30 Open Forum Joe Bein	12:30 IBMA Sponsored Luncheon	
	12:15 PM Adjournment	7:00 Cocktail & Dinner Party Hosted by Mfgs.	
	12:30 IBMA Sponsored Luncheon		
	2:30 Kiddie Olympics—Outdoor Pool		

And he found that his foreground music tapes comprised nine to 10 percent of his yearly volume. Yet, he said he was anticipating an increase of almost 20 percent across the board in a burgeoning music industry. He also said that although *Music-on-the-Hold* was a concern, it did not take anywhere near the bite that was at first expected. He felt his program was superior to a radio receiver hooked up to a telephone hold button.

The big bite on revenues from music accounts has been the licensing bureaus, ASCAP and BMI, occasioning squeals and howls from operators and their associations. There have been on-going negotiations for some time now, attempting to erect an equitable pricing/licensing formula.

For example, an ASCAP spokesman reports its licensing fees for 1985/1986 are set at 9 percent of gross billing, “but not less than the product of \$37 times the number of all such premises.” (Premises are described as office, factory, bank, church, private club, professional buildings for doctors, dentists, private club, etc.) For services to a hospital, for example, the ASCAP fee for 1985 is 4.2 percent of the gross billings. In 1986, the fee advances to 4.5 percent for the same location. A storecasting 1985 license costs 4.11 percent for each announcement.

Based on figures supplied by BMI, fees for “1984, 1985 and all subsequent calendar years,” are industrial locations, annual fee per serviced premises with one percent of the gross amount charged or billed to each premises. The same annual licensing minimum fee for non-industrial locations apply. However, for shopping centers, “one-and-one half percent of the gross amount is charged or billed to each premise. As for storecasting, \$10 per floor served, plus \$1.20 per loudspeaker installed for outside audibility.”

Transmission modes have remained fairly constant—music is delivered on premise, or over the landline, or over the air via an SCA channel. Satellite transmission has been added, but this service has been deemed a substitute for wire line reception.

Yet, satellite has been a substantial earner for some suppliers. Take the Satellite Music Network Inc., Dallas, TX, reporting that their second-quarter revenue was expected to climb to \$3.4 million from about \$1.5 million in the year-earlier quarter.

## NOW, ONE MICROPHONE CAPTURES IT ALL.



All components available separately.

The Sennheiser Telemike Electret Microphone System.

Its unique modular design provides all the flexibility and precision of a collection of separates—from omni to super cardioid, spot to shotgun, telescopic boom to tie-clip lavalier.

All, at a fraction of the price of comparable separates.

And all, with the most advanced electret technology available: our unique back-electret.

See your Sennheiser dealer for details. And capture it all.

**SENNHEISER®**  
Sennheiser Electronic Corporation (N.Y.)  
48 West 38th Street • New York, NY 10018 • (212) 944-9440  
Manufacturing Plant: D-3002 Wedermark, West Germany

©1982, Sennheiser Electronic Corporation (N.Y.)

Reader Service #211



On-premise equipment has been substantially improved by one manufacturer, with the addition of pre-programmable features through a 24-hour period. With the introduction of this feature, the flexibility of delivery—at the location—of contemporary music, including rock vocals, country, urban, dance disco, has been enhanced immeasurably. Thus, the locations “customizes” to its individual tastes! And, interestingly enough, this manufacturer reported no increase in price for its music, or for the lease’s fees for the hardware.

SCA outlets have been increased by as much as 25 percent, one music library reported. And with the introduction of “central studio operations,” the SCA operators have been given a wider choice of tunes, arrangements, and regional selection. Some SCA operators have been investigating the feasibility of a second channel for just foreground presentations.

With more sophisticated music programs, and a higher quality of recording (although digital recording techniques have not penetrated this area. “Everything is analog, anyway,” one music librarian commented.), the music library suppliers are packaging their offerings. For example, one supplier now has eight five-hour tapes at \$45 per month retail price to the operator; or eight four-hour tapes at \$45 per month retail as a starter package. For this fee, the music source will run a monthly exchange, tape for tape. Additionally, several suppliers bill and collect from the location for the operator.

There are as many variations on the package as there are operators. But there is universal agreement that music cannot be leased to a location for less than \$28 per month, elevating to \$50 per month or more, as dictated by the location’s need, the regional tastes that bring customizing of programs into play, and the mode of transmission.

No matter whether it’s foreground music or background music as individual services, or as “kissin’ cousins” in a mix, programming reflects today’s lifestyle. And elevator music is passe. Today’s music is the best sales enhancer thousands of locations have found. And the background/foreground music operator, in most business metropolitan areas of the nation, has found his sales curve and recurring revenue rising above a linear curve that’s been around for too long.

## MOVING?

Please attach your Sound & Communications mailing label or print your address exactly as it appears on the label.

### NEW ADDRESS

NAME (Please Print)

COMPANY

ADDRESS APT NO.

CITY STATE ZIP

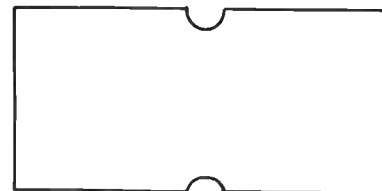

Return to:  
Circulation Dept.  
Sound & Communications  
220 Westbury Avenue  
Carle Place, NY 11514

## NO MOVING PARTS—ZERO MAINTENANCE

# Solid-state, Natural Voice Digital Message Repeater

MacKenzie’s Digital Message Repeater is a revolutionary new concept in repetitive sound.

Our all-solid-state DMR has *no moving parts* and requires *no periodic maintenance*. It uses EPROM memory cartridges to store digitized recordings of human voices, music or sound effects. Upon demand, the digitized information is reconverted to analog, and the message is played to an audio output.

The sound is completely natural—just like a conventional tape recording—and the audio quality is excellent.

Messages are permanently stored and may be played over and over again without loss of sound quality.

Designed to handle short messages, the DMR is ideal for:

- Fire alarm announcements
- Voice evacuation
- Fireman’s return
- Weather warnings
- Parking warnings
- “Watch your step” messages
- Rental car return instructions
- Sound effects
- Dark rides
- Exhibits and displays

The DMR consists of the message cartridge and the controller main frame. The complete unit is very compact—only 8 x 4.8 x 2.4 inches.



MacKenzie’s new, solid-state Digital Message Repeaters use EPROM memory cartridges to play messages. The sound is excellent—and completely natural.

DMR message cartridges are recorded at the MacKenzie factory. If a message requires changing, the cartridge is returned to the factory for re-recording. An exchange service is available to eliminate downtime. Standard message time is up to 60 seconds; longer message time is available.

MacKenzie Laboratories has been manufacturing rugged, reliable message repeaters for over 25 years. Our new DMR series is built to the same exacting standards which have made our name synonymous with repetitive sound.

For more information, call MacKenzie Laboratories toll-free at 800-423-4147.

## **MACKENZIE**

MacKenzie Laboratories, Inc.  
5507 Peck Rd., Arcadia, CA 91006 USA  
Telephone: (818) 579-0440

# The new AT-RMX64 6-channel mixer/ 4-track cassette recorder from Audio-Technica®

Between the little battery-operated "portable studio" cassette recorders and full-scale pro equipment lies an important – and largely ignored – market. Now Audio-Technica has created an entirely new mixer/recorder category with the AT-RMX64, to fill the real needs of many important markets.

Start with the basics. Six input channels, not four like most "portable studios." And any input can be routed to any tape track. Record in compatible stereo at normal speed. Or on any combination of 1 to 4 tracks (from any other combination when dubbing) at double speed. With Dolby\* B or C noise reduction. And punch-in/punch-out on any track. Even vary



speed  $\pm 15\%$  to match instrument pitch exactly.

All of the above and more makes the AT-RMX64 a very impressive cassette recorder. But the mixer section is even more remarkable...not only as an input to the tape, but as a free-standing mixer on its own. Every input accepts balanced or unbalanced mike or line signals with 60 dB of available attenuation,

and 72 dB of overall gain. With patch-in/out for every channel. Plus two "send" circuits for every channel. Even 48V to phantom-power professional condensers. But that's not all.

Dual-frequency EQ of each input gives far more control than the usual glorified tone controls. Peak or dip at selectable low and high

## Grow with it!



frequencies. Or select a high pass filter for the bass and shelving of the highs up or down. That's truly impressive flexibility. And send any input to any sub output and/or tape channel. Add signal processing from two return channels. Pan between channels 1 and 2 if desired. Or monitor any combination of channels with the solo bus. Create both a PA mix and a monitor mix and also record the output...all at once.

The AT-RMX64 feeds amps at +4 dBm, not -10 dBm like the "little" mixer/tape recorders. With up to +18 dBm before clipping so

that all the power in the amps is available.

In short, every basic feature needed for the corporate, institutional, and performance markets. Yet the AT-RMX64 is so easy to use even a beginner can benefit from its almost intuitive design.

And as mixing and recording talent becomes more sophisticated, the AT-RMX64 design grows with the user. Both as a "live" mixer and a full-feature recorder. Indeed, the more you know, the more the AT-RMX64 has to offer.

Specify the recorder/mixer that takes your clients all the way to the top! Ask your A-T rep to show you the AT-RMX64, or write or call for more information today.



# audio-technica®

Audio-Technica U.S., Inc., 1221 Commerce Dr., Stow, OH 44224  
(216) 686-2600

Reader Service #213

World Radio History

# Maturing Market . . .

The background/foreground music market is maturing. The largest population segment that listens to background and foreground music are those who belong to the baby boom generation, ages 24 to 40. As this group matures, their tastes in music becomes more sophisticated.

Traditional background music, often referred to as dentist office music or elevator music, is no longer satisfactory to the majority of listeners. Their tastes have also outgrown the hard rock they preferred in their younger days. The music they do enjoy is light contemporary adult rock, often intermingled with jazz, country, or blues depending on the location.

To serve this need, Yesco of Seattle, WA, has introduced its Studio 1000, a commercial free private radio network (SCA) which delivers "customized" foreground music programming to match listening preferences of specific markets, what Yesco calls "market matching."

"It's a perfect example of market

segmentation. Programs are arranged for each individual market," Ken Heim of Yesco explained. "If you're a dealer in the South, your listeners may prefer a lot of country music. While in Chicago, almost no country is listened to."

***Traditional background music, often referred to as dentist office music or elevator music, is no longer satisfactory to the majority of listeners.***

Studio 1000 allows dealers to choose musical selections which are appropriate for their listeners. According

to Heim, Yesco will assist the dealer in his selection with research in information including direct subscriber feedback as well as radio play record sales in each area which are compiled by the company.

Benefits of the system include cost effectiveness. All royalty payments required to play the music in a commercial environment are covered by Studio 1000. Also included is exclusivity. The private radio network and its programming are exclusive to business subscribers and will not be available to the consumer market.

Other benefits are said to include continuous uninterrupted programming, improved employee morale, and increased productivity and sales for the business environment.

Along this line, the Seeburg Music Satellite Network has announced the signing of several major distributors of its new foreground music, Lifestyle AC, described as adult contemporary music, featuring top vocal hits including the current *Billboard* chart leaders appealing to the 20 to 49 year old age group.

"Response to our Lifestyle AC product has been absolutely phenomenal," said Bill Fox, Seeburg's general manager. "It is clear that this is the type of music people want to hear. Today's younger work force is not relating to traditional background music and Lifestyle provides us with an exciting new product to offer businesses. We must be responsive to the marketplace. If we don't offer the kind of music people want to hear, then we'll lose our business to over-the-air radio. Lifestyle is our answer to meeting this challenge."

Seeburg's Lifestyle AC foreground music is delivered via the Galaxy I satellite for use on FM subcarriers as an alternative to foreground tape players.

"When you analyze the capital cost, maintenance and music costs, it's hard to make money with tape players. With Lifestyle, the profit margins are much more like those of our traditional SCA background music business. And you get the added benefits of continuously updated, professionally programmed music. You just don't have to worry about the problem of repetition with a customer whose tapes

## ENGINEERING EXCELLENCE

**NOW AVAILABLE AT AFFORDABLE PRICES. THE COMPLETE LINE OF SPECO BACKGROUND/FOREGROUND SYSTEMS. DESIGNED AND CONSTRUCTED WITH UNCOMPROMISED QUALITY. AVAILABLE FOR IMMEDIATE DELIVERY FROM STOCK.**

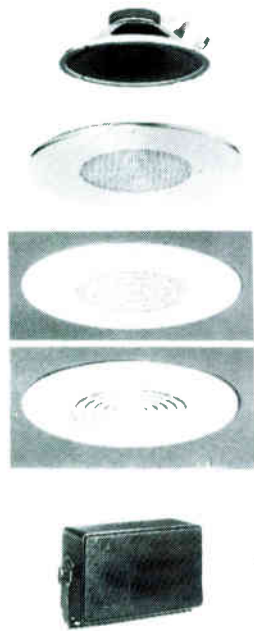

**8" Speakers  
Speaker Assemblies -  
With Grilles, Transformers  
Sound Columns  
Wall Baffles  
Wall Baffle Assemblies  
Line Transformers  
Ceiling Grilles  
L-Pads**

**PA Horns  
PA Amplifiers**

**NEW**

**All-Weather Polypropylene  
Speakers  
Enclosed Mini-Speakers  
With Built-In  
Line Transformers**

**For Complete Information,  
Write or Call:**

**SPECO**

Division Components Specialties, Inc.

1172 Route 109, P.O. Box 624 • Lindenhurst, New York 11757

N.Y. State Only - (516) 957-8700

Out of State - (800) 645-5516

are updated monthly or quarterly. The programs can be updated daily if necessary to insure the product is as fresh as the music charts.

"We have invested in almost 100 new hours of music in our Lifestyle format," Fox said. "It is definitely the most contemporary *instrumental* format available and is perfect for those businesses that need *instrumental* programming."

On the background front, Environmental Music Services (EMS), Inc., of Seattle, WA, has made available three new tape players with current drive amplification (CDA). The CDA allows for speakers to be connected in parallel without transformers, according to Dick Bothell, director of sales and marketing at EMS. "This improves the fidelity and lowers the cost," Bothell said.

"The marketplace is changing," Bothell noted. "The sentiments of the consumer has turned against the traditional concept of background music. The demand is for a combination of instrumentals and vocal programming—a format that is more adult and modern. This is mostly due to the fact that the listeners are getting older. They don't want to be rocked and socked anymore.

"A large part of this gearing is toward a higher fidelity. It is now necessary to deliver a higher fidelity so that the listener is pleased," he said.

#### Other Offerings

Also along the foreground music line is the new 8325A Surround Foreground Music System from JBL. The system is designed for use in restaurants, lounges, theaters and other business locations.

A three-way system, the 8325A features a 10-inch low-frequency driver, a five-inch transducer for mid-range frequencies, and a one-inch dome tweeter.

From Tape-Athon of Inglewood, CA, is the model 770 Dual Cassette Inter-Mix System. The system features eight-hour program capability with continuous play and automatic reverse.

The 770 consists of two TR 200 transports (standard Phillips Type) and the "Round Robin Sequencer" capable of program inter-mix, housed compact, steel cabinet.

Tape-Athon also offers the Model MM720A player/amplifier. The MM720A is a 20-watt, compact, solid

state, mixer/power amplifier and cassette player meant for the most exacting applications encountered by audio engineers, according to the company.

The "Music-Master" cassette player/amplifier features: microphone input, either high z, low z or optional low z balanced; selectable dialog equalization; mute; tone control; overload protection; multiple output impedance (4 ohms, 8 ohms, 25 volts,



**Tape-Athon's Model 770**

and 70 volts); music pre-amp output/music input for the insertion of accessory equipment; AGC; knob or screwdriver adjust level controls; pilot light; power switch; stereo-mono switch; auto-reverse cassette player (with eject button, reverse button and run indication light) and 20 watts RMS power.

Also from Tape-Athon is the Messenger II System designed for inserting messages in an environmental music

systems which desire point of purchase advertising; the 702 Reel-to-Reel Type Tape Playback Unit for narrative and environmental music application; and environmental music tapes for the 702. Tape-Athon's Programmer for SCA or wire operation background music centers offers time of day and sequencing control of three programs with a multitude of preselected music tempos eliminating repetition.

OWI Inc. of Compton, Ca, has come out with two new versions of its BAP 100 two-way mini loudspeaker for background and foreground applications. The new speakers, the OWI 70/2 and 70/3 are weatherized versions of their predecessor.

—Nancy Peterson

**COMING IN AUGUST  
SOUND &  
COMMUNICATIONS  
1985 BLUE BOOK**

## TEK-ENTRY SERIES



TekTone's Tek-Entry Series Telephone Entry Systems are complete, automatic call and entry control systems, designed for easy operation and reliability.

Entering a simple 2 (or 3) digit code initiates a system call to the correct phone number. Entry is then permitted by the tenant, if desired. Front panel programming is push button simple.

**Telephone  
Entry  
Systems**

a 1 or 4 minute selectable talk time limit.

Tek-Entry Systems are of aluminum construction and include a metal telephone touch pad and hook switch, armored handset cable and a Lexan® display window.

Features include busy and door open displays, memory retention during a power failure, relay output for controlling elevators, doors or gates and

**TekTone®**  
Reader Service #215

SOUND & SIGNAL MFG. INC.

1331 S. Killian Dr., Lake Park, Fla. 33403-1988  
(305) 844-2363 Toll-free order (800) 327-8486

# EMERGENCY!

When a few seconds  
can mean the difference  
between life and death...

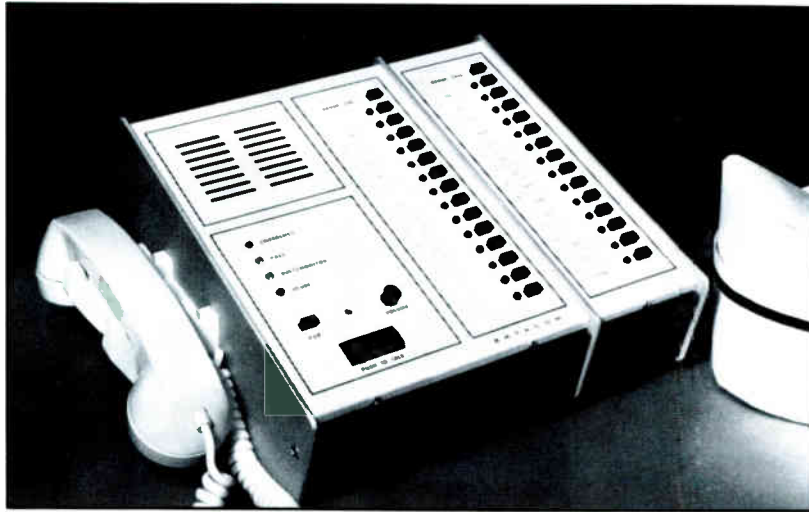

## EKTACOM HB Nurse Call System SERIES

With literally thousands of existing hospital and/or nursing homes that have either out-dated or code-deficient systems now in use, you want a system that is ideal for rehabilitation as well as new construction...EKTACOM HB IS THE ONE!

- Simpler to install.
- Usually negotiated—no competitive bidding.
- Existing conduit probably O.K.
- Existing wiring usually adequate. Using the HB-CAP (Circulating Audio Pair) module, even replacing "X" brands should be a snap.
- With FA adapter plates, professionally customizing ugly holes is automatic.
- State of the Art electronics.
- UL 1069 Listed system.
- Provides all the essentials.
- Costs about 1/3 less than a conventional system.
- Plug-in patient/staff/duty/master stations.
- Exceptional voice quality.
- Stainless steel room stations—standard.
- Nurses love the simplicity.
- Patients love the clarity.
- Administrators love the reliability and PRICE!

Remember, in health care, don't settle for less than Simplicity, Reliability, and Clarity...in other words—the best!



**FISHER BERKELEY CORPORATION**

5800 Christie Avenue, Emeryville, California 94608

**FISHER BERKELEY CORPORATION** • 5800 Christie, Ave., Emeryville, CA 94608, (415) 655-9696

Gentlemen: Please send me information.

Name \_\_\_\_\_ Street \_\_\_\_\_

Title \_\_\_\_\_ City \_\_\_\_\_

Company \_\_\_\_\_ State \_\_\_\_\_ Zip \_\_\_\_\_

Reader Service #216

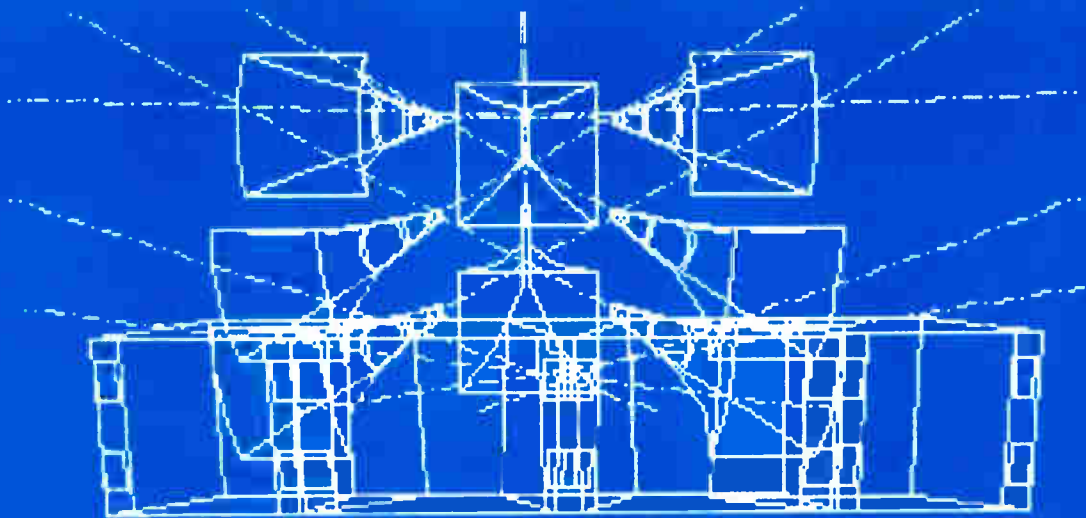

## *The Evolution of* **Loudspeaker Cluster Designs**

*by Barry McKinnon*

In the beginning, there was the multicell horn. Sound contractors saw it and said, "Well it might not be great, but it's all we have." Sound systems were installed and horns pointed so that all the seats had as many high frequency hot spots covering them as possible. Everybody knew that there was not much more you could do than that, besides there wasn't all that much extreme high frequency response coming out of a multicell anyway. This was OK, as it was the beginning of what would be the baby boom period and people had more interesting things to think about than how even the high frequency coverage of their sound systems was.

Mono changed to stereo, multicell horns evolved (at least branched out) into sectoral or radial horns, which allowed the sound contractor to spread the hot spots over a much wider area than before. There were now entire horizontal rows of seats that had 10 kHz coverage instead of every third seat. The baby boom was in full swing, as were Elvis Presley's hips. Again, nobody really paid much attention to how even coverage was when a sound system was hung from the rafters, they had color TV to think about.

The contractor put the system in and walked around the room while someone spoke into a microphone. If

he couldn't hear anything, he might move a horn to the left or right. Sound system installation was still in the craftsman phase, not yet to the technician level.

Sound systems were being installed into auditoriums and theaters for serious artistic works. Architects and engineers who always sat in the seats that had been missed by the multicells started to wonder if some scientific method could be devised to determine in advance where the speakers should point. The contractor should not need to send his oldest son into the cluster 75 feet off the floor to point horns so the entire auditorium is covered.

Bolt, Beranek and Newman of Cambridge, MA, an acoustical consulting firm that existed at the forefront of audio technology, first presented an optical system for doing just that sort of predicting in October 1964. Their system consisted of a small light projector with a variable aperture to simulate the rated coverage pattern of the high frequency horns of that era. This, combined with scale models of the rooms involved, allowed a fast and relatively effective method for determining the location of the loudspeaker cluster, as well as the required devices for the cluster.

The world continued to turn, Vietnam was on everyone's mind and again

few people considered the problems in sound system coverage. Why was there still such discrepancies between what the design said should happen and what was seen in the room? Oh well, Jimi Hendrix, Woodstock, the dawn of outdoor concert sound, the hey day of muscle cars, the baby boomers were in high school and it just wasn't a big problem.

Nixon finally decided to get out of the war in Vietnam, people again noticed a lack of high frequency response in their seats. But this system was designed scientifically. What has gone awry? Is there a problem with the design method? No, it appears valid. Is there a problem with the data the engineers have been working with? Surely, the 90 x 40 horn should be what it claimed to be. They wouldn't print it if it wasn't true! Then came Watergate and suddenly people took a hard look at everything printed.

One of those people was Don Davis, his insightful work into loudspeaker directivity and "Q" spurred many private consultants and manufacturers to take a detailed look at just what all the multicell, sectoral, radial, and diffraction horns and lenses did.

Well, imagine the surprise of the entire audio industry when they found that many of the facts provided by the manufacturers turned out to be less

factual than they anticipated. To be fair, we have to remember that much of this surprising information came as a result of new approaches to old problems, new measurement techniques and new emphasis placed on old parameters. The bottom line was the discovery that almost nothing worked quite as anticipated, coverage was either wider, narrower, taller or shorter than rated, except for some frequencies which turned out pretty darn close.

One of the surprised people was Don Keele Jr., who then worked for Electro-Voice. He thought about these discrepancies quite a lot and in 1975, presented a *new* horn design that was specifically configured to reduce the rather ambiguous nature of the horns that acoustical consultants had to work with.

The competitive nature of our North American society had everyone looking at these rather unusual devices and marveling at how close to specifications they performed. Calculators and computer screens came to life (and computer time was a valuable commodity then) and a couple of years later, in 1977, Mark Ureda and Cliff Hendrickson of Altec Corporation

produced a different style of horn that did a very good job of performing close to its specifications.

As all of this industrial flurry continued, people had more time on their hands to notice how mediocre many sound systems installed in the late fifties and early sixties were. But none of them sounded like the discos they went to or even the rock concerts or even their home hi-fi systems. In short, people were achieving and increased awareness of how *good* sound *could* be and weren't happy sitting in the seats with no high frequency response. Well, it would seem that it should be much easier to improve the quality of the sound systems rather than start another war to distract these audio critics. The decisions were made and budgets were assigned to buy this new technology.

By this time computers had become commonplace, nearly every major audio manufacturer had new horns that worked just like they claimed they did. The audio consultants became happier with the results of their designs. The new horns agreed closely with the designs when transferred from paper to real world.

### McMahon East Side

#### Loudspeaker Data

Reference Power: 1 W

Frequency Band: 2 kHz

Name: S1

Type: JBL2366

Axial Directivity Index: 17

Axial Sensitivity for 1 W at 1 meter: 118 dB

Maximum Power: 150 W

Relative Drive Level: -10 dB

#### Mounting Location

X coordinate: 0

Y coordinate: 30.5

Z coordinate: 93.2

#### Mounting Angle

azimuth: 0

rotation: 0

elevation: -28

Name: S2

Type: JBL2366

Axial Directivity Index: 17

Axial Sensitivity for 1 W at 1 meter: 118 dB

Maximum Power: 150 W

Relative Drive Level: -11 dB

#### Mounting Location

X coordinate: 0

Y coordinate: 30.5

Z coordinate: 92.7

#### Mounting Angle

azimuth: -40

rotation: 0

elevation: -18

Name: S4

Type: JBL2366

Axial Directivity Index: 17

Axial Sensitivity for 1 W at 1 meter: 118 dB

## La Belle Info Series - Two Great Ways to Communicate



INFO 152



INFO 102-B

Tell retail customers about your sale merchandise or other special items. Draw attention to displays, welcome guests, and inform your customers. With a full range of features, the affordable La Belle Info series message displays are fast and easy to program in several eye-catching modes.

Dealer inquiries welcome.



**LABELLE  
MARKETING  
SYSTEMS**

For additional information  
call Elaine Ludwig at  
800/558-9526 or  
414/567-9101

510 So. Worthington, Oconomowoc, WI. 53066

Reader Service #218

Because almost all manufacturers had reached effective designs from different directions to avoid patent infringements, the real competitive race developed in software and data. The manufacturer that can provide the most detailed and useful data along with a system to manipulate it tends to get the edge on the competition.

In 1981, Altec Lansing took the initiative with Ted Uzzle, developing new coverage description techniques, along with new methods of mapping the coverage of horns on drawings and providing the calculator programs to crunch the numbers. These design methods involved taking the spherical coverage of a horn and transferring it to the plane surfaces found in architecture. By using the Altec calculator programs for the Hewlett Packard HP41CV, the sound contractor could do all sorts of accurate advance design work on the location and content of his cluster.

While all of this data collection and design of software was going on, the private consultants and test equipment manufacturers were finding new areas



to explore, such things as Bruel & Kjaer's Time Delay Spectroscopy, which amounted to taking still snapshots of the spectrum at any point in the room you might select. It did allow the contractor and consultant to look at the effects of early reflections and adjacent loudspeaker interference on the overall cluster performance. With the advent of advanced computer technology, Crown introduced TEF™, which amounts to a picture of a three dimensional sculpture of the frequency spectrum, showing amplitude vs. frequency vs. coverage angle.

The addition of the time scale element in these new measurement systems has produced a new emphasis on phase relationships in the cluster design. The realization that a cluster is not a group of speakers working independently of each other, but a group of devices interacting together in ways not envisioned until the advent of TDS and TEF measurement. Corrections in phase response of clusters is being accomplished with more consideration in physical layout and applications of delay lines. The resulting improvement in overall system response and evenness of coverage has

Maximum direct field.

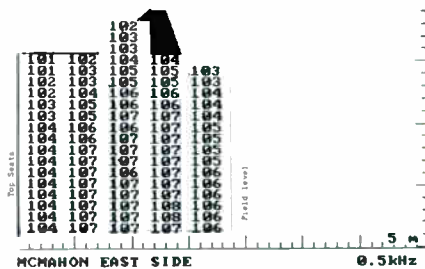

been proven through measurement and subjective approval.

These new measurement tools provide another aspect for the acoustical consultant and architects to look at, allowing accurate verification of the design's viability once the system is installed.

As a prime example of the latest in design software to incorporate these factors, the JBL Central Array Design Program features a multitude of design aids. The program is user friendly, offering a variety of information on room acoustics including SPL mapping over designated coverage areas, intelligibility estimates, direct/reverberant field mapping, normalized field SPL charts for uniformity of level, effects of phase on cluster performance at specific frequencies, as well

Est. intelligibility (R').

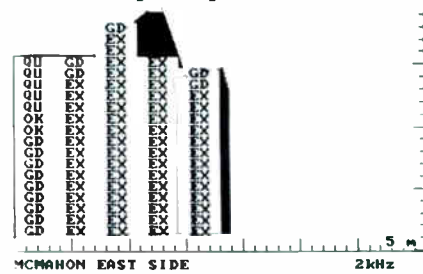

as offering options for the above data, such as various frequency points empty and full house, various reverb times, driver power levels and loudspeaker orientation.

The program can handle up to 20 loudspeakers in the cluster and up to 20 planes in the seating or target surfaces. It can also work with more than one point source. The variables for the loudspeakers include: loudspeaker type, bandwidth, mounting location, rotation angle, azimuth, elevation angle, and relative drive level (expressed in dB below full rated power). As well as producing a graphic display output, it also can provide aiming points on the target planes.

By first establishing the coordinates of the cluster in relation to the target areas, various horns and horn aiming

# GO WITH THE PRO!



The DM 1900 is Numark's top-of-the-line stereo audio mixer: an easy to operate studio quality console with built-in six band equalizer, designed to meet every professional need.

Its outstanding features include complete front-panel operation, a fast-acting 12 segment, multi-colored peak reading LED output meter and easy mixing of sound-on-sound recordings for making video and movie sound tracks. There's a switchable sound processor loop facility for adding effects

devices. Three phono/one tape or two phono/two tape stereo capability. Independent left and right channel volume controls. The DM 1900 matches any power amplifier with its variable output selector. A two-position "talk over" switch provides smooth professional voiceovers. Easy-access headphone input comes with separate volume control.

The DM 1900 is available at select Numark Professional Products Division Dealers. **Suggested retail \$615.00.**

For more information about the DM 1900 or Numark's complete line of professional products, please write or call Paul Friedman, National Sales Manager.

**PPD Numark**  
Electronics Corporation

503 Raritan Center, Edison, NJ 08837 • (201) 225-3222



can be tried quickly and detailed data can be obtained in much less time than tedious point by point mapping of spots on the target plane. Certainly, one of the biggest plus factors is the high speed number crunching of the computer that provides such a large quantity of data for each minute change in the parameters of the design. This sort of time consuming calculation would have kept the junior engineer busy for days, now the time can be well spent trying more variations and fine tuning the design.

To see what value design programs of this type have in the real world, a look at a real world design was in order. John Taves, a partner with Raines, Finlayson, Barrett & Partners told of his use of the new JBL program in the design of a sound system for the University of McMahon Stadium in Calgary, Canada. John Taves, a professional engineer and Syn-Aud-Con graduate has been with Raines, Finlayson Barrett & Partners for 15 years, when the University of Calgary engaged the firm, he was given the task of designing a sound system for the stadium upgrade. The seating was to be expanded to 50,000 to accommodate the opening ceremonies of the 1988 Winter Olympics and the sound system was to be of wide bandwidth, powerful and low in distortion. A point source system was chosen to meet those criteria. And rather than build an immense system at one end, a suspended system hung over center field was selected for reasons of aesthetics and reducing required distances.

Initial estimates for equipment required allowed a feasibility study on

the suspended central cluster. After it was determined to be a practical reality, design work was started. "A gut feeling of what will be needed is very important to use the program effectively, you have to have a clear picture of your goal to get relevant data from it," said Taves. "Without a solid starting point for the design, you could manipulate data all day and get no closer to a workable design. The program is only a design tool. Its biggest value lies in quick output of data for various horns, orientations, and power levels."

In fact, the data produced by the program allowed the completed design to use less equipment than the original estimate for the feasibility study. More effective use of a smaller amount of equipment is something almost everyone can relate to.

The final design of the cluster includes a total of 22-JBL 2366 horns with 2445 drivers, four-JBL 2365 horns with 2445 drivers, and 16-JBL 4550 LF enclosures. The system will be capable of 103 dB in the seat decks with a target SPL of 95 dB for most events. The cluster is divided into five separate zones; north, south, east, west, and field, all of which are independently controllable.

The cluster is only a portion of a very large and involved sound system design. As the work nears its May 1986 completion date, a more detailed look at the system is forthcoming.

When asked about any unusual aspects of the design the program may not have been equipped to deal with, Taves mentioned two points that were kept in mind while the design was in

progress. The first was the program's inability to recognize overhangs and the resultant shadows in coverage. These areas required individual attention. The other factor was reverb time in open stadiums. Because the time involved, they appear more as reflections than reverb. While intelligibility maps were being done, many RT60 times between one second and 10 seconds were tried to see the trends indicated by very long decay time. Because every seat is in the direct field of the cluster's coverage, very little difference was noticed.

A study of reflective surfaces in the stadium did show some problem areas. Some surfaces providing reflections up to 100 milliseconds later when compared to the direct sound, acoustical treatment was specified for these surfaces. This was not a function of the design program.

Several examples of the design program's output taken from some of the initial design phase of the project are shown here.

As impressive as this sort of design software is, one can only speculate on what the future holds. Certainly, the computer will play a larger part in sound system design as more involved software is made available. And as more advances are made in computer-interfaced measurement systems, a better understanding of interaction between devices and the room will follow. One can picture design programs that will take into account such things as boundary effects and proximity effects of other enclosures on low frequency performance. Even to the point of providing estimates of required equalization of inner or outer enclosures in a large array, maybe even to the point of computer controlled equalizers, operating in real time to correct for deviations in response that may be caused by dust, humidity, and crowd size. How about computer controlled delay lines to bend the wavefront to compensate for temperature changes? Or seat sensors to control the portions of a cluster activated to cover occupied areas only? Or a system that can detect changes in localized ambient noise levels and adjust levels and response of specific areas of cluster coverage to compensate? As advanced as we view the cluster design technology today, tomorrow is only limited by imagination. We'd no sooner use a light projector to design a cluster today than we'd take a stage coach to work.

# How do you Plug into the Background Music and Sound Contracting World?

INNOVATIONS '85

By Connecting  
With The I.B.M.A.

The International Background Music Association is composed of companies like yours, independents, Muzak, 3M, Rowe, Tape-Athon and many more, with members all across the United States, Canada, Mexico, and Puerto Rico. We represent every facet of the Background Music and Sound Contracting business.

We maintain a direct line of communication vital to aggressive business in an aggressive market. You're kept informed as to all the latest trends, and their effects on you, with monthly newsletters discussing sales tips, and technological developments, along with coverage at important trade shows and conventions.

An all-in-one organization, the I.B.M.A. plugs you into the best in the business, and that means more profits and a brighter future.

**TO ATTEND  
THE 1985 IBMA CONVENTION  
ON AUGUST 4<sup>th</sup>—7<sup>th</sup>, 1985 AT  
THE WESTIN BAYSHORE RESORT HOTEL  
VANCOUVER, CANADA**

**CALL  
JOE ELUM  
(216) 833-4164**



## Cetec Raymer's New Catalog Display New Product Line

A new eight-page catalog presents Cetec Raymer's complete line of paging amplifiers, tuners, receivers, telephone interconnect, paging system installation accessories and test equipment. Fully illustrated, it has description and specifications for each product, including five new wall-mountable amplifiers with voice activated automatic music mute.

From: Cetec Raymer, 7315 Fulton Ave., North Hollywood, CA 91605; (213) 875-0423.



## New Plastic Cable Harness Brochure From M.M. Newman

An updated brochure that describes its complete line of UL recognized, spirally cut expandable plastic cable harness is being offered by M.M. Newman Corporation. The Heli-tube® Spirally Cut Cable Wrap Brochure provides the operating temperatures, abrasion resistance, flammability, MILSPECS, and other characteristics for its line of six different plastic cable harness materials which are UL recognized.

Describing clear polyethylene, black polyethylene, fire-resistant polyethylene, nylon, black nylon and teflon expandable plastic cable harness, the

four-page, brochure lists the standard sizes available from one-eighth-inch to one-inch, including dimensions, weights and packaging alternatives.

From M.M. Newman Corporation, Marketing Dept., P.O. Box 615, Marblehead, MA 01945; (615) 631-7100.

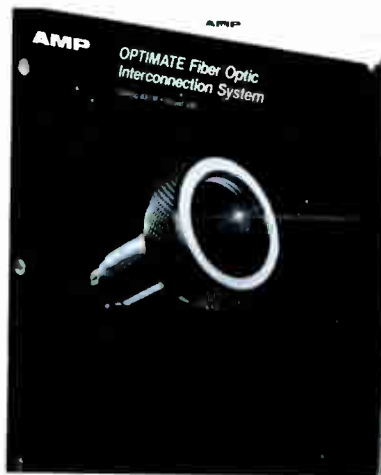

## New AMP Catalog Describes Fiber Optic Product Line

A new 72-page catalog from AMP Incorporated describes its standard line of fiber optic connectors and accessories for simplex or duplex fibers with 50/125 to 1000 micron cores, as well as fiber optic cables, standard jumper assemblies, installation hardware, undercarpet systems, and installation tooling and supplies.

The cables include dual-fiber (duplex) construction of 50/125, 85/125, and 100/140 micron glass fibers for light duty, heavy duty, and plenum use. The same fibers are available in single-fiber (simplex) construction for light duty use. A 1000 micron single-fiber plastic cable is also available.

From: AMP Incorporated, Harrisburg, PA 17105; (717) 564-0100.

## Mogami Wire and Cable Introduces Reference Catalog

Mogami Products Div. has introduced its new General Wire & Cable Catalog featuring flexible multi-conductor cables with specific applications in broadcasting, satellite transmission, medical equipment, computer interfacing, and audio installation.

The compact reference catalog includes a new series of ultra-miniature

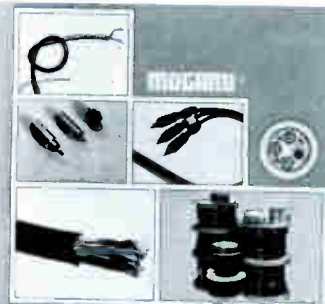

## MARSHALL ELECTRONICS, INC.

MULTI-CONDUCTOR CABLES  
SUPERFLEXIBLE CABLES  
COMPUTER CABLES  
MOLDED CABLES & CONNECTORS  
SPEAKER & MICROPHONE CABLES

GENERAL WIRE & CABLE CATALOG

multi-conductor cables, superflexible computer cables, and a series of high-conductivity cables with oxygen-free copper conductors developed through Mogami's Neglex Research Program.

From: Marshall Electronics, Inc., Mogami Products Division, Department WC, P.O. Box 2027, Culver City, CA 90230; (213) 390-6608.



Over 10,000 items in stock, for immediate delivery!

1985

## Contact East's 1985 Electronic Tool and Test Instrument Catalog

Contact East is offering its 1985 Electronic Tool and Test Instrument Catalog, featuring over 5,000 technical products for assembling, testing, and repairing electronic equipment.

Products include precision hand tools, test instruments, tool kits, soldering supplies, plus a new, full selection of telecommunication tools and instruments and a complete range of static protection products.

From: Contact East, 7 Cypress Dr., PO Box 160, Burlington, MA 01803; (617) 272-5051.

by Ted Uzzle

## The Limits of Hearing

Kono, Shunichi, Yoiti Suzuki, Toshio Sone, "Some consideration on the auditory perception of ultrasound and its effects on hearing," *Journal of the Acoustical Society of Japan (E)*, Vol. 6, No. 1, pp. 3-8 (January 1985).

Gerald E. Loeb, "The functional replacement of the ear," *Scientific American*, Vol. 252, No. 2, pp. 104-111 (February 1985).

An understanding of hearing is basic to understanding audio. This has to do with more than a tree falling in an empty forest; it has to do with our ability to create sound amplifying and recording channels that do what their users expect of them. Audio engineering extends the limits of hearing, backward in time or across distance.

Today, engineering continues to extend the limits of hearing, although the effort is now largely a part of medical technology, law enforcement, or some other activity not usually thought a part of audio.

Two recent papers describe studies of hearing beyond its ordinarily accepted limits: the hearing of high frequency sound and hearing by the deaf.

In the early days of medical X-rays, around about World War I, X-ray generating tubes were completely unshielded, and when the technicians returned from lunch they routinely tested the apparatus by shooting an X-ray of their own hands. Many of them died horrible deaths from what we now know to be radiation sickness before the safe use of these devices became commonplace. When medical ultrasound came into use in the 1970s, it was hailed as a safer technique, but with the infinitely wiser limitation, "So far as we know."

Workers in factories that build and test ultrasonic equipment, report that they reliably know when the equipment is running at high levels. How? Is there a temporary effect on hearing or on the body? Is there permanent injury to their hearing from long-term exposure? Traditional studies of the ear suggested that the ear simply had no mechanism for transmitting ultra-

sonic signals to the nervous system.

Three researchers at Tohoku University in Japan report in the English translation edition of the *Journal of the Acoustical Society of Japan* that high-level ultrasound does have measurable effects on the performance of the ear, at frequencies well within the ordinary hearing range. They applied an ultrasound transducer to the forehead with a pressure just under one pound. Then, with headphones, the subjects were given audio signals to which they could compare the ultrasound.

Probably the most startling result was that ultrasound was perceived as tones in the audio passband. When the ultrasound was varied between 30 and 70 kHz, the subjects reported them as pitches between 10 and 15 kHz. The audible pitch changed slightly or not

at all as the ultrasound frequency changed.

The threshold of audibility varied quite a bit from subject to subject, equivalent to an underwater sound level between 130 and 150 dB-SPL. Remember that none of this testing used airborne ultrasound. Each subject found that at some particular frequencies he perceived nothing.

Exposure to ultrasound caused temporary hearing threshold shifts in all listeners, at audio frequencies. Thirty seconds after shutting off the ultrasound, these shifts amounted to between 2 and 3 dB at 4 kHz and 8 kHz, slightly lower after two minutes. The ear was less sensitive to audio frequencies above 6 kHz presented simultaneously with the ultrasound; this masking effect amounted to 10 to 30

(continued on page 49)



## GROMMES PRECISION BACKGROUND MUSIC AND PAGING RECEIVER



### PR-510 FM-AM PR-513FM

#### FEATURES

- ★ Super-sensitive FM-AM tuner section—(1 9uV IHF sensitivity on FM)
- ★ High or low (switchable) input impedance
- ★ Microphone input can be blended with music
- ★ Microphone precedence mutes music for paging
- ★ Output for voice coil as well as 25 or 70 volt line
- ★ Booster amplifier output for adding more power output
- ★ Output for telephone music on hold amplifier
- ★ 600 ohm line input or telephone page
- ★ Built in antenna for AM or FM and provision for external antennas
- ★ Signal strength tuning meter
- ★ Silent tuning for FM
- ★ Loudness contour control
- ★ Auxiliary input for tape
- ★ Separate off-on power switch

#### AUDIO SECTION

Power Output 10 Watts RMS with 0.5% or less harmonic distortion  
 Frequency Response ± 1dB 20 to 20,000Hz 8 ohm output  
 ± 1dB 50 to 15,000Hz 25 or 70 volt output



### PR-540 FM-AM

#### FEATURES

- ★ Super-sensitive FM-AM tuner section—(1 9uV IHF sensitivity on FM)
- ★ 40 watts RMS power
- ★ Microphone input can be blended with music
- ★ Microphone precedence mutes music for paging
- ★ Bass treble and loudness controls for music only
- ★ Output for voice coil as well as 25 or 70 volt line
- ★ Booster amplifier output for adding more power output
- ★ Output for telephone music on hold amplifier
- ★ 600 ohm line input or telephone page with separate control
- ★ High or low impedance balanced microphone input
- ★ Built in antenna for AM or FM and provision for external antennas
- ★ Signal strength tuning meter
- ★ Fly wheel tuning
- ★ Silent tuning for FM
- ★ Separate off-on power switch
- ★ Monitor speaker and main speaker switch
- ★ Auxiliary inputs for tape

#### AUDIO SECTION

Power Output 40 watts RMS with 0.25% or less harmonic distortion  
 Frequency Response ± 1dB 20 to 20,000Hz 4 or 8 ohm output  
 ± 1dB 50 to 15,000Hz or 70 volt output

PRECISION ELECTRONICS INC., FRANKLIN PARK, ILLINOIS 60131

Reader Service #220

## Installation Profile:

# Quality Sound for Trendsetting Retailers

by Nancy Peterson

*The following is the first edition of the new Sound & Communications section called "Profile." This feature will profile installation jobs, contractors, consultants, and manufacturers that offer information on new installation techniques or an unusual problem that they successfully solved, new markets they discovered, feedback on a market they specialize in, or even side business to get involved in that complement your present business.*



*Consultant Doug Pomeroy at Unique Clothing Warehouse, New York.*

*This month's profile is on Doug Pomeroy of Pomeroy Audio in Brooklyn, NY. Earlier this year, Doug was a consultant on an engineered sound installation. What was unusual about the job is that it was for a clothes store, Unique Clothing Warehouse on lower Broadway in New York City. Retail store sound installation offers a whole new market to both the contractor and consultant. Many stores are hungry for a professional sound system—but often settle for a diet of stereo equipment intended for the home consumer—equipment that can't possibly offer the quality and endurance of a professional sound system.*

When Richard Wolland, owner of Unique Clothing Warehouse, expanded his store last winter, part of the plan included the installation of a professional sound system. Since Wolland's store is located in the Greenwich Village area of New York City, he caters to a young clientele that is interested in the latest in new wave, punk rock, and bohemian fashions. Therefore, an important part of the store's atmosphere also includes the music that is played.

But Wolland, who has been a self-proclaimed audiophile for many years, had many requirements he wanted met by the system.



*SITE Architects' unique upside down plaster statues among loudspeakers on ceiling.*

"Music is very important to our ambience," Wolland said. "Everything we do is quality and value to me. I want our sound system to reflect that too. The system should not only be loud but clean. No distortion is primary to me."

Another important aspect of the system, is that it would allow Wolland to play the new wave, off-beat music his clients enjoy. It was also important that the system could function at disco levels, since the store would also be used for parties after hours.

"The main purpose was to get the sound to fill a large space. (The store is approximately 110,000 cubic feet—about half the size of a football field.) It was also important that the music didn't beam at people," Wolland said, "or that we'd have to turn the sound up high to fill the room and then kill people with the volume."

Also to be considered was that the speakers blend in with the interior design which is also reflected in the style of the store. The store, which was designed by SITE Architects of New York, is decorated with lifesize, plastered statues which hang upside down from the ceiling, including an

entire rock band, as well as a woman pushing a baby carriage.

The consultant Wolland chose was Doug Pomeroy, a former Columbia Records engineer who mostly freelances in recording production and editing.

It was important also to Pomeroy to achieve optimum dispersion. To do so, Pomeroy chose 32 suspended Polk speakers and positioned them around the columns which line the large room.

"The speakers on the columns are situated so no matter where you're shopping the sound comes in good," Pomeroy said.

To assure that the music would be everywhere, he also placed speakers in the dressing rooms.

According to Pomeroy, another reason why he chose Polk speakers is because of their bass response. "Speakers won't sound loud if they don't have a good bass response. The bass response of the speakers is approximately 30 Hz, as measured in the factory.

So that the speakers blend in with the store's unique decor, Pomeroy spent an entire night painting all 32

speakers and their grilles grey.

The system also includes Hafler Pro Power, amplification which will provide the near disco levels for the parties and special events the store holds after hours. Also installed was the Hafler 500 and an NAD stereo tuner.

To make certain that the music during store hours is continuous, Pomeroy installed a Benjamin automatic cassette changer which can play up to 10 hours of continuous music.

To update the system, Pomeroy said he would eventually like to install a Compact Disc player which would not only play several more hours of music, but would offer a higher sound quality.

At present, Wolland said he does not want to install a CD player because the music that is being put out on CDs right now is not the music his customers want to hear.

Pomeroy also wanted to offer the option of playing the radio if desired.

"With all the tall buildings in New York, FM reception is a big problem. Originally, we planned to put a radio antenna on the roof for better radio reception," Pomeroy said. "But after a little research, I discovered it would be a horrendous job."

So, Pomeroy installed a Parsec power antenna instead, which he said "is just a little better than a piece of wire. But at least now they can receive some of the more powerful New York stations."

Union electricians did the actual installation of the sound system which took about two weeks.

"It would have taken less time but they were doing other work as well.

"I've only been back once since the system was installed in February," Pomeroy said, "and that was to clean the heads on the tape machine."

But Pomeroy added that he will be doing some additional work.

"The architects aren't happy where the speakers are, so I'm going to reposition them on the ceiling," Pomeroy said that he is a little nervous what it might do to the sound since the speakers will be further away from the shoppers. He did add one consolation, "Bass response is better when it is coupled with a flat surface, such as ceiling."

But most important, how do the customers like the new system?

"I know people like the sound," Wolland said, "because they're dancing in the store."

## TIRED OF THE SAME OLD SOUND? we hear you!

ENVIRONMENTAL SOUND® has developed a new class of loudspeaker technology engineered primarily for SOUND CONTRACTING, CONSULTING, and ARCHITECTURAL FIRMS.

If you haven't already heard, introduce yourself to the PROFESSIONAL DROP CEILING MONITOR SERIES. Innovative versatility, allowing numerous applications so as to shape the future state-of-the-art loudspeaker and to improve cost effectiveness from installation to sound quality, ENVIRONMENTAL SOUND® has heard what the sound contractor needs.

PRO DROP CEILING MONITORS represent a brilliant achievement required for today's technology that until now has been overlooked and neglected.

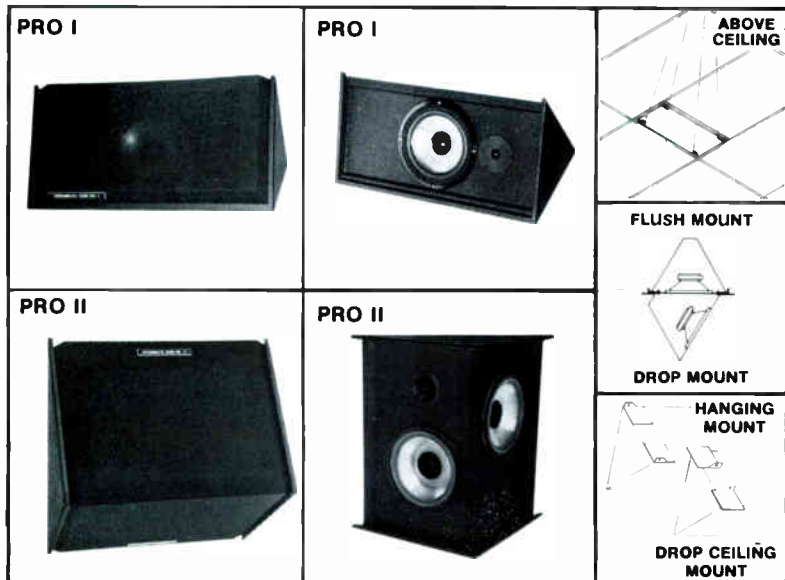

**ENVIRONMENTAL SOUND®**  
31220 La Baya Dr. #110, Westlake Village, CA 91362 (818) 706-0228



# PRODUCTS IN REVIEW



## SHURE'S NEW PORTABLE TELECONFERENCING SYSTEM

Shure Teleconferencing Systems, a division of Shure Brothers Inc. has unveiled the ST3000 Portable Teleconferencing System.

Designed for audio teleconferencing in small- to medium-size conference rooms and offices, the Shure ST3000 is a multi-microphone, two-component system which combines acoustical engineering with electronic processing.

Automatic microphone gating and gain control not only provide the ST3000's interruptability feature, they also compensate for different voice levels and varying locations of participants in a room. Once the volume level is set, no readjustment is required.

Two components comprise the system—an audio module and the controller unit. The round audio module contains three microphones and a designed loudspeaker. This module distributes the called party's speech evenly around a full 360 degrees. Similarly, the automatically selected cardioid directional microphones pick up the conferee's speech uniformly around the module with significantly less room noise and reverberation than is normally associated with an omnidirectional microphone.

The controller allows the conference leader to maintain control of the teleconference at all times through a simplified control panel which provides for switching from normal telephone operation to teleconference mode, muting either incoming or outgoing signals, and setting the volume level of the module loudspeaker.

User net price for the ST3000 is \$5,280

□ Contact: Shure Teleconferencing Systems, 222 Hartrey Ave., Evanston, IL 60204; (312) 866-2400.

Reader Service #9

## CERWIN VEGA'S NEW FULL RANGE SPEAKER SYSTEM

Cerwin-Vega has introduced the V-43, a self-contained, all horn-loaded, three-way speaker system designed for a variety of professional applications including sound reinforcement, keyboard, bass guitar, vocal applications, and stage monitoring.

The V-43 is said to be a high efficiency system capable of extremely high sound output with low distortion, low coloration, and controlled directivity.



According to Cerwin Vega, the secret of the V-43's exceptional performance is in its large throat horn and driver combination replacing power hungry midbass cones. Typical compression drivers with small throat horns generate large amounts of distortion when driven at high levels. This distortion is due to the basic non-linearity of air subject to high pressure changes. The V-43 midrange is a large throat driver/horn design which lowers distortion by reducing sound pressure densities. This accurate midrange contributes to the vocal sound quality of the system.

Manufacturers suggested retail price is \$1,500 each.

□ Contact: Cerwin-Vega, 12250 Montague St., Arleta, CA 91331; (818) 896-0777.

Reader Service #10

## FISHER BERKELEY'S NEW INTERCOM SYSTEM

Fisher Berkeley Corporation has announced a new small, sophisticated intercommunications system utilizing a proprietary integrated circuit "chip" developed by the company.

The chip in the "S" Series is said to be equivalent to over 1,000 conventional discrete components. The new system is designed to provide op-

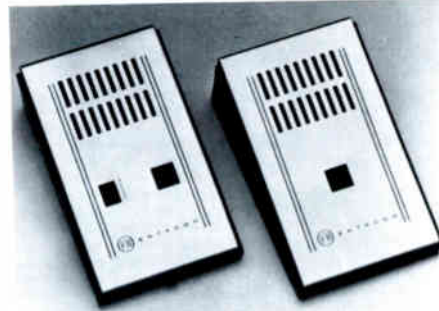

timum voice communication between two points with many user programmable features never before offered in a limited station system.

Applications of the system include offices, laboratories, and industrial.

Power is supplied by an integrated module which plugs into any 117 V AC source.

□ Contact: Fisher Berkeley Corp., 5800 Christie Ave., Emeryville, CA 94068; (415) 655-9696.

Reader Service #11

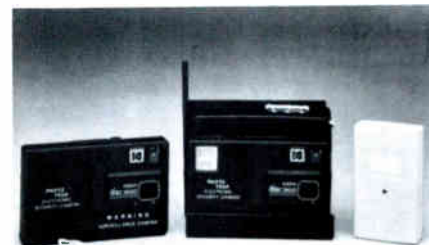

## ECONOMICAL SECURITY CAMERA BY MOUNTAIN WEST

Mountain West has announced Photo Trap, a new security camera that snaps a picture when triggered. Any device with a normally open dry contact (motion detector, door contact, holdup switch) can be used to trigger the camera. The camera uses disc film for quick development.

Applications include security, burglary, vandalism, shoplifting, holdup, and employee theft. Take a picture of "smash and grab" burglaries, entry/exit to a restricted area, unauthorized use of company equipment, or even an intruder.

Photo Trap can be used as a stand-alone device or connected into an existing security system.

□ Contact: Mountain West, P.O. Box 10780, Phoenix, AZ 85064-0780; 1-(800)-528-6169.

Reader Service #12

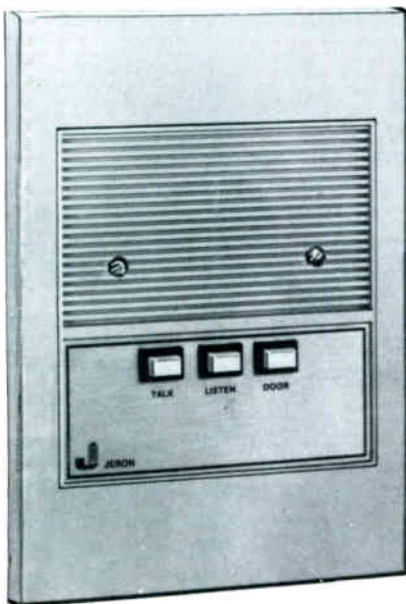

### JERON PRODUCT AIDS IN REHAB AND RETROFIT

Jeron Electronic Systems, Inc. has expanded its Series 2015 Intercom Panels to include additional products that help simplify installation of intercom-entry security systems during rehab and retrofit or conversion projects.

Series 2015 Oversized Room Stations may be used to reduce installation time, when an existing wall cut out is too large to be covered by a standard-size panel, or to utilize the existing backbox when replacing obsolete equipment such as Couch.

Series 2015 are available with durable hi-impact cameo white faceplate, or silver anodized metal. Models are available with easy to operate pushbutton controls for 'talk-listen' or voice-activated systems.

For further information, contact: Jeron, 3554 N. Clarke St., Chicago, IL 60657; (312) 528-4020.

Reader Service #13

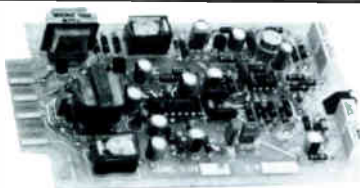

### MONROE INTRODUCES AUDIO LINEAMP WITH VOX

Monroe Electronics, Inc. has introduced a new Model 3138B Audio Line Amplifier with VOX. The threeby

five-inch circuit card is intended for use in telephone and other communication systems where low level amplification, audio level control, or audio controlled switching is required.

The 3138B can be configured as a single or dual stage compression amplifier, an AGC amplifier, or as an audio amplifier without AGC or compression. A quiescent noise muting squelch is adjustable over the entire -46 dBm to +20 dBm input signal range and provides a five millisecond attack time and an adjustable one to five second release time.

Contact: Monroe Electronics, 100 Housel Ave., Lyndonville, NY 14098; (716) 765-2254.

Reader Service #14



### SOUND REINFORCEMENT FOR SMALL FACILITIES

Providing flat power response at low frequencies and requiring less equalization than traditional horn-loaded, low-frequency systems, the new JBL 46710K Sound Reinforcement System is designed for smaller halls and theaters.

A two-way direct radiator system, the 46710K is said to deliver smooth response, low distortion, tight transient response, uniform coverage and natural uncolored sound quality.

System components include the 2225H 15-inch (380 mm) low frequency loudspeaker, the 2425J high frequency compression driver, the 2370 flat-front bi-radial horn for constant horizontal coverage from 500 Hz to 16 kHz and the 3110A frequency dividing network.

The 46710K system has a frequency range of 25 Hz to 20 kHz, power capacity of 150 W pink noise to 300 W continuous program material, a sensitivity level of 97 dB SPL, a crossover frequency of 800 Hz, horizontal beamwidth of 90 degrees and a nominal im-

pedance of 8 ohms.

For further information, contact: Ron Means, Professional Products Division, JBL Incorporated, 8500 Balboa Blvd., Northridge, CA 91329; (818) 893-8411.

Reader Service #15



### CODE-A-PHONE'S NEW MODELS WITH LCD DISPLAY

Code-A-Phone® has announced that its Models 8410 and 8420 are two significant entries in the company's line of distinctive, intelligent custom phones designed for the home and office. Both custom phones offer a variety of user-friendly microprocessor-controlled features.

The 8410 and 8420 offer automatic dialing of up to 32 pre-programmed numbers, LCD display, call timer, last number redial, auto redial of a busy number, on or off-hook dialing, true hold, switchable rotary or touch tone dialing and a convenient battery backup in compact design. The Model 8420 is additionally equipped with a convenient built-in two-way speakerphone.

The Code-A-Phone custom phone Model 8410 has a suggested retail price of \$139.95 and the Model 8420, complete with built-in speakerphone retails for \$289.95.

For further information, contact: Code-A-Phone, 16261 Southeast 130th Ave., Clackamas, OR 97228; (503) 655-8940.

Reader Service #16



### LOFT IS NEW 410 DYNAMICS PROCESSOR

The new Model 410 is a two channel processor by Loft that can be  
(continued on page 42)

## a closer look

by gary davis

### Sennheiser Wireless Mic

It seems that every issue carries a release on a new wireless microphone system. The once-shunned "necessary evil" of location filming has become a popular tool for film, live and taped video, and live stage performance.

Sennheiser's EM 2003-9 receiver appears to have the technological features most often sought: VHF high band operation (to reduce business radio and electrostatic interference), companding (to increase dynamic range capability), independent balanced and unbalanced outputs (for simultaneous feed to a local monitor system as well as to a mixer, recorder, sound system or broadcast point), and diversity reception (to reduce fades and dropouts).



EM 2003-9 receiver and wireless mic

It appears that the receiver is indeed a true professional system. The ability to turn off the companding will be important to some users. The helical front end should afford optimum selectivity to avoid adjacent channel interference from nearby TV stations, FM radio broadcast harmonics, or other wireless mics in the same area.

The crystal oscillator ensures stability, although it makes field conversion to another frequency more difficult (most professional wireless mics share this difficulty).

Optional rack mounts permit convenient packaging of several systems. The LED meter provides a handy means to monitor either RF signal strength (in microvolts) or modulation level (in percent deviation).

The price of a system including the receiver plus an SK 2012-9 "body

pac" transmitter which accepts any mic input is \$2,270. With the SKM 4031-9 hand-held electret-condenser cardioid mic/transmitter, the system is \$2,090. Either transmitter extracts four hours of operations from three 1.5 V AAA cells. This is done by using a DC-DC converter to step up the 4.5 V nominal source to a regulated 8 V.

One important item is the method by which diversity is achieved; there are many possibilities. A so-called "antenna diversity" system will utilize two antennas, basically "Y" connected together into the same front end. This inexpensive approach may sometimes help to pull in a signal, but can create its own dropouts due to electrical phase-cancellations.

A so-called "true diversity" system can be achieved by different means. There may be two RF front ends, with switching to feed the best RF signal to the audio detector and output; or there may be two complete receivers, with switching done at the audio stage. The latter is used by Sennheiser, with rapid switching to the source of the stronger RF signal done after the detectors (up to several times per second). Because the audio level at this point is a function of the RF deviation and the transmitted signal, it remains fairly constant regardless of changes in RF signal strength at the two antennas.

Reader Service #7

### Auditel's Chairman-Controlled Conference Sound System

The Auditel "Chairman-Controlled, Delegate Operated Conference System" is intended for use in configuration of anywhere from two to 100 microphones.

In essence, it performs the functions of an automatic microphone mixer, with some useful enhancements. The system becomes competitive at six mic stations and economical in even larger configurations. A typical installation, for example, might be in a city council chamber. The mayor or council president would have the "chairman's unit," and other council members would have the "delegate stations."



Conferencing for two or 100 users

The operating modes, according to the company, allow for automatic mic mixing in the "unrestricted mode," although there is a practical limit of about 15 to 20 live mics in this mode; up to 100 mics can be used in the exclusive mode.

The same system is also applicable in court rooms, as well as legislative halls (An Auditel system was installed in the Massachusetts legislature and another in Intelsat headquarters in Washington, D.C.). Other applications include corporate board rooms.

According to Jim Wood of Auditel, because each delegate station can be equipped with a built-in speaker, this system can eliminate the need for a PA system in certain installations like the corporate meeting table. In such cases, the sound level in the room remains more manageable, and speech intelligibility is optimized. Even with a large sound system in operation, those seated at a dais may be able to use the delegate station built-in speakers for foldback.

A pre-amp, limiter, and speaker amp are built into each delegate station and therefore line level signals are applied to the audio bus. Special seven-conductor cable is used to link the units (multi-pin DIN connectors). The floor mic input to the chairman's unit is a balanced five-pin XLR (to accommodate logic lines), and the output to the main PA amp/speaker system is a balanced, 600-ohm line-level circuit. Frequency response of the system is said to be 150 Hz to 15 kHz, with an intentional low-end rolloff to avoid rumble.

Reader Service #8

## ADVERTISING TABLE OF CONTENTS

RS#	Company	Page Number
207	<b>Aegis</b>	12
213	<b>Audio-Technica</b>	24, 25
222	<b>Cornell</b>	45
204	<b>DIS•USA</b>	6
201	<b>Electro-Voice</b>	II
221	<b>Environmental Sound</b>	38
216	<b>Fisher Berkley</b>	28
220	<b>Grommes</b>	35
—	<b>IBMA</b>	33
208	<b>JBL</b>	13
218	<b>LaBelle</b>	30
212	<b>Mackenzie</b>	23
217	<b>Numark</b>	31
214	<b>OWI</b>	49
205	<b>Paso</b>	7
210	<b>Ross</b>	19
206	<b>Rowe</b>	10
211	<b>Sennheiser</b>	22
225	<b>Shure</b>	IV
209	<b>Sonic Systems</b>	15
223	<b>Speco</b>	26
215	<b>Tek-Tone</b>	27
203	<b>Telex</b>	5
—	<b>TOA</b>	3
224	<b>Yesco</b>	III

(continued from page 40)

operated in a dual/mono or stereo mode. Each channel is comprised of an expander/gate, compressor and peak limiter section. The 410's compressor can be switched into a full range (AGC) or above threshold mode. A mild de-esser circuit (75 ms.) can be switched into the compressor path. All three of these sections can be operated independently. Only one VCA (the Valley People TA-101) is used per channel. This gives a similar performance to separate processors without the signal degradation of running through three VCAs.

The Model 410 has applications in the broadcasting, recording and sound reinforcement fields.

Suggested retail price is \$699.

□ Contact Peter Nimirowski, Phoenix Audio Lab; (203) 649-1199, telex 333666 LOFT.

Reader Service #17

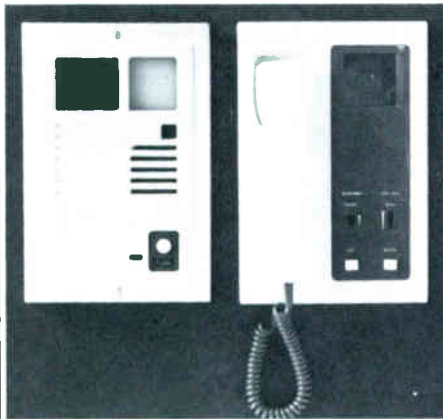

### NEW VIDEO INTERCOM FROM AIPHONE

Aiphone Corporation has introduced the Aiphone Video Intercom System.

Said to be simpler and less obtrusive than CCTV equipment, the compact system allows residents to see and talk with visitors before opening the door. The system is wired, with only a single coaxial cable between stations handling sound, video, and power.

"This system was originally designed for business, so it's built with the reliability and durability that heavy business use demands," said Hiko Shinoda, president of Aiphone.

Room stations for the system are less than seven inches wide, project only

2 $\frac{5}{8}$  inches from the wall and are only 1 $\frac{1}{16}$  inches deep.

Each station has an instant-on TV screen, handset, volume control, contrast/brightness adjustment, door release button and a monitor button for audio and visual surveillance of the entry area.

Outside, the vandal-proof heavy aluminum door station houses a wide-angle camera lens with 50-degree coverage, protected by a high impact resistant shield. A beam sensor protects against excessive light.

When the call button is pushed, a lamp automatically illuminates the caller with a soft, unobtrusive light. The caller's image is displayed inside immediately after the call tone sounds.

□ Contact Aiphone Corp., P.O. Box 90075, Bellevue, WA 98009; (206) 455-0510.

Reader Service #18

### PEAVEY UNVEILS CS<sup>TM</sup>-1200 POWER AMPLIFIER

Peavey has begun shipment of its new "power house" amp, the CS<sup>TM</sup>-1200. This unit is larger than the Peavey CS-400<sup>TM</sup> and CS-800<sup>TM</sup> models. The new CS-1200 is said to be a "brute" of an amplifier and is built for ruggedness, reliability, and performance.

The large continuous duty power transformers are of a new semitoroidal type, and the entire unit is designed to meet European electronic and heat dissipation specifications.

The CS-1200 is *not* a warmed over high power amp, but is designed for continuous high power operation, according to the company. It has two separate channels and its two power



supplies are complemented by a large number of silicon output transistors in a "tunnel-like" dissipation tube that maximizes heat dissipation. It is rated 600 watts RMS continuous per channel into 4 ohms and 1,200 watts RMS continuous into 8 ohms in bridge mode.

Peavey's patented DDT<sup>TM</sup> compres-

sion is also standard CS-1200 as well as the CS-400 and CS-800. The CS-1200 features Peavey's new "back porch" accessory plug-in patch panel for balanced input transformers and crossover/special function modules.

Suggested U.S. Retail Price: \$1,199.50.

□ Contact: Peavey Electronics, 711 A St., Meridian, MS 39301; (601) 483-5365.

Reader Service #19

### TANGENT'S NEW RSM-8 POWERED MONITOR MIXER

Tangent has announced its PCM-8, the industry's first powered monitor mixer. It replaces a separate mixer, two stereo amplifiers, and a rat's nest of interconnects with one compact eight by five rack-mount monitor system with four built-in amplifiers (130 watts each).

The PCM-8 with a suggested retail price of \$2,000, doubles as a flexible, cost-effective zone mixer.

(continued on page 47)



# **SOUND & COMMUNICATIONS IS NOT JUST A MAGAZINE... IT'S AN INDUSTRY.**



NO POSTAGE  
NECESSARY  
IF MAILED  
IN THE  
UNITED STATES

**BUSINESS REPLY MAIL**  
First Class Permit No. 155 Carle Place, N.Y.

POSTAGE WILL BE PAID BY ADDRESSEE

**SOUND & COMMUNICATIONS MAGAZINE  
220 Westbury Ave.  
Carle Place, New York 11514**



NO POSTAGE  
NECESSARY  
IF MAILED  
IN THE  
UNITED STATES

**BUSINESS REPLY MAIL**  
First Class Permit No. 155 Carle Place, N.Y.

POSTAGE WILL BE PAID BY ADDRESSEE

**SOUND & COMMUNICATIONS MAGAZINE  
220 Westbury Ave.  
Carle Place, New York 11514**



# Sound & Communications is not just a magazine, it's an industry.

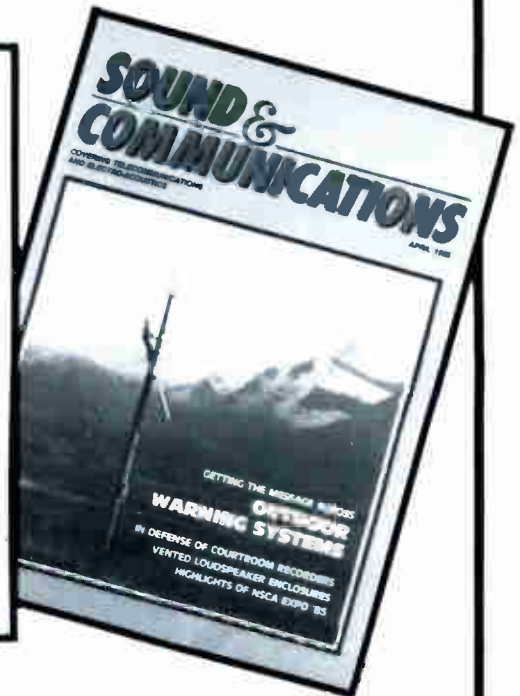
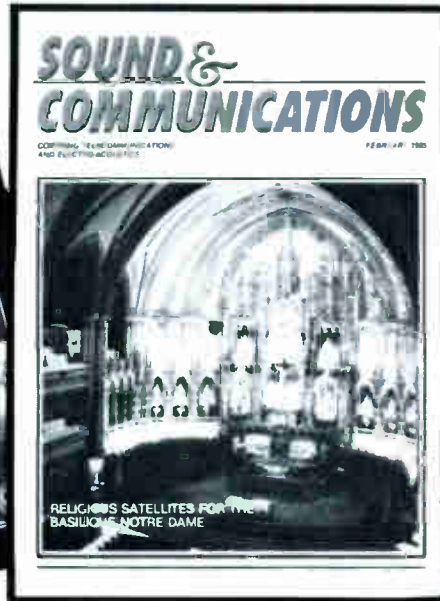
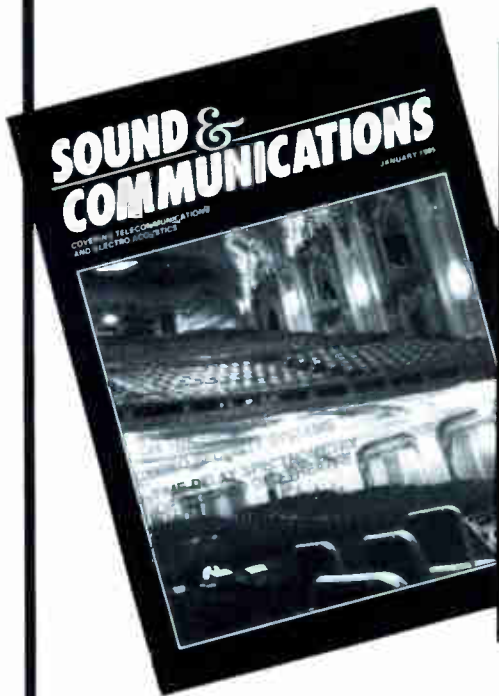

## The Best Editorial . . .

The team of Chris Foreman, Editorial Director, Jerry Brookman, Editorial Consultant, Elliot Luber, Managing Editor and Nancy Peterson, Assistant Editor, supported by a staff of over 30 people have the **RESPECT** of every important writer and reader in this business.

## The Best Graphic Design . . .

Compare for yourself. The All-New Sound & Communications not only **LOOKS BETTER** than ever, it is the best designed, most colorful magazine in this market today.

## The Most Important Readership . . .

Let's stop kidding around now, we know there aren't 20,000 people in the sound and/or video contracting industry. Not unless we start sending "free," "unrequested" copies to every recording studio, production house, electrical contractor and distant relative we know.

Sound & Communications remains the only magazine whose circulation is 25% **PAID, TOTALLY REQUESTED**, and **QUALIFIED**.

**SOUND &  
COMMUNICATIONS**

For advertising information call Cliff Capone,

(516) 334-7880

# FACES AND PLACES

## AEI Names Behrens As Director Of National Accounts

Jeffrey Behrens has been named vice president, director-national accounts, Audio Environments, Inc., as announced by Michael J. Malone, president, AEI. Behrens comes to AEI, one of the largest foreground music programming services, from the Pepsi-Cola Company, where he was national account sales manager, and primarily responsible for the headquarters management of the firm's Burger King account.

In his new position with AEI, Behrens will be responsible for expanding and maintaining the company's national accounts.



**JEFFREY BEHRENS**



**WILLIAM G. HOLBERT**

## NEC America Appoints Holbert National Sales Manager

The Switching Systems Division of NEC America, Inc., has announced the appointment of William G. Holbert as national sales manager. Holbert joins NEC from Telco Systems, Inc. of Dallas, TX, where he was national sales manager.

Holbert has been involved in the telecommunications industry for 20 years. He has served in engineering, product management and sales management positions for Anaconda Wire and Cable, R-Tec, Anaconda Telecommunications, and Anaconda-Ericsson.

Holbert is a graduate of Penn State University, with a B.S. in Electrical Engineering. He is a member of Sales and Marketing Executives International and IEEE Communications Technology Group.

## Franklin and Klakis Elected to Electronic VIP Club

Howard B. Franklin and Michael J. Klakis have been elected Life

Members of the Electronic VIP Club, it has been announced by Sanford Levey, Electronic Distributors, Inc. (EDI), club's president.

Franklin is president of the Bell Industries Distribution Group in Sunnyvale, CA, and is a member of the Board of Directors of the National Electronic Distributors Association and of the IEEE.

Michael Klakis is vice president, marketing, of Alpha Wire Corporation, and has been active in various committees of the Electronic Industries Association/Distributor Products Division.

The Electronic VIP Club is the industry's vehicle for recognizing achievement, including significant contributions to one's own company as well as participation in the public business of the industry.

## USTA Elects Dawson To Board of Directors

Allen W. Dawson, Chairman of the Board of Directors and Chief Executive Officer of Siec Corporation, has been elected to the board of directors of the United States Telecommunications Association (USTA).

USTA represents the interests of the nation's over 1,400 local telephone company operations.



**GREG SILSBY**

## Greg Silsby Accepts New Audio-Technica Post

Greg Silsby has been appointed marketing manager, studio products at Audio-Technica, as announced by Jon R. Kelly, Audio-Technica U.S. president.

"Selecting a person of Mr. Silsby's eminence and expertise to oversee our studio products program can be seen as an indication of the high priority we assign to this facet of our growing professional products program," Kelly said.



**JIM HOLT**



**ADOLPH SANTORINE, JR.**

## Holt and Santorine Join Electro-Voice, Inc.

Jim Holt has been named director of marketing and Adolph Santorine, Jr. has been named OEM sales manager for Electro-Voice.

Holt reports to the vice president of marketing, Paul McGuire, and is responsible for tactical marketing efforts in EV's music, professional, pro sound reinforcement, and commercial business sectors.

Holt comes to Electro-Voice from American Sterilizer, a manufacturer of hospital equipment and furniture, where he was marketing director of the Unicell Division.

In his position, Santorine will report to EV vice president of operations F. Davis Merrey, who said, "Dolph Santorine is responsible for marketing EV's experience and expertise to a variety of manufacturers in the form of customized product, and doing so at margins beneficial to both Electro-Voice and its OEM customers."

Most recently, Santorine was a partner in Park Concepts, Inc., a manufacturer of electronics.

## Industrial Networking Inc. Names Gardner VP, Marketing

Industrial Networking Inc. (INI), a joint-venture company between Ungermann-Bass Inc. and General Electric Company, has named Michael S. Gardner to the new post of vice president of marketing, announced Joseph P. Schoendorf, Industrial Networking president and chief executive officer. Gardner will be responsible for all marketing and sales activities at the company, which was established to develop, manufacture, and market vendor-independent local area network (LAN) communications systems for the industrial automation market.



# REP NEWS

**Switchcraft, Inc.** of Chicago, IL, has named **Jack Gonzalez** the recipient of the "Switchcraft All American" award.

The award recognizes the sales representative "for outstanding achievement in selling All-American Switchcraft products," said Ed Larabee, vice president of marketing and sales. "The award is given with thanks, in appreciation of professionalism, dedication, and exemplary performance."

In related news, Switchcraft announced that it has appointed a new representative, **Data Modul** of Munich, Germany to handle its products in Germany and Austria.

**Aiphone Intercom Systems** of Bellvue, WA, presented its highest annual representatives award, **The Bent Oar**, to **Paul and Elizabeth Pusecker** of Pusecker Sales of Upper Montclair, NJ.

Pusecker Sales received the award for turning in the highest percentage of quota sales and for outstanding effort in promotion of the Aiphone product line.

"Pusecker Sales increased its '84 sales performance by 78 percent over the previous year, and exceeded sales quote by 35 percent," said Jim Morrison, Aiphone's national sales manager.

Other rep firms honored were: **Bassett Sales** (Southern California); **Henry W. Phillips Co.** (southeast); **G. DuVall Co.** (Chicago); **Stan Sliz & Associates** (Rocky Mountain states); **Hutto-Hawkins-Peregoy** (FL); and **Forti Associates** (Mid Atlantic).

In related news, **Bob Gunn Associates** was appointed representative for Aiphone in UTP 22, 23, and 21 territories, Texas, Oklahoma, Louisiana, and Arkansas. The electronic rep firm has offices in Dallas, TX, and Oklahoma City, OK, with resident

representatives in Houston, San Antonio, and Beaumont, TX.

**The Winstead Corporation** of Minneapolis, MN, has appointed **Michael J. Dollacker & Associates, Inc.** as authorized sales reps in Texas, Oklahoma, Arkansas, and Louisiana. The firm will represent Winstead's line of professional video support systems and security support systems.

The electronics manufacturer's rep firm, **LCA Sales Company** of Tuckahoe, NY, has launched an advertising and promotion campaign celebrating its **40th year in business**. A highlight of the campaign is LCA's "**Birthday Bash!**" contest, which invites participants to guess the total number of years of experience represented by all the LCA people combined.

Joel Schwartz, LCA president, said, "This birthday promotion demonstrates in form and content that we intend to be just as aggressive in the future as in the past. We remain dedicated to professionalism, customer service, and innovation in serving the electronics marketplace."

Signal Cable Company of Chicago, IL, has announced the appointment of **Pinz Sales Corporation** of Yonkers, NY, as its rep in the New York City, Long Island, and northern New Jersey areas.

**Norris and Warren Associates** of Denver and Colorado Springs, CO, received **Cetec Raymer's** second annual **MVP award** for outstanding performance as Raymer's rep in the mountain west territory.

"They have significantly enhanced Raymer's presence in the mountain west territory and 1984 sales far surpassed any previous year," said Hugh Wilcox, executive vice president.

**Williams Sound Corporation** of Eden Prairie, MN, has appointed **Bi-State Marketers** of Ridgefield, NJ, as its new rep in New York City.

## A-1000 SERIES DOOR MONITOR SYSTEMS

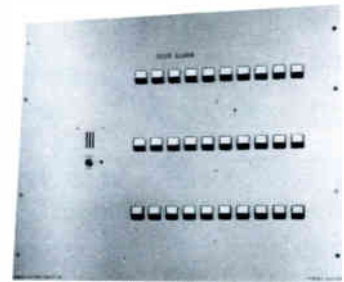

MASTER PANEL



5 ZONE REMOTE CONTROL

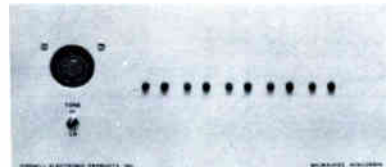

5 ZONE REMOTE MONITOR



REMOTE ZONE CONTROLS



**Cornell  
Electronic  
Products, Inc.**

P.O. Box 23411  
4911 W. Good Hope Road  
Milwaukee, Wisconsin 53223  
(414) 351-4660

**NEXT MONTH  
25<sup>th</sup> Annual  
Bluebook Edition**

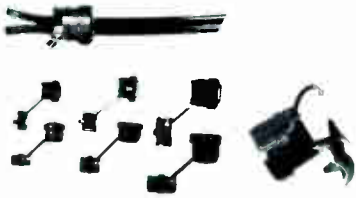

## MICRO PLASTICS NEW NYLON STRAIN RELIEF BUSHINGS

Micro Plastics Inc. has introduced its line of one-piece molded nylon 6/6 strain relief bushings.

Micro Plastics strain relief bushings securely anchor and absorb push/pull and twist forces placed on wire and cable assemblies while they protect the wire insulation from irregular or sharp panel edges.

The nylon bushings meet all the Underwriters' Laboratories temperature and pull-out specifications and are recognized under their certified electrical component program.

Contact: Micro Plastics, Hwy. 178 N, Flippin, AR 72634; (800) 643-2356 or (501) 453-2261.

Reader Service #1



## JENSEN INTRODUCES RS-232 COMMERCIAL CONNECTOR KIT

New from Jensen Tools Inc. is a 273-piece RS-232 Commercial Connector Kit priced below market at \$69.50.

An aid to on-site fabrication and maintenance of RS-232 cable connectors, the kit includes 16 plug (male) and six receptacle (female) connectors (25 pin); 100 each stamped and formed pins and sockets; 50 cable ties; and one insertion/extraction tool. All are contained in a sturdy, compact plastic case.

Contact: Jensen Tools Inc., 7815 S. 46th St., Phoenix, AZ 85040; (602) 968-6231.

Reader Service #2

## NEW APPLICATION FOR WYBAR ELECTRONICS' RT-2

Wybar Electronics has announced a new application for its Model RT-2. Originally developed for use in stripping fine enamel coated magnet wires, the Model RT-2 can also be used for cleaning and polishing the leads of small electronic components.

Leads may be cleaned within one-eighth-inch of the component body,

Contact: Wybar Electronics, P.O. Box 4961, Vincent Drive, Syracuse, NY 13221; (315) 454-3237.

Reader Service #3



## NEW NOISE DOSIMETER/SOUND LEVEL METER

A new combination noise dosimeter and integrating sound level meter with data storage and printing units has been introduced by Simpson Electric Company. The new system for industrial (OSHA) noise measurement, analysis, and record keeping is said to be easier to use and lower priced than comparable systems.

The Model 893 Noise Dosimeter/Sound Level Meter is a pocket-size, portable instrument that computes noise dose and projected eight-hour TWA (time weighted average). It measures continuous, intermittent and impulsive noise from 80 dBA to 130 dBA according to present OSHA and DOD requirements.

The noise dosimeter/sound level meter is priced at \$590.

Contact: Simpson Electric Company, 853 Dundee Ave., Elgin, IL 60120-3090; (312) 697-2260.

Reader Service #4

## BIDALERT EXPANDS CONTRACTOR OPPORTUNITY

Information America, Inc. announced the formation of a new division, BidALERT, with headquarters in Baltimore, MD, and sales offices in Wilwaukee, WI. BidALERT electronically identifies federal govern-

ment bidding opportunities for small to medium sized firms in the audio or video fields.

Market studies conducted by the company determined that of the \$200-plus billion dollars spent annually by the federal government, large firms win most of the awards, even though smaller companies could be as competitive.

Using a computerized search system, BidALERT supplies weekly reports on bidding opportunities custom tailored to the specific product or unique service of the subscriber for the annual subscription price of \$595 per year.

BidALERT will also contact, on behalf of the subscriber, the government officer purchasing the goods or services so that the subscriber receives not only the notice of the bidding opportunity, but also the specifications needed to bid on the contract.

Contact: BidALERT, 3406 Belair Road, Baltimore, MD 21213; (301) 485-1500.

Reader Service #5



## MELCO UNVEILS LINE HOLD UNIT FOR PABXs

Melco has introduced the new S-321M TeleHold modular line hold unit for single-line telephones. It is recommended for use in small businesses with telephones on PABX lines. Designed especially for retail sales, TeleHold is contained in colorful packaging which includes everything necessary for installation.

TeleHold allows a call to be placed on hold by pressing the button on the unit and placing the telephone receiver on-hook. A red lamp (LED) lights to indicate that the call is holding. The call can be retrieved from any telephone on the premises (including the original one) by lifting the receiver.

Contact: Melco Labs, Inc., 14408 N.E. 20th St., Bellevue, WA 98007; (206) 643-3400 or (800) 426-8900.

Reader Service #6

(continued from page 42)



Each input channel boasts a mic splitter, gain, pad, ground lift (for eliminating ground loops), and phase reverse (for combatting feedback), plus mid-frequency sweep control in the three-band equalizer zeros in on resonating frequencies as well. Each output features solo, reverb return, master level, and independent buss output.

□ Contact: Tangent, 8206 N. Dreamy Draw, Phoenix, AZ 85020; (602) 997-4308.

Reader Service #20



### UHER'S MONITOR PORTABLE CASSETTE RECORDER

Uher of America, Inc. has introduced the Uher CR-1601 monitor portable cassette recorder. It features three magnetic heads, three three-speed monitor facility, and full logic control with two motors.

Its three record/playback speeds permit up to ten hours of total recording time. Also included is Uher's exclusive Akustomat® (voice activated control with adjusted delay time).

Suggested retail price is \$1,749.

□ Contact: Uher of America, 7067 Vineland Ave., No. Hollywood, CA 91605; (818) 764-1120.

Reader Service #21

### AMPLIFIER RESEARCH OFFERS 150-WATT RF AMPS

Smaller and lighter than most other rf amplifiers in their power range, the new Models 150LB and 150 LC from Amplifier Research are rated at 130

watts minimum, 150 watts nominal power, through 120-210 MHz and 200-290 MHz respectively.

Amplifier Research said the units will continue to operate regardless of magnitude or phase of source and load impedance, without oscillation, shut-down, or damage. Their selected bandwidths provide a comfortable range of frequencies for varied clinical and research purposes.

The new amplifiers combine solid-state low power stages with a vacuum-



tube final amplifier, providing instantaneous bandwidth (full power at any frequency in their operating spectrum, without need for tuning or band-switching), and exceptional pulse and blanking characteristics for NMR experiments. According to the company, a typical rf envelope exhibits pulse droop of less than 1 percent.

Model 150LB retails for \$6,200. The Model 150LC retails for \$7,000.

□ Contact: Amplifier Research, 160 School House Rd., Souderton, PA 18964-9990; (215) 723-8181.

Reader Service #22



### WIRELESS MIC FROM HM ELECTRONICS

HM Electronics, Inc. has announced its new handheld wireless microphone system incorporating the Shure SM87 condenser mic element. The HME System 87 provides dy-

namic range, frequency response and maximum SPL input.

Similar in appearance to the HME System 85, the 87 is said to offer smoother high end response and greater gain before feedback. The transmitter is the smallest available using an SM87 element.

The System 87 is available at a net price of \$2,600, including case.

□ Contact: HM Electronics, 9675 Business Park Ave., San Diego, CA 92131; (619) 578-8300.

Reader Service #23

### BES FIXED/PORTABLE ALL WEATHER SPEAKER

BES has introduced the B-81, a full range loudspeaker, with a total radiating area said to be far greater than a conventional 15-inch low frequency speaker. BES technology extends performance well below 50 Hz without the need for heavy and cumbersome enclosures. At the same time, sound radiation is essentially spherical throughout the entire operating bandwidth.

Frequency response is flat within  $\pm 3$  dB, from 50 Hz to 10 kHz, with useful response to 16 kHz. High acoustic output is combined with extremely low distortion. The spherical radiation pattern is intrinsically phase coherent. This combines with smooth frequency response to reduce greatly susceptibility to feedback.

The complete BES B-81 speaker weighs 11.5 pounds, and is highly resistant to mechanical damage. It can be equipped with feet and carrying handle for easy transport and set up. There also are provisions for permanent wall mounting, with an available mounting bracket accessory.

In addition to indoor applications, the speaker has been field tested under sonically demanding conditions for permanent outdoor use. Extremes of temperature do not affect its long-term performance.

□ Contact: BES, Commercial Sound Products Division, 345 Fischer St., Costa Mesa, CA 92626; (714) 549-3833/(800) 592-4644.

Reader Service #24

**SUBSCRIBE TO  
SOUND &  
COMMUNICATIONS**

# DATE BOOK

DATE	EVENT/COMMENT	LOCATION	CONTACT
August 4-7	<b>International Background Music Association's</b> Meeting and Conference.	Westin Bayshore Hotel Vancouver, Canada	Roger Van Brackel (419) 782-2741 Bruno Fulde (604) 682-3141
August 5-10	<b>NPEC '85</b> , The Professional Electronics Convention.	Parkview Hilton Hartford, CT	NPEC '85 2708 W. Berry St. Fort Worth, TX 76109 (817) 921-9061
August 19-20	<b>Recent Developments in Telecommunications—Signal Processing and ICs.</b> Two-day intensive course geared to managers and engineers in telephone network design and operations, equipment design and integrated circuit design.	Continuing Education in Engineering and the College of Engineering, University of California, Berkeley	University of California Extension 2223 Fulton St. Berkeley, CA 94720 (415) 642-4151
August 27-29	<b>Interconnect '85</b> Sponsored by the United States Telecommunications Suppliers Association.	San Mateo Expo Center San Mateo, CA	USTSA 333 N. Michigan Ave. Suite 1618 Chicago, IL 60601 (312) 782-8597
September 5-6	<b>Electronic Sound &amp; Systems Conferences, Inc.</b> Regional educational conference and product exhibit sponsored by the NSCA and the ERA.	The Red Lion Inn at Seatac Airport, Seattle, WA	ESSC Bob Barba (313) 781-2010 NSCA (312) 593-8360
September 9-10	<b>Electronic Sound &amp; Systems Conferences, Inc.</b> Regional educational conference and exhibit sponsored by the NSCA and ERA.	The Hyatt at Palo Alto San Francisco, CA	ESSC Bob Barba (313) 781-2010 NSCA (312) 593-8360
September 10-12	<b>Midcon '85</b> High Technology Electronics Exhibition and Convention.	O'Hare Exhibition Center Rosemont, IL	Electronics Conventions Management J. Fossler (213) 772-2965
September 12-13	<b>Electronic Sound &amp; Systems Conferences, Inc.</b> Regional educational conference and exhibit sponsored by the NSCA and ERA.	The Sheraton at Universal City Los Angeles, CA	ESSC Bob Barba (313) 781-2010 NSCA (312) 593-8360
September 26-27	<b>Sound Engineering Seminars</b> Two-Day Seminar in Audio and Acoustics by Syn-Aud-Con.	Ramada-The O'Hare Inn Chicago, IL	Synergetic Audio Concepts Don Davis (714) 728-0245
September 26-28	<b>Electronics Industry Association's</b> Mobile Communications Show.	Washington Convention Center Washington, DC	Jack Wayman EIA, Sr. Vice President (202) 457-8765

## FUTURE DATES

November 4-8	<b>110th Meeting</b> of the National Council of Acoustic Consultants/ Acoustical Society of America.	Nashville, TN	NCAC 66 Morris Ave. P.O. Box 359 Springfield, NJ 07081 (201) 379-1100
November 6-10	<b>30th Annual Convention</b> International Planned Music Association.	Lake Buena Vista Palace Hotel Orlando, FL	Oland Chan (215) 667-6666 Steve Randall (801) 328-4245

## BOOK REVIEW

(continued from page 35)

dB, depending on the listening subject, and the masked frequency.

\* \* \* \*

Artificial organs have their origin in antiquity. Through its history acoustics has contributed to devices that enable the hard of hearing to understand what is said to them, from the ear trumpet to the modern hearing aid. Both these devices require that the hearing mechanism work, at least a little. For some of the hard of hearing, the mechanism that transduces sound waves to mechanical motion is completely unable to function; and for these a new artificial ear is being tested.

Described by Gerald Loeb in *Scientific American*, the device consists of a wire with a series of contacts along its insulation, at each of which the wire can generate electrical currents. This wire is inserted surgically in the tympanic canal of the cochlea of the inner ear. The audio signal presented to a sound processor outside the body is transmitted through this wire, which acts by direct electrical stimulation of the auditory nerve.

Extraordinarily subtle problems occur with this device. The electrode inserted in the cochlea must be of exotic materials to avoid electrochemical generation of toxins by interaction with the fluid of the inner ear. Also, this fluid conducts the electrical impulses and stimulates a large number of nerve fibers. Putting in a sine wave generates a chorus of inharmonically related "sounds." Speech and music are reported to sound like the quacking of ducks or the clanging of garbage cans.

Not yet a practical device, it is far from useful for speech intelligibility. Still, it provides important auditory cues (a doorbell or a smoke detector ringing), and is teaching researchers a great deal about the electroneural behavior of the ear.

These two papers suggest we are decades away from understanding the mechanism of the ear, much less the gray matter at the far end of the auditory nerve. Nevertheless, it has important results for everyone in audio.

*The publication office of the English translation edition of the Journal of the Acoustical Society of Japan is: Maruzen Co., Ltd., P.O. Box 5050, Tokyo, 100-31 Japan.*

## IDEAS & VIEWPOINTS

(continued from page 6)

and that is the multitude of new transmission suppliers and technologies. I know that Seeburg is now transmitting via satellite. More and more suppliers are transmitting via FM SCA. Fiber optics can't be far behind. On-site music via CDs also seems feasible. You may know of someone who's already supplying music that way (versus continuous loop tapes or other such media). Other digital storage media may occur and digital control and switching will certainly follow.

If background or foreground music is something customers want, then a smart contractor will use it as a foot in the door to persuade that customer to purchase their other communications needs from that same contractor. Telephone systems (with music on hold), PA and paging systems, intercom systems and so on all fit into many of the same businesses that want background music in their cafeterias and lounges and shopping areas.

The bottom line is that there's a lot going on in this area of our sound and communications industry.

# THE AUGUST 1985 SOUND & COMMUNICATIONS BLUE BOOK IS COMING

O W I  
Think Small,  
Think Quick.  
B A P - 1 0 0



OWI brings forward a special kind of qualitative, extension mini-speaker, one intended for the installer as well as the end user: The BAP-100./SMALL BUT EFFECTIVE. Dimensions of 7-1/8" x 4-1/2" x 4-1/8" allow easy handling and unobtrusive installation, yet this 2-Way sacrifices little else./SPEEDY INSTALLATION. With features such as a built-in line matching transformer, input power selector knob (2.5W, 5W, 10W or 15W) and an input line voltage of 70.7V, nothing extra is necessary beside a screwdriver or possibly, a power drill. Needless to say, this aluminum die-cast model comes complete with a bracket and hardware. OWI also makes available the BAP-25 (with a 25V line).

Exercise sound judgement — investigate the BAP-100, BAP-25 and OWI's complete mini-speaker line, including the weatherized, outdoor BAW-50. The quicker the better.

Designed For Background/Foreground Music.  
OWI INCORPORATED 1160 Mahalo Place., Compton, CA 90220, (213) 638-4732

# CLASSIFIEDS

**Background Music for  
SCA-CATV-Telephone  
BGM INTERNATIONAL**  
A Division of  
**F. T. C. BREWER COMPANY**  
P.O. Box 8057  
Pensacola, Florida 32505  
904 433-7932



**SESCOM, INC.**  
1111 Las Vegas Blvd. North  
Las Vegas, NV 89101 U.S.A.

"the audio source" FOR ALL OF YOUR AUDIO NEEDS  
CALL OR SEND FOR A COPY OF OUR CATALOG  
CATALOG REQUESTS & ORDERS: (800)834-3457  
OTHER BUSINESS: (702)364-0993 TWX (810)367-8998

**Current Cable Company, Inc.**  
1801 W. Diversey Parkway  
Chicago, IL 60614  
Suppliers of quality sound, intercom  
and telephone cable.  
For Prompt service call Toll Free  
**1-800-821-2432**  
In Illinois: 312-472-7790

## EXCESS STOCK

Audio manufacturer liquidating un-used wire, connectors, transformers, components, heatshrink tubing, hardware, multicable, roadcases and many Kelsey mixing consoles at wholesale prices. Call Craig for a complete listing. (201) 423-1300.

## FREE 32pg Catalog & 50 Audio/Video Applic.

PWR SUPP. EQ.  
PHONO, MIC,  
TRANS. ACN  
TAPE, VIDEO,  
LINE, OSC.  
Stere Mono Pwr Ampl  
8-in 2-out, 12-in 4-out, 16-in 4-out  
Video & Audio Dist Amps TV Audio & Recd Prod Consoles  
**OPAMP LABS INC (213) 934-3566**  
1033 N Sycamore Av LOS ANGELES CA, 90038

**Ideal Wire Products, Inc.**  
Electrical Wire & Cable  
Lorum Street Tewksbury Mass 01876  
Tel (617) 851-8541  
Manufacturers of quality sound & com-  
munications cable.  
Stock & price list mailed on request

**MUSIC SUPPLY CO. - SC  
808 N. MADISON**

**TIME SAVERS**

- PUSH-PULL RODS Get Cable through tight places
- TEST-SET. For the Audio Serviceman
- EASY KARY™ Wire Reel Holders 3 sizes
- SPEAKER SUPPORT TRUSS (T-Bar Bridge)  
Prevent ceiling sag Speed Installation
- SPEAKER GRILLES For 8" Speakers
- EXTENSION CORDS 3 ft and 10 ft U.L. Listed

CALL - WRITE - 30 DAY FREE TRIAL  
Tex. Call Collect (214)946-8450, All Other 1-800-527 1522

**INSTALLATION & SERVICE AIDS**

DALLAS TEXAS 75208

## RJ31X JACKS & CORDS

from  
**cabletronix**  
800-432-WIRE  
(Nationwide)  
800-942-WIRE  
(New York State)

**in stock now!**  
WIRE & CABLE  
UL-PLENUM-FIRE  
"B" CONNECTORS  
TIE WRAPS  
DRIVE RINGS & PINS  
ARROW STAPLERS  
FASTENERS  
toll free  
call today

## CLOCK AND PROGRAM SYSTEMS by MONTGOMERY

**NEW! MULTI-CIRCUIT** —  
Provides complete automatic  
operation of 1 to 5 separate  
schedules on 1 to 5 Groups  
of signals. Signals adjust from  
2 to 25 seconds. Calendar  
switch regulates automatic oper-  
ation. Clock and program  
mechanism set by turning  
hands. Special signals, by  
push-buttons, do not disturb  
automatic operation. 12 or 24  
hour models.  
Write **MONTGOMERY  
MFG. CO., Owensville,  
Ind. 47665**

## POSITIONS

**GULFTRONICS, INC.**  
ELECTRONIC SYSTEMS CONTRACTORS

## SALES ENGINEER

Houston-based alarm & communication systems contractor seeks experienced individual to market fire alarm, school & healthcare communications, CCTV & related electronic systems. Edwards & Rauland distributor. Attractive compensation plan includes draw against commissions, fringe benefits & car allowance. Responsibilities include calling on specifying engineers, electrical contractors & end users. Interested career-oriented individuals should submit a detailed resume including salary history to:

**GULFTRONICS INC.**  
8520 Sweetwater, Suite F-55  
Houston, TX 77037

All inquiries will be held in strict confidence.

# CLASSIFIEDS

- Regular Classified — \$52 per column inch.
- Marketplace Display — 25 percent off rate card (up to 1/3 page).

Classified listings are accepted up to the 25th of the month preceding publication.

Name \_\_\_\_\_  
Address \_\_\_\_\_  
City \_\_\_\_\_ State \_\_\_\_\_  
Zip \_\_\_\_\_ Telephone \_\_\_\_\_  
Credit Card # \_\_\_\_\_

### Check Heading You Want

- SERVICES
- MISCELLANEOUS
- FOR SALE
- SITUATIONS WANTED
- FOR RENT
- BUSINESS OPPORTUNITIES
- HELP WANTED

Please send copy & payment to:

Sound & Communications Classifieds  
220 Westbury Avenue Carle Place, New York 11514  
TELEPHONE: (516) 334-7880

Steely D  
BILLY JOEL  
AMERICA PERSPECTIVE

ANNE MURRAY

Neil D

Dan For

## We're Playing Your Songs

The long-awaited marriage of Foreground Sound and SCA delivery is now a reality. Introducing Studio 1000, Yesco's Foreground Central Studio Service. Studio 1000 is unique because it's the only service that delivers songs to match the listening preferences of your region. Bring Studio 1000 to your city. A huge new market is waiting . . . waiting to hear your songs.

See us at the IBMA or call:  
800-426-9248

Reader Service #224

# STUDIO 1000

Technics QUARTZ  
Direct Drive Turntable System SL-1200MK2

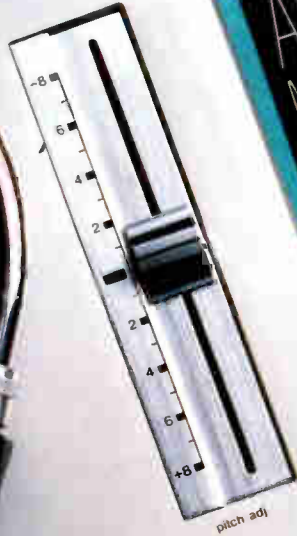

Out Of Nothing At All  
Inc.

The Doobie Brothers  
You Belong  
Warner Bros.

OK Joe Jackson  
Breaking Us In  
A&M Records Inc.

Linda Ronstadt  
Easy For You To See  
Asylum Records Inc.

L Rita Coolidge  
Something Said Love  
A&M Records Inc.

4:53 Anne Murray  
Nobody Loves Me Like  
Capitol Records

L Manhattan  
Baby Come Home  
Atlantic

Crosby, Stills, Nash & Young  
Cry Like a Baby  
Atlantic

at Away From Me

Rankin  
Here's That Rainy Day  
Little David Records/Atlantic

Paul Simon



# The world's first unidirectional surface- mounted condenser mic. Clean and simple.



No carpet strips or plastic baffles needed. Until now, all surface-mounted mics have been omnidirectional. Trying to add directionality has required a lot of busy work. The new SM91 brings the big advantages of unidirectionality to boundary effect microphones by incorporating a condenser cartridge with a half-cardioid pattern that isolates the speaker from surrounding noises.

The new smoothie. The sleek SM91 delivers wide-band, smooth response throughout the audio spectrum, while greatly reducing the problems of feedback, low-frequency noise and phase cancellation.

Low visibility, high versatility. The SM91 is an excellent mic for meetings and conference rooms. It also does a great job of isolating a vocalist or instrument

in musical applications. And it's the ideal mic for live theater.

A preamp ahead of its time.

The ultra-low noise preamplifier provides switch-selectable flat or low-cut response, excellent signal-to-noise ratio and a high output clipping level. A low-frequency cutoff filter minimizes low-end rumble—especially on large surfaces. If you're going omni. Our new SM90 is identical in appearance to the SM91 and just as rugged.

For more information or a demonstration, call or write Shure Brothers, Inc., 222 Hartrey Ave., Evanston, IL 60204. (312) 866-2553.

**SHURE**

THE SOUND OF THE PROFESSIONALS... WORLDWIDE

Reader Service #225