

Mickey Hart's Planet Drum · Hans Zimmer Scores Prince of Egypt · Denny Purcell Interview

A PRIMEDIA Intertec PUBLICATION

WWW.MIXONLINE.COM • U.S. \$4.95 CANADA \$5.95 DECEMBER 1998

# MIX<sup>®</sup>

PROFESSIONAL RECORDING · SOUND AND MUSIC PRODUCTION

**Drum  
Recording Tips**  
**Sound Advice  
For Club Mixers**

**Mastering  
Engineers  
Discuss  
New  
Formats**

**Studio  
Amplifiers**



**KORN's  
Family Values  
Spectacular**



# The Birth Of A Legend

## The Diaphragm

All GT Electronics AM Series mics use a super-thin 3-micron, gold-evaporated mylar diaphragm for the ultimate in sensitivity and transparent response. Over 1" in diameter, the extra-large diaphragm is precisely tensioned by hand to ensure perfect accuracy.

## The Tube

The GT AM61 and AM62 maintain an all-tube signal path for preamplification. The tube, a military-spec GT5840M, is the most advanced audio vacuum tube ever made. It offers incredibly low self noise, a long life and nearly non-existent microphonics. The result...classic, warm, rich tone that you demand from a legendary tube mic.



What turns a studio microphone into a legend?

Natural **warmth**. Rich character. Crystalline clarity that perfectly captures the fine details of every **nuance**. Most importantly, it provides an indescribable intimacy that makes listening a deeply emotional experience.

Legendary mics are made by people who share a passion for the art of sound. So we gathered together some of the most **passionate** designers in the world to create GT Electronics, a new division of Alesis that's dedicated to the qualities of **legendary** audio equipment design. It all starts with the AM Series large diaphragm studio condenser microphones, which offer **everything** you'd expect from a legendary mic except the legendary price.

**GT**. The new legend has arrived.



Fixed Cardioid

AM51

CLASS A FET



Cardioid, Omni, Figure 8

AM52

CLASS A FET



Fixed Cardioid

AM61

TUBE



Cardioid, Omni, Figure 8, Super-Cardioid

AM62

TUBE

**GT Electronics - A Division of Alesis Corporation**

© Alesis is a registered trademark; AM51, AM52, AM61, AM62 and GT Electronics are trademarks of Alesis.

GT Electronics 1633 26th Street Santa Monica CA 90404 [www.gtelectronics.com](http://www.gtelectronics.com)

CIRCLE #001 ON PRODUCT INFO CARD



the new legend

# Focused on Film ...



## Perfect for Post

Avant is the only digital console with a control surface designed specifically for multi-channel film mixing and video post production. SSL's Real Time Resource Processing means that all the controls on every channel are always available, whether the console has 24 channels with a single operator or 96 channels and three film mixing positions.

Avant combines the look and feel of a traditional analogue console with all the digital benefits of dynamic automation plus global or selective snapshot instant reset. With 32 main mix buses, 24 pre-dub buses and a 64 x 8 digital monitor matrix, Avant becomes the logical choice for multi-channel surround sound mixing.

## ENTERPRISE P.O.S.T



"Avant is an incredible product that is specifically made for large Hollywood-style pictures."

André Perreault, chief operating officer and head mixer,  
Enterprise Post.

## Solid State Logic

### International Headquarters

Begbroke, Oxford OX5 1RU, England

Tel: +44 (1865) 842300

Fax: +44 (1865) 84218

Email: [sales@solid-state-logic.com](mailto:sales@solid-state-logic.com)

<http://www.solid-state-logic.com>

New York

+1 (212) 315 1111

Los Angeles

+1 (213) 463 4444

Tokyo

+81 (3) 5474 1144

Paris

+33 (1) 3460 4666

Milan

+39 (2) 2522 4936

Toronto

+1 (416) 431 9131

Singapore

+65 (0) 488 2272

PROFESSIONAL RECORDING EQUIPMENT

MANLEY

Langevin



**COMPANY PROFILE:** Manley Laboratories, Inc. in recent years has expanded and thrived under EveAnna Manley's leadership. Our 11,000 sq. ft. building houses our own machine-shop, printed circuit board manufacture, audio transformer winding, engraving, and silk-screening facilities. All custom design, R&D, assembly, testing, and quality control processes are performed with precision and pride at the Manley factory, located just 35 miles east of Los Angeles.

**NEO-CLASSIC:  
MANLEY ALL-TUBE GEAR**

We take a purist approach to everything we build; refining, executing, and expanding upon Manley's legacy of vacuum tube design philosophies proven over years of real-world experience, using high quality modern components, many of which are fabricated in-house. This attention to detail delivers the rich, present, and natural sound our vacuum tube designs are renowned for. Never small, sterile, or boring.

Beyond this, Manley means reliability, real technical support, and a company attitude that professionals depend on.

**BIG BANG FOR THE BUCK: LANGEVIN**

**LANGEVIN** is a legendary marque of premium electronics whose lineage goes back to World War II. **MANLEY** acquired the **LANGEVIN** brand name several years ago. With these products we offer you the different sonic flavor that **ALL-DISCRETE CLASS A CIRCUITRY** brings using fresh, original designs built alongside and to the same exacting standards as the Manley equipment.

We believe that good music and those who create it deserve the finest gear.

The choice is yours.

**MANLEY LABORATORIES, INC.**  
13880 MAGNOLIA AVE.  
CHINO, CA. 91710 USA  
TEL: (909) 627-4256  
FAX: (909) 628-2482  
email: emanley@manleylabs.com  
http://www.manleylabs.com

WorldCIRCLE #002 ON PRODUCT INFO CARD

# 5.1 SURROUND

The unique Tannoy Dual Concentric point source technology offers the professional recording engineer a strategic advantage when mixing and creating effects for film and music in the 5.1 surround format.

True surround sound is a virtual 3-dimensional sound stage that demands linear phase and amplitude response vertically as well as horizontally to be convincing.

The smooth, conical dispersion of the Dual Concentric propagates a naturally holistic wavefront in all directions into the mixing environment, empowering the engineer with accurate 3D spatial imaging for superior results.

Unlike stereo which only has to create an accurate image between and somewhat to the sides of the mix position (usually a small sweet spot), convincing 5.1 surround mixing and scoring demand much more from your monitoring system. The environment must be transformed into a totally 3-dimensional sound stage to be done effectively. This relies on a linear response from the loudspeaker both on and off axis in both the horizontal and vertical planes.

This is simply not possible with conventional multi-driver discrete loudspeakers, which pose a plethora of problems with amplitude linearity, especially off-axis in the vertical dimension. While they might work fine in a fixed position for stereo music production, they just cannot compete with the Tannoy Dual Concentric's ability to reproduce accurate imaging and placement in a 3D stage requiring a linear response on all axis.

If you're interested in superior results when scoring, producing and mixing 5.1, you should know what the best in the business have known for years, Tannoy

Dual Concentric point source constant directivity driver technology can accurately steer your next surround project into the big time.



Please contact TGI North America for more information.

CIRCLE #003 ON PRODUCT INFO CARD  
World Radio History



*Whether I am creating a pounding action cue or a subtle mood piece, it is essential that I know how the music truly sounds. The detail and accuracy of the Tannoy Dual Concentric gives me complete confidence that my score will bond seamlessly with the scene and the characters and not clash with the dialogue or the sound effects.*

**Brad Fiedel**

**Credits:** Terminator II • True Lies • Striking Distance  
• The Accused • Tom Hanks 'Earth to the Moon' • Blue Steel



*For my Music, Sound Design, Editorial, ADR, Foley and 5.1 Surround Film Mixing, Tannoy Dual Concentric Speakers deliver transparent, meticulous quality throughout all the studios. This contributes to a seamless audio environment from room to room without the listening fatigue associated with other designs. I can trust my results from Tannoy on all my projects.*

**Frank Serafine**

**Credits:** Orgazmo • Field of Dreams • Hunt for Red October  
• Flight of the Navigator



Tannoy/TGI North America • 300 Gage Avenue, Unit 1  
Kitchener, Ontario, • Canada N2M 2C8  
519 745 1158 • Fax: 519 745 2364  
Web site: <http://www.tannoy.com>

Toll free dealer order hot line: (FAX): 1-800-525-7081

# MIX<sup>®</sup>

PROFESSIONAL RECORDING • SOUND AND MUSIC PRODUCTION

DECEMBER 1998, VOLUME 22, NUMBER 12

## AUDIO

- 20 **Fast Lane:** Two States, Two Parts *by Stephen St. Croix*
- 28 **Insider Audio:** The Ups and Downs of Upgrades  
*by Paul D. Lehrman*
- 34 **1998 TEC Awards Highlights**
- 42 **Recording Drums** *by Rick Clark*
- 70 **International Update**
- Music Recording in Brazil *by Adinaldo Neves;*  
Virginia Rodrigues' "Sol Negro" *by Barbara Schultz;*  
Project Recording in Porto Alegre  
*by Charles Di Pinto*
  - Facility Spotlight: Circo Beat, Buenos Aires  
*by Barbara Schultz*
- 90 **Power Amplifiers:** New Designs for the Studio  
*by Loren Alldrin*
- 97 **Mix Masters:** Dave Jerden—Taking Care of  
Fundamentals, From Jane's to Chains  
*by Maureen Dronney*
- 168 **Recording Notes**
- Mickey Hart Beats the Planet Drum  
*by Blair Jackson*
  - The Blue Man Group's First Record *by Dan Daley*
  - Telarc Label Still on Digital's Leading Edge  
*by Eric Rudolph*
  - Classic Tracks: Sly & the Family Stone's "If You  
Want Me to Stay" *by Blair Jackson*
  - Cool Spins: The Mix Staff Picks Some Favorite CDs

PAGE 90



PAGE 136

- 232 **Power Tools:** Steinberg Cubase VST Tips for  
Navigation and Optimization *by Simon Millward*

## MEDIA & MASTERING

- 54 **Mastering Engineers on Working With New  
Technologies** *by Philip De Lancie*
- 60 **Insights:** Georgetown Masters' Denny Purcell  
*by Mel Lambert*
- 80 **Meridian Lossless Packing:** Enabling High-Resolution  
Surround on DVD-Audio *by Philip De Lancie*

## SOUND FOR PICTURE

- 136 **Post Script**
- Sound for Film: "The Future, Mr. Gittes"  
*by Larry Blake*
  - Hans Zimmer Scores "Prince of Egypt"  
*by Maureen Dronney*
  - Post Logic Goes HiDef *by Kim Wilson*
  - Bob Seiderman Remembered

## PRODUCTS

- 108 Preview/Hot Off the Shelf**
- 112 New Software and Hardware for Audio Production**
- 114 Field Test:** Microboards DSR-8000 CDstation Desktop CD Duplicator  
*by George Petersen*
- 116 Field Test:** Event Electronics Layla 8-Channel Computer-based Recording System  
*by Mike Lawson*
- 120 Field Test:** M&K Sound 5.1 Pro Solutions THX Surround Speaker System  
*by Larry the O*
- 128 Field Test:** Prism Sound Maselec Master Series MLA-2 Stereo Compressor  
*by Michael Denton*
- 130 Field Test:** Alesis M20 20-bit ADAT Recording System  
*by George Petersen*

## LIVE SOUND

- 153 New Sound Reinforcement Products**
- 154 The Korn Family Values Tour** *by Anne Eickelberg*
- 158 Survival Tips for Club Sound Mixers** *by Mark Frink*
- 159 Club Spotlight:** The Wildhorse Club Rides Into Orlando  
*by Dan Daley*
- 160 All Access:** Rancid *by Steve Jennings*

PAGE 128



World Radio History



PAGE 28

## DEPARTMENTS

- 8 From the Editor**
- 10 Feedback**
- 12 Current**
- 16 Industry Notes**
- 40 On the Cover:** MasterVision
- 192 Coast to Coast** (Includes L.A. Grapevine, NY Metro Report, Nashville Skyline, Sessions & Studio News)
- 201 Studio Showcase**
- 208 Ad Index and Product Information Card**
- 213 Marketplace**
- 219 Classifieds**

**On the Cover:** MasterVision, the DVD authoring extension to MasterMix in Nashville, is centered around a Panasonic DA7 digital console, Sonic Solutions DVD Creator and custom PMC monitoring system. For more, see page 40. **Photo:** James S. Wilson. **Inset:** Steve Jennings.

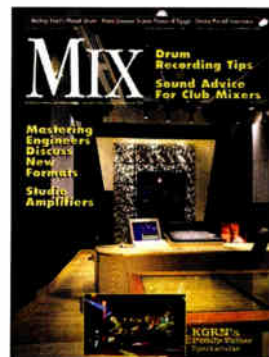

Check out Mix Online!  
<http://www.mixonline.com>

# TOTAL CONTROL. TOTAL CREATIVITY.

**MORE CAPABILITY** 72 channels, 56 inputs • **MORE SENDS** 8 mono and 2 stereo aux sends per channel • **MORE PROCESSING** 48 channels of digital parametric EQ, compression, and gating, plus reverb, delay, and chorus • **MORE AUTOMATION** More dynamic and snapshot-automation parameters than any comparably-priced digital console • **MORE INTUITIVE** One-touch commands and an analog look and feel make the D8B easy to use • **MORE CONNECTIVITY** Ethernet port and connections for optional mouse, keyboard, and monitor • **MORE STORAGE** Internal hard disk for saving seeds of automation files for instant session recall • **MORE OPTIONS** Open architecture for adding more I/O, "famous name" effects, and software upgrades • **MORE CONTROL** The Mackie Real Time OS™ automates nearly every D8B function and all are accessible from the console and optional monitor • **MORE CREATIVITY** Put all of these features together and you've got the Digital 8-Bus—a creativity powerhouse

**EASIEST TO USE** *"It acts, walks and talks very much like an analog console."* — BRUCE NAZARIAN, VIRTUAL POST, BURBANK CA • *"With some digital consoles, you feel like you're working on a computer. The [D8B] feels just like working on a regular, analog console. Right out of the box, it's so easy to use, I couldn't believe it."* — BRIAN FORAKER, RECORDING ENGINEER FOR YES, HEART, AND OINGO BOINGO • *"With the Digital 8-Bus, you just go for it. It's very much like analog boards—not a lot of pages to step through. You can keep your mind on the music and the task at hand."* — STEVE BOYCE, AUDIO DEPT. MANAGER, REDMOND, WA • **MORE D8B DETAILS** 12 discrete high-definition mic preamps • Support of all SMPTE frame rates and MIDI Machine Control • Full 5.1 and 7.1 surround sound capabilities • **SUPERIOR AUDIO QUALITY** 24-bit, 128X oversampling D/A and A/D converters • 32-bit internal processing • Apogee UV22® Super CD Encoding

Instead of doing digital first, we did digital right.

All along, our goal has been to create the first affordable no-compromise digital console. We designed the D8B to sound as pristine as the finest analog consoles—and to perform automation tricks even \$500,000 digital desks can't do. We believe that the result—by any standard—including sonic quality, ease of use, reliability, and sheer processing power—is worth the wait. I invite you to visit your authorized Mackie Digital Systems dealer for an in-depth demo and our 36-page tabloid brochure. Call us for your local dealer and a free video.



GREG MACKIE, FOUNDER





# THE MACKIE DIGITAL 8-BUS.

**EQUALIZER**

MEMU 2  
MEM A  
MEM B  
ON

F1 76 Hz	F2 303 Hz
Q1 0.0 dB	Q2 5.0 dB
F3 1.9 K	F4 3.2 K
F5 4742 Hz	F6 20000 Hz
Q3 6.4 dB	Q4 9.8 dB
Q5 0.3 Q	Q6 0.3 Q

**GATE**

THRESH ATACK HOLD RELEASE RANGE

35  
MENU  
MEM A  
MEM B  
ON

**AUX 3** TYPE DELAY FEEDBACK

PARAMETRIC



RECORD	RECORD	RECORD	RECORD
ASSIGN	ASSIGN	ASSIGN	ASSIGN
WRITE	WRITE	WRITE	WRITE
21	22	23	24
45	46	47	48
SELECT	SELECT	SELECT	SELECT
SOLO	SOLO	SOLO	SOLO
MUTE	MUTE	MUTE	MUTE
BUS 5	BUS 6	BUS 7	BUS 8
RET 5	RET 6	RET 7	RET 8
21	22	23	24
45	46	47	48

Mackie Digital Systems logo and product information.

**MACKIE**  
Digital Systems™  
World Radio History

BUILT IN SCENIC WOODBRVILLE  
USA BY CERTIFIED MACKJIDS  
**800/898-3211**  
[www.mackie.com](http://www.mackie.com)

# FROM THE EDITOR

## LOOKING FORWARD, LOOKING BACK

Sometimes the best way to get a grasp on the future is to look at the past. A century ago, filmmakers were in the formative period of creating the art of cinema. At the time, the camera was typically used simply as a means of documenting whatever took place before it, and it was years later when the camera was established as a creative tool used to shape moods and emotions through a rich palette of choices in angles, perspectives, exposures and editing.

Meanwhile, in audio, producers and consumers were struggling with the format wars of disk vs. cylinder playback systems. The disk emerged victorious, but as in the film world, recordings were also relegated to the role of documentarian, merely capturing any audio performance that took place in front of the horn. By the mid-1920s, breakthroughs such as electrical recording brought the microphone into the chain, although critics at the time were far from unanimous in their praise of the new process, often complaining that—compared to acoustic recordings—the newfangled electrical recordings were lifeless, unnatural and harsh. (Sound familiar?) But eventually, as other advanced techniques—multi-miking and eventually multitracking—were developed, audio engineering became a creative partner in the recording process.

Today, the entertainment industry faces challenges similar to those of the past. Will DVD (Video and Audio) simply be relegated to the role of a convenient—albeit higher-resolution—means of storing product created for other media, or will it emerge as a legitimate new creative medium of its own, with fully developed interactive properties? As a more recent example, consider CD-ROM, which although successful as a storage medium, never went much farther than the stage of providing talking—but mostly print-based—encyclopedias, text databases (such as dictionaries and phone books), searchable books (such as the Bible or the works of Shakespeare) and the ever-popular chase/hunt/shoot/loot games. In most cases, the degree of user interactivity provided by CD-ROMs has been limited to either typing in search keywords or deciding which alien to destroy first—hardly a brilliant use of an unexplored new medium.

On the audio side, new formats may offer untold interactive possibilities beyond the simple bonus track. In addition to providing lyrics and band graphics, new formats could include several mixes on a single disc, such as a surround mix, a limited-dynamic range stereo mix for playback in cars, extended remixes, and instrumental mix synched to lyrics for karaoke playback (don't laugh, a market's there!). At the same time, an artist's comments could be tied to a playlist of music clips, with comments on techniques, ideas or themes as they play back, providing a mini-documentary on the release, with or without graphics (guitar lessons anyone?). Add in the promotional possibilities, such as short movie-style trailers plugging earlier releases by the artist, and we're on to something that any label—large or small—would support.

The point is, we've barely scratched the surface of what new media has to offer. And like those filmmakers who were tied to an unmoving camera 100 years ago, we have a world of possibilities before us.

Let's start looking forward.



George Petersen



American Business Press

Mix magazine is published at 6400 Hollis St., #12, Emeryville, CA 94608 and is ©1998 by PRIMEDIA Intertec Publishing Corp. Mix (ISSN 0164-9957) is published monthly. One year (12 issues) subscription is \$46. Single copy price is \$4.95, back issues \$6.00. Send subscription applications, subscription inquiries, back issue requests and changes of address to Mix magazine, PO Box 41525, Nashville, TN 37204 or call (800) 843-4086. Outside U.S., call (615) 377-3322. POSTMASTER: Send address changes to Mix magazine, PO Box 41525, Nashville, TN 37204. Address all other correspondence to Mix magazine, 6400 Hollis St., #12, Emeryville, CA 94608; (510) 653-3307. Fax: (510) 653-5142. Periodical class postage paid at Oakland, CA, and additional mailing offices. Editeur Responsable (Belgique), Christian Desmet, Vuurgatstraat 92, 3090 Overijse, Belgique. This publication may not be reproduced or quoted in whole or in part by printed or electronic means without written permission of the publishers. Printed in the USA. Canadian GST #129597951. Canada Post International Publications Mail Product (Canadian Distribution) Sales Agreement #0478733.

PUBLISHER Jeffrey Turner

EDITOR George Petersen

EXECUTIVE EDITOR Blair Jackson

MANAGING EDITOR Tom Kenny

ASSOCIATE EDITORS Adam Beyda Barbara Schultz

TECHNICAL EDITORS Sarah Jones Chris Michie

EDITORIAL ASSISTANT Anne Eickelberg

SOUND REINFORCEMENT EDITOR Mark Frink

MEDIA & MASTERING EDITOR Philip De Lancie

LOS ANGELES EDITOR Maureen Droney

EAST COAST EDITOR Dan Daley

NEW YORK EDITOR Gary Eskow

CONSULTING EDITOR Stephen St. Croix

TEC AWARDS EDITOR Karen Margroff Dunn

CONTRIBUTING EDITORS

Larry Blake Rick Clark Michael Cooper

Bob Hodas Paul Lehrman

ART DIRECTOR Tim Gleason

ASSISTANT ART DIRECTOR Kay Marshall

GRAPHIC DESIGNER Mika Chisaki

GRAPHIC ARTIST Alex Butkus

SPECIAL PROJECTS ART DIRECTOR Judy Oliver

PHOTOGRAPHY Steve Jennings

MARKETING DIRECTOR Debby H. Courtney

MARKETING ASSISTANT Daniela Barone

### EASTERN REGION

5 PENN PLAZA, 13TH FLOOR

NEW YORK, NY 10001

EASTERN ADVERTISING DIRECTOR

Michele Kanatous (212) 613-9711

EASTERN ADVERTISING ASSOCIATE

Jason Perl (212) 613-9709

### WESTERN REGION

12424 WILSHIRE BLVD.

LOS ANGELES, CA 90025

WESTERN ADVERTISING DIRECTOR

Terry Lowe (310) 207-8222

WESTERN ADVERTISING MANAGER

Shawn Yarnell (510) 653-3307

### MIX MAGAZINE

6400 HOLLIS ST., SUITE 12

EMERYVILLE, CA 94608

(510) 653-3307

SALES ADMINISTRATION MANAGER Dan Hernandez

SALES ASSISTANTS

Alex Boyd Marianne Moro Mari Stancati

CLASSIFIEDS & MARKETPLACE MANAGER

Robin Boyce-Trubitt

CLASSIFIEDS SALES ASSISTANT Jef Linson

CLASSIFIEDS ASSISTANT Mark Hopkins

FACILITIES SALES MANAGER Shawn Langwell

DIRECTOR, SPECIAL PROJECTS Hillel Resner

DIRECTOR OF OPERATIONS AND MANUFACTURING

Anne Letsch

PRODUCTION DIRECTOR Georgia George

PRODUCTION ASSISTANT Jessica Duttlinger

ADVERTISING PRODUCTION MANAGING COORDINATOR

Liz Myron

COLLATERAL PRODUCTION DIRECTOR Ellen Richman

PRODUCTION ASSISTANT Jeremy Nunes

COMPUTER SUPPORT TECHNICIAN Mike Castelli

CIRCULATION DIRECTOR Phil Semler

CIRCULATION ASSOCIATE Heidi Eschweiler

CIRCULATION FULFILLMENT ASSOCIATE Austin Malcom

BUSINESS MANAGER Cindy Elwell

FACILITIES/HR ASSISTANT Lauren Gerber

EXECUTIVE ASSISTANT Monica Cromarty

RECEPTIONIST Carrie Gebstadt

### PRIMEDIA Intertec

PRESIDENT AND CEO Raymond E. Maloney

PRESIDENT, COMMUNICATIONS AND

ENTERTAINMENT DIVISION Cameron Bishop

DIVISION DIRECTOR OF MARKETING Stephanie Hanaway

PRIMEDIA Information Group

PRESIDENT Curtis Thompson

PRIMEDIA Inc.

CHAIRMAN AND CEO William F. Reilly

PRESIDENT Charles McCurdy

VICE CHAIRMAN Beverly C. Chell

ALSO PUBLISHERS OF

ELECTRONIC MUSICIAN

MIX BOOKS

RECORDING INDUSTRY SOURCEBOOK

MIX MASTER DIRECTORY

NATIONAL EDITORIAL, ADVERTISING AND BUSINESS OFFICES, 6400 Hollis St., #12, Emeryville, CA 94608. (510) 653-3307, FAX: (510) 653-5142. Web site: www.mixonline.com. PHOTOCOPY RIGHTS: Authorization to photocopy items for internal or personal use of specific clients is granted by PRIMEDIA Intertec Publishing, provided that the base fee of U.S. \$2.25 per copy, plus U.S. \$0.00 per page is paid directly to Copyright Clearance Center, 222 Rosewood Dr., Danvers, MA 01923 USA. The fee code for users of this Transactional Reporting Service is ISSN 0164 9957/1997 \$2.25 + \$0.00. For those organizations that have been granted a photocopying license by CCC, a separate system of payment has been arranged. Before photocopying items for educational classroom use, please contact CCC at 508/750-8400. Organizations or individuals with large quantity photocopy or reprint requirements should contact Cherie Woods at (913) 341-1300. Microfilm copies of Mix are available by calling/writing UMI, 300 N. Zeeb Rd., P.O. Box 1346 Ann Arbor, MI 48106-1346; 313/761-4700, 800/521-0600.

Founded in 1977 by David Schwartz and Penny Riker Jacob



# PUSH IT TO THE PEGS.

Introducing GP9, Grand Master™ Platinum. The ultimate in analog audio mastering media from the global master of sound – Quantegy.

With GP9's increased output and lower noise, you can lay down a signal hot enough to melt your



meter. GP9 is also virtually shed-free, so you never risk losing a note or your sterling reputation.

It took Quantegy 40 years to produce a tape this good. It'll take you about 40 seconds to realize it was worth the wait.



Phone 800-752-0732 [www.quantegy.com](http://www.quantegy.com)

CIRCLE #005 ON PRODUCT INFO

# FEEDBACK

## DAYS OF WINE AND DIGITS

I confess. I read Stephen St.Croix's "Fast Lane" every month. Yes, he is out of his mind, yes he often confuses the bejesus out of me and, yes, he does offend many with his straight-to-the-jugular approach. But damn it, we need it.

Our industry is often so confused and misled that many would-be leaders are becoming either so jaded or so submissive to market claims that they can barely make a decision on their own. The issue of 96k 24-bit devices being the be-all and end-all, when the real end-all is 44.1k 16-bit, makes my skin itch (The Fast Lane: "96 bottles of Beer on the Wall, 96 Kilos of Hurts," Sept. '98). Here we are in our sweatshop, developing a great 16-bit device, but before we can even get the idea out of the gate, it is tossed aside because it ain't where our 24-bit industry is!

I turned 40 this year. One week full of pranks and obscene liquor fests crowned by a surprise party. One of my pals was kind enough to give me three albums (original 33 rpm vinyl—no really, they did exist) with a "Happy 50th" card! Andy Williams, CCR and Tom Jones (funny like a dagger). The 1963 recording of Andy Williams, *Days of Wine and Roses*, states: "This guaranteed high-fidelity recording is scientifically designed to play with the highest quality of reproduction on the phonograph of your choice, new or old. If you are the owner of a new stereophonic system, this record will play with even more brilliant true-to-life fidelity. In short, you can purchase this record with no fear of its becoming obsolete in the future."

Wow! I thought to myself, we are in an age where audiophiles are arguing that vinyl may still outperform the finest digital, while tubes sound better than the solid-state that fixed the tube problems we had in the first place. Now we are building mega-bit digital recorders to solve the problems we had with the analog ones while introducing phase distortion and compression schemes to reintroduce tape saturation. When it is all said and done, we are then zapping the least significant bit down to 14-bit resolution! Yikes! Do we not know our history?

I do not have a solution, but I do

have a significant first step. Let's assign the least significant bit to the accordion, or better yet, that overplayed, over-processed bagpipe sound that everyone is using since that sinking boat movie and those noisy, green tap dancers made the scene. The world would be a better place.

*Peter Janis*  
Director, CableTek  
Port Coquitlam, B.C.

## A MONITOR BY ANY OTHER NAME

Compact Monitor Corporation is gratified that you successfully guarded our anonymity and thereby kept the best secret in professional audio. We appreciate our new, clandestine "Compact Systems" identity [as the company was incorrectly identified in the Bonnie Raitt Tour Profile in Sept. '98].

If you swear not to reveal them, we'd be pleased to share other secrets with you. The only requirement is that you be in the Hollywood area: We do accept MasterCard, but we don't give out stage passes.

*John DeBord*  
President and CEO  
Compact Monitors Corporation  
Studio City, Calif.

## CONSOLE CORRECTION

Michael Hedges was wrong about the retirement date of Abbey Road/Studio 2's EMI Mark IV desk [International Update, Oct. '98]. I engineered America's "You Can Do Magic" in Studio 2 on that very desk in 1982, and I have photos to prove it.

*Chuck Kirkpatrick*  
Cooper City, Fla.

## BREATHING IN THE STUDIO

Regarding "Studio Equipment Modifications" by David Ogilvy (Oct. '98), did I correctly understand a phrase from the final paragraph from Fred Hill: "...dirt and fine particles in smoke are certainly the biggest factor in decreasing longevity"?

Did Mr. Hill mean tobacco smoke? Are there truly any idiots left today that still allow the carcinogenic poison known as tobacco smoke to pervade not only their bodies, but to help de-

stroy expensive equipment as well?

Interestingly, the same October issue included a comprehensive article on protecting hearing. Perhaps you should include an article on protecting the lungs, hearts and other organs of all of your readers from tobacco smoke. Unlike those of sound, the dangers of tobacco smoke are easily eliminated by enforcing a smoke-free policy.

*Mark A. Thomason*  
Fort Worth, Texas

## CLARIFICATION

I read with interest the Technology Spotlight on the Neumann M147 microphone in the October issue of *Mix*. I found it very informative, as I am very interested in this microphone. However, the article makes a reference to the fact that the M147 is not a hybrid design but is a true tube microphone. As the M147 is a transformerless design, I verified this with Neumann. Their response was that the M147 uses the same output configuration as the M149, which is a tube impedance converter followed by a solid-state line driver circuit operating at unity gain. I thought *Mix* readers would appreciate this clarification.

*Dean Richard*  
Milwaukee, Wis.  
[www.execpc.com/~drichard](http://www.execpc.com/~drichard)

## MISSING PERSON

In the September issue of *Mix*, a picture appears of George C. Scott. The caption states that the picture was taken in 1968/1969; that is not true. The picture was taken in 1988. The reason I know this is because the beautiful woman sitting in back of Mr. Scott is my mother. Patricia Childs is a Nashville-based producer, and a lovely lady. A published correction would be appreciated, including a mention of my mother, for, without her, Mr. Scott surely would not have done as fabulous a job that day.

*Jeremy M. Childs*  
Nashville, Tenn.

Send Feedback to Mix, 6400 Hollis St. #12, Emeryville, CA 94608; fax 510/653-5142; or [mixeditorial@intertec.com](mailto:mixeditorial@intertec.com).

# Simply the best

When it comes to quality,  
digital innovation and true  
client appeal, the facts  
speak for themselves.

This year's TEC nominee  
studios own:

18 AMS NEVE DIGITAL  
CONSOLES

13 AMS NEVE ANALOG  
CONSOLES

3 SSL SL9000 J SERIES  
CONSOLES



**VX/VXS**  
Advanced analog console



**Capricorn**  
Large-format digital console



**Logic 3**  
Digital editing & mixing system



**Libra**  
Compact digital music console



**DFC**  
Digital film console

## Defining success



**HEAD OFFICE** – AMS Neve plc · Billington Road · Burnley · Lancs BB11 5UB · England · Tel: +44 (0) 1282 457011  
Fax: +44 (0) 1282 417282 · **LONDON** – Tel: 0171 916 2828 · Fax: 0171 916 2827

**GERMANY** – Tel: 61 31 9 42 520 · Fax: 61 31 9 42 5210 · **NEW YORK** – Tel: (212) 965 1400 · Fax: (212) 965 3739

**HOLLYWOOD** – Tel: (818) 753 8789 · Fax: (818) 623 4839 · **TORONTO** – Tel: (416) 365 3363 · Fax: (416) 365 1044

e-mail: [enquiry@ams-neve.com](mailto:enquiry@ams-neve.com) – <http://www.ams-neve.com>

CIRCLE #006 ON PRODUCT INFO CARD  
World Radio History

# Advanced Digital Mixer

Panasonic is taking digital further today with the DA7 digital mixer, an entirely new standard in quality, flexibility, affordability, ease-of use and value. 24-bit converters, 32 inputs, 8 buses, 32-bit processing, moving faders, instantaneous recall of all settings, surround sound mixing...nothing this fully featured has been this easy to use or affordable... and it's available NOW! Incredible sound quality, Internal 32-bit processing and 24-bit A/D and D/A converters give this mixer sound worthy of consoles costing several times its price.

**Easy-to-use.** The DA7 is one powerful mixer. If you know how to run a traditional mixer, you already know how to run a DA7, since it has a smart, user-friendly design. To access any of the 32 channels, just press its select button and all parameters for the channel-EQ settings, bus and aux assignments, and dynamics and delay settings come up on the large backlit LCD screen. To access individual parameters, just touch the appropriate knob in the console's master section. This automatically calls up the sub-menu on the LCD screen and zooms in on the appropriate function. No more digging through menus or getting lost in functions; just adjust EQ, Pan/Assign, Dynamics/Delay, or Aux... and you're there.

**The power to control.** The EQ section offers 4 true overlapping parametric bands active on every channel (with the top and bottom bands switchable to low or high peak/shelving, or low pass, or high pass filters). Each Aux return also provides two bands of fully parametric EQ. The dynamics section offers variable attack/release times and levels for threshold and ratio on each channel, and delay is adjustable up to a maximum of 300ms. 50 Memories each are provided for EQ, Dynamics and individual channel settings. In addition to full dynamic moving fader automation of 32,000 events, there are 50 "snapshot" or "scene" memories. Plus, a Macintosh and

windows software package (that greatly expands the capabilities of the DA7), will soon be available.

**Surround sound at your command.** You'll be mixing surround soon.

The DA7 is equipped to mix 5.1 channel today. The DA7 has 3 built-in panning modes, and all modes provide full dynamic control of panning, and can be copied, stored, and transferred to any other channel. An optional MIDI joystick gives you yet a fourth method of surround control.

**MIDI and more.** The DA7 features 4 up/down/left/right cursor keys that can be switched to output MIDI Machine Control commands to MDMs, sequencers, or workstations. Data entry is done through the large parameter dial or an alphanumeric keypad. There's also an undo/redo button, a solo-mode set, and a built-in Talkback mic.

**Take on the world.** The rear panel sports 16 analog mic/line inputs (8 XLR with individual software-switched phantom power, and 8 with TRS); 16 channel inserts (pre-A/D); and 6 auxiliary send/return jacks (1,2 use S/PDIF; the rest use +4dB 1/4inch connectors). Along with the 2 digital and 4 analog Aux returns, the DA7 has 38 total inputs. Digital I/O, provided via XLR connectors switchable between AES/EBU and S/PDIF, offer the master out signals and they can be assigned to inputs 15 and 16.

The DA7 rear panel also offers MIDI In and Out, word clock I/Os, both a 9-pin RS-422/485 serial port and PC port for Mac or Windows with software support for both, a 1/4 inch footswitch jack for controlling Talkback on/off or automatic punch in/out, and a D-15 subconnector for the optional meter bridge. So, take your digital mixing further today by going to the nearest Panasonic dealer and auditioning the DA7 for yourself!

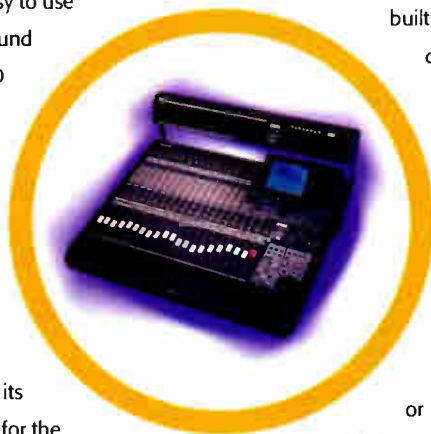

For more information call:  
1-800-777-1146 or visit our website at  
[www.panasonic.com/proaudio](http://www.panasonic.com/proaudio)

Available at a Store Near You

# DA7 Digital Mixer

1-Step Functionality

24 Bit A/D and D/A

Moving Faders

Surround Sound

Full Automation

Easy to use



Taking Digital Further

**Panasonic**  
Broadcast & Digital Systems Company

# INDUSTRY NOTES

Digital Audio Research Ltd. (Surrey, UK) announced the appointment of Studer North America as its exclusive sales representative for the USA and Canada, effective immediately. The partnership was finalized following discussions during the 105th AES convention in San Francisco...**Otari Corporation**, based in Foster City, CA, for 28 years, announced its relocation to Southern California. The new address is 8236 Remmet Ave., Canoga Park, CA 91304. Phone 818/594-5908; fax 818/594-7208...**Sascom Marketing Group** announced the addition of new technical support staff (Micheal Morissette in Montreal and George Dobo in Toronto), the opening of a service center in Montreal and plans to open an office in Vancouver. Sascom recently withdrew from representing Auggan, Spondor, Stage Tec and TL Audio products in the U.S. For additional info, call 905/469-8080...**Wayne Freeman** was tapped for director of sales and marketing at Amek (Manchester UK). Freeman, a 25-year industry veteran, last served as marketing manager for Otari and has held top-level positions at Fairlight, Trident and Soundcraft. Freeman can be contacted at Amek's SoCal office: 310/789-5204...**Avalon Design** (San Clemente, CA) appointed **Brad Zell** to the newly created position of product manager...At Montebello, CA-based **Tascam**, **Patrick Killianey** was appointed product specialist in the sales department. Killianey previously worked for Limelight Audio Services as a sound system designer and at Guitar Center as an in-house clinic instructor...**Jennifer Jones** was brought onboard as media and artist relations coordinator at Rochester, NY-based **Applied Research and Technology (ART)**...**JBL Professional** (Northridge, CA) announced the promotion of **Michael MacDonald** to the position of president. MacDonald will report directly to **Mark Terry**, who will serve as CEO. The promo-

tion of MacDonald follows the reorganization of the Harman Pro Group into two geographic-based operating units, Harman Pro Group, America, and Harman Pro Group, International...The **International Teleproduction Society (ITS)** elected **Howard Schwartz** (President/CEO of Howard Schwartz Recording Inc., NYC) board vice chairman. The position was formerly held by Townhouse Post Productions (Washington, D.C.) CEO **John Prescott**...**Raper & Wyman Ltd.** (Manor House, UK) announced its acquisition of specialist cable manufacturer **Connectronics**. The company now comprises four divisions: Raper & Wyman Pro Audio, R&W Sound Engineering, Ticket Audio Productions and Connectronics. For further info, e-mail r+w.proaudio@dial.pipex.com...**Madison, WI-based Sonic Foundry** announced the promotion of **Doug Nestler** to director of retail business development. The company also signed a licensing agreement with **Hewlett-Packard**, wherein Sonic Foundry will produce software to be included in HP's hardware...**David W. Carlin** was appointed director of sales at **Cintas Technologies'** (Chula Vista, CA) new Information-Communication-Entertainment division (ICE)...**Paul D. Bauman** was appointed project manager, research and development, at **Heil Acoustics** (Gometz-la-Ville, France)...**Jaffe Holden Scarbrough Acoustics Inc.** (Norwalk, CT) announced the hiring of **Anthony Nittoli**, **Sam Brandt** and **Byron Bishop**...**Natalie Stocker** joined **EMTEC Pro Media** (Valencia, CA) as marketing manager...Audio and video systems designer **Lenny Berlingieri** returned to **AST Sound** (NYC) as part of the sales team...**Verne Searer** was named director of market development for **Pro Co** (Kalamazoo, MI). Searer previously worked for Crown International...**Level Control Systems (LCS)** moved to new headquarters at 13 Montecito #236, Sierra Madre, CA 91024. ■

—FROM PAGE 12, CURRENT

## DVD "CONVERGENCE" FORUM

Immediately after the AES convention, hundreds of entertainment industry professionals gathered 45 minutes south of San Francisco for a DVD Forum that emphasized convergence. Appropriately, the first day of the conference concentrated on DVD-Video and DVD-ROM, with projections for the emerging DVD-Audio format.

Warren Lieberfarb, president of Warner Home Video, provided the keynote address. He said that without the driven support by Warner Home Video and early adoption by Columbia/TriStar, the format would not have the success it is now experiencing. Now "every major studio is in DVD," he said, and the format has grown ten times faster than VHS and four times faster than CD in the same introductory time period.

Dan Russell, Director of Platform Marketing from Intel Corp., demonstrated "convergence," the newest industry buzz word, by showing New Line Cinema's *Lost in Space* on a DVD-Video player—and then in a DVD-ROM drive utilizing the "value added" aspects of the disc. Intel discussed a new high-performance system designed around their new Katmai Processor, which would provide Web access and act as a movie player and stereo. Projections show there will be an installed base of 8 to 12 million DVD-ROM drives by the end of 1999.

But most of the day was devoted to DVD-Audio. Representatives from the WG-4 updated progress on the DVD-Audio spec. The "pure audio content structure" will include scalable linear PCM multichannel audio; super-high-quality linear PCM stereo; downmix control for multichannel-only content; and optional audio formats. The International Steering Committee's requirement of longer than 74 minutes of playing time for all playback modes without any loss of original music data led to the inclusion of Meridian's lossless encoding scheme, MLP (see page 80). The WG-4 hopes to see ratification by year's end.

## CORRECTION

Since our October "Technology Spotlight" on the Yamaha D24 Digital Multi-track Recorder, Yamaha has supplied updated information. While the D24 will simultaneously record and play up to eight tracks at sampling rates of up to 48 kHz, it can record and play a maximum of four tracks when operating at a 96kHz sampling rate. ■





**Been  
disappointed  
with digital?**

Maybe it's because the new digital technology often gets shoehorned into an outdated concept called "a console." Try Otari's new Advanta Digital Production System — the Anti-Console. Blasphemy? Use it, and listen. You'll believe. Call 1-800-877-0577.

**OTARI**

FOR THE WAY DIGITAL  
IS SUPPOSED TO SOUND.

[www.otari.com](http://www.otari.com)

24/96

R&D in cooperation with Sanyo Kogyo, a member of The Otari Group.

**CIRCLE #008 ON PRODUCT INFO CARD**

World Radio History

FROM THE PRODUCERS OF THE CRITICALLY ACCLAIMED...

CSII  
CS2000

*CS3000*

**Recording and Mixing Consoles. Best known for:**

Superior Sound Quality

Precision Surround Panning

Hi-performance Dynamics

High Reliability

Total Automation

Instant SnapShot™ Recall

Powerful Machine Control

Modular Expandability

Headquarters (Palo Alto, West US) Tel:(650)855 0400 • Los Angeles (West US & Int'l) Tel:(818)766 1666  
New York (East US) Tel:(212)889 6869 • Nashville (Central US) Tel:(615)327 2933 • London (Europe) Tel:(171)602 4575 • Tokyo (Japan) Tel:(03)3288 4423

World Radio History

EUPHONIX INTRODUCES THE NEXT INNOVATION...



# R-1 MULTI-TRACK RECORDER



Coming soon to a studio near you

### Highest Sound Quality

24-bit, premium converters,  
40-bit DSP

### Modular and Expandable

Open architecture supports future I/O options, sample rates, machine control, track expansion, editing and networking

### Reel Feel™

Familiar tape-style remote and transport feel

### Non-Destructive Recording

No fear of erasing tracks, multiple takes per track, records hundreds of tracks, plays any combination of 24 tracks

### Solid Reliability

Rugged construction, premium components, fault tolerant design

### Non-Degrading Storage

No head wear or media degradation during repeated use, long shelf-life media

### Recording and Editing

24-track punch in/punch out, no need to transfer to an editor for basic edits

### Random Access

No waiting for locate, auto-fade looping

Web site: <http://www.euphonix.com>

World Radio History

# TWO STATES, TWO PARTS

## THE ALIENS AMONG US, PART 0

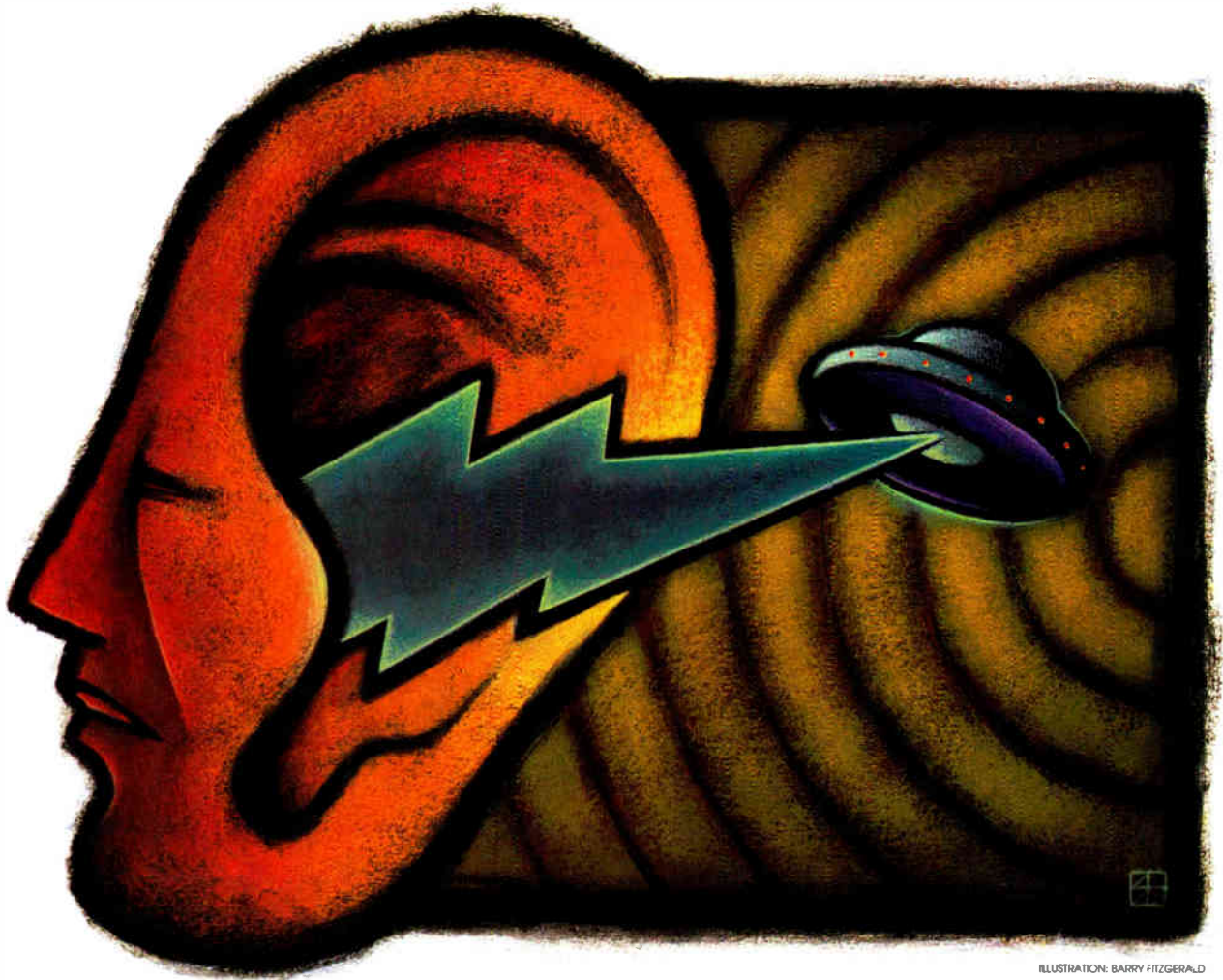

ILLUSTRATION: BARRY FITZGERALD

**I**NTRO  
Over and over I hear warped and confused interpretations of what goes on in the binary world. Recently there have been way too many of these over and overs, so I thought I would do a column on what really goes on in there. Then, as I was writing it, I realized that even more is happening than I had originally thought, so now it's two columns. Yes, this is a two-part column. Personally, I hate when they do that, but in this case...I guess I had that much to say. So here we go.

Ones and zeros. That's all. That's it! Ones and Zeros. Digital data is only a stream of ones and

zeros. Two states. And our own dear-to-our-hearts digital audio data is just one format of those one and zero streams. How could it be any more simple? Ah, how could it be any more complex? Or any more confused?

Well, I will touch on the most common areas of confusion, based on what people ask me, and what other poor, confused souls *tell* me. These points may look a little rudimentary to you, but I ask you to take a look anyway—there just might be a new fragment of data for you, or maybe even a new look at the implications of the dig-

BY STEPHEN ST. CROIX

ital world that we are all moving into.

### CHARMINGLY MISGUIDED BELIEF NUMBER ONE

"Once it's digital, it's safe." Upon interrogation, it is usually revealed that those who say this do in fact have some sort of loosely structured belief that once audio has been converted to digital data, it magically becomes immune to all of the horrible potential fates that threatened it in the analog world. Some go so far as to pontificate on what a wonderful world it would be if all audio were all digital, all the time.

We, humans that most of us are,

DON'T  
I THINK WE'RE  
IN KANSAS ANYMORE.



DC2476 DIGITAL MASTERING PROCESSOR



DC2486 TWINSCREEN DIGITAL PROCESSOR



DC2496 HIGH RESOLUTION AD CONVERTER

ENTER A NEW TERRITORY...  
THE WORLD'S FIRST 24 BIT / 96K  
SAMPLE RATE DIGITAL DYNAMIC  
PROCESSORS.

THE NEW DRAWMER DIGITAL SERIES  
OFFERS HIGHER SPEC, LOWER NOISE,  
AND THE WIDEST DYNAMIC RANGE  
THIS SIDE OF THE RAINBOW.

DRAWMER  
DIGITAL



TRANSAMERICA AUDIO GROUP INC.

2721 CALLE OLIVIO • THOUSAND OAKS • CA 91360

PHONE: (805) 241-4443 FAX: (805) 241-7839

WWW.TRANSAUDIOGROUP.COM • TRANSAMAG@AOL.COM

DRAWMER (ENGLAND) • PHONE: +44 (0) 1924 378669 • FAX: +44 (0) 1924 290460

WWW.PROAUDIO.CO.UK/DRAWMER.BTM • SALES@DRAWMER.CO.UK

IN CANADA • GERRAUDIO DISTRIBUTION INC.

PHONE: (898) 462-8346 • FAX: (888) 329-4377 • SALES@GERR.COM • WWW.GERR.COM

World Radio History  
CIRCLE #010 ON PRODUCT INFO CARD

# GS3000

Fully-Featured 8-Bus Inline Recording Console

British EQ Section with 2 Fully Parametric Mids

4 Stereo Inputs, 4 Mute Groups

Full MIDI Mute / Automation

Talkback, Solo-In-Place, PFL and Oscillator

Comprehensive Group and Input Metering  
VU-Meters on Main Bus Outputs

**Vacuum Tube Preamps  
On Board!**

Hmmm.... it's a concept.... take a world class recording console with stunning British EQ, dual fader in-line monitoring, build in a couple of brilliantly warm tube preamps and offer it at a fabulous price. That's what our engineers at Allen & Heath have done and the reviews are rave.

The preamps are located in the master section of the console and are available to any strip on the desk making them marvelously easy to use, and (very importantly) consistent in their phase

relationship with the rest of the signal path.

With our famous British 4 band (fully parametric dual mid band) equalizer, the most comprehensive routing system available and extraordinarily versatile metering topology it begs the question, "Why hasn't anyone done this before?"

We've done it, and you're gonna love it. Audition your Allen & Heath GS3000 at your dealer today.

# Tube Preamps in a

# Console?

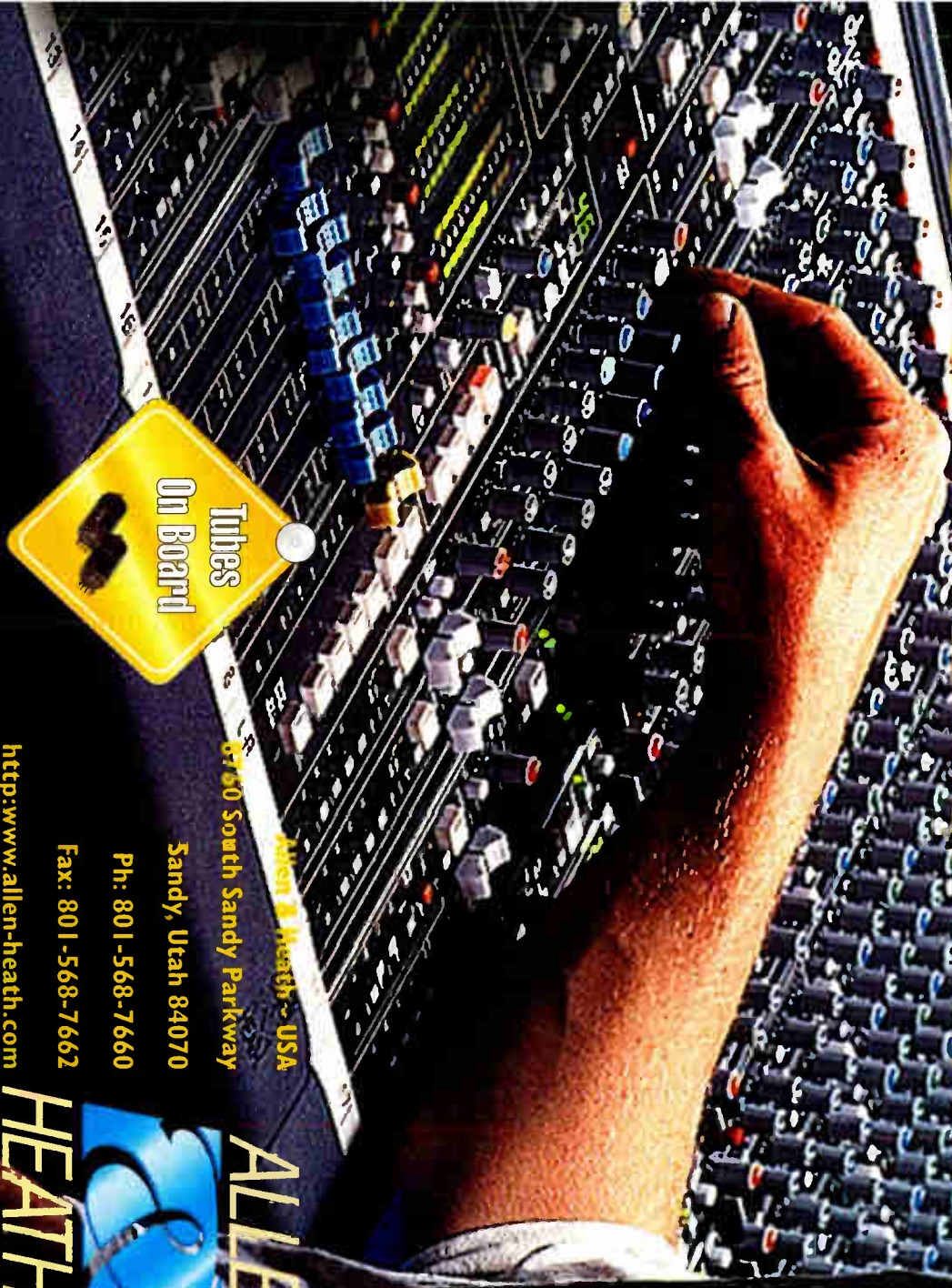

Allen & Heath - USA

8760 South Sandy Parkway

Sandy, Utah 84070

Ph: 801-568-7660

Fax: 801-568-7662

<http://www.allen-heath.com>



# AnthroCarts!®

Built like tanks with a Lifetime Warranty!



Configure Them for *Your* Music Application • Tough as Nails  
Dozens of Shapes and Sizes • Over 75 Accessories • Order Direct!

Call for a free Catalog:

**800-325-3841**

5:00 AM to 6:00 PM PST, M-F

  
**ANTHRO®**

**Anthro Corporation**  
**Technology Furniture®**  
Tualatin, OR 97062  
Fax: 800-325-0045  
Japan 03 (Tokyo)-3947-2735  
[www.anthro.com](http://www.anthro.com)



## THE FAST LANE

must face the fact that we reside in an *analog* world—so far. Now, of course, not all humans reside in their original analog world. Many programmers and a good 50% of the gamers out there do seem to reside within an imaginary construct—an analog model of a digital world that emulates their original analog world. They often aren't even aware that they are peering through the monitor's glass into a virtual reality that is working hard to emulate the real reality that they are sitting in. They know more about, and do better in, that world than the irrational, unpredictable organic one outside. But digital autism aside, we live in an analog world. Digital music is meant to eventually be converted to analog so that our silly old organic ears can capture it. This really frustrates those hard-core bit-heads.

## THE CIRCLE MUST REMAIN UNBROKEN

Okay. A/D conversion. Getting better all the time. But all A/D conversion adds noise, distortion and many other unpleasant artifacts. Of course, the trick is to bury these problems as deep as possible, and 24-bit converters do dig a deeper hole than 16-bit converters. I know that you already know all this, so I will not waste your time elaborating. But I *will* tell you this.

The human brain has been evolving for quite some time. Duh! Ever since the first undifferentiated cell decided to become a brain (and the very first heavy metal drummer came to be), additional cells have been joining up for the express purpose of enhancing survival odds.

We are organic beings, and we evolved solely within an organic, analog world. This is a crucial point. Survival is pretty important for any species. Without survival, the other two functions, eating and procreating, just aren't quite the same, are they?

Hearing is a hemispherical sense. You can hear sounds from anywhere around you, as opposed to sight, which only works in straight lines (and you have to literally aim the sensors, as well).

Since hearing is a surround sense, it is of course a perfect candidate for an early warning system, and so it is. We are *very* sensitive to tiny changes in surrounding background sounds and noises. It is believed that, in the interest of keeping CPU load down to a reasonable level, the brain is most interested

—CONTINUED ON PAGE 231

Since 1984. Prices from \$295. GSA contract. Available for OEM applications.

World Radio History



PHOD. NO.  
SCENE  
TAKE  
ROLL  
DIRECTOR  
MUSIC

# are you ready for this?

New delivery channels, including DVD, satellite, cable, digital TV and the internet, are providing an explosive increase in the number of routes available to deliver material to an ever-more enlightened audience, demanding complex levels of audio format.

This in turn has created a requirement for powerful audio tools capable of generating and controlling these significantly more complex formats, effortlessly combining and distributing the increase in the numbers of audio channels.

Manual operation is no longer an option.

Are you ready for this?

People who work with Soundtracs DPC-II Digital Production Consoles are.

They're assured of 160 automated channels with comprehensive digital audio processing, controlled by an intuitive worksurface.

They're also dubbing in all current and known future mix formats in 24 bit and feeling secure with the knowledge that 'future proof' 96kHz resolution and 7.1 operation is built in.

And they're saving time by opening up creative possibilities with each new project they produce.

For a full colour prospectus, or better still book a personal demonstration simply call Soundtracs.



POST PRODUCTION



MUSIC RECORDING



FILM SOUNDTRACK



## the new DPC-II

- 160 Digital Channels
- Worksurfaces from 16 to 96 motorised faders
- 24 bit Conversion
- 96kHz operation
- Stereo, LCRS, 5.1, 7.1

### digital production console



**SOUNDTRACS**

SOUNDTRACS 316 South Service Road, Melville, NY 11747-3201

Telephone: (+1) 516 393 8520, Fax (+1) 516 333 9108, email: soundtracs@korgusa.com

Soundtracs PLC, Blenheim Road, Longmead Business Park, Epsom, Surrey KT11 9YN, UK

Tel: (+44) (0)181 388 5000, Fax (+44) (0)181 388 5050, email: sales@soundtracs.co.uk, web: http://www.soundtracs.co.uk

CIRCLE #012 ON PRODUCT INFO CARD

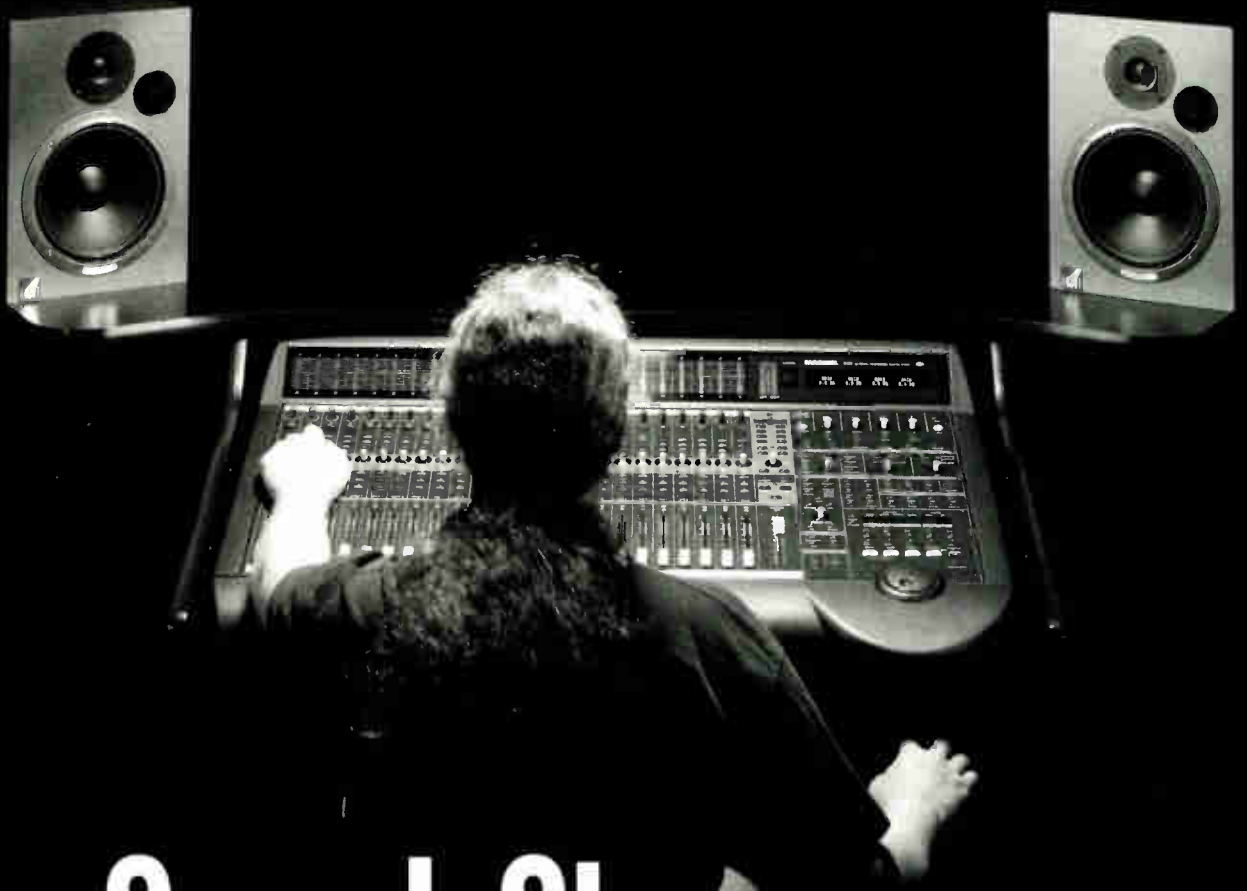

# Superb Stereo...

20/20*bas* Biampified System: a name synonymous with detailed, precise audio reproduction. Unparalleled imaging. Smooth, accurate frequency response. True sound—for true mixes. (Just ask the engineers whose *bas* mixes have won Grammy Awards.)

**20/20*bas* Biampified System.**



# ...Spectacular Surround!

Expand your stereo 20/20*bas* system to full-blown surround with the addition of center, right-rear, and left-rear *bas* and our new active **20/20 System Subwoofer**™—a thundering 15"/250W monster featuring our unique dual input/dual crossover design. Simultaneously monitor the discrete Dolby™ Surround LFE (Low Frequency Effects) channel while extending the low-end response of each *bas* satellite.

**20/20 Triamplified Surround System.™**  
**Yes, you can believe your ears.**

P.O. Box 4189, Santa Barbara, CA 93140-4189  
Voice: 805-566-7777 Fax: 805-566-7771  
E-mail: [info@event1.com](mailto:info@event1.com) Web: [www.event1.com](http://www.event1.com)

CIRCLE #013 ON PRODUCT INFO CARD



# THE UPS AND DOWNS OF UPGRADES

## CAN YOU AFFORD TO LEAVE WELL ENOUGH ALONE?

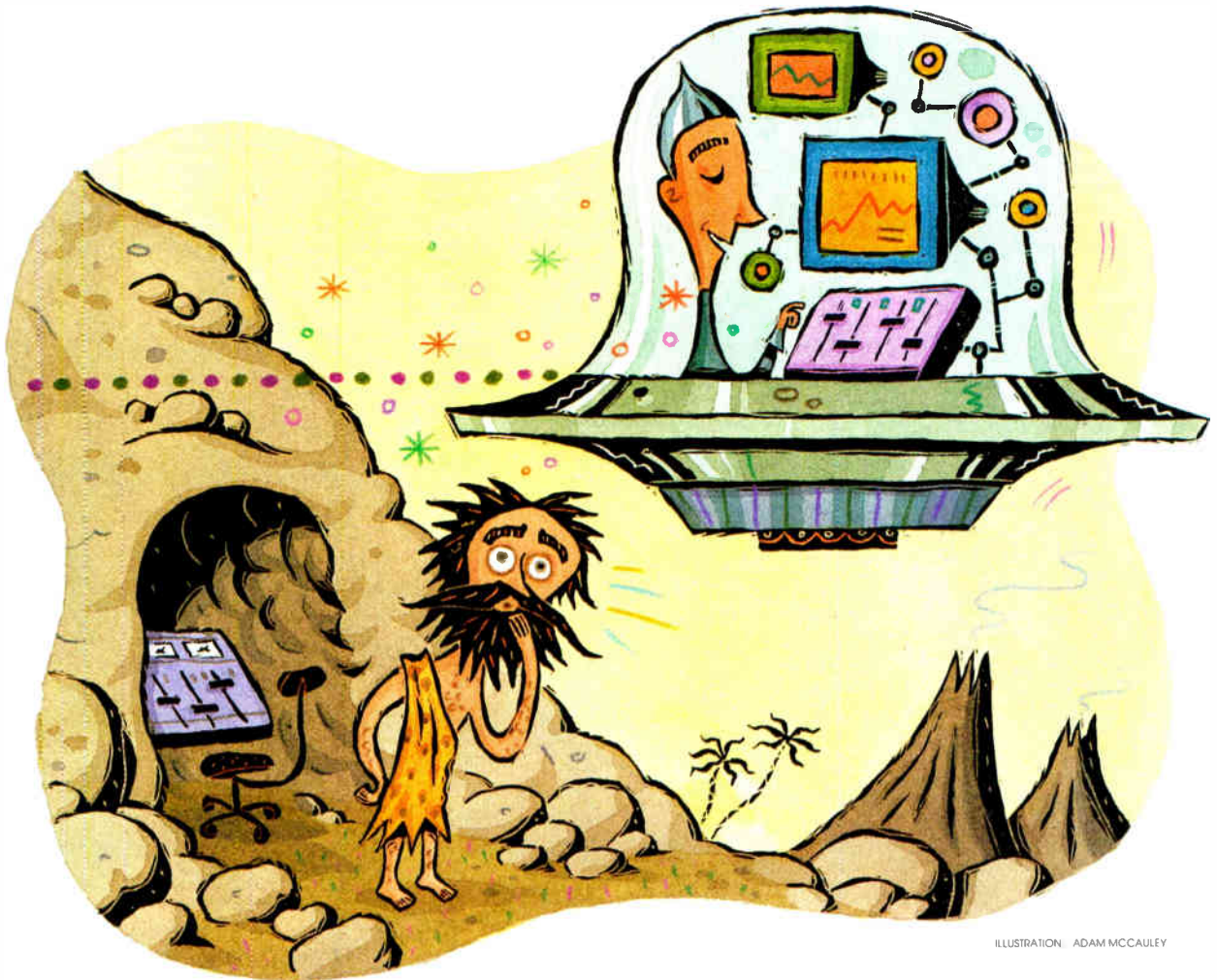

ILLUSTRATION: ADAM MCCAULEY

Probably the biggest question every studio owner has to face every day—besides whether to get out of bed in the morning—is when to upgrade. Just the word “upgrade” is enough to strike fear into the heart of anyone with an investment in audio or computer equipment. By accepting that you need an upgrade, you’re admitting that you’re behind the times, that you’re not competitive, that the investment you made just a few short years or even months ago is worthless, and that you’re going to be spending a lot of money you didn’t know you had. Not to mention that you’re about to head into the Valley of Death By Down Time.

Not too long ago, the decision to make a major equipment change in a recording studio was relatively easy. It was sort of like deciding to get rid of an old car: If the cost of keeping and maintaining it was higher than the value of whatever you could still get out of it, it was time for it to go. If you were in a competitive market with a ten-year-old mixing board, and you discovered the guy down the street was beginning to siphon business away because he had a newer, flashier, more-LEDs-per-square-inch board, then it might be time to replace the old desk with something a little more *au courant*.

BY PAUL D. LEHRMAN

Like trading in your old car to a dealer or selling it in the classified ads, you could always find another studio that would be happy to have your old console, or you could build a “B” room and stick it in there, and so you could recover at least a part of the cost of the upgrade.

But there are far more complex issues facing studio owners today than simply calculating the “remaining useful life” of a major piece of gear, or trying to keep up with the Joneses down the street. The concepts and buzz words of modern audio technology are much better known (if no better understood) among nonprofessionals—i.e., clients—than they

In 1990, Sweetwater Sound Inc. created an exciting new way to serve musicians and studios. We combined the convenience of direct-to-your-door service with a solid focus on music technology.

Like L. L. Bean, Dell and other specialty direct marketing leaders,

Sweetwater is fortunate to have

grown by leaps and bounds, while earning your trust and providing

greater and greater value. Our exclusive "Music Technology Direct"

approach has helped over 150,000

satisfied customers make

their musical dreams come true.

# Music Technology Direct!



MICROPHONES • RECORDERS • MIXERS • EFFECTS • KEYBOARDS • GUITARS • AMPS • SPEAKERS • STUDIO FURNITURE & MUCH MORE

What does Music Technology Direct mean to you and your music?

1. Convenience. You get the right gear, when you need it!

It's like having a huge warehouse of music gear right outside your front door! One call gets you all the top brands—no chasing around all over town! Why put up with any hassles?

2. Savings. You get a fair "ProNet" price.

We stock in tremendous quantity to get the lowest possible cost from our vendors. We pass the savings directly to you with our "ProNet Pricing." Why spend more?"

3. Service. You get great Tech Support and Service, when you need it.

Help with an installation? Confusing problems? We know our stuff cold! We don't pass the buck, we get you back to your music as fast as possible. Why wait?

4. Respect. You get treated with respect.

Shouldn't shopping for gear be easy and fun? We'll do everything we can to make sure you have a great time selecting and building your rig, without pulling out your hair! Why not enjoy yourself?

**Sweetwater**  
SOUND INC.

**(800) 222-4700**

**MUSIC TECHNOLOGY DIRECT & THE BEST VALUE, GUARANTEED**

(219) 432-8176 • FAX (219) 432-1758 • SALES@SWEETWATER.COM • WWW.SWEETWATER.COM • 5335 BASS ROAD, FORT WAYNE, IN 46808

CIRCLE #015 ON PRODUCT INFO CARD

World Radio History

What turned the music technology industry on its ear?

Acoustic-X™

Acoustic X

## THE ULTIMATE ROOM OPTIMIZATION SOFTWARE



Design, Layout & Optimize Your Own

- Recording Studio
- Project Studio
- Video Edit Suite
- Home Theater
- Critical Listening Room

For Stereo or Surround-Sound Monitoring, or just to learn more about acoustics

You Will Believe Your Ears



With Acoustic-X software you are the **eXpert**

Acoustic-X™ Software Corporation



376 Queen Street East  
 Toronto, Ontario, Canada  
 M5A 1T1  
 Phone: (416)868-0809  
 Fax: (416)861-0620  
 WWW: pilchner-schoustal.com  
 E-Mail: acoustic@idirect.com

Inquire about a Demo at a music store near you

CIRCLE #016 ON PRODUCT INFO CARD

### INSIDER AUDIO

used to be, and as the saying goes, a little knowledge is a dangerous thing. Whether or not they have anything to do with their projects, some clients will insist that you have the latest plug-ins, operating systems, digital effects and tube preamps, or they'll take their business somewhere "hipper." It doesn't make any difference that they're producing a video that's going to end up on a kiosk in the middle of a railroad station waiting room—if you haven't got 24-bit 96kHz converters and a mixer with automated effects and 5.1 surround panning, they're not interested in you.

Coming from the opposite side, manufacturers are much more aggressive than they used to be when it

**Whatever you buy  
 today will be obsolete—  
 not in a year,  
 not in three months,  
 but the moment  
 you take it  
 out of the box.**

comes to pushing stuff into customers' hands. A few years ago, the average pro audio ad said something like, "This will make your records sound better," or "This will save you time." Today, the same hype machine that has made the people in the top income brackets of the richest nation in the history of civilization feel inadequate if they don't drink the right colored soda water has been called into service to sell gear to you and me: "Buy this, or you'll be left behind by the people who are cooler and know better than you do." And getting something back for your old gear? Forget it! You're in the 28% tax bracket, so you're significantly better off donating that three-year-old computer or five-year-old reverb to a local school or nonprofit than trying to get cash for it.

But upgrading anything in today's highly interdependent studio, as I opined in one of my very first "Insider Audio" columns about three years ago, can be very tricky. When life was more discrete, trading in one compressor or

equalizer for another didn't affect anything else in the studio one iota—unless you count having to re-label the patch-bay. But in digital and computer-based systems, changing just one element can throw dozens of others out of kilter.

To stretch the automobile analogy a little further, in the days of discrete analog components, mastering a new piece of gear wasn't that different from getting used to a new car: After you figured out where they put the rear defroster control, found the hood release latch, set the buttons on the radio, and realized the hard way that you can't close the sunroof if you're parked on a hill in the rain, driving a new car is pretty much the same experience as driving an old one, only the potholes don't seem as annoying, the exhaust system is quieter and the world seems to go by faster. In today's studios, however, after you've changed the operating system on a computer or DAW, it might feel like the steering wheel is on backward, the turn signals open the gas-tank cover, the clutch operates in reverse, and the horn doesn't sound, it blinks. And, oh yes—there seems to be an extra wheel or three (or 3.1) attached.

Since no one company is in charge of all the components—hardware and software—in a computer, you will undoubtedly find that when you change your operating system (or almost anything in that operating system, like new sound drivers), some cherished programs will no longer be functional and will need to be replaced to remain compatible. You may need to add more RAM to support all these new versions—and the cost of doing all this can easily be more than the cost of the upgrade you started out with. Worst of all, you may have to reformat your hard disk and risk losing everything that's on there.

Even more annoying—and more expensive—is the amount of time all this takes. Down time for installing new programs and revisions, and for fixing all the things that subsequently break, has become a significant factor in many studios' budgets, as well as a nasty Catch-22 in their business strategies: If you're busy, you can't afford the down time, but if you don't do the upgrade, you'll lose business. More than one studio owner has expressed a perverse desire for business to slow down for a little while, just so they can have time to do a simple upgrade in their studio.

Ignoring the problem is no answer, either. I was once told by a tech support director at a major manufacturer

that if I didn't want to deal with constantly messing around with my system, and I was happy with how my studio was working, I could "freeze time": Leave everything just the way it was, and do my gig. But after a remarkably short period of time, that is going to stop working. Not only wouldn't I be able to take advantage of any of the latest goodies that require an updated system, I wouldn't even be able to get bugs fixed—because the bug fixes are only available in the new versions that contain all the latest goodies, which needs the updated system, which requires new versions of utility software, which needs extra RAM, and so on ad nauseam. I wanted to ask him whether he was still maintaining his bug report database in Lotus 1-2-3 on a PC-AT, but I figured I knew the answer.

Since I wrote that column three years ago, the situation has, if anything, gotten worse. The pace of new technology introductions has continued to accelerate, and whatever you buy today will be obsolete—not in a year, not in three months, but the moment you take it out of the box. And if it isn't, then it will be at the next trade show, when the manufacturer announces its next

generation of toys. These will be faster, cheaper and have more tracks/bits/wingdings, but—and we're really sorry about this—they won't work with what you have now. While a new automobile (last car analogy, I promise!) loses maybe 15% of its value the moment you drive it off the lot, the SuperWonderMachine you just spent a few thousand dollars on will have lost about 75% of its value by the time you get it running. Assuming that you do.

For people without unlimited sources of funds and rows of technicians to solve their problems, all of this causes fear, panic, sleepless nights and, in a lot of cases, complete and utter paralysis. How many of us have put off getting that new software, or installing a hard disk or CD-R drive, or subscribing to the next operating system, because we were terrified of getting the "wrong" product, or of what this change would do to our work schedule and our bottom line?

Fortunately, this issue is being addressed by people other than audio writers. At Mix's StudioPro98 conference in New York this past summer, the organizers came up with a panel topic called "That Dangerous Upgrade

Path." Not surprisingly, because of my outspokenness on the subject (and the fact that they didn't have to pay airfare for me to get there) they asked me to moderate it. I recruited people from a number of different parts of the industry to sit on the panel and was heartened at their enthusiastic response—not even the manufacturers I asked to join me winced when I told them what the topic was.

Besides the manufacturers, we had three studio engineers and managers on the panel, along with a representative from the retail side. Next month, I'll get into what they said. I'll also share with you some rules I've developed, over the years and with the panel's help, about how to deal with upgrades in today's studio environment. ■

*In the past year, Paul D. Lehrman, editorial director of Mix Online (www.mixonline.com), has bought two new consoles, three computers, a set of primary monitors, a synchronizer, a mastering deck, a reverb, and he has installed new operating systems in three samplers. And he has changed jobs. He intends to spend the next year trying not to go broke.*

RECORDING CHANNEL

TUBE-TECH MEC 1A

# Get Serious

If you're ready for some serious recording, then you're ready for the MEC 1A. It's an all tube based microphone preamplifier, equalizer and opto-compressor - designed and hand crafted to deliver the warmest vintage quality recordings with pure and realistic accuracy.

And if you're serious about specs the MEC 1A boasts a frequency response of 5Hz to 60kHz and extremely low noise <-85 dBu. But the real truth is in the listening.

Visit your local Tube Tech dealer today to hear the difference, and seriously consider putting the MEC 1A in your studio. You deserve it.

Tube Tech... in a class by themselves. For a dealer near you call 1-888-4WARMTH.

*"Great sound and high quality performance."*  
Dave Boyer, Audio Media Magazine

*"It's extreme value for the money. This really is a killer box."*  
Zenon Schoepe, Studio Sound

*"We threw everything at it and it kept on spittin' it back, bigger and better."*  
Little Feat - Under The Radar

Exclusively Distributed and Supported by:

**t.c. electronic**  
ULTIMATE SOUND MACHINES

TC ELECTRONIC INC., 790-H HAMPSHIRE ROAD,  
WESTLAKE VILLAGE, CA 91361  
PHONE: (805) 373-1828 · FAX: (805) 379-2648  
EMAIL: INFO@TCELECTRONIC.COM  
WWW.TCELECTRONIC.COM

CIRCLE #017 ON PRODUCT INFO CARD

World Radio History

# You Get 2 Channels Of Classic dbx

- Extensive Metering
- Easy-To-Use Limiting
- Full MIDI / SysEx Functions
- TYPE IV™ Conversion System
- TCM™ Transient Capture Mode
- Intuitive Graphic User Interface
- TSE™ Tape Saturation Emulation
- Unlimited Setup Chain Combinations
- 50 Factory Presets / 50 User Presets

Digitally



24 bit A-D-A Conversion

48 bit DSP

Digital I/O\*



DDP Digital I/O module\*

Digital Dynamics Processor



# Compression... And The Rest Of It For Free

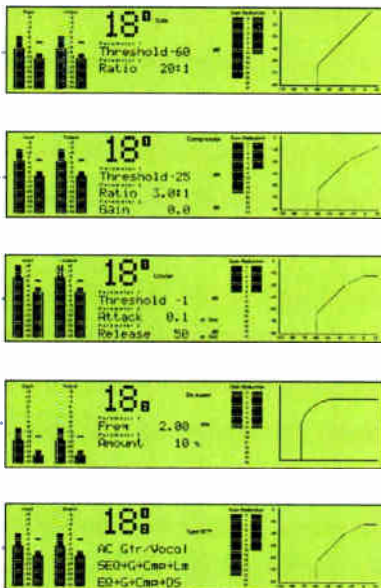

So, you're finally getting around to putting some real gear in your studio. . . and if you know your stuff, you're already planning to buy at least two channels of dbx compression. And you could always use a good de-esser, a limiter, a great gate with tons of frequency and amplitude control, with the ability to trigger it all with some sidechain stuff, right? So why not get all that other stuff for the same price as 2 channels of great dbx compression?

Or maybe you just got one of those PC recording cards with the "amazing 20 bit digital performance" on RCA jacks. Blah Blah Blah. Big Hairy Deal. So where's the dynamics processing? No compression? Limiting? De-essing? EQ? Oh, and where's the rest of the bits? They left off the bits that really count: the noise floor bits. If you want to record anything serious, do yourself a favor and leave the amateur RCA jacks behind and join the world of true 48 bit DSP horsepower. You'll hear a huge difference.



More  
than  
a  
BIT  
Better

We took our industry standard compression—we wrote the book on compression, and added all sorts of other goodies. Stuff like a limiter that is a true brick wall, a de-esser that has precision control, the most versatile parametric EQ section around, and sidechain functions, and stuffed it all into the DDP. Then, in a fit of overkill, we added 48 bit internal processing, as well as 24 bit input and output capabilities via the optional I/O card. That's super-quiet, super-powerful 24 bit digital in AES/EBU or S/PDIF, you choose. Nice to have choices, isn't it?

**Hurry up and get down to your pro audio dealer today, before somebody else beats you to your DDP.**

CIRCLE #018 ON PRODUCT INFO CARD

\* Digital input/output module optional

**H** A Harman International Company

email: [customer@dbxpro.com](mailto:customer@dbxpro.com) • URL: <http://www.dbxpro.com>

World Radio History

**dbx**<sup>®</sup>  
PROFESSIONAL PRODUCTS



# 14th Annual TEC

Photos by Eric Slomanson

**P**resentation of the 1998 Les Paul Award to rock 'n' roll legend Neil Young was the highlight of the 14th Annual Technical Excellence & Creativity Awards, held September 27 at the Fairmont Hotel in San Francisco.



*(L-R) George Duke and Ray Benson present the TEC Award for Signal Processing Technology (Software) to Harvey Schein for the Lexicon LexiVerb.*

Young shared his wry view of the current state of audio technology with an appreciative audience of nearly 800 industry professionals. Led by the ever-popular master of ceremonies Father Guido Sarducci, the crowd also witnessed the induction of the late Colin Sanders, founder of Solid State Logic, into the TEC Awards Hall of Fame. The award was accepted on Sanders' behalf by his sister, Elaine Elliot-Smith, and SSL's Derek Hobbs.



*Father Guido Sarducci keeps the audience laughing during the 14th Annual TEC Awards.*

TEC Awards were also presented in 27 categories of Institutional, Creative and Technical Achievement. (A complete list follows.) The evening's presenters included musicians Ray Benson, Jonathon Cain, Craig Chaquico, George Duke and Pete Escovedo, studio owner David Porter, producers George



*Guitarist Craig Chaquico, who presented awards in the Creative Achievement categories, and TEC Awards Executive Director Karen Dunn.*

Massenburg and Narada Michael Walden, engineers Al Schmitt and Leslie Ann Jones, Recording Academy president Michael Greene and entrepreneur Barbara Orbison, widow of the late Roy Orbison. Previous Les Paul Award winner Alan Parsons presented this year's award to Neil Young, and Mix editor George Petersen made the Hall of Fame presentation for Colin Sanders.



*Bob Clearmountain accepts the TEC Award for Recording/Mixing Engineer.*

The House Ear Institute's Hearing Is Priceless campaign and Hearing Education and Awareness for Rockers (H.E.A.R.) will once again receive 50% of the evening's proceeds to continue their efforts in hearing conservation. The remaining funds will be divided between the AES Educational Foundation, the SPARS student assistance program, the recipients of the TEC Awards Scholarship Grant (see "Current" on page 10 for details) and various audio scholarship programs throughout the United States. ■



*Elaine Elliot-Smith and SSL's Derek Hobbs accept the Hall of Fame award on behalf of the late Colin Sanders.*



*(L-R) Mix Foundation president Hillel Resner presents House Ear Institute's Dilys Jones and Jim Boswell with a check from the proceeds of the Mix L.A. Golf Tournament held last June.*

# Awards Highlights



*Neil Young accepts the Les Paul Award.*

*Producer  
Narada  
Michael  
Walden (L)  
and  
percussionist  
Pete Escovedo  
present  
awards  
in the  
Creative  
Achievement  
categories.*



*Recording  
Academy  
president  
Mike Greene  
and Barbara  
Orbison  
present  
awards in  
the  
Institutional  
Achievement  
categories.*



*Ryan Hewitt  
accepts the  
TEC Award for  
Remote/Broadcast  
Recording Engineer  
on behalf of his  
dad, David.*



*Presenters George  
Massenburg (L)  
and Al Schmitt  
enjoy an amusing  
moment while  
presenting the  
Technical Achievement  
awards.*



*Clair Brothers'  
Gene Pelland  
accepts the  
TEC Award for  
Sound  
Reinforcement  
Company.*



*Peter  
Chaikin  
accepts the  
TEC Award  
for the  
Yamaha  
02R V2  
in the  
category  
of Small  
Format  
Console.*



*Neil Young,  
Les Paul  
Award winner,  
Mix Publisher  
Jeff Turner and  
Neil's wife,  
Pegi.*

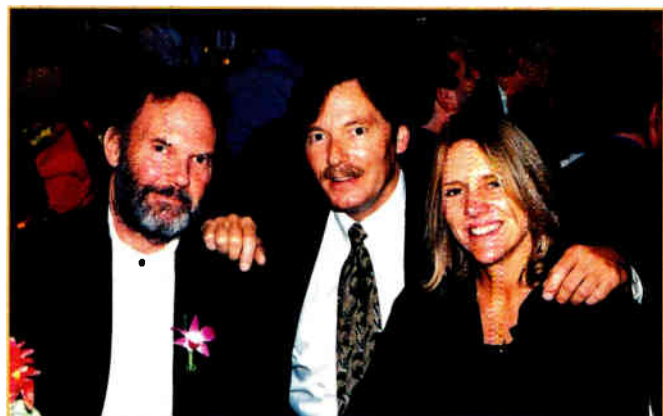

The 14th Annual TEC Awards were partially funded by the generous donations of:

#### PLATINUM SPONSORS

JBL Professional  
Mix Magazine  
Quantegy Inc.

#### GOLD SPONSORS

Alesis Corporation  
AMS Neve  
Audio-Technica  
Disc Makers  
Eastern Acoustic Works  
Gibson Musical Instruments  
Harman Music Group  
Solid State Logic  
Sony Professional Audio  
Yamaha Corporation of America

#### SILVER SPONSORS

AKG  
Aphex Systems  
Apogee Electronics Corporation  
Clair Brothers Audio  
Digidesign  
E-mu Systems  
Emtec Pro Media/BASF  
Euphonix  
Lexicon Inc.  
Mackie Designs  
Meyer Sound Laboratories  
The Recording Academy  
Neumann  
Ocean Way Recording Inc.  
Oram Consulting Inc.  
Roland Corporation U.S.  
Shure Brothers  
Skywalker Sound  
Studer North America  
TC Electronic  
Telex/EVI Audio  
The Village Recorder

#### BRONZE SPONSORS

Akai Musical Instrument Corp.  
CreamWare US  
Dolby Laboratories Inc.  
Mick Guzauski\*  
Howard Schwartz Recording  
Otari Corporation  
Lisa Roy's Studio A Consulting  
Sony Music Studios  
Tannoy/TGI North America  
Todd-AO Studios

\*Mick Guzauski's name was inadvertently omitted from the video screen of Bronze Sponsors. The TEC Awards apologize for the mistake.

If you are interested in purchasing a video of the 14th Annual TEC Awards, please send a check for \$29.95 to: TEC Awards, 1547 Palos Verdes Mall #294, Walnut Creek, CA 94596.

# 1998 TEC AWARDS WINNERS

## OUTSTANDING INSTITUTIONAL ACHIEVEMENT

**Acoustics/Facility Design Company**  
Walters-Storyk Design Group, Highland, NY

**Sound Reinforcement Company**  
Clair Brothers, Litzitz, PA

**Mastering Facility**  
Gateway Mastering, Portland, ME

**Audio Post-Production Facility**  
Skywalker Sound, San Rafael, CA

**Remote Recording Facility**  
Effanel Music, NYC

**Recording Studio**  
Ocean Way, Nashville



## OUTSTANDING CREATIVE ACHIEVEMENT

**Audio Post-Production Engineer**  
Gary Rydstrom, Gary Summers, Chris Boyes, Tom Johnson, Lora Hirschberg

**Remote/Broadcast Recording Engineer**  
David Hewitt

**Sound Reinforcement Engineer**  
Dave Kob

**Mastering Engineer**  
Bob Ludwig

**Record Producer**  
Don Was

**Recording/Mixing Engineer**  
Bob Clearmountain



*John Sanborn accepts the TEC Award for the Euphonix CS3000 in the Large Format Console category.*

## OUTSTANDING TECHNICAL ACHIEVEMENT

**Ancillary Equipment**  
Apogee AD-8000 8-Channel Analog to Digital Converter

**Amplifier Technology**  
Hafner P4000

**Mic Preamplifier Technology**  
Manley VoxBox

**Computer Software & Peripherals**  
JBL SMAART Pro

**Microphone Technology**  
Neumann TLM103

**Sound Reinforcement Loudspeaker Technology**  
JBL Professional Venue Series

**Studio Monitor Technology**  
Mackie HR824

**Musical Instrument Technology**  
Roland VDrums

**Signal Processing Technology (Hardware)**  
TC Electronic FireworX

**Signal Processing Technology (Software)**  
Lexicon LexiVerb

**Recording Devices/Storage Technology**  
Tascam DA-98

**Workstation Technology**  
Digidesign Pro Tools|24

**Sound Reinforcement Console Technology**  
Soundcraft Series FIVE

**Small Format Console Technology**  
Yamaha O2R V2

**Large Format Console Technology**  
Euphonix CS3000



*(L-R) Producer Narada Michael Walden, musician Ray Benson, Mix Foundation president Hillel Resner and producer/musician Alan Parsons.*

The World's First

# 24-Bit

## DAT Recorder

(No Hype Required)



DA-45HR

The 24-bit Master  
\$2,149\*



DA-60MKII

Half-head Time Code Master  
\$6,999\*



DA-30MKII

The Studio DAT Master  
\$1,399\*



DA-20MKII

Project Studio DAT Master  
\$969\*



DA-302

The Dual DAT Master  
\$1,869\*



DA-PI

Portable DAT Recorder  
\$2,059\*

For the facts on the first family of DAT  
and the entire line of TASCAM  
professional audio products visit:  
[www.tascam.com](http://www.tascam.com)

Call TASCAM FaxBack at 800•827•2268.



TASCAM America, Inc. 7733 Telegraph Rd.  
Northridge, CA 91340 (323) 774-0303  
TASCAM Canada Ltd. 5939 Wallace Street  
Mississauga, Ontario L4Z 1Z8 Canada (905) 890-8008  
TASCAM Mexico S.A. de C.V., Pineda Corona #18  
Carretera del Carmen, Copacaco, Mexico D.F. 04100 (52) 658-1943

\* Manufacturer's Suggested Retail Price (US)



### Now Available At Your TASCAM Dealer

With digital and analog I/O, word clock, and a menu driven environment, TASCAM's 24-bit DA-45HR DAT recorder is brilliantly designed to master from DAWs and other digital recording systems. Plus, its Standard mode provides complete backward compatibility with 16-bit DAT machines.

Make every mix a master work with the First Family of DAT. See the entire line of TASCAM

professional DAT recorders at your dealer now.

# TASCAM

Take advantage of our experience.

World Radio History

CIRCLE #019 ON PRODUCT INFO CARD

# 9000 WATTS



## PowerLight™ 9.0 PFC Features

- Power Factor Correction Technology (PFC)
- Ultra-high power N-channel MOSFET's
- Constant high damping, 2000 or greater (up to 1kHz), even during clipping
- Four-step Class H Current-Cell™ MOSFET output
- Uncompromised 20Hz-20kHz full bandwidth performance.
- Distortion- <0.03% THD, 4Ω, 20Hz-2kHz @3200 watts



- Massive current capacity for huge bass
- Variable speed fans

- Lowest AC current draw per output watt
- Computer Control Data Port
- Neutrik Speaker™ output connectors
- DC, sub-audio and thermal overload protection
- Patented Output Averaging™ short circuit protection
- Balanced inputs, Neutrik "Combo" (XLR & 1/4") and Phoenix-type detachable barrier strip
- Zero-inrush at startup
- Stereo/Bridging/parallel mode switch

# 3RU, 59 LBS.

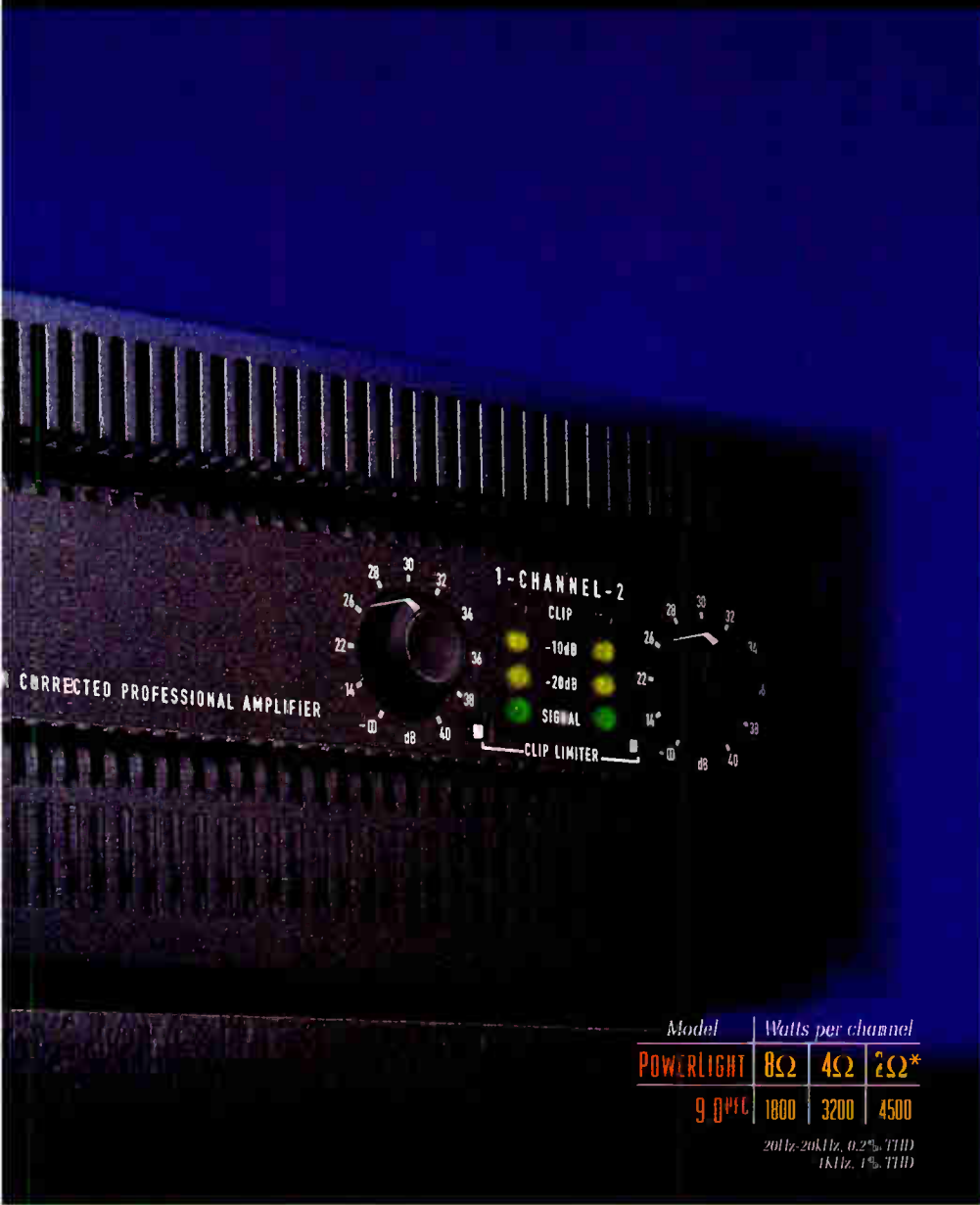

## INTRODUCING THE POWERLIGHT 9.0<sup>PFC</sup>

The new flagship of the PowerLight family, the PowerLight 9.0<sup>PFC</sup>, delivers the highest continuous output capacity of any audio amplifier. With an unequalled 4500 watts/ch at 2 ohms, even the most power hungry subs will never run out of gas again. And because it includes our exclusive Single-stage Power Factor Corrected (PFC) power supply combined with a four tiered DC supply, average AC current draw is 30-50% lower than conventional amplifiers.

The 9.0 delivers more than just raw power. State-of-the-art high-speed components and high-power MOSFETs ensure the lowest distortion and noise, while its high damping factor maximizes speaker control. And because it's a PowerLight, you'll have a compact 3RU chassis weighing only 59 lbs, so you can drop the name "B Breaker" from your amp rack.

So check out the most powerful amp on the planet. Better yet, listen to it. For the dealer nearest you call (800) 854-4079 or visit our website for more information.

[www.qscaudio.com](http://www.qscaudio.com)

Model	Watts per channel		
<b>POWERLIGHT</b>	<b>8Ω</b>	<b>4Ω</b>	<b>2Ω*</b>
<b>9.0<sup>PFC</sup></b>	<b>1800</b>	<b>3200</b>	<b>4500</b>

20Hz-20kHz, 0.2% THD  
1kHz, 1% THD

### Power Factor Correction: The Ultimate Power Supply.

The non-linear current draw of conventional amplifiers severely distorts the AC waveform, using less than 70% of the power. The smooth current draw of the PowerLight 9.0<sup>PFC</sup> uses 99% of the AC energy — the result is 9000 watts of undistorted music with an average current draw of less than 25 amps at 120VAC.

CIRCLE #020 ON PRODUCT INFO CARD

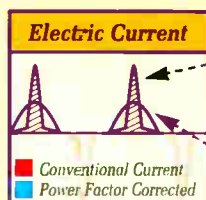

Sharp AC draw with distortion constricts usable current.

Smooth AC draw results in more usable current

World Radio History



HEAR THE POWER OF TECHNOLOGY.

# MASTERVISION

## ON THE COVER

When Hank Williams decided to expand and build an all-new MasterMix in Nashville, he was aware of all the uncertainties associated with being a studio owner in the late '90s. New technologies. New formats. New delivery systems. New business. New competition. So, he decided, when you have the chance to build from the ground up in the audio industry, it's no longer enough to stay current; you have to look ahead. And looking ahead for Williams translated to DVD authoring.

The new MasterMix includes sister company facility MasterVision (pictured on this month's cover), Nashville's highest-profile DVD-authoring environment to date. A joint venture between Williams, Mike Poston and Tracy Martinson, MasterVision shares the same Russ Berger-designed space, shares files over the same Sonic MediaNet network and shares clients with MasterMix. But the new facility brings new opportunities, and the markets seem to be there.

"Corporate is a huge market here in Nashville," Martinson says. "It's a short plane ride to Chicago and Atlanta, and we're centrally located to tap into a lot of that work. As DVD-ROM becomes more prevalent in laptops and office machines, there will be more interest. I think DVD-ROM is what people wanted CD-ROM to be.

"Then one of the more interesting markets, especially being here in Nashville, is the Christian-religious market," Martinson continues. "A lot of the religious organizations have archival footage of their speakers and their leaders, on both film and video, as well as audio-only. We get everything from S-VHS to 1/2-inch to 8mm film to Digital Betacam to D1—the whole gamut—and we clean it up, NoNoise for video, basically, and assemble it. To have the ability to put their message out and have picture being played, with access to eight different languages, becomes very interesting to them."

The project Martinson is most excited about, however, is a benefit for the Center for Missing Children, with a song written by veteran Nashville songwriter Peter McCann and performed by Kathy Mattea and Michael McDonald. The song was recorded and mixed at Seventeen Grand by Gary Paczosa and Jake Niceley, produced by George Massenburg. Video was shot, documenting the process, and the resulting DVD, due out on RCA in January, will feature a randomize function to pop up screens of the hundreds of missing children across the country. All the time and effort was donated. To Martinson, who has five of the top ten reviewed DVD-Video discs to her credit from her days at Sony, it was a perfect use of the medium.

As we went to press, the stereo mix had been com-

pleted, and Martinson was awaiting a 5.1 mix and video of the performers. MasterVision houses a production room with three Sonic Solutions stations, along with the DVD Theater (on the cover) for client presentations, quality control and critical listening. An 8-channel Sonic Solutions system sits to the left of the Panasonic DA7 digital console in the spare, comfortable room. Monitoring is via a custom PMC surround system, with IB1s left and right, a custom IB1 in the center and TB1s in the rear. Bryston 4B amps power the system, and all wiring is from Kimber Kable. The choice for high-resolution converters had been narrowed to Apogee or dB Technologies at press time; the facility can encode/decode in Dolby and can decode in DTS (though MasterVision is in negotiations with DTS to develop onsite encoding).

DVD-Video has garnered a lot of the glamour press, and with 2 million players already out there (yes, it's true, they won't play DVD-Audio discs), that makes sense. Still, there is a lot of technical misinformation out there, Martinson says, and much of her job in the early going has been educating clients about the possibilities for the format, whether Video, ROM or Audio.

"People ask me all the time how much a DVD costs to make," Martinson says. "I ask them what they want to do. You can't say that

it's ten songs and is going to take x amount of hours. It's so much more layered. You have to sit down with the client, storyboard it, work with the video people—the misnomer is that it's like mastering an album. But it's not. Mastering is a part of the process, not the end of it. For a full-on DVD-Video project, the client will be more like the director of a film working with the picture editor—day-to-day interaction.

"One thing about moving to Nashville that surprised me was that DTS has done an excellent job of getting the word out here," Martinson continues. "I was surprised about the debate between DTS and Dolby being as hot as it was. It's not something I saw in New York or L.A. My personal opinion is that it's not just an audio quality issue, but also a marketing issue. It's very different for a corporate client who will make a kiosk or give them to sales people vs. someone who is going to mass-produce a disc and send it out to Tower Records. To say which is better, DTS or Dolby, takes more looking into than just bit rate. I hope in the future it's possible to put both formats on the same DVD-Video disc. But with DVD-Audio, there's no reason to choose, since you can have multichannel, high-resolution audio. It's not up to me to decide on a specific format and hawk it; it's my job to provide the best options to my clients, for their individual projects." ■



*MasterVision principals, left to right, Hank Williams, Tracy Martinson and Mike Poston*

PHOTO: DONNIE BOTT





**Brendan Capucci/Steve Tasch:**  
The Toy Specialists, NYC.

"... we recommend the CDR800 without missing a beat ..."

**Forrest Lawson:** Frostbite Productions, Haskell, N.J.

"... marvellous - I don't know how I ever got along without it ..."

**Andy Hewitt:** 2<sup>nd</sup> Sense, Watford, UK.

"The CDR800 is superbly well-equipped with all digital formats ..."

**Dave Dusman:** Recording Studio Manager, Eastmar School of Music, University of Rochester.

"... the CDR800 works beautifully ..."

**Barbara Hirsch:** University of California - Santa Barbara.

"... the opportunity to do a digital transfer from DAT to CD without a computer is simply fantastic ..."

**Tom Stanley:** Town House Studios, London.

"... It's a beautifully simple machine to operate which makes it a pleasure to use ..."

**John Jones:** Producer of Céline Dion, U.S.A.

"... just brilliant ... the CDR800 is the best CD-R on the market ..."

# THE HHB CDR800. #1 IN CD RECORDING.

When we launched the world's first affordable pro quality CD recorder, we thought we might have a hit on our hands. But even we've been amazed at the popularity of the CDR800. Thousands of machines are now in daily use around the world in every conceivable application (and some we could never have conceived of!).

You're kind enough to tell us how you love the way it sounds, that superior build quality makes the CDR800 exceptionally reliable, and that pro- features like balanced analogue inputs, an AES/EBU digital in and 5 simple record modes with built-in sample rate conversion are essential for the ways you work. So we'd like to say thanks for making the HHB CDR800 #1 in CD recording.



HHB Communications USA - 626 Sanb: Monica Boulevard, Suite 110 - Santa Monica, CA 90401, USA - Tel: 310 319 1111 - Fax: 310 319 1311 - E-Mail: sales@hhbusa.com  
 HHB Communications Canada Ltd - 260 King Street East, Toronto, Ontario M5A 4L5, Canada - Tel: 416 867 9000 - Fax: 416 867 1050 - E-Mail: sales@hhbcanada.com  
 HHB Communications Ltd - 73-75 Scrubs Lane, London NW10 6QU, UK - Tel: 0181 952 5000 - Fax: 0181 952 5050 - E-Mail: sales@hhb.co.uk  
 Visit HHB on line at: <http://www.hhb.co.uk>



CIRCLE #021 ON PRODUCT INFO CARD  
 World Radio History

# RECORD DRUMS

BY RICK CLARK

ILLUSTRATION BY JEFF FOSTER

Ask anyone in music which instrumentalist gets the brunt of the jokes, and most would say, “the drummer, of course.” Most

drummers don't seem to mind, though, probably because they know that there is precious little popular music that would function properly without them.

There are plenty of recordings that rock or groove without any combination of vocals, guitars, keys or horns, but imagine the Rolling Stones without Charlie Watts, “A Night in Tunisia” without Art Blakey, Rush without Neil Peart or hip hop without drum loops. ■ Whether it is Stevie Wonder's playfully funky grooves, Tony Williams' wondrous, lyrical phrasing and sense of dynamics, Keith Moon's explosive roar or Stewart Copeland's agitated synthesis of rock, reggae and ska grooves, drums support and heighten the emotional essence of music with a rhythmic physicality and grounding. ■ For this *Mix* application feature, we enlisted four well-known producers and engineers to discuss everything from

# RIDING

TIPS FROM FOUR TOP PROS



## DRUMS

equal in level to how loud it is in the overheads and mess with the phase until you get it right. I usually use 57s on the toms, too.

"Sometimes, some drums don't give you that 100% happy feeling in the resonance department. Adding a mic underneath the tom tom, usually out of phase with the top mic, adds back that boom boom you are so used to hearing. I usually use 421s for that, and I generally don't EQ. I just knock it out of phase. Knocking it out of phase will do a little bit of a natural midrange dump because of its distance to that top mic. A lot of times, that mid-dump is proportional to the size of the drum. What I mean by that is, the bigger the drum, the farther those mics are apart and the lower that canceling frequency is, which is about right for the bigger drums. You want to go down with the frequency with the mid-dump.

"A lot of times, when you lean on an overhead picture like this, the ride cymbal—just by virtue of the fact that the drummer generally keeps the ride cymbal lower and closer to the drum kit than a crash cymbal—sometimes needs a little help. So although it is totally against everything I know, I'll put another mic on the ride cymbal to help bring it into the picture. The more mics, the more of a headache it becomes to keep it all phase-coherent.

"A lot of times, in rock music especially, it gets hard to keep that soundstage picture clear, and I understand that a lot of people nowadays—you kids out there—don't necessarily want it to be clear. Fine! But in case you are one of those who want to keep it a little cleaned up, usually the best way out of that is to put some of that super high 16 or 17kHz-type EQ on those overheads. It makes an artificially detailed drum picture, but it has a tendency to detail the drums in a place that is well above the smear of electric guitar

crunch stuff. The higher frequencies are not really in those guitar sounds. So those higher frequencies are a good place to go to pull the drum detail out of the guitar hash.

"My favorite reverb is the room the drums are sitting in. That is actually air molecules moving around in sympathy with the drum kit. When I do set up room mics, I like to set up *room* mics, meaning I don't mike the drum kit from the room. I mike the room. I usually have a tendency to use large diaphragm condenser mics looking away from the drum kit toward parts of the room that sound good. I'm getting what's coming off the walls and floor and ceiling. I think the reason I like that is because it enables me to maintain a detailed drum picture and yet add a room sound to it.

"If you put your room mic up looking at the drum kit, you will often encounter some problems with maintaining the clarity of the drum's sonic picture. Let's just set up a typical scenario: The stick hits the ride cymbal.

**I USUALLY LIKE TO USE  
CLICK TRACKS, WHICH ARE NOT  
METRONOMES, BUT ACTUALLY TONAL  
SEQUENCES THAT FOLLOW  
THE CHORD CHANGES.**

**—PETER COLLINS**

The sound gets to the overhead mics in, say, 2 milliseconds. Then that sound arrives to the room mic in 47 milliseconds. Now you have smeared the definition of the drum picture. And that's happening with all of the cymbals and all of the drums and everything. But if you're just getting the reflections off the wooden walls of the tracking space, the wood doesn't reflect those higher frequencies, and therefore, they don't have a tendency to smear the detail of the drums.

"There are some pretty bright-sounding rooms out there, and Ardent's C studio is one of the brightest. But even our C studio doesn't ever get up to the point of smearing that detail. If I do end up mixing stuff where people had mics looking at the drum kit, I have a tendency to dump everything from about 3 or 4 kHz up. I then let the overheads serve as the providers of the

detail and not the room mics. That's often helpful."

**PETER COLLINS**

Peter Collins has produced an amazingly wide range of critically and commercially successful projects, ranging from Rush and Queensryche to Jewel, Indigo Girls and Brian Setzer. Collins, based in Nashville, more recently produced Bare Jr. and a duet with Elton John and LeAnn Rimes.

"Generally speaking, these days, I like for the listener to be able to 'see' the kit in its entirety, rather than split up over the stereo system, with each component cleanly separated. I'd rather be able to 'see' the drummer sitting in the room with the kit, with the kit sounding like one instrument, rather than a whole bunch of percussive elements. So when I'm recording, I want to have that vision at the end of the day. I think that's found on most of my records, over the last few years; particularly on the Brian Setzer record, which has a very organic sound to it that isn't hyped up.

"I'm a huge fan of pre-production, so that the drummer is totally prepared and we can nail it very quickly in studio. I try to catch the early performances. They don't get better. They usually get worse. It's important to catch the drummer while they're fresh and not 'thinking.'

Then you just get a natural flow of performance.

"I usually like to use click tracks, which are not metronomes, but actually tonal sequences that follow the chord changes. It's also helpful for everybody concerned, in terms of reminding them what the pre-production was. It gives everyone some room to breathe around it, because it isn't as rigid as a metronomic-type click.

"For me, a personal landmark record was *Rites of Passage* by the Indigo Girls, which we recorded with Jerry Marrota over at Woodstock. We used Bob Clearmountain's mix room, which was normally not used for recording. We had Jerry in a booth in this small room, and the drum sound was extremely present. It is the complete antithesis of the stadium rock sound.

"On the last two Rush records, *Counterparts* and *Test For Echo*, I went for a much more organic, less-hyped sound. My philosophy with Neil's [Pearl, Rush's drummer] drums has



Technology  
That Gives You  
the Competitive  
Edge

# So Powerful... They're Taking Over TWO Platforms!

**Pro Tools | 24 and Pro Tools | 24 MIX Systems**  
Available on Mac OS and Windows NT\*

## Introducing

### Pro Tools | 24 MIX:

*Incredible Mixing and Processing Power*

- 3 times the DSP power of Pro Tools | 24
- 64 tracks — all with a single card
- Amazing 24-bit fidelity, from input to output; recording, editing, automated mixing, and mastering; world-class Plug-Ins from the best names in audio; and great-sounding new DigiRack™ Plug-Ins included for FREE
- Seamless session and audio interchange between Mac OS and Windows NT

\*Windows NT availability expected late 1998

### Pro Tools | 24 MIXplus:

*Even More Mixing Power — 7 Times the DSP Power of Pro Tools | 24!*

Check out this sample Pro Tools | 24 MIXplus setup:

- 32 tracks (up to 64 possible)
- 4-band EQ and dynamics on every disk track
- 2 TC reverbs
- 10 delay-based effects
- 5 sends (1 stereo, 4 mono) on all disk tracks
- 48x32x2 mixer

All running simultaneously and in real-time!



For more information, or to schedule a free demo, call 1.800.333.2137, code 414.  
To learn more about Pro Tools software capabilities, ask for a free video. Already own Pro Tools? Call about our special Pro Tools | 24 MIX exchange offers!

[www.digidesign.com](http://www.digidesign.com)

[www.avid.com](http://www.avid.com)

**digidesign®**

# RECORDING

# DRUMS

changed over the years. In 1985, when I first worked with him, they wanted an ultra-high-tech sound, which was very fashionable in those days—the days of Trevor Horn, Yes and Frankie Goes to Hollywood and all those British bands.

Rush specifically wanted to be in that arena. It was not a particularly organic sound.

In those days, when we did *Power Windows* and *Hold Your Fire*, the engineer James 'Jimbo' Barton was instrumental in achieving a unique sound, utilizing high compression on the drums and a very clever use of reverbs that were very much larger than life.

At the time, Neil was triggering samples of African drums and all sorts of other odd things, plus he had a small kit behind him and a big kit in front there in the studio together, with all his toms and percussion stuff. He would spin around in the middle of a song and play the smaller kit and then come

back to the big kit.

"A very good example of understated drums are the drums on the single remake I did of Jewel's 'Foolish Games,' which was a Top 10 hit. The drums created a really cool momentum to the track, without you being very aware that they were there. Omar Hakim played, and it was a really beautiful, subtle performance."

## NILE RODGERS

During the late '70s, Chic were unquestionably the most elegant band with the deepest R&B grooves in the world of disco. A key component in Chic's artistic vision was producer/guitarist Nile Rodgers. Rodgers (newly in-stated president of Music Producers Guild of the Americas) has since produced some of the biggest acts in popular music. Rodgers has created drum tracks featuring signature musical hooks as memorable as any great lyrical or melodic instrument line in pop. Over the last year, there have been three Number One hip hop hits (Will Smith, Notorious B.I.G., Puff Daddy and Mase) using grooves from Rodgers' productions. Among Rodgers' many credits are Madonna, Peter

**IN R&B MUSIC, PUTTING HOOKS IN THE RHYTHM SECTION USED TO BE A VERY POWERFUL TRICK. AFTER ALL, WHEN A PERSON IS SINGING YOUR SONG, THEY SING LYRICS, AND THEN THEY SING SOME PART OF THE GROOVE. —NILE RODGERS**

## Reliable Remote Mixing

• Large calibrated VU meters for easy viewing in any light

• Slate Mic with a 20Hz tone

• High-volume Headphone Output for monitoring in loud environments

• 400 Hz Setup Tone

• Stereo Panning on each channel

• Plenty of Output Level

• 6-Position Headphone / Monitor select

• Balanced XLR Outputs

• Stereo Headphone Output

• External Monitor Input

• Auxiliary Input

• Switchable +4/-25 dB Output Level

• 20 dB Pad switch on each channel

• Low-Cut switch on each channel

• Balanced XLR Inputs with Trim controls

Introducing the new Rolls MX442 Field Mixer. The MX442 includes a built-in limiter, operates in mono or stereo, and it runs on two 9-volt batteries with an expected life of between 8 - 20 hours of operation depending on usage. Each XLR input has switchable +48 volt phantom power available, and the unit is housed in lightweight, sturdy aluminum. Price: \$1,100.



ROLLS CORPORATION  
5143 South Main Street (801) 263-9053 • FAX (801) 263-9068  
Salt Lake City, UT 84107 email: rollsrfx@rolls.com • www.rolls.com

CIRCLE #024 ON PRODUCT INFO CARD

# DON'T TRY THIS WITH YOUR ANALOG MIXER.



**Saturday 9:30-9:45am**

**Commercial mix** – You've cut a spot using your new 01V Digital Mixer. The agency loves it. Run off a final mix and you're done. Store your settings in 01V Memory just in case.



**Saturday 9:45-11:55am**

**Demo Session** – Vocal overdubs. Plug a mic into one of 01V's twelve phantom powered mic inputs, press RECALL and return instantly to the exact eq, compressor and headphone settings from your last session.



**Saturday 12:05-12:10pm**

**Commercial mix, take II** – Agency calls wants music up under dialogue. With 01V memory of all settings, you recall the mix, make the changes and still get to your wedding gig on time.



**Saturday 12:30-3:30pm**

**Live Gig** – With 6 outputs, compressors, parametric eq and effects, 01V has the tools you need to mix live sound. With MEMORY, you instantly recall your settings from the last gig.



**Saturday 3:50-4:00pm**

**Commercial mix, take III** – Agency calls – wants hotter dialogue. Easy. Call up 01V compressor setting to keep the music under control. Done.



**Saturday-Sunday 4:15pm-3:00am**

**Cutting tracks** – Client: You. Mixer: 01V Digital.

What you can accomplish in one day with the 01V is completely impossible with an analog mixer. The 01V gives you two top-drawer digital effects processors, 22 limiter/compressor/gates, four band parametric eq, 32-bit digital performance and optional digital I/O for popular multitrack recorders\*. In addition, all 01V settings can be stored in memory so you can recall your entire mix at the touch of a button. Connect your MIDI sequencer and capture real-time moves of 01V's motorized faders and more. You get all of this for just \$1,999.00 MSRP\*. Don't muddle along with your analog mixer anymore. Take charge of your mixes, and your life, with the Yamaha 01V today. Call (800) 937-7171 ext. 682 for information.

**DIGITAL POWER TO THE PEOPLE**



© Yamaha Corporation of America.

P.O. Box 6600, Buena Park, CA 90622-6600. [www.yamaha.com](http://www.yamaha.com). [www.yamaha.co.jp/product/proaudio/](http://www.yamaha.co.jp/product/proaudio/)  
Yamaha is a registered trademark of Yamaha Corporation.

## DRUMS

Gabriel, Duran Duran, Power Station, Vaughan Brothers, Paul Simon, Al Jarreau, Sister Sledge and David Bowie.

"I look at the drums as the foundation of the record, the foundation of the groove, the foundation of the song and the foundation of the mix. Everything is based around the drums. I think of the drummer as an instrumentalist and a composer, so we are composing a drum part. We're not just playing the record; we are playing a composition with a beginning, middle and end.

"Most of the time, we all play together when we are cutting a rhythm track. Often, I'll say to the drummer, 'You're the only person who counts right now. We are all subordinate to you, because we can all change our parts.'

"When I'm recording drums, I'm expecting some unique, wonderful thing to happen that is going to inspire me to say, 'Wait a minute! Let's make that a hook!' That was certainly the case with Madonna's song 'Like A Virgin,' which Tony Thompson played drums on. I'm not sure that I gave Tony the actual pattern, but I sure know that when I heard it, I went, 'Hey, I want you to do that every time at this point.' It just became a hook.

"In R&B music, putting hooks in the rhythm section used to be a very powerful trick. After all, when a person is singing your song, they never sing a lyric all the way through. They sing lyrics, and then they sing some part of the groove.

"Another song that jumps out at me is 'Modern Love,' by David Bowie. When we sat down and rehearsed the song, I said, 'Okay, Omar, this is what your pattern is going to be.' He played it, and we started grooving, and while we were playing the song, I noticed that he was changing the pattern. After we finished the performance, I liked what he did so much that we then went back and changed our parts to sympathize with his parts.

"A drummer's ability to understand the beat and how to shift the feeling

and vibe, to be on top of the beat or behind the beat, is essential for me to feeling comfortable with a musician. If a person doesn't understand the difference in interpreting a beat and interpreting swing feel or isn't able to rock and groove behind and on top of beats and all of that stuff, then that isn't a person I want to play with. I'd feel uncomfortable with them.

"When I think about those days with Chic, we played the songs like 10, 11 or 12 minutes at a pop with no click track. We just grooved like that. 'We Are Family' has to be like ten minutes long. When you start the record at the beginning, all the way toward the end, you don't feel like there is some big groove shift.

"I grew up in a vibe that was like, 'The only time you speed up is if the conductor makes you speed up.' But R&B bands were all about pocket and laying and sticking right there and being able to set your watch to the tempo. We were like metronomes. We would just practice grooving. You had to be able to play the same thing, over and over and over again, and be able

game and start every hand with two aces, you would feel pretty good. So every time I walk into a recording studio, I'm trying to get in there with as many aces as possible—a great engineer, great equipment, great musicians and hopefully great songs. Then I try to make it as good as it can be."

**ELLIOT SCHEINER**

Elliot Scheiner has worked with many of the most successful and influential acts in pop and rock. Many of his productions feature a drum sound that is immediate and organic, while not overwhelming of the emotional thrust of the material. On radio and in critical listening environments, Scheiner's work sounds great, and the string of Platinum artists he's worked with (including The Eagles, Fleetwood Mac, Jimmy Buffett, Aerosmith, John Fogerty, Billy Joel and Steely Dan) attest to that fact. Most recently, Scheiner's projects have included Stevie Nicks, Toto and a new Steely Dan album.

"I go in with the attitude that I don't want the players to do what I want them to do. I want them to do what

**I NEVER PUT MICS UNDERNEATH. I DON'T SEE THE BENEFIT. IT'S MORE PHASE SHIFT THAT I HAVE TO WORRY ABOUT, AND IT ISN'T ADDING ANYTHING. I CAN USUALLY GET WHAT I WANT OUT OF THE TOM TOMS FROM RIGHT ABOVE.**

**—ELLIOT SCHEINER**

to keep it there for an hour if you had to. Nowadays, I use click track all the time, because all the drummers I know are completely comfortable with them. As a matter of fact, I only started using click tracks when drummers I knew started requesting them.

"Traditionally, it is older players who have been playing in blues bands or more freestyle bands who have problems with click tracks. I've been a good enough coach with these drummers to make them very comfortable with clicks. That's because I program something that feels musical to them. It feels like part of the arrangement, and they are not just playing to a metronome. Instead, they're playing to something that is swinging.

"If you could go into every poker

they do. Obviously, somebody saw something in them. In the case of a band, I feel that it is my obligation to capture what somebody saw. The whole trick with a lot of this is in placing the mics right.

"I've always felt that the drums and bass were the heart of the record. On most of the records I've mixed, the drums are fairly loud. With the exception of a few rock 'n' roll records, where they are sitting back a little more, most of the records I've done are records where I can afford to keep the drums way up there, like The Eagles and Fleetwood Mac. John Fogerty loves loud drums. He had the drums louder than I have ever mixed them. I wouldn't have thought about mixing them that loud, but they definitely



# The New PCM 81 Digital Effects Processor



**"You'll run out  
of ideas before you  
run out of effects."**



**NEW FEATURES • Pitch Shift algorithms on-board • 20 seconds of delay • AES Digital I/O**



**T**he new PCM 81 Digital Effects Processor has everything that made the PCM 80 the choice of professionals – and more. More effects, more algorithms, longer delay and full AES/EBU I/O. Each effect has an uncompromised stereo reverb with several voices of additional effects. A full complement of *Pitch Shifters* provides everything from pitch correction to unique special effects. 300 meticulously-crafted presets give you instant access to pitch, reverb, ambience, sophisticated modulators and dynamic spatialization effects for 2-channel or surround sound applications.

With its huge assortment of superb effects, the PCM 81 is the

perfect tool for a sound designer like Scott Martin Gershin of *Soundelux Media Labs*. Scott, who used the PCM 81 to process his voice as the voice of *Flubber*, says, "This is the best pitch shifter I've used. Our job is to create emotional illusions in audio and the PCM 81 is a powerful tool to get us there. I feel I have only scratched the surface of what can be created on the PCM 81 and encourage everyone to explore the depths of this processor."

Explore the depths with Scott's customized presets – Send us proof of purchase and your PCM 81 serial number by July 30, 1998, and we'll send you the Scott Martin Gershin Preset Card – FREE.

Heard In All The Right Places

**Lexicon**

A Harman International Company  
world radio history

3 Oak Park, Bedford, MA 01730-1441  
Tel: 781 • 280-0300 Fax: 781 • 280-0490  
Email: info@lexicon.com Web: www.lexicon.com

Scott Martin Gershin's film credits include:  
*JFK, True Lies, Braveheart, Flubber*  
and *Mouse Hunt*

CIRCLE #028 ON PRODUCT INFO CARD

# RECORDING DRUMS

worked that way."

"Nine out of ten times, I find the same mics will work for most any drummer's kit. On the kick, I normally will use a [AKG] 112. Occasionally, I'll find a bass drum that won't work with that mic. In that case, I'll go to an RE-20. It seems to be working in those situations where a drum is tuned a little bit differently—usually a little lower—and where I'm not getting enough attack. The RE-20 gets me a little bit more attack on the drum.

"For snare drum, I use one mic and one mic only. It's on top, and I seldom use a bottom mic, unless somebody insists on it. I have always used an SM57. It gives me the natural sound of the drum. They take a beating and they

don't overload.

"For the rack toms, I used to use 421s. The 421s worked great on just about anyone's toms. I did some live recordings for The Eagles, and 421s worked out fine. But when I worked for Fleetwood Mac, their front of house guy was using SM98s on Mick's toms. The live mixers use them, because you don't see them. They are teeny, and the front of house guy gets everything he needs out of them for live stuff, but I wasn't getting everything I needed out of them for recording.

"I ended up putting ATM-25s in there, and those worked out great. I close-miked each tom, and I didn't have to use any EQ. The 98s were already in place, and the front of house guy wasn't going to lose his 98s. So I had to position my mics pretty close to the 98s and pretty close to the heads. Those mics take a beating as well. I was surprised. I've been using the ATMs in the studio as well.

"I never put mics underneath. I don't see the benefit. It's more phase shift that I have to worry about, and it isn't adding anything. I can usually get what I want out of the tom toms from right above.

"For overheads, I've always used C-12s. I keep them up fairly high. I try to get more than just the cymbals. I try to get as much good leakage as I can from the rest of the kit. I usually place them right above the cymbals, anywhere from four to six feet, depending on how many cymbals there are. I will also angle them a bit.

"For hi-hat, I'll mostly use a KM81, positioned away from the drummer on the back side of the hat. If you're looking at the drummer from the side, and the top of the hat that is closest to the drummer is like 12 o'clock, then I will place the mic at about 4 o'clock, not too close to where his stick hits.

"I've been using RE-20s as room mics, and I bring them down to chair level for somebody who is sitting down. Sometimes I will face the drums, and sometimes I'll face them away from the drums. Either way, I end up capturing what I want, with very little EQ. I really like big, live rooms to put drums in. I can always put baffles around the drummer, but I like to start with a very live room and then work down." ■

*Rick Clark is a writer, songwriter and producer based in Nashville.*

## B Burlington A/V Recording Media, Inc.

106 Mott Street • Oceanside, New York 11572



maxell

- Shipped From Stock
- Priced Right
- Immediate Delivery

USA & Canada  
1-800-331-3191  
NYC Area:  
516-678-4414  
Fax: 516-678-8959



Visit our Website: <http://www.burlington-av.com> • E-mail: [sales@burlington-av.com](mailto:sales@burlington-av.com)

Call or Fax for FREE CATALOG!

CIRCLE #027 ON PRODUCT INFO CARD

Precision Digital Performance

# SADiE 24-96

Digital Audio Workstation

**“Sonic neutrality.....  
that's why I've chosen SADiE  
as my 24 bit 88.2kHz and  
96kHz digital audio editor”**

*Jenny Purcell*

president, Georgetown Masters

Studio Audio Digital Equipment Inc.  
1808 West End Avenue  
Suite 1119  
Nashville TN 37203  
USA  
phone: 615 327 1140  
fax: 615 327 1899  
www.sadieus.com



**Call: 615 327 1140**

World Radio History

RIBBLE 4024 UN BRONDT IJZER 6430



Rick Essig

PHOTO: FRANKFORD WAYNE

# Mastering Engineers

## On Working With New Technologies

It's been 15 years now since the Compact Disc arrived on the U.S. scene and began its slow but steady climb to the top, stimulating in the process a then-nascent market for digital recording technology. The impact on both the recording industry and the pre-recorded music market has been profound. Mastering engineers, in their role as liaison between the worlds of recording and manufacturing, have been at the center of these technological upheavals, dealing with changes in recording formats on the one hand and in consumer formats on the other.

Today, the music industry finds itself in a position similar in many ways to that of the period leading up to the CD's emergence. Sales of the flagship product (then the LP, now the CD) have leveled off after years of strong growth (then the disco boom, now the CD boom). On the horizon is new, higher-fidelity technology for audio delivery (then CD, now DVI-Audio or Super Audio CD) that would require major investments in new methodologies (then digital, now surround and higher resolution). But consumers are largely oblivious, and the industry itself is not uniformly convinced of the value or wisdom of the new formats.

BY PHILIP DE LANGIE



Robert Vosgien



Hank Williams

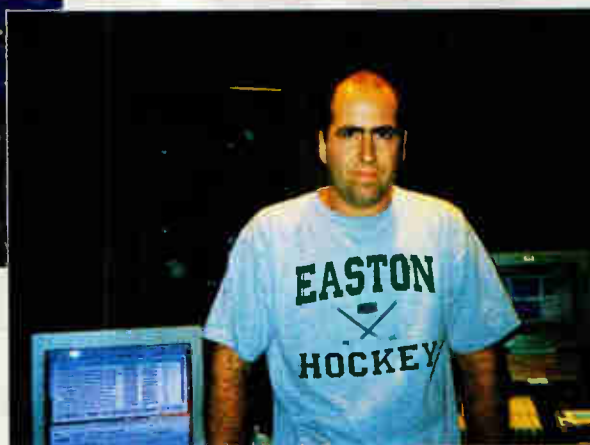

Chris Gehringer

With this in mind, it seems like a good time to pick the brains of a few mastering engineers on the impact of all these technological changes, taking stock of the current situation and looking where trends might lead in the future. For this forum, I posed a few such questions to those laboring on the front lines of mastering, including Hank Williams of Nashville's MasterMix (Alan Jackson, Brooks & Dunn, Steve Earle); Robert Vosgien (John Hiatt, Lee Ritournour, Fourplay, Charlie Musselwhite), newly returned to Capitol Mastering in Hollywood after a decade-long stint at CMS Mastering; Chris Gehringer of New York City's Hit Factory (Dr. Hill, Method Man, Divine); and Rick Essig of Frankford/Wayne Mastering Labs (Rolling Stones, Elton John, Tori Amos, Sarah McLachlan), also in New York.

*What are the most important changes you've seen over the last several years in the way material comes into your facility for mastering? Have new technologies affected the extent to which mastering involves not only sound enhancement and making production masters, but also editing and master preparation?*

**Rick Essig:** New technology has definitely affected the state of the art of mastering in virtually all aspects of the craft, from digital audio workstations to computer-controlled cutting lathes. The DAW is perhaps the biggest asset in terms of allowing much more work to

be done in a single day than any other new tool to come down the pike in quite a few years. We're equipped with three SADiE workstations here at Frankford/Wayne, and they have increased productivity 110%. The DAW has also allowed a more creative environment for me as the engineer because of the unlimited editing capabilities of SADiE. I find myself doing things to songs that would have been impossible in the analog 2-track domain, or even the early digital systems such as the Sony DAE-3000, which was the de facto editor until a few years ago.

As far as master preparation, on the older systems everything had to be sequenced in realtime. Sequencing can now be done after initial recording much faster and more efficiently with SADiE. That goes double for jobs that require curse removal and song spacing. Sound enhancement is still pretty old-school with us; 30 years worth of vintage and custom analog gear just sounds better than most of the digital stuff out there now.

Another big change I've seen has been with the advent of digital tape products. Most masters that come in today are either on DAT, CD-R or PCM-1630 U-Matic tape. We still get the occasional half-inch or quarter-inch analog tape, but it's the exception rather than the rule. For the client who is on a budget, digital tape is far less prohibitive from a cost standpoint than analog. Storage is greatly increased on digital vs. analog, as well. But you still can't beat the sound of a

# Mastering Engineers

## ABSOLUTE AUDIO MASTERING STUDIOS

Noreaga  
Aerosmith Ace Frehley  
Republica Robyn  
Lisa Stansfield  
Millie Jackson Barron  
Natalie Imbruglia Skank  
Aretha Franklin Francis Dunneery  
Dream Theater  
Eddie Palmieri  
Nine Days Olive  
Deepak Chopra  
The Black Crowes  
La Bouche Rusted Root  
Jill Sobule Cold Chisel  
N-Sync Naughty By Nature  
INXS KRS-One  
Daniela Mercury  
Celly Cel Skid Row  
The Macarena Ryo Kawasaki  
Mino Cinelu & Kenny  
Toninho Horta Deborah Cox  
James Blood Ulmer  
Toni Braxton Jerry Seinfeld  
Mobb Deep Big Punisher  
Studio 54 D Generation  
Ace of Base Kent  
Merrill Bainbridge

### MASTERING ENGINEERS

LEON ZERVOS

TOM BRICK

JIM BRICK

BRAD JOHNSON



### ABSOLUTE AUDIO, INC

56 WEST 45TH ST, 3RD FLOOR  
NEW YORK, NEW YORK 10036  
TEL • 212 • 730 • 2044  
FAX • 212 • 730 • 2204  
absaudio@aol.com  
CONTACT MELISSA OR JIM

well-recorded half-inch analog tape, provided both record and playback machines are properly calibrated.

Chris Gehringer: The magneto-optical machines are very easy to use. The transport is instant, and there's no degeneration of the material. It might be the wave of the future, and I really enjoy using it. Another plus is that with the MO you can choose your bit preference—16, 24, etc. Also, DATs and half-inch can wear down over the years. But I like half-inch because it generally has a fuller and richer sound than DATs. Digital does what digital does—it doesn't change the sound.

Hard disk recording—I use Sonic Solutions—has limitless abilities on editing, multichannel recording in mastering and assembly of albums. It has given me the ability to EQ, edit and assemble while focusing on each song at one time. This allows me to focus on each step more clearly than when mastering used to be a live procedure. It allows me more of an individual focus. People used to bring projects in all together on a 14-inch reel; now they can bring an album in piecemeal and we can put it together. You can demo as many nondestructive edits as you like with total recall.

Robert Vosgien: Almost all the major-label projects—the bigger-budget stuff that I see—is coming in on half-inch tape with no noise reduction, which is my favorite format. But a lot of projects come in on DAT now, which is a big change from the days of mostly quarter-inch. Also, with some of the affordable disk-based editing systems available, some of the smaller independents are dumping things out on CD-Rs and bringing those in as masters.

I actually find that with some of the lower-priced editing systems, going in and out can degrade the sound, so the damage can be done before it even gets on a CD-R master. Many times when mastering I need to check the client's edited version against their pre-edited version, and lots of the time there is a quite a difference: The original has a clear, open sound, and the edited has a veil over it. Sometimes people who try to save money by doing the editing before they come into mastering end up spending more, because after we hear the difference, we end up going back to the original and re-editing on our own

system. It's tough to pin down the cause, but the bottom line is that clients have to be really aware of the systems they are doing that kind of editing on. But overall, for the people who have access to a decent system for their editing, we spend less time putting things together in mastering now than we used to.

Hank Williams: Fortunately, we are seeing more analog sources after so many years of DATs. We also have some clients that are using high-bit-rate MOs. I see a tendency for clients to want us to use our editing systems as multitracks, adding elements of vocals or lead instruments to change the mix they brought in. The boundaries between post work, mastering and other entertainment services are slowly going away.

*What have been the most important changes over the past few years in the tools you use in the mastering environment? How do you expect to see those tools evolve in the future?*

Essig: Again, it has to be my DAW that stands out in my mind as the single biggest change from the days of writing detailed EQ and level-change cards that had to be reproduced exactly for every different master that you made, be it a quarter-inch Dolby B cassette master or master lacquers. Now I can dump into SADiE and generate any sequence to any format with no hassle. So I see the workstation as the tool of the future. Once the design of digital sound processes gets up to speed in terms of sound quality, the sky's the limit.

Gehringer: Hard disk editing, automated consoles, EQs and compressors. When mastering was a live procedure—such as with vinyl—you couldn't do as many things or make as many changes as you can now.

As for the future, that's very hard to say. Did you ever think, years ago, that computers would be used for music? Computers are going to bring tapeless transfers to the forefront of the music industry. The day will come when I no longer have to actually send a tape to the plant; I'll be able to e-mail it. Someday, sessions might be done via computer links to studios or homes live so producers, artists and engineers can listen in an environment that they feel comfortable in, though I don't know if that will necessarily be a good thing.

Vosgien: I'd have to say that the biggest change has been from tape-based editing to the hard-disk based editing systems. I do all my processing either before or after A-to-D conversion, and

When the future of Digital Audio is needed now

24<sup>BIT</sup>  
96<sup>kS/s</sup>

24<sup>BIT</sup>  
192<sup>kS/s</sup>

DSD

Direct Stream Digital

The *dCS* 950, 952, 954 - digital to analog converters (DACs) and the *dCS* 900D, 902 and 904 - analogue to digital converters (ADCs) offer full 24 bit capability in all the standard sample rates from 32 KS/s to 192 KS/s. Sony DSD® compatibility is also provided with the *dCS* 954 (DAC) and the *dCS* 904 (ADC). A Comprehensive set of standard inputs, outputs, and user controlled functionality enable these units to be used in a wide range of digital audio applications. Applications include studio recording, mastering and archiving.

[www.independentaudio.com](http://www.independentaudio.com)

INDEPENDENT

AUDIO

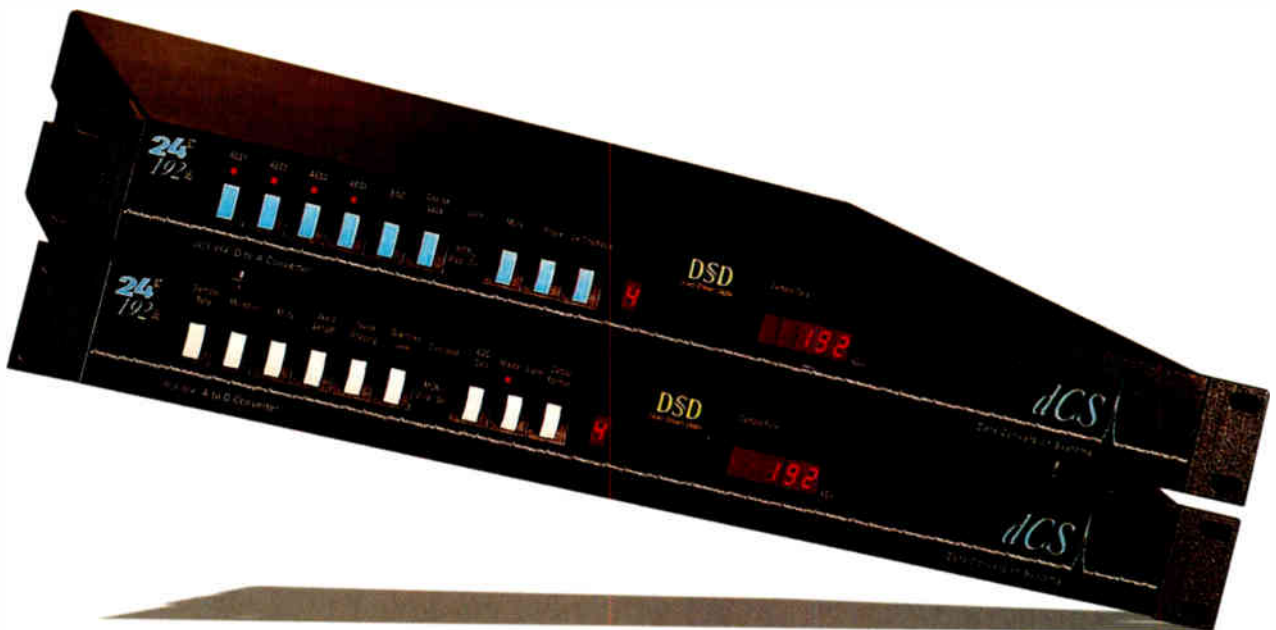

Data Conversion Systems

*dCS*

mail it @ [www.independentaudio.com](http://www.independentaudio.com) or 43 Deerfield Rd. Portland, ME 04101-1805 (207)773-2424 Fax (207) 773-2422

CIRCLE #030 ON PRODUCT INFO CARD

# Mastering Engineers

then use a Sonic Solutions system just for editing. The flexibility you get with Sonic is light years ahead of any tape-based system, and I expect that in the future Sonic and the other systems will all be quicker and easier to use, with less crashing and other weird stuff going on. But I am also still using the Sony 3000, which is based on the PCM-1630 format. As far as the masters that go to the plant, I am more in favor of going right from the 1630 than sending a PMCD [Pre Master CD] or a CD-R.

For the enhancement tools themselves, I love a lot of the tube stuff that's out there now from companies like Tube-Tech and Manley. It's kind of like "new old stuff." I always loved the sound of the original tube gear, and I think the new stuff is quieter and more reliable. The tube gear helps a lot of the DAT and other digital material. At the same time, the Daniel Weiss digital gear is just fantastic.

Williams: Our major changes have been designing our own mastering preamps

to enable us to monitor digital and analog signals both pre- and post-EQ with a Class A signal path. We have also purchased 24/96 modules from Daniel Weiss. Oh, and we've just moved into a brand new facility. That's our biggest tool change!

*You've seen the introduction (with varying degrees of success) of a number of different audio delivery formats (consumer) over the course of your career. What's your take on how the leading mastering facilities have adapted to these new technologies without being thrown off by all the changes?*

Essig: We've always had a wait-and-see approach to emerging technology. If it catches on, then we get the necessary gear to provide masters with. On the whole, most of the consumer product is generated at the production plant—they still pretty much take standard digital formats from us.

Gehring: DCC and MiniDisc never took off. Although we used the same technology, the record companies saturated the plants and consumers with too many formats in too little time. The 1630 is still alive and kicking. Most of the main changes are absorbed by the plants and not the mastering facility.

Digital was probably the greatest change in my career, and just like anything else, you learn to use it as best and as fast as you can to keep up.

Vosgien: From a business standpoint, I don't think it's good to run out and jump into something real quick. It's really risky to get involved in things that won't be out for a couple of years. When I was at CMS, we ran a real lean and mean operation, without a lot of extra capital to make those kinds of jumps. There are certainly bigger budgets over here at Capitol, but I would rather sit back a little bit and see how things develop before jumping in and making the investment.

Williams: Everyone has their own mix of formats they deal with. If you are taking care of your clientele, you won't get "thrown off." With DVD being used in more than the music end of the entertainment industry, I think there is a far greater possibility of success compared to some of the past consumer formats.

*How important do you think surround formats will be in the near-term to the daily work lives of mastering engineers? What changes have you or will you be making to accommodate mas-*

—CONTINUED ON PAGE 209

## ADVERTISEMENT

# HOLLYWOOD'S BEST KEPT SECRET IS OUT!

## GKS ENTERTAINMENT MASTERING STUDIOS - History In The "Re-Making"

HOLLYWOOD, CA—The fine art of tearing down the old to make room for the new has left our architectural landscape with strip malls for everyone. Why spend more money preserving historical landmarks when you can start from scratch? GKS Entertainment's Senior VP of Mastering & Creative Services, Lou Hemsey, can tell you why.

Hemsey, along with his team of creative gurus, has restored and renovated the historical "Sound Labs" mixing room and recording studios in Hollywood. Originally designed by the legendary Armin Steiner, the studios were used by Columbia Records to mix and record top artists in the 70's. They have converted the mixing room into a fully equipped, state-of-the-art HDCD Sonic mastering suite.

Steiner, who was enthusiastic about the remodel, said, "Every famous 70's artist that you could think of mixed in that room. It is great to see it live on. The room was one of the first 'Quad' studios in the country, premiering the Neve automated console, Sony DAE 1000 editing bay, and was all built transformerless."

"One of the things I loved about the room was its size," states Hemsey. "I am not a fan of huge, pristine monitors positioned three feet

away from the creative team in a room that has little cubic volume. Steiner's 'Quad' design (a forerunner to today's 5.1 surround and the new DVD Multi-Channel Audio format) gave us space; this room 'breathes correctly'. With

**Steve 'Coco' Brandon**, we redesigned the main monitor soffits, changed their center azimuth and resealed the back casings, leaving the fronts exposed with part of the speakers protruding over the front of the soffit." Hemsey chose the Genelec 1038A, tri-amped, self powered

monitors with a 15 inch woofer rather than go with two 12's on a side with a sub: "For me, much better reality when mastering, especially for records. Additionally, with the speakers in the soffits and an appropriate distance between the engineer and the speaker...

everything we hear reflects the real world a little better. subsequently our CD masters, both for records and film, translate beautifully outside the studio."

Hemsey chose the Sonic Solutions USP High Density Workstation, Pacific Microsonics HDCD AD/DA Converter (24 bit @ 96kHz and 88.2kHz), Massenburg 9500 Mastering EQ and

Cranesong's STC-8 Stereo Limiter/Compressor. "The room's pedigree is impeccable," states Hemsey. "All the best have passed through this room, mixing hit after hit, overdubbing and tracking." With Hemsey's creative edge, "The Musician's Mastering Engineer" is seeing a new era of groundbreaking music pass through these good ol' walls.

Hemsey is not the only fan of GKS Entertainment's Studio One. In less than a year it has seen a series of radio edits that climbed the charts. Hemsey edited MCA artists **Blink 182** and their releases *Josie* and *Dammit*, followed by **Tracey Chapman & B.B. King's** *The Thrill Is Gone*; later, the clean version of **Sublime's** live LP *Stand By Your Van*. Others include **The Murmurs**, **Semisonic**, **New Radicals** and, most recently, MCA recording artist **Dada** worked with Hemsey to complete a smokin' radio edit of their new hit single *California Gold*.

Recent mastering sessions include MCA artists **Dada**, **Melky Sedeck**, **Richard Buckner**, **Elektra's** *Old '97's*, **Alligator Records' Little Charlie And The Nightcats**, latin/rap artist **Lucky Luciano**, rising rap stars **DA Congregation**, the return of 80's rockers **Pretty Boy Floyd**, and **Joshua Kadison** (pictured above).

—Peter Kluge

GKS Entertainment Studios 323.962.2444





# In the fog about multichannel audio?



As the worldwide leader in multichannel audio, we wrote the book on multichannel audio delivery formats with Dolby Digital and Dolby Surround. Whatever your surround mixing task, whatever the program format, Dolby has everything you need. A 5.1-channel Dolby Digital encoder for only \$5,000. A surround technology for

every medium from VHS to DVD to DTV. And a global market of millions of surround-equipped households.

Visit [www.dolby.com](http://www.dolby.com) for more information on our multichannel audio products and call us for the name of your nearest Dolby dealer and distributor.

## DOLBY DIGITAL ENCODERS AND DECODERS



**Dolby DP569:** Multichannel Dolby Digital encoder (up to 5.1 channels).



**Dolby DP567:** Two-channel Dolby Digital encoder.



**Dolby DP562:** Multichannel reference decoder for Dolby Digital and Dolby Surround programming (up to 5.1 channels).

## DOLBY SURROUND ENCODERS AND DECODERS



### **Dolby Surround Tools TDM**

**Plug-Ins:** Dolby Surround encoder and Pro Logic decoder for Digidesign® Pro Tools® workstations.



**Dolby SEU4 and SDU4:** Dolby Surround encoder and reference decoder.

# DENNY PURCELL

## PRESIDENT OF GEORGETOWN MASTERS, NASHVILLE

Mastering is a job for the highly patient and the consummate diplomat. Denny Purcell is both. He has spent more than two decades as one of Nashville's finest, and most respected, mastering engineers.

Born and raised in Indiana, Purcell was a musician in the '60s and moved to Music City USA in the early '70s after trying his hand at engineering in New York. As a second engineer at Quadrafonic Sound Studios, he worked with the likes of Neil Young, Dan Fogelberg, Linda Ronstadt, Jimmy Buffett, Joe Walsh and countless others. When producer Elliot Mazer wanted to record Young's *Time Fades Away* tour, Purcell and Gene Eichelberger helped build a mobile in just two weeks, and remained with His Masters Wheels—which featured a custom Neve console and the last pair of Ampex MM-1000 16-tracks ever built—for two years.

When the fuel crisis hit in the early '70s, artists stopped touring. Mazer bought the Grateful Dead's Alembic Studios in San Francisco and moved the truck's equipment into the control room. Deciding that his fate lay elsewhere, in 1974 Purcell moved back to Nashville; the only job he could find was as a mastering engineer at Woodland Mastering. There, he cut gospel music for eight hours a day. "I was allowed two pencils per day, and I had to use the cutoff filters," he recalls. "I was allowed no clients."

He later mastered Kansas' hugely successful album *Masque*, and ended up running Woodland Mastering, remaining there for some 11 years. In 1985, he struck out on his own and founded Georgetown Masters, where he remains today.

During his long career, Purcell has earned more than 500 Gold and Platinum albums in just about every musical genre. "Some weeks," he offers, "Georgetown garners 50 percent of the country charts, 50 percent of the inspira-



PHOTO: C. CAIN PHOTOGRAPHY

tional charts, as well 20 percent of the pop charts." Success indeed.

We caught up with this busy, soft-spoken professional between remastering sessions for a series of DTS-sponsored DVD-Audio releases by MCA artists.

### *What attracted you away from remote recording to mastering?*

That's a really simple answer. I moved back here to Nashville to see more of my daughter, Rissie, from my first marriage, and the only job I could find was mastering. I much prefer mastering because I'm a guy who has to see the end of his work. I get to do at least 200 albums a year. When I worked in the studio with some really famous artists, they might work on two or three projects, and the product might never come out. If you're a studio engineer, at best you might be able to work on ten albums in a year. Now I get to work on [between] 150 [and] 200 albums; I've

been doing that for 20-some years.

### *Did you sometimes find it frustrating as an engineer that your work didn't make it onto vinyl?*

Always! Lots of wonderful things I got to hear nobody's ever heard. You mixed the master tape in the studio as an engineer, then you hear the vinyl come out...For years I cut lacquers. But when I started [Georgetown Masters], I bought Alan Zentz's systems: two highly modified [Neumann] VMS-70 [lathes] with SX74 cutter heads, and battery-powered electronics. They were incredible; then we put the Compudisc [cutting automation computer] on them. They also had Panasonic quartz-lock direct drive [motors]. It was like the hot rod of hot rods!

### *Because that combination would give your clients an advantage, a much better-sounding cut?*

A big advantage. At that time, in 1980, the Neumann VMS-80 had bearing problems, and for two years they didn't sort that out. In the meantime, a few people had

BY MEL LAMBERT

# REVERB REDISCOVERED



**M3000**  
STUDIO REVERB PROCESSOR



Beginning in 1996 TC Electronic undertook an in-depth study into the re-creation of acoustic environments. The outcome of this extensive research resulted in the creation of VSS technology - the most dense and natural acoustic environment simulation ever. Nothing short of astounding!

## Ultimate Realism

Setting the new industry standard with the VSS3 technology, the M3000 is the best sounding, most versatile and easiest to use professional reverb today and well into the future. Combining ultimate control of early reflections with a transparent and harmonically magnificent reverb tail, the art of reverberation is brought to a new and higher level.

Trust your own ears - they will tell you the rest of the story!

## Main Features:

- ◆ VSS™3 technology
- ◆ Based on TC's award-winning Dual Engine processing
- ◆ 250 high-grade factory preset-algorithms:
  - Halls, Rooms, Plates and Springs
  - Ambience, Concert Halls
  - Post Small, Post Large, Post Outdoor, Post FX
- ◆ Up to 200 user presets
- ◆ Intuitive user interface with instant preset recall
- ◆ Soft Compressor
- ◆ Advanced Expander and Dynamic EQ
- ◆ De-esser
- ◆ Chorus/Flanger
- ◆ Tremolo
- ◆ Phaser
- ◆ Delay
- ◆ Pitch Shift
- ◆ 5 band parametric EQ

**t.c. electronic**  
ULTIMATE SOUND MACHINERY

CIRCLE #059 ON PRODUCT INFO CARD

# Does your mix make the *Earth Move?*



MLA-2 Compressor

MEA-2 Equalizer

You just know when  
you've hit the sweet spot

  
**Prism Sound**  
MASELEC MASTER SERIES

PRISM MEDIA PRODUCTS INC.  
21 Pine Street  
Rockaway  
New Jersey 07866 USA  
Tel +1 973 983 9577  
Fax +1 973 983 9588

PRISM MEDIA PRODUCTS LTD  
William James House  
Cowley Road  
Cambridge CB4 4WX UK  
Tel +44 (0)1223 424988  
Fax +44 (0)1223 425023

CIRCLE #033 ON PRODUCT INFO CARD

## INSIGHTS

Computisc. The headache back then was, you went to all this work to get the sound right, then you had to walk behind the console, address the lathes and figure out how that physics would apply to a disc. You know, a whole other question. But with the Computisc, I didn't have to worry about that as much. *How long did it take you to learn the limitations of vinyl?*

Doing it wrong several times and then having it come back. There's lots of things I could do that, by the time they were replicated, might not work. It took me at least two years to figure out a lot of that.

*Is patience a necessary attribute for a mastering engineer?*

There's no question that it's patience with clients, patience with technology. In other words, calm, linear thinking amid an ever-changing terrain of musical and human dynamics.

The typical client that comes to work with me has been with a project for two or three months. He's "Octinoid," meaning eight-times paranoid. In mastering houses, we usually stay "Quadrinoid," four-times paranoid. And a client will come in and say, "Please listen to the guitar on cut number 3; it's driving me nuts!" I've never heard the music in my life—I'm gonna hear it for one or two days, and that's it. I have an entirely different focus. I listen to the same song and say, "You know, the guitar doesn't bother me, but I can't hear the vocal." Then he goes even more Octinoid.

Basically, patience is very important: you end up being sonic therapy for your client. But I have a big advantage: I have an assistant who does setups,

writes cards for everything I do, and who actually lays down everything. All I do now is EQ. Most of my time is just spent listening to the music—seeing what I think it needs and then leaving my room. I have a little \$3.00 bell like they have at hotels. When the bell goes off, it means I've done my part. Then the client comes in and listens. When he's done listening, he rings the bell and I come back in.

*You don't like being there with the client?*

Oh, I'm there talking with the client, but not while he's checking what I did. It's wasted time for me. (I call that bell a \$3.00 answer to a complicated question!) If he's happy with what we did, my assistant, Jonathan Russell, lays it down. If he's not, we make changes until he approves it. We always EQ first in my place.

*What sort of reference system do you have in your room?*

My main monitors are Duntech Sovereign 2001 Mark IIs with the Nelson PAS X1000 amps, which is 2,000 watts into 4 ohms, with Alphacore silver wire. I drive [the Duntechs] simply bi-wired. Before, I was using the Threshold SA12E's—and I still like them—but of late I prefer the X1000s. I audition amplifiers and wire pretty much all year round.

*What do you use as a reference source?*

I have different things that I listen to. I go to the Dire Straits or Mark Knopfler [CDs] that I've gotten to work on. I just did *Sultans of Swing: The Very Best of Dire Straits*. I've done [Knopfler's soundtrack albums for] *Wag the Dog*, *Princess Bride*, *Last Exit to Brooklyn* and *Metroland*. Then I did *Golden Heart*, which is a marvelous CD; one of his best albums to me.



Clients turn around from the console for critical listening on Georgetown Masters' own Wall of Sound

# Richard Dodd

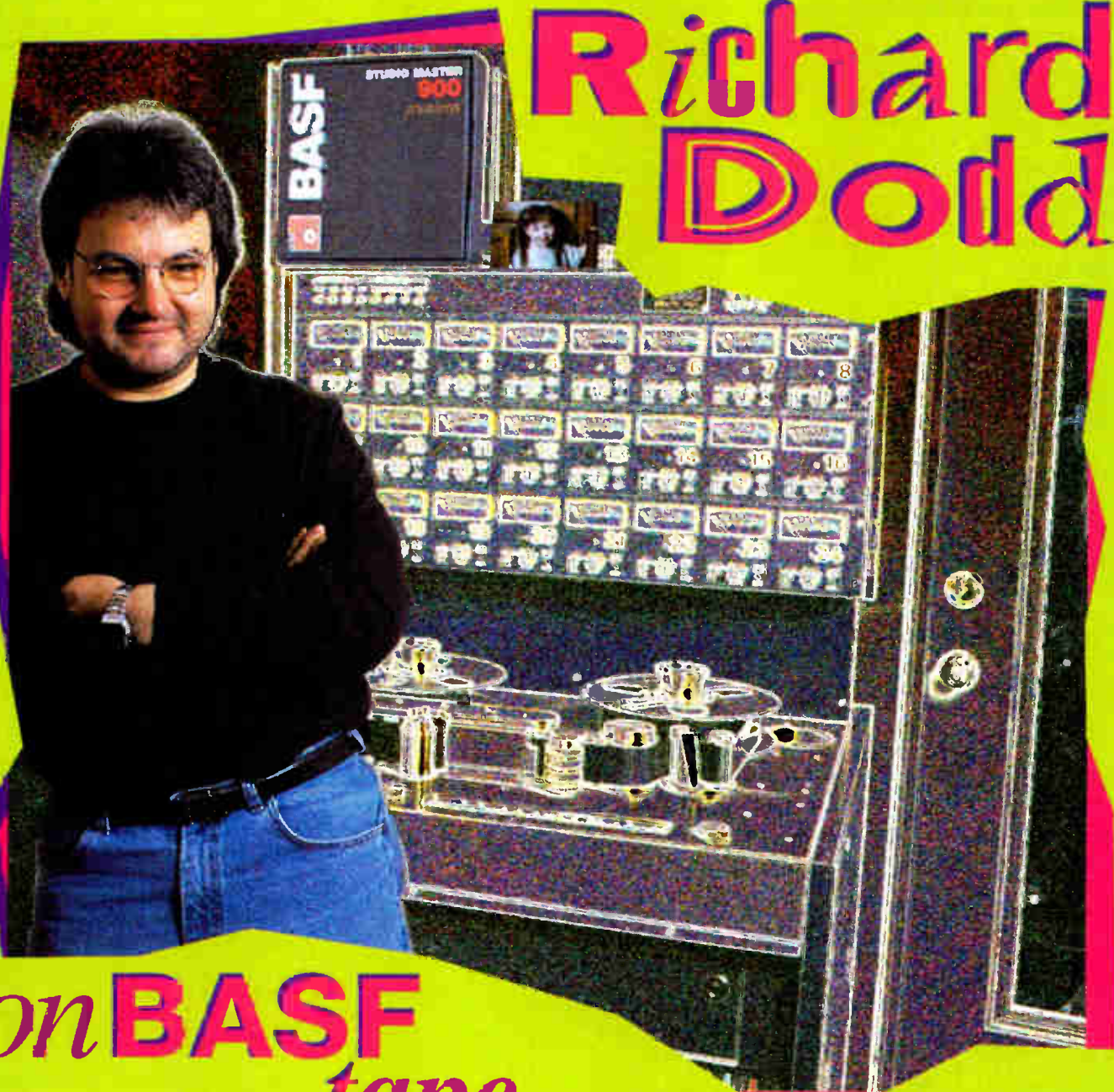

Photo: Peyton Hoge Studio: Vital Recordings

## on **BASF** tape

“**For music** recording I believe that analog sounds better. I prefer **BASF SM 900 maxima** because it represents the best balance of virtues available in an analog tape. **SM 900** has a good tone to it and the sound sticks to it better than other tapes I’ve used. It’s that simple.”

Grammy® winning producer/engineer **Richard Dodd's** credits include work with **Tom Petty, George Harrison, Bob Dylan, The Traveling Wilburys, Francis Dumas, and Edwin McCain.**



Studio SM 900 maxima is a high-output analog tape designed specifically for multi-track recording and mastering, with extra wide dynamic range, low noise and low print through.

**EMTEC** Magnetics



Distributed in North America by EMTEC Pro Media, Inc. ☎ US 1-888-295-5551 Canada 1-800-205-0070 or visit our web site at [www.emtec-usa.com](http://www.emtec-usa.com)

CIRCLE #026 ON PRODUCT RED CARD

**What was your most memorable mastering project?**

That's hard to say. One of the most memorable, in the pop arena, was the Kansas album, *Masque*. Then, in the popular music/country category, it would be working on Garth Brooks' first album. The producer came in on the third song and said, "Hey, Denny, I don't know what you're thinking, but do it like you always do it. These tapes aren't going any place." That was a big deal to me because Garth Brooks is the biggest-selling solo artist of all time. We just finished a live album, which is a double-CD set [*Garth Double Live*].

**Do you work with Nashville artists primarily, or a wider range?**

I get [projects] from all over the world. In the '70s, pretty much what was going on in Nashville was just local people. A lot of them, let's say 20 to 30 percent, wanted to fly to L.A. or New York to do mastering. When I built this place, I studied the world market for equipment, with my friend Rick McCollister, who built most of my electronics. When I was a teenager, I used to race go-carts all over the United States. I could never

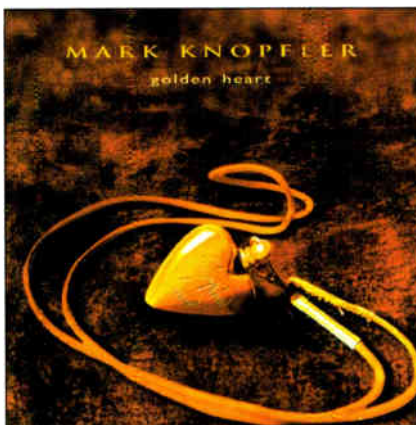

do better than 13th place in the Nationals. I watched the person who won first place. I'd never seen a go-cart like that: It was handmade; it was all "esoteric." That day, a light bulb went off in my head. You can't win a stock car race with a stock car. Nobody in Nashville had built discrete, handmade, proprietary circuits; since that time, we've been off and running and very competitive in the world market. We're one of the Top 10 places in the world.

**What's the most popular mastering format you're seeing?**

Right now, what we're seeing is half-inch analog on [Ampex] ATR without

noise reduction, 30 ips. I have two fully modified ATRs with three different headstacks, three different outputs and different electronics.

**Why different electronics?**

Because we listen to each on each project and decide which personality suits where the music wants to go. If the project is digital, it's either [Sony] PCM-9000 at 44.1 or 48; Genex [GX8000] if it's 88.2 or 96 kHz. Everything I'm doing is 24-bit; has been for several years. If you want to hear pretty much exactly what you hear in the studio monitors, then the answer is digital, 24-bit 88.2 or 96 kHz, on a Genex. Since 1982, I have been trying to get digital to sound equivalent to analog; I don't mean colored, I mean equivalent in resolution. I'm convinced now that Pacific Microsonics at 88.2—or soon to be 96k—at 24-bit is higher-resolution than half-inch analog. That's dramatic to me.

**If the project arrives on analog tape, how do you get into the digital domain?**

We choose first of all which headstack to play it on, which electronics and then we listen through converters. We spent one whole day [on] Knopfler's *Golden Heart* album listening to converters. And we picked the Pacific Microsonics.

**THE AMEK DIFFERENCE****A FULLY AUTOMATED CONSOLE FOR THE SAME PRICE AS SOME VERY ORDINARY DESKS**

**BIG**

- 28 & 44 INPUT FRAME SIZES
- VIRTUAL DYNAMICS
- RECALL (INCL VOCAL RECALL)
- 8 AUX INS
- 24 TRACK CAPABILITY
- SMPTE & MIDI SYNCHRONIZATION

AMEK's SUPERTRUE automation system, which is used on all AMEK consoles, is standard on Big. With the largest installed user base of any automation system, you could start your project on Big and move easily to the largest AMEK-equipped studio.

A fully automated console, with Vocal Recall and AMEK Virtual Dynamics for the price of other very standard desks? You may just want to finish the whole project on Big!



A Harman International Company

AMEK UK +44 (0)161 834 6747 • AMEK USA, LOS ANGELES +1 (818) 973 1613 • AMEK USA, NASHVILLE +1 (615) 360 0488  
WWW.AMEK.COM

CIRCLE #035 ON PRODUCT INFO CARD

"I knew it could be all over one day..."

...until I used the  
Aphex Dominator."

"As a musician, you've got to take care of your ears, which is why I always insist on guaranteed protection for our in-ear monitor systems - for myself and my band."

The Dominator allows the audio to hit an exact maximum point above which the level does not go any higher. Other devices may effectively limit the signal, but the resulting sound may not be a faithful reproduction of the original. If you're looking for complete protection, as well as true fidelity, the Aphex Dominator is the only choice for ear monitors. Don't gamble with your ears - they're your most precious instruments.

Clint Black



CIRCLE #036 ON PRODUCT INFO CARD

**APHEX**  
SYSTEMS

*Improving the way the world sounds<sup>sm</sup>*

11068 Randall Street, Sun Valley, CA 91352 U.S.A.  
818-767-2929 • Fax: 818-767-2641 • <http://www.aphexsys.com>

The Dominator is covered by U.S. Patent #: 4843626. Foreign patents issued or pending. Aphex and Dominator are trademarks of Aphex Systems Ltd.

In a normal day's work, if I get a half-inch analog master, I record it 24-bit/88.2, using the PMI Model One and a Genex 8000.

**What are you listening for?**

Once you've heard something once, you never again hear it the same. A producer, engineer or artist who's been on a project for two or three months is always wanting to hear it like other people hear it. I have the distinct advantage of listening every day in the same room, to the same monitors.

If you go up to a guy who does a

painting in 30 minutes and ask: "How do you do that?" he just says, "What do you mean how do I do that? That's what I do." There's a great jazz guy who explained that "Talking about music is like dancing about architecture."

**What's your editing system?**

I have three Sonic Systems and a SADiE. Unlike a lot of people, we EQ first. The concept behind that—which is backwards to the way that I worked before we started using computers or digital audio workstations—is that, these days, the product ends up being spit out of some sort of digital audio workstation, whether it be Exabyte, 1630, PMCD,



CD-R, whatever. All I try to do is simple logic. If it has to go through a digital audio workstation, I have it go through no more than once. I have two edit suites, a production suite, an analog suite and a digital suite.

**If it's an analog tape, you EQ in the analog domain?**

Yes, I EQ in the analog domain.

**For digital projects, you EQ in the SADiE?**

No. With digital, it depends. But 90 percent of the time with digital tapes I EQ in the analog room. If touch-ups are necessary, I do them with my Muse digital console.

**What do you use for compression?**

Different things for different projects. Years ago, a friend of mine came to me with a CD and said, "Tell me how they did this." I gave the CD to [design engineer] Rick McCollister, and he came back a few weeks later with a box and said, "Try this; see if this does what you want." He came up with a digital compressor that allows me to add up to 6 dB of gain without getting any overs [digital clipping]. It certainly changed the sonic integrity, but it depended how important the level was. That's an arena that I wish we never would've gotten into! But if you don't use it, you're not as loud. And then people think that's not as good.

**Do you think you could pull out a vocal that was buried in a mix and make it sound the way the producer wanted it to?**

I get some of the best tapes in the world delivered to me, and the engineers and producers have spent at least a day or two on each mix. The magneto-optical disk or tape is full of versions. In other words, I get one song title and maybe ten versions: "Vocal up a half"; "Vocal up one"; "All vocals up a half"; "All vocals up one"; "Bass up"; "Bass down."

Usually, within that will be a version that'll work. Most of my clients either let me pick the version as I hear them, or they

**meeek and potatoes**  
**"Add A Little Phat To Your Sound"**

**JOEMEEK**

When it comes to our ads we love to play around, but when it comes to compression we are very serious. If you're serious about your sound, then it's time you try JOEMEEK.

**PMI AUDIO**  
 23773 Madison Street, Torrance, California 90505  
 toll-free 877 JOEMEEK (563 6335) fax 310 373 373 4714  
 site www.joemeeek.com email info@joemeeek.com

**got meek?**

PMI Audio, distributor for JOEMEEK, BPM Microphones and CLM Dynamics.

CIRCLE #037 ON PRODUCT INFO CARD





...and it  
sounds  
even  
**bigger!**

With high speed, low noise and low distortion electronics, the **VSM-1 Tube Microphone's** servo-valve topology and CAD's exclusive 1.10" Optema™ Series capsule achieve extraordinary bandwidth with exceptional frequency and transient response.

In other words, it **sounds big. Really big.**

The new high performance **VSM-1 Tube Condenser Mic** from CAD.

For a dealer nearest you, call 1-888-702-7075.

**VSM-1**

The future of studio recording has arrived.



**The Revolution Continues.**

[www.cadmics.com](http://www.cadmics.com)

dictate to me which version. Sometimes we edit together several different versions.

But to answer your question, I certainly have brought vocals out, to some degree. The thing to remember about mastering is that anything you improve in one area—if you're not very, very careful—you suffer in another. And the constant decisions that we make are, is the gain worth the loss?

*Obviously, your overall aim is to keep the artist's or producer's intention, but at the same time retain the "magic" that was in the session.*

That's exactly right. The whole reason I do this is that I love songs; what I do each day allows me to help other people hear songs better.

*What do you do for a 5.1-channel mastering project? Somebody brings you in a new mix. What are you listening for?* It's important that I tell you first that I got into this arena thanks to Chuck Ainlay. DTS wanted to [remix a number of 5.1-channel tracks] for [several] MCA artists. Tony Brown, president of MCA here in Nashville, uses Chuck Ainlay for most of his mixes, so I got into it very early on. I've been doing it for over a year, and I've done ten or 11 projects.

What DTS has done is to fund the simultaneous 5.1 releases when the [normal stereo CD] album comes out. Chuck and I came up with a 20-bit solution, since the DTS [DVD-Audio format] is 20-bit. Instead of some inexpensive A-to-Ds, D-to-As and [bit splitters] using a DA-88, we decided to use three Pacific Microsonics Model Ones, because we like that [converter] better than any others, and then to record all that to a Genex.

*So that's six channels of 20-bit audio onto a Genex MO?*

Yes, 20-bit, through three \$20,000 A-to-D/D-to-A systems. We did the first project that way, the Vince Gill album *High Lonesome Sound*. And that, according to people at the MPGA and other mastering engineers, has gotten acclaim as one of the best of all the 40-odd DTS projects.

*How do people listen to these? Do you need a modified CD or laserdisc player?* You need a CD player with a digital output, a DTS decoder and then six channels of playback. But for remix, and mastering, the most critical thing I've learned from Chuck is properly setting up the monitors.

*What do you use as a mastering array?* Right now, my dream case—and I'll give this up—is five Duntechs.

—CONTINUED ON PAGE 210

**BASIC ACOUSTICS**

- ▲ Sound Absorbers
- ▲ Sound Barriers
- ▲ Sound Diffusers

from **ACOUSTICAL SOLUTIONS INC.**

ALPHASORB FABRIC-WRAPPED WALL PANELS

SONEX FOAM

ALPHAPYRAMID FOAM

SKYLINE DIFFUSOR

AUDIOSEAL SOUND BARRIER

FREE Catalog & Sample  
(800) 782-5742  
www.acousticalsolutions.com

CIRCLE #039 ON PRODUCT INFO CARD

SAVOY JAZZ • ROCK & ROLL HALL OF FAME • STRICTLY RHYTHM • REPRISE • RAVE MUSIC • SON MUSIC • BLUENOISE • WARNER BROTHERS • SONY • MAW RECORDS • HYBRID • DIGITAL DUNGEON • TOUCHWOOD • BEGGAR'S BROTHERS • ATLANTIC • CRISTA RECORDS • A • ROCK • VOY JAZZ • RAVE MUSIC • CHW • MUSIC • WILLIAM • DUNGEON • CK NORTH SO • BRID • ARISTA • GAR'S BANQUET • HALL OF FAME • STRICTLY RHYTHM • ET MUSIC • DENON • TOUCHWOOD • MAW • UPAYA • ROCK & ROLL

**MEDIAFORCE**

**DIGITAL MASTERING AND EDITING**

*Rick Rowe*

SADIE CDR REDBOOK • SONY PCM 1630 • DAT • EXABYTE DDP

TRANSFERS FROM ANY / TO ANY FORMAT  
AUDIO POST:  
DIALOG EDITING/SYNC • MULTITRACK MIXING • SOUND DESIGN  
SOUND FX EDITING • MIX TO PICTURE

630 9TH AVE SUITE 1012 NY, NY 10036 • 212.262.2626 • OUTSIDE NY 1.800.847.4123

CIRCLE #040 ON PRODUCT INFO CARD

# The Meyer Sound Self-Powered Series

Since the 1995 introduction of the Self-Powered Series, over 13,000 units have been sold. With the advent of this new innovative series, Meyer Sound took a huge technological leap beyond all existing loudspeaker systems. Listen to what some of audio's top professionals have to say about these powerful, industry-defining tools...

*"We really nailed it! Our new Self-Powered cabinets give us the flexibility to adapt to any environment on tour, and we now have the best stadium sound I've ever heard."*

Jeff Thomas ◦ FOH Engineer, The Dave Matthews Band

*"Self-Powered speakers mark a new beginning for both Meyer and the live sound industry."*

Mark Frink ◦ MSL-4 Review ◦ Mix Magazine, August 1996

*"Only Meyer Sound's Self-Powered Series guarantees us a world-class sound system preferred by most artists and producers."*

Marcio, Nelson & Marcos Pilot ◦ Loudness Sonoriza, Brazil

*"Setting up 18 stages in one week... we never could have done it without the Self-Powered Series. Nothing is easier to use, easier to maintain, or sounds as great."*

Miguel Lourtie ◦ Systems Engineer - EXPO '98 ◦ Lisbon, Portugal

*"The sound was amazing, incredible... the music almost came at you in 3-D! ...Simply, I have never experienced speakers like these before."*

Mike Klasco ◦ UPA-IP Review ◦ DJ Times Magazine, May 1998

## Imagine what you'll be hearing...

Meyer Sound Laboratories • 2832 San Pablo Avenue • Berkeley, California 94702  
phone: 510 486-1166 • fax: 510 486-8356 • e-mail: [sales@meyersound.com](mailto:sales@meyersound.com) • [www.meyersound.com](http://www.meyersound.com)

World Radio History  
CIRCLE #041 ON PRODUCT INFO CARD



**Meyer Sound**

# MUSIC RECORDING IN BRAZIL

## HOT SOUNDS, BIG BUSINESS

Brazil has always been famous for its music, especially world music and jazz. What many people don't know is that Brazil's music industry is the third largest market in the world. This is remarkable not only relative to the size of the country, but because the market is almost entirely self-contained. Brazilian artists rarely go outside the country to record or mix, and most of the music that's made is purchased in Brazil. The music-lovers support their own vital musical community.

"Our market, in the past four years, has doubled in size," says Sergio de Carvalho, artistic director at the Universal Music label.



PHOTO: MARCELO SANTA ROSA

*Midas Studios is one of Sao Paulo's newest commercial facilities.*

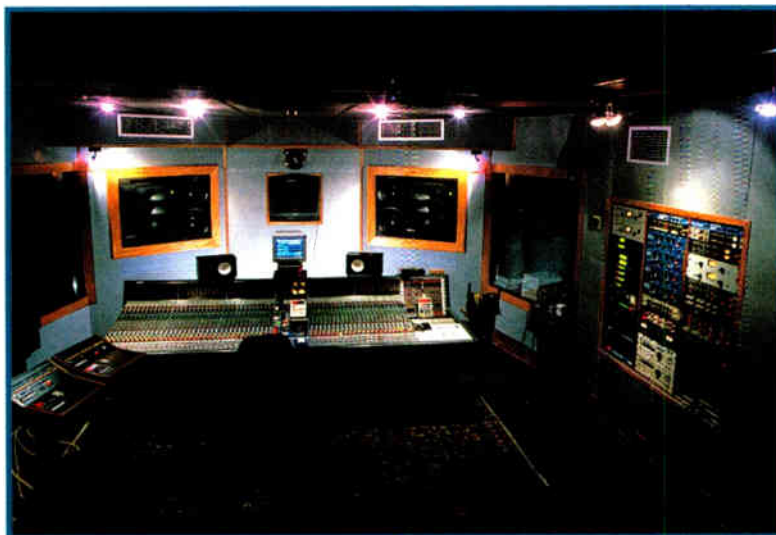

*Mosh Studios' new VIP Suite*

"Nowadays, around 100 million CDs are sold per year. And at the moment, domestic production represents 75 percent of the market." The rapid growth is most likely a result of a relatively stable economy—people now can afford to buy CD players—and the fact that the best-selling albums are local productions. The samba style called *pagode*, for example, is responsible for 50% of the market share inside Brazil.

Most of the musical production done in Brazil—for domestic and international release—takes place in world-class studios in Rio de Janeiro and Sao Paulo. Rio, the best-known city in Brazil, is surrounded by a spectacularly beautiful landscape and is where the majority of artists choose to live. Sao Paulo, on the other hand, is the biggest city in South America with

almost 20 million people, and it has the highest per-capita income in the country. This is why a high percentage of the advertising companies and commercial post-production studios are located in Sao Paulo. *Mix* visited a few of the studios in each city.

### ROCK IN RIO

In the beautiful area of Barra da Tijuca in Rio de Janeiro, just one block from the Atlantic Ocean, is AR Studios. With three rooms and extensive amenities, including reserved parking and a good snack bar, AR is one of the newer studios in the market. Studio A was designed by John Storyk of the Walters-Storyk Design Group, based in New York.

We asked Storyk about his experience working in Brazil, on this studio as well as on Midas Studios in Sao Paulo. "Professional studios in Brazil have the same high level of quality and demands as any other studio in the States or Europe," Storyk says. "The few projects that we have been involved with are truly world-class." But, he adds, "These studios have taken a bit longer to build. Some materials

BY ADINALDO NEVES

—CONTINUED ON PAGE 74

# CIRCO BEAT

## *Buenos Aires, Argentina*

The Walters-Storyk Design Group (Highland, N.Y.) has, in addition to its many U.S. and international projects, been designing high-profile Latin American studios for about five years. Most recently, the designers celebrated the opening of Circo Beat; located in Buenos Aires, it is the personal studio of multi-Platinum pop star Fito Paez.

Paez is regarded as “one of Argentina’s true superstars,” designer John Storyk says. “He is a wonderful piano player and anthemic, melodic pop songwriter. He has a magnetic voice—very captivating. When he performs and records, he loves to use lots of live instruments: strings, etc. This was important information to us in configuring the studio. The studio room needed to be capable of live string work, as well as deader rock ‘n’ roll.”

Paez had chosen and purchased a well-situated build-



PHOTOS: MANVER VERSTRAELEN

*Circo Beat Studios is the personal studio of pop star Fito Paez. The recording room includes two iso booths, a 3M 1000 ANSI Lumins LCD projector, motorized screen and variable acoustics via adjustable side panels and motorized ceiling panels.*



*Circo Beat’s control room, with SSL 4056 console and Argentina’s first Genelec 1039 monitors*

ing for his facility, but a great deal of work went into turning the place into the versatile and attractive studio pictured here. “Fito liked the building because of its location—somewhat out of the center of town, quite private,” Storyk explains. “The building had been deserted for some time and had originally been constructed as a sort of recording studio, but the design left quite a bit to be desired.”

To achieve the flexible acoustical environment that Paez’s musical inclinations require, Storyk designed an elaborate system of adjustable side panels and remote-controlled, motorized ceiling panels for the recording room. “These panels, having one reflective and one absorptive side, can

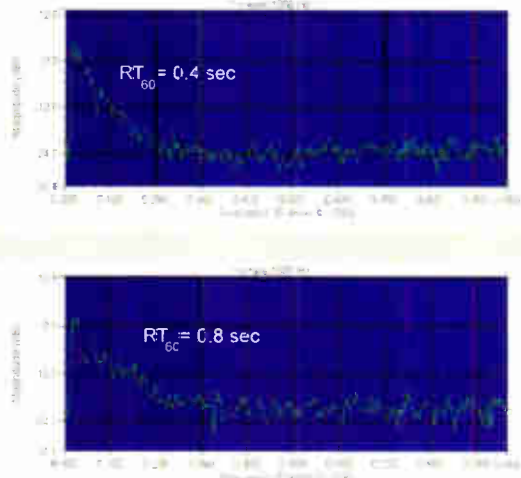

*Figure 1: Reverb time measurements of the Circo Beat studio show RT60 Decay (Magnitude over Time) at 1 kHz. Decay time is 0.4 seconds for closed-panel configuration, 0.8 seconds for open-panel configuration.*

be rotated to one’s taste to change reverberation time and reverberation patterns.” Storyk says, “so a broad range of applications and instrument placement can be accommodated. Repositioning the panels can reconfigure the room’s reverberation time [RT60] from 0.4 seconds to 0.8 seconds at 1 kHz [see Fig. 1]. This versatility makes the room equally suitable for classical recordings, film work, pop

**BY BARBARA SCHULTZ**

music and a wide range of other applications." Two dead iso booths are also part of the impressive 1,200-square-foot room.

In the control room, acoustics are controlled with three custom-designed hanging clouds seen in the photo. A large wood Diffraactal mounted at the back wall is used to control sound distribution and reflection patterns at the mix position. Transfer function measurements—which show the time-compensated level difference between a source signal and its reproduction by the room speakers (Fig. 2)—were taken in this room using the JBL SMAART Pro system, which was designed by

WSDG principal acoustician Sam Berkow. The control room is equipped with an SSL 4056 console and Genelec 1039 main monitors, Genelec 1031 and Yamaha NS10 reference monitors are mounted on motorized lifts. Also featured are an Otari 24-track, 2-inch analog recorder, Pro Tools and four Alesis ADATs.

Because Storyk lives in New York and has numerous project commitments at any given time, he is assisted in his South American work by an Argentine partner, Sergio Molho, who owns Fingers Multimedia, a Buenos Aires radio and TV production facility. "Working in South America has proven to be not that different

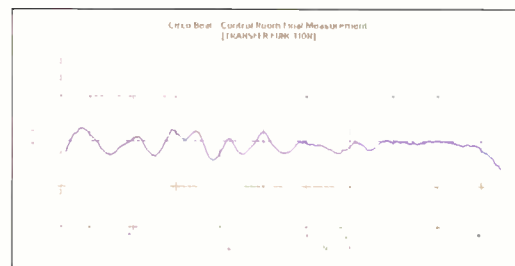

Figure 2: Transfer function graph (decibels over frequency) after system equalization, showing the level difference between a source signal and its reproduction by the room speakers

than most locations outside of the major media centers in the U.S.," Storyk says. "Having partners in these locations is the key for quality control on our projects." For more on Circo Beat, visit [www.wsdg.com](http://www.wsdg.com). ■

## THE ANT TRAIL'S "CARAVANSARA"

### PROJECT RECORDING IN PORTO ALEGRE

by Charles Di Pinto

For the past year, my second home has been Porto Alegre, a Brazilian city about the same size as my hometown, Philadelphia. Growing up in the States, I developed my musical ideas based on listening to artists like Thelonus Monk, Stevie Wonder and Jimmy Smith. Half of my family is from Brazil, however, and several visits to the country added names like Eunir Deodato and Tom Jobim to my influences.

Porto Alegre is quite different from the rest of Brazil due to the influences of German and Italian colonization. I'm considered somewhat of a gringo here, but most of the time, it's been several aspects of my American upbringing that have allowed me to help artists realize their musical expectations; some of the elements that pop up in Brazilian music are very American, and I can deliver an authentic approach to the production.

Before coming to Brazil, I'd worked with Philly-based artists like Dean Freeman and done commercial audio for companies like GMA/Muller Martini. Here, I'm producing bands like Dive, Pedro Verissimo, Miro Fagundez, Dell Carter, and "Gabriel, Mano Sa, e a Trilha da Formiga."

During September, I had been in the studio with Gabriel, Mano Sa, e a Trilha da Formiga, or The Ant Trail, a band comprising nine top-flight artists.

I first met these guys back in July, when their two vocalists, Gabriel and Mano Sa, approached me to listen to some of their work. We were soon in the studio putting together their current effort, *Caravansara*.

*Caravansara*, which means "mix-



L to R: Engineer Charles Di Pinto with Mano Sa and Gabriel Mooger of Ant Trail

ture of cultures," has strong Afro-Brazilian Middle Eastern and African-American influences. At times, it doesn't come off as a predominantly Brazilian work, as it draws so convincingly from other genres. And then there's a bit of the American culture and experience that I brought to the project, as well.

The concept for the sessions was clear from the beginning. This was a group that thrived in a live setting, and that was the energy I was after. On-stage, they count on the participation

of contemporary dancer and backing vocalist Thais Petzhold, making their performances visually, as well as musically, exotic.

Recording was done direct to hard disk where possible, and with ADATs where practical. I've never been the greatest fan of the onboard A/D converters on the ADAT, so in this case I used the 20-bit converters on a Yamaha 03D. On the computer, I'm a Logic Audio guy, which I've been using on several platforms for nearly a decade, since my Atari 1040 days.

Tracking took place at my private studio, Upstairs Productions. My 12x16-foot personal room is on the upper floor of a house in Porto Alegre's "chic" residential area, called Moinhos de Vento. The recording room has a flexible wall and 10-foot ceiling, all treated with thick acoustical foam. We started with only a few bandmembers (guitars, drums, vox and bass), laying down guide tracks to a synchronized ADAT/Logic Audio system. The whole project relied on a lot of overdubs, where we would spend several days working with each instrument. Percussionists were tracked separately and as a group.

The band members are mostly session musicians, and all are studio veterans. *Caravansara* relies heavily on the Cozinha, which translates to "Kitchen," and refers to the percussion

—CONTINUED ON PAGE 211

# Everyone has a good word to say about our AD-8000.

**S**INCE ITS INTRODUCTION, the AD-8000 has rapidly become an industry standard for high-quality A/D and D/A conversion. Owners and reviewers alike agree: the Apogee AD-8000 delivers a uniquely flexible, versatile conversion solution for any facility. And it's an Apogee — it sounds great! Quite simply, it's the heart of digital audio.

"I stopped a mix [on Prince of Egypt] to use the AD-8000 because it sounds so much better," —Alan Meyerson, engineer with Hans Zimmer.

"If you're doing any recording whatsoever on to digital, the AD-8000 is a prerequisite," —Simon Franglen, music producer on the movie Titanic.

"Nothing else I've used sounds so much like analog... I've never heard a digital system like it." —Don Was, producer, Bonnie Raitt, Rolling Stones etc.

"It's the sound of the AD-8000 we like most of all: we're using it on all our projects!" —Marty Frasu & David Newman, Oscar-nominated for the music to Anastasia.

"The AD-8000 is a massive improvement: it makes Pro Tools sound like a 2-inch tape machine!" —Juan Patiño, producer with Lisa Loeb.



"If you're looking to upgrade the front end of your signal chain to a world-class standard, the AD-8000 will take you there." —Michael Cooper, Mix Magazine

"...the AD-8000 is necessary for virtually anyone serious about digital recording... [great converters] simply are a must. And so is the Apogee AD-8000." —David Frangioni, EQ Magazine

"Project studios running Pro Tools 24... should strongly consider buying an AD-8000... Highly recommended!" —Mike Collins, Sound On Sound

"The AD-8000 is a very flexible box... a natural companion to MDMs and DAWs. This one is going to turn some heads." —Frank Wells, Audio Media

"...a complete digital toolkit which could quickly find itself the hub of a digital systems for high-quality recording, flexible dubbing and multiformat transfers" —Dave Foister, Studio Sound

**... We just call it  
"The heart  
of digital audio."**



**ELECTRONICS**  
www.apogeedigital.com

APOGEE ELECTRONICS CORPORATION,  
3145 Donald Douglas Loop South,  
Santa Monica, California 90405, USA.  
Tel: +1 310/915-1000 Fax: +1 310/391-6262.  
Email: info@apogeedigital.com.

Apogee, UV22 and Soft Limit are registered trademarks of Apogee Electronics Corporation. Other trademarks are the property of their respective owners.

—FROM PAGE 70, RECORDING IN BRAZIL

are not available in Brazil. We either had to manufacture them—such as custom acoustic treatments—or, in fact, import them. In the case of AR in Rio, most of the materials were imported.

“Also relevant is the kind of music people record in these studios,” he continues. “They have to be versatile enough to accommodate anything from orchestras to world music. In our experience, Brazilian music demands more live recording spaces. Lots of ‘acoustic’ room for percussion and rhythm work.”

AR’s control room is equipped with a Neve V3 with Flying Faders and Genlec 1034A monitors. The outboard rack

has plenty of vintage tube gear, as well as state-of-the-art digital processors. The spacious recording room contains a Yamaha C7 grand piano, plus two iso rooms. Studio B has a Euphonix CS2000 board and Westlake Audio HR-1VF monitors. The recording room in B was designed by Brazilian engineer Carlos Dutweller, and the control room was by George Augspurger. Studio C is a mastering and editing room, based on Pro Tools|24 and Westlake Audio BBSM-12 monitors (this room was also designed by John Storyk).

Just under the statue of “Christ the Redeemer” is Discover Digital. This colonial-style house is the place where many well-known Brazilian artists come to track and mix in a familial environ-

**TAYTRIX**  
WHEN ALL YOU WANNA DO IS PLAY

**Stack It...**



**Rack It...**



**Hang It...**



**Patch It...**



It doesn't get any easier than that  
**Call**  
**1-800-TAYTRIX**  
When All You Wanna Do Is Play

**Pre-fabricated Studio Accessories**  
Stackit modular gobo system  
Studio furniture -Acoustical panels  
Cables and patchbays

**http://www.taytrix.com**

## VIRGINIA RODRIGUES' "SOL NEGRO"

“In my voice/I bear the night and the sea./My song is the light/of a black sun in pain.” That’s the first verse to the title track of Virginia Rodrigues’ first album, recently released in the States on the Hannibal/Rykodisc label. This recording is a hypnotic blend of ethereal, almost operatic vocals with mostly traditional Brazilian percussion instruments; strings and horns are added to the more samba-able tracks. Milton Nascimento, Djavan and Gilberto Gil also guest on the release.

Three engineers—Marcos Vicente, Denilson Campos and Mario Possolo, who mainly works for Gilberto Gil—worked on different songs on this project. Vocal tracking was done at the offices of the artist’s Brazilian record label, Natasha Records (Santa Teresa, Rio de Janeiro), where the engineers set up a purpose-built project studio. “Virginia doesn’t like real studios,” explains Vicente. “She feels the ambience is too cold to get a good vocal performance.” Using untraditional methods, Rodrigues likes to lay down her vocals first, to a guide guitar or piano. “All of the vocals were recorded in a room with no acoustic treatment,” Vicente says. “It’s just a small room with a big ceiling and a closed door between her and the equipment.”

The setup at Natasha is similar to many U.S. project rooms: two ADAT

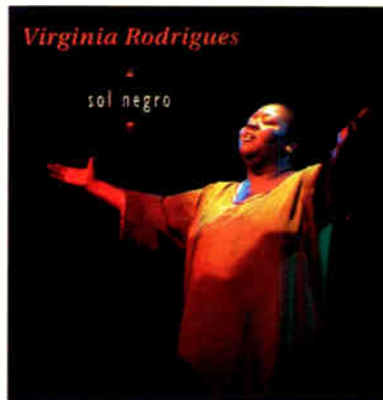

XTs, a 32-channel Mackie console and Yamaha NS10 monitors. A variety of AKG, Sennheiser and Schoeps mics were used. Once they had the vocals down, the project moved to Fibra Studios to record instruments and to mix. Fibra is a smallish commercial facility that mainly hosts music and jingle recording sessions. For consistency, the same recorders, console and monitors were used there, along with Lexicon PCM 70 and 80 reverbs, Yamaha SPX990 and 1000 reverbs, and dbx 160XT compression.

The instruments were recorded one by one and added to the tracks, but the vibe of this album—with the otherworldly beauty of Rodrigues’ voice and the intoxicating rhythms of the musicians—is as genuine as if it had been all recorded in performance.

—Barbara Schultz



# ULTIMATE SOUND MACHINES

## Gold Channel



### DIGITALLY ENHANCED MIC PRE-AMP

The TC Electronic Gold Channel is a Digitally Enhanced Microphone pre-amplifier and a DSP signal refinement toolbox. Plug in your microphone, connect the Gold Channel's outputs to any analogue or digital recorder, and safely capture your signal in the best possible recording quality.

## M2000



### STUDIO EFFECTS PROCESSOR

The Engineering Group at TC Electronic was given carte blanche to create the optimal studio effects processor. Being musicians and studio engineers themselves, they have a feel for what is needed in modern high-grade processors. The library of effects includes: Reverb, Pitch Shift, Delay, Chorus, Ambience, Equalization, De-essing, Phasing, Compression, Gates, Expansion, Limiting, and Stereo Enhancement.

## M3000



### STUDIO REVERB PROCESSOR

Setting the new industry standard with the VSS3 technology the M3000 is the best sounding, most versatile and easiest to use professional reverb today and well into the future. Combining the ultimate control of directivity in the early reflections with a transparent and harmonically magnificent tale, the art of reverb is brought to a new and higher level.

## FIREWORX



### MULTI EFFECTS PROCESSOR

Want to breathe some fire into your music? Get ready for FireworX! An explosive Multi Effects Processor. The FireworX' broad palette of effects includes: Vocoder - Ring Modulation - Synth Generator - Formant Filter - Resonance Filter - Multitap Delay - Reverse Delay - Reverb - Dynamics - Chorus - Flange - Phase - Pitch Shift - Fractal Noise and more ...

## Finalizer EXPRESS



### STUDIO MASTERING PROCESSOR

The Finalizer Express is the fast and efficient way to turn your mix into a professional master! Based upon the TC Electronic Multi-Award winning Finalizer Mastering Technology, it delivers the finishing touches of clarity, warmth and punch to your mixes, putting the world of professional mastering within your reach.

## Finalizer PLUS



### STUDIO MASTERING PROCESSOR

The Finalizer Plus gives you the extensive and complete range of controls you need to add the finishing touches to your mix. Compared to the Finalizer Express the Finalizer Plus offers an even wider range controls allowing you to fine-tune every aspect of the mastering process.

**t.c. electronic**  
ULTIMATE SOUND MACHINES

CIRCLE #044 ON PRODUCT INFO CARD

TC ELECTRONIC INC., 790-H HAMPSHIRE ROAD, WESTLAKE VILLAGE, CA 91361, USA · PHONE: (805) 373 1828 · FAX: (805) 379 2648  
FOR LITERATURE CALL TOLL-FREE: 800 288 5838 · E-MAIL: INFO@TCELECTRONIC.COM · HTTP://WWW.TCELECTRONIC.COM/FINALIZER  
TC ELECTRONIC A/S, SINDALSVEJ 34, DK-8240 RISSKOV, DENMARK · PHONE: + 45 8621 7599 · FAX: + 45 8621 7598

## INTERNATIONAL UPDATE

ment. The recording room is large enough for 20 musicians, and the control room has an 80-input Amek Einstein with Supertrue automation; Westlake Audio BBS 15 monitors; and a variety of recording options via three ADAT XTs, two M20s, a 24-track Otari



AR Studios' control room A

MTR-90 and a Pro Tools 124 system. The studio is perhaps best known for the quality of its hard disk-based editing/mixing. "We started doing edits, tuning voices and mixing in the digital domain much earlier than anybody else in Rio," says Guilherme Reis, Discover's chief engineer and part-owner. "People used to bring their vocal tracks here to be fine-tuned.

Next year, we'll be able to exchange files between the two rooms and mix a complete project without leaving the digital domain."

Discover has hosted some of the best-known Brazilian artists, including Grammy Award winner Tom Jobim, Leila Pinheiro, Ivan Lins and many others. Amenities that contribute to the studio's relaxed vibe include a swimming pool, hammocks and a restaurant with Brazilian home cooking.

Also in Barra da Tijuca is Impressao Digital. Studio One was designed by Carlos Dutweller and has a 48-channel



PHOTO: RANPHIS ZEITUNE

Discover Digital is built into a colonial-style house.

SSL 4056 G with VCA automation and Total Recall; the console is scheduled to be upgraded to a G Plus by the end of the year. The Westlake Audio TM-1 main monitors are powered by Bryston 4BST amps, and tape machines are two Studer A820s with 32 tracks of Dolby SR. Some very high-profile work has been done in Studio One: Liza Minnelli recorded her vocal track for Frank Sinatra's *Duets* album there; Tom Jobim recorded his part for *Duets II*; and Paul Simon, Dionne Warwick, Milton Nascimento and Djavan are also on the client list.

# ADGIL Surround Sound Monitor System

The **Complete Solution** To Multi-Format, Multi-Channel Loudspeaker Control



- ◆ 5.1 or 7.1 From Any Console
- ◆ 200+ Inputs By Up To 8 Outputs
- ◆ Fully Programmable
- ◆ Mute, Dim, Mono, Solo & Cut Controls
- ◆ Pec / Direct Switching
- ◆ Use As Mixer For Stems & Sub-mixes
- ◆ Programmable Parametric Room Equalizer / Monitoring Format Selector
- ◆ Insert For Encoding / Decoding Matrixes
- ◆ Modular, Expandable Design
- ◆ Noise -96dBu @ 22Hz to 22kHz

www.sascom.com Ph 905.469.8080 . Fax 905.469.1129

## SASCOM

CIRCLE #045 ON PRODUCT INFO CARD



## Now including:

Batch Converter™ and  
Spectrum Analysis™  
plug-ins

Advanced loop editing  
tool set supporting  
Sonic Foundry's ACID™

NetShow services and  
RealSystem 5.0 Support

Microsoft  
**WindowsNT**  
NetShow Services



# SOUND FORGE 4.5

digital audio editing for windows

## Forge Ahead With Confidence

When you need absolutely brilliant audio for your next project, look to the ultimate sound editing software for Windows, Sonic Foundry's Sound Forge 4.5. Discover a new level of interactivity, accuracy and overall control. Extensive effects. Flexible features. Expandable power. Isn't it time to start using the one audio editing package that gives you complete confidence and control?

FOR MORE INFORMATION SEE OUR WEBSITE [WWW.SONICFOUNDRY.COM](http://WWW.SONICFOUNDRY.COM) OR CALL 1 800 57 SONIC

CIRCLE #046 ON PRODUCT INFO CARD

Sonic Foundry® and Sound Forge® are registered trademarks of Sonic Foundry, Inc. Other products are trademarks of their respective manufacturers.

World Radio History

# MERIDIAN LOSSLESS PACKING

## ENABLING HIGH-RESOLUTION SURROUND ON DVD-AUDIO

by Philip De Lancie

It's been a long time coming, but the technical specifications for a new audio-oriented format based on DVD are now essentially complete. The DVD-Audio specification is being prepared by Working Group 4 of the DVD Forum, a group (composed largely, but not exclusively, of consumer electronics hardware manufacturers) dedicated to ensuring the orderly development of a versatile and inter-operable family of DVD products. With DVD-Audio presentations at the 105th AES convention and a DVD Forum conference just two days later (also in the San Francisco area), WG4 formally revealed the basic outlines of the new format (much, but not all, of which was previously known).

Still, WG4 chairman "Bike" Suzuki of JVC referred to the specification as being only "almost" ready. A final recommendation from WG4 was expected to go for approval to the DVD Forum's own steering committee at the end of October, at which time pressure was likely to be mounted on WG9, which deals with copy protection issues, to come up with a solution that will allow the DVD-Audio format to finally see the light of day.

The basis for WG4's work has been a set of requirements set forth by the International Steering



*Meridian Audio's Robert Stuart is flanked by Colin Aldridge, marketing director, left, and JVC's "Bike" Suzuki, WG4 Chairman*

Committee (ISC), representing the interests of the world's major record label trade associations (the RIAA, IFPI and JRIA). Most of the 15 requirements—concerns like support for high-resolution audio, multichannel (surround) playback and CD compatibility—have long been part of WG4's brief. But this

summer the ISC recognized that even DVD is limited in terms of both bandwidth (the playback data rate) and total storage capacity, and added to its list the requirement that playing times, even for high-resolution multichannel sound, approach those of the 74-minute CD benchmark.

To meet this requirement, WG4 mandated that all DVD-A players support a lossless data compression scheme championed by Meridian Audio of Cambridge, England, a 21-year-old hi-fi manufacturer best known for its audiophile CD players, receivers and other home stereo gear.

Unlike "perceptual coding" schemes that reduce data rates by discarding "unnecessary" audio data, Meridian Lossless Packing is more analogous to Stuffit and other software utilities that reduce the size of computer files without altering the information. According to Meridian and WG4, MLP yields a decoded output that is bit-for-bit identical with the original signal.

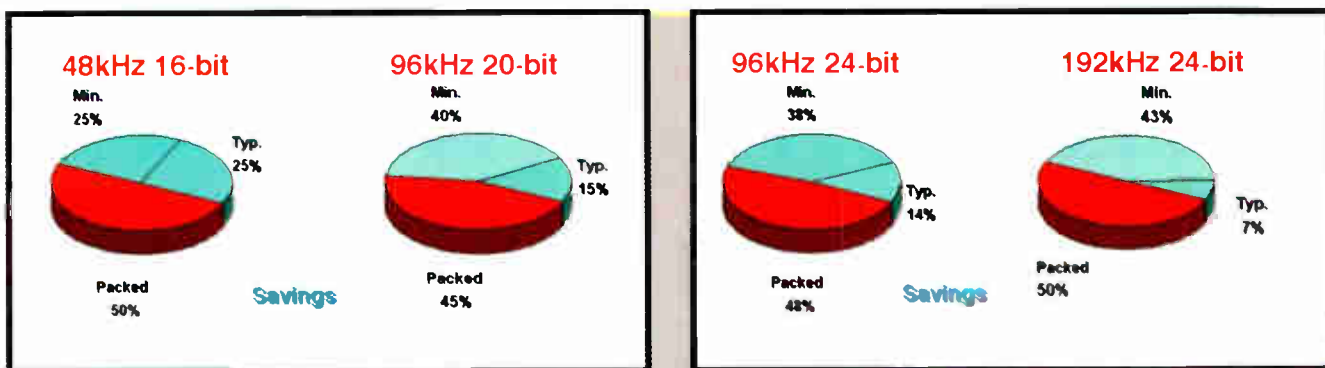

Figure 1: Meridian Lossless Packing savings

The actual degree of compression achieved by MLP depends on the program material itself, but the claimed reduction in bandwidth and storage requirements is significant (see Fig. 1). Without compression, for instance, 96kHz/24-bit audio requires 2.3 megabits per second per channel. That works out to 13.8 Mbps for 6-channel sound—which exceeds DVD-A's 9.6 Mbps bandwidth—and a total required capacity of 7.7 gigabytes, which exceeds the 4.7 GB capacity of DVD-5, the least expensive

the licensing of MLP for DVD (see sidebar).

*What is the history of MLP and Meridian's involvement with its development?*

Meridian has supported the development of MLP both with funding and with system design and engineering input. Through my efforts in WG4, Meridian has also supported the not inconsiderable problem of getting MLP adopted as mandatory in the DVD-Audio format. We became involved through my efforts as chairman of ARA, which formed a technical committee in 1995 and wrote a proposal for a high-quality audio format based on the DVD disc.

There was a long-standing relationship between myself, Meridian and two of the advisers to ARA—Michael Gerzon and Peter Craven. We had long had a passion for signal coding questions and had made several projects together. At that time, it was clear to all concerned that lossless compression was an obvious way to go. Over the following year, Peter, Michael and I evolved some strong ideas on good ways to approach this, and one or two key

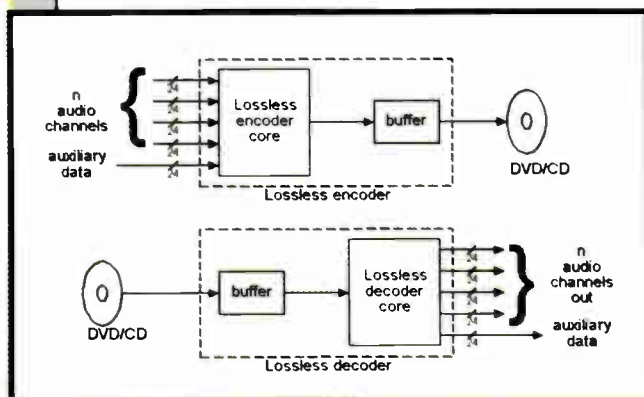

Figure 2A: Meridian Lossless Packing—encoder and decoder

DVD to replicate (and thus most attractive to labels). Used on typical program material at that resolution and channel configuration, MLP is expected to reduce bandwidth by 38% to 52% (to 6.6-8.6 Mbps), allowing anywhere from 73 to 89 minutes on a DVD-5.

That capacity might fall as low as 54 minutes if a separate MLP-encoded 96/24 stereo mix is also provided on the same disc, in which case DVD-A's ability to deliver some channels of a multichannel mix at lower resolution than others could be used to reduce data requirements and thus lengthen duration.

To find out more about MLP and its application to DVD-A, I interviewed Meridian chairman Robert Stuart, a co-developer of MLP and longtime activist in the Acoustic Renaissance for Audio (ARA) group, which has pushed for super-fidelity audio on DVD since 1995. I also contacted Roger Dressler of Dolby Laboratories about his company's involvement in

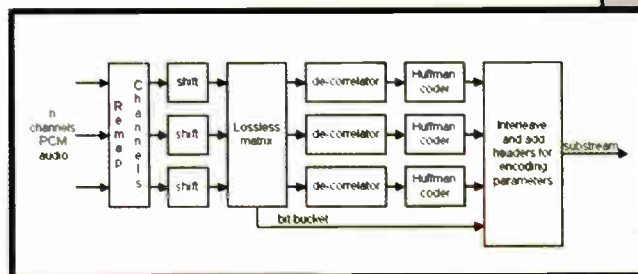

Figure 2B: Encoder core

inventions appeared. As it turned out, at the time these first inventions were being patented, Michael Gerzon died.

Around two years ago, I could see clearly that the specification for DVD-Audio had moved forward—multichannel and high-resolution were now accepted—but that there would still be a strong requirement for lossless compression. So, Meridian decided to fund the development of a lossless coding system. This development process has taken two years of steady effort on the part of Peter

Craven, Malcolm Law, myself and others at Meridian. In that time we turned the concepts into a working system, evolved it, tested it and managed to build in all the very powerful features that we knew would appeal to content providers.

Meridian Lossless Packing (MLP) is now integrated into MLP Ltd., a subsidiary company in the Meridian Audio Group. MLP Ltd. will take the core technology and develop encoders, decoders and other products and ideas.

***How did MLP come to be adopted by the WG4 for the DVD-Audio specification?***

MLP was selected in a committee process that took place this year because of its superior compression and peak data-rate performance. These were central factors for best supporting the DVD-Audio format and providing a safety margin for encoding and playing time. Interestingly, these were the very features on which we had initially concentrated and laid out in the ARA Proposal.

***How and by whom has the bit-for-bit accuracy of decoded MLP material been independently confirmed?***

Bit-for-bit accuracy is determined by encoding and decoding audio files (as .WAV, AIFF or DVD format) and doing a bit comparison. We also do this by capturing the output of a real-time decoder and making the same bit comparison. In the selection process for DVD-Audio, JVC performed independent tests on a number of different audio items.

The MLP encoder also inserts check data into the MLP bitstream. A patented check method is used, and this allows the MLP decoder to indicate that the complete process from encode to decode has been lossless. We imagine a "lossless" light. The MLP decoders in the Meridian Surround Processors implement this feature.

***What is the input format to MLP encoding? Does it work from audio that is already in linear PCM form, or are the data reduction techniques applicable as well to audio in other digital formats? Is there the possibility of direct conversion from analog, or is there always an analog-to-PCM conversion before MLP enters the picture?***

The MLP core always accepts and delivers PCM. It is not applicable to low-resolution bitstreams, or text and picture compression.

***What is the range of word lengths and sampling rates to which MLP can be applied?***

## DOLBY TO HANDLE MLP LICENSING

When it comes to the licensing of technology for consumer electronics products, few companies have the depth of experience of Dolby Laboratories Licensing Corporation. Perhaps it's not surprising that Meridian Audio turned to Dolby—already deeply involved in DVD formats due to the mandated inclusion of Dolby Digital (AC3) surround playback in DVD-Video players—to handle licensing for MLP.

"Dolby is the exclusive licensee of Meridian for MLP and is acting as the licensing entity for MLP technology," says Dolby's Roger Dressler, director of technology strategy. "Dolby will handle all the licensing and technical support aspects in the same manner as for other Dolby technologies, such as Dolby Digital. This includes IC implementations, consumer products and professional encoders."

Dressler describes MLP as a "good fit with Dolby's technology and strategy. MLP is a form of signal processing used to reduce data rate and storage capacity, which is very much in line with our core businesses at Dolby, and it represents a very high standard in its field of lossless coding. Furthermore, MLP incorporates a 'systems approach,' which is very much in line with our philosophy for Dolby Digital. It's not just a compression system, but a comprehensive system for efficiently delivering audio to a range of user requirements, and it includes particular attention to factors such as compatible stereo reproduction, sidechain data for assisting the decoder with future, additional processing applications, and additional channels."

It is actually a bit unusual for Dolby to handle licensing for technology developed out-of-house. "We don't seek to handle outside technologies," Dressler says, "and have turned away many such proposals. But we were approached by Meridian to consider handling the licensing of MLP should it be adopted in DVD-A. Recognizing that the fit was so good—and that most of the prospective licensees for MLP were already Dolby licensees—made the decision quite straightforward on a business basis."

Beyond the strict business reasons, a touch of nostalgia may have played a role in deliberations at Dolby, whose beginnings in studio gear have been somewhat overshadowed by later ventures into sound for film and home theater. "MLP gives Dolby the opportunity," Dressler says, "to provide technology for a unique market segment that harkens back to our roots: the music industry. With the transition to digital meaning less use of A-type and SR in studios, we feel that MLP once again gives Dolby the opportunity to offer music producers and artists greater freedom of creativity: more channels, better quality or both, and to assure it can be delivered through to the consumer."

Deep as Dolby was in the technology and politics of DVD, the company was well-positioned to support Meridian in its efforts to win MLP's incorporation into the DVD-A specification. "Much of our role was in helping Meridian with their technical presentations through our liaison office in Tokyo. Several such occasions occurred well before the WG4 decided to formally consider adopting a lossless system. Dolby also has been in touch with the U.S. music industry to explain the benefits of lossless technology, which we believe helped move the concept forward. This grew into Dolby helping Meridian with some of the meetings in the U.S. and Japan during the evaluation of the lossless systems for the format. Many of the questions about how MLP would be supported and licensed for all the manufacturing companies were quickly answered once Dolby and Meridian were able to announce their relationship. Since Dolby is a known quantity in this regard, that was of some comfort. But it did not affect the selection of MLP, which was done on a purely technical basis."

—Philip De Lancie

*cakewalk*

# **Pro Audio**

**24-bit**  
**96 kHz**

Vector Automation

Real-time

MIDI Plug-ins

Sync **AVI** MPEG

QuickTime

***Now Shipping***

*The new version of the leading MIDI and digital audio software*

[www.cakewalk.com](http://www.cakewalk.com)  
888-CAKEWALK

***cakewalk***

All trademarks mentioned are held by their respective owners.

CIRCLE 4048 ON PRODUCT INFO CARD

Although the limits are not strict, we envisaged MLP for sample rates from 32 kHz up to 192 kHz and for word-lengths between 14 and 24 bits.

*Describe the MLP process: the stages the material goes through, how MLP distinguishes redundant from unique data, what patterns it looks for, and what assumptions are made about the content of the incoming signal.*

The MLP process (see Fig. 2) uses a number of proprietary technologies. It uses three methods to reduce the data rate. Lossless processing and lossless matrixing are used to reduce the correlation between channels. Lossless waveform prediction is used to reduce the inter-sample correlation, with a very large palette of special filters. And Huffman coding is used to reduce the data rate by efficiently encoding the most likely occurring successive values in the serial stream.

This combination of methods has been designed to ensure not only a very good compression ratio, but also to ensure the all-important issue of holding down peak data rate; lossless coding produces a variable rate of output data, and it is necessary to keep the peaks low enough for use on carriers. MLP also uses a proprietary data buffering scheme to smooth the data rate.

MLP makes no assumptions about the incoming data, and it is not looking for patterns. It operates on waveforms. However, the lossless processing is applied to lossless IIR prediction methods, and this is particularly helpful on real-world audio signals from real microphones, which tend to have an output that falls with frequency.

*Since MLP's ability to reduce bandwidth requirements varies depending on the program material, how is absolutely lossless performance at a given data rate assured in the fixed-*

*bandwidth mode?*

The fixed data rate mode may be achieved by a two-pass process, in which case the encoder and packetizer determine the bandwidth that is needed. Alternatively, the operator may "dial-in" a fixed data rate. If the MLP encoder cannot achieve the compression, the encoder will issue an error message and the operator needs to take action. The likelihood of this arising depends on the rate requested. There are a very small number of signals that can be made up to prevent MLP from achieving adequate compression, but on real audio material, we have never been able to catch it out in the task of fitting any audio within the bandwidth of the DVD-Audio specification.

That said, the issue of the amount of compression is important. If there isn't enough compression to control peak data rate or to get that extra two minutes of playing time, MLP's method allows the content provider to make fine adjustments to the incoming signal to save on data rate. For example, input precision can be moved in 1-bit steps. In addition, the system is very effective at detecting band-limiting. So playing time can be increased by redithering a 24-bit signal to 23 or 22 bits—with or without noise-shaping—or by filtering one channel to LFE [low frequency effects], or reducing the audio bandwidth at 96kHz sampling from 48k to 40k before feeding it to the MLP encoder. This gives content providers almost limitless scope to tweak playing time and channel options.

*What are the various multichannel options supported by MLP for the DVD-Audio application, and what kind of mixed-resolution playback options are available?*

MLP's bitstream supports up to 63 channels, with sampling

AEROSMITH • RITCHIE BLACKMORE • TULKU • THE MUSTARD SEEDS

CHICAGO • BLACK 'N' BLUE • TALAS

STUART SMITH • KAI • PATTI AUSTIN

# MASTER your MUSIC to the HIGHEST LEVEL

CDR CLONES AS LOW AS \$5. NEXT DAY!



**QUADIM MASTERING**

We're Quadim Mastering. We have top engineers using world-class gear in some of the most comfortable, true-sounding studios around. We offer a fresh approach, attention to detail, amazing service, and a reputation for producing award-winning mastering. So come on by, or send us a tune and hear for yourself what we can do.

Call us at 818-706-8843 • Fax 818-706-8426

Free pick-up and delivery in the Los Angeles, Hollywood, Santa Monica and Valley areas.

CARMINE APPICE • ZACK WYLDE • SHAWN GOLVIN • PURE SUGAR

CIRCLE #049 ON PRODUCT INFO CARD



# Mean Business

ALESIS

M20

S-VHS

adat  
TYPE II



**adat**  
TYPE II

Although the M20 uses our new 20-bit ADAT Type II recording format, it's completely compatible with more than 110,000 ADATs in use around the world.



An all new remote/autolocator, the CADT™, provides control of up to eight M20s from hundreds of yards away. Remote metering in the control room is made possible by the new RMD™ meter display.

In commercial recording and post production, there's no room for compromise and no time for excuses.

While you're up and running 24 hours a day, seven days a week, your recording equipment has to set the pace for your facility. So the Alesis M20™ was designed to handle all the business you take on. With features like a direct-drive, servo-controlled tape transport that offers the fastest lock times of any MDM ever made. Comprehensive built-in synchronization. And many more features we added off the professional ADAT users' wish list.

Let's not forget audio quality. The M20 features ADAT Type II, the only MDM recording format that writes 20 bits to tape. State-of-the-art 24-bit A/D converters that yield an astonishing 115dB of dynamic range. Whether you're mixing a jazz combo or posting a feature film, you'll hear the difference.

So if you've been waiting for an MDM that works as hard as you do, it's here. Take care of business with the M20. Available today at a select range of Authorized Alesis Professional Audio and Broadcast dealers.



The M20's comprehensive feature set includes built-in SMPTE/EBU sync, MIDI Machine Control, provision for 9-pin edit control, a true jog/shuttle wheel that scrubs forward and backward, and dedicated aux and time code tracks. Everything you ever wished for in an ADAT. And more.



The M20's S-VHS recording media is the least expensive, most effective storage for digital audio data. Over 3.4 gigabytes of data gets stored on each tape. Cost? About fifteen bucks.

CIRCLE #050 ON PRODUCT INFO CARD

For a complete list of Alesis M20 retailers in the US, call us at 800-5-ALESIS or get on the internet at [www.alesis.com/m20dealers](http://www.alesis.com/m20dealers). In other parts of the world, contact your Alesis distributor. \* Alesis and ADAT are registered trademarks; M20, CADT and RMD are trademarks of Alesis Corporation.

Alesis Corporation

1633 26th Street Santa Monica CA 90404 800-5-ALESIS [www.alesis.com](http://www.alesis.com)

ALESIS

Professional recording

rates ranging from 32kHz up to 192kHz—including the set based on 44.1kHz—and up to 24-bit resolution. Mixed rates are supported in that some channels can have sampling at twice the rate of others. Mixed resolution is supported automatically—you can feed 24-bit to some channels and 16 to others, and the compression will be automatic.

The MLP stream has an information channel that allows decoders to know if it is dealing with speaker feeds—and if so, which speakers—or if the signals are hierarchical. It also has provenance data describing if speaker feeds are

from hierarchical or binaural sources, as well as copyright and ownership data. This allows the stream to be very complete and enables sophisticated receiving equipment to reconstruct more accurate surround.

*How will MLP handle downmixing from surround to stereo on DVD-Audio, and what are the MLP options allowing producers to influence the downmixed result?*

DVD-Audio has four ways of delivering a 2-channel version of a multichannel mix. Which one will be used will depend on the playing-time requirements, the data rate of both mixes, and the de-

sires, prejudices, budget and time-scale of the content provider. A separate 2-channel mix can be placed on a second layer, on a second side, or in a separate track or separate audio stream in a track on the same layer as the multichannel mix.

Alternatively, the player can make a downmix at playback time of a multichannel mix stored on the disc. The downmix is not fixed; DVD-Audio has a huge number of options for the tables of mix coefficients used to create the 2-channel mix, and the mix parameters can change. The downmix option can be very helpful if the multichannel content is very long, or if it is high-precision, which uses a lot of the disc budget, or if the provider cares less about the 2-channel or cannot afford to make two different mixes.

MLP supports all of the options offered by the DVD-Audio specification, but it offers a number of added benefits. It allows longer playing time and/or higher resolution in both mixes. It can, in some cases, remove the need to use a second layer. Also, with MLP the downmix is made by the MLP encoder rather than the player. The MLP stream then carries both the 2-channel and multichannel versions in the same stream and delivers both losslessly. The 2-channel version is carried virtually for free in the payload. And because the MLP encoder is in a piece of pro gear and its downmix can be monitored, the mixer can make the mix using the encoder and listen to it before signing off on it.

*Many producers would prefer to create their own stereo mix rather than rely on an algorithm to downmix from a 5.1 mix.*

Some will, some won't. Some will care more about the 2-channel mix and may put on a restricted-precision multichannel mix.

*Assuming a limited-bandwidth LFE channel, side-by-side delivery of separate 5.1 and stereo mixes would require storage space equivalent to 7.1 channels. Using MLP on all 7.1 channels, how many minutes of 24-bit/96kHz audio would fit on a DVD-5 DVD-Audio disc?*

DVD Audio only allows six channels in a stream. So, rather than having the multichannel and 2-channel mixes in the same stream, you have two separate regions, one containing multichannel and the other containing two channels. This is necessary anyway in order to constrain peak data rate. Using MLP, these two sets of content at

## The future of professional audio is right here. Right now.

When top audio professionals in New York City need the best people, products and support, there's only one place to call. Sam Ash Professional.

**People.** You'll get the right information. Because our courteous and knowledgeable staff have years of hands-on experience in every phase of professional audio.

**Products.** The products you need will be in stock. Because we have the world's largest inventory of the latest in digital recording hardware and software, digital video, signal processing, microphones, studio monitors, mixers and MIDI equipment. More importantly, we'll give you all the time you need to explain exactly how these products integrate into your project.

**Service and Support.** You will feel confident after your purchase because of our unparalleled technical support and friendly personal service.

**Parts Department.** Our Parts Department is unmatched in the industry with a huge selection of professional components, cables, connectors, patchbays, custom wiring rigs and more.

**Convenience.** To make things easier, we accept all major credit cards and extend corporate accounts. We ship fast and on time—just the way you need it.

**We're Just A Phone Call Away.** So, no matter where you are, please call and find out what top professionals in New York have known for years. If you want to know where pro audio is going, go to Sam Ash Professional.

Call (212) 586-1100  
Fax (212) 586-3375

Experience The Very Best In Professional Audio  
From The Heart Of New York City

**Sam Ash**  
PROFESSIONAL AUDIO GROUP

1600 Broadway, 8th Floor, New York, NY 10019  
Between 48th and 49th Streets

# PURE CONVERSION.

*We concentrated first on the quality of conversion with the AUDI/OTM series. Then we added the professional features you need to get the job done right. Nothing fancy, just great sound and ease of use. 24 bits is our standard, as always. ADAT lightpipes provide compatibility, low cost, ease of use, and freedom from ground loops and EMI/RFI. Check them out at your favorite music/pro audio store. Full specifications and suggested list prices available on our website.*



AD/24  
DA/24

*Eight channels in a standard half rack package. Mix and match octets of conversion. Balanced XLRs (+4/-10) and 117dB S/N ratio make sure your audio is pure. Features word clock, activity/peak LEDs, 48KHz/44.1KHz sample rates.*



AD/9624  
DA/9624

*Mastering quality converters run at 96KHz/88.2KHz switchable to 48KHz/44.1KHz. Eight channels made them great for DVD/surround. Can also be used as an AES/EBU interface. Connects to STUDI/O via the S/MUX™ system. Features +4dBu balanced XLR, switchable dither, bit splitting, precision analog level trims, LED indicators for status and signal level.*



AES/8

*Designed for video post, to connect AES/EBU, SPDIF, and TDIF equipment to your DAW via STUDI/O. Features word/video lock, source switching per channel (AES/TDIF), input sample rate tracking (async. sample rate conversion), pull-up/pull-down locked to NTSC/PAL video, activity LED's on each input and output channel, illuminated buttons, switchable SPDIF/AES output format, full 24-bit signal path (20-bit sample rate conversion).*

STUDI/O

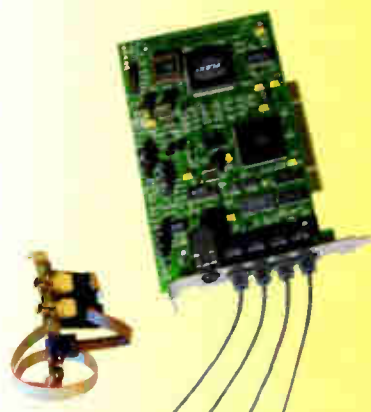

*Of course, the Award Winning DAW interface which gives you everything you need (pristine 24-bit audio, compatibility, expandability) without everything you don't need (high price). Just about every audio editor around - Mac and PC - is compatible (check our website for up to date compatibility info and application notes), and with the new the S/MUX™ system you can now use your favorite application for 96KHz projects.*

Sonorus, Inc., 111 E. 12th St., NY, NY 10003, USA Phone: +1-212-253-7700 Fax +1-212-253-7701  
<http://www.sonorus.com> [info@sonorus.com](mailto:info@sonorus.com)

All trademarks registered by their respective companies. ©Sonorus, Inc.

CIRCLE #051 ON PRODUCT INFO CARD  
World Radio History

# AUDI/O



SONORUS

Handcrafted  
ONE AT  
A TIME



### THE CUSTOM CONSOLE

*The Custom Console  
for Yamaha, Mackie,  
Soundcraft, Ramco*

*Custom Cabinetry  
for studio, audio,  
video, post*

*Sound Construction and Supply, Inc. creates every Custom Console from the finest materials, one at a time, providing each piece with the durability of rugged construction and skillful craftsmanship. If we don't have what you need, we will work with you to create a unique Custom Console exactly to your specifications. Call us at (615) 313-7164 or visit our website at [www.custom-consoles.com](http://www.custom-consoles.com) for more information.*



CIRCLE #052 ON PRODUCT INFO CARD

96kHz/24-bit would typically play for more than 70 minutes each. The play time increases to 76 or 83 minutes for 23-bit and 22-bit resolution. It also increases if the bandwidth of the audio is less than 48 kHz. The reduction in word-size can be made with any suitable box and can use an arbitrary set of dithering/noise-shaping methods, including no shaping.

*Aside from the capacity issue, are there other obstacles to putting both a 5.1 MLP and a stereo MLP mix on one disc, and letting the listener choose depending on personal preference and the configuration of the playback system?*

There are none. The limit will be what the content provider wants to do. A multichannel player will allow playback of the multichannel or the 2-channel versions. Of course, a 2-channel player must play the 2-channel version.

*What is the current state of MLP encoding gear? Are encoding devices commercially available? From whom? Right now, MLP encoders exist as development tools, but they should be available for content generation by year's end. We consider that there will be a significant market for MLP encoders in recording, mastering and distribution systems, so real-time and near-real-time stand-alone hardware encoders are under development, as are PC-based encoders. And Meridian is in discussion with all the major makers of DVD authoring systems.*

*What is the current availability of MLP decoding equipment? What major semiconductor suppliers have agreed to market MLP-capable playback chips?*

Meridian has already added MLP decoding to its surround decoders. The next commercial phase is expected to be MLP decoders in DVD-Audio players. We are in discussion with ten semiconductor makers, all of whom we expect to make the decoder available in IC form.

*What applications do you foresee for MLP in addition to the DVD-Audio format? What steps have been taken or planned by Meridian or others to ensure widespread adoption of MLP decoding capability in settings other than DVD-Audio players?*

We see applications in recording, archiving, distribution and filmmaking, but our current efforts are concentrated on DVD-Audio. Following this, we will focus on outboard decoders and professional applications ■

*Phil De Lancie is Mix's media & mastering editor.*

**In Your Dream...** you're producing a session while reclining leisurely on a stack of goose-down pillows, surrounded by agreeable musicians with golden, perfectly-tuned instruments and super models who feed you fresh tropical fruits, fan you with palm fronds and massage your feet...and any piece of professional audio or midi equipment you could possibly desire can be rented day or night, and delivered to almost anywhere in the world and in perfect working condition...

Oh, did we mention we're nice people, too, sensitive to your tight budgets and

**Dreamhire**

PRO-AUDIO RENTALS

deadlines? Call us on it. You'll think you'd died and gone to heaven.

New York City: (212)-691-5544 / (800)-234-7536 Nashville: 615-321-5544 / (888)-321-5544 London: 011-44-181-451-5544

CIRCLE #053 ON PRODUCT INFO CARD

# FINALLY, A POWERFUL 24-BIT DIGITAL EQ THAT THINKS IT'S ANALOG



## Protēa

The incredible new Protēa Digital Equalizer from ASHLY is like nothing you've ever experienced for live sound, permanent installations, or even recording. It completely redefines the possibilities of equalization with four independent channels of 28-band, 1/3-octave equalization, accomplished in full 24-bit digital resolution. Its simple, push-button interface is as close to analog as you can get, while maintaining unprecedented control over all parameters via a high-resolution LCD display which provides immediate visual representation of all functions. Need to adjust a frequency? Press the button and watch the fader move in real-time on the LCD display. Plus, it provides built-in full-function compressor/limiters, time-delay alignment functions, high and low pass filters, and much more, all fully



Optional 4.24RD Full-Function Remote Control with Display

programmable and storable. Whether you operate it from the front-panel, from the available full-function remote (which works from up to 1000 feet away with an ordinary mic cable or snake), or via the free Protēa System Software for Windows™, you won't believe the control and quality the Protēa affords you. We've even designed it to grow with you, with 2- and 4-channel digital equalization slave units available for expansion of up to sixteen channels of precise, reliable digital equalization. Never has digital equalization been so easy to use.



Optional Slave Units in Two (2.24GS) or Four (4.24GS) Channel Versions, Which Can Operate Independently, are Controllable From The Master, Remote, or a Computer, to Greatly Expand Your Possibilities

Power Amplifiers • Graphic Equalizers • Parametric Equalizers • Crossovers • Remote-Controllers • Mixers • Signal Processors

## ASHLY

Ashly Audio, Inc. • 847 Holt Road, Webster, NY 14580-9103

Toll Free: 800-828-6308 • Tel: 716-872-0010 • Fax: 716-872-0739 • <http://www.ashly.com>

International Agents: E&E Exports, Inc., 17922 Sky Park Circle, Suite P, Irvine, CA 92714 • Tel: 714-440-0760 • Fax: 714-440-0766

In Canada: Gerraudio Distribution Inc • Toll-Free Tel: 888-462-8346 • In Mexico: Comercializadora Gonher S.A. de C.V. • Tel: 52 (17) 16-82-00



# Power Amplifiers

## New Designs for the Studio

by Loren Aldrin

In the average recording studio, it's a safe bet that the power amp is one of the least-appreciated pieces of gear in the rack. With a dismal number of LEDs and knobs for the money, the power amp doesn't exactly pack the wow factor of a new digital processor.

Thankfully, power amps are too busy with their crucial role to be concerned with fanfare. The power amp is responsible for turning a trickle of electrons into a mighty flow of current, strong enough to fill a room with sound. A good power amp responds almost instantaneously, all the while maintaining a ruler-flat frequency response with

negligible distortion and noise.

There are as many approaches to building these workhorses as there are manufacturers. Output topologies, power supply designs, input stages, tube vs. solid-state—the amplifier design field is as varied as any other in the studio realm. And price points can range from several thousand dollars for a mono block to a few hundred for a stereo.

So whether you're after a high-dollar amp with more tubes than a '60s electronics store or an inexpensive MOSFET design to drive a pair of near-fields, today's market has something for you. Here is a survey of new studio power amps introduced this year.

**AB International** introduces new 3-, 4- and 6-channel amps; each amp style is available in three different output power configurations. All models offer balanced XLR and 1/2-inch inputs, bridge switches, selectable input sensitivity and "soft clip" circuitry. The 3-channel versions offer an internal crossover with selectable frequencies for bi-amplified operation. Output power for 4- and 6-channel amps ranges from 200 watts to 600 per channel into 4 ohms; prices range from \$1,108 to \$1,849 (4-channel), \$1,479 to \$2,490 (6-channel). Three-channel amps offer stereo output power from 350 to 800 watts, with sub-woofer outputs between 750 and 1,500 watts. Prices for 3-channel models range from \$1,572 to \$2,490.

The Millennium 2 and Millennium 3 2-channel power amps from **BGW** are now available with a built-in processor card for bi-amplified monitoring applications. The MIL 2 TMC-2 and MIL 3 TMC-2 offer switch-selectable crossover points, highpass filter, screen loss equalization, horn equalization, low-frequency delay and low/high-frequency output attenuators. The MIL 2 TMC-2 (\$1,048) puts out 300 watts per channel into 4 ohms, while the MIL 3 TMC-2 (\$1,408) delivers 450 watts.

New from **Bryston** is the 9B 5-channel monitor amplifier. Designed for surround monitoring applications, the 9B delivers 200 watts per channel into 4 ohms or 150 watts into 8 ohms. Each amplifier channel has its own dedicated power supply and is modular for quick service. Other features include ultralow output distortion (0.007% at rated power); quad-complementary output section; balanced XLR, 1/4-inch and unbalanced RCA inputs; and 20-year transferable warranty. The 9B is available in standard (\$3,695) and THX-approved versions (\$3,795).



*Carvin DCM 2000 stereo amp*

**Carvin** introduces four redesigned stereo amps suitable for studio or live sound use. All four offer improved cooling, redesigned chassis, XLR and 1/2-inch balanced inputs, opto-isolator limiting circuits, hand-wound toroid transformers, signal/clip/protect LEDs, bridging switch for mono operation and multispeed fan. Power output per channel into 4 ohms is as follows:

DCM 600 (\$360) 250 watts, DCM 1000 (\$440) 350 watts, DCM 1500 (\$540) 500 watts, DCM 2000 (\$640) 700 watts.

Made in England and now distributed on our shores, the **Chevin Research** line (a division of Sennheiser) includes 11 single-, dual- and quad-channel amplifiers designed for studio or live sound applications. The compact, single-rackspace A500 (\$999, stereo) only weighs nine pounds yet delivers 350 watts per channel into 4 ohms. The stereo A750 (\$1,349) puts out 425 watts per channel; the Q6 (\$2,849) delivers 600 watts to each of four channels. All Chevin Research amps offer variable-speed fan, sophisticated speaker and amplifier protection, symmetrical audio signal path, wide power bandwidth and fast transient response.

**Chord Professional** (distributed by Professional Audio Design, Rockland, Mass.) introduces the SPA 1424 amplifier for critical studio

monitoring applications. The mono block APS 1424 delivers 500 watts into 4 ohms through 24 specially designed MOSFET output devices. The Class AB SPA 1424 also offers high-frequency switching power supply, lightweight chassis (10.5 pounds), unique "dynamic coupled" rail system, balanced XLR input and dual output connectors for bi-wiring. The SPA 1424 has a list price of \$4,295.

Ready for double-duty in studio or live sound racks are the new CE 1000 and CE 2000 amplifiers from **Crown**. Both offer stereo or bridged mono op-

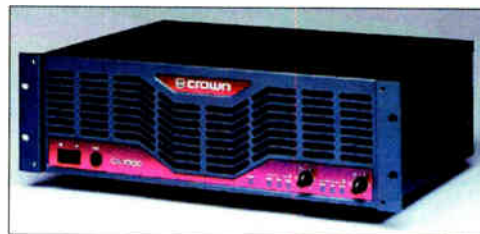

*Crown CE 1000 amplifier*

## FEATURED AMPLIFIER MANUFACTURERS

**AB International**  
916/783-7800  
www.abamps.com  
**CIRCLE #236 ON PRODUCT INFO CARD**

**BGW**  
310/973-8090  
www.bgw.com  
**CIRCLE #237 ON PRODUCT INFO CARD**

**Bryston**  
800/632-8217  
www.bryston.ca  
**CIRCLE #238 ON PRODUCT INFO CARD**

**Carvin**  
800/854-2235  
www.carvin.com  
**CIRCLE #239 ON PRODUCT INFO CARD**

**Chevin Research**  
860/434-9190  
**CIRCLE #240 ON PRODUCT INFO CARD**

**Chord Professional**  
Distributed by Pro Audio Design  
781/982-2600  
www.proaudiodesign.com  
**CIRCLE #241 ON PRODUCT INFO CARD**

**Crown Audio**  
219/294-8329  
www.crownaudio.com  
**CIRCLE #242 ON PRODUCT INFO CARD**

**Demeter Amplification**  
818/986-7103  
demeteramps.com  
**CIRCLE #243 ON PRODUCT INFO CARD**

**Hot House Professional Audio**  
914/691-6077  
**CIRCLE #244 ON PRODUCT INFO CARD**

**LAX Sonic Solution**  
818/710-7604  
**CIRCLE #245 ON PRODUCT INFO CARD**

**Nagra**  
Distributed by Canorus  
615/252-8778  
www.canorus.com  
**CIRCLE #246 ON PRODUCT INFO CARD**

**QSC Audio**  
714/754-6175  
www.qscaudio.com  
**CIRCLE #247 ON PRODUCT INFO CARD**

**Samson**  
516/364-2244  
www.samsontech.com  
**CIRCLE #248 ON PRODUCT INFO CARD**

**Yorkville**  
716/297-2920  
**CIRCLE #249 ON PRODUCT INFO CARD**

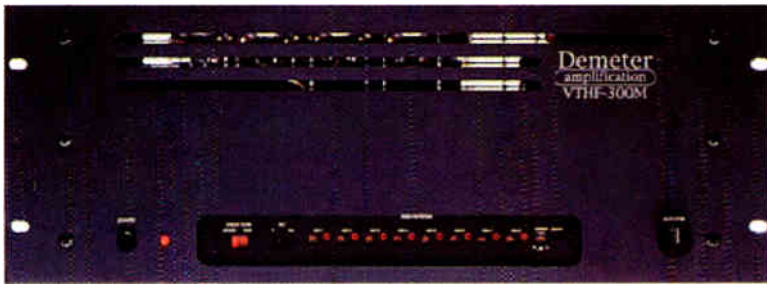

Demeter VTHF-300M mono block tube amp



Hot House Four Hundred studio amplifier

eration, three-way balanced inputs, variable-speed cooling fan, signal present/clip/fault LED indicators, SST plug-in module compatibility and three-year warranty. The CE 1000 (\$700) delivers 450 watts per channel into 4 ohms; the CE 2000 (\$1,000) puts

out 660 watts per channel into 4 ohms. Targeted at both studio and audiophile applications, the Demeter VTHF-300M mono block tube amp delivers 350 watts output in pentode mode and 180 watts in triode. The VTHF-300M (\$2,650) offers gold-plated RCA con-

ductor, 31-detent input potentiometer, polypropylene caps, eight Ruby selected and matched power tubes, individual tube bias controls, tube adjustment pins and variable feedback control.

Hot House Professional Audio debuts its model Four Hundred high-resolution control room amplifier. Designed from the ground up as a studio monitor amp, the Four Hundred offers 200-watt output per channel into 4 ohms, bridging capability, 3 to 180k Hz bandwidth, balanced XLR and 1/4-inch inputs, and toroidal transformer with split-dual secondaries for improved stereo separation. The Hot House Four Hundred has a list price of \$1,699.

New from LAX Sonic Solution is the MA-2400, a stereo amp that delivers 220 watts per channel into 8 ohms (330 into 4 ohms) and can be bridged for mono applications. The Class H MA-2400 (\$680) offers LAX's NLR circuit to reduce nonlinearity caused by overdriving, with two-rackspace chassis, balanced XLR inputs and three-year warranty.

Nagra's newest offering into the studio and audiophile markets is the stereo MPA MOSFET power amplifier. Delivering 350 watts per channel into 4

**MediaFORM's NEW Driving Force...**

**NEW!** World's Most Advanced CD Duplicator

**CD-3707**

Automated Systems Start at \$4,995.00



**AUTOMATED Spindle Based CD-R Copier**

- 7-Drive / 200 CD-R Capacity
- Networkable to 28 CD-R Drives
- Analog / Digital Audio Import Options
- Simple ONE-BUTTON Operation
- Copies All Current CD Formats
- Best Selling CD-R Duplicators in the WORLD!

**THE BEST JUST GOT BETTER**

**MediaFORM**

400 Eagleview Blvd., Suite 104  
 Exton, PA 19341  
 Phone: 610-458-9200  
 Fax: 610-458-9554  
 Toll Free in the USA 800-220-1215  
 email: info@mediiform.com  
 web: http://www.mediaform.com

CD-3707 is a trademarks of MediaFORM, Inc. All other trademarks remain the property of their respective companies.

CIRCLE #055 ON PRODUCT INFO CARD

World Radio History



# And the Winner is...

## Hafler P4000

Once again Hafler's superior amplifier technology is confirmed! Winner of the 1998 Mix Magazine Tec Award; the Hafler P4000 was chosen as best for performance and value. It is the professional standard."

**Hafler**  
trans.nova  
P4000 DIABLO



**Hafler**  
the standard

Tempe, AZ 85281 USA • 888-HAFLER1 (phone) • 602-894-1528 (fax) • [www.hafler.com](http://www.hafler.com)

World Radio History

CIRCLE 106 ON PRODUCT INFO CARD

©1998 Hafler

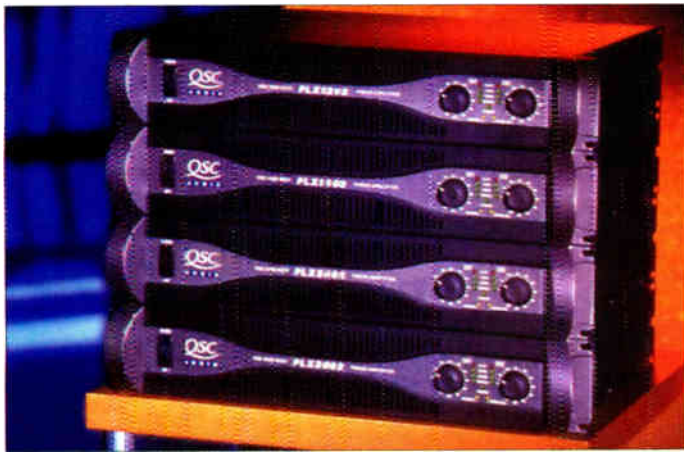

QSC PLX Series stereo amplifiers

## When you use **soundbusiness** to track recording budgets, you're in good company...

PolyGram • Virgin • MCA • Worlds End Management  
 Universal Music • Interscope • BMG Classics  
 N2K Encoded Music • Warner Bros. Nashville  
 Def Jam • Elektra Entertainment • Glen Ballard  
 Pioneer Music Group • Mercury Nashville  
 Freeworld Entertainment • Windham Hill • Don Was

The most powerful and innovative software system ever for creating, editing, and tracking phonograph recording budgets, payments, AFM and AFTRA reports, and *much more*.

**Step into the future...call today!**



**soundbusiness**  
 MUSIC PRODUCTION MANAGER

E Ware Systems, Inc. 888-600-4934 Developed in association with XWare, Inc.  
 www.soundbiz.com • eware@soundbiz.com Windows or Macintosh

CIRCLE #057 ON PRODUCT INFO CARD

World Radio History

ohms, the MPA offers Class AB output through eight hand-selected MOSFETs, Power Factor Correction technology for smoother power draw and balanced XLR inputs. The MPA remote control version offers an infrared remote, 4-input switching capability, output power meters, balance control and mute button. Distributed by Canorus Inc. (Nashville, Tenn.), the Nagra MPA has a list price of \$12,000 for the standard version and \$14,500 with remote control/multiple input option.

The new PLX Series of stereo amplifiers from QSC includes four models, all sharing the same two-rackspace chassis and low 21-pound weight. All PLX amps offer high-frequency PowerWave™ power supplies; variable-speed fan; switch-selectable highpass filter, bridge mode, parallel mode and clip limiter; balanced XLR and 1/2-inch inputs; 3-segment LED signal level meter with clip indicator; and detented input level controls. Output power per channel at 4 ohms: PLX 1202 (\$798) 325 watts, PLX 1602 (\$1,198) 500 watts, PLX 2402 (\$1,498) 700 watts, PLX 3002 (\$1,798) 900 watts.

For monitoring needs that can be satisfied with an affordable, low-power amplifier, Samson introduces the Servo 120. The Servo 120 delivers 60 watts per channel (into 4 ohms) with low distortion and a 10 to 100k Hz bandwidth. This single-rackspace amp offers silent convection cooling, bipolar design, toroidal power supply, 5-segment stereo input level meters, balanced or unbalanced inputs and front-panel headphone jack with speaker-disable switch. The Servo 120 has a list price of \$199.



Yorkville Studio Reference SR-300 amp

Yorkville introduces a new amplifier and a new amplifier line with their Studio Reference SR-300 amp. The stereo SR-300 delivers 150 watts per channel into 4 ohms, balanced 1/2-inch inputs, push-terminal and 1/2-inch outputs, front-panel attenuators, signal present/limit/clip LEDs, convection cooling and selectable highpass filter. The SR-300 lists for \$499. ■

*Loren Alldrin is a Nashville-based engineer, producer and studio owner.*

# Learn to Mix with the best



The world's biggest educator in audio and multimedia is coming to America, and when it comes to the WOW! factor - it is hard to compare anything to the SAE Institute of Technology.

For three very simple reasons.



(Total practical education)

US.

(And only us)

First, there are 27 SAE Institutes in 14 countries around the world. Our students have an impressive graduation rate leading to a high percentage of them obtaining professional employment. Only SAE makes it possible for students to transfer between any of our schools. Imagine starting in the US, moving on to London, Paris, Munich or even Sydney! It's all part of the better SAE education system. Currently there are over 12,000 students at SAE!

Neve VR and SSL G+ consoles in all our US Institutes (The studio standard)



YOU.

(And only you)

Second, we teach the whole person. Our practical curriculum is designed for the individual student, we have more studios and facilities than any other audio or multimedia school. Our programs are standardized throughout the world, each SAE Institute adapts its courses to fit in with local market needs. There is no chance of a class of 30 being taught mixing in cramped conditions - not at SAE!

Third, we offer fully recognized qualifications, with our accredited Sound Technology Diploma\*\*, the Multimedia Producer Diploma, the Bachelor of Arts (Honors)\* degrees in Recording Arts and Multimedia Arts that lead to Masters and Doctorates. Graduates of SAE have the opportunity of a paid internship with the Walt Disney Corporation. Our programs are industry recognized and widely respected since 1976.



For more information and a free color catalog call any of these centres of educational excellence:

New York (212) 944 9121 Nashville 1-877-272 8346

London Paris Singapore Sydney Athens Auckland Zurich Milano Stockholm Hamburg Rotterdam Amsterdam Munich Geneva Melbourne Frankfurt Vienna

Tel: 1-877-27 AJDIO

**SAE**  
INSTITUTE

[www.sae.edu](http://www.sae.edu)

\* In exclusive educational association with  
MIDDLESEX UNIVERSITY - LONDON

\*\* In cooperation in sound engineering with  
Walt Disney Entertainment®

World Radio History  
CIRCLE #058 ON PRODUCT INFO CARD

# Way More Than Four More

The New Fostex FD-8: Eight Tracks of Unprecedented Flexibility and Power—Priced at Under \$900

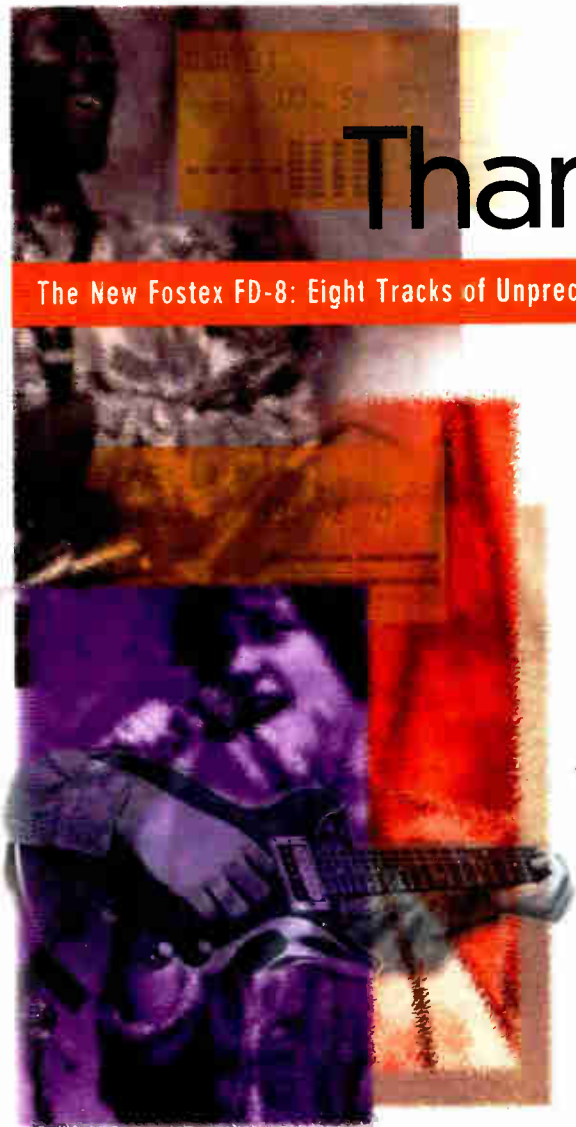

**Y**ou could say that the new Fostex FD-8 is a duplicate version of Fostex's groundbreaking FD-4 digital recorder plus 4 channels more. But you'd be overshadowing the FD-8's amazing list of powerful, professional features. Because in addition to offering 8 channels of pure Fostex digital audio, the FD-8 also gives you two independent recording modes (one maximizes sound quality, the other recording time), 16 Virtual Tracks (for a total of 24 recording tracks), "Digital Track" inputs and outputs, and much more. Even full MIDI implementation. Plus, just like the FD-4, it gives you the freedom to choose your own optional SCSI recording media from a wide variety of available removable and hard drives. And with an M.S.R.P. of only \$899, it shines a whole new light on what you can expect from a portable digital multitracker.



I/O jacks provide best solution to exchange up to eight tracks of data with an ADAT™.



Full Cut/Copy/Paste/Move plus Undo and Redo.



Uncompressed 44.1kHz, 16-bit linear CD-quality digital audio.



With Mic Trim on channels 7 and 8 for use with low-Z microphones.



Input digital signals from other sources and output directly.



Analog 8 IN x 2 OUT familiar mixer with 105dB dynamic range.



3-point EQ (2 shelving & 1 parametric types) on all 8 channels.

**FD-8**  
**LIMITLESS**  
**Fostex**



Don't need a full eight channels? The original limitless multitracker, the FD-4, gives you four channels of pure, "no-compression" digital recording and many of the professional features you'll find in the FD-8. It's the only four-track multitracker that lets you choose your own recording media from a variety of removable and hard drives. And—best of all—you can get your hands on one for under \$600!

Fostex Corp. of America • 15431 Blackburn Ave. • Norwalk, CA 90650  
Tel: 562-921-1112 • Fax: 562-802-1964 • <http://www.fostex.com> • e-mail: [info@fostex.com](mailto:info@fostex.com)

**Fostex**

# DAVE JERDEN

## FUNDAMENTALS FROM JANE'S TO CHAINS

A quick perusal of his credits shows that Dave Jerden has worked on a lot of really cool records. He blends a bit of the purist with the iconoclast, and he's assembled a discography that cuts a wide swathe through musical styles. One of the very first engineers to use samples (Jerden was recording and mixing engineer on Herbie Hancock's groundbreaking 1984 album *Future Shock* and its hit single "Rockit"), he was also the guy behind the board for that unforgettable moment when the guitars come slamming in on Alice In Chains' "Rooster" from 1996's *Dirt*. A few other highlights: Jerden was the recording and mixing engineer on Talking Heads' *Remain In Light* and David Byrne and Brian Eno's *My Life in the Bush of Ghosts*, and the producer/mixer of Jane's Addiction's *Nothing's Shocking* and *Ritual De Lo Habitual*, Social Distortion's *Social Distortion* and *Somewhere Between Heaven and Hell* and The Offspring's *Ignray on the Hombre*. He has also worked with Frank Zappa, Tom Verlaine, Jane Child, Red Hot Chili Peppers, Anthrax and the Rolling Stones.

A previous interviewer called Jerden a "sonic bricklayer," an apt description that conveys his unique blend of skills—artistic, yet all business. He's a guitar-loving rock engineer who is also totally comfortable with technology. In person, he comes across as intense, highly creative and quite serious, with a demeanor rescued from severity by frequent flashes of dry humor.

He'd just finished mixing The Offspring's latest release, *Americana*, when we found him at El Dorado, his Los Angeles recording studio of choice. It's an industrial, warehouse-type space, and the control room was equipped with three separate computer rigs, a super-sized roadcase packed with guitar amp heads, and a second wall-sized roadcase filled with



PHOTO: MAUREEN DRONEY

Summit tube gear. As we talked, Jerden seemed to be in constant motion—opening road cases to display a piece of gear, paging through screens on a computer, pacing out to the studio to point out a detail. Even in repose he emanates a considerable energy field.

### *Did you start out as a guitar player?*

Guitar and bass; I started playing in bands when I was 12. My father was a bass player, and he encouraged me. Most kids, when they get their first guitar, it's a piece of crap. But when I took an interest in playing guitar my father bought me a really nice Gibson. Then, when I had an opportunity to play bass in a band, he bought me a Fender Precision bass. I played in bands early on, not because I was any good, but because I had good equipment.

### *Did you take lessons?*

For a few years. My dad was always trying to push me toward heavy reading—he had goals for me to be a jazz musician.

*Wait a minute. Nobody's parents' goal is for their kid to be a jazz musician!*

I was really fortunate. All along the way I had encouragement from my family. And when I crossed over to engineering, they were also totally supportive.

### *How did you make that transition?*

I wasn't making any real money as a musician. I was in a band with Eddy Schreyer, who has Oasis Mastering now, and he went to engineering school, so I decided to try it. It was called the University of Sound Arts; it wasn't any great shakes, but one thing I learned there was what books to read. I bought this one book, *Modern Recording Techniques*, by Runstein, and I memorized it. I figured if I knew everything in that book, it would give me a good start. I still to this day use a lot of what I learned in that book.

### *So you went to school and read books and got a job as an assistant?*

I got a job at Smoketree Studios as engineer/assistant/whatever. After that I worked at a studio called Redondo Pacific, and after I left there, El Dorado hired me because they'd just purchased an MCI automated console, which I knew how to run. That was the first El Dorado—it's now torn down—a studio built in

BY MAUREEN DRONEY

the '60s for rock 'n' roll. Of course, this was the late '70s and it was still in the '60s. I went in there and the owner gave me \$4,000 to redo the whole studio. So I hired an acoustician for one hour for \$160 and had him write down on a napkin what he would do if he was going to remodel. Then I hired a foreman, brought in a crew and redid the control room. And that was the room where I did "Rockit" and Talking Heads.

That's where I really learned, because I was by myself—I did everything that came in the door and all the maintenance, too. Disco, country or rock 'n' roll, I approached it all the same. If I didn't know how to do something, I'd get the book and read about it, or I'd make phone calls and pick people's brains.

**How did "Rockit" come about?**

I'd already worked with David Byrne and Brian Eno, and Tony Meilandt, who worked for Herbie Hancock, came to the studio and said, "This will sound crazy, but if I put you with Herbie and this production team called Material, I know we'll get a Gold record."

Bill Laswell and Michael Beinhorn

were the two Brooklyn guys who were Material. They had recorded the tracks, then they came out here and we did overdubs in Herbie's garage and mixed it in a couple of days. The record com-

**When I set up mics,  
for doing drums,  
the first thing I'm always  
thinking about is phase—  
will one mic serve  
better than putting  
up four mics?**

pany people came to the studio for the playback, and when it was over they just sat there...stunned. Because there was this new thing called sampling on it, and scratching. And no singing. They were like, "We've got to have vocals, let's put some vocals on it!" Bill Laswell was sitting there with a beer in his hand and he laughed

and said, "I've got a plane to catch."

About three months later I was in Manhattan and I saw a kid on the street with a beat box dancing to "Rockit." People were throwing money into a jar in front of him and I thought, "My God, I've just recorded something big."

**You met Herbie because you'd worked with Eno and Byrne. How did you meet them?**

After we'd redone El Dorado, we were going to run an ad in *Mix* magazine. I looked at our pitiful equipment list—people back then were using nice live chambers and EMT 140s, and our reverb unit was a BX10, a little cheap, dark, spring reverb. I couldn't advertise that, so I made up something. I said we had a new digital thing called a Lexicon 224. My plan was to go to the owner if we got any bites and say we had to go out and buy it. I'd done this before—he always came through when he saw a need for something that we'd actually make money on.

About a week after *Mix* came out, Brian Eno called—he'd read about the 224 and wanted to look at it. In a panic I called an equipment broker who had one that was going to The Village Recorder. It was the only one in town,

**David Bowie**

Magic Dick & J Geils  
Polygram

**Frank Zappa**

Burning Spear

**Heartbeat**

MGM/UA

**Richard Thompson**

Phish

Rounder

**Roy Orbison**

NRBQ

Rykodisc

**Alison Krauss**

Morphine

**Bob Marley**

Bruce Cockburn

Tone-Cool

**Arlo Guthrie**

**Medeski Martin & Wood**

Sweetfish

**The Beach Boys**

Bob Mould

*know these guys?*  
**they know us!**

**THEY TRUSTED US WITH THEIR MASTERING.**  
508-481-9322 [www.cdndr.com](http://www.cdndr.com)



**...ndr...**  
NORTHEASTERN DIGITAL RECORDING, INC.

**northeastern digital**  
unparalleled service, experience, and technology

# digital engine™

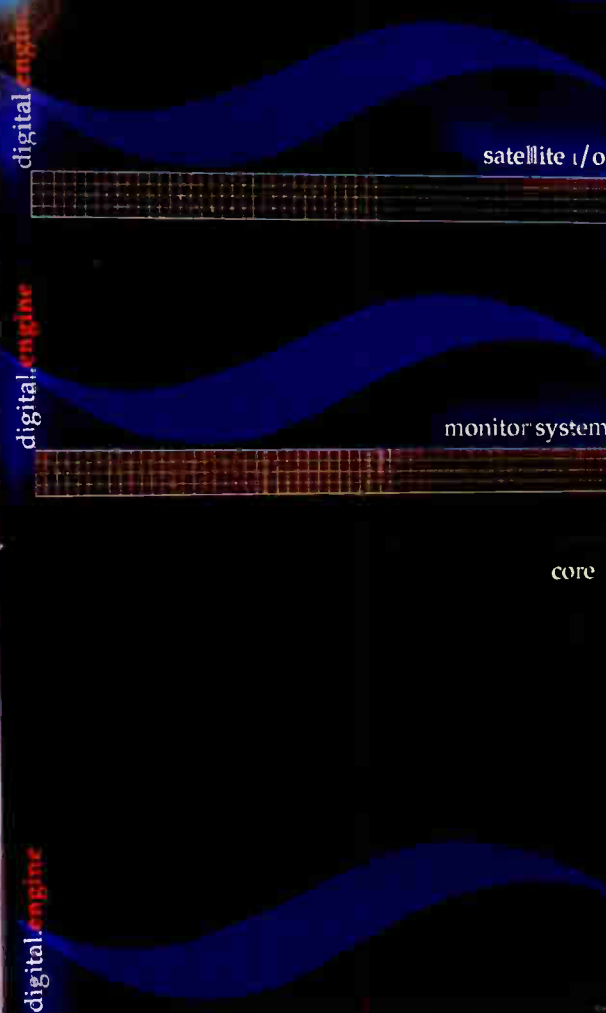

You knew someone would eventually build the state-of-the-art digital console you really want. No convoluted menus or arcane control systems, no 10-year-old technology - just a digital console that works like a console should. Harrison's revolutionary new digital.engine™ mixing system finally delivers! Utilizing Harrison's proven Series Twelve/MPC control surface and automation system, the digital.engine™ provides unparalleled digital processing power with a control surface common to that of its analog counterparts. The digital.engine™ is the only console architecture designed to address the issue of digital transition with an upgrade path for existing Series Twelve and MPC users. The digital.engine™ provides:

- 40-bit internal processing with sample rates from 44.1 KHz to 96KHz and 24-bit converters
- 576 full processing channels without resorting to processing allocation schemes
- 136 console-wide buses digital routed to 1344 inputs and 1344 outputs
- Full console automation from the inventors of the fully-automated console
- Surround panning and monitoring in every surround format available
- Harrison's exclusive DDSIP™ hybrid architecture allows intermixing of analog and digital processing within the same console
- The digital.engine™ has the lowest latency of any large-format digital console

# finally!

 Harrison

**European Operations**  
4 Cooper House • Ravens Lane  
Berkhamsted, Herts HP42DX  
Phone: +44 (0)1442 875 900  
Mobile: +44 (0) 973 748 351

For more information:  
[www.digitalengine.glv.com](http://www.digitalengine.glv.com)  
[www.glv.com](http://www.glv.com)

World Radio History

#### Headquarters

7104 Crossroad Blvd • Suite 118  
Brentwood, TN 37027  
Phone: 615-986-7700  
Fax: 615-986-7707

## MIX MASTERS

and everybody was screaming to get their hands on it, but I begged him to let me borrow it and he did.

*Luckily it was easy to use.*

I learned it literally an hour before Eno got there. He walked in, and I acted like I knew all about it. How he listened to it was by using some cassettes of beats that he was working on—we scrolled through the different sounds and I said, "These tracks are really cool." Brian said, "You like this stuff?" and we started talking about music and then he left. A few days later the studio manager said, "You must have made a great impression on Brian Eno; he just booked nine weeks with David Byrne." And out of that I went to the Bahamas and did *Remain in Light*.

Somebody told me once, "If you can picture yourself doing something, you can get there." Well, for me, it's the same with equipment: If I imagine myself using the piece of equipment I want, somehow it arrives in my life. The latest thing my engineer Brian Carlstrom and I were imagining was a full digital studio, and now we've got 48 tracks of 24-bit Pro Tools.



*Dave Jerden produced and engineered the album that took Social Distortion from L.A.'s punk scene to a national audience.*

*You've thought about a digital studio for a long time.*

I've always been interested in the idea of hard disk recording—the problem was reliability. The Pro Tools sounds great, and I like all the plug-ins. We haven't had any problems—no system crashes, no loss of information. The biggest problem, I think, even for those with experience, is it leads you to a lot of choices; you can get lost in it. We're good at avoiding that problem. Brian [Carlstrom] and my assistant, Annette

Cisneros, and I have done a lot of records together. So we approach our recordings the same as always. We don't get lost in the process, and instead of adapting to the Pro Tools method, we have the Pro Tools method adapt to us. *Do you record directly to Pro Tools?* We do on overdubs. We start off on the Studer for tracking, and I mix to the Studer half-inch.

*I'm surprised that you record guitars directly to Pro Tools.*

Some of them we do, some go to analog. There's so much opinion about digital and analog, and through the years I've been involved, on the sidelines or actively, in all these different arguments about equipment: about VCAs not being any good, Neve vs. SSL, blah blah blah. My whole philosophy has always been to use what gets the job done the best.

I've mixed stuff that's been done on really cheap equipment that sounds gorgeous, and I've worked on a lot of stuff that's been done on all the proper high-end gear and it sounds like crap. It's all in how you record it. Because most people don't know what a good sound is, they just go fishing.

*I've always heard that if you replaced a*

20% of the power  
24% of the size  
28% of the weight  
34% of the cost



And 100% of the speed, accuracy and definition of our renowned top of the line Model Two Thousand... the world benchmark for professional studio reference amplification. The Hot House Model Four Hundred High Resolution Control Room Amplifier is the *ultimate* nearfield amplifier at only \$1699.

*True Control Room reference monitoring for those who can bear the difference.*



275 Martin Avenue, Highland, NY 12528  
TEL 914-691-6077 FAX 914-691-6822

World Radio History  
CIRCLE #002 ON PRODUCT INFO CARD





# Now there's RADAR II HDR Series Digital Multitrack



**OTARI**<sup>®</sup>  
FOR THE WAY DIGITAL  
IS SUPPOSED TO SOUND.

Otari, Inc., Japan  
Phone: (81) 424-81-8626  
Fax: (81) 424-81-8633  
[www.otari.co.jp](http://www.otari.co.jp)

Otari Corporation, USA  
Phone: (800) 877-0577  
Fax: (650) 341-7200  
[www.otari.com](http://www.otari.com)

Otari Europe GmbH  
Germany  
Phone: (49) 2159-50861  
Fax: (49) 2159-1778

Otari Singapore Pte Ltd.  
Singapore  
Phone: (65) 284-7211  
Fax: (65) 284-4727

24/48

You know and trust the great sound, speed and user familiarity of RADAR<sup>®</sup>. Now enjoy 24/48 tracks of 24-bit record/replay from a single removable hard drive. RADAR II – everything you want in a random-access equivalent of a conventional multitrack. An enhanced controller for track arming and optional metering of up to 48 tracks, multiple machine control, user-definable macro keys and digital I/O.

No wonder RADAR has replaced analog and digital multitracks in hundreds of facilities. Call 1-800-877-0577. [www.otari.com](http://www.otari.com)

RADAR and RADARLINE are trademarks of Creston Technologies Inc.

sound, you were quick to get rid of the original.

[Laughs] It's not that I have to erase stuff to keep my psychological center; it's just practicality. Sometimes I'd do that only because I didn't have the opportunity to save stuff, because I didn't work in studios where I could make slave after slave. But I don't see any point in holding on to something if I know what I'm going with. I don't always erase everything, but I have absolutely no problem making decisions.

When I first started out, I had a 24-

track machine and a 28-in board, so all my recording had to be very organized, and I had to print all my effects. When I shoved up my faders for mixing, it was pretty much just balancing and we were done. I still print any important effects; I'm economical, and I don't leave choices for later.

*The studio here seems very live—is that where you like to put the drums?*

Actually, I usually put the drums in the smaller iso booth, then I put a P.A. system out in the studio and pump the drums back out through that. It's a way to control the amount of cymbals, because when you set up in a live room,



you often get too much of them. I also control how much cymbals I get by how far I open the sliding door between the booth and the room. That way I can vary the sound and tailor it for each song, instead of having the same drum sound for the whole album.

I also use Ibanez DM1100s on the room sounds. I got turned onto them when I was doing Jane's Addiction—Perry [Farrell] used one onstage for his vocal so he could adjust the delays and effects as he was singing. He lost the box, though, after the Nothing's Shocking tour, and we couldn't find another one. Then just a couple of years ago I was in Black Market Music and I found two of them. The guy said, "You can have these pieces of junk for a hundred bucks each." I've been using the hell out of them since, and one thing I use them on is drums.

*It's a chorus and delay.*

It's a delay unit. Within that you can get chorus and phasing. See, the most important thing for me in recording is taking care of the fundamentals. The physics of sound are so simple, there aren't really that many things that you can do with it. You can change the level, the amplitude, the phase, anywhere from zero to 360, and you can change the time, you can delay a sound. That's it.

Everything you hear in the studio comes from those fundamentals. If you look at phase and use it to your advantage, being aware of how time can relate to phasing and being aware of amplitude, as far as the Fletcher Munsen curve—all that stuff—you can create the effects you want. You've got to be aware of the basics. For example, I use a sound pressure meter when I work.

*That's pretty rare in a recording studio.* Well, the optimal level for mixing is 84 dB. I have a mark here [on the monitor pot] where 84 dB is, but I still check it every once in a while.

*Why optimal?*

Remember, 84 dB on the Fletcher Munsen curve is the optimum between highs and lows, as the human ear hears

## Awesome Specs!

- THD+N: < -110 dB FS (0.0003%), measured @ -3 dB FSD (20 Hz - 20 kHz)
- Ultra-low intrinsic jitter ≈ 9 pico seconds
- Sophisticated phase-locked-loop circuitry achieving jitter attenuation which exceeds 50 dB at all frequencies > 50 Hz, with sidebands and idle tones below -134 dB while phase-locked to external AES sync.
- Internal, external, or redundant power supply options available
- I/O - Connections: all gold pin connectors  
Analog inputs: balanced XLR  
Digital output options: AES/EBU (110 Ω XLR), or SMPTE 276M (75 Ω BNC)
- Size: (19" W) x (1 7/8" H) x (12" D)



## Incredible Sound!

The eight channel AD2408-96 is the finest A-to-D converter available. It has sample rates up to 96 kHz, selectable word lengths, noise shaped redithering, and full digital metering on all channels. It provides master or slave operating modes. The unique PLL guarantees ultra-clean lockup to an AES reference, in block, frame and sample boundary alignment. How does it sound? In a word - *Incredible!* Call today.



**The AD2408-96, 24-bit, 96 kHz Analog to Digital Converter**



**BENCHMARK MEDIA SYSTEMS, INC.**  
Phone 800-262-4675, FAX 315-437-8119  
<http://www.benchmarkmedia.com/>

CIRCLE #064 ON PRODUCT INFO CARD

them. When things get lower in volume, the bass tends to go away, so you'll put too much in. At low volumes, you may also tend to put on too much high end. If you listen too low, when you turn it back up it may be too bassy and too bright. On the other hand, if you listen too loud, the stuff may come out bass and presence shy.

Those fundamentals are the most solid ground you can work on; I think people often overlook that now. They think in terms of, "This is recording." But it isn't—it's sound. I also like to keep track in a mathematical way of all that stuff. I know what my delay times are from the earliest room sound, all the way up to a half-note, and the triplets.

*Why?*

I don't use reverb much, so how I get a spacious sound if I want it (instead of just slapping on a reverb unit, which may just sound dark) is to use various delays.

Reverb is just reflections, coming from how far the walls are apart within a certain spatial environment. Digital reverbs use algorithms, which are mathematical templates that will simulate a room size with delays. What I do is to take the tempo and meter of the song and set up delays that correspond to those reflections—the earliest reflection in a room sound would be about 30 milliseconds, all the way up to a half note, and the triplets, and the dotted... I set up all these delay times for the tempo of the song. If the tempo changes, I recalculate.

*Having the basics down frees you up to be creative.*

It's easier to learn a few basic rules than it is to try to learn every piece of equipment. You can spend your time learning how a Harmonizer 949 works, then some day you don't have one and you want that sound. Well, think about what that 949 is doing. There's so many different ways to solve a problem—you don't need to have a 949 to have its sound.

If I was stuck on a desert island, I'd need something that could delay, and it could just be a tape machine. And I'd need something that you could change the phase with—that could be a soldering iron. So maybe a tape machine and a soldering iron is all I'd need.

When I set up mics, for doing drums, the first thing I'm always thinking about is phase—will one mic serve better than putting up four mics? I keep that in mind, thinking, one foot equals one millisecond. Sound travels at 1,100 feet per second at 70 degrees at sea

level, and a millisecond is one-thousandth of a second, so, basically, one foot is one millisecond.

*So you're using the three-to-one rule to prevent phase cancellation.*

There's that, and there's also the other one, the 9dB one, where you can look at your console meters, and, if you have a mic on the snare, and it's picking up a tom over here, the tom should be 9 dB down from the main snare signal so there's no phase discrepancies.

*Uh, do you own stock in Summit?*

[Laughs] No, my engineer does. I like the sound of tubes. We use the preamps, compressors, EQ...line mixers,

too; there's a full studio in this rack. We mainly just use the console for monitoring and mixing. Even though I use the VCAs on the SSL to mix in the end, and I'm recording on Pro Tools, the first introduction from the outside world into the studio of every sound is always through tubes.

*What are your favorite microphones?*

Lately I've been using really cheap mics, like ones that come with phone machines, because there's a color I'm going for. But I do like Telefunken 251s, U47s and C-12s. As for a desert island mic, probably the most versatile is an SM57, and for a good, balanced condenser

# EuropaDisk

All Manufacturing In-House

- **CD Replication In Bulk**  
(minimum is only 100 CDs!)
- **Retail-Ready CDs with Graphics**
- **7"/45 & 12" Vinyl Records**
- **Cassette Duplication**
- **Graphics Design & Printing**

Why deal with brokers when you can work directly with our factory and save? You can rely on our 20 years of experience to get your project done right and on time!

**Best Service...Best Price...Period.**

Free catalog or quote: (800) 455-8555

**EUROPADISK, LTD.**

75 Varick Street, New York, NY 10013 (212) 226-4401 FAX (212) 966-0456

<http://www.europadisk.com> Major credit cards accepted.

CIRCLE #065 ON PRODUCT INFO CARD

mic, the U87, or my favorite, the U67.

**What mics do you use on drums?**

My setup for drums is pretty much the same all the time, and probably the same as anybody else's. More important than the selection of the mics is the selection of the drums. I use The Drum Doctor, Ross Garfield, a lot; he's got three snares I like. I mike the top and bottom of the snare with SM57s, with the phase flipped on the bottom. I like a fatter hi-hat sound, almost like a heavy metal hi-hat, so I go for those kind of cymbals, and on that I'll use either a KM84 or a Sennheiser 451, with pads. I always top- and bottom-mike the toms, unless they're concert toms, and I almost always use toms with top and bottom heads. I use Sennheiser 421s on the top and SM57s or 421s on the bottom, with the phase flipped on the bottom. For overheads, C-12s or 87s or 414s, and I try to make sure the ride cymbal is picked up properly. Sometimes I have the mics over the drummer's head with a stereo technique, or I'll just have them spread out. Sometimes I'll use various condenser mics, 84s or 451s, as filler mics to pick up china cymbals, or whatever else they may have.

For bass drum I use an AKG D112; I put a sandbag in there, and usually I have a front head on with a hole cut in it. I like using smaller bass drums; they've got more punch—a 22- or an 18-inch kick sounds great to me. A 26 is good if you've got the right room for it and you want to go for a Bonham

sound, but if I'm going for a sound like that, I use less mics and a lot of compression with Fairchild 670s, going for that classic "Andy Johns" drum sound. But usually I stick to smaller kick drums. And of course I compress everything when I'm recording.

**How do you mike electric guitars?**

A 57 angled in at 45 degrees, coming in somewhere between the center or the edge of the cone.

**That's quite a large road case your amp heads are in.**

I prefer to have the amp heads in the room when I record. I had the cases designed by Anvil—we hook them all up, and I can go through them, boom, boom, boom, and see what we want to use.

**Do you tri-amp the speakers?**

What you mean I think is what I call triple tracking—I approach guitar sounds with highs, mids and lows. So, instead of bringing all three up with one sound, and one amp, using EQ, I'll use an amp basically dedicated to lows, one delegated to midrange and one for high end. I might use a Vox, or a Matchless cabinet like an AC30 with a Big Muff, that will give a big bottom end, especially with a Les Paul. Then for midrange I'll use some kind of Marshall, a 50- or 100-watt lead, or a Bogner, and for high end I'll use a Soldano or another Bogner for a more piercing sound. The basis of the sound is the Marshall in the middle, and I'll bring the others into the mix. I don't mix them onto one track; they stay on separate tracks all the time—for some reason it

just sounds better. I'll use three amps for the bass, too, when I'm tracking.

To split the tracks, I use something called the Lucas Deceiver, which is a box that takes care of the ground problems. It's an active splitter, with an op amp. Terry Manning builds them down in the Bahamas. I love the Deceiver. People ask me all the time how I split the signal; then they try to do it without one, and they give up because of all the ground buzzes and stuff.

**Do you own a lot of outboard gear?**

What I own is more musical stuff—amps, synths. I do own some EQs—Trident A range, a Neve Prism rack, Massenburg, API 550s—but the outboard tools I use are pretty simple. When I mix, I have only a couple of things plugged in on the board: an H3000 Harmonizer, my AMS DDL and maybe a long delay—all the other effects have already been recorded. It's not like some guys who have to have 100-input boards because they have all this stuff set up.

I understand setting up a bunch of equipment and just seeing what's going to happen. I've done that, but in the mixing process there are already a lot of creative decisions to be made, so I believe that when you get to mixing, you're not recording anymore, you're not creating in that sense anymore—you're creating in the sense of putting together the song.

**What's new on the market that impresses you?**

Software. Acid, by Sonic Foundry, is very interesting. It puts together loops for you, one against the other, automatically. Pretty amazing. Unfortunately, it only runs on IBM, and our setup here is Mac—I have it loaded in my IBM notebook. I also really like AMP Farm. It emulates like 40 different amplifiers quite well. If I want a really authentic AC30 sound, I have AC30s I will use. But AMP Farm does get a pretty good AC30 sound. It's the guitar equivalent of drum samples.

**Do you still spend a few days in the studio getting comfortable before you record?**

When I'm recording a whole album, there's a period where I'm trying to acclimate the band to the studio. I get them used to the headphones, the smell of the studio, what the coffee tastes like—it only takes a couple of days. The point being, if you are going to do something important in the creative world, you have to look beyond just pushing around faders; there has to be a bond made between the producer,

**DAVE JERDEN SELECTED CREDITS**

**PRODUCING/  
MIXING**

The Offspring  
*Ixnay on the Hombre,  
Americana*

Flight 16  
*Flight 16*

Stabbing Westward  
*Darkest Days*

Edna Swap  
*Wacko Magneto*

Biohazard  
*Mata Leon*

Orange 9mm  
*Driver Not Included*

Alice in Chains  
*Facelift, Dirt*

Rust  
*Bar Chord Ritual*

Anthrax  
*The Sound of  
WhiteNoise*

Jane's Addiction  
*Ritual De Lo Habitual,  
Nothing's Shocking*

Social Distortion  
*Social Distortion,  
Somewhere Between  
Heaven and Hell*

**ENGINEERING/  
MIXING**

Rolling Stones  
*Dirty Work*

Talking Heads  
*Remain in Light*

Herbie Hancock  
*Rockit, Future Shock,  
Soundssystem*

Red Hot Chili Peppers  
*Mother's Milk,  
Red Hot Chili Peppers*

1925

*A new Standard  
for Concert Pitch*



440 Hz

\$ 440



1998

*A new Standard for  
Condenser Microphones*



**ADK, Inc.**

NEW 1999 Model from MARANTZ...the CDRC630 —  
 now at The **DAT** Store only **\$1200!!!**  
LIST PRICE

PRO AUDIO CD-RECORDER ReWritable & Write Once



The DAT Store, celebrating its 7th anniversary selling Marantz CD-Recorders, is proud to introduce the bargain of the decade. It uses the inexpensive pro disks and you get all the pro features you would expect: balanced XLR ins, RCA outs, optical and co-axial ins/outs, no SCMS, and a sample rate converter w/44.1kHz bypass

Free shipping anywhere in the world - limited time offer!

The DAT Store will beat any deal. Free loaners.



Pro Audio & Recording Equipment • Digital Video • Digital Multitrack Recorders • Cassette Decks • CD Recorders • Digital Mixing Consoles  
 DAT Recorders • Hard Disk Recorders • Microphones • MD Recorders

2624 Wilshire Blvd, Santa Monica, CA 90403

310-828-6487 Fax: 310-828-8757

Open: Mon-Fri 11-5 • All Major Credit Cards

CIRCLE #067 ON PRODUCT INFO CARD

the band and the engineer. It's almost like a family, and you have to understand each other and establish trust.

Also, recording should be fun, it shouldn't be this arduous process of 18-hour days, seven-day weeks, to where you've totally lost perspective and you're completely burned out. It should be fun, like going to play a baseball game.

*Bill Szymzyck once said to me his philosophy in the studio is, "If you're not having fun, it's time to go home."*

I agree. I don't have any problem going all night if everybody's having a good time and it's working, but how I generally schedule my work is six days a week, eight hours a day. Now that's the hours I'm in the studio—the engineer will be here more hours, making back-ups, etc. But the eight hours I'm here are all focused work. I've got a goal for the day, and when I'm done with it, we go home.

*I saw a quote from you in HiFi where you said your style as a producer is to do your job and to let everybody else do theirs. But you didn't say what your job is.*

When people ask me to produce a record, that means, to me, to make a record by whatever means. I may be a psychiatrist, a technician, a musician, but the overlying important thing is that I have a point of view all the time. The main job, which may include all those other duties on top of it, is to be a person who has a point of view and maintains it on the whole project. I let the musicians make the record and do their parts, but it's in the framework of a point of view that we've all agreed on. Because productions can get lost really quickly if the objective has not been maintained.

To do this, I use my initial reactions as a listener, and I ask questions. What do I expect to hear from this person or this band? What is the essence of this band? That is, stripping away everything they're not, and then looking at what's left. We get in agreement, musically and stylistically, about what they are, and we form a general image of what it's going to be, the theme. We fine-tune as we go along, but we're always moving toward the objective, so at the end of the day we can say, 'Yeah, we made the record we wanted to make.' That's the job. ■

*Maureen Droney is Mix's Los Angeles editor.*

# masterdisk

DVD NEUMANN SONIC SOLUTIONS VINYL  
 APOGEE SONTEC GML TUBE TEC AVALON  
 TC ELECTRONICS STUDER MANLEY DUNTECH  
 GARBAGE DEF SQUAD CREED BEASTIE BOYS  
 MONICA SLAYER THE SMASHING PUMPKINS  
 DMX MARCY PLAYGROUND AEROSMITH  
 SARAH MCLACHLAN GANG STARR TRICKY  
 BUTCH VIG KEVIN EVANS DALLAS AUSTIN  
 RICK RUBIN PREMIER FLOOD ANDY WALLACE  
 DAWSEY WEINBERG HULL VANDETTE LIAN

PROFESSIONAL EQUIPMENT  
 PROFESSIONAL PRODUCTIONS  
 PROFESSIONAL SERVICES  
 WORLD CLASS MASTERING

masterdisk corporation

545 West 45th Street, New York, NY 10036, (212) 541-5022, fax (212) 265-5645

www.masterdisk.com



CIRCLE #068 ON PRODUCT INFO CARD



*Monster*

*Blue*

Must  
Power  
100 WATTS  
4KHZ  
MODEL  
BM 15W  
P. Audio  
ent. company Co. Ltd

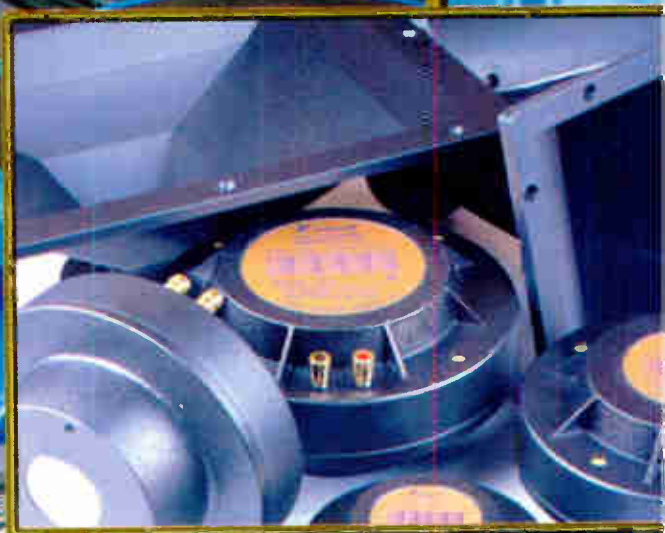

**P. Audio**<sup>®</sup>  
Pro. Loudspeaker

P. AUDIO AMERICA (800) 984-3789 [www.paudiosystem.com](http://www.paudiosystem.com)

World Radio History  
CIRCLE 71 ON PRODUCT INFO CARD

# PREVIEW

## SOUNDELUX OFFERS THREE NEW CONDENSERS

Soundelux Microphones (Hollywood, CA) has introduced three new condenser microphones. The U95S is a multipattern tube condenser, similar to the company's U95 but with improved specs and slightly longer body. Price is \$3,599. The PTM, a cardioid tube condenser optimized for vocals, is aimed at the project studio market



and is priced at \$1,199. The U97 is a smaller, multipattern FET condenser and is priced at \$599.

Circle 327 on Product Info Card

## APOGEE ROSETTA A/D CONVERTER

The Rosetta AD from Apogee Electronics (Santa Monica, CA) is a cost-effective 2-channel analog-to-dig-



ital converter that offers two AES/EBU outputs in addition to ADAT, TDIF and S/PDIF interfaces. The first unit in the company's new Solution Series, the one-rack-space Rosetta AD converts to 44.1/48 kHz sampling rates and includes Apogee UV22HR processing for reducing the word length of 24-bit signals to 20- and 16-bit formats. Designed as a front end for a computer-based DAW or DAT and MDM recorders, the Rosetta AD features the Soft Limit<sup>®</sup> process to maximize levels and reduce "overs"; bar graph meters and LEDs indicate levels. The unit accepts both balanced and unbalanced inputs.

Circle 328 on Product Info Card

## COLLIER 2X3PM PARAMETRIC MIXER

Collier Electronics (Austin, TX) offers the 2x3PM Parametric Mixer, a combination 2-channel mic or instrument preamp and 3-band parametric EQ. Channels may be EQ'd separately and are also

available on a mixed output. Additional inputs may be added to the mixed output. Front panel controls include input gain controls for both inputs on each channel, high- and low-cut shelving, and center frequency, Q and boost/cut controls for each of the 3-band parametric EQ sections. I/O connectors are XLR and 1/4-inch.

Circle 329 on Product Info Card

## LUCID TECHNOLOGY 24-BIT DACS

Lucid Technology (Lynnwood, WA) debuts a complementary pair of 2-channel, 24-bit digital audio converters. The half-rack analog-to-digital AD9624 (\$899) and digital-to-analog DA9624 (\$749) operate at sample rates of 32, 44.1, 48, 88.2 and 96 kHz. Twenty-segment peak-hold LEDs and a headphone output provide monitoring facilities. Additional features include 16-bit noise shaping, external sync via word clock and simultaneous digital output on multiple con-

nectors. I/Os include XLR analog and AES-3 S/PDIF and TosLink optical connections.

Circle 330 on Product Info Card

## HAFLER POWERED SUBWOOFER

The TRM10S Trans•ana powered subwoofer from Hafler (Tempe, AZ) is a one-cubic-foot vented enclosure containing a single 10-inch woofer and a 200-watt amplifier with MOSFET output stage and Class G/Trans•ana topology. Designed to augment Hafler's new TRM6 Active Monitor System (or any small monitor that requires a subwoofer), the TRM10S includes an adjustable crossover (24dB/octave Linkwitz/Riley) and covers a 25 to 110Hz frequency range.

Circle 331 on Product Info Card

## DYNAUDIO ACTIVE SUBWOOFER

The BX30 active subwoofer from Dynaudio Acoustics (distributed by AXI, Rockland, MA) is a compact design incorporating a 12-inch woofer and 140-watt amplifier. Switchable crossover frequencies are 80, 95 and 120 Hz, and the BX30 offers continuously adjustable phase control. Targeted at the surround market, the BX30 offers low-frequency response down to 22 Hz (-3dB). Inputs are stereo XLR. Price is \$2,999.

Circle 332 on Product Info Card





# PREVIEW

## CLM DYNAMICS EXPONDER

The DB500s Expounder Dynamic Equalizer from CLM Dynamics (distributed by PMI Audio, Torrance, CA) is a stereo mastering EQ that includes dynamic equalization capability. Each channel of the three-rack-space DB500s offers two bands of parametric EQ over the 200-8k Hz range, plus high- and low-frequency controls selectable between bell and slope curves; these high and low filters may be switched to act on the signal dynamically. Similarly, a pair of high- and lowcut filters may be switched to track the frequency content of the treated signal, allowing for automated hiss and rumble reduction. Additional features include  $\frac{1}{3}$  controls (divides by three) on individual EQ band gain controls, 12dB/24dB-per-octave filter roll-off selection and individual in/out switches for each of the five EQ and filter sections per channel. LEDs indicate input level and peak signals. The unit may be stereo-linked. Price is \$3,999.

## TC ELECTRONIC M3000 STEREO PROCESSOR

TC Electronic (Westlake Village, CA) has introduced the M3000 Studio Effects Processor, a single-rack-space, dual-engine stereo processor featuring 24-bit A/D and D/A converters. Effects include reverb, delay, chorus, flange, tremolo, pitch change and phasing. Dynamic effects include dynamic EQ and compressor/limiter and gate/expander functions. The user interface includes an LCD readout and



LED metering, and presets may be stored in RAM or may be written to PCMCIA cards. I/Os include AES/EBU, S/PDIF, TosLink optical, ADAT, MIDI and analog connections; 16- or 20-bit dithering may be selected. A pedal input is standard, and the unit offers multiple simultaneous digital outputs. Price is \$2,499.

Circle 333 on Product Info Card

## LINE 6 POD GUITAR AMP EMULATOR

The POD from Line 6 (Culver City, CA) is a programmable amplifier emulator and effects unit for electric guitar. The stereo desktop unit offers a choice of 16 "amplifier" types, which

may be combined with 16 digital effects. Eight rotary pots emulate the tone and effects controls for each amp selected, and additional effects may be programmed or edited via MIDI on either Mac or PC. Additional features include stereo outputs and a headphone monitor output. Price is \$399.

Circle 334 on Product Info Card

## WESTLAKE ADDS TO LC MONITOR LINE

Westlake Audio (Newbury Park, CA) adds two compact speakers to the company's LC monitor series. The Lc3w12 contains a 12-inch paper woofer, a 6-inch midrange woofer and a 1-inch dome

tweeter. Frequency response is 40 to 18k Hz; the Lc3w12 handles 100 watts. The smaller Lc3w10 (12.25x21.5x13.375 inches) has a 10-inch polypropylene woofer, 5-inch cone mid and  $\frac{1}{2}$ -inch tweeter. The Lc3w10 is capable of handling 80 watts and offers a frequency response of 42 to 20k Hz. Both units contain integrated passive crossovers but may also be bi-amped. Westlake also has redesigned its BBSM-5 Near Field Monitor System for improved performance; frequency response is 55-20k Hz.

Circle 335 on Product Info Card

## YAMAHA POWERED NEAR-FIELDS

Yamaha's Professional Audio Group (Buena Park, CA) introduces the MSP5 powered, bi-amplified, near-field studio monitor. Featuring a magnetically shielded cabinet, 5-inch woofer powered by a 40-watt amplifier and 1-inch tweeter driven by a 27-watt amp, the MSP5 has +4 XLR and -10 RCA inputs. Trim switches allow for modification of the system's high- and low-frequency response to suit the monitoring environment. Price is just under \$600 per pair.

Circle 336 on Product Info Card

## ART DUAL MULTIVERB-PRO

Applied Research and Technology (Rochester, NY) introduces the DMV-Pro, a rack-mount dual-engine/dual-stereo multiprocessor with 72 digital effects from each of its two 24-bit engines. Each stereo processor is controlled via a rotary encoder and an editing switch. Presets are selected from a



# Testing...

...1, 2, 3, 4... it takes more than one kind of tester to get the job done on the road or in the studio, and we have a lot of them ready to ship your way. On the right is our new SC-48EP speaker cable checker. It tests EP cables with 4-pin and 8-pin connectors for shorts, opens, and cross-wiring. For systems with 6-conductor systems, we have the SC-46EP. Both



models also check standard 3-pin XLR's. Down at the lower left of the page is our SC48NL, the companion 4-pin and 8-pin NL connector cable checker.

To your left is the Qbox audio line tester, featuring a complete set of tools for the person who has to find out what went wrong and fix it. For sending signal up a line it has a built in tone generator and a built-in microphone. For monitoring signals it has a built-in speaker and amp (along with a headphone jack for private listening).



The Tester checks cables with virtually every possible combination of XLR, 1/4", or RCA Phono connectors for shorts, opens, and cross-wiring.

The Qbox includes Voltage Present LED's for checking pins 2 and 3 for phantom or intercom voltage. It operates at mic or line level, and once you've had one for a while, you'll wonder how you ever did without it.



This practical, affordable phase checker gives a clear visual indication of driver polarity. Just play the source CD through your system and point the tester at the drivers you want to check.

The Phase Checker comes with a carrying case and source CD. It's powered by a standard 9V alkaline battery with an auto-off feature to preserve battery life.

Put your cables to the test — not your patience — with these handy testers.



# whirlwind™

99 LING RD • ROCHESTER • NY • 14612 • 888.733.4396 • 716.865.8930 (FAX) • <http://www.whirlwindusa.com>

CIRCLE #070 ON PRODUCT INFO CARD

# PREVIEW

multilayered menu, and an LCD editing interface indicates status. The four I/Os (featuring 20-bit ADCs) are on  $\frac{1}{4}$ -inch connectors, and the unit may be run as a 4-channel processor. Price is \$199.

Circle 337 on Product Info Card

## MXL STUDIO CONDENSER

Marshall (Culver City, CA) distributes the MXL 2001, a large-capsule, gold-sputtered diaphragm condenser microphone. Supplied with a custom aluminum flight case and suspension mount, the cardioid 48V phantom-powered MXL 2001 features a 1-inch diaphragm, 6dB octave 100Hz roll-off switch and transformer-balanced output. Price is \$399.

Circle 338 on Product Info Card



## HOT OFF THE SHELF

Ampex specialist ATR Service Company offers the OneTwo, a 1-inch 2-track modification to double the track width of the  $\frac{1}{2}$ -inch ATR102. The new 1-inch headstack lowers the noise floor by 6 dB, channel, improves tape-to-head contact and eliminates the need for noise reduction. Call



650-574-1165...MotorMix from CM Automation is a cost-effective (\$995) fader control surface featuring eight motorized faders, rotary pots for control of DSP plug-ins, a 40x20 backlit LCD screen, mute, solo, rec/rdy tactile switches with LED status indicators and function and system keys. Call 818-772-0262...Fairlight has introduced the DaDplus, a stand-alone 24-channel, disk-based digital playback system offering 24-bit audio, with 48-bit signal processing. DaDplus is backward-compatible, and up to 24 units can be remotely controlled and configured in 4-track increments. Call 310-287-1400...Sound Dogs has posted a large portion of its sound effects library on its Web site for purchase and royalty-free use. The database is organized by category, sub-category, unique quality and file name; each sound is tagged with a one-paragraph description. Sounds are available in a variety of formats including AIFF, AU, WAV, and 24-bit/16-bit/8-bit depths; 48, 44.1, 22.05 and 11kHz sampling rates are available. Visit [www.sounddogs.com](http://www.sounddogs.com)...JRF Magnetic Sciences' 1-inch/2-track conversion package for the Studer A80 offers increased headroom, lower noise and improved high-frequency response. Call 973-579-5773...Tascam's IF-TAD

converts digital signals between ADAT and DTRS formats. At \$349, the unit allows for economic transfers between these otherwise incompatible digital tape formats. At your dealer or call 213-726-0303...The JG Junior power distribution device from Juice Goose is a rackmount AC unit with six power outlets, a master power switch and circuit breaker, and integrated voltage spike protection and AC line noise suppression. Price is \$59. Call 713-772-1404 or e-mail [info@juicegoose.com](mailto:info@juicegoose.com)...HHB Communications' new high-performance DVD-RAM disks have a capacity of 5.2 GB. The disks are rewritable and can accept more than 100,000 erase/read/write cycles and are expected to be stable for more than 30 years. Call 310/319-1311...Plexor's UltraPlex 40X Max is a SCSI CD-ROM drive capable of 24-times real time speed when retrieving bit-accurate digital audio data from disk. Call 408-980-1838...Analog Devices has published Vol. 3, No. 3 of *Communications Direct*, a newsletter dedicated to digital communications issues. Call 800/AnalogD or visit [www.analog.com](http://www.analog.com) publications...AKG Acoustics' new "spider" suspension is for use with AKG large-diaphragm mics such as the C3000, C414B/ULS and C414B/TLII. This H100 spider suspension may also be used with any mic with

a circular shaft of between 0.86 and 1.02 inches diameter. Call 615/360-0499...

Furman Sound adds two Balanced AC Power Isolation Transformers to its line of power conditioning and distribution products. The IT-1210 (10-amp) and IT-1230 (30-amp) are designed to supply single-phase balanced AC power. In addition to multiple AC outlets, the units feature a self-checking AC voltmeter, an Extreme Voltage Shutdown circuit and a "Soft Start" circuit to prevent large-inrush surge currents. Call 707/763-1010...Acoustics First's new high-efficiency foam absorbers include The Bermuda Broadband, a corner trap with a rolling pattern front; the 4-foot-long triangular traps are available in two-pair sets and are packed two pairs to a box. A shorter set (Bermuda Shorts) come in 2-foot lengths. Sound Cylinders are foam cylinders 10 inches in diameter and four feet high, bored through the center for mounting vertically on a mic stand. Arranged in a semicircle, Sound Cylinders form a semi-anechoic zone for voice or instrument recording. Call 804/342-2900 or visit [www.acousticsfirst.com](http://www.acousticsfirst.com)...TOA Electronics has published its 1998/99 Product Guide (3rd Edition), a 110-page catalog of the company's audio products and intercom systems. Call 650/588-2538. ■

# NEW HARDWARE/SOFTWARE FOR AUDIO PRODUCTION

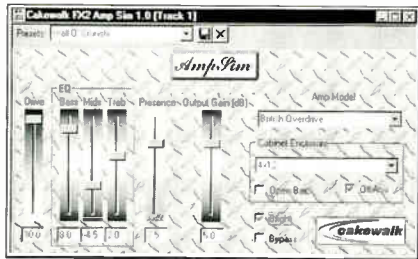

**CAKEWALK AUDIO FX 2**  
Cakewalk ([www.cakewalk.com](http://www.cakewalk.com)) introduces Audio FX 2, the second in a family of real-time 32-bit effects plug-ins for Windows. Audio FX 2 offers two plug-ins in one application, both designed to add "analog warmth" to digital recordings. An amplifier/speaker simulator emulates the sound characteristics of a variety of classic amplifiers, including Solid State, Fuzz and American and British tube models. All amplifier settings offer customization of parameters such as EQ, brightness and drive, and of speaker characteristics such as output levels, cabinet size, microphone position and open/closed back. An analog tape simulator applies sound characteristics associated with magnetic tape recording to digital audio: Parameters include input/output and record levels, warmth, tape speed, tape hiss and curve. Price is \$159.

Circle 339 on Product Info Card

## ANTARES AUTO-TUNE FOR PC

Antares Audio Technologies recently announced Auto-Tune DirectX, a PC version of the real-time pitch-correction plug-in previously available only for Macintosh (or in a hardware version). The application offers two modes of operation: Automatic

mode corrects pitch in real time, within customizable scale and rate of correction parameters; Graphic mode offers a graphical representation of a phrase's pitch contour and provides graphic tools for modifying pitch. List price is \$299.

Circle 340 on Product Info Card

## WAVEFRAME 7.0

WaveFrame Inc. ([www.waveframe.com](http://www.waveframe.com)) has debuted V.7.0 of the WaveFrame workstation system. New features include 24-bit capability (96kHz support is on the way), Windows NT support and an automated mixer (with support for the JI.Cooper MCS-3000 and the Mackie HUD). In addition, the system incorporates the plug-in architecture of WaveFrame's new hardware partner, Digital Audio Labs—meaning plug-ins will be available from companies such as Waves, Wave Mechanics, Qsound, Antares and Aphex. OMF and AAF interchange are also supported.

Circle 341 on Product Info Card

## METALITHIC ELITE STUDIO

New from Metalithic Systems ([www.metalithic.com](http://www.metalithic.com)), Elite Studio is a Windows audio interface designed to complement various popular recording and editing applications, such as Cubase VST, Cakewalk, Studio Vision, Sound Forge, SAW

and WaveLab. Comprising a 32-bit PCI card and 10x10 breakout box, the Elite Studio employs Metasynth's proprietary FPGA (Field Programmable Gate Array) processing for software optimization of hardware, and can be equipped with up to 128 MB of DRAM and an optional ADAT I/O. The rackmount breakout box features eight analog I/Os plus S/PDIF I/O; all A/D/A conversion is 20-bit, and S/N ratio is said to be greater than 95 dB. Retail is \$1,098.

Circle 342 on Product Info Card

## UPGRADES AND UPDATES

Emu-Ensoniq ([www.emu-ensoniq.com](http://www.emu-ensoniq.com)) announced plans to release Macintosh software drivers for the Emu Audio Production Studio, and has begun enlisting the support of development partners. In other Emu-Ensoniq news, Darwin V.2.5, featuring support for a new SMPTE sync option card, and PARIS Version 1.8, supporting 3rd-party DirectX and VST plug-ins, are now shipping... Two new Opcode ([www.opcode.com](http://www.opcode.com)) releases: Vision DSP (\$495 list), an audio and MIDI sequencer with real-time effects and support for a variety of audio cards; and Fusion:VST FX, a cross-platform plug-in

bundle (\$295) combining the Filter and Vinyl plug-ins with six new VST-only effects... Steinberg ([www.steinberg.net](http://www.steinberg.net)) released Cubase VST/24 V.3.6 for Windows. New features include 96 tracks, 8 aux and effects sends, and support for the Yamaha DSP Factory. In addition, Steinberg announced that Cubase VST/24 4.0 is Pro Tools|24-compatible... Microboards Technology introduced two new duplicators: The DSR 1000, an easy-to-use stand-alone 4x CD copier, and the CopyWriter A2D, an 8x-read/4x-write duplicator with built-in A/D conversion. Also new from Microboards, two new DVD authoring software toolkits for Windows. Visit [www.microboards.com](http://www.microboards.com) for more information... Symbolic Sound ([www.symbolicsound.com](http://www.symbolicsound.com)) is shipping the Copybara-320 Sound Computation Engine, a 28-processor accelerator for the Kyma workstation, said to deliver 5 to 8 times more processing power, at a 25% lower price, \$3,300... Arboretum Systems ([www.arboretum.com](http://www.arboretum.com)) released Hyperprism 2, featuring a real-time, analog-style Vocoder and Arboretum's new HyperVerb, plus frequency shifter, talk-box and other effects. In addition, Arboretum introduced Ray Gun V.1.1 noise reduction software, an AudioSuite edition of Ionizer... Digigram ([www.digigram.com](http://www.digigram.com)) announced development of a Mac driver for the PCX-pocket, making the PCX-pocket and PCX-pocketAD compatible with all current PowerBook models, and many earlier units. ■

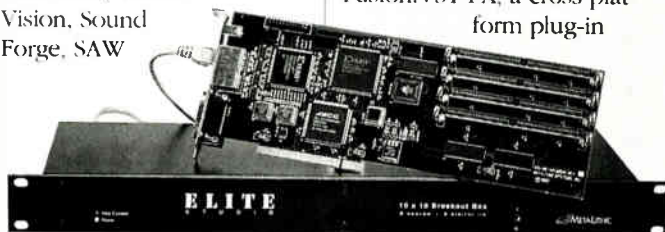

From cutting vinyl to the cutting edge.

# Sony Music Studios

## M A S T E R I N G

Frontline • Vinyl • Surround • Blue Book • DVD Audio • Super Audio CD

### Mark Wilder

Bruce Springsteen  
Pearl Jam  
Herbie Hancock  
Will Smith

### Chris Athens

Jermaine Dupri  
Lauryn Hill  
Company Flow  
Black Star

### Vlado Meller

Celine Dion  
Pras  
Maxwell  
Divas Live  
Mariah Carey  
Savage Garden  
Julio Iglesias  
Harry Connick, Jr.  
Barbra Streisand

### Vic Anesini

Lauryn Hill  
Gloria Estefan  
Korn  
Jamiroquai

### David Mitson

Santana  
Kenny Loggins  
Neil Diamond  
Mighty Blue Kings

## Sony Music Studios



460 West 54th Street New York, NY 10019 (212) 833-4441  
2100 Colorado Avenue Santa Monica, CA 90404 (310) 449-2100

CIRCLE #071 ON PRODUCT INFO CARD

# MICROBOARDS DSR-8000

## DESKTOP CD DUPLICATOR

Once upon a time, CD duplication was an expensive, overly difficult process, requiring skilled technicians, a clean room and tens—if not hundreds—of thousands of dollars' worth of gear. Today, with the price drop in CPUs, CD-R drives, and with recordable CD media hovering around the \$1.00 mark, the CD duplication business is booming. And just as many studios diversified into the short- (and even long-) run cassette duplication

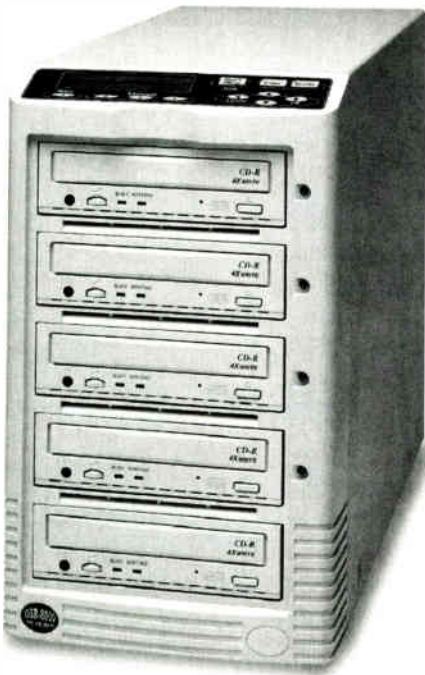

business in the 1980s, affordable, simple-to-use duplicators such as the Microboards DSR-8000 may open lucrative sidelines for audio businesses in the '90s.

The DSR-8000 is just part of the DSR family, which includes products ranging from single master units with one/two/three slaves; or the new DSR-8800 (\$6,995), with one master and seven drives in one tower. Distributed by Microboards and made by Hoei Sangyo, the DSR-8000 is a stand-alone (no computer required) CD-R duplicator—

based on 5-drive, 4x-write drive bays—that supports CD-ROM (Modes 1 and 2), CD-Audio, CD-I and CD-ROM XA (Forms 1 and 2), Mixed Mode, Multi Session and CD-Extra. A basic 5-drive starter system lists at \$5,995, and the system can be expanded with up to three additional 5-drive units (priced at \$4,295 each) for a 15-drive system. A 10-drive system retails at \$9,495. The system also supports the Pioneer DVR-S101 DVD-R drive, so it can produce up to eight DVD-R discs simultaneously. An optional onboard hard drive speeds overall operations. Just out is an optional Fusion DA card that installs into the VMI slot of the 8000 or 8800, allowing duplication of DAT masters via S/PDIF; an S/PDIF optical out is also provided for monitoring.

A Direct SCSI connection allows the DSR-8000 (with CD-R or DVD-R drives) to operate in stand-alone mode or it can be fed from a PC or Mac. In addition, the system's use of Virtual Media Interface (VMI™) cards allows for easy system expansion for more drives, or for networking of up to 200 drives for high-volume applications. In any case, the DSR-8000 system is designed so users can start off with a simple system and easily expand as needs or capital increase.

System setup is simple: Just use SCSI cables to connect the master unit to an (optional) slave bay and an external CD-ROM drive that acts as the source material reader. As one who rarely reads the manuals before starting, I was dismayed to see a blank menu screen, while the LEDs were lit. After double-checking the cables and cursing for a while, I finally read the handy "quick connect sheet," which notes that the correct power-up sequence is: reader-slave-master. Once powered correctly, it worked fine

(there's a lesson here somewhere...) and I clicked through a simple scroll-through menu. Once "Press Start to copy" is displayed, you simply load your master CD in the reader, insert one or more blanks in the burner bays and press the Start button. The duplication process begins immediately; be aware that this is an industrial unit and superfluous messages like, "Are you really sure you want to do this?" are nowhere to be found.

The DSR-8000 offers numerous possibilities from its menu pages, such as: changing the read or write speed, duplicating multisession DA discs or tweaking the Duplication Complete buzzer volume. However, 98% of all menu use will probably involve nothing more than designating the master source (hard disk or CD) or occasionally using the test mode to check a suspicious master disc for errors before copying.

Duplication time for a one-hour audio CD is 17 minutes—15 minutes for the 4x data burn, plus two minutes for "fixing" or finalizing the TOC on the disc. At this rate, theoretically, an operator using a four-bay, 20-drive system could produce 140 CDs (60-minute length) in two hours. The DSR-8000 adds little touches like ejecting all discs when the duplication is completed, which makes the loading process much simpler, especially when you need a lot of discs in a hurry.

Overall, the Microboards DSR-8000 is a high-quality system offering fast operation, in an affordable package that's easy to use and expandable to handle larger jobs or new technologies, such as DVD-R. Studios looking for sideline business would do well to check this one out.

Microboards Technology Inc., 1480 Park Road, Suite B, Chanhassen, MN 55317; 612/470-1848; fax 612/470-1805. Web site: [www.microboards.com](http://www.microboards.com). ■

BY GEORGE PETERSEN

# Pure Audio ...

## 24 Bit / 96 kHz



For WINDOWS 95/98  
and WINDOWS NT

**Samplitude 2496 - Red Roaster 5.0**  
Multi track audio recording, editing and CD-mastering software

**SEK'D PRODIF and ARC audio I/O devices**  
Up to 24 bit, 96 kHz digital, AES/EBU, S/PDIF coax and  
lightpipe, ADAT™ and analog I/O's, wordclock, drivers for  
WINDOWS™ 95, 98 and NT (MAC and ASIO soon)



**Real 24-Bit 96kHz converters**  
ADDA 2496 S: Stereo ADDA, AES/EBU, S/PDIF, balanced analog I/O or  
XLR, 113 dB dynamic range, built-in power supply.  
ADDA 2496 DSP: Adds word-clock, real-time resampling and dithering,  
records 24 bit 96 kHz audio on Dait tape. 128 dB dynamic range.



*Digital Audio for the World!*

For more information and a dealer  
near you, please call

**1 800 330 7753**

World Radio Inc. CIRCLE #072 ON PRODUCT INFO CARD

### Best Audio Quality

According to Bob Edwards, staff engineer at Lucasfilms Skywalker Sound; Baker Vaughn, mastering engineer at Tennessee Productions; Rainer Weber, mastering engineer at Night-walker Studios, Germany.

### High Performance Interface

Recording Magazine: "Best of the host based breed".

### A wealth of effects

Multi-Band dynamics and stereo enhancer, declipper, denoiser, FFT draw filter, 36,000 band EQ, room simulator and more at no additional cost.

### The object editor

Apply EQ, dynamics, volume, pan, fade curves and stereo imaging surgically per region (in addition to any effects being used on the whole track).

### CD Burning "On the Fly"

Master Redbook CD's directly from a multi-track project, while processing effects and plug-in's in real-time.

### Total Compatibility

Doesn't lock you into a dead end system: By using the Intel CPU and any 95™ or NT™ compatible audio I/O devices, you are free to choose!

**SEK'D America**  
P.O. Box 5497  
Santa Rosa, CA 95402  
Tel: 707-578-2025  
Fax: 707-578-2025  
eMail: info@sekdc.com  
Web: www.sekd.com

# EVENT ELECTRONICS LAYLA

## COMPUTER-BASED RECORDING SYSTEM

Unveiled at the Winter NAMM show in January 1997, the long-awaited Event Layla system is finally available. Essentially a 20-bit multitrack recording, editing and mixing system for the PC and Macintosh, the \$999 core Layla by Echo system comprises a PCI

port for any sample rates.

Event's audio assignment architecture lets users configure the outputs as aux sends, monitor mixes, discrete track outs and more. You can play back on all ten output channels while you're recording on all eight inputs, or make a 24-bit

rebooted my machine, ran the Echo console installation program, installed the drivers for Layla and set about patching my mixer into Layla. The card features true Plug-and-Play for Windows 95 and 98. I didn't have to fool with jumper settings or IRQ conflicts. Layla



bus card (equipped with Motorola's powerful 56301 chip for onboard 24-bit DSP) and a rackmount breakout box handling analog and S/PDIF digital audio I/O, word clock and MIDI sync connections. The system includes multitrack recording/editing software, although the hardware is compatible with various PC and Mac audio recording and editing software packages (except Digidesign).

Layla's hardware features include eight 1/4-inch TRS balanced analog inputs with 20-bit, 128x oversampling ADCs; Ten 1/4-inch TRS balanced analog outputs with 20-bit 128x oversampling DACs; 24-bit S/PDIF stereo digital I/O; word clock/super-clock I/O (for sync and expansion); 24-bit data resolution maintained throughout the internal signal path; and sup-

stereo master mix to send to the digital output. Specs include frequency response (analog in to analog out) of 10 to 22k Hz ( $\pm 0.5$ dB); dynamic range greater than 98 dB; and 0.005% THD+N, from 20 to 22k Hz.

### READY...SET...INSTALL!

Event recommends a PCI 2.1 Pentium system running Windows 95 and 16 MB RAM—32 MB or more highly recommended. (Actually, I'd say if you aren't running at least 64 MB, don't bother with professional audio on your computer at all, unless you have a lot of patience and extra time.) I took the Layla package home and eagerly replaced my Gina card (a scaled-down system) with Layla. I

uses only one IRQ for both audio and MIDI functions, and no DMA channels are used at all. Just insert the card in the PCI bus slot and connect the multipin cable to the rackmount audio I/O and you are ready to roll.

I began my test by mixing an 8-track ADAT project to two tracks of Layla for mastering. Layla worked like a charm on this attempt, something I've found to be unusual for anything related to computers and pro audio! Once the card is installed, using Layla is as simple as selecting the I/O you want to use in the software of your choice and patching up your mixer with the rack unit. Listening through Event 20/20ps (the monitor of choice for my project studio), I was impressed with Layla's sound quality.

The package contains a com-

BY MIKE LAWSON



# ACCURATE MONITORING IS NOW A RIGHT, NOT A PRIVILEGE.

Accurate monitoring used to be expensive. Not any more. Available in both active and passive versions, the new HHB Circle 5 incorporates a number of unique breakthroughs in loudspeaker technology to create a compact, high performance studio monitor that's ideal for use in a wide range of professional applications. An investment of \$250,000 in research and development has produced



a loudspeaker of exceptional clarity, with a sound that doesn't fatigue the listener, even after a long session. So if you're looking for a great sounding studio monitor, listen to the Circle 5 at your nearest HHB dealer and prepare to be impressed. Then ask the price and prepare to be amazed.



- Varied cone thickness minimises low frequency distortion
- Low Q filters deliver an untiring sound during long listening sessions
- Detailed and accurate on and off axis sound
- 120W LF / 70W HF integral amplifier pack (active version)
- Delivers 'large monitor' performance from a compact loudspeaker
- Individually tested and matched ferro-fluid cooled soft dome tweeters
- Magnetically shielded for use near computer and video monitors
- Solid State Pclyswitch<sup>®</sup> tweeter overload protection

HHB Communications USA LLC · 626 Santa Monica Boulevard, Suite 110, Santa Monica, CA 90401, USA  
Tel: 310 319 1111 · Fax: 310 319 1311 · E-Mail: sales@hhbusa.com

HHB Communications Canada Ltd · 260 King Street East, Toronto, Ontario M5A 4L5, Canada  
Tel: 416 867 9000 · Fax: 416 867 1080 · E-Mail: sales@hhbcanada.com

HHB Communications Ltd · 73 75 Scrubs Lane, London NW10 6QU, UK  
Tel: 0181 962 5000 · Fax: 0181 962 5050 · E-Mail: sales@hhb.co.uk



British sound at its best

<http://www.hhb.co.uk>



# MxTrax™

Get the  
**Full Power**  
from your

**DSP**™ **YAMAHA**  
**FACTORY**

Before you buy software for your DSP Factory, check to make sure it supports all of the amazing features of this powerful card. MxTrax supports all of the features including:

- REALTIME** mixing using DSP
- REALTIME** 4-band parametric EQ on 24 input channels\*
- REALTIME** DYNAMICS on 24 input channels\*, including compressors, expanders, compressors, gates, and ducking
- REALTIME** DELAY on 24 input channels\*
- REALTIME** FADERS on 24 input channels\*
- REALTIME** PANNERS on 24 input channels\*
- REALTIME** ATTENUATORS on 24 input channels\*
- REALTIME** DSP FX - 2 stereo FX (4 with 2 cards),  
your choice of these 40 effects.

Reverb Hall, Reverb Room, Reverb Stage, Reverb Plate, Early Ref, Gate Reverb, Reverse Gate, Mono Delay, Stereo Delay, Mod. Delay, Delay LCR, Echo, Chorus, Flange, Symphonic, Phaser, Auto Pan, Tremolo, HQ Pitch, Dual Pitch, Rotary, Ring Mod, Mod. Filter, Distortion, Amp Simulate, Dyna.Filter, Dyna.Flange, Dyna.Phase, Rev+Chorus, Rev->Chorus, Rev+Flange, Rev->Flange, Rev+Sympho, Rev->Sympho, Rev+Pan, Delay+ER, Delay->ER, Delay+Rev, Delay->Rev, Dist->Delay

(\*48 input channels with 2 cards)

## Plus these great MxTrax features:

Create your own mixers with MxTrax's famous drag-and-drop mixer architecture! No kidding, *build your own mixer*. Create from 1 to 24 input channels. Drop on EQ's, Compressors, Panners, Aux Sends, Solo/Mute/Automate buttons, Expanders, Attenuators, Phase Inverters, Delay. It's as easy as drag-and-drop. Save your mixer to use later in other projects.

**AUTOMATION** All mixer controls can be automated! Record movements in Faders, Panners, Compressor and Gate settings, EQ parameters, and much more. And updating automation is as easy as grabbing a control during playback and moving it.

**PROJECTS** Save your tracks and soundfiles, your custom mixer, your control automation, and your edits, all with a single mouse click! The Project file remembers your entire project. You can even load in a previous project, and *undo an edit you did last week!*

**EDITING** Cut-and-Paste edits are lightning fast. Instantaneous Fades and Gain Change. Unlimited undos!

 **Minnetonka**  
AUDIO SOFTWARE, INC.

17113 Minnetonka Blvd. • Suite 300  
Minnetonka, MN 55345 • (612) 449-6481  
www.minnetonkaaudio.com

World Radio History  
CIRCLE #074 ON PRODUCT INFO CARD

**Nondestructive Waveform Editing**

Cut  
Copy  
Paste  
Replace  
Delete  
Cut Time  
Copy Time  
Delete Time  
Insert Time  
Fade  
Crossfade  
Trim  
Snap  
Nudge  
Group/Ungroup  
Split  
Move to Back  
Gain Change  
Normalize  
Select  
Move in Time  
Markers  
Zoom In/Out  
Independent Vertical Sizing  
of Each Track  
Scroll Left/Right  
Add/Insert/Delete Tracks  
Group Cut  
Group Copy  
Group Paste  
Group Delete  
Group Fade  
Group Crossfade  
Group Trim  
Group Split  
Group Gain Change  
Group Normalize  
Group Move in Time  
Play from Beginning  
Play Selection  
Play from Cursor  
Play to In Point  
Play to Out Point  
Loop  
Jump to Splice Point  
Jump to In Point  
Jump to Out Point  
Jump to Marker  
Zoom In by 2  
Zoom Out by 2  
Zoom to Sample Level  
Zoom to Full Recording  
Rescale waveform  
Scale in Real Time  
Scale in Beats per Minute  
Scrub Automation  
Autorewind on Stop

plete multitrack digital recording, editing and mastering system complete with a variety of software, including Syntrillium Software's Cool Edit Pro-Special Edition multitrack recording/editing software, the full version of Sonic Foundry's CD Architect Red-book authoring software and Sound Forge XP 4.0 graphic waveform editing software.

Also included with the package is the Echo Console, a software-based mixer handling audio inputs and outputs, monitor assignments, volume, pan and metering. The console application is a wonderful tool allowing for a variety of uses when controlling your Layla card. This audio routing control interface is grouped into four main areas: Input Controls, Input Monitor, Output Controls and buttons for selecting destinations and clock sources. The inputs are grouped together in channeled pairs with each channel having its own fader, display value, meter, mute and solo button. Each channel also has Event's "EasyTrim" automatic input gain adjustment circuitry, allowing for easy automatic gain control on each channel. The output section also provides faders, value LEDs, mute, solo and gang selections making this software console very friendly in use and versatile in functionality.

Layla's 20-bit inputs and outputs are balanced, and feature independently selectable +4dBu and -10dBV nominal operating levels—flexible interfacing. With the Echo Console, you can assign the sources, destinations and clock types for Layla. Layla can generate the master clock, translate one clock format to another and act as a slave to an incoming clock; in addition, the system supports word clock, superclock, S/PDIF digital clock and MIDI Time Code. The MIDI In/Out/Thru ports are handy for MIDI sequencing or other MIDI-controllable sound modules and effects.

The hardware is compatible with a variety of popular digital audio software applications. I tried it with Sound Forge, Steinberg's Wavestation, Cool Edit Pro and Cakewalk Pro Audio 6. Each application worked flawlessly with the Layla card in my system, as they did with the Gina card.

However, using Cakewalk Pro Audio 8.0's real-time effects processing features with Layla (while running Windows '98) caused crashes. Cakewalk is working with Event to solve

## Layla: Say Pentium, Please...

Designed to work with any CPU having a PCI 2.1-compliant Pentium processor, Layla is a great addition to anyone's PC-based studio. And as long as your Pentium system has PCI Bios 2.10 or higher, Layla operations should be solid, smooth and reliable.

Yet, to many people, merely stating "Pentium required" may simply imply that the system works with any PC that isn't a Mac. I, too, fell into that trap when earlier this year, I installed Layla's little sister, Gina. Not having experienced any trouble with Gina, I eagerly installed Layla. However, my system has an AMD K6 chip, which runs faster than Intel chips of the same clock speed: My AMD K6 200 benchmark tested at speeds comparable to the Intel Pentium II 300, and it cost \$200 less. Event warns that other processors, such as my K6, will "sometimes work but may exhibit intermittent problems." I haven't seen those problems exhibited yet, but Event doesn't suggest using anything but the genuine Intel Pentium chip for any of the cards it manufactures. All of Event's recording card drivers are written to specifically support only genuine Intel products.

Event doesn't recommend using Layla with the following computers: Hewlett Packard Pavilion; Acer Aspire; Packard Bell models (with onboard sound); IBM Aptiva (models with the AMD K6 processor); and Compaq. However, Event's excellent Web site offers a number of workarounds, such as disabling the onboard sound card in the computer's BIOS if your computer has an onboard sound card. And with systems with OSD (onscreen display) programs—such as Compaq—Event suggests the age-old Windows trick of renaming the conflicting file. A number of video cards are also *non*-PCI 2.1-compliant, and in such cases, try setting the Hardware Acceleration to None under the System Performance/Graphics section of your Win 95 Control Panel. Setting your display to 256 colors might also help: Who really needs millions of colors to cut some digital audio tracks?

If you have any questions about the compatibility of your current PC with the Layla, Gina or Darla card, call Event directly. I called ten different music/audio dealers in different locations nationwide to ask about the Layla's compatibility with my computer. I described my processor, motherboard, RAM, hard drive sizes, etc. Nine out of ten stores said I would have no problem with any of these cards with my system. Only one store actually suggested I call Event first. Good advice. Anyone with questions can call 805/566-9993 or check out [www.event1.com/newsletter/news2-3.html](http://www.event1.com/newsletter/news2-3.html).

—Mike Lawson

this issue. But according to Cakewalk, running real-time effects with Layla under Windows 95 does not cause any problems, nor is this known to be a problem with Win 98 and Cakewalk 6.0 or 7.0.

Now, if you're running a compatible program with the Layla card, you're going to have a wonderful time. The system sounds great. It's easy to use. You can expand your system over time with more Layla cards without giving up multiple IRQ settings on your computer, which is really nice. If you have the PCI bus slots open, three of these cards can give you a nice 30-in/36-out, professional-quality recording studio right on your PC. Multiple Layla systems synchronize with ease. Simply plug in another card and connect the

word clock output of the master unit into the word clock input of the slave. You can literally connect as many Layla units as you have PCI slots in your computer.

With the right system, you'll truly enjoy using Layla. For its \$999 price, Layla's features are incredible, it sounds great and it's easy to use. Not a bad deal, if you ask me.

Event Electronics, Box 4189, Santa Barbara, CA 93140-4189; 805/566-7777; fax 805/566-7771. Web site: [www.event1.com](http://www.event1.com). ■

*Songwriter/guitarist Mike Lawson is the publisher of MixBooks and recently released a CD, Ticket to Fly, with Merl Saunders, Bob Welch, Jorma Kaukonen and others.*

# M&K SOUND 5.1 PRO SOLUTIONS

## THX SURROUND SPEAKER SYSTEM

Miller & Kreisel Sound Corporation's roots began when Steely Dan asked recording engineer Ken Kreisel in 1973 to build a subwoofer for the *Pretzel Logic* album mixing sessions. Since M&K's formation in 1974, the company has pioneered several areas of loudspeaker design, most notably powered subwoofers, satellite powered and surround sound systems. Most of M&K's initial growth was in home



theater and audiophile consumer speakers, but the rise in demand for surround mixes for multichannel delivery systems such as Dolby Digital, DTS and SDDS in theaters, as well as the advent of DVD in the home market, presented a natural opening for M&K to move further into the professional loudspeaker market.

Last year, M&K introduced the 5.1 Pro Solutions product line, a collection of subwoofers and satellite speakers that offered several variants of a basic surround loudspeaker system.

### THE SPEAKER DESIGN

There are actually three different variations of the MPS150 main and satellite speakers available, all with the same sonic characteristics (and the same price: \$1,350), but different orientations of the front baffle. The MPS150 L/R is a matched pair for use as the main left and right speakers in the system. The front baffles are angled in toward each other,

creating a toe-in intended to yield better focus at the primary listening position. Besides the baffle angling, the left and right speakers differ in that the HF drivers are placed on opposite sides of the LF drivers, so that the HF is always on the outside.

The MPS150 AL (Angled Left) and ACR (Angled Center/Right) have no angling in the horizontal plane, but the baffles are angled down 7.5 degrees to allow the monitors to be placed above the mixing position. As with the L/R, the AL and ACR differ in the placement of the HF drivers relative to the LF drivers.

Finally, the MPS150 SL and SC are square cabinets with no baffle angling at all. As before, the SL is for use on the left and the SC for center or right.

M&K also offers the MPS150SUR (\$1,250/pair) for use as surround speakers. The 150SUR can either operate as a THX dipole speaker or in a configuration M&K calls "Tripole," which is intended to combine the diffuse operation of a dipole with the focused operation of a direct ra-

diator. Since my intended uses for the Pro Solutions system included music mixing with sources discretely panned to the left and right surrounds, I opted not to include the 150SUR in the review system.

Instead, the satellites in the review system consisted of an MPS150 L/R pair, two ACRs for center and right surround, and an AL for left surround. Otherwise similar to M&K's home THX systems, the Pro Solutions system provides crossover directivity switches on the 150's rear panel (described below), ferrofluid-cooled tweeters and a balanced XLR input on the subwoofer. The system was powered with two Bryston 5B-ST amplifiers.

The 150s can be mounted on M&K's series of stands with their mounting brackets or Omnimounts. I'd say go with the Omnimounts; I was not enamored of the M&K brackets' tilt capabilities.

The Pro Solutions line includes two powered subwoofers: the MPS5000 Mk II (\$2,950) and the MPS350 (\$2,000). The primary dif-

## Lab Analysis: M&K MPS150 Monitors

by John Schaffer and Rob Baum

The MPS150 cabinet is constructed of 1/2-inch MDF and features robust diagonal bracing on all four sides. The sealed cabinet is finished in a black textured paint and stuffed with polyfill fluff. On the rear of the cabinet are four inserts for rigging hardware or stand mounting. Also on the rear of the cabinet is a plastic input cup with dual, gold-plated five-way binding posts. The crossover board is mounted to the back of the gasketed cup and uses air-cored inductors. A switch on the rear selects for "stacked vs. single" speaker use. Another switch selects between "wide" and THX settings for controlling vertical radiation.

THX specifications call for "focused" vertical directivity above 1 kHz and wide horizontal dispersion, as well as magnetic shielding. The MPS150 features three tweeters arranged in an array for controlled directivity. The tweeters are sourced from Peerless of Denmark, a high quality supplier, and feature 1-inch cloth-domed diaphragms. The custom plastic tweeter faceplates are recessed into the baffle, and are molded in the shape of a very shallow, wide dispersion waveguide. The tweeter magnet is shielded by using a "bucking," or counter (reversed polarity) magnet, but there is no shielding cup or "can." However, unless a video monitor is pressed up

—CONTINUED ON PAGE 127

BY LARRY THE O

ference is greater power in the MPS5000, with an attendant increase in size and weight. My review system employed the MPS5000.

All of the speaker systems in the Pro Solutions line are certified by Lucasfilm THX as meeting their specifications. THX sets performance standards for a battery of parameters, including distortion and directivity, which components must meet in stringent testing (conducted by THX) before the THX logo can be affixed. (In fact, the letters "THX" are actually part of the model names in the Pro Solutions line; they have been omitted here for the sake of brevity.) The THX settings on the subwoofer adjustments described below are intended for when the system is fed by a THX-certified controller.

Returning to the 150 main speakers, the cabinets are quite compact, with dimensions of 12.5-inches H x 10.5-inches W x 12-inches D (give or take a fraction of an inch for the various baffle angles), and a lightweight 23 pounds. No problem fitting these into any decently sized edit suite or project studio. Each 4-ohm cabinet contains three 1-inch soft dome tweeters and two 5-inch polypropylene LF drivers and is capable of handling anywhere from a minimum of 10 watts all the way up to a whopping 400 watts; M&K recommends using at least 50W of amplification per channel.

On the rear panel are gold-plated 5-way binding posts and two switches. The first switch alters the vertical directivity from Normal (THX) to Wide. The Wide setting is meant to enable producers or anyone sitting behind the "sweet spot" to still get quality sound. The other switch is for use when several MPS150s are vertically stacked to create an array for greater SPL.

The MPS5000 is, of course, larger (23.25-inches H x 15.5-inches W x 26-inches D) and heavier (105 pounds) than the satellites, and contains two 12-inch drivers. I used the rear panel's XLR input (pin 2 hot, thank you), but there is also an RCA input.

#### THE CONTROLS

If you want configurable, you've come to the right place with the MPS5000. The rear panel features no less than four switches and two knobs. The interaction of a subwoofer in a room is determined by the room's dimensions and the subwoofer's placement; the MPS5000's Phase switch allows the user to compensate when these factors combine to put the subwoofer out of phase with the low end of the Mains.

The Bass EQ switch sets the MPS5000 to either THX mode, which M&K states

is the most accurate and provides maximum output level, dynamic range and headroom; or Anechoic mode, which is said to produce a rising output below 30 Hz. Listening tests seemed to bear this out: For general music listening at moderate levels, I found the Anechoic mode to yield more "oomph," while the THX mode sounded more even.

The Bass Level section consists of a switch that flips the response between THX and Variable, with an accompanying pot for the Variable mode. When the switch is flipped to Variable and the pot set to the Reference label, the output is the same as when in THX mode; the pot

goes up from there to a maximum of +6dB of output boost. For film monitoring, everything was set to the THX positions, while music monitoring, which was not done through a THX controller, sounded best in the Variable mode. With most of my music monitoring being done at a fairly low level, I tended to crank the Bass Level up to +4 dB or so, which gave a nice, full low end at low volume.

The lowpass filter section is set up similarly to Bass Level—a switch and a pot, but the switch is three-position: THX (no LPF), Variable and 80 Hz 24dB/octave. A THX controller incorporates an LPF, which is why no filtering is

# NO COLOR ADDED

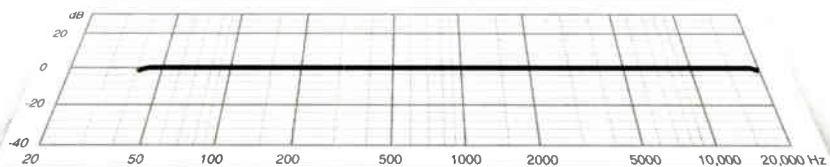

Capture exactly what you hear. Sennheiser's MKH microphones give you the flattest response, as well as the lowest noise and distortion available. For sampling, nothing comes close. For acoustic and orchestral recordings they're a natural. Plus, our unique electronic output design makes them immune to humidity, allowing you to use them confidently outdoors. When you need the absolute truth, the choice is pure and simple.

THE EVOLUTION OF AUDIO



SENNHEISER ELECTRONIC CORPORATION  
P.O. BOX 987, DEPT: 205, OLD LYME, CT 06371 • TEL: 860-434-9190 EXT: 205 • FAX: 860-434-1759  
CALIFORNIA: TEL: 818-845-7366 • MEXICO: TEL: 525-639-0956  
SENNHEISER CANADA: 221 LABROSSE AVE., PTE-CLAIRE, PQ H9R 1A3 • TEL: 514-426-3013 FAX: 514-426-3953  
World Wide Web: <http://www.sennheiserusa.com>

CIRCLE #076 ON PRODUCT INFO CARD

provided in the THX position. M&K recommends that the 80Hz position be used in conjunction with the 80Hz high-pass filter on the satellite speakers. The Variable position provides a 12dB/octave rolloff from the low setting of 50 Hz up to the high setting of 125 Hz, where the rolloff switches to 36 dB/octave.

In fact, there's only one switch notably missing from the MPS5000: the power switch. This left me with the choices of A, leaving it on all the time; B, plugging it into a power strip for the sole purpose of gaining a power switch; or C, plugging and unplugging the damn thing to turn it on and off. I just chose option C and grumbled each time about my very personal and fervent belief that a professional power amplifier should have a power switch and a third-pin grounded AC cable (which the MPS5000 does not).

#### THE TESTS

The system's use in a THX surround environment seemed critical to evaluate, but I did not have a surround film mixing project during the review period, so I set up a DVD screening party at the house of a friend with a glorious 61-inch TV. Using a THX-certified Onkyo processor/amplifier system, we set up the M&Ks and calibrated them with the Onkyo's internal calibration signals and a sound pressure level meter.

We screened two films: *Contact*, the adaptation of Carl Sagan's book, and a Japanese anime film called *Ghost in the Machine*, as well as snippets of several DVD demonstration discs. The movies turned out to be good choices because of the contrast in mixing styles that they showed, especially in the use of the surround speakers. *Contact*, mixed by Randy Thom, used the surrounds sparingly and subtly, except in a few key climactic moments. *Ghost in the Machine*, on the other hand, took the "find the biggest hammer around and apply to the viewer's brain" approach, making very liberal use of the surrounds with a great deal of dynamic source movement throughout the multichannel sound field.

We were not shy about cranking the volume to theatrical levels (although we did vary our listening level over the course of the two films). The first thing we noticed was how many objects in the room were prone to rattling; that subwoofer can CRANK! Once the rattles were tracked down and silenced, we got into some serious listening.

I won't wear you down with a string of superlatives. I will simply say that the

PRO  
TOOLS

## LEARN AUDIO RECORDING AT THE CONSERVATORY LIKE NOWHERE ELSE.

**Avid** | Authorized  
Education Center

- Multi-Studio Facility
- Hands-on Training
- Affordable Tuition
- Internships
- Small Classes
- 22 Week Master Recording Program
- Financial Aid to Qualified Students
- Our Graduates are in Demand

Call Today!

1-800-562-6383

CONSERVATORY OF  
Recording Arts & Sciences

2300 East Broadway Rd.  
Tempe, AZ 85282

©C&A 1997

The Conservatory is the only recording school in the *entire country* that's authorized by Avid to teach ProTools recording, editing, and mixing functions. If you're serious about starting a career in the music industry, the Conservatory is the place to make it happen.

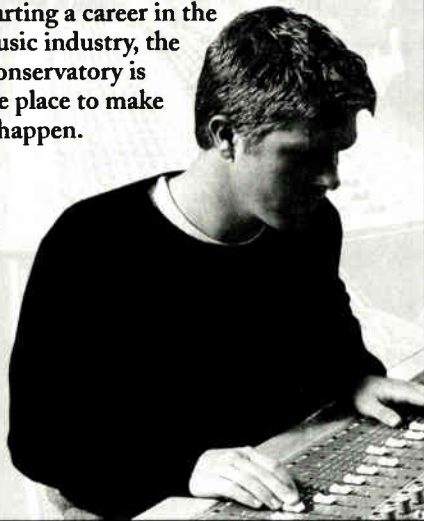

CIRCLE #077 ON PRODUCT INFO CARD

# ANNOUNCEMENT

## CD of 100 Free Sound Effects

- No Cost - No Obligation
- Production Ready
- From The Hollywood Edge Library
- No strings attached
- For working sfx pros only

Available Now - Call

1-800-292-3755

[www.hollywoodedge.com](http://www.hollywoodedge.com)

"Best Sound Effects Library without a doubt," - Oliver Stone

"Excellent," - Martin Scorsese

"Kicks Butt!" - John Hughes

CIRCLE #078 ON PRODUCT INFO CARD

# WE KNOW OUR LIMIT.



## Know your limits using the new L2 Ultramaximizer™ precision peak limiter in a convenient 19-inch rackmount box!

Waves' famous L1 Ultramaximizer software plug-in has been used on thousands of CD masters and records, and on millions of game and movie sound-effects all over the world. Now it's twice as good featuring 48-bit and 96KHz-capable signal processing. Plus it comes in a box! The new L2 hardware rackmount can be taken with you and patched in wherever you go, to any world-class mastering house, live-sound venue, recording studio, broadcasting station or wherever else your ears may desire.

Precise brick-wall peak limiting and 48-bit resolution make L2 ideal for increased resolution of production masters, safety limiting when mixing to digital formats, transient protection of downstream components, or extra hot CD's.

Ultramaximizer means we maximize levels and resolutions in high quality audio applications. Of course 48-bit processing eventually needs to 'come down' to the real world of 16-bit CD's and DAT's (or 20-bit masters - should you have the pleasure!). That's where IDR™ comes in.

### IDR

Waves developed IDR, a true uncorrelated stereo word-length reduction system, with your choice of bit-depth and noise-shaping. Simply put, this means that when you 'downsize' L2's 48-bit signal, IDR gives you the best possible output, without tonal shift, without stereo image alteration, and with a clarity and detail that gives the competition something to dream about.

Go ahead. Ask the competition if their systems are truly uncorrelated stereo. Ask about tonal coloration and image-shift. Waves IDR master dither is simply exemplary, so your productions will be too. Simply put: amazing sound.

This is not an "all in one" box. Waves L2 is The Essential Tool, in one box, for professionals.



### And now for the tech talk

**IDR output:** 24, 22, 20, 18, and 16-bits

**I/O:** balanced analog, S/PDIF, AES

**Sync:** internal, S/PDIF, AES, or external

**clock (BNC) Sample rates:** 32, 44.1,

48, 88.2, and 96KHz **Dither:** IDR

type1™/type2™ **Noise-shaping:** Moderate,

Normal, Ultra **Threshold and ceiling:**

-30.0 to 0.0dBFS in 0.1dB steps **Release:**

0.01 to 1000ms, plus Auto-release option.

Plus, dedicated numeric displays and

rotary encoders for Threshold, Ceiling,

and Release, with infinite peak hold

meters. Stereo or dual mono operation.



performance of the Pro Solutions system in reproducing film soundtracks is stunning. First of all, every word, let me repeat that for emphasis, EVERY SINGLE WORD of dialog was completely intelligible. I don't even find that to be the case in the best theatrical THX systems, not to mention most home theater systems. I really was thoroughly blown away by the clarity of the dialog reproduction in two effects-laden soundtracks. This was even the case with *Ghost in the Machine's* frequent use of panned and offscreen dialog.

The channel localization was also excellent; it was no problem at all to pinpoint specific sound effects. However, the surrounds were still capable of generating solid phantom images and smooth, even sound fields when ambiences were mixed into them. Dynamically panned effects moved smoothly from speaker to speaker. *Ghost in the Machine* contained significant numbers of flybys and drivebys, as well as "sci-fi" effects that moved around in circles, diagonally and every which way. The M&Ks' reproduction of these movements was eminently satisfying.

In addition to the screening party, I

worked with the Pro Solutions system for some 5.1 music mixing, as well as some regular old two-channel stereo work, at Toys In the Attic, my personal studio. For this part of the evaluation, the good folks at Bryston loaned me two of their quite lovely three-channel 5B-ST amplifiers to power the Pro Solutions system.

Multichannel music mixing is pretty new to me and I'm still horsing around and finding out what works. When I started getting into discrete instrument placement, I realized how glad I was that I had gotten direct radiators for the surrounds. Once I built up some musical elements, the M&Ks emanated a thoroughly immersive soundfield. I was least moved by their performance in two-channel stereo, which did not localize as coherently as the multichannel configuration. This seemed in part to be the effect of the subwoofer, as the imaging improved some when I muted the sub.

Many people feel that accurate monitors should be neutral, but I've never heard any loudspeaker that truly was neutral; each has its own sound. The 150s were what I would call "well-mannered," and did not show any aggressiveness, which worked well for lush or symphonic textures. However, when reproducing music

in two channels, the speakers left the overall impression that they had a tad less "life" or "character" than when playing in 5.1.

I found the M&K Pro Solutions system to be an outstanding surround speaker system with the ability to generate immersive, coherent soundfields. For multichannel music and, especially, film work, that has to be done in an edit suite or a typical control room (as opposed to a mixing stage), the compact size of a system of this quality is another major plus. I imagine we will be seeing a sharp increase in the number of companies introducing surround speaker systems in the next few years. Just keep in mind when you shop that M&K has been at it for a while now. And, boy, does it show in the Pro Solutions system.

The author would like to thank Bryston Ltd., (Monrovia, CA) for the loan of amplifiers used for this review.

M&K Multichannel Pro Solutions, 10391 Jefferson Blvd., Culver City, CA 90232. 310/204-2854; fax 310/282-8782. [www.mksound.com](http://www.mksound.com).

*Larry the O has been a regular contributor to Mix since 1984. He performs and provides musical and technical services under the aegis of Toys In the Attic.*

## Digital EQ plus FBX Feedback Exterminator, Compressor/Limiter, & Delay, ALL IN ONE!



GRQ-3101S & 3102S: one and two channel slave units

# HANDS-OFF DIGITAL EQ!

All four models include serial port & GRQ Remote software to control up to 8 units. View and edit response curves, save up to 70 presets, and use contact switching for remote scene changing.

Sabine's new GRAPHI-Q™ 3100 Series gives you computer-based control of the industry's most advanced digital processing, all at one third the price of products with half the features. Our 24-bit A/D and D/A gives the cleanest audio possible, and Analog Devices' new 32-bit floating-point SHARC digital processor powers every Graphi-Q, allowing simultaneous use and independent control of these essential functions:

- 31-band Digital Graphic EQ, with  $\pm 6$  or 12 dB range and High & Low Cut Filters
- FBX Feedback Exterminator: Up to 12 Filters; industry standard automatic feedback control; works in setup and during the program. Super-accurate algorithm places filters on feedback, not on music.
- Parametric filters: Up to 12, fully programmable
- Full-featured digital compressor/limiter
- Digital Delay, with up to 1 second delay, adjustable in 20 microsecond increments

### OR HANDS-ON!

Full front-panel versions with analog-style controls.



GRQ-3102: 2U, dual channel (two in / two out)



GRQ-3101: Single channel (one in/two out)

**SABINE®**  
ADAPTIVE AUDIO

PATENTED • MADE IN USA  
[www.sabineusa.com](http://www.sabineusa.com)  
Tel: (904) 418-2000 • Fax: (904) 418-2001  
Fax-Back Product Info: (904) 418-2002

\*FBX and FBX Feedback Exterminator are registered trademarks of Sabine, Inc., and are the brand names of its line of automatic feedback controllers. Covered by U.S. Patent No. 5,245,665, Australian Patent No. 653,736, German Patent No. 69118486.0, U.K. Patent No. 0486679, and Canadian Patent No. 2,066,624-2. Other patents pending.

CIRCLE #080 ON PRODUCT INFO CARD



WaveLab 2.0. Simply the fastest way to master.

Curve Editing  
Master Section  
True Mastering  
Audio File Comparer  
Real-Time Processing  
Sampler Support  
Real-Time Plugins  
Exabyte Support  
Batch Processing  
Audio Database  
MPEG-1 Audio Export  
24-bit/96 KHz Support  
Redbook CD Burning



Introducing new 24-bit  
Wavelab 2.0 from Steinberg.  
The fastest, most complete tool  
for mastering digital audio on your PC.  
Period. Don't waste another minute.

**Steinberg**

[www.us.steinberg.net](http://www.us.steinberg.net)

21354 Nordhoff Street, Suite 110, Chatsworth, CA 91311 (818) 993-4161  
Fax: (818) 701-7452 Fax On Demand: (800) 888-7510  
Steinberg Canada: (416) 789-7100 Fax: (416) 789-1667

CIRCLE #081 ON PRODUCT INFO CARD  
World Radio History

# PRISM SOUND MASELEC MASTER SERIES

## MLA-2 STEREO COMPRESSOR

Prism Sound is well-known for its quality A/D and D/A converters; the Prism name commands justifiable respect among discerning professionals. Now producer/engineer Leif Mases, known for his direct replacement EQ card on the SSL E Series desk, has collaborated with Prism in the design of a new stereo compressor, the Maselec Master Series MLA-2 Precision 2-channel analog compressor.

From the outside, the 2U rack-mount unit looks quite plain. The symmetrical front panel features white lettering on a grayish back-

ground, and both channels are identical in operation. In the middle of the unit are two toggle switches, one for AC power and the other for stereo linking. Though the VU meters are very large, they are not backlit, which makes them difficult to read in low light. Under each meter is a switch for displaying output level (VU) or average gain reduction (GR). Two large knobs control input and output gain for each channel. The input gain knob (which effectively controls the compressor threshold) offers stepped settings in 1dB increments from -20 dB to 0 dB. The output gain knob is also stepped and yields output, or makeup gain settings from 0 dB to +20 dB. Three additional control knobs per channel control compression ratio and attack and release times. Ratio settings are 1.4:1, 1.7:1, 2:1, 3:1, 5:1 and 8:1. Settings for nominal attack times (ms/dB) are 0.005, 0.020, 0.100, 0.500, 1.0 and 1.5. Nominal release rate (sec/dB) settings are 0.02, 0.05,

0.10, 0.20, 0.40 and 1.0. A green light indicates when the compressor In/Out switch is engaged. When the gain reduction threshold is passed this light turns red, which gives a good indication of compressor action from a distance. When the switch is in the Out position, both input and output gain knobs have no effect, and the VU meter switches to input instead of output. This feature allows input levels to be set easily using the VU meters, and it allows you to monitor the uncompressed signal.

The unit's rear panel features

ment as opposed to the more commonly used VCA. Even when driving the unit hard, I found it difficult to get the unit to pump, and the output level stayed fairly constant. Despite the fixed threshold level, I found that using the input level to control compression felt comfortable and intuitive. A dynamic stereo linking system that Prism calls Imagelink matches the gain reduction applied to both channels yet allows for different ratio, attack and release settings. To maintain a stereo image without pumping, momentary peaks of short duration are not "linked."

One of the key features of the MLA-2 is dynamic control. Attack and release times are dynamically controlled, and settings are automatically modified according to the program source: Longer transients are awarded a longer release time, shorter transients get shorter release times. This helps control distortion and pumping and results in smooth and musically transparent operation.

I put the MLA-2 to work on a variety of instruments, synthesizers and vocals and found it extremely versatile. However, the MLA-2 really sounded its best on complex, full-bandwidth material, and I frequently used it to tighten up a mix while dynamically controlling the stereo peaks. In fact, I found the MLA-2 sounded so good during mixing and tracking that I would not hesitate to include it for any project. The stepped settings enable absolute repeatability of particular settings, the sonic quality is superb, and the unit is easy to use. Though the retail price of \$3,170 puts the MLA-2 in the upper mid-price range, I think the investment is well worth it.

Prism Media Products, 115 Rt. 46 B-16, Mountain Lakes, NJ 07046. Tel. 973/299-7790; fax 973/299-7759. Web site: [www.prismsound.com](http://www.prismsound.com). ■

*Michael Denten is a producer, engineer and owner of Infinite Studios in Alameda, Calif.*



standard XLR I/O connectors, a ground binding post and a power switch with an on/off light. There is also a switch marked high/normal. In the normal position, the compression threshold ranges from -10.5 dBu to +14.5 dBu; on the high setting, the range changes to -1.5 dBu to +23.5 dBu. The ostensible reason for the normal/high switch is that it enables one to move the threshold up or down relative to an existing program level, thereby increasing or reducing the amount of compression without altering front panel settings. However, since the switch is located on the rear panel, it is effectively unreachable during a session if the unit is installed in a rack, which seems the most likely practical setup.

The first thing I noticed when compressing finished mixes is how smoothly the MLA-2 makes the transition over the threshold into compression. This is no doubt due to the use of an optical gain ele-

.....

BY MICHAEL DENTEN

THEY SAY  
KNOWLEDGE  
IS A  
DANGEROUS  
THING.

COOL.



[www.xnewmedia.com](http://www.xnewmedia.com)

CIRCLE #084 ON PRODUCT INFO CARD

CIRCLE #085 ON PRODUCT INFO CARD

## FIELD TEST

ple-accurate ADAT sync (interlocking multiple transports): RJ-45 jack for the CADI autolocator/controller and remote meter display (RMD); two ¼-inch jacks for the LRC small remote and (optional) punch-in/out footswitch; 9-pin connector for Sony P2 protocol input; two pairs of BNCs for word clock in/out and video sync in/thru (with 75-ohm termination switch); and two +4dBu balanced XLRs for timecode in/out, supporting the following frame rates: absolute time (ADAT 32-bit), SMPTE (30 & 29.97 DF and NDF), 25 fps EBU and 24 fps film.

The M20's MIDI implementation supports MIDI Time Code for locking to

sequencers, MIDI Machine Control for controlling the M20 transport functions via an MMC-capable console (such as the Mackie D8B or Panasonic DA7) and MIDI data dumps for loading software updates. Unlike the earlier ADATs, whose operating software was on pricey EPROM chips, new software updates for the M20 can be downloaded from the Alesis Web site as MIDI data and exported from a sequencer into the M20. Alternatively, those who don't have access to the Internet or MIDI can update an M20's software simply by connecting a MIDI cable between one M20 with new software (say a deck at a dealer or friend's place) and transferring the operating system to the old machine. I tried this when I needed to up-



**Whisper Room** INC.  
Sound Isolation Enclosures

Recording • Practicing • Broadcasting  
etc.  
Various Sizes

Tel: 423-585-5827 • Fax: 423-585-5831  
Website: [www.whisperroom.com](http://www.whisperroom.com)  
116 S. Sugar Hollow Rd., Morristown, TN 37813 USA

CIRCLE #086 ON PRODUCT INFO CARD

## M20 + CADI + RMD = "THE SYSTEM"

Used alone or synched to form a huge multitrack array, the M20 is a formidable piece of studio gear. However, an integrated system can be formed by adding the CADI and RMD options.

Housed in a sleek, 18.5x11x3.5-inch wedge, the \$1,499 CADI (Controller Autolocator Desktop Interface) offers remote access to all of the M20's front panel controls, including the jog/shuttle wheel. A large, bright, vacuum-fluorescent display shows machine status and alphanumeric information, such as the names of location points. Individual M20s can be taken offline from the remote (allowing tape formatting operations on two transports while recording or mixing using two other M20s in the chain). CADI even includes an indented groove that keeps your pencil or Sharpie from rolling off the top panel. Individual "Locked" LEDs indicate all machines in a system are in sample-accurate sync, and individual M20s may be taken offline from the remote.

Unlike the BRC controller, CADI does not house all the system synchronization circuitry (SMPTE chase and MIDI sync is built into every M20). Communicating to any Type II deck via a single RJ-45 Ethernet-style cable (up to 300 meters), CADI merely acts as the interface telling the system what to do, even if CADI is controlling M20s located in a machine room hundreds of yards away. The real power is in the M20 itself.

Also on the RJ-45 bus is display information for the 32-track Remote Meter Display (\$799), which like the M20, also provides a choice of metering modes (including a high-res 0.2dB/division setting) as well as error/interpolation indicators. The meter display's Peak Mode and Peak Clear mode may be set from the front panel of the M20, or from the CADI. In addition, eight LEDs on the meter's front panel warn of any error conditions or tape problems. Its rack ears offer convenient mounting options, and the action of its 22-segment LED ladder displays are easy to read from a distance. And like the CADI, the RMD includes a 30-foot connector cable, which provides ample length in most studios.

For commercial studios that keep recorders in a separate area from the control room, the M20/CADI/RMD combo provides an elegant and affordable solution.

—George Petersen

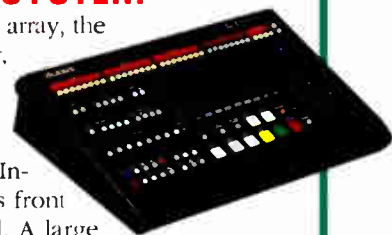

**Rich Music**

Before you jump...  
**CALL US LAST!**  
**1-800-795-8493**

ALL YOUR FAVORITE BRANDS!  
PRO AUDIO  
KEYBOARDS  
EFFECTS  
MIXERS  
PA GEAR  
SOFTWARE  
ACCESSORIES  
MICROPHONES

The only way to buy for less is to own your own music store!

**RICH MUSIC**  
260 SOUTH I-35E • DENTON, TX 76205  
FAX: (940) 898-8659  
STORE HOURS: MON. - FRI. 10-6:30, SAT. 11-5  
<http://www.richmusic.com>

**WE ACCEPT VISA • MASTERCARD**  
DISCOVER • AMERICAN EXPRESS

CIRCLE #087 ON PRODUCT INFO CARD

# Soundscape™

DIGITAL TECHNOLOGY

# mixtreme™

Digital Mixing, Real-Time Effects, 16 inputs & outputs, any questions?

Designed for



Microsoft  
Windows NT  
Windows 95

UNBEATABLE  
\$549.00

There are many companies in the market place offering multi-channel audio PCI cards, but for most, this is where it ends. Most companies can at best just 'put chips on boards', but from Soundscape Digital Technology there is an unbeatable combination of software and hardware... **mixtreme**.

The **mixtreme** PCI card has a completely different concept, as not only does it provide 16 channels of 24 bit digital I/O via two industry standard 8 channel TDIF (Tascam Digital Interface) ports, but it also has 24 bit custom digital mixing and real-time DSP effects plug-ins from some of the worlds' leading audio companies. **mixtreme** performs like you expect, without the annoying in/out delays that make native mixing and effects impossible to use in real time.

You can connect two Soundscape SS8IO-3 8-Channel TDIF to Analogue interfaces to **mixtreme**, for a full 16 channels of 20 bit analogue input and output, or you can connect the TDIF directly to a digital console or Tascam DA-88.

For ADAT users, there is the SS8IO-2 TDIF to ADAT converter, and you can connect two of these, or combine one ADAT and one Analogue interface. Optional SPDIF completes the range of Digital Connections available.

With standard Multimedia drivers for Windows 95 and Windows NT, plus VST compatible ASIO drivers, **mixtreme** can be used with most PC based MIDI/Audio sequencers or PC based recording/editing software.

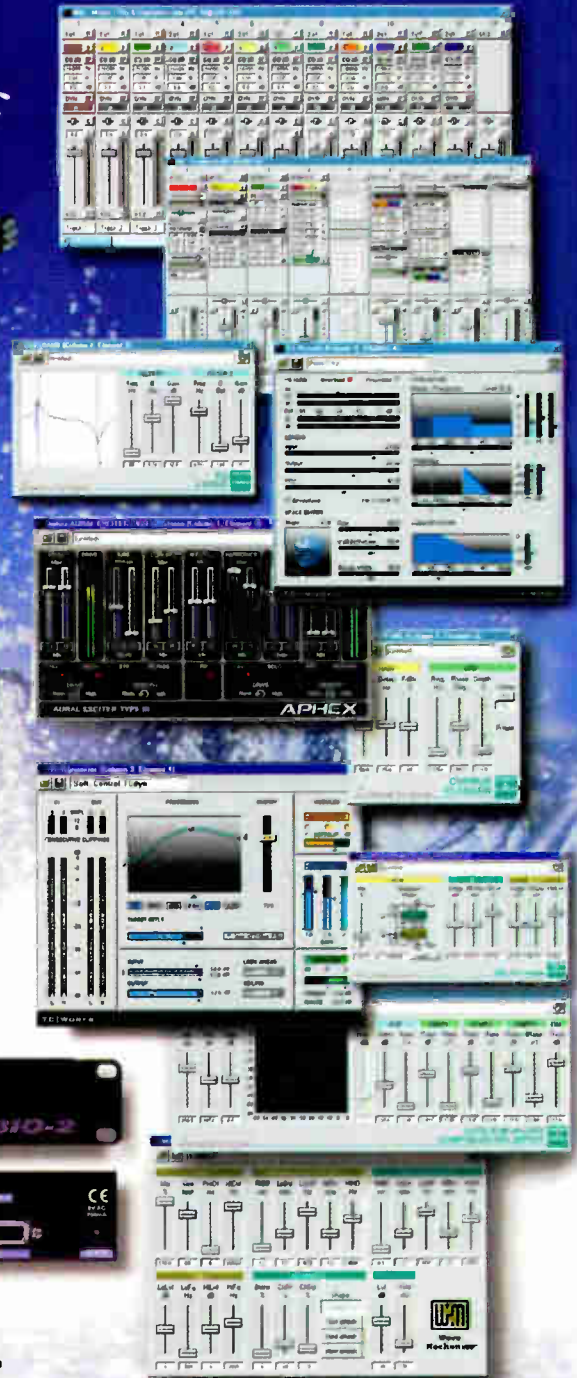

### SS8IO-3 Interface

- 8 channel TDIF to unbalanced analogue I/O (cinch/RCA connectors)
- 20 bit AD/DA Converters
- Wordclock/Superclock in/out

SS8IO-3  
\$599.00

### SS8IO-2 Interface

- 8 channel TDIF to ADAT 'lightpipe' conversion in both directions (simultaneously)
- Wordclock/Superclock in/out

SS8IO-2  
\$399.00

# Soundscape™

DIGITAL TECHNOLOGY

USA SALES: SOUNDSCAPE DIGITAL TECHNOLOGY INC.  
4478 Market Street, Suite 704, Ventura, CA 93003  
Tel: (805) 658 7375 Fax: (805) 658 6395  
email: us-sales@soundscape-digital.com



date one of the decks from 1.00 to rev 1.10 and it worked like a dream.

### HORSEPOWER!

Inside the M20 is the Matsushita "IQ" transport used in Panasonic's high-end video editing systems, and it operates twice as fast as the Alesis XT. A 40-minute (T-120) tape rewinds in 30 seconds; wind speed is 80-times play speed; and shuttle is variable from 1/2-speed to 10-times play speed. Variable-speed forward/reverse "Reel Rocking" is also possible, and, if desired, audio from the aux track can automatically be routed to any track output in Jog mode.

The transport offers more than mere speed. Dual direct-drive motors under servo control move the tape efficiently, and this design eliminates the idler wheel, so tape handling is gentler, yet provides for faster sync from Stop and greater control in Jog/Shuttle mode. With no brake adjustments needed, no idler to clean/replace and an automatic head-cleaning wand, maintenance needs should be greatly reduced. An off-line mode allows formatting on one deck while recording on others, without repatching sync lines. After formatting, a Tape Certify function can check the tape and provide a count of tape errors.

The M20's analog Aux track acts as a "ninth track" for purposes ranging from a cue track to click track, or slating, note taking—or even for recording tone pulses for triggering slide projectors in multi-image presentations. Additionally, the M20 provides a simple onboard mixer that can record the output of any combination of tracks to the Aux track whenever needed. Just select the tracks you want to copy, arm the Aux track and press Record. The Aux track has its own XLR input and output, and is recorded on a linear track near the top edge of the tape in the same manner that linear audio tracks are recorded on a VTR; however, due to the ADAT-increased tape speed (faster than standard VHS transports), the quality of the Aux track is higher than that of most VCR linear audio tracks.

I found all sorts of uses for the analog aux track. Although its AM radio-quality reproduction is not much to write home about, I liked using it to record a scratch track while tracking drums. This way, I could use all eight digital tracks for kit miking (K-S-HH-T1-T2-T3-OL-OR)—plus a scratch track—only needing to run a single transport. Yeah!

—CONTINUED ON PAGE 212

AUSTRALIA  
AR Audio Engineering  
02 9810 5300

BELGIUM  
EML  
011 23 23 55

CANADA  
Audionova  
888 247 8580

DENMARK  
StageGroup  
38 60 73 97

EIRE  
Seadna Productions  
01 497 0661

FRANCE  
SCV Audio  
01 48 63 22 11

FINLAND  
U.S.E.  
9 7594180

GERMANY  
SEA  
05903 93880

GREECE  
Even Studio  
041 554355

HONG KONG  
Top Plot International Ltd  
2419 1868

ITALY  
Audiosales  
0521 690290

JAPAN  
Onkyo Tokki  
03 3237 1201

KOREA  
Fine Trading  
02 326 2032

LEBANON  
Etek  
01 249666

NETHERLANDS  
Iemke Roos Audio  
020 6972121

RUSSIA  
C.S. Company  
095 573 7444

SINGAPORE  
Ultra Sound Agency  
284 8123

SPAIN  
LMC Audio Systems  
93 471 14 40

SOUTH AFRICA  
Tru-Fi Electronics  
011 462 4256

SWEDEN  
TTS  
031 525150

SWITZERLAND  
Soundhouse  
041 240 4231

TAIWAN  
Splendid Sound Technic  
02 279 2347

UNITED KINGDOM  
SCV London  
0171 923 1892



## PRO-SERIES



Digital Processors

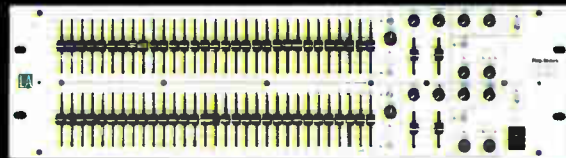

Graphics



Parametrics



Compressors



Conference Mixers

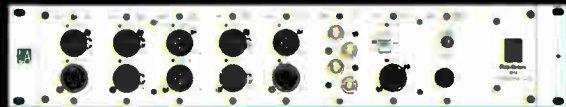

Interfacing Systems



Distribution Amplifiers

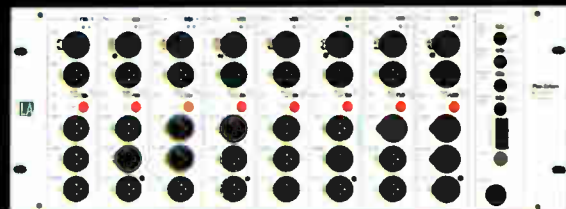

Mic Splitters



DI's and Accessories

## The better choice.

6-24 Southgate Road London N1 3JJ Tel: +44 (0)171 923 7447. Fax: +44 (0)171 241 3644  
email: sales@laaudio.co.uk LA Audio is a division of SCV Electronics Limited

web: <http://www.laaudio.co.uk>

# A PERFECT PAIR

## TC Electronic Gold Channel and Audio-Technica AT4060

What do you get when you cross the most amazing new mic preamp/dynamics processor/EQ with a pair of the best sounding, lowest noise new tube microphones?

You get more than exceptional sound. You get more than extraordinary flexibility — from pristine digital to warm valve flavor.

You get the most talked about, lusted after and in demand pair of studio tools of the year.

Sure, you could use a \$500,000 console and a pair of \$20,000 vintage mics. Or, for about a hundredth of the investment, you can have a pair of AT4060s and a Gold Channel in your studio tomorrow morning!

AUDIO-TECHNICA  
AT4060

- Tube, Large Diaphragm Condenser
- Low self-noise
- High SPL



audio-technica®

t.c. electronic  
ULTIMATE SOUND MACHINES



TC ELECTRONIC GOLD CHANNEL

- Two Channel Mic Preamp
- Full Dynamics Processing and EQ
- 24 Bit Conversion / Up to 96kHz Internal Processing

**MUSIC TECHNOLOGY DIRECT — and the Best value Guaranteed!**

No matter what gear you already own, The Gold Channel and AT4060s will take your studio and your music to stunning new heights. Why not call us right now and start enjoying the tremendous power and awesome sound of this perfect pair immediately?

**Call (800) 222-4700**

(219) 432-8176 • FAX (219) 432-1758 • sales@sweetwater.com  
5335 BASS ROAD • FORT WAYNE, INDIANA 46808

**Sweetwater**  
SOUND INC.  
www.sweetwater.com

## SOUND FOR FILM

"THE FUTURE,  
MR. GITTES"

by Larry Blake

The lack of clear, rational thinking that is so prevalent these days is defined very precisely by the "fallacy of the excluded middle." This describes the inherent lapse in logic when people discuss a situation as if one side has to be right and the other wrong,

to the world of pro audio. Well, you'll find out in this, the last of three parts looking back at my work on the *post* post-production of the film *Out of Sight*. This month's column mulls over a crucial part of film sound that many of us don't give much thought to, if any: preserving our work for future generations.

The archiving of the assets of movie studios—the picture and sound elements of their feature films—has been a topic of growing concern over the past decade. The catalysts are pretty self-evi-

trend toward recording digitally, with digital dubbers finally offering the key benefits of mag in a zeroes-and-ones format. Nonetheless, there is still a mantra that mag (and its first cousin, 2-inch 24-track) is the only way to salt away movie soundtracks.

Of course, I understand the wisdom behind these beliefs: Analog machines can be found in every major city of the world, they are not reliant upon software versions to extract the sound from the reels, etc., etc. All of this is true, and analog indeed fits the "sending it out on Voyager" paradigm: You could give blueprints to someone Out There, and they could probably figure out a way to build it (although I would want to spare them the trouble of having to come up with Dolby SR cards). Yeah, yeah, I am well aware of all this.

It's clear that there is a solid argument for making sure that key elements such as stems, printmasters, and music & effects mixes exist on analog tape. I do *not* agree with Current Wisdom that this is The Best Way. Speaking here, in the fall of 1998, I'm going to go out on a limb and call that thinking wrong-headed.

There is no excluded middle here, no false dichotomy. I have no problem with ensuring worst-case playability by recording on analog film and tape, but I believe that the primary archiving energy should be devoted to preserving yesterday's (and today's) soundtracks on fluid, 24-bit digital audio files.

The benefits are obvious. Digital audio is not tweak- and alignment-sensitive, as is always the case with analog. Is the azimuth on the nose? Are the heads worn? Is the repro EQ adjusted properly? (This affects not only the frequency response but the ability of the Dolby SR noise reduction to track accurately.) Is the master itself worn? Is the transport tweaked? Are

—CONTINUED ON PAGE 140

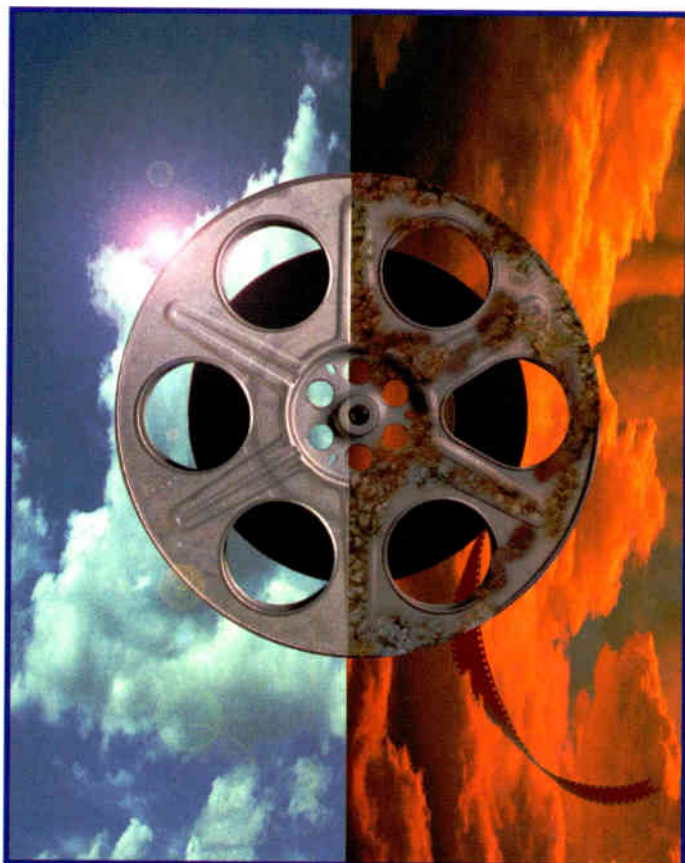

without acknowledging the possibility that both sides could be wrong or right.

Maybe some recent developments will help improve this situation. I think the Starr Report has brought this issue clearly into focus: It's pretty clear that a great number of Americans simultaneously think that Starr was wrong to dig and Clinton was wrong to lie.

You must be wondering how I'm going to tie this back

dent. First and foremost, there is the ever-changing and expanding market for reselling the catalog, usually involving remastering of the elements to state-of-the-art video. Second, many films have badly deteriorated, and if the masters are not dealt with soon, there will be no rescue.

The major studios have been reliant upon 35mm mag film for almost five decades now and have only in the past year or two started any



# IN THE DESERT, ON THE EDGE

## HANS ZIMMER SCORES "PRINCE OF EGYPT"

by Maureen Droney

Bigger and better: When you've been nominated four times for an Academy Award and won once (Best Original Score for a Musical on *The Lion King*), won two Grammys for Best Original Score (*Crimson Tide* and *The Lion King*), and have composed for pictures from *Rain Man* and *Driving Miss Daisy* to *As Good As It Gets*, how do you top yourself? Hans Zimmer and his team found out once again while working on Dreamworks SKG's first in-house animated feature, *The Prince of Egypt*.

A three-year process, the soundtrack took on epic proportions as it encompassed

dozens of musicians and singers, numerous recording formats and hundreds of real and virtual tracks. Prerecording of Zimmer's synthesizers and samplers was done at his own Media Ventures Studios in Santa Monica, Calif., using six Yamaha 02R consoles and a 32-track Otari DTR900II. Then it was off to London for Zimmer and engineer Alan Meyerson to record orchestra and choirs at Air Lyndhurst onto a 24-channel Augan 0MX24 hard disk recorder, synched with a Sony 3348. Back in L.A., ethnic percussion was recorded to a Pro Tools|24 system by Jeff Rona. Final music mixing, also at Media Ventures, was handled by Meyerson (with the assistance of Slamm Andrews and Gregg Silk) on a Euphonix CS3000 console, with sources including all the formats with completed music being delivered to the Todd-

At right, Hans Zimmer sits at the piano, going over the score for Prince of Egypt with lyricist Stephen Schwartz.

Below, a scene from the dramatic chariot race.



One way Zimmer continues to top himself is by taking chances, pushing the envelope creatively and technically. The choice of the Augan

AO dubbing stage on ultra-wide SCSI III drives. (Final mix stems were saved in Pro Tools 24-bit sessions.)

hard disk recorder was a case in point. "Hans saw it and said, 'Let's try it in London,'"

—CONTINUED ON PAGE 146

## FACILITY SPOTLIGHT

# POST LOGIC GOES HD

by Kim Wilson

In light of the FCC's mandate to start the conversion to digital TV by the end of 1998, Post Logic Studios in Los Angeles has decided to lead rather than follow by opening a 5,000-square-foot High Definition center. Located on the second floor of its Hollywood location, the HD facility consists of two identical HD bays, a separate quality control/layback suite, business offices and a vault to hold film masters to ensure their safety. Designed by Studio 440 Architecture & Acoustics, it is the first such facility to receive TMH qualification.

"In addition to our existing full-service video, film and audio post-production

At right, one of the high-definition film transfer bays at Post Logic Studios.

Below, Dick Voss, president of the facility.



PHOTO: ROBERT ZUCKERMAN



services," says Dick Voss, president of Post Logic Studios, "the two telecine suites in this new HD facility offer our clients uncompromising, state-of-the-art technology and talent. It is one of the country's most advanced all-digital, high definition film transfer facilities."

In order to supply broadcasters with an array of feature films from both the past and the present in the new High Definition format, the films must be transferred to an HD-D-5 tape, which also contains four channels of 20-bit digital audio. Post Logic's Telecine suites were developed just for this task.

The main telecine bay is home to some of the most

—CONTINUED ON PAGE 150

## BOB SEIDERMAN, 1947-1998

*On October 9, Bob Seiderman lost his two-year battle with cancer. He left behind a loving family, an international collection of friends and colleagues, and an unmatched legacy in the sports audio world. For 30 years, he brought stunning television audio to the viewing public, coming up with such innovations as mics on the Fenway Park Green Monster and parabolics aimed at the football field. He mixed Final Fours, World Series, Daytona 500s and Super Bowls. We asked those who knew him to say a few words about the man affectionately known as "Spider."*

Bob was the best. He was the best in his business because he cared. He cared about his profession, he cared about the job he did, and he cared about the people he worked with. Nothing that you



PHOTO: STEVE JENNINGS

**Bob Seiderman at the Neve VR Legend in his weekend home, the back of the John Madden truck, 1994.**

could ask for would ever be considered a problem.

I worked with Bob for 18 years, so it was more than working together. It was a friendship. You know I travel by bus, and whenever we would pull into town for a game, Bob would be the first guy on the bus—just to sit in the chair and say hello. When you have the best, he can never be replaced.

—John Madden

For over 25 years I had the privilege of calling Bobby friend. He not only was the great audio man that we knew, but the kindest, most considerate soul that I have ever met. Out of all his wonderful accomplishments and beautiful sounds that emanated from his audio booth, the most wonderful sound to my ears was when he called his stepsons, Alexander and Troy: "Gentlemen...Homework."

The first time I heard that via a phone call from the other side of the world, I broke out in a big smile. I knew he was happiest in the role of husband and dad. Receiving the gift of little Ashley Morgan made him the proudest of all. Hearing him say, "My daughter" was a treat for me.

—Gayle P. De Poli, MTV Networks Latin America

Back in the late '70s, Bobby was already a top audio man at CBS, while I was still a mutt. In an effort to get smarter fast, I went to Bob and asked him what could really help me in my career. He didn't miss a beat: "Always fly first class," he said, and he always did. I didn't see Bobby the last few years. That's my private regret. His spirit, however, will forever be around, and he'll be flying first class.

—Gary Kiffel, CBS

more about audio than anyone else, and he taught me about life personally—he had a great perspective on life. His innovations and ideas will live with us for years to come.

—Fred Aldous

What set Spider apart was his ability to understand the challenges at hand and create innovative solutions. Spider was at the forefront along with guys like Jerry Gepner, Stan Honey, Jerry Steinberg and the rest of the team that brought to broadcast sports such innovations as FoxTrax and Sounds of the Game. Although the work he did helped bring the impact of sports broadcasting into our homes, Spider will always be remembered in my heart for his humanity.

—Scott Schumer, Vice President, Sennheiser-Neumann USA

I started at CBS about the same time as Bob. I used to do boom for him in the early '70s on the TV show *Love of Life*, which he did right after the *Merv Griffin Show*. When he didn't need me in an Act, he would say, "Go to 30,000 feet and circle." I loved working with Bob because he was always low-key and very professional. He would always give me good advice and help me with whatever questions I had about the CBS Mobile units and pass along his experience freely. Bob Seiderman will be missed by all of us in television audio.

—Jim Rose, Late Show with David Letterman

I have known and worked with Bob for a very long time. He was the kind of person that set the standards for everyone else. By definition, he was "one of the good guys."

—Larry Estrin

Bob was my best friend. I will always cherish his memory and the honor he bestowed upon me to be with him at the end of his time with us. I asked many of his friends to come up with amusing anecdotes or stories for his memorial. I specifically asked that no one say how much they would miss him, that he was a great audio man or how much he was loved. We all knew those things, I said. What I wanted was for his family to know that he had a wonderful life and a lot of friends.

—Jeffrey Pollack

Donations may be sent to the Robert Seiderman Children's Education Fund: P.O. Box 397, Jericho, NY 11753-9998.

# 5.1 Surround Sound...

## It's a jungle out there

Mixing six or more discrete channels of audio for film is already well established but the scope afforded by 5.1 surround for music and broadcasting has yet to be realised. There are no rules. There are challenges, there are opportunities - but there's only one certainty - it's on the way.

Before venturing into the unknown, be comforted to learn that Solid State Logic consoles are already equipped to tackle the surround sound future - in all current and envisaged formats, including DVD. And, come the 5.1 revolution, the enormous advantages of proven SSL technology such as snapshot and dynamic automation, instant reset and unparalleled audio quality will be even more apparent.

Clear your path through the surround sound jungle with cutting edge technology from SSL, the world's leading console manufacturer.

**SL 9000 J Series** - The ultimate analogue console that's become the benchmark for the international recording and film scoring communities.

**Axiom-MT** - The in-line digital multi-track console with a control surface so intuitive it could be analogue.

**Aysis Air** - The digital broadcast console for studios and mobiles, designed for a painless transition to the era of DTV.

**Avant** - The digital film and post production console which mixes in all formats from stereo to 7.1 surround.

## Solid State Logic

### International Headquarters

Begbroke Oxford OX5 1RJ England

Tel: +44 (0)1865 842300

Fax: +44 (0)1865 842118

Email: [sales@solid-state-logic.com](mailto:sales@solid-state-logic.com)

<http://www.solid-state-logic.com>

New York

+1 (1)212 315 1111

Los Angeles

+1 (1)213 463 4444

Tokyo

+81 (0)3 5474 144

Paris

+33 (0)1 3460 4666  
World Radio History

Milan

+39 (0)2 2622 4956

Toronto

+1 (1)416 431 9131

Singapore

+65 (0)438 2272

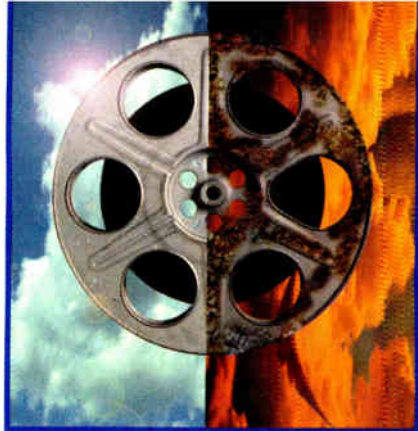

—FROM PAGE 136. "THE FUTURE, MR. GITTES" the heads *clean*?

And on top of all of this, an analog master will simply not represent exactly what was heard at a final mix, on input, as much as a 24-bit digital master will. I can *bear* that analog generation, if you catch my drift.

The most unique up-side of digital dubbers is the above-mentioned "fluidity." Do you need to re-edit the materials for a "director's cut" ten years from now? You want to assemble your print-masters to match the home video version? You need to re-edit the track *today* for the airline version? All elements, as far back as you want to go

(premises, even), can be easily conformed, without having to go through the laborious process of loading everything in (whereupon you come back to the tweak issue of analog). With digital, any challenge can be met easily with a "save as." Those are the primary benefits of handling audio as files, as opposed to linear pieces of sound, either analog or digital, mag film or multitrack.

Many of these points were debatable just a few years ago. Post-production was ruled by 16-bit digital audio, both multitrack and disk-based, and that just ain't a match for SR analog. Disk storage was getting cheaper, but 4-gig drives were the most common "large" size knocking around pro audio.

On *Out of Sight*, which was mixed at Vine Street Studios in Hollywood, we used 9-gig hard drives exclusively to record on Tascam MMR-8 digital dubbers and to play back premixes and stems on their MMP-16 players. I think for the near future, 9-gig drives will remain the most convenient drive size because they fit eight tracks of 24-bit audio (a little more than 8 MB/track minute) for over two hours. To be cautious, during the mix, we backed up all 9-gig drives to a clone sister drive, just in case.

We recorded everything on 24-bit Waveframe files; MMR-8s were not quite up to Sound Designer II files when we started premixing in mid-May. Having recorded a whole show 24-bit, I have now seen the light: I won't accept anything else for my theatrical mixing, if only because of the additive noise.

The final mix begins with all premixes at 0, and certainly there is no time whatsoever to write mutes. Thus, there were frequently 64 tracks of noise adding up in the monitor. When working in 16-bit digital audio (on the DASH format), I drove my colleagues crazy with elevating the record levels to reduce every bit of noise that I could. Even boosting the 0 VU level to -16 from -20 would make a noticeable difference in noise when added across 70 tracks recorded during premixing and finals. (I would fill up 48 tracks of a DASH machine for premixes and record stems across approximately 22 tracks.) This number on *Out of Sight* was 96, with the 64 tracks of premixes and 32 tracks of stems. (It should be clear that even if your source material is 16-bit, as was the case with almost everything during *Out of Sight*, the benefit of 24-bit premixes and finals is still needed.)

**Call or Fax  
for FREE  
CATALOG!**

**Inquire about  
products & brands  
not listed.**

**USA  
1-800-331-3191**

**NYC Area:  
516-678-4414  
Fax: 516-678-8959**



**Visit our Website: <http://www.burlington-av.com> • E-mail: [sales@burlington-av.com](mailto:sales@burlington-av.com)**

**At Burlington We Have All The Media So You CAN Record!**

**Shipped From Stock • Priced Right**

**• Immediate Delivery •**



**SONY**  
PROFESSIONAL MEDIA



**Burlington A/V Recording Media, Inc.**

**106 Mott Street • Oceanside, New York 11572**

CIRCLE #091 ON PRODUCT INFO CARD

# SOUND MAKES THE PICTURE.

# YOU MAKE THE SOUND.

## TASCAM MAKES THE TOOLS.

The race to all-digital post is on and it's critical to choose the right tools. Unfortunately you're faced with many choices that create as many problems as they solve — like system incompatibility due to closed, proprietary platforms and file formats, for starters. That's why TASCAM is dedicated to an open systems approach to audio post with recording, dubbing and mixing technology that broadens your horizons, not limits them.

TASCAM's complete line of advanced digital audio tools helps you manage the wide array of media and file formats you deal with every day. Each is designed with input from leading industry professionals who know what works — and that means better technical and creative control of production, ADR, foley, scoring environments and dub stage.

TASCAM's advanced tools include the new MMR-8 Digital Dubber and MMP-16 Digital Player. Both feature removable hard drives and true cross-platform, multi-format capability that virtually eliminates transfers. Hi8 Modular Digital Multitracks like the DA-88 and the DA-98 with Confidence Monitoring offer the industry standard DTRS® tape medium and performance. And perhaps the best surround sound and DVD mixer in its class — the TM-D8000 digital console — gives you superbly flexible routing plus complete control of your video and audio machines. These open system production tools read, write and deliver the most popular recording formats making the handling and management of your audio assets a breeze. Open your mind. Call TASCAM today and get to know the tools that will increase your productivity, creativity, and ultimately give you the one thing you really want — more credits.



DA-88 Modular Digital Multitrack



DA-98 Modular Digital Multitrack



MMR Series Digital Dubbers & Players



DA-60MKII Time Code Synchronized DAT



TM-D8000 Digital Mixing Console

# TASCAM®

Take advantage of our experience.



TEAC America, Inc., 7733 Telegraph Rd., Montebello, CA 90640 (213) 726-0303 TEAC Canada Ltd., 5939 Wallace Street, Mississauga, Ontario L4Z 1Z8 Canada (905) 896-8808  
TEAC Mexico S.A. de C.V., Privada Corina #18, Colonia del Carmen, Coyoacan, Mexico D.F. 04100 (525) 658-1943 www.tascam.com  
Call TASCAM FAXBACK at (800) 827-2268 for additional information.

CIRCLE #092 ON PRODUCT INFO CARD

World Radio History



Now, with 24-bit recording doing a good impersonation of adding Dolby SR noise reduction to the 16-bit digital medium, I used the -20dBfs reference

level throughout, keeping engineering tweak-time to a minimum. So for this film the whole mix kept to a consistent -20 dBFS=0 VU=85 dBc/slow level.

I knew that I was opening up something of a Pandora's box by recording the show 24-bit. Sure it would sound better, but how would I be able to play it back in that format in the years to come? Yeah, we could (and did) make DTRS copies, but they didn't preserve the mix in its full 24-bit glory. The obvious option—to purchase the 9-gig drives we used on the mixing stage—is not as ludicrous as it might seem. Figure it this way: If a studio sells the client 35mm fullcoat

at 10 cents/foot, at \$1,400 for each set of 6-track mags (OOS was in seven big "2,000-foot" reels), it would have taken approximately 12 sets of mag to accommodate the 64 tracks of premixes. (The additional amount is because of the odd ways needed to fit 8-track mixes onto 6-track increments.) This would have cost \$16,800, as opposed to \$8,000 in hard drives. Pretty amazing, huh?

But, on the next film, unless there is a playable archive medium available (see below), I will indeed purchase a few 9-gig drives to hold key sound elements needed at various times during the home video mastering process. I think it's irresponsible of those of us who supervise and mix feature films to just hand our colleagues in video mastering a few dozen rolls of mag and have them figure it all out.

This is the lesser-known and perhaps least talked about aspect of archiving films—to provide elements that will help others weed through your film in the future. For example, we mixed OOS in the full 8-track SDDS format with five speakers behind the screen active during premixes and final mixes. (No "spreading" at the last minute for this longtime admirer and first-time user of the most delicate and powerful of film sound formats.) When it came time to create the 6-track discrete and 4-track matrixed versions, I decided to create every possible printmaster to cover all contingencies.

For the 6-track version, I recorded an "archival master" mix at 24-bit resolution and a 48kHz sampling rate on one 9-gig drive while recording on another drive a DTS mix in the 16-bit/44.1kHz format, which "bandpass encodes" the sub and surround channels. (Similarly, back at the 8-track printmastering stage, I created 24/48 and 16/44 SDDS versions.) From both 16/44 masters we made DTRS clones, with the 8-track version going to NT Audio to go digitally into its SDDS camera, and the 6-track to DTS, where the company made the one-off CD-ROMs, which would eventually be used for mass duplication. By putting the responsibility of the A/D conversion for these formats on my shoulders, I could sidestep any possible run-in with the transfer gremlin, especially with regard to level shifts. The two additional printmaster elements that we recorded were to standard Dolby SR-encoded mag (but of course!) and to Dolby's proprietary AC-3 magneto-optical drive, which was used to shoot the Dolby Digital and stereo optical tracks.

In addition to the multiple printmasters, we also recorded a new set of

**96kHz Performance 44.1 Price**

*From the company that meets and beats the standards.*

dB 44-96



dB Technologies'

**dB 44-96**

**MULTICHANNEL SYSTEM**

**M•DA820**

2 CH - D to A module

**M•AD824**

2 CH - A to D module

**M•DD1-2-1**

Single/double wire AES Translator

- 44.1, 48, 88.2 or 96kHz
- 2, 4, 6, or 8 channels

- Selectable interface
- 96kHz bandwidth requires more precision and tighter tolerances which makes audio at all sample rates sound better.
- **NO JITTER** - Exclusive Crystal-Lock™ for clocksolid performance. Your incoming signal is buffer suspended, Crystal-Lock™ for absolute accuracy, and sent out with high-resolution perfection.

*From the think tank at*



Distributed worldwide by:

**AUDIO INTERVISUAL DESIGN**  
1155 N. La Brea, W. Hollywood, CA 90038  
(213)845-1155 FAX (213)845-1170

CIRCLE #093 ON PRODUCT INFO CARD

# What Kind of Musicians are on Your Holiday List?



Call 1-800-776-5173

and we'll RUSH a FREE copy of our special holiday catalog to your doorstep in time to order great gifts for everyone on your list.

Mention this code for your free catalog: 76-13



Shop early, shop often at [www.musiciansfriend.com](http://www.musiciansfriend.com)



CIRCLE #082 ON PRODUCT INFO CARD  
World Radio History

PUT YOUR HEAD WHERE  
YOUR HEART IS...



Come to  
New York City

the center of the  
recording industry.  
Learn recording  
engineering at the

## INSTITUTE OF AUDIO RESEARCH

Our 6 month  
Recording Engineering  
and Production Program  
includes:  
Multitrack Recording,  
Mixdown Techniques,  
MIDI, Digital Audio  
& more. + a diploma  
from a world  
renowned school.

Call 800-544-2501

212-777-8550  
(NY, CT & NJ)

Your focus is music,  
our focus is you.



INSTITUTE OF AUDIO  
RESEARCH

64 University Place  
New York, NY 10003

CIRCLE #095 ON PRODUCT INFO CARD



stems reflecting these moves made in the 6- and 4-track mixes. We spent a bit of time experimenting with the best way to fold down the five screen speakers in the original SDDS mix to the three speakers used for all other versions. And in the case of the 4-track stereo optical mix, we made some slight moves to the effects stem to bring in the few loud moments. Yet another 4-track mix was made, this time restricting the peaks of the composite Lt-Rt to 12 dB, the magic number required for network broadcast and airline viewing. I learned this time to do whatever compressing or limiting on the individual stems only, and not also on the composite mix. This way the stems can be conformed for other uses without having to do additional limiting.

If doing all of these alternate versions might seem to be a luxury, splitting the master stems out definitely is not, in my book. The separation of individual elements is a big help when making M&Fs. By recording them as individual stems, production sound effects (PFX) can have a straight path without having to dig through dialog, Foley can be raised or remixed altogether without worrying about phasing (had they been bused to the effects stem), and group walla can be picked through to weed out clear English.

Splitting out stems even a bit further (for example, separating backgrounds, hard effects and design effects within the effects stem) should be considered in the future when virtual premixing becomes more and more common. The scenario I'm talking about is when a few hundred sound effects elements might be pre-mixed in automation and recorded only at the final mix. This procedure is indeed possible on many of the completely automated consoles being installed today.

It wouldn't be too smart to have a composite effects stem as the only recording of all these elements. Any fixes at a later date, not to mention alternate versions, would be a huge pain in the ass in even the simplest of films. Complicated mixes with material being

flown in from various sources would be a total nightmare. You're simply being a wise guy asking to be boned by the gods of software versions.

Speaking of sweeteners added at the final mix, even if you have recorded your premixes in the standard fashion, you should always be careful to document those last-minute fixes. On *Out of Sight*, I saw to it that the "fixes" Pro Tools session, which had tracks assigned to faders in the dialog, PFX and sound effects sections, in addition to the Foley cloth track, was copied to DTRS tapes.

You should also do the same for sweeteners that are flown in during the M&E mix and for the final, edited music. While you of course have your music stem separate, any edits that are made on the stage should be documented, again, by welding this information to a piece of tape playable anywhere, anytime. Said tape should also include *all* tracks that came from the workstation; on *OOSI* used TDM processing to generate center- and surround-channel information, in addition to reverb.

While I agree that it's highly unlikely that someone will need to use any of my anal retentive versions of *Out of Sight* 20 years from now, by salting them away we're hopefully covering worst-case situations. Yes, I acknowledge that low-budget films don't have the time and money to document their soundtracks in such a thorough fashion. And while I'm not going to say that even I will do this on all films, major features can certainly afford it.

But what about the archiving of my precious 24-bit masters? Paying lip service to the fact that everybody believes analog will outlive the cockroaches in case of nuclear attack, we made two sets of 2-inch 24-track SR-encoded multi-tracks, one with the 8-, 6- and 2-track theatrical printmasters, plus the 2-track compressed version for home video. The second set contained the 8-, 6- and 4-track M&E mixes, along with an Lt-Rt version of the 4-track. On both sets of tapes I printed my 2-track dialog stem on tracks 1 and 2 for reference. These were all copied from the 24-bit hard drives.

Insofar as the digital data on the hard drives is concerned, we transferred the Waveframe files via OMF conversion to Mac-formatted 9-gig drives, which we then opened up as Pro Tools sessions. Once the tracks were "popped," the disk files were renamed from the serial-number-ish file name that the MMR-8s give them to a more understandable file name usable by anyone in the future, such as OOS R1AB FX STEM L.



# BRYSTON PROFESSIONAL ST AMPLIFIERS

## Introducing a New Standard in Professional Amplifier Design and Performance

In the demanding professional environment, you need an amplifier that is transparent, neutral and uncolored. You want to hear the music, not the electronics.

Preserving the integrity of the source signal is paramount to Bryston's design philosophy.

Bryston amplifiers are versatile performers, designed for use in a variety of demanding professional and commercial applications, including high quality recording studios, radio and television broadcast facilities, theater and soundstage amplification, arena and nightclub installations and multi-amplified speaker systems of all types.



*Listen past the equipment and experience the performance as intended. Bryston professional ST amplifiers, from the top: 8B ST 4 channel 120 wpc, 5B ST 3 channel 120 wpc, 4B ST 250 wpc stereo, 7B ST 500 watts mono. Not shown is the 3B ST 120 wpc stereo.*

Our ultra-linear input buffer-with-gain feeds the amplifier channels from both balanced and unbalanced inputs, resulting in sizable reductions in noise floor and distortion.

Power supplies are completely independent per channel and employ multiple smaller filter capacitors, rather than single large filter cans, improving high frequency response.

Wiring harnesses have been completely eliminated, so that channel plug directly onto the power supply PCB, reducing resistance and improving current flow.

20 YEAR WARRANTY

Music for a Generation

Bryston Ltd. P.O. Box 2170, 677 Neal Drive, Peterborough, Ontario, Canada K9J 7Y4  
Tel: (705) 742-5325 Fax: (705) 742-0882 World Wide Web Site: [www.bryston.ca](http://www.bryston.ca)

CIRCLE #096 ON PRODUCT INFO CARD

BRYSTON





These drives were then backed up (via Mezzo software) to Digital Linear Tape, utilizing 2000XT drives for over 18 gigs per tape. We would have made two tapes of each drive, but as it was, it took over two weeks to do all 33 drives! (I have since made additional DLT tapes of key stems, figuring that the printmasters were already backed up to hell and breakfast on mag, 2-inch and DTRS.)

Okay, I can see you chuckling out there. "Nyuck, nyuck. What's he going to do in ten years when he can't find a DLT drive or he discovers when it's too late, a software incompatibility?" You're absolutely right, these are problems that need to be addressed carefully. I'll be keeping a very close eye on technology the next few years, and am at the ready to dig these tapes out of the vault and re-archive them to whatever formats (both file and physical media) the film industry settles on. I believe that this will happen soon. Some of the formats on the horizon promise inexpensive, removable archive storage that, unlike DLT, is playable. At an eventual cost (again, speculation) of not much more than a dollar per gigabyte, this will indeed be the Holy Grail.

At that point I'll restore my DLT tapes (having held onto my drive and all software revisions, and knowing the location of additional copies of both) and make two copies onto this new format. As I said earlier, it would be smart to send a third copy of selected elements to be stored with HDTV, D-1 and Digital Betacam video masters, in all their versions and permutations.

Prudence dictates multiple copies, perhaps even on multiple formats. While this may seem outlandish, again, it's still cheaper than mag. Mag copies could be made, but the cost and pain-in-the-ass factors are overwhelming. These are less with 2-inch, but that format still shares the factor of generation loss. (I remember seeing all the sound elements for a Major Film being wheeled down a street in midtown Manhattan. Had something happened to this truck... Then again, remember that hard drives

themselves are cheaper than mag!

Also, not to belabor the obvious, since you are saving a Bloody Fortune by archiving your film in this manner, you should spring for a solid shipping/storage case with custom foam inserts. Yeah, you don't do this on mag or multitrack shows, but you never had everything from a feature film in such a small space, either. Do it right; please don't just use a flimsy cardboard box!

Some of you have noticed the blooper in the lead paragraph of my October column. Quint was not waiting to be rescued by helicopters, for heaven's sake. *Airplanes* were overhead. Okay, shoot me. Or write to me with your opinions on archiving films: PO Box 24609, New Orleans LA 70184; fax 504/488-5139; or via the Internet: swelltone@aol.com. ■

*Larry Blake is a sound editor/re-recording mixer who lives in New Orleans for reasons too numerous to mention, although one of them would have to be that not only do we have many beautiful old buildings here, we preserve them with TLC.*

—FROM PAGE 137, "PRINCE OF EGYPT"

says Media Ventures studio manager Tom Broderick. And so, on the scoring stage at Air Lyndhurst, the Augan, which features 24 channels of 24-bit recording, was linked with a Sony 3348.

"The Augan was intended as backup," explains Meyerson, "because we didn't know if we'd like it. We slaved it along to the 3348, recording the orches-

tra to both machines, and when I A/B'd them, it was like, 'Hello!' There was such a difference in the 24-bit sound. The digital noise floor was much lower on the Augan, and there was much more depth to the sound. The bad side of that was that all of the noises in the room were also lot more present: the couple of punches that maybe weren't the greatest punches in the world, the music editor coughing in the background, papers rattling. But we did decide to go with the improved sound of the Augan."

According to Broderick, the Augan's designer, Jan De Witt, was on hand for the London sessions, organizing files and making sure operation was smooth, even installing an additional MO drive (augmenting the three already in place) to ensure enough memory.

The Air Lyndhurst hall was originally a church, and all of those churchly attributes were put to use for the recording. Surround mics were hung in the galleries, about 45 feet above the floor, and the French horn players and some of the choirs were also physically placed in the upper levels to help achieve the rising sound desired by Zimmer for certain scenes. "We did ten orchestra dates," says Meyerson. "It was really like doing three scores, because we did the string sessions for the entire film, then the horns, then the choir. Then we did a boys' choir on top of that. When you add them all up, it comes to a couple of hundred voices. One of the really nice things about the Augan was being able to do premixes in the computer—because there's no console big enough to bring up all



Hans Zimmer, center, surrounded by some of the Media Ventures crew, l to r: Jay Rifkin, co-owner, Adam Smalley, Alan Meyerson, Slamm Andrews and Gregg Silk.



# HEARD A GOOD MOVIE LATELY?

With the advent of the digital era fully integrated into the entertainment industry, Post Production facilities are quickly evolving towards digital processing to provide state-of-the-art technologies and services necessary to support growing demand for DVD based products. In order to compete in this new digital world, the facilities' audio monitor sound systems are critical to the success of their finished products.

Pioneer's Technical Audio Devices (TAD) speaker and monitor systems have long been the benchmark in the audio industry for high quality, unequaled sound reproduction. Top Studio, Mix Room and Sound Reinforcement system designers insist on TAD components to provide accurate sound reproduction and a feeling of *reality* in their finest installations worldwide.

When your Customers expect the best, rely on TAD products to deliver nothing but the sound they envisioned.

*Experience the evolution of sound.*

**Visit us in Demo Room 110  
at the AES show**



PIONEER ELECTRONICS SERVICE, INC. • 1925 East Dominguez Street, Long Beach, California 90810  
300-872-4159 • e-mail: tadpioneer@pioneerservice.com • http://www.tad-pioneer.com

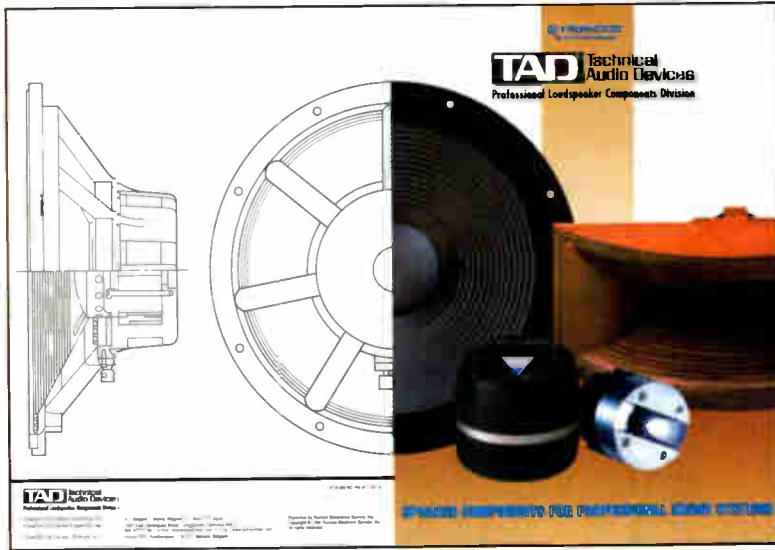

CIRCLE #097 ON PRODUCT INFO CARD

those tracks in one place."

As if recording that number of tracks wasn't challenging enough, there were changes to deal with—internationally. "I don't go in for challenging physical sports," muses Zimmer. "When I ski, I ski very slowly, because I can get all my adrenaline rush just sitting there at the orchestra session waiting for Dolby Faxes to come through."

Example? One particular cue that required re-orchestration had to be recut back at Zimmer's house in the Los Angeles area, then sent over ISDN lines as the orchestra was already assembled for the date in London. A 32-track produc-

tion, it required 16 passes of Dolby Fax phoned in from Media Ventures to Air Lyndhurst. Once received, there were rewrites of the orchestra parts to do.

"The orchestra was sitting there while we were doing it," recalls Meyerson, "and there was also a film crew documenting the session. And there was this truly memorable moment, when the final changes came in, and Hans is writing on the spot at the piano with the cameraman standing on top of the piano shooting down at him."

"It was quite a challenge, that one," says the unflappable Zimmer. "Actually, the sending part was easy, and the writ-

ing part was easy. The perilous part was getting the music from my house in Malibu to the studio to fax, because it was in the middle of El Niño, and the Pacific Coast Highway was closed."

Zimmer takes the same kind of chances musically that he takes technically. "In some ways this score is over the top," he comments. "There are two orchestras going on at one point, there's a chorus up in the gallery—there's the male choir, the female choir, the complete choir, the children's choir—the ethnic instruments, the samples... I knew all these elements, but I never knew they would all work together. And I was smiling at everybody saying, 'Oh it's going to work, trust me,' but the only person I wasn't trusting was myself. I had no idea if this was going to work. You keep having ideas, and ideas are truly the enemy of budgets and accountants and things like that. What's wonderful is, when you deal with super-creative people like Jeffrey Katzenberg and Steven Spielberg, they don't stop you.

"I was terrified the first week, because I knew I had written things that were so on the edge of unplayable," he continues. "The difference between doing a score of sounds and a score of real players is not just the emotion that you get—you can also get *fear*. Part of what makes my work process dangerous is that people hear the music beforehand on the samples, and it sounds really good, so they expect that but just more. And so what happens then is, it runs the risk of becoming unplayable. Because if you write just at the edge of playable, it heightens the tension. By doing that, you serve the film and that's your job, but you don't know, when you step over that line, if it will work. So when we were doing the chariot race, I was holding my breath while the horns were blowing away like crazy. There are always those moments where you think it's just not going to work, and you're there with an orchestra and you can't really change it."

"The funny thing about the chariot race scene," adds Meyerson, "is that when the musicians tried to slow it down and learn it, they couldn't play it. They could not play it slowed down; they had to play it in tempo and just let it happen."

The technical setup and operation at Media Ventures is built to accommodate Zimmer's unique recording and composing style. There are three music editing suites, three Euphonix-equipped mix rooms, seven MIDI composing suites, two sound design rooms and

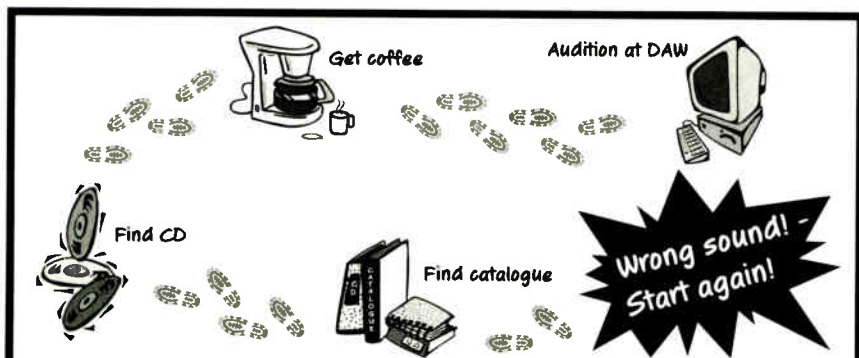

## Change the way you work.

**Every editor in your studio can audition effects, share and print project files, or transfer sound files from the hard drive array, anywhere, anytime. Even at the same time.**

- Compatible with PC, MAC and UNIX™
- Local network or internet access.

"ServerSound gave us a way to finally organize everyone's personal audio material that was on countless DATs, CD-Rs, or duplicated 10 times on local drives into one centralized library. And, it gives producers a quick way to listen to temp sounds at home via the internet."

*Charles Deenen, Interplay Productions  
Irvine, CA*



# ServerSound<sup>SM</sup>

Music & Effects Network System

**ServerSound is improving the  
way sound editors are working.**

**Call us at: (800) 489-9314 or (818) 716-7081**

**FAX: (818) 716-0547**

**EMAIL: mSoft@mSoftInc.com**

CIRCLE #098 ON PRODUCT INFO CARD

# The winners' choice just got a new partner.

**Post-production is complex enough  
without those equipment-conflict detours.  
Let the team of WaveFrame + TASCAM®  
keep you on track... and on time.**

It's no surprise that 4 of the 5 Oscar nominees for Sound and the Emmy winner for Sound chose WaveFrame to edit on. Because WaveFrame is the only editing platform designed with them in mind.

WaveFrame's innovative editing commands speed post-production, leaving you time to make the decisions that will make your project a winner.

No other system gives you tools this effective at a price this good. If you're doing audio work that goes with picture, you need tools that work every time — not that latest oh-so-cool plug-in. It's simple: You need WaveFrame.

Enter Tascam... with the perfect follow-through.

With the Tascam MMR-8 8-track recorder/player and the Tascam MMP-16 16-track player, you'll be fully prepared to record your project, then play it back directly or edit it on your WaveFrame — to keep right up with changes that bounce in from the producer and director.

WaveFrame + Tascam's MMR/MMP Series = 100% compatibility.

The Tascam MMR/MMP series offers the only digital disk recorders that are fully compatible with WaveFrame editors.

Which means that your project will play back on the stage just the way you edited it, and that your MMR recordings will play back with perfect accuracy on the WaveFrame for editing.

**No extra settings. No translations. No lost time.**

**Just plug and play. For Real. We guarantee it.**



**WaveFrame**

**TASCAM®**

Advanced Systems Group, LLC, 5447 Telegraph Ave., Oakland, CA 94609  
510/654-8300 Fax: 510/654-8370 [www.waveframe.com](http://www.waveframe.com)

TEAC America, Inc., 7733 Telegraph Road, Montebello, CA 90640  
213/726-0303 Fax: 213/727-7635 [www.tascam.com](http://www.tascam.com)

World Radio History  
CIRCLE #099 ON PRODUCT INFO CARD

Zimmer's main composing room, which, besides his banks of vintage and new synths and samplers, contains six Yamaha 02R consoles, five for inputs and one for summing.

"The way we work is that Hans' sample tracks are a really good representation of what the final product is going to sound like," explains Meyerson. "They're great samples, and it sounds like it will in the final, just not as deep, wide and theatrical. We keep those tracks, so that means there are already a gazillion premixes to start with. They get transferred to 32-track, then we make a slave of that, take it to the

scoring stage, score the orchestra and the choir on top of that, then add whatever live instruments—in this case the ethnic percussion.

"The Euphonix makes it pretty easy," he continues. "I have it all grouped down, so that all these tracks ultimately come down to me having to mix only 12 or 13 faders. The stereo faders also help—I can bring up all my stereo synth prerecords to just 16 inputs."

Media Ventures' CS3000 is equipped with 24 film mix buses, 16 aux sends, and dynamics on every channel. "The HyperSurround system gives you 16 buses assignable in whatever matrix

you want to assign it to," Meyerson says. "So, in this case, one stem will be an LCR for the choir, which can then go back into the surrounds or anywhere I want, and it's all automated. Another stem will be just a left-right stem on stereo passes, and each of those can go back to the surround. Another three buses might exist on all of the stems, so anything I want to pump into the surrounds or into the subwoofer automatically goes there. Then I can automate how much of it I want to go into it at a time, and I can automate the EQ, which has been a real help on this project because some of the singing is done by actors, and their mic technique isn't quite the same as a singer's might be."

*The Prince of Egypt* score may be the first to entail so much 24-bit recording. "The only 16-bit elements in the chain for this project were the synths and samples recorded to the 32-track, 16-bit Otari," concludes Meyerson, "and considering they are coming out of samplers that are 16-bit, it didn't really matter. Everything that needed extra bits on this project got them, and the difference is pretty stunning." ■

**do they really know pro audio?**

*A music store is a great place to buy your musical instruments. But sophisticated recording equipment like workstations, tape machines and high end signal processing are not the forte of music stores. Never has been, never will be.*

*At EAR, professional audio for recording, production and sound reinforcement has been our speciality since 1977. We offer expert advice from veteran professionals in the industry and sell professional audio equipment at nationally competitive pricing.*

*This business means more to us than just a quick sale. We're here for the long haul.*

**PROFESSIONAL AUDIO IS WHAT WE DO!**

Digital Multitrack  
Audio-Video/Workstations  
Recording Consoles/Mixers  
Signal Processing  
Studio Monitors/Microphones

**EAR**  
PROFESSIONAL AUDIO/VIDEO

2641 E. McDowell Rd.  
Phoenix, AZ 85008  
602.267.0600  
Fax 602.275.3277  
<http://www.EAR.NET>  
info@EAR.NET

—FROM PAGE 137, POST LOGIC GOES HIDEF

sophisticated equipment available, including the Rank Turbo 3D-HD Telecine machine and the Pandora Platinum with Mega Def/Pixi Telecine controller incorporating digital color correction. In fact, some products are still in development, such as the Panasonic HD Serial Digital Switcher/Keyer, of which there are only three in the world.

"To give you an idea how new this equipment is, the Digital Vision, which provides advanced noise/grain reduction, real-time dirt/scratch concealer and aperture correction, has the serial number 1," says Voss. "When we first talked to the manufacturer, it was something they had on paper but hadn't even built yet."

Except for an analog input stage and a 4-foot analog cable to the main monitor, the entire room is completely wired in serial digital. According to Lou Levinson, director of theatrical mastering in charge of the facility, there have been few problems with the digital infrastructure. "There are a number of runs well over 100 feet," states Levinson. "We thought they might have to be replaced with fiber links, but they haven't caused us any problems."

Prior to his move to Post Logic, Levinson was a colorist at Universal/MCA's HDTV Research Center, where he

CIRCLE #100 ON PRODUCT INFO CARD

# SONIC BLUE

Introducing the THAT 2002 Modular VCA Upgrade for SSL Consoles



*Clarity*  
*Transparency*  
*Accuracy*

For over 10 years the engineers at THAT Corporation have been improving the sound of the world-famous 202 VCA. Each new 202 model has advanced the state of the art in sonic quality and performance...Well, the state of the art just took a big leap forward!

## ***INTRODUCING THE BEST SOUNDING VCA ON THE PLANET - THE THAT 2002***

With the lowest noise, lowest distortion and widest dynamic range of any 202-series VCA ever made, the THAT 2002 is not just about better technology or better specs - it's about better sound.

## ***AVAILABLE AS AN UPGRADE FOR ALL 202 MODULAR VCAs***

Regain that industry leading audio performance with the THAT 2002. Available as pin-for-pin upgrades for every 202 ever made. You and your clients will hear the improvement!

"THAT Corporation has outdone themselves with their new VCA module! With lower distortion and increased transparency, it is A&M's new standard for both the Recording and Mastering facilities."

Bob Borbonus, Asst. Studio Manager  
A&M Recording and Mastering Studios

*Give us a call or visit our web site for all the details.*

**THAT** Corporation

***MAKING GOOD SOUND BETTER™***

THAT Corporation, founded by senior engineers from dbx, designs and manufactures high performance integrated circuits and products for the professional audio industry.

734 Forest Street, Marlborough, MA 01752 USA • Tel: 508-229-2500 • Fax: 508-229-2590 • [www.thatcorp.com](http://www.thatcorp.com)

***The THAT 2002 is available to owners and operators of consoles from SSL, Neve, Sony, MCI, and Harrison.***

CIRCLE 101 ON PRODUCT INFO CARD

helped develop their first HD bay. "With 20 years of film-to-tape experience, five of that being direct HD experience, Lou was the only colorist we could imagine in this position," emphasizes Voss.

Integral to the ground-up design of the telecine rooms was TMH Consulting, ensuring that the sound reproduction would be equally as uncompromising as the picture quality. The suites are appropriately optimized for 5.1 and 6-track audio, since they deal primarily with film print masters.

Though Post Logic isn't the first post-production facility to benefit from TMH Consulting's expertise, it is the first THM Qualified facility, a certification process that has just recently been developed. As explained by Tomlinson Holman, co-founder of TMH Consulting, extensive testing was conducted using multiple listeners and double-blind tests to determine the best possible solutions with regard to room acoustics and audio component acquisitions for these HD suites.

"As a consultant, TMH was invaluable; they were involved at every stage of the process," recounts Levinson. "The other thing that TMH does is they don't just get you to the place where the room is done. They also provide you with an easy, daily repeatable way of confirming audio performance, which is an absolute must in a top-level facility."

Operationally, Levinson is the eyes of the room, while Dave Iveland, the HD chief audio engineer, provides the ears. Before jumping on staff at Post Logic, Iveland worked for Warner Bros., Lorimar and A&M Records as an independent mixer and recording engineer. The entire room is computer-controlled, and there are no assistants. However, once the HD facility is completely operational, it's expected to require a support staff of 10 to 15.

All HD transfers are recorded to D-5 machines. The Lt/Rt, which contains the encoded 5.1 soundtrack, is recorded on tracks 1 and 2 while the M&E (music and effects) are recorded on tracks 3 and 4. No limiting or compression is applied. "It's important not to effect the audio in any way," stresses Iveland. "However, we do check for any glitches or scratches in the audio tracks. Stuff that gets by in the theatrical release can sometimes show up in near-field monitoring. If we hear anything suspect, we immediately call the studio. Sometimes the audio track has to be taken back to the original dubbing stage to be reworked, since AC3-encoded audio can't be edited."

In addition to the master D-5 tape, submasters are created based on the

needs of the client, such as when the audio's overall dynamic range must be limited for network or VHS playback. Certain regions of the world may require certain scenes and dialog removed based upon its violent or sexual content. Also, instead of using subtitles, many mediums prefer dubbed dialog. In these instances, additional audio is delivered by the studio on a DA-88 tape and played on the newest Tascam recorder for that medium, the DA-98 digital recorder, which is located in the facility's machine room.

The console of choice at the new facility is the flexible and all-digital Yamaha 02R. Bryston amps power the B&W loudspeakers that are used in the audio



*Lou Levinson, director of theatrical mastering*

room along with two subwoofers from Australian manufacturer Audio Precisions. The three front speakers and the subs are mounted behind the wall coverings for a familiar dubbing stage appearance.

Two different rear-monitoring configurations were set up. There is a primary set of directional rear speakers to provide an accurate representation of the spatial cues. "I prefer the directional monitors, because if the left rear goes away for a second, I'm more likely to hear it," points out Levinson. "The secondary set of rear speakers are dipoles, which deliver a bigger, more theatrical sound, though they are less accurate spatially."

To further demonstrate the care that went into the design of this facility, a completely neutral environment was created. The wall coverings and cold-cathode lighting in the hallways and suites were carefully chosen to emit no more than 6500 Kelvin. "It's the first

telecine room I have ever worked in that someone can open the door and no one notices," comments Levinson. "You don't have to worry about your eyes readjusting to the screen every time you leave the room or someone enters the bay."

Both telecine rooms were originally scheduled to open simultaneously; however, the dynamic nature of HD equipment forced Voss and Levinson to step back and study the industry for a few months before equipping the second room. "From a business point of view, it might make sense to get the second room up and running so we could start to recoup our investment," Voss says, "but I think in six months time we will have an even better grasp of the HD market, and we'll have the opportunity to see some of the gear we know is currently in development.

"We chose what we consider to be equipment that will deliver the best possible HD transfer today," Voss continues. "We are committed to always providing our clients the highest-quality masters, so we may have to consider upgrading within six months to a year depending on how this transition shakes out."

In the short term, the types of projects requested by major motion picture studios—such as Paramount, Warner Bros. and MGM—have been archival in nature. A surplus of HD material is required so when a network orders a film, it can be supplied in any of the various proposed formats.

"Basically, we're creating archival-level masters," explains Levinson. "Two separate masters are needed. One version will be a standard 1:78 representation of the frame, while the other is a 4:3 pan-and-scan version, sized for standard definition TV, requiring a fair amount of recomposing."

Building high-definition, archival masters is just the beginning. Voss believes that within the next four to six months, editing of high-definition pictures will be possible. "That would complete the loop. We could do transfers, visual effects and online assembly, all in Hi Def.

"The theory behind the design of these rooms is they provide a service few rooms in town offer," Voss concludes. "Yet they won't feel any different than other telecine suites. We want people to work in an environment that feels comfortable and familiar, even though this medium is breaking new and untried technical barriers." ■

*Kim Wilson is a freelance writer based in the Los Angeles area.*



# New Sound Reinforcement Products



## JENSEN UHF IN-EAR MONITORS

Jensen Music (Lake Mary, FL) has introduced a low-cost UHF wireless in-ear monitor system that offers the choice of two stereo signals on fixed frequencies. The PM TX transmitter is \$99, and the PM RX-100 body pack receiver is from \$129 to \$149, depending on the ear molds selected.

Circle 314 on Product Info Card

## XTA 8-CHANNEL MIC/LINE SPLITTER

XTA Electronics (distributed by Group One Ltd., Farmingdale, NY) has introduced the DS800, an 8-channel active mic/line splitter offering four outputs per input in its standard configuration (two transformer-isolated, two actively balanced). Each input features a remotely activated pad, adjustable input gain, mic/line switch, 48V phantom power and five-segment LED metering. A headphone-listen facility allows monitoring of individual channels; the facility may be ganged for multiple units. The unit also can be configured to provide more than four outputs per channel. Price is \$2,495.

Circle 315 on Product Info Card

## SA EFFICIENCY SERIES AMPS

Stage Accompany (Bay Ridge, NY) has launched the Efficiency Series (ES) 2-channel amplifier range with two models, the \$2,205 ES 20 (1,000 watts/channel peak into 4 ohms) and the \$1,650 ES 10 (500 W/ch peak into 4 ohms). The amps feature a high-



speed, high-current Class G design, include SA's Dynamic Damping Control (DCC™) system for a damping factor of 10,000, and are housed in 3mm thick aluminum chassis.

Features include "Soft Start," variable fan speed, easy bridge mode, ground lift and front panel LED status indicators, in addition to comprehensive protection circuitry. A modular design allows for the addition of crossover, limiting and EQ functions via plug-in modules.

Circle 316 on Product Info Card

## MILES TECHNOLOGY COMPACT TESTER

Miles Technology (Niles, MI) offers the ACT-1 Audio/Cable Tester, a compact handheld tester for cables with XLR, ¼-inch or RCA connectors. Featuring LEDs to indicate continuity, the unit includes a 500Hz test oscillator (switchable between mic and line levels) and may be used to test long cables for conductor shorts from one end (a shorting plug on the far end is necessary for continuity testing). Powered by a 9V battery, the unit carries a three-year warranty. Price is \$119.

Circle 317 on Product Info Card

## LAKE DSP 3D AUDIO SOFTWARE

Lake DSP North America (Hollywood, CA) has developed a spatial audio technology that allows sound designers to graphically place and move audio sources anywhere in a three-dimensional soundstage. Lake's Audio Display Tools (ADT) software, which runs under Windows NT 4.0 or later, can manage up to 32 sources and provides a 3D graphical authoring environment that allows users to draw positions and trajectories with ease. The system synchronizes with SMPTE and MIDI timecode protocols and accepts direct input from motion capture software such as Polhemus Insidetrek. The system also includes a range of preset movements such as fly-bys and circles. The Lake ADT system also offers realistic reverb algorithms for natural-sounding

room effects, and 3D sound fields recorded in B-Format Ambisonic mode may be incorporated. Audio output may be either 24-bit digital or analog.

Circle 318 on Product Info Card

## MARTIN WAVEFRONT LONGTHROW SPEAKERS

Martin Audio (distributed by TGI North America, Kitchener, Ontario) has introduced its Wavefront Longthrow™ range of high SPL, long-throw speaker systems. The W8CT is a mid-high unit that covers the range from 750-18k Hz. Containing six 1-inch exit HF drivers in a vertical array and three vertically aligned 6.5-inch mid drivers, the high-power, two-way loudspeaker system is capable of 147dB SPL. The companion W8CM low-mid cabinet covers the range 120-750 Hz and includes two vertically aligned low-mid horns, each driven with a single 12-inch woofer. Both units share the physical dimensions of Martin Audio's W8C enclosure (562x799x925 mm, including wheels) and may be integrated within W8C arrays for additional long-throw coverage.

Circle 319 on Product Info Card

## YAMAHA ADDS TO CLUB IV SPEAKER LINE

Yamaha Corporation (Buena Park, CA) has added two models to its Club IV Series speaker line, the S215IV full-range, two-way system (\$799) and the SW215IV subwoofer cabinet (\$749). Featuring a trapezoid cabinet for simple arrays, the S215IV features two 15-inch woofers and a 2-inch titanium HF driver. The SW215IV subwoofer contains two 15-inch woofers with 3-inch voice coils. Both units feature driver protection circuitry, are carpet-covered with metal corner protectors and include sockets for pole mounting.

Circle 320 on Product Info Card



# FAMILY VALUES

Korn teamed up with Limp Bizkit for the raucous and raunchy finale.

The  
Korn

# FAMILY VALUES

By Anne Eickelberg  
Photography by Steve Jennings

Tour

About 14,000 kids pumped their fists into the air, screaming, crowd surfing and moshing. The Y Generation—13- to 19-year-olds, wearing funny hairdos, floppy pants, sporting piercings and tats—mashed together in San Francisco's Cow Palace on October 10 and proved that heavy rock is not dead.

Referred to as part of the New Metal brigade, Korn, hailing from Bakersfield, Calif., is riding a wave of success (their raw new record, *Follow the Leader*, debuted at Number One) that enabled them to bring their friends and favorite bands on the road. Besides headliner Korn, the "Family Values" tour included

German industro-techno-pyromaniacs Rammstein, rapper, movie star and all-around icon Ice Cube, aggro-hop Limp Bizkit and glammy metal punks Orgy. The show is a nonstop onslaught of volume, attitude, and insane and hilarious stage sets—an end-of-the-millennium party of youthful angst and jubilation.

Ten semis' worth of equipment has to be loaded in and set up for each stop of the 28-city tour. Each night, five bands play in less than five hours. While one is onstage, the backline and stage props for the next are being set up on the backside of the turntable stage. When the band finishes, the cur-

### RAMMSTEIN LIGHTS UP THE STAGE

Rammstein singer Till Lindemann bursts into flames, shoots off flame throwers and engages in some theatrical S&M onstage. He uses a Shure Beta 58 wireless system. FOH engineer Michael Bauer submitted a wish list of all his favorite out-board gear and was happy to receive every piece. His most trusted box, however, is the Eventide H3000, which he uses for vocal effects and some guitar. "It's got a warm color," he says. "It doesn't sound as digital as some others. If you [compare it with] a voice doubler on a Yamaha SPX, it's like the difference between a studio recording and a live recording. It sounds warmer, it's got a higher resolution, the top end is smoother. It doesn't change the shape of the voice."



### A SAMPLING OF ICE CUBE

Ice Cube's set is the most stripped-down, but it sure looks impressive. There's an 18-foot statue of a glowering Ice Cube with a top hat at center stage. Several of Ice Cube's crew, dressed as grim reapers, stand frozen throughout the performance.

"It's just Cube and WC on the Shure Beta 58A UHF wireless mics, with DJ Crazy Tunes spinning and throwing down samples from the top of the statue of Cube's top hat," says Chris Sorlie, Ice Cube's FOH mixer and a production assistant on the tour. "I use a little bit of compression, and mainly TC Electronic 2290 for delay—that's all I really ride." Because everything is direct, there's virtually no stage volume. He uses three Countryman DIs—two for the sampler, one for the turntable. "The sampler is custom built. [DJ] downloads samples and punches them up at the touch of a button. He downloads tunes. He downloads the samples that are on the record. Everything from sound effects like gunshots to sirens to cuss words. And the background music."



### FIRST-TIME ORGY

Shepell and Tatter do double-duty mixing for Orgy, a new band recently signed to Korn's Elementree label. "When we started we had some problems just getting the drum sample stuff together; it's an all-trigger kit," Shepell says. "But that's all leveled up now and things are cruising along pretty good." Vocalist Jay Gordon sings through an SM58. Guitarists Amir Derakh and Ryan Shuck each have Avalon DIs in their racks, which Shepell uses in combination with SM57s.

Gordon uses Shure PSM in-ear monitors and seems very happy about it, Tatter says. "It makes my life easier with him in-ears, because he likes to listen to a lot of effects, and that allows me to give him what he wants. For the rest of the band, I keep the stage clean."



Excited contest-winners danced in the cage behind Korn.

### LIMP BIZKIT ON THE LOW TIP

Limp Bizkit: Fred Durst, vocals, Wes Borland, guitar, Sam Rivers, bass, John Otto, drums and DJ Lethal, sound development. FOH engineer: Nitebob.

"DJ Lethal plays a turntable and a sampler through a Marshall 100-watt amp miked with an SM57, placed slightly off-center on one of the 12-inch speakers," says Nitebob. "I use three microphones on the guitar player. He tunes way low, so I use an EV 868 kick drum mic. Rather than trying to get it all out of one microphone, I do a three-band thing—one to deal with low end, then I use an Audix D3 to deal with a detailed high end, and then a 57. The cabinet is a Mesa Boogie, with 12s. The big-diaphragm 868 is EQ'd to be like a kick drum, so you get a lot of low-end stuff and still some detail. So you mix that with the D3, and you have a pretty detailed guitar sound. I try to run my guitars flat. I roll a little bit of low end off of two of the mics.

Monitor mixer Scotty Riekawsky, who doubles for Ice Cube, says, "I've got eight SRMs across the front on three mixes, some big ol' side fills. For the DJ I use a single 600 Series Showco wedge. I'm not even using the third-octave inserts on the console at all. Whatever each individual channel does, that's what it is. It's an awesome board. The drummer's got two 18s with two wedges, and then two more wedges on a different mix for guitar and vocals. He's the loudest up there."





The folks who help bring Family Values to your town: L to R, Scotty Riekowsky, monitors for Ice Cube and Limp Bizkit; Chris Sorlie, FOH for Ice Cube; Nitebob, FOH for Limp Bizkit; Scott Tatter, monitors for Korn and Orgy; Bill Sheppell, FOH for Korn and Orgy; Achim Zell, monitors for Rammstein; Michael Bauer, FOH for Rammstein.

tain is drawn and the crews frenetically patch in, while the engineers do line checks as fast as they can. During the ten-minute (really!) changeover between acts, a DJ spins tunes to keep the party going.

Bill Sheppell, a longtime independent who's worked with Ministry since '89, and has done stints with Jeff Beck and Green Day, among others, mixes front of house for both Korn and festival-openers Orgy. This is his second time out with Korn, and this time he coordinated the system logistics for the entire tour with Ed Spoto, Showco's system manager.

Out front are three consoles: Korn and Ice Cube are mixed on a 32-channel Harrison HM5 that's hooked up to a 20-channel extender; Rammstein's on another Harrison HM5, in 32 channels; Orgy and Limp Bizkit are on a Yamaha PM3000. Altogether, there are 127 inputs. There are three snakes, and the monitor system is set up as one huge system. "We can swap between the three consoles out front, so basically the biggest challenge is not ever having soundcheck," Sheppell says. "We do line checks as the gear goes up. You don't have the time to work on things like you would in a normal day.

"[But] we haven't had a mishap yet on any of the normal sets. For the encore, there's another Korn backline set on the backside of the turntable, and Limp Bizkit is reset. They do this song 'All in the Family,' which is like a

battle of the bands. So as Korn goes off, the stage spins, Bizkit's all checked, but there's no chance to check Korn because all we're doing is swapping sub-snakes onstage. So it's like, 'Boom!' I've missed a channel once or twice, but you can't complain when it's by the seat of your pants. Kids dig it because they see the stage turn and they go, 'Oh, that's how they make everything happen!'"

The tour is out with a huge Showco Prism setup: nine columns a side with 24 sub-bass cabinets on the floor. Sheppell says, "It's got tons of power. Especially with a band like Korn, you want lots of bottom end, and it's got plenty. The thing about using the Prism is there's really no distortion. [The show is] all loud, all the time. If you're gonna listen to loud stuff every day, you don't want to hear distortion because that's going to grate on your ears. I can do a 122dB show and walk away and my ears aren't ringing."

Limp Bizkit FOH engineer Nitebob, a veteran engineer who honed his chops on Iggy & The Stooges and Aerosmith, agrees: "You can walk around and the coverage is really good. You don't find the comb filtering, the dead spots. When you walk from the console to the front of the stage while the band's playing, it doesn't change. The way all the drivers overlap, I think it has the best coverage of any P.A. You have tons of headroom, and it's well-powered."

## KRANKED KORN

Korn's members go only by first names. Jonathan sings (and screams), Fieldy plays bass, Head and Munky play guitar, and David beats the daylight's out of the drums.

"The band has an endorsement from Shure," says Sheppell. "Jonathan likes using the Beta 87. I'd rather use a 58 because he has a lower output than a lot of people, so the gain on that mic is super-hot. When I ring it out during the afternoon, you can hear the carpenters behind the stage talking. It's that hot. I think a 58 would be a little easier to control, but he likes the flat windscreen and he's comfortable with it. His vocal is on the edge of feedback all the time. By the end of the show, when I've pushed up the masters and the VCAs on the system, it's really loud and he's walking out on the subs underneath the P.A., which has downfill speakers. It's right there [near feedback]. Right now I'm using the Shure DFR11, which is a digital feedback reducer. It has very narrow notches, tenth of an octave, so I can get rid of the feedback frequencies and still have plenty of meat left in the vocal. It works good, especially with the gain. I use the Summit tube limiters on him, which just sound really nice."

For drums, Sheppell uses his normal SM91 Beta 52 kick setup. Although there were already four SM81s placed around the kit from the side, he recently added a stereo Shure VP88 over the kit to help pick up all the cymbals. To get a bigger ambient sound he put them dead-center and mixed them in with the other overheads.

Guitarists Head and Munky use Mesa Boogie heads, but Munky also uses a Line 6 amp to get his clean sound. Top and the bottom are caught by a 52, with all the mids from a 56. Bassist Fieldy's setup is simple. Although he has roaring Hartke cabinets, they're only used for stage sound. Sheppell runs a DI straight out of his Mesa Boogie head, post-EQ. "He's got the sound he wants, and he wants me to have that. It's the Korn sound, so it's fine."

Scott Tatter, monitor mixer for Korn and Orgy and a seven-year Showco employee,

—CONTINUED ON PAGE 190

# It's Not Science Fiction. It's Reality.

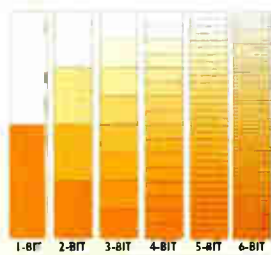

Every bit you add doubles the resolution of a digital recorder. Compared to 16-bit formats, ADAT Type II's non-compressed, linear 20-bit recording offers a wider dynamic range, less quantization distortion at low levels, more headroom and even lower noise. Result: detailed, full-spectrum audio fidelity that far exceeds the quality of any analog recorder.



Don't get fooled by the science fiction of some "24-bit" recording systems. Just read the fine print: the state-of-the-art ADAT Type II recorders offer audio specs that rival any 24-bit system, without resorting to tricks like data compression or track sharing.

While the rest of the world is trying to figure out the final frontier of recording formats, you need to make a decision. What's the best choice today that will keep you ahead of the game tomorrow?

The answer: **ADAT Type II**. It's the next generation of Alesis' award-winning digital audio technology that combines the proven power of ADAT with the astonishing fidelity of true 20-bit linear recording.

With the new **XT20™**, you get a serious improvement on the world standard for professional recording. The new **LX20™** is the most affordable ADAT ever made. Both provide all the real-world qualities that made ADAT the most popular professional recording format: modular design, efficient tape-based media and complete compatibility with over 110,000 ADATs around the world. Plus, as the only modular digital multitracks that write 20 bits to each track of tape, the new ADAT Type II recorders offer audio quality that's miles ahead of any 16-bit system, period. And with the introduction of the **ADAT-PCR™** interface card, you get the advantages of nonlinear editing on your Mac® or Windows® computer seamlessly integrated with ADAT format recording.

Most importantly, the intuitive ease-of-use, comprehensive features and incredible affordability of the ADAT Type II systems put no limits on your creativity. Because, after all, the final frontier is really your imagination.

**adat**  
**TYPE II**

There are over 110,000 ADATs in use today, and the new ADAT Type II recorders are compatible with all of them. The XT20 and LX20 will work with your 16-bit ADAT tapes, and you can combine the Type II recorders in a system with any model of older ADAT.

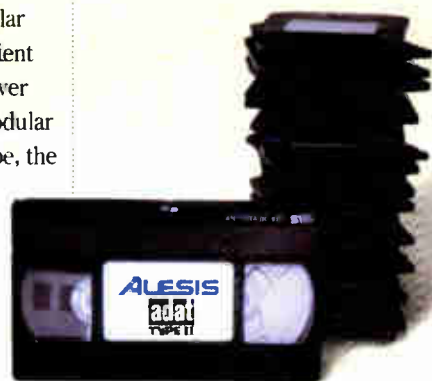

If you think tape isn't as advanced as other removable recording media, think again. You'd need more than 30 Zip® disks to equal the 3.4 gigabyte storage capacity of just one inexpensive ADAT tape.

For more information on ADAT Type II, the XT20, the LX20 and the PCR, see your Authorized Alesis Dealer. Or call 800-5-ALESIS to order the ADAT Type II Systems video and brochure (\$4.95 for shipping and handling).

© Alesis and ADAT are registered trademarks; XT20, LX20 and PCR are trademarks of Alesis Corporation. Mac is a trademark of Apple Computers. Windows is a trademark of Microsoft. Zip is a trademark of Imagem.

Alesis Corporation

1633 26th Street Santa Monica CA 90404 800-5-ALESIS alecorp@alesis1.usa.com www.alesis.com

CIRCLE #102 ON PRODUCT INFO CARD

World Radio History

**ALESIS**

# SURVIVAL TIPS FOR CLUB MIXERS

## GETTING QUALITY SOUND UNDER ADVERSE CONDITIONS



PHOTOS: STEVE JENNINGS; PHOTO ILLUSTRATION: MIKA CHIGAKI

Every vanful of musicians that hopes to ascend from the garage to the arena must first graduate from the punishing circuit of clubs, beer halls and other less desirable venues. Of course, a relative handful of showcase clubs feature state-of-the-art sound and lighting systems, but all too many seem to be run by penny-pinching managers who, even if they knew what good equipment was, would much prefer to spend money on video games and beer taps than upgrade the sound gear. Hand-me-down consoles, beat-up microphones, marginal outboard processing and decades-old speakers with ravaged transducers are among the many hurdles that club engineers must overcome. But a sound engineer's willingness to slog through the club sound

trenches may eventually earn a bunk when there is a bus tour.

Though most engineers mixing in clubs do not enjoy the luxury of carrying their entire sound system to every show, they must nevertheless aspire to the same goals as their more fortunate peers: to each day forge a stable, predictable platform from which to mix. The only gear that's practical to bring into clubs is a portable, compact field kit of the most important inputs and processing. The larger chunks—each club's amps, speakers and consoles—are the variables that must be dealt with daily.

### CHECKING OUT THE SYSTEM

All successful live engineers have a

daily "pre-flight" routine that allows them to 1) confirm that the sound system is working correctly and to 2) optimize the system EQ before soundcheck begins. Along with repeating the time-honored mantra of "check, one, two," and using the sophisticated analyzers that the good lord installed on the sides of their heads, many engineers play familiar CD cuts. In this day of recordable CDs, it's a simple matter to organize your own favorite tracks onto a DAT master and then burn a couple of CDs (always have a spare). Cuts from your own band's album(s) are a useful reference, and individual tracks isolated from the multitracks can help set necessary effects and processing long before the band hits the stage. Most important, a comprehensive

—CONTINUED ON PAGE 162

BY MARK FRINK

# WILDHORSE RIDES INTO ORLANDO

Remember Minneapolis? Remember Seattle? Remember Orlando? Orlando? Orlando was the once and future post-production nexus that came close to being the event that never happened. Disney started expanding its presence there in the late 1980s and opened some post-production rooms to handle some of the town's theme park audio. The plan was to have Orlando grow into film work. That didn't happen on schedule, but another segment of the industry, the club scene, has blossomed.



The region that gave us Molly Hatchet and other hard rock bands in the '70s has remained a stop on the touring circuit, but by the early '90s was experiencing a rash of raves (which were quashed by city officials who were looking to promote wholesome family values). The city then spawned a revamped downtown with a slew of clubs. Then came the House of Blues, the Soundstage club (licensed by the Black Entertainment Network) and the newest addition, the Wildhorse Saloon, a country-themed venue and the first of five projected to open in the U.S.

The Wildhorse is a joint venture between Gaylord Entertainment, which at the time owned TNN and CMT—since sold to CBS—and Levy Restaurants. The first one opened on June 1, 1994, on Second Avenue in Nashville; other future locations include Washington, D.C., Los Angeles and Las Vegas. Baker Audio of Atlanta, which did the original bid for the Orlando club and did the club's video installation, called in Burbank, Calif.-based Audiotek for the sound install.

"The whole [sound] installation was planned out before construction even began," says Jack Funk, production manager at Wildhorse Orlando and a self-described "old road dog." Funk is one of many of his generation of live touring sound professionals who have gravitated to Orlando in their middle years.

At 27,000 square feet, the new Wildhorse is less than half the size of the Nashville location. Management sought a more



*LeAnn Rimes*

PHOTOS: TONY FERRIOLLO



*Above left, the spacious stage. Above, production manager Jack Funk at the Soundcraft Series Five FOH console.*

intimate club environment and wanted to accommodate more diners. As a result, the balconies were extended farther over the dance floor, creating a straight-on cross-section approximating a Coke bottle. "It had the effect of pinching the entire space into two nearly separate rooms—one upper and one lower," explains Scott Harmala, vice president of operations and engineering at Audiotek. "At first I was perplexed. I was very concerned about the upper and lower right and left arrays displacing each other and turning it all into mush."

In the design phase, using an RT-60 and an EASE program, and referring only to the blueprints, Harmala built a three-dimensional model of the club, predicting corner nodes and sound planes to what turned out to be an extremely accurate degree. He also decided to handle the pinched upper and lower sections of the room as separate entities, hanging a total of 12 Audiotek C6 cabinets—which Harmala himself had

**BY DAN DALEY**

—CONTINUED ON PAGE 162

# RANCID

## ALL ACCESS

TEXT AND PHOTOS BY STEVE JENNINGS



Rancid played at the Greek Theatre in their hometown of Berkeley, Calif., as part of their four-week U.S. tour before heading for Australia and Japan. Pictured are Tim Armstrong (L) and Matt Freeman.



Guitarist Lars Frederikson



Monitor engineer George Squiers creates eight monitor mixes on a Ramsa 840. "The band loves a serious sidefill mix," says Squiers, who also sets up a drum fill and center wedges for singer Tim Armstrong. Drummer Brett Reed has two seat shakers under his stool to help simulate subwoofers. Mics include Shure SM98s for toms and an SM91 for the kick drum. Vocal mics are Audix OM-7s, selected for their tight pattern and high volume capabilities. Squiers always sets the band up fairly close together. "I shrink the largest stages because these guys love to be right next to each other," he explains. "They're so much a band, very united, they feel more together right on top of each other. I think a lot of that goes back to them playing the small club scene for years, on those tiny stages."

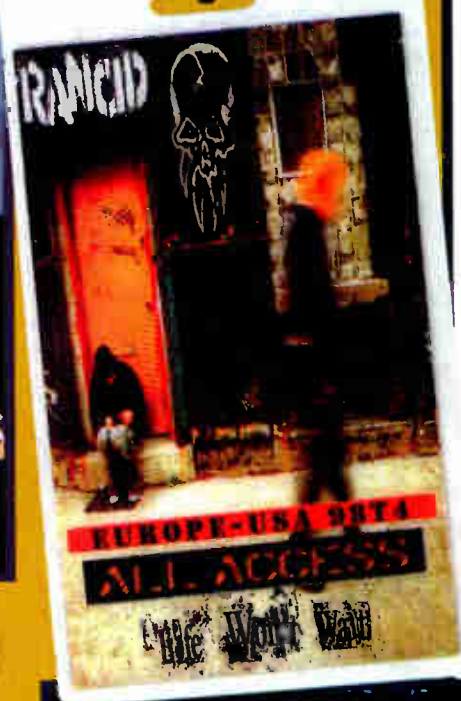

FOH engineer and Ratt Sound co-owner Brian Ratt is back at the FOH position after a spell as monitor mixer. He is using a 24-input Yamaha PM4000 and uses the matrix and aux sends for various P.A. feeds. Ratt has been using an Aphex Tubessence compressor on vocals and guitars and is trying out some Aphex mic preamps. Ratt's FOH mix for Rancid is "really simple—there's hardly any effects. I use a little reverb on drums—a PCM-60, which I like, and an Eventide 3500 for real simple pitch changes and delay on one song. A band like this doesn't need a lot of gadgets and effects." All Ratt Sound speakers, including the wedges, are tri-amped and are loaded with Electro-Voice drivers. Amps are from Crest. "They're road warriors," says Ratt. "They'll take a beating, and the circuitry is great."





**'I Never Dreamed  
a Wireless Unit Would  
Become an Integral  
Part of My Tone.**

**In the Studio and  
on Stage, I'm Hooked  
on Being Unhooked!"**

**Hershel Yatovitz, Guitarist for  
Chris Isaak and Silvertone**



**W**hile tracking guitar parts for the new Chris Isaak CD, Hershel Yatovitz's Xwire X905 Digital Wireless System delivered nothing but pure tone. Something that, according to engineer/producer Mark Needham, cable didn't do.

"I must admit I was very skeptical at first," says Mark, "But after using the X-Wire, I feel the high frequency response was even better than standard 1/4" cables."

How can a wireless unit sound better than cable? Instrument cable has capacitance which acts as a filter that rolls off high frequencies. The longer the cable, the more highs you lose. You may be able to make up for the loss with outboard gear or adjustments at the console but you're still doing just that. Making up for it.

**Xwire**<sup>TM</sup>  
Digital Wireless Systems

4630 Beloit Drive • Suite 10 • Sacramento CA 95838 • U.S.A.  
Voice (916) 929-9473 • Fax (916) 924-8065 • Internet: [www.xwire.com](http://www.xwire.com)  
"Quadiversity" is a trademark of Xwire Corporation. X905 patents pending.

What if you didn't have to lose it in the first place? With the X905 20-bit Digital Wireless System, you eliminate the cable and get nothing but pure tone as it was meant to be. Clean, clear and punchy. And while we should mention the invaluable benefit of being free to move about the studio and control room, it should be said that with the X905 Digital Wireless System it's not all about wireless. It's all about tone. Let us do the same for you.



# Radial

THE WORLD'S FINEST DIRECT BOXES

When **MIX** said "Clear Winner" we went one step further and lowered noise by another 6dB

Mix July 1998

When **RECORDING** said "Platonic Ideal of DI's", we devised a scratch test for durability

Recording July 1998



**JDV**

- Active Class-A
- Ultra-low noise
- Rechargeable

When **EQ** said "no-compromise" we added a rugged protective carry pouch

EQ June 1996

When **BASS PLAYER** said "sounds just like This bass" we figured this is exactly what a DI should do

Bass Player October 1998

**JDI**

- Jensen Equipped
- Zero-phase deviation
- Completely passive



When **PROFESSIONAL SOUND** said "remarkable-clean transparency" what could we say...

Professional Sound August 1997

When **CANADIAN MUSICIAN** said "it sounded like I put new strings on the bass" we smiled

Canadian Musician 1996

When **ELECTRONIC MUSICIAN** said "you won't find anything out there offering better performance"

Electronic Musician November 1998

We said "Thank You"



Radial Engineering

#114-1585 Broadway - Port Coquitlam, BC - V3C 2M7

Tel: (604) 942-1001 - Fax: (604) 942-1010

[radialeng.com](http://radialeng.com)

CIRCLE #104 ON PRODUCT INFO CARD

## LIVE SOUND

—FROM PAGE 159, WILD HORSE CLUB

designed—in four arrays of three cabinets each: upper right, lower right, upper left, lower left. The 227-pound C6 cabinet is a trapezoidal three-way system. Each is loaded with dual-15 JBL 2226G woofers, a JBL 2446J 2-inch driver, a modified JBL 2426 1-inch driver and a JBL 2385 horn. Each is powered in three stages by QSC 4.0 and 2.0 power amps and processed by an XTA DP-200.

A single center cluster using EV Delta Max 1152 APF cabinets rounds out the rest of the flown, dead-hang array. Beneath the stage are four ATK CSW-28 bass cabinets. Four EAW DS-122E cabinets handle front fills. The FOH console, a 48-input/4-stereo Soundcraft Series Five, is located on the second floor, above and to the left of the DJ/VJ booth on the floor. Aside from the main arrays and subs, the club has several zones using JBL Control 28 speakers (including ceiling-mounted ones in the bathrooms) with delayed rear speakers.

Stage monitors are an Audiotek design, using M2 (loaded with an EV DL-12X speaker and a JBL 2426J 1-inch driver) and M5 (two MacCauley 6232 12-inch woofers and JBL 2446J 2-inch driver) designs. The monitor console is the first U.S. installation of the new Soundcraft SM 20 console.

"The target we were shooting for was an under-one-second reverberation time," says Harmala. "We wound up with 0.9 seconds, so the 40 hours I put into the modeling paid off. We got very even, smooth coverage throughout the room." Harmala had visited the Nashville installation and acknowledges that he took some of his cues from there, including deadening every other

panel of the corrugated metal roof to maintain a balance of reflectivity and absorption.

The system has a potential 65,000 watts, although with its 16-ohm driver terminal limitations its actual output is closer to 35,000. But within a space of 27,000 square feet, it's enough to put out a sustained, A-weighted 105 dB, and peak transients at the FOH position in the rear of the club of over 125 dB (unweighted).

"This system was intended to meet the requirements of at least 80 percent of the [contract] riders that come through here," says Funk. It's an important issue, because the club intends to book major country acts on a regular basis. The grand opening on May 30 featured Alabama playing to an SRO crowd; Harmala included a 56-channel three-way split feed for mobile and FOH live recording applications.

While Florida's main contributions to country music are the Bellamy Brothers and The Mavericks, the Orlando area has been a hotbed of successful new acts in recent months, including Matchbox 20, Sister Hazel and Seven Mary Three. And the city's music infrastructure—abetted by multibillion-dollar theme parks—is building itself up to the point where it can both fill homegrown artists' recording, performance and post needs, and attract artists, performers and producers from other areas.

"This place is a reflection of what's happening in Orlando," says Funk. "There's a lot of people with major league backgrounds coming down here now. The post-production houses are busy, and there's new recording studios popping up. The clubs are also getting bigger and better. Orlando is really changing." ■

Dan Daley is Mix's East Coast editor.

—FROM PAGE 158, CLUB SURVIVAL TIPS

and repeatable pre-soundcheck routine of system verification and adjustment allows you to enter the "right-brain" mode of mixing during your band's performance.

Inexpensive PC-based FFT analyzer software now makes it relatively easy to take the system evaluation and setup process a step further. If you're carrying a laptop anyway (for e-mail, faxing technical documents and finding veggie restaurants on the Internet, for example), it's a snap to plug a measurement mic into a spare channel on the board and compare the output of the console to the sound in the room. Since this can

be done using a variety of playback sources instead of just pink noise, the P.A.'s response can even be checked and tweaked after the doors are open. (For more on PC-based analysis software, see Ted Leamy's evaluation of JBL's SMAART Pro in the April 1998 issue of *Mix*.)

But before you do any room tests, CHECK THE POWER! All too often the stage power is derived from wall outlets that have been ravaged by constant use and are caked with a film of duct-tape adhesive. Safe AC power is essential to your band's safety and the continuing usefulness of your equipment; check the wall outlets at every gig, no matter

what the house engineer tells you. A simple (and inexpensive) hardware-store 3-LED circuit tester will tell you if the Edison wall outlets are wired correctly. Even better, a volt-meter allows you to check for AC voltage between the guitar amp's chassis and the vocal mic, and will verify the DC charge of 9-volt batteries.

#### CARRY ON

Gear you can carry is carry-on. Though some engineers choose to bring everything but the kitchen sink, the "two-hands" rule dictates that if it can be carried in one trip, it is more likely to stay with you, safe and sound. Stuff left in the van overnight can disappear as quickly as you can say "broken window," and the cost of replacing good equipment is more than you might earn on even the longest club stint.

If you'll be flying on commercial carriers, save your equipment from baggage handlers who see road cases as a challenge for the drop test: take it into the airplane cabin. Soft-sided equipment racks would never be considered for air cargo and have a short life span in the back of a truck, but they are usually lightweight and have a shoulder strap, a good choice for hit-and-run production. The three-rackspace version fits in most aircrafts' overhead bins, and you can usually get away with two of these on domestic flights. A three-space rack limits the number of processors you can bring along, but if you can always carry it, the chances of it staying in your possession and in working order for the entire tour are much greater.

On the club circuit, the stages are usually small enough that gating the kick drum and toms will clean up the sound of most bands. Bring your own gates and you'll be sure of their quality, plus they'll be familiar enough that you can concentrate on getting accustomed to mixing on the console du jour. The same goes for compressors. It's not uncommon for clubs to have one or two usable compressors, but don't count on it. If your lead vocal is important, bring a vocal processor that includes a mic preamp and some combination of an equalizer and a compressor. Most club consoles have marginal mic pre's, so bringing your own ensures quality and consistency for the "money" channel. And because these are yours, you can simply unplug them and button up your rack after soundcheck, confident that they won't be readjusted by your support act.

It's inevitable that you'll run into

# PROJECT STUDIO EXPERTS



## WORLDWIDE DELIVERY



The Largest Selection Of The Best Products In The Business

- ▶ DIGITAL & ANALOG MULTITRACKS & CONSOLES ▶
- ▶ EFFECTS, MONITORS, MICS & PRE-AMPS ▶
- ▶ KEYBOARDS, GUITARS & ELECTRONIC PERCUSSION ▶

CALL NOW

**800-264-6614**



OUTSIDE U.S.: 860-442-9600  
FAX: 860-442-0463

# CARUSO MUSIC

94 State Street • New London, CT 06320 USA • E-mail: sales@caruso.net • <http://www.caruso.net>

CIRCLE #105 ON PRODUCT INFO CARD

# STUDIO MANAGEMENT SOFTWARE



**YOUR LOGO HERE** Your Studio Here  
**MAIN MENU** **NEW! 4.0** **GET YOURS TODAY!**

office	studio	tech
Contacts	Production Orders	Sessions
Calendar	Invoices	Tape Library & Labels
Media Inventory	Recording Budgets	Songs & Track Sheets
Bar Codes	To Order	Recall Sheets
Events & Alarms	Help	Sample Library
Rooms	Equipment Inventory	Maintenance Log
	Patchbay Labeler	Part Stock

Setup Open All Open Preferred About Set Menu Log Out

by **AlterMedia™** Call: **1.800.450.5740** get a FREE demo at  
International: 1.770.303.0970 [www.studiosuite.com](http://www.studiosuite.com)

CIRCLE #106 ON PRODUCT INFO CARD

# 1-877-FSI-EARS

CALL TOLL FREE

**Ear Monitors®** brand custom earphones are the most widely used and recognized earphone monitoring instruments in the world. Our commitment and simple philosophy is to provide only the highest quality products and services available. From Reba McEntire to Kiss, **Ear Monitors®** are the choice of today's top performers.

For your customized monitoring package, consult with Future Sonics Today.

PROVEN RELIABLE

**FUTURE  
SONICS**  
Incorporated

tel. (215) 598 8828 / fax (215) 598 8827 / www.futuresonics.com

© Future Sonics Inc. 1998

#### EAR MONITORS® APPLICATIONS:

*Live Concert Sound  
Reinforcement*

*Theatrical*

*Church Installations*

*Television / Broadcast*

*Film and Video  
Production*

#### SERVICES AND HARDWARE:

*Audiologist Network*

*Custom Ear Plugs  
and Filters*

*Audio Consultation  
and Mixing Services*

*Wireless and  
Hardwired Systems*

*Seat Shakers*

*Sales, Rentals  
and Service*



mixing boards with both kinds of insert connections. Most will have single 1/4-inch TRS jacks, while the better ones will have dual send-and-return inserts. It's essential to carry both kinds of insert cables, or to just use dual cables with TRS "Y" adapters—a male stereo TRS jack with two female 1/4-inch mono jacks, so one feeds the TRS tip and the other feeds the ring. For the occasional console that has its TRS inserts wired backward, it's a simple matter of reversing the adapters to make them work.

For effects you'll often be limited to four rows of auxiliary sends on the console, but the average club can be counted on to provide little more than a delay and a reverb. Bringing your own effects guarantees that you'll be able to consistently find the sounds you want without learning a whole new set of devices each night. The time saved can be spent wrestling with the other aspects of the system (like ringing out the monitors). You may want to use the club's effects for a standard combination of snare reverb and vocal delay, while using something you've brought for vocal or instrument effects. The better single-rack-space units can be used for multiple effects, and some can even be split to use as two dual-mono machines. Also, if your band is just plain loud, you can do your lead singer a huge favor by using one or two aux sends at FOH to provide him or her an in-ear monitor mix.

#### EQ TO TASTE

In most clubs you have little control over the main speakers other than the ability to adjust their EQ. Often, the crossover and system limiting is locked up to protect the P.A. Even if it is available and conveniently located, the EQ may be some budget or vintage model. Bringing a good equalizer that you are familiar with allows you to integrate it into your pre-soundcheck routine more easily. Bypassing the club's EQ and using your own can not only improve the sound, but also allows you to lock it up, reverting back to the club's graphic for the other band's engineers who need to make their own adjustments on the house EQ while you're eating dinner.

The selection of mics and DIs available in clubs tends toward a minimal inventory that's often seen considerable abuse. You wouldn't want to put your lips on many of the vocal mics you'll come across, so don't ask your singers to. Bring your own dynamic mics that can be swapped for the beat-up 58s the

CIRCLE #107 ON PRODUCT INFO CARD

Double Duty Diffusers™

**AcousticsFirst™**

## Amazing Product Cures Flabby Bottoms

**R**ecently, a Pennsylvania physician called to see if we could cure his "flabby bottom". We prescribed our Double Duty Diffuser. ▲ The long bass waves tend to roll around the room cancelling here, reinforcing there. The bottom end tends to sound boomy, mushy or flabby. ▲ The solution is a bass trap such as our highly efficient DDD.

Similar devices have been around for years but only large sound stages and

recording studios could afford them. Now,

Acoustics First has a superior product for

under \$200. ▲ And the Double Duty

Diffuser does more than trap bass. It

disperses high frequencies, eliminating

standing waves and flutter echoes.



**Toll Free**

**1-888-765-2900**

**Acoustics First Corporation**

2247 Tomlyn Street

Richmond, VA 23230-3334 USA

Fax: 804-342-1107

E-mail: [acoustics@i2020.net](mailto:acoustics@i2020.net)

Web: <http://www.acousticsfirst.com>

© 1998 Acoustics First Corporation

CIRCLE #108 ON PRODUCT INFO CARD

club is likely to have—without forcing the monitor EQ to be radically readjusted. After soundcheck, the club's mics can be put back on the stands for the support act without it being a big deal. Avoid condensers and phantom power if possible—they're more likely to cause problems on marginal systems. If you use active DIs, check their batteries regularly. Having your own drum mics and DIs means that the club's can be used for the other band(s), but there probably won't be enough stands for everyone. Drum claws eliminate this need, allowing changeovers to be as simple as moving each XLR (which you've labeled) to the club's mics for the other acts; plus, there are fewer stands to be bumped on a small stage during your show. Direct boxes can be integrated into each musician's rig, either Velcro'd or duct-taped right to their amp or keyboard.

All mics and DIs should be clearly labeled. Remember, you may have to rely on your own bandmembers and the house engineer(s) for setup and stage changes. In fact, all your gear should carry your name (phone and address) so ownership issues can easily be resolved. Furthermore, color-coding all pieces with a unified scheme makes it easier to recognize and retrieve gear at the end of each night. Etching your social security number only seems drastic until something's missing. Marking, labeling and inventorying serial numbers makes recovery much easier when it's misplaced or stolen, and if you go to Canada, you'll need a carnet anyway.

#### MIX AND MATCH

The console you mix on each day will vary widely—from the latest cheap music store offering to the prehistoric hand-me-down from the regional sound company. A clear understanding of the console's and the system's gain structure each day is helpful. Ask your system engineer if there is a "standard" setting for the master and sub-group faders. Less expensive consoles lack headroom and add noise at their summing amps, so it's a good idea to start the groups at -10 or forgo sub-masters altogether and just assign inputs to the main L/R bus.

When sharing channels with opening acts, you'll want to note the position of all your controls after soundcheck to ensure that you can reset the console before your band's set. A simple way to chart the board is to turn a legal pad sideways and draw a line for every row of knobs you want to document. Each knob can be depicted by a dot with a line coming out at its approximate

angle. When mixing from an even row of faders, the input gain is the most important knob, so the quickest way to chart is to just write the input gain beside each channel's name on your board tape or on a stripe across the top. You'll find that good inputs require less EQ if the system is properly adjusted to begin with. If you use mostly your own mics, each channel's EQ adjustments will be predictable if you've consistently pre-adjusted the system EQ each day as part of your routine.

Your input list should be as compact as possible. Club stages are small, so forget the bass amp mic and the drum

overheads (the vocal mics will pick up the cymbals). Fancy miking techniques are best left for large tours and studios. Remember the KISS principle (keep it simple, stupid) and just use what you need. However, your list should include a spare vocal and a spare instrument input to use when the inevitable problems crop up. Plus, they can double for sit-in guests or for the solo support acts that you'll come to love.

#### FAX IN ADVANCE

Advance your show by faxing a one-page document that shows your "stage map" on the top half, using triangles for

# In the Studio?

**FREE Guide Saves You Time and Money!**

**\$7.95 value**

**Bonus Offer!**

*We'll include our 37 Recording Tips brochure, packed with advice and simple tips on how to save big bucks in the studio, FREE!*

Nothing is more frustrating than making CDs or cassettes and finding out that there is something wrong with your master tape. **Disc Makers' Guide to Master Tape Preparation** provides insider information, as well as common sense tips, on preparing an error-free master tape on the first try. *No matter where you record or manufacture your product, you need this 32-page booklet before leaving the studio.*

**Contact Us Today:**  
**1-800-468-9353**  
**www.discmakers.com**  
**info@discmakers.com**

**DISC MAKERS**  
**EXPECT MORE**

CIRCLE #109 ON PRODUCT INFO CARD

# West L.A. Music

## WE WILL BEAT ANY DEAL!

EVERY MAJOR BRAND!

DIGITAL AND ANALOG RECORDING • WORKSTATIONS  
 MIXING CONSOLES • EFFECTS PROCESSORS • MICROPHONES  
 DAT AND CASSETTE DECKS • STUDIO MONITORS  
 CD RECORDERS • COMPUTERS • SOFTWARE  
 KEYBOARDS • SYNTHESIZERS • SAMPLERS • SOUND SYSTEMS  
 GUITARS • AMPS • DRUMS AND ACCESSORIES



Brian Auger (c) and Jackson Browne (r) with Mark Spiwak.



Peter Criss, (r) of Kiss with drum manager Glenn Noyes.



Michael MacDonald with a friendly West L.A. Music staffer.

### "WHERE THE PROS SHOP"

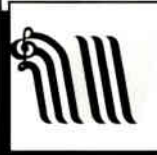

Southern California's Legendary Music Store!

## WEST L.A. MUSIC

11345 Santa Monica Blvd. Los Angeles, CA 90025  
 Two blocks West of the San Diego (405) Freeway  
 (310) 477-1945 Fax: (310) 477-2476

ALL MAJOR  
 CREDIT CARDS,  
 FINANCING,  
 AND LEASING.

CIRCLE #110 ON PRODUCT INFO CARD

- ◆ Analog and Digital Mastering
- ◆ Sonic Restoration
- ◆ Full Range of Processing Options



## TimeCapsule Mastering

**323/468-9550**

Fax 323/468-9560  
 6054 Sunset Boulevard  
 Hollywood, CA 90028

"Music for the Future"

CIRCLE #111 ON PRODUCT INFO CARD

LIVE SOUND

wedges, rectangles for band gear and numbered circles for inputs. The bottom half is your input list, indicating the mics you'll bring, the stands you need and contact info (beeper, e-mail, voice-mail, roommate, whatever works). Requesting anything more complicated than four wedges and some 58s or 57s is a shot in the dark, but you have to start somewhere. Remember, if it's remotely important to your show, bring it with you. You can bet some of these faxes will get lost, so a week before the gig it's a good idea to re-fax this document and then call to confirm load-in, sound-check and set times.

If your band's management has it together, you'll find that the itinerary will include in-store appearances, festivals and special radio station events. At all of these, your survival kit of processing gear, mics and DIs becomes invaluable. Arrangements for all your sound system needs can be reduced to checking on monitors, mains, console, stands and cables. Also, opening for other groups on larger bills is less of an imposition for their engineers if, other than the console, you are self-contained. The only friction you may get is from the local sound company or house techs who think they may have to work a little harder to help get your stuff plugged in. However, if you've kept it simple and compact, you can do it yourself quicker than you can explain it to them.

One last piece of advice: Forget about making a recording of the show on the club's cassette deck as anything other than an archive for yourself. Because of their volume in the room, any instruments with stage amps will be too low on the board tape's mix to leave a good impression on the musicians who play them. Unless you can record via a matrix (which will allow you to add the backline instruments to the tape mix, regardless of their levels in the mix), your board tape will be mostly drums and vocals. The only good reasons to record the board mix are to check your drum and vocal effects and to keep the house mixer from bootlegging your show. Bring a bag of bulk-loaded chrome tapes, but don't let the guitar players in the band hear any recordings off the console. Insist on using their portable DAT with a room mic if they want to hear a recording of the show. ■

*Mark Frink (mfrink@teleport.com) paid his dues at the Rusty Nail Inn in western Mass.*

# INDISPENSABLE MULTI-EFFECTS PROCESSING

## MPX 1



No-compromise stereo reverb in combination with as many as 4 additional stereo effects, 200 superbly crafted presets, database sorting, and complete flexibility of routing and effect order in every program make the MPX 1 an indispensable recording and performance tool.

Powered by two separate DSP processors, the MPX 1 is loaded with 56 Pitch, Chorus, EQ, Modulation, Delay and world-class Reverb effects – each

with the audio quality and control flexibility you'd expect in a dedicated processor. The 200 presets, designed for a wide variety of performance, sound design and production applications, exploit the unique characteristics of each effect – and a built-in database function makes it easy to find the right program fast.

An interactive front panel gives you instant access to each effect and its essential parameters, as well as push-

button control over tempo, morphing, and mix and level settings of any or all effects. Whether you're looking for a rotary cabinet, a 4-Band Parametric EQ, Ducking Delay, Pitch Shifting, or virtual rooms of any size and description, the MPX 1 is the right tool for the job.



*For studio effects on the road, put an MPX 1 in the effects loop of your stage rig and an MPX R1 on the floor. A single cable provides stomp-box control of MPX 1 effects.*

Heard In All The Right Places

## Lexicon

A Harman International Company  
World Radio History

Lexicon Inc., 3 Oak Park, Bedford, MA 01730-1441  
Tel: 781/280-0300 Fax: 781/280-0490  
Email: info@lexicon.com Web: www.lexicon.com

CIRCLE #112 ON PRODUCT INFO CARD



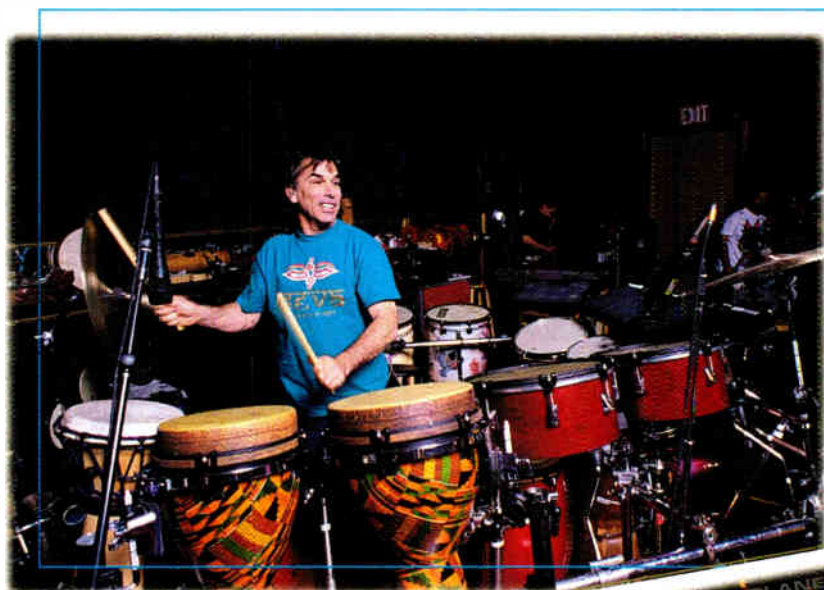

PHOTOS: JOHN WERNER

## MICKEY HART BEATS THE PLANET DRUM

by Blair Jackson

When Grateful Dead guitarist Jerry Garcia died of a heart attack in the summer of 1995, the other members of the suddenly defunct group lost not just a great friend and colleague, but their primary source of income and the principal activity in each of their lives. Drummer Mickey Hart recalls being

shattered by the news, "but at the same time you don't have any choice but to accept death, so what I did was I went into the studio and dug in here for months and didn't come out. I finished *Mystery Box* [released on Rykodisc in 1996], and that helped me come to grips with Jerry's death: with the loss and the grief. Working is always good therapy.

"Still, I couldn't listen to Grateful Dead music for a long time, and I thought I would never play Grateful



Dead music again. It was just too painful for me to hear his guitar. It's still difficult for me; it's a little too close. But you have to put the past behind. I've got my drums and my group [Planet Drum], and I get into my zone. I stay busy."

Hart smiles at what he knows is an understatement. Even when Garcia was alive, Hart worked almost constantly during those brief periods when the Dead were not touring. In addition to making his own percussion records, he is producer of Ryko's popular international music series known as The World, and he has been a regular contributor to the Smithsonian's various music ventures, including the restoration of historic tapes and anthropological recordings. This is a man with nearly boundless energy; every

—CONTINUED ON PAGE 174

Hart and engineer Tom Flye in Studio X.





# BLUE MAN GROUP

THE OFF-BROADWAY SENSATION'S FIRST RECORD

by Dan Daley

The Blue Man Group's award-winning off-Broadway show, *Tubes*, debuted in 1991 and has had an uninterrupted run ever since. It's quite an achievement in Manhattan's notoriously fickle alt-theater scene. In the show, an eerily engaging trio of blue-tinged figures wordlessly roams a small stage, turning every item imaginable into a percussive musical instrument and point of philosophical inquiry. It's musical, it's dramatic, it's funny and serious. And popular: It's now expanded with simultaneous satellite shows in Boston and Chicago.

As fundamentally musical as the show is—much of it



PHOTOS: RANDALL MARKEJ

Above: Steve White, John Grady and Jeffrey Doornbus play PVC tubing in full Blue Man regalia. Left: Todd Perlmutter at the board

centers around instruments created from polyvinyl chloride (PVC) pipe—Blue Man Group is high concept. The three founders—Chris Wink, Phil Stanton and Matt Goldman, all veterans of fringe theater in New York—speak of “Blue Man values,” a so-

cial code that transcends the rules of theater, and media in general. Like their mute, Buster Keaton-esque stage personalities, they regard technology with a graceful combination of bemusement, skepticism and child-like joy. These same values have come to the rescue over the years as they found that, as musically

powerful as *Tubes* is, it did not necessarily translate beyond the edge of the stage. “We’ve done *The Tonight Show* six times, and the first two times we did pieces from the show, and it just didn’t work,” recalls Goldman, the quiet, studious one of the three, and a steady foil for Wink’s hyperkineticism. “We realized we had to write  
—CONTINUED ON PAGE 185

# TELARC

STILL ON DIGITAL'S LEADING EDGE

by Eric Rudolph

Things used to be so simple at Telarc. The label's first recordings were cut in the late 1970s in the simplest way possible: direct-to-disk, one LP side at a time. But the company quickly moved to the forefront of new technologies. Soon after making some of the first modern orchestral direct-to-disk recordings in 1978, using two Neumann lathes for redundant masters of orchestral and pipe organ recordings, Telarc's owners were ap-



Left: Telarc co-founder, CEO and chief recording engineer Jack Renner. Right: engineer and new technologies manager Michael Bishop

proached by digital pioneer Tom Stockman with the first Soundstream digital recorder. “The Soundstream was a

50kHz digital system that used a 1-inch Honeywell data deck running at 30 ips with 10.5-inch reels,” ex-

plains Michael Bishop, recording engineer and director of new technology at Telarc. “It was capable of recording four tracks, but we usually used it for two. It was our mainstay from 1977 to 1988. There was, of course, no format for digital release at first; it was just viewed as a superior way to record that would allow editing, unlike cutting straight to disk. To make a CD master, the Soundstream recordings had to be down-converted to 44.1 through a hand-wired Studer sampler rate converter. We currently have the only working Soundstream recorder-player outside of the Smithsonian.”  
—CONTINUED ON PAGE 180

# SLY & THE FAMILY STONE'S "IF YOU WANT ME TO STAY"

by Blair Jackson

It's shocking to me that Sylvester Stewart—Sly Stone—is not revered more today, for he is unquestionably one of the most talented and influential musicians of the modern era. His band, Sly & the Family Stone, was one of the first great interracial soul bands, a beautiful polyglot of good-time guys and women whose innovative and always danceable fusion of horn-driven soul, R&B and psychedelic rock had not only mass appeal but also an underlying intelligence that was completely in tune with the late '60s and early '70s. Along with James Brown—one of the band's major influences—Sly and his group helped define funk music, paving the way for Parliament/Funkadelic, Kool & The Gang, the Ohio Players and scores of other bands that capitalized on a style the San Fran-

cisco group originated. You can hear Sly in the early '70s music of Miles Davis and in countless songs by artists as diverse as Bob Marley, the Rolling Stones and Prince. A few of Sly's hits still turn up on "classic rock" and oldies stations, but not with the regularity they deserve, and it's a *crime* that no one has seen fit to make a box set of this incredible group's best material—sorry, a single "Greatest Hits" disc does not do the job; the quality material runs much deeper than that. America needs to know that "Everyday People" wasn't written to be a Toyota commercial; once it was an anthem of racial harmony and good vibes!

Sylvester Stewart is one of popular music's great enigmas. It's been 20 years since he's made a really good record, and that disc—1979's *Back on the Right Track*—was not a commercial success. There have been scant few sightings of

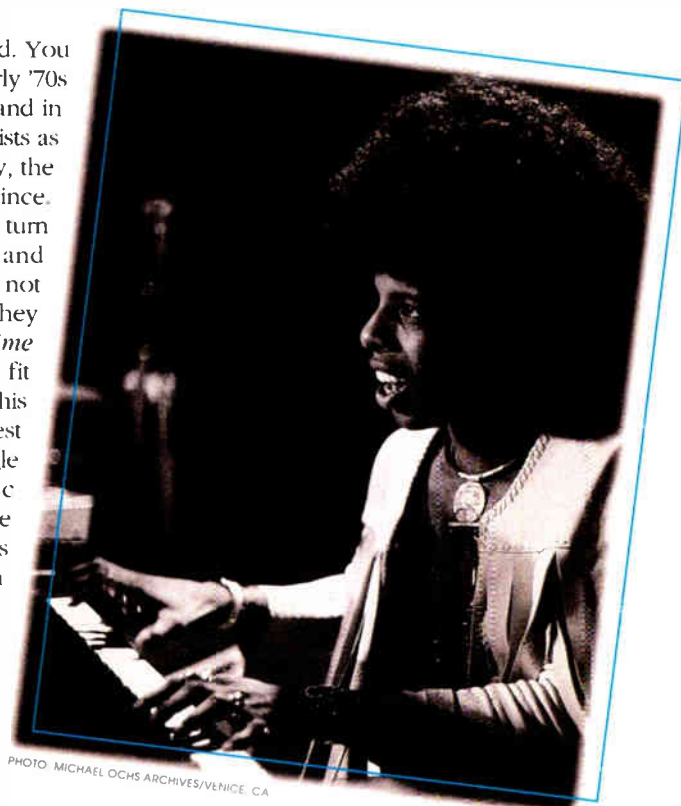

PHOTO: MICHAEL OCHS ARCHIVES/VENICE, CA

the elusive Sly during the intervening period, and most of the stories about him that do come out are negative. By now the world has about given up on Sly—chalked him up as another drug casualty (which he clearly

## Cool Spins

The Mix Staff Pick Their Current Favorites

Elvis Costello and Burt Bacharach: *Painted From Memory* (Mercury) By the time this issue of *Mix* hits the stands, readers



will already have heard a lot about this collaborative effort by one of popular music's most famous and one of its most infamous songwriters, but let me add my two

cents. So much talent and passion went into this one-off. Even if these swelling Bacharach arrangements of horns and strings and keyboards and cocktail percussion don't appeal to you, don't miss Costello singing with more range and more subtlety than ever in his career. Just listen to the achingly beautiful songs and enjoy what this really smart, sincere singer and writer has brought to the Bacharach oeuvre.

Produced by Costello and Bacharach. Recording and mixing engineer: Kevin Killen. Studios: Ocean Way, Hollywood (all but last track); Right Track, NYC. Mastering: Bob Ludwig, Gateway (Portland, ME).

—Barbara Schultz

### Duncan Sheik: *Humming* (Atlantic)

The long-awaited follow-up to Sheik's critically and commercially successful eponymous debut, *Humming* is a sprawling and ambitious work filled with songs that mix the confessional with the impressionistic in a moody, often brilliant pastiche. The arrangements are all over the map, with small groups on some tracks, members of the



London Session Orchestra dominating others, and lots of interesting, atmospheric touches throughout, but it's held together by the strength of Sheik's vocals, songwriting and guitar work. At its best, this disc has some of the thoughtful vibe of Van Morrison's *Astral Weeks* or some of Jackson Browne's early work. "A Body Goes Down" is a haunting tribute to the late Jeff Buckley. The production by Sheik and Rupert Hine showcases Sheik's songs beautifully.

—CONTINUED ON PAGE 187

was/is) and perhaps judged his legacy unfairly based on his tremendous unfulfilled promise. There was a time when he was as big as rock stars get and everything he touched turned to gold. Unfortunately, he took that gold and traded it for white powders...

Originally from Texas, Stewart and his family moved to the working-class S.F. Bay Area city of Vallejo in the '50s. He sang gospel music in church from a young age, but he always enjoyed pop and R&B radio, and he learned the rudiments of a number of instruments—guitar, keyboards, drums—while still in his early teens. He studied trumpet, composition and music theory at Vallejo Junior College but also played in soul bands, like the Stewart Bros., formed with his younger brother Freddie. He became a popular disc jockey at a pair of top Bay Area soul stations, KSOL and KDIA, and his musical smarts and dynamic personality landed him a job producing bands for Autumn Records, a short-lived but important label run by KYA radio DJs Tom "Big Daddy" Donahue (who went on to pioneer "underground" radio) and Bobby Mitchell. Among the acts Stewart worked with were the Beau Brummels, Bobby Freeman and the Great Society,

Grace Slick's first band. He also cut several sides for Autumn himself.

Around the time he was producing the Great Society, Stewart was playing in a band called Sly & The Stoners, while brother Freddie fronted a group called Freddie & the Stone Souls. When



those bands fell apart, Sylvester and Freddie joined forces again to form Sly & the Family Stone, with Sly on keyboards and vocals, Freddie on guitar, Cynthia Robinson—also from The Stoners—on trumpet, Greg Errico of the Stone Souls on drums, Jerry Martini on sax and a magnificent young Oaklander

named Larry Graham on bass. The group attracted a large local following playing at dances around the Bay Area, sometimes on the same bill with psychedelic rock groups, and managed to land a deal with Epic Records, which released their first album, *A Whole New Thing*, in the fall of 1967. Shortly after that, Sly and Freddie's sister Rose joined as a second keyboardist. The group's debut album didn't sell many copies, but their second record, *Dance to the Music*, which included the hit title song, did. From there it was onward and upward for the group: They scored hits with melodic songs such as "Everyday People," "Sing a Simple Song," "Stand," and "Hot Fun in the Summertime," and their increasingly political material in the late '60s and very early '70s also found a wide audience. Sly & the Family Stone was one of several groups to benefit greatly from appearing in the 1970 film *Woodstock*: Their incendiary performances of "Dance to the Music" and "I Want to Take You Higher" were highlights of the movie and helped make Sly & the Family Stone one of the top concert attractions of the era.

The group recorded most of their biggest hits at CBS's New York studios,

## Need a New Point of Reference?

If you've ever wondered why, for nearly 30 years, so many hits have been mixed on Westlake Monitors - now is the time to find out. Go straight to your dealer and demand a demonstration.

Westlake Audio Speakers are designed as reference tools for the most demanding of audio engineers and golden-eared audiophiles. The no-compromise manufacturing process includes extensive internal cabinet bracing, hand built crossovers with precision matched components, and drivers that are meticulously selected, tested, measured and matched. Cabinets, drivers and crossovers are also thoroughly damped to eliminate any resonance or vibrations. You have to listen for yourself. We know you'll be impressed!



If you already own a pair of BBSM-10s and want to extend the bottom end, or if you're looking for a full range speaker system- you have to listen to the BBSM-10s with the BB10-SWP subwoofer system. Awesome!!!



Lc3w10 • The 10" 3-way monitor done the Westlake way. Perfect for the higher end project studios that demand a little more.



Lc265.1 • Multi-use system for dedicated center channel, L/C/R or 5 channel configurations. Dual 6.5" 3-way.

### MANUFACTURING GROUP

2696 Lavery Court, Unit 18, Newbury Park, CA 91320 • 805-499-3686 FAX [805] 498-2571 • <http://www.westlakeaudio.com>

## Westlake Audio

CIRCLE #113 ON PRODUCT INFO CARD



"I wish everyone could hear this..."

**Bruce Swedien**

Barbra Streisand • Michael Jackson • Count Basie • Duke Ellington • Quincy Jones • Edgar Winter



### TRACKING

Surround your talent and mic with *Studio Traps* and turn any room into a great sounding studio. Our Quick Sound Field iso system can be set up to get the traditional dead studio sound or simply rotate the traps to dial in that bright and clear, high presence effect of live sound.

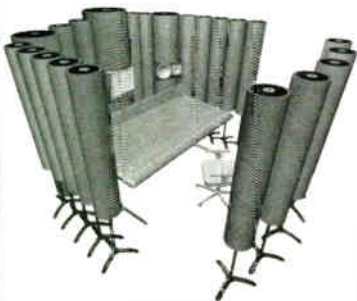

### MIXING

Enclose your monitors, console and mix position with *Studio Traps* and convert any room into a world class control room. Our ATTACK Wall iso system creates an acoustic subspace that delivers a very accurate and powerful bottom end, along with precise detail and pinpoint imaging. Your mix will truly hold together.

- 100% SATISFACTION GUARANTEED -

**800-ASC-TUBE**

**ASC** ACOUSTIC SCIENCES CORPORATION

PO BOX 1189, EUGENE, OR 97440  
541-343-9727/WWW.TUBETRAP.COM

CIRCLE #114 ON PRODUCT INFO CARD

with Don Puluse (now head of the Berklee College of Music) and others engineering what were, for the most part, live sessions. Beginning with the moody, politically conscious album *There's a Riot Going On* (1972), however, Sly and company changed their approach to recording, building from spare rhythm tracks, one instrument at a time, and rarely playing together as a group in the studio. Much has been written about Sly's erratic behavior during this period—he was notorious for showing up hours late for concerts or missing them altogether, and his prodigious consumption of cocaine is legendary—but he loved working in the studio. As the '70s wore on, his role in the group's albums increased dramatically to the point where he not only wrote arranged and produced nearly all the material, but also sometimes played most of the instruments on a given tune.

This month's Classic Track, "If You Want Me To Stay," comes from Sly's last acknowledged masterpiece, the 1973 album *Fresh*, recorded mostly at the Record Plant in Sausalito, Calif., by Tom Flye and a gaggle of other engineers including Bob Gratts, Willie Greer, George Engfer, Mike Fusaro, James Green, Chris Hinshaw, Don Puluse, Roy Segal, Bill Scruggs and Richard Tilles. Flye recalls, "Sly was kind of the innovator of the track-by-track, build-your-record overdub style. When I was working with him, he almost never tracked more than one instrument at a time. He really did that way before most people. And the reason he could do that is he could play all the instruments himself, including drums. But usually he'd start out with a Maestro Rhythm King; we called it the Funk Box. It could do real simple stuff: *dum-do-dit-dit, dum do dit-dit*. But it gave him a foundation to work on, and then he'd build his record to the rhythm box. Sometimes he'd replace it with real drums, but on some tracks [including "If You Want Me To Stay"] the Funk Box is still on there, or he'd use both.

"But he didn't always start that way," Flye continues. "Sometimes he'd put down an organ track first, and that would tell you the chord changes. Then he'd go onto whatever idea he had next—it might be a little guitar lick; put that in there. So there was no set way of working. The first versions were like demos, and the demos would evolve. If someone else could play the part better than him, okay. If they couldn't, he'd do it. Quite often the drums went on last."

The album's credits don't delineate who played what on each song, so

there's no way of knowing how much of what we hear is Sly and how much is the other bandmembers; by '73 most of the original group were still involved, except for the rhythm section (Larry Graham, who left to form Graham Central Station, was replaced by Rusty Allen; and the fine session drummer Andy Newmark took over for Greg Errico). Certainly the group's patented horn sound is intact on the disc, and the male-female vocal blend is still very much in evidence on some tracks.

The peripatetic Sly was an unpredictable work partner, to say the least. When Flye got involved with the project, Sly had already constructed versions of some songs working at various other studios, including the Record Plant in L.A., but his vision of what a song should be was constantly shifting over time, so the finished record bore little resemblance to the first tracks Sly cut. Flye basically had to be on-call to work whenever and wherever Sly wanted to record.

"We'd work for days at a time almost without stopping," Flye says, "plus we'd travel, too. There were times when we'd do a gig, and I'd mix the house for him, and then we'd hop on a Lear jet and fly to New York or L.A. or San Francisco, whichever was closest, and record all night, then hop on the plane, do another gig. He had a studio in his apartment in New York and he had a studio in his house in L.A. and then I had a portable rig that I used to take over to his mother's place over near Stonestown [in San Francisco]. That had an Audiotronics board."

Not the least of Flye's concerns was dealing with the many different kinds of equipment in the various recording environments. At the Sausalito Record Plant, where Sly virtually lived for days and weeks at a time in a room dubbed The Pit, there was an API board and 3M 16-tracks. At Sly's home studios in L.A. and New York, he had Ampex MM1000 recorders. Flye says, "I remember one time we were doing a bass part in Sausalito at the Plant and he got about halfway through it and he said, 'You know, I think I can do a lot better job if we go over to mother's house.' So I got out the portable rig and we went over there, set it up, cued up the song and he started playing the bass again. He got maybe three-quarters of the way through it and then he said, 'You know, the reason I'm having trouble with this bass part is I've got to put the new guitar part on first, but the guitar is in L.A. So let's go to L.A.' So we went to L.A. and

sure enough he put on a guitar part down there. And actually, he only wanted to punch in during the verses or choruses; I can't remember which. But it was a different guitar, a different sound, different board, different everything. And I was sitting there a little bit worried and he said, 'Don't worry. Tom, just do it.' So I started punching in every other eight bars and it *was* totally different—but it was great; it worked great that way.

"An engineer has to be cautious, because you don't want to mess up anything, but if there's a way you can sort of mark your path, so to speak, then you've got to let the artist go for it. Because that's the creative part of it. Good taste is sometimes the worst enemy of creativity. You have to give the artist the freedom to be creative, or everything is going to sound the same. I don't want to sit around and make Tom Flye records. I was happy to help Sly do the records he wanted to do."

As for specifics about "If You Want Me to Stay," Flye says, "I don't remember exactly the sequence of instruments on that track, but I do remember that the drums went on fairly late in the game. Andy Newmark played on that. Sly always liked to sing his vocals in the control room with the speakers up quite loud, and I'm sure that was probably the case there. Generally, I used an SM57 on vocals with a good pop filter on it. You couldn't use a big diaphragm condenser because the speakers were running 95+ dB. Actually, most of that album was recorded in the control room, except for the drums and the Leslie. But the B-3 would be in the control room, too. Almost all of it was recorded direct."

Both *There's a Riot Goin On* and *Fresh* are notable for their dry, in-your-face sound, though in places the horns sound eerily distant, making their bleating sound like a textural wash more than an actual part. There's very little reverb on either voices or instruments, which was Sly's preference. "We used the API EQs and some Pultecs," Flye recalls. "I particularly liked the 550As, which sounded so good. But he liked the sound to come and go quickly. If you were EQ'ing, he'd want to go for the heart of the sound and get rid of the rest of it."

Given Sly's highly unusual work habits and his drug consumption during this era, it's remarkable that *Fresh* sounds as cohesive as it does. I ask Flye if it was a non-stop party in the studio. "Not for me," he says with a chuckle. "Work got done. He worked very well

## What's the industry saying about audio education?

*'Students need to concentrate on the basics of audio...cultivating a strong ethic for hard work and attention to detail...developing appropriate attitudes to deal tactfully with people and gain real experience in a pressure environment.'*

## What can you expect from OIART?

A solid foundation in theory reinforced with the most hands-on time available in Canada. An environment that promotes positive work habits and fosters people skills. Lots of time to express your own creativity. An immersion-style integrated curriculum completed in 1 year instead of 2-3 years in less streamlined programs – without cutting corners – so you can get at it sooner.

## Compare before you choose.



# OIART

**Ontario Institute of Audio Recording Technology**  
502 Newbold Street, London, ON CANADA N6E 1K6  
Telephone 519.686.5010 Fax 519.686.5060  
Website: [www.oiard.org](http://www.oiard.org) E-mail: [inquiry@oiart.org](mailto:inquiry@oiart.org)

CIRCLE #115 ON PRODUCT INFO CARD

## ROCKET LAB LLC

DIGITAL & ANALOG MASTERING

NO NOISE

SPECIALIST IN MUSIC  
DOCUMENTARIES

MUSIC VIDEO  
PRODUCTION & POST

"WE MAKE ROCKIN' DOGS!"

[WWW.ROCKETLAB.COM](http://WWW.ROCKETLAB.COM)

[BLASTOFF@ROCKETLAB.COM](mailto:BLASTOFF@ROCKETLAB.COM)

415-495-2297

CIRCLE #116 ON PRODUCT INFO CARD

# SPEIR MUSIC CO.



•RECORDING

•PA GEAR/SPEAKERS

•KEYBOARDS/SAMPLERS

•MICROPHONES/WIRELESS

•MIXING/PROCESSORS

MUCH, MUCH MORE!

510 S Garland Ave  
Garland, TX 75040

M-F 9-7

www.spelmusic.com

email:spelr@dcx.net

# 800-219-3281

CIRCLE #117 ON PRODUCT INFO CARD

alone, but a lot of times there would be an entourage. I'm the engineer. I just put it in Record." How did you keep it together, Tom? "Well, that's the engineer's job. You're the designated driver."

Although *Fresh* didn't quite hit the commercial peaks of Sly's late '60s work, it still sold more than a million copies and made it to Number 7 on the *Billboard* chart. "If You Want Me To Stay" reached as high as Number 13 on the pop charts and Number 3 on the R&B charts. Another tune from *Fresh*, "Frisky," was a minor hit. The decline following that album was fairly precipitous. Even the always gracious Flye admits that the next LP, *Small Talk*, "never sounded finished to me." Still, the true fans—like me—are still waiting for that next burst of genius from Sly. Every couple of years there are rumors that something's on the fire, yet somehow it never materializes. Maybe *next year*...

For more on Sly, check out the "official" Web site: slyfamstone.com, and by all means read Joel Selvin's darkly compelling new book, *Sly & the Family Stone: An Oral History*, published by Avon Books. ■

## 3.5 MM Heavy-Duty Stereo Plug

Made in the USA Since 1946 • ISO-9001



35HDBN  
Black Handle,  
Nickel Plug

35HDBAU  
Black Handle  
Gold Plug

35HDNN  
Nickel Handle  
Nickel Plug

35HDNAU  
Nickel Handle  
Gold Plug

### Features and Benefits:

- One piece tip rod with flat for easy solderability
- Compliments current line of 3.5mm jacks
- Insert molded plug finger
- Tubular insulator included to prevent solder joints from contacting handle
- Longer cable clamp for easier plug assembly and more room for solder connections
- Knurl on the back of handle provides ergonomic gripping surface to tighten plug
- Heavy duty cable clamp provides better strain relief for larger cables



## CALSWITCH

95 Authorized Vendors Catalogs. Person-to-Person Distribution. Custom Warehousing. Custom Assembly. Technical Assistance

**(800) CAL-SWCH**

Fax: (310) 632-4301 • www.calswitch.com • ISO-9002

CIRCLE #118 ON PRODUCT INFO CARD

# Switchcraft®

—FROM PAGE 168, MICKEY HART

waking moment not spent with his family seems to be devoted to music. In fact, on the fall morning I interview him at his lovely, secluded spread in rural Sonoma County, Calif., Hart informs me that he has stayed up all night in the studio banging away on electronic percussion pads. As usual he has at least two projects going—rehearsing Planet Drum for a national tour to support his latest Ryko effort, *Supralingua*; and mixing tracks for a live CD by the Other Ones, a Grateful Deadish band that included four former members of the Dead (Hart, Bob Weir, Phil Lesh and Bruce Hornsby), a second drummer, and two outside guitarists and a saxophonist filling the Garcia slot.

The Other Ones' rapturously received five-week summer tour found Hart and company playing both familiar and rearranged versions of Grateful Dead classics, as well as a number of new tunes, and Hart says, "The heat coming out of the audience was tremendous. They were hungry and so were we, and we all sat down together for a big feast. They were desperate and so were we for that *feeling*. It was mutual, and it all seemed quite soulful and real."

At the time of our interview, no decisions had been made about future Other

# Real-Time DirectX Effects Software

# DSP•FX Virtual Pack

## Version 5.0

### Now with TEN great plugins!

#### • OPTIMIZER

Maximize the output level of your files using this powerful look-ahead peak limiter with proprietary dithering algorithms—a must-have tool for CD mastering and Internet audio distribution

#### • AURAL ACTIVATOR

Add sizzle to a mix, energize a dull track, regain lost high-frequency content—this spectral enhancer can dramatically improve the sonic impact of your recordings

#### • STEREO REVERB

Imagine a reverb where the very tail end of the decays disappears into total silence; with no noise or grunge—this is it, thanks to the 32-bit floating-point design

#### • MULTIBAND EQUALIZER

Tweak your tracks with 1/100th dB accuracy using 16 fully programmable bands of parametric EQ and four bands of shelving EQ—ideal for mastering

#### • MULTI-ELEMENT DELAY

Go from simple slap to massive thickening with eight individually programmable delay lines

#### • MULTI-ELEMENT CHORUS

Simply the sweetest, fattest chorus ever

#### • ANALOG TAPE FLANGE

True thumbs-on-the-reel, dive-bomber flanging

#### • STEREO PITCH-SHIFTER

Create vocal harmonies, make a 12-string guitar, change the key of a part

#### • AUTO-PAN

Too busy to do your own panning? Let this plug-in do it!

#### • TREMOLO

Recreate classic tremolo effects, from vintage guitar amps to electronic keyboards

**PLUS:** Incredibly Efficient CPU Usage, Full Real-Time MIDI Control of All Parameters, Live Input Mode, Stand-Alone Mode, Parameter Settings Saved with Projects, Support for 24-bit Audio Files, and Much More....



Totally indispensable...  
...and at \$299,  
simply irresistible.

U.S. MSRP

P.O. Box 4189  
Santa Barbara, CA 93140-4189

Voice: 805-566-7777

Fax: 805-566-7771

E-mail: info@event1.com

Web: www.event1.com



Download the Virtual Pack demo from [www.event1.com](http://www.event1.com)

The DSP•FX Virtual Pack is designed in the U.S. by DSP/FX, Inc., an Event Strategic Partner  
DSP•FX Virtual Pack is a trademark of DSP/FX, Inc. ©1998 DSP/FX, Inc.

World Radio History  
CIRCLE #119 ON PRODUCT INFO CARD

Ones tours, but Hart wasn't waiting around for things to happen on that front. Topic 1A for Hart these days is *Supralingua*, his extraordinary new CD that once again puts him together with great rhythmists from several different cultures, including Zakir Hussain (India), Giovanni Hidalgo (Puerto Rico), Sikuru Adepoju (Nigeria), Bakithi Kumalo (South Africa), Chalo Eduardo (Brazil), Jorge Bermudez (Nicaragua) and David Garibaldi (U.S.). This is truly "world music" in a way that few ensembles wearing that tag are—all the musicians play many different rhythm instruments, and their influences weave in and out of

each other from track to track. And this time out Hart has added an intriguing vocal element to the rich percussion stew: "Supralingua" means "beyond language," and each of the 12 strikingly different rhythmic landscapes that make up the album also contain vocalizations of various sorts, from the guttural chanting of the Tibetan Gyuto Monks (who have had a long association with Hart), to the sonorous and hypnotic singing of Afro-Cuban music specialist Rebeca Mauleon; from African call-and-response chants to samples of the whimsical giggles of Hart's 5-year-old daughter, Reya. "I'm not using the vocals for the words," Hart

comments. "I'm using them as instruments, as other textures."

*Supralingua* was recorded on and off over a period of several months at Hart's studio, which is located in its own barn-like building a few yards from the Hart family house; both are surrounded by carefully manicured gardens and overlook a small barnyard menagerie and a lovely, sylvan lake. "The studio is ever evolving; we're always building the studio," says engineer Tom Flye, who has worked with Hart for the past 14 years on various recording projects. Flye is a respected veteran whose credits include albums with Don McLean (yes, he recorded "American Pie"), Donny Hathaway, Curtis Mayfield, the New Riders of the Purple Sage, all of Rick James' best records and a couple of albums with Sly & the Family Stone (see this issue's "Classic Track," p. 170). "We customize the studio to whatever project we're working on at the time, and we're still in the process of building the control room."

Studio X, as it has been dubbed, was constructed within a 45x95-foot structure. "It has a cement floor with carpeting that we move around, and then we have various 'clouds' we've made out of old draperies and polyester batting and various things," Flye says. "We also have a portable wall system made out of an old stage—these 4-foot by 8-foot portable wall systems; some have glass in them, some don't—that give us some isolation. There's also a small iso room."

The day I visit, the main studio room looks like a veritable percussion museum, with exotic drums of every size and shape imaginable, a host of beautiful handmade mallet instruments including huge Chinese gongs, African balafons and Indonesian gamelans, shakers, gourds, Indian tablas, and more modern instruments such as roto toms and conventional trap drums. The tie-dye wall panels are the only hint that Hart comes from the Grateful Dead world.

The control room sits at one end of the room, only partially isolated from the tracking space. Flye tells me that he's moved some of the equipment from the control room down to the Grateful Dead's studio in Marin County, where he's helping the Other Ones mix their live record (which he recorded using Le Mobile's 48-track digital). Still, there's plenty of equipment remaining on view: the Neve 8058 console (which originally belonged to Jerry Garcia), the Studer A80 16-track, a Mackie sidecar, and rack after rack of new and vintage processing gear. "Mickey is always real

Full Sail is one of the most extraordinary educational experiences in the world, offering hands-on training in thirty-two cutting-edge studios. Full Sail's powerful list of lab equipment includes the **SSL 9000J**, **Neve Capricorn**, and **Neve VR** super consoles, **Studer 48-Track Digital and Analog Recorders**, **Arri 35mm and 16mm film cameras**, **Quantel and Avid** digital video editing systems, and **Silicon Graphics** and **Intergraph** graphics workstations. The only thing more impressive than our gear is the long list of successes, credits and awards that thousands of Full Sail grads have earned.

*If you're serious about your dreams, we'll take your dreams seriously.™*

# FULL SAIL

## Real World Education®

School of  
**Audio • Film • Video • Digital Media**  
**Game Design • Show Production**

3300 University Boulevard Winter Park, FL 32792  
 Financial aid available to those who qualify. Job placement assistance. Accredited by ACCSCT.

CIRCLE #120 ON PRODUCT INFO CARD



# Pure Power...Pure Sound!



"A best buy"... "The Carvin DCM1500 - with its detailed top end, punchy low end ... sounds great."

© No. 1997 Miller Freeman, Inc. Reprinted by permission from Bass Player magazine

"Carvin gives the end user a roadworthy, high-powered amplifier (DCM2000) at a price that is almost too good to be true. Little wonder, then, that these amps have been showing up in quite a few local bands' rigs."

© Pro Audio Review, March 1998 - Roger Williams III: Systems Engineer

## MATCHED COMPONENTS — SUPERIOR PERFORMANCE

Face it. The two most important things to consider when buying pro-sound gear is how good it sounds and how long it will last. Otherwise, it's just not worth it. At Carvin, we put great sound and bulletproof reliability first.

Carvin power amps offer the finest sound reproduction at high volumes delivering one of the most transparent sounds for superb clarity. Four models ranging from 600 watts to 2000 watts deliver thundering bass and shimmering highs with no audible distortion. Rock-solid construction was demonstrated with our engineers tossing the DCM amps 15 feet onto solid concrete and they still worked perfectly. These nearly indestructible amps are backed by our 3 year warranty.

Our new C2440 four buss mixing consoles will enhance your sound dynamics with ultra low noise, high headroom, audio taper faders, silky smooth controls & active equalizing. The versatile 4 buss (4 out) design also includes a center mono mix for subwoofers.

Carvin Concert Speakers feature studio quality sound at concert levels. Each enclosure is computer tuned and made of light weight 7-ply poplar hardwood. Every system is covered in Curatuff II™ and utilizes steel corners with steel protective grates. Professional twist lock Speakon™ & 1/4" connectors are featured.

Try a custom matched system & find out why Carvin is the value leader for quality & price! Call 800-854-2235 for quotes & a free factory direct catalog.



Carvin engineers tested the DCM amp construction by tossing them onto solid concrete. All amps worked flawlessly after impact! Of course, Carvin doesn't recommend trying this kind of abuse, this test just shows the lengths Carvin goes to test its gear.

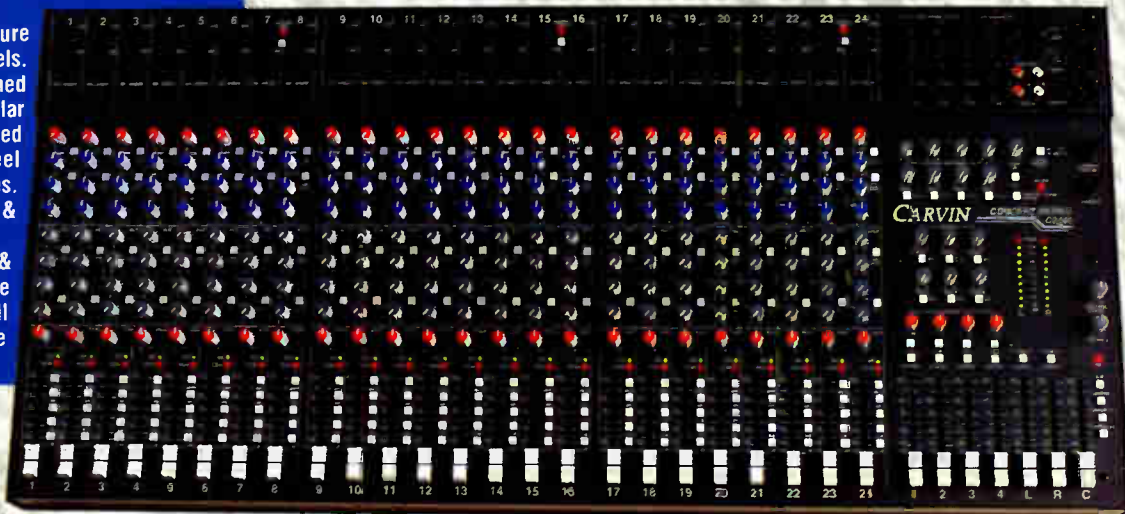

Call 800-854-2235 for immediate delivery from our factory.



**CARVIN**  
The Professional's Choice

[www.carvin.com](http://www.carvin.com)

USA, Alaska, Hawaii, Canada

FREE CATALOG 800-854-2235 M-F 9:30-6, SAT 9-4 PST

CARVIN 12340 World Trade Dr., San Diego, CA 92128

AVAILABLE FACTORY DIRECT or at the following Carvin stores:

- San Diego, CA 619-487-8700
- Hollywood, CA 213-851-4200
- Santa Ana, CA 714-558-0655
- Covina, CA 626-815-8787



CIRCLE #121 ON PRODUCT INFO CARD

# MIX

p r e s e n t s

# Studio Pro99

## Emerging Technologies & The Future of Audio Production

*Monday & Tuesday, June 14-15, 1999  
Universal City Hilton, Los Angeles*

- Two information-packed days of panels and workshops with the leaders and innovators of professional audio, moderated by the editors of *Mix*.

Panel discussions with world-renowned producers, engineers and film sound editors on the technologies and issues that are shaping the industry today. Learn about new audio formats, surround sound mixing, audio production for the Web and much more!

Talk face-to-face with the industry's foremost technologists, equipment manufacturers, studio designers, facility owners and others.

### **DON'T MISS**

**THE INFORMATION EVENT OF THE YEAR FOR  
RECORDING AND SOUND PROFESSIONALS!**

TO RECEIVE ADDITIONAL INFORMATION AND REGISTRATION MATERIALS,  
CALL DANIELA BARONE AT (510) 653-3307 OR FAX (510) 653-5142.

World Radio History



Top: Renowned producers at StudioPro98 (L-R): Ed Cherney, George Massenburg, moderator David Schwartz, Nile Rodgers, Tommy LiPuma, Barry Beckett. Above: Mel Lambert introduces the panel on modular digital multitracks, moderated by *Mix* editor George Petersen.



Looking down into the control room area of Studio X. The main room is in the top of the photo.

interested in processing," Flye says. "He'll take a simple acoustic sound and make it into something much more elaborate. He's done that as long as I've worked with him, and on *Supralingua* there's a lot of really interesting processing going on.

"We still use a lot of the old Quantec, PCM 80, 81, PCM 70, tape delay, TC delays and delayed reverbs. I have my own EMT plate that I've moved there. We've also used outdoor space—he has a big meadow and sometimes we'll pump things out there and mic them." Of his miking technique, Flye says, "Quite often I'll stick to dynamic mics on the percussion—421s, M88s, that kind of thing. But sometimes I'll also put up some condensers a little farther away from the instruments to add some air to it."

"The processing is part of my fun," Hart notes. "It's where I get to experiment, where I get to forage for new sounds and ideas." On the *Supralingua* track called "The Wheel of Time," for example, Hart had Zakir Hussain chant in an other-worldly mock-Arabic—"You're Achmed the camel driver!" Hart says he told Hussain, to get him into character—and then later altered the voice using a host of different devices. "Zakir knew I would do something with it, but he didn't know in advance I'd pitch it like I did," Hart says. "I didn't get into detail with him because there's no need to. And most of the time I don't know exactly what I'll do with something, I'll throw it through the 90, the 80, the Harmonizer, just to see what each does; or I'll do combinations. When you have your own studio it allows you the freedom to experiment day and night if you want. I just come in, put the track up and start throwing shit up on it to see what sticks. That's one way I compose. I'm not composing from my head all the time. And that's a fun way to work, be-

cause some things you're not going to imagine; they have to pop out."

Hart's music has always been a study in contrasts: ancient instruments aided by modern technology. He was a very early proponent of sampling—he sampled all sorts of ethnic instruments that were too delicate to take on the road, then triggered them during Dead shows when the whim arose. These days, he has taken his love of sampling to a level that was

unimaginable even five years ago. Working with the Dead's MIDI/processing wizard Bob Bralove, Hart has poured upwards of a quarter-million dollars into the development of a live performance instrument called RAMU—Random Access Musical Universe. It puts Hart's extensive library of original samples and an impressive rack of outboard gear at his disposal, to be used in multiple combinations in real time (with Bralove's offstage assistance) and in combination with live drums and percussion.

"With the [E-mu] E4 [sampler] the whole landscape has opened up in terms of what you can do," Hart says. "There's no more having to wait three or four minutes between songs, and you're able to access things so much more quickly. The sampling was a long, involved and delicate process, first of finding all the sounds, sampling and then spreading them and making them dynamic and not just on- and off-triggered. Most of the sounds I use are combination sounds. They're not one instrument; they're two, three or four instruments.

"I took all the samples I've collected through the years, put them all in a database and then burned CDs of all them. I have an enormous database of what we call presets, which are the combinations of the sounds, as well as the raw sounds. They have impressionistic names—"Irish Spring," "Speedbag," "Indo Powwow," "Madhouse," "Charles Ives." Then there are the palettes, which are environmental sounds—jungle sounds, forests, the sea, the wind, thunder, rain. I don't get my stuff from CD-ROMs. There are no Yamaha presets here.

"And then there's the processing of it and the automation. It's not just a sampling machine, it's a processing unit as well, a sound droid; a bot. A real percussion-based robot. RAMU contains

The Soundelux  
U-95

is the  
winner of

the 1998  
Las Vegas  
Tube Mic  
Shootout

Sign up now for the 1999  
U.S.A. Tube Mic Shootout.

For FREE CD call  
The Hollywood Edge  
1-800-292-3755  
[www.hollywoodedge.com](http://www.hollywoodedge.com)

You will compare original voice recordings using:  
The Soundelux U-95, Neumann, AKG, 414-TL2,  
CAD VX2, and Rode Classic.

CIRCLE #122 ON PRODUCT INFO CARD

**FUTURE DISC SYSTEMS**

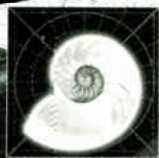

ALANIS MORISSETTE  
 BABYFACE  
 CHRIS ISAAK  
 FLEETWOOD MAC  
 GOD'S PROPERTY  
 GOD GOD DOLLS  
 GREEN DAY  
 KIRK FRANKLIN  
 MADONNA  
 MASTER P  
 RICK BRAUN  
 SNOOP DOGG  
 TAKE 6

**MASTERING STUDIOS**

HOLLYWOOD  
 323/876-8733  
 FAX 323/876-8143

www.futurediscsystems.com



PHOTO: JEFFREY SCHROEDER

**At the 5.1 mixing sessions at Chicago Trax. Back row, L to R: Jim Sammons (Palm Pictures), studio owner Reid Hyams, Mike Egan (Palm Pictures), Mickey Hart, Marvin Gleitcher (Palm Pictures). Front: Assistant/engineer Ester Navarez, chief engineer Chris Steinmetz and Tom Flye.**

90s, 80s, H3000s, Quantecs. Then it has the MIDI and the automated board—the Yamaha 02R—which allows me to scroll and go from one tune to the next and come back with fully automated roads.”

Given his love for sonic experimentation, it’s not surprising to learn that Hart’s newest love is 5.1 surround mixing. This past summer, Hart and Flye flew to Chicago Trax studio to make 5.1 mixes of two songs from *Supralingua*, the techno-rhythmic “Indo Scrub” and the gentle, flowing “Endless River.” Rykodisc made videos to accompany the songs, and they’ve been released in 5.1 as the company’s first DVD “single.”

“Mickey’s always been interested in motion with the sound,” Flye says. “That’s one of the things we’ve done with the processing up until now. But working in 5.1 really gave us a lot more freedom. All of a sudden you have more real estate to work with, and we definitely used all the capabilities of the system—spun things around the room, things like that. It’s everything Quad wanted to be and much more. I did a lot of Quad work when that first came out because all the Record Plant rooms were built for Quad. But unfortunately the systems the industry came up with really hindered the art form. You couldn’t put anything in the center of the room [sonically], you couldn’t put anything in the center of the back: you were limited to a small horseshoe. But with 5.1, it’s a discrete system and it’s really opened up the art form.”

“For me it was like a religious experience!” Hart adds. “There’s nothing that localizes sound better than percussion. Now I have six discrete sound sources; that’s what’s so exciting. You can move leakage. You can get vertical movement.

by starting down at the subs and moving sound up the frequency range. You can take a group of congas and move one around and leave the others stationary. And you move them in rhythm. You’ve got joysticks, you’ve got automated panning. And we were mixing on the [Neve] Capricorn, which is just amazing. It’s like the gods have come down and given us a new instrument.”

Is there a danger in indulging in too many tricks? “Of course! That’s where taste comes in.

You don’t want things moving all the time. But there are so many subtle things you can do. Coming back after that experience to mixing the Other Ones in stereo took some real discipline. The physical real estate of six speakers going down to two was just a drag. It was like coming back to some old lover you didn’t really want to be with.

“But now I’m thinking in 5.1. I’m going to be composing in 5.1. I’m dreaming in 5.1!” Hart laughs at his own enthusiasm. “I think 5.1 was made for me. I’m completely spoiled.” ■

—FROM PAGE 169, TELARC

In 1988, Telarc went to a 20-bit 44.1 PCM system, recording through proprietary 20-bit A/D converters to a Mitsubishi X-86 reel-to-reel deck. Today, most Telarc sessions have two or more recording formats going at once—including the new Sony/Philips Super Audio CD—and the company is known for direct-to-2-track classical and jazz recordings, and 20-bit mastering.

Based in Cleveland, Ohio, Telarc averages about 60 releases a year. “Telarc started as an audiophile label, but we couldn’t stay in that niche and grow, so now we’re A&R-driven but holding onto the audiophile aspect, which puts us in a unique position,” Bishop says. “We’re shifting our emphasis somewhat from classical because that market has weakened; we’re fine-tuning, issuing fewer but more important classical releases.” (The breakdown now is about 50% classical, 30% jazz and 20% blues.)

Toward that end, the company is going for more exclusive recording deals with major jazz artists. “We’re just

about to release our first Al DiMeola recording as part of a three-CD deal," Bishop notes. "Guitarist Jim Hall, who is an exclusive Telarc artist, also recently did a duets record for us with Pat Metheny." One of the jazz world's most important pianists, Oscar Peterson, is also an exclusive Telarc artist. Bishop says that Peterson, an electronics buff, appreciates working with state-of-the-art techniques and equipment. "Jack Renner [Telarc's co-founder and chief recording engineer] and myself did the first 8-channel DSD recording ever done in jazz, with Oscar live in Munich in July," Bishop says. Eight-channel sur-

round? "We recorded eight channels of surround but of course will only release the recording with six. We placed mics so that the extra tracks of surround recorded height information from the soundstage. There is no format to release this; it is purely experimental."

Clearly, Telarc has no fear when it comes to new formats. And, in its cutting-edge tradition, the label also became one of the first to adopt the new Sony/Philips Super Audio CD (SACD) high-density format. The fully backward-compatible Super Audio CD is "a two-layer disc that, unlike the DVD, is not locked to any video standard," Bish-

op explains. "It looks just like a regular CD, and it can be played on any ordinary CD player because one layer is a Red Book standard 16-bit CD layer; another layer contains a 2-channel and a 6-channel discrete surround high-density Direct Stream Digital layer."

All Telarc recordings are now being recorded in one high-density format or another so they can be released on Super Audio CDs when the technology is ready for the marketplace. The typical Telarc session these days is also cut direct to 2-track and direct to 5.1 for surround sound. It makes for a busy control room.

## RECORDING RAY BROWN AND GUESTS

Telarc's search for new, more transparent technologies doesn't stop with recording media. During sessions for a new CD by famed bassist Ray Brown and some of his favorite singers (produced by Brown and Elaine Martone, Telarc's vice-president in charge of production and A&R), Telarc engineers used what Bishop terms a "very special pair" of custom-modified prototype mics to capture the singers. "David Smith, Sony Music Studios' director of engineering, and Steve Lee at Canorus modified a pair of AKG C-12VRs to the point where there was really nothing left of the original mics except the capsule. Everything else had been changed, from an internal pre-amp to a highly esoteric vacuum tube circuit and a custom power supply. They are the most phenomenal mics I've ever heard for vocals," Bishop says.

The Ray Brown sessions consisted of a classic acoustic jazz trio plus singers, so the music was allowed essentially to mix itself. This approach enabled Bishop to use the Neumann KU-100 dummy head microphone as the main stereo pickup. "The dummy

—CONTINUED ON PAGE 182

# M-1

## MICROPHONE PREAMPLIFIER

(ACTUAL SIZE)

Gloria Estefan, Dolly Parton, Neil Young, Lou Reed, Laurie Anderson, Bob Dylan, Madonna, Eric Clapton, George Harrison, Paul McCartney, Paul Simon, Joe Henderson, James Carter, Ernie Watts, Bill Hollman, Saturday Night Live, The Muppets and many others have done great work with the M-1. The M-1 is clearly superior, *satisfaction guaranteed*. Here's why:

**The Jensen JT-16-B Input Transformer.** The world's best mic-input transformer. If you thought transformers were a compromise, you haven't heard the JT-16-B!

**The 990 Discrete Op-Amp.** The 990 discrete op-amp is superior to the monolithic op-amps found in other equipment.

**No Coupling Capacitors in the Signal Path.** DC servo circuitry and input bias current compensation circuitry eliminate all coupling capacitors and the degradation they cause.

**Standard features:** LED-illuminated push-buttons; phantom power switch; polarity reverse switch; conductive plastic gain pot and high-gain switch; shielded toroidal power transformer with 6-position voltage selector switch; gold plated XLRs; ground-lift switches.

**Options:** VU-1 meter (shown); PK-1 meter; Jensen JT-11-BM output transformer;

### THE JOHN HARDY COMPANY

P.O. Box AA631  
Evanston, IL 60204

Phone: 847-864-8060
Fax: 847-864-8076

CIRCLE #123 ON PRODUCT INFO CARD

# WSDG

WALTERS-STORYK  
DESIGN GROUP

BETH WALTERS  
JOHN STORYK  
SAM BERKOW

- Audio Recording
- BROADCAST
- Video Production
- DISTANCE LEARNING
- Multi Media Conferencing
- AV SYSTEMS DESIGN,  
INTEGRATION AND INSTALLATION



SUPERDUPE RECORDING, NYC

[www.wsdg.com](http://www.wsdg.com) 262 Martin Avenue, Highland, NY 12528  
914-691-9300 fax 914-691-9361 e-mail [info@wsdg.com](mailto:info@wsdg.com)

CIRCLE #124 ON PRODUCT INFO CARD

## Listen to Our Mix

studio  
consultants,  
inc.

321 West 44th Street  
New York, NY 10036  
(212) 586-7376

**BRYSTON**



api

Westlake  
Audio



ZSYS.

GENELEC



PMC



Aardvark, API, Apogee Electronics, Audix, B&B Systems, Brauner, Bryston, Calrec, Drawmer, Gefen Systems, Genelec, Lexicon, MediaFORM, Middle Atlantic, Mytek, PrismSound, PMC, Rorke Data, Sonic Science, Sonic Solutions, SoundField, Sound Ideas, Star Case, Westlake, White Instruments, Z-Systems and other exceptional audio products.

Equipment, support, and design services for professional audio facilities and broadcasters in the New York area—since 1971.

CIRCLE #125 ON PRODUCT INFO CARD

The direct-to-2-track and the direct-to-5.1 versions are usually recorded with a bank of Tascam DA-88s, configured as 20-bit recorders via the Prism MR-2024T interface. "The Prism MR 2024 adapter interface for the DA-88 makes that machine into a 20-bit, 6-track recorder, splitting the extra data onto tracks seven and eight," Bishop says. "With the Prism, the DA-88 can also be used as a 4-track 24-bit recorder, depending on the configuration." Apogee AD-8000 A/D converters are normally used for the 5.1 ADC/DAC. When available, a Genex GX8000 Magneto Optical recorder is used in place of the Tascam/Prism combinations. Most recently, Telarc began recording much of its high-density and surround versions using a prototype Sony/Phillips Direct Stream Digital hard disk recorder.

"It's exciting; there is always something new," Bishop says. "We have a lot of our own high-end gear, and manufacturers lend us bleeding-edge equipment for recording and post-production. This can make life a little difficult because we are often working with things that have only barely made it out of the alpha stage."

—FROM PAGE 181, RAY BROWN

head is a binaural unit that has recently been made more loudspeaker-friendly, so I was using it as the main stereo mic for an overall acoustic pickup," Bishop says. "Spot miking was done where needed to get a little bit of a closer sound, using the various Neumann mics and Sennheiser MKH series condensers."

The truly complicated part of a Telarc session ends with production. "Essentially there is no post-production, just edits on Telarc's Sonic Solutions or SADiE editors," Bishop says. "It's straightforward—we don't do compression or EQ; we do that at the session." However, using the prototype DSD hard disk recorder presented the problem of "getting the material to a form we could edit," Bishop notes, "as there is presently no editor made for that system; we're waiting for a Sonic Solutions prototype." The DSD source had to be transferred in Tokyo by Sony down to 16-bit PCM, using the Sony Direct Super Bit Mapping (SBM) process. ■

# ASK HHB ABOUT DIGITAL RECORDING MEDIA AND WE'LL THROW THE BOOK AT YOU.

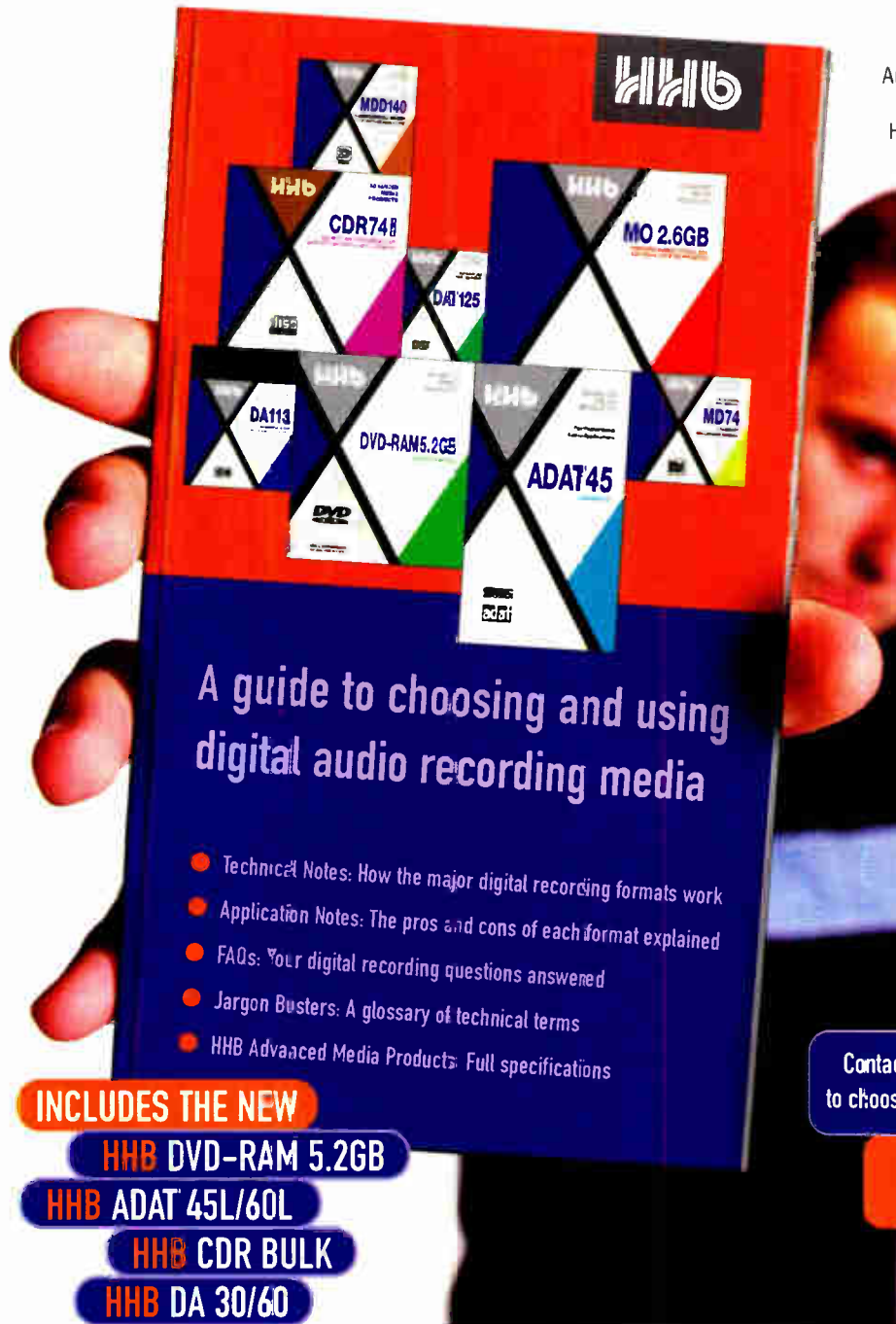

Audio professionals the world over rely daily on HHB Advanced Media Products. In every major format, HHB digital recording media sets the standards for performance, compatibility and long term archival security.

Now, to help you get even more from your digital recordings, the latest HHB Advanced Media Product is a book – **A guide to choosing and using digital audio recording media.** It's essential reading for all audio professionals. Contact HHB today for your free\* copy.

\* While stocks last

Contact HHB today for your free copy of 'A guide to choosing and using digital audio recording media'

Phone: 310 319 1111

(In Canada: 416 867 9000)

E-mail: [sales@hhbusa.com](mailto:sales@hhbusa.com)

(In Canada: [sales@hhbcanada.com](mailto:sales@hhbcanada.com))

INCLUDES THE NEW

HHB DVD-RAM 5.2GB

HHB ADAT 45L/60L

HHB CDR BULK

HHB DA 30/60

## A guide to choosing and using digital audio recording media

- Technical Notes: How the major digital recording formats work
- Application Notes: The pros and cons of each format explained
- FAQs: Your digital recording questions answered
- Jargon Busters: A glossary of technical terms
- HHB Advanced Media Products: Full specifications

HHB Communications USA - 626 Santa Monica Boulevard, Suite 110, Santa Monica, CA 90401, USA - Tel: 310 319 1111 - Fax: 310 319 1311 - E-Mail: [sales@hhbusa.com](mailto:sales@hhbusa.com)  
HHB Communications Canada Ltd - 260 King Street East, Toronto, Ontario M5A 4L5, Canada - Tel: 416 867 9000 - Fax: 416 867 1080 - E-Mail: [sales@hhbcanada.com](mailto:sales@hhbcanada.com)  
HHB Communications Ltd - 73-75 Scrubs Lane, London NW10 6QU, UK - Tel: 0181 962 5000 - Fax: 0181 462 5050 - E-Mail: [sales@hhb.co.uk](mailto:sales@hhb.co.uk)

Visit HHB on line at: <http://www.hhb.co.uk>



# NO MAIL ORDER RETAILER CAN OFFER THE SAME VALUE & SELECTION!

- RECORDING • PRO AUDIO • KEYBOARDS
- ACOUSTIC & DIGITAL PIANOS • BAND INSTRUMENTS • GUITARS • AMPS • BASSES
- DRUMS • PERCUSSION • & MUCH MORE!

**OUR EXPERT SALES STAFF & ACCLAIMED SERVICE TEAM WILL ASSIST YOU IN YOUR SELECTION FROM OUR MULTI-MILLION DOLLAR INVENTORY**



**1-800-800-4654**

**THOROUGHbred**  
MUSIC

**THOROUGHbred** RETURN FOR FREE 1 YEAR SUBSCRIPTION  
Please send all correspondence to 7726 Cheri Ct., Tampa, FL 33634

NAME \_\_\_\_\_  
ADDRESS \_\_\_\_\_ ST \_\_\_\_\_  
CITY \_\_\_\_\_ PHONE \_\_\_\_\_  
ZIP \_\_\_\_\_ SOURCE CODE: TMIX1196

MAIL ALL CORRESPONDENCE TO:  
**7726 Cheri Court, Tampa, FL 33634**

VISIT ONE OF OUR STORES IN  
TAMPA, FL, CLEARWATER, FL, ORLANDO, FL, SARASOTA, FL

**NOW OPEN IN NASHVILLE, TENNESSEE!**

visit our website at <http://www.thoroughbredmusic.com>

CIRCLE #127 ON PRODUCT INFO CARD

## Must everything beautiful be fast?

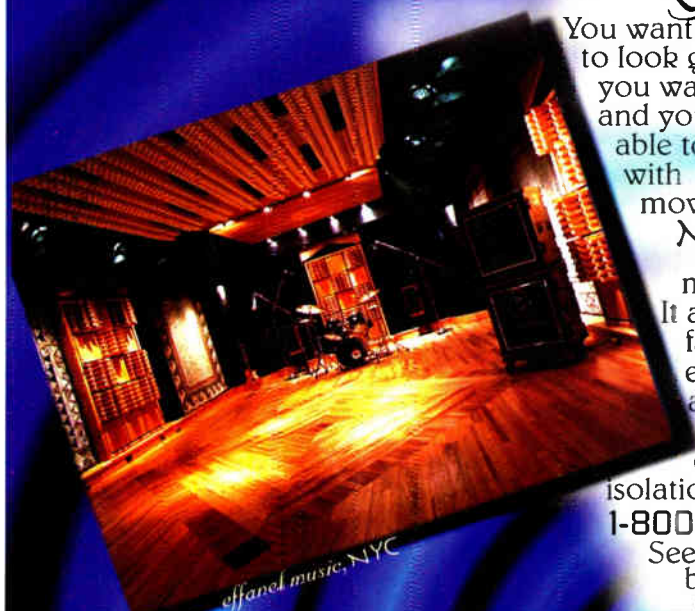

Yes.

You want your studio to look great, but you want it quickly and you want to be able to take it with you if you move.

Modular means movable.

It also means faster and easier installs and a higher degree of sound isolation. Call us:

**1-800-749-1460**

See how fast beautiful can be.

**ACOUSTIC SYSTEMS**

modular sound isolation  
[www.acousticsystems.com](http://www.acousticsystems.com)

the science of silence

CIRCLE #128 ON PRODUCT INFO CARD

One high-definition process that Telarc experimented with briefly was 24-bit 96k PCM recording, for possible DVD-Audio release. "We dabbled in it and decided not to pause there for very long once we started with DSD, which we found much superior. DVD, being locked into a video standard, is not seen by us as a viable music medium," explains Bishop. (Although some dates were recorded in 24-bit 96k PCM, no such releases are planned.)

Bishop elaborates on the new DSD format's qualities: "DSD has fine detail and tremendous smoothness of sound; it is like the best of analog but without analog's shortcomings. And the quality trickles down to today's CD format. When we make a standard Direct Super Bit-Mapped 16-bit CD from the DSD master recording, it sounds much better than present-day CDs."

Bishop says the SACD format—which can hold text, graphics and video as well as a high-definition, lossless-compacted 6-channel surround mix and a 2-channel mix—also has a tremendous market advantage over 96k 24-bit. "Retailers don't have to have a double inventory. It is hard enough to just get ordinary CD product in the stores, and retailers are adamant that they don't want another format," he notes, adding that the lossless-compacting aspect of the surround channels is important. "With the Dolby Digital surround system and their compression schemes, much of the information doesn't make it to the listener. DTS encoding is much better with its 3:1 compression, but it is still somewhat lossy. In SACD, the surround information is compacted without compression, and all the sound comes out intact in playback."

While consumers wait for the new SACD format to become a reality, they'll have to settle for the trickle-down effect, which Bishop says is significant. "The Sony Direct SBM process retains a great deal of the resolution of the source DSD master, even on the 16-bit PCM copy. The process is giving us 16-bit CD masters that have better definition and better sound than what we could achieve with 20-bit PCM. The end result is that with SACD we can release an exciting new audiophile-quality product *and* still have a clear-cut win-win situation in the marketplace. The consumer gets high-definition stereo and 5.1 plus a better-sounding regular CD layer all on one disc. And the retailers get a music format that can be sold and played anywhere without getting involved with the dreaded double-inventory." ■



—FROM PAGE 169, BLUE MAN GROUP

something that worked for television, not the stage."

Similarly, they also learned that they had to reformulate the message to fit the medium when it came to recording the show. For the past five years, Blue Man had been through several studios trying unsuccessfully to capture the show's essence on tape for a commercial recording. "This doesn't work as a cast album," Wink says. Rather, they found that a live recording would have to have Blue Man values applied to new music that didn't rely on visuals. So, in the same manner in which they have adapted society's raw materials into found instruments, this past fall they began converting the bare-walled space of their personal theater on East 3rd Street into a recording studio, one that will be as mutable as the show itself.

"The thing about doing this in a regular recording studio is that we couldn't find one that would also let us set up a machine shop in it," jokes Wink. Indeed,

their performance-rehearsal space is littered with their musical instrument experiments. For instance, the Tubulum is a more complex version of the PVC musical instrument used in the show at the

just four mics, the Tubulum is more like a calliope, requiring a Shure SM98 lavalier microphone to be lowered down each of its dozen or so pipes. Then there's the DrumBone, which has sliding components that produce thunderous, funny glissandi. The Star Spangled Rocket Backpack is part musical instrument, part urban assault vehicle, with PVC tubes arching over the wearer-player's head and fireworks loaded into the non-music tubes like bazookas. Not everything is centered around low- and mid-frequency blasters. There is the Shaker Gong—an aluminum plate suspended by rubber bungees in a frame—whose sharp racket is attended by coiled aluminum strips that, when released, make a fast, crisp attack sound. Less original but equally exotic instruments like a Hungarian

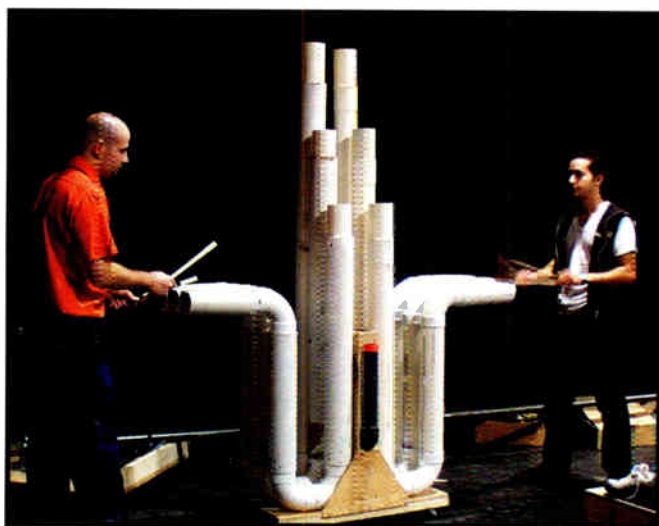

PHOTOS: RANDALL WANKER

Randall Makiej (L) and Aron Sanchez playing the Snake Tubulum

Astor Place Theater. Where the latter's multiple tubes (one for each note, hit with a flat-sided mallet on one end to produce sound) converge in front, allowing it to be miked sufficiently with

cymbalum (a sort of zither) are also part of the arsenal.

All this and more (plus a three-piece band that plays along during the show) will play for the recording, once an iso-

# Listen.

\$595  
Shipping Jan 1999

**Listen** to what happens when Digital Audio Labs' engineering experience and discipline is applied to the latest 24 bit, 96 kHz technology.

**Listen** to the striking difference in clarity and imaging between a computer "sound card" and a truly professional, ultra precise audic instrument.

**Listen** to the next generation, all new standard for audio fidelity on the PC.\*

**Listen** to CardDeluxe,  
from Digital Audio Labs.



Digital AUDIO LABS

www.digitalaudio.com 612-559-9098

## CardDeluxe™

### Features include:

- Analog two channel in/out via 1/4" TRS connectors
- S/PDIF digital in/out via RCA connectors
- 22 to 96 kHz sampling rate
- +/-10 balanced/unbalanced operation
- PCI Interface
- 8 to 24 bit resolution
- 4 channel operation using both analog and digital
- Slaving of multiple CardDeluxes to single sample clock
- Windows 95, 98, and NT drivers\*

\*Macintosh compatibility - Q2 '99

CIRCLE #129 ON PRODUCT INFO CARD

# See Our FREE Fall Catalog and be sure to drop by our web site

WE BRING THE STORE TO YOUR DOOR



**FULL COMPASS**

AUDIO, VIDEO, A/V, LIGHTS  
**800-356-5844**  
[www.fullcompass.com](http://www.fullcompass.com)

CIRCLE #130 ON PRODUCT INFO CARD  
World Radio History

lated control room area is built at one end of the 110x40-foot space. Pro Audio Design in Boston is designing the room-within-a-room. Blue Man co-producer Todd Perlmutter (a musician who has played in various incarnations of the show as a drummer) originally considered renting a console and other pieces of equipment, but then suggested purchasing a 56-input Neotek Elite console with DiskMix automation and Otari MTR-90 MkIII 24-track deck, with the intention of reselling them after this initial project is complete.

"The console will give them the large number of inputs they need at a cost-effective price," says Dave Malekpour, vice president of Pro Audio Design. "The control room is going to be 18x24 with a typical LEDE design approach oriented for rear diffusion and designed with good sight lines. And all the acoustical treatment is modular, so they can take it down and put it back up somewhere else if they want to."

"We don't want to own a recording studio," says Wink. "Our initial attempts to record ourselves in other studios somehow diminished what we were trying to accomplish—partially, I guess, because we couldn't fit half this stuff through the door! I think the kind of freedom that recording it here will give us is what we really need. It doesn't have to look nice; in fact, it's good that it still looks a little rough. It's more what we're used to."

The Blue Men all agreed to record using analog tape. Perlmutter says they had tried using Tascam DA-88s, but "[digital] wasn't really a good match for how much percussion there is. We really want to play the tape like a musical instrument on this project." The Blue Man group and Perlmutter will bring in Boston recording engineers Carl Plaster and Andrew Schneider, as well as live sound engineer Ross Humphrey, who will mix some of the sound through a P.A. system with EAW speaker components, which in turn will be miked and recorded. "That's being done to give the recording a sense of being a live performance," says Perlmutter. Humphrey engineered a recent live Blue Man performance in New York, supervising 130 inputs, mostly of percussion instruments. "That was like a dress rehearsal for this," says Perlmutter, who adds that the MTR-90 MkIII version was specified because he expects to do some backward recording.

Regardless of how much of the studio remains after the project is completed, this has been a learning process for

Blue Man. Perlmutter says that they are experimenting more with microphones and mic placement. "We've been trying these Shure 98s on the PVC musical instrument," he says. "The thing we're trying to get is as much gain-before-feedback as possible. When they perform, they're right at the edge of the stage and right in front of the monitors."

Blue Man's approach also illustrates the business side of this proposition. There is no record company involved in this project, just Blue Man's own production company. But the economics are compelling: Three theaters in three cities seat 600 people for about ten performances per week. If even one tenth of them buy the finished CD, Blue Man will be selling in excess of 30,000 units annually. And that's for only three markets; they also plan to sell the CD via other conduits, such as the Internet and Tower Records. One-off events such as film and television synch licenses sweeten the deal even further. Wink and Goldman are quite aware that any of the major record labels might gladly give them substantial sums to get in on the ground floor of this deal. But in the years they have been doing this, they have learned that what you give up in return for celebrity and money is artistic control, and they're not at all ready to do that. "We really just don't need the money," Goldman says, "not in a way that would cause us to lose control over what we've put together here." ■

—FROM PAGE 170, COOL SPINS

Producers: Duncan Sheik, Rupert Hine. Engineer: Ruadhri Cushman. Additional engineering: David Boucher, Gerry Leonard, Mark Plati, Gary Thomas, John Gallen. Mixer: Bob Clearmountain. Studios: El Cortijo (Andalucia, Spain), Warm Pod (NYC), Mix This! (Pacific Palisades, CA), Looking Glass (NYC), Angel Studios (London), Abbey Road (London), Adyel Studios (Casablanca, Morocco). Mastering: Greg Calbi, Masterdisk (NYC).

—Blair Jackson

**James Brown: *Say It Live and Loud, Live in Dallas 8/26/68* (Chronicles/Polydor)**

James Brown's early '60s *Live at the Apollo* discs set an almost impossible standard of excitement for the soul great to live up to subsequently, but this wondrous 24-song live set from 1968 shows Mr. Please Please Please in absolute top form, as he leads a big, super-dynamic band (which includes Pee Wee Ellis and Maceo Parker on reeds and the fine Jimmy Nolen on guitar) and a small string section through a selection of uptempo R&B,

**sometimes only  
the best will do**

When CMS  
went looking  
for a Mastering  
Engineer, it  
was not a  
hard choice  
to make.

NO DOUBT  
BLACK SABBATH  
BUSH  
PHUNK JUNKEEZ  
HUFFAMOOSE  
OUTCRY  
JOHN HIATT  
JOHNNY WINTER  
COREY STEVENS  
RICHARD ELLIOT  
SHAQ  
CHARLIE  
MUSSELL WHITE

Welcome RON BOUSTEAD



**cms mastering**  
Old Town Pasadena 626.405.8002

CIRCLE #131 ON PRODUCT INFO CARD

**PRO  
TOOLS**

Avid Authorized Education Center

## TRAINING

### Future Media Concepts

- Certified Instructors and curriculum
- Digidesign Certificate of Merit
- Beginner and advanced level courses
- Financing available
- Small class size

**Satisfaction Guaranteed**

Future Media Concepts • 305 East 47th Street  
New York, NY 10017  
212.888.6314 • www.fmctraining.com

CIRCLE #132 ON PRODUCT INFO CARD

# Elite II Console With Audiomate 32 Channel Desk - 64 Moving Faders

## Motorize Both Paths

The Elite II from Neotek offers exciting new features. Imagine a 32 channel console that gives you 64 moving faders in mixdown. The Elite can now have both the channel and monitor paths automated.

Neotek has been a standard in recording for 25 years. It's wide bandwidth and brilliant transparency give you absolute confidence that product from your room will be outstanding. Audiomate has all of the

bells and whistles; dead-on accuracy and an easy, intuitive, Macintosh interface. Add the Neotek MultiMAX multi-channel monitor controller and you're ready for DVD, post and other applications that demand LCRS, 5.1 or 7.1 mixing.

## Buy Factory Direct

You can now purchase a made-to-order console, built to your specifications, direct from Neotek, a Martinsound company. No middleman means direct communication, less confusion, and lower cost.

From a company used to supplying the most demanding clients in the business. 20th Century-Fox, the Tonight Show, Signet Soundelux, Beachwood in Nashville and Synchronized Sound in Atlanta are recent customers.

Are you ready to join the Elite ranks?



1151 W Valley Blvd, Alhambra CA 91803  
Phone (800) 582-3555 or +1 (626) 281-3555  
Fax +1 (626) 284-3092 [www.martinsound.com](http://www.martinsound.com)



CIRCLE #133 ON PRODUCT INFO CARD

weepy ballads and protofunk gems. This is a time when "Say It Loud—I'm Black and I'm Proud" was brand-new, and tunes such as "Papa's Got a Brand New Bag" and "Cold Sweat" still sounded fresh and vital. A great performance by a band at its peak and a singer still discovering new ways to connect with his audiences. The only thing missing is the dance steps. A great find.

Producers: Harry Weinger and Alan Leeds. Original 4-track engineer: Ron Lenhoff. Remix engineer: Suha Gur. Mastering: Kevin Reeves, PolyGram Studios (NYC).

—Blair Jackson

## Hole: *Celebrity Skin* (Geffen)

Courtney Love can't win. This late summer release was decried as a sell-out by some of the band's staunch fans because unlike its punkier predecessors, *Celebrity Skin* features a heaping helping of genuinely pretty melodies, strong hooks and occasional acoustic guitar textures that would be right at home on a Fleetwood Mac album. As usual, the songs sound like a journey through Love's troubled psyche, but at least it's an interesting psyche, and Love deserves credit for trying to grow as a writer and singer. Smashing Pumpkins leader Billy Corgan helped write several songs, as did other members of Hole. A top-

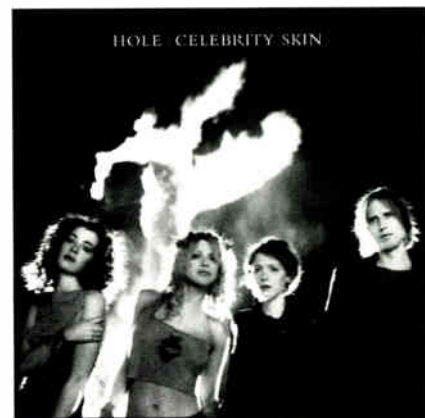

flight team of mixers help give the record tremendous depth and punch. And lush vocal and instrumental textures aside, it still rocks hard.

Producer: Michael Beinhorn. Additional production: Eric Erlandson. Engineer: Paul Northfield. Additional engineering: Rob Eaton, Frank Filipetti, Joe Barresi. Mixers: Tom Lord-Alge, Chris Lord-Alge (four songs), Jack Joseph Puig (one song). Studios: Conway (L.A.), Quad (NYC), Olympic (London), Record Plant (NYC), South Beach (Miami, mixing), Image (L.A., mixing), Ocean Way (Hollywood, mixing). Mastering: Ted Jensen, Sterling Sound (NYC).

—Blair Jackson

## Rare On Air, Volume Four (Mammoth)

From the basement studio at Los Angeles public radio station KCRW comes the fourth

# GRACE

d e s i g n

boulder, colorado • usa  
303.443.7454 fax 303.444.4634  
<http://www.gracedesign.com>

model 201 two channel

## high fidelity

Grace Design  
microphone  
preamplifiers  
reveal all the subtlety  
and detail found in *music*.

model 801 eight channel

CIRCLE #134 ON PRODUCT INFO CARD

in a series of CDs culling live performances recorded during the station's "Morning Becomes Eclectic" show. Volume Four includes live-to-2 track DAT gems from Ani DiFranco, Jeff Buckley, Sarah MacLachlan, Tom Waits and Café Tacuba, among others. Instrumentation ranges from just piano (Randy Newman) to band with five-piece horn section (Ozomatli), with a couple of synthetic-based numbers (Gus Gus) thrown in as well.



Stray noises and the occasional missed note only add to the feeling of unvarnished spontaneity that characterizes this latest installment (and the whole series). Introducing "Subterranean Homesick Alien," Radiohead's stirring, all-acoustic contribution to Volume Four, singer Thom Yorke says, "Should we do the new one first? It's never been played before..." It's that fresh.

Producers: Chris Douridas and Bob Carlson. Engineers: Bob Carlson, Scott Fritz. Mastering: Stephen Marcussen, Precision Mastering (L.A.).  
—Adam Beyda

**Triakel: Triakel (NorthSide)**

I'm not just trying to be interesting when I say I love Swedish folk music. NorthSide, a Minneapolis-based label dedicated to Eastern European sounds has revealed some astonishingly moving groups to American listeners in the past couple of years, and Triakel is one of the stand-outs. Three musicians—Kjell-Erik Eriksson, Janne Strömstedt and Emma Hardelin—perform on fiddle, harmonium and voice, respectively. The combination of the solemn harmonium and Hardelin's angelic and intimate voice, as they follow traditional folk melodies together, is so dark and sweet, and Eriksson's harmonious violin playing provides strength and air that lift and move the arrangements. The liner notes include English translations of the lyrics, many of which are too sad for the faint of heart. Such beautiful sounds and songs from the land of dark days.

Produced and arranged by Triakel. Recorded and mixed in the band's home studio, Revund, Sweden. Engineer: Gustav Hylen. Mastering: Bernard Lohr.

—Barbara Schultz

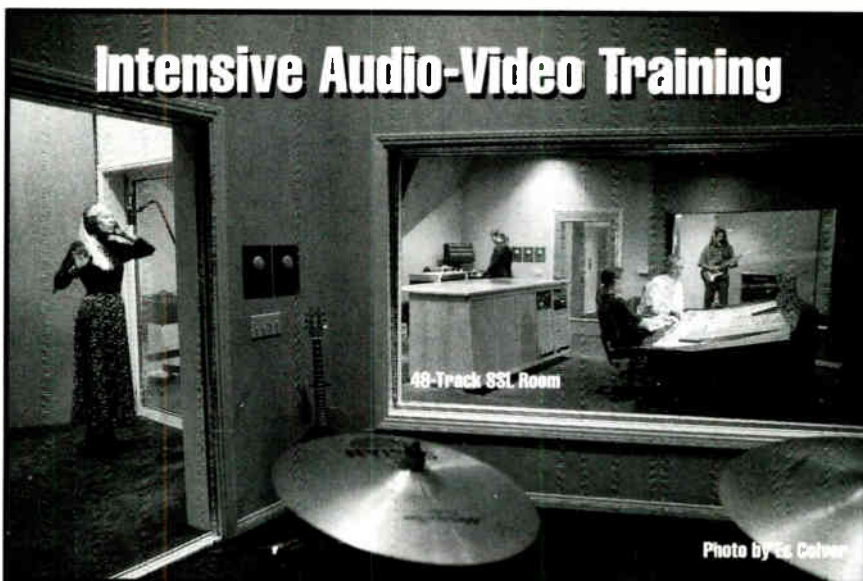

**Hands-On Training • Financial Aid Available • Dorm Housing**  
**20 Week Recording Engineer Program • 10 Week Video Editor Program**  
**11 Studios in 12,000 sq. ft. training facility filled with the latest equipment**  
**Outstanding Job Placement Assistance**

Call for Brochure

**818-763-7400**

Internet: <http://village.ios.com/~larw>

5278 Lankershim Blvd. • N. Hollywood, CA 91601



America's Largest Volume Dealer is Now a Part of  
**America's Largest Musical Instrument Chain**

Guitar Center's **RHYTHM CITY**

- **MORE BUYING POWER!**
- **MORE GEAR!**
- **MORE SAVINGS!**

- All Major Brands • New and Used
- All Major Credit Cards Accepted
- Easy Terms - Financing Available
- Professional Sales Staff • Speedy Shipping



**NOBODY BEATS OUR PRICES!**

**(404) 320-SALE**  
 1485 Northeast Expressway  
 Atlanta, GA 30329  
[www.musician.com](http://www.musician.com)

CIRCLE #135 ON PRODUCT INFO CARD

# Introducing Shure's NEW STUDIO KSM-32

Our Limited Intro Price **\$549.**



**AVAILABLE NOW!**  
at **NATIONAL SOUND & VIDEO**

6500 McDonough Drive • Norcross, GA

**(800) 541-9140**

Call for  
friendly  
service!

CIRCLE #136 ON PRODUCT INFO CARD



**Bernie  
Grundman  
MASTERING**

1640 N. Gower St.,  
Hollywood, CA 90028  
Tel: (323) 465-6264  
Fax: (323) 465-8367

HOLLYWOOD • TOKYO

CIRCLE #137 ON PRODUCT INFO CARD

—FROM PAGE 156. THE FAMILY VALUES TOUR worked closely with Sheppell to design the optimal FOH and monitoring setup. Rather than an A/B system configuration, there's one monster console left of the stage, made up of two Harrison SM5s and a Harrison extender. "There are 128 inputs," Tatter says, "one center system with all the matrixing and mastering, and the rest is just channels. Once we're patched, we're ready."

"It's got huge output compared to anything new or old that I know of," adds Tatter, who worked with Korn on Ozzy's '96 "Ozmosis" tour. "You can blow the cones out of any monitor before you'll crap that board out. It's a little temperamental at times, but if you've got a box full of chips, you can keep it rollin'."

There are eight SRM wedges and 12 BRM600's onstage, with two Prism Full Range and two Prism subs on the sides. "David, Korn's drummer, is in-ears, with Shure PSMs. He has six Showco B/I 18s under and around his riser. That's about 10,200 watts of sub-bass just for him. He's got thumpers in his seat, too. John has some [in-ear monitors] ready to go on nights where he doesn't feel comfortable with the way the room sounds, or he's having trouble hearing a little bit. He doesn't like the hardware, though. He doesn't like the pack, because he dances around, jumps around, pours water on his head."

Despite the hectic schedule and nonstop action of each night's show, the entire operation has a well-oiled feel about it, and the crew seemed to feed off the energy of the bands and the crowds. It seemed to help that they were all fans of the music.

"Every day is a different game," says production assistant/Cube mixer Sorlie. "Same ending, hopefully, the perfect rock show, but it's just getting there that is so insane. It's so intense, but it just flows. The carpenters have one of the roughest gigs out here. A logistical nightmare. Tons of lights, tons of set, huge P.A. People out here make it look easy. I think this is one of the most intense indoor festivals that's come around in a long time. It just doesn't stop. I would have been here at this show ten years ago, and I would've had a great time." ■

*Anne Eickelberg, Mix's editorial assistant, thinks that people who don't like Korn's song "All in the Family" have no sense of humor.*

# Serious About Your Music?

Get serious information from these new books.

The latest releases from the leader in pro-audio publishing!

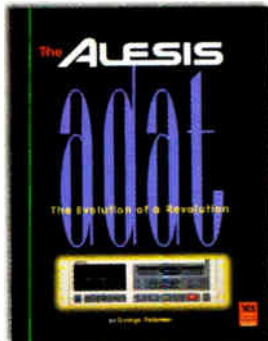

**THE ALESIS ADAT**  
"The Evolution of a Revolution"  
George Petersen

Discover the rich history of the development of the Alesis ADAT, complete with interviews with the originators of the recording machine format that rocked an industry. This easy to understand "power user's guide" shows how to get the most from your talent and time working with the "MDM" recorder that caused the biggest boom in personal recording since the invention of multitrack recording technology!

ISBN#0-87288-6867 \$29.95 list price HL#00330425

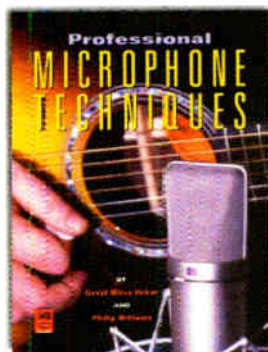

**PROFESSIONAL MICROPHONE TECHNIQUES**

David Miles Huber and Philip Williams

By the author of industry bestseller "Modern Recording Techniques." Intensely focuses on microphone usage for dozens of different instruments as well as vocals, amplifiers, Leslie cabinets and much more! Accompanied by an audio CD that allows you to hear the different effects of microphone placement techniques in real time for a full understanding of how to get the best recordings from any type of microphone!

ISBN#0-87288-6859 \$39.95 list price HL#00330424

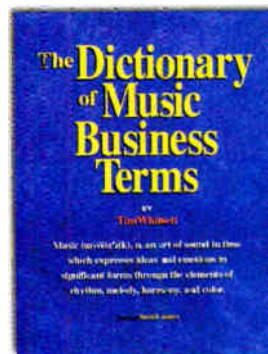

**THE DICTIONARY OF MUSIC BUSINESS TERMS**

Tim Whitsett

Finally, a book that will completely demystify the often confusing terminology of today's music business! This exhaustive compendium of over 3000 music business words, phrases and terms used every day in every aspect of this industry explains in plain English definitions to help you better understand the language of the music industry.

ISBN#0-87288-6840 \$23.95 list price HL#00330423

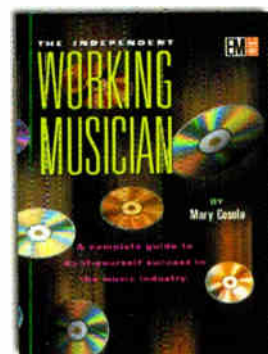

**THE INDEPENDENT WORKING MUSICIAN**

Mary Cosola

The Independent Working Musician gives you all of the information you'll need to forge your own success path in the music industry. From publishing to copyright law to financing your band to harmonious collaboration, this book shows you how to tackle the business side of your music on your own terms.

ISBN#0-87288-6875 \$24.95 list price HL#00330426

Available From These Fine Retailers

State	Dealer	Location
California	McCabes Guitar Shop	Santa Monica
	Sam Ash Music	Westminster
	Sam Ash Music	Cerritos
	Sam Ash Music	Canoga Park
	Sam Ash Music	Los Angeles
Connecticut	Sam Ash Music	New Haven
Florida	MARS	Ft. Lauderdale
	MARS	Orlando
	MARS	Tampa
	Sam Ash Music	Margate
	Sam Ash Music	Miami Lakes
Georgia	MARS	Atlanta
	MARS	Marietta
	MARS	Lawrenceville
Indiana	MARS	Indianapolis
New Jersey	Sam Ash Music	Cherry Hill
	Sam Ash Music	Edison
	Sam Ash Music	Paramus
New York	Sam Ash Music	Brooklyn
	Sam Ash Music	Carle Place
	Sam Ash Music	Forest Hills
	Sam Ash Music	Huntington Station
	Sam Ash Music	Manhattan
	Sam Ash Music	White Plains
North Carolina	MARS	Charlotte
	MARS	Raleigh
Ohio	Lentine Music	Akron
	MARS	Cincinnati
	Sam Ash Music	Columbus
	Sam Ash Music	Lyndhurst
Maryland	MARS	Baltimore
Pennsylvania	Sam Ash Music	King of Prussia
Tennessee	MARS	Nashville
Texas	MARS	Dallas
	MARS	Houston
Virginia	MARS	Virginia Beach
Wisconsin	Cascio/Dynamic Music	New Berlin
Canada	Steve's Music	Ottawa, Ontario
	Steve's Music	Toronto, Ontario
	Steve's Music	Montreal, Quebec



exclusively distributed by



# COAST TO



John Musgrave

PHOTO: MAUREEN DRONEY

## NY METRO REPORT

by Gary Eskow

All New York mastering houses have some critical decisions to make with respect to DVD. Rooms built to mix stereo can be set up to accommodate 5.1 work, but everyone agrees it's not an ideal scenario. Building new space is an investment anywhere, but the New York rental market is sky high, and that puts added pressure on mastering facilities based in the city. We checked in with a number of these houses and found most owners (with a few notable exceptions) convinced that most records will be mixed in surround in the near future. What preparations are they making?

Sterling Sound is jumping in with both feet. In fact, the biggest news in the New York mastering community these days is the acquisition of Sterling by mastering engineers Greg Calbi, Tom Coyne and Ted Jensen (in partnership with Absolute Audio cofounder Murat Aktar and London, UK-based audio services company Metropolis Studios). The partners are planning the construction of a wholly new facility—to be called Metropolis Mastering—in the Chelsea District, due to open sometime in 2000.

Sterling technical director Bob Tis says a big part of the plan for the new facility involves accommodating 5.1 mixing, adding that, "Right now we're doing some multi-speaker mixing in our present space, getting our staff prepared for the work that we're sure is going to come in the near future."

Tis mentioned the limited success of enhanced CDs but feels that DVD will enjoy widespread popularity. "We believe totally in the DVD-Audio spec. It's the first real enhancement for the listener in a long time. It finally moves us beyond the 16-bit CD standard."

Artists are asking Sterling Sound about 5.1 mixing regularly, according to Tis, who feels that one strength of the DVD spec is that it will let every DVD player accommodate multiple formats. "Not

everyone who owns a DVD player initially will have multiple speakers, so the spec lets the user choose whether to play back a stereo or multiple-speaker mix."

Tis agrees that an entirely distinct set of architectural relationships is demanded in a room designed for surround mastering. "What makes this process so interesting is the fact that we have limited precedents," he says. "Films place different material in the center speaker—dialog, for example—and that doesn't pertain to the music industry. Even though real estate expenses in New York are high, we're confident that constructing new space specifically to handle surround sound mixing the proper way is the right decision." The new facility—comprising five main mas-

—CONTINUED ON PAGE 195

## L.A. GRAPEVINE

by Maureen Droney

Stopped in at John Musgrave's MAD Labs in Shadow Hills for a rundown on what the company's been up to. On the day I was there, Musgrave, who has been building custom audio electronics since 1977, had three Neve VR consoles in-house to which he was adding MAD Labs' center-section upgrade. That package, well known to legions of loyal Conway Recording Studios clients, results in a dramatic improvement in the signal-to-noise ratio of the desks, and adds flexibility and features that make the popular and familiar VRs able to rival operation of many modern digital consoles for scoring, mixing, post-production and discrete surround.

Musgrave himself is a hybrid; his varied background includes both top-of-the-line audiophile system design and nuts-and-bolts recording studio maintenance—two areas that, contrary to what the general public may believe, ordinarily don't intersect that often.

You'd rightly guess he was one of those kids who built stereo systems, and his first real job was with speaker manufacturer Infinity Sound. "I worked with some of the premier audio designers for the hi-fi world," he recalls, "and one of the ways I got started was because I was a Deadhead—one of those kids who schlepped from city to city recording them. Bascom King at Infinity, who had helped Marantz design the Models 8 and 9 amps and other famous tube

—CONTINUED ON PAGE 194



In Effanel Music's L-7 mobile studio, Lou Reed (l) and engineer John Harris worked on a remix of Reed's performance from the PBS series *Sessions* at West 54th Street on the truck's 128-input Neve Capricorn.



# COAST

## NASHVILLE SKYLINE

by Dan Daley

Two historic Nashville studios lost something precious this year. When Owen Bradley passed away on Jan. 7, 1998, at the age of 82, Bradley's Barn lost its guiding light, and the modern country music business lost one of its founding fathers. And on April 16, two tornadoes ripped through Nashville's downtown area, one of them taking away an equally critical aspect of Woodland Digital Studios—its roof. Both studios are dealing with their losses in their own ways, but both continue to move ahead.

Bradley's Barn was the creative home of Owen Bradley, who along with Chet Atkins is generally credited with creating the role of the modern country music producer/label head and the model on which the country music business is run. Bradley ran Decca Records and produced hits for scores of country greats, including Patsy Cline, every year until his retirement from MCA Records, which had acquired Decca, in 1976. "He was down to about one project per year after that," says Michael Bevington, studio manager at the Barn and an associate of



Producer/composer Scott Spock (center) recently finished up work on the score for the forthcoming feature film *Free Enterprise*. Joining Spock in his studio during mix sessions were producer Mark Altman (l) and director Robert Burnett. Spock also produced tracks for Capitol artist Ruben's next LP, and is working with jazz trumpeter Jim Manley.

Bradley's for 20 years. "So we've really been running as a for-hire facility ever since then."

When Bradley died, he was working on singer Mandy Barnett's album at the Barn, and the record was finished by his brother, guitarist and longtime A.F. of M. local president Harold Bradley. The Barn, in the Nashville suburb of Mt. Juliet, still has the Otari Concept One console it's used for many years, as well as Studer A80 multitracks and Alesis ADATs. But Bevington says one of the studio's main attractions is its microphone collection, which numbers over 100—mostly vintage pieces, some of which traveled with Bradley for much of his career. Bradley acquired many of these mics when he bought the former RCA Studio A in 1977, which he ran as his in-town facility until eight years ago.

—CONTINUED ON PAGE 196

## SESSIONS & STUDIO NEWS

### SOUTHERN CALIFORNIA

Warren G recorded and mixed for his upcoming Def Jam release at *Scream Studios* in Studio City with engineer Charles Nassar...Crumbox tracked with producer/engineer Caleb Southern for *Time-Bomb Records* at *Grandmaster Recorders* in Hollywood...At *Skip Saylor Recording* (L.A.) Qwest/Warner artist Shannon mixed new material with producer Rory Bennet, engineer Ian Boxill and assistant Daniel Romero...Tevin Campbell worked on his next Qwest release at *Music Grinder* in Hollywood with producer Stevie J., engineer Bob Brown and second Dean Fisher...Producer Rick Rubin and Joe Strummer worked on

material for the *South Park* soundtrack on Sony at *Sound Image* in Van Nuys. Dave Schiffman was at the controls...At *Sound City* (Van Nuys), Polydor artists *Expanding Man* tracked on the Neve 8028 in Studio A with producer Matt Hyde. Marc Chevalier engineered, assisted by Mike Terry...Live overdubbed and mixed for their upcoming fourth album on *Uni Radioactive* with producer Jerry Harrison and engineer Karl Derfler in Studio A at *The Village Recorder* (West L.A.)...

### NORTHEAST

Mercury recording artist Lee Feldman edited and sequenced his sophomore release on the 24-bit *Sonic Solutions* system at *Permanent Records* (NYC), with studio owner/engineer Pier Giacalone and pro-

ducer Roger Peltzman. The studio recently installed a Yamaha 02R V.2 console...Kim Ritchie tracked in the new Studio C at *Sear Sound* (NYC) for Mercury/PolyGram with producer/engineer Hugh Padgham and assistant Dave Fisher... At *Bias Recording* in Springfield, VA, Mary Chapin Carpenter lent her vocal talents to a new song by *The Chieftains*. Basics and vocal tracking sessions for the song, "The Deserted Soldier," were produced by bandleader Paddy Maloney and engineered by Jeffrey Lesser... Daniel Lemma tracked and mixed for *Palace Records* at *Bear Tracks Recording* in Suffern, NY, with producer/engineer Stan Wallace and assistant Rick Pohronezny. The studio recently hired

—CONTINUED ON PAGE 198



Paquito D'Rivera (l) and producer/arranger Bob Belden teamed up at New York City's *Avatar Studios* for work on Rivera's new *Heads Up International* release, *100 Years of Latin Love Songs*, featuring instrumental renditions of ballads and dance tunes from throughout Latin America.

—FROM PAGE 192, L.A. GRAPEVINE

stuff, was also a Deadhead. When I came in my first week as an assembler at Infinity, wearing my Dead T-shirt, Bascom noticed me, and at the end of that first week he brought me a prototype preamp and said, "Can you finish this?" I went home and studied over the weekend, figured out how to read schematics, came back in on Monday and finished it; by the end of that week I was working in engineering. One of the best things about working at Infinity was that I spent more than half of my time the first year in the listening room reviewing speakers with super audiophile people like Harry Pierson from Absolute Sound, and the whole parade of audiophile reviewers and writers. They were into the smallest nuances, and I heard all their opinions—it was great training in how to listen."

After Infinity, Musgrave worked for several other high-end audio manufac-

clean it up and optimize, finding the things that manufacturers, for whatever reasons, had to cut corners on, and improving them. We get a piece of equipment to how it would have been built if it had been an individual item."

A quick explanation of the VR upgrade: The console frame wiring and connectors are replaced, with a new motherboard for each bucket; the DC power distribution system is replaced and upgraded with copper busbars; in effect, a whole new grounding system is installed. "It varies console to console," Musgrave says, "but for the most part we're seeing a 20dB drop in noise floor across the center section and about a 6 to 8dB drop in noise from the channel direct outputs. Then, we replace and improve all of the main audio path of the center section, using GML, API or my own amplifiers. We use high-quality, hand-picked buttons, switches, indica-

tors and other components, with a number of options possible depending on the specific needs of the studio.

"As far as the functional upgrades, we take the board from being a normal 4- or 8-bus to being able to do all the basic film formats, with bus/tape switching and stem mixing to monitors, so that you can actually do the mixing, not just the tracking. The

center monitor section is eight wide, so you can work in any mode you want, setting up speakers in any style you want with a central level control—that takes care of something that is ordinarily a very cumbersome part of the job. In a nutshell, what the upgrade does is to give you a center section that's current, and a major sonic upgrade, for the cost of an external film monitor system. It future-proofs your studio, without committing to the costly purchase of a new console."

In addition to being a hot rod and customizing house for almost any piece of audio equipment, MAD Labs offers large-scale system design and installation of both audio and video networks, and can also provide their services on-site. "We cover a lot of areas," explains Musgrave, "from large-scale distributed production networks to designing and installing a free form mix environment at Disney's Imagineering with movable speakers for mixing sound for rides. For any project, we can recommend what technology to use, then design, build, install and maintain systems. It just de-

pends on what they need."

Over in the Fairfax Delta (Pico/Fairfax), Jimmy Sloan's King Sound and Pictures and Kitsch 'n' Sync Equipment Rentals and Sales has been keeping busy. Sloan's production and engineering credits include Throw Rag's upcoming Epitaph release, the Carter Brothers' *Coming Back Singing the Blues* and The Jupiter Effect's eponymous release on Aerial Flipout. He's also engineered for Weezer, 1000 Clowns, Lifter, Hot Sauce Johnson and did a Grammy-nominated project for Five Blind Boys of Alabama. Sloan has combined his twin passions for music and gear collecting into, mostly, one place. The studio, featuring a 32-in API console with Flying Faders automation and a Neve BCM-10 sidecar with 1073 modules, has been the cozy home to projects for Dandy Warhols and Beck remixes, The Muffs, Meshelle N'Degeocello, Social Distortion, the Negro Problem, The Wondermints and many others who enjoy the cool vibe and classic gear.

Starting out as a musician, Sloan made his first demo at age 15 at Radio Tokyo, a studio owned by Ethan James of Blue Cheer. He was hooked. "I wanted to know how to work everything there," he recalls, "so I went to recording school, learned signal flow and mics and how to align a Studer tape machine—which, by the way, they don't seem to teach these days; they should, along with the basics of a ½-inch Ampex ATR! I assisted at a few studios and worked at Guitar Center and Guitar Guitar. After I left those places about five years ago, people started calling me at home and asking for my help in finding gear. I started going through the *Re-cycler* ads and went from buying compressors and mics to selling tape machines and consoles to people like Rick Rubin, Neil Young and Peter Aykroyd."

According to Sloan, King Sound was named after the "four kings": Elvis, B.B., Freddie and Albert. His love for retro is apparent; the studio is packed with gear like a Fairchild 670, an EMI EQ, an EMT 140 plate, lots of tube and ribbon mics, and instruments including a Hammond B3, Wurlitzer, Mellotron and Mini Moog. The furniture and fixtures also reflect vintage style, down to a sparkle nautical amrest on the API. There's also plenty of current gear, of course, from an Antares ATR-1 vocal processor to Apogee converters and a Marantz CD-R.

Being a collector, buyer and seller of older gear, Sloan understands the importance of upkeep. "I believe highly in maintenance," he says. "That's the difference between me and a lot of the



turers, and he put in time as a technician at Kendun Recorders, The Complex and Conway. "When I started at Kendun," laughs Musgrave, "it was quite a shock. I couldn't believe that, at the consumer end I'd been working in, we'd spent all that time doing critical listening, and then I get to the recording studio and there's a 57 on the drums going 'Rak kak, rak kak!' I looked at the circuits in the console, and it was an eye-opening experience, because they would never have flown in an audiophile environment. I guess that's when my passion was born. It drove me, in a lot of ways, to know that there was so much room for improvement."

At MAD Labs, as Musgrave and his wife and partner Kelle put it, "The options are many, and the limitations are few." "We have the ability to take the manufacturer's idea that last step," Musgrave says, "to that 'holy grail' of audiophile sound quality. We do that not only for consoles, but for tape recorders, room EQs—anything that's been brought to us. We go through and

smaller studios. It runs 10 to 25 percent of my budget every month, but it's worth it. Pat Schneider and Steve Firlotte are my techs, and I just added the Firlotte center section to the console."

Kitsch 'n' Sync Rentals & Sales does a steady business—besides engineering and running the studio, Sloan continues to put together packages and locate gear for clients, and he's one of the two U.S. distributors for the Purple Audio line of compressors. "I've been around long enough that people trust me," he explains. "They know I can put together a package and get them the best deals."

Tube, condenser and dynamic mics, preamps, mini-consoles, effects, tape recorders, amps and instruments—all are to be found on Kitsch 'n' Sync's rental list. "I find a lot of my market is not so much to other studios as it is to producers," Sloan says. "Everyone has a Pro Tools rig, but they don't have great mics, preamps, compressors and converters when they're making a record at home. That's really our market, and we try to service them by sending out knowledgeable people to deliver the equipment; we can help them set it up if they need that."

"You just have to adjust to the trends," Sloan continues. "Personally, I

think technology is great, but it's not the way I want to make records. I'm a fan of the old school, and that's what I love: great players recording on good equipment in a real studio. But I'm happy to make a living helping out people who want to record in another fashion.

"Just as people drive a '59 Cadillac or a '65 Mustang with pride," Sloan adds, "people will always want API, 80 Series Neves... because they'll never be duplicated. They will never make a U47 that sounds like an original again, no matter who tries; they'll never make a Fairchild—it's physically impossible now because they can't get the proper metals for the transformers because of the pollution laws. My prediction for the future is that there will always be a place for certain quality gear, and people will always want to record some things to 2-inch, just like you always want to play a Les Paul or a Stratocaster. But other than that, it's all up for interpretation, because people can do it all at home and sell millions of records. I have to be aware of that, and that's how I survive." ■

*Got L.A. news? Fax Los Angeles editor Maureen Droney at 818/346-3062 or e-mail msmldk@aol.com.*

—FROM PAGE 192, NY METRO REPORT

tering rooms in more than 25,000 square feet—is being acoustically designed by Francis Manzella of FM Design.

Emily Lazar of EBL Productions also believes that new spaces will be required. "I think DVD will be huge, and retrofitting rooms designed for stereo is just a stopgap measure. We've gone through preliminary room designs to establish exactly what the requirements would be to put together a space that would be right for surround sound mixing."

A possible cost savings measure for New York mastering houses would involve partnering with film and video facilities who need to execute 5.1 masters. "We're talking with people who are working on the video side of DVD to see if we might be able to establish a relationship," Lazar says. "It's still early in the game. The bottom line is that artists are inquiring about mixing for surround sound, and we believe that the possibilities for new and existing mixes are tremendous."

Over at Masterdisk, chief technical engineer Don Cuminale says business is excellent and they're beginning to get into 5.1 mastering. "Ideally, we'd like to build a room from scratch for 5.1 mixing. We don't have space available to us

# CD-Recordable by MICROBOARDS Technology, Inc.



**NEW!**  
**Jam Session**  
Your complete Macintosh solution for burning audio CDs!

**NEW!**  
**DSR8800**  
Copy up to 280 CDs from one master.  
• SP/DIF interface available  
• DVD upgradable



**NEW!**  
**CopyWriter A2D**  
Copy existing or create original CDs with our new 1 to 1 duplicator.  
• Analog in / Digital out  
• Track extraction



**▲ Cedar CD Publisher**  
4 drive desktop CD duplication and full color CD printing all in one! Now with Macintosh and Audio software support.



**Dealer Inquiries Welcome!**



**Web Site:**  
[www.microboards.com](http://www.microboards.com)

**U.S.A. Corporate Headquarters**  
Phone: (612) 470-1848  
Toll Free: (800) 646-8881  
Fax: (612) 470-1805

**East Coast**  
Phone: (888) 215-3966  
Fax: (610) 495-5437

**United Kingdom**  
Phone: 44-1789-415-898  
Fax: 44-1789-415-575

CIRCLE #140 ON PRODUCT INFO CARD

on the 5th floor, so we're considering acquiring more space, although the expense would be substantial, obviously. In the interim, we've modified some office space. Our rooms are intended to be more like a home environment than a traditional mix space."

Cuminale pointed out a concern that kept coming up in conversations with other facility owners and engineers—the size of mixing consoles. "When you need to hear the material coming out of the center speaker, for example, the console tends to get in the way of things," Cuminale says. "Some basic rethinking about room design needs to be done."

Jim Brick, owner of Absolute Audio, is taking a more cautious approach. "We're definitely keeping an eye on where 5.1 is heading, but we're not jumping in yet. Remember the MiniDisc? Need I say more! The important thing is to stay ready, stay informed about 5.1 technologies, and keep watching the market. The bottom line is, 'Is the consumer going to buy DVD-Audio?' I'm not entirely convinced of the answer."

Over on West 13th, Herb Powers Jr. was celebrating the fact that the week we spoke, Powers House of Sound was the Number One mastering facility in

the country, according to *Billboard*, having mastered more of the week's Hot 100 and R&B hits than any other house. Powers' plans for the next millennium include constructing new space for surround sound mixing, even though the public's satisfaction with CDs remains the wild card.

"5.1 mixing is definitely the thing of the future, and we don't want to be behind the times. Yet the expenses involved—especially when you work in Manhattan—are extreme, so I have to ask myself if the public is ready to embrace the new technology. Will they buy a DVD player to replace their VHS and CD players? I hope so!"

Powers' short-term strategy is to immerse himself in 5.1 technique and mix in his current space. "If and when DVD takes off, I'd have to reconstruct my present room to get it properly set up to handle this work, or build a new space. But my room is large enough to get into DVD mixing as it's presently configured. You don't want to make a major expenditure and find out later you misread where the market was heading." ■

*E-mail your New York news to New York editor Gary Eskow at scribeny@aol.com.*

—FROM PAGE 193, NASHVILLE SKYLINE

when it became Javelina Studios. Another draw for the studio is its 3,500-square-foot main recording room, which gets calls for everything from orchestral sessions to video shoots to showcases.

But the studio's most notable attraction was Owen Bradley himself, who despite late-life illnesses never stopped being both creative and cheery. When I first met him five or so years ago, he was immersed in putting together a MIDI studio for himself to help in his development of new artists. As someone who had started making records direct to (lacquer) disk in the 1940s, he laughed about the learning curve and just said he'd figure it out eventually.

"Whenever anyone came out for the first time to the Barn, you know they wanted to see Owen as much as they were there to see the studio," says Bevington. "And he would always come around and say, 'Good morning' to whoever was working in the room every day. We hate to say that he was our main attraction," she adds with a laugh, "but he was a big part of it."

Nonetheless, Bevington is aware that Nashville has become a multitiered city in terms of recording studios, and that facili-

## There are two ways to interconnect all your digital gear:



### The Digital Detangler way and the wrong way.

So you've got a pile of workstations, DAT machines, ADCs, DACs, processors, and digital consoles. And they have digital cables coming out of the back. And, to make matters worse, some of them are AES/EBU, some are S/PDIF, and some are optical. To complicate matters further, you constantly need to unplug and replug everything every time you need to reconfigure. How in the world are you going to hook everything up?

A Digital Detangler from z-systems is the smartest way to hook up all your digital gear. It's an automated digital patchbay, distribution amplifier, and format converter, all in one package. It supports AES/EBU, S/PDIF, and optical formats. Available in sizes from 8x8 stereo pairs to 64x64 stereo pairs. Options include custom input/output configurations, remote control, computer control, and multi-user network control. It's fully asynchronous and it'll do 24/96 *today*. Put one in your rack and you'll wonder why you used to do things the wrong way.



don't forget...  
we also make great sample rate converters



**z-systems audio engineering**

4641-F NW 6 Street 352.371.0990 (tel) z-sys@z-sys.com  
Gainesville, FL 32609 352.371.0093 (fax) www.z-sys.com

CIRCLE #141 ON PRODUCT INFO CARD

World Radio History

ties in the increasingly crowded mid-tier need to have something that differentiates them. "We haven't got a billion dollars' worth of equipment," she says. "We've been around since 1964 in one way or another. [The original Barn was partially destroyed by a fire in the 1970s.] There's a lot of history here. And that means a lot to some people. Only [former RCA] Studio B is older in Nashville." The Barn no longer has the 40 or so projects Bradley himself would produce every year in his heyday, when five days was a long time to make a country record. But the place's vibe and Bradley's spirit have kept others coming.

At Woodland Digital, the loss was more material. Moments after the tornado hit that April morning, sky could be seen through the ceilings of the three-room facility, one of Nashville's oldest studio complexes. In addition to literally rolling the roof off the structure, the accompanying rain did considerable water damage to the building and possibly to some of the electrical infrastructure—examination of wiring and equipment status was continuing even five months after the event.

The trauma was severe—two projects for Radney Foster and Shannon Brown were under way, and both finished elsewhere; no bookings were expected to be taken until at least November, according to studio manager Justin Tocket. Tocket, along with studio owner Bob Solomon and one office assistant, is the only staffer left at Woodland as it undergoes reconstruction; the rest have moved on to other facilities.

The damage was compounded by the fact that the business is owned by one entity and the building by another. As a result, sorting out and collecting insurance on both the business and the physical plant was considerably delayed. The tomado also interrupted Solomon's long-term plans to purchase the building from its owners. That pursuit will be revived once reconstruction is finished, as will the search for another company to take over the third studio area of Woodland, after studio designer Steve Durr relocated his API console to another studio in Nashville earlier in the year.

Tocket says that there are no major changes planned for Woodland—restoration of the original acoustics is the goal, though some slight modifications may be made to Studio A's control room. "We're very optimistic about getting back up and running," he said. "This is a great studio, and we don't want to let it go. We'll be back." ■

Send Nashville news to Dan Daley at [danwriter@aol.com](mailto:danwriter@aol.com) or fax 615/646-0102.



## LEARN THE ART OF RECORDING

You can get the practical, real-world skills needed to successfully start your career as a recording engineer, producer or studio musician. •Hands-on approach, learning by doing •Previous experience not required •Complete 300 hours of training in less than 2 months •6 studios filled with the latest equipment •Small classes, excellent personal attention •Job placement assistance •Financial aid available •Low cost, on-campus housing



For free brochure, call or write today  
1-800-848-9900 1-614-663-2544

**THE RECORDING WORKSHOP**  
455-X Massieville Rd  
Chillicothe, Ohio 45601

Ohio State Board of Proprietary School Registration #80-07-0696T

CIRCLE #142 ON PRODUCT INFO CARD



A problem free studio...

...begins with the AARDSYNC II.  
Having all your digital audio devices locked to one jitter-free master clock solves every click, pop, out-of-sync, digital incompatibility problem you ever had.



- Pro Tools®
- Sonic Solutions™
- Tacam® DA-88/38
- Yamaha® O2R/O3D
- ADAT®
- NTSC/PAL Video
- Sony® PCM-800
- DAT Machines



**Aardvark**

<http://www.aardvark-pro.com>

Ph 313•665•8899 • Fax 313•665•0694 • 202 E. Washington Ste 306 • Ann Arbor • MI • 48104

CIRCLE #143 ON PRODUCT INFO CARD

—FROM PAGE 193, SESSIONS & STUDIO NEWS

**Phil Brennan** as general manager and **Nadine Toomey** as director of client services... At **Inner Ear Studios** (Arlington, VA), **The Dismemberment Plan** recorded for Interscope with producers **Chad Clark** and **Jay Robbins** and engineer **Don Zientara**... Original Rolling Stones manager and founder of **Immediate Records** **Andrew Oldham** brought some vintage Stones tracks (including Mick singing in Italian) in for remix at **Trod Nossel Studios** (Wallingford, CT)...

#### NORTHWEST

At **FM Studios** in Emeryville, CA, the **Braxton Brothers** recorded a new release for the **Windham Hill** label... Producer/engineer **Elliot Scheiner** recorded **Hanson** during a show at **Seattle's Key Arena** for a live CD on **Mercury** using **Xtreme Studio's** mobile recording facility. **Steve Smith** assisted... Smooth jazzers **Glass Brick Boulevard** completed work on their second **Reitzel Records** release, titled *A Simple Dream*, at **Laughing Tiger Studios** (San Rafael, CA). **Jim Reitzel** and bandleader **Greg Johnson** produced, and **Reitzel** and **Daniel Daniel** engineered... At **Cherub Way** (Seattle), **R. Chris Murphy** remixed the **King Crimson** album *USA* for **Virgin Records**...

#### NORTH CENTRAL

**Janet Jackson** cut vocals with engineer **Steve Hodge** and assistant **Matt Prock** at **Hinge** (Chicago). Also in was producer **Tommy Lipnik**, mixing a **Candlebox** track for the **Adam Sandler** movie *Waterboy*...

#### SOUTHEAST

**Atlantic Starr** recorded a forthcoming release for the **Allure** label at **Funky Bottom Studio** (Washington, D.C.) with producer **Jonathan Lewis**, producer/engineer **Wayne Lewis** and engineer **Adrian "Ace" Boston**... At **Doppler Studios** in Atlanta, **Bad Boy** artists/producers **112** recorded vocals for an upcoming release with engineer **John Frye**... **Neal Coy** tracked for **Mercury** at **Sound Emporium** (Nashville) with producer/engineer **John Kelton** and assistant **Paula Montondo**... **Lonestar** tracked for **RCA** at **Masterfonics** (Nashville) with producer **Dan Huff**, engineer **Jeff Balding** and assistant **Mark Hagen**... At Nashville's **Emerald Sound**, **Neal McCoy** tracked for **Atlantic** with producer **Kyle Lehning**, engineer **Steve Tillisch** and assistant **Tim Waters**... **Capricorn Records** artists **2 Skinny J's** mixed in **Studio A** at **Tree Sound Studios** (Atlanta) with producer **DJ Hurricane**, engineer **Shawn Grove** and assis-

tant **Chris Fleming**. Also in was **Anunnaki Entertainment** president **Phil Tan**, engineering mix sessions for a new single by **Anunnaki** artist **Lackie**. **Grove** assisted... **Lorrie Morgan** tracked for her next **BMG** release at **Oceanway Nashville** with producer/engineer **Csaba Petocz**. **Joe Chiccarelli** engineered, as well.

#### SOUTHWEST

Recent activity at **Arlyn Studios** in Austin, TX, has included **Arista** artist **Robert Earl Keen**, in with producer **Gurf Morlix** and engineer **Stuart Sullivan**, and **Titty Bingo**, working with producer **Andy Johns** and engineer **Larry Greenhill**. At sister studio **Pedernales** in nearby **Spicewood**, **2 Below** were in with producer **Rob Fraboni** and engineer **Boo MacLeod**...

#### STUDIO NEWS

**House of Blues Studios**, Memphis, installed a winged **SSL 9080 J Series** console with **Ultimation** in **Studio A**. The first sessions on the board were string overdubs for **Mercury/PolyGram** artist **Shelby Lynne**, produced by **Bill Bottrell** and engineered by **Mark Cross**. Also, **Susan Hesson** was recently appointed studio manager... **Debbie Haney** was promoted to director of sales and marketing at **Music Annex** (Menlo Park, CA). **Music Annex** is celebrating its 25th anniversary this year... **Kelly Erwin** was named studio manager for **Ocean Way** and **Record One Studios** in L.A... **Studio Litho** in Seattle is now available for hire. The studio, open since 1995, is owned by **Stone Gossard** of **Pearl Jam** and had been booked previously with private projects and by word of mouth. Past Clients have included **Soundgarden**, **The Deftones** and **Queensryche**... **Irascible** recordist **Steve Albini** installed a new, custom **Neotek Elite II** console in **Studio A** at his **Electrical Audio** recording studio in Chicago... **Quad Studios** (NYC) installed two custom **Dynaudio/Munro M4+** systems in **Studios A** and **3**; a third system is on order... In other **Munro Associates** news, NYC's **Chung King Studios** commissioned the London, UK-based company (and their U.S. associates, **Professional Audio Design**) to handle the acoustic design (including a custom 5.1 monitoring system) for the studio's new mix room, equipped with a **Euphonix CS3000**... Atlanta-based production company **RM Audio** introduced its new 24-foot mobile production truck, the **Digivan**, which features 32 tracks of **Tascam DA-88/38** and a 40-input **Soundcraft Spirit** console... **Digital Music Technologies** (San Francisco) added 19 dB **Technologies A-to-D** and **D-to-A** converters to its inventory. ■

# DVD Media

## DELAWARE VALLEY DIGITAL MEDIA

CD Mastering • DVD Authoring • 44.1/48/96k/NoNoise  
MPEG-2 & AC-3 Encoding



...has  
moved

Our greatly expanded facilities include 5 post rooms, acoustical design by Doug Jones of EASI, surround monitoring up to 7.1, 4 Sonic Solutions DAW's (3 with NoNoise™), full version of DVD Creator (including MPEG-2 video encoding), enhanced archival storage, and much more.

From Lockheed-Martin and Johnson & Higgins to the Philadelphia Orchestra and the Museum of Jewish Heritage, DVDM continues to service the expanding needs of clients around the country.



charter member  
ADVANCED AUDIO ALLIANCE

DVDMedia@DVDM-online.com



21 West Highland Avenue • Philadelphia, PA 19118-3309

(215) 248-2100 FAX (215) 242-2177

CIRCLE #144 ON PRODUCT INFO CARD

# TOUCH

the

# Future



INTERACTIVE PRODUCT SHOWCASE



## DEALERS

Alta Loma Music

Brook Mays

Cascio Music

Daddy's Junky Music

E.U. Wurlitzer

Gand Music & Sound

George's Music

Lentines Music

Manny's Music

Mars

## DEALERS

McMurray Music

Reliable Music

Rondo Music

Sam Ash Music

Sam's Music

Skip's Music

Thoroughbred Music

Victor's House of Music

Washington Music

Whitaker Music

Experience video demos of the latest gear at a music store near you or visit our website at [www.demovision.com](http://www.demovision.com)



# Your Passport to 25,000\* Latin American Recording and Sound Professionals

**N**o other Spanish-language magazine delivers equipment information and in-depth applications-oriented coverage of this caliber on the following topics:

**RECORDING**

**SOUND REINFORCEMENT**

**AUDIO FOR FILM/VIDEO**

**MUSIC PRODUCTION**



More than 25,000\* copies of *Mix-Edición en Español* are distributed bi-monthly to live sound and recording professionals, aspiring pros and musicians in virtually every country in Central and South America, plus Spain and Spanish-speaking regions of the United States.

## *Mix-Edición en Español*

For Advertising Information call

**Dan Hernandez, Advertising Director: (510) 653-3307**

\*Publisher's Own Data (includes newsstand single copy sales)

**CIRCLE #145 ON PRODUCT INFO CARD**





## Lobo Recording

2103 Deer Park Ave.  
Deer Park, NY 11729  
(516) 242-0266 or (516) 243-2983  
Fax (516) 243-3964  
e-mail: music@loborecording.com  
http://www.loborecording.com

Located 35 minutes east of NYC, Lobo Recording is the place to achieve your creative goals. Recent acquisitions include an SSL 9096J, Neve VR 72, Studer D827 and Yamaha C7 Grand Piano. Other equipment includes Amek Angla IIs, Studer A827s, A80s, ADAT XTs 64 tracks and an extensive list of microphones and outboard gear. Please call for more info.



## NPR

635 Massachusetts Ave., NW  
Washington, DC 20001-3753  
(202) 414-2482; Fax (202) 414-3033  
e-mail: rgi@npr.org  
http://www.npr.org/inside/technical

Located in downtown Washington, D.C., Studio 4A offers a spectacular recording environment well-suited to all music genres. Studio 4A, at 2,600 sq. feet, is one of the largest recording facilities on the East Coast. We offer digital and analog multi-track recording, an extensive mic collection, digital editing suites and CD mastering. NPR also offers satellite uplinking, fiber and ISDN capabilities worldwide.



SSL / DIGITAL / ANALOG

## Sheffield Remote Recordings

13816 Sunnybrook Rd.  
Phoenix, MD 21131  
(800) 672-3220 or (410) 328-7260  
e-mail: sheffield@sheffieldav.com  
http://www.sheffield@sheffieldav.com

Sheffield is America's largest SSL recording truck. This is not just a remote truck, it is a complete audio facility. Add to this the best crew in the remote business. Partial credits include The Grammy Awards, MTV Music Awards, Live from the House of Blues and Aerosmith.

## American Holly Studios

### American Holly On the Park

139 Calloun Street  
Charleston, SC 29401  
(843) 577-0780; Fax (843) 577-0067  
e-mail: a.holly@dyncon.com  
http://www.americanholly.com

Three brand-new studios with 56-ch Cadac & 24-ch MCI consoles, 48-tk/96-tk hard disk (Akai) and linear digital (ADAT), plus 2-inch 24/16-tk, all formats. Also, outboard by Avaton, TC, Bellari, Aneus Melcor, ADM, Neve, ART, dlx, monitors by JBL, Altec, UREI, Yamaha (Crown, Audio Techniques amps); Korg Trinity, Kawai EP 308, Weber grand. Downtown, beaches, entertainment, hotels, restaurants. Control rooms A&B linked to mix studios and mix room via fiber optics. Liquid Audio uplink.



### Ultimate music corporation

40 Lopez Ave.  
Cambridge, MA 02141  
(617) 576-2855; Fax (617) 576-8094  
e-mail: info@U-music.com  
http://www.U-music.com

A digital music production/post facility near Boston featuring a Euphonix CS3000, with up to 96 tracks of tape and disc-based multitrack recorders including Sony 3524, Studer 82, RADAR, ADAT, DA-88, Pro Tools 24 and Avid Audio Vision. All rooms are fitted with world-class outboard gear from Focusrite, Avalon, Manley, API and an extensive collection of new and vintage keyboards. All this set in a relaxed and elegant environment. Call for our brochure or additional information.



### M Works

432 Columbia St., Ste. B-14A  
Cambridge, MA 02141  
(617) 577-0089  
e-mail: studio@m-works.com  
http://www.m-works.com

M Works offers state-of-the-art mastering employing digital, analog or hybrid signal paths. Gear by Neve, Sontec, Weiss, Junger, PMI, Ampex and Sonic. More than 2,000 credits span the world of music, e.g. Rahsaan Roland Kirk, David Bowie, Seattle Symphony, Windham Hill, Aimee Mann, Reeves Gabrels. We offer NoNoise and HDCD mastering. Call for schedule and rates. Your superior ingredients plus our unsurpassed know-how give our masters refreshing and long-lasting flavors.



## Colossal Mastering

1644 N. Honore #101  
Chicago, IL 60622  
(800) 730-2468; Fax (773) 292-1698  
cmastering@aol.com  
[www.colossalmastering.com](http://www.colossalmastering.com)

Colossal's 4,500-cu.-ft. mastering suite provides the focal point for Chicago's new dedicated mastering facility. Outfitted with names like Avalon, Sonic Solutions, Manley, Legacy and Apogee, we are proud to introduce ourselves as the area's most finely equipped mastering studio. Couple that with great client service and a comfortable and creative studio environment (not to mention experienced ears...), and we hope you'll make us your new source for top-notch mastering.



## Atlanta Digital

500 Means Street, Suite E  
Atlanta, GA 30318  
(404) 522-4777; Fax (404) 522-3723  
<http://www.promastering.com>

Best Gear? Got it. Credits? We can name-drop. But what sets us apart? Training, experience and EARS!

Equipment: Sonic Solutions 24-bit 96k, fully expanded with NoNoise. Focusrite Blue Range EQ. Manley Vari-MU compression, TC Electronic M5000/MD2, Apogee 24-bit AD/DA, Dynaudio/REL/Bryston monitoring. Spaciously designed and tuned room.

Clients: Arrested Development, Speech, DARP, Sony/Columbia, EMI, Warner, Chrysalis, Toshiba-EMI Japan.

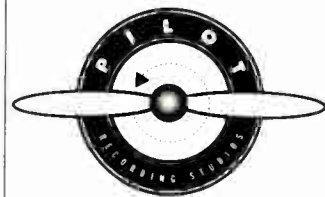

## Pilot Recording Studios

59 W. 19th Street  
New York, NY 10011  
(212) 255-5544; Fax: (212) 255-9434  
e-mail: [pilot@interport.net](mailto:pilot@interport.net)  
<http://www.interport.net/~pilot>

Pilot Recording is an outstanding live tracking facility, located in the heart of Chelsea, NYC. We offer a spacious, acoustically exceptional live room with a Steinway M piano, Pearl drums, 20 snares, Hammond C-3 Leslie, Estey pump organ, harmonium, over 25 guitars and many amps. Our 24/48 track analog/digital control room features a Trident Series 80C console, Otari and Sony 3324 tape machines, along with an impressive collection of vintage gear and tube mics. Please call for more info.



## Paradise Sound Recording Inc.

P.O. Box 410  
Index, WA 98256  
(800) 877-MTNS (6867); Fax (360) 793-7713  
<http://www.ParadiseSound.com>

SSL 4056G console  
Otari RADAR digital system  
Otari MTR90 24-track  
Digidesign Pro Tools  
Kodak CDR  
Vintage microphones  
Spectacular mountain view  
Indoor plumbing!!!



## Laughing Tiger Productions

110 A East Francisco Blvd.  
San Rafael, CA 94901  
(415) 485-5765; Fax (415) 485-5742

In the San Francisco Bay, we are the affordable world-class studio, with two 48-track rooms and a full-service mastering suite. Featuring tuned and beautiful rooms, 2-inch Studer, ADAT and Pro Tools recording formats, plus vintage mics, preamps and instruments. We focus on providing the local community of independent labels, producers and artists with service and quality only available to major labels... until now.



## Spectre Mastering

3136 E. Madison  
Seattle, WA 98127  
(206) 726-4821  
<http://www.spectrestudio.com>

Located minutes from downtown Seattle in historic Madison Park, Spectre Mastering provides the Northwest with a professional mastering alternative. Exposed timber beams, large windows, many plants and warm lighting all add to Spectre's relaxed feel. Spectre's gear list includes Sonic Solutions, Manley analog processing, a Spitz modified ATR-102 1/2-inch and much more. Please call for a personal tour of the Northwest's largest and most unique mastering facility.



## Gallery Recording Studios

132 West 22nd Street, 6th Floor  
New York, NY 10011  
(212) 366-6640; Fax (212) 727-7187  
e-mail: claysmash@aol.com

It's a recording studio and an art gallery! A beautifully designed, spacious facility with outstanding acoustics, based in the heart of Manhattan. The best in vintage/modern gear and an inspiring atmosphere enhanced by ever-changing exhibits of striking modern artwork. Built to spoil the most demanding engineer, producer or musician. Some names: SSL 6064 w/ Total Recall, Studer 827S, Lexicon, Quested, Pro Tools, DA888s, Focusrite, Neve, Summit, Pultec, TC, Neumann, Steinway.



## SNB Mastering

8400 Cote de Liesse  
St. Laurent, QC, Canada H4T 1G7  
(514) 342-8513; Fax (514) 342-2910  
(800) 361-8153

The world's largest Weiss Eng. Mastering Console 102 Series 16-band EQs & two Dynamics processors at 32-bit/96kHz & famous Weiss De-esser, sampling rate converter. EMT Digital Reverb, PCM 9000 & Genex 8000, MO format accepted. Super Analog 20-bit converter. CD-R recorders, interface for analog outboard.\*  
*\*Bring your favorite box.*  
5 minutes from Dorval Airport. Special prices for hotels. 25 years of excellence.



## John Golden Mastering

2373 Teller Road, #103  
Newbury Park, CA 91320  
(805) 498-3490; Fax (805) 499-1633  
<http://www.JohnGoldenMastering.com>

Specializing in fine CD & Lacquer Mastering for the Independent Music Industry.

## Wildstyle Studios

### Wildstyle Studios

27-24 Jackson Ave.  
Long Island City, NY 11101  
(718) 937-7749; Fax (718) 937-7734

Wildstyle Studios is a full recording facility located in Long Island City, Queens, NY, across the bridge from Midtown Manhattan. A George Augspurger-designed studio featuring a 48 track, automated MCI console, 24-track 2-inch machine and (3) ADATs locked for 48 tracks with Pro Tools editing and a custom Augspurger monitoring system. We have a full lounge, pool table, video games, etc., and live-in loft for month-to-month lock-outs. Live room dimensions: 28'L x 18'W x 17'H.



## Sonorous Mastering Inc.

2519 W Geneva Drive  
Tempe, AZ 85282  
(602) 453-9648; Fax (602) 453-9641  
e-mail: shirk@sonorous.com  
<http://www.sonorous.com>

Sonorous Mastering is a cutting-edge facility that combines a ten-year mastering history with the finest analog and digital electronics available. Our clients can enjoy the shopping and sites of Mill Avenue or downtown Phoenix within minutes of our facility. For more information visit us on the Web at [sonorous.com](http://www.sonorous.com), and see why many independent and major labels are switching to our services. Please call for rates and availability, major credit cards accepted.



## Coast Recorders

665 Harrison Street  
San Francisco, CA 94107  
(415) 546-0200; Fax (415) 546-9411

Classic expanded 72-input discrete Neve with GML automation; 75+ pieces of modern and vintage outboard gear; large assortment of tube microphones; huge 40x45-foot recording space plus four iso booths. Clients include: Counting Crows, Green Day, Live, Journey, Joe Satriani, Chris Isaak, The Breeders, Tower of Power, Soul Coughing and Faith No More.



# THE PROFESSIONAL'S SOURCE FOR PHOTO,

**FOR ORDERS CALL:**  
**800-947-5508**  
**212-444-6698**

**OR FAX (24 HOURS):**  
**800-947-9003**  
**212-444-5001**

**MOST ORDERS SHIPPED  
 WITHIN 24 HOURS**  
**OVERNIGHT SERVICE AVAILABLE**

On the Web: <http://www.bhphotovideo.com>

## HARD DISK RECORDERS



### VS1680 Digital Production Studio

The new VS-1680 Digital Studio Workstation is a complete 16 track, 24-bit recording, editing, mixing and effects processing system in a compact tabletop workstation. With its advanced features, amazing sound quality and intuitive new user interface, the VS-1680 can satisfy your wanderlust.

#### FEATURES-

- 16 tracks of hard disk recording, 256 virtual tracks.
- 24-bit MT Pro Recording Mode for massive headroom and dynamic range.
- Large 320 x 240 dot graphic LCD provides simultaneous level meters, playlist, EQ curves, EFX settings, waveforms and more.
- 20-bit A/D converters
- 2 optional 24-bit stereo effects processors (VS8F-2) provide up to 8 channels of independent effects processing.
- New EZ routing function allows users to create and



save various recording, mixing, track bouncing and other comprehensive mixer templates for instant recall.

- 10 audio inputs: 2 balanced XLR-type inputs w/ phantom power, 6 balanced 1/4" inputs, and 1 stereo digital input (+optical/coaxial)
- 12 audio outs: 8x RCA, 2x stereo digital & phones.
- Direct audio CD recording and data backup using optional VS-CDR-16 CD recorder.

## SOFTWARE



### SONIC FOUNDRY CD Architect & CD Factory

CD Architect is the perfect solution for designing professional audio CDs to Red Book spec on Windows NT and Windows 95. Sample audio from compact disks, record from DAT, or digitize material through a sound card. It comes complete with an editor including dozens of effects and tools to process sound files; and can optionally operate as a Sound Forge plug-in. CD Factory adds a CD burner, SCSI card and cable for a complete production package.

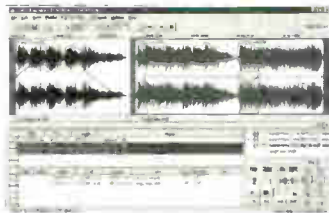

#### FEATURES-

- Multi file playlisting
- Master volume faders (-96dB to +20dB)
- Adjustable envelope levels for any region
- Mix or crossfade overlapped regions
- Convert from mono to stereo on the fly

- Multiple levels of undo/redo
- Up to 99 tracks with 99 subindexes per track
- Make glass-masters directly from burned CDs.

## STUDIO DAT-RECORDERS

### Panasonic SV-3800 & SV-4100

The SV-3800 & SV-4100 feature highly accurate and reliable transport mechanisms with search speeds of up to 400X normal. Both use 20-bit DA converters to satisfy even the highest professional expectations. The SV-4100 adds features such as instant start, program & cue assignment, enhanced system diagnostics, multiple digital interfaces and more. Panasonic DATs are found in studios throughout the world and are widely recognized as the most reliable DAT machines available on the market today.



#### FEATURES-

- 64x Oversampling A/D converter for outstanding phase characteristics
- Search by start ID or program number
- Single program play, handy for post.

- Adjustable analog input attenuation, +4/-10dBu
- L/R independent record levels
- Front panel hour meter display
- 8-pin parallel remote terminal
- 250x normal speed search

### AKAI DR16 16-Track HD Recorder

The Akai DR16 is a digital hard disk recorder with sophisticated non-destructive editing functions for near instant data access. Recording & playback is as straight forward as tape. The DR16HD ships with an internal 2GB drive for 24 minutes per track of record time.



**TURN YOUR DR16 INTO A PRODUCTION WORKHORSE WITH THESE POWERFUL EXPANSION OPTIONS!**

- MT8 Mixer controller • DL16 Remote control unit • IB801S SCSI Interface board
- IB802T SMPTE interface board • IB803M MIDI interface board • IB804A ADAT interface board
- IB805R RS422 Interface board • IB806B Bi-phase interface board
- IB807V VGS monitor interface board • EQ16 16-channel digital EQ board • ALX50 Remote Cable

## DIGITAL MULTI-TRACK RECORDERS

### TASCAM DA-98 Digital Audio Recorder

The DA-98 takes all the advantages offered by the DTRS format and significantly ups the ante for the professional and post-production professional alike. With enhanced A/D and D/A converters, a comprehensive LCD display and full compatibility with the DA-88 and DA-38, the DA-98 delivers the absolute best in digital multitrack functionality.



#### FEATURES-

- Confidence monitoring for playback and metering
- Individual input monitor select switch facilitates easier checking of Source/Tape levels
- Switchable reference levels for integration into a variety of recording environments with internal tone generator
- Digital track copy/electronic patch bay functionality
- Comprehensive LCD display for easy system navigation

- Dedicated function/numeric keys make operation easier
- Built-in sync with support for MMC and Sony P2
- D-sub connector (37-pin) for parallel interface with external controller
- Optional RM-93 rack-mount ear for use with Accuride 210 system

## TASCAM DA-30MKII

A great sounding DAT, the DA-30MKII is a standard mastering deck used in post-production houses around the world. Among many other pro features, its DATA-SHUTTLE wheel allows for high-speed cueing, quick program entry and fast locating.



#### FEATURES-

- Multiple sampling rates (48, 44.1, and 32kHz)
- Extended (4-hour) play at 32kHz
- Digital I/O featuring both AES/EBU and S/PDIF
- XLR balanced and RCA unbalanced connections.

- Full function wireless remote
- Variable speed shuttle wheel
- SCMS-free recording with selectable ID
- Parallel port for control I/O from external equipment

**DA-88** A standard digital multitrack for post-production and winner of the Emmy award for technical excellence, the DA-88 delivers the best of Tascam's Hi-4 digital format. Its Shuttle/Jog wheel and track delay function allow for precise cueing and synchronization and the modular design allows for easy servicing and performance enhancements with third-party options.

**DA-38** The DA-38 was designed for musicians. Using the same Hi-8 format as the highly acclaimed DA-88, the DA-38 is an 8 track modular design that sounds great. It features an extremely fast transport, compatibility with Hi-8 tapes recorded on other machines, rugged construction, ergonomic design and sync compatibility with DA-88s.

## Fostex D-15

The new Fostex D-15 features built-in 8Mbit of RAM for instant start and scrubbing as well as a host of new features aimed at audio post production and recording studio environments. Optional expansion boards can be added to include SMPTE and RS-232 compatibility, allowing the D-15 to grow as you do.



#### FEATURES-

- Hold the peak reading on the digital bargraphs with a choice of 5 different settings
- Set cue levels and cue times
- Supports all frame rates including 30df
- Newly designed, 4-motor transport: is faster and more efficient (120 minute tape shuttles in about 60 sec)
- Parallel interface • Front panel trim pots in addition to the level inputs

### D-15TC & D-15TCR

The D-15TC comes with the addition of optional chase and sync capability installed. It also includes timecode reading and output. The D-15TCR comes with the further addition of an optional RS-422 port installed, adding timecode and serial control (Sony protocol except vari-speed)

### ALESIS ADAT XT20 Digital Audio Recorder



The New ADAT-XT20 provides a new standard in audio quality for affordable professional recorders while remaining completely compatible with over 100,000 ADATs in use worldwide. The XT20 uses the latest ultra-high fidelity 20-bit oversampling digital converters for sonic excellence, it could change the world.

#### FEATURES-

- 13-point autolocate system
- Dynamic braking software lets the transport quickly wind to locate points while gently treating the tape
- Remote control
- Servo-balanced 56-pin ELCO connector

- Built-in electronic patchbay
- Copy/paste digital edits between machines or even within a single unit. Track Copy feature makes a digital clone of any track (or group of tracks), and copies it to any other track (or group) on the same recorder.



## SONY PCM-R500

Incorporating Sony's legendary high-reliability 40:1 Mechanism, the PCM-R500 sets a new standard for professional DAT recorders. The Jog/Shuttle wheel offers outstanding operational ease while extensive interface options and multiple menu modes meet a wide range of application needs.



#### FEATURES-

- Set-up menu for preference selection. Use this menu for setting IDE, level sync threshold, date & more. Also selects error indicator.
- Includes 8-pin parallel & wireless remote controls

- SBM recording for improved S/N (Sounds like 20bit)
- Independent L/R recording levels
- Equipped with auto head cleaning for improved sound quality.

TO INQUIRE ABOUT YOUR ORDER:  
 800 221-5743 • 212 239-7765  
 OR FAX 24 HOURS:  
 800 947-2215 • 212 239-7549

**New Address:**  
**420 Ninth Ave. (Bet. 33rd & 34th St.)**  
**New York, N.Y. 10001**



**MIDI HARDWARE**



Mark of the Unicorn  
**MIDI**  
**Time Piece™ AV**  
 8x8 Mac/PC MIDI Interface

The MTP AV takes the world renowned MTP II and adds synchronization that you really need like vice genlock, A/EAT sync, word clock sync, and even Digidesign superclock!

- FEATURES-**
- Same unit works on both Mac & PC platforms.
  - 8x8 MIDI merge matrix, 128 MIDI channels.
  - Fully programmable from the front panel.
  - 128 scenes, battery-backed memory.
  - Fast 1x mode for high-speed MIDI data transfer.

**Digital**  
**Time Piece™**  
 Digital Interface

Think of it as the digital synchronization hub for your recording studio. The Digital Timepiece provides stable, centralized sync for most analog, digital audio, and video equipment. Lock together ADATs, DA-88's, ProTools, word clock, S/PDIF, video, SMPTE, and MMC computers and devices flawlessly. It ships with "Clockworks" software which gives you access to its many advanced features and remote control of some equipment settings such as record arm.

**O P C O D E**

**Studio 64XTC**  
 Mac/PC MIDI Interface

The Studio 64XTC takes the assorted, individual pieces of your studio-your computer, MIDI devices, digital and analog multitracks and even pro video decks, and puts them all in sync.

- FEATURES-**
- 4 In / 4 Out: 64 channel MIDI/SMPTE interface/patchbay with powerful multitrack & video sync features
  - ADAT sync with MIDI machine control
  - S multimecus wordclock and Superclock output, 44.1kHz or 48kHz for perfect sync with ADAT, DA-88 and ProTools
  - Video and Blackburst in (NTSC and PAL)
  - Cross-platform Mac and Windows compatibility

**SAMPLING**

**E-MU**  
**e-6400**  
 Sampling and more!



The e-6400 from EMU features an easy interface that makes sampling easy. Automated features like looping, normalizing and more allow you to flexibly create your own sound palettes or access any of the 400 sounds provided on 2 CDs for unlimited sound creation. It's upgradeable to 128MB of RAM (4MB standard) and features 64 voice polyphony, 8 balanced analog outputs, SCSI, stereo phase-locked time compression, digital re-sampling and more. A dream machine.

**KEYBOARDS & SOUND MODULES**



**XP60 & XP80 Music Workstations**

The XP-80 delivers everything you've ever wanted in a music workstation. An unprecedented collection of carefully integrated features provide instant response, maximum realtime control and incredible user expandability. The XP-80 features a pro-quality 76-note weighted action keyboard while the NEW XP-60 features the same sound engine in a 61-note keyboard.



**XP80 FEATURES-**

- 64-voice polyphony and 16-part multitimbral capability
- 16 Mbytes of internal waveform memory; 80Mbytes when fully expanded (16-bit linear format)
- 16-track MRC pro sequencer with direct from disk playback. Sequencer holds approx. 60,000 notes
- New sequencer functions like "non-stop" loop recording and refined Groove Quantize template
- Enhanced realtime performance capability with advanced Arpeggiator including MIDI sync and guitar strum mode and Realtime Phrase Sequence (RPS) for on-the-fly triggering of patterns
- 40 insert effects in addition to reverb and chorus
- 2 pairs of independent stereo outputs, click output, a.k.a. with volume knob
- Large backlit LCD display

**SR-JV80 Series Expansion Boards**

Roland's SR-JV80-Series wave expansion boards provide JV and XP instrument owners a great-sounding, cost-effective way to customize their instruments. Each board holds approx. 8MB of extremely new waveforms, ready to be played or programmed as you desire.

**Boards Include-**

- **Pop, Orchestral, Piano, Vintage Synths, World, Super Sound Set, Keys of the 60's & 70's, Session, Bass & Drums, Techno & Hip-Hop Collection.**



**KURZWEIL**

**K2500 Series Music Workstations**

The K2500 series from Kurzweil utilizes the acclaimed V.A.S.T. technology for top-quality professional sound. Available in Rack mount, 76-key, and 88 weighted key keyboard configurations, these keyboards combine ROM based samples, on-board effects, V.A.S.T. synthesis technology and full sampling capabilities on some units.

**FEATURES-**

- True 48-voice polyphony
- Fluorescent 64 x 240 backlit display
- Up to 128MB sample memory
- Full MIDI controller capabilities
- 32-track sequencer
- Sampling option available
- Dual SCSI ports
- DMTI Digital Multitrack interface option for data format and sample rate conversion (Interfaces with ADATs or DA-88s)



**KORG**

**Trinity Series Music Workstations DRS**

Korg's Trinity Series represents a breakthrough in sound synthesis and an incredible user interface. It's touch-screen display is like nothing else in the industry, allowing you to select and program patches with the touch of a finger. The 24MB of internal RDM are sampled using ACCESS which fully digitizes sound production from source to filter to effects. Korg's DSF based Multi Oscillator Synthesis System (MDSS) is capable of reproducing 5 different synthesis methods like Analog synthesis, Physical Modeling, and variable Phase Modulation (CPM).



**FEATURES-**

- 16 track, 80 00 note MIDI sequencer
- Flexible, assignable controllers
- **DRS (Digital Recording System)** features a hard disk recorder and various digital interfaces for networking a digital recording system configured with ADAT, DAT recorder and hard disk.
- 256 programs, 256 combinations
- Reads KORG sample DATA library and AKAI sample library using optional 8MB Flash ROM board



- **88 Weighted-key/Solo Synth**
- **76-key/Solo Synth**
- **61-key/Solo Synth**
- **61-key**

*\* (Digital IF, SCSI, Hard Disk Recorder, and sample Playback/Flash ROM functions are supplied by optional upgrade boards)*

**MONITORS**

**KRK**  
**V8**

**Powered Studio Monitors**

These new powered studio monitors from KRK supply 130 watts of clean performance. Their 8" woofer & 1" silk dome tweeter ensure crystal highs as well as the bass response needed for today's studio environments.

**FEATURES-**

- 49Hz - 22kHz
- Magnetically shielded for use near video monitors



**Hafler**  
**TRM-8**

**Powered Studio Monitors**

Winner of Pro Audio Review's PAR Excellence Award in 1997, Hafler's TRM8s provide sonic clarity previously found only in much more expensive speakers. They feature built-in power, an active crossover, and Hafler's patented Transnova power amp circuitry.

**FEATURES-**

- 45Hz - 21kHz ±2dB
- 75W HF, 150W LF
- Electronically & Acoustically matched



**MACKIE**

**HR824**

These new close-field monitors from Mackie have made a big stir. They sound great, they're affordable, they're internally bi-amped. "What's the catch?" Let us know if you find one

**FEATURES-**

- 150W Bass amp, 100W Treble amp
- Full space, half space and quarter space placement compensation
- Frequency Response 39Hz to 22kHz, ±1.5dB



**TANNOY**  
**Reveal**

The latest playback monitor from Tannoy, the Reveal has an extremely detailed, dynamic sound with a wide, flat frequency response

**FEATURES-**

- 1" soft dome high frequency unit
- Long throw 6.5" bass driver
- Magnetic shielding for close use to video monitors
- Hard-wired, low-loss crossover
- Wide, flat frequency response
- Gold plated 5-way binding post connectors



**B&H**

PHOTO - VIDEO - PRO AUDIO

THE PROFESSIONAL'S SOURCE FOR PHOTO,

FOR ORDERS CALL:

**800-947-5508****212-444-6698**

OR FAX (24 HOURS):

**800-947-9003****212-444-5001**

Store &amp; Mail Order Hours:

Sunday 10-5

Monday thru Thursday 9-7

Friday 9-2 • Saturday Closed

On the Web: <http://www.bhphotovideo.com>

## OUR NEW EXPANDED LOCATION



## THE PROFESSIONAL'S SOURCE

**For All Your Photo, Video,  
Electronic Photography  
and Pro-Audio Needs**

### 420 Ninth Avenue

(Between 33rd and 34th Streets)

### New York N.Y. 10001

On the Web:

<http://www.bhphotovideo.com>

Store & Mail Order Hours:

**Sun. 10-5 • Mon. thru Thurs. 9-7  
• Fri. 9-2 • Sat. Closed**

For Info Call:

### 1-800-947-5508

### 212-444-6698

or FAX (24 Hours)

### 1-800-947-9003

### 212-444-5001

**We Ship Worldwide**

TO INQUIRE ABOUT YOUR ORDER:  
 800 221-5743 • 212 239-7765  
 OR FAX 24 HOURS:  
 800 947-2215 • 212 239-7549

**New Address:**  
 420 Ninth Ave. (Bet. 33rd & 34th St.)  
 New York, N.Y. 10001



**DIGITAL MIXERS**



**Digital 8 Bus Mixing Console**



Everything you've been waiting for and more!!! The new digital 8 bus from Mackie features great sound quality, full recording and mixdown capabilities, motorized faders and an array of digital features geared to take you flying into the next century. See for yourself what the entire industry is raving about.

**FEATURES-**

- 48 channels of automated compression, gating, EQ and delay
- Built-in 3-way meter display keeps you on top of your mix.
- Built-in meter bridge.
- Ultramix II automation for complete control, hook up an S-VGA monitor and you'll feel like you spent a lot more money.
- All functions can be automated, not just levels and mutes. Stereo EQ, reverb, compression, gating and even Aux send information.
- Fast SCENE automation allows you to change parameter snapshots on every beat.
- Reads Standard MIDI tempo maps, displaying clock info on the built-in position counter.
- Truly the cutting edge of mixing technology.



**Panasonic**

**WR-DA7 Digital Mixing Console**



Step dreaming about your digital future, it's here! The Panasonic WR-DA7 digital mixer features 32-bit internal processing combined with 24-bit A/D and D/A converters as well as moving faders, instant recall, surround sound capabilities, and much more. Best of all, it's from Panasonic.

**FEATURES-**

- 32 Inputs/6 AUX send/returns
- 24-bit converters
- Large backlit LCD screen displays EQ, bus and aux assignments, and dynamic/delay settings.
- 4-band parametric EQ
- Choice of Gate/Compressor/Limiter or Expander on each channel
- 5.1 channel surround sound in three modes on the bus outputs
- Output MMC
- Optional MIDI joystick

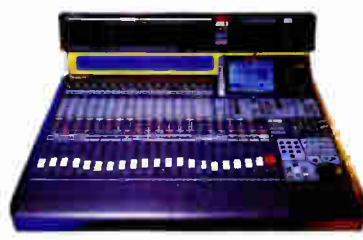

**TASCAM**

**TMD1000 Digital Mixing Console**



You want to see what all the digital mixing buzz is about? The NEW TMD1000 from Tascam will have you smiling & automatin' in no time. It features fully automated EQ, levels, muting, panning and more in an attractive digital board with an analog 'feel'. Your digital future never looked, or sounded, so clear.

**FEATURES-**

- 4 XLR mic inputs, 8 1/4" balanced TRS inputs.
- 20-bit A/D D/A conversion, 64x oversampling on input, 128x on output.
- Store all settings, fully MIDI compatible.
- Optional IF-TD1000 adds another 8 channels of TDIF and a 2-channel sample rate converter.
- Optional FX-1000 Fx board adds another 4 dynamic processors and another pair of stereo effects.



**MIC PREAMPS**

**Focusrite**

**Green 3 "Voicebox MKII"**



The Voicebox MKII provides a signal path of exceptional clarity and smoothness for mic recording, combining an ultra-high quality mic amp, an all new Focusrite EQ section optimized for voice, and full Focusrite dynamics. The new MKII now includes a line input for recording and mixdown applications

**FEATURES-**

- Same mic pre section as found on the Green Dual Mic Pre includes +48V phantom power, phase reverse, and 75Hz high-pass filter. Mute control and a true-VU response LED bargraph are also provided
- EQ section includes a mid parametric band with frequency and gain control as well as a gentle bell shape to bring out the character of the voice.
- Dynamics section offers important voice processing functions of compression and de-essing combined with a noise reducing expander
- Single balanced Class A VCA delivers low distortion and a S/N ratio as low as -96dBu

**EFFECTS PROCESSING**

**t.c. electronic**

ULTIMATE SOUND MACHINES

**Finalizer Plus**



Improving on the multi-award winning Finalizer platform, The Finalizer Plus delivers an unprecedented level of clarity, warmth and punch to your mix. Inserted between the stereo output of your mixer or workstation and your master recording media, the Finalizer Plus dramatically rounds out your material, creating that "radio ready" sound.

**FEATURES-**

- Balanced Analog as well as Digital outputs including AES/EBU, S/PDIF & TOS.
- 24-bit precision A/D & D/A Converters
- 5-band 24-bit stereo EQ
- Enhance - De-essing, stereo adjust or digital radiance
- Real-time gain maximizer
- Variable slope multi-band expander
- Multi-band compressor • Word Clock Sync
- MIDI section useful for controlling sequencer faders or any of the Finalizer's parameters from a remote MIDI controller.

**lexicon**

**PCM81 Multi-Effects Processor**



The PCM-81 has everything that made the PCM80 the top choice among studio effects processors, and more. More effects, more algorithms, longer delay and full AES/EBU I/O.

**FEATURES-**

- 300 Presets include pitch, reverb, ambience, sophisticated modulators, 20 second stereo delays, and dynamic spatialization effects for 2-channel or surround sound applications
- 2 digital processors including Lexchip for the reverb and a second DSP engine for the other effects.
- 24-bit internal processing
- Dynamic patching matrix for maximum effects control.
- PCM card slot

**EQUALIZERS**

**Focusrite**

**Green 2 "Focus EQ"**



The Green 2 Focus EQ is suitable for a variety of applications combining a Focusrite equalizer section with a multi-source input section. Use it as a high-quality front end for recording applications or patch it into the send/return loop to upgrade a single channel of console eq, either way, it sounds great.

**FEATURES-**

- XLR & 1/4" inputs are similar to the Dual Mic Pre but have been adapted to cope with a wider range of levels.
- VU metering via a 10-LED bargraph
- EQ section derived from the Red and Blue range processors for superb audio quality.

**COMPRESSORS**

**JOE MEEK**

**VC1 Studio Channel**



The Joe Meek Studio Channel offers three pieces of studio gear in one. It features an excellent transformer coupled mic pre-amp, a great compressor and an enhancer unit all in a 2U rackmount design. Find out why more and more studio owners can live without one.

**FEATURES-**

- 48V phantom power, Fully balanced operation
- Mic/Line input switch
- Mono photo-optical compressor
- High pass filter for large diaphragm mics
- Extra XLR input on front makes for easy patching
- Compression In/Out and VU/compression meter switches
- Twin balanced XLR outputs with one DI XLR output for stage use
- Enhancer In/Out switch and enhance indicator
- Internal power supply 115/230V AC



**dbx**

**Blue Series 160S Stereo Compressor**

The dbx 160S combines the best features of all the great dbx compressors in a well-built unit where the craftsmanship is as stunning as the engineering is innovative. This is truly a desirable compressor.

**FEATURES-**

- 127dB dynamic range • Program dependent "Auto", or fully variable attack and release
- Hard knee/OverEasy switchable



SEVEN DAY CUSTOMER SATISFACTION GUARANTEE

World Radio History

CIRCLE #147 ON PRODUCT INFO CARD

# Ad Index & Advertiser

PAGE	PRODUCT INFO NUMBER	ADVERTISER
197	143	Aardvark
56	029	Absolute Audio
172	114	Acoustic Sciences Corporation (ASC)
184	128	Acoustic Systems
68	039	Acoustical Solutions
164	108	Acoustics First
30	016	AcousticX
76	045	ADGIL/Sascom Marketing
105	066	ADK
79	047	Akai
IFC	001	Alesis (GT)
85	050	Alesis (M20)
157	102	Alesis (ADAT Type II)
22-23	011	Allen & Heath
163	106	AlterMedia
64	035	Amek
11	006	AMS Neve
24	•	Anthro
65	036	Aphex Systems
73	042	Apogee Electronics
89	054	Ashly
204-207	147	B & H Photo-Video
63	026	BASF
102	064	Benchmark Media Systems
190	137	Bernie Grundman Mastering
145	096	Bryston
52	027	Burlington/Maxell
140	091	Burlington/Sony
67	038	CAD Professional Audio
83	048	Cakewalk Music Software
174	118	CalSwitch
163	105	Caruso Music
177	121	Carvin
187	131	CMS Digital
122	077	Conservatory of Recording Arts & Sciences
106	067	The DAT Store
142	093	dB Technologies
32-33	018	dbx Professional Products
57	030	dCS/Independent Audio
198	144	Delaware Valley Digital Media
199	•	Demovision
47	023	Digidesign
185	129	Digital Audio Labs
165	109	Disc Makers
59	032	Dolby
21	010	Drawmer/Transamerica Audio Group
88	053	Dreamhire
94	057	E Ware
150	100	EAR Professional Audio/Video
45	022	Electro-Voice (EV)
IBC	149	Emagic
18-19	009	Euphonix

PAGE	PRODUCT INFO NUMBER	ADVERTISER
103	065	Europadisk
26-27	013	Event Electronics (20/20)
175	119	Event Electronics (DSP•FX)
129	084	Ex'pression
96	•	Fostex
186	130	Full Compass
176	120	Full Sail
180	•	Future Disc Systems
187	132	Future Media Concepts
164	107	Future Sonics
58	031	GKS Entertainment
188	134	Grace Design
189	135	Guitar Center's Rhythm City
93	056	Haffler
99	061	Harrison/GLW
127	083	Hermes Music
41	021	HHB Communications (CDR800)
117	073	HHB Communications (Circle 5)
183	126	HHB Communications (Media Guide)
122	078	The Hollywood Edge
100	062	Hot House Professional Audio
144	095	Institute of Audio Research
BC	150	JBL Professional
66	037	Joemeek/PMI
181	123	The John Hardy Company
134	089	LA Audio/SCV London
51	028	Lexicon (PCM 81)
167	112	Lexicon (MPX 1)
189	•	Los Angeles Recording Workshop
131	085	Lucid Technology
6-7	004	Mackie (D8•B)
2	002	Manley Laboratories
188	133	MartinSound
106	068	Masterdisk
68	040	MediaForce
92	055	MediaFDRM
69	041	Meyer Sound
195	140	Microboards Technology
118	074	Minnetonka Software
191	138	Mix Books #1
211	148	Mix Books #2
200	145	Mix en Español
148	098	mSoft
143	082	Musician's Friend
190	136	National Sound and Video
13	007	Neumann/USA
98	060	Northeastern Digital
173	115	Ontario Institute of Audio
17	008	Otari (Advanta)
101	063	Otari (RADAR II)
107	069	P. Audio Systems
14-15	•	Panasonic
62	033	Prism Media Products

PAGE	PRODUCT INFO NUMBER	ADVERTISER
38-39	020	QSC Audio Products
84	049	Quadim Mastering
9	005	Quantegy
162	104	RADIAL
197	142	The Recording Workshop
132	087	Rich Music
173	116	Rocket Lab
48	024	Rolls
124	080	Sabine
53	034	SADiE
86	•	Sam Ash Professional
95	058	School of Audio Engineering (SAE)
115	072	SEK'D
121	076	Sennheiser
1	•	Solid State Logic (Avant)
139	•	Solid State Logic (5.1)
77	046	Sonic Foundry
87	051	Sonorus
113	071	Sony Music Studios
88	052	Sound Construction & Supply
179	122	Soundelux
133	088	Soundscape Digital
25	012	Soundtracs
174	117	Speir Music
125	081	Steinberg North America
182	125	Studio Consultants
178	•	Studio Pro 99
126	094	Summit Audio
29	015	Sweetwater Sound #1
135	090	Sweetwater Sound #2
147	097	TAD/Technical Audio Devices
3	003	Tannoy
37	019	Tascam #1
141	092	Tascam #2
149	099	Tascam/Wave Frame
74	043	Taytrix
31	017	TC Electronic (MEC 1A)
61	059	TC Electronic (M3000)
75	044	TC Electronic (Family)
151	101	THAT Corp
184	127	Thoroughbred Music
166	111	Time Capsule Mastering
182	124	Walters-Storyk Design Group
149	099	Wave Frame/Tascam
123	079	Waves
166	110	West L.A. Music
171	113	Westlake Audio
110	070	Whirlwind
132	086	Whisper Room
161	103	X Wire
49	025	Yamaha
196	141	Z Systems



—FROM PAGE 58

## Mastering for multichannel formats?

**Essig:** I think in the near term it will not be a dramatic change to most engineers. There are enough high-end facilities that are equipped to do surround that can accommodate the niche market as of now. Like many others, we will have to accommodate this new format as demand dictates. I have already taken delivery on our first 24/96 SADiE upgrade card set, which is able to process surround matrix up to 24-bit/192kHz in 5.1 surround. As far as peripherals go, we will wait and see.

**Gehring:** We're still waiting for people to mix in the 5.1-channel surround sound format. Time will tell if it turns out to be another Quad. What I've heard in our 5.1 room sounds great, but I thought the same of QSound. It will all be based on the consumer who is willing to go out and buy another six-speaker surround-sound stereo and sit in the middle of their living room. I feel this format will most likely be used for those people with home theaters. Still, we're getting ready.

There is talk that mastering is no longer going to be 2-channel. It will be 8 or 16, thereby giving the producer or mixer the ability to give the mastering engineer the chance to change levels of questionable tracks and different mixes (vocal up, vocal down, instrumental, TV track, a cappella). I generally do a lot of R&B and hip hop, where various mixes are used on half-inch. This multichannel process would leave the mixer to do one mix with selected tracks (8 or 16); then I could master one track and generate whatever the record company feels is necessary. This process would also be useful with sampling. The producers could option different mixes if they don't get clearance without doing a recall at the recording studio.

**Vosgien:** I see surround as being sort of a specialized thing. I can see it being used a lot on live albums, and for that type of recording it's perfect. But I can't see it on a lot of different music, like the heavy R&B and rap, where even now there is a lot of mono information going on. We do have a DVD-ready room here, based around a Sonic system, with the monitoring environment set up for mastering surround. But the formats are still too much up in the air. When they get nailed down, we'll be going full

speed ahead. But as far as multichannel processing gear in the digital domain, I hear that those things are coming out, but I haven't seen the gear yet.

**Williams:** In our new place, all of our client rooms are designed to monitor in surround. So we put our money where our mouth is. What I think the industry is short on is signal processing. We have the storage mediums. We have the delivery worked out. But we really don't have signal processing of the same caliber as our stereo processing. A lot was said about this at the '97 AES, and it looks like it's been slow going from a development standpoint over the past year.

*Of all the new audio technologies that have come (and gone) over the last several years, which have had the greatest impact on your actual day-to-day work, and which do you see having the greatest impact in the future?*

**Essig:** I hate to sound redundant, but yet again it has to be the digital audio workstation—the best single tool advancement that I have seen. Increased productivity, ease of control and expandable flexibility. In mastering, once you get past critical EQ adjustments, it's all about compiling, editing, QC, formatting. All of this has been infinitely easier with the SADiE system.

**Gehring:** Hard disk recording with Sonic Solutions. It gives you the ability to do more work and recall more information, make changes more easily and transfer media more accurately. Internal networking also helps when it comes to shipping masters parts. Assistants can generate masters and references faster. If you've ever dealt with record companies, everything is: "It's got to ship yesterday."

**Vosgien:** I expect to see all the processing go to 24-bit/96kHz, and also to see a higher-bit storage for consumer formats, something like DVD. To be able to have 20-bit CDs would be great.

**Williams:** Let's face it, a lot of mastering guys have been doing this since the days of lacquers and vinyl. CDs changed our craft and had a huge impact on our businesses. Everything since then has been incremental by comparison. DVD is going to create the same kind of major change. We will have to be much more versatile in what we do. You will begin to see graphics people, sound designers, video editors and other never-before-seen persons lurking around your mastering house. ■

*Philip De Lancie is Mix's media & mastering editor.*

**FEBRUARY 1999**

## • THE PROJECT STUDIO

### ▲ Acoustics and Design

### ▲ In-Ear Monitors

### ▲ New Mic Preamps

### ▲ Repetitive Stress Injury Prevention

*Ad Close:*

**December 16**

*Materials Due:*

**December 18**

UNITED STATES POSTAL SERVICE  
STATEMENT OF OWNERSHIP, MANAGEMENT, and CIRCULATION  
(required by 39 U.S.C. 3685)

Publication Title: *Mix* Publication No: 0047-3870  
Filing Date: October 1, 1998 Issue Frequency: Monthly  
No. of Issues Published Annually: 12  
Annual Subscription Price: \$46.00  
Known Office of Publication: 6400 Hollis St. Suite 12, Emeryville, CA 94608-1052  
Headquarters of General Business Office of Publisher: 6400 Hollis St. Suite 12, Emeryville, CA 94608-1052  
PUBLISHER: Jeffrey Turner (same address)  
EDITOR: George Petersen (same address)  
MANAGING EDITOR: Tom Kenny (same address)  
OWNER: PRIMEDIA Intertec Corporation  
9800 Metcalf Overland Park, KS 66212-2216  
Known Bondholders, Mortgagees, and other Security Holders: None  
Issue date for circulation data: October 1998

Extent and Nature of Circulation	AVERAGE NO OF COPIES DURING PRECEDING 12 MONTHS	ACTUAL NO COPIES OF SINGLE ISSUE PUBLISHED NEAREST TO FILING DATE
	Total No. Copies (Net Press Run)	69,352
Paid and/or Requested Circulation (Sales through dealers, carriers, street vendors, counter sales)	9,521	9,763
Paid or Requested Mail Subscriptions	44,142	45,541
Total Paid and/or Requested Circulation	53,663	55,304
Free Distribution by Mail	1,549	1,758
Free Distribution Outside the Mail	2,140	4,300
Total Free Distribution	3,689	6,058
Total Distribution	57,352	61,362
Copies Not Distributed (Office use, leftovers, spoiled)	1,808	923
Return From News Agents	10,192	10,152
Total	69,352	72,437
Percent Paid and/or Requested Circulation:	93.57%	90.13%

I certify that all information furnished on this form is true and complete.

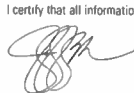
  
Jeffrey Turner, Publisher

—FROM PAGE 68, DENNY PURCELL

**How do you orient the channels? Left, center, right in a line, with the surrounds firing into the sweet spot?**

Here's the way Chuck does it. We have the front two and the rear two speakers as equilateral triangles, with each overlapping by one foot over the center. We use KRK Model 8s on Sound Anchor stands, because they're very good and heavy. The center speaker is on an arc [equidistant from the sweet spot]. And then we use an M&K subwoofer.

We mark the center of the room, do the physical setup, put the monitors on the stands and then use a laser to adjust them perfectly to the center.

**And the front and back pair are crossed a foot, respectively, behind and a foot ahead of your mix location?**

Correct. Then we have to balance the output using pink noise and an SPL meter. And, right now, we set the sub up 3 dB. **Which is different from film mixes. With DVD-Audio formats, all five speakers receive a full-bandwidth signal, and the 0.1-channel sub becomes a band-limited LFE. Where do the discrete sources end up in a surround mix?**

The secret of the way Chuck does it—which people are trying to figure out—is that when you sit in the center, you seem to be the vocalist; it seems to be radiating through your bones. Duane Eddy, a very good friend of mine who lives over in Franklin, came down here about a week ago, and I took him over when Chuck was doing a mix. Duane kissed me—never done that in his life! He said, "Hey, I've heard mono. I've heard stereo. I heard quad. But I've never heard anything like this in my life." He's crazy over it.

**What do you do in the surrounds? Is it natural ambience, or created from a 480XL?**

I'd rather you talk to the map-maker, rather than his apprentice. Chuck is the one who can answer that question.

**You also mastered Kevin Beamish's 5.1 mixes from Reba McEntire's new album, If You See Him, which he mixed at Starstruck. Was that a different type of project?**

No, I do all of Kevin's work. We had done Reba's album in 2-channel two months before, so I knew what it was.

**Did Kevin mix his 5.1 in a similar kind of way to Chuck? Hard-centered vocals?** Similar, but not the same.

**Okay, that's valid; different music?**

Pretty much. I tell studio engineers that the most critical thing when setting up

the monitors is what I equate to "stretching the canvas." If you don't stretch the canvas right, the painting will be no good; if you stretch it right, you can paint anything you want.

**Are these 5.1-channel mixes intended to be mono/stereo compatible?**

I don't think that most engineers take that into mind at all.

**But should it be that way in the future?**

If I told you that I knew, that would be a lie. I don't know that they should. If something is intended strictly for 5.1, I don't know that the mono should be considered.

**Do you check compatibility for left-back folding into left-front, for example, and whether the mix collapses into mono?**

No.

**Maybe a 5.1-channel balance "am what it am"?**

That's a good question, but I don't check it. Somebody called me years ago and said that some product didn't sound good on a mono radio station in Boston. My first answer was, "So what?" **What console do you use to remaster these 5.1 mixes?**

That'll be answered permanently at some later date. I'm working with SSL, Studer, Neve, Sony, lots of different people. I've even talked about an analog console. But right now, I'm using a [Yamaha] 02R and the Panasonic Ramsa [DA7]. I come out of the Genex into an 02R or Ramsa, then into a Sonic System. Out of the Sonic into the PMI Model Ones, out into an Otari PicMix [Monitor and Panning System]. Then out of the PicMix into the monitor speakers. We use six channels straight up, full 20-bit onto the Genex. I've remastered albums in 5.1-channel surround sound for Vince Gill, Trisha Yearwood, George Strait and The Mavericks, to name but a few of Nashville's leading country acts.

The reason I use the Sonic in the loop is that I want to hear the through-put. My guys edit it as we go; we lay down a song and then play it back, until we're out of songs. We edit to get the same times between cuts that we put on the stereo [version]. Very soon, we'll be doing all of it here, so that my clients can leave with a 5.1 ref.

**So what leaves you is an Exabyte from the Sonic that goes to the DTS plant. They have a Sonic that is used to recover and master it. Are you going to change that mastering system?**

What we're planning on doing, with help from my friends at DTS, is to be able to do the whole process here, so that my clients will be able to hear the CD/DVD-Audio refs that day or the next

day, rather than waiting for a week.

**What does the future hold? Where do we go from here?**

My main concern is if we shoot a picture with an 8-by-10 negative, and it's a postage stamp that's presented to the consumer, it will still look better than if I took the picture with a postage stamp-sized negative.

**You need to have a better resolution for mastering?**

In ten years it won't matter because I'll be off some place at some lake, enjoying nature and letting someone else worry about this! But sound is getting smaller: People are beginning to accept mediocre as tolerable. If you don't believe it, look at what the average computer person [believes] is an acceptable picture. It's disheartening. And they're doing the same thing to audio.

Imagine a normal sheet of paper. That represents the interest the record company has in the artist, what they have to offer, how excited the record company is, and what they want to present to the public. When the album is done, it turns into a CD. You tear off the corner about the size of a stamp, and that's all the consumer is getting. How could the record companies wonder why the consumer isn't as excited as they thought they should be?

Take that postage stamp, tear off just a corner of it, and that's what the consumer gets on his computer at home over the Internet. And it's only gonna be worse.

People promise me: "Oh don't worry, we'll figure it out in a couple of years." But I'm dealing with people who say that if I can measure the ones and zeroes and they're the same, then the music is the same. I'm dealing with people in different countries who say that the method of delivery doesn't matter—CDs, Exabyte, DAT, 1630, MOs, they're all the same; if the numbers are there, it's the same.

I'm really concerned that people are accepting mediocre sound as tolerable. In one article, I said, "Good enough is not good enough for me." And what I meant was: I can only strive to get better and better resolution, so that by the time the consumer does get it—with all the things that have been done to hurt it—it may still look better than it would had I not shot it high-resolution. That's really all I can do. ■

*Mel Lambert currently serves as international marketing director for Otari Corporation. Formerly, he ran Media&Marketing, a consulting service for pro audio firms and facilities.*

—FROM PAGE 72, THE ANT TRAIL.

section. Ariston Correia, from Bahia, and Esdras Bedai, from Olinda, were in charge of percussion, while drummer Duda Guedes laid down the backbeat.

With drums, we were going for a quasi-vintage sound. I captured the drum kit with a single overhead, a Soundelux U95. Snare was handled by an AT4050 and kick with a D12. Djembe, by percussionist Esdras Bedai, was recorded from the instrument's skin and rear soundhole. The body of a djembe, however, resonates significantly and makes up a good part of what is usually perceived as this instrument's natural sound. We managed to get a full, captivating recording of the instrument with a condenser from a few feet out.

Recording Ariston's berimbau was more straightforward. This bowed and stringed percussion instrument is a simple yet important element of many of Brazil's most traditional rhythms. A single large-diaphragm condenser, in our case a Neumann TLM 193, took care of the task quite well. There are more than 13 percussion elements on

*Caravansara*, and we spent a lot of time devising a concept for the way they would function within the project. The traditional approach of using these components to establish the groundwork for the song was not used; instead, we let Duda Guedes' groove drive the rhythm on its own, and the other instruments were used in more musical ways.

Bass guitar was handled by Alex Cheruti, a craftsman whose handmade guitars and basses are used by artists such as Stanley Jordan, Steve Morse, Carlinhos Brown and Artur Maia. Cheruti has also played on projects by Gilberto Gil and Marisa Monte. We recorded his own piccolo-bass direct with a Countryman DI, compressed moderately. Formiga has two major influences happening in their music. One comes from the traditional rhythmic styles native in the north of Brazil, mostly from Candomblé. The other is undoubtedly North American, more specifically from blues and R&B. And that's basically what you hear when Cheruti adds a funky bass line to Formiga's predominantly percussive arrangements, as well as in Luciano

Zanatta's baritone sax and exotic flute contributions.

On *Caravansara* I had the pleasure of working with guitar guru Paulinho Supekovia. His Marshall amp was recorded via a Beta 57 only two inches or so from the speaker, with a D112 placed at the rear of the cabinet enclosure. An AT4050 was used as an ambient mic at seven feet. The vocalists were recorded using a U95 through Joemeek preamps, direct to Logic Audio. Mano Sa, one of the vocalists, also played acoustic guitar. His vocal counterpart is Gabriel Moogen, whose segments of spoken word give the project much of its unique character.

As I wrap up *Caravansara*, I prepare for several interesting, yet contrasting projects. I'll be finishing Pedro Verissimo's rock album for summer release, and working on some classic MPB for Miro Fagundes. And as for Ant Trail, they're gearing up for a series of concerts throughout the south of Brazil. ■

*Charles Di Pinto is a freelance engineer and project studio owner based in Porto Alegre, Brazil.*

—FROM PAGE 78, MUSIC RECORDING IN BRAZIL  
**MORE TO COME**

Though Brazil has what seems like a great number of well-appointed commercial studios, the quickly expanding music market and the onset of DVD have combined to create more projects than the high-end facilities can handle. "The studios in Brazil are well-equipped and we have good engineers, but not enough for the size of the market," says Midas' Rick Bonadio, who is also director of Virgin Records Brazil.

But new import laws coupled with the lower cost of a lot of pro gear have made it easier for producers and musicians to afford equipment for their home studios, and those project rooms pick up the slack. The producers can bring semi-finished work to the big studios, where they track the acoustic instruments and vocals, and mix. This is a relatively new development in Brazil, but because there is more than enough work to go around, the industry seems to be thriving, not "shaking up." ■

*Adinaldo Neves is a Brazilian MIDI and digital audio consultant.*

UPDATED EDITION

## The Studio Business Book

Revised Ed. by Jim Mandell

This updated edition of the informative, wide-ranging guide presents all you need to know about:

- Writing a business plan
- Getting funding
- Buying equipment
- Determining expenses and rates
- Bidding on projects
- Developing new income and contacts
- Advertising and PR
- Scheduling
- Managing, hiring, and firing personnel
- And more

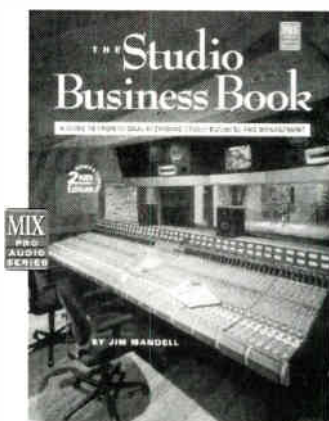

*If you need in-depth, detailed, specific information on all aspects of putting together and managing a recording studio, then this book is for you!*

**You can order it right now from MixBooks**

(#7104X for \$34.95) plus S&H

Call (800) 543-7771 — Fax (800) 633-6219 within the U.S.

Call (913) 967-1719 — Fax (913) 967-1901 outside the U.S.

Mail to MixBooks: c/o PRIMEDIA Intertec, 9800 Metcalf Ave., Overland Park, KS 66212-2215

**MIX**  
BOOKS  
<http://www.mixbooks.com>

**PRIMEDIA**  
Intertec

Also available through your local book or music retailer exclusively through: Hal Leonard Corp.

**HAL LEONARD**  
CORPORATION

CIRCLE #148 ON PRODUCT INFO CARD

## Coming in Mix January 1999

### LIVE SOUND!

#### • FEATURES

Business Quarterly: The Changing Face of Audio Retail

Compression Tips

Hollywood Vaults: State of the Art Media Storage

#### • LIVE SOUND

Touring Loudspeakers

Audience Miking Techniques for Live Recording

Tour Profiles: Beastie Boys, Alan Jackson/Deana Carter

All Access: PJ Harvey

#### • EQUIPMENT FIELD TESTS

Dynaudio BM15A Monitors

Earthworks Z 30X Mics & Lab 102 Preamp

Symetrix 562E Expander/Gate

#### • PLUS!

Engineer/Producer Jimmy Douglass' Flying Faders Tips,

The Mix Interview:

Producer Chris Thomas, Grammy-Winning Jazz

Producer John Snyder, Northeast Regional Focus

#### ATTENTION ADVERTISERS:

Call (510) 653-3307 for a 1999 *Mix* Editorial Calendar, space reservations and complete advertising information.

# MIX<sup>®</sup>

VISIT MIX ONLINE AT  
[www.mixonline.com](http://www.mixonline.com)!

### FIELD TEST

—FROM PAGE 134, ALESIS M20

#### AUDIO IS EVERYTHING

Soundwise, the M20 is impressive—the record electronics are based around 24-bit, 64x oversampling, Delta-Sigma, analog-to-digital converters; the playback side has 20-bit, 128x oversampling, Delta-Sigma, digital-to-analog converters. The sound quality is superb—sparkling and clear. In comparisons between the 20-bit M20 and 16-bit recorders (Alesis XT, various studio DAT recorders) there's a difference that's immediately noticeable, even to the casual listener. And all of the DACs and ADCs used are single converter-per-channel chips.

The M20 has the same varispeed range ( $\pm 200$  cents at 44.1 kHz,  $-300/+100$  cents at 48 kHz) as the ADAT classic and XT models, although the M20 displays pitch change values both as cents and percent.

#### OPTIONS, OPTIONS, OPTIONS

Although the M20 offers a lot, a number of optional accessories are available, allowing users to customize a system to fit various specific applications or installation/production needs. The M20 is shipped with removable rack ears—including power-amp-style rear rack rails, which are required to support the M20's substantial 32-pound left safely.

To simplify routine maintenance procedures, one useful option is a rack slider kit: Requiring a 20-inch-deep rack with rear rails, the kit provides a pull-out, drawer-style mounting for the M20. The rack slider kit also includes new rack ears with handles; although these handles provide a convenient hand-grip for sliding the ADAT when it's mounted within the rack slides, these handles should never be used to lift the ADAT when it's removed from the rack slides.

An LRC mini-remote is included with the machines. For those requiring more, the optional CADI (Controller Autolocator Desktop Interface) can control up to eight M20s (64 tracks) with access to all controls, track arming and sync functions.

#### THE AES/EBU OPTION

For facilities needing a digital interconnect in addition to—or in lieu of—the ADAT Lightpipe digital I/O ports, the M20's back panel has a slot for the EC-1 optional AES/EBU interface card (\$699), which plugs in and installs in minutes by replacing four screws on the back panel. This relatively inexpensive option provides eight XLR connectors: four stereo pair AES/EBU inputs and four stereo pair AES/EBU outputs.

Especially well-suited for users who need to transfer two (or multiple) channels of digital audio directly to/from a workstation, digital video recorder or for loading/offloading multichannel DVD or digital cinema surround mixes, the AES/EBU ports also offer a simple way to gain access to external converters, DSP units or digital consoles that don't have ADAT Lightpipe interfacing. Perhaps best of all, the M20's audio output data is always routed to the analog outs, Lightpipe and AES/EBU ports, allowing all kinds of possibilities, such as simultaneously monitoring through an analog console while transferring tracks to an AES/EBU-equipped workstation and making a safety clone tape with the Lightpipe connection. And as the M20 can simultaneously record through its analog and digital (Lightpipe or AES/EBU) inputs, it's no problem, for example, to record two tracks via an outboard analog converter on tracks 2 and 3 (perhaps for a piano or other delicate instrument) while using the onboard converters for tracks 1, 4, 5 and 6.

#### THUMBS UP!

Overall, the Alesis M20 is a solid, well-constructed package that really focuses on the important touches that make the difference between a piece of pro or MI equipment. And in several months of heavy use in post and pop album production, the dual direct-drive transport proved smooth, fast and flawless in operation. SMPTE lock was fast and efficient, whether locking to disk-based picture or the old faithful BVU-800s in my studio. The front panel layout and/or CADI offer ergonomically sensible, flexible control, and the addition of an aux track adds both 9th-track functionality as well as ultrasmooth scrubbing. But best of all, it sounded great with a punchy sound that is light years ahead of the old blackface "classic" ADATs.

Priced at \$6,999, with LRC mini-remote, two optical dubbing cables and even an Alesis sync cable(!), the M20 brings the cost of a 24-track, 20-bit digital recorder below that of a new analog 24-track. Combined with some of the new 20-bit workstations on the market, a variety of useful options (CADI, meter bridge, AES interfacing, rack slider kit, etc.) and an existing base of 100,000 machines, the ADAT Type II format should provide new choices for large and small studios alike.

Alesis, 1633 6th St., Santa Monica, CA 90404; 310/558-4530; fax 310/836-9192. Web site: [www.alesis.com](http://www.alesis.com). ■

# MARKETPLACE



**CD DUPLICATORS**  
& Speedy Duplicating Services

**YOU CAN'T BEAT THIS!**

- ✓ Expert Advice
- ✓ Guaranteed Lowest Price
- ✓ Best Selection Anywhere

MediaForm  
Rimage  
Champion  
Fargo  
Super Image  
Hoei Sangyo  
Cedar

**MRS**  
MULTIMEDIA RECORDING SYSTEMS

**800-210-0265**  
610/594-1603 fax: 610/594-6199

**ONLINE CATALOG**  
[www.gomrs.com](http://www.gomrs.com)

CIRCLE AD NUMBER 250 ON PRODUCT INFO CARD

**DIGITAL BOMAIN™** Hear the Magic  
CD Mastering & Replication

in Orlando, FL (800) 344-4361  
(407) 831-0233

*Master with us...and make an impact!*

Unsurpassed mastering quality by Bob Katz. Custom hardware and software, 128x Oversampling 20-Bit A to D, Unique Digital Processors, Sonic Solutions Editing, Tube and Solid State Analog Recorders.

*CD Mastering is an art. Levels, dynamics, fades, equalization, spacing... everything is important to you and to us.*

**CD Replication...**  
1000 CDs at \$1.30 w/jewel, shrink, insertion.

**CD Booklet Printing and Graphic Design...**  
1000 4-Panel Booklets: \$0.37/ea. Full-Color Outside & Tray, B&W Inside.  
Internet CD mastering website - <http://www.digido.com>

CIRCLE AD NUMBER 252 ON PRODUCT INFO CARD

**Class A Vacuum Tube Signal Processors**



MDP-1 Stereo Mic/DI Preamp  
OCL-2 Electro-Optical Compressor/Limiter  
6386 Variable Mu Limiter (same tube as the Fairchild!)

**Pendulum Audio** (908) 665-9333 VISA/MC  
[www.pendulumaudio.com](http://www.pendulumaudio.com)

CIRCLE AD NUMBER 251 ON PRODUCT INFO CARD

**300 CD PACKAGE: \$975**

**1000 CD PACKAGE: \$1499**  
order: S1349

**INCLUDES:**

- ORIGINATION • 1-COLOR 1-PAGE BOOKLET AND TRAY CARD • 1-COLOR CD LABEL
- JEWEL BOX & SHRINK WRAP • QUICK TURNAROUND

*from your print-ready/film (in Rainbo's specs)*

IN-HOUSE CD, VINYL & CASSETTE REPLICATING & PACKAGING

**Rainbo Records and Cassettes**  
1730 Berkeley Street, Santa Monica, CA 90404 • (310) 829-3476 • Fax (310) 528-8765 • [www.rainborec.com](http://www.rainborec.com)

ASK FOR OUR FREE BROCHURE!

CIRCLE AD NUMBER 253 ON PRODUCT INFO CARD

**SPINNER WORLD WIDE**  
disc

Call for our wholesale manufacturing guide  
**1-800-582-3472**  
[www.spinnerworldwide.com](http://www.spinnerworldwide.com)

## Complete Full Color Package

CD package includes: color 2 pg. insert, 2 color CD label, all mastering, jewel box, shrink wrapping, graphic insertion, from client supplied film separations.

**500 CDs**

**\$999<sup>00</sup>**

## We Do It All - Package

CD package includes: graphic design, film, color 2 pg. insert, 2 color CD label, all mastering, jewel box, shrink wrapping, graphic insertion.

**500 CDs**

**\$1299<sup>00</sup>**

**Also Available CD-Rom, Cassettes, Mastering, Posters**

CIRCLE AD NUMBER 254 ON PRODUCT INFO CARD

**LOW PRICES AHEAD!**

<b>CD/CD-ROM Manufacturing (bulk)</b>	<b>7-10 Day Turnaround</b>
1000 - 3999	\$0.68
4000 - 7499	\$0.60
7500 - 9999	\$0.57
10000 - 14999	\$0.53
15000 - over	\$0.51

RUSH ORDERS AVAILABLE!

**CD REPLICATION • GRAPHICS • PRINTING • PRODUCTION**

**Crystal Sand Multimedia Services**

(877)864-7771v (415)864-7778f www.crystal-sand.com

CIRCLE AD NUMBER 255 ON PRODUCT INFO CARD

**BONUS 5 CDR FREE** TEAC 4x12 CD-R bundle... **\$399**

**BONUS 5 CDR FREE** Panasonic 4x8 CD-R bundle... **\$309**

**BONUS 5 CDR FREE** Yamaha 4x2x6 CD-RW ext. bundle... **\$429**

**Pioneer DVD Recorder bundle..... \$16,499**

**AFFEX CD Color Printer bundle Prints 2 CD at a time..... \$1,399**

**LabelMaker with 100 FREE labels... \$39**

**NEW! Fastest CD-R 8x20 bundle... \$849**

**MediaFORM DUPLICATORS:**

2701 Autoloader... **\$4,899**

5900 8CD-R... **\$5,999**

3704 Autoloader 4 drives... **\$7,499**

**CD-R BLANKS** as low as **99¢** also available TOK & More

**Shimad** 1-888-4-SHIMAD

toll free 888-474-4623 PH. 650-493-1234  
http://www.shimad.com FAX: 650-493-1333

Easi-OAT/Easi-Audio option available

CIRCLE AD NUMBER 258 ON PRODUCT INFO CARD

**Looking For Affordable Cassettes and CDs?**

**Why search the world over... when you can get them here?**

We offer top quality cassette and CD packages which can be customized to fit your individual needs.

Audio Cassette...  
CD Audio...  
CD Rom... Mastering...  
Digital Editing... Graphic Layout...  
Film Output... Printing...  
you'll find it all here!!!

**Call Today for your FREE catalog...**

**SAS Industries, Inc.**

**1-800-955-7271**

New York Sales Office: 1-800-727-7181  
DELIVERY AND SATISFACTION GUARANTEED  
Manufacturing Facility Centrally Located In St. Louis, MO



CIRCLE AD NUMBER 256 ON PRODUCT INFO CARD

**You Provide the Talent... We'll Supply the Rest.**

**Professional Blank Media**

- Featuring SONY Digital Audio Tape, CD-Rs & Data Media
- Custom & Stock
- Cable Assemblies
- "Plug & Play" Patch Cords

**Duplication & Replication**

- CD Audio & CD-ROM
- Audio Cassette & CD-R
- NTSC/PAL/SECAM Video
- Packaging, Printing & Fulfillment

**CALL Toll Free 888-776-3712 or 518-828-2000**  
FAX: 518-828-2008  
pro\_sales@haveinc.com  
dup\_sales@haveinc.com  
309 Power Avenue Hudson, NY 12534

**HAVE INC.**

Since 1977: Doing Business by the "Golden Rule"  
Rely on your Friends at HAVE.



CIRCLE AD NUMBER 259 ON PRODUCT INFO CARD

**REAL TEACHERS. REAL EDUCATION.**

"The responsibilities of the recording engineer are many. To be the best, you need to learn them all."

**MICHAEL MCKERN**  
RECORDING DEPARTMENT HEAD

**Associate Degrees and Diploma Programs in Recording • Production Filmmaking**

Also:  
Guitar • Bass • Voice • Drums  
Brass and Woodwinds  
Keyboards • Business  
Songwriting

**MUSIC TECH**  
MUSICIANS TECHNICAL TRAINING CENTER

1-612-338-0175  
1-800-594-9500  
www.musictech.com  
304 N Washington Ave  
Minneapolis, MN 55401



CIRCLE AD NUMBER 257 ON PRODUCT INFO CARD

**MANUFACTURERS OF CDs and CASSETTES**

CD REPLICATION - CASSETTE DUPLICATION - DIGITAL MASTERING - GRAPHIC DESIGN - PRINTING - PACKAGES - ONE OFF CDS - DEAL DIRECT AND SAVE!

Professional Service  
**FREE CATALOG**  
*You'll Hear and Feel the Difference*

Ask about our **FREE WEB PAGE** offer

**800-289-9155**

OUTSIDE U.S. 516-244-0800  
HTTP://WWW.PB.NET/~CCMUSIC

**C&C MUSIC**

CIRCLE AD NUMBER 260 ON PRODUCT INFO CARD

**Fleetwood MultiMedia**  
 Stop Here For Your Best Deal

**1000 CDs \$1099**

PACKAGE INCLUDES:  
 Jewel Box, Shrink Wrap  
 2 Color CD Imprint  
 FREE Mastering  
 Fast Turnaround

Full CD & Tape Packages  
**From 300 up**

Our Services Include:  
 CD Replication  
 Cassette Duplication  
 Graphic Design & Film  
 Printing & Packaging  
 Custom Mastering  
 CD One-Offs

Specials Every Month  
 Call for a quote that fits your budget

1000 CDs bulk with 2 Color Imprint **\$799**  
 500 Chrome Tapes Includes Everything! **\$715**

800-353-1830 (781) 599-2400 [www.fleetwood.com](http://www.fleetwood.com)

CIRCLE AD NUMBER 261 ON PRODUCT INFO CARD

**CLEARSONIC PANELS**

Effective & Portable  
 Volume Control  
 & Separation!

For a free brochure call  
**1 800-888-6360**  
<http://clearsonic.com>

CIRCLE AD NUMBER 264 ON PRODUCT INFO CARD

**DRIVERS:**

- ▶ AIRBORNE
- ▶ ATC
- ▶ AUDAX
- ▶ DYNAUDIO
- ▶ ETON
- ▶ LPG
- ▶ MOREL
- ▶ PEERLESS
- ▶ SCAN-SPEAK
- ▶ SEAS
- ▶ VIFA
- ▶ VOLT

**CUSTOM COMPUTER AIDED CROSSOVER AND CABINET DESIGN**

**HOW TO BOOKS**

**VOLT**

**Volt 15" bass driver with radial chassis cooling.**

The Volt radial chassis works as a giant heatsink to keep the motor system cool. Bass response, output level and reliability are all improved. Contact Solen for more information.

Call, write, email or fax for the Solen '98 Catalog.

An \$8.00 purchase price will be charged to non-professionals and discounted off the first order over \$50.00. Businesses and professionals may request one copy free of charge.

**SOLE IN INC.**  
 4470 Avenue Thibault  
 St-Hubert, Q.C. Canada J3Y 7T9  
 Tel: 450.656.2759  
 Fax: 450.443.4949  
 Email: [solen@solen.ca](mailto:solen@solen.ca)  
 Web: <http://www.solen.ca>

MasterCard VISA

CIRCLE AD NUMBER 262 ON PRODUCT INFO CARD

**DESIGN • PRINT • APPLY • INSERT**

with **NEATO** Media Labeling Products

**KIT INCLUDES**

- ★ The amazing NEATO CD Label Applicator
- ★ Assorted NEATO CD Labels, Jewel Case Inserts and Other Media Labeling Products
- ★ MediaFACE™
  - Design Software (PC), Templates (Mac)
  - Digital Background Art for Labels and Inserts
  - Disc and Jewel Case Templates for Popular Graphics Programs (Mac/PC)

CD/DVD LABELS  
 JEWEL CASE INSERTS  
 AUDIO CASSETTE J-CARDS AND LABELS  
 ZIP™ DISK INSERTS AND LABELS  
 DAT TAPE J-CARDS AND LABELS  
 FLOPPY DISK LABELS

VISA / MC / AMEX

Also Available...  
 JAZZ™ CARTRIDGE INSERTS AND LABELS • VIDEO CASSETTE INSERTS AND LABELS

NEATO LLC 250 Dodge Ave • East Haven, CT 06512  
 888-575-3873 • 203-466-5170 • Fax 203-466-5178 • [www.neato.com](http://www.neato.com)

CIRCLE AD NUMBER 265 ON PRODUCT INFO CARD

**SOUND TECHNOLOGY**  
 Instrumentation and Automation

**SPECTRA SERIES**

Transform Your PC Into A Powerful Spectral Analysis System

Call To Order 1-800-401-3472  
 Fax: 408-378-6847  
[info@soundtechnology.com](mailto:info@soundtechnology.com)

<http://www.soundtechnology.com>  
 Free Solist Demo

The Best In Test offers a totally new dimension in Audio Testing...

CIRCLE AD NUMBER 263 ON PRODUCT INFO CARD

Disc & Cassette Manufacturing  
 Design • Film Output • Audio CD • DVD  
 CD-ROM • VHS Tape • Printing • Packaging  
 Timelines and Accuracy You Can Trust.

**american media**  
 MANUFACTURING

To discuss your project, call today toll free:

**1 888 442 8994**

MasterCard VISA

CIRCLE AD NUMBER 266 ON PRODUCT INFO CARD

*Brook Mays*  
**Professional**  
*a division of Brook Mays Music Co.*  
**THE DIGITAL AUDIO SPECIALIST!**  
 CREAMWARE • DIGIDESIGN • SONIC SOLUTIONS • SPECTRAL • ENSONIQ PARIS  
 MACKIE DIGITAL • YAMAHA 02R • SONY • TASCAM • TC ELECTRONICS • JOE MEEK  
 HMB • AARDVARK • DBX • FOSTEX • APPLE/PC SALES • AND MUCH MORE!

**214-631-0984**  
 spunky@cyberramp.net

CIRCLE AD NUMBER 267 ON PRODUCT INFO CARD

**COMPLETE**  
**CD and cassette packages!**  
 CD package price \$1,599 (1,000 order)  
 Cassette package price \$1,299 (1,000 order)

Mention this ad and receive an additional 25 CD's or cassettes FREE! a \$400 retail value!

Includes graphic design (4 hours), all film, mastering, 4/1-color printing, on product imprints, jewel box, polywrap. 4-week turn around on most jobs.

**SMG**  
 MEDIA SERVICES  
 (800) 791-7464 • www.SmithMusicGroup.com/media.html

CIRCLE AD NUMBER 270 ON PRODUCT INFO CARD

new & used \* buy, sell, trade

**vintage kings**  
 audio

empirical labs  
 "distressor"  
 alan smart  
 genelec  
 shep  
 spendor  
 velodyne  
 retrospec  
 purple audio  
 tracy korby mics  
 please inquire about products not listed

**huge inventory**

AKG C12/C12a/C24/C28/C30/C61/D25/D30/D36/D45/460; AC701;  
 ADA STD-1; ADR COMPLEX; ALAN SMART CL1+2; Altec Big Reds; AMS RMS/DMX;  
 AMEK Angela/Hend/Molz/Remb; AMPEX MM1200/ATR104; API 550/325;  
 AUDIX 35102; B+K 4011/4003; COLES 4038; CALREC pq15/1061/1161;  
 DOLBY SR XP24; EAR 660 (used); ECKMILLER Eq; FAIRCHILD 660;  
 FAIRMAN TMC; FOCUSRITE ISA110/130/215; HELIOS eq/pre; 30x24 console;  
 IRT 12x2/8x2 tube mixers; KLARK TECH. DN780; LANGEVIN;  
 LOFT Flanger; MCI JH24 mint;  
 NEVE CONSOLES melbourn/8068/BCM10/VR/5104/5316;  
 NEVE MODULES  
 1066/1073/1084/1089/31102/31105/32264+rack/33609/83065/2254+rack/1271/1272/3415;  
 NEUMANN  
 U47/U47tel/U48/M49/TLM50/U64/UM57/U87/582/KM53/54/56/84/85/86/88/  
 CMV563/IRFT Leipzig 7151/SM69let;  
 PULTEC MEQ5; PYE comp/lim; RCA DX44/77; ROLAND Dim D;  
 Scheopp 221b/CMS1U; SSL 4048; STUDER A800/820/827/820 1/2;  
 TC M5000; TELEFUNKEN V72/76/77/78; TRIDENT /85/980/B range;  
 UREI LA3/565

www.vintageking.com info@vintageking.com  
 phone (313) 965-0645 fax (313) 964-3338

credit cards accepted  
 financing available

CIRCLE AD NUMBER 268 ON PRODUCT INFO CARD

**SALE! PLUS FREE ADHESIVE!**

**GIANT 54" x 54" MARKERFOAM™ ACOUSTIC FOAM**

Immediate Shipping 2" Reg. \$29.95 Now \$19.99  
 3" Reg. \$39.95 Now \$29.99

**KILL NOISE QUICK!** High performance, full-size sheets of super high density Markerfoam. EZ mount. Blue or gray. Super-effective sound absorption for studios. Markerfoam offers best value, looks professional & is proven in studios worldwide. Request Foam Buyers Guide/Catalog, specs & free samples today.

**MARKERTEK JUMBO SOUND ABSORB BLANKETS**

Heavy-duty 72" x 80" padded blankets absorb sound wherever they're hung or draped. Fabulous for stage, studio and field use. Top professional quality at a super saver price! Weight: 6 lbs. Black.....\$19.99

**MARKERTEK BLADE TILES™**  
 HIGH PERFORMANCE - LOW, LOW COST!!!  
 America's best acoustic tile value only from Markertek!  
 \$3.49 per tile, 16"x16"x2", charcoal or blue \$4.49 per tile, 16"x16"x3", charcoal or blue \$5.49 per tile, 16"x16"x4", charcoal.

**MARKERSTIK™ FOAM ADHESIVE**  
 FREE with any foam purchase in this ad! Limited offer. A \$4.00 per tube value.

**SONEX**  
 All the Colors, Styles and Sizes Plus Great Prices!

**FREE!** America's most unique catalog featuring 328 pages of over 6,000 exclusive and hard-to-find supplies for Pro Audio, Broadcast Video, Audio Visual & Multimedia production.

**MARKERTEK®**  
 VIDEO SUPPLY

4 High St., Box 397, Saugerties, NY (USA) 12477  
 800-522-2025 • Fax: 914-246-1757  
 Web: www.markertek.com • E-Mail: sales@markertek.com

CIRCLE AD NUMBER 271 ON PRODUCT INFO CARD

**Anchor Your Speakers**  
 WITH  
**Sound Anchor Stands**

Your system will perform to its potential when you get your monitors off of the meter bridge, properly positioned and supported.

• STABLE • RIGID • DAMPED •

**Sound Anchors Inc.**  
 (407) 724-1237

**ADJUSTABLE MONITOR STAND**

**SOUND ANCHORS**

CIRCLE AD NUMBER 269 ON PRODUCT INFO CARD

**CopyPro CD Duplicators**

**Make CD copies in your studio!**



- Instant CD Copies
- Disc-at-once copying
- Track Editing
- Custom Compilations
- Up to 7 CD recorders

SX Series Rack Mount CD Duplicators

**Up to 28 or more CD copies per hour!**

Tel: 510-689-1200 Fax: 510-689-1263  
 Email: sales@copypro.com Web: http://www.copypro.com  
**1-800-887-9906**

CIRCLE AD NUMBER 272 ON PRODUCT INFO CARD



**CD and Cassette Manufacturing**

WMG is a full service audio & video duplicator specializing in custom manufacturing and special packaging. Besides working with the largest players in the entertainment and education industries, our operation boasts over 10 years experience working with people like you. Our goal is to provide quality product & service that is rivaled by no one in the business. We also offer full-package deals at the lowest possible price.

- Cassette Duplication
- CD Replication
- Digital Mastering: Editing, Assembly
- CDR Reference Creation
- Vinyl Record Pressing
- Video Duplication
- Graphic Design
- Pre-Press & Printing
- Custom Packaging

8737 East 30th St. Indianapolis, IN 46219  
 317-549-8484 fax: 317-549-8480  
 visit our website: [www.worldmediagroup.com](http://www.worldmediagroup.com)

we provide...  
**top quality**  
 product at the lowest price!!

**IN BUSINESS OVER 10 YEARS**

CIRCLE AD NUMBER 273 ON PRODUCT INFO CARD

**VT-2 Dual Channel Vacuum Tube Microphone Preamplifier**



Everything you want to know is available at

[www.dwfearn.com](http://www.dwfearn.com)

**D.W. FEARN** 610-793-2526  
 P.O. Box 57 • Pocopson, PA 19366

CIRCLE AD NUMBER 276 ON PRODUCT INFO CARD



**MULTIMEDIA REPRODUCTION SERVICES**

AUDIO/VIDEO CASSETTE - CD ROM/AUDIO - FLOPPY DUPLICATION

fast • affordable • guaranteed quality

**Bulk AUDIOCASSETTE DUPLICATION**

ferric	C15	C30	C60	C90
500	\$ .43	\$ .54	\$ .62	\$ .68
1000	\$ .34	\$ .42	\$ .51	\$ .57
2500	\$ .24	\$ .32	\$ .39	\$ .49

State Of The Art Digital Bin 1000 C-40's \$620.00  
 Includes J cards and Norelcos\*

**1000 CD's** (includes glass master)

Bulk packaged with 2 color silkscreen\* \$ 530

Jewel case, 4 panel folder, tray card, overwrap\* \$ 1,050

\*From your master and films

**MULTIMEDIA REPRODUCTION SERVICES**

AUDIO/VIDEO CASSETTE - CD ROM/AUDIO - FLOPPY DUPLICATION

**(800) 789-2173**

MASTERCARD, VISA, AMEX [www.multimediarepro.com](http://www.multimediarepro.com)

CIRCLE AD NUMBER 274 ON PRODUCT INFO CARD

**Your Best Choice For Audio Duplication!**

**DELUXE CD PACKAGES STARTING AT \$995.00**

- CD/CDRs
- Cassettes
- Mastering
- Design
- Printing



Major-Label Quality!

Why Settle For Less?

- FREE WEBSITE!
- FREE BARCODE!
- FREE CLEAR TRAYS!
- FREE 3RD DISC COLOR!
- With Deluxe CD PKG. \*

**1 (800) 553-8906**

(206) 285-2642 • FAX (206) 285-2394  
 duplication@martinaudio.com

PLANTS IN: SEATTLE • SAN FRANCISCO • MIAMI • MINNEAPOLIS

CALL TODAY FOR A FREE CONSULTATION & ESTIMATE



**FREE CATALOG**

From customer supplied DAT/CDR and print-ready film Subject to + or - 10% overrun/underrun adjustment. \*At retail. 50% deposit required. Ask for full details at purchase.

CIRCLE AD NUMBER 277 ON PRODUCT INFO CARD

**IT'S YOUR BABY AND WE DELIVER.**

- Services:
- Mastering
  - Design
  - Film & Printing
  - Web Development
  - Enhanced CDs

500 \$750.00

1000 \$1,100.00

5000 \$4,500.00

ALL PRICES INCLUDE MASTERING & DESIGN

**800-DIGIDOC DIGIDOC**  
[www.digidocpro.com](http://www.digidocpro.com)

CIRCLE AD NUMBER 275 ON PRODUCT INFO CARD

**GET IT FAST**

Don't trust your audiophile duplication needs to anyone else!

**Progressive Music**

[www.progressivecds.com](http://www.progressivecds.com) Avail. VISA & Master Card

2116 Southview Ave.  
 Tampa, FL 33606  
 (813) 251-8093  
 FAX: (813) 251-6050  
**Toll Free: (800) 421-TAPE**

"Fastest Turn-Around in the Known Universe!"

**ALL COMPLETE:**

Full color PKgs. with Inserts, from your CDr & Film

500 CD'S	\$980.00
500 CASS	\$690.00
1000 CD'S	\$1275.00
1000 CASS	\$905.00

\*\*\*also\*\*\*  
**\*NEW! 100 CD, RETAIL READY PACKAGE IN 5 DAYS!!! \$589.00**  
 (just give us a photo & mockup!!!)

CIRCLE AD NUMBER 278 ON PRODUCT INFO CARD

# Hardware Research

COMPUTER WORKSTATIONS



Rack Mounted Mac™ OS G3 and Windows NT™ workstations

Fully compatible with ProTools® 24 and ProTools® 24 MIX

For more info call:  
336-282-8450

www.hardwareresearch.com  
Info@hardwareresearch.com

CIRCLE AD NUMBER 279 ON PRODUCT INFO CARD

## CD and Cassette Prices That Are Out Of This World!

CD Packages include:  
PMCD & Glass Master  
2 Color On CD Printing  
Full Color 2Page Booklet  
And Much More...



COMPACT  
disc  
DIGITAL AUDIO

Call Toll Free 1-800-928-3310	500	CD's	1075	Cassettes	506
	1,000		1637		752

American Clients: No Tax \* No Duty \* No Problem!

CIRCLE AD NUMBER 281 ON PRODUCT INFO CARD

# EARTH DISC

cd rom cassettes vinyl mastering graphic design

**\$986.00 500 CDs**  
package includes:  
full color 2 page 4panel insert  
3 color on cd printing/glass master,  
jewel box, shrink wrap

**\$1299.00 500 CDs**  
we do it all  
package includes:  
graphic design/film  
full color 2 page 4panel insert  
3 color on cd printing/glass master,  
jewel box, shrink wrap

cd rom cassettes vinyl mastering graphic design

## 1-800-876-5950

the aliens have left the building

CIRCLE AD NUMBER 280 ON PRODUCT INFO CARD

# STOP!

CHECK OUT OUR  
SUPER LOW PRICES



# MS

- CDR REPLICATION
- PRE-PRESS SERVICES
- PRINT SERVICES
- AUDIO CASSETTES
- GRAPHIC DESIGN
- ASSEMBLY
- CUSTOM PACKAGING
- COMPLETE FULFILLMENT

## MEDIA SERVICES

WWW.MEDIAOMAHA.COM

# 1.888.891.9091

CIRCLE AD NUMBER 282 ON PRODUCT INFO CARD

## A sound philosophy...

SERIES 980

- classic 24 bus split console -

SERIES 900

- project studio 24 bus split console -

SERIES 990

- inline "virtual split" console -

### MTA AMERICA

716.589.2100 Web: Toft.co.uk

MTA mixing consoles are the creation of Malcolm Toft, a former recording engineer, who founded Trident Audio in 1972.



MTA

Malcolm Toft Associates

CIRCLE AD NUMBER 283 ON PRODUCT INFO CARD

# CLASSIFIEDS

**MIX** Classified Ads are the easiest and most economical means to reach a buyer for your product or service. The classified pages of **Mix** supply our readers with a valuable shopping marketplace. We suggest you buy wisely: mail-order consumers have rights, and sellers must comply with the Federal Trade Commission, as well as various state laws. **Mix** shall not be liable for the contents of advertisements. For complete information on prices and deadlines, call (800) 544-5530.

## Acoustic Products

### ★ACOUSTIC FOAM★

Diffusers • Bass Traps • Broadband Absorbers • Sound Barrier & More



**Introducing the Eclipse™ Stand-Mounted Modular Acoustic Environment!**

Famous artists, motion picture companies, studios & networks choose Auralex time & time again because we make the world's best sound control products regardless of price. We offer free, no-pressure advice & can solve any sound problem. Call us today!

USERS: James Taylor, Journey, Sammy Hagar, Quincy Jones, Smashing Pumpkins, Linn Buck, Debbie Dixon, Diane Perry, Lethro Tull, Dennis, McYoung, James Young, Todd Sucherman (Sly), Spyros Poulos (Madonna), Al Demosio, Kathy Troccoli, Taylor Dane, George Terry (Eric Clapton), Andrew Gold, Christopher Cross, Mike Winchick (John Mellencamp), Ross Valvelli, Skid Row, Mark Lindsay (Paul Revere & The Raiders), Norbert Shoroff (D. Pankin), Galin Broz, K. Rogers, E. Rabbit, etc. Mark Taper (Grand Funk Railroad), Todd Boda, B. Bellamy Bros., Wayman Fendley, Nora Hendry, John Baxter (Re-Flex), Disney, MUMFORD (A Lawrence Kasdan Touchstone Film), Elize Harjo Studios, LucasArts, Silicon Graphics (SGI), Todd-AO, JBL, Qualcomm, Time Warner Cable, Shure, Petros Acoustics (F. U. S. S.), Loggins, Skywalker Sound, Steven Klien, Pink, Sr. Eng., J. Crilena Studios (E. Clapton, Bee Gees, A. W. B.), & Studio Design (Don Was, Kenny G, Yip Yip Entertainment, Laurabe), Star Spound (R. Merchant, S. Colwell), Castle Oaks Prod. (Hilary Tremor, Wings, 21 Jump Street, S. Mendes, J. Feliciano), Sound Kitchen (P. Frampton, Petra), Digital Insight, AIT&I, NASA, Sony, CBS Sports, NBC Sports, ABC, TV & Radio, ESPN, MSNBC, Discovery Channel, Bill Putton (I Am Wasel/Carroll Network), Soaring, Collet, Bertels, College of Music, The Lincoln Center, Investor (Business Daily, Show Co, Qinyard), Music Bakery, Audio Grouping, WhisperRoom, Hiachi, Toshiba, 20th Century Fox, Universal Studios, NPR, Warner Bros., Polygram, chel Wolfgang Puck, Fruit of the Loom, Country, Common Tour, Manley Audio Labs, Lucant Technologies, 38TV, Electropex, Auden, Macromedia, Adapter, Martin Logan, Crawford Post, Mormon Church-TV, Pioneer, Cobra Golf, Carvin, MTX, Silver Dollar City, the voices of McDonald's, Miller Brewing & Sports on Fox and more.

**www.auralex.com • auralex@auralex.com**  
(317) 842-2600 • Fax (317) 842-2760  
(800) 95-WEDGE

**Auralex**  
acoustics

## ARCHITECTURAL ACOUSTICS FROM Professional Audio Design, Inc.

- DESIGN AND CONSULTATION FOR EVERY PROJECT - NO MATTER THE SIZE OR BUDGET
- EXCLUSIVE U.S. REPRESENTATIVES FOR MUNRO ASSOCIATES DESIGN, LONDON
- ROOM ANALYSIS AND MONITOR SYSTEM TUNING
- CUSTOM DYNAUDIO/MUNRO MAIN MONITOR SYSTEMS
- CUSTOM WIRING SYSTEMS DESIGNED AND INSTALLED
- EXCLUSIVE U.S. RESELLER FOR PRE-OWNED SSL CONSOLES

V (781) 982-2600 F (781) 982-2610  
www.proaudiodesign.com

THE SYSTEMS COMPANY  
RECORDING STUDIOS • MASTERING  
FILM • POST • BROADCAST



## IMPROVE YOUR ROOM SOUND!



**3'x3'x8" Wood & Foam Absorber/Diffuser Boxes**

- FREE-STANDING • PORTABLE
- LIGHTWEIGHT • STACKABLE

**SOUND ACOUSTICS**  
(630) 832-3064  
www.soundacoustics.com

## AcousticsFirst™

Toll Free: 888-765-2900

Full product line for sound control and noise elimination.  
Web: <http://www.acousticsfirst.com>

### SILENT

58 Nonotuck St., Northampton, MA 01062

**INFO (413) 584-7844 • FAX (413) 584-2377**  
**ORDER (800) 583-7174**

info@silentsource.com • www.silentsource.com

AcoustiCore Fabric Panels • Sound Barrier Isolation Hangers • A.S.C. Tube Traps Silence Wallcovering • WhisperWedge Melaflex • S.D.G. Systems • TecniFoam R.P.G. Diffusers • Sonex • Sound Quilt

## ETF

**ETF** is a software application that runs on your computer using Windows 95/NT, any 16 bit sound card, and an omni-directional microphone.

- **ETF Room Acoustic Analysis** measuring - Early and Late Reflections
  - Room Resonance
  - Frequency Response
  - Distortion
  - Reverberation Time Analysis
- **Device Designer** - Design of Helmholtz Resonators and Acoustic Diffusers
- **A primer and tutorial on Room Acoustics**
- **Using Time Delay Spectrometry techniques**
- **Used by Professional Studios Worldwide**

**The ETF System lists for \$199.95US Call: 1-800-301-1423**  
Visit [www.etfacoustic.com](http://www.etfacoustic.com) e-mail: [sales@etfacoustic.com](mailto:sales@etfacoustic.com)

## Business Opportunities

### SOUND EFFECTS WANTED

Company looking for original SFX in the following categories:  
extreme weather, animals, sports, European, cartoon & other. Leave message @  
**(415) 472-3023**

## Employment Offered

**Director of Sound Recording Technology**, in a strong, nationally-known college program that stresses an equal balance between musicianship and technology. Candidate should be experienced in recording, teaching, administration, and be knowledgeable in digital audio, computers and possibly multimedia. Candidate should also have a masters degree and be a practicing musician. For more information contact: Prof Keith Peterson, Chair SRT Search Committee, School of Music, SUNY College at Fredonia, Fredonia, NY 14063 (kpeterson@ait.fredonia.edu) SUNY-Fredonia is an equal opportunity, affirmative action employer and actively seeks and encourages women and minorities to apply.

## Computer Products



Full line of CD-Duplicators, CD-Recorders, CD-Printers and CD-R Media  
**1-888-474-4623**

SEE OUR AD IN MARKETPLACE pg. 214

## Acoustics by db

...all the others are just brokers.  
*Building Studios & Keeping 'em Alive for 29 years!*

- Total studio concepts designed by creative people.
- Control rooms, studios and turnkey packages.
- Wiring system design, custom cabling & full installations.
- Existing plans, custom traps.
- Consultation & advice on equipment or system choices.
- Room tuning, noise problems.
- Existing plans, custom traps.
- Equipment packages with used & vintage consoles, 24 tracks, mics & processing available.

1194 Walnut St, Suite 205  
Newton, MA 02461  
617 909-0585 • fax 617 904-1500  
email ob1db@earthlink.net

**Building a project studio? Designs from existing plans start at \$1,000 per room.**

**AES '98 SPECIALS**

4096G+ ULT: \$345k • SSL 9072J ULT: \$45 k  
6084EG: \$110k • Artek Mozart 56RN: \$75k  
Neve VF72FF: \$350k • Trident 80C: \$30k  
Neve 8078: \$225k • VIII48: \$65k • 8038: \$120k  
Neve 8128 56FF: \$85k • API 3224: \$40k  
Studer A827: \$36k • A820 w/SF: \$40k  
A800 MKIII: \$35k • Sony PCM3348: \$85k  
Otari MTR90 MKII: \$16k • MX80: \$11k  
EMT 250: \$12k • Quantec QRS: \$5k  
Teletronix LA2: \$3.7k • Neve 1064: \$1.9k  
Urei 1176LN: \$2.5k • 1178: \$2.5k • LA3A: \$1k  
Lex PCM42MEO: \$1.7k • AMS RMX18: \$3.8k  
Tele ELAM 251: \$12.5k • Tele U47/MF14: \$6.5k  
AKG C24: \$6.5k • C451E • C12 clone: \$3.6k  
C414EB Silver: \$1.2k • Dolby XP/SR24: \$13k

New products from Quedsted-Daking, TL Audio AlanSmart, PrizmAD/DA & Mastering eq Inward Connections-Optiflex, Sontec-Tident



## DO YOU WANT A GREAT CAREER?

**POSITIONS AVAILABLE NOW!**

Musical and Recording Equipment Sales, Desktop Publishing, Sales & Administrative Assistant, Tech Support & More! Contact Kristine!  
**(800) 222-4700 • (219) 432-8176 • FAX (219) 432-1758 • email: [careers@sweetwater.com](mailto:careers@sweetwater.com)**

## Employment Offered

The United States Air Force Band of the Rockies  
Colorado Springs, Colorado  
announces an opening for

# Audio Engineer

Audition Date: March 29, 1999

Peterson Air Force Base, Colorado Springs, Colorado

(Call by January 29, 1999 for audition information)

- Annual Salary approximately \$28,100\*  
\*married, living off base
- 30 days annual paid vacation
- Full military benefits  
(Includes medical/dental package and retirement plan)
- Maximum age at enlistment is 34

For audition requirements call (719) 556-9916 FAX (719) 556-9963

Director of Auditions  
The USAF Band of the Rockies  
520 Oils Street  
Peterson AFB, CO 80914-1620

Visit our web site at: <http://www.spacecom.af.mil/hq/afspc/band/index.htm>

## SALES REPRESENTATIVES

Location Sound Corporation in North Hollywood, CA and Las Vegas, NV has openings for pro audio sales representatives. Candidates must possess strong knowledge of professional audio equipment and previous sales experience. Partial reimbursement of relocation costs may be provided for successful out-of-state applicants. We offer a competitive salary based upon experience and an attractive benefit package.

Contact Steve Joachim in North Hollywood  
at (818) 980-9891 ext. 302

or Payam Sahihi in Las Vegas at (702) 895-8935  
for additional information.

## SERVICE TECHNICIANS

Location Sound Corporation in North Hollywood, CA has openings for full-time, experienced service technicians for walkie-talkie and wireless microphone, or digital and analogue tape recorder repair. Successful candidates will possess strong diagnostic skills, at least two years of bench experience, and management potential. Audio knowledge and recording experience are pluses. Partial reimbursement of relocation costs may be provided for successful out-of-state applicants. We offer a competitive salary based upon experience and an attractive benefit package.

Contact Edwin Somers at (818) 980-9891 ext. 311  
or [service@locationsound.com](mailto:service@locationsound.com)



## Employment Wanted

Independent Monitor or  
FOH engineer seeks  
quality live production  
team for short-term audio  
projects in 1999.  
Resume available:  
[mfrink@teleport.com](mailto:mfrink@teleport.com)  
(503) 223-2345.

**Experienced Audio Engineer**  
available for hire. Credits include  
editing, mixing & sound design  
for TV & Radio production, National  
Commercials, Surround  
sound, Music & Multimedia presentation.  
Demo CD, VHS and  
references available for review.  
Willing to relocate. Please call  
(248) 945-0337 or (810) 385-  
1460. Email: [golberg@wwnet.com](mailto:golberg@wwnet.com)

Mix Classifieds (800) 544-5530

## Equipment Financing

# LFCI Equipment Leasing

DIRECT LENDERS

SPECIALIZING IN AUDIO - VIDEO EQUIPMENT

⇒ No Down Payment

⇒ Application Only For Up To \$50,000

⇒ New & Used Equipment

CALL: (800) 626 - L F C I

VISIT OUR WEB SITE: <http://www.lfci.net>  
APPLICATIONS, QUALIFICATIONS, THE LEASE PROCESS

ALSO APPLY FOR OUR \$10,000 CREDIT CARD / LEASE

## EQUIPMENT FINANCING

• FAST, EASY APPROVALS

• We Specialize in  
Audio-Visual Equipment

• No Financials Necessary

• True Lease or Finance  
Lease Option

• New or Used Equipment

LOANS BY PHONE

Call Jeff Wether

(800)699-FLEX

24hr. Fax (972)578-0944



**FLEXLEASE, Inc.**  
COMMERCIAL EQUIPMENT FINANCING

Funding Provided By  
**WINR**  
Business Credit

## GREAT RATES ON INSURANCE!

\$45,000 of Studio Gear for \$500  
\$100,000 of Gear for \$900  
\$250,000 of Gear for \$1,875

### GREAT COVERAGE!

Includes Theft, Breakage & Loss  
Covered Wherever Located\*  
Coverage for Rented Gear Also  
\$1,000 Deductible

### GREAT SERVICE!

Immediate Coverage Available  
Easy Enrollment  
Local Claims Offices

(800) 800-5880



UNITED AGENCIES INC. Insurance

Pasadena, California  
CA. License # 0252636  
[www.UnitedAgencies.Com](http://www.UnitedAgencies.Com)

## Equipment for Sale

**ANALOG  
AMPEX & SCULLY PARTS**

**SEQUOIA  
ELECTRONICS**

Tel (408) 363-1646  
FAX (408) 363-0957

**Sound  
thinking**

**Digital Audio:  
It's What We Do!**

**digidesign ALESIS**

...and more

**new!**  
wwwbite  
**541-386-2682**  
[www.soundthinking.com](http://www.soundthinking.com)

# Check Out MIX Online

<http://www.mixonline.com>

# Looking for Pro Audio Equipment ? (Like to buy it at your own price?)

Then you'll love **www.digibid.com**

The Online Auction For Buying Hard-to-find Gear!

*Open 24 hours every day...we'll leave the light on for you!*

#### MOBILE RECORDING STUDIO

- 42' lead-lined semi-trailer
- All steel w/large storage bays
- Solid 4" floor
- Overdub booth/lounge
- Control room 15' wide
- Machine room/shop
- 300' snakes w/pwr spoolers
- Air conditioned
- Security and phones
- Proven mix environment!

(615) 292-2300  
Fax (615) 297-6688

Otari Concept One console. 48  
100 mm moving faders in 64  
fader frame. 24 bus w/split  
bus option. DiskMix auto,  
external patchbay. Like new.  
\$25,000 obo.

Ed (404) 522-6430.

#### 1996 API CONSOLE FOR SALE

Custom Built. 64-channel  
with Ultimition & moving  
faders. (305) 769-9700

#### AMS/Neve Audio Systems

Logic 1 w/audiophile spectra 24  
Logic 2 w/audiophile spectra 24  
Logic 3 w/audiophile spectra 24

Contact: Andy Lewis  
Cutters, Inc.  
(312) 644-2500

**Klay Anderson Audio Inc.**  
PRO AUDIO SALES AND SERVICES  
"Good Sound is the Absence of Bad Sound"  
**1.800.FOR.KLAY**  
7054 SO. 2300 EAST • SALT LAKE CITY, UT 84121  
VOICE 801.94.AUDIO • FAX 801.942.3136  
HOMEPAGE: <http://www.klay.com>

**Uvista Enterprise Music**  
Digital Musician's  
Gear For Sale  
VOICE-AUTOMATED SHOPPING  
MC/Visa/Amex/Ch/MO  
sejones@erols.com • Fax (610) 631-2227  
Ph: (610) 631-2224

LOOKING FOR  
BETTER SOUND?  
Component-level upgrades for mix-  
ing consoles, tape machines, mics &  
all outboard gear. Also, high-speed  
high-quality mic preamps.  
AUDIO UPGRADES  
6410 Matilija Ave.  
Van Nuys, CA 91401  
(818) 780-1222  
Fax (818) 886-4012  
<http://home.earthlink.net/~jwilliams3/>

 **Optical  
De-esser  
#31**  
918/809-3604  
De\_esser31@aol.com

Soundcraft TS-24 32-ch inline  
console, 64 in, 24 Bus 8 Aux, 4-  
Band Para EQ, MeterBridge, TT  
Patchbay, Stand, \$7.5k OBO;  
Sonic Solutions, 4-ch I/O, 12-ch  
PB, SSP Medianet, Nubus, Mac  
Q950, \$4k; UREI 815 Time-  
Aligned, 3x15 monBlueCo-ax  
horn, Xover, \$2.5k OBO/Pr; Tas-  
cam BR20T Timecode 1/4"R-  
R, \$600; Soundcraft Delta 200,  
16 Frame, 27 in, 3 Stereo Channel  
8 Rtms, 4 Bnd Dlx Swp EQ, 6 Aux  
ATA Case, mint \$2.5k; TC Elec-  
tronic 1128 EQ/Analyzer, Video  
out, All options, \$1k. (818) 609-  
0746.

**AUDIO TOYSHOP LTD**  
NEVE VRL 60 as new £190k  
NEVE V3 48 uptown FF £75k  
AMEK ANGELA recons from £8k  
AMEK HENDRIX22 supertrue £8k  
AMEK MOZART RN 40 £27.5k  
HARRISON X10 amazing £15k  
STUDER 928 console NEW £30k  
STUDER D827 48t ex.cond.£70k  
SONY PCM 3348 £40k  
EMT 251 R2D2 reverb £3.5k

+loads more totally cool gear+  
Don't buy until you talk to us  
Tel: +44/1225 447-222  
Fax: +44/1225 447-333  
[www.audio-toyshop.co.uk](http://www.audio-toyshop.co.uk)

#### VINTAGE NEVE™ 1272 PREAMPS with D.I.



**\$989 Single w/p.s. \$1659 Two channel w/p.s.**

VINTAGE NEVE™ 3405 PREAMPS with D.I. (PRE FROM NEVE 1081 EQ)  
**\$749 Single w/p.s. \$1249 Two channel w/p.s.**

VINTAGE API™ PREAMPS with D.I. (MADE FROM API 312 CARDS)  
**\$1349 Two channel w/p.s. \$499 Plug-in module**

POWERED RACKS FOR VINTAGE API™ PREAMPS AND EQ'S  
**\$499 6-Module portable \$539 6-Module rack mt \$799 11-Module rack mt**

**Brent Averill**  
ENTERPRISES

14300 Hortense Street • Sherman Oaks, CA 91423  
818 784-2046 FAX 818 784-0750  
[www.brentaverill.com](http://www.brentaverill.com)

  
HUGE SELECTION OF VINTAGE EQUIPMENT

**NEW, USED & VINTAGE  
CONSOLES • RECORDERS  
MICROPHONES • OUTBOARD**

- Complete Studio Installs
- Great Package Pricing
- We Purchase Your NEVE or SSL Console Anywhere Worldwide
- Specializing in Neumann Microphone Capsules
- We Buy and Trade Equipment. Fax Us Your List
- Full Service & Repair Department

AKG • API • COLES • NEUMANN • NEVE • SONY  
SSL • STUDER • TELEFUNKEN • TRIDENT

FINANCING AVAILABLE    3% CASH DISCOUNT

**PHONE 818.992.0999 • FAX 818.340.4331**  
[WWW.CLASSICELECTRONICS.COM](http://WWW.CLASSICELECTRONICS.COM)

## Equipment for Sale

### Colossal Sound Services

New & Used Equipment  
Mics Recorders Mixers  
Booms Wireless & More  
(818) 990-1895  
(818) 501-4845  
[www.ColossalSound.com](http://www.ColossalSound.com)

## HARBOR SOUND

### HUGE SELECTION OF USED, VINTAGE & NEW GEAR

Consoles, Mics, Recorders.  
Buy & Sell vintage NEVE & API  
modules, Pultecs, Tube mics.  
New Equipment in stock.  
Credit cards accepted.

Ph: (781) 231-0095  
Fax: (781) 231-0295  
[www.harborsound.com](http://www.harborsound.com)

FOR SALE  
OTARI CONCEPT ONE  
32-frame, 64 chs in mix, SMPTE  
automation, extra patchbays,  
speaker mounts, PERFECT  
condition, MUST sell!  
Gary (810) 264-7500

**Masterpiece A/V, Inc.**  
Call Aaron & Jamey  
For a Wide Selection of New Professional  
Audio/Video Gear Media & Accessories  
Toll-free (888) 776-2835  
fax (860) 354-9057  
<http://www.masterpieceav.com>

VT-2 Vacuum Tube Mic Preamp  
[www.dwfearn.com](http://www.dwfearn.com)



**D.W. FEARN**

SEE OUR AD IN MARKETPLACE pg. 217

### IT'S BACK!! AM5116C Preamplifier



Inward  
Connections  
(818) 883-9012

Lexicon Opus audio work-  
station with 12-channel  
mixing console. Best offer.  
Call Lorie or Dave at (612)  
333-5480. Fax (612) 333-  
6927.

**"this is not a problem"**

(508) 543-0069 TEL  
(508) 543-9670 FAX  
<http://www.mercenary.com>

**NEVE™ 1272  
MIC PREAMPS  
2 CH- RACKMOUNT  
BEST PRICES!  
813-643-8114**

**THE MIC SHOP**  
TUBE MICROPHONES  
BOUGHT/SOLD/SERVICED  
Mic Power Supplies & Cables  
Bill Bradley (615) 595-1717  
Fax: (615) 595-1718  
Visa/MasterCard  
<http://www.micshop.com>

**DAN ALEXANDER AUDIO  
BUYS, SELLS AND REPAIRS  
RECORDING EQUIPMENT.**  
(415) 546-0200  
FAX (415) 546-9411  
[da.audio@internetMCI.com](mailto:da.audio@internetMCI.com)

### 6386 Variable Mu Tube Limiter



A Modern Approach to Classic Tube Compression  
• Same Gain Control Tube as the Fairchild Limiter  
• Class A Sonically Accurate Signal Path

Pendulum Audio (908) 665-9333  
[www.pendulumaudio.com](http://www.pendulumaudio.com)

SEE OUR AD IN MARKETPLACE pg. 213

## OMNIRAX STUDIO FURNITURE



Custom Design  
and  
Modifications Available

**800.332.3393**  
FAX 415.332.2607  
Outside U.S. 415.332.3382  
[WWW.OMNIRAX.COM](http://WWW.OMNIRAX.COM) P.O.Box 1792 Sausalito, CA 94965

Available for  
All Machine  
to Bus moves &  
Eurodesk

**MARQUETTE  
AUDIO LABS**  
\*RECORDING EQUIPMENT\*  
Mics, Preamps, Comp/Lmtrs, Consoles + more  
Custom Racking of Vintage Gear  
V72, V76, Neve, Calrec, Langevin, ECT...  
Phone (510) 581-3817 Fax (510) 581-3917  
[www.marquetteaudiolabs.com](http://www.marquetteaudiolabs.com)



Yo Ho Ho...  
who'd be a Turkey at Christmas?  
YOU... that's who!

If you don't check out our prices first  
before writing to Santa.  
Call, fax or e-mail for your copy of "stocking fillers."  
We would like to take this opportunity  
to wish you all a very Merry Christmas  
and a seriously funky New Year...  
cluck...woof!

funky junk, Ltd. 505-507 Liverpool Rd., London N7 8NS  
Telephone: 011 (44) 171-609-5479  
Fax: 011 (44) 171-609-5483  
<http://www.funky-junk.co.uk>  
[sales@funky-junk.co.uk](mailto:sales@funky-junk.co.uk)

Directors: Mark Thompson, Helen Rider, Stephen Lane, Clive Richards

### Equipment Appraisal Facility Liquidation

Hamilton Brosious  
Associates  
(800) 423-5499

### GREAT NEW LOW PRICE! Vac Rac Systems



Inward Connections (818) 883-9012

API, Jensen, etc....

**2520™ / 990™**

Finally, pure Class-A, all discrete  
direct replacement J-FET op-amps  
of exceptional musical realism.  
From Millennia Media, Inc.

T 530-647-0750 [www.mil-media.com](http://www.mil-media.com)  
info@mil-media.com

**VINTAGE**  
NEUMANN • NEVE • AKG • STUDER  
API • TRIDENT • AMEK • UREI • RCA  
EMT • TELEFUNKEN

Package Deals • Buy-Sell-Trade  
Call for List • Worldwide Shipping

**COOL GEAR**

**512.338.6777 • [www.kdi.com/~stardog](http://www.kdi.com/~stardog)**

**The Professional Choice**  
Recording • ENG • Film Sound Studios • Broadcast • Post  
Equipment sales, tech support and great prices.

**turner audio**

(203) 270. 2933  
www.turneraudio.com

**MILAM AUDIO**  
"THE SOURCE"  
SINCE 1967

SPECIALIZING IN ALL TYPES OF RECORDING EQUIPMENT, SUPPLIES, DESIGN, INSTALLATION, AND CONSULTATION

CONSOLES ■ D.A.T. ■ MICS  
MULTI-TRACKS  
MONITORS ■ AMPS

CALL US TODAY

**MILAM AUDIO**

1470 Valle Vista Blvd.  
Pekin, IL 61554  
Orders (800) 334-8187  
Info (309) 346-3161  
Fax (309) 346-6431  
www.dpc.net/~milamaud  
e-mail: milamaud@dpc.net

**Looking for Music & Recording Equipment?**  
**CALL SWEETWATER — YOUR MUSIC TECHNOLOGY AUTHORITY!**  
**Want the Best Selection?**  
Massive stock of recording, MIDI, Sound Reinforcement Guitars, Bases, Amps and Accessories.  
**Want the Greatest Convenience?**  
Shop by phone—no running around! We deliver to your door! Top-notch assistance—no high pressure!  
**Want the Best Value — Guaranteed?**  
The right gear at a fair price! Outstanding tech support & service. Genuine respect. A great experience!

**Music Technology Direct — and the Best Value, Guaranteed!**

**Sweetwater SOUND INC.** (800) 222-4700  
(219) 432-8176  
Fax: (219) 432-1758  
www.sweetwater.com • sales@sweetwater.com

**PATCHBAYS VINTAGE GEAR**

we buy-sell-trade, see our list at  
www.audiovillage.org  
**(760) 320-0728**

Every major brand of everything. Millions of dollars of musical gear in stock. ALTO MUSIC. Guitars, recording, keyboards, amplifiers, drums, pro sound, new & used. One of the largest selections in the country. We ship everywhere!  
**(914) 692-6922 • 680 Rt. 211 East Middletown, NY 10940**  
Ask for Uncle Freddy—He loves ya!

**Coles 4038 RCA 44s & 77s**  
(800) 798-9127  
Call Wes Dooley

**SOUTHERN CALIFORNIA PRO AUDIO**  
NEW, USED AND VINTAGE THE LAST CALL YOU'LL HAVE TO MAKE!  
Phone: (818) 222-4522  
Fax: (818) 222-2248

**vintage kings audio**  
(313) 965-0645  
SEE OUR AD IN MARKETPLACE pg. 216

**Odyssey pro sound**  
new, used & vintage recording equipment

BUY • SELL • TRADE  
Vintage, Tube, Classic, Consoles, Tape Machines, Mics and Outboard!

Neve, API, Fairchild, Pultec, Urei, Neumann, Studer, Manley, Quedest & more...

Customer Satisfaction & Quality Guaranteed!

Phone (978) 744-2001  
Fax (978) 744-7224  
MC VISA AMEX  
www.odysseyprosound.com

**POWER HOUSING YOUR MACKIE D8B**

EXPANDABILITY  
MULTIPLE CONFIGURATIONS  
IN STOCK, READY TO SHIP

**STUDIO FURNISHINGS**  
(800) 427-5698 (573) 346-8543  
argosyconsole.com

United States Audio  
SSL Screensound, \$20k\*TRIDENT A Range 28/24/48 \$ Call\*HARRISON 4032, \$10k\*SONY JH-24, \$10k\*24 Ch DOLBY XP, \$10k\*FOCUSRITE & MORE! \*STUDIO LIQUIDATION\*  
Ph(818) 887-6600 Fx(818) 887-4700

35mm MAGNETIC DUBBERS:  
Magna-Tech Reproducer Recorders w/Interlock: MD-235, MD-636, MR-436 for sale. Call Michael Temmer, (212) 206-1475. Fax: (212) 929-9082.

**ALAN SMART COMPRESSORS**

C-1, C-2, & Multi-channel versions  
Now available in the U.S. exclusively from:  
Sunset Sound, Hollywood (213) 469-1186  
• Sales (888) 463-7012 •

**UPGRADE YOUR VOCALS**  
with Variable Acoustic Compression™  
You choose 1 or 2 screens & distance between screens  
User List: Westlake Audio, Sony Music, MCA Music, Masterfonics, Paisley Park, CBS, ABC, Fox Broadcast...

• 6 or 3.5 inch diameter screens \$32\*  
• with gooseneck & mic clamp \$54\*  
• washable, replaceable screens \*plus  
• money back guarantee shipping PO Box 1014, New Paltz, NY 12561  
call, fax or write for FREE brochure (800) 252-1503 or (914) 255-3367

**VOICES**  
ball and socket positioning w/ mic thread  
3 position screen holder

"A HALFWAY HOUSE FOR THE SERIOUSLY AUDIO ADDICTED"

Aardvark • AKG • Amek/Langley • API • Apogee • ATI • Avalon Designs • B&K • Beyer/pl • BLUE Dirk Brauner • Bryston • Cedar Audio • Crane Song • DB Tech. • Digidesign • DK Audio • Dolby Pro D&R • Drawmer • Dynaudio • Earthworks • Empirical Labs • Equi-tech • Eventide • Focusrite Genelec • GML • Grace Designs • Great River • H&B/Genex • Lexicon • Mackie • Manley/Langevin Microtech Gefell • Mytek • Neumann • NTI • Otari • Prism Sound • Purple Audio • Panasonic Pro Rorke Data • RPG • Sennheiser • Sony Pro • Soundlux • Soundfield • Summit Audio • TAYTRIX TC Electronics • Timeline • Tube Tech • Tube Trap • Waves • Yamaha Digital • Z Systems and many more

Quality Audio Tracking, Mixing and Mastering Tools  
Sales • Service • Installation • Consultation • Leasing

**STUDIO TECH SUPPLY**  
9982 Monroe #407 Dallas, TX 75220  
Phone: 214 358 0050 www.studiotechsupply.com Fax: 214 358 0947

WEB PAGE - www.questx.com/bae  
Phone: (615) 242-0596 Fax: (615) 242-0599

LOTS TO SELL-----  
SEVERAL MCI 24-TK MACHINES  
OTARI MTR-90 III, VARIOUS MULTITRACKS  
NEUMANN AND SANKEN MICS  
OUTBOARD GEAR  
MCI JH600 PARTS - MCI MACHINE CARDS

**END OF THE YEAR CLEARANCE SALE**  
**(B.A.E. Inc.) aka BLEVINS AUDIO EXCHANGE**

## Equipment for Sale

**THE CASE SPECIALISTS**  
FREE CATALOGUE

 (800) 346-4638  
(516) 563-8326, NY  
(516) 563-1390, Fax  
Custom or stock sizes.  
Our prices can't be beat!  
Discount Distributors

**OCEAN AUDIO INC.**  
SELLS AND BUYS USED EQUIPMENT SINCE 1962  
LOTS OF RARE, OLD & NEWISH, STRANGE AND SOME VERY FUNNY PIECES  
LIST YOUR UNDER-USED EQUIPMENT FREE ON OUR DATABASE  
THE LARGEST USED EQUIPMENT LISTINGS IN THE WORLD  
Phone (310) 459-2743 (303) 449-8322  
Fax (303) 449-8558  
Email: hadlerd@netOna.com  
Now internet Listings  
<http://www.visionwork.com/oceanaudio>

**Digital Recording**  
Factory Direct Discount Dealer  
\* Alesis \* Yamaha \* Sony \*  
Tascam \* Roland \* Akai \*  
\* Event Electronics \* Digital  
Audio \* Fostex \* Korg \*  
**Pro Audio Plus**  
(800) 336-0199  
Division of Rolls Music Center

VINTAGE NEVE, NEUMANN  
AND MORE

[WWW.MUSICVALVE.COM](http://WWW.MUSICVALVE.COM)

MUSIC VALVE ELECTRONICS, INC.  
NEW YORK CITY

## Professional Audio Design Inc.

SSL  
API  
GML  
AKG  
RØDE  
Otari  
Avalon  
Neotek  
Manley  
Lexicon  
Daking  
Focusrite  
Brüel & Kjær  
Tube Tech  
Soundscape  
Soundcraft  
T.C. Electronics  
Dynaudio Acoustics

... Call for complete list of new products

[www.ProAudioDesign.com](http://www.ProAudioDesign.com)

(781) 982-2600 fax(781) 982-2610  
357 Liberty St. Rockland, MA 02370

New, Used and Vintage Equipment  
• Sales • Service • Design • Installation

**EQUIPMENT SPECIALS**  
SSL 4096+/UIE • SSL 40S6E/G • SSL 6048E/G • SSL 6060E/G • Neve VR60FF • Neve VR48FF • Neve V-III 60FF • Neve V-I 48FF • Neve 8088-48I/O FF • Sony MXP3036 • Amek Einstien 80 Input • Trident 80C 32x24 Auto-Trident 80B 32x24 • Trident 24 36x24 • API 32x24 • API 3124 micpre's • API 550B • API 512B • Neve modules and racks • Neumann U47, U67, M49, Km54, Km56, U87, Km84 • Studer A800MKIII • Studer A827 • Studer A80MKIV • Urei I176, I178, LA3A, LA4's • Telefunken V72, V76 systems • Tube-Tech LCA-2B, Manley Vari-Mu • Pultec EQPIA3, EQPIA • Dynaudio Acoustics M4's, BM15, BM6A • AKG C12, C24, C414 • Lexicon 480L, PCM42, PCM70, 224XL • T.C. Electronic M2000, Finalizer • Many other items in-stock and available.  
Call for complete list.

 **SSL**  
authorized preowned console sales & service

## OKTAVA BEST RUSSIAN MICS

- MK-012 condenser.....\$200
- VM-100 tube, condenser...\$650

## VINTAGE BEST GERMAN & AUSTRIAN MICS

from RUSSIA  
TEL/FAX: 011-7-095-299-1161

**We've got your n'hummer.™**  
Kills the hum in audio lines. No transformers, noise gates or comb filters. It works; guaranteed! \$249.95 + s/h for a 2-channel unit.  
[www.stro-lion-technologies.com](http://www.stro-lion-technologies.com)  
**800.567.0881**



Harrison Raven 32x24, w/JL Cooper auto., w/patch bay, \$12k; Otari MTR90MKII, 16 tk, 2", w/remote/locator & new play head, \$8k; Roger Meyer 5-band EQs, 10 in roll-around track, \$3k; Complete studio & building for sale in Boston, ready to go, \$299k. Call Paul @ (617) 484-6938 or e-mail paul@belmontmusic.com

**The RACKIT™ System**  
Modular, stackable oak units hold all recording formats and equipment  
**Free mail-order brochure** (please mention Mix)  
**Per Madsen Design**  
(415) 822-4883 • P.O. Box 882464  
San Francisco, CA 94188



**SINGERS! REMOVE VOCALS**  
**Unlimited Backgrounds™**  
From Standard Tapes, Records, & CDs with the Thompson Vocal Eliminator™  
Call for Free Demo Tape.  
Internet <http://itsound.com>  
LT Sound • Dept. MK-4  
7988 LT Parkway  
Lithonia, GA 30058  
24 Hour Demo Info  
Line (770) 482-2485 • Ext 8  
Best Vocal Eliminator™, Key Changer, Voice Enhancer!



**NEW, USED, DEMO EQUIPMENT**  
**BEST SELECTION OF DIGITAL/ANALOG RECORDERS, CONSOLES, DAWS, OUTBOARD GEAR**

Otari C1 4032, Yamaha 02R, API 1200 rack system, Dynaudio Monitors, Alesis ADAT, Tascam DA-88, Sony PCM800, Otari Radar 24tk, Pro Tools III, All Digidesign Plug-Ins, Mackie 8-Bus, Apogee AD1000, Lexicon PCM80/90, TC Elec. M5000, CD Recorders, API, GML, ADL, Summit, Focusrite, Demeter, Lucas, TL Audio, Neumann, AKG, Microtech, RØDE, B&K, Genelec, Dynaudio.

Studio and System Design, Financing, Factory Service/ Installation, Experienced and Knowledgeable Sales Staff.  
**EAR PROFESSIONAL AUDIO**  
(602) 267-0600  
<http://www.ear.net>

**The AMPEX Source**



- ATR100 sales & restoration services
- 1/2" two-track mastering conversion featuring Flux Magnetics heads
- HDV-2 modular tube electronics and transformerless I/O for ATR100
- Transports upgraded for better-than-new performance and reliability
- MM1200 service and upgrades

Call Michael Spitz at 650-574-1165  
Fax 650-574-2064

**ATR SERVICE COMPANY**  
AMPEX SPECIALISTS  
Visit us at our AES booth

**BALANCED AC POWER SYSTEM**  
Balanced AC power is as good as they say it is, but doesn't cost as much as they say it does. \$499 buys 1,500 watts packaged the way you'd use a B.P.S. Call (673) 334-6740 or [www.spectrumxfm.com](http://www.spectrumxfm.com) for info.

VINTAGE GEAR PARTS  
Tubes, Wire & Cable, semiconductors, ICs, pots, switches, relays, caps.  
All your Pro Audio parts needs.  
Retrospec/RETRO-PARTS DIVISION  
ph: (914) 688-7329

**MAGIC AUDIO**  
**PRO AUDIO SALES CONSULTATION INSTALLATION**

ATLANTA  
phone: 404.873.6161  
fax: 404.873.8318  
[magicchk@bellsouth.net](mailto:magicchk@bellsouth.net)  
[www.magicaudio.com](http://www.magicaudio.com)

**SOUND ANCHOR SPECIALTY AUDIO STANDS (407) 724-1237**

DESIGNED FOR ULTIMATE PERFORMANCE BEHIND CONSOLE AND FREE SPACE APPLICATIONS.  
Standard & Custom Models  
**SEE OUR AD IN MARKETPLACE**



SEE OUR AD IN MARKETPLACE pg. 216

EXCLUSIVE FACTORY AUTHORIZED RESELLER  
**www.UsedSSL.com**  
PROFESSIONAL AUDIO DESIGN, INC.  
(781) 982-2600

**NEUTRIK TT CABLES \$10.99 ... 24"**  
3-Yr Warranty! also 12/18/36  
**REAN 96 pt TT BAYS**  
\$229-\$269 / Better Than SW  
**HHB CDR800: best \$**  
**HHB ADAT45: \$6.99**  
GREEN DOT (615) 366-5964

**How BIG is Yours?**  
HARD DRIVES Digital Audio Specialists!  
CD RECORDER  
MEMORY CHIPS  
SOUND CARDS  
**BIG DISC** MIDI SOFTWARE  
(954) 749-0555  
<http://www.bigdisc.com>

**sonic world**  
quality new and vintage gear from germany  
<http://www.thatworks.com/sonicworld>

**FRX your Mix Classified**  
510 • 653-8171



**Bayview Pro Audio**  
 Tumwater, WA, USA  
 Toll-Free (888) 718-0300  
 Int'l: (360) 753-3862

**Software**

Sound Forge 4.5 \$299  
 Sound Forge CD Architect \$249  
 Steinberg WaveLab 2.0 \$319  
 Waves Native Power Pack PC/MAC \$285  
 Sek'd 24/96 CALL  
 Red Roaster 24 \$179

**Sound Cards**

Digidesign ToolBox CALL  
 Zefiro Acoustics ZA2 \$419  
 Sonorus STUDI/O w/cables \$629  
 AdBMulti WAV/24 Digital & Analog \$389  
 Event Gina \$399  
 Event Layla CALL

**Monitors, Mics & Processors**

Rode NT2 Ormi & Cardioid \$499  
 Rode Classic "Tube" CALL  
 Rode NT1 cardioid \$289  
 TC Electronic Finalizer Plus CALL  
 Event 20/20 bas Pwr. Biamped \$799  
 AKG C 3000 \$269  
 AKG SolidTube CALL  
 ART-Tube PAC \$209.95

[www.bayviewproaudio.com](http://www.bayviewproaudio.com)  
 We Accept Major Credit Cards

**Pro Tools/24 Rentals**  
 888 24 Mac 9600 300 128ram  
 Sony Monitor, Autotune, Focusrite, Digi  
 Plug Ins, Cheetah 10k 999 drives & more.  
 Editors Avail. Short & Long Term Rates.  
**YOUR PLACE OR OURS**  
 Nave, Otart, Automated, DA-68, 2" 24Trk,  
 Yamaha Drums, Baby Grand, John Storyk  
 Designed Visit [www.mediarecording.com](http://www.mediarecording.com)  
**Media Recording**  
 Merrick, NY 516-783-5201

**Equipment Wanted**

**(800) 264-6614**  
 We want your used keyboard, recording and audio equipment. We'll airmail you \$\$\$ or take your stuff in trade toward over **350 brands** of new and used products. **Come in, or do it all through the mail.** 69 years in business. **Worldwide delivery.** Visit our new **22,500-sq.-ft.** location. Call, fax or e-mail us today. **carusomusi@aol.com** OR **sales@caruso.net.** Visit us at [www.caruso.net](http://www.caruso.net). Start saving money today. Call **Caruso Music**, 94 State St., New London, CT 06320 USA. Outside of the U.S. call **(860) 442-9600.**

**EQUIPMENT WANTED**  
 BUY OR TRADE  
 YOUR USED MULTITRACK  
 RECORDERS  
 AND CONSOLES  
**EAR PROFESSIONAL  
 AUDIO/VIDEO**  
 (602) 267-0600

**USED ADATS WANTED**  
 Easy exchange toward a newer or different format. Everything available. Save **THOUSANDS** when you deal with our 70-year-old company. **UPGRADE TODAY.** Call, fax or e-mail for details. Worldwide delivery. **CARUSO MUSIC**, New London CT: **sales@caruso.net**  
**(800) 264-6614 TOLL FREE**  
 (860) 442-9600  
 (860) 442-0463 (FAX)  
<http://www.caruso.net>

Check out our affordable financing packages!



**Trident Owners!**

Join the hundreds of studios worldwide! Transform your great sounding Trident into a state-of-the-art console by installing **Uptown's** moving fader automation! Call for a free brochure or free demo disk!

**800-343-3237**

Uptown Automation Systems, Inc.  
 9017-C Mendenhall Ct.  
 Columbia, MD 21045  
 410-381-7970 (phone)  
 410-381-5025 (fax)



[www.mixonline.com](http://www.mixonline.com)

**Equipment Rentals**

**"RENTALS WITH SERVICE"**



Professional Audio Rental Company for **Music • Film • Post**  
 We Carry Everything!

**818/843-6555 800/441-4415**

**Instruction**

**Recording Engineer Broadcasting**

Multimedia/Digital/Video/Film  
 Radio/TV/Sports/News/DJ/Talk Show

No experience required!  
**On-the-job-training**  
 in local major Recording Studios & Radio/TV Stations  
 Part-time, nights, weekends - Call recorded info line for FREE video  
**1-800/295-4433** <http://www.sna.com/musicbiz>



**Comprehensive Audio Engineering Program**  
 AUDIO RECORDING TECHNOLOGY INSTITUTE  
 Music Prod. & Digital Recording.  
 Extensive hands-on instruction.  
 Call (888) 543-ARTI

**The Midwest's Premiere Recording School.**



New for Fall 1997!  
**MUSIC TECH**  
 Associate Degree in Music Production  
**1-800-594-9500** [www.musictech.com](http://www.musictech.com)

SEE OUR AD IN MARKETPLACE pg. 214

**FREE CATALOG!**  
**(800) 275-0797**  
 Computers • Music • MIDI  
 Digital Audio • Guitar Catalogs!  
 Lessons • Books • Tapes • Videos  
**CALL PEBBER BROWN**  
**(800) 275-0797**  
[www.angelfire.com/ca2/pebber](http://www.angelfire.com/ca2/pebber)

**BE A RECORDING ENGINEER**



**★ TRAIN AT HOME**  
 Easy Home-Study practical training in Multi-track Recording. Join our successful working graduates or build your own studio. Career guidance... Diploma... Licensed.  
**FREE INFORMATION:**  
**Audio Institute of America**  
 814 46th Ave. Suite AL, San Francisco, CA 94121  
 Or visit us at [www.audioinstitute.com](http://www.audioinstitute.com)

**MUSIC RECORDING INDUSTRY CERTIFICATE PROGRAM**  
 San Francisco State University  
 College of Extended Learning.  
 Classes taught by Bay Area pros. Expand skills and earn certificate. Engineering, management, songwriting & more!  
 Call (415) 904-7700.

**Subscription Questions?**  
 Call (800) 843-4086

**Maintenance Services & Repairs**

**Pro Digital Inc.** **DAT ADAT DA-88**  
 DAT Recorder Service Specialists

- ★ Fast, expert repairs on all DAT and MDM brands and models
- ★ Warranty service on most brands!
- ★ The **FIRST**, the **BEST...over 7000** digital recorders serviced!
- ★ FedEx return shipping at UPS prices!
- ★ Compare our rates & turnaround time!

**(610) 353-2400** (610) 359-0937 FAX  
[prodiginc@aol.com](mailto:prodiginc@aol.com)

**DATs FIXED FAST!**

Expert solutions for all DAT recorder problems

- All makes and models
- Experienced, factory-trained techs
- Fast turnaround
- Repairs, overhauls, parts

"The DAT doctor is in!"

**NXT GENERATION**

973-579-4849 FAX 973-579-7571

HEAD RELAP/REPLACEMENT  
 multitrack analog specialists

**iem**  
 Palatine, IL  
 (800) 227-4323

Mix Classifieds are your best advertising buy in the industry.  
 Phone (800) 544-5530.

## Maintenance Services & Repairs

Midwest Digital Services Inc.  
DAT and DA-88 Repair  
(Chicagoland Area)  
Professional DAT Service since 1985.  
Authorized by  
Panasonic, Sony & Tascam  
(888) 809-3309  
Ph: (708) 448-7539  
Fax: (708) 448-7678

VINTAGE GEAR REPAIR  
Tubes, Transistors, (yes even ICs), Mic pre's, limiters, amps, consoles, tape machines. We repair & restore it all!  
Field service too!  
retrospec/TROUBLE REPORT  
Ph: (914) 688-7329

## ANALOG HEADS

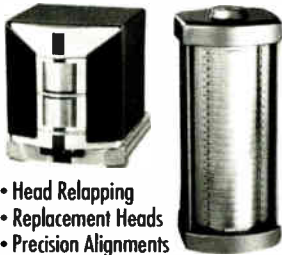

- Head Relapping
- Replacement Heads
- Precision Alignments
- 1/2" 2-Track Conversions
- Custom Heads and Assemblies

Unsurpassed service for over 19 years!



973-579-5773 fax 973-579-6021  
e-mail jrf@jrfmagnetics.com  
www:jrfmagnetics.com

## Music Products/ Software

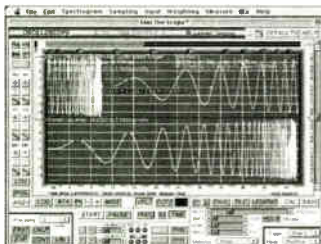

Mac the Scope™ RTA, oscilloscope, vector scope, spectrum analyzer, sonogram and signal generator software • uses Macintosh built-in sound input and output • (732) 933-9388 • for demo, information: visit [www.channid.com/software.html](http://www.channid.com/software.html)

Invisible Sound Design  
Introducing CueDriver  
MIDI cue automation for MacOS computers. And AudioDriver: MIDI trigger QuickTime and CD playback. The Web site:  
<http://invisible.freesevers.com>  
Tod Nixon (415) 759-8069.

## Recording Services

**CUSTOM COMPACT DISCS**  
Affordable single copy CDs starting at \$15.

**\$5.00 OFF WITH THIS AD**  
46 PRODUCTIONS  
42W557 Hawk Circle  
St. Charles, IL 60175  
TEL (800) 850-5423  
FAX (800) 203-1725

Contact us on the Internet at [info@46p.com](mailto:info@46p.com)  
Visit our Web page at <http://www.46p.com>

**Hear the Magic**  
Master with us...and make an impact!  
CD MASTERING...  
CD MANUFACTURING...  
CD BOOKLET PRINTING...  
...SEE US in MARKETPLACE  
Orlando, FL (800) 344-4361  
<http://www.digido.com>

SEE OUR AD IN MARKETPLACE pg. 213

small ad...big savings  
cd...cassettes...graphics  
(800) 801-SONG

**Better CD/Tape Duplication!**  
Premium CDs: As low as \$5.54 ea.  
Warner Media-Digital Cassettes  
(Sound more like CDs)  
Creative Sound  
  
(800) 323-PACK  
[www.csoundcorp.com](http://www.csoundcorp.com)

**Punch. Warmth. Air**  
DRT delivers a big, clear sound for your album, using hand-built, custom-designed mastering gear.  
DRT Mastering Analog Specialist  
800-884-2576 [www.drtmastering.com](http://www.drtmastering.com)

**Our CD & Cass's are BETTER & CHEAPER!**  
(800) 421-8273  
Progressive Music

SEE OUR AD IN MARKETPLACE pg. 217

CD and Cassette Manufacturing  
State-of-the-art Audio Mastering  
Complete Graphic Design Services  
Enhanced CD Creation  
  
**americanmedia**  
MANUFACTURING  
To discuss your project, call today toll free  
**1 888 442 8994**

# 888.999.1760

Short Run Duplication • Printing • Design  
CD's • Cassettes • DVD • Vinyl  
Conversion Media  
[www.conversionmedia.com](http://www.conversionmedia.com)

**CDs Fast!**  
500-\$750  
**800-DIGIDOC**  
[www.digidocpro.com](http://www.digidocpro.com)

SEE OUR AD IN MARKETPLACE pg. 217

## EuropaDisk

Why deal with brokers when you can work direct with our factory and save?  
Major credit cards accepted.

- Retail-Ready CD Packages
- Bulk CD Replication (as few as 100 pieces)
- Cassette Duplication
- 7"/45 & 12" Vinyl Records
- Graphics Design & Printing

BEST PRICE. BEST SERVICE. PERIOD.

**EUROPADISK LTD.**

<http://www.europadisk.com>

Free catalog or quote:  
(800) 455-8555

Disks With No Risks

OPSONIC & MONSTER  
HAVE JOINED FORCES TO CREATE THE NEW  
**MONSTER X**  
digital media  
CD'S & CD-ROMS  
GRAPHIC DESIGN  
REAL TIME & HI SPEED CASSETTES  
WEB SITE DESIGN & HOSTING  
FREE WEB SITE WITH CD PACKAGES  
**1-800-475-8211**  
[www.monsterx.com](http://www.monsterx.com)  

**1000 Bulk CDs \$620!**  
**III MEDIA**  
1888.891.9991

SEE OUR AD IN MARKETPLACE pg. 218

You Can  
**Sound Great**  
For An Affordable Price.  
➤ **MASTERING**  
24 bit Sonic Solutions, TC Electronic, Lexicon  
➤ **CD DUPLICATION**  
➤ **CD RECORDING**

We use the best equipment without being overpriced

**SOUND CONCEPTS**  
[www.soundconcepts.net](http://www.soundconcepts.net)

Call NOW for FREE Brochure  
(800)524-5706 x115

## Records Tapes CD Services

**Fleetwood MultiMedia**  
1000 CDs from \$799  
500 Chrome Tapes \$715  
Includes Everything  
Fast Turnaround  
800-353-1830 (781) 599-2400

SEE OUR AD IN MARKETPLACE pg. 215

(617) 577-0089  
**mWORKS**  
MASTERING  
DIGITAL EDITING  
1630 transfers  
cd replication  
individual cds  
multi-media  
digital noise  
reduction and  
restoration  
call today.



Call:  
1-888-387-8273  
www.klarity.com

KLARITY QUALITY ... KLEARLY DIFFERENT ... KLEARLY BETTER

• Fair Prices • Great Quality  
Call for Free Sample Log  
Duplicators of CD's, Cassettes & Videos



## CD & CASSETTE MANUFACTURING

Serving the country with over 25 years of experience.  
The Southwest's premiere full-service manufacturing facility!

PRINTING • GRAPHIC DESIGN • BLANK CASSETTES  
DIGITAL MASTERING & EDITING • ONE-OFF CD-RS

RETAIL READY PACKAGES! CALL FOR FREE CATALOG!



## CRYSTAL CLEAR SOUND

1-800-880-0073  
mc/visa accepted www.crystalclearsound.com

### CD Packages!

Includes: Glass Master, 3 Colors On Disc print,  
Jewel Case, Assembly & Overwrap!

www.bmmi.com



300 - 599.00  
500 - 749.00  
1000 - 1090.00

800-579-7010

BASE Multimedia Inc.

Don't just make CDs...

# make some NOISE

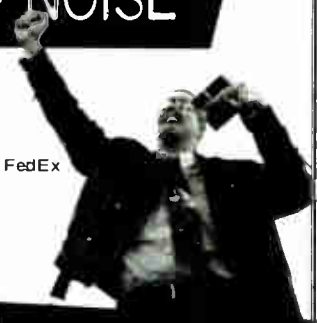

CD packages starting at \$595:  
500 raw CDs with design, film & FedEx  
Many packages available

Guaranteed delivery date

Free graphic design

Exact pricing policy!<sup>™</sup>

Your quote is your final price



PUBLISH your own web site  
GET HEARD on the radio  
SELL T-shirts, posters & more

CALL 1-888-347-2634

ask about our new promo packages

## artist development associates

CD Singles Special \$559

- 500 CD's, 2 Colors on CD
- 500 Window Envelopes
- Layout, Design & Films included
- Glass Mastering included

no tricks, no gimmicks, just bring us your CD!

Digital Dime Bag \$1,499

- 1000 CD's, Jewel Boxes & Over-wrap
- 2 Color on CD printing
- 1000 4/1 4 PP folders & 4/0 tray cards
- Film output
- Glass Mastering included

full color, retail ready, quick turns

UNBEATABLE DUPLICATION PRICES  
(888) rubber-8

PRICES SUBJECT TO CHANGE WITHOUT NOTICE

500 CDS w/ 2PG COLOR  
BOOKLET OR 1000 CDS  
W/ JEWEL CASE,  
INSERT YOUR  
BOOKLET AND  
SHRINKWRAP \$999

800-401-8273  
BALLISTIC COMMUNICATION



RELIABLE  
"ON HOLD"  
TAPES\*PLAYERS  
\*MADE IN USA  
CALL OR FAX FOR  
SAMPLE TAPE

MANN ENDLESS CASSETTE INDUSTRIES  
3700 SACRAMENTO ST., S.F., CA 94118  
TEL: (415) 221-2000 FAX (800) 683-7569

## MEZZOMAN PRODUCTIONS

The best quality, price and service!  
1000 REPLICATED CDS  
PACKAGE

We'll Print your full Color Booklets & Traycards and  
Assemble into Jewel Boxes w/ Shrinkwrap.

ANNOUNCING OUR NEW  
FREE GRAPHICS  
PACKAGE

CALL FOR DETAILS!  
1-888-231-9927

mezzoman productions inc. 100 greene street worcester ma 01605



1,000  
CD'S  
\$1,330

256-851-8101

www.moontown.com

Good Vibrations-R/R Digital  
Mastering and Graphic Design  
1-800-828-6537

1000 CDs - \$1245

Complete retail ready packages available.  
Promo CDs \$2.50 each / ROM or Audio  
www.sandiegoweb.com/goodvibrations

# CDs On Time and ON Budget!

Now get 1000 CDs, 4 page full-colour folder and  
tray card, jewel case, assembly and poly wrap for

# \$1399.00

from CD-ready master and final film supplied

**MUSIC  
MANUFACTURING  
SERVICES**

Not just different, better!

- Fast, friendly, reliable service since 1988
- Promo CDs with NO MINIMUM ORDER
- FREE WEBSITE with min. 500 order

## 1-800-MMS-4-CDS

Full Service including Mastering, Design & Packaging for  
all your CD, Cassette and Vinyl! Record pressing needs

## Records Tapes CD Services

### CD REPLICATION

- Cassette Duplication
- Mastering & Digital Editing
- Graphic Design & Printing
- CDR Blanks



We Anticipate Your Every Need

**1-800-527-9225**

(716) 691-7631 • Fax (716) 691-7732

### ARE YOU GETTING YOUR MONEY'S WORTH?

CD - CASSETTE - VINYL - DVD

FULL-SERVICE MASTERING AND POST-PRODUCTION  
REVOLUTIONARY GRAPHIC SERVICES  
COMPLETE INTERNET DEVELOPMENT AND HOSTING  
DIGITAL BIN CASSETTE REPLICATION  
DIRECT TO METAL VINYL MASTERING (HQ180™ VINYL)  
CLIENT GRAPHIC PROOFING ON THE INTERNET  
DIGITAL COLOR PROOF AND SERVICE BUREAU  
COMPLETE CUSTOM RETAIL-READY PACKAGES  
DISTRIBUTION SERVICES ARE AVAILABLE

FREE WEB SITE WITH AUDIO FILES

WWW.GATEMUSIC.COM



The Gate Music Services, Inc.

1-800-655-1625 - 510-350-9045 - F 510-350-9504

300 CD SINGLES	\$1295.00
1000 CD'S	\$1895.00
5000 CD'S	\$2295.00

PACKAGES INCLUDE: PACKAGING, MASTERING, GLASS MASTERING, FULL COLOR INSERT, 3 COLOR PRINTING ON CD OR VINYL, BAR CODE, CUSTOM GRAPHIC SERVICES, FILM, CONSULTATION AND MUCH MORE... NO HIDDEN COSTS, TAX, "MISCELLANEOUS FEES" OR "SURPRISE" EXPENSES!

**100 CD's**  
**\$349**

**1000 CD's**  
**\$699**

www.eastcopro.com

FREE COLOR CATALOG

**1-800-365-8273**

- COMPACT DISCS
- VIDEOS
- CASSETTES

Direct from Digital  
• Complete Graphic Design  
• Printing/Packaging  
• Blank Tapes & Accessories  
• 100% Guaranteed

13 Years Serving The World

**EASTCO PRO**

Audio/Video Corporation

69¢ CD'S?!  
THEM BOYS  
IS  
CRAZY!



### THE NAMES YOU KNOW AND TRUST...

HIGH BIAS BULK-BLANK AUDIO TAPES  
UNBOXED-UNLABELED

FULL LINE OF RECORDING  
AND DUPLICATION SUPPLIES

LENGTH	TDK PRO-SA COBALT	maxell XL II	BASF CHROME PLUS	BASF CHROME SUPER
C-10	24¢	25¢	25¢	28¢
C-15	26¢	27¢	30¢	31¢
C-20	28¢	30¢	31¢	35¢
C-30	33¢	36¢	35¢	45¢
C-46	40¢	45¢	42¢	58¢
C-62	47¢	50¢	50¢	68¢
C-80	56¢	68¢	65¢	85¢
C-92	62¢	75¢	72¢	87¢
C-100	70¢	83¢	76¢	95¢



DIRECT ON CASSETTE PRINTING  
CUSTOM LABELS AND J-CARDS

ALL LENGTHS AVAILABLE - 1 MINUTE TO 126 MINUTES

### ...FROM THE COMPANY YOU KNOW AND TRUST

764 5th Avenue,  
Brooklyn, New York 11232  
In NYC Tel: (718) 369-8273  
24 Hour Fax: (718) 369-8275



National Recording Supplies Inc.

145 Lauro Pinerio Ave.,  
Ceiba, Puerto Rico 00735  
In Puerto Rico Tel:

(809) 885-2316



**CALL TOLL FREE 1-800-538-2336**

Mix Classifieds (800) 544-5530



Call for our wholesale manufacturing guide  
**1-800-582-3472**  
www.spinnerworldwide.com

SEE OUR AD IN MARKETPLACE pg. 213

1-800-TAPE WORLD or 1-800-245-6000  
We'll beat any price! 6.95 SHIPPING • FREE CAT.

SONY	MAXELL	TDK	FUJI
4" 100 5.29	4" 100 5.39	4" 100 5.49	4" 100 5.99
4" 100 6.99	4" 100 7.99	4" 100 8.99	4" 100 9.99
4" 100 1.99	4" 100 2.99	4" 100 3.99	4" 100 4.99
4" 100 5.49	4" 100 6.49	4" 100 7.49	4" 100 8.49
4" 100 9.99	4" 100 10.99	4" 100 11.99	4" 100 12.99
4" 100 13.99	4" 100 14.99	4" 100 15.99	4" 100 16.99
4" 100 17.99	4" 100 18.99	4" 100 19.99	4" 100 20.99
4" 100 21.99	4" 100 22.99	4" 100 23.99	4" 100 24.99
4" 100 25.99	4" 100 26.99	4" 100 27.99	4" 100 28.99
4" 100 29.99	4" 100 30.99	4" 100 31.99	4" 100 32.99
4" 100 33.99	4" 100 34.99	4" 100 35.99	4" 100 36.99
4" 100 37.99	4" 100 38.99	4" 100 39.99	4" 100 40.99
4" 100 41.99	4" 100 42.99	4" 100 43.99	4" 100 44.99
4" 100 45.99	4" 100 46.99	4" 100 47.99	4" 100 48.99
4" 100 49.99	4" 100 50.99	4" 100 51.99	4" 100 52.99
4" 100 53.99	4" 100 54.99	4" 100 55.99	4" 100 56.99
4" 100 57.99	4" 100 58.99	4" 100 59.99	4" 100 60.99
4" 100 61.99	4" 100 62.99	4" 100 63.99	4" 100 64.99
4" 100 65.99	4" 100 66.99	4" 100 67.99	4" 100 68.99
4" 100 69.99	4" 100 70.99	4" 100 71.99	4" 100 72.99
4" 100 73.99	4" 100 74.99	4" 100 75.99	4" 100 76.99
4" 100 77.99	4" 100 78.99	4" 100 79.99	4" 100 80.99
4" 100 81.99	4" 100 82.99	4" 100 83.99	4" 100 84.99
4" 100 85.99	4" 100 86.99	4" 100 87.99	4" 100 88.99
4" 100 89.99	4" 100 90.99	4" 100 91.99	4" 100 92.99
4" 100 93.99	4" 100 94.99	4" 100 95.99	4" 100 96.99
4" 100 97.99	4" 100 98.99	4" 100 99.99	4" 100 100.99

TAPE WORLD 22 SPRING ST. BUTLER, PA 16013 • FAX 717-322-8273  
OVERSEAS DIFFERENT! SAVE DAY SHIPPING! VISA M.C.

### COMPACT DISC ALL SERVICES AVAILABLE

- Highest Quality • Low Prices
- Superior Service • Est. 1986
- Member Better Business Bureau

1-800-800-7995

1-802-453-3334

Fax 1-802-453-3334

CD AUDIO • CD ROM  
AUDIO & VIDEO CASSETTE  
PRINTING / PACKAGING  
MASTERING • GRAPHIC DESIGN

**PROTOSOUND**

MASTERCARD • VISA • AMERICAN EXPRESS

# HEALEY disc

Manufacturing

Premium Quality CD/CD-ROM, VHS and  
Cassette manufacturing

**300 CD**  
singles

Includes: pre-master, glass master,  
2 color CD label printing,  
5" sleeve & manufacturing.

**\$695.00**

CD PACKAGE INCLUDES:

Color 4 page /2 panel insert, 2 color on CD printing  
pre-master, glass master, jewel box and shrink wrap.  
BARCODE INCLUDED.

~~\$1099~~  
~~\$1599~~

\*Professional mastering at affordable rates.\*  
\*Special STUDIO and INDIE label rates.\*

**Call now 1-800-835-1362**

for your free catalogue \* www.healeydisc.com

taag  
DESIGN  
GROUP

design for the music industry

Make your  
CD Interactive!  
CD Enhanced/  
Interactive Press Kit

**\$500<sup>00</sup>**

**1-800-410-4855**





Bulk CD's  
as low as

60¢

### CD-Audio & CD-ROM

- Audio & Video Cassette Duplication
- Mastering • 1630 • PMCD • CDR
- Graphic Design & Printing
- Retail-Ready Packages • Fast Turn

## CD SONIC

Tel: (617) 424-0670 Fax: (617) 424-0657  
Toll Free 1-888-CD SONIC (237-6642)

### 1000 CDs, Complete — \$1400!

Includes 2 colors on CD, 4-panel, full-color insert booklet, full-color tray card, all films/color separations, jewel case, and shrink wrap. Free barcode if desired. Quick turn-around. Call for free samples!

### 25 CDs- \$99!

24-hour turn-around in most cases. Up to 74 min. From your CD-R, add \$20 if from DAT Booklets/packaging available! 50- \$189; 100- \$359.

Implosion Publishing, Inc. • 1921 E. Colonial Dr. • Orlando, FL 32803  
toll-free 1-888-323-5431 • 407-898-5573 • fax 407-898-7565

When consistency counts...

Choose **BASF**



Great tape at great prices!

2732 Bay Road  
Redwood City, CA 94063  
1-800-272-2591  
<http://www.arcal.com>



- CD/TAPE/DVD DUPLICATION AND PACKAGING
- GRAPHIC DESIGN & PRINT PRODUCTION
- AUDIO/MEDIA SUPPLIES [nfaudio.com](http://nfaudio.com)

**LOWEST PRICE PERIOD!!!**  
1-888-256-DISC

If you find a lower price for duplication or blanks, buy 'em

AUDIO/VIDEO CASSETTE - CD  
**MULTIMEDIA**  
REPRODUCTION SERVICES  
(800) 789-2173

SEE OUR AD IN MARKETPLACE pg. 217

10 CDs • \$65  
20 CDs • \$120  
50 CDs • \$250  
1000 CDs • \$1280

Random Access Media  
1-800-684-8071

**MINIDISCS**  
best prices in the world!!

Minidisco  
2124 Kittredge St. #56  
Berkeley, CA 94704  
[sales@minidisco.com](mailto:sales@minidisco.com)  
[www.minidisco.com](http://www.minidisco.com)  
sales: 510-848-6703

### VINYL PRESSING SPECIAL RADIO & PROMO PACKAGES

(under 10 minutes/side)

100 12" RECORDS - \$575  
500 12" RECORDS - \$950

1000 CD's  
with 2-color label, jewel box,  
stuffed and shrink wrapped:  
**\$1000.00**



- 12" Vinyl Pressing
- Compact Discs
- Cassettes

214-741-2027

Visa/MasterCard Accepted

1-800-527-3472  
OUTSIDE TEXAS

**A+T Record & Tape Manufacturing**  
902 N. Industrial Blvd., Dallas, TX 75207

### RECORDING & DUPLICATING SUPPLIES

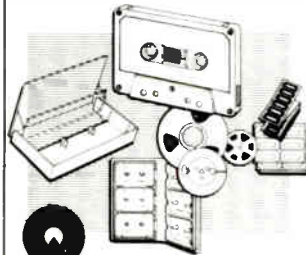

**ARCAL® TDK BASF SONY QUANTEGY MAXELL**

- Cassettes • Reel-to-Reel Tapes
- C-0's • Cassette Albums • Labels
- R-Dat's • CDR's • Video Tapes
- Data Storage Media

### ARCAL CORP.

2732 Bay Rd., Redwood City, CA 94063  
TOLL FREE 1-800-272-2591  
FAX (650) 369-7446  
Visit our web site: <http://www.arcal.com>

### In the Studio?

**FREE Guide**  
Saves You Time and Money!

Contact Us Today:  
**1-800-468-9353**  
[www.discmakers.com](http://www.discmakers.com)  
[info@discmakers.com](mailto:info@discmakers.com)

**DISC MAKERS**  
EXPECT MORE

### THE WAREHOUSE Studio Sales & Services

CD & Cassette Packages  
1000 color CDs from \$1,899  
CDR's • DAT's • ADAT's • Rt&R  
Custom Graphics  
Blank cassettes (BASF, TDK, Maxell)

Behringer Equipment

Warehouse prices

Call

**800-GUD-TAPE • 800-483-8273**  
<http://www.Warehouse-Studio.com>

Visa • MasterCard • Discover  
2071-207x Emerson St., Jacksonville, FL 32207  
904-399-0424 Fax: 904-398-9685

### CD - R DUPLICATION

1+ 3.99 100+ 2.49  
25+ 3.49 200+ 2.24  
50+ 2.99 300+ 1.99

Price Includes: CD - R Duplication, Direct Imprinting, Jewel Box, Insertion, and Shrinkwrapped

**THE 4th CREATION DUPLICATION**  
(409) 756-6861

### TAPE COMPLEX

RETAIL READY  
**1000 CDs \$1349.**  
With 4-panel 4/1 booklet + tray card  
FROM YOUR CD MASTER & FILMS

10 - \$85 • 25 - \$135  
50 - \$195 • 100 - \$295

**STUDIOS!**  
BLANK CDRs WITH YOUR LOGO AS LOW AS \$2.11 EA

**1-800-381-2717**

### Studios

Fully equipped recording facility w/cient base & great lease. Silicon Valley/San Fran area. Owner relocating. Serious inquiries only. Pkg deal \$225k. (510) 656-8729.

[bigfoot@hypersurf.com](mailto:bigfoot@hypersurf.com)

**Great career opportunity. Busy San Francisco Recording Studio for sale. Solid Client Base Fully Equipped, Asking \$90k (415) 584-3874.**

### Golden Oldie

1830 Colonial on 20+ acres in rural Hudson Valley. 4,000 sq. ft., 5 BRs, 2.5 baths, 2 flcs. Separate state-of-the-art recording studio. Total privacy yet only 2 hrs NYC. \$9350k. THE KINDERHOOK GROUP (518) 392-8640 [www.thekinderhookgroup.com](http://www.thekinderhookgroup.com)

### SOHO PENTHOUSE LOFT!

Skylights, huge windows North, South & East, dazzling light & views, 2,300-sq.-ft. loft w/ state-of-the-art recording studio, fab potential, Prime SOHO location. Asking \$1.3M. Robert Manzari (212) 780-2459.

**FIREHOUSE, Top NYC recording studio 4 SALE. The price is \$385k. Will be financed in part by owner. Great opportunity! Busy and with a hot track record. For serious buyers only please!! (212) 645-0666.**

## Studios

### STUDIO FOR SALE

Busy 24-trk. recording studio with 3 tracking rooms, Iso booth, accurate control room, lounge, kitchen, repair shop and storage. Central heat & air. Convenient location to NYC (Douglaston, NY), great vibe and landlord/lease. 2,500 sq. ft. Very low operating costs. Equipment includes: API, Studer, Otari, Lexicon, Eventide, Summit, Bryston, Hot House, Neumann, AKG, Hammond B-3, Yamaha G-2 piano, Marshall, Fender, Ampeg, etc...Meticulously maintained. Large client base for continuing income. Not an auction! Turn-key operation. Call for details. **Ask for Bill or Chris (718) 224-9158.**

### Video Equipment, Services & Supplies

#### VIDEO w/TC FOR LOCKUP.

Rebuilt 3/4" w/Warr., Betacam.  
1" VTRs: SONY, JVC & AMPEX.  
JVC & SONY Remote Controls.  
SONY VP-5000, 5600, 5800,  
5850, BVU-800, 950, VO-9800,  
9850. Four-Month Warranty.  
(212) 580-9551 or (212) 206-  
1475. Fax: (212) 929-9082.  
Michael Tenmer.

### What Are You Looking For?

Buy it —  
Rent it —  
Sell it —

through *Mix Classifieds*

**(800) 544-5530**  
**FAX (510) 653-8171**

## Miscellaneous

MASTERING • MANUFACTURING • PRINTING

### DIGI-ROM

CD-AUDIO • CD-ROM  
REAL TIME & HIGH SPEED AUDIO CASSETTES

COMPLETE PACKAGES • CD-ROM STRIKE-OFFS • GRAPHIC DESIGN STUDIO  
CD-ROM PRODUCTION & ARCHIVING • 1 TO 500 DISCS DUPLICATED OVERNIGHT



**(800) 815-3444**  
(212) 730-2111  
[www.digirom.com](http://www.digirom.com)



130 West 42nd Street • New York, NY 10036

### 10 CD-Rs for \$59.95

Package Includes:  
Direct to Disc Imprinting  
Duplication  
Media  
Jewel Box

Call: 888.387.4202



SEE OUR AD IN MARKETPLACE pg. 214

### DIGITAL FORCE

149 MADISON AVENUE NY, NY 10016

**212-252-9300**  
[www.digitalforce.com](http://www.digitalforce.com)

Expanded State-of-the-Art  
Mastering Facility

TOTAL CD, CD-ROM, DVD  
& CASSETTE PRODUCTION



## MIX CLASSIFIEDS WORK FOR YOU

**Text rate:** \$105 per inch; eight (8) lines per inch (approximately 27-32 character spaces per line); one-inch minimum. \$10 per bold line. Each space and punctuation mark counts as a character. \$105 minimum charge for each ad placed.

**Enhancements:** \$10 black border, \$15 for a grey-screened background, \$25 for a reverse, \$25 for Post Office box service. Charges are based on a per-insertion basis.

**Display rate:** \$135 per inch (1" minimum/half-page maximum). Display Classified advertising must be camera-ready, sized to MIX column widths and specs. Frequency discount rates available; call for information.

**Closing:** Fifteenth of the month, six weeks prior to the cover date (ex: April issue closing is February 15). Ads received after closing will be held for the next month unless otherwise stated. Cancellations will not be accepted after the closing date. Copy changes and cancellations must be submitted in writing.

**Other requirements:** Full street address (PO boxes aren't sufficient) and phone numbers must accompany all requests. All words to be bold should be underlined. Copy must be typed or printed legibly in standard upper/lower case. Publishers are not responsible for errors due to poor copy. Arrangement of characters may be altered in typesetting process due to space. The publishers are not liable for the contents of advertisements.

**The small print:** No stated or implied discounts allowed on new equipment sales. Publishers reserve the right to refuse or discontinue any ad deemed inappropriate. Payment must be included with copy: check, Visa, MasterCard or American Express accepted. Sorry, no billing or credit available.

**Send ad and Mix Magazine Classifieds:**  
Attn: Robin Boyce-Trubitt, 6400 Hollis St., #12, Emeryville, CA 94608, tel. (800) 544-5530 or (510) 653-3307; fax (510) 653-8171. e-mail: [mixclass@intertec.com](mailto:mixclass@intertec.com).

## Mix Marketplace/Mix Classifieds

For Rates and Deadlines  
Call Robin Boyce-Trubitt

**(800) 544-5530**

**fax (510) 653-8171**

[mixclass@intertec.com](mailto:mixclass@intertec.com)

—FROM PAGE 24, TWO STATES, TWO PARTS

in *change* and rapidly notices anything new and unusual. Once the brain identifies and accepts an audio event, it apparently backs off and gives it a much lower priority, then returns to the constant testing needed to identify new sounds that may come along. This makes sense when you consider that it is much more important for survival to notice something unidentifiable than to keep an alert analysis going on of, say, a bubbling brook.

### TODAY'S FIRST WANDERING SIDE TRIP

Back when samplers sucked, I often used a trick to get hyper-realistic synth sounds. The saxophone was always a rough instrument to sample, for obvious reasons. I would start off a sax track with a real sax, and after a while change over to a sampled one as the song progressed. Listener's brains would hear the real sax first, identify it as real, be impressed or satisfied, and go on to listen to the rest of the song. As long as I continually introduced other new sounds or arranged the piece so that there was always some new, interesting thing appearing, they *never* noticed the bait-and-switch to the lame sampled sax. It was amazing! I got paid. Nobody asked for their money back.

### THE ALIENS AMONG US

So the human brain is interested in change, not already-analyzed and accepted constants. And here is where it finally comes back to A/D and D/A conversion. This same brain is even *more* interested in alien artifacts. I don't mean obscure metal from beyond our galaxy, but close...

It is generally the nature of analog sound that overtones and harmonics are mathematically related to the tonic, or fundamental, in some reasonable, definable relationship. And so, as each of us grows and learns in our respective analog worlds, we are exposed to these harmonic relationships, and we in turn expect most future sounds to have them as well. Not only do we expect this, but *all* generations before us expected it as well, from our very beginnings to...well, until right now!

### IN THE VILLAGE, THE SLEEPING VILLAGE...

When a lion roars, it produces harmonically related overtones. The more overtones, the harder the cat is pushing its

vocal chords, and the more seriously we should examine the immediate situation. Same with human calls—not too urgent or loud—some overtones. But as we push harder, from stress, fear or just to be heard, the overtones increase in number and relative amplitude. It's very easy for other humans to read those harmonics, even in recordings where the total amplitude factor is removed by level matching.

The brain is quite good at sensing and interpreting harmonic content. How hard has a bat hit a ball? You can easily tell by how the bat rings, wood or metal. We are very good at hearing and rapidly understanding harmonics, even if they are quite low in relative amplitude.

**It's a treacherous path  
from the analog  
to digital world,  
and the audio  
never entirely  
survives—never.**

The voices of organic beings, most pitched musical instruments and even many percussion instruments have harmonics that largely fall within two categories, even or odd. Yes, I know that you know this. And I know that you know that metal and stone are the two well-known exceptions (unless they are shaped and processed to produce structured harmonics).

### THE ALIENS AGAIN

But now we have a third exception, a weirder, more unnatural exception than has ever existed before, one that the human brain has no previous exposure to and experience with. This new exception truly captivates the brain, as it is so alien that it can *never* be identified and accepted. And Exception Number Three is...digital distortion.

Aliasing, A/D and D/A conversion, and many DSP functions (such as pitch changing, time fitting and sample rate conversion) produce wholly unnatural artifacts that are *not* harmonically related to the original material in *any way*. They are instead multiple sidebands representing both the multiplication and division of the audio frequencies with the steady-state carrier, or sampling

frequency. Digital conversion artifacts include many linearly spread components, and are therefore so unnatural that we can easily hear them at *much* lower levels than we could if they were conventional harmonic overtones.

So while you might be able to detect 5% conventional even-order harmonic distortion on a given track at -50, you might hear odd-harmonic components at -60, and this digital garbage may easily be audible at -80! It's just too alien for our brains to ignore.

### CAN IT GET ANY WORSE?

This whole thing is, of course, compounded by the fact that all organic or analog harmonic content (like distortion) *increases* as the overall amplitude increases. All, that is, except digital. Its relative garbage level *increases* as the original signal level *decreases*. You already know this, but think about what it really means considering our sensitivity to digital distortion. As digital audio gets quieter, it gets rattier—the exact *opposite* of the analog world that trained our ears and brains! That alone is enough to catch our ears—well, our brains. And since this is unnatural inharmonic distortion, it's really amazing that engineers ever got digital audio to work at all, much less as well as it does today.

### THE OLD ONE-TWO PUNCH

So right off the bat, it's a treacherous path from the analog to digital world, and the audio never entirely survives—never. And while it is happily getting stored, edited and “harmonically enriched” in the way only DSP can, it has ahead of it almost as dangerous a return path from digital to analog.

This is only the first challenge that must be overcome to make digital music sound right—just getting it to *be* digital and then back to analog. Today it is being done by various converter sets with varying success, but it *is* being done. I just wanted you to think about what the entire bidirectional conversion process means to our ears—not in a specmanship way, but in a musical way. Now you know why A/D and D/A specs have to be *so* good compared to analog specs—because the digital artifacts are much, much more noticeable than their analog counterparts.

Next month I will cover what we think we can and can't do to our audio while it's digital, and how most of it is wrong. Of course. ■

*SSC turned in no bio this month, just to see if you would notice.*

# STEINBERG CUBASE VST

## TIPS FOR NAVIGATION AND OPTIMIZATION

Since it came out last year, Steinberg's Cubase VST has become a popular choice in digital audio sequencers among PC and Mac users alike, and it supports a wide range of plug-ins using the VST architecture. Here are some tips to optimize your use of the VST and audio aspects of Cubase.

### MULTIPLE IMPORT

If you use the Import audio function in the File menu of the Audio

the start and end points of the Part. Select Cycle, then open the required editor. The SPP will now cycle more conveniently within the editor, and you can use "1" on the numeric keypad to return to the left locator whenever required. To help navigate while in any editor, try using Shift + 1 and Shift + 2 (numeric keypad) to store the current song position to the left or right locators. This is convenient for placing the locators around a

in the Audio menu, the positions of all changes to the insets for Audio events in the Audio editor will snap to the closest zero crossing point in the waveform. Zero crossing points have the least amounts of energy in the waveform, and editing here reduces audible clicks and makes for a clean "splice" when one Audio event is butted against another.

### TIMING DRIFT

If you experience timing drift between your audio and MIDI Parts, try setting Pre-roll in the Synchronization dialog to the same value as the latency of your audio card.

### MONO MIXDOWN

Export Audio uses the level of the master faders to set the level of the exported file. If, for example, you have compressed or noise-gated a mono sound via the Insert effects and you wish to export this to a mono mixdown file, keeping the file at the same level as seen on the Monitor mixer faders, you should boost the master faders by 6 dB before using Export Audio. This applies to any case of exporting single mono Tracks (with or without Insert effects) to a mono mixdown file.

### COMBINATION EFFECTS

Creative effects can be achieved by using more than one effect in the Insert effects rack. Try the following: compressor followed by fuzzbox (typically used by guitarists to achieve more sustain), fuzzbox followed by chorus/flange, chorus/flange followed by chorus/flange etc. Note that using multiple effects can very quickly use up your computer's processing power! ■

*Simon Millward has an MS degree in Music Technology and is the author of The Fast Guide to Cubase VST. More details on his book can be found at the PC Publishing Web site ([www.pc-pubs.demon.co.uk](http://www.pc-pubs.demon.co.uk)).*



*Cubase VST offers comprehensive recording and editing functions, and supports a variety of plug-ins.*

Pool, you can make a multiple audio file selection from the File select dialog by pressing Control (Mac: Command) on the keyboard while clicking on the names of the files required.

### DROPPING IN

When dropping in over existing material on a single track, the new recording creates a new audio file and segment. The new segment does not overwrite the existing audio but takes precedence when the audio is played back.

### EDITOR NAVIGATION

Before opening the editor, select the Part to be edited and press Ctrl + Alt + P (Mac: Option + P) to place the left and right locators at

specific section and might be used in conjunction with Cycle mode.

### CYCLE STORAGE

As the length and position of the cycle is regulated by the left and right locators, try storing the locator positions for different sections of the song using Shift + F2 to F11 (Mac: Option + Command + Typewriter 1 to 0). Each stored setting can then be instantly recalled by pressing F2 to F11 (Mac: Command + Typewriter 1 to 0). This is good for concentrating on specific sections of the arrangement.

### SNAP TO ZERO

If Snap to Zero is enabled (checked)

BY SIMON MILLWARD





Keith Thomas –  
Grammy winning,  
multi-platinum, cross-  
genre producer

“I’m finding  
new  
levels...”



...of creativity buried deep within the multitude of functions in Logic Audio.”

Jazz, rock, fusion, blues, country, hip hop, rap, R&B, pop, techno, remix, film scoring, jingles, TV no matter the genre Logic Audio is the tool of choice.

Multi-Platinum artists need complete and reliable solutions. That’s why more professionals use Logic Audio

Platinum than any other digital audio sequencer.

The most comprehensive integrated feature set available: multiple hardware support, a myriad of plug-in options, real-time DSP, high powered MIDI sequencing, quality scoring, and the list goes on...

Available at the finest music and computer stores worldwide.

Emagic Inc.  
Tel. +530.477.1051 E-mail: info@emagic.de  
Fax +530.477.1052 http://www.emagic.de

CIRCLE #149 ON PRODUCT INFO CARD

All rights reserved. Logic™ and Logic Audio™ are Registered Trademarks of Emagic®.

World Radio History

**emagic**

Technology with Soul.

# "When A \$2,000 System Sounds As Good As A \$50,000 System, I'd Say They Got It Right."

William Wittman, Engineer/Producer

## The First Integrated Professional 5.1 Monitoring System With THX® Approval

The All-New JBL LSR Monitors are, quite literally, just that. Highlighted by a long list of performance-tailored components and customer-inspired features, they're like no other systems on the market today. The entire line, including the LSR32 3-way, 28P 2-way and 12P Subwoofer, is a technical triumph; resulting in new standards and performance levels for a rapidly emerging multi-channel recording industry.

## Performance-Tailored Components

Revolutionary transducer designs, optimized network topologies and innovative materials are some of the reasons why the LSR line is being hailed as 'the world's most advanced monitor'. JBL's all-new *Differential Drive*® woofer permanently dispels the notion that better linearity, higher power handling and greater dynamic accuracy are somehow an unobtainable, evil triangle. *Dynamic braking* produces truly accurate bass at higher SPLs with maximum reliability. Composite materials, including *Carbon Fiber* in the woofer as well as *Titanium* and *Keclar*® in the high and mid frequency components, insures performance that is always optimally maintained.

## Not Just A Better Spec... A Better Monitoring System

While all companies boast about their specifications, JBL went one step further. To guarantee that every component of the LSR family worked together for optimal performance, LSR development employed JBL's unique 'system-engineered' design philosophy. Simply put: the entire line was researched and refined as one, with an overall performance goal in sight. What this means to you is a monitor and subwoofer that work together as a system; delivering stunningly uniform and accurate performance in both stereo and multi-channel applications.



**LSR 32**  
12" 3-way mid-field monitor with rotatable Mid/High Elements.



**LSR 28P**  
8" 2-way close field monitor with bi-amplification and active filtering.



**LSR 12P**  
12" Active Subwoofer with Bass Management System.

Carbon Fiber Composite Cone

Dual Top Plate

Dynamic Brake Coil

Neodymium Magnet

Aluminum Diecast Heatsink

Dual Drive Coils

Diecast Frame

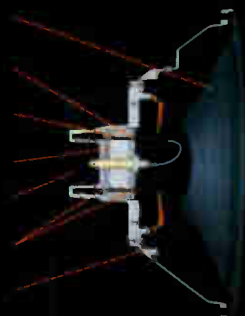

A Harman International Company

To find out more about the revolutionary LSR Monitors, visit JBL Professional at [www.jblpro.com](http://www.jblpro.com)

CIRCLE #150 ON PRODUCT INFO CARD