

What's New in Workstations · Producer Hugh Padgham · Restoring Tube Gear

U.S. \$4.95 CANADA \$5.95 OCTOBER 1990

MIX

**Roy Halee
on Paul Simon's
"Rhythm of the Saints"**

**Sound for
"The Arsenio Hall Show"**

THE RECORDING INDUSTRY MAGAZINE



**Jeff Lynne
On His Own**

**Hundreds
of New Products
for AES!**

**Mastering Services:
A User's Guide**

***** 5 DIGIT 91329
91329GAMDEM008 01890804001
MARK R GANDER
JBL PROFESSIONAL
8500 BALBOA BLVD BX2200
NORTHRIDGE CA 91329
1430



 **MITSUBISHI**

32-CHANNEL
PROFESSIONAL DIGITAL
AUDIO TAPE RECORDER **X-880**

**Some manufacturers want
you to believe filters don't
make a difference.**

But you know better.

That's why so many of you have specifically
requested Apogee Filters on your Mitsubishi
32-channel digital audio recorders.

Now every X-880 comes fully enhanced from
the factory with Apogee 944 Series Digital Audio
Filter Modules*.

You can hear the difference.

 **Neve**
A Siemens Company

CT: (203) 744-6230 • NY: (212) 956-6464 • CA: (213) 461-6383 • TN: (615) 329-9584 • Toronto: (416) 365-3363
Apogee Electronics Corporation • (213) 399-2991

World Radio History

Standard on X-880's sold in U.S. and Canada only

THE POWER PACKAGE



City Lights Recording Studios
Howell Township, NJ
(201) 938-4565

- **Neve VR 60**
- **Flying Faders Console Automation**
- **Mitsubishi X-880 • Mitsubishi X-86HS**

 **Neve**
A Siemens Company

1990
NOMINEE

Exclusive North American Distributor of

 **MITSUBISHI**
DIGITAL PRO AUDIO

CT: (203) 744-6230 • NY: (212) 956-6464 • TN: (615) 329-9584 • CA: (213) 461-6383 • TORONTO: (416) 365-3363

MIX

THE RECORDING INDUSTRY MAGAZINE

OCTOBER 1990, VOLUME 14, NUMBER 10

AUDIO

- 15 Insider Audio:** The CD-I Conference
by Ken Poblmann
- 32 The Fast Lane:** Fish Fins and Finnish Singles
by Stephen St. Croix
- 36 "One World One Voice":** The Making of a Musical Chain Letter
by Paul Tingen
- 88 The Byte Beat:** Sound Effects Library Management at Zoetrope
by Paul Potyten
- 100 Sound for "The Arsenio Hall Show"**
by Brad Leigh Benjamin
- 108 Artist's Studio:** Mike Hedges
by Paul Calderon
- 148 International Update:**
"La Bohème" in Australia
- 156 The James Jamerson Project:**
The Making of the Award-Winning Audio Book
by Michele Picozzi

PRODUCTS

- 20 Juxtapositions:**
Digital Audio Workstations
by Mel Lambert



PAGE 20

- 117 NED MultiArc:**
Pointing DAWs to the Next Generation
by Dan Daley
- 187 MI Update:** NAMM, Part 2
by Craig Anderton

RECORD PRODUCERS

- 48 Jeff Lynne Lightens Up** *by James Hunter*
- 55 Roy Halee:** Recording Paul Simon's New Album
by Bill Milkowski
- 63 Shel Talmy:**
The '60s Hitmaker Is Back
by Blair Jackson
- 71 The Fast Climb of Keith Cohen**
by John Thomas
- 75 Matt Wallace:**
Out of the Garage and Onto the Charts
by Alex Behr
- 82 Lunching with Bonzai:**
Hugh Padgham *by Mr. Bonzai*
- 92 The 1990 Survey of Independent Producers and Engineers**
- 190 Music & Recording Notes:** Top Producers Choose Influential Albums
by Daniel Levitin



PAGE 63

MAINTENANCE

- 128 The Politics of Power:** Taking Care of Your Electrical Environment
by Herb Levitin
- 138 Maintaining Digital Outboard Gear**
by Greg Hanks
- 144 Restoring Tube Audio Equipment**
by Joseph Carr



PAGE 172

STUDIO BUSINESS

- 113 Studio View:** The Survival of the Small Studio *by Dan Daley*

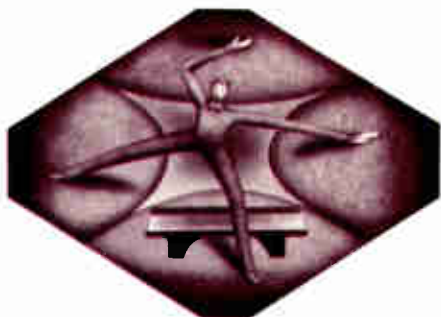

PAGE 113

- 122 Wrestling with the Health Insurance Beast**
by Lawrence Henry

LIVE SOUND

- 164 Sound Reinforcement News/Tour Update**
by Mark Herman
- 172 The New Orleans Jazz & Heritage Festival:**
A 14-Ring Circus of Sound
by Howard Mandel
- 182 Problems with Acoustics:**
One Shed's Solution
by Richard Zueibel

TAPE & DISC

- 198 Mastering Services:**
A User's Guide
by Philip De Lancie
- 208 Tape & Disc News/Splices**

DEPARTMENTS

- 6 From the Editor**
- 9 Current**
- 10 Industry Notes**
- 212 Coast to Coast (Including Sessions & Studio News)**
- 279 Feedback**
- 281 Classifieds**
- 287 Ad Index**

DIRECTORY

- 223 New Products for 1991**

Cover: Installed earlier this year at Right Track Recording's Studio A is the largest music recording console in New York City. The board, a custom 80-input Solid State Logic G Series, was configured by producer Frank Filipetti and chief technical engineer Robin Thomas in a winged design, with 48 inputs in the center section and 16 inputs in each 45° wing. The facility also sports two Sony PCM-3348 digital multitracks. Acoustical design: Frank Filipetti.
Photo: Robert Lewis.



POWER. PERFOR

What do you really need in a digital audio hard disk system? Simple operation, total creative control, a high level of recording and editing power, and lower cost?

Yes, Studer Dyaxis exactly.

The New Dyaxis 2+2. Building upon the original Dyaxis' overwhelming and continuing success, Dyaxis 2+2 is now providing 4-channel simultaneous playback and many new advanced features, such as overdub, multi-take record and programmable in/out, making it the ideal tool for production and post facilities where multichannel applications are required. (Original Dyaxis owners can upgrade!)

Synchronization Is Easy. With the System Synchronizer and Timecode option, Dyaxis (and Dyaxis 2+2) is a "master" of sample accurate timecode-based slave applications. By a simple click of the mouse, Dyaxis is ready to lock to SMPTE, EBU, VITC, video, and film tach. Never before has synchronization of audio been so easy.

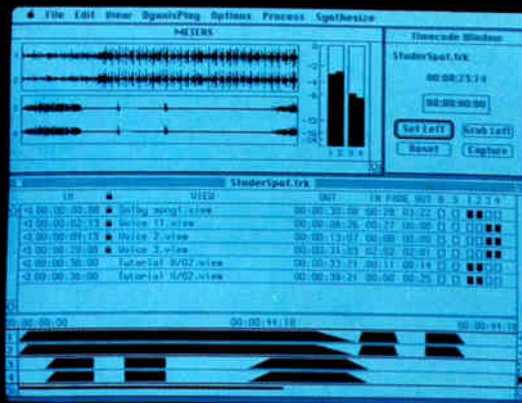

Superb Audio Quality. Dyaxis has achieved a reputation for the best sound quality of any digital audio hard disk system. Through Studer Editech Corporation's own proprietary A-D/D-A convertor implementation, anti-aliasing filter and analog circuit designs, Dyaxis maintains the superb audio quality that you've come to expect from Studer products.

RDAT Backs Up More. While others may lose necessary editing and control information by using consumer RDAT units for back-up, Dyaxis' integrated data RDAT subsystem stores all soundfiles along with their precise editing instructions. When restored to disk, Dyaxis users may resume the project exactly where they left off, without the need to re-record soundfiles or re-create critical editing information, or to load in additional instructions from other media.

STUDER



MANANCE. PROFIT.

Digital Compatibility. Dyaxis communicates with and transcodes between all major digital audio formats such as DASH, AES-EBU, PD, SDIF, 601 and more. Up to 100 different sampling rates including 44.056, 44.1 and 48 kHz are available on line. The friendliest of all digital audio systems, Dyaxis makes compatibility and studio interface a breeze.

DYAXIS

2+2.

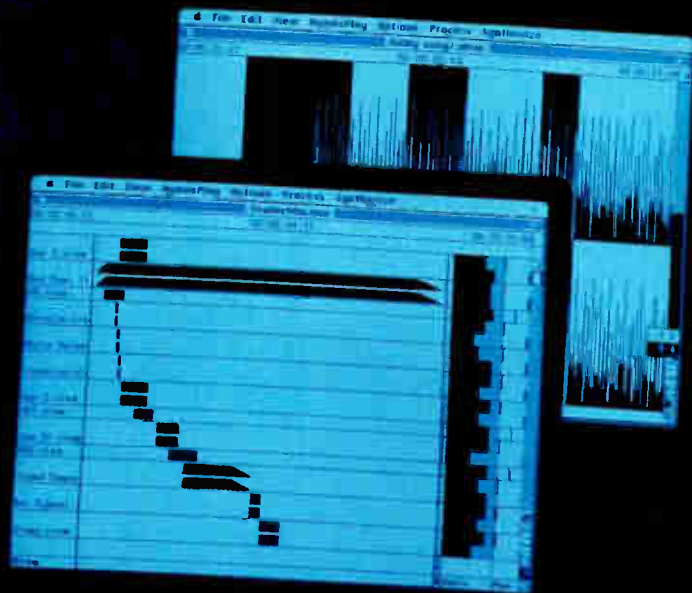

Hard Disk At Its Best. From instant random access to precise nondestructive electronic editing, from internal unlimited multitrack soundfile assembly and mixing to time-scaling without pitch change, Dyaxis is hard disk digital audio recording and editing at its best.

Studer Dyaxis—Designed For You. Discover digital technology that's flexible, powerful and easy to use—all the right stuff at a price that might pleasantly surprise you. With Studer's legendary technical support and financial capabilities, Dyaxis is a sound investment in your future. Call us at 1-800-366-4900 for our free 12-page color brochure on Studer Dyaxis, or call any of our regional offices for an immediate demonstration.

Picture your sound. On Dyaxis.
From Studer, a name you can trust.

STUDER REVOX

Studer Revox America, Inc.
1425 Elm Hill Pike • Nashville, TN 37210 • (615) 254-5651
New York (212) 255-4462 • Los Angeles (818) 780-4234
Studer Revox Canada Ltd., Toronto (416) 423-2831

Circle #105 on Reader Service Card

FROM THE EDITOR

As part of our efforts here at *Mix*, we regularly conduct surveys of particular segments of the audio production industry to help us stay abreast of trends in the marketplace. This month, you can find out what characterizes the recording life of independent engineers and producers.

Along the same lines, we mailed a survey to a cross section of readers who identified themselves in our files as owners and operators of U.S. audio production facilities. We wanted to get an idea of the industry's business climate at a time when much of the overall economy is slowing down, or at least being threatened. The results are in, and we will be passing along a detailed breakdown in an upcoming issue, but in the meantime, we wanted to share some of the highlights with you.

The top three primary categories of studios surveyed were commercial music recording (58.4%), private/home recording (14.2%) and audio post-production (11.4%). The "average" studio is 8.8 years old, has 1.5 control rooms, one studio/stage, 0.5 MIDI/music production rooms, 0.6 machine rooms, 1.2 vocal/instrumental booths and 1,239 square feet of studio/stage space.

Most of today's studios offer a wide variety of services, and the most popular include recording/mixing (89.5%), creative services/musical assistance (55.9%), MIDI pre-production (50.5%), audio post-production for video (48.6%), tape duplication (36.4%) and location/mobile recording (31.8%). Looking to future areas of growth, audio post is in more studios' plans (36.8%), with the addition of both MIDI pre-production and tape duplication capabilities being contemplated in the next 12 months by 23.2% of the studios.

This past year's leading purchases among the facilities we surveyed were microphones/headphones (58.7%), reverb/delay devices (48.1%) and DAT recorders (41.3%). Predictions for the next 12 months show DAT recorders as the leading new acquisition by 45.5% of studios. Of the studios that added video equipment last year, 53.8% purchased video monitors, 48.8% bought 1/2-inch video recorders, and 42.5% purchased 3/4-inch decks, which also placed highest in next year's buy list (53.7%). For general business equipment, the list is topped by computers/office systems (62.7% this year, 47.6% next year) and fax machines (45.2% this year, 44.7% next).

The average audio equipment expenditure per studio is \$61,965 this year and \$43,099 next year. It is important to point out, though, that the median (the studio which ranks at the 50th percentile) in each of these cases is \$12,031 this year and \$10,714 next year. Those buying video equipment will be paying considerably more—almost double the budget of audio equipment.

And what about trade show attendance? 59% of the respondents said they attend the AES, more than twice the second place NAB. Speaking of AES, that's really the theme of this issue, and we've got pocket descriptions of hundreds of new products being featured at the show, just waiting to crawl onto your equipment budget.

Keep reading,



David Schwartz
Editor-in-Chief

 **BPA** Circulation independently audited and verified by Business Publications Audit of Circulation since 1985.

Mix magazine is published at 6400 Hollis St., #12, Emeryville, CA 94608 and is © 1990 by NBB Acquisitions, Inc. *Mix* (ISSN 0164-8957) is published monthly. Subscriptions are available for \$46.00 per year. Subscriptions outside U.S.A. are \$61.00 per year. Single copy price is \$4.95, back issues \$6.00. Missed issues within the U.S. must be claimed within 45 days of publication date and abroad, within 90 days. Send subscription applications, subscription inquiries and changes of address to *Mix* magazine, PO Box 41094, Nashville, TN 37204 or call (800) 888-5139. Outside U.S., call (615) 377-3322. POSTMASTER: Send address changes to *Mix* magazine, PO Box 41094, Nashville, TN 37204. Address all other correspondence to *Mix* magazine, 6400 Hollis St., #12, Emeryville, CA 94608. (415) 653-3307. Fax: (415) 653-5142. Second Class postage paid at Oakland, CA, and additional mailing offices. *Mix* magazine is distributed in pro audio stores, music stores and other related businesses. If you have a recording or music-related business and would like to distribute *Mix*, please give us a call at (212) 251-5925. Display advertising rates, specs and closing dates are available upon request. This publication may not be reproduced or quoted in whole or in part by printed or electronic means, without written permission of the publishers.

S T A F F

EDITOR-IN-CHIEF David M. Schwartz

PUBLISHER Hillel Resner

MANAGING EDITOR Blair Jackson
ASSOCIATE EDITORS
Paul Potyem Tom Kenny
PRODUCT EDITOR George Petersen
ASSISTANT TO THE EDITOR Alexandra Behr
EDITORIAL ASSISTANT Jeffrey Fortenau
TECHNICAL EDITOR Ken Pohlmann
SENIOR EDITOR John Woram
CONSULTING EDITOR Stephen St. Croix
EDITOR-AT-LARGE Mr. Bonzal
SOUND REINFORCEMENT EDITOR Mark Herman
TAPE & DISC EDITOR Phillip De Lancelle
TEC AWARDS EDITOR Karen Margroff Dunn
NEW YORK EDITOR Randy Savicky
LOS ANGELES EDITOR Amy Ziffer
CONTRIBUTING EDITORS
Craig Anderson Iain Blair Lou CasaBianca
Dan Daley Bob Hodas Mel Lambert
Larry Oppenheimer Bruce Pilato

ART DIRECTOR Tim Gleason
ASSISTANT ART DIRECTOR Patricia Law
PRODUCTION ARTIST Linda Gough

PROMOTIONS MANAGER Annie Jenkel
MARKET RESEARCH MANAGER Elise Malmberg
SPECIAL PROJECT DESIGN & PRODUCTION
Michael Zipkin

ASSOCIATE PUBLISHER
Jeffrey Turner
SOUTHERN CALIFORNIA/SOUTHWEST AD MGR.
Sue Horwitz
EASTERN ADVERTISING MANAGER
Michele Kanatous
NORTHWEST/MIDWEST AD MGR.
John Pledger
SALES ADMINISTRATOR Jean Mahon
SALES ASSISTANTS Laura Kujubu Tina Spinelli
ASSISTANT TO THE PUBLISHER Jane Byer
CLASSIFIEDS MANAGER Robin Boyce
CLASSIFIEDS ASSISTANTS Hugh Swarts Mary Cosola

DIRECTORIES ADVERTISING MANAGER
Lauri Newman
DIRECTORIES ASSISTANTS
Cindy Lukk Vieni Pawloski

DIRECTOR OF CALIFORNIA
OPERATIONS AND PRODUCTION
Anne Letsch
PRODUCTION MANAGER Georgia George
PRODUCTION COORDINATOR Ellen Richman
ADVERTISING TRAFFIC COORDINATOR
Donna Burrilston
PRODUCTION ASSISTANT Rosanne Marmor

ASSOCIATE CIRCULATION DIRECTOR
Maria Di Placido
ASSISTANT CIRCULATION MANAGER
Gina Lombardino

BUSINESS MANAGER Craig Kennedy
ASSISTANT CONTROLLER Ron LeRouicz
ACCOUNTING CLERKS
Theresa Wellington Cathy Woolley
PERSONNEL/OFFICE MANAGER Barbara Kochioulos
WAREHOUSE MANAGER Charles Nielsen
RECEPTIONIST Bettye Gardner

ACT III PUBLISHING

PRESIDENT
Robert C. Gardner
SENIOR VICE PRESIDENT, OPERATIONS & PLANNING
Martha Lorini
VICE PRESIDENT, FINANCE & ADMINISTRATION
Sam Schechter
DIRECTOR OF MARKETING & COMMUNICATIONS
Jennifer P. Ware
DIRECTOR OF CIRCULATION Steve Wigginton
DIRECTOR OF MANUFACTURING
Craig Bolick
ACT III PUBLISHING, TECHNICAL GROUP
ALSO PUBLISHERS OF:
ELECTRONIC MUSICIAN
CORPORATE VIDEO DECISIONS
BME'S TELEVISION ENGINEERING

NATIONAL EDITORIAL, ADVERTISING and BUSINESS OFFICES, 6400 Hollis St., #12, Emeryville, CA 94608. (415) 653-3307. IMC 736. FAX: (415) 653-5142. SOUTHERN CALIFORNIA ADVERTISING OFFICES, 19725 Sherman Way, Suite 380, Canoga Park, CA 91306. (818) 709-4662. EAST COAST ADVERTISING OFFICES, 401 Park Ave. South, New York, NY 10016. (212) 545-5166. DIRECTORIES ADVERTISING, (800) 344-LIST. CLASSIFIEDS ADVERTISING, (800) 747-3703. CIRCULATION OFFICES, 401 Park Ave. South, New York, NY 10016. (212) 251-5925.

Founded in 1977 by
David Schwartz and Penny Riker Jacob

Feature Shock!

Otari's new MX-50. Built around the premise that you can have everything you ever wanted in a two-track tape machine, and still stay within your budget. For example:

The Transport

—DC quartz PLL capstan motor with front panel selection of operating speeds (from either a 15/7.5 or 7.5/3.75 ips speed pair).

—Capstan speed variable by $\pm 7\%$ from the front panel, and by $\pm 50\%$ from SMPTE

time-code external controllers via an Otari-standard 37-pin connector.

The Electronics

—Lighted VU meters with peak-reading LED indicators.

—Transformerless active balanced inputs with XL-type connectors.

—Optional Voice Editing Module (VEM) for twice normal play speed with normal pitch.



A built-in tape timer displays current tape position in hours, minutes, and seconds, and includes a search-to-cue locator with cue point and zero location memories.

Otari's MX-50. For whenever or wherever you need a professional audio machine at an affordable price.

For more information, call your nearest Otari professional audio dealer, or Otari Corporation at (415) 341-5900.

OTARI

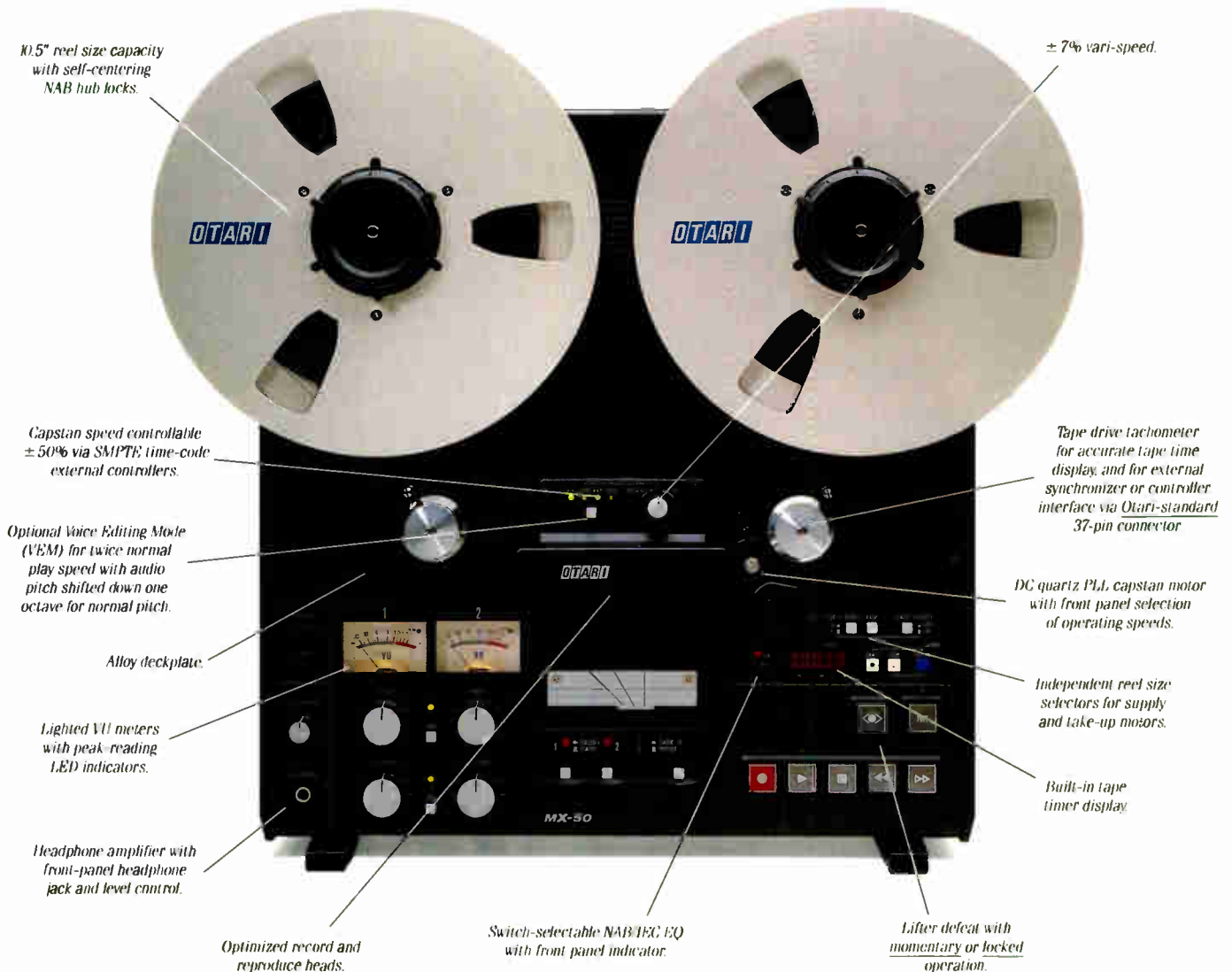

The APR-24.

In a couple of years,
it will become even clearer
why you bought it today.



The Sony APR-24 Analog Multitrack Audio Recorder not only meets your production needs today, but those of the future as well.

It's a remarkable combination of reliability and advanced engineering that won't become obsolete as your requirements expand.

To provide dependability and alignment stability, we've constructed a die-cast aluminum webbed deck and tubular welded frame. And the state-of-the-art amorphous-metal heads give the APR-24 significantly longer head life and a smoother, more extended frequency response.

The APR-24's microprocessor fully integrates control of the

transport, alignment, signal routing and timecode functions. So you can take advantage of the built-in synchronizer and precise automated punch-in/punch-out operation.

Since these operations are software-based, the APR-24 can incorporate new features and performance improvements. Such as our unique serial interface that enables the APR-24 to control a Sony VTR for a video sweetening project. Or a second APR-24 in a dual 24-track music recording session.

To learn more, call us at 1-800-635-SONY. With the APR-24, it's clear today why you can look forward to the future.

SONY

PROFESSIONAL AUDIO

CURRENT

AKG Purchases Turbosound and BSS

AKG Acoustics Ltd., the London-based subsidiary of AKG GmbH, has purchased the controlling interest in Brooke-Siren Systems and Turbosound. AKG Acoustics in the U.S. (San Leandro, Calif.) will take on distribution of the product lines sometime in September, according to company president Richard Ravich.

Turbosound is a manufacturer of speaker systems and components for the sound reinforcement/contracting market. BSS manufactures signal processing equipment for broadcast, recording and live sound applications. AKG will be exhibiting both product lines at the AES convention September 21-25 in Los Angeles.

Soundmaster Acquired by LTI

Soundmaster International Inc., best known for its machine control synchronization systems, has been acquired by Linear Technology Inc., a public Canadian high-tech company specializing in custom chip and integrated circuit design. The move became official on August 1.

LTI also develops crosspoint switches for video, and according to Soundmaster vice president Curt Smith, the company has plans to expand aggressively into the broadcast industry with the formation of a Broadcast Communications Group.

Soundmaster had been incorporated for five years with approximately 130 sound editing and control systems in use worldwide. The company recently introduced Syn-cram, a modular disk-based digital audio recording system that can be integrated with the company's ma-

chine control technology to provide a workstation-like environment. The majority of manufacturing now takes place in Westlake Village, Calif. Plans are for all Soundmaster units to continue shipping uninterrupted.

"It's business as usual here," says Smith. "This move doesn't affect our sales staff, distribution or manufacturing facilities. What LTI provides is a substantial financial base with corporate financial stability."

Bienstocks Buy into TRF

Freddy and Johnny Bienstock have acquired an interest in TRF Production Music Libraries and its associate music publishing company, Alpha Music. As part of the investment, TRF has moved to the Brill Building in Manhattan, headquarters for Freddy Bienstock Enterprises.

TRF Production Music Libraries currently offers more than 50,000 selections on roughly 4,000 compact discs. According to TRF president Michael Nurko, this past year TRF became the first music library to release music on DAT.

"This is the first step of our expansion program," Nurko says. "Before the end of 1990, we will be introducing a major new music library, now being recorded by a leading music publisher." For more information, contact Allan Tepper at (212) 265-8090.

"Music Makes the Difference"

From Oakland, California, to Fort Wayne, Indiana, and many stops in between, public school systems have eliminated or drastically cut music education programs. It's happening in grade schools as well as high schools, big schools and small.

To bring national attention to the value of music in education, NARAS

has joined with NAMM and the Music Educators National Conference to establish a national music education commission and program titled "Music Makes the Difference." Plans call for three forums to be held this fall in L.A., Nashville and Chicago. A national symposium on music and the arts will be held in March 1991 in Washington, D.C.

For information on the forums, contact NARAS at (213) 849-1313.

CD-ROM Committee Formed

The Special Interest Group on CD-ROM Applications Technology (SIGCAT) has formed the CD-ROM Consistent Interface Committee (CD-CINC) in an attempt to standardize basic functions inherent to contemporary search and retrieval software.

The committee will suggest new or endorse existing standards for function key assignments so users will not have to learn a new interface for each new title. Also, general guidelines for installing and exiting applications will be explored. It is not the committee's intent, however, to make recommendations about screen design, the search engine, the index structure, or any other internal operation of the software.

CD-ROM users and producers are encouraged to participate in the work of CD-CINC. If you want to contribute an audio perspective, contact Susan David at (202) 707-7169 or Fred Durr at (301) 243-0797.

AES Educational Foundation

The Audio Engineering Society Educational Foundation has announced the names of awardees for

INDUSTRY NOTES

Hans Tschernig, president of West German audio manufacturer **Dynacord**, will also be a VP of **Mark IV Audio** (Amherst, NY), which acquired Dynacord in early 1990...**New England Digital** left its Vermont home for a 100,000 sq.ft. space in Lebanon, NH, and product specialist **Jim Bonevich** relocated to NED's sales office in Los Angeles. Also, **Ted Pine** was promoted to the position of director of marketing...**Allen and Heath** (Brighton, UK, and Orange, CT) named **Vic Steffens** as product specialist and customer support rep; he will continue work as a producer and studio owner with **Horizon Studio** in CT...**Sony Magnetic Products Group of America** promoted **Kenneth F. Wiedeman** to director of marketing, Professional Tape Division (Park Ridge, NJ)...In Evanston, IL, **Nancy A. Calvert** joined **Shure Brothers** as manager of advertising and PR. **Christopher Lyons**, author of the "Guide to Better Audio" handbook, now holds the post of product line manager, wired microphones, at Shure...**AKG Acoustics** promoted **Dave Ogden** to product manager and **David Roubush** to U.S. marketing and sales manager in San Leandro, CA. **Scott Heineman** now holds the title of product manager for **dbx** and **Orban**, divisions of AKG...**Studer Revox** (Nashville) added three reps: **Communications Task Group** (Buffalo, NY), **Blevins Audio Exchange** (Nashville) and **+4 Audio** (Salem, MA)...In NYC, **Scharff Weisberg Inc.** purchased the audio and communications equipment rental portion of **VRI Scharff Rentals**; **Scott Schachter** will continue as head of audio rentals...In Northvale, NJ, **Video Services Corp.** sold its controlling interest in **Compton Capital Corp.**, which specializes in pro audio financing and leasing, to Compton's management team...London-based **Cliff Electronic Com-**

ponents Ltd. opened a North American sales office in Houston, which **Robert Tupper** will manage...Communications equipment dealer **Audiovisual Inc.** (Omaha, NE) purchased **Video Midwest/AVC Systems**, a division of Vaughn Communications Group (Minneapolis)...**Australian Monitor** is now distributed in the States through headquarters at 11845 Wakeman St., Santa Fe Springs, CA 90670...In Santa Monica, CA, **Pam Mongeon** will manage **Apogee Electronics'** purchasing department...**Audio Animation** moved to 6632 Central Ave. Pike, Knoxville, TN 37912; the company brought aboard **David L. Ball** as applications engineer and **James M. Ruse** as product manager...In San Francisco, mastering engineer **John Acoca**, whose credits include **The Residents** and **Squeeze**, joined **Rock-et Lab's** digital editing and CD mastering suite...**Shure** (Evanston, IL) awarded **Pro Tech Marketing** (Salt Lake City) its Sales Representative of the Year award...In Northumberland, PA, **Susquehanna Sound/Ascension Video** opened a MIDI production division called **Bullet Productions**. **Paul Vanderbeck** will be in charge...The fourth annual **West L.A. Music Keyboard Show** will be held October 13-14 at the L.A. Airport Hilton. This consumer-oriented show gives musicians a chance to meet manufacturers, and is held in association with **UCLA Extension's** Entertainment Studies. Phone (213) 477-1945 for info...In Northvale, NJ, **Audio Plus Video International** promoted **Beth Simon** to director, sales and marketing...**Bill Daniels** formed a field service rep firm for audio/video and CCTV manufacturers called **Quad-Tech Inc.** Contact them at 18500 Midland Dr., Shawnee Mission, KS 66218...**Tim Ready** has been named sales manager at **Lyon Lamb Video Animation Systems Inc.** of Burbank, CA. ■

its educational grants for the 1990-1991 academic year. Grants for graduate studies with an emphasis on audio topics have been awarded annually since the foundation was established in 1984.

Ten grants were awarded this year, five to first-time awardees. They are: Carl Casey, University of Colorado; Robert Dunn, University of Miami; Brent Karley, University of Miami; Timothy Leishman, Pennsylvania State University; and Rene Quesnel, McGill University. Renewal grants were awarded to Jayant Datta, John Klepko, Kenneth Linton, Rebecca Mercuri and Rainer Michelis.

AES Educational Foundation awards are made possible by contributions from private benefactors, the John K. Hilliard estate, AES Inc. and the Mix Foundation for Excellence in Audio. For additional information and applications, contact the AES at (212) 661-8528.

EIA Announces Speakers for Winter CES

Richard A. Kraft, president and COO of Matsushita Electric Corp. of America, will deliver the keynote address at the 1991 International Winter Consumer Electronics Show, to be held in Las Vegas January 10-13, 1991.

Also speaking will be Frank J. Myers, economic forecast; Robert W. Carver, audio outlook; Sidney Topol, video outlook; and Marc S. Regberg, home office outlook. For more information, contact Cynthia S. Upson at (202) 457-4919.

Corrections

In our August directory listing for Intelligent Services of Riverside, Calif., the contact name should be Chuck Herron.

In our July feature on "Recording in the Pacific Rim," the photo caption for Toshiba EMI should read Studio Pan. Toshiba EMI owns Studio Terra, pictured on the same page. ■

ScreenSound. A fully integrated audio for video editing suite

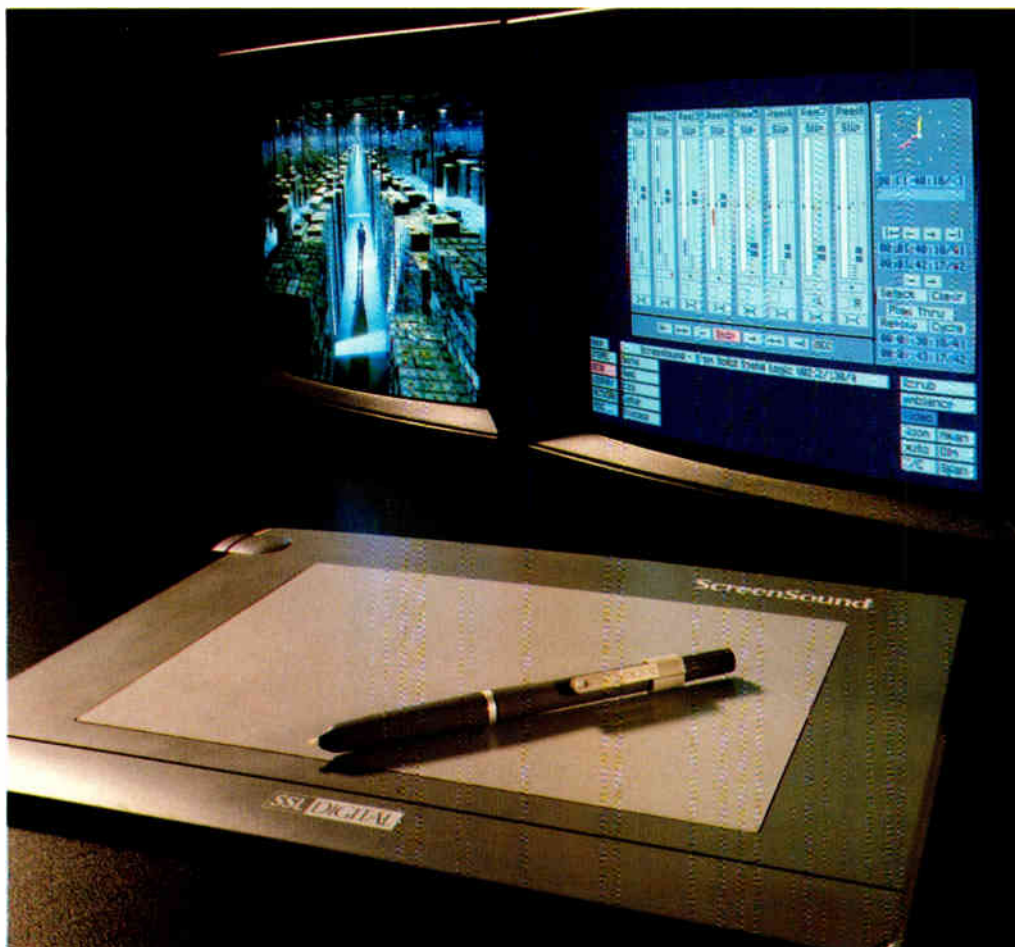

Post production facilities need to take advantage of the efficiency offered by today's technology. Speed and creative flexibility are essential to commercial success. Digital sound quality is no longer a luxury.

ScreenSound is a fully integrated audio for video editing suite. It combines digital audio storage and editing with machine control of multiple VTRs, Laserdisc or film reproducers. It also interfaces with Quantel's digital video editor, Harry.

Simple to learn and fast to use, a cordless pen, tablet and RGB monitor provide control of all ScreenSound functions.

Multiple sound reels enable music,

dialogue and effects to be laid back to picture and synchronised to the exact video frame.

Edit, review, time offset, track slipping, cross fades and many other production techniques are available at the touch of a pen. Gain and stereo pan controls can be automated to timecode.

AES/EBU interfacing keeps digital audio transfers free of analogue distortions and losses, preserving the highest audio integrity through to the final format.

Above all, ScreenSound is a dedicated system - purpose-built to bring the advantages of hard disk sound manipulation to audio post production.

AUDIO STORE

The hard disk store of sound clips gives title and duration, in addition to powerful search and sort routines.



SCRUB EDITOR

Provides accurate edit marking and scrub of audio waveform.

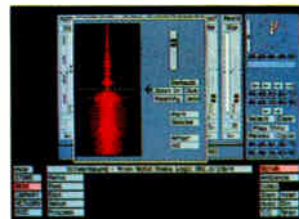

OPTICAL LIBRARY

An off-line library of sound clips and effects can be compiled on a Write Once Read Many (WORM) optical disc.



MACHINE CONTROL

For control of multiple VTRs, laserdisc or film reproducers.



TEC
1990
NOMINEE

SSL DIGITAL
Solid State Logic

Begbroke, Oxford, England OX5 1RU (0865) 842300

London (01) 706 4948 • Paris (1) 34 60 46 66 • Milan (2) 612 17 20 • New York (212) 315 1111 • Los Angeles (213) 463 4444

• Toronto (416) 363 0101 • Tokyo (03) 5474 1144

U.S. Toll Free Number 800 343 0101

World Radio History





MORE STUDIOS GO GOLD ON AMPEX THAN ON ALL OTHER TAPES PUT TOGETHER



EVERY STUDIO PICTURED HERE HAS EARNED THE PRESTIGIOUS

Ampex Golden Reel Award for having recorded or mixed a gold album exclusively on Ampex audio tape. In fact, of all the gold albums released last year—and the year before—most of them were laid down exclusively on Ampex tape. And it's a good bet that most of the others used Ampex for the majority of their work, too. • At Ampex, we appreciate the unique blend of wit and wisdom demanded in the studio business. Running a studio means balancing the passion of art with the reality of money. It means soothing egos, settling arguments, saving souls. It means never compromising your client's standards—or your own. • We've made our own commitment to provide you with the highest quality, most consistent, most dependable audio tape in the world. A tape built with the same practical passion you bring to your business. • For all the details on what makes Ampex tape a pleasure to work with, just call or write for a copy of our new 456 Technical Brochure, and see why Grand Master® 456 is engineered like no other tape in the world.

AMPEX
A MASTER OF ENGINEERING

mix•er

(mik'sēr) *noun*. An electronic device used to *mix* music. Must be clean, transparent and punchy. See Alesis 1622 Mixer. Better yet, listen to it.

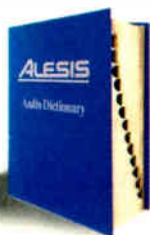

Better yet, own it. That's what every major music magazine is saying about the Alesis 1622 Mixer, because its radical new design redefines the concept of a professional mixer. Reason enough to make it the center of your studio.

Need more reasons? How about 16 channels with 100mm faders for precise control over all inputs. And 6 independent auxiliary sends on every channel so you can drive all the stereo effects you'll ever need to create masterful mixes.

The 1622's ingenious design uses surface mount technology on a scale that nobody ever thought possible. It's the key to the 1622's incredible value.

We call it the Monolithic Integrated Surface™. Our competition calls it terrifying, because it shatters the price barrier for a pro mixer.

Your mixer is the single most important piece of gear in your studio. It defines the sound of your music. It must be flexible, reliable, and above all, it should have impeccable audio credentials*. That's why the 1622 is your first choice for a mixer. It might be the only choice. Listening to it will convince you.

Visit your Alesis dealer today and hear the 1622. Better yet, buy it.

Call 1-800-5-ALESIS, 9 AM to 5PM Monday-Friday, and we'll send you a brochure on why Monolithic Surface Technology is important to your music.

* Total Harmonic Distortion + Noise: too low to measure. Keyboard Magazine July 1990.

TEC
TECHNICAL EXCELLENCE & CREATIVITY
1990
NOMINEE



LOS ANGELES: Alesis Corporation, 3630 Holdrege Avenue, Los Angeles, Ca 90016 LONDON: 17 Letchworth Point, Letchworth, Hertfordshire, SG6 1ND.

Circle #106 on Reader Service Card



THE CD-I CONFERENCE

The theory and technology of Compact Disc-Interactive (CD-I) has been developing for several years. Merging motion video, digital audio, text, graphics, animation, database and interactive software on a single compact disc has proved to be both stimulating and challenging to its designers. Indeed, it's been more stimulating and challenging than anyone had first imagined. It's taken a long time to develop the hardware product line, authoring infrastructure, titles and marketing plan to anywhere near the point of introduction.

On June 19 and 20 in London, all that changed, or at least everything took a definitive step forward. PolyGram, Philips, Sony and Matsushita co-sponsored the first conference to present a status report on CD-I, and preview many of the new tools and titles for the June

1991 launch of this remarkable new format. While conference planners expected only 150 attendees, over 500 showed, perhaps a significant omen for the future.

Although similar to interactive video systems, CD-I carries the concept a decade further in terms of technical clout. Things that previously were difficult or impossible to achieve on interactive video are part and parcel of CD-I. For the audio community, CD-I represents an unprecedented opportunity to form stronger ties with the video post-production and computer communities, and expand audio recording and post-production in markets such as book publishing. CD-I is the biggest potential market for the '90s (and beyond) and, if successful, could radically change the audio industry.

Always eager to witness (and sometimes try

by Ken C. Pohlmann

to participate in) history in the making, I booked myself on a jet to Britain and lent an ear to CD-I hardware manufacturers, in particular to an up-and-coming CD-I software guru, Andrew Bonime, for an insider's look at the birth of a technology.

Appropriately, Jan Timmer, president-elect of Philips and past head of PolyGram, delivered the introduction speech. He pointed out that the expected sales of CD players in 1990 are 33 million. Its success is tied to its universality, convenience and fidelity. CD-I will use the same tenets, but play a unique role in people's lives: providing entertainment, education and information. With initial hardware prices tagged at \$1,000, and software ranging from \$15 to \$50, worldwide hardware and software standardization (including NTSC/PAL compatibility), and over 100 licensed publishers and manufacturers supporting the format, CD-I is well-positioned for launching into the professional, consumer and education markets.

Gordon Stulberg and Bernard Luskin of American Interactive Media described

that company's pioneering efforts in developing CD-I titles. Over the last year, AIM has authored over 25 titles, with the goal of illustrating the broad spectrum of material that can be presented successfully on CD-I. Titles such as *Sargon Chess*, *Rand McNally's America: United States Atlas*, *The Palm Springs Golf Open/ABC Sports*, *Time-Life Photography*, *Caesar's Palace Casino Gambling*, *Sesame Street* and *Treasures of the Smithsonian* certainly accomplish AIM's mission and blaze the trail for other CD-I authors.

Other presenters also described a wide variety of CD-I titles. For example, Renault has turned to CD-I to answer the growing problem of providing technical training for the many mechanics who service Renault cars worldwide. Rather than incur the cost of training seminars, Renault developed interactive training discs. By describing the symptoms of a problem, the disc helps the user identify the cause of the problem and find a remedy. Because a CD-I disc can carry multiple soundtracks, a single release can hold many different languages and be used in many countries.

Of course, even the best concepts

can be hindered by implementation hardships. Thus, an early focus of the CD-I plan was development of authoring tools. Robert Sorensen of OptImage described the tools that company offers to CD-I authors. Although a number of environments are available, each provides a point-and-click method of interface. For example, using a Macintosh or IBM PC, a CD-I art package allows the user to manipulate existing images or create new ones; in addition, text can be added to the image using several fonts. A menu editor package lets the author add interactivity to the presentation. Regions on the screen are selected and linked to sequences. Using this and other software, authors can develop complete CD-I titles, emulate their operation and prepare master tapes ready for shipment to the CD pressing plant.

The toughest thing about interactive publishing is trying to explain it, without being able to demonstrate it. Fortunately, a gallery was set up at the conference with CD-I players galore, running the newest trial balloon software. Everything from innovative children's games to physical fitness and medical advice, from science fiction to urban gardening was offered on interactive CD software. This stuff actively stimulates the user and provokes an appetite for information. That, of course, is what CD-I is all about.

In addition to demonstration titles, there was a taste of new CD-I hardware. Along with a variety of home and professional players was a trio of startling Sony portable CD-I players. Based on the Dataman concept, these portables hold either a CD-ROM or CD-I disc, and with the help of simple control buttons or QWERTY keyboard, provide full access to the disc's information, which is displayed on a color LCD screen. When you consider the amount of information contained on a CD (650 MB) and that you have full portable access to it in the palm of your hand, the Dataman players must rank among the technical marvels of the century.

But even the most advanced information carrier/retrieval system is moot unless the information itself is valuable. So, exactly what kind of information should belong on CD-I? How should it be presented? Is interactivity a benefit or a liability? For answers to all those questions, on the flight back to

—CONTINUED ON NEXT PAGE

THE DAT STORE

DIGITAL AUDIO TAPE RECORDERS

MONDAY THRU FRIDAY: 9:00-6:00 / WEEKENDS: 1:00-4:00

OVER 35 MODELS IN STOCK NOW!

**PANASONIC SONY JVC AKAI
HITACHI AIWA KENWOOD NEC
HOME/PORTABLE/PROFESSIONAL/TIME CODE
DENON TASCAM SHARP FOSTEX
PIONEER CASIO NAKAMICHI**



PANASONIC

SV-3700

& Introducing the

**2624 WILSHIRE BOULEVARD
SANTA MONICA, CA 90403
213-828-6487 / FAX-213-470-6176**

NUMBER ONE* AGAIN.

AKG

HEADPHONES
#1 Four Years In A Row

AKG

MICROPHONES
#1 Two Years In A Row

dbx[®]

SIGNAL PROCESSING
#1 Four Years In A Row

*in recording studios as reported in Billboard's 1988, 1989, 1990,
1991 U.S. Studio Equipment Brand Usage Surveys.



1525 Alvarado Street, San Leandro, CA 94577
(415) 351-3500

©AKG 1990 © Akustische und Kino-Geräte GmbH, Austria

the States I took an aisle seat next to Andrew Bonime, president of Infotainment Ltd., a New York CD-I publishing company. During the flight Bonime sketched out his perspective of CD-I publishing.

"CD-I is at a stage where everything hinges on software. It's a little like the early days of motion pictures. When Edison first brought out the motion picture camera and projector, everyone scrambled around trying to come up with innovative ideas for it. First they showed someone sneezing, then they showed a fire being put out. Later, stage plays were shot from a single perspective in a theater.

"Similarly, nobody seems to know what will, and will not work on CD-I as a consumer medium. The stumbling block seems to be interactivity. Those who come to CD-I from other media, like film and music (and let's face it: *everybody* comes to CD-I from another medium), often try to impose interactivity on a linear concept. When this happens, the interactivity actually gets in the way of the experience instead of enhancing it.

"To illustrate, let's suppose we took a picture book and made it interactive on CD-I. At various points, menu-based choices are put to the user. The user has to go through these artificially imposed decision points to experience the visual material. The same material presented in a book is much more accessible. You can pick it up, flip through it, look anything up in the table of contents or index—all the while retaining a direct relationship with the material.

"Let's suppose you had a dictionary on CD-I, and you want to look up a word. Simply input an approximate spelling of the word (or just the first few letters to get to those words with the same beginning), and you have instant access to the desired information. If the word refers you to another word, you would simply point and click to get to that reference. If the word requires sound or a graphic diagram, full motion, animation or still picture, that, too, can be delivered along with the text. In this case, the interactivity is an *improvement* over the paperbound book because the computer technology is doing the work of delivering appropriate material to

the user. Whatever CD-I offers must benefit from the technology.

"Because of the confusion, there is a sense that CD-I is like a record, only less exciting. The record industry people seem to feel CD-I needs something akin to a Michael Jackson of CD-I. At Infotainment, we see CD-I not as a less exciting record, but as a more exciting *book*. We have developed a broad range of titles that have strong usefulness and/or entertainment qualities. We focus on interactivity's ability to serve the user. We also focus on the enormous quantity of data that can be presented on a single disc.

"Another key idea in CD-I is the worldwide, universal standardization. In the computer industry there is not quite the need for such universality. Computer manufacturers and users have accepted a world of multiple platforms and languages (I'm not saying they *like* it). Mass market consumers want to know that this CD-I disc they are about to purchase in London will play on the CD-I machine they have at home in Detroit. In CD-I that compatibility is guaranteed. Moreover, since CD-I is fully compatible with existing CD-Audio discs, a CD-I player becomes, in effect, an enhanced, universal CD player. We believe strongly that CD-I is and should be presented as an extension of the compact disc, not of the computer.

"Initially, CD-I presenters have been under pressure to dazzle the audience with technology. Unfortunately, they rarely dazzle the potential user with *content*. In the end, CD-I will succeed if it presents material that interests users and maintains their interest. A long time after the thrill of interactivity has worn off, the user must still find the content itself useful and entertaining. That is the key to success in CD-I. If you are looking for raw interactivity, go buy an Action Glove."

With those and many other ideas fresh on my mind, I cleared customs at JFK and caught the next flight to Miami. Bonime wasn't on the other side of the aisle, but a child with a Nintendo Gameboy was. Today, thanks in part to that kid's allowance, the video game industry is pegged at \$5 billion annually. CD-I is pegged at \$0. The way that ratio changes will change the audio industry. ■

Ken Pohlmann is working on an interface between the Action Glove and his word processor.



We didn't invent time, but we helped pioneer the use of time on audio and video tape with time code readers, Shadow synchronizers, and friendly Softouch edit controllers. We wrote the book a few years ago—everything we knew about time—and have distributed thousands of copies to schools and individuals. If you don't have a copy of our *Time Code Handbook*, just ask for one. Free. And we'll even pay for the call. We're still pioneering time with

our new family of time code products; the Phantom II VTR Emulator, the Softouch II Edit Controller, plus a new digital random access recorder to be formally announced at AES. See it in booth 635. But take the time to call us now for your free *Time Code Handbook*.



cipher digital, inc.
5350 PARTNERS COURT, P.O. BOX 170
FREDERICK, MD 21701
TOLL-FREE 1-800-331-9066
(301)695-0200 FAX: (301)694-5152 TELEX 272065

TANNOY
MONITOR
SERIES



*Search out the
Gray and Gold*

PREMIER DEBUT

SEE US AT A.E.S. BOOTH #
926, 928 & 930
-LOS ANGELES-



by Mel Lambert

DIGITAL AUDIO WORKSTATIONS

CURRENT STATE OF THE TECHNICAL NATION

Things are definitely heating up in the ever-changing world of professional audio. What was state-of-the-art technology a year ago might soon be superseded by new developments from the R&D labs of leading U.S., European and Japanese firms. Nowhere are these advances more profound as in the sphere of digital audio workstations. With second- and third-generation designs now having an impact in music recording, broadcast, film and video

interchange and file standardization, followed by a series of one-on-one demo sessions. Because several



workstation manufacturers were not invited to the SPARS gathering, details of some other systems are provided in an accompanying sidebar.

Hardware Developments

More than 300 AMS AudioFile systems are now in regular use worldwide,



post facilities, prospective customers expect more functionality.

It's hardly surprising then that facility owners and engineers find it increasingly difficult to remain current. With this in mind, the Society of Professional Audio Recording Services organized one of its regular series of business seminars on this timely topic. Held in Nashville earlier this year, the weekend seminar focused on the long-term implications of digital audio workstations in the recording, broadcast and audio-for-video markets.

Three disk-based audio systems (counterclockwise from above):

WaveFrame
CyberFrame;
NED PostPro
DSP; and Lexicon
Opus/s.

Eleven companies presented hour-long overviews of their respective hardware. The second day of the SPARS conference was devoted to a lively roundtable discussion of data



according to AMS president Jim Stern. AudioFile is now available as AudioFile+, a higher-speed version utilizing transputer-based technology.

AudioFile+ includes an enhanced set of macros for defining routine functions via softkey sequences, and sometimes play speed archiving to external magneto-optical disk storage. A 16-track version of the random-access recorder/editor is available, with an enhanced eight-hour storage capacity. Gefen Systems has

also developed FileMaster software as a companion to its existing M&E Organizer, which allows automated upload of selected sound files from a Sony CDK-006 "CD Jukebox" into AudioFile+ via the digital ports; labeling and storage to hard disc. Online use of CMX-compatible edit decision lists for automated audio conformation to picture is also available.

Pro-user prices for AudioFile+ begin at \$95,000 for a two-hour/8-channel package; a hardware update is available for retrofitting existing systems to the enhanced version.

While not really a "workstation" by current definitions, the new Alpha Audio DR-2 represents an initial overture into the market. Currently being offered as a "simple-to-use digital recorder/editor for the price of an analog 2-track," the DR-2 demonstrated at the SPARS conference features a choice of 15, 30 or 60 minutes of stereo recording at a sampling rate of 44.1 kHz (dependent upon disk size), plus an Exabyte drive for archiving. A dedicated scrub/shuttle wheel provides edit location, with selectable crossfade profiles. Menu-driven software and conventional transport controls allow a total of 256 cue points to be labeled and accessed as automated play lists, or to provide fast, random access to recorded segments. Additional SCSI-equipped drives provide total storage times of up to several hours of stereo audio, while a serial port enables full remote control via standard Sony P2-compatible protocols. Multiple transports can also be synchronized with one another via conventional time code tracks. DR-2 pro-user prices begin at around \$10,500 for a 15-minute stereo model.

Digital Audio Research's SoundStation II offers a choice of 8- or 16-

track capacity with up to eight hours of disk storage; some 60 systems are in use at locations around the world. Designed to behave like a tape-based editing system, the SoundStation's unique control surface comprises a touch-sensitive screen, edit wheel and several dedicated function keys. A unique feature is the unit's ability to perform background

archiving and uploading from magneto-optical disk while the primary processor is performing real-time

playback and editing of digital audio. The WordFit option provides automatic editing of one dialog track to sync it to another guide track.

Two recent software upgrades for the SoundStation II include Multichannel Drop-In and Autolocation System, which allows the selection and return to key points in the audio program. Scheduled to be unveiled at the October AES: a DSP option, allowing 4-band EQ, pan and gain settings to be attached to audio segments; and the new DASS 100 multifunction digital audio synchronizer, multiple interface and signal processor, which provides sampling-rate conversion, sample synchronization, digital I/O conversion, gain trim, digital mixing and other

—CONTINUED ON PAGE 24



SSL ScreenSound

Just When You Thought It Was Safe to Go Back into

The Workstation Jungle...

In addition to the companies demonstrating wares at the recent SPARS conference, here are new developments from nine firms that also have developed viable workstation designs.

The DSE-7000 from AKG Acoustics is a RAM-based workstation that includes an 8-track random-access recorder, editing control surface and 10-channel mixer; the stand-alone unit is controlled from a menu-driven video display. Front-panel control elements include conventional channel faders, an edit/scrub wheel, virtual "recorder" controls, and software-definable keys for track routing and assignment. Both 32kHz and 44.1/48kHz sampling frequencies are available. Companion software controls the operation of all recording, cut/paste non-destructive editing and track assignment functions. Each plug-in RAM card holds a total of 264 seconds of mono audio, with input/output via analog or optional AES/EBU-format digital I/O; a total of four memory cards can be added to provide a storage capacity of 17.5 minutes. Hard disks are also available for long-term storage and archiving of sound files between recording and editing sessions. On the horizon: enhanced time code synchronization plus additional DSP functions (including EQ, reverb, special effects,

time compression and dynamics control).

Since its introduction last year, Digidesign has reportedly delivered more than 2,600 Atari- and Macintosh-based Sound Tools systems, which offer stereo direct-to-hard disk recording, as well as SMPTE

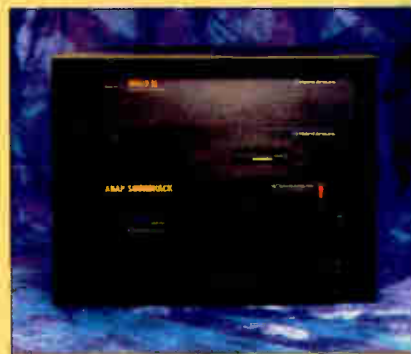

Hybrid Arts ADAP II

lock, time compression and powerful editing features. Recently, Digidesign unveiled PRO I/O,™ a single-rackspace option that provides two channels of 64-times oversampled A/D and 18-bit, 8-times oversampled D/A converters, along with Apogee digital filters, balanced XLR analog I/O, metering and hardware-based video synchronization. The company is also shipping its Deck software, which, when used with Sound Tools, allows 4-track hard disk recording

—CONTINUED ON PAGE 23

AMS AUDIOFILE.. THE PLUS POINT



During the 1980's, one hard disc recorder both established and dominated the market - AMS AudioFile!TM

AMS now announce AudioFile PLUSTM as part of a continuing policy of upgrades that take AudioFile into the 90's and beyond.

With a transfer of operating software to the latest technology 32 bit, 4 Megabyte transputer platform, AudioFile PLUSTM offers yet faster operation and the ability to accommodate a range of major new features - further distancing AudioFile from other disc based recorders.

Extended System Architecture also provides for 8 simultaneous inputs/outputs, in analogue and/or several digital formats.

Whether you have yet to make up your mind about hard disc recording or you already own an AudioFile, you'll find it comforting to learn that this system upgrade is once again available for all existing AudioFiles.



See us at AES
booth #336 & #338,
IBC booth #F7 and SMPTE
booth #1662



ams



AUDIOFILE+

Setting the pace for hard disc recording

AMS Industries plc
Billington Road, Burnley,
Lancs, BB11 5ES, UK
Tel: (0282) 57011 Fax: (0282) 39542

AMS London: (01) 722 3925 AMS USA: (707) 762 4840

New York: (212) 586 7376 Chicago: (312) 527 4569
LA: (818) 845 0199 Seattle: (206) 842 7182

Circle #107 on Reader Service Card

World Radio History

—FROM PAGE 21, JUNGLE

that can be synched to MIDI.

Digital Dynamics' ProDisk 464 utilizes a Macintosh as master controller, and is available with between four and 64 hard disk tracks and full SMPTE/EBU time code interlock. Sampling rates are 32, 44.1 or 48 kHz; storage capacity per data track is between 30 and 180 minutes per track at a sampling rate of 44.1 kHz. In addition to auto punch-in/out, visual waveform editing, digital crossfade and rock 'n' roll scrubbing, new enhancements include a Cue List mode that allows audio-edit locations from an editing session to be sorted against time code values, and then copied re-arranged and/or cut and pasted to different locations.



Digidesign Sound Tools

Doremi Labs'

Digital Audio Workstation Nucleus (DAWN) is controlled from a Macintosh Plus/SE/II and provides up to four simultaneous analog inputs, eight outputs and eight tracks of hard disk recording. Various sizes of add-on SCSI-equipped hard drives and an expandable system architecture offer recording capacities up to several hundred track-minutes of sound files; a 300MB hard drive stores 52 track-minutes of data at a 48kHz sampling frequency. Sampling rates can be set between 44.1 and 96 kHz. Also available for DAWN are WORM and magneto-optical drives, plus Exabyte and similar backup tape drives. Custom-developed software for the Mac controller provides forward/backward play, full cut-and-splice editing and other system functions. Synchronization to external time code sources is via conventional SMPTE-to-MIDI conversion devices. Digital-DAWN is a functionally similar version with fully digital I/O—optional outputs to AES/EBU, IEC 958 Type II (SPDIF) and Yamaha cascade formats, with AES/EBU or IEC

958 Type II input.

Ediflex Systems has developed Audiflex, designed specifically for assembling, editing and otherwise cleaning up dialog, ADR and sound effects elements. The system consists of a hard disk-based recorder/editor, controller PC and graphics VDU, and a 660MB magneto-optical drive for archive/backup storage. Standard configurations are equipped to handle four channels, but can be expanded to 8-channel capacity. EDLs can also be imported directly from any CMX-compatible offline editing system via floppy disk. Full cut-and-splice editing, "shaving" or "scraping" also is provided, with assignable crossfade and edit profiles. TimeLine Lynx modules are used for time code sync to external trans-

ports and editing systems.

Now back in business as Electric Sound & Picture, the former participants in Australia's Fairlight Instruments are currently developing a series of enhancements for the Series III workstation. The new XDR package includes enlarged RAM capacity to 32 MB (for online storage of up to 360 seconds of sound files); a new stereo input module for analog and/or AES/EBU-format signals; plus REV 8 software with Cue List management and improved time code functions. Standard Series III features include four track-hours of stereo 16-bit sampling to hard disk at a 50kHz sampling frequency (100 kHz for mono samples). Also being revived is the Series III's custom-designed control surface for audio post. The MFX (Music and Effects) hardware/software package features dedicated transport controls, rock 'n' roll scrub editing, programmable soft keys, plus time code-based sequencer and controller software. A hard disk recording option with 24 "virtual" tracks and full-function random-access editing will

Sound Effects Software

Sound & Music Catalogging

- Organizes Tapes, DATs, Samples, Floppy Disks, Compact Disks, Broadcast Carts & LPs.
- Contains presorted catalog listings of Compact Disk sound effects & production music libraries.
- Provides easy data entry for your own libraries, checks spelling and allows descriptions of virtually unlimited length.
- Searches library catalogs by sound, style, mood, category, title, synonym or description.
- Enables multiple word searches using AND, OR, ALSO & NOT to specify exceptions, alternatives.
- Sorts & Cross-references by Format, Length, Media, Project, Recordist or Source Roll.
- Allows unlimited number of custom categories.
- Controls Compact Disk playback via Sony CDK-006 60 disk multi-player "jukebox".
- Networks up to 32 stations and 16 jukeboxes.

Sound Effects Spotting

- Manages spotting lists referenced to reel, scene, time code or feet/frames.
- Provides search, copy & paste from library to spotting lists.

Dialogue (ADR) Spotting

- Organizes replacement dialogue lines, sorts by character, reel, scene & footage.
- Prints standard cue/line sheets as well as a variety of other forms
- Transfers data to Cueprinter for mixing cue sheets.

Cue Sheet Printing

- Prints standard re-recording cue sheets in feet/frames or timecode on any size paper.
- Conforms footages to picture changes.

LEONARDO SOFTWARE
 10378 Holman Avenue
 Los Angeles, California 90024
 PH: 213.277.5161 • FAX: 213.277.9086

Circle #030 on Reader Service Card

—FROM PAGE 21, DIGITAL WORKSTATIONS

useful functions. Pro-user price of an 8-track/two-hour system with four inputs, eight outputs and TimeWarp software is \$108,000; WordFit costs around \$19,500.

Lexicon Opus and Opus/e systems have now been installed at more than 50 facilities throughout the world. The Opus comprises a console-style control surface with 12 channels of digital mixing and eight simultaneous tracks of hard disk recording at a sampling frequency of 44.1 or 48 kHz; 480 track-minutes of storage are available at 44.1 kHz. The time code-capable system is available with an EQ/filter option providing 12 channels of real-time, 4-band digital EQ, with selectable filter profiles per section. Recent en-

hancements include a control-surface grouping package; EQ grouping; time code-controlled record punch-in/out



DAR SoundStation II

for dialog replacement; and shuttle lock mode for locking audio replay to external time code sources as low

as 1/20th normal playback speed. Opus/e is a pared-down, stand-alone version that features the random-access recording and editing section, but without the mixing console functions.

New England Digital emphasized the combination of RAM-based recording, sampling and hard disk recording offered by the new PostPro/SD (Sound Designer) system. Configured with a choice of four, eight or 16 hard disk tracks and eight or 16 RAM-based tracks, PostPro/SD offers random access to a total of 24 or 32 tracks of digitized material locked to time code. New backup formats are also available, including DDS DAT, with CMX Autoconform for EDL compatibility and VPR-3/P2 machine-control protocols. A powerful new DSP option includes real-time, 5-band parametric EQ, mixing between four inputs and

—FROM PAGE 23

be unveiled at the AES convention.

Hybrid Arts' ADAP II is a direct-to-hard disk recorder/editor controlled by an Atari Mega that can store around 50 minutes of stereo 16-bit audio at a 44.1kHz sampling frequency using a 760MB hard drive. All functions can be locked to external or internal SMPTE/EBU time code and/or MIDI data; a built-in TC reader/generator is also included with the system. Custom-developed Atari software enables waveform editing, rock 'n' roll scrub editing, crossfade editing and a host of other functions. Also offered is an erasable magneto-optical drive for archiving and long-term storage (capacities from 170 to 760MB), plus AES/EBU digital I/O. Scheduled to be unveiled at AES: "Time Page" time-compression/expansion software; a DAT archiving utility; and an LTC/VITC time code chase-lock interface.

The Sonic System from Sonic Solutions comprises a Macintosh II, additional hard disk drives for data storage, custom-developed controller software, and SSP (Sonic Solutions Processor) plug-in cards for the Mac that handle both analog, AES/EBU and SDIF-2 digital I/O at 44.1 and 48kHz sampling rates. Software is available for full-function 4-track (soon to be 8-track) digital editing, mixing, real-time EQ and dynamics control, plus the

firm's proprietary NoNoise processing for removing unwanted noise, pops and clicks. Full lock to external time code for audio-follows-video editing will also be in-



Ediflex Audiflex

troduced by early fall. First shipments have now begun of Sonic Solutions' CD Maker, an add-on encoding and recording unit for the system that produces Red Book-standard CDs using Start Lab WORM drives and media. Scheduled to be unveiled at the AES convention: an unbundled version of NoNoise that provides selectable declipping, background noise elimination, hum and buzz reduction, etc., for post applications; and new Sound for Picture software for dialog, effects and music editing.

In Australia, veteran sound designer/film mixer Roger Savage has been developing a digital workstation so new that details of its existence only reached me during

very late July. The Soundfirm Soundtracker, scheduled to be formally unveiled at AES, has been designed specifically for feature-film sound editing. Due to the large amount of raw material that must be cataloged and collated, the system places specific emphasis on sound-file management.

Configured as the "electronic equivalent of a Moviola, splicing block and 8-gang synchronizer," Soundtracker is intended to allow sound editors to make the intuitive transition from film-based techniques to new random-access, disk-based technologies. The operator's console is equipped with a plasma display and membrane-type touchscreen, dedicated keys and two edit/scrub and transport shuttle controls. A 386-based PC acts as the time code-capable master controller with serial/Sony 9-pin control of external transports, and connects to an audio frame equipped with four inputs (64x oversampling via sigma-delta converters) and eight internal hard disk tracks. A VME card cage allows multiple frames to be interconnected for multiple track outputs and multi-user access to hard drives. CMX-format EDLs can be imported for use during audio conformation. The system constantly backs up sound files and edit data in background mode to a removable magneto-optical drive.

—ML

“WaveFrame At War”

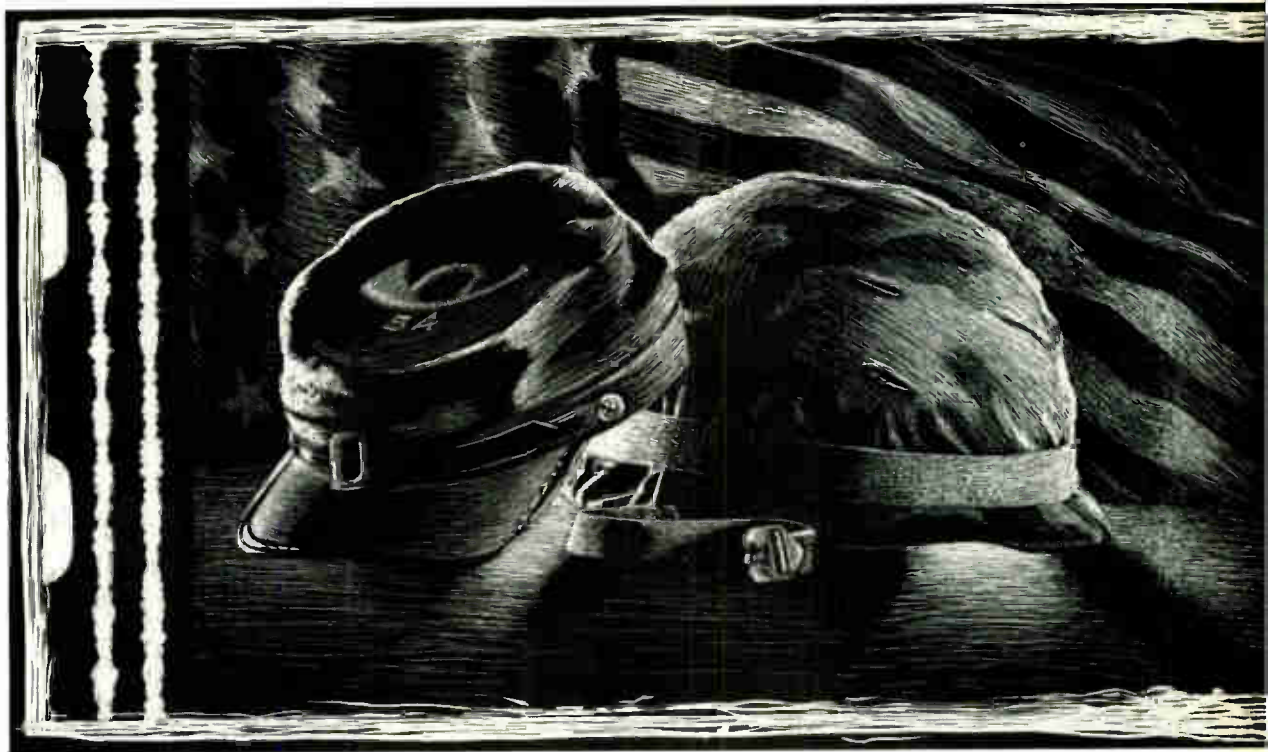

When Scott Gershin and Wylie Stateman of Sound Deluxe in Hollywood were drafted to post the sound effects and Foley work for Universal's award-winning motion picture, **BORN ON THE FOURTH OF JULY**, they turned to the AudioFrame for the firepower they needed.

“Using the AudioFrame's sampler and EDL to spot the sound effects to picture, coupled with its internal mixer and 24-bit multitrack disk recorder, we were able to produce a product which exceeded our expectations for audio quality *and* beat our deadlines significantly.”

BORN ON THE FOURTH OF JULY has been nominated for an Academy Award for Best Achievement in Sound.

Likewise, when James Horner composed the breathtaking score for **GLORY**, he turned to *his* AudioFrame.

“The purity of the sound of AudioFrame lets the beauty of my music come through.”

James Horner's original score for **FIELD OF DREAMS**, which was composed and performed on the AudioFrame, has been nominated for an Academy Award.

So, in *your* battle against man and machine, choose the ultimate weapon.

The **AudioFrame**... by WaveFrame.

 **WaveFrame**

2511 55TH STREET BOULDER, CO 80301 303 447-1572
BOULDER • LOS ANGELES • NEW YORK • COPENHAGEN

eight track outputs, plus various multi-user, multitasking functions.

The company is also actively pursuing third-party development of software for PostPro and PostPro/SD systems. Lucasfilm's new SoundDroid software package is the first such product to be released, comprising an "electronic cue sheet and audio waveform editor" designed specifically for film-style mixing and episodic TV-type



AMS AudioFile/Logic 2

mixing. Based upon the new DSP option and utilizing NED's proprietary SyncNET controller protocol, the new software will also be offered in a version that runs on non-DSP-equipped PostPro systems.

Otari Corp. demonstrated a pre-production version of its new Digital Audio Recorder and Editor—now renamed DDR-10—that the firm is developing in conjunction with Digidesign and J.L. Cooper. The stand-alone system, which includes built-in monitor speakers, utilizes a Mac IIci as a workstation controller that houses Digidesign's proprietary D-to-A converter cards with Apogee anti-aliasing filters. Controlled from a version of Digidesign's Sound Designer II recording and waveform editing software, the new stereo-capable unit features a 350MB hard disk holding up to 60 minutes of mono sound files. Multichannel versions are also under consideration. The system archives to conventional audio and data DAT formats. A hardware control panel (HCP) provides a dedicated jog/shuttle wheel, 100 cue points and dual LED displays for current and event time. New application-specific software versions to be unveiled at the AES convention include CD mastering, ADR and other functions.

Solid State Logic showed its

ScreenSound Digital Audio-for-Video Editing Suite in a real-world post/ADR environment, with material from a *Back to the Future III* trailer. A new bit pad and cordless pen now provide easier data entry into the system, which features eight simultaneous channels of hard disk recording/playback (with an additional eight available for submixing); non-destructive editing of up to 60 track-minutes of audio; a removable WORM drive for storing sound effects, music and other sound files; plus a real-time, automated, 8-channel graphics mixer. Upcoming ScreenSound enhancements include the importing of CMX- and Sony-compatible EDL files, real-time DSP, and software extension for automating a variety of ADR functions. At the AES convention, SSL will unveil SoundNet, a new ScreenSound networking option allowing different processor racks to be addressed by different control surfaces, and/or multiple processors to be commanded from a single controller.

Sony Professional's current approach emphasizes the use of "hybrid technology" in a production environment, including tape and disk-based technologies. Products spotlighted during the SPARS presentation in-

ber of editing sessions, material is being arranged sequentially from 2-channel source reels; in these and other applications, a viable market exists for existing tape-based digital editors with add-on digital-domain processors such as the SDP-1000.

With a worldwide customer base now approaching 400 Dyaxis systems, Studer Editech recently announced a 4-channel version. Dyaxis 2+2 (which began shipping in May) comprises two Audio Processors linked via controller software running on the Macintosh. The company is currently evaluating a variety of archiving formats, including C-3 data DAT and erasable magneto-optical media. Other enhanced DSP-based options soon to be offered for the Dyaxis Series include real-time equalization with low/highpass filters and a 3-band parametric section, selectable for mono or stereo modes, plus a digital fader and gain-trim functions. An analog-digital effects/insert loop is also available. The company is actively pursuing third-party developers to provide additional software modules for the Dyaxis platform. Pro-user price for a standard 2-channel Dyaxis with 60 track-minutes of storage is \$16,000 (a Mac IIcx/ci is extra), while

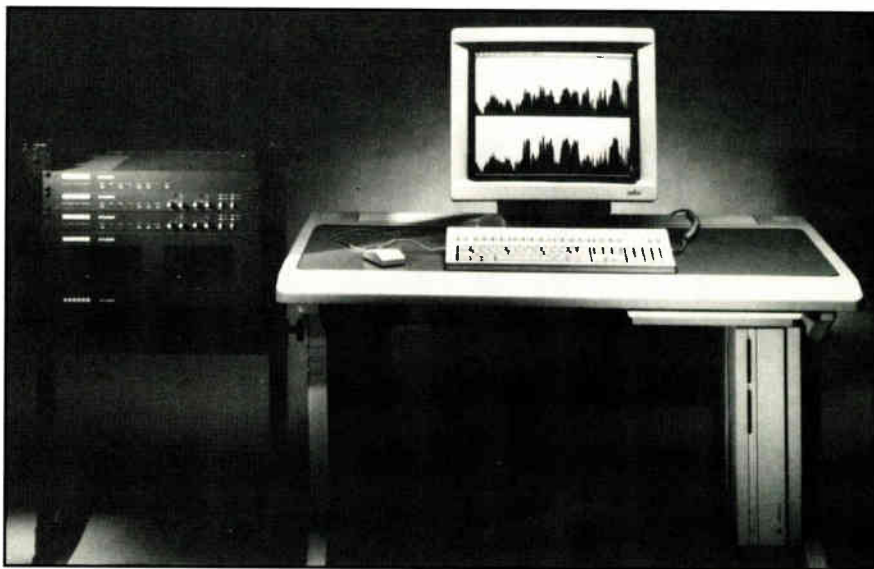

Studer Editech Dyaxis

cluded the new SDP-1000 Digital Effector (featuring automated digital compression, limiting and 4-band EQ with high/low filter sections), Twin-DASH PCM-3402 stereo tape machines capable of holding 94 minutes of material at 44.1 or 48kHz sampling rates, and the DAE-3000 Digital Editing System. As marketing director Courtney Spencer emphasized, for a large num-

a similar-capacity Dyaxis 2+2 sells for \$26,000; DAT backup drives cost \$4,000.

Symetrix was showing final screen displays for the DPR100 Digital Processing Recorder, and announced that a new 4-track Recording and Editing Station with full-function 4-band EQ, dynamics control and mixing would be unveiled at AES. As system designer and *Mix* columnist Stephen St. Croix

The Future. We've Been There Before.



The DSP Option, a 24-bit digital mixer/digital signal processor.

This is not the first time we've introduced a revolutionary new digital audio product today with the promise of a long and profitable future.

As a matter of fact, as the company that started it all, we've made our share of promises. But a look at our track record (at right) shows we've delivered on those promises — and in the process changed the way the industry works. At the same time, customers who bought systems even way back in 1977 have been able to upgrade every step of the way.

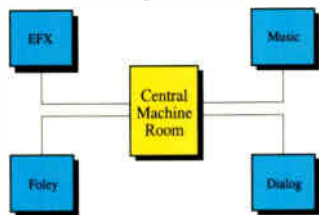

With MultiArc,™ multiple users user share processing and storage resources from a central machine room.

Take, for example, our latest breakthrough, the DSP Option. It's a 24-bit, multitasking mixer/digital

signal processor that provides 5-band EQ, automated level control, multitrack digital I/O, plus sample rate conversion. And it's compatible with all current Synclavier and PostPro systems.

What's more, the new DSP Option eliminates the Achilles' heel of digital audio: back-up. Loading and saving can occur in the background while you continue working.

Synclavier, Sample-to-Disk, The Tapeless Studio, and the New England Digital logo are registered trademarks of New England Digital. Direct-to-Disk, PostPro, EditView, AudiMation and MultiArc are trademarks of New England Digital. Apple and Macintosh are registered trademarks of Apple Computer, Inc. SoundDroid is a trademark of LucasArts Entertainment. © 1990 New England Digital. Product specifications are subject to change without notice.

1977

We make history with the introduction of the first digital synthesizer/sequencer — the Synclavier.®

1980

A new Synclavier keyboard design accompanies powerful new features like sound layering and real-time digital effects.

1982

New England Digital introduces the first commercially available disk recorder, Sample-to-Disk.®

1985

Presenting the new polyphonic sampling Synclavier and the first multitrack disk recorder/editor, Direct-to-Disk™ — The Tapeless Studio!®

1988

New England Digital goes Macintosh,® paving the way for new, easy-to-use screens like our own EditView™ and third-party software like SoundDroid.™

1991

Enhanced with the new DSP Option, today's Synclavier and PostPro™ workstations revolutionize the industry again as multiuser systems.

Our commitment to third-party software development ensures the widest variety of user interfaces. For example, with our EditView window and Lucasfilm's new SoundDroid Audio Editing System, you now have your choice of tape- or film-style editing.

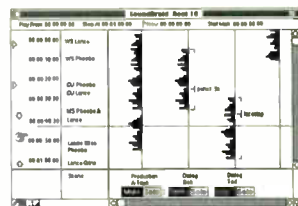

Lucasfilm's SoundDroid is the first in a series of third party user interfaces created for NED.

And here's a look at the future: because the DSP Option incorporates our new MultiArc platform, it provides for a true multiuser system tomorrow, where multiple users will share the same disk and processing resources.



Our AudiMation™ virtual mixer gives you fast, intuitive control over EQ, levels, routing, and other system parameters.

By investing today, you can take advantage of such powerful features as 24-bit signal processing and multitasking. What's more, your investment will be rewarded in the future, as true multiuser operation becomes a profitable reality.

To find out more, call 1-800-848-4400 ext. 356 and receive our new brochure on the DSP Option and MultiArc.

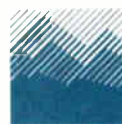

New England Digital
Rivermill Commercial Center
Lebanon, New Hampshire 03766
(603) 448-5870

See us at AES, Room 214 A,B,C

Circle #082 on Reader Service Card

explained, full compatibility between the "flagship" multichannel system and the RES will allow material that has been edited and processed to a time code-related EDL to be exported to the DPR100. Both systems now feature object-oriented editing software (four layers for the RES and eight for the DPR). Currently, the DPR100 is designed for use with a monochrome 19-inch monitor, while the RES is compatible with a 13-inch color system and features a handheld Graphics Control Tablet with transport controls, soft keys

and shuttle wheel. The DPR100 includes an optional Dedicated Control Surface featuring long-throw moving faders, record safe/ready switching, autolocator and a touch-sensitive data entry/display screen, a jog/shuttle wheel for edit location, and transport controls. Prices for the new 4-track RES start at \$60,000 for a base system with 206 track-minutes of audio storage, to \$75,000 for a similar version with time code sync, mixing, equalization, dynamics control and full sample-accurate editing.

WaveFrame used the SPARS conference to emphasize the modularity of

AudioFrame; some 110 systems have been installed worldwide. AudioFrame systems are controlled from an IBM PC-compatible platform, and can be assembled from four basic hardware elements: a RAM-based Sampling Module; a 16 x 4 x 2 Mixing Module with EQ and reverb; a 4/8-track Disk Recording Module with selectable 16- or 24-bit capabilities; and a 4-channel Digital Interface (4-in or 4-out, or simultaneous stereo I/O) with variable, 32 to 50kHz sampling rate and format conversion.

Two demos showed off the system's capabilities both for sampling and hard disk recording with time code interlock, as well as use of EDL information to enable replay of sound files stored on hard disk. Also being demonstrated: CyberFrame, an 8-track digital sound system designed specifically to speed up the editing of sound for feature film and episodic TV.

Data Interchange Standardization

An increasing number of projects are moving from facility to facility during their recording, editing and mixing stages. And producers and directors cannot always find time on the same workstation for last-minute sound changes to picture, not to mention the need to re-edit the material for different applications. Inevitably, the primary focus during the SPARS conference's round of panel discussions became one of data exchange.

As many participants were quick to point out, there are two primary factors to consider: the archiving or off-loading of all data, including sound files, edit pointers, DSP profiles and automation information, from the particular workstation in greater than real-time, for reloading into the same type of system at a later date; and the off-loading of the same data for subsequent transfer to a different platform.

In the former case, we need to determine the following:

- ◆ What information should be off-loaded?—raw data files, plus standardized formats for timing, editing, processing and level information (on systems equipped to handle such functions);

- ◆ How should the data be off-loaded?—standardized 16/20/24-bit sound file formats, possibly compatible with 2-channel AES/EBU or 56-channel MADI bitstreams, plus formalized EDL structures;

The Next Generation in CD Mastering Systems Is Here Now. The ODC 530.

Optical Disc Corporation, the acknowledged leader in optical disc recording technology around the world, has set a new standard in CD Mastering with its Model 530 Master Disc Recording System.

CD manufacturers who are developing or expanding their mastering capabilities should take a careful look at the 530.

Our new Master Disc Recording System offers:

- Extremely high throughput and yields.
- QC while mastering through the use of DRAW technology.
- Fully compatible with all replication processes.

- Extraordinary price/performance combination.
- Worldwide service and support.

Call, write or fax us. We'd like to tell you more about the better way to handle your disc mastering needs. Be part of the next generation.



OPTICAL DISC CORPORATION

Optical Disc Corporation
12150 Mora Drive
Santa Fe Springs, Calif., USA
Telephone (213) 946-3050
Telex 510-101-2615
Fax (213) 946-6030

Learn more about ODC's Series 500 Laserdisc Mastering Module at AES.

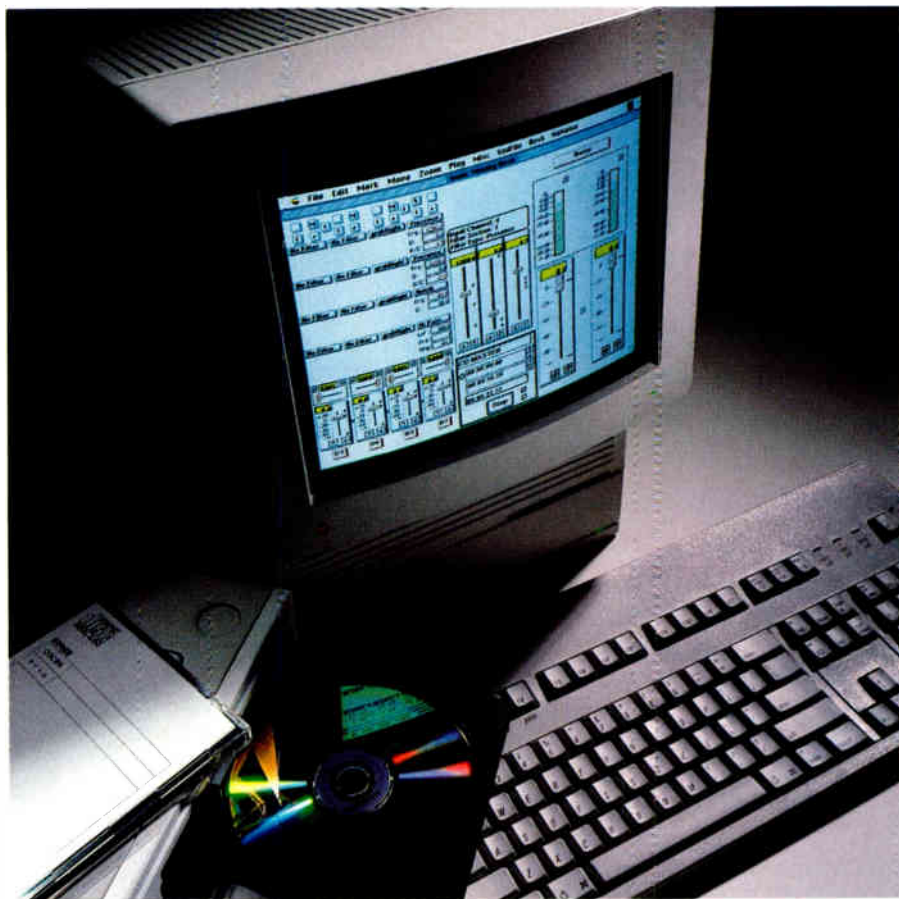

Like no other.

No other digital workstation fits this picture because no other system matches the flexibility and productivity of the Sonic System.

The Sonic System offers a series of "firsts." The first (and only) digital audio workstation that can record directly to a compact disc. The first to offer background loading and unloading to hard disk. And no other system gives you from 16 to 24 bit audio at such a reasonable price.

The Sonic System offers unprecedented ease, speed, and power. All editing and mixing can be previewed in real time, so there's no waiting for the system to compute edits and write them to the hard disk.

EDITING - We surrender complete control over crossfades, allowing you to make smooth edits which are impossible on other systems. All editing is "non-destructive," so you can make changes quickly and save multiple versions for those finicky producers.

MIXING - Our Mixing Desk includes a broad array of filters, dynamics, and full automation. You can change filter settings and audition your EQ in real time.

NoNOISE® - The **NoNOISE** system has restored thousands of recordings. Now you can add any **NoNOISE** "tool" for de-clicking and noise reduction to the Sonic System.



Whether you edit or mix music, dialog and sound effects, or multi-track recordings, chances are there is a Sonic System package that could enhance your productivity without breaking your budget.

Call us for more information:

Sonic Solutions

1902 Van Ness Avenue
San Francisco, California 94109
Tel (415) 394-8100
Fax (415) 394-8099



Circle #083 on Reader Service Card



A NEW TRACK RECORD

Fairlight's MFX is the new front runner for Audio Post



MFX is a 24-track disc recorder for post production. It can play up to 16 tracks simultaneously, for around the same price as many 8-track disc recorders. So it's cost effective enough to be used for track lay to multi-track tape, yet it has enough tracks to be used directly for the final mix.

The MFX console has dedicated keys for track selection, sound effect performance, external machine control, and most importantly - fast and powerful editing features. You can edit, cut and paste non-destructively on all 24-tracks before committing anything to tape.

Twenty-four outputs connect straight to your mixing console, with AES/EBU in/out for digital stereo

transfer. Audio is 16-bit linear at 44.1 or 48K. MFX incorporates the latest generation 2 and 3 hour capacity hard-disc drives which can provide over 20 hours of on-line storage.

It's fitting that Fairlight should set a new track record for audio post. Chances are the music soundtracks you're laying up now were produced using sampling, sequencing and waveform editing techniques that our designers introduced in earlier decades. In fact, with the addition of a MIDI keyboard, MFX can also run all of Fairlight's Series-III sampling and sequencing software.

With hundreds of Fairlights in use around the world, it's the track record that counts.

◆ Where should the data be off-loaded?—possibly as time code-linked 2-channel files with labeling to conventional DAT or Exabyte carts, or to a removable, high-speed magneto-optical disk format.

Having selected an appropriate storage media and developed a proprietary format suitable for their specific workstation, are manufacturers going to be able to agree on a common archiving format? I have my doubts, primarily because too many conflicting

**“The Tapeless Directory”:
A Guide for the Confused**

Two London-based independent consultants recently published a directory listing some 50-plus digital audio workstations, with brief technical and operational descriptions of each. Carefully compiled by Yasmin Hasmi and Stella Plumbridge of Sypha, “The Tapeless Directory” (\$55) is available through Mix Bookshelf—call (800) 233-9604 or (415) 653-3307 for details.

Each entry in the 40-page directory provides a single-paragraph product description; a succinct analysis of salient features; an operational overview; a list of technical specifications, applications, integration plus backup formats; future developments; and approximate pricing.

data-storage formats currently exist. Also, the “complexity spectrum” between different designs—ranging from a “plain vanilla” 2-channel recorder/editor to a time code-driven, multitrack system with real-time EQ, dynamics and multichannel mixing—means that a common data format will need to accommodate a great deal of redundant data, all of which can slow down the archiving process on smaller-format configurations.

Several compromises were proposed during the Nashville conference, including a Transcode Utility that would convert a firm’s proprietary format into a universal structure capable of being input to other hardware. Unfortunately, such processing would

probably need to be done in something approaching real time, with inevitable inefficiencies and delays at the end or start of a session.

Several participants pointed out that both audio DAT and data DAT formats are being used more and more for simple archiving and data exchange of 2-channel audio, in addition to the familiar AES/EBU, IEC 958 Type II (SPDIF) and other digital I/O formats for 2-channel data transfer within a multiroom facility. It was also proposed that consideration be given to stripping the data back to its component sound files, and then transferring these with the information necessary to reconstitute the multichannel, processed and edited mixes against time code. However, because of disparate differences between the system architecture and operational capabilities of different workstations, and the unique functions offered by each, some inevitable compromises might lead to frustration in extracting all of the necessary information from the imported data.

Although complete data interchange might remain a dream for the foreseeable future, several companies—including New England Digital, WaveFrame and Solid State Logic—agreed at the SPARS conference to publish their respective interface protocols and file structures so that disk and optical files can be read by “foreign” systems.

While the debate continues, the topic is being examined by the AES Subgroup on Operational Requirements for Disk Recording. Seeking to “define the operational and technical requirements for disk-based professional digital audio recording with emphasis on applications for television and motion-picture media,” the subgroup is currently looking at the complex pros and cons of various magneto-optical archive and data-exchange formats, including ISO3-format, 650MB drives and WORM CD drives capable of recording 24-bit data at higher rotational speeds.

I’ll be back next month with a detailed look at current developments and future design options for analog, digitally controlled and all-digital recording and production consoles. ■

Mel Lambert is the principal of Media&Marketing, a high-tech consulting and marketing service for pro audio firms and facilities.

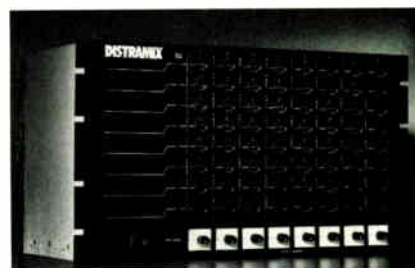

©
DISTRAMIX

• 8 X 8 Distribution Amplifier/Mixer Combination • Studio sound, live sound, teleconferencing and permanent installations • Linking capability for input and/or output expansion • Both +4 balanced (XLR) and -10 unbalanced (1/4") inputs and outputs • -10 output adjustable to 0 dBu

For more information, contact:

MERIDIAN COMMUNICATIONS

PO Box 97, Alameda, CA 94501
Telephone: 415.769.1515
Facsimile: 415.523.6296
Dealer inquiries welcome

by Stephen St. Croix

FISH FINS & FINNISH SINGLES

Well, I can see by the old shadow on the rocks that it is about 11:30 p.m., time to think about going to bed. The sun is a bit low on the horizon now, and it'll be good and dark by 2 a.m. Besides, we've eaten all the fish we caught and smoked, the bread we baked, and the wild raspberries and strawberries that we picked. There is beer and even some vodka and cloudberry juice left, but it's over there, and we're over here.

I guess I'll hit it when the fire burns out, or when I finish this column, whichever comes first.

I write to you this time from a small island off the coast of Finland, latitude 60°24', longitude 21°12'. I guess it has a name, but if it does, the chances that I could pronounce it are so slim that I never even asked. A friend has a summer house here, a very Scandinavian version of a log cabin. It's up the hill a few meters, the ocean is down the hill a couple of meters, and I'm in between, sitting around the fire with friends, on a naturally polished flat rock somewhat larger than my entire house in the U.S.

It has been a packed week. Yester-



day we crossed over to Swedish-speaking islands in a little fishing boat to see the sunset. We caught it from an island somewhat *smaller* than the above-mentioned house in Maryland. We swam in an ocean that had been totally locked up with six to eight feet of ice only a few months before. Now, we didn't exactly hang out in it for hours, but we did swim in it, mostly so that I could say we did.

A couple of days before, an evening in southern Finland turned out to be quite electrifying. We were in the middle of a major storm, wherein lightning struck less than three meters from where we were relaxing with a few beers. That's *nine feet* for you locals! Really. Five witnesses. What a sound. It actually whistled, sort of a

downward chirp. I went to sleep that night thinking that it sounded like the fabric of space itself was being ripped apart, only to wake up the next morning realizing that within the ionized plasma of the lightning itself, that was exactly what happened.

And, a couple of days before that, we caught the total eclipse of the sun from the top of a ski jump a little after

4 a.m. Nice.

Actually, I came to Finland to produce and engineer a single for a well-known Finnish artist named Anna Hanski.

It has been several years since I actually worked in a studio outside of the major recording countries. I have worked in the U.S., the UK, other countries in Europe that sport international Top 10-track records, and on some well-known sunny islands.

In these studios (at least the major facilities where money is in evidence) there have always been constants that provided a sort of uniformity, so I've never really felt too far from home. Overlooking obvious differences in working environments, such as IEC vs. NAB tape equalization, instrument and speaker choices, processing gear chosen primarily as a function of national pride, language and the prevailing music formula *du jour* for each country, it has always been pretty much a matter of different shades of the same old rock 'n' roll: Dolby racks with a third of the lights burned out, XLRs (wired wrong), a few Gibsons, a Fender, a Marshall, a Yamaha synth, loose RCAs, noisy monitor pots, a mystery hum. Constants is constants, continent to continent.

Well, as I said, I found myself working in a studio in Finland with a very good female artist, currently on the charts in gold. I was brought in by the label to produce and track the A/B sides for a single, to be sent to my facility in the States for mixing.

They wanted a more pronounced American influence for this single, in the hope of breaking out of the relatively small Finnish market and into the continental European and American markets. I guess their line of reasoning was that this would happen if I was imported to track there, and then mixed in the USA.

This gave me a chance to compare the major world facilities with a smaller, but no less serious, studio in a country that produces successful product but is not known worldwide.

The feeling I got when I walked in the door wasn't exactly like stepping out of a time machine after a ten-year trip backward; it was a bit more like falling into a parallel universe.

Remember what it was like when you were just starting out? How you spent endless hours learning how to

CRAMOLIN® DeOxidizer

DEOXIDIZES • CLEANS • PRESERVES • LUBRICATES • IMPROVES CONDUCTIVITY

For All Metals, Including Gold!

CRAMOLIN® DeOxidizer... is a fast-acting deoxidizing solution that cleans, preserves, and lubricates all metal surfaces including gold.

When applied to metal contacts, connectors and other metal surfaces, CRAMOLIN® DeOxidizer removes resistive oxides and forms a protective molecular layer that adheres to metal surfaces, preventing future oxidation. CRAMOLIN® DeOxidizer maintains maximum electrical conductivity, reduces wear, and has excellent migration properties.

IDEAL FOR:

- Switches & Relays • Connecting Cables & Adaptors
- Edge Connectors • Terminal Strips • Plugs & Sockets
- Gold Plated Connectors • Potentiometers • Battery Contacts

USED BY THOSE WHO DEMAND THE BEST;

- Bell & Howell • Capital Records • Dolby Laboratories
- Hewlett Packard • John Fluke Mfg. • McIntosh Labs
- MCI (Sony) • Motorola • NASA • Nakamichi
- RCA • Switchcraft



Since 1956
P. O. Box 1 • Escondido, CA 92025-0051
(619) 743-7143 • FAX: (619) 743-2460

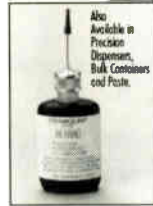

- Economical/ Long Lasting
- Ozone Safe Propellants
- Operates in Any Position
- Contents Completely Dispensed
- Uniform Spray Pattern



Circle #153 on Reader Service Card

audio cassette printers

video cassette printers

r-dat cassette printers

See the incredible high-speed
rotoscreener and the new rotary gravure
offset CS-80 in booths 448, 450, 549 & 551.

apex

of course.

since 1903

apex machine company

3000 n.e. 12th terrace ft. lauderdale, fl 33334-4497 u.s.a.
phone 305-565-apex telex 271601 apex ur fax 305-563-2844

Circle #162 on Reader Service Card

trick the absolute maximum out of each piece of precious gear? How this was usually expanded to an art with signal processing equipment? Of course, the reason for this was economic.

I saw the same thing there, but somehow different. Much less in the way of processing gear than we are generally used to, but not solely due to money—though in Finland, for example, you can pretty much count on at least twice the price for any given item, with a quadruple price increase if it falls into the ambiguously defined

“luxury” category. To give you an idea, cars fall into that category. How would you like to spend \$80,000 for a Miata

What they didn't know was what really goes on in America.

that you could get in the U.S. for \$17k? Yeah, me too.

After talking to the people who worked at the studio, it became clear that the additional factors of availability

and technical support had contributed to this lack-of-effects effect. They simply don't enjoy the freedom to casually try out gear that we do. No mega-dealer sends stuff out to evaluate. Selections are extremely limited.

The people I worked with on this project were all very professional. They knew what they were doing. What they didn't know was what really goes on in America. They had heard stories, rumors, foggy descriptions of equipment and techniques. They were very interested in the U.S. tricks, but for some reason they felt that this particular magic was just too far away to reach. Interesting.

Let me give you an example. This singer pops. It's not so much a pop as it is a burst of breath *after* certain consonants. Using a U87 at one-and-a-half feet, this puff phenomenon was being removed with the highpass filter on the recording console, with the expected phase damage and transient slurring. To complicate matters, her voice is just a bit smooth—maybe even thin—so I didn't like working the mic far away.

So I sent someone out for nylon stockings and a couple of wire coat hangers. They got all excited, because they knew what this was for, and had always wanted to try it. They had never actually gone out and tried it on their own, as they assumed there must be some other secret U.S. factors that they were not privy to.

One hour later and \$40 (!) lighter, the runner came back with the goods. We made a pop screen *à la* USA, took out the HP filter on the console, moved the singer real close (and a bit sideways) to the mic, and got exactly the intimate sound I was looking for, without the puff. We even went on and replaced existing vocals on other tunes.

In a world as small as ours is today, it was surprising to see distant attitudes of isolation like these prevail. On the other hand, it *did* take me 21 hours to fly there.

There are many other examples that I could tell you about, but there is no room left because I used up half of my column telling you about hanging out on the little Finnish islands. Priorities, you know. ■

Stephen St. Croix speaks enough Finnish to proudly order an elaborate five-course dinner...and end up getting a Toyota, three spiders and four bags of scented kitty litter.

THE SOLUTION TO DIGITAL AUDIO INTERFACING PROBLEMS DASS 100 DIGITAL AUDIO SYNCHRONISING SYSTEM

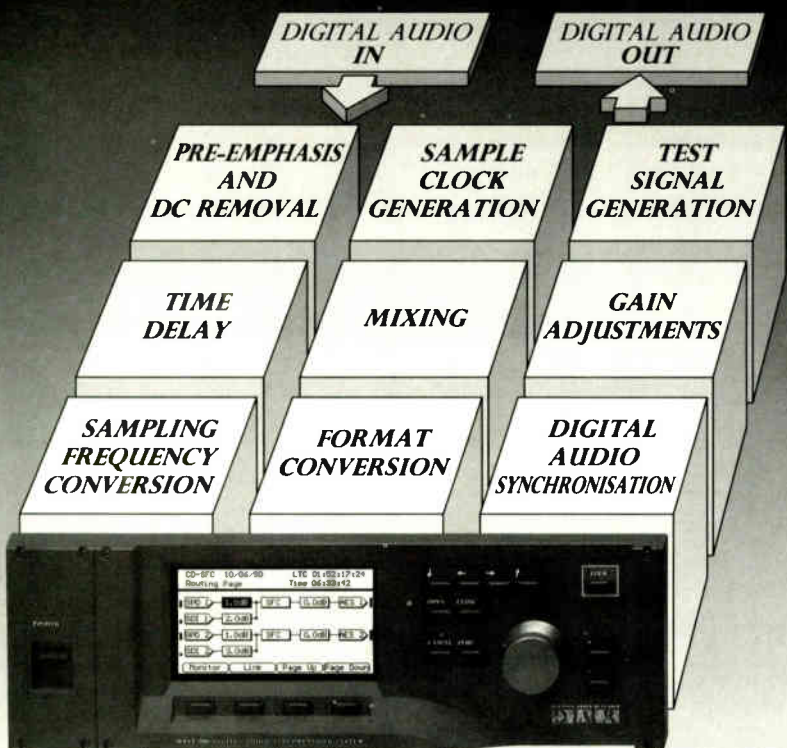

DASS 100 keeps digital audio signals in the digital domain and is essential for transferring between different pieces of professional audio and video equipment.

DIGITAL AUDIO RESEARCH



Distributed by:

DIGITAL AUDIO RESEARCH LIMITED
2 SILVERGLADE BUSINESS PARK · LEATHERHEAD ROAD
CHESSINGTON · SURREY KT9 2QL · ENGLAND
TELEPHONE (0372) 742848 · FAX (0372) 743532

- Los Angeles EVERYTHING AUDIO Telephone 213-276-1414
- Chicago SG AUDIO INC. Telephone 312-266-1901
- New York SAM ASH PROFESSIONAL Telephone 212-719-2640

See us at AES'90 LA

Circle #025 on Reader Service Card

Engineered For Those With A Passion For Performance.



200 Delta. From the smooth contours of its sleekly styled shell to the advanced circuitry that delivers unprecedented performance, Delta is the compact console of the nineties. Expanding on the modular versatility of its 200 Series predecessors, Delta incorporates many innovations unique to Soundcraft. Advances in low profile console design that go well beyond the obvious restyling.

Delta delivers superb sonic quality, with an improved electronic design that incorporates a new microphone preamp and active panpot. And, because Delta selectively bypasses any circuitry not in operation, you can be assured of optimum transparency.

Delta delivers unmatched versatility and control. With Standard, Deluxe, Stereo and Dual-Line Input Modules, Delta can meet a wider variety of applications. By adding up to four Group Modules, configuring just the right console for your application couldn't be easier.

200 Delta. Engineered for those who hunger for perfection.

New Deluxe Input Module includes expanded 4-band EQ with two mid sweeps, high pass filter and post-fader direct output. The rackmount Delta, shown below in a 12x2 version using Deluxe Inputs, can be expanded to 24x2 using Dual Line Inputs. Both the streamlined consoles and rackmount models are built to withstand the demands of recording and sound reinforcement.



1990
NOMINEE

Soundcraft



Soundcraft USA, JBL Professional
8500 Balboa Boulevard, Northridge, CA 91329

A Harman International Company

World Radio History

"ONE WORLD ONE VOICE"

THE
MAKING
OF A
MUSICAL
CHAIN
LETTER

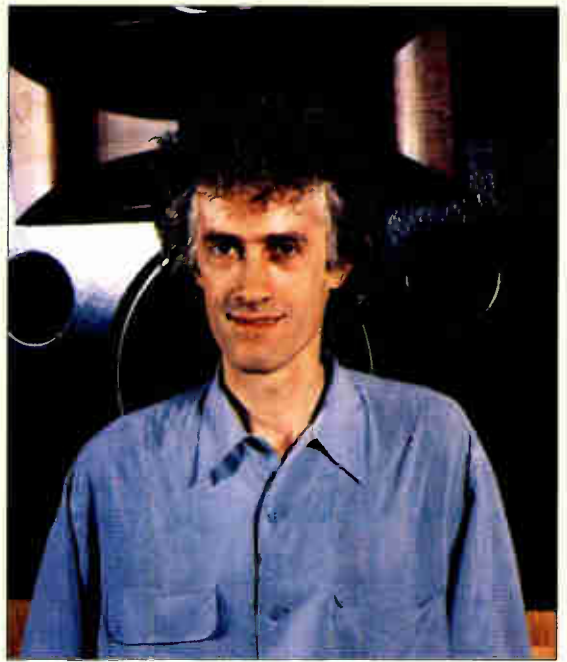

S ometime in the middle of February, Rupert Hine, British pop producer, received a phone call. Kevin Godley, formerly of Godley & Creme and now one of pop's foremost video directors, said, "Rupe, I've got this project. You know what a chain letter is, don't you?"

"Yes, Kevin."

"I've got this idea of a chain tape... Musician A in country A starts a piece of music, and musician B in country B adds something to it and so on. The piece travels the planet in six weeks. I film it and someone has to record it and fit it all together."

"You mean me, Kevin?"

"Yeah."

"Sounds great, Kevin; I've never been involved in anything like it. When does this project start?"

"Kind of now, really."

"What?"

Within a few days Hine, whose previous credits include Howard Jones, Stevie Nicks and Tina Turner, and his fellow collaborator and engineer, Steve Tayler, were involved in a project so crazy and unique that it defies comparison. The result, an hour-long TV program called *One World One Voice*, was broadcast in 20 countries to about 500 million viewers last spring. It featured Sting, Peter Gabriel, Lou Reed, Wayne Shorter, the Gipsy Kings, Suzanne Vega, Remmy Ongala, Johnny Clegg, Robbie Robertson, Laurie Anderson and others—a total of almost 300 musicians collaborating in a spectacular visual and musical collage. The music has since been released on CD, vinyl and cassette.

One World One Voice was part of "One World," a week of international broadcasts designed to raise awareness about global issues like the greenhouse effect, deforestation and pollution, and how they interlink with poverty. Or, as Godley says, "Care for

Peter Gabriel

"Pollution doesn't respect national and political boundaries. What we do in one country will have lasting and dramatic effects on people in other countries. The only thing I know of that spreads as fast and reaches as far as pollution is music. In the same way that the musicians in the *One World One Voice* project have come together in a spirit of good faith with no idea in advance of how we will work together, governments must come together if they are really going to right environmental wrongs. They have to find ways of working together to solve our many common environmental problems if there is to be something worthwhile left of the planet for our children and our children's children to enjoy."

BY PAUL TINGEN

Photo left: Rupert Hine;
Photo right: Stephen Tayler with
the equipment he carried around
the world in three flightcases.

the environment must be matched by care for people."

Ten weeks and 250 hours of tape after Godley's first phone call, Hine and Tayler sit on the roof of Nomis Studios in London, answering questions about *One World One Voice* while enjoying an unusual English heatwave. They are still in the middle of mixing, trying to make sense out of the most hectic and chaotic recording project they'd ever been involved in.

Hine remembers with a mixture of amusement and pride that the six weeks they'd spent recording artists and traveling the globe were organized—or rather improvised—on a day-to-day basis. "There was no modus operandi. Artists were con-

tacted and recording sessions and dates organized as we went along. Planning was a word that didn't exist on this project. If you planned something one night, everything would

change by the next morning."

One thing that complicated the whole process was that they weren't just recording music, they were heavily involved in the making of a TV pro-

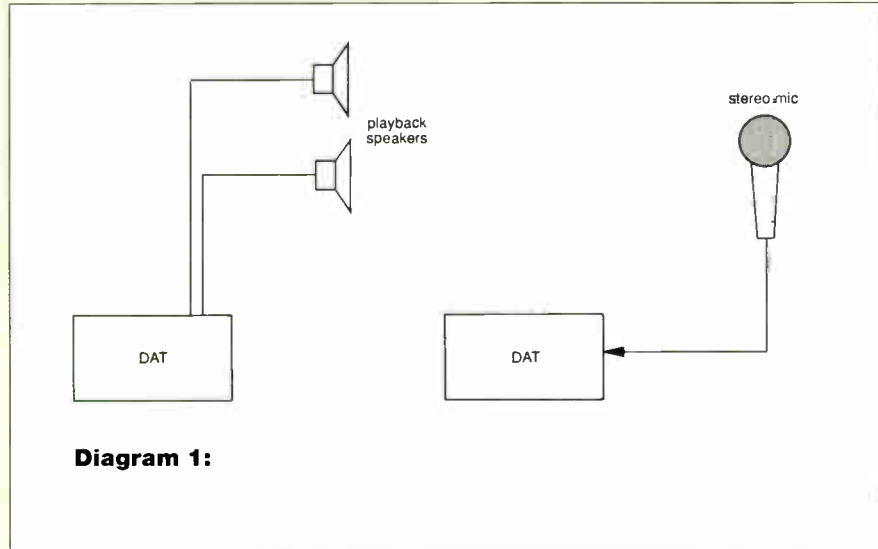

Diagram 1:

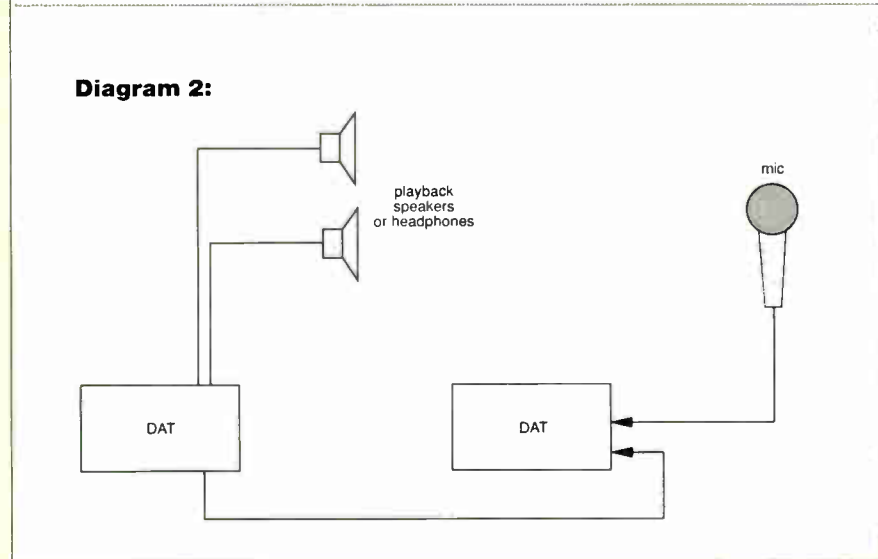

Diagram 2:

Methods to the Madness

Four of Tayler's Recording Schemes

Diagram 1:

"This was my most basic setup, used to record, for example, the Bagamoya Players. They played thumb pianos in my hotel room in Dar es Salaam, Tanzania. I was getting enough spill from the playback speaker to know where I was for later sync purposes. There were three players, and I balanced them by moving them around the stereo mic.

"I used a variation of this setup to record the samba group A Vehlha Guarda da Portella in Rio de Janeiro. They played in the street, and everybody was dancing and moving around. Here I used two DATs and two stereo mics. I placed one stereo mic, the SASS-P, in front of the seated musicians. I held the other mic and followed the soloists and the singers as they moved about."

Diagram 2:

"This was how I recorded a lot of people, for example Wayne Shorter and Courtney Pine. Courtney played in a New York music shop. The film crew thought it would make a great location. I'd planned to give Court-

—CONTINUED ON PAGE 39

BILLY PRESTON AND DIC//DAT TAKE MUSIC TO THE Nth DEGREE.

THE DIC//DAT Musician's Musicians Series #2



PHOTOGRAPH KAREN ANDERSON
LOCATION THE VILLAGE RECORDER L.A.

They called him the "Fifth Beatle." When they weren't calling him the first genius of the electronic keyboards.

From the Fab Four to number one on the charts, Billy Preston's career adds up to three decades of pure legend. A musician's musician, he takes charisma and the keyboards to their logical conclusion. And makes music to the *Nth Degree*.

Like DIC//DAT. The definitive digital audio tape.

As sound enters the DAT decade, DIC Digital is emerging as the one metal particle tape expert. Original source manufacturer of the one DAT tape audio pros are choosing more and more.

Proprietary coating and dispersion technology produces a magnetic medium more than three times as dense as conventional tape. Which produces an astonishing range and clarity beyond any way you've ever heard—and recorded—music before.

The sound of the future. Available now to uncompromising audiophiles.
Call toll-free for the Official DIC//DAT Dealer nearest you: 1-800-DAT-1-DIC.

DIC//DAT TAKING MUSIC TO THE Nth DEGREE.

World Radio History



DIC
DIC Digital

© DIC DIGITAL SUPPLY CORPORATION 1990

Circle #116 on Reader Service Card

—FROM PAGE 37, TYLER'S RECORDING

ney headphones, but when I was setting up in the shop I managed to borrow a small guitar practice amp, which I used as a playback speaker. It worked really well. As he was playing, members of the public walked in and out, wanting to buy things. New Yorkers, being what they are, just barged in and walked in front of the camera.”

Diagram 3:

“I recorded some of the Johnny Clegg sections and the Kodo drummers this way. The Kodo drummers were playing in a concert hall in L.A. I felt they were too big and too spectacular to record with just one stereo mic, so I set up three stereo mics and two mono mics and put them in radically different parts of the hall. When we reconstituted this recording a few days ago it sounded fabulous.

“The main reason for lining the whole system up like this is that the Tascam doesn't have mic inputs. So I used the DAT machines as mic amps and level controls, and took line outs from them to the Tascam.”

Diagram 4:

“I used this setup for acts who overdubbed to what we already had on tape. The Tascam was again used as a reference and a notebook, but also used in cases where bands wanted to overdub themselves. I recorded Remmy Ongala like this, as well as the remaining Johnny Clegg takes.

“We caught Clegg just after the soundcheck in a big stadium in Lilles, France. A P.A. mix went into DAT A; his concertina was recorded on DAT B; I had two ambience mics recording on DAT C; and DAT D provided playback. This was for the first recording. I then went into playback mode on the Tascam and fed tracks 1 and 2 via the Yamaha mixer to the stage monitors. Clegg did some vocal overdubs, and we even managed to double-track his vocals. All the overdubs were recorded on the Tascam. It was a crazy situation, because we were completely pressed for time. The doors were supposed to open in half an hour, so it required very fast thinking. But it was fantastic; it came out really well.”

gram. All performances had to be filmed as well as recorded. This meant that many artists were put on the spot, having to improvise an addition or an overdub to a piece of music they'd never heard before, in front of rolling TV and film cameras. The visual aspect required that a lot of the recordings be done at interesting locations, usually outside. Says Hine, “An hour of images of people playing and singing in studios would look very boring.”

In other cases, as with sessions in Tanzania and Brazil, there wasn't even a recording studio around, and they were forced to record in the streets and hotel rooms. All this required an unusual and inventive approach to recording. Tayler remembers how it was at the outset: “The week leading up to the beginning of the project was a nightmare of trying to figure out how on earth we were going to do this. We used the multitracks available in the studios, but the problem was on-loc-

tion recording. Film sound people have all their equipment dedicated to recording under the most adverse conditions. They have the most incredible wind socks and pop shields and shock-mounts, but they restrict the audio quality. You interview somebody in the street with film sound equipment and it sounds great, but when you record music with it, it sounds terrible.”

Another problem was compatibility. Tayler realized that they needed a unified format which was small, light and reliable enough to be carried around everywhere. “Initially we had lots of high-flown ideas like using some kind of hard disk system or digital workstation,” he says. “That would have been great, except that they all weigh a ton. It seemed that every time we had an idea, like taking the Akai 12-track digital, or the DAR SoundStation, the question crept up, ‘What on earth will we do in the middle

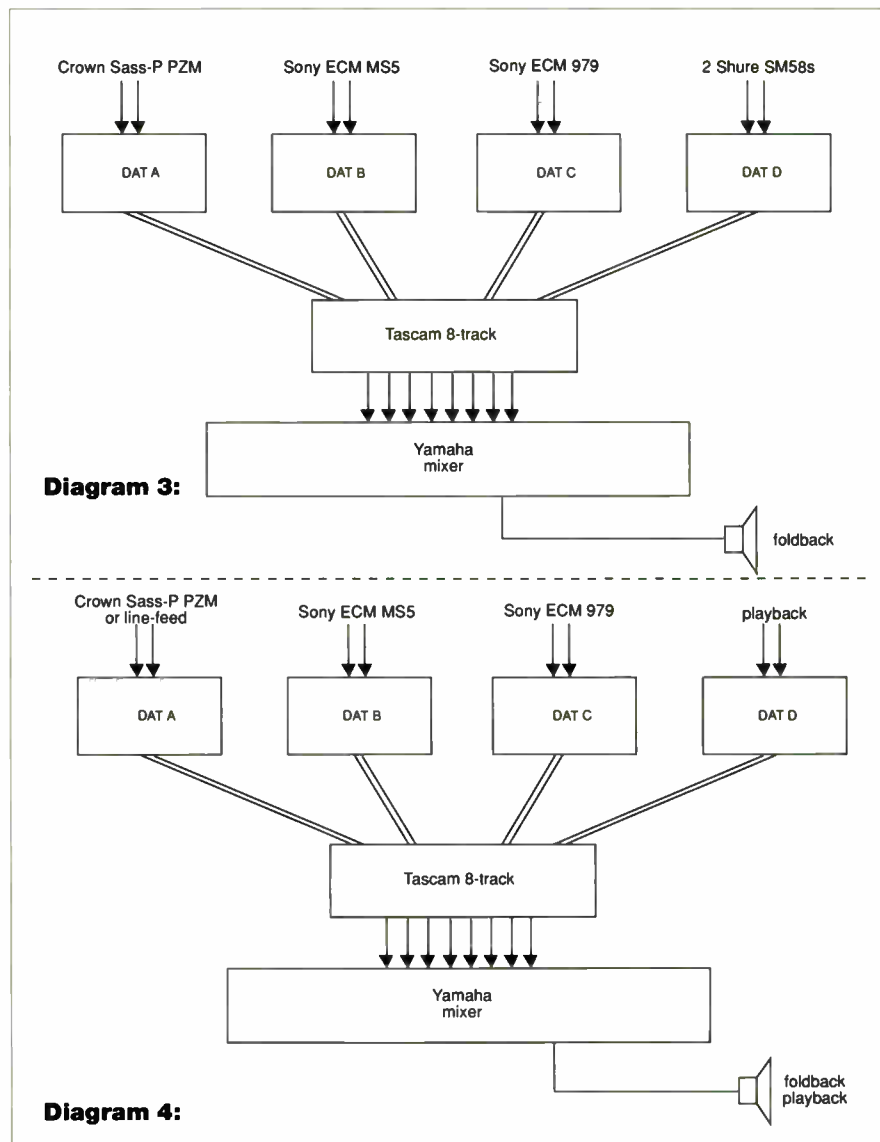

Kevin Godley

"The *One World One Voice* project is about the future of mankind. The idea is to tune people everywhere into new ways of thinking. 'Green' awareness is beginning to take off, but care and respect for the environment must be matched by care and respect for people. Wherever we have traveled, we have heard this message loud and clear, not just from the musicians, but also from people in the street.

"*One World One Voice* is an impression of the world. It's a collage documentary bringing together musicians who wouldn't under normal circumstances work together. Music can unite people much more quickly and effectively than the spoken word. I'd like to think of the program as a celebration of the humankind, even though we are touching on some pretty grim issues.

"The main problems of the project were technical and organizational. We have done something in six weeks that would normally take a year if done with the usual amount of planning. One minute we're recording in someone's house, the next we're out in the street recording hundreds of people. Half the places we visited don't even have power. We had to carry absolutely everything with us—at the last count we had 65 flight cases of equipment."

of Africa when something goes wrong?" So we figured that the best way to handle this was to choose the simplest option."

Taylor opted to carry four Sony D10PRO DAT recorders with him, plus a Tascam 238 8-track cassette recorder and a rack-mount Yamaha MV1602 16-channel mixer as the main workhorses. When working in studios he would mix down recordings to DAT stereo, which gave him an easy format for playback, either in other studios or on location.

"I originally brought four DATs," Taylor states, "because I thought I would need two and then have two as backup, in case there were technical problems. As it was, the DATs were 100 percent reliable, which enabled me to use all four of them most of the

time. We initially took the Tascam with us as a sketch pad, the idea being that we could make rough mixes of what we'd recorded and see how things fitted together. We actually ended up using the Tascam to record full-blown bands in live situations, like Johnny Clegg in Lilles [France] and Remmy Ongala in Tanzania."

Audio quality limitations of the Tascam aside, this makes sense. But when Tayler explained he recorded bands, an orchestra, a samba group out in the street, and many other artists on four DATs simultaneously, madness seemed to be creeping in. Sure, it's a cheap way to do 8-channel digital recording, but how do you fit the whole thing together later on? Things must be drifting all over the place...

At that stage Hine, who was dozing off in the scorching sun, opens one eye and calls out that synchronization was done by "thin air." Very enlightening. Hine tries again, saying that their system was "optical synchronization, meaning that you could see that the DATs were all running at the same time!"

"One of the reasons that we're recording at Nomis is that they have the New England Digital Direct-to-Disk system," Tayler explains. "It's basically an 8-track digital recorder and sequencer, so you can shift whole tracks backward and forward. I used the time and date code on the DATs to identify a certain take. The four DAT recordings of that take were then loaded into the Direct-to-Disk. Mark Willie or Ben Darlow at Nomis would find a start point, line the tracks up and press 'play.'"

Sounds easy. And DATs are likely to be very exact. But didn't he still have to correct the synchronization every half a minute or so? Even a couple of milliseconds delay on a drum take can become distracting.

Taylor patiently explains that the DATs were so accurate that there was no noticeable drift, even after five minutes. "In fact," he stresses, "the only synchronization problems we have are with analog multitrack tapes, because we never used SMPTE when we recorded. Analog tapes drift a little bit, but we're getting around that either by trimming with the varispeed or by adjusting offsets and dropping in."

After Hine and Tayler returned to London, they faced the daunting task of sorting out 250 hours of compact cassettes, DAT tapes and multitracks, and mixing them down to a one-hour

stereo.

"The first day that we weren't recording, Rupert started working on a master plan," Tayler recalls. "We sat down and listened to all our DAT tapes. The first of hundreds of lists was drawn up, and we would test these all the time to see if they worked."

Hine continues: "Steve and I had notes of the keys and tempos of all the pieces, and while traveling I continuously tried out things either in my head or with Steve on the Tascam 8-track. Every time we sat in a plane, I went through loads and loads of notes and was comparing keys, tempos and moods, constantly shuffling the cards and finding two or three pieces that would work well together. I might realize that I needed something at the end of a section and had to remember to pick that up somewhere on the planet.

"I picked up *en route* whatever I could. Sting's piece, for example, was recorded at 96 bpm. The Chieftains and Hermeto Pascual's drainpipes were about 100 bpm. They were all in the same key so I knew that they would work well together. The piece of the Gipsy Kings was about 100 bpm, too, so I asked them whether they were willing to start at 96 and end at 100. They were quite happy about that, so that whole section started taking shape early.

"A lot of that kind of thinking went on, but when we came to Nomis halfway through April, there were still many loose ends and a lot of combi-

Stewart Copeland

"There is something very symbolic about bringing together musicians and singers from all over the world who speak different languages and play different styles of music, yet are able to interrelate easily and naturally in the same way that environment and nature interrelate. We all know that the world is in trouble. Since musicians have the platform, the stage and the microphones pointing at us, and people listen to what we have to say, it is our duty to shout about it and bring it to the attention of the rest of the world. That's not to say we know more about it than anyone else, but it's obvious that the world is falling apart and if we shout loud enough things will change."

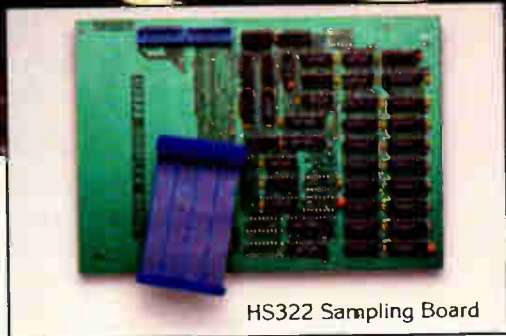

HS322 Sampling Board

Looping Is Only Our Newest Trick.

Eventide engineers just can't stop teaching the Ultra-Harmonizer® new tricks. First the eight new algorithms and 200 new presets in our SE ConKit. Now, 11.8 seconds of stereo or 23.7 seconds of mono sampling with the HS322 Internal Sampling Board option.

For \$995, the HS322 adds 16 bit, 44.1 kHz sampling to any H3000 Ultra-Harmonizer's audio processing capabilities. And Eventide's unique pitch change technology makes it easy to do things no ordinary sampler can. Change playback length on the fly without changing the pitch, to make rhythm loops that groove perfectly at any tempo. Or change playback pitch (from the front panel or any MIDI keyboard) without changing length, to transpose parts or tweak timbres without EQ-ing. The HS322 can also work like an ordinary sampler if you do want to change pitch and length simultaneously.

The HS322 board records two stereo or mono sounds, with the flawless audio quality that's

made the H3000 a studio favorite. You also get fast, flexible, precise control. Start recording and playback manually, via MIDI or audio trigger. Edit Start, Stop and Loop points using the famous Eventide Knob to "rock" audio, or enter locations on the keypad.

Impressed? Ultra-sampling is just part of the H3000's best trick—the way it keeps your original investment growing in power and performance, without making you buy a whole new box. If you're ready for the digital audio processor that's more than just another "fad box," it's time to visit your Eventide dealer. And sample the future.

Eventide®
the next step

IIC
1990
NOMINEE

One Alsan Way • Little Ferry, New Jersey 07643
Tel (201) 641-1200 • Fax (201) 641-1640

Sample responsibly: Credit and compensate your sources.

nations to figure out.”

Hine and Tayler spent another three days at Nomis, recording artists like Suzanne Vega, Eddy Grant, Chrissie Hynde and Nusrat Fateh Ali Kahn (a Pakistani singer as big in Asia as Michael Jackson is in the West). Then they flew to Leningrad to record the Leningrad Symphony Orchestra. They played a section written by Hine to the Japanese Kodo drummers, who came through with a mindblowing ending to this “first truly global composition,” as it has been called.

With the overdubs out of the way, and an overall plan of what the “world symphony” was going to sound like, it was time to mix. Tayler explains, “At the moment we’re mixing all the elements we have onto digital 32-track tapes—the whole piece is divided into four segment reels for easier compiling and mixing. We’re reconstituting the DAT recordings we’ve made in the Direct-To-Disk and dumping them on the Mitsubishi X-880 multitrack, which is now SMPTE-locked to the NED. We’re mixing 16-, 24- and 32-track tapes into the NED, too, usually in sections. These sections are all given specific start points and mixed back onto one of the 32-track tapes.

Geoffrey Oryema

(A Ugandan-born singer and multi-instrumentalist now living in Paris.)

“My reason for getting involved in the *One World One Voice* project is a political one, a statement to the Ugandan government and my people back home. The quality of life in Uganda has been going rapidly downhill for the past 20 years, and we have to make some drastic changes now. You can put a message across by throwing stones or shouting at people, but in recent years we’ve seen that music is a much more powerful way of making people in positions of power take notice of ordinary people’s wishes. Albums and tapes are effective ways of spreading messages. If any serious environmental change is to take place and people everywhere in the world are to live together in lasting peace and harmony, then someone has to sow the seed. Without it there will be no plants, no harvest, nothing will grow and man will simply cease to exist.”

“Once everything is on these four 32-track reels we will put it through the Direct-To-Disk again, do more editing and mixing, and transfer all the musical sections in stereo to an hour-long 32-track tape. This master will have the different musical sections compiled in eight tracks of stereo mixes. There are a lot of overlaps and crossfades, and we want to be able to change things till the last moment—make the Kodo drummers a bit louder, or add a bit of bass to Sting’s backing track, or bring the Gipsy Kings in earlier. The last phase consists of mixing those eight tracks down to stereo. It’s a process of mixing and mixing and mixing...”

What came out of the monitor speakers while he was mixing was absolutely wonderful, and seemed to underscore the destiny of *One World One Voice* as a musical classic as well as a landmark in digital technology. Let’s pray it will also benefit both the environment and the hungry poverty-stricken people of the world. ■

Paul Tingen is a London-based freelance writer who contributes to music and trade magazines in Europe and the U.S. He’s also a songwriter, singer and guitarist.

More Power To You

FET-1000, FET-1500, FET-2000. Introducing the latest series of professional power amplifiers from Ashly, featuring more models, with more power, than ever before. From movie theaters featuring the sonic excellence of Lucasfilm’s THX™ sound reproduction systems to outdoor stadium events covering well over 80,000 satisfied audio enthusiasts, Ashly amplifiers have developed a solid reputation for rock steady performance and near-perfect reliability. And now that legendary Ashly power advantage is available in even more configurations to meet the needs of any amplification situation.

Ashly amplifiers utilize Power MOS-FET Technology to achieve superior overload and square wave response, with no ringing or unwanted transients that degrade program material. Ashly amplifiers are stable into virtually any load and deliver full output even under the most demanding circumstances. Unrestrained, uncolored sound reproduction with remarkable accuracy is assured by choosing Ashly for all your power needs. All Ashly amplifiers are now backed by our exclusive **Five Year Worry-Free Warranty.**

**RATING
ASHLY'S
FET SERIES**

MODEL	PER-CHANNEL WATTS		TOTAL WATTS	
	STEREO	MONO-BRIDGED	STEREO	MONO-BRIDGED
FET-2000	500	300	1000	600
FET-1500	300	200	600	380
FET-1000	190	120	380	

EIA Specification

**5
YEAR
WARRANTY**

**UL LISTED 35E5
COMMERCIAL
SOUND EQUIPMENT**

Ashly Audio Inc. 100 Fernwood Ave. Rochester, NY 14621
Toll Free (800) 828-6308 In NYS (716) 544-5191

In Canada: Gerraudio Dist. 363 Adelaide St. E. Toronto, M5A 1N3 (416) 361-1667

ASHLY

Lucasfilm and THX are trademarks of Lucasfilm Ltd.



Circle #060 on Reader Service Card

If you're working to bust out into the big time, Yamaha has the right console to take along for the ride.

It's the MR Series Professional Mixing Console. A live mixing console when you're gigging. And a recording console when you're laying it down for keeps.

The MR Series console comes in three configurations—eight, 12 or 16 inputs. Each input accepts mic, line and tape sources. It has a three-band channel equalizer with sweepable mid-band for tone adjustments. Three aux sends so you can set up mixes to headphones, stage monitors or effects processors. Two stereo aux returns. A cue buss to monitor inputs and outputs without skipping a beat.

A talkback system. Six calibrated VU meters for accurate monitoring and matching of signal levels. Plus a host of other features that make this console easy to work with whether you're on stage or off. At a price that's reasonable for any console, let alone one that does the job of two.

The MR Series Professional Mixing Console. When you start going places, it'll show you the way. Check one out at your Yamaha Professional Audio dealer.

Yamaha Corporation of America, Professional Audio Division, P.O. Box 6600, Buena Park, CA 90622-6600. In Canada, Yamaha Canada Music Ltd., 135 Milner Avenue, Scarborough, Ontario M1S3R1.

YAMAHA®

Professional Audio Division

Tonight, this console hits the road. Tomorrow, it'll make tracks.



Circle #086 on Reader Service Card

LISTEN.

If you think audio quality is the most important part of audio post, call Chris Fichera at 213-306-8823. We'll take you on a personal tour through the extraordinary sounding DCM 224V post-production console from DDA.





Circle #109 on Reader Service Card

How To Get The Perfect Mix.

With MAGI II Console Automation Series from J.L. Cooper Electronics.

The mix down process isn't what it used to be. Recording engineers are finding it increasingly difficult to maintain calm, creative control over both the console and the battery of outboard gear. As these demands escalate, the need for console automation is further amplified by the need for perfection. The MAGI II and MAGI III Console Automation Series from J.L. Cooper Electronics are designed to save you time, money and give you the ability to achieve perfection!

Freedom Of Choice

Both MAGI II and MAGI III interface with virtually any console to provide precision SMPTE-locked automation for 8 to 64 channels. The MAGI II is an outboard system for the audio facility preferring "portable" automation that can be moved from desk to desk. The MAGI III is an internally installed system that uses the console's existing faders.

Flexibility & Control

MAGI II memorizes fader, mute and other real time events. These events can be performed in as many passes as you wish, or you can work on the mix one section at a time, or even one track at a time. MAGI II can be used to automate effects sends and sub-groups as well as controlling your outboard effects processors. The MAGI II allows



MAGI II External System

a very complicated mix to be quickly constructed, edited, and refined in real time or off-line with absolute accuracy. In addition, these mixes can be saved to disk for future use.

Fast, Intuitive & Transparent!

Every aspect of MAGI II has been designed for the working engineer. MAGI II features a straight ahead user-interface incorporating clean, uncluttered moving fader graphics that make it extremely easy to learn and use. Even a "guest engineer" can be up and running in 15 minutes!

MAGI II and MAGI III Features:

Both the MAGI II and MAGI III feature high quality dbx VCA's for audio transparency. The MAGI II Controller reads and generates all SMPTE formats. The powerful software program runs on either a Macintosh or Atari computer.

Mixes may be performed and edited in real time, or off-line with MAGI II's powerful cue list. Cut, Copy, Paste, Merge, Undo, Redo, and other precise numeric edit decisions are fully supported. Our MIDI Event Generator allows the recording and triggering of all types of MIDI events. Film and Video composers can take advantage of our hit list to spot cues in real time. No other automation system gives you this flexibility!

The Bottom Line

Other manufacturers would like you to believe that an automation system must have a high price tag to be on the cutting edge. The MAGI II dispels that myth. The MAGI system with its wealth of professional features starts at just \$5,000.00, and it works! That's the bottom line.

MAGI is being used in a number of applications from

standard music recording, to film, TV, broadcast, commercial and live sound. MAGI is automating consoles from Trident, Soundcraft, Allen & Heath, Harrison, D & R, Biamp, Neotek, Tascam, DDA, Soundworkshop, Soundtracs, AMEK/TAC and Ramsa.

Guaranteed Satisfaction!

J.L. Cooper Electronics and its Authorized Dealers are confident that once you own MAGI II, you'll never go back to manual mixing again. So confident that we're putting our money where our mouth is. For a limited time, our participating dealers are offering a money back guarantee*. If you're not totally satisfied within 30 days, return the system and they'll refund your money.

With the cost of perfection finally within reach, why wait? Call us today for the location of a dealer in your area. It's time to see what MAGI II can do for your mixes.

The Video

You can preview the MAGI II with our video demonstration. This Video offers a complete overview of the system's operation. It's just \$13.95 and can be charged to your VISA or MasterCard. To order, contact J.L. Cooper Electronics at: **(213) 306-4131.**

Visit us at AES booth #130-131

JL COOPER ELECTRONICS

13478 Beach Avenue · Marina del Rey, California 90292 · FAX 213-822-2252

*limited restrictions may apply, contact your local dealer for details

World Radio History

Circle #157 on Reader Service Card

Style and Substance from Six of the Best

Jeff Lynne:

"We're spoiled because we've got 24 tracks and we can keep second-guessing it forever, which can be a bad thing."



PAGE 48

Keith Cohen:

"I mix very aggressively and get dynamics with big drums, big rhythms. For me, the low end and the rhythm prove the song. I like the rough edge."



PAGE 71

Roy Halee:

"The idea was to create these grooves by strictly using percussionists, adding on melodies and harmonies later, with vocals coming last."



PAGE 55

Matt Wallace:

"The only way I learned was by making every mistake possible: blowing something up, breaking it, distorting it. You just plug it in and see what happens."



PAGE 75

Shel Talmy:

"As we got more tracks we did more overdubbing, and I always liked to overdub voices. One of the things I started doing was double-tracking voices."



PAGE 63

Hugh Padgham:

"It's not so much that I think of [the music] in visual terms; I just get a concept when I hear a song. I get a vibe and keep fiddling around until it equals what I'm thinking in my head."



PAGE 82

by James Hunter

Jeff Lynne Lightens Up

The Ex-ELO Leader Is on His Own as Producer and Artist

Since 1987, when without much fanfare he produced some songs on a Duane Eddy album for Capitol, Jeff Lynne gradually has turned his old job of Electric Light Orchestra leader into his current position as superstar rock producer. Following Eddy, the clients have been enormous, often legendary names: George



Harrison (*Cloud Nine*), Brian Wilson, Randy Newman, Tom Petty (*Full Moon Fever*), the late Roy Orbison and Del Shannon. And with Orbison, Petty and Bob Dylan, he teamed up for a best-selling album that made him a Traveling Wilbury.

His most recent triumph is his solo album, *Armchair Theatre*, named after an old TV show that ran in his native Britain. Recorded in the studio he recently had installed in his sprawling 15th century home in England, the album contains rockers and ballads, a couple of pop standards ("September Song" and "Stormy Weather"), and a transcontinental lament featuring Indian vocalists from Ravi Shankar's group.

In this interview, Lynne talks about *Armchair*

Theatre and some of the principles that have guided his recent productions.

Mix: When you were growing up, did particular pop records obsess you? The Beatles, maybe? The Beach Boys?

Lynne: That's funny. I wasn't going to mention them. I think the first records that inspired me to want to do music were Del Shannon's. I also loved Roy Orbison, for a different reason. I think some of Orbison's recordings are still some of the best pop records ever made.

Mix: Which Orbison record seems finest to you?

Lynne: I'd probably have to say "Only the Lonely," followed by six or seven other ones. It captures whatever it is that gives you goosebumps.

Mix: Do you think of Orbison's singles as examples of vocal-centered productions?

Lynne: Obviously, the vocal was very important. I since learned from Roy and from Del—as I recorded both of them—what the techniques were. It's quite amazing. They told me that they recorded Orbison on three tracks, that there would be three discrete channels, and that there would be three speakers as well. So they'd have the strings coming out of one speaker, the voice coming out of the other and the backing track out of the other. It was like a three-way stereo system.

Mix: But those recordings remain models for you, correct?

Lynne: Those recordings—the atmosphere, the sound! I just can't account for the skill of the session guys who used to play them. If it was exactly as they tell me it was, they'd just walk in, learn the songs, have a three-hour session, and do it. How they thought of all those fantastic riffs and brilliant drum breaks in that short period of time... They must have been of a much higher standard than we are today.

We're spoiled because we've got 24 tracks, or whatever, and we can keep second-guessing it forever, which can be a bad thing. It's nice to have the luxury, but sometimes you lose track of what you're doing, because you keep fiddling about so much, mainly because you're able to.

Mix: Maybe '50s and '60s session musicians were hungrier, better able to capitalize on the limited

time they did have.

Lynne: I guess so, but it also tells you where the priorities were, because if they were making million-selling records, then given three hours to record—how much could it have cost? It seems a bit daft that everyone was making fortunes, and yet in the studio you could only spend three hours. George Harrison has a nice line about sessions of that era: "Yeah, the first album took eight hours to make, and the next one took even longer."

Mix: Do you hear a so-called "Jeff Lynne sound" on your recordings?

Lynne: Yeah, I do, actually, because people keep telling me there is one, so I've come to believe it. I do have a sound and I know what it is, but I can't explain it.

Mix: It seems real live on the one hand, highly crafted on the other.

Lynne: I have to spend days making it sound like it was done in minutes. The way I mike things is what makes some parts sound live; other parts *are* live. I'm trying to create out of the same set of values that informed a record from the '60s, with people knowing what they're doing and being good at

it, even though I don't think people can really do it anymore like the old guys did. But on the other hand, you get the later Beatles stuff, for example, which took a year to make and is brilliant.

Mix: People associate a certain looseness with the *Traveling Wilburys* and *Full Moon Fever*. Did you intend a similar feel for *Armchair Theatre*?

Lynne: Well, Tom's record was done in a second. When I met with him to do it, he'd heard George's *Cloud Nine* album and he really liked the sound of that. He said, "Would you fancy writing a song together and see what we come up with?" So we came up with "Free Fallin'" in Mike Campbell's garage, and we recorded it there. I didn't treat Tom's album as I'd normally treat a project. We did the track, I went home and worked out all the parts for the guitar, keyboards, everything. And I always play bass if I'm producing someone—it's in the fine print—just kidding. But then when we finished it, we said, "Well, that was fun. Let's do another one." So we finished that song and mixed it. The whole album went like that: "Well, let's do another one." I ended up doing the whole lot. Usu-

ally, I would be working on ten songs at once.

Mix: And being more hands-on about it?

Lynne: Well, hands-on in the arrangements, yeah. I like to play a lot of things if I'm producing. I like to do my homework. I like to take home a rough mix, and I like to try and develop parts so that when I come "round the next day I can say, "How about this?" You don't have to sit and agonize over the parts while we're all sitting around doing them.

Mix: Which, in your view, is a waste of time.

Lynne: Absolutely. I like to have things to play. I like to see if they work.

Mix: How did you approach *Armchair Theatre*?

Lynne: The same, really. It's just that I'd go into a different room, like going to my office, to work out late at night the different bits I'd do the next day. I really worked hard on my album. I probably put in 12 hours a day, on and off, mainly on, for about six months.

Mix: But you still wanted to get some of the Wilburys-style nonchalance?

Lynne: I didn't try and compare it to

Hear the Apogee Difference

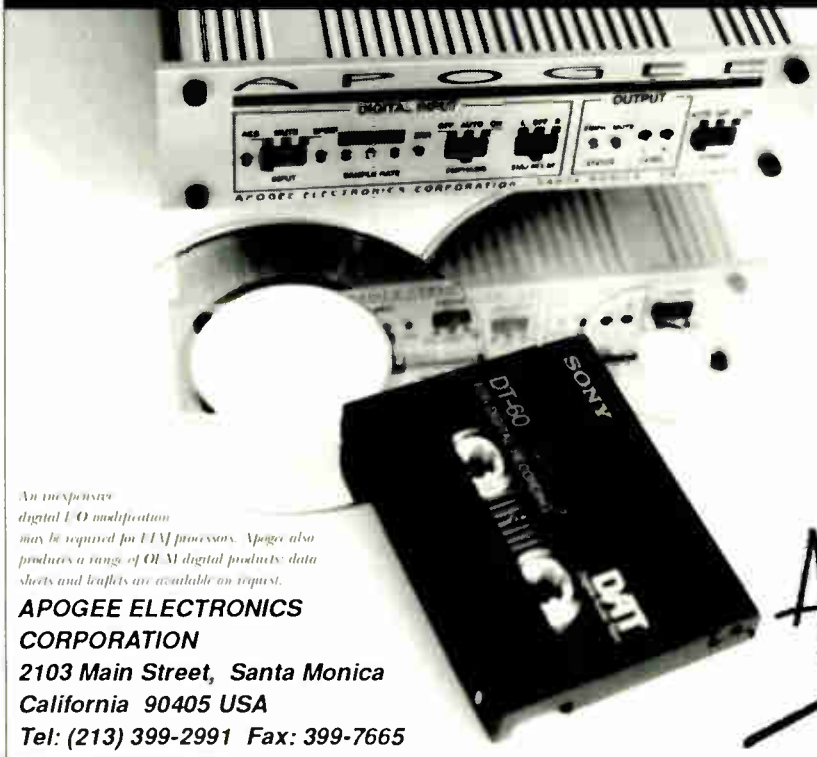

Over the past few years, Apogee has become famous for enhancing the sound of digital audio recorders and processors. Now Apogee quality is available for virtually any digital audio system, with the introduction of the AD1000 and DA1000 Portable Reference Converters. They're free-standing, can be battery-powered, and use the very latest Apogee digital components. They'll interface with most systems with digital I/O, including DAT machines and EIAJ/EI format digital audio processors.

Contact us today for full details.

Then hear the Apogee difference for yourself.

anything. I had this bunch of songs I'd just written. I approached them individually—songs take on their own lives, anyway, and you have to treat them like that. I just sort of bashed away at them until I'd knocked them into shape. There are acoustics on them, which I do like a lot.

Mix: Did you follow your recent thinking about the importance of vocals up in the mix?

Lynne: I wanted to get the vocals real dry and up there, like I did on Tom's album, because Tom's got a great voice, and I think in the past he's always been sort of swamped in reverb and stuff. I'm not a fan of reverb at all. I spend a lot of time putting the mic in different places, because the sound of a room is much nicer to me than the sound of a gadget. I love the intimacy of a dry vocal up front.

Mix: Dimensionality improves.

Lynne: You can almost picture it. The singer is right there in front of the band in the middle, then the instruments are where they should be. That's what I try to get, anyway.

Mix: A rock bias against recording vocals clearly seems to have asserted itself over the years. Maybe it was because the Rolling Stones' recordings did such great stuff with murk.

Lynne: There was a lot of reverb there. I went through it with ELO records—I mixed myself right down, with echo—not reverb, particularly, but all gadgets, ADT and all that. But that's insecurity—hiding—that's all. I've lately gotten into the thing of, well, if he's singing it, we might as well hear it. Otherwise, don't bother. I've really taken a lot of care over the past years with miking. And Richard Dodd, my engineer, is a great one. He takes absolute care over stuff like that. We don't actually have to spend much time. It's strategic.

Mix: Do you have some techniques you favor over others?

Lynne: It's evolving all the time. There are certain things that I like to do. For example, in miking drums I only use a couple of tracks for drums, ever. I see sessions where there are 17 drum tracks and three machines locked together. I like to get it all on 24 tracks. If I can't get it all on that, I think I shouldn't bother.

Mix: But didn't you used to do that sort of thing with later ELO? Do you now view that music as fairly left-field?

Lynne: Yeah, some of the stuff seems amazingly left-field when I hear it now. And I wonder, "What was I thinking?"

Before, on
ELO tracks, I would
never even sing until the
backing track was finished,
with a 40-piece orchestra
and a whole chorus
and everything on it. And
nobody ever knew what
the tune was except me. Now
I put rough vocals on things.
I don't worry as much.

being the ELO producer. I mean, I said I was the group's producer, and they said, "Oh, okay." And, as we all know, you've got to learn to be a producer. But some of my early ideas were good, and a bit wacky and bold. And then I learned more and more as I went on, and I made some real pop records, proper ones that were within the scope of the pop-rock mainstream. But I probably messed up a few of those recordings by burying the voice too low.

Mix: Your work, in some ways, is simpler now.

Lynne: People always thought that ELO was very complex. Actually, it was just lots of very simple parts all put together. It's the same process I use now, really: This should go there and this goes there. It's a bit like a jigsaw puzzle. But what I've tried to do more recently is thin it down a bit, to try and make it more like a small group than an enormous one. Although I've tried to leave it sounding big.

Mix: Scaled down and blown up?

Lynne: Fast decisions. I've learned a lot of basic things that I probably never learned in the first place, just things that are so simple that I may have overlooked them in the past. I feel really good about making records again. I went through a period where I wasn't enjoying it, where I started getting into digital sequencers and all that stuff, typing numbers in, which I hated. What I'm referring to is the later ELO albums, where I was dabbling in all this gear. So, when George [Harrison] called me to do his album, we both said how much we didn't like playing at computer operators, and how much we really liked to play. So we played everything by hand and had fun play-

ing. And since that album, all the stuff I've done has been done by hand.

Mix: Why a solo album now?

Lynne: Well, because Warner Bros. asked me if I'd like to make an album for them. At the end of ELO, I didn't know what I wanted to do. I was still playing about in my little studio—I used to have a small one upstairs—and I used to make up songs and demos, for my own fun, really. But I never realized that I wanted to be a producer. Well, I sort of did, but having gone through the experience of all that digital stuff, I'd gone off it a bit. And then while I was working on *Cloud Nine*, Warner asked me if I'd like to do an album for myself.

But it took me all this time because I did the Wilburys, Tom's album and parts of Roy's album. As soon as I had some clear time, I booked my engineer for six or seven months. We built the studio in two days—this little company in England called Raindirk. And I got a desk from Cyril Jones, its owner. He made this lovely 40-channel desk, with really nice EQ—not that we have to use it much, because we put the mics in the right place.

Mix: *Armchair Theatre* puts you center stage. Are you at home there?

Lynne: Before, I liked hiding more. I mean, I'm still not a performer in the sense of a showman. But I just love making records. So to make my own record was an absolute pleasure, because there were a lot of musical statements that I wanted to make, and I wanted to make them without being under any constraints.

Mix: Your vocals are up front now.

Lynne: I'm more confident now just singing and not being such a drama queen—just sing it. I'm still a bit picky with my own vocals, but in fact there are a few tracks on *Armchair Theatre* where I've sung all the way through in one take, which I'm pleased to do. Before, on ELO tracks, I would never even sing until the backing track was finished, with a 40-piece orchestra and a whole chorus and everything on it. And nobody ever knew what the tune was except me. And I would save it, because I was embarrassed to sing it at first. Now I put rough vocals on things. I don't worry as much.

Mix: Do you want to be a star?

Lynne: I'm just a record maker, and I'm a singer. But I don't particularly want to be on TV every day. ■

James Hunter is an Atlanta-based freelance writer.

Dual Domain Audio Testing

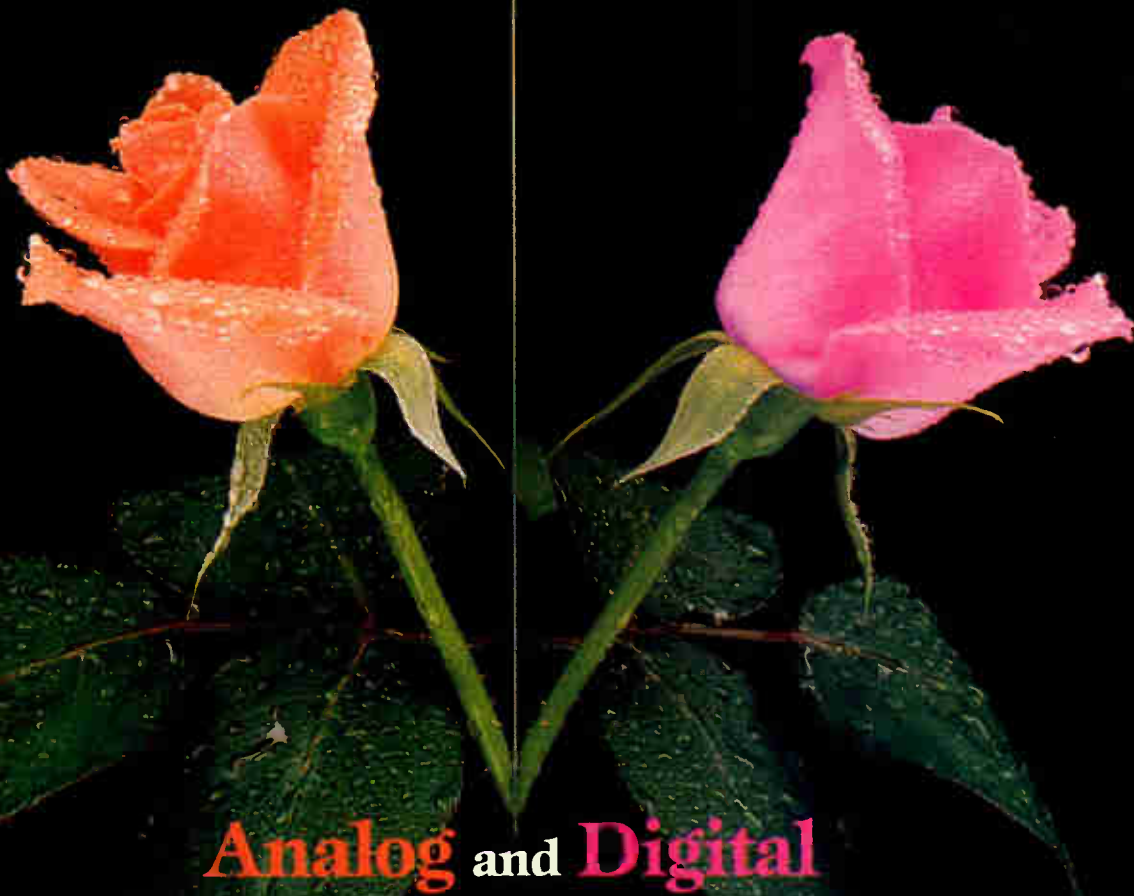

Analog and Digital

There are two worlds of audio... analog and digital. These two domains share many basic attributes but when it comes to audio testing, they're distinctly different. Until now custom hardware was needed to test digital audio devices in their own domain. Now the System One Dual Domain combines both analog and digital testing capability in one unit.

ANALOG audio testing with System One Dual Domain is even more comprehensive than before. Data acquired can be further analyzed using the Digital Signal Processor, which adds harmonic analysis, waveform display and FFT spectrum analysis to the already extensive list of System One's capabilities. New version system software supports color VGA graphics and on-screen cursor function with numeric readouts.

DIGITAL audio testing directly in the digital domain is available for the first time. System One Dual Domain provides signal generation, analysis and Input/Output capability and also mirrors familiar analog measurement techniques, now implemented digitally. The multiple-DSP architecture supports both AES/EBU serial and two-channel parallel inputs and outputs at a variety of sampling rates.

Integrated analog and digital domain audio testing... only from Audio Precision.

System One

Audio precision

P.O. Box 2209, Beaverton, OR 97075
503/627-0832 1-800/231-7350
FAX: 503/641-8906, TELEX: 283957 AUDIO UR



INTERNATIONAL DISTRIBUTORS: Austria, Eastern Europe: ELSINCO elektron GmbH 222871/51. Benelux: Trans European Music NV, Brussels (02) 4665010. Canada: Glentronix Ltd. (613) 475-4944. China, Mainland: Harvest Scientific and Technology Company Ltd. Hong Kong: 5-722983. Denmark: npp Elektronik ApS 86-57 15 11. Finland: Info OY 0 755 7711. France: S. Mesureur (1) 45 83 66 41. Germany, West: RTW GmbH 221 09180. Hong Kong: TRP Consumer Electronics, Ltd 5-887 2008. Italy: Medea S.r.l. 24453828. Japan: TOYO Corporation 32790771. Korea: Mveung Corporation 784 9942. Mexico: VARI S.A. 250 7394. New Zealand: Audio & Video Wholesalers, Ltd. 7173414. Norway: Lydcosult (09) 19 03 81. Portugal: Acutron ELA 251 40 87. Singapore & Malaysia: TME Systems PTE Ltd 286 4805. Spain: Telec Electronics, S.A. 231 7840. Sweden: Tal & Ton AB 31803620. Switzerland: Technad SA (021) 806 06 06. Taiwan: Audio Precision Technologies Ltd. 703 6280. U.K.: SSE Marketing Ltd 128 11262.

Circle #081 on Reader Service Card

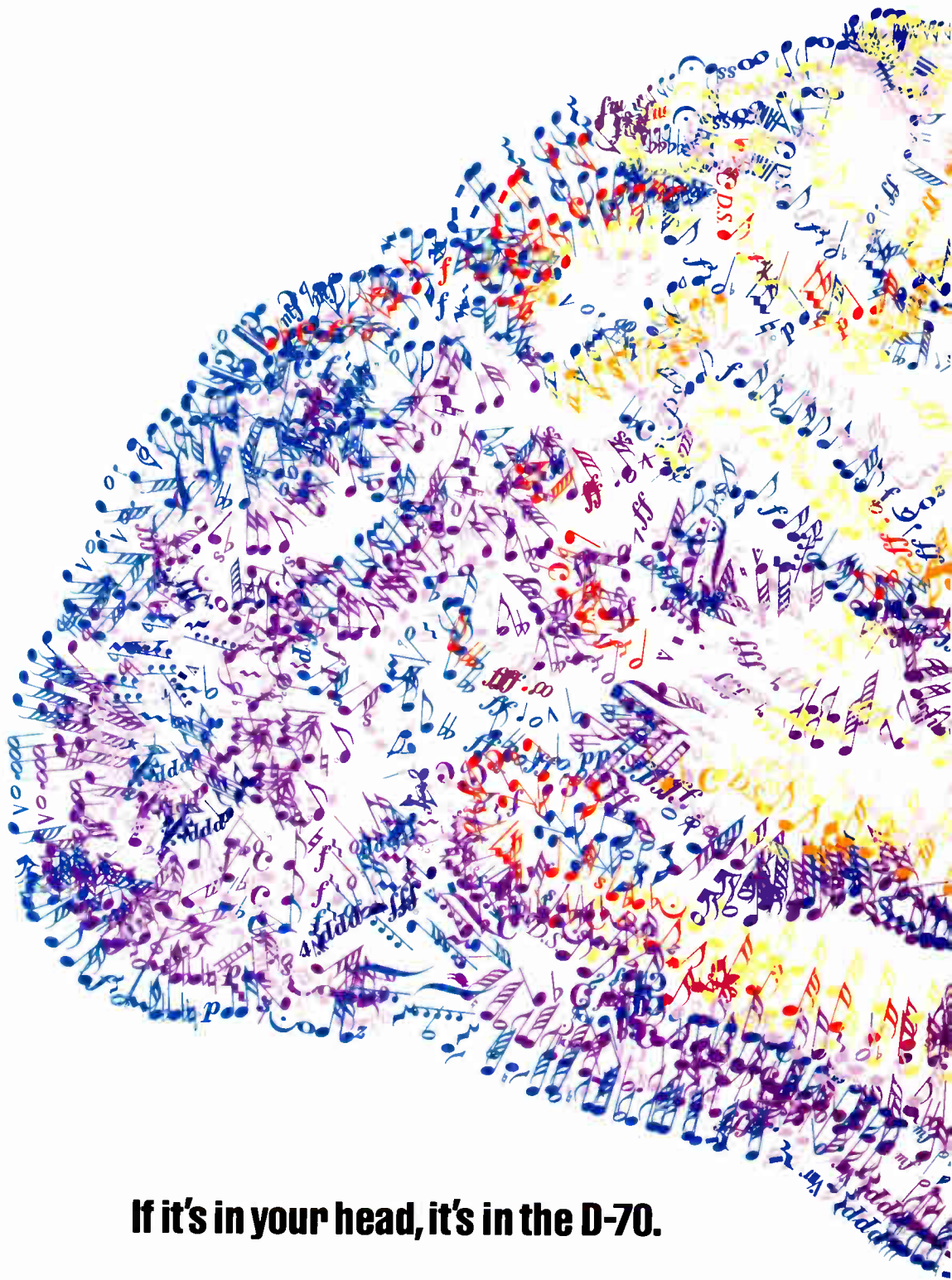

If it's in your head, it's in the D-70.

As scientists see it, 90 percent of your brain's creative potential is untapped. Which, as we see it, isn't so much a reflection on your brain as it is on not having the right tool to do the tapping—a tool that now exists in the extraordinary new D-70 Super L/A Synthesizer from Roland.

The D-70 provides a radically new level of creative flexibility. Thanks to our new Differential Loop Modulation technology, there are thousands of new distinctive, modulated waveforms

and a slew of new PCM samples to work with. And since the D-70 layers up to four multi-samples at once, it's not only easier to create new sounds the moment you conceive them, it's also possible to produce some of the brightest, fattest sounds imaginable.

The D-70 also delivers tremendous hands-on creative control, courtesy of a Tone Palette editing system which gives instant access to the most widely-used synthesizer parameters. And since you can use the four sliders to modify any of four

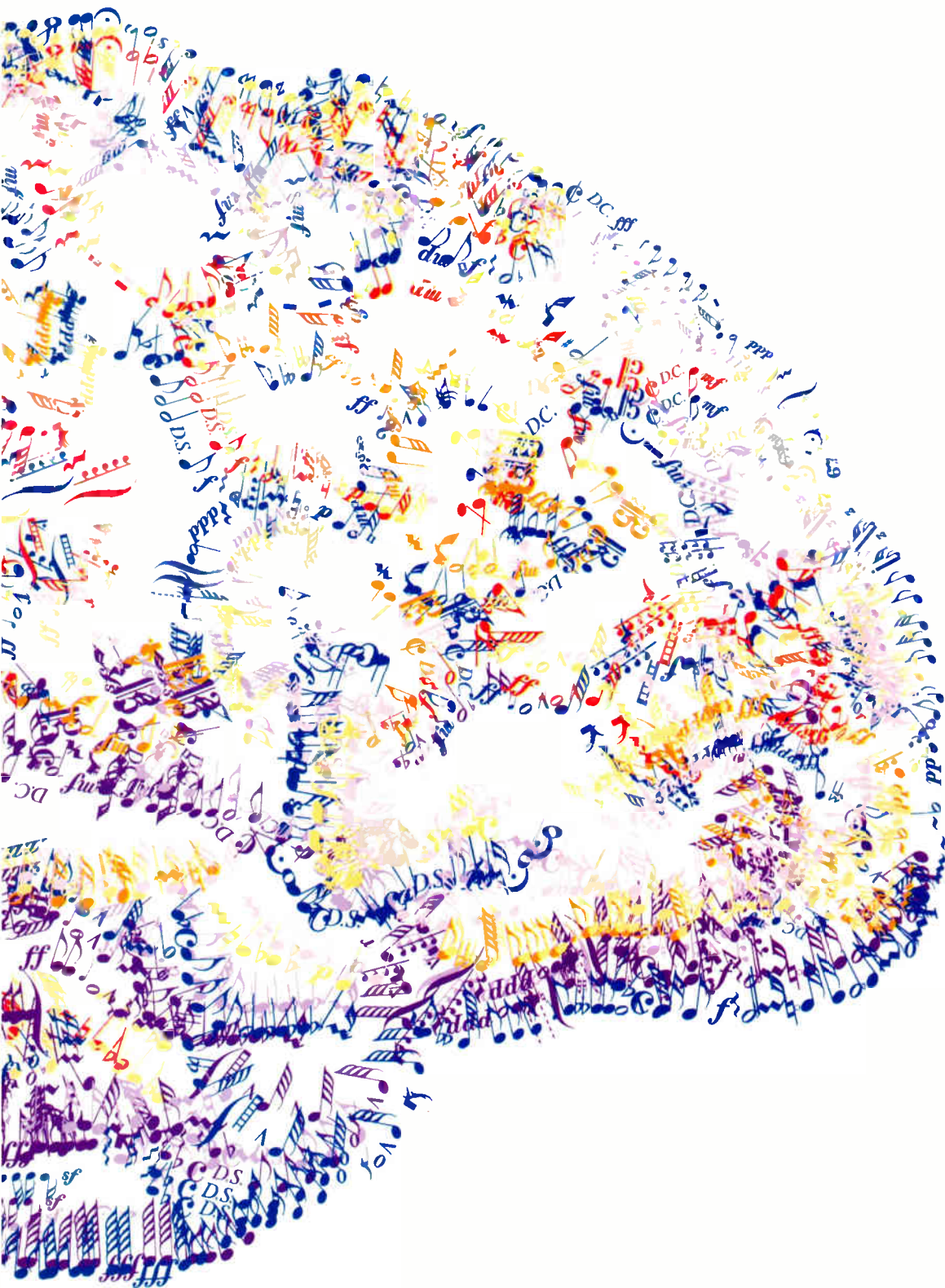

Tones simultaneously in real time, you can create new sounds instantly.

We realize this is a lot for 10 percent of your brain to take in. So if you have questions, call (213) 685-5141. And if you want to skip the call and just buy one, **Roland®** that's ok with us, too.

RolandCorp US, 7200 Dominion Circle, Los Angeles, CA, 90040-3647



Technology Embraces Art.

There was a time when these words were seldom used together. The disciplines necessary to produce *art* had little patience for technology. *Today* the union is prerequisite. With this fusion in mind, Trident engineers set out to combine vintage sonics with adaptable studio integration and control.

The Vector 432 in-line console. Featuring balanced bussing, 32 groups, 4 stereo mix busses, 4 band equalizer splittable between channel and monitor and 8 auxiliary send busses. The 16 mute groups, fader automation, and multiple machine control are all accessible from our Central Command Panel.

With Audio specifications straining theoretical limits and sonics that can only be described as Trident, the Vector 432 is clearly the console for the creative. Audition a Vector and hear for yourself. After all, you've been listening to us for years.

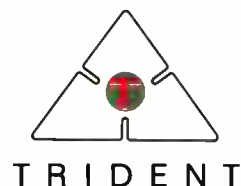
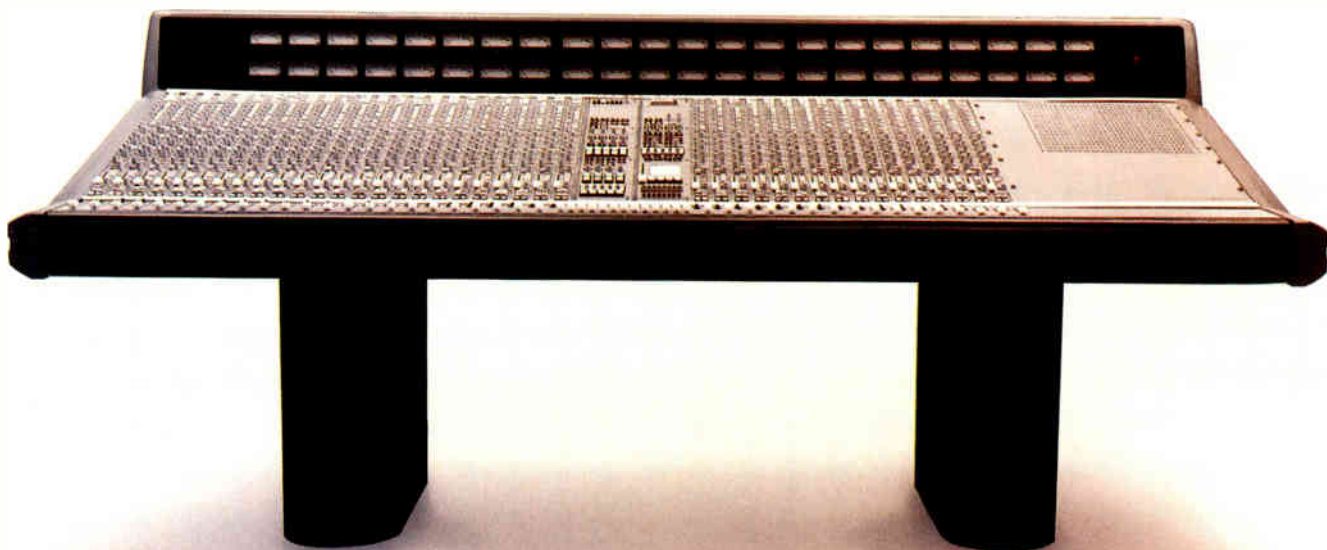

1990
NOMINEE

TRIDENT AUDIO DEVELOPMENTS LTD • Trident House, Rodd Estate, Govett Avenue, Shepperton, Middlesex TW17 8AQ, England • Phone 0932-224665 • Fax 0932-226721

TRIDENT AUDIO USA • 2720 Monterey Street, Suite 403 • Torrance, California 90503, USA • Phone 213-533-8900 • Fax 213-533-7072

World Radio History

TRIDENT AUDIO NEW YORK • 914-591-3741

Roy Halee

Recording Paul Simon's "The Rhythm of the Saints"

Sitting behind the SSL board at The Hit Factory in New York City, engineer/producer Roy Halee casts a keen ear to the groove while listening back to a track from *The Rhythm of the Saints*, Paul Simon's latest blockbuster project.

Percolating percussion pours through the speakers, a tenor sax jumps out from the throbbing pulse, a booming bassline undulates beneath layers of congas and berimbaus as voices unite in triumphant harmony. It all fits like a glove and Halee, an intense perfectionist in the studio, seems pleased. Finally, after 26 months of recording, overdubbing, editing, re-editing and fine-tuning, the tracks are ready for Simon to lay down his signature vocals.

As *Graceland* before it was Simon's excursion into the music of South Africa, *The Rhythm of the Saints* represents his baptism in Brazilian music. Halee, who has worked with Paul since the very beginning of Simon & Garfunkel, is calling it Simon's greatest project to date. It's got to be one of Halee's proudest accomplishments as well. Consider all that went into it: a sprawling, international cast of musicians

from Rio to Cameroon to New Orleans, South Africa, Trinidad and New York are assembled in different studios throughout the globe and brought together in seamless fashion through digital editing. It was certainly the most ambitious

project that Halee's had to tackle; and given the unorthodox nature of several of the homemade percussion instruments he had to deal with, the most challenging as well.

Born on April 17, 1934, in New York City, Roy Halee studied to become a classical trumpet player but got side-

tracked into another vocation when he began working in audio at CBS Television in the late '50s. "I was at CBS for a while until a big union layoff hit there," he recalls. "I probably would've never left that job had there not been this layoff."

From there he went to Columbia Records in the early '60s and worked as a technician editing classical music tapes. "I spent about a year-and-a-half doing that before they finally put me in the studio. That's when I started doing some mixing."

One of the first recording projects he engineered was a 3-track session for an up-and-coming folk duo from Queens, New York, by the unlikely name of Simon & Garfunkel. The year was 1964, the album was *Wednesday Morning 3 A.M.* "It ended up being a masterpiece," Halee says of that debut album that produced the hit single "The Sound of Silence."

Halee continued to



PHOTO: CLAYTON CALL

**LOOKING TO
BUY
NEW EQUIPMENT?**

**Consider Buying
Thru Leasing...
IT'S EASY!**



LEASING

leas·ing (le'zin) *n.* [ME. *lesinge*] 1. a new age approach to *buying*; 2. a *financing* plan tailored for *professional* recording studios, musicians, churches, schools, hotels, lounges, institutions, or any other commercial customer; 3. an easy, no hassle, convenient way to *buy* musical equipment; 4. a wise *business* decision.

For more information, call:

ORIX Leasing Service

A Division of ORIX Credit Alliance, Inc.

9400 S.W. Barnes Road - Suite 200

Portland, OR 97225-6655

1-800-289-0001, Ext. 307

Circle #187 on Reader Service Card

work with Simon & Garfunkel on and off over the years and more recently has established a tight working relationship in the studio with Simon. We spoke to the engineer about *The Rhythm of the Saints*, the latest achievement in an illustrious career.

Mix: This project has been over two years in the making. How did it begin?

Halee: The project actually started when Paul went down to Brazil with Phil Ramone to cut percussion tracks. Shortly after they did one or two tracks, I inherited the project. So the concept of going down to cut these percussion tracks had already been established. We went back to Brazil to cut more. This must've been about a year after *Graceland*.

Mix: And the idea was to capture some of the energy there in its natural environment?

Halee: Correct. Specifically, the Brazilian percussion feel. We linked up with a guy down there named Mazzola, who's a big pop producer in Rio, and he got the musicians for us. The first time I went down there with them, there were about ten guys just laying out these incredible percussion grooves. And we went back several times after that for more recording and overdubbing. The idea was to create these grooves by strictly using percussionists, and then build the songs up from there, adding on melodies and harmonies later, with vocals coming last. These initial percussion grooves served as the foundation for the entire project.

Mix: What kind of inherent problems did that present to you as an engineer?

Halee: It's hard under the best of circumstances to record percussion, in my opinion. To capture the sound of congas or anything being played with the hands—to get the tonality and the roundness of the instrument's sound in the room—has always been difficult. They tend to sound like cardboard boxes and what-have-you. That made me nervous right from the start. We had to do it all live with no overdubbing to get the kind of grooves we wanted to get. There'd always be ten or 12 guys in a small room playing at once.

The studio we were in down in Rio was really a radio studio, so the microphones and the console were not what you would normally pick. We were at a disadvantage to begin with. I would've preferred having more AKG 421s on hand, because I like using

them on congas.

Mix: Did you bring any special equipment with you?

Halee: No, I didn't because I like to go and grab whatever they've been used to doing rather than walk in with my own stuff I ended up using as many 421s as I could get for close-miking. Plus, I had many room mics strategically located around the room, mostly 87s.

Mix: Was there any problem with leakage?

Halee: The usual problems. But the leakage in this case was good because it gave it a real live, full sound.

Mix: So at that point there were no melodies or lyrics?

Halee: Nothing. We were just going after the groove.

Mix: I understand that some percussion grooves were recorded outside using street musicians?

Halee: Yes, one track was recorded in a courtyard down there with 14 drummers—a group called Ola Dum. That particular track was a Phil Ramone track, so I wasn't party to that. I was involved with the overdubbing in the studio and any repairing, fixing and editing that went on later.

Mix: So those guys down in Brazil were basically just jamming up grooves?

Halee: Sort of. I don't know whether I'd call it jamming. It was a little more than jamming because the patterns are so disciplined and come out of a particular school of percussion. But they were playing unrestrained, more or less.

Mix: How did you treat those original percussion tracks once you got back to New York?

Halee: We transferred them from analog to the Sony 3324 digital, strictly for editing purposes. That allowed us to do all types of quick editing, which is really the only reason I would use that particular machine. I certainly did not choose it for any sound reasons. I'm not what you would call a big proponent of digital. But that did enable us to edit and edit and edit—in some cases to go down to nine masters starting with one—repeating grooves, moving things around and so forth, to construct some sort of a form for a song.

Mix: Did you enhance the percussion tracks in any way?

Halee: Yes. Basically, I'm trying to make it sound as contemporary as possible, so I'm not against using AMS, DDL, the Lexicon 480L, the Quantec

unit. I'm not adverse to using the modern delay and reverb sounds. There's a lot of embellishment, but I tried to do it in good taste; it's not obvious. It's basically to fatten up sounds and make it sound '90s, shall we say. But for the recording process, in general, I went for a lot of room sounds.

Mix: What was the studio like in Rio?

Halee: It had three separate rooms. One was a dead room joined by a live room joined by a very live room, with doors leading into each room, all visible from the control room.

Mix: Where did you end up recording those percussionists?

Halee: I used the medium room to cut all the live stuff. Then I dabbled with the other rooms for my overdubs. I tried to keep everybody very close together with no go-bos and nothing separating them, in order to get the feel happening.

Mix: What were the next steps involved in this project?

Halee: We got hooked up with a guy from Cameroon, a West African guitarist named Vincent Nguini, who came in and played some West African melodic grooves over the Brazilian percussion grooves. And that's what the album is: West African grooves and Afro-Brazilian percussion.

Mix: You mentioned a fantastic new bass discovery who appears on this album.

Halee: Yes, Armand Sabal-Lecco, a fabulous bass player from Cameroon. He's got to be the best bass player I've ever been involved with. I don't know if it's fair to tout him as another Jaco Pastorius on the strength of what people will hear on this record, but certainly on the strength of what I heard him doing in the studio, just vamping and playing between takes. When they go out on tour and people actually get to see and hear this guy, he'll become a star. Mark my words. He's a monster.

Mix: Were there other overdubs done in Rio other than percussion?

Halee: Many, because when we came back to New York to edit these tracks and put on the West African melodic grooves, there was room for many overdubs. We would then take the digital tape and make an analog slave of it, take the analog slave down to Brazil and overdub on it. Then we'd bring that back and dump it onto the digital and re-edit again. That's how the process went.

Mix: What were some of the overdubs

done in Rio?

Halee: We locked into three or four guys who did a majority of the work on the record: Nana Vasconcelos, Dom Chagal, Cidhino and Mingo. They were the core of the original percussion tracks. When we went back we got these same four guys to overdub. We also had a fabulous classical nylon-string guitar player on one song, Rafael Rabello. He's very well-known down there. And we also overdubbed Milton Nascimento down there rather than in New York. He sings a little piece in one of the songs called "Spirit Voices." We also overdubbed some accordion. And then there was the Uakti group, a fairly well-known percussion ensemble who make their own instruments. It's something you have to see to believe—some stringed instruments, some percussion instruments, marimbas, big, long tubes for bass sounds that can be tuned by increasing or decreasing the length of the tube. It was a challenge to preserve the sonic integrity of those instruments.

[The percussionists] love to do their overdubs together. It can't be just one guy at a time; it's gotta be four guys at a time. So you have to get it when it happens. The chemistry is very important to those guys. Like on this Uakti track, "Can't Run, But," with all these bass tubes. That started out with homemade vibes made out of little squares of glass played with homemade mallets. They sound wonderful, man. Then they put on these bass pipes and percussive pipes. Then they put on straight percussion, like two batas and this box that a guy sits on and plays. We also had a Nigerian talking drummer, and Nana plays bells on this track. It's amazing!

Mix: Who were some of the other special guests on this project?

Halee: There was Michael Brecker on tenor sax and Akai EWI, and his brother Randy on trumpet. We had Milton Nascimento and Ladysmith Black Mambazo on vocals, C.J. Chenier on accordion, Kim Wilson on harmonica, Greg Phillinganes on keyboards, Adrian Belew and J.J. Cale on guitars, Steve Gadd on drums and Dave Barger, a great trombone player from New York who plays with Gil's band.

Mix: At what point did Michael Brecker come into the picture?

Halee: Much later, after the songs were really songs and had real musical forms. Then he came in and did his schtick. Just beautiful, particularly on

VACUUM TUBE SIGNAL PROCESSING AT ITS FINEST

SEE US AT A.E.S. BOOTH 1421

Summit Audio Inc.
P.O. Box 1678, Los Gatos
California 95031 U.S.A.
408-395-2448
FAX: 408-395-1403

Circle #188 on Reader Service Card

"She Moves On."

Mix: How diverse is the personnel on some of the tracks?

Halec: Incredibly so. To give you an idea, there's one track called "Proof." It's like the U.N., man. We cut the track in Paris because the Cameroonian rhythm section live in Paris. That was two guitars, bass, keyboards and a drummer playing a foot pedal and a hi-hat for time. Then we brought in "legit" horn players from Paris. We came back to New York and put a South African bass player on it [Bakhiti Kumahlo, who appeared prominently on *Graceland*], an American drummer [Steve Gadd], an accordionist from New Orleans [C.J. Chenier]. It was really wild.

Then we took it down to Brazil. The tape that originated in Paris goes to New York where we put it on a digital machine so we can overdub Americans onto it. Then it becomes an analog tape and goes down to Brazil where we put on all kinds of added percussion. Then we bring it back to New York and add on female singers from Cameroon and a shakere player from New York, Ya Yo. And then after all that, Paul put his vocals on.

Mix: Did you go about this project differently than others you've worked on with Paul?

Halec: Sure; we've never done anything like this. Never went to a place to get a percussion groove and then write a song over it.

Graceland also involved lot of editing, but the original grooves that went on there were melodic grooves with a rhythm section and a guitar player or keyboard player. The big difference here was beginning with just percussion. You'd bring it into the studio and just hear percussion, no melody. To construct it so it was some sort of a song, from a percussion standpoint—that was a whole different approach. Let me add, too, that when the guys from Brazil heard the editing and heard the reconstruction we did back in New York, they flipped out. They thought it was great.

Mix: What is your method of collaboration with Paul in the studio? Does he have specific ideas of what he wants?

Halec: Oh, that's a tough one. We're just a good team. He thinks so; I think so. I'm strong in an intonation sense—tuning and mistakes. He's a very strong songwriter; the best in the world, as far as I'm concerned.

Mix: How has technology over the years affected your methods in the

The percussionists

love to do their overdubs together. It can't be just one guy at a time; it's gotta be four guys at a time. So you have to get it when it happens. The chemistry is very important to those guys.

studio?

Halec: It's changed it a lot lately, with the advent of digital. I think we're coming full circle in that area, as far as mic techniques go. When I first broke into the studio, everything was miked pretty much at a distance. There was a lot of room sound, a lot of leakage, very few microphones. Then we went into a situation where it evolved and records became very tight, isolated, overdubbed and close-miked. Now, with digital—with the harsh, hard, brittle sound—we have to back the mics off or get a lot of distortion and a very ugly sound. I also see studios becoming more live now because of this; more ambience is used. Even with symphonic records, they're going back to using just two or three mics, far over the orchestra.

Mix: How did you record some of the melodic stuff—the guitar player, the bassist. Was that straight to the board or did you work with amplifiers in the room?

Halec: Well, the bass player, Armand, has such a fantastic sound that I used MIT shotgun cable plugged directly into the machine. I wouldn't dare put an amplifier on that bass. [With the guitarist] I think we used the Roland JC-120 mostly, and also a Fender Super Reverb. And then there's some direct work being done also.

Mix: How did you mike the accordion?

Halec: That was a bitch. It depends. Sometimes one, sometimes two mics closer to it, and always one about nine feet back from it.

Mix: Any other instruments that presented problems or unusual challenges

for you?

Halec: Yeah, they have an instrument down there called a sordu. It's like a big bass drum and they put it on everything—it's generally played on one or three of each bar. And it runs through this record quite a bit. It's a monster. The thing is extremely low, and in the hands of a good player, he can dampen it, double up on it, bend the thing. So to just capture the tonality of the sucker was a real challenge. I think I used an AKG 414 on it, up close and in the bi-direction pattern. Plus, a room mic. Again, always a room mic on everything.

Mix: Any particular mics that you used on the vocals?

Halec: I used an AKG tube mic on both Paul and Milton. For all the other background vocals by the Cameroonians and Ladysmith, I used AKG C-12s.

Mix: What are some other highlights on the album?

Halec: There's a horn section from Trinidad that plays some great stuff on two tracks, "The Cool, The Cool River" and "The Coast." Uakti playing with J.J. Cale on "Can't Run, But" is out of this world. Are you kidding me?! These schooled musicians from Brazil who make their own instruments and J.J. Cale playing guitar on top of it! Then there's Adrian Belew, who plays on the Milton Nascimento track "Spirit Voices." Isn't that an interesting combination? That one's also got Nana all over the place. Paul plays acoustic on that, too, and it also has Bakhiti, the South African bass player, on it. What a track it is!

Mix: What track does Ladysmith sing on?

Halec: "The Coast." Band one, side one. They don't really sing, they do a vocal rhythm thing, kind of like chanting.

Mix: Do you have a favorite track?

Halec: It changes from day to day, man. I like "She Moves On" a lot. Great groove, wonderful playing by Michael Brecker, sensational lyrics by Paul Simon. And the sound of the percussion on that particular track was captured pretty damn well. I won't say perfect, 'cause nothing's perfect. But I will say it's most representative of what I wanted to hear. The right blend of the direct microphones and the room microphones made it sound big. I would say that was my favorite from an engineering standpoint. ■

Bill Milkowski is a Brooklyn-based freelance writer.

If Michelangelo had a QUADRAVERB, he might have mixed music instead of paint.



It's true. Music and painting are very similar. A stroke of red, a touch of chorus. A splash of blue, a wash of reverb. Either way, it's art. And every artform has its masterpieces. And its tools.

Introducing the Alesis QUADRAVERB. An all-new 16 bit digital, simultaneous multi-effects processor and dead-serious musical tool. With QUADRAVERB, your mixes will be mirror images of the sound in your head. No letdowns. No noise. No nonsense. No boundaries between art and creation.

Inside, QUADRAVERB is alive with colors. Chorus, flange, phase shift, pitch detune and delay... all in stereo, to give your music depth and space. For absolute tonal control there are 5 bands of parametric and 11 bands of graphic e.q. And, of course, there's the unmistakable clarity and drama of the award-winning Alesis digital reverb programs.

With full programmability, 100 memory slots, and 90 factory programs created by the best ears in the business, QUADRAVERB gives you total artistic freedom. Plus, in QuadMode™, four of these flawless 20kHz bandwidth effects occur simultaneously. Like crunching thousands of dollars worth of studio gear into one rack space.

With very little cash, and even less effort, you can use QUADRAVERB on your next mix... plug it into your instrument rig... perfect your sound.

See your Alesis dealer today and hear what state of the art really means.

Michelangelo would agree, QUADRAVERB is a masterpiece.

ALESIS
STUDIO ELECTRONICS

LOS ANGELES:

Alesis Corporation • 3630 Holdrege Avenue • Los Angeles, Ca. 90016

LONDON:

Alesis Corporation • 6, Letchworth Business Center • Avenue One, Letchworth, Hertfordshire SG6 2HR

New
QUADRAVERB
Plus

Now with:

- Sampling
- Multi-Tap Delays
- Panning
- Ring Modulator
- Resonators

See Your Alesis Dealer

Circle # 210 on Reader Service Card

Time Is



Porsche 911 Slant-Nose Turbo Coupe 0-60 mph 4.2 seconds

Automobile courtesy of Premier Motor Cars, Nashville, TN

Using the SeriesTen's unique SAVE/RECALL system, every parameter on the entire console is reset in less than 1.5 seconds. With our optional ARS-9 router/switcher, this includes inputs to and outputs from the console.

Want to know HOW WE DO IT?
...Call Martin, Brad or Gary at 615-331-8800

Money.



Harrison SeriesTen B Client A-Client B 1.5 seconds

 **Harrison** by GLW
SERIESTEN

GLW, INC. • Manufacturers of Harrison Consoles • 437 Atlas Drive,
Nashville, Tennessee 37211 USA • Telephone (615) 331-8800 • Facsimile (615)
331-8883 • Telex 413838 (GLW.NASH)

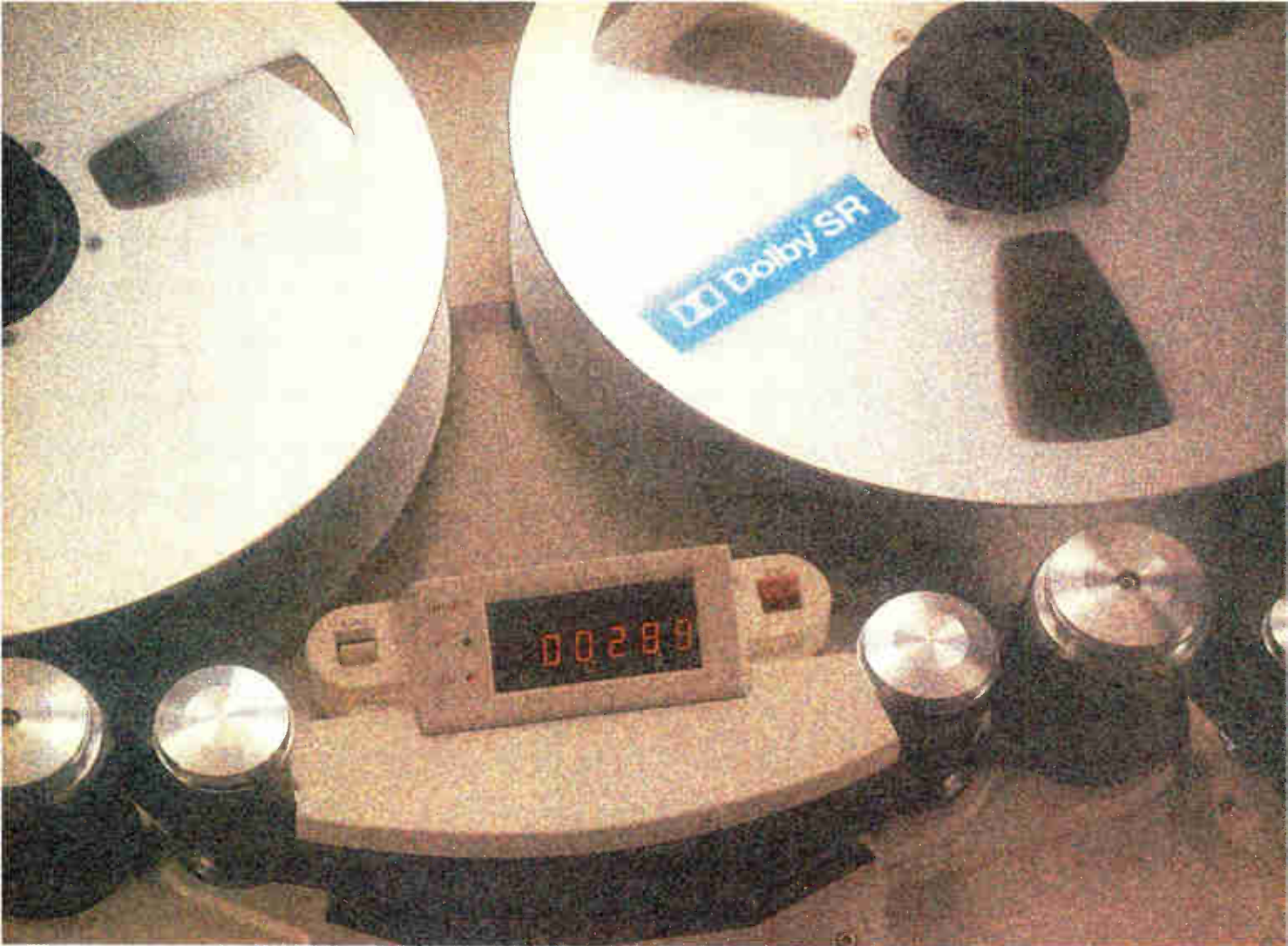

Dolby SR. The sound investment for analog multitracks.

When everyone else was making noise about digital, we quietly developed Dolby SR. But it's no secret: Dolby SR makes analog multitrack recording a cost-effective alternative to digital.

Improves the preferred sound of analog

At both 15 and 30 ips, Dolby SR dramatically increases headroom, and virtually eliminates tape hiss and modulation noise. Dynamic range is improved by more than 25 dB over unassisted analog, preserving all the warmth and purity of the original sound.

Increases the return on your investment

Dolby SR upgrades your multitrack at a fraction of digital's cost. Add our Model XP SR (configured for up to 24 channels), or update an existing Dolby mainframe with plug-in SR modules. If you are in the market for a new multitrack, Otari and Studer offer models with Dolby SR built-in.

Simple to use

Set-up is quick and easy with Dolby SR. A unique

Auto Compare feature lets you instantly verify frequency response and playback calibration.

And editing is as convenient as ever, with no need for special equipment.



Worldwide acceptance

Tapes recorded with Dolby SR can go anywhere, anytime. In fact, with more than 25,000 channels in over 30 countries, analog with Dolby SR is a firmly-established format you can't afford to ignore.

Put it to the test

Call your Dolby dealer to arrange for a demo at your facility. Hear for yourself why Dolby SR is

the sound investment for analog multitracks in today's competitive marketplace.



100 Potrero Avenue, San Francisco, CA 94103-4813. Phone 415-558-0200, Telex 34409, FAX 415-863-1373. 346 Clapham Road, London SW9 9AP, Phone 01-720-1111, Telex 919109, FAX 01-720-4118. Dolby and the Double-D symbol are trademarks of Dolby Laboratories Licensing Corp. © Dolby Laboratories Inc., 1989. S89/8676

by Blair Jackson

Shel Talmy

The Producer Behind Legendary Hits by The Who and The Kinks is Back Behind the Board

The first surprise is that he isn't British. Despite making a name for himself producing a string of UK hits in the mid-'60s for such artists as The Kinks ("You Really Got Me," "All Day & All Night," "Tired of Waiting," etc.), The Who ("I Can't Explain," "My Generation," "The Kids Are Alright," etc.), the Manfred Mann Group ("The Mighty Quinn") and The Easybeats ("Friday on My Mind"), Shel Talmy is a Yank from Chicago. He also produced hits for Chad & Jeremy, albums for the great British folk group Pentangle, he "discovered" the 17-year-old British singer/songwriter Davy Jones, who went on to become David Bowie, and he was at the helm of albums by a number of other great—but less heralded—English artists such as Bert Jansch, Roy Harper and Nicky Hopkins.

By the end of the '60s, though, Talmy had grown weary of the day-to-day grind of recording, and his work trailed off through the '70s as he became consumed by a plethora of other interests. He worked as music supervisor on several films (including *Butch Cassidy*), he dabbled in real estate, started a book publishing venture, wrote three adventure novels, and also began a successful computer company involved with optical scanning and storage.

Still, he always kept up with changes in recording technology, and then, two years ago, he began recording bands again. A stint with The Fuzztones for RCA inaugurated the latest phase of his long, distinguished career. More recently,

he was at the helm for a new album by the popular Milwaukee acoustic band Ecoteur (on Chameleon Records).

I talked to Talmy about some of his career highlights and about his decision to get back into music after an eight-year absence.

Mix: Why did you decide to come back to producing, working with The Fuzztones?

Talmy: It's a simple and mundane answer: They



approached me shortly after they'd signed to Beggar's Banquet Records. I listened to their tape, and I liked what they were doing a lot, so I thought it might be fun. And it was. I liked the label, too. They've been good at promoting their releases. Also, this came at a time when I had sold my interest [in the computer company], and I frankly missed being around artistic people.

That's something you just don't find as much of in straight business. I ended up liking the experience so much I decided to go back into it full time.

Mix: I guess working with a raw band like that hasn't exactly thrust you into the world of digital recording.

Talmy: Hardly! They're really adherents to the '60s way of doing things. We're using Farfisas and old Vox amps that buzz like crazy, ancient guitars. It was great fun.

I want to be selective about who I work with. There's only so many records I can do a year, and I don't want to get into that thing of overcommitting by booking too many projects. So I've been moving slowly, letting the industry know I'm back

The Who onstage in 1965, another of the bands Talmy produced



producing again and seeing what develops.

Mix: Is it a liability that you haven't been around much, and that your name is so closely associated with artists from a specific time period so long ago?

Talmy: Oh, definitely. This is the sort of business where if you're out of it for a year, people wonder if you're retired, and I hadn't done anything [in music] for about eight years. Personally, I'm trying not to look at this as a "comeback," because it's not like I was

ever dismissed in the first place. I just got out of it. I got bored with it, I got burned out on it, and I thought I probably wouldn't return to it; but things change. The climate in the business has changed. I hear more bands playing straight-ahead, good songs, which is what I've always liked. Down here [L.A.], most of the bands I've seen are playing live without synthesizers, and they want to go into the studio and record live. There's a move back to actual drummers, instead of machines. Those are all encouraging developments to me.

Mix: You made your name in England. Where did you get your training—Chicago?

Talmy: No, I only lived there until I was about 15. I got into recording after I moved to Southern California, where I worked in TV for a while, and

done much at that point. He used to let me do whatever I wanted after our regular sessions were over, so I used to get guys in and work out miking techniques for how to make drums sound better, or guitars sound better. A year or two earlier it was almost all mono, and engineers weren't that concerned about separation. So all the work we did there on separation held me in good stead as the number of tracks available increased through the years. We weren't the only ones doing that, by any means. There were many good engineers around L.A. who recognized when 3-track came in that it was probably just the tip of the iceberg, and that both tape and recorders would continue to get more sophisticated. This is really even pre-transistors.

Mix: When you moved to Britain in the early '60s, what was happening musically over there?

Talmy: Very little. A lot of people were doing covers of American records, and there was a lot of local stuff that would obviously never make it out of the British Isles.

Mix: How did recording there differ at that time?

Talmy: It didn't really differ very much. The equipment was similar; everyone was using Ampex recorders and Altecs. I think EMI had some old Philips machines.

Mix: Most of the top producers in England worked with specific record companies, didn't they?

Talmy: That's right, and that meant that most of them were on salaries and not really getting royalties. I declared myself an independent producer

when I arrived and got royalties from my first record, so I was always a little bit out of the system. I don't know if people resented me for that, or what. But I always got along well with other producers.

Mix: Were there specific producers who influenced your style?

Talmy: It's hard to say. I can honestly say I never heard a record and then said, "I want to use that drum sound on my next record." On the other hand, I can say I was influenced by some records, like I loved that Marty Robbins

eventually I met an engineer named Phil Yeend who had a studio called "Conway"—in fact, the Conway of today is an outgrowth of that earlier one—and he trained me. It was 3-track, and I picked up on it immediately. Three or four days later I was an engineer. I had always liked technical things, and I just took to it. This was 1960 or '61.

It was a very good little studio. Phil was fairly avant-garde for that time. We did a lot of experimenting on separation of instruments, which hadn't been

record that had what was the first fuzz guitar I'd ever heard. It happened by accident, apparently; there was a short in the amp, and the guitar made this distorted sound. Well, that was a real revelation to me.

But with the kind of music we were recording, there weren't many precedents, so we were all doing it for the first time together. It was all totally new.

Mix: What was it about The Kinks that knocked you out originally?

Talmy: The songs—which is virtually where it started with everyone I've ever worked with. They were called "The Ravens" and had already been together a couple of years, and they were already quite good when I heard their acetate. They had this upper-class manager and were playing mainly debutante dances. [Laughs]

Mix: Did they pose any special challenge in the studio?

Talmy: Well, I don't know if Dave [Davies, lead guitarist] had heard the Marty Robbins record, but he sure loved fuzz guitar, and he used to slash the cones of his amp and kick it to get it as grungy-sounding as he could; and it certainly worked. They had great energy and a different sound than anyone I'd heard in England or the States at that point.

Mix: I have this sense of The Kinks, the Stones and the Beatles coursing together through the late '60s on similar but still different paths. Were you constantly checking out "the competition," seeing what new tricks George Martin came up with?

Talmy: Not really. I certainly admired his production; obviously, he knew how to make great records, but I didn't analyze it too much. As for the Stones, well, frankly, I thought the sound on some of their early records sucked, but they had something that was clearly unique. It was obvious they were a great band.

We all were aware of each other, and, of course, we all knew each other. At the beginning we were all a little naive, I think.

Mix: You didn't do much overdubbing, did you?

Talmy: Well, as we got more tracks we did more overdubbing, and I always liked to overdub voices. One of the things I started doing as an engineer was double-tracking voices. You talk about deficiencies in equipment and acoustics—these days you can go in, find all the dead spots and correct them in no time at all. But that wasn't the case

in that era. It was trial and error, and so I discovered that double-tracking the voices let me fill in some of the holes in the sound. I'd also move the singers around the mic to alter the way it sounded in relation to the first track, to fill in the sound. I did that with The Bachelors, with The Kinks, virtually everyone.

Mix: Did you have to deal with many old-guard engineers during the early '60s?

Talmy: Oh sure, especially at Pye [Recording], where I did most of The Kinks records. There were a couple of older guys there who really resented both the music and all of us, because we were all young. It was all crap as far as they were concerned, and they wanted to do big bands and ballads. However, a lot of younger engineers came on the scene right around that time. I still did a lot of my own engineering with The Kinks, even though I was mainly producing, in part so I could have more control over my sessions. I'd hire a good assistant to do some things.

Mix: How involved was Ray Davies with the early Kinks records?

Talmy: Quite a lot. He was without a doubt the most prolific writer I've ever

known. He'd come in with 30 songs that he'd written over a few days, and we'd go over the material—putting stuff aside for later, choosing what we'd do immediately. And then we'd talk extensively about the arrangements. I was always happy to hear what his ideas were because they were usually good.

Mix: Looking through your discography, it seems like you did an awful lot in a very short time. Was it actually a situation where you'd work with The Kinks one week, The Who the next and so on?

Talmy: At one point, yeah. It sounds more difficult than it actually was at the time. We were all young and full of energy and right in the middle of... well, I know you've read about the "swinging '60s" in London, but if you didn't actually experience them, it's hard to explain what they were like. They were *energy-filled*. Nobody got a lot of sleep, but nobody gave a damn. We all worked long into the night, and then we'd go out to parties.

Mix: So you socialized with the bands outside of the studio?

Talmy: No, I didn't really. We went to *different* parties. [Laughs] I always felt it was important for me to keep some



See us at
AES Booth
#32

MUSIC WITH IMPACT

Audio Action represents the finest composers and producers of production music from around the world. There is always new material being added to the library — making it fresh, original and suited to your production needs.

From the traditional to the outrageous, Audio Action has it — all on CD. Audio Action offers a unique combination — music that lets you stretch your imagination and creativity — without stretching your budget!

FOR A FREE COMPACT DISC SAMPLER, CALL:

AUDIO ACTION 1-800-533-1293 • CA: 1-818-845-8020
4444 Lakeside Drive, Suite 340, Burbank, CA 91505
FAX: 1-818-845-8039

Circle #032 on Reader Service Card

distance from the people I worked with, though I must admit I now regret that decision. I wish I had spent more time socializing with them and getting to know them outside of work. I thought at the time it might not be good for the work, but now I believe the opposite.

Mix: You were with The Who during

The Kinks, one of the many bands produced by Shel Talmy



a brief but seminal period in their career. What ended your association with them?

Talmy: Actually, it had nothing to do with anything I *did*. The Who were managed by a fellow named Kit Lambert, who was very gay and much older than all of us, and he was extremely jealous of anybody he thought was usurping his influence over the band. As a producer, of course, I *did* have some influence over them. From the first record, I made hits with them, but then one morning I got a letter from Kit saying, "Your services are no longer required." I didn't like that and my contract didn't agree with that, so I sued him and won. Unfortunately, winning didn't mean that I got to record the group any more, and I've always been sorry about that.

To be fair, I think the the group felt like they had to listen to Kit, because obviously he was great at PR and did a great job of marketing them. So if he said I was a bad guy, I guess they had to go along with that. I don't think they

gave a lot of thought to it. They were all very young; we all were.

Mix: What's the deal with Manfred Mann? I've liked a few songs, hated others, and I could never quite figure out who he was and what he brought to those records he did.

Talmy: That's a very good question. [Laughs] He's what people would now call "a concept man." In other words, if he wasn't in music he'd probably be in marketing, or at an ad agency. The

Manfred Mann Group was his band, to be sure, but his main strength was choosing other people's material and then knowing what to do with it to make it commercially palatable. Obviously, Dylan was a favorite of his, and he did very well with a few of his songs.

He brought a bunch of disparate personalities together so they could work together, though there were times when I felt like my role in the studio with them was as resident shrink. He was a strange guy in a lot of ways, but he was also very nice and very bright, as were all the people in the band. And they were very successful, of course.

Mix: As an independent, did you have to be particu-

larly budget-conscious?

Talmy: Absolutely. Either I worked for a company and was in charge of the budget, or I did it out of my own production company budget, like with The Who, where I put up the money myself. So I was very aware of what I was spending. With The Kinks, which Pye was initially funding, they had a real scumbag president who said that if we went one penny over budget, it would come from me, so I was under a lot of pressure.

Mix: Did you ever have any of those classic, late-'60s projects that went seven months longer than they were supposed to, and you wanted to put a calliope on this track but decided on a full string quartet instead?

Talmy: [Laughs] I saw it happening around me but it never happened to me, thank God. I never had the patience for that kind of stuff.

Then and now, I've always tried to have everything pretty well worked out in advance in terms of the material and the arrangements. We'd work in

rehearsal rooms and really have it to about 90 percent of what we wanted when we actually recorded it. I don't really like big surprises in the studio. I like to leave enough room for startling creativity if it happens, but it's still nice to know what you're doing.

Mix: In the '70s we saw more and more bands writing their material in the studio and spending horrendous sums.

Talmy: I think it got to be an ego trip for those bands—to see who could spend the most time and money in the studio. I never put up with that. I was very careful about the bands I chose, and I was very upfront: The studio is a place I like to *work*. It's not a place I like to eat and hang out and play pinball.

Mix: In the late '60s you moved in more of a folk direction with Pentangle and Bert Jansch. Was that strange for you?

Talmy: No, it was great. I grew up loving folk music, so when I got the chance to work with some of the best people of that time, I jumped at it, and I loved doing it. They were all great musicians and real individualists, to say the least. It was a real pleasure, and *Basket of Light* remains one of my favorite albums that I've worked on.

Mix: You're returning to music in such a conservative climate in terms of what gets played on the radio. That must be a little frustrating for you.

Talmy: There really isn't very much good radio out there, it's true. Even here [in L.A.] it's hard to find a station that's at all adventurous. Fortunately, college radio seems to be filling the gap somewhat.

Mix: College radio may play The Fuzztones, but who's going to play the next Pentangle that comes along? There are entire genres of music now that can't find a home on radio.

Talmy: That's a good point. It *has* gotten narrower. But at the same time, things do break through, whether it's Tracy Chapman, who has helped get more folk music on the radio, or other people who are somewhat out of the mainstream. The fact is, you never know at any given time what's going to be popular.

Mix: So what's the answer as a producer? Be true to yourself and keep your fingers crossed?

Talmy: That sounds like pretty good advice. I've always tried to do work I could be proud of, and I expect to continue that way. ■

Blair Jackson is managing editor of Mix.

STAND No 001
ES 90 LOS ANGELES



Metropolis is one of the most prestigious recording studios ever designed. And within it, you'll find the ultimate in audio equipment.

The new Focusrite studio console.

It embodies Focusrite's commitment to the highest standards of sonic purity.

When compared with the approach taken by Metropolis, it becomes apparent that they have shared the same vision.

To create the finest recording environment in the world.

An experience we're sure you'd like to share.

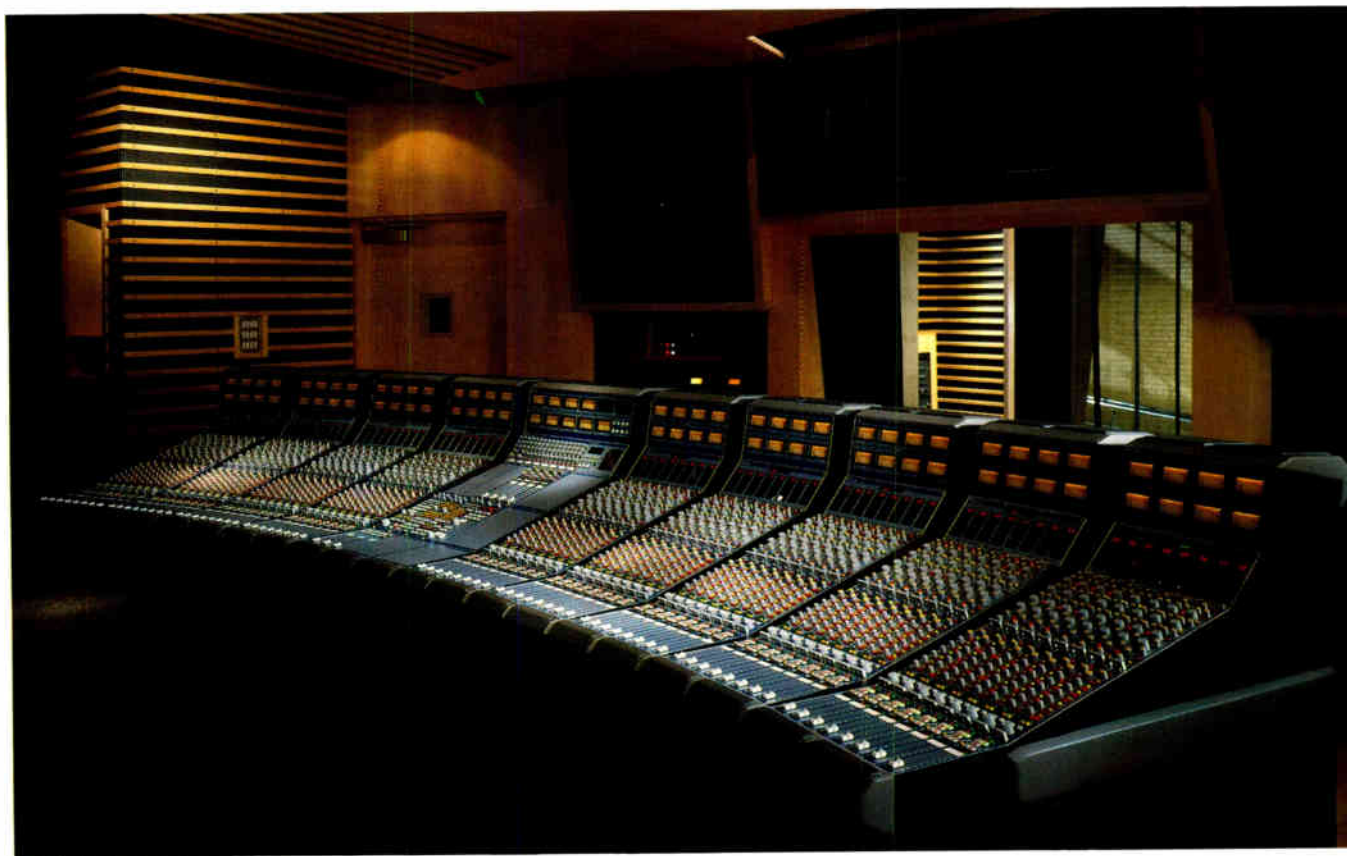

No Compromise



NOTHING SHORT OF EXCELLENCE

Circle # 207 on Reader Service Card

The Audio Ana

If you ask five different audiophiles which is the best high bias audio cassette to record music on, you're likely to get five different opinions. But if you ask the Audio Precision Analyzer™ you'll get a definitive answer, right there in living color: TDK SA-X.

The Audio Precision Analyzer is one of the most sophisticated pieces of laboratory equipment of its kind. It's used by audio engineers to evaluate an audio cassette's performance in a variety of areas. Two of the most critical of these areas are MOL (Maximum Output Level) and bias noise, which together are used to measure what is known as *dynamic range*.

MOL is indicated by the curve at the top of

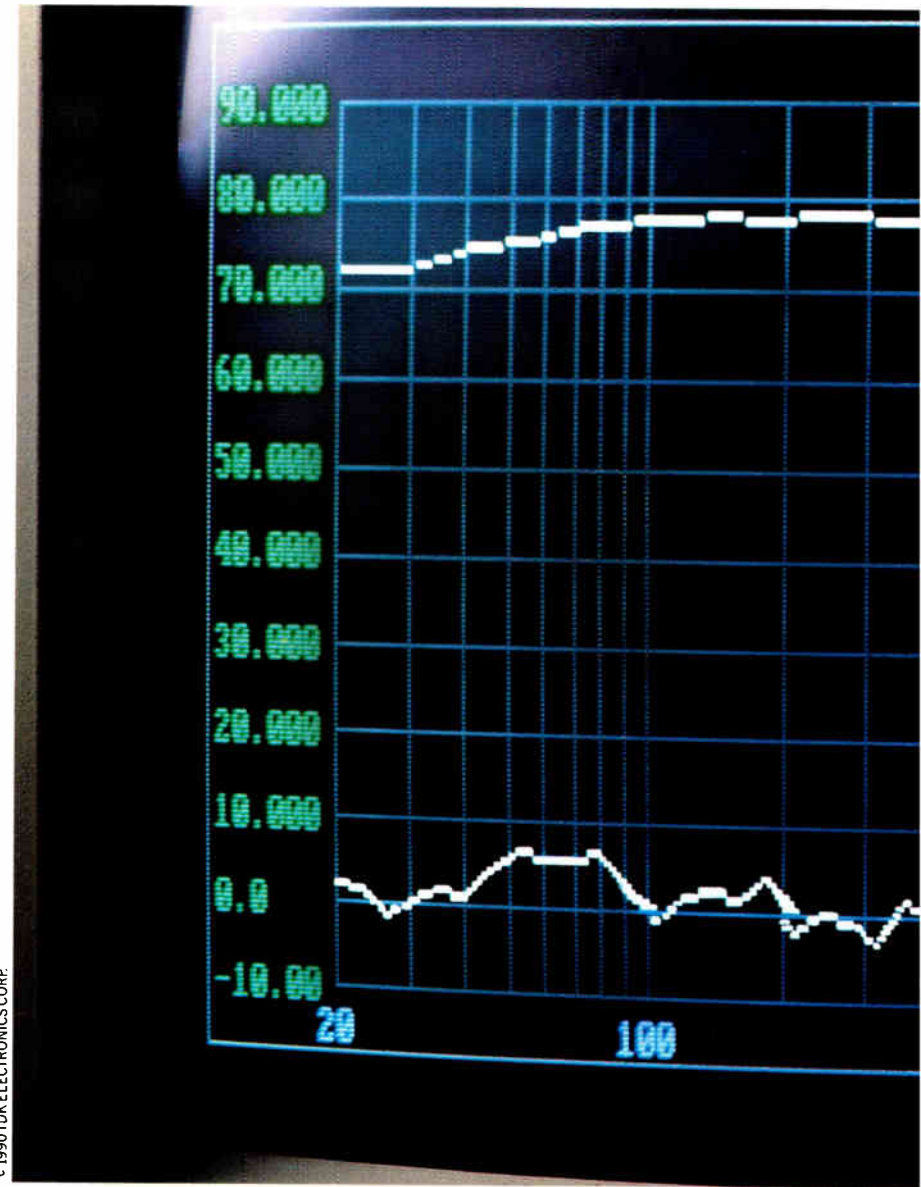

TDK SA-X's DYNAMIC RANGE, THE WIDEST OF ANY HIGH BIAS

the analyzer's monitor; bias noise is indicated by the curve at the bottom. The vertical distance between any two points on these curves is the

measure of an audio cassette's dynamic range at that particular frequency.* The greater the distance, the greater the dynamic range. And the greater

Analyzer Never Lies.

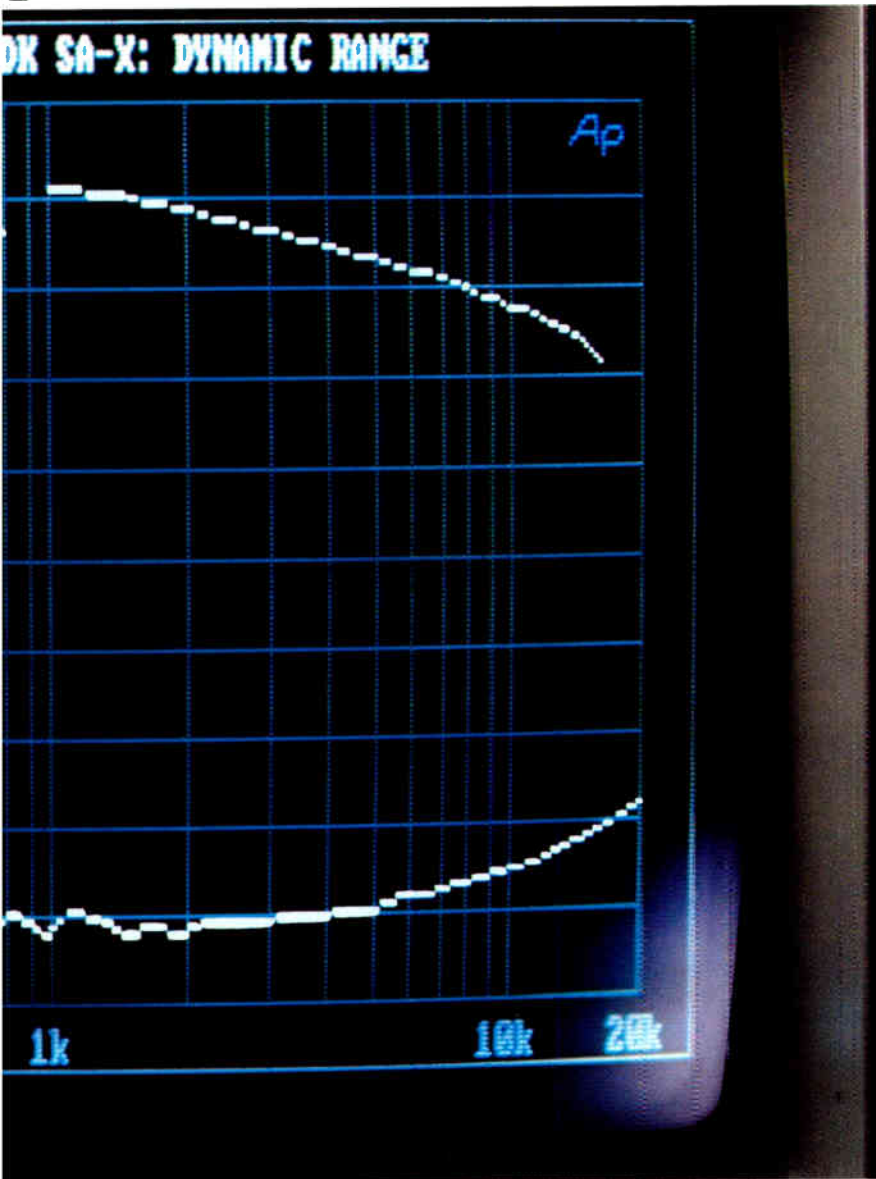

*Vertical Scale normalized to 0 dB for illustration purposes.

What the analyzer told *Audio*—in no uncertain terms—was TDK SA-X's dynamic range was the widest of all Type II audio cassettes tested. Which makes it the best tape you can use to capture the fortissimos, pianissimos, and transients of today's music sources.

So if you want the most faithful sound reproduction you can get from a high bias tape, look at what the Audio Precision Analyzer is telling you. And listen to TDK.

PE, IS SHOWN HERE ON AN AUDIO PRECISION ANALYZER.

the dynamic range, the more sound the cassette can faithfully reproduce.

When *Audio* magazine conducted an exhaustive test of 88 blank audio

cassettes (the results of which were published in the March 1990 issue), it utilized an Audio Precision Analyzer to evaluate dynamic range.



As Serious
As You Can Get.

Don't Let The Sound Gremlins Derail You.



Those mischievous Sound Gremlins are always trying to create audio calamity. But the dbx® family of world standard compressor/limiters will give you the technical and musical muscle to fortify your sound. Our compressor/limiters can fatten up a drum sound...resurrect a dead spot on a bass...and help you avoid those catastrophic overloads.

Kick the Sound Gremlins off your tracks with dbx's OverEasy® transition into compression, and patented dbx VCAs and human-ear compatible true RMS detection.

From live performance to field production to industrial installation, dbx has the products to suit your needs. Call your local dealer now to demo a dbx compressor/limiter. Then you'll know why our signal processors have been rated #1 in professional recording studios for the past four years.*

Don't wait. Catch the *dbx Express* now.

*In recording studios as reported in *Billboard's* 1988, 1989, 1990, 1991 U.S. Studio Equipment Brand Usage Surveys.



A division of
AKG Acoustics, Inc.
1525 Alvarado Street
San Leandro,
California 94577, USA
Tel: (1) 415/351-3500
Fax: (1) 415/351-0500

INDUSTRY STANDARD

COMPRESSOR/LIMITERS • NOISE REDUCTION SYSTEMS • EQUALIZERS • MODULAR PROCESSORS

by John Thomas

The Fast Climb of Keith Cohen

Producer/engineer Keith Cohen is enjoying the limelight these days. Touted as one of the hottest young remixers in Los Angeles, Cohen's very first forays into record production—Paula Abdul's "Straight Up" and "Cold Hearted Snake" (with co-producer/songwriter Elliot Wolff)—both hit Number One on the *Billboard* charts.

Over the course of just three years, this New Yorker-turned-Californian has compiled a discography that would be impressive even for a veteran. He's already worked his remix magic with top artists such as Prince, the Jacksons, Bobby Brown, Robert Palmer, The Bangles and Luther Vandross. Album projects (besides Paula Abdul) have included work for Cheryl Lynn, The Calloways, Mother's Finest, After 7, The System and a new Virgin act called Aftershock.

While Cohen denies that he has a specific trademark sound, he likes the music to sound raw and powerful while still having some polish.

"I mix very aggressively and get dynamics with big drums, big rhythms," he says. "For me, the low end and the rhythm prove the song. I like the rough edge. I can always warm things up, but I like the real punch. It should jump out of the speakers. It's got to get up in your face."

His approach is an amalgamation of personal touches and skills gleaned from working with music experts like Barney Perkins, Louil Silas, and Reggie and Vincent Calloway—skills that were nurtured during a tenure at Yamaha R&D Studios, centering almost exclusively around R&B. He freely credits those who have helped him along the way and modestly chalks up his success to a never-ending obsession with music and sound.

In high school Cohen thought he might become a guitarist, and he did gig with a variety of

student bands. However, at the University of Miami's Music Engineering School he abandoned the fretboard for the console. Then, after graduating from Full Sail Center for the Recording Arts, he says, "I had some assistant engineering jobs in Florida, but I realized I had to move out West, to L.A., if I wanted to be successful."

He didn't just bump into Paula Abdul, though. His first job in "recording" was working as a janitor at Record Plant. "I had to beg them to let me be a janitor," he says. "To become an assistant, you had to start out cleaning toilets and fetching coffee." He remembers the period—despite its hardships—as both a happy and educational time when he would frequently work upward of 70 hours a week.

During this time Cohen first learned his way around an SSL—a technical appreciation he carries to this day. "I realized that all the major clients [at Record Plant] wanted the SSL, so I figured that was the console to learn," he

says. Today Cohen does virtually all his work on Solid State Logic desks, though now it's L.A.'s Larrabee Sound—with its 72-input model—that he calls home.

In 1986, Cohen left Record Plant to begin a stint as an assistant engineer at Yamaha R&D Studios. It was at Yamaha that he began his still-standing association with R&B. "One of my first projects at Yamaha was working as Barney Perkins' assistant on 'Rapture' by Anita Baker," he says. "I learned a lot from Barney. He was always very confident, and his confidence was passed on to the client. No matter what happens, he doesn't panic. People just knew it would come out well, and it always did. Working with him really gave me my base."

It wasn't long before Cohen felt confident



enough to strike out on his own as an independent engineer, and, working mainly at Larrabee, he quickly built a discography that included engineering for Pebbles, LaVert and Jesse Johnson, and remixes for Robert Palmer, Chaka Khan, Alexander O'Neill and others.

"I'll never forget the first time a song I had worked on climbed right up the charts," he says. "It was The Bangles' 'Walk Like an Egyptian.' I engineered it with remixer Steve Beltran and producer David Kahne." Cohen's mix of "Casanova" for LaVert, produced by Reggie and Vincent Calloway, was quick to hit Number One on the black charts. "That really led me into R&B,"

he notes, adding that it is in that genre that he developed his most successful studio techniques.

"I often link up the gates to create effects," he says. "You can have the hi-hat open a gate across the keys, and you can keep the keys on three tracks and have one trigger the rest. I go for a raw approach with a lot of hard panning and short, gated echoes and reverbs to let the song breathe on its own.

"You can also use the compressors to color the sound a little," he continues. "If you compress a snare, you get more stick noise. Then the quad compressor takes out the peaks and makes

everything easier to master."

He also crows about "these old Pultec EQs at Larrabee. I use them on every mix I do."

Cohen describes his work on Pebbles' "Mercedes Boy" with Louil Silas (who is head of black music A&R at MCA) as another learning experience that honed his R&B edge. "Louil has a great sense of club and dance music," he says. "He brings everything in with him, from his experience as a DJ to his work with MCA. I learned from him what works and what doesn't. And it did work—consistently. We'd do a song one week, and I'd hear it on the radio the next."

By 1987 Cohen had built a well-respected name in the music business. Then Gemma Corfield of Virgin Records called to say that the label had just signed a new act—Paula Abdul—and wanted him to work with her.

"I mixed one song on Paula's first album, which Jesse Johnson produced," Cohen says. "Virgin liked what I had done, so they asked me to co-produce two songs with Elliot Wolff. Working with Paula is sheer pleasure. She is extremely talented, and she works very hard."

The past year has been busy for Cohen, as usual. He did extensive work on Abdul's next album (due for release in late 1990), producing it in tandem with various songwriters. He also was involved in mixing the soundtrack for the new Prince movie, *Graffiti Bridge*, and with some remixes for Was (Not Was). And that just touches the surface.

Cohen intends to keep mixing and remixing while advancing his career as a producer. "Remixing was a great transition for me," he says, explaining that "the biggest difference between remix and production, when it comes right down to it, is getting a good vocal performance. You have to create the right mood for the artist, the right feel. You've got to be able to catch a lot of different performances and take the best from each. And most of all, you have to keep everything loose, not let anyone get uptight."

Cohen seems anything but uptight. "Besides Paula, I'd like to produce a few more artists this year," he says casually. "A day off might be nice. I'll still do remixes, mix a couple of albums. I'm going to keep it rolling, keep learning and keep having fun." ■

John Thomas is a writer living in New York.



RUSSIAN DRAGON®

The **RUSSIAN DRAGON** is a brand new type of measurement meter. It measures the timing accuracy of two sounds that were *meant* to happen at the same time. For example, it shows how closely a drummer is playing along with a click track; it detects the time delay between an acoustic drum and its triggered replacement; it reveals timing inaccuracies in MIDI systems; it monitors how tightly a percussion overdub is performed; it checks for the right amount of delay in a delayed loudspeaker system. The **RUSSIAN DRAGON** compares the timing of any two events, and gives an instantaneous visual display of who's rushin' and who's draggin' and by how much.

JEANIUS ELECTRONICS
2815 Swandale Drive • San Antonio, TX 78230 • (512) 525-0719
Call for a free **RUSSIAN DRAGON** owner's manual or see us at AES Booth #1030

Circle #063 on Reader Service Card



Jenny 1990

HEARING IS PRICELESS.

The TEC Awards, supporting The House Ear Institute.

 **Neve**
A Siemens Company

FOR THE TOP OF THE RACK... ..THE CHOICE IS YOURS...

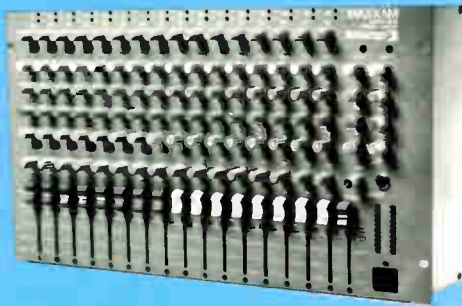

MAXXAM 8+8. The mixer for *serious* electronic musicians.

- 8 STEREO + 8 mono channels...24 line-level inputs.
- 2 mic preamps.....assignable to any input.
- 4 Auxiliary Sends.
- 4 STEREO Returns.
- Patch insert jacks on every channel.

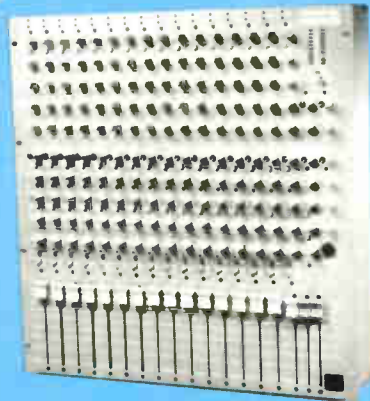

RackMax IIex. A new industry standard for rack mount mixers.

- 4-band channel EQ.
- 6 Auxiliary Send busses.
- 4 Returns (3 STEREO).
- Balanced Main Left/Right, Mono and Monitor outputs.
- Channel mutes and complete solo system.

RackMax II. The *affordable* work-horse 16-channel rack mount mixer.

- 4 Auxiliary Sends.
- 3 Returns (2 STEREO).
- Patch insert jacks on every channel.
- Balanced Main Left/Right, Mono and Monitor outputs.
- Channel solo system.

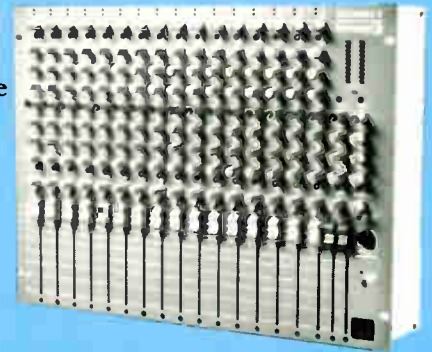

RackMax II/12. When 16 inputs are too many and 8 are too few.

- Same great features and performance as the 16-channel model.
- Discrete transistor preamps for superb sonic quality.
- +48 volt phantom power.
- *Only 8 rack spaces high.*

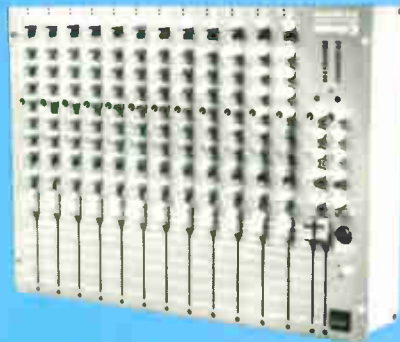

CASCADE 8/332r. Compact and affordable.....without compromise.

- 8 input channels.
- 3 Auxiliary Sends.
- 2 Returns (One STEREO).
- Signal present and peak LED channel indicators.
- Balanced outputs.

If you need rack mount convenience without compromising performance or reliability, you should give us a toll-free call at 800-826-1457 for free descriptive literature and the name of your nearest BIAMP dealer.

biamp  **AMERICAN
SOUND
CRAFTSMANSHIP**

14270 N.W. Science Park, Portland, OR 97229 (503) 641-7287

MATT WALLACE

OUT OF THE GARAGE AND ONTO THE CHARTS

Wgot a bottle of bourbon and some liverwurst," one grizzled man says to another down the block from Alpha & Omega Recording. This studio, in San Francisco's Tenderloin district, is where producer Matt Wallace and engineer David Bryson have been wrapping up a project with Chagall Gueverra, a new band signed to MCA. After laying down tracks at Bennett House (located in Franklin, Tenn.), they chose Alpha & Omega for its all-discrete API board (with ARMS moving faders). This project comes on the heels of Wallace's production of Faith No More's latest LP, *The Real Thing*, which was nominated for a Grammy in the metal category and recently went gold. He knows how to help a band get a distinctive sound.

The setting of Alpha & Omega—both inside and out—is a far cry from his parents' suburban garage in neighboring Contra Costa County, where Wallace constructed his first 8-track Tascam studio. He typified the spirit of the post-punk early '80s by dropping out of school—not recording school, but UC Berkeley's English department—and learned recording by bringing in friends' bands. "It was really wild having a lot of kids with spiked haircuts from San Francisco come out to this garage," Wallace says.

He and Faith No More practically grew up together—he recorded their first single (when they were called Faith No Man) in his parents' garage. In an interview with *BAM*, Wallace describes working with the band: "Doing tracks with them is like laying down in the middle of the road waiting for a bulldozer to run you over. Just really strong. Like a herd of thundering elephants."

These days Wallace can pick who he wants to record. After a stint at Slash (in L.A.) as a staff producer and at independent work since the spring of 1989, he now has records by the Replacements, Lock Up and Wildflowers to his credit. He can even afford to take a vacation.

Mix: Was there any particular sound you were

looking for when you were recording those first bands in your parents' garage?

Wallace: A lot of the punk bands, obviously, were hard to record since the music was more fast-paced and blurry. Trying to get that on tape so it was powerful and you could hear it was the whole objective. When I started I just had an 8-



input mixer, which is pretty limiting when you're trying to record a band. You have to be pretty innovative. We eventually moved up to a 16-input mixer [when he moved a studio to Oakland], which was a lot better.

Mix: Were there any people you emulated?

Wallace: One inspiring person was Steve

HOW TO FIT A SYMPHONY ORCHESTRA INTO A SMALL STUDIO.

It's simple. Buy a Proteus/2. The latest member of E-mu's acclaimed family of 16-bit digital multi-timbral sound modules.

Proteus/2 is the first—and only—instrument to offer the complete resources of a world class symphony orchestra. All in a single rack space.

Specifically, you get 8 megabytes of new sounds including solo and ensemble violins, violas, cellos, and basses. Arco and pizzicato. Winds. Brass. Orchestral percussion. All of which are instantly accessible in ROM.

And every sound takes full advantage of our amazing G chip. Providing the unparalleled audio quality that led Proteus/1 to be selected *Keyboard Magazine's* "Technological Innovation of the Year."

Besides a complete orchestra, the new Proteus/2 gives you dazzling new synth sounds. Made possible by the

instrument's extensive user editing functions and new complement of digital waveforms.

Like every Proteus sound module, Proteus/2 features 32-voice polyphony and 16-channel multi-timbral capability.



Six programmable polyphonic outputs with integral effect send/returns for on-board mixdown. And E-mu's MIDIPatch™ modulation system for real-time access to over 40 performance parameters.

Built in the U.S., Proteus/2 is remarkably easy to use. And even easier to get your hands on. Just visit your E-mu dealer.

And discover a true classic.



E-mu Systems, Inc.
applied magic for the arts

Circle #100 on Reader Service Card

© 1990 E-mu Systems, Inc. 1600 Green Hills Road,
Scotts Valley, CA 95066. All trademarks are
property of their respective companies.

THIS WILL CHANGE THE TUNE OF THE MUSIC INDUSTRY.

They're already singing the praises.

"The cleanest, clearest, quietest electronic instrument I've ever heard," reports *Electronic Musician*. A top contender for "Technological Innovation of the Year," says *Keyboard*.

What's elicited this chorus of raves is Proteus™—

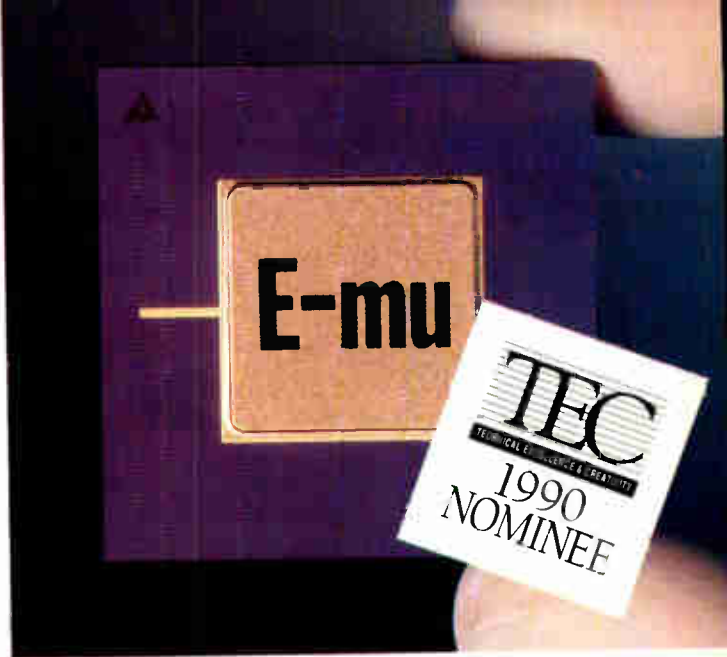

provides real-time access to over 40 performance parameters. So you'll never have trouble expressing yourself again.

To handle your most complex compositions,

Proteus' 32-voice polyphony responds multi-timbrally to all 16 MIDI

channels simultaneously. There are also six programmable stereo polyphonic outputs with integral effect send/returns for on-board mix-down.

Designed and supported in the U.S. by the people who pioneered sampling, Proteus is incredibly easy to use. Yet will satisfy even the most power-hungry programmer.

To hear the new sound of music, simply visit your local E-mu dealer.

Where Proteus is available for a song.

E-mu Systems, Inc.
applied magic for the arts



How can we deliver the uncompromised sound quality of the E111 for under \$1000? That's the \$10,000 question.

E-mu's new 16-bit digital multi-timbral sound module.

And what makes Proteus such a noteworthy achievement is our G chip. A sliver of silicon that combines the legendary sound quality of the Emulator™ III with total, unfettered creative freedom.

For under \$1000.

An undeniably modest price to pay for 4



With 192 different presets, you can boot your own horn and then some. Our Proteus XR version has an additional 192 user presets.

Megabytes (internally expandable to 8 MB) of multi-sampled acoustic

and electronic instruments selected from the E111 library. Plus a rich palette of digital waveforms. All stored in ROM and available simply at the touch of a button.

With Proteus' extensive programmability, you can reshape and reassemble sound endlessly. Our unique MidiPatch™ modulation system

Proteus is your library card to the world's most revered sound library: the Emulator III.



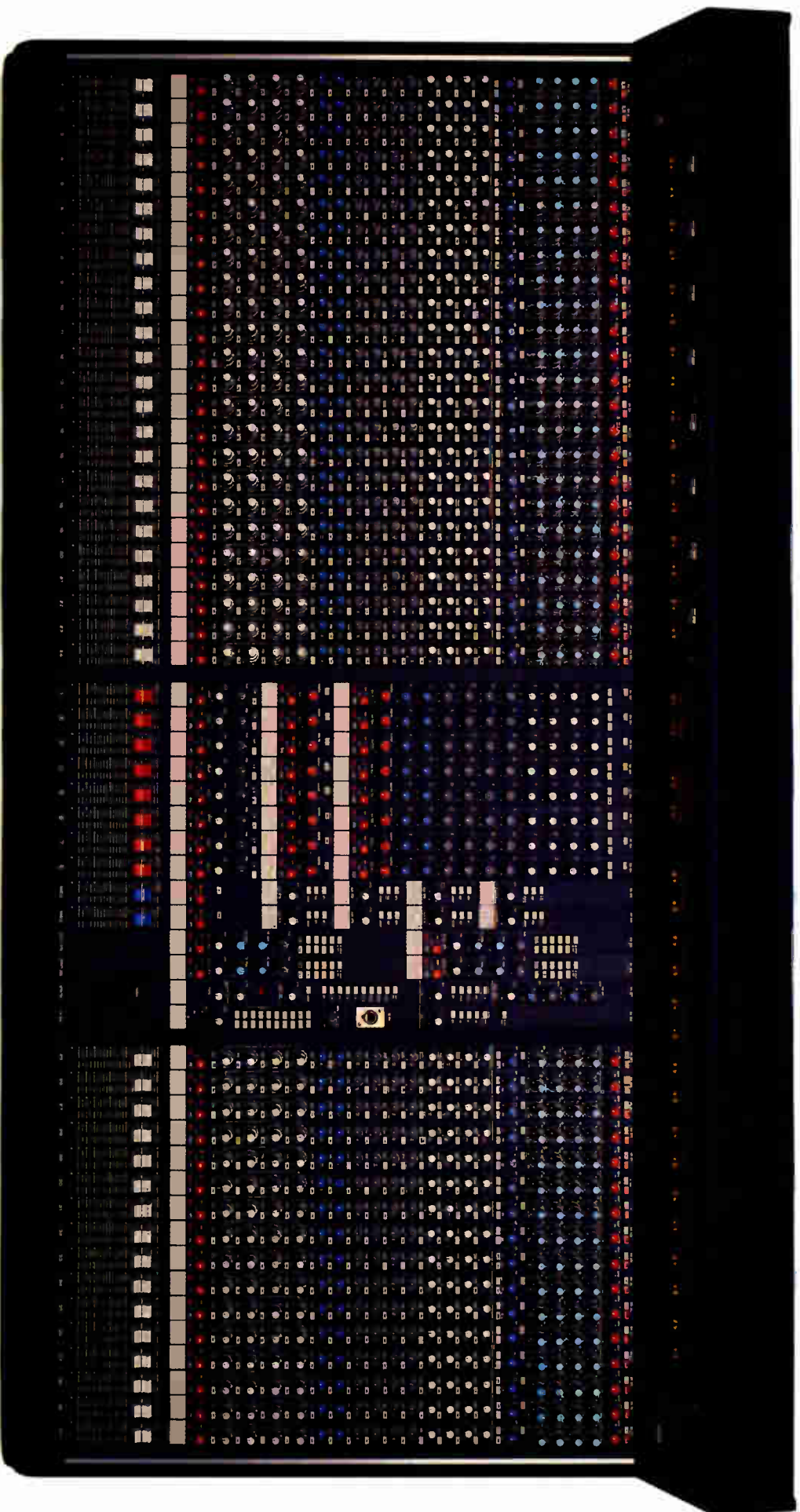

RAMSA WRS-840 Monitor Console. Just ask these sound companies: AI -Audio (Frank Sinatra, Liza Minelli, The Temptations, Tony Bennett, K.T. Oslin, Gladys Knight), **Burns Audio** (Academy Awards, Grammy Awards, Golden Globe Awards, Academy of Country Music Awards, Kennedy Center Honors, San Diego Civic Auditorium (Summer Season), San Diego Starlight Bowl (Summer Season), Soul Train Music Awards, Las Vegas Spring Mountain Ranch (Summer Concert Series), Warner Brothers Re-dedication Ceremonies), **dB Sound, Chicago** (Aerosmith, Stryper, New Order, P!nk, Sugarcube, Prince), **Eighth Day Sound** (Erasure, Bad English, Alice Cooper, Lisa Stansfield, Jethro Tull, The Escape Club, The Tom-Tom Club/Deborah Harry/Ramones/Jerry Harrison Tour, Tom Jones, Kool & The Gang), **Maryland Sound** (David Bowie, Neil Diamond, Debbie Gibson, Anita Baker, Kenny G, Luther Vandross, Hall & Oates, Miami Sound Machine, Neil Young, David Lee Roth, Belinda Carlisle, Melissa Manchester, Patii LaBelle, Paul Simon, George Benson, Steve Miller, Pink Floyd, Roberta Flack, Dolly Parton, Ann Murray, Joe Jackson, Roy George, Stevie Wonder, Earth, Wind and Fire, The Cure, Whitney Houston), **Naked Zoo** (Wayne Newton, The Commodores, Roger Whittaker), **Pro Media** (Luciano Pavarotti), **See Factor** (Lou Reed, Smokey Robinson, David Byrne), **Sound Image** (Barbara Mandrell, Jackson Browne, John Denver, Jimmy Buffett, The Robert Cray Band), **Sun Sound Audio** (Joe Cocker). For more information, contact: Ramrsa, 6550 Katella Avenue, Cypress, CA 90632, 714-373-7278.

RAMSA

Panasonic

Communications & Systems Company

Lillywhite. The first U2 record was cool because it was relatively accessible and commercial, but it had a lot of guts and feel to it. Hugh Padgham, who's now a pretty mainstream guy, did a lot of early XTC stuff. He had a great ear for sound. We patterned ourselves after the records that were out at the time and tried to get our records and demos to sound close to them.

Mix: You never went to recording school?

Wallace: No, I never did. I bought all this equipment and got it delivered to my parents' house. I didn't know how to use any of the gear. It arrived in all these boxes and I thought, "Oh, great." The only way I learned was by making every mistake possible: blowing something up, breaking it, distorting it. Most engineers do the same thing. You just plug it in and see what happens.

Mix: Do you consider yourself a "producer/engineer"?

Wallace: I'm more of a producer now than anything. I've engineered many records, but I'm trying to step back and concentrate on the band's performance, their attitude and what they're trying to accomplish. It's difficult when you're engineering *and* producing; you're worried about getting the right EQ and level on tape, etc. I kind of go back and forth—about 75 percent production and 25 percent engineering.

Mix: Do you interact differently with the band vs. the engineer?

Wallace: The engineer is someone who's just capturing everything on tape. I'm trying to be more of a catalyst [with the band]. I'm trying to deal more on the emotional/creative level. Some bands need structure because the band's so spread out. I'll help with arranging a song, which usually happens before we go to the studio. Some bands are so well-organized that there's not much of a spark. You've got to get them excited, either by giving them a pep talk or breaking something so there's some kind of energy. Get them pissed off at you—all is fair in the studio.

Mix: How did you get started with Slash?

Wallace: After I sold my studio in Oakland, I worked at different 16- and 24-track studios, and I ended up doing Faith No More's *Introduce Yourself* for Slash. Then I went down to L.A. and did some other projects. I did this zany song by the New Monkees for Warner Bros. Then, Warner Bros. and Slash hired me in January 1988, and since

April 1989 I've been independent.

Mix: How do you keep a perspective throughout a whole album?

Wallace: The best way to do it is if I have an engineer. I did two projects where I did producing and engineering, and the combination was really difficult. On *The Real Thing* I did everything, but it got to the point where it was hard for me to hear anything. Also, we did the album really quickly—in two months. We would finish overdubbing, have two days off and do mixing, which is not a good idea. It was hard for me to keep any perspective at all. I'd be mixing and had heard these songs every day for the past month and

a half. When I sat down to master, I remembered feeling really disappointed and thought it sounded terrible at the time. Looking back, the record sounds good, but I still want to remix it, add more low end...

These days an engineer and I do a tag team. The engineer will be at the board and I'll be able to pop in and out. Same thing with mixing. That way you can keep working at a good pace and also get your best mixes. I usually let the band hear the result after we have a mix done. Invariably I know what the band wants, but I leave time for them to change it.

Mix: What kind of sound do you try to

**VIDEO
PANCAKE
INSPECTION**

ELECTRO SOUND VIDEO QUALITY CONTROL (VQC III) PANCAKE VERIFIER



- ▲ Incoming pancake inspection
- ▲ Quality control of finished pancake
- ▲ Continuous recording of full pancake
- ▲ Fast forward and rewind – servo controlled
- ▲ Footage counter – checks pancake length
- ▲ Test before loading – save time and shells
- ▲ Plays or records individual video cassette
- ▲ Precision tension control
- ▲ Low cost



Electro Sound

A MARK IV Company
160 San Gabriel Drive, Sunnyvale, CA 94086
Tel: (408) 245-6600 TLX: 34-6324 FAX: (408) 733-0632

Circle #058 on Reader Service Card

get from Faith No More or the Replacements, who had an underground audience and now want to go more mainstream?

Wallace: I try to get them on record sounding as clear as possible and make sure their performances are good, because a lot of times bands will let performances go by that aren't quite acceptable. I try to get them sounding as big as possible, spending a lot of time on getting the drum and guitar sounds right.

That's one thing I learned during Faith No More's latest record and Lock Up's [a Geffen release]—how to mic a guitar. With those records, setting the guitars up in the room and moving the mic an inch can make a big difference. I used to put up a mic and say, "That's good, that looks fine." But if you sit in the control room and have the second engineer move the microphone, you will hear the sound change. If you can get the guitar sounds without an EQ, you're ahead of the game. That's what we did with those records. There's no EQ on them at all.

With the Replacements we definitely messed with EQ, because we recorded it well over a year ago before I learned some recording tricks. The Replacements never needed that crunchy, hard rock guitar sound. They're more of a rock 'n' roll band and a little more pop. I knew how to get that kind of sound. What I learned since then was how to get that big, Marshall, nasty metal guitar sound with just mic placement. Same thing with drums. Once you get the mics set up, you can pretty much roll right through it and print it all on tape.

Mix: What outboard equipment do you like?

Wallace: There are a couple of reverb and effects units I like to have. Lexicon 480, Eventide H3000 and the AMS reverb are the top of the pile. Less expensive reverbs like SPX90s and PCM70s are really fun, and people are usually familiar with them. There are some really good vocal compressors, the LA-2As, which are tube compressors; and tube EQs like Pultec are wonderful for getting a warm sound.

Outboard compressors are really great. There's this thing called the Dominator, made by Aphex. I use that a lot during mixing. It's a really smooth, unheard limiter. You don't notice it working. I find myself compressing the hell out of things lately. I just did some Faith No More remixes and compressed stuff once, twice, three times.

“Setting the guitars up in the room and moving the mic an inch can make a big difference. If you can get the guitar sounds without EQ, you're ahead of the game. That's what we did with those records. There's no EQ on them at all.”

I remember Steve Lillywhite was asked what he thought was the most important tool in the studio and he said the compressor. I tend to agree with him on that. You can change the sound of the instrument with a compressor. They were originally intended to keep the level from fluctuating too much, a gain reduction device. But if you really compress things you can get them to change their sound by making them more squashed. If you put a drum mic up in a big room and compress it, it sounds great, like a huge room. And with guitars, if you compress them to death they're in your face, really apparent.

Mix: What about consoles and mics?

Wallace: During basics, the best consoles are APIs, Neves and Tridents, which are older consoles. They have old transistors, usually hand-wired-type stuff. The neat thing about those is they're not made with integrated circuits, which most consoles are today. They tend to have a warmer sound, not as sharp or harsh. The all-automated SSL and new Neve VR are the top of the pile. The computer will remember how much EQ you have, how much compression, reverb, what the level is, all your mutes.

I definitely prefer older tube microphones. The Neumann U47 is really great for vocals. I'm in the process of buying one of those. If you can, it's nice

to have a vocal microphone to rely on no matter what studio you're in.

Mix: Are you trying to get a certain sound for yourself, like Phil Spector has a certain sound, or do you build your reputation on being able to record a lot of different kinds of bands?

Wallace: I'm definitely not like Phil Spector because I don't have my own sound. Making different bands sound like you just doesn't make any sense to me. I'm not the artist, I'm the guy trying to get it on tape, and I like to work with really different bands. Obviously, working with the Replacements is very different than Faith No More; same thing with the Wildflowers [another Slash band] and Lock Up, which is more of a hard rock band.

Mix: Tell me about your most recent project.

Wallace: Chagall Gueverra is a brand-new band. We chose Bennett House, a residential studio outside Nashville, to record because it is a big house with a lot of rooms with hardwood floors, wood on walls, very live, ambient and real-sounding. Our goal on this record is to make it a sonically amazing record. I'd like to make it without any digital reverb. I'd like it to sound very pure and real. We're just going with a lot of great tube microphones and trying to stay away from any fake effects.

We used a lot of tube preamps and tube microphones, recording on 24-track Dolby. For drums we used a Calrec Sound Field, which is a unique microphone—basically four mics in one. Once you print the mic's signals on tape and you get to the mix, you use a decoding box that allows you to actually zoom the microphone into the drums, which will make them sound tighter and less ambient, or you can zoom it away from the drums for more ambience.

Mix: What is unique about your personality that lets you do this job well?

Wallace: Being in the studio is difficult for most bands. I'll do whatever it takes to make them comfortable. With Faith No More I've done stripteases. They'd laugh and say that was goofy, and I'd say, "Sure it was goofy but I got a take out of you." Making people comfortable is my forté, and the fact that I'm a musician and can relate to what they're trying to do helps, too. ■

Alex Bebr is assistant to the editor at Mix and associate editor of Banana-fish, a fanzine that covers "difficult" music and topics.

Sweden brings to mind some of the safest and most exciting engineering in the world.

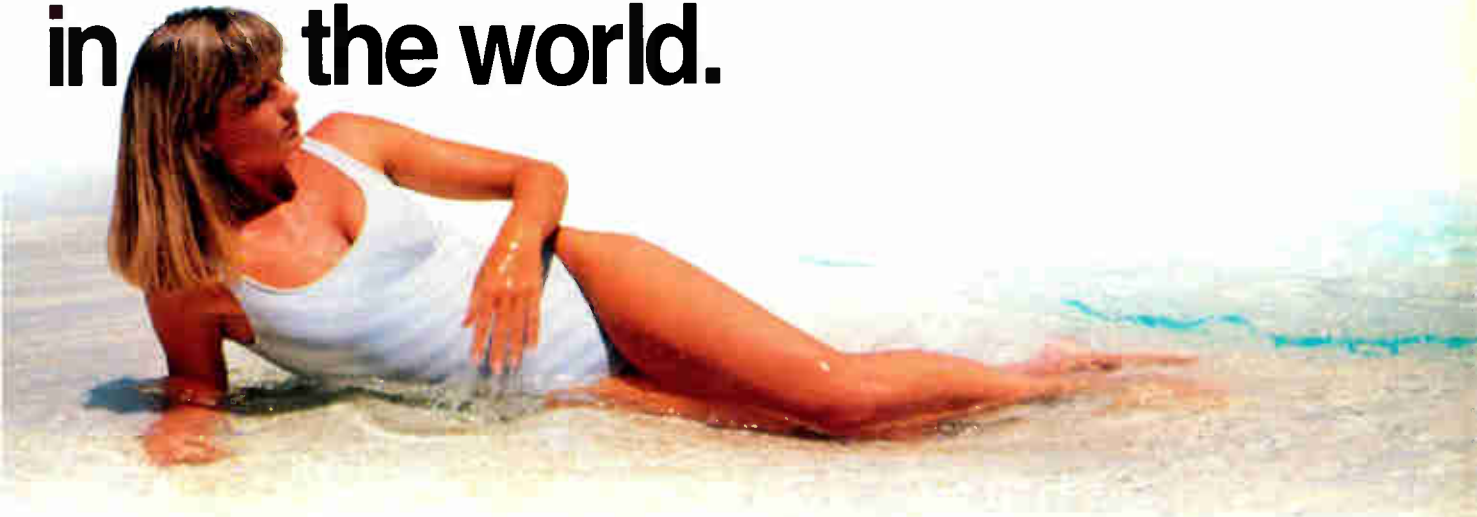

Milab falls somewhere in between.

Our microphones come from a country that goes to any extreme in the pursuit of engineering excellence.

Fortunately, we've managed to incorporate the best of those extremes into the Milab line of precision microphones. Both the heart-stopping sound quality and the stolid reliability Sweden has become famous for.

The redoubtable VIP-50 condenser pictured above is one of a wide range of Milab studio microphones currently winning raves from leading engineers.

They all share a meticulously detailed, smoothly transparent sound coupled with an exceptional level of performance only quality-obsessed engineering can provide.

Experience the beautiful extremes of Swedish engineering. Audition a Milab.



Milab

For more information on our studio condenser and dynamic microphones, write for a free Milab catalog or the name and location of your nearest Milab dealer. Exclusively distributed in the U.S. by Klark-Teknik Electronics, 200 Sea Lane, Farmingdale, NY 11735 Tel: (516) 249-3660 Fax: (516) 420-1863

Milab International AB, Box 510, S-260 50, Billsholm, Sweden. Tel. 042-730 70.

by Mr. Bonzai

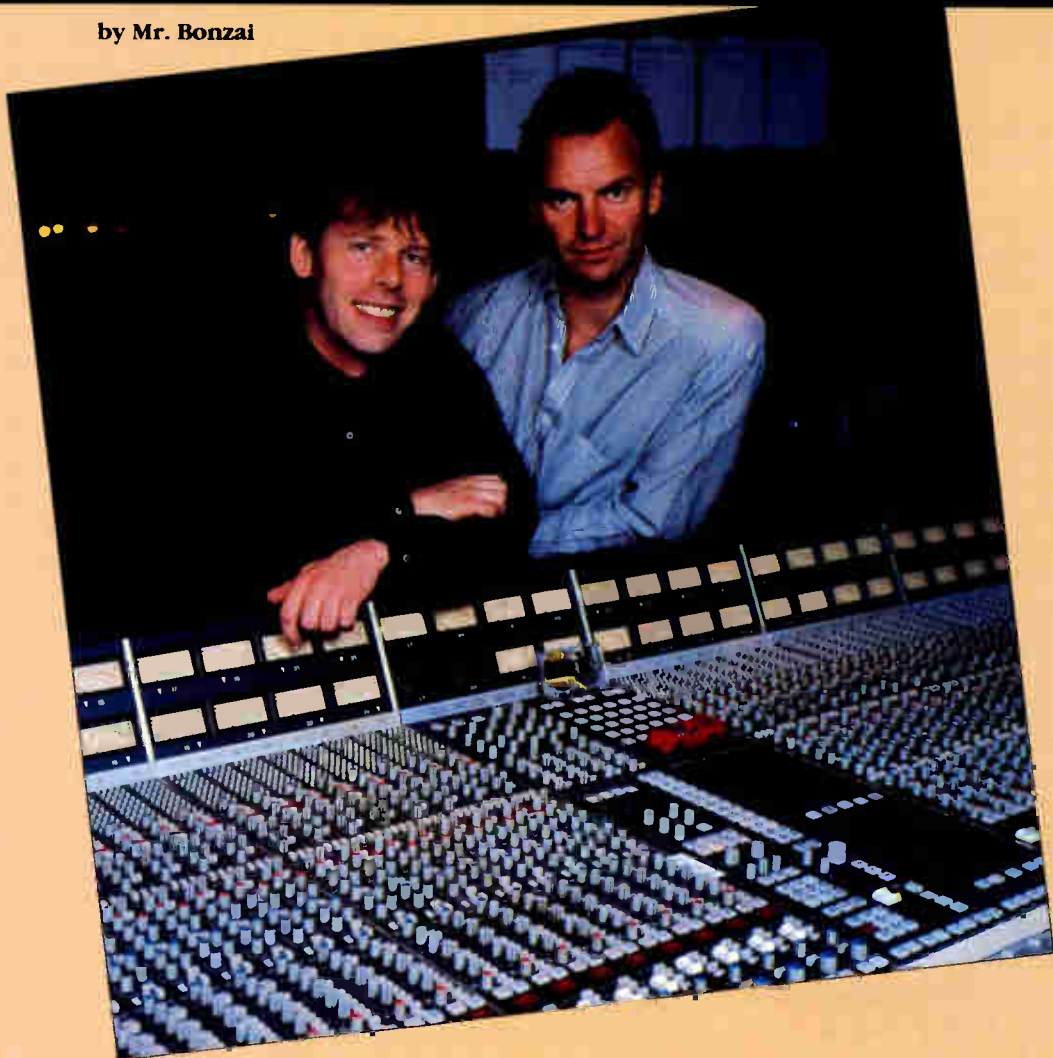

HUGH PADGHAM

STUDIO SYNCHRONICITY

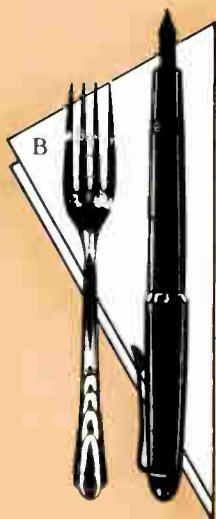

For this lunching, let's slip our imagination into the phone lines, bounce our thoughts off the bird and hook up with Hugh Padgham in Paris. I can almost smell the hot croissants and ripening Camembert. Perhaps you'll join us in a glass of beaujolais?

Now working with Sting, Padgham is at the peak of his career as producer/mixer/engineer. He's produced and recorded artists such as Phil Collins, The Police, David Bowie and Paul McCartney; engineered and/or mixed Genesis, Peter Gabriel, Brian Wilson, Suzanne Vega, Hall & Oates and Julia Fordham; and has numerous awards on his mantel, including 1985 Grammys

for Producer and Album of the Year. Just goes to show what can happen when you get your ears, your mind and your hands in synchronicity. Cheers.

Bonzai: How long have you been working in Paris?

Padgham: This is our seventh week. We'll take a few weeks off and then we're off to Italy. Back to the old days—using a mobile truck, *Le Voyageur* from Paris. It's brilliant.

Bonzai: Where are you working?

Padgham: At a studio built in an old cinema called *Guillaume Tell*. It's got an SSL desk, and we're working on a Sony 3348. It's one of the best studios

in Paris.

Bonzai: You and Sting go way back, don't you?

Padgham: We certainly do, about 12 years. I first worked with Sting on a project unrelated to The Police when I was an engineer at Virgin Studios in London. He was doing a production project soon after the beginning of The Police, and I was the designated engineer at The Townhouse. That's where we originally met.

Bonzai: How did you make the move from engineer to engineer/producer?

Padgham: Mainly by accident. When I started at The Townhouse in 1978, I was engineer there and one day a session came in. The producer happened to be a guy named Steve Lillywhite and we more or less hit it off from the word go. He ended up doing all his work at The Townhouse because it was the "hip" place to work in those days—probably still is, in fact. Through Steve, we ended up doing lots of work, including two XTC albums together and an album with Peter Gabriel. That is how I met Phil Collins; we did songs like "The Intruder" and "No Self Control" on Peter Gabriel's third album.

When we had finished the album three or four months later, Phil's manager rang me up and told me that Phil was interested in doing a solo album and asked if I would like to produce it with him. With the success of that album I got asked to do other productions. And also through my work with XTC; they were on tour with The Police, who were looking for another producer. Andy Partridge from XTC recommended me. Since Sting had worked with me before, he said they'd give me a try. All a bunch of lucky accidents, but I think that's how everyone's career gets off the ground.

Bonzai: Going back before your fortunate days, did you start off looking for a career in music?

Padgham: Yes, I left school at 18 and always knew that I wanted to work in a studio. I come from quite a musical family, and when I was at school I read science subjects and was also very interested in music. The amalgamation of the two equaled the recording studio. When I first saw a copy of *Studio Sound* and the consoles with all the knobs, I thought, "That's the life for me." I also wouldn't have to get up early in the morning, which I was never good at.

Bonzai: It's pretty late there in Paris now, isn't it?

Padgham: Yes, it's quarter to 2, but we've been working late hours, starting around lunchtime and going till midnight. Then I've usually got an edit or a rough mix to do.

Bonzai: What can we look forward to with this new Sting album—any differences from the past?

Padgham: Well, without giving too much away, it's very much back to a four-piece rock band. I would say that generally it's much less jazzy than the last two Sting records.

Bonzai: Who's playing on the album?

Padgham: Manu Katche is playing drums, as he did on the last Sting album. He also plays drums with Peter Gabriel. That's all very in-house in a way—we all know each other. And Sting's back playing bass, which is great because in my mind he is one of the best bass players in the world. Dominic Miller is playing guitar. I first met Dominic through working with Julia Fordham, an English singer who's recently had some success in America. Dominic is incredible at playing any style. The last person involved is Kenny Kirkland, the piano player who also played on the last couple of Sting records.

Bonzai: The Police were really a breakthrough—a simple trio translated so well musically, so powerfully. In your mind, why did it have such a big impact?

Padgham: Well, I don't think while you're in the studio you ever realize that you are doing something that might end up so special. I am just trying to relate the music to the recording medium. I think it was partly because I was the new boy on the scene, and Sting was writing songs that were somewhat more serious in terms of music and lyrics. Where I fit in was being able to understand what Sting was doing musically and it all worked out well. I didn't do anything special or different for me at all. It was just me in the studio with them and it gelled.

Bonzai: Is it difficult for you to travel from country to country, studio to studio?

Padgham: No, not really. Nowadays it's much easier than it used to be because most studios have similar equipment. When I first started as a freelance engineer, there weren't that many freelancers around and you would go to studios that had very particular equipment. Now, most studios

have either an SSL or a Neve console and you just get to know how they work. After a few days you understand the anomalies of the studio. To me, it's no problem at all, apart from being away from home.

Bonzai: What are the basic pieces of equipment that you rely on as you travel around?

Padgham: My main source of reference are my own monitor speakers. I use these Acoustic Research AR-18LS. They're similar in size to [Yamaha] NS-10s, but they sound quite different. I've used them for ten years now and they haven't even made them for five years. When I heard they had stopped making them, I bought all the existing ones from the factory—about ten pairs.

The first or second album I ever mixed on these was *H₂O* for Hall & Oates. That was also when I met Bob Ludwig, who has cut every record I've made since then. I went to Bob Ludwig at Masterdisk in New York, and I was a little worried because I had mixed it on these little speakers that only cost £100, because the main monitors were no good. And he told me he couldn't believe the sound of this record. We did virtually no EQ'ing to transfer the tape to the disc. This was before the days of CD. He gave me major confidence in the mixes I thought sounded good. Ever since then, I've used these speakers.

Bonzai: Shall we touch on consoles? What's your comfortable mode of desk these days?

Padgham: I like to mix on SSL because to me it's a bit like driving a car. You don't think about it, rather like steering around a corner or changing gears. I know the console so well that I can more or less operate it with my eyes closed. Being able to work on a console where I don't have to think technically is very important.

And I've been involved with SSL from the early days, because we had one of the first production consoles in Studio 2 at The Townhouse. Two of the guys who were maintenance engineers at the studio are now with SSL: Andy Wild, who runs SSL in L.A., and Chris Jenkins, who's now very high in the company as well. He's basically in charge of new development stuff, so we still have quite a close rapport.

Bonzai: Do you provide input for further development of the console?

Padgham: In a way, yes. We've been friends for so long, and if Chris has an idea we'll have dinner and he'll throw

suggestions at me. I'll also go to the factory every so often and have little talks with them.

Bonzai: Tape machines?

Padgham: I hoped that you wouldn't get around to that question.

Bonzai: Let me put it this way: On the new Phil Collins album, I noticed it said drums and bass were recorded on analog.

Padgham: This is my big problem with digital: I think good digital recorders, such as the 3348 or the 3324 with Apogee filters, do sound faithful, but I don't love the sound of drums and bass off digital. I like what analog tape does to the sound, as far as making a record is concerned.

Bonzai: When you do the final mix, are you running an analog multitrack alongside a digital and combining the two?

Padgham: In the case of Phil's album, yes. Just synched up with a Lynx. The digital machine is absolutely fantastic, because you are able to bounce without generation loss. I do a lot of recording for such things as vocals with four takes and then combine to one

track. On analog you are losing a generation when you combine, but with digital you're not. The other great thing with digital is you can choose your crossfade times and your splice angle, which isn't possible on an analog machine when you're dropping in. You can get away with murder doing drop-ins and dropouts on a digital machine.

Bonzai: Let's talk about two vocalists you work with, Sting and Phil. What is the difference in approach to getting their voices on tape?

Padgham: With Phil, we have a setup we've used for some time and Phil feels quite comfortable with it. He actually sings to the sound of his voice going through this setup, which is basically a cheap mic and a cheap compressor.

Bonzai: Can you reveal the actual tools?

Padgham: I will, because what sounds good on Phil doesn't necessarily sound good on other people. I've tried this particular setup on Sting and it doesn't sound good. On Phil I use a Beyer M88, a dynamic mic (which he also uses onstage). It gives a nice rough edge to his voice, and then we go through an Allen & Heath mini-limiter. It's a vicious limiter, but it's fantastic for me because

it works well with Phil. I can set my VU meter with this limiter and it's like the meter hits a brick wall, wherever you set it: 0 or +1, or whatever. With Phil I know I've got his sound, and I don't have to look at the console again when I'm doing his vocals. I can concentrate on what he's singing and how he's singing. This limiter has a slow attack and a fast release. It gives that guttural sound to his voice.

Bonzai: How about getting Sting on tape?

Padgham: Well, Sting is an experienced singer. He's got good microphone technique, and I'm still looking for the perfect mic. I've used all sorts: an 87, an AKG-414. We've been doing a lot of vocals in the control room for this new album, and I've been using a Sennheiser 441, mainly because it has a tight cardioid response for when we are using the big speakers in the control room. I'm not getting too much leakage on the mic, and, of course, my level can be that much higher before it feeds back. However, recently Sony lent me a new prototype valve microphone that is not available on the market yet, and this sounds very good on Sting's voice.

Bonzai: When you're working on a project, recording and mixing, do you visualize the music?

Padgham: Oh, yeah, very much so. It's not so much I think of it in visual terms; I just get a concept when I hear a song. Almost immediately, I have a feeling of where I am going to put delays or reverb. I just get a vibe and keep fiddling around until it equals what I'm thinking in my head.

Bonzai: I've been studying Phil Collins' "But Seriously" and it's very complex. There's a lot of material there. How do you keep everything clear? How do you keep it from getting muddy?

Padgham: I have a quick realization when we're putting parts down in the studio whether the parts are going to work against each other musically, and also, from an audio point of view. When I produce or mix a record, I hear the music in a sort of sonic spectrum. Obviously, if you have too many things in the same register they are going to, from a sonic point of view, work against each other. It's going to be harder to hear them. I work hard on musical arrangements when I'm producing with the artist, so there are few things in the same sonic spectral area. I'm talking about making a big sound

"The Hollywood Edge ... the best sound effects library, without a doubt!"

Oliver Stone, Director
(Born on the Fourth of July, Platoon)

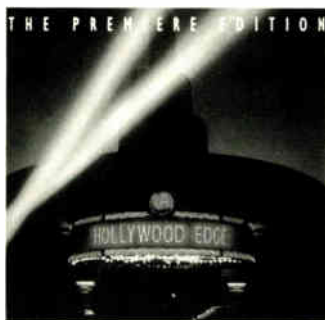

Listen for yourself—If you buy sound effects for your company,
Call us for a free Premiere Edition demo disc.

Call 800-292-3755 In CA 213-466-6723

7060 Hollywood Boulevard, Suite 700, Hollywood, CA 90028

Circle #020 on Reader Service Card

out of as few elements as possible. When Phil and I are working together in the studio, we say, "Okay, we'll have a bass player in this evening. We'll have a guitar player in this week." When we do Phil Collins records, they're completely overdubbed. Whereas, when I'm working with Sting, there is a band in the studio.

Bonzai: Do you have a preference?

Padgham: No, because they are both interesting.

Bonzai: Are there any of your peers you especially admire? Whom do you look up to as producer/engineers?

Padgham: The list is probably endless, although as a peer Bob Clearmountain deserves a special mention. I'm lucky enough to work with some incredible people in the music business. I'm probably the luckiest person in the world to be able to work with Sting. I respect him as a musician and as a person I like to work with in the studio.

Bonzai: Are there any exceptional artists you've worked with and felt they were overlooked?

Padgham: Yes, I think a lot of projects are like that, because not everything you do becomes a hit. I'm very proud to work with Phil Collins, Sting and

Peter Gabriel. I couldn't choose better people to work with, but I think that groups like XTC deserved greater recognition.

Bonzai: How about Split Enz?

Padgham: Exactly what I was going to say next. Split Enz, to me, was one of the best bands ever and I did two records for them. They were brilliant, and it's a huge shame that they never "made it" in a bigger way. But I recently mixed The Makers, Eddie Rayner's new band. My problem with pop music is that it's the lowest common denominator factor. Unfortunately, what I think is good doesn't necessarily appeal to Martha in St. Louis.

Bonzai: Yes, it's a cryin' shame that a very good record may fail because of timing or promotion. If it doesn't make it during its release time, it disappears and has no chance of being rediscovered.

Padgham: Well, pop music is very transient. In the world of painting, van Gogh and Monet were not particularly respected in their own lifetimes, but luckily for us, the medium is still there to look at and appreciate a hundred years later. With pop music, it's dispensable. That's why I prefer to work

with people like Sting, who are making albums for the sake of music, not just for making a hit record. I know he has some hit records, but I enjoy making music I will be proud of for years to come.

Bonzai: How old are you?

Padgham: 35.

Bonzai: Ah, just a lad.

Padgham: Yes, a lad, no less. Everybody in America always thinks I'm about 50. When I meet new people in the studio, they go, "You're so young!" It's weird for me, because I was a struggling tape-op and assistant engineer for years.

Bonzai: Any broad advice for survival in this studio game?

Padgham: When you're not in the studio it's a good idea to do something else. I have interests outside of music, and one of them is trying to keep healthy because the studio is not a very healthy environment. I try to keep as fit as possible. The other bent I have is motor racing. I'm a complete motor racing fanatic, and I have a part ownership in a prominent English racing car team, Richard Lloyd Racing.

Bonzai: Would you consider yourself a good businessman?

SMPTE TimeWindow™

SMPTE for a song!

SMPTE TimeWindow — The first and only dedicated audio SMPTE Display, Reader, Writer and Regenerator for the professional or home studio.

Features:

- Reads, Writes and Regenerates all standard SMPTE formats.
- Reads and displays SMPTE in forward or reverse.
- Reads and displays SMPTE at reel-rock speeds.
- Records and displays up to 8 SMPTE "Hit" points.
- Stripes SMPTE from any settable offset time.
- Measures and displays elapsed time between events.
- Switchable Input and Output levels (-10 or +4dB).
- Built-in Stop Watch.

...All for under \$300.00 MSRP!

And we guarantee it! All Midiman products carry a lifetime warranty and are backed by a seven-day-a-week technical support/sales "helpline" (818) 449-8838. Give us a call!



midiman™
Guaranteed for life.

30 North Raymond Avenue, Suite 505, Pasadena, CA 91103 Tel. (818) 449-8838 Fax: (818) 449-9480

Padgham: No, that's why I have a manager. Dennis Muirhead has guided me since just before I did Phil Collins' first solo album. And I've involved him in the motor racing team as well.

Bonzai: Do you have any business tips for those who are entering a competitive industry?

Padgham: I say I am not a businessman, but I have strong ideas for business. One rather obvious thing I haven't gone into as a business venture is owning my own recording studio. Number one, I've had the honor to be involved in the Fisher Lane Farm studios, the Genesis studio in Surrey, England. That's where we did the last Genesis album and Phil's last album. It's a fantastic studio, and we built the control room about five years ago from the ground up. It's the best control room that we could think of building. I'm proud to have been involved, but basically I haven't gone for my own studio because when I work with an artist it's important to work in the environment he wants to work in. When Air Montserrat existed, Sting loved the

studio and wanted to do his records there. If I had a studio in London, we would be at loggerheads and my studio would be empty. I would also get bored working in my own studio all the time. I find it a challenge to work in other studios, with different acoustic environments, different equipment. It keeps me on my toes as an engineer. And I still enjoy engineering.

Bonzai: Can you see yourself as just a producer, foregoing the engineering side of things?

Padgham: No, not really. I've tried it once or twice and I always end up sort of knocking the engineer out of the way and fiddling with the knobs because I know exactly what I want to hear. It seems stupid to try and relay it through someone else, when all it takes is twiddling a few knobs to get what I want without explaining it to anyone else.

Bonzai: Have you ever had any particularly ridiculous experiences in the studio?

Padgham: Oh, yes, but I'm sure they're too censorable. I think craziness in the studio happens less now because the music business is much more on a

budget. It's somewhat more serious now, but when I first started, at a studio called Advision in London [now closed], it was different.

I'd only been there three or four weeks and I was on a session with Mott the Hoople. One night, everyone was very drunk and they wanted a crash or explosion to follow a sax line. We just couldn't get a sound that was good enough, so in the end, one of the guys saw this metal tea tray, which I used for bringing tea. He took it and whacked it on his knee and thought it sounded great. So we went out into the studio and one of the members of the band kneeled on the floor while another smashed it on his head. I had to mike his head up!

Bonzai: How many takes?

Padgham: There were enough takes that the tea tray became so mangled that he couldn't hit him over the head any more. The bass player, Overend Watts, was doing the hitting. The other guy was lying on the floor with an 87 about two feet away, going "Harder, hit me harder!"

Bonzai: Andy Summers told me about people getting covered with trash if they fell asleep in the studio.

Padgham: That's right—we had this couch in front of the desk in Montserrat, which was the kiss of death because it was so comfortable. We were so active swimming and running during the days, that during the evening anybody who sat on the couch immediately fell asleep. We would then cover the person with as much stuff as we could find, bits of tape and such, as well as painting him and whatever else you could do. Eventually, the person would wake up with all this stuff crashing off around him. In the best of occasions, we would just leave the person, who would wake up at 3 in the morning all alone and well-decorated. We called it "sending someone to the party."

Bonzai: Are you still having fun in the studio?

Padgham: Oh, absolutely. Going into the studio is like a breath of fresh air with this band. We go in and have a good time, but also there are serious undercurrents. Having a good time reflects in the music, and it's so difficult to capture that feeling on records sometimes. ■

Mix roving editor Mr. Bonzai uses no compressors or limiters on his articles. But his editors do.

I N N O V A T I O N



Hear it for yourself. Call for our new demo.

OMNIMUSIC

52 Main Street Port Washington N.Y. 11050
1-800-828-6664

Circle #028 on Reader Service Card

Digital Recording. Hard Questions. Simple Answer.

Considering a direct to disk digital recording system? Separating the hype from the hard facts isn't easy. You've got tough questions, and we've got the answer—Sound Tools™, our Macintosh-based digital recording and editing system. With more than 2000 Sound Tools systems installed worldwide, it's the best selling system of its kind. Here's why:

How does it sound?

In a word, superb. The new Pro I/O™ Professional Analog Interface featuring oversampling converters, Apogee filters and balanced XLRs guarantees there isn't a better sounding system available.

What about storage?

Sound Tools uses virtually any Macintosh-compatible storage media (hard disks, optical disks, etc.). And with our unique DATA™ software, you can save all edit parameters with your recordings on regular DAT cassettes.

I'd like to offer my clients CDs. Can Sound Tools help?

Absolutely. Sound Tools, equipped with the DAT I/O™ and Master List™ will create a CD-ready, DAT master. Through CD Express™ from Optical Media International, you can turn your clients' final tracks into a pressed CD in as little as 48 hours.

We do a lot of film and video work. How does Sound Tools fit in?

Add our industry standard software, Q-Sheet A/V™ with its audio EDL (Edit Decision List) and the Pro I/O for flawless video sync and you're set—a digital post production workstation.

Okay. Now what about multi-track?

Simple. Add DECK™ software and you've got 4 independent tracks with automated mixing and unlimited digital track bouncing in stereo. And that's just the beginning.

Great. Now what's it all going to cost me?

Sound Tools is affordable and flexible. Configure the system to your needs—here's what it takes: \$3285 for Sound Tools with DAT I/O. Options include Pro I/O: \$2995. Q-Sheet A/V: \$995. Master List: \$95. Deck: \$349.*

Best of all, Sound Tools grows with you. It's simple to expand your system with any of a growing number of hardware or software options—such as Studio Vision™ from Opcode Systems, which lets you integrate MIDI sequencing and digital audio in one powerful package.

So call Digidesign today at 1-800-333-2137 for a free brochure and find out how easy it really is to step up to digital. We'll include our step-by-step guide to CD pre-mastering with Sound Tools.

Sound Designer II 2.0

New Features

- New DSP Modules
Compressor/Limiter/Expander
Pitch Shift with Time Correction
- Continuous SMPTE Sync
- Enhanced Editing Features

Pro I/O Features

- 2 in/2 out balanced XLR connectors
- 8x Oversampling 18 bit DAC with Apogee Filters
- 64x Oversampling ADC
- Video "House" Sync (PAL, NTSC)
- High Resolution Digital Meters



digidesign

1360 Willow Rd #101
Menlo Park, CA 94025
415.688.0600



*Macintosh and hard disk drive not included. All prices shown are suggested list price in the US. Also available for the Atari Mega ST. Some features and specifications may vary.

©1990 by Digidesign. All prices and features subject to change without notice.

Circle #111 on Reader Service Card

by Paul Potyen

NETWORKING & AUTOMATING YOUR SFX LIBRARY

ZOETROPE INSTALLS GEFEN SYSTEM

Music and sound effects libraries have been around almost as long as audio production and post-production studios. Until the last five years or so, the main format for delivering this information was 1/4-inch tape, LPs and 35mm mag. One of the biggest drawbacks of these systems was that as your library increased in size, it became progressively more time-consuming, laborious and chancy to figure out where all your thunderstorm sounds were located. And once you found them, it was a royal pain to audition each sound.

Enter the database. While most facilities used some kind of 3 x 5 card system, computerized database systems went a long way toward minimizing the hassles of filing and searching for the sound you wanted.

Now the availability of library music and FX on CD (and increasingly on CD-ROM) has provided a more convenient access method using computers. Software programs tailored to the needs of this market are now available. Manufacturers like Leonardo Software of Venice, Calif., now offer PC-based database systems for cataloging library material, with computer-controlled playback of that material from a multiple disc player.

And Lucasfilm—a company known for its appetite for state-of-the-art in the film industry—has been rumored to be developing a system allowing a network of workstations to search a database for sound effects, which then can be played from the workstations using broadcast FM technology. As with other projects at Lucasfilm, the system is designed primarily for its own multistudio film environment.

However, a commercial multi-user system has been developed by Gefen Systems of Woodland Hills, Calif., and is now being used by a number of post houses. Recently I went to Francis Ford Coppola's Zoetrope Studios in San Francisco, where I talked to Charlie

Lamm, who is responsible for getting Gefen's Multi M&E (music and effects) Organizer up and running. Lamm, who is assistant to the technical director at Zoetrope, comes to that facility with a strong background in computers, as well as engineering experience. He currently divides his time between the Gefen system and his second-engineering chores.

Mix: How would you describe what goes on at Zoetrope Studios?

Charlie Lamm: We do a lot of sound design and ADR here.

Zoetrope Studios, San Francisco



We've got two pictures in-house right now. The filming for *Godfather III* ended about two months ago, and is now being edited here. And we've been doing post-production on a film called *Spirit of '76* with David Cassidy and Leif Garrett.

Mix: How long have you had the Gefen M&E Organizer?

Lamm: About eight months. It was one of the first projects I was given when I came here three months ago. It was in bits and pieces, and it was set up in only one studio. It was my job to make it happen throughout the whole building.

Mix: What are the components in your system?

Lamm: The server is a 386 clone. It's got a Digiboard I/O card in it that provides multiple RS-232 ports. The CD player is a Sony CDK-006, which can handle up to 60 CDs. There's a little box in-line that converts the RS-232 data to something the CD player can understand. It also processes the stereo left and right audio out of the Sony. The audio goes to a patch bay, where it's routed to each workstation. There are distribution amplifiers on each line to boost the level for signals going as far as the eighth floor from the player, which is located in the basement.

We have it working in four studios, three of which are Macintosh-based, and one is PC-based. There's also a second PC online located next to the server, and in addition we'll be hooking up a sixth workstation soon.

Mix: So the server talks to both PCs and Macs?

Lamm: Yes, the server just looks for RS-232 data. The front ends of the two types of workstations look totally different but do most of the same things. One difference is that on the Mac version you can shift-click on several sounds and the CD will play them consecutively. It's not a multi-user system in that two people can't be listening to different effects at the same time.

Mix: But can you search the database for a list of effects while others are using the system, and then audition

those effects after the other user quits the playback portion?

Lamm: Yes, you can use the database portion at any time. But I find that most of the users here want to *bear* things. Just knowing it's on a CD doesn't help that much. The whole idea of the sys-



Charlie Lamm in one of Zoetrope's Gefen-equipped studios

tem is to allow them to quickly audition sounds.

Mix: How much time have you spent installing and fine-tuning the M&E Organizer network?

Lamm: When I first got the job I was spending two to three days a week hooking up and troubleshooting the system. By now it's pretty problem-free.

Mix: What kinds of problems did you run into when installing the network?

Lamm: There are two aspects to the installation. The RS-232 protocol is used to tell the CD player what to play. And then there's stereo audio coming out of the CD player. RS-232 is just twisted-pair cable. We've got short-run modems on a few of the longer runs. Gefen is spec'd to go 200 feet on twisted-pair without a modem. That

works fine.

Getting the audio around is actually more difficult than getting the RS-232 data out. We run the audio through the phone lines in the building. I discovered some of them were out of phase. Sometimes the left and right were backward; or the left would work and the right wouldn't. The continuity of the phone lines wasn't perfect. This is the first place I've ever worked where they've run stereo audio information through twisted pair phone cables. As long as it's balanced and we use the DAs it works fine.

There are a few idiosyncrasies in the Gefen system, too. For example, with the IBM version, MUSEF232.EXE is the main file you use to run the program. What confused me at first was I didn't know there are two versions of MUSEF232.EXE: one for the server and one that runs on the station. They're different programs with the same name, and if you use the wrong one, the system won't work.

On the Mac version there were certain INITs, like Vaccine, that I had to remove in order to install the Gefen software. I'm having a weird conflict on one machine that I think

I've traced to a MIDI program that's fighting for control of the RS-232 port. Also you have to turn AppleTalk off. That's unfortunate because we live by QuickMail here, and we have to turn AppleTalk off in order to run Gefen.

Mix: Does the server know which workstation to direct the audio to?

Lamm: No, it plays it out to all stations, but it needs to be patched in at the station that wants it. We were worried that someone would be in the middle of a session and he'd suddenly hear a car crash that someone else had auditioned. So we made it necessary to use a patch cord and turn on an amp so that wouldn't happen. In the studios that are equipped with Soundcraft 200B consoles, you have to turn on the stereo fader to hear the effect.

Mix: How much do you use the Gefen CD system compared to using custom 1/4-inch tapes of sound effects?

Lamm: It varies from one operator to

A

TIMELY INTRODUCTION

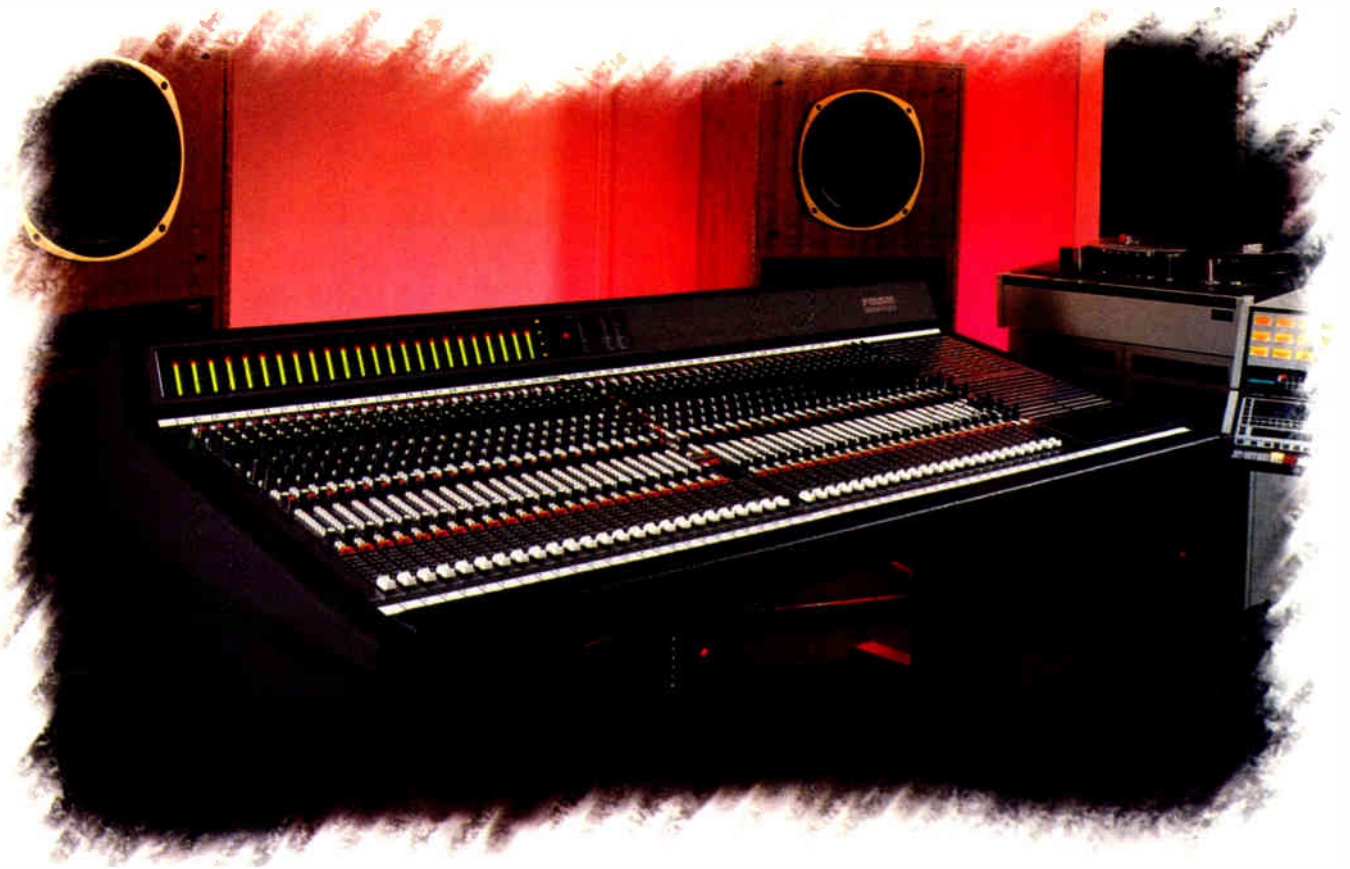

The new Soundtracs Quartz Series

A direct response to changes in recording techniques and styles.

Combining the latest technological developments with the requirements of modern music. Balanced bus (24 group : 6 aux) architecture throughout producing low noise and minimal crosstalk.

Over 100 inputs available in an ultra-compact desk, most with access to the comprehensive four band parametric equaliser.

MIDI mute automation enabling exceptionally dynamic digital or analogue recordings to be achieved simply and efficiently.

Applications from track-laying to mixing direct to disc in a variety of environments.

The new QUARTZ – perfectly timed for the 90s.

SOUNDTRACS
QUARTZ

Soundtracs distributed exclusively in the United States by: Samson Technologies Corp., Hicksville, NY 11801 Tel (516) 932-3810 FAX (516) 932-3815



91 EWELL ROAD, SURBITON, SURREY, KT6 6AH, ENGLAND
TEL: 081-399 3392, 081-390 8101
FAX: 081-399 6821 TELEX: 8951073 STRACS G

another. Richard [Beggs] has been doing this for 20 years and has a room full of tapes. He'd rather use his own sounds. Other operators tend to use the Gefen system a lot. The folks working on *Spirit* are using it a lot—mostly adding ambiences and stuff to their own original libraries.

Mix: Do the users tend to load the sounds into an editing program like Sound Tools or Alchemy, in order to edit it to fit a particular situation in the film?

Lamm: There's no way to do it in an all-digital domain using the Gefen; it would be neat if you could. But they do send the effect through an AD/IN converter made by Digidesign, and then edit using either of those programs on the Mac. We have them both. For *Spirit* almost all of the effects are going into the digital domain for manipulation. It's a kind of pseudo-science-fiction film, so they're looking for interesting effects. On the other hand, somebody like Richard might just play the sound onto 1/4-inch tape. Everybody uses it differently.

Mix: What improvements would you like to see?

Lamm: Well, the load times can be as long as 20 seconds, depending on the

last CD played. But that's really more a function of the CD player than the Gefen software.

On short sounds it sometimes starts at the end of the previous cut and ends after the start of the next cut. Users don't want to have to trim that off. They want exactly what they asked for.

I'd like to see more than one user access the CD player at a time. I don't know how you could do that mechanically, but it's something that we need.

And lastly, I've found that Gefen's documentation is a little skimpy. But to be fair, Gefen has always been willing to talk to me and help me fix whatever problems I encounter.

Mix: What features do you like in particular?

Lamm: There's some degree of artificial intelligence in it. You can get close to describing the effect you want and the system will make guesses as to what you mean and bring it up as an option. If you're not sure whether you want a creaking door or a slamming door, just type in "door" and you'll get all doors.

We wanted to centralize this process and cut down on the costs. To me the strength of it is the networking aspect, because for just the cost of the software [assuming you have a computer] every

room can have access to the same sound library. It's really a cool thing when it all works. And it gets a lot of use.



Hagai Gefen confirmed that it would be easy to modify the Gefen system to address a CD-ROM drive for access to sounds on CD-ROM. And for anyone willing to take the time to transfer their library of custom sounds to DAT (and catalog that information), Gefen supplies an interface to address those sounds on a DAT player. And the new generation of professional DAT machines will make it easier to provide more accurate locating than the present generation.

Both M&E Organizer (the single-user version) and the Multi M&E Organizer System include a database and player driver (for either a single CD player or the Sony jukebox); the M&E Library program uses the same database software *sans* player. Any of the components, including the Sony CDK-006 player and production music and effects libraries, can be purchased directly from Gefen Systems. ■

Mix associate editor Paul Potyén is also a musician, producer and composer, including music for commercial production libraries.

Chip Shots

Just announced from Digidesign is SampleCell, a 16-voice, 16-bit, user-configurable RAM-based sample player on a Mac II card. It's designed to accept up to 8 MB of RAM (the same type used on the Mac). You can load your own samples directly from the Mac in a number of formats, such as Sound Designer II and AIFF. It comes with a CD-ROM containing more than 500 MB of samples configured for SampleCell, many of which are from the Prosonus library of sounds. The card has four stereo 1/4-inch outputs. Software is included to provide easy loading and configuration of its many features. As with Digidesign's MacProteus card, access is provided via MIDI Manager. The product is available without any RAM (so you can buy your own from a third party) or with the full 8 MB. SampleCell was expected to be available in late September.

Digidesign, Menlo Park, Calif., (415) 688-0600.

Inspire I is a MIDI sequencer for the IBM PC/AT and compatibles, developed by Wild Rose Technology. Features include online context-sensitive help, phrase extracting and splicing, visual step editing and song pointer. The program is designed for first-time users, home-studio recorders and performers, and is offered with the Music Quest MIDI Interface for \$149.95. Wild Rose Technology, Volcano, Calif., (209) 296-4813.

New from Dr. T's Music Software is an IBM PC version of its X-oR universal editor/librarian. It runs under Windows 3.0 in "Real" mode, and a run-time version of Windows 2.11 is included. A mouse, hard disk, 640K of memory and a high-density floppy disk drive is required. X-oR also comes with complete editing profiles for over 80 popular instruments. It is not copy-protected, and is priced at \$325. Dr. T's, Chestnut Hill, Mass., (617) 244-6954.

Antex Electronics Corporation has introduced the AV-16 Audio-graphics add-in board for IBM PCs and compatibles, which integrates 16-bit digital stereo audio output, extended VGA graphics and NTSC-compatible video output on a single card. The audio is compatible with standard 16-bit PCM or 4-bit ADPCM data compression algorithms. Designed for applications where audio must be digitally stored, processed and interleaved with full color computer graphics, the card is available for \$895. Antex Electronics, Gardena, Calif., (213) 532-3092.

MIDIMAN has released SMPTE Player, a program for IBM PCs and compatibles that allows any standard MIDI file to be played using MIDI time code. Previously IBM sequencers have relied on special non-MIDI, time code-compatible, SMPTE interface cards to sync to SMPTE. The program supports all SMPTE formats and is equipped with many other features. MIDIMAN, Pasadena, Calif., (818) 449-8838.

Independent Engineers & Producers Survey

1990

In early 1990, *Mix* conducted a detailed survey of independent recording engineers, technicians and audio producers. Of *Mix*'s total qualified subscriber circulation (approximately 36,500), nearly 4,500 identify their primary job title as such. We decided it was time to take an objective look at what shapes the audio life of the independent.

Some interesting new information emerged. For example, the average amount of time a *Mix* IEP subscriber has dedicated to an engineering/producing

GRAPH A

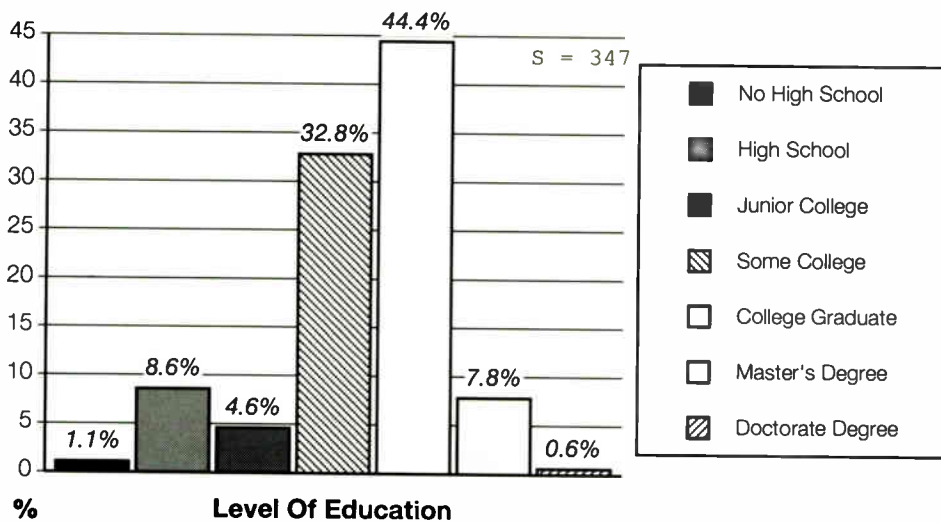

GRAPH B

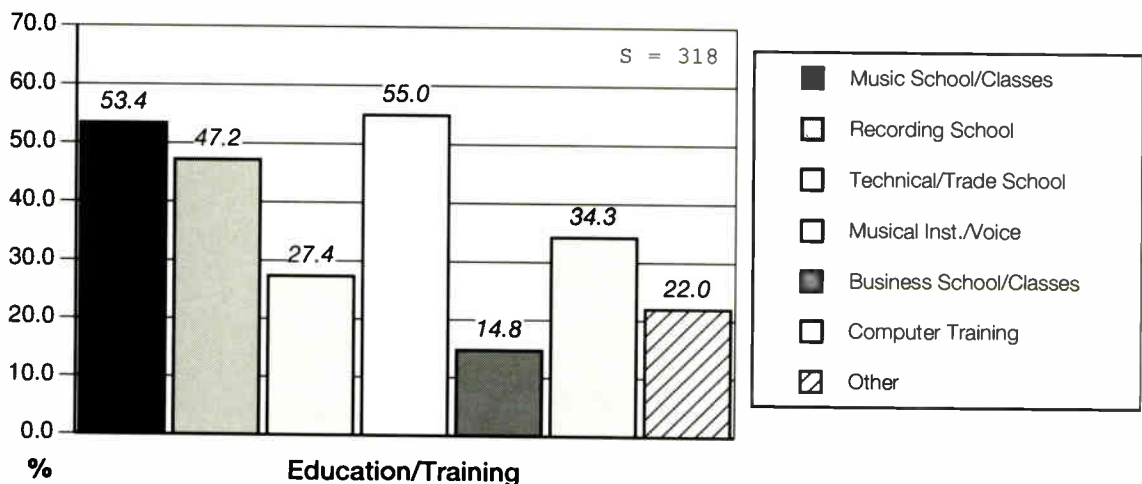

career is a little over eight years. And more than 75% own or operate a private recording studio. Not surprisingly, 96% of IEPs are male.

The following data presents a statistical profile of many of you. All calculations and graphical data come from a detailed, four-page questionnaire that more than 1,100 *Mix* IEP subscribers completed and returned in March 1990—a 30% response rate. The numbers can then be projected confidently to the larger universe of *Mix* IEP subscribers.

The data clearly shows that as a group, the IEP is an influential and active professional. Whether or not IEPs derive their entire income from music production, the activities and influence of an independent engineer, technician or producer drive much of the music production machinery. *Mix* would like to sincerely thank everyone who took the time and energy to participate in the survey.

An IEP Profile

Age. The median age of the survey's respondents is 32 years, 9 months; the average age is 28. The majority

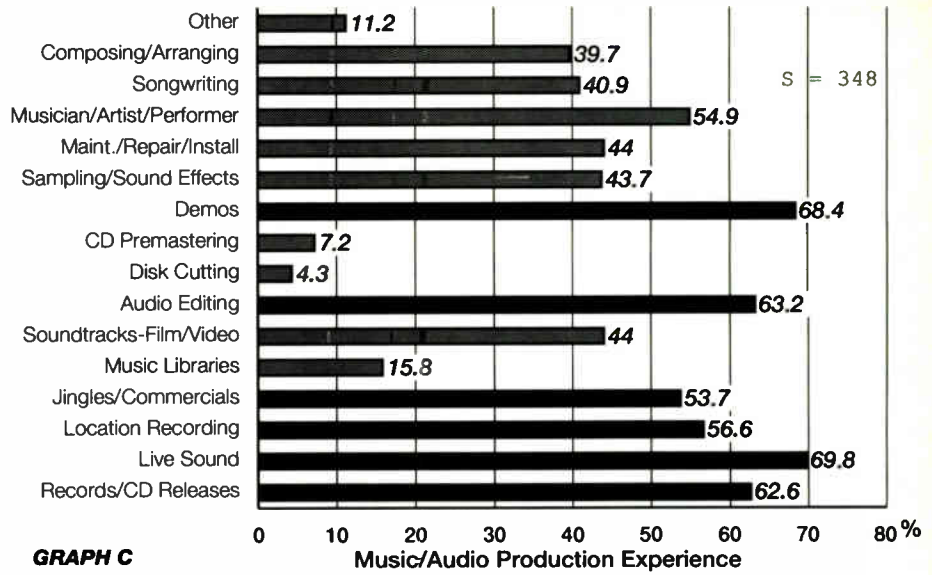

GRAPH C

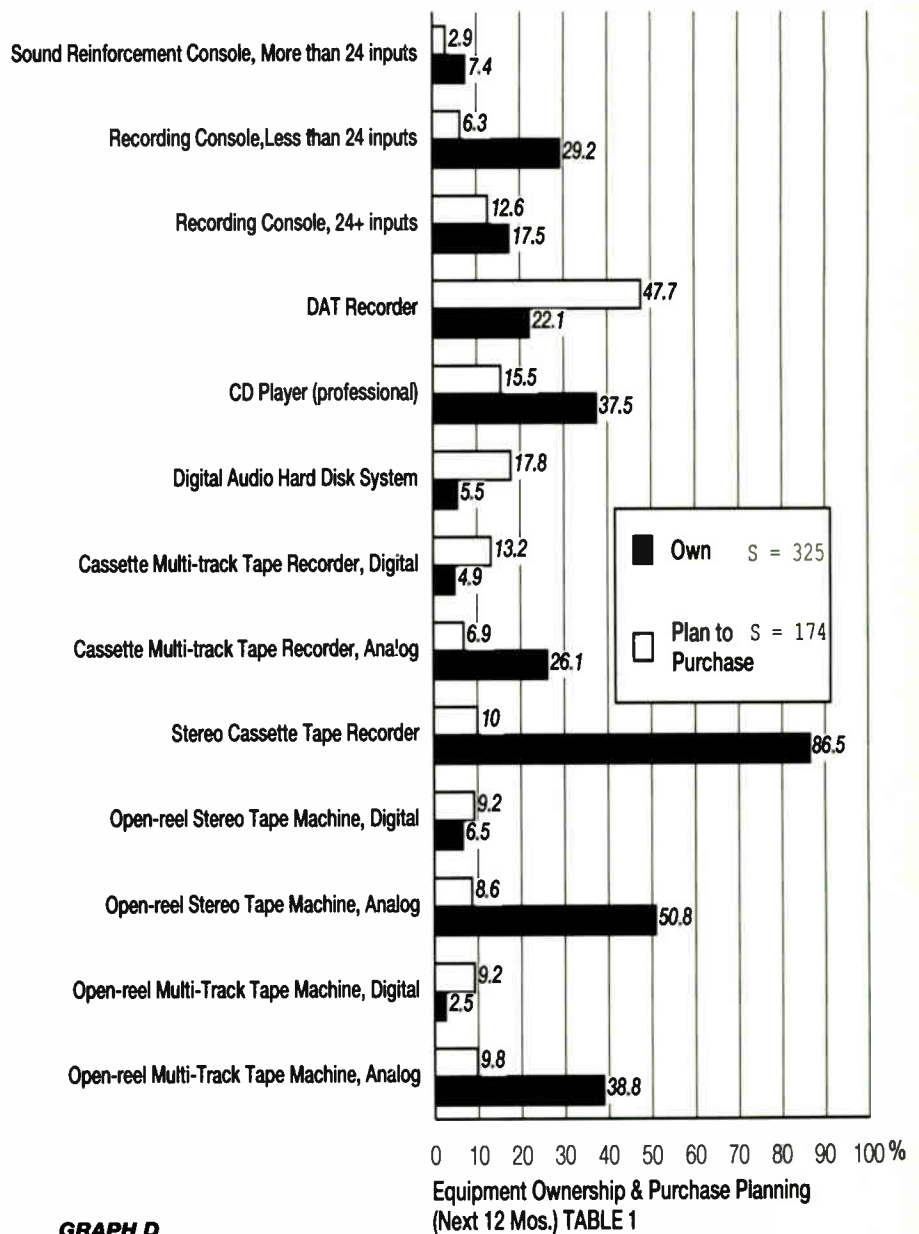

GRAPH D

CD-LIKE
QUALITY
ON CASSETTES!!

KLARITY
CASSETTE

REAL-TIME
CASSETTE DUPLICATION

"THE
ULTIMATE
RESPONSE"

... Find Out How ...

Post Office Square
Waterville, ME 04901
1-800-458-6405
207-873-3911

Circle #185 on Reader Service Card

ROCKET



L A B

MASTERING
DIGITAL EDITING
COMPLETE CD
SERVICES

51 Federal St. #100
San Francisco, CA 94107
(415)495-2297
Fax:(415)495-2684

Circle #186 on Reader Service Card

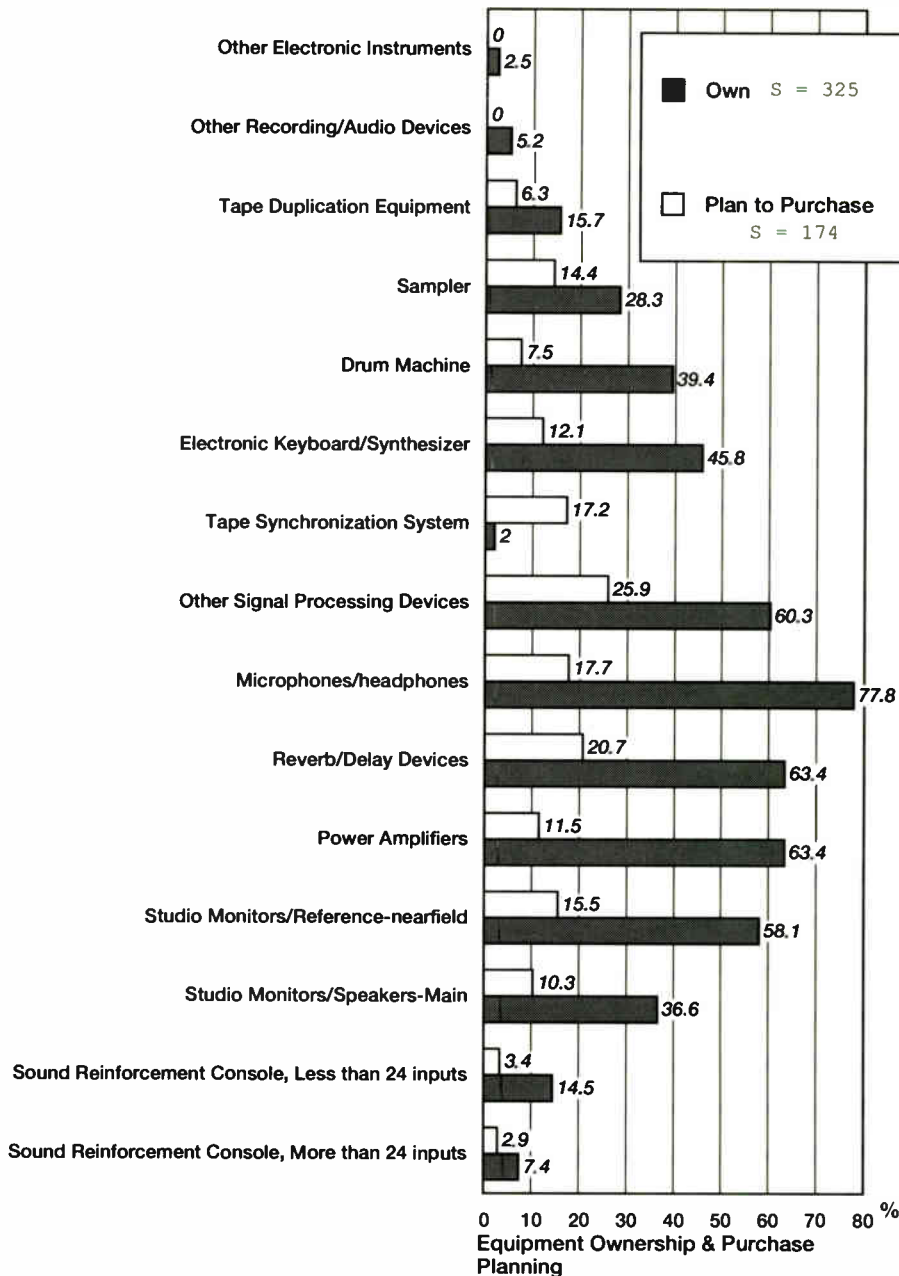

GRAPH E (Next 12 Mos.) TABLE 2

are under 35 (68.7%), and most others are between 36 and 42 (24%). Ten percent fall between 43 and 50. Only 3.4% are over 50; 3.7% are between 18 and 21.

Education. A significant majority of respondents are four-year college graduates: 52.2% (see Graph A). Master's degrees and doctorates are reported by 8.4%. Nearly one-third (32.8%) indicate they had "some college," and 4.5% have graduated from a junior college. Education ended with a high school diploma for 8.6%; 1.1% have not completed high school.

Audio/Music Education & Training. More than half of the respondents (55%) have received musical instrument and/or voice lessons (see Graph

B). A majority of 53.4% report attending music school or classes, while 47% indicate recording school or classes. A surprising 34.3% have computer training, and 27.4% have technical or trade school backgrounds. 14.8% have a business school education. This question allowed for multiple responses, so the percentages do not total 100%.

Income. Annual personal income from involvement in music/audio production reveals the following: 32.4% of those surveyed earn less than \$19,000; 23.2% between \$20,000 and \$29,999; 23.2% between \$30,000 and \$44,999; 10.1% between \$45,000 and \$59,999; 3.9% between \$60,000 and \$74,999; 1.8% between \$75,000 and \$99,999; and 5.3% earn more than

**NO AUDIO TAPE
HAS EVER GONE
SO HIGH.
SO LOW.
SO HOT.
SO QUIETLY.**



Introducing 3M 996 Analog Audio Mastering Tape. It's the first tape that lets you record as hot as you want (level +9), capturing the highest highs and lowest lows with virtually no distortion or print through. From its consistently clear sound, to its protective TapeCare™ Library Box, 3M 996 audio tape takes analog recording where it's never been before. Call 1-800-245-8332 for more information. We won't be satisfied until you are.

3M Professional Audio/Video Products Div.
3M Center, St. Paul, MN 55144

Circle # 213 on Reader Service Card

World Radio History



*"It's *@#\$\$!&% incredible!"*



Jeff "Skunk" Baxter

B.A.S.E.

BEDINI AUDIO SPACIAL ENVIRONMENT
A GAMMA ELECTRONIC SYSTEMS, INC. SUBSIDIARY

TEC
1990
NOMINEE

HEAR US AT AES CONVENTION, DEMONSTRATION ROOM 101

World Radio History
Circle # 212 on Reader Service Card

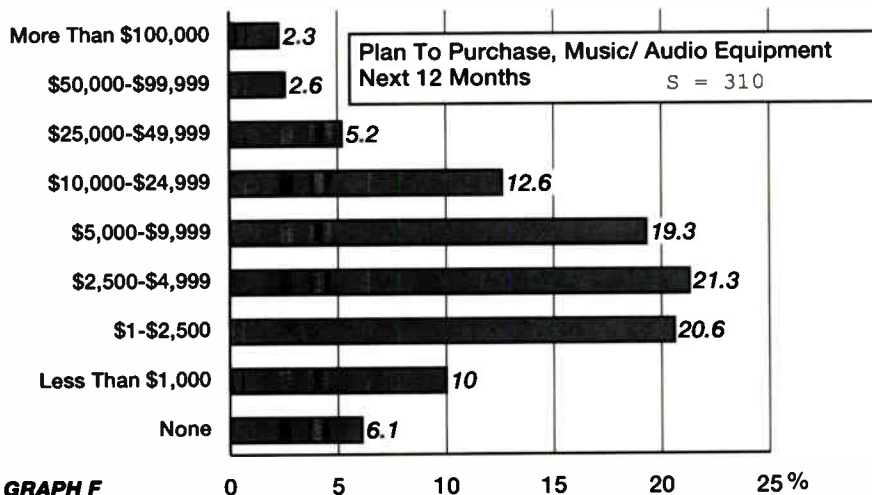

GRAPH F

\$100,000.

Career Longevity. The average length of time that respondents indicate they have been engineering/producing is eight years, three months. 27% report from four to six years; more than half, 53.8%, have been an IEP for more than seven years. 16.1% have been at it for 16 or more years.

Music/Audio Production Experience. As a general rule, IEPs have worked a lot of gigs (see Graph C). Survey respondents list live sound (69.8%), demos (68.4%), editing (63.2%), records/CD releases (62.6%), location recording (56.6%), musician/artist/performer (54.9%), soundtracks for film/video (44%), sampling and sound effects (43.7%), songwriting (40.9%), composing/arranging (39.7%), and many others. This question allowed for multiple responses.

As expected, 95.9% record and/or produce material for others. In addition, 55.5% record and produce their own material.

The average number of projects per year was 7.5. Slightly more than half (50.4%) are involved with ten or more projects per year.

Work Patterns

Three-fourths (75.6%) of those responding to the survey report that they work full-time in the music/audio production industry. Nearly 65% are self-employed engineers, technicians or producers, while the remainder are self-employed and work for a company at the same time.

The prevalent job title is recording engineer (71.4%). In descending order by percentage, 52.8% say they are audio producers; 32.9% are audio technicians; and 39.4% are musicians, composers or arrangers. About one-

fifth indicate a wide range of additional titles. Some of these titles include: studio owner, studio manager, publisher, educator, teacher, writer, store owner, account executive announcer, etc. This question allowed for multiple responses.

A significant 76.4% own or operate a private recording studio. One-fourth (25.7%) own or operate a commercial (public) recording studio. Nearly one-third (31.8%) indicate a variety of other music production business interests, including: location recording, A/V de-

Survey Methodology

The *Mix* 1990 Independent Engineer & Producer Survey is based on a direct mail questionnaire sent out in February 1990 and returned in March. It was conducted entirely by RESOURCE Market Research, an independent publisher's research company.

The mailing list for the survey was taken from the *Mix* subscriber list. A total of 3,713 questionnaires were sent to BPA-qualified subscribers on February 15, 1990; 1,165 were returned by the March 15 deadline. Of those, 350 were randomly selected for tabulation.

The 30% response rate results in a statistical confidence of 88%, $\pm 5\%$. This means that if ten identical surveys were undertaken, we would receive the same data 8.8 times, within $\pm 5\%$.

The sample size (S) for each question varies slightly, because not all respondents answered every question. The tabulated results included responses from 36 states.

"AUDIOPHILE QUALITY"...

EUROPADISK, LTD.

• CASSETTES

Finest European HX PRO Equipment - Lyrec/Studer THE BEST AT NO EXTRA COST!

• COMPACT DISCS

Low-cost packages from ANY source!

• DMM LP MASTERING & PRESSING

ONLY THE FINEST! DMM Quality - Imported Vinyl!

• GRAPHICS PACKAGES

Cassette, CD, LP Printing & Artwork

• DIGITAL STUDIO

CD Premastering, Sony Editing, Neve Digital EQ, Format Conversion

Call, write or FAX for our brochure



EUROPADISK, LTD.

75 Varick Street,
New York, NY 10013
(212) 226-4401 • FAX (212) 966-0456

Circle #184 on Reader Service Card

OCTOBER 1990, MIX 97

A PEEK BEHIND THE BOARDS AT

“THE ARSENIO HALL SHOW”

“Let’s...get...busy!” chimes the new rogue prince of late-night TV. With three lightning-quick orbits of an upraised clenched hand, he coasts sideways, smoothly, kickin’ his house band, The Posse, with a subtle shimmy-shuffle. Arsenio’s theme winds its way to multiple consoles via triple mult, Jensen three-way splitters.

*Arsenio with
guest Farrah
Fawcett ▼*



Production mixer Gordon Klimuck pilots an Amek console like Buckaroo Bonzai, riding inputs and subgroups through an airborne audio rodeo. Coming out of commercial, easing the attenuated Posse groove back to full gain, Klimuck prepares to open

B Y B R A D L E I G H B E N J A M I N

Arsenio's RF lavalier. The audio crew's steady patter of one-liners calmly belies their focus and impeccability, each one a joker, everyone fair game. Their headsets, alive with the brisk hum of communication, give rise to an atmosphere of casual urgency, relaxed efficiency.

Guest band mixer Bart Chiate brings up the master faders on his Soundcraft 8000 console for Soul II Soul, ready to perform their hit single "Back To Life." Chiate, a veteran of live tours and recording projects, mixes the band live-to-videotape in stereo, with exceptionally high fidelity for television, typical of the trademark musical productions being turned out by the staff of *The Arsenio Hall Show*. No lip-sync. On *Arsenio* you either play *live*, or you don't play at all. It's an unusual phenomenon in an age of lip-synched, album-cloned performances, especially in front of a live audience and a viewing public accustomed to flawless, album-cut audio for televised musical performances *à la* VH-1 and MTV.

A long list of major recording artists are vying to play on this show. According to Chiate, the reason is a strong commitment on the part of the staff to the *listening* audience and the acts themselves. "Even though this is television," adds Chiate, "we approach this purely from an audio perspective. We want the listeners/viewers to really get their money's worth. We take a lot of time for scratching out levels, doing soundchecks and rehearsals. We pay attention to details and use plenty of inputs on the board to isolate and process individual sources. Also, we try to work with the artists and make certain *they're* happy with the sound. A lot of television audio people just don't take the time. That's the difference. We take the time."



Let's Get Busy

The day starts at 9 a.m. with load-in of the guest band. For most acts this procedure takes a couple of hours. For Soul II Soul, however, an ensemble of 19 players and five dancers, basic setup and staging will go well past noon. Boom operator Jim Braakenridge, fully familiar with the layout, interfaces with the road crews, ensuring proper placement of gear and smooth communication between the roadies and the audio staff.

Audio technicians John Caswell and Jan Parent, whose primary responsibilities lay with The Posse, also assist in



CALL U.S. TOLL FREE NUMBER 800-343-0101



guest band setup. Although their main objective is to oversee, maintain and configure The Posse's musical gear, they also supply supplemental gear to touring guest bands arriving without their full complement of instruments.

Floor A2 engineers Mark Weber and Pete San Filippo place and patch all guest band microphones. Later on they'll be responsible for placing production mics and hanging lavs on Arsenio and his guests.

All mic and direct lines on the set are divided into three groups or mults, consisting of house band lines, guest band lines, and mics and production mics. Each mult winds its way into a three-way splitter designed by Jim Showker of Audiotek, L.A. The direct signal goes to the audio booth, source of phantom power for those mics that require it. One split goes to the house P.A. mix position and one to the stage monitor mix position.

Each mix position independently processes raw signal information. For the most part, the house band line, production mic levels and processing are fairly well dialed in. Levels, EQ and processing for the performing guests are set individually. Tonight, for instance, comedian Charles Fleischer (the voice of Roger Rabbit) is going to do a rap tune with The Posse.

The major audio challenge lies in setting up the guest band within the scheduled timetable. Once the basic risers are in place and the drum kit is assembled, the process of scratching out levels begins. Bart Chiate, in communication via headset with house P.A. mixer Steve Anderson and stage monitor mixer David Velte, navigates this process from the audio booth.

Chairmen of the Boards

Adjacent to the main control room is the audio booth, domain of Klimuck and Chiate, both of whom worked together previously on *Solid Gold*. Chiate prides himself on working effectively with the guest bands to get a sound that works for them and sounds good going out over the air. While a liaison between Chiate and the band is welcome, engineers are not permitted to come in and mix the bands themselves. However, Chiate is willing to take suggestions on relative levels, EQ, imaging and signal processing. He acknowledges that he's learned all sorts of live-mic and signal processing tricks from a myriad of producers, players and engineers who have worked with him in the booth.

The \$100,000 digital recording and editing you want... for under \$10,000

The MTU MicroSound™ gives you multitrack digital audio-to-disk recording with the editing power you have dreamed of. Install it on your PC/AT computer, or purchase complete, ready to use workstations. Graphically edit with precision, moving instantly thru uncompressed multi-track files up to 94 stereo track minutes. Mix entire files or segments, selected from up to 30 files. The studio quality 16-bit A/D and 18-bit D/A, 64x and 8x converters with linear phase filters and -110db noise floor gives you true sonic purity for professional mastering.

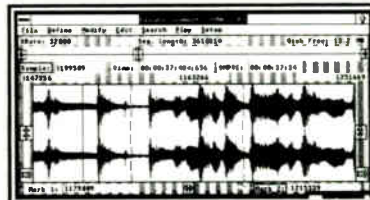

WINDOWS 3.0 BASED

Multitrack Audio on your PC/AT... Now!

Call, write or fax today
for your free brochure.



Micro Technology Unlimited

156 Wind Chime Court • Raleigh, NC 27619 • (919) 870-0344 • fax: (919) 870-7163

Circle #034 on Reader Service Card

**NEW FROM OMNICRAFT...
GTS Stereo Noisegate**

Omnicraft's unique optical system has enabled us to design a noisegate with the lowest levels of noise and coloration of any noisegate on the market!!

The GTS also features:-

- 24dB/Octave hi & lo-pass filters.
- Balanced inputs & outputs (on XLR-type connectors).
- Ducking, Keying and modes of triggering.
- 2 separate channels can be ganged for stereo.

...and many more features.

Call 1-800 CT AUDIO
for full specifications and literature.
In Canada call 604 688 2444

Circle #035 on Reader Service Card

**On Arsenio
you either play live, or
you don't play at all.
It's an unusual
phenomenon in an age
of lip-synched, album-
cloned performances.**

Interfacing with Chiate for Soul II Soul is jazz/funk producer/engineer Frank Clark, veteran of the L.A. film/TV soundtrack scene. Soul II Soul's leader, Jazzie B., and the band's musical director, Patrice Rushen, are in and out of the booth periodically, running ideas by Clark and Chiate.

Chiate's console, a Soundcraft 8000 32x8x2, is solely dedicated to guest bands. The master stereo outputs on this console are routed directly to two adjacent inputs on Klimuck's console, where Gordon has control of the

show's overall mix. All guest bands are routed through Chiate's console. The only exceptions are single guest artists performing with The Posse, who require only a production mic input, or rap groups with little or no instrumentation. Rap groups are the only acts allowed to bring in prerecorded bed music, since that is acknowledged as part of the artform. They must, however, rap and scratch *live*—no sequenced vocals or FX.

Today, working with such a large ensemble, Chiate is maxed out on his inputs. Therefore, the mic signals from Soul II Soul's six violinists will be routed directly to a 6-channel Yamaha M406 mixer and bused in stereo to two inputs of the Soundcraft 8000.

Chiate employs a variety of signal processors, including reverbs, delays, limiters, noise gates and a harmonizer. Before the guest band arrives, he is already in possession of their CD. He auditions the tracks to be performed and dials in his effects accordingly. Effects receives are turned up a notch past where one thinks they sound good, because little details like reverb tend to get lost in broadcast.

For televised audio, Chiate must

utilize an array of limiters, while still retaining dynamics in the sound. That's an art in itself. The extensive use of limiters during taping keeps the non-discriminating broadcast limiters (which affect the entire sum mix at the transmitter) out of the broadcast chain. Broadcast limiters pump, alias and do all sorts of nasty things that are distasteful to the home viewer/listener. By selectively limiting potential trouble-making sources, Chiate circumvents these problems.

His monitors are the Yamaha NS-10s. Chiate sets up the mix in stereo, but monitors in mono during the actual taping. He comments, "Eighty-five percent of our viewers receive the broadcast or listen in mono. Mono-monitored mixes sound better in stereo than vice versa, so we monitor in mono." While many of the show's affiliates broadcast in mono, the show is taped in full stereo, and plans are to go to a quad, Dolby surround format.

Gordon Klimuck's board is a custom-designed 56x24x2 Amek console from the 2500 Series. It has six sends and receives in each channel, 4-band parametric EQ and 11 grouping buses. It's wired for automation but he prefers

IF YOU'RE THINKING OF BUYING AN 8-TRACK, MAYBE YOU SHOULD THINK TWICE.

Think 16 tracks. Think MSR-16. Because for around \$7500* you get a full 16 tracks for just a little more than your average 8-track. Which doubles your capabilities. All in a cost effective 1/2-inch format.

What's more, the MSR-16 is loaded with features usually found on units selling for twice the price.

Like a rehearse mode that allows

you to listen to an insert without committing it to tape. When it's right, you record it.

Plus, our exclusive circuitry assures gapless, punch-in/out, and spot erase capabilities.

The MSR-16 is now playing at your local Tascam dealer. So grab your checkbook, and head on down. It's a deal you won't have to think twice about.



TASCAM®

© 1989 TEAC America Inc., 7733 Telegraph Road, Montebello, CA 90640, 213/726-0303. *Manufacturers suggested retail price.

Circle #114 on Reader Service Card

TASCAM MSR-16



to use it manually. Considering the live application, having the console remember where he *was* isn't nearly as important as having the console ergonomics expedite where he *is*.

Klimuck's console handles all the individual Posse line inputs, a stereo feed of the guest band from Chiate's Soundcraft 8000, all RF and hard-wired production mics, three stereo VTR machines, two Studer A10 1/4-inch stereo tape machines, and four cart machines (soon to be replaced by an Akai S1000 sampler). In addition, a rack-mount Yamaha M406 6-channel mixer handles all the Posse tom-tom and overhead mics, busing them down to two inputs on the Amek. Two additional Yamaha M406's are used as inputs for 12 Countryman Isomax audience reaction mics, bused down to two inputs on the Amek. Klimuck can adjust audience response signal levels with either the input faders or via a foot pedal located beneath the console when both hands are occupied. Gordon monitors the overall mix on a pair of JBL 4345 mains. He mutes the JBLs and goes to headphones only when the guest bands perform, enabling Bart Chiate to get a clear listening perspec-

tive from his Yamaha NS-10s.

A multitude of cooling fans utilized for 60 Varilights and five Super Trooper Xenon spots present the audio crew's most difficult challenge. The noise from the fans bleeds into the boom mic that is frequently trained on Arsenio and his guest. To address this and other ambient problems, a signal processing chain consisting of a notched Orban 672A active parametric EQ, a Brook-Siren compressor/de-esser and a Cat 43 single-ended Dolby noise filter are inserted into the boom's channel on the Amek.

Spread Out!

Above and behind the audience, at a 40x8x8 Yamaha PM3000 console, is Steve Anderson, mixing the sound for the house P.A. The Posse is premixed on an adjacent Amek console and bused to four of the Yamaha's eight subgroups, where they are processed through Anderson's EQ and outboard gear along with the console's production mic and guest band inputs. The audio fans out from the console through five outputs of an assignable matrix to six speaker locations.

Just off stage left, David Velte hov-

"If you want to tape live acts, you have to go the extra mile to make the music happen. We're dealing with the MTV generation. They want sound, real sound."

ers over a Ramsa 840 40x18 console, part of a touring road system (unusually elaborate for television stage monitors). Velte sends six mixes to the house band and can send up to ten mixes to the guest band. The ten guest band mixes each go through its own Klark-Teknik EQ. Velte, working with the band's production liaison, always tries to take care of the players by setting the relative levels and EQ of each monitor to the players' exact specifications.

The small wedge monitors designed by Audiotek are extremely ef-

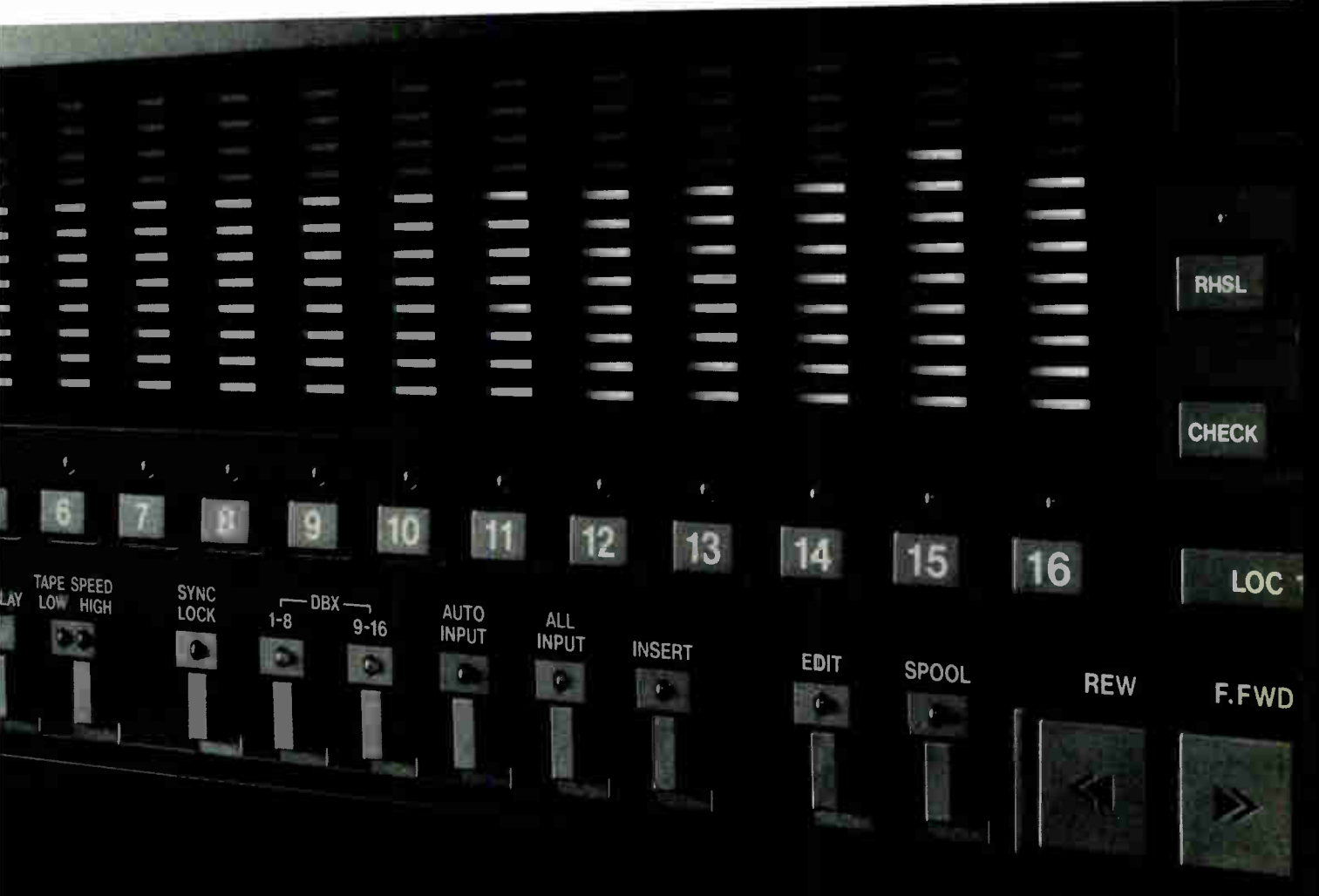

fective for television. Director Sandi Fullerton likes them because they're visually unobtrusive. She also likes the EV408 mics on the toms and overheads for the same reason.

The audio crews' vocal mic of choice is the AKG 535 condenser mic because it puts out the hottest levels and sounds great. The crew uses a variety of microphones, however, to mike the band. For the more mobile vocalists, there are several Cetec Vega Dynex 2 System wireless remote R42 diversity receivers coupled onto the back of the production mult splitter, with plenty of dipoles onstage for complete coverage. Quite often, though, vocalists just want a good old Shure SM57.

Showtime

After the final band rehearsal with cameras, the crew runs through a final soundcheck. There'll be a break before taping. Pete San Filippo and Mark Weber dress the cables and make final adjustments. Gradually appearing one by one on the set, Posse players Mike Wolff, John B. Williams, Starr Parody, Peter Maunu and Chuck Morris take their places on the stand and start

warming up.

In the control room crew members take their positions. It's showtime. The show runs smoothly and is the icing on the cake. After the wrap, roadies and crew people mill around the set. Chiate cheerily takes me aside. "It's like this," he says, "if you want to tape live acts, you have to go the extra mile to make the music happen. We're dealing with the MTV generation. They want sound, real sound. Before this show started, we submitted a budget to Paramount for what we needed to do it right. They thought we were crazy but we stuck to our guns. Tom Bruehl, VP of video operations at Paramount, and his staff were extremely helpful in getting us state-of-the-art gear and technical support. Without him none of this would have ever happened."

Gordon Klimuck adds, "A lot of our success also has to do with our director, Sandi Fullerton. She used to direct *Rock Concert*, and she's really into music. No matter how many rehearsals we need or how much time we take, she's right behind us. A lot of directors won't do that. That's what makes the difference."

Throughout the day it's become

increasingly evident that these people really like working together. There exists a tremendous spirit of cooperation. "We're freelancers on this audio crew," adds Klimuck. "We all do other projects, and that keeps this really fresh. We love to come here and work together, and frankly, Arsenio's a great guy. He loves music and he does whatever he can for us."

The audio crew has already been nominated once for an Emmy. The Arsenio set has been graced by many renowned artists including Luther Vandross, Whitney Houston, Phil Collins, Patti LaBelle, Gloria Estefan and Miami Sound Machine, Tears For Fears, Tracy Chapman, k.d. lang, Randy Travis, Dolly Parton, The Wynans, Smokey Robinson, Stanley Jordan and Bobby McFerrin.

"Everyone works hard," comments Joe Hall, the man in charge of maintaining all the pro audio gear on stage 29, "but we still have fun."

"Yeah," adds Chiate, "If you can't have fun, go get another job." ■

Brad Leigh Benjamin is a freelance writer who splits his time between lives in Los Angeles and Washington State.

FOR CD MASTERING:

QUALITY TRANSFERS TO DIGITAL:
FROM:

- analog (dolby, dbx)
- DAT
- PCM-F1/501/601
- DASH
- dbx-700



NORTHEASTERN DIGITAL RECORDING, INC.

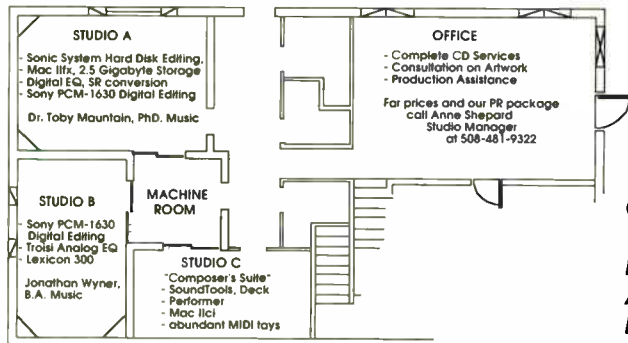
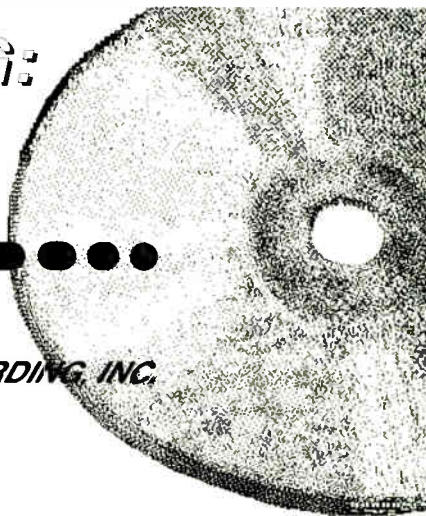

508-481-9322

CREDITS:

**DAVID BOWIE, FRANK ZAPPA
ARLO GUTHRIE, RITCHIE HAVENS
PAUL WINTER, NRBQ, ROUNDER
RYKODISC, NORTHEASTERN
TITANIC, BIOGRAPH, OMEGA
NEWPORT CLASSIC, BOSE, LOTUS**

Our new studios offer state of the art equipment and excellent acoustics with the experience and service that you deserve.

UNPRECEDENTED.



Industry standards. To be redefined at AES.
Booth 200

GUARANTEED EXCELLENCE



crown

World Radio History

by Paul Calderon

MIKE HEDGES

USING THE PAST TO CREATE THE FUTURE

Mike Hedges is almost boiling over with enthusiasm. An immensely tall and sturdy man graced with bright red hair and beard, he looks impressive as he walks around his front room in Willesden, North London, England. The room is impressive, too. It's large, high-ceilinged and covered in posh, blue carpet and light-blue wallpaper. The windows are set in cute alcoves, and on one wall there's a square mir-

son on the planet, is certainly unusual, too. He's well known in the United Kingdom as the producer of a string of some of the most successful left-field albums of the last decade. Siouxsie & The Banshees, The Cure, Marc Almond, The Associates and Everything But The Girl are just a few of the acts who were willing victims of his formidable production and engineering skills. Only recently did Hedges cross



Hedges and "the ultimate EMI recording console."

ror, set in a gigantic mass of wood, covering half the wall. Amid all this grandeur, the elegant pink lampshades and the collection of frail Egyptian statues on the fireplace are a welcome contrast. What's most impressive, however, is the very thing Mike Hedges is so enthused about. Because rather than the usual TV, armchairs and table, this living room contains one of the most extraordinary home studios on the planet.

Mike Hedges himself, though perhaps not the most extraordinary per-

son over to the area of mainstream pop with a production of The Beautiful South, a band featuring former Housemartins singer Paul Heaton. *Welcome to the Beautiful South* was a huge hit in Europe.

If Hedges likes to produce left-field music, he certainly likes left-field equipment, too, albeit not the kind of stuff you'd expect from someone who's known to work on the forefront of progressive music. Rather than a collection of the latest samplers, computers and effects boxes in his front

PHOTO: IAN GELBERG

REFERENCE. WITHOUT PEER.



Into a technological world where 16 bit digital sound is the norm comes The Reference. At 20 bits, it's unprecedented for sonic purity. Without peer in performance.

Incorporating more than 40 years of Crown's technological achieve-

ments, The Macro Reference represents our philosophy of going beyond industry expectations. We have once again created new standards in sound amplification.

With The Reference, you will truly experience the sound of the live

performance. This is an advantage you must hear to fully appreciate... in an amplifier designed to be displayed.

For complete specifications visit your nearest Crown dealer. Or call Crown direct at 1-800-535-6289.

GUARANTEED EXCELLENCE



crown®

Made in America

Exported as Amcron

True to the Source



Since 1979, Meyer Sound Laboratories has built loudspeaker systems for consultants, producers, engineers and performers. Our goal has been to design systems that support the artistry of your work.

Guided by uncompromising standards of performance, Meyer has pioneered in the areas of control electronics, arrayability and room equalization (SIM®). As a result, Meyer Sound remains the system of choice for clients as diverse as Grateful Dead, Les Miserables, Lily Tomlin and Carnegie Hall.

Our motivation is simple: to reproduce sound accurately and coherently, true to the source.

**Sound
engineering
for the art
and science
of sound.**



**Meyer
Sound**

Meyer Sound Laboratories, Inc.
2832 San Pablo Avenue
Berkeley, CA 94702
(415) 486-1166
FAX (415) 486-8356

©1990 Meyer Sound

room, the space is dominated by a gigantic mixing desk. It's black, consists of three sections angled at 120° of each other, and it's got bizarre, round faders and many enormous, old-fashioned knobs in black, gray and red. It dates from the '70s and was used on some legendary sessions. At the same time it's the only one of its kind in the world.

"This is the ultimate EMI recording console, the biggest and best they ever made," he enthuses. "It's an EMI TG12345, Mark 4, 44 channels, and it comes from Abbey Road Studio 2, the legendary Beatles studio. It was installed in 1970 and dismantled around 1980-1981. They broke it up and stored it somewhere damp, so after I bought it in February last year I had to do a lot of work to get it in a good state again."

So was it used by the Beatles? "No, it was installed shortly after they broke up, but it has been used during numerous famous sessions of the '70s, like Pink Floyd's *Dark Side of the Moon* and the first two albums by Kate Bush. Mark 1 of this console, which went with an 8-track, has been used by the Beatles."

Hedges owns a Mark 2 desk, which is a modular mobile, used by the Abbey Road Mobile Studio and dating from the late '60s. He rents it out on a commercial basis. Apparently, there was also a Mark 3 used by the Rolling Stones in Pathé Marconi in Paris, and there was a classical version of the Mark 4, but that's it. EMI never built a Mark 5, and each Mark version of these consoles is the only one.

Looking further across Hedges' front room, one stumbles over more heaps of "antique" equipment. There's a Studer A80 16-track recorder, a bizarre-looking patch bay, a battered Dolby A box, and lots of tube processing gear. It turns out that Hedges has managed to acquire considerable amounts of Abbey Road's old equipment, including the three Studer A80 8-track machines from the mobile.

"The patch bay comes from Abbey Road Studio 3," Hedges says. "It's a Siemens and it has self-cleaning plugs, so it doesn't crackle. The 16-track Dolby A comes from Abbey Road, too. I use it because I run the Studers at 15 ips, rather than 30 ips. The quality of the bass end is better at the lower speed.

"The Studer 16-track dates from

when their 16-track was introduced, around 1975-1976, and was, in fact, an update of the 8-track. The 8-track

"Having a studio has become a big snob thing."

had a 1-inch headblock, so they installed a 2-inch headblock and combined the electronics of two 8-tracks.

So basically, the 16-track is a more modern head in an old deck."

Having such vintage equipment is all very quaint, but one has to wonder if Hedges doesn't feel a little like the owner of some expensive 1930s car that is great to look at, prestigious to own, but a pain in the neck to maintain and unreliable to drive. When I put this question to him, he becomes passionate and animated.

"This equipment is better than anything you can buy today," he asserts. "A massive amount of R&D went into the making of this desk and these decks. They were built like lab test

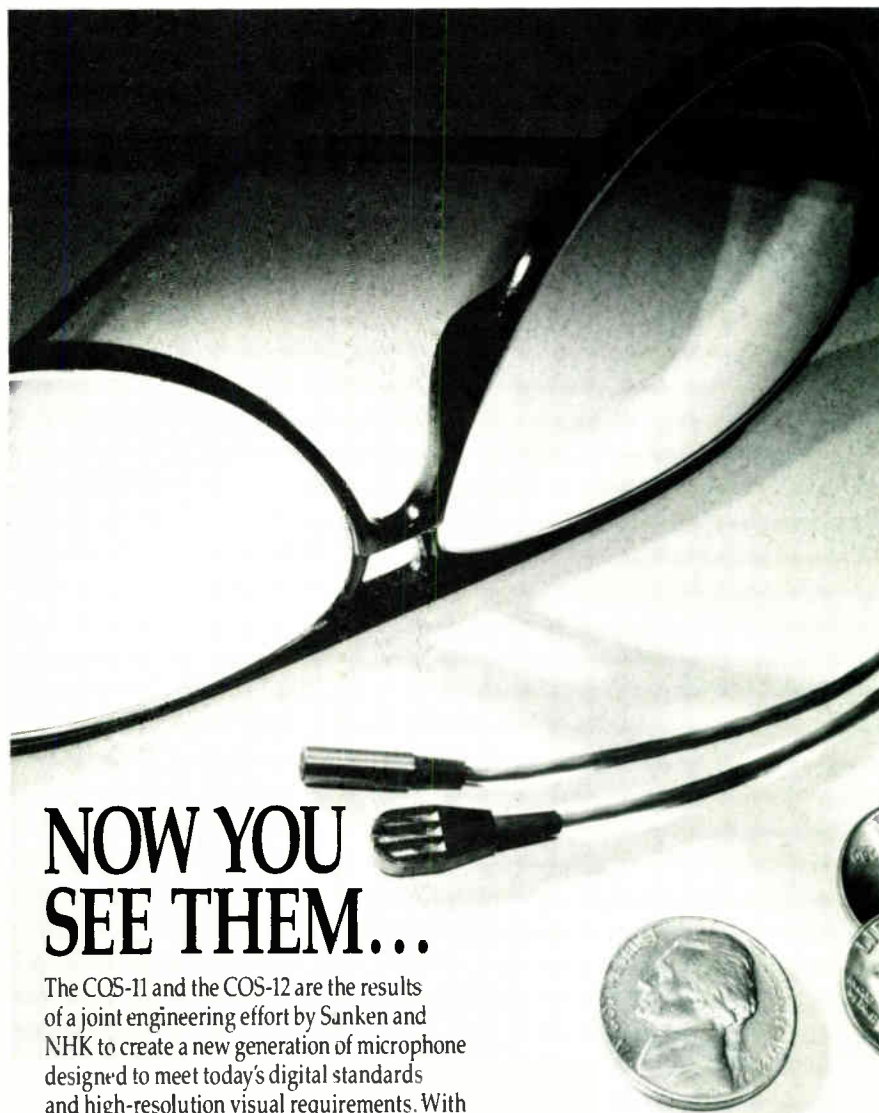

NOW YOU SEE THEM...

The COS-11 and the COS-12 are the results of a joint engineering effort by Sanken and NHK to create a new generation of microphone designed to meet today's digital standards and high-resolution visual requirements. With over 50,000 microphones in daily use, Sanken is foremost worldwide in progressive technology and precision craftsmanship. These new lavalier microphones combine advanced miniaturization in electret condensers with a unique vertical diaphragm design for the ultimate in sensitivity, natural response and *hidden* capabilities.

For the name of your nearest dealer, call:
AUDIO INTERVISUAL DESIGN
Exclusive U.S. Distributor (213) 469-4773

sanken

Japan's most original microphone maker

equipment. The story goes that when Studer developed 1-inch 8-track, they quickly figured that it was possible to make 2-inch tape and have 16-track. What they didn't take into account was that people would be crazy enough to put 24 tracks on 2-inch tape and accept a drop in quality. Their policy was always to have only the best, and 24 tracks on 2-inch tape was never optimal.

"It's only recently that the quality of the very best and expensive 24-tracks is back to what 16-track was.

And I, and many people with me, would still maintain that 16-track sounds better. It actually sounds better than digital, there's no doubt about it. The problem with all the digital machines is that the makers don't seem to realize that they've got the top end pretty good, even though some machines have this digital *zing* to them, but that their bass end is flawed. A 16-track analog console can record cleanly and straight until 30 Hz, but if you sweep an oscillator through digital you can see the meter drop at the low end. And because of compact disc, those very low frequencies are sud-

denly important."

As if to demonstrate that his attitudes are in no way dogmatic, Hedges has just bought the Akai 12-track digital because it's so cheap he says, and because "it doesn't have that digital *zing*. On top the drop-ins and outs are incredibly accurate. Fantastic!"

He now uses the Studers in conjunction with the Akai, either using the digital as slave or linking them up, thus taking advantage of the best of both worlds.

So what about the EMI TG12345 Mark 4? Is that better than the finest contemporary consoles? Hedges has no hesitations: "The desk is perhaps not as easy to use as an SSL, and it's more time-consuming to keep up and running, but it sounds much better, it's as simple as that. It's the best-designed and best-sounding desk I've encountered in my career. The equalization, for example, is very musical; it's like having a Pultec on every channel. It has switchable frequencies that are selected on musical notes, so when you're EQ'ing a guitar you can boost or take out one note, which is what EQ is for."

Still, Hedges warns against too big a focus on equipment. More important than the quality of the equipment, he says, is the quality of the person manning it: "The emphasis on technology is completely overstated. Having a studio has become a big snob thing. If you haven't got 48-track with an SSL, you're not a professional studio. It's become a re-equipping rat race in which nobody is making any money. Studios don't realize that recording engineers are their main asset.

"A good engineer can get a good sound on virtually any equipment, whereas a half-trained person wouldn't be able to get a good sound out of the best equipment. Studios invest millions in equipment, and because these are hard times, they save on personnel. I would guess that the size of studio staff in training in the UK in 1990 is perhaps 20 to 25 percent of that in 1980. There are, of course, up-and-coming stars, but in general the standard of young engineers is dropping dramatically." ■

Paul Calderon is a London-based freelance writer who contributes to music and studio trade magazines in Europe and the U.S. He's also a songwriter and guitarist.

SIMPLY THE BEST!



Simon Systems™ is setting a new standard of excellence in professional audio signal processing equipment. It began with the **DB-1A Active Direct Box**. Boldly designed and independently powered*, the DB-1A delivers performance that blows every other DI away. The DB-1A's unique design is based on totally active (transformerless) circuitry with no insertion loss. With features like line level output, rechargeable battery capability, and automatic power system check, it's easy to understand why so many professionals refer to it as simply the best direct box money can buy!

Then came the **CB-4 Headphone Cue Box**. With four outputs independently controlled by conductive plastic stereo power controls, the CB-4 allows up to four headphones to be driven from the same amplifier. A three-position switch selects left mono, right mono, or stereo mix, and XLR input/output connectors are provided for paralleling additional cue boxes. It's no wonder why the CB-4 has become a standard in the industry.

The tradition of excellence continues with the **RDB-400 Integrated Direct Box**. Based on the same design technique which made the DB-1A the premier direct box of the industry, the AC powered RDB-400 is four direct boxes in one. It can be rack or floor mounted and has countless uses. It features line level output mode with infinitely variable trim, attenuation mode with stepped variable trim, input overload LED, speaker level input pad, balanced and unbalanced buffered outputs with front and rear XLR connectors, ground isolation switch, and a toroidal power transformer.

*Simon Systems PS-1 Power Supply is recommended



So the next time you think signal processing equipment, think like a pro:
Simon Systems — Simply the Best!™

Thanks for setting the trend:

GLENN CAMPBELL • JOHN COUGAR • FLEETWOOD MAC • WHITNEY HOUSTON
KENNY LOGGINS • JEAN-LUC PONTY • JEFF PORCARD • RED SPEEDWAGON
UNIVERSAL STUDIOS • TITO JACKSON



SIMON SYSTEMS™ ENGINEERING, INC.

707 Clear Haven Drive, Agoura Hills, CA 91301. (818) 707-9980

Circle #062 on Reader Service Card

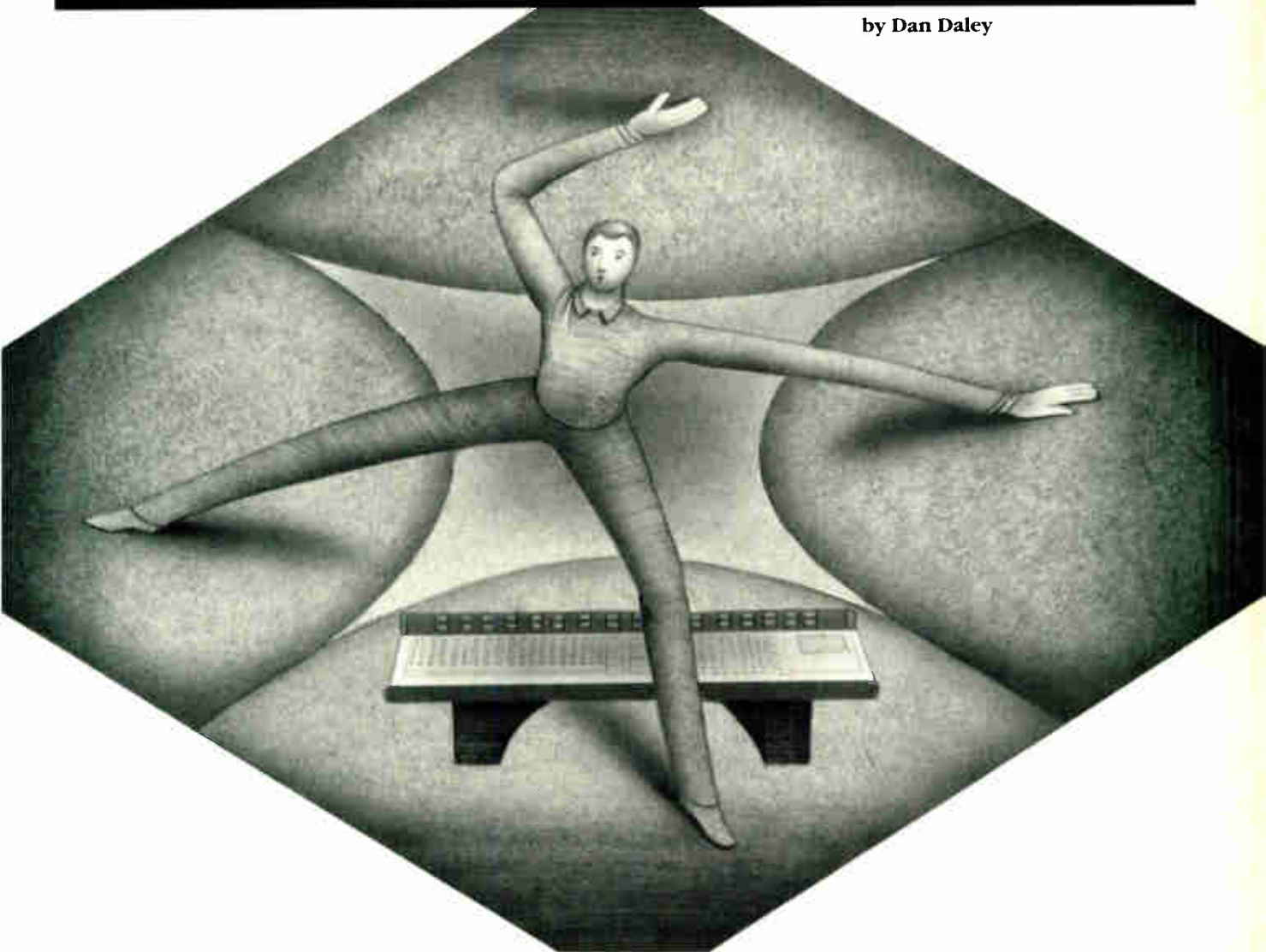

HOW WILL THE WOLF SURVIVE?

CHANGING TIMES FOR THE SMALL STUDIO

For anyone who has spent any length of time in the audio recording business, the image of the single-room, 24-track facility will be easily remembered as the backbone of the industry. During the '70s and early '80s these rooms thrived (allowing for the Great Disco Disaster/general recession of 1979-1980), the more successful ones going on to open additional rooms with additional decks. For the ones that moved up, there was a steady stream of other, newer single rooms behind them. It was, in retrospect, a halcyon time for

recording: record sales grew, audio-for-video began to make its presence felt, equipment formats became standardized and widespread while costs remained reasonable, in some cases actually going down. It was a good time to be in the studio business.

Then something happened.

Actually, more than one thing. Digital entered the picture, driving up the ante for state-of-the-art. It was alluring enough even in the beginning to cause many of the larger facilities to begin the transition to the new tech-

RACK-MOUNT POWER CONDITIONING

From the people who specialize in Power Protection.

Tripp Lite's Rack-Mount ISOBAR® Surge Suppressors and Rack-Mount Line Stabilizers protect your keyboards, samplers, rack effects, amps and MIDI systems, giving you the performance protection you need.

Rack-Mount ISOBAR® Surge Suppressors feature cascade circuitry design providing various levels of protection. Individually isolated filter banks (2 front, 10 rear) prevent "cross-talk" between components. The rack-mount ISOBAR® also provides superior RFI/EMI line noise attenuation.



Rack-Mount Line Stabilizers maintain constant voltage levels during both high & low power fluctuations. Large toroidal chokes and capacitors offer superb low-frequency filtering. Surge suppression is controlled by the built-in ISOBAR® filtering network (12 rear outlets, 2 front).



500 N. Orleans
Chicago, IL 60610-4188
312/329-1777
FAX 312/644-6505

A09991-5

Circle #064 on Reader Service Card

nology and create a new strata in an already segmented industry—a new caste of elite facilities servicing upscale clients.

Then, like some Stephen King scene, the ceiling spun and the floor came crashing up, revealing a nascent troglodyte whose mere mention is still anathema to some commercial studio owners: Home Recording. (Cue Theramin effect here.) To many others, though, home recording became the icon for an undreamed of technological and artistic freedom.

As the upper end of the recording business receded upward, home recording gnawed away at one of the supporting staples of the mid-sized studio: demo work. Artists began to realize the cost-effectiveness of spending several thousand dollars on personal equipment that could be used over and over again at will rather than on one-shot trips to the studio. Home recording spawned its own unique litter, chief among them the project studio, often a home studio grown too big for the living room. Project studios, as anyone who reads this space knows, owe their existence to an owner/operator/creator/musician, usually the same person, servicing one or more audio or audio-for-video accounts on a regular basis, thus not having to rely on selling time to an increasingly fickle audio public.

The once proliferous single-room 24-track house is still with us, but it now exists in a world very different from that of 15 years ago—a drastically changed technological and business landscape that forces those who remain to cope in a variety of ways. Some are taking in boarders—owners of digital equipment whose economic resources allow for technological investment, but not rent—and hoping that this added dimension attracts new business. Others are forming alliances with producers, composers and programmers in the hope of selling production and creative services as well as studio time. Still others are diversifying into new areas, buying 3/4-inch video decks and sync gear, looking to crack the commercial and industrial audio-for-video market.

In an unscientific poke around a couple of corners of the country, I found single-room owners coping, but not necessarily enthusiastically. "The low end of the recording spectrum is

SSP-100 SPATIAL SOUND PROCESSOR

A PROGRAMMABLE MULTI-CHANNEL AUDIO SIGNAL PANNER FOR THE CREATION OF SURROUND SOUND

FEATURES

- Works with any loudspeaker system (up to eight loudspeakers) including THX®, Dolby Surround Sound®, Omnimax®, Imax® and Stereo.
- Mono sound sources can be placed or moved in real-time with the joysticks anywhere inside the loudspeaker array. These movements can be recorded in the internal position sequencers or externally on a MIDI sequencer (and synced to SMPTE) or on a FSK data audio track.
- Also movements or sound positions can be recorded in step-time, by specifying the starting point, trajectory and the speed of the movement or by jumping to consecutive sound locations in a 3-D space.
- Movements can be rotated, scaled up or down, speeded up or down, expanded, reversed etc.
- Proportional reverberation can be added with an external reverberation unit (reverb proportion depending on spatial position). MIDI control of the reverberation characteristics is optional.



- Doppler Shift simulation with an external Digital Delay.
- Control of sound position in real-time with a MIDI keyboard.

APPLICATIONS

Surround Sound • Post-Production for Film
Discotheques • Foley Work • Multi-Media Shows • Live Performances • Planetariums
Theatres • Laser Shows • Discotheques

For full details on the SSP-100 Spatial Sound Processor please call, fax or write:
Spatial Sound, Inc. 743 Center Boulevard Fairfax, CA 94930 (USA)

Tel: (415) 457-8114 Fax: (415) 457-6250

SEE US AT THE AES 1990 IN BOOTH# 1042

*THX, Dolby Surround Sound, Omnimax and Imax are trademarks of respectively Lucasfilm Ltd, Dolby Labs, Inc. and Imax Corporation

Circle #065 on Reader Service Card

definitely hurting us and it's becoming more apparent," says Steve Savage, manager of Soma Sync, a \$250,000 single-room studio in San Francisco with an Otari MTR-90 and a 32-input SSL 4040. Savage says the automated SSL is a draw that helps keep him competitive with other studios. "You need a main attraction of some kind," he explains. "Otherwise some budget clients might opt for more time at less per hour at a 16-track place."

Savage says large, new audio equipment investments aren't in the cards for the immediate future. Rather, he's looking to add to his audio-for-video capability to diversify his client base. "I have some video work coming in now," he says, "but I also realize that my background is audio and music, not video. I have to develop a reputation for the room in these new areas, and that's going to take time."

While Soma Sync has a card rate of \$125 per hour, Savage admits to rarely getting it. "With the pricing competition out there, I find people negotiate and haggle more," he says, "and I realize I need to negotiate more to keep the room busy."

"I'm pessimistic about the studio

business in general," he continues. "I enjoy the work but I'm glad I'm not the owner. I'm optimistic about the future of this room, but I know that's not necessarily reflective of the state of affairs in the rest of the business."

Another example of diversification as a survival tactic is practiced by Songbird in Atlanta. Owner David Romine says his single room, equipped with an Ampex 1100 24-track and a Sound Workshop 1600 with AMS automation, has been squeezed by home recording technology, most notably within the last few months of the studio's four-year history. "The demo market is not what it used to be," he says. "[Personal recording] technology is getting so good it's cutting into it more."

Romine just added a 3/4-inch video deck and synchronization equipment in search of more audio post work. He supplements the studio's income by working as a musician and composer for industrial A/V work. The rub is that much of that work has been done for-hire at other area studios. Romine would like to bring more of it into his own studio but knows the trade-off might damage relations with some of

his clients who are other studios.

At the moment, Romine is mulling over two offers he's received from other studios: to bring his MIDI gear to a corporate production house, and to become a staff engineer at another facility. Either would mean giving up his own studio as a commercial venture, which he is loathe to do. "I'd rather stay in business for myself," he says. To that end, until increased revenues justify added equipment purchases, Romine plans to change his advertising tack, adding to the demo-oriented local musician free press and ads in audio-visual industry trade publications. "Only the studios that can afford to upgrade will stick around," he says. "There's no future on the demo level for studios unless you move them back into the house."

In the New York area, price wars have created a virtual Third World economic environment for smaller 24-track rooms. A quick perusal of *The Village Voice* shows well-equipped rooms renting for \$40 to \$50 per hour. Ted Wender's Databank Studios offers a D&R 8000 console with Megamix automation and a Sony/MCI JH-24 multitrack for as low as \$30 an hour.

Write or Call for **FREE CATALOG**

USA & Canada
1-800-331-3191

NYC Area: 516-678-4414
FAX: 516-678-8959



Distributors of **3M** Professional
Audio and Video Products including:

- Digital Mastering Tape
- Logging Tape
- Leader & Splicing Tape
- Reels, Boxes, Flanges
- All hard-to-get audio & video products
- Custom loaded cassettes
- R-DAT & other packaged cassettes
- Calibration Tape & Splicing Blocks

Shipped From Stock - Priced Right - Immediate Delivery

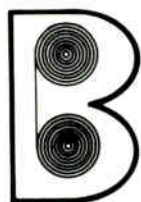

Burlington Audio / Video Tapes, Inc.

106 Mott Street • Oceanside, New York 11572

"We'll honor that advertised rate for bulk bookings but prefer to see closer to \$40 per hour for the room," he says, adding that a reasonable rent (and remember, in Manhattan "reasonable" has a unique meaning) plus the fact that he can get talented engineers for \$10 to \$15 per hour helps keep him in business in this most competitive of all markets.

Wender has another, quintessentially New York, advantage: He has actively pursued an ethnic niche market. Twenty-five percent of Data-bank's clientele are Haitian artists. He

has recently initiated a joint venture in which a Synclavier owner will occupy a room at the studio. Using a Digi-design software package and a Macintosh computer, Databank will have tapeless capability next to its 24-track analog. "New York is a different animal," says Wender. "If your overhead is low enough you can make it at \$40 per hour."

"Rent is crucial," echoes Ron Rogers, owner of Shadow Sound Studios, another single-room Manhattan facility that rents for \$25 an hour with a Harrison 3224 Series console and a Sony/MCI JH-24 deck. "The price wars have hurt everyone," Rogers says. "Ten

years ago a 24-track room went for \$75 per hour. But with rents, the number of studios in town and home recording, price wars seemed inevitable."

Rogers' roughly break-even studio revenues are supplemented by his royalties as a songwriter (he's penned several singles for King Creole) and production income. He says single-room 24-track studios can survive, but staffs need to be cut to the bone and all other expenses held as low as possible. He no longer uses a staff maintenance person, noting that New York has become a boom town for journeyman technicians, who can earn twice the hourly rate he gets for his room. "When you consider the outlay of money necessary to open a studio here, I don't think there's another business with such a small rate of return," he says.

Rogers says he has no plans for expansion or major upgrades; rather, he will try to put more emphasis on selling his production services as well as studio time. "The one advantage I have [over personal recording studios] is that I have a recording room," he says. "There'll be a premium on them at some point."

Incoming SPARS president Pete Caldwell, owner of the multi-room Doppler facility in Atlanta, is aware of the difficulties faced by smaller facilities but expresses an optimistic tone. "The smaller rooms that are successful are ones that tend to become niche-oriented," he explains. "For instance, in Atlanta there are several studios that do a lot of gospel and contemporary Christian music. Further, they need to analyze the present marketplace and buy their equipment accordingly. An increased business acumen is needed to stay in business in the '90s. But I wouldn't paint a black picture. There are guys [on that level] who are making it out there. You need to balance a dream vs. the realities."

The 24-track single-room operation will be important for some time to come. At the very least, 2-inch 24-track is still the industry-standard for analog recording; you can take your reel to far more studios than you can with any other format, analog or digital, tape or disk. And this type of facility is still the big fish of the smaller ponds outside the major markets. So say a prayer for the hard-workin' people. ■

Dan Daley is a Mix contributing editor. He has owned a small studio in New York and has the scars to prove it.

TC 1128/TC 6032

We listen to the pro's

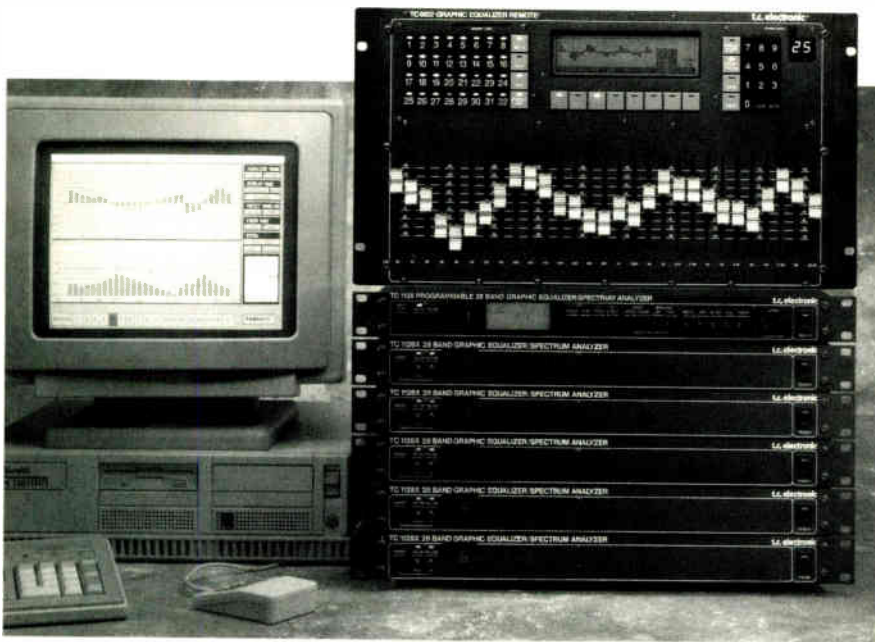

T.C. Electronic and Clair Brothers have jointly developed the TC 6032 motor fader remote.

This "state of the art" user interface gives you instant access to up to 32 TC 1128's - the worlds most versatile equalizer.

Call for more information.

OF DENMARK
t.c. electronic

INTERNATIONAL HEADOFFICE: T.C. Electronic A/S, Grimbjvej 3, DK-8220 Brabrand, Denmark. Ph. +45 86 262800, Fax +45 86 262928 • USA: T.C. Electronic USA Inc., North Hollywood, (818) 503 0404 • UK: T.C. Electronic, UK Ltd, Oswestry, 0691-658550 • GERMANY: T.C. Electronic of Denmark GmbH, Detmold, 05231-32972 • AUSTRIA: Bauer Sound Musikinstrumente, Wien, (222) 601 17 • AUSTRALIA: East Coast Audio, Melbourne, (03) 241 2244 • BELGIUM: Ampco Audio Products, Maarssebroek (Holland), 0031 30 433134 • CANADA: T.C. Electronic USA Inc., North Hollywood, (818) 503 0404 • FINLAND: Studiotec, Ispoo, 90-592 055 • FRANCE: High Identity Services S.A., Bondy, 48 47 45 26 • GREECE: Lyrikon S.A., Athens, 3628 541 • HONG KONG: Jolly Sound Ltd., Kowloon, 3620202-5 • HOLLAND: Ampco Audio Products, Maarssebroek, 030 433134, ITALY: CD Videosuono S.p.A., Milano, (02) 5084.1 • JAPAN: Otaritec Corp., Tokyo, (03) 332-3211 • NORWAY: T.C. Electronic, of Denmark, +45 86 262800 • SINGAPORE: Team 108, Singapore, 748 9113 • SWEDEN: Elfa Studio AB, Solna, (08) 7340750 • SPAIN: Larpro, Barcelona, (93) 212 70 50 • SWITZERLAND: Riverside Music, Maggia/71, 09 37826 56.

NED

Pointing DAWs Toward the Next Generation

MultiArc

The integration of New England Digital's Synclavier and PostPro™—announced at this year's NAB as the PostPro SD—reflected a confluence of technologies aimed at creating a more powerful stand-alone workstation. But the quest for a more comprehensive convergence—between the computer industry and digital audio—has led NED to develop a series of innovations, some available presently, others scheduled within the next six to eight months, that will expand the horizons of what a digital audio workstation is and what it can do.

MultiArc, one new NED approach, incorporates multitasking and multi-user concepts with the recently announced DSP option for current NED sys-

tems. MultiArc allows systems to handle multiple audio and audio-for-video tasks simultaneously in a star

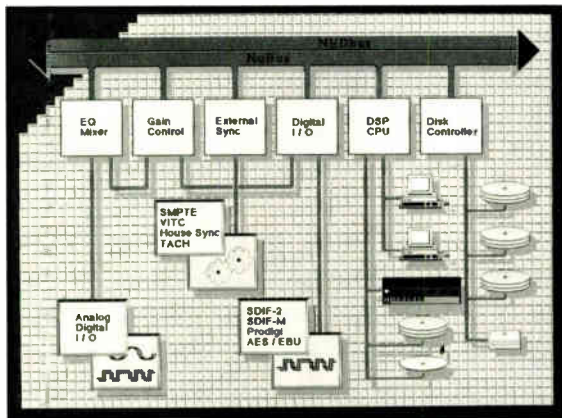

The MultiArc platform provides for 24-bit audio pathways, synchronization clocks, multitasking capability and the possibility of future multi-user expansion.

arrangement, whereby four—or potentially more—stations could operate from a central PostPro system. In a film or audio-for-video environment, for example, one station could do Foley, another ADR and another pre-lay, while yet another manipulates dialog, all simultaneously, sharing tracks within the cen-

by Dan Daley



- Digital Hard Disk Multitrack, Digital Automated Console, Digital Editing, CD Master Prep
- Studer 24track, 2track, lockup to all formats
- Living accommodations, heated pool, two wooded acres near fishing, boating
- Extras included!!

Call our Studio Manager at 1-800-969-LOLA for rates, info, and advice!!



BLANK PRODUCTIONS / BLANK TAPES
 SECLUDED - COMFORTABLE - STATE OF THE ART

Circle #177 on Reader Service Card

trally located PostPro. Each station could use four of the 16 available tracks, or two stations could use eight tracks each.

Another implication the system brings is the elimination of downtime associated with loading material to and from the hard drive. While digital audio workstations can halve the time needed to accomplish many audio tasks, much of that saved time is consumed by data backup/transfer operations. Within MultiArc, any station could continue to operate while others back up. Thus, a facility need never go completely "down," as the workstation becomes a continuous, overlapping mode of operation.

The heart of this new approach lies in a new internal software and hardware architecture: the Macintosh Nubus. "In a sense, the computer industry caught up to digital audio and now dovetails with it," says Sydney Alonso, NED's chairman and director of research. "Over the years we spent a lot of time developing and implementing our own creations. But in the process, we realized it made more sense to find a standard computer bus rather than invent one ourselves."

MultiArc's open architecture was intended to accommodate not only current computer industry improvements but also unforeseen ones. "We know that the [Motorola] 56000 is the chip of choice now," Alonso explains, "but in five years we may want to switch when something more powerful comes along. We wanted to make sure the architecture could propagate that change with minimum disruption. The same goes for accommodating disk drive improvements."

The DSP option, an upgrade for existing PostPros and Synclaviers, marks the first product for the MultiArc platform. It is the first MultiArc component to use the Macintosh IIx as a graphics display and systems control interface. The DSP provides a 24-bit signal path and operates at 32, 44.1/44.056, 48 or 50 kHz. DSP enhances the PostPro with capabilities including automatic gain control, mixing and equalization.

The DSP option will also offer track capability expansion for PostPro systems. A future software release will double the simultaneous event capability, with no change in existing hardware. NED envisions 32 or 64 tracks, and future tracks are at least a theoretical possibility. Track configuration, in concert with the multi-user



COMPLETE DIGITAL
 MASTERING SERVICES FOR:

- Compact Disc
- Records
- Cassettes
- Archiving Analog to Digital

NEVE DTC DIGITAL TRANSFER CONSOLE:

All mastering parameters performed completely in the digital domain and fully automated for precise accuracy and repeatability.

- Sony 1630/DMR-4000
- Sony 3202 DASH
- Sony 2500 R-DAT
- Sony 601 (Beta/VHS)
- Mitsubishi X-80

CREDITS: Dirty Dancing Soundtracks, Eric Carmen, Expose, Will to Power, Eric Clapton, Betty Wright, Bee Gees, Judas Priest, Julio Iglesias, and many more.



Engineer: Michael Fuller

1755 N.E. 149 STREET / MIAMI, FLORIDA 33181 / (305) 945-6697

Circle #179 on Reader Service Card

Aphex Studio Clock

Make the Impossible ... Possible.



"A major record company came to me with master tapes that were an absolute disaster. One tune was comprised of several different takes that had been spliced together. The time code was gone and there was no way to sync it to the drum tracks. Short of bringing everyone back in the studio, there didn't seem to be any hope for this project. I put my butt on the line and said I could fix the tapes *over a weekend*.

Monday I delivered the tapes with new time code, new drum tracks. Everyone thought I was a miracle worker ... in fact now they call me the *Rhythm Doctor*. My secret, the Aphex Studio Clock, without it I couldn't have delivered. By the way, that \$700 Clock made me \$4000 that weekend."

Steve Klong
Drummer/Electronic Percussionist
Session Musician, "Rhythm Doctor"

"Some marketing types decided to resurrect some 70's hits with new sounds, sequencers, drum machines, etc. In some cases they wanted to save only the vocals and replace all the music.

Since the beats in the original tracks were so complex, nothing on the market would lock up to do the job. Then we discovered the Aphex Studio Clock. This thing can sync to almost any sound ... not just drums. It made the impossible possible.

It's one piece of gear we take with us everywhere today. Besides using it for the remixes, we use it on new production too because the SMPTE to MIDI Converter is tighter than anything we've used before."

Courtney Branch and Tracy Kendrick
Producer/Engineers Total Trak
Productions

You too can make the *impossible possible* with the Aphex Studio Clock TEMPO MAPPER And SMPTE to MIDI Converter. Available at authorized Aphex dealers.

NOW!!
SPECIAL FEATURES FOR D.J.'S,
LIVE PERFORMANCE, FILM SCORING.

All Aphex products are designed and manufactured in the U.S.A.

© 1990 Aphex Systems

APHEX
SYSTEMS

11068 Randall St.
Sun Valley, CA 91352
(818) 767-2929

function, will allow, for instance, a 32-track arrangement to be split into a pair of 16-tracks, each working off a different software interface. (Multitasking capability is expected to become available in early 1991; multi-user in mid-1991.)

The DSP architecture allows for third-party software. The first example of this is the SoundDroid software, a Mac-based editing and list package developed jointly by NED and Lucasfilm.

Tim Schaaff, manager of applications development, expects that software will be the dominant issue in the future: "With the MultiArc approach,

we're looking at an interrelation between parts rather than the parts themselves," he says. "Before, no one contemplated taking a Massenburg automation program in the studio and running it off your Macintosh with Performer. But now we're talking about building software around off-the-shelf software modules, the same way things happen these days with hardware."

Ted Pine, NED director of marketing, states that the MultiArc approach will be compatible with existing Post-Pros and Synclaviers and combinations of the two. "The big problems facing digital audio workstations are their

While digital audio workstations can halve the time needed to accomplish many audio tasks, much of that saved time is consumed by data backup/transfer operations.

expense, the lack of non-standardized interfaces and the learning curves," he explains. "The latter is being reduced drastically by a combination of the systems becoming simpler and a generation of computer-literate users coming online. All current interfaces—ProDigi, AES/EBU, SDIF—are addressed within the MultiArc concept.

"As cost-effective as digital disk-based audio is, the multitasking/multi-user approach is exponentially so," Pine continues. "You buy one box as a shared resource for multiple stations, as opposed to buying one box for each station. Doubling the number of tracks, then, doesn't entail doubling the cost; rather, a 20 to 25 percent increase will be typical."

"Recording studio profits are shrinking, and a way to survive is to use new technology," NED president Brad Naples adds. "Now digital audio has its cost barrier, but this approach can let the facility owner spread the cost over a number of rooms and keep the rooms constantly busy."

Beyond the present plans for MultiArc, Sydney Alonso envisions further development of control surfaces, both physical and virtual. "We plan to introduce virtual automated faders at AES and eventually physical faders," he says. "We want to have adequate control surfaces, and clearly the mouse is not the end of the line. Also, many of the screens have been redesigned to take advantage of the Macintosh."

This system represents a departure in thinking for digital audio workstations. At once evolutionary and revolutionary, NED is banking on an installed base of 843 users (at this writing) to raise the stakes on digital audio. At the very least, it'll make for a provocative AES show and an interesting 1991.

You'll Love Our PLAYING FIELD



GREAT ACCURATE SOUND ...WITH TRUE BASS

The HRM-1 Near Fields represent a significant departure from other reference monitors...Great accurate sound with natural, well-defined bass.

Audix engineers have redefined near-field performance standards. 100-percent increase in voice-coil motor size for 200 watts power handling and unprecedented 48 Hz low end. An acoustic neoprene front baffle absorbs unwanted cabinet refractions, the number one cause of phase problems. Stereo-matched components assure three-dimensional definition for exact instrument placement within the sound field.

State-of-the-art accuracy, high resolution, superior depth of field, and precise imaging. *Audix HRM-1. Love at first play.*

USA: 5653 Stoneridge, Pleasanton, CA 94566
PHONE: 415-463-1112 FAX: 415-463-2149
CUSTOMER SUPPORT: 1-800-888-9992
IN CANADA: TMI, P.O. Box 279, Port
Coquitlam, BC V3C 3V7
PHONE: 604-464-1341 FAX: 604-464-9275

AUDIX[®]
TOOLS FOR SERIOUS PLAY

Circle #180 on Reader Service Card

PRESENTING THE LEXICON 300

A unique digital effects processor with analog and digital inputs and outputs, time code automation, and magnificent sound.

There may be digital effects processors that rival some of the 300's features, but you'll never find one with them all. The 300 delivers precise delay and stereo pitch shifting, as well as stunning

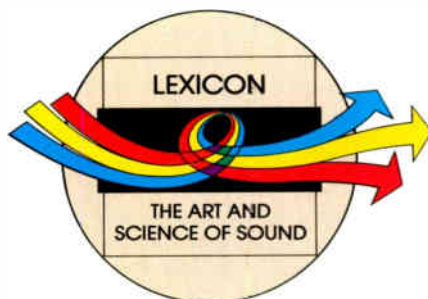

Connectivity redefined

The 300 redefines connectivity standards for digital signal processors. Unique analog and digital circuits accept analog signals or digital signals in the consumer SPDIF or professional

Total MIDI control

With the 300's real time MIDI automation you can record parameter changes on most any sequencer. The 300 also includes Lexicon's Dynamic MIDI® allowing you to control the 300's effects parameters from any MIDI controller.

And of course, the sound is superb. The 300 delivers nearly unmeasurable distortion and exceptional phase linearity through the use of state-of-the-art converters.

They're so advanced you can use their outputs as a system reference.

The 300 joins the Lexicon family of digital effects processors. From the economical LXP-1 to the world renowned 480L, they all share the Lexicon Sound.

For more information about the 300 or any of Lexicon's products, call (617) 891-6790, FAX (617) 891-0340, or write Lexicon, Inc., 100 Beaver St., Waltham, MA 02154.



reverb and ambience. It automates sound changes with SMPTE/EBU time code. And it inputs and outputs analog, as well as consumer and professional digital formats — in any combination. All with magnificent Lexicon Sound.

The 300 is a powerful tool in audio for video applications where time code synchronization is essential. And in digital video editing, the 300 ensures that scene changes are handled smoothly — in the digital domain. Because the 300 has digital inputs and outputs, it's the perfect choice for RDAT and CD mastering. And for music production there is an incomparable set of sounds, as you would expect from Lexicon.

AES/EBU formats. Whether the source is a CD player, RDAT recorder, or open reel digital deck — the 300 identifies and locks onto the incoming format.

You can then select between analog and consumer or professional output formats, regardless of the input format.

Consumer in, professional out, analog in, digital out. The 300 handles them all. You can even mix analog and digital signals.

This kind of connectivity just isn't available anywhere else.



lexicon
The Art and Science of Sound



Wrestling with the Wondrous Insurance Beast

H health insurance?

You want to talk health insurance? Talk to recording studios. Studios find themselves at the bottom of a big, nasty, inverted pyramid of costs.

From top to bottom, the blocks in this pyramid are:

- U.S. health care costs in general, which now amount to about 12 percent of the gross national product. That's just the whole-dollar number, which isn't standing still.

- The rate of increase in health care costs. That rate is significantly higher than the Consumer Price Index, or any other commonly accepted measure of inflation.

- As a result of those cost increases, insurance companies are getting fussier about who they will and, particularly, *won't* insure. And they're raising their rates rapidly on any insured group that's the least bit questionable.

- Last and toughest, insurance companies, which are notoriously conservative, just don't like show business. Joseph H. (Bud) Strauss, senior vice president of General Insurance Consultants (Van Nuys, Calif.), summarizes his industry's attitude to-

by Lawrence Henry

ILLUSTRATION: CHARLIE POWELL

ward recording studios, regarding them as "risky business[es] in an unreliable industry populated by irresponsible flakes."

Bang, bang, bang. You're dead.

Actually, not quite. Recording studios, like any other business, large or small, can play the numbers game, too. The idea is to join together with like businesses to create a larger insured population, to "spread the risk" as the insurance companies say.

But numbers alone will just get you started. To play the health insurance game well requires getting involved with claims administration, managed care, premium collections and perhaps even with self-insurance, an option created under provisions of the Employee Retirement Income Security Act of 1974 (ERISA). It takes an insurance company's expertise to play the insurance industry's game, though it numbs the brain, frankly. As John Lennon says in his story "The Wrestling Dog": "But who would fight this wondrous beast? I wouldn't for a kickoff."

Unfortunately, if you don't fight this wondrous beast, you've got to pay him off, as the Hollywood Association of Recording Professionals is finding out.

Studios find themselves at the bottom of a big, nasty, inverted pyramid of costs.

Jim Mandell of Interlok Studios, HARP's director of membership, states he's been "spending a fair amount of time looking into what it would take to provide an overall health plan for HARP, and how it compares to the plan we have in place at the studio."

The Interlok health insurance experience is typical. Mandell character-

izes the studio's insurance plan as "very good and very expensive. The average cost per person is about \$155 per month. In two years, we've seen about a 100 percent increase [in premiums], which, my insurance company loudly trumpets, is very low compared to the rest of the industry."

Mandell says he has been talking to several agents about a group plan for HARP, among them Mike Rezinis of Simon & Weisberg, Sherman Oaks, Calif., an associate of the aforementioned Bud Strauss.

"The advantage to an organization such as HARP," Rezinis explains, "is that you're able to put together a larger number of employees, thereby making it more interesting to an insurer."

Can a group like HARP protect itself against rate increases or plan cancellations? "The answer is 'yes,'" Rezinis says. "The larger the organization, the more likely that insurance is going to work. With 5- or 10-life groups, which is where studios often are, if you've got one person who goes into the hospital for a couple of days, it changes the group from being very good to very bad. The law of numbers comes into play. Two hundred employees is gen-

Get in Gear for the 90's



▼ TAC MAGNUM

24 buss in-line recording console with 32-track option, 4-band EQ, up to 72 inputs with EQ at mixdown, 8 aux sends assignable to monitors, in-place solo or PFL, 2 mute groups, high-resolution 30-segment bargraphs with peak hold, 288 point patchbay, fader muting/automation ready.

▼ OTARI MX-80 2" RECORDER

MX-80 features a microprocessor-controlled constant-tension transport, a full-function remote

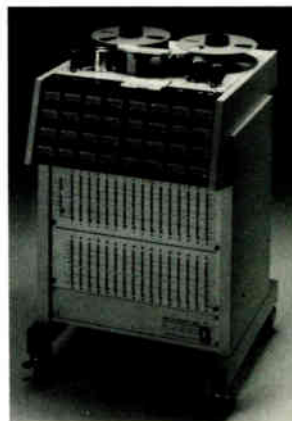

controller, exceptional audio electronics, and connectors for interfacing to any SMPTE/EBU timecode-based editing system, controller, or synchronizer. Available as: 24-track, 24/32-track.

See us at AES booths #29 & #30

**PROFESSIONAL
AUDIO SERVICES
AND SUPPLY CO.**

619 So. Glenwood Place, Burbank, CA 91506. Tel: 818/843-6320. Fax: 818/843-5754

erally considered a starting point for association programs.”

“And at that point the rate comes down? That’s news to me,” Mandell counters. “Because from what I’ve heard, that number needs to be closer to 2,000 to make any kind of difference. The best thing I was able to get from the agent I was talking to was that if 20 studios jumped on, and we had a couple of hundred people, we would be able to petition the insurance companies a year or two down the road. [And depending on] how we fared in terms of claims and payments, we might be able to get them to drop their rates 5 or 10 percent. Which means

nothing.”

As for getting involved in fighting the beast through claims administration, premium collections and managed care strategies, neither Mandell nor the HARP membership at large has the stomach for it. “I don’t know of anyone, including myself, who would be interested in putting the time and effort it would take to form an administrative group to oversee something like this,” Mandell says.

To be fair, HARP was formed as a trade association, not a health insurance lobby. Health insurance is only one of many questions it’s confronting. “In one meeting,” Mandell says, “we

spent an hour talking about the health insurance plan we’ve been kicking around. And what we discovered is that virtually every member studio has a plan in effect that they are either moderately or very pleased with at the moment. And the longer you have a single plan, the more benefits pile up.

“The cumulative effect of that, of course, is that you get a lot of people with folded arms saying, ‘Okay, we’re interested in what you have to say here, but it better beat the pants off what we’ve got or there’s no percentage in it for us.’ And that’s really where we’ve left it.”

HARP member or not, a studio owner might think, naturally enough, to turn to a professional society like NARAS, AES, SMPTE or NAMM for insurance. Unfortunately, these societies mostly don’t offer insurance.

According to insurance agent Bud Dolinger of L.A. Financial (Glendale, Calif.), “You can’t really get an insurance plan with an association. There’s no employer/employee relationship.”

Dolinger acts as an ex officio agent for NARAS members shopping for insurance. “The people who belong to NARAS pay dues, and that’s their affiliation,” Dolinger explains, adding that the only way NARAS could offer an insurance program “is if everybody paid their dues, and if NARAS sent one check to an insurance company.” But, like HARP, “NARAS doesn’t have the facilities to do that.”

Dolinger, an agent himself, puts his finger squarely on one problem of shopping for insurance from agents. “I had three reps from three different health insurance companies come out here,” he says. “All of them told me on the phone that there was no problem. They could [write a NARAS group plan]. Then when they came out, they said they couldn’t. We found out they had some ulterior motives.” The agents hoped to use Dolinger to obtain the NARAS membership list, which they would then use to prospect for new business.

Now wait a minute. There’s some serious confusion going on here. You might well suspect, correctly, that insurance agents are creating much of it.

First, Dolinger is wrong about one thing. Any association can offer insurance coverage if it is willing to become an MET, a Multiple Employer Trust. As a matter of fact, when an insurance agent offers what he or she will call “a group insurance plan,” an MET is almost certainly what he or she’s selling.

THE TRUCK FOR TRACKING

- Neve 8068 MkII
- Multi-track Digital or Analog
- Portable Packages Available

Sheffield
REMOTE
RECORDINGS

PHONE
(301) 628-7260

FAX
(301) 628-1977

Circle #076 on Reader Service Card

You could blow a lot of time resetting EQ's, or you could do something serious.

Like relaxing with your "best friend" after the session. The new Orban digitally controlled, fully-parametric 764 delivers sonically superior EQ in a fully-programmable system. You can build it up to 99 channels of sweet-sounding 4-band parametric, and reset every channel instantly—tomorrow, next week, or five minutes after someone realizes they've made a "really big" mistake on that last track. Download your settings and walk away for a month, or carry them to a new room and load them into another 764. Rapid, non-destructive before/after comparisons keep clients happy and you ahead of your deadlines.

Check out some channels at your local Orban Professional Products dealer. Hook it up to your favorite sequencer or run the 764 from its own easy-to-navigate master panel. It feels right, and it sounds right. You'll get all the benefits of digital control in a mastering-grade EQ for less than \$1000 a channel.* Then you'll have to decide how to spend your extra time—making more money or having more fun.

* Systems of nine channels or more. Prices are set by dealer and may vary. Shown: eight channels in eight units of rack space. Suggested price: \$8,180.



The Orban 764A Programmable Parametric Equalization System

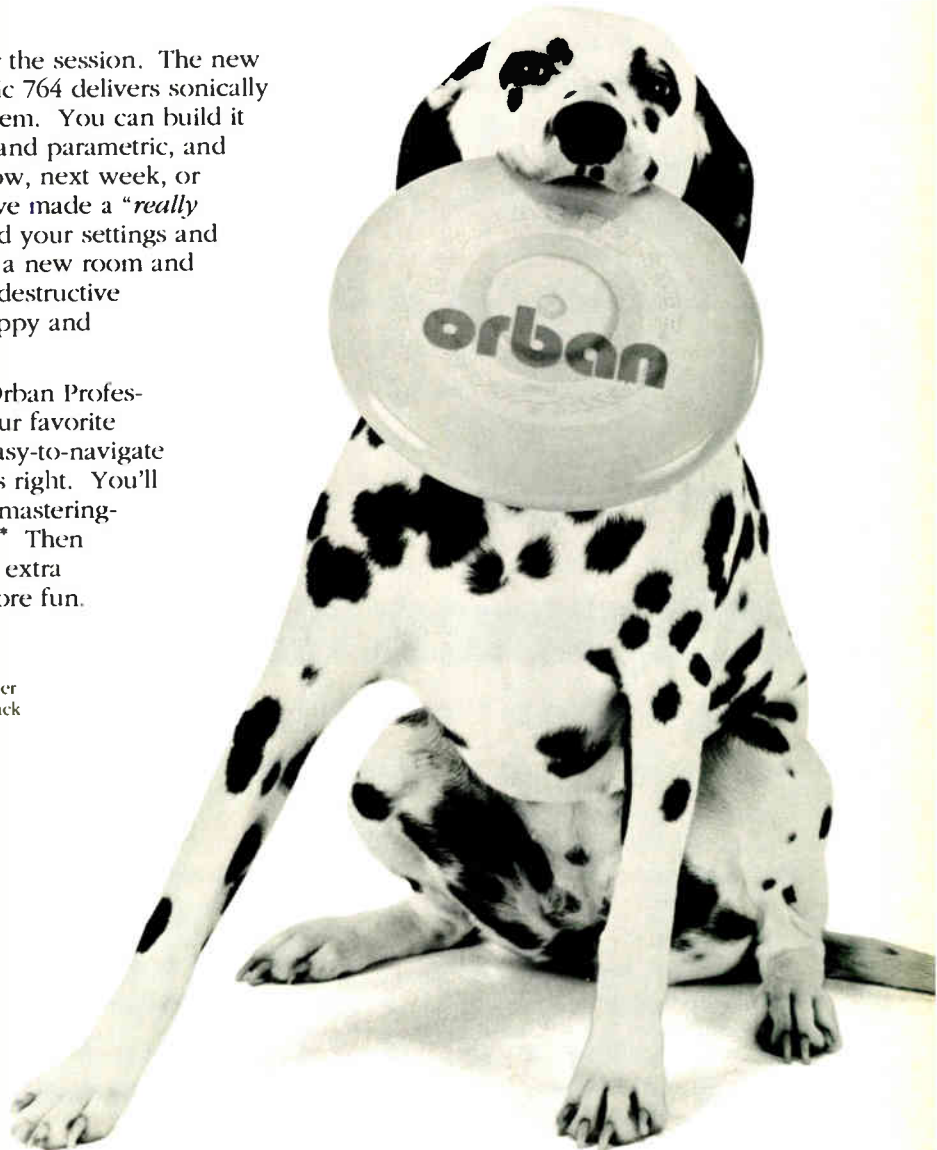

orban
a division of AKG Acoustics, Inc.

LISTEN TO THE DIFFERENCE.

1525 Alvarado Street, San Leandro, CA 94577 USA
Telephone 415/351-3500 FAX 415/351-0500

1ST DIGITALLY DESIGNED ENGINEERING DISC

- 68 Audio Tests • AES/EBU Standard
- Standard reference level for digital & analog 1630/1610, DAT, MIDI, Hard drive virtually to any digital port.

\$79⁹⁵ CALL 805/984-2626

QUAD TECK DIGITAL

4007 West 6th Street
Los Angeles, CA 90020

Circle #077 on Reader Service Card

 **UCLA
EXTENSION**

Entertainment Studies

The School of Hard Rocks

Personal Views of Success in the Music Industry

Important figures of the music industry—world-class artists, composers, producers, publishers, and engineers—join **Mr. Bonzai**, Editor-at-Large of *Mix*, in four evenings of lively, revealing discussion about their personal paths to survival and success in the highly competitive music business.

Guest speakers scheduled to appear:

Jeff "Skunk" Baxter, of Steely Dan and The Doobie Brothers fame; **Hal Blaine**, drummer, the world's most recorded musician; **Ed Cherney**, Grammy Album of the Year engineer; **Jim Keltner**, drummer, The Traveling Wilburys; **Steve Lukather** of Toto; **Ray Manzarek** of The Doors; **Joel Moss**, award-winning scoring engineer; **Van Dyke Parks**, recording artist and film composer for *The Two Jakes*; **Stephen Paul**, musician and high-tech audio authority; **Chris Stone**, founder of the Record Plant recording studios; **David Schwartz**, Editor-in-Chief, *Mix*; **Tommy Tedesco**, session guitar player for records, TV, and film; **David Was**, recording artist; **Don Was**, Grammy Album of the Year producer.

Tuesdays, 7-10 pm, October 30-November 27
UCLA: Neuropsychiatric Institute Auditorium
Fee: \$125 EDP M8793L

To enroll with VISA or MasterCard call (213) 825-9971 or (818) 784-7006. For more information call (213) 825-9064.

HL A81

Circle #078 on Reader Service Card

But you'll never hear the term from the agent.

METs assemble a large group, and then "METs typically take over the premium billing function from insurance companies," says insurance expert, writer and tax consultant Milton Zall. "They send one big check to the insurance companies. Also, typically, METs will handle claims processing for insurance companies. Insurance companies like to deal with them."

Second, hundreds of METs already exist. There's no need for HARP or NARAS or any other professional association to re-invent the wheel. "There's really no need to form a new MET," Zall says. "Some METs are restricted to membership in a particular industry. But lots of them are fairly flexible."

One business owner Zall mentioned owned a garbage collection company. Shopping around for lower insurance rates, this garbage hauler belonged to three METs in as many years: an association of small business owners, a nationwide garbage haulers' trust, and the third a statewide unrelated business trust.

Insurance agents and brokers know about METs, Zall says, and can tell you about any METs "you may qualify to be a member of." But there's the rub. An insurance broker is also selling a MET. And he or she's likely to favor those few METs the broker represents to the exclusion of all others. You can dig up more METs through chambers of commerce (there are dozens of chambers in Southern California alone), labor unions and trade associations. Zall himself, as a self-employed professional, buys disability insurance through a MET called the "Entertainment Industry Group Insurance Trust" in New York.

The moral is to call more than one broker. Call lots of brokers, in fact. And when you do, Zall recommends asking about cost comparison services, computerized online databases to which many agents subscribe. In half an hour, you can get a printout of 100 or more insurance providers' plans specializing in small businesses.

"It's just a question of shopping," Zall says. And of realizing that insurance brokers won't encourage you to shop. ■

Lawrence Henry is a freelance writer whose work has appeared in Investor's Daily, Psychology Today and Adweek.



1990
NOMINEE



IF A·DAM IS JUST ANOTHER
DIGITAL MULTI-TRACK,
STEVIE IS JUST ANOTHER MUSICIAN.

You know how good this guy is. For total musical abilities there's simply no one better. So when an impressive guy like Stevie tells us he's real impressed with A·DAM, it's music to our ears.

Well, what Stevie is doing for music, Akai is doing for digital multi-track. A·DAM. The world's first portable digital multi-track, with the convenience of universally accepted 8mm tape, gives you the flexibility to expand to 36 tracks. It's the only digital machine within the means of any professional application.

A·DAM is the ultimate satellite multi-track. In a midi facility, A·DAM is the ideal primary machine because its SMPTE

compatibility lets you devote 12 digital tracks to vocals. And with single frame editing, you can now eliminate the most difficult breaths and pops with absolute precision.

A·DAM. Just another wonder from Akai. Call today for the authorized AKAI Digital dealer nearest you.

AKAI
DIGITAL

P.O. Box 2344 · Fort Worth, TX 76113
(817) 336-5114

Circle #091 on Reader Service Card

POWER

THE
POLITICS
OF

by
Herb
Levitin

Taking Control of Your Electrical Environment



ILLUSTRATION: BARON STORREY

Power corrupts! I am not referring to conventional political power, but the AC power we use to do our everyday work. Unfortunately, we are all victims to a few unwanted "extras" that accompany the energy we pay for: high-frequency and high-energy impulses, notches, transients and voltage fluctuations—all of which create electrical stress for sensitive equipment. And we are also subject to political fallout of another sort: Users are being victimized by manufacturers, utility companies and service people. They use AC power as an excuse to point their fingers at someone else.

In my six years of involvement with electronic and computer grade power issues, I have seen fingers pointed, poked and waved by all parties involved in equipment reliability issues. Solutions to power problems seem to be based on folklore and tradition rather than analyzing causes and testing solutions. Rather than getting caught up in the politics of power, we should take control of our electrical environment and resolve potential problems before they arise.

What is the cost of ignoring the AC power interface? Equipment and studio downtime, performance unreliability, customer dissatisfaction, and excessive maintenance costs. Manufacturers are concerned with some of these issues, while users are concerned with others. The bottom line is that if you invest money in a product and it fails, operates erratically or unreliably, then you are not getting any value from your investment.

Typically, the aural environment of a studio is given more attention during the design and construction phase than its electrical aspects. But before we review those electrical aspects we should define the most important elements of electronic and computer grade power.

The ground is the reference. Virtually every electronic device—whether analog or digital—uses the ground of your electrical system as its reference point. Computers use five volts DC for their integrated circuits. What happens

to the 5VDC logic of a microprocessor if the reference point is moved from zero to five volts and back to zero volts in a couple of microseconds? Since a 5-volt change of the reference is a 100% change, there is a good possibility that the logic may change its state from a "1" to a "0," altering an instruction to go to the next address into an order jumping it to never-never land. At that point, the microprocessor becomes lost, and the system typically hangs up and must be reset manually. The likelihood of a ground reference change (referred to as common-mode noise) affecting reliability has increased with each new generation of microprocessor and digital signal processor chips. To improve performance, the clocking speeds have increased and the width

of the traces inside the chip have decreased. Until manufacturers become more aware of the electrical environment of their equipment, things are going to get worse before they get better.

Lack of voltage regulation has been one of the perceived problems affecting older, linear-type power supplies used in analog circuits. It is less of an issue with computers using a switch-mode power supply (SMPS). This type of power supply has a wide operating voltage range; as an example, a typical Macintosh computer will work down to 60 VAC. Some of the common voltage regulation devices still available today are incompatible with SMPS types and aggravate equipment reliability. An SMPS is a current-sensitive (not voltage-sensitive) device, which requires a low-impedance power source. If power outages are of any concern to you, an online, low-impedance, uninterruptible power system (UPS) is a better value than a voltage regulator. An online UPS will regulate voltage much better than either the active or passive regulators available and will save the day by preventing your computer from crashing. If your computer system is on a PC network or is running under the UNIX or PICK operating systems, owning a UPS is *essential*. Although a standby UPS is less expensive than an online UPS, it can generate noise when (and if) it switches on, and most do not produce a waveform anything like a sine wave.

Computer reliability problems can also stem from excessive electrical noise between the line and neutral wires, referred to as normal-mode noise. Typical surge suppressors address only normal-mode noise. They are available from \$5 to over \$150. (Rule of thumb: The slicker the marketing material, the higher the price of the surge suppressor.) Normal-mode noise is a problem that should be controlled, but surge suppressors convert normal-mode noise to common-mode noise, which *changes your ground reference*. You want your ground reference to be zero volts at all frequencies, at all times.

If your electrician wires condos, find another electrician. The majority of electrical environmental problems in a studio are caused by electricians.

**A SYSTEM
HAS THE POWER
TO KILL IF THE
GROUND ROD IS
NOT CONNECTED
TO THE REST
OF THE
ELECTRICAL SYSTEM
WITH
COPPER WIRE.**



Stack the deck in your favor.



- compressor/limiters
- noise gates • expanders
- duckers • amplifiers
- microphone preamps
- telephone interfaces
- automatic level controllers
- headphone amplifiers
- parametric equalizers
- precision meters
- voice processors
- noise reduction

Symetrix Inc. 4211 24th Ave. W. Seattle, WA 98119
 Tel: 1-800-788-8855 (206) 282-2555 • Fax: (206) 283-5504

Europe: WMM Marketing Tel: 44 0367 52605 Fax: 44 0367 52614 • Canada: SF Marketing Tel: (514) 733-5344 Fax: (514) 733-7140 • Great Britain: Sound Technology Tel: 44 0462 480000 Fax: 44 0462 480800

Circle #129 on Reader Service Card

To clean up noise in studios (and in many computer rooms), electricians have been installing isolated ground (IG) receptacles. These are easily identified by their orange color. If you have orange plugs, or have been told you have isolated ground circuits, you should inspect your wiring. An isolated ground is simply an insulated ground wire that runs to the main building service entrance or the last stepdown transformer. The ground reference of your electrical system is, therefore, either the building service entrance or at the last stepdown transformer feeding your subpanel. This is the point where the neutral wire is bonded to the ground wire.

If you inspect your building wiring you may find a ground rod connected to an insulated bus where all the insulated ground wires from the IG receptacles are tied together. If there is no direct connection from this ground bus to the building ground reference by means of a grounding conductor (usually green or black wire with green tape), you have the makings of an electric chair. The National Electrical Code (NEC) is *very* specific about grounding.

A system has the potential to kill if

the ground rod is not connected to the rest of the electrical system with copper wire. The ground wire is primarily for electrical safety. A separate ground rod that is not connected directly to the electrical service will have a high resistance path back to the building service entrance. If an electrical or electronic device develops a short circuit, the amount of current flowing in the ground circuit may be too small to trip a circuit breaker. The grounded parts of equipment will then approach a potential of 120 VAC. If you then come into contact with any plumbing or building steel you may complete the circuit with your body. This is an unsettling side-effect of having chosen such a noiseless system.

There are solutions to grounding problems that are legal, safe and really work. The first thing you want to do for your studio is establish a new ground reference and electrical subsystem that has only sensitive electronics as loads. Air conditioners, fluorescent lights and anything that has a motor or an inductor (including lamp dimmers) should not be part of this system. The best method is to install a low-impedance power conditioner that feeds a dedicated subpanel. The power condi-

tioner uses a transformer and an output network. The transformer isolates the common-mode noise by simply bonding the neutral to the ground on its output. The ground wire is continuous from the building service entrance through to the receptacle.

Now that I have given away the secret of a multimillion-dollar industry there is one more item to resolve: the normal-mode noise. The power conditioners' transformer has electrostatic shielding, which cuts the normal-mode noise to a reduced level. This remaining noise is filtered by the output network, providing an AC short for the unwanted high frequencies. A properly designed low-impedance power conditioner can reduce the worst-case noise impulse of 6 kVA at 100 kHz to less than ten volts on normal-mode and less than 500 millivolts on common mode.

You could install your ground rod to the reference point of the power conditioner, but I do not advise this. A newly driven ground rod has much lower resistance than the original building ground rod. Common-mode noise generated in your building wants to go to ground. It is far better for the

—CONTINUED ON PAGE 134

HALF SIZE DOUBLE SOUND

The Rolls HR210 dual 10 band EQ and the HR250 stereo 50 watt power amp. will solve your toughest size/performance problems. These units feature rugged steel chassis in the half rack standard format, high reliability circuitry and are available now. The HR210 is the quietest EQ we've ever seen and the HR250 uses mosfet design and LED power meters to make it a performance leader in half rack products.

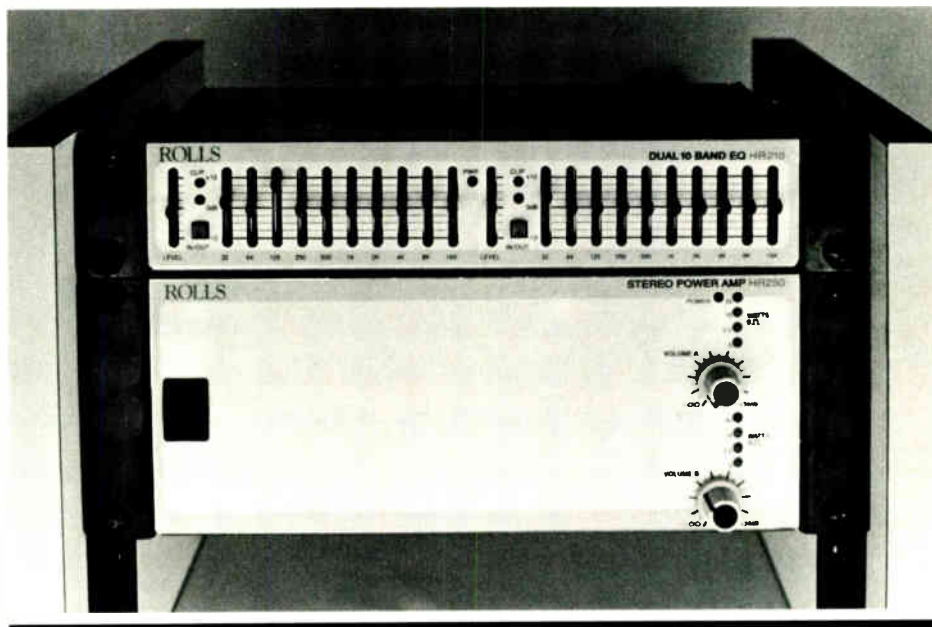

For more information contact:

ROLLS CORPORATION
7023 South 400 West, Midvale, Utah 84047
Telephone 801-562-5628, Fax 801-562-5655

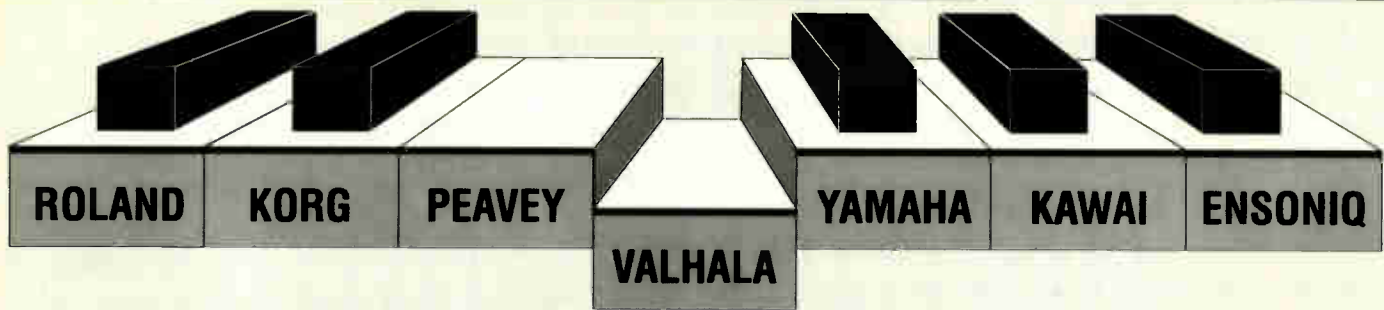

DISCOUNT ROM and RAM PRICES!

BEST VOICES WORLDWIDE!	ROLAND			KORG			PEAVEY	ENSONIQ	YAMAHA		KAWAI	
	D50/D550	D10/20/5	D110	M1/M1R	M3R	T1/T2/T3	DPM3	VFX / VFXSD	SY55	SY77	K1	K4
ROM STYLE	\$40.00 _{ea}	\$40.00 _{ea}	\$40.00 _{ea}	\$45.00 _{ea}	\$45.00 _{ea}	\$40.00 _{ea}	\$50.00 _{ea}	N/A	TBA*	TBA*	\$40.00 _{ea}	\$50.00 _{ea}
NEW AGE	V200	V210	V220	M-103	M-303	TD-3	DP-203					
ANALOG	V201	V211	V221									
ORCHESTRAL	V202	V212	V222	M-102	M-302	TD-2	DP-202		S-502	S-702	K-102	
TOP 40	V203	V213	V223	M-101	M-301	TD-1	DP-201		S-501	S-701	K-101	
DIGITAL	V204	V214	V224									
PCM	V205	V215	V225									
EFFECTS	V206	V216	V226									
ROCK				M-104	M-304	TD-4	DP-204					
International Gold	\$45.00 _{ea}	\$45.00 _{ea}	\$45.00 _{ea}	\$50.00 _{ea}	\$50.00 _{ea}	\$45.00 _{ea}		\$50.00 _{ea}	TBA*	TBA*	\$45.00 _{ea}	\$55.00 _{ea}
BRITISH MIX #1	D-501	D-121	D-131	B-101	B-301	B-401		FX-101	B-501	B-701	BK1-01	BK4-01
BRITISH MIX #2	D-502	D-122	D-132	B-102	B-302	B-402		FX-102	B-502	B-702	BK1-02	BK4-02

ROMS

Peavey Voice ROMS on disk only **\$40.00** ea
 Ensoniq VFX Voices on VFXSD disk only **\$40.00** ea
 Ensoniq VFX 'dual-cartridge' containing both
 Int Gold™ banks (FX-101 & FX-102) only **\$90.00**
 Korg TD-1 thru TD-4, B-401 and B-402 are diskettes.

*{TBA} Call (313) 548-9360 for availability & pricing.

RAMS

Korg MCR-03 RAM **\$65.00** ea
 Kawai K1/K1r RAM **\$45.00** ea
 Kawai K4/K4r RAM **\$60.00** ea
 Peavey "Cache Card" RAM **\$65.00** ea
 Roland M-246D or M-256E RAM **\$55.00** ea
 Yamaha MCD32 RAM (for SY55/TG55) (Call for pricing)
 Yamaha MCD64 RAM (for SY77/TG77) (Call for pricing)

RAMS loaded at time of purchase for only \$10.00 per RAM
 (your choice of any one of Valhala's ROM cards)

**VALHALA PRODUCTS ARE AVAILABLE
 DIRECT ONLY-NOT IN RETAIL STORES!**

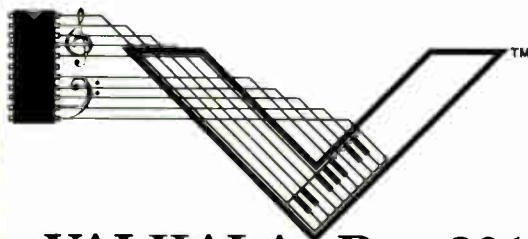

For information, voice listings, assistance
 or to check on the status of an order call:

1-313-548-9360

The number below is for placing Visa or MasterCard **ORDERS ONLY!**
 When calling, have your card number ready along with the expiration date.
 Minimum ChargeCard order: \$20.00 Business Hours 9am-5:00pm M-F (EST)

ORDERS ONLY call: 1-800-648-6434 ext. 508



VALHALA Box 20157-MX Ferndale, Michigan 48220

THE ULTIMATE DIGITAL SAMPLING CDs!

\$59.00 each - Any two for \$110.00, or three for \$160.00

SONIC IMAGES

MASTER BITS

SAMPLING COLLECTION 500

VOL 1: DRUMS, PERCUSSION, MUSICAL EFFECTS
288 Sounds organized in 24 Drumsets and 9 instrument categories, includes 24 short demos.

{528 Synth & Drum Samples in Stereo}

M1 • D-50 • K1 • K5 • DX7II • K-1000 • ESQ-1
PPG 2.3 • FZ-1 • MiniMOOG • TR-808 • Alesis HR-16
Simmons SDS-5 • Linn 9000 • plus more.

SAMPLING COLLECTION 600

VOL 2: PERCUSSION SPECIAL {290 Stereo Samples}
Asian, African, Latin and Other Percussion Instruments
(Including: Waterdrum, Surdo, Bougarabou, Dondo, Rain Stick, Djun, Marimbula, Tibetan Crotales, Sourouba, Chinese Opera Gong, and more)

{649 Stereo Digital Studio Samples}

Waldorf-Microwave • Korg T1 • Proteus-XR
Akai S-1000 • Kawai K4 • VFX • Prophet VS
Oberheim X-pander • Roland CR-78 • plus more.

SAMPLING COLLECTION 800

VOL 3: STACK SOUNDS A {216 Stereo Samples}
VOL 4: STACK SOUNDS B {247 Stereo Samples}
Each volume contains 24 stereo stacks consisting of 4 to 8 layers of; Symphonic Orchestra, Strings, Brass, Flutes, Piano, 12 String Guitar, Harpsichord, Choir, Historical Instruments, HighEnd Synth Sounds & more...

{830 Stereo Digital Studio Samples}

Ensoniq VFX • EMUII • Kurzweil PX-1000 Plus
Roland R-8 • Oberheim Matrix 1000
Kurzweil HX-1000 • Casio VZ-1 • Roland MKS-70
Casio FZ-10M • Korg M1R • plus more.



VOL 5: MUSICAL EFFECTS {243 Stereo Samples}
Percussive, Acoustical & Electronic Effects. Including; Orchestra Hits, Tibetan Monks, Whale Screams, Japanese Flutes, African Percussion Effects, Cobra Strike, Space Clusters, VCS 3, Moog FX and much more...

VOL 6: GRAND PIANOS {404 Stereo Samples}
Steinway "D"..... the classic - no comment needed
Bosendorfer..... concert grand, rich sounding
Bechstein "EN"..... the famous german concert grand
Seiler MIDI Grand..... very bright sounding
Klavins Mod. 370..... 12-foot upright piano the World's largest stringed instrument!

SONIC IMAGES Demonstration CD Disk \$10.00 (+ S/H).

Features audio examples from all six volumes.
{Refundable toward the purchase of 2 or more CDs.}

CLIMAX-COLLECTION Vol 1 • VOCALS*

{664 Digital Studio Samples}

Contains the standard-vocals (ooh, ah, oh, mmh, etc) multi-sampled. Different timbres (clean voice, powerful soul voices, rock lady, etc). The ultimate sampling CD for human vocal sounds - no limits to your creativity!

*CLIMAX Vol 1 VOCAL CD \$69.00

(Cannot be applied toward multi-purchase CD discounts)



20 diskettes per volume!

- | | | | |
|------------------------|-----------------------|------------------------|-------------------------|
| VOLUME 1 | VOLUME 2 | VOLUME 3 | VOLUME 4 |
| • Symphonic Orch. | • Percussion 1 | • Musical Effects 1 | 20 Drumsets including |
| • Seiler Autogrand | • Percussion 2 | • Musical Effects 2 | Percussion in 10 banks |
| • Drumset 1+2 | • Bass Stack* | • Klavins GrandPiano | & 80 Programs. |
| • Drumset 3+4 | • Harpsiflute* | • Mystery Pad* | |
| • Bright Guitar Strgs* | • Bright E-PnoStrgs* | • JapanFluteOrchestra* | VOLUME 5 |
| • Glockenflute* | • Six Pianos* | • Staccato Orchestra* | 156 Musical Effects and |
| • Industrial Bamboo* | • Soft Piano Strings* | • Rainstick Choir* | exotic Percussion in 10 |
| • Plug Mix* | • Spacelanding* | • Octave Bellstrings* | banks & 93 Programs. |
| • Full Choirstrings* | • Soft Voices* | • Piano Orchestra* | |
| • Rough Stack* | • Fast Attack Fuzz* | • Piano Strings* | * STACK SOUNDS |

\$178.00 per volume
Each volume contains 70 programs minimum. (for each volume ordered add an extra \$1.50 s/h, for 2nd Day \$2.25 extra. AK, HI, PR & CANADA add \$3.50 extra). This S/H per volume is in addition to the normal S/H prices listed below.

DIRECT ORDER FORM Mail to: VALHALA Box 20157-MX Ferndale, MI 48220

SHIPPING & HANDLING INFO

QTY	PRODUCT DESCRIPTION	PRICE	EXTENDED
All orders are shipped UPS, a street address is required! **Print or Type Information**		SubTotal	\$
Name _____		MI 4% Tax	\$
Street _____		SHIPPING	\$
City _____		Extra Shipping	\$
State _____ Zip _____		TOTAL	\$
Area Code/Daytime Phone _____			

Continental USA \$4.50 Shipping/Handling; 2nd Day UPS \$8.00 S/H (2nd day air means you will receive your product 2-working days after your order is processed - provided it is in stock). Mich res add 4% tax. Alaska, Hawaii, PR & CANADA add \$12.00 S/H. All other countries add \$25.00 S/H plus \$3.50 for each additional item ordered. All payments must be in USA FUNDS drawn on a USA bank!

Business hours 9am - 5pm Monday-Friday (EST)

Card # _____

Exp. Date _____

Signature _____

VOICE: (313) 548-9360
FAX: (313) 547-5949

VISA Minimum ChargeCard order \$20.00

MasterCard

—FROM PAGE 131, POWER

noise impulse created by an air conditioner to go away from your studio than toward (and through) your sensitive equipment on its way to earth. In an exhaustive test of clean power systems, a low-impedance power conditioner without a ground rod reduced printed circuit board replacements by 90% and service calls by 50% over using a ground rod and a surge suppressor. In larger facilities a power conditioner can be built on site by adding an output network to an existing stepdown transformer.

At least once a week I am asked to quote a system with a UPS having from one to four hours of backup time. The first question I ask is: "What's going to keep the equipment and people cool while the power is out?" Unless you operate a missile control center for the Strategic Air Command or a major financial institution that processes credit card transactions, you do not need engine generators, diesel preheaters, underground storage tanks, day tanks, ground pollution monitoring and EPA reporting. Since 90% of power outages are five minutes or less, the 15 minutes of battery backup is usually sufficient, and you can obtain a true online UPS

that has 1.25 kVA of power (enough to handle 18 Macintosh SEs), weighs 70 pounds and uses only 5.25 inches of rackspace. Unfortunately, the majority of UPS types do not clean up the common-mode noise, but tend to pollute the ground reference. An oscilloscope with a line viewer will give you a true indication of the electrical cleanliness of any UPS.

If you are having problems and use a large computer or telephone system, the manufacturer or service organization will probably monitor your site. This is the opening move in the "politics of power" game. Be aware that the monitoring equipment is usually rigged—not by the service organization—but by the designer of the equipment. One of the most popular power monitors measures frequency by counting the number of pulses in a given amount of time. A common AC power phenomena is a notch. A notch is usually caused by a large load being switched on or a power factor correction capacitor being energized. A subcycle notch will eliminate one-half of a power cycle, causing the power monitor to report a low frequency. Is it time to install a \$30,000 motor generator or online UPS? No. More likely,

it is time to get a better monitor.

The utilities have relays that take a generator offline if the frequency varies by 0.4 Hz. Your computer doesn't care about AC frequency as long as it is somewhere between 47 and 63 Hz. The computer's SMPS will actually work on just about any frequency, including DC, and the DC polarity does not matter (although a cooling fan will have a problem with a DC voltage if it has an AC motor).

Before you waste a lot of time on expensive power surveys (with sometimes confusing results and wasteful politics), try to borrow or rent a power conditioner and/or UPS and install it for a month. If you have a power-related problem, it should go away. If you have provided a clean reference for your sensitive load, filtered out the normal-mode noise, provided a clean, uninterruptible power source and are still having problems, you are either experiencing backdoor hits from unprotected peripherals or your problems may not be environmental.

Recently, we installed a large UPS and a power conditioner to protect a \$1.5 million computer. The system refused to work after the cutover to the new power protection equipment. The



Neutrik SpeakOn™ Connectors... safe for sound

A speaker/amplifier interconnect that is virtually indestructible and ensures safe conditions for audio equipment and operators.

Another
Neutrik
innovation

Neutrik USA, Inc. • 195-S3 Lehigh Ave. • Lakewood, NJ 08701-4527
TEL: 201-901-9488 • FAX: 201-901-9608

NEUTRIK
USA, INC.
CONNECTORS
AUDIO TEST SYSTEMS
INFOMATIC SYSTEMS

Circle #068 on Reader Service Card

World Radio History

THE SOUND OF PERFECTION



- WAREHOUSE SNARE
REV: POSITH= 83%
- INFINITE PLATE
REV: DTFEUS= 100%
- DREAM FLANGE
7 CMP+EQ+EXP
- NIGHT DEMON GTR
7 EQ+CMP+DST
- MIDI CTL=176 CH01
MIDWHEEL=001:054

A short time ago, A.R.T. stunned the recording world with the release of the SGE Mach II. Offering 12 simultaneous effects and a 400% more powerful processing section, the Mach II offered spatial realism that defied description. The all new DRX uses that same processor and is expressly designed for studios and live sound applications. The DRX will do 10 simultaneous audio functions and features an exciter, compressor, limiter, noise gate, expander, envelope filter, 24 different reverb algorithms, 21 different delays, sampling, pitch transposing, panning, equalization, leslies, stereo flange and chorus and more—over 60 effects to choose from with bandwidth to 20 KHz! The creative power is astonishing. The noise gate can gate off microphones so the wash from live drums doesn't trigger your effects buss. The compressor can smooth out wild dynamic swings on vocals. The exciter will increase the edge and clarity of any type of material. The noise gate can "turn-off" noisy guitar amps in between songs or allow you to run higher gain levels without feedback on vocal and drum mics. The limiter can hard limit any source so that clipping can be totally prevented. And you can pick and choose effects and mix and match at random into 200 memories!

- SHIMMERING CHOR
7 EQ+CMP+EXP
- BRITISH THUNDER
PT: PITCH = -12
- PITCHBND=224 CH01
LSB=126 MSB=127

The all new Multiverb III uses the same revolutionary processor as the DRX and offers more than 50 effects to choose from! The Multiverb III features everything the DRX does except the dynamic effects section (comp/limit/gate). It will do four simultaneous effects and unlike other units allows you to pick and choose effects at will and change their locations—you're not limited to confusing configurations. Like the DRX, it features a Midi Data Monitor that allows you to see the digital midi data stream—simply connect a keyboard, foot controller or any other midi device and the LCD will give you a real time readout of channel pressure, patch change or any other midi info! And the sound and spatial realism of the Multiverb III is absolutely stunning.



The Multiverb LT offers the power of the Multiverb III in an ultra simple format. It will do 3 simultaneous effects and contains 192 of the finest studio effects combinations ever created. Lush reverbs, delays, flange, chorus, and special effects combinations are available at the touch of a button! The sound for the price is unbelievable—and midi addressable. The NEW X-II Midi Foot Controller works with all midi effects units—at a great low price.

Circle #292 on Reader Service Card



TAC Magnum

QUALITY ASSURED, PRICE UNBEATABLE

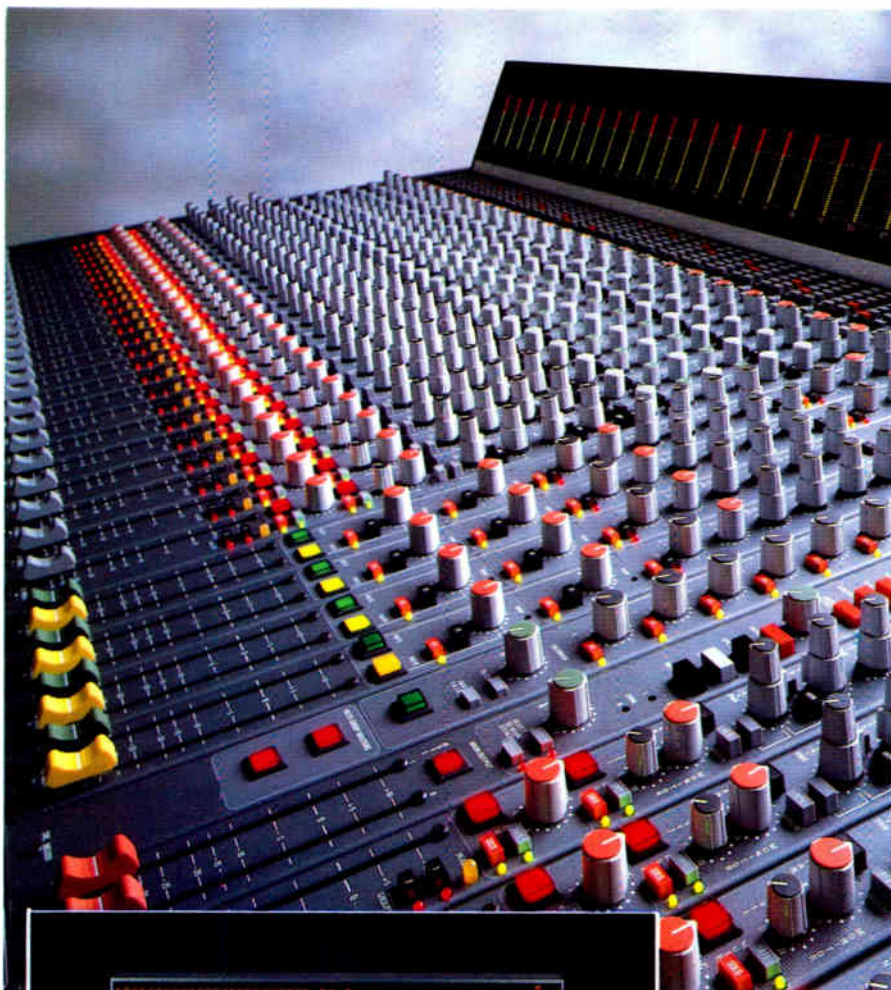

You need an edge. The world is competitive and you're creative but hard-pressed. You need a console that allows your creativity to shine through without compromising your finances.

Building consoles to meet that specification is what TAC does to perfection. We deliver an unbeatable combination of performance, features, construction and price.

We know console technology. The MAGNUM is proof positive and is perfect for multitrack, video post and broadcast production. Look at this checklist for comparison:

CONFIGURATION: 24-buss in-line console with dual-input technology, allowing each channel to have two independent signal paths.

EQUALIZER: the powerful 4-band semi-parametric equalizer can be split between channel and monitor paths, giving 72 inputs with eq on mixdown in the 36 input chassis.

AUXILIARIES: 8 Auxiliary sends – four mono and two stereo – can be fed from channel or monitor signal paths. Sends 7 & 8 can also be routed to the 24 busses for extra effects feeds. 8 effects returns, with sends to all 8 Auxiliaries, are provided.

SOLO/PFL SYSTEM: MAGNUM has a Master Status controlled in-place solo switch on both channel and monitor paths. When de-activated, solo switches provide a full Pfl facility. MAGNUM also has two independent Mute groups.

AUTOMATION: channel mutes can be automated via MIDI; C-MIX fader and mute automation system can be fitted.

CHASSIS: welded steel with a pcb-based bussing system and an expandable 288-point TT jackfield.

Some of the many other vital facilities include channel fader reverse, 30-segment LED meters with peak hold, optional stereo line inputs, 8 audio subgroups and comprehensive control room monitor system.

TAC MAGNUM. The only choice.



Total Audio Concepts
Unit 17, Bar Lane Industrial Park, Bar Lane, Basford,
Nottingham NG6 0HU.
Telephone: 0602 783306.
Telex: 37329. Fax: 0602 785112.

In the USA:
10815 Burbank Blvd, North Hollywood,
California 91601.
Telephone: 818/508 9788. Fax: 818/508 8619.



company's manager of information services was certain the new equipment was at fault. The problem was traced to one missing character in a configuration file. Programmers, field engineers and design engineers always have the catch-all "it's your power" up their sleeves when they are unsure what the reliability problems are. Rather than be a victim of the "politics of power," be prepared to ask questions, analyze and solve your site problems. ■

Herb Levitin is a consulting distributor of computer-grade power products. He has also worked as an electrical contractor, and has spent ten years doing R&D as an electronic engineer.

Graham Nash's "Power" Problems on the Road

A Case Study

Graham Nash was on the road touring with CSN and was having some problems with computer reliability. A quick check at his home studio with an oscilloscope and a line viewer showed an excessive amount of normal-mode and common-mode noise. A ground rod without a connection to the building ground reference was found in the subpanel feeding the studio. Correcting the wiring error did not substantially affect the noise on the insulated ground receptacles. Nash had a requirement for uninterrupted power that could operate in Europe, the USA and in Japan.

The solution for both the road and home studio equipment was a 1.5kVA ONEAC rack-mount power conditioner with an input range of 100 to 240 VAC (50 to 60 Hz) and an online 1.25kVA UPS made by Clary Corp. (San Gabriel, Calif.). The latter could also run on 50 Hz (the standard line frequency in Japan and Europe) and produce USA-standard 60 Hz. The two units were installed in a road rack and shipped off to the tour. When the tour ends, the rack will power the home studio, providing clean, uninterrupted power for multiple computers and MIDI instruments.

—HL

Take Your First Step Toward A Career In The Music Business

TEC
1990
NOMINEE



**TREBAS
INSTITUTE**

- Highly selective, two year training program
- Five campuses throughout North America
- Current theory mixed with practical hands-on training
- Modern state-of-the-art 24-track recording studios
- All classes taught by qualified, working professionals
- Job placement assistance
- Financial assistance available for eligible students
- Fully accredited by ACCET

6464 Sunset Blvd.
The Penthouse
Hollywood, CA
90028
(213)467-6800

112 East 3rd Ave.,
Suite 305
Vancouver, B.C.
V5T 1C8 Canada
(604) 872-2666

410 Dundas St., East
Toronto, Ontario
M5A 2A8 Canada
(416) 966-3066

200-440 Laurier
Ave. W.
Ottawa, Ontario,
K1R 7X6 Canada
(613)782-2231

451 St. Jean St.
Montreal, Quebec,
H2Y 2R5 Canada
(514)845-4141

Circle #216 on Reader Service Card

Uniquely Markertek!

MARKERFOAM™ ACOUSTIC FOAM



GIANT
54" x 54"
\$19.99
Per Sheet!!

Blue
or
Grey

KILL NOISE QUICK! Soundproof studios, rehearsal spaces, vans, rooms with super-effective, E-Z mount, 2" thick studio gray or natural blue (specify color). Markerfoam offers outstanding sound absorption qualities. Immediate shipping. Add \$3.50 sheet shipping. NYS residents add 7% tax. MC Visa Amex. COD Check Terms. 3-inch sheets also available at \$29.99.

MARKERTEK BLADE TILES™

HIGH PERFORMANCE
LOW, LOW COST!
\$2.99 per tile, 16x16x2
America's best acoustic tile
value, only from Markertek!
Charcoal. Also available 16x
16x3" as shown \$3.99 each.



MARKERSTIK™ foam adhesive.
Works with any standard
caulking gun. Mounts up to
50 square ft. \$3.80 per tube.



MARKERFLAGS™
Custom microphone flags
in ten styles with our
exclusive engraved look.



Get our **FREE 120-page catalog** of
over 3,000 exclusive and hard-to-
find supplies for audio & video.

MARKERTEK™
145 Ulster Ave., Saugerties
New York 12477 U.S.A. **VIDEO SUPPLY**

MARKERFLASH™

Studio warning sign imprinted on all three sides. Large, bright, flashing unit is white but flashes in red. Ultra-high impact housing with EZ mounting to any surface. AC operated. 8x5x4" \$59.95
FSL-1 ON AIR
FSL-2 STOP RECORDING
FSL-3 STOP IN SESSION
FSL-4 STOP STUDIO IN USE
FSL-5 QUIET



MARKERTEK PATCHADAPS™

America's largest selection of highest quality studio patch cords—60 types let you interface anything quickly to your patch panels.

DIGITAL MASTER AUDIO ON BOTH CHANNELS EDITED MASTER DUB DAT CLONE

MARKER MARKERS™

America's largest collection of over 500 hot orange status labels plus blank pin-fed and laser labels for audio and video.



MARKERPATCH™ CABLE ORGANIZER
32 isolated BNC feed thru jacks on both sides will organize your cables. 19" wide x 2 rack spaces \$164.00



MARKERKLAMPS™

19x6". Behind the rack cable organizer holds five big bundles of cable \$29.95

800-522-2025 America's most unique catalog for audio & video!

Circle #075 on Reader Service Card

MAINTAINING DIGITAL EQUIPMENT

KNOW USER-SERVICEABLE PARTS

Technology is great. Except when the blasted things break and the question of whom to call becomes the crux of the matter. In the past, studios had personnel on hand to care for the equipment. However, even with an adequate tech staff, the philosophy of dealing with equipment servicing and/or failure is different today.

For one thing, personnel qualified to perform component-level repair are becoming more and more expensive; even manufacturers have difficulty retaining people of this caliber. To the end-user, repairs are more difficult and the equipment's reliability becomes an important factor. Many manufacturers have responded to this situation by engineering more careful designs. Televisions don't break every six months, and the PC clone with the cheap motherboard seems to last forever.

The "average" commercial studio today has invested significantly in sophisticated signal processing gear. While a studio operator may have a common sense understanding of the technology, in order for the facility to function smoothly there has to be at least one person on staff who can operate each piece of equipment in the place. Without complete equipment understanding, the studio cannot effectively recognize and deal with equipment malfunctions.

A Builder's Perspective

Most manufacturers place a lot of weight in customer service. Since the end-user is not usually fully literate in technical matters, suppliers need to have a multilevel support system in place. This is true for things analog as

well as digital. Support from the manufacturer includes: training, regional spare parts and/or repair, field service, warranty replacement, module replacement/exchange, service contracts ("uptime insurance"), telephone advice, loaner units and modules, etc.

An educated consumer is the supplier's best customer. Just understanding how audio commonly works is no longer sufficient to cope with today's advanced technology. To perform any troubleshooting to reduce the problem area to a subsystem, we need to know what the subsystems are and how they interact. To this end, many manufacturers supply technical training and product-specific information. This sometimes takes the form of in-depth classroom education for either the owner or the technical staff from independent schools. With a fundamental understanding of what goes on inside the gear, you can operate as the eyes and ears of the factory personnel for troubleshooting purposes.

Service contracts are not very popular, since they are little more than an extended warranty; but this doesn't have to be the case. Equipment reliability expectations of a unit can be measured via the availability, price and quality of a manufacturer's service contract. The company that is willing to back up its product without additional expense is confident in its product's reliability.

When the Stuff Hits the Fan

The help you get from the manufacturer depends on a number of factors, not the least of which is the price of the unit and your geographic location.

You will find help in New York, L.A., Nashville and Chicago in the form of spare units, replacement PC boards and field service personnel for most of the industry players (if not from the factory, then from their dealers and reps). In the secondary markets and beyond help can get a little spottier. What this means to you as an owner is significant differences in what is required from you in way of preparedness.

Here in New York (at least when the unit is still under warranty), you can usually get a factory rep to come in and swap the defective subassembly. From the supplier's position, it is always far wiser to replace a defective *assembly* than to attempt a component-level repair. The offending module is then returned to the shop and either repaired there or at the factory. Component-level restoration with modern, high-speed digital electronics is very difficult (or impossible) without specialized tools and test equipment. At least while the unit is under warranty, this work is best left to the factory. Expedient service is the goal, and assembly-level replacement is usually the fastest route to relief.

The most common failures involve moving parts. Disk drives, switches, pots, connectors, motors, drums, guides and the like are most prone to an inopportune "vacation" from full and proper function. For instance, tape recorder electronics fail far less often than the transports.

Here in New York City, the troubleshooting process goes something like this:

1. Trouble is noted.
2. Determine that an actual failure

BY GREG HANKS

has occurred and call the manufacturer.

3. The factory rep walks through some of the system diagnostics and/or failure symptoms with the operator and gets an idea of what could possibly be wrong.

4. Some elementary tests are performed by the operator (with factory urging), and either the trouble is isolated and gotten around or a field service rep is dispatched with the appropriate modules.

5. The offending subassembly is replaced, and the studio is back online.

At least that's how it works in theory. It usually gets a little messier in reality. The financial powers in most successful companies feel that unless the service personnel are overworked then they must be overstaffed! This means you might not get the immediate attention you may require.

In less-populated areas, a growing number of suppliers have initiated 24-hour tech support hotlines. This makes it

are your most important tools, as they usually include system diagnostic procedures. Diagnostics—in the form of embedded or free-standing software—will usually point to where the fault lies. Unfortunately, today's generally available diagnostics are often of limited value to the end-user. Logic analysis typically occurs only in the realm of the manufacturer, where the analyzer records the data and address bus activity of a system, rather than just telling you that "U12 is latched low on input A!" Logic stimulation and pattern recognition is the benefit of this type of equipment.

The Universal Logic Programmer is a useful new PC-based tool. Its primary function is to burn EPROMs, PALs, GALs and such. Since programming modern devices requires using a set of A/D and D/A converters, this tool can exercise and test logic devices. However, it only works with 24-pin and smaller devices. The primary equipment tested are 74 series, and with an extended IC clip hooked to a



possible to at least talk to a human being at 2 a.m. who understands how the bloody piece is supposed to be working.

Tools of the Digital Repair Trade

Servicing digital electronics is fundamentally the same as any other form of technical repair. Working at a component level is sometimes not only feasible but mandatory, particularly with a piece of out-of-production gear that still retains its "most-favored" status among a studio's clients and engineers. Digital-based equipment of this nature will often require special attention, since the methods outlined above may not apply with older gear.

In addition to the standard armada of technical aids, digital repair is expedited with additional tools such as: system diagnostics, logic analyzer, logic comparator, logic probe, IC clips, surface-mount clips and surface-mount soldering/desoldering tools.

Every system has a user's manual. As systems become more complex and expensive, the manuals get heftier. They

header it operates with in-circuit chips.

Don't attempt repairs on surface-mount technology unless you have the right tools. Workstations integrating soldering, vacuum materials handling (with static protection) and desoldering are available from Viking or SMD tools but can cost over \$2,000! In most cases, when the unit employs VLSI attached via surface-mount technology, replace the board. It is really only feasible to work on SSI and MSI (74XXX, 46XX, 80XX and discrete) technology.

An Ounce of Prevention...

With a preventative philosophy, the first order of business is to assure that the environment is not hostile. To ascertain the most efficient methods of preventing future difficulty, it's a good idea to figure out what types of failures are most common or most financially serious and attack the *cause* rather than the symptoms. This may include: optimizing the environment where the equipment is situated, performing routine service as recommended by the manufacturer, and

The Alternative Music Library!

Call for our
Compact Disc
Demo

800-227-1954
212-333-5766

FAX
212-262-0814



MANHATTAN

PRODUCTION MUSIC

P.O. Box 1268, Radio City Station
New York, New York 10101

Circle #198 on Reader Service Card

FREE

R&M PRO AUDIO SPECIAL

3M PRO DAT 120



Buy 9 of the industry's finest PRO DAT cassettes and receive one 3M PRO DAT 120-minute cassette **FREE** with this limited-time AES promotional special. Offer is limited to two cases per customer starting Sept. 21 thru Oct. 31, 1990. Cassettes are available in 46, 60, 90 and 120-minute lengths.

CALL
R & M PRO AUDIO
1080 Pacheco Street
San Francisco, CA 94116-1318
(415) 665-8480

Circle #199 on Reader Service Card

ensuring that all service performed uses reliable methods.

Some factors that affect the long-term reliability of equipment are electrical service and ground integrity, temperature, humidity and the possible presence of electromagnetic or electrostatic fields.

The electrical service is common to all equipment. Urban environments traditionally require some form of power protection. Line sags, overvoltage conditions, spikes and line noise all contribute to reliability problems. In the past, most computer companies required power conditioning in order to honor the warranty. Nowadays, most equipment is manufactured with MOV and inductor protection as an integral part of the IEC power socket. You *really* need power conditioning when your computers begin latching up because of dirty power. Line sags lead to premature failure in motors and transformers due to increased heat loads, and in extreme cases the power rails can drop out of regulation, leading to all sorts of interesting phenomena.

Grounding is as important in digital circuitry as it is in analog, and it is necessary to keep signal common and electrostatic shield separate! Component interconnect lines may ring, SCSI devices fail to initialize, monitors will look fuzzy and other nasty things may happen.

We routinely recommend power conditioning throughout an entire facility to alleviate such concerns. Remember that a low source impedance is necessary to attenuate noise generated on the conditioned side of the line. Power conditioning is an effective form of insurance. One lightning strike to your power line can destroy every piece of equipment in your facility, and while that is exceedingly rare, it does happen.

Temperature affects the operation of electronics in many ways. The safe operating area of any semiconductor is a function of junction temperature. Bipolar devices have a positive temperature coefficient, meaning that when the temperature goes up, so does the current gain, which increases the current flow, which increases the junction temperature. FETs and CMOS devices have a negative temperature coefficient: When they get hot, the input capacitance goes up and the circuit slows down.

This latter condition is also true of bipolar devices, although to a lesser degree. The junction temperature of

the devices employed must fall within the device rating. It is controlled through conduction to the surrounding air, either directly or through heat sinks. When the ambient temperature of the environment becomes elevated, the heat sink's ability to function decreases. Linear increases in the ambient temperature become *logarithmic* increases in the junction temperature.

Operating equipment at elevated temperatures can lead to two different results: "soft" failures, such as timing errors, and "hard" failures, like component degradation or failure. Component degradation is an insidious problem, as it leads to component failure at some future time through a "weakening" process. Continued operation at higher temperature is one of the reasons that certain pieces of equipment become a service problem. A good rule of thumb is when the room is too warm for your personal comfort, the equipment is probably not happy. When the air-conditioning system breaks, you jeopardize the future reliability of your equipment by continuing to use it.

Humidity is also affected when the air conditioner breaks. Although it's a lesser problem than temperature, when the humidity is high the heat sinks work less efficiently. The two main consequences of excessive humidity are an increase in the overall capacitance of the exposed circuitry (which lowers the operating speed) and the increase in surface oxidation. Generally, humidity is not a concern unless you see condensation trails.

Field radiation is less of a problem now that the world is going digital, but is nevertheless worth mentioning. More common are problems relating to the fields radiated by our digital devices. Unterminated lines or data bus extenders will sometimes "ring," and this can drive you nuts. Because of the relative immunity of most bit-based gear to field radiation, I was surprised to discover that a client's hard disk problem was traced to a tape degausser placed on top of the disk drive cabinet!

Spare Parts on Hand

The level of financial risk you face in case of failure will determine the spare parts requirements of your facility. If you cannot afford to be down at all, then look at having full redundancy in all your equipment. However, you don't need to worry about this if you can live with the schedule and parts

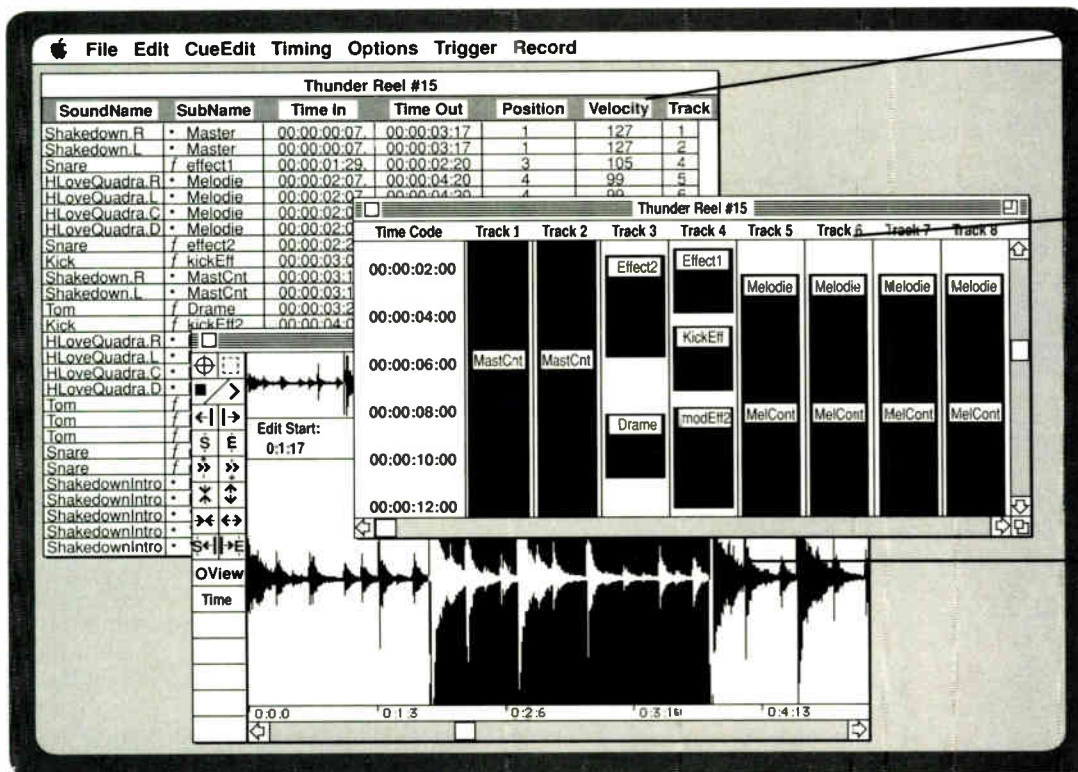

Event List window.
Transfer, record, edit, tune, erase, or save your sounds...

Track sheet window.
Place your sounds in time on any of the 8 tracks. Fade in or fade out individual sounds. Crossfade, splice and merge multiple sounds...

Editing window.
Precisely edit or mark individual sounds. Fill, clear or clean certain parts of a recording. Scrub and playback your sounds at a variable speed...

Performance within reach

The Digital Audio Workstation Nucleus,

(Dawn™), is designed to offer you the flexibility of operation of digital audio in a still predominantly analog world.

Dawn is *user friendly*, it complements your existing system. It lets you manipulate your sounds much faster than with analog recorders. It is *affordable* yet it offers features only available in large and expensive systems. It has a wide variety of applications, including:

- **Digital multitrack recording**
- **Automatic dialog replacement**
- **Sound effects editing**
- **Sound design**
- ...

"Dawn" is *expandable*. Its internal structure allows easy integration of new features. As it expands, "Dawn" retains its ease of use and simple user interface. Its list of features includes:

- **Macintosh SCSI based system**
- **Direct to hard disk or to ram**
- **2/4/8 input and 8 output channels**
- **MIDI, SMPTE-MTC, Digital I/O...**
- **16-bit digital audio**
- ...



Doremi Labs, Inc.
4927 Glen Arden Ave., Covina, CA 91724.
Phone: (818) 966 2454.

AMPEX
AmpeX Corporation • One of The Signal Companies

Blank Audio/Video Tape



MasterCard AMERICAN EXPRESS Card VISA

B Burlington
Audio/Video Tapes, Inc.
106 Mott Street
Oceanside, New York 11572

**FOR HARD TO GET
ACCESSORY ITEMS**
Reels, Boxes, Custom Cassettes,
Leaders and Splicing Tape
Digital Audio Tape Available
In Stock and Priced Right!
Immediate Delivery

Call for Free Catalog
USA & Canada
1-800-331-3191
NYC Area: 516-678-4414
FAX: 516-678-8959

Circle # 204 on Reader Service Card

AUDIOFORCE
Your Digital Source...

NY rental exclusives:
Mitsubishi X-86HS, Harmonia
Mundi Sample Rate Converter.
Plus Sony 3324 & 3348,
Lexicon, AMS, Yamaha...

With The Best Of Analog.
Call—we've got what you need.

**PACKAGE RENTAL RATES
24 HOUR SERVICE
WORLDWIDE DELIVERY
TECHNICAL SUPPORT**

Call 800-847-4123 toll free in
USA. (212-741-0919 in NY State).

DIGITAL ASSOCIATES d/b/a
AUDIOFORCE

SOUND RENTAL LOGIC

37 West 20th Street, NY, NY 10011

Circle # 205 on Reader Service Card

availability of your technical service vendor. Most facilities find themselves somewhere between these two extremes.

It's no longer practical to maintain a complete collection of spare parts for all critical functions. Most of these new toys have an amortized life of two or three years, and they use far too many critical boards to keep spares in stock. When a piece is no longer being manufactured, then it's time to buy replacements for any boards that have a history of failure. What you should have on hand is determined by many things, not the least of which is how well the manufacturer stocks replacement assemblies. Another consideration may be what redundant features are designed into the unit to allow partial modular replacement with limited functionality. You no longer can carry the generic semis and passive components; more often than not it just ain't feasible! The spares you should concentrate on are spare sources of supply. Maintain a relationship with the factory reps on both coasts. Your Rolodex is one of your best tools.

Routine Maintenance

No generic routine service tasks exist for digital equipment other than keeping the cooling vents clear and the insides clean. Each equipment will have its own recommendations from the manufacturer. These things should be explained in the owner's manual. Read it! I usually learn something when I do.

Given that the most expeditious method of repair is on a board level, we must be conscientious in our methods. High-speed digital electronics coupled with a proliferation of CMOS has elevated static control to a required science. I used to think that it was sufficient to grab a grounded chassis before handling boards. Not so! One of the most important tools used by aspiring repair techs should be the static strap and ground lead. When you pull out a PCB, you need a grounded surface to lay it on, so carry a conductive mat. The preferred methodology is to wear a conductive wrist band that is physically hard-wired to a conductive mat, which in turn is tied to technical ground.

In addition to static control, always shut off the equipment before swapping modules: Hot plugging is about as close as you can come to Russian roulette with your electronics! Powering up equipment in the wrong se-

quence can introduce "soft" errors that corrupt the system's integrity. Another way to prevent premature failure is to turn off equipment before plugging and unplugging other equipment. You never know when you'll get the power and data lines terminated just a few microseconds before the system ground and electrostatic shields are made, creating potentials of much greater level than the system was designed to handle. I've "zorked" systems by unplugging the 422 data line with the power on. The equipment was unusable until we performed a full "hard" reset. Once you've corrupted the operation of a logic device, it is best to power everything down and start everything from ground zero.

Good work habits should carry over from your analog discipline, such as examining all traces on the PC board after a solder job to ensure that no "spooze" remains to short out adjacent traces. Use flux remover and clean the board after any repairs, as flux residue can provide a capacitive path between conductors, making for strange operation! Note: Don't install sockets when you replace a chip unless you are going to use gas-tight ones. There are more reliability problems with sockets in digital electronics than in the logic devices themselves. Conscientious work methods will provide for more satisfactory results.

Thanks to the increased reliability of today's systems we can realistically own, operate and service the technological wonders that fill our studios. Becoming educated to the topography of the individual systems, meeting and becoming friendly with the factory service personnel, keeping the necessary tools and parts on hand, and maintaining impeccable work habits all contribute to the long-term success of your facility.

Acknowledgment

I would like to thank the following persons for their assistance in getting this article together: Ron Rimshell and Bob Manilla from Sony Corp.; Neal Karsh and Griff McCree of New England Digital; and Robby Hidalgo of Neve/Mitsubishi. ■

A former chief engineer at Wally Heider Recording (L.A. and San Francisco), Greg Hanks now heads New York Technical Support, providing installation, service and consulting to the audio industry.



Introducing the New Technique for achieving worry-free audio. It's called technical support.

Eric Marchal, Senior Technician, Kenny Patnaude, Technical Manager.

People talk a lot about service and support. But when you get right down to it, it's frequently just talk.

Personal Service

At AudioTechniques, technical support isn't just a buzzword. It's what sets us apart. Because we give our clients the personalized service they deserve, no matter what comes up.

We support everything we sell

with our expert technical staff.

They specialize in customized setups, updates and installations for consoles and tape machines. On-site training for sophisticated recording equipment. And special modifications, spec-matching and quality control checks that ensure peak performance — even after warranty.

We're also the convenient drop off point for Triple S, the

nation's largest musical instrument and pro audio service complex.

Total Support

We lead the way in professional audio sales because our involvement doesn't stop when we close a sale. We build a continuing relationship of service and support with each client.

AudioTechniques. We support the idea of worry-free pro audio.

AudioTechniques

A Manny's Music Company.

AudioTechniques, 1600 Broadway, New York City, N.Y. 10019
(212) 586-5989 FAX: (212) 489-4936

T REFURBISHING TUBE AUDIO GEAR

An audio salesman once said there is nothing that loses its value quite as quickly as sound equipment after the next generation comes out. But for elderly vacuum tube gear from several generations back, a renewed and vigorous life is possible because of the interest in the tube sound by musicians and engineers. Yet tube equipment such as power amps, guitar amplifiers, equalizers and limiters stored away in basements and attics may be considered “junk” by its owners and is thus available for cheap bucks.

Elderly vacuum tube equipment can often be had for a song, but it's not always such a wonderful bargain. You need a good “nose” and a little common sense before buying such gear. And then certain steps are needed to refurbish it prior to use.

The Nose Knows... Most of the Time

Why a nose? The answer, quite literally, is to sniff out potentially serious problems. Most older tube equipment has a slight “burnt” odor to it, but that's not typically a problem. However, an acrid odor—like burnt pitch or tar (which it often is, by the way)—is a reliable indicator of a kaput power or audio output transformer. Although some of those transformers are replaceable, many are not and may be a lost cause, suitable only for parts cannibalization. The odor might be detectable around any surface, but is most likely around the bottom panel, and it's very faint in many cases.

In some instances, however, the nose can fool you unless you are familiar with the odor of burned transformers, and even then one can be wrong. One of my hobbies is collecting antique radios (1919-

1950). Not long ago I nearly turned down a late 1940s communications receiver that was in cherry shape because of a faint but acrid odor wafting out from underneath. Removing the bottom panel and visually inspecting the innards revealed the problem. There was a burned-out 1-watt carbon resistor (which, as it turned out, resulted from a shorted capacitor). The resistor was laying on a length of PVC wiring and had burned its insulation away. It was the melted and charred insulation of that piece of wire that produced the acrid odor, which I almost missed.

Burned transformers often ooze a bit of pitch out onto the chassis. Yet it

Power supply section of a piece of tube-type gear showing three electrolytic capacitors

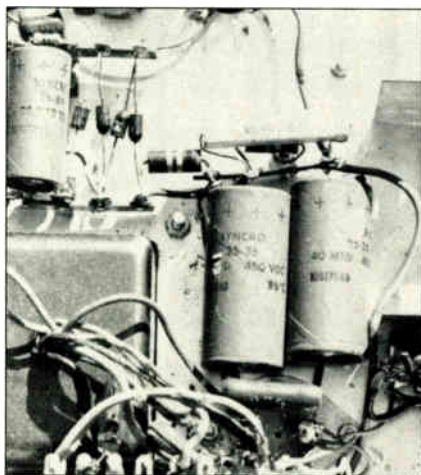

Keeping That Classic Sound Alive

by Joseph J. Carr

is also nearly normal for a *small* amount of pitch to ooze over time, especially if the transformer ever overheated.

Testing and Refurbishing Power Transformers

If you suspect a bad power transformer, then you can perform a few simple tests to confirm this condition. An ohmmeter is useful for testing the transformer windings for continuity and shorts to ground, but unfortunately, this will not indicate shorted windings. (*Caution: The following procedures involve dealing with potentially lethal voltages. If you are unsure of your abilities, seek out qualified assistance.*)

Fig. 1a shows the standard “power transformer” symbol with the color codes normally used for the different voltage windings. To perform the ohmmeter tests:

Starting with the X100 scale, measure the resistance across leads of the same color and also those of the same color plus a second color. For example, the high voltage leads are typically red, while the center tap is red/black. To properly check for opens, make sure there is continuity between both reds and between each red and the red/black leads. The resistances from each red to the red/black should be approximately equal.

To check for shorts to chassis, disconnect the leads of the transformer from the circuit, go to the highest resistance scale, and measure the resistance from each lead in a set (e.g., one of the red leads or the red/black lead) to the transformer case or the equipment chassis.

Testing the transformer for a shorted winding condition is also quite easy. First, there is the inelegant method, unceremoniously referred to as the “smoke test.” Remove the rectifier tube (it's usually

the one with the "5" and/or a letter from late in the alphabet in the type number—e.g., 5U4), turn the equipment on with a fresh fuse (of proper value!) in place, and see if the fuse blows. If it blows, then most likely the power transformer is shorted. If there are any noise bypass capacitors in either the transformer primary or secondary circuits, then check these with an ohmmeter or disconnect them; they could simulate a shorted transformer if they are shorted.

A slightly more elegant method is shown in Fig. 1b. In this test, place a 25- to 40-watt 110-volt lamp in series with the primary winding of the transformer. Remove the rectifier tube from the equipment and turn on the power switch. If the transformer is in good order, then the lamp will be either dark or glow very dimly. If the transformer has a shorted winding, then the lamp will glow much brighter.

Even if the equipment is working and requires no further troubleshooting, some things should be checked or replaced as a routine procedure. Some electronic components don't age well in service, and others age very poorly when stored. A few judicious parts replacements and a little cleaning will go a long way toward keeping the equipment working long after your initial evaluation.

Electrolytic Capacitors

Electrolytic capacitors in the power supply ripple filter and the cathode bypass circuits are examples of components that go bad when *not* used. Old tube equipment will often show a marked 120Hz hum because of excess ripple on the DC power supply lines. Yet, a few hours of "bench cooking" can reduce the hum level appreciably. This phenomenon is a good indication of age-failed electrolytic filter capacitors.

The electrolytic capacitors can be identified easily. Tubular electrolytics are typically cylindrical and have the polarity marked on them (in most cases the "+" end is identified). Electrolytic capacitors are also made in metal cans mounted to the chassis. The metal can often contain two to four capacitor sections.

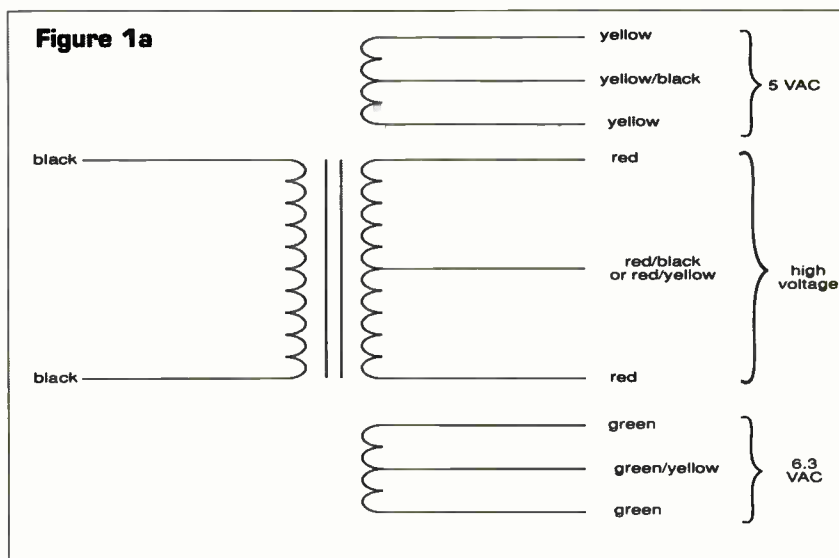

Fig. 1a: Standard transformer color code to identify windings

I recommend replacing all electrolytic capacitors as a matter of course. Use a replacement with at least the same working voltage and capacitance ratings. You can use parts with higher ratings, but not lower. If the capacitor appears bulged out, then it might be wise to select the next higher voltage rating.

If you opt to not replace the electrolytics *en masse*, then at least do a visual inspection of each capacitor. On paper-encased tubular electrolytics look for paper discoloration. On all electrolytics, look for bulging and evidence of either liquid or dry material oozing out around the connections or the ends of the capacitor. Any of these symptoms, or hum that won't reduce and go away, is an indication that the capacitor needs to be replaced.

A warning is in order regarding electrolytic capacitors. They are extremely sensitive to the polarity of the applied voltage. The new capacitor *must* be connected into the circuit the same way as the original: "+" side of the capacitor to the positive side of the power supply, and the "-" side to the negative side of the power supply. If the capacitor is connected backward, it may explode like a cherry bomb when power is applied.

If the original capacitor is not properly marked, or the markings are obscured or damaged, then it is possible to identify the positive end by inspection. On metal-can electrolytic capacitors, the body of the can is the negative end and the connections are the positive end. On tubular electrolytics (such as the

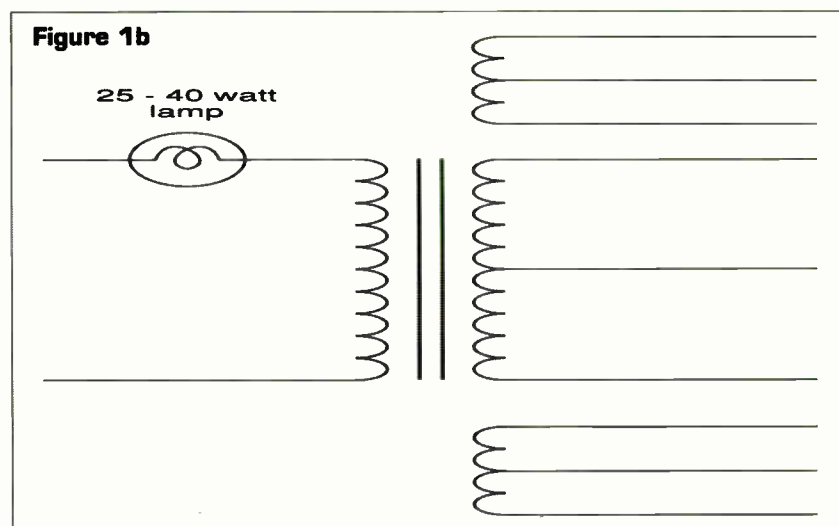

Fig. 1b: Method for finding a shorted winding

MC•VISA•AMEX•DINERS•DISCOVER HRS: MON-FRI 10AM-6PM SAT 12PM-5PM

DAT

AUDIO GALLERY

AMERICA'S BEST PLACE TO BUY DIGITAL AUDIO TAPE RECORDERS

- Best Prices
- Best Service & Best Warranty
- Newest Models in Stock
- Demos Available
- No Commission Sales Staff
- DAT Accessories, PCMs, more

SPECIAL SALE

Name brand
2-HR DAT TAPE \$9⁹⁵

Call us before you buy elsewhere

AUDIO GALLERY

"the friendly store"

213 • 829 3429

2716 Wilshire Blvd
Santa Monica, CA 90403
FAX: 213 • 829 0304

THE 1ST AND STILL THE BEST!

Circle #009 on Reader Service Card

THRIFTY ELECTRONICS

THE SOUND SHACK



Speaker Components

NS-10M • Visonik • David • JBL

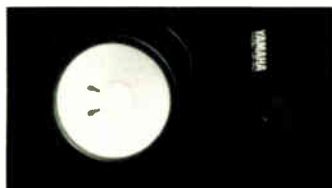

YAMAHA Nakamichi Hafler

JBL Professional Products Repair delivery and much more

13643 Burbank Blvd
Van Nuys, CA 91401
(818) 786-1610 (213) 873-2976
Since 1953

Circle #010 on Reader Service Card

three shown in the photo on page 144), the positive end is identified by the fact that the wire connection is attached to a cardboard or plastic end plug (Fig. 2), while the negative lead is spot-welded to a metal surface (which is, incidentally, the metal can beneath the paper outer covering).

Still another word of warning: Multisection electrolytic capacitors are a bit difficult to replace, so many people opt to bridge a good tubular electrolytic across the bad section. This is always bad practice! The bad sec-

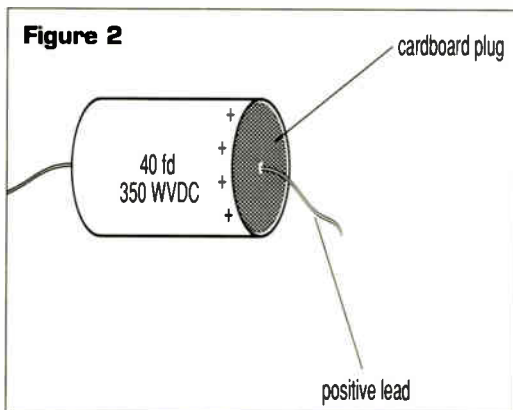

Fig. 2: Typical paper-encased tubular electrolytic capacitor

tions of such capacitors have a high probability of shorting out at a later date, causing substantial damage.

Paper Capacitors

Most of the other capacitors in elderly tube equipment are paper dielectric types. These capacitors can be easily identified because they are either paper cylinders with wax plugs in the ends or they are made of black plastic. Typical ratings are from less than 0.001 μF to about 1 μF , at voltage ratings of 400 or 600 WVDC. Some people who refurbish vacuum tube equipment believe in replacing all old paper capacitors. Others believe it is sufficient to replace only those that are either open, shorted or show physical symptoms, such as damage to the body or crumbling/popping out wax plugs. With black plastic body capacitors, look for cracking, liquid oozing out or dried corrosion that may indicate that the liquid once oozed in the dark ages but is now dried.

Paper capacitors can be replaced with mylar dielectric types. Use the same capacitance rating, and a WVDC rating that is equal to or higher than the original capacitor's rating. The newer capacitors are usually considerably

smaller than the older types of the same ratings. As a result, sometimes the new leads are too short to reach the connection points, and wire extensions must be soldered to the ends of the capacitor leads.

Resistors and Controls

Carbon composition resistors used in tube-type audio gear are very similar to modern resistors. The main differences are that many solid-state circuits can use 1/4-watt resistors nearly everywhere, while tube equipment tends to use 1/2-watt, 1-watt and 2-watt resistors. The new resistors, like new capacitors, tend to be a little smaller than the older types. Look for evidence of cracking, crumbling or charring. Replace those resistors that seem to have been stressed or damaged.

The controls on the audio equipment include both wire-wound and carbon composition potentiometers. These controls wear out from use and can suffer from the same indignities as other electronic components. They also get dirty, which creates noise in the circuit. Clean them with a switch or control spray cleaner. If the cleaning fails to restore normal operation, then replace the control. Volume controls are typically audio taper types, while bass and treble controls are usually linear taper types.

The replacement control will probably be a "universal" replacement type, so the shaft will have to be cut to fit. Mark the correct point with a single stroke from a hacksaw and then proceed to saw off the unneeded portion of the shaft. Use a file to round off and smooth the end of the shaft before installing it.

Refurbishing elderly audio equipment can be a good way to obtain choice gear at low cost. Many people undervalue it because, to them, it is considered junk. But to the knowledgeable audio engineer, such "junk" is like the sterling silver antique samovar found in a trashpile because the owner thought it was a dented tin pot (sigh). ■

Joseph J. Carr is an electronic engineer and technical writer. Before getting his degree he had 16 years of on-the-bench repair experience that spanned from the vacuum tube era to integrated circuits.

BEST SELLER



See us
at AES
booth #441

What does it take to become the world's best selling sound effects library? Quite simply, our success is in our book.

Sound Ideas is the author of the world's largest collection of realistic, professional sound effects. We have also created one of the industry's most comprehensive production music libraries. And we ensure there is always a happy ending by providing customer service worth writing home about.

When you want to guarantee your production is a success story, reach for the best seller that can handle all your needs. Call today and book your free demo.

SOUNDS INCREDIBLE!

**Sound Ideas, 105 West Beaver Creek Road, Suite 4, Richmond Hill, Ontario, Canada L4B 1C6
In Canada call (416) 886-5000 Fax (416) 886-6800
In the U.S. call toll free 1-800-387-3030**

NEWS

FROM AROUND THE WORLD

A PRS Restructures for New Challenges

In one of the most radical developments in its 43-year history, APRS—The Association of Professional Recording Studios—has cleared the way for more effective representation of the views and interests of its growing membership. The 12-person APRS board of directors decided at its April meeting to go ahead with the fostering of special interest groups, which will each be closer to the issues and topics relevant to its particular sector than is possible for the main board.

The British Record Producers Guild (BRPG) has operated successfully as a semi-autonomous group on these lines since 1985. The APRS is now extending the principle to sectors such as commercial recording studios (the original core of the association), to suppliers (manufacturers, distributors and dealers) and to the pressing/duplicating field.

In early May a number of existing and prospective members met to form

APRS Takes Over D.I.E.

The Digital Information Exchange, firmly established as one of the industry's finest showcases for new recording technology and techniques, started the '90s under the auspices of the APRS.

This year's exchange will take place October 30 through November 1, and will be held at the same London Zoo venue that has housed the event every year since 1985. Previously, the Digital Information Exchange was sponsored by Sony Broadcast & Communications and HIB Communications. A 1990 program was being put together by the APRS Technical Committee, which intends to make it more practical and applications-based than those of previous years. There is also a move to broaden its scope to include business-related topics.

Tickets for the event are £150 per day (£120 for APRS members) and £400 for all three days (£350 for APRS members). For further information contact the APRS at (44) 0923 772907.

a pressers/duplicators group (provisionally called the PAD Group). Under chairman Keith Lloyd of Tape Duplicating Co., the group held an open house at the June APRS show. Piers Ford-Crush of Eden Studios is acting chairman of the professional studios

**Studio Spotlight:
Metropolis Recording**

Located in the heart of downtown Milan, Italy, Metropolis Recording is noted for its work in both music recording and commercial production. Studio 1 is the bigger of the facility's two recording environments. It features a Soundcraft TS24 40-channel console with automation, Studer 24-track recorders, UREI 813s as the main monitors, and a sizable selection of outboard gear.

A section of Studio 1 is also devoted to MIDI equipment controlled from a Macintosh, and includes a wide array of electronic instruments such as the Emulator II, Roland D-50 and D-550, Korg EX-8000, Yamaha TX816, Prophet T8, and more. The studio's Mac II runs a variety of music software, including Performer and Alchemy.

group, which also met for discussions during the APRS show. The development of the Suppliers Group, chaired by Chris Hollebhone of Sony Broadcast, is underway, and other groups are expected to emerge in the coming months.

Roger Bain, APRS chairman, states, "The association has survived and grown for over 40 years, and can point to solid and useful achievements. But we have to evolve to meet new challenges. The board felt it was time to promote changes that will give all members a more direct voice. The association is flourishing and our plans are aimed at maintaining a leadership position."

European SMPTE Sections Created

Two new SMPTE sections have been established in Europe. The inaugural meeting for the German section was scheduled for Munich on September 27, two days after the International Broadcasting Convention in Brighton, England. In April the Nordic section was inaugurated at the Film House in Stockholm, Sweden.

President Maurice French comments, "Local sections provide an excellent opportunity for members to exchange technical information through the presentation of papers and discussion. Participation and involvement in section affairs by members is fundamental to the future success of our society."

The society now has 24 local sections, including 17 in the U.S., three in Canada, one in Australia and one in Italy.

Neve Receives Prestigious Award from Queen

Her Majesty Queen Elizabeth approved that her Award for Export Achievement be conferred on Neve Electronics of Melbourn, England. The award presentation took place on June 27.

The Queen's Award is based on a company's last three years of business performance. The companies qualifying for the award must show that their exports have grown in relative, as well as absolute, comparison to their output.

"Over the last three years, the firm has doubled its export turnover," states Neve UK's managing director, Laci Nester-Smith. Exports currently account

—CONTINUED ON PAGE 152

Sound for Television ABC-TV Wins Emmy for La Bohème by Comrie Bucknell

1989 was a momentous year for the Australian Broadcasting Corporation. Not only did it totally dominate the Australian Film Institute Awards, as well as many other Australian film and television prizes, it was also the recipient of the 1989 Emmy for "Outstanding Achievement in Performing Arts Programming" from the International Council of the National Academy of Television Arts and Sciences.

The award was the culmination of many years of very close cooperation between the Australian Opera, the Elizabethan Philharmonic Orchestra and ABC. Their goal was to overcome the complex technical requirements of a live production for two differing audiences.

Producing a world-class sound recording from the Opera Theatre

of the Sydney Opera House has never been an easy task, and that job is not made easier when it's necessary to conceal all microphones from the audience's view and to position them so as not to interfere with the activities onstage.

For many years, sound engineers from ABC-Radio have sought to get the best possible recordings from this awkward-to-record-in acoustic environment. At least half the orchestra is underneath the front section of the stage, a situation that does not allow the orchestral sounds to fully "bloom" before they are captured by the microphones. Microphone selection, placement and direction become very critical, and the mixing process requires the delicate addition of reverberation and equalization to get the best sound

Figure 1: Microphone positions in the Opera Theatre of the Sydney Opera House for La Bohème

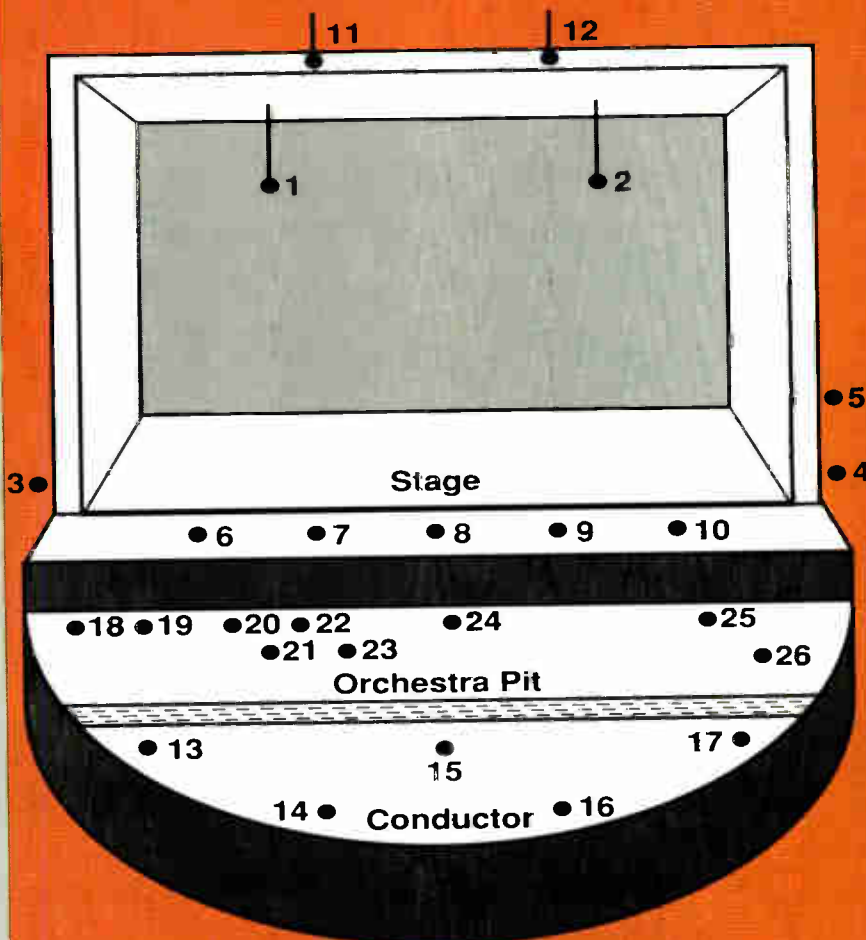

balance. Recent advances in audio technology have made that task a little easier.

ABC's sound engineers, together with sound producer Chris Lawrence, used a large array of microphones to record the audio components onto a multitrack recorder in ABC Radio's outside broadcast van, which was locked to videotape recorders in the TV van. The console in the radio van was custom-built by Neve and fitted with 40 inputs feeding 16 buses with a simultaneous 2-track mixing bus. Despite the age of the console (it's 15 years old), it is still reputedly one of the best sounding of any installed in an outside broadcast van in Australia, and has been used for numerous major broadcasts.

"Sound recording of live opera in the Opera Theatre for TV is extremely difficult," Lawrence says. "The acoustics of the theater are dry and unrewarding. The orchestra pit fits only 55 players, so the voluptuousness of Puccini's scoring can only be hinted at. The orchestra

TABLE 1: Microphone setup

Position	Make	Model	Function
1-2	Sennheiser	MKH-415	Chorus #1—L & R
3-4	Sennheiser	MKH-816	Chorus #2/Vox spotter Act 2, L & R
5	AKG	C-414EB	Offstage band Act 2, panned
6-10	Crown	PZM160	Lead vocals, panned
11-12	Neumann	KM83i	Orchestra, "off the arch" L & R
13-14	Neumann	U89i	Violins spotters, panned
15	Neumann	KM83i	Violas spotter, panned
16	Neumann	U89i	Cellos spotter, panned
17	Neumann	U89i	Cellos & basses spotter, panned
18	Neumann	KM86	Horns spotter, panned
19	Neumann	KM86	Harp spotter, panned
20-23	Crown	PZM	Woodwinds spotters, panned
24	Neumann	KM86	Percussion spotter, panned
25	Neumann	KM83i	Brass spotter, panned
26	Neumann	U89i	Bass spotter, panned

had to be close-miked and then mixed into a cohesive, bigger sound.

"The floor-mounted Crown PZMs

on stage [mics 6 through 10 in Fig. 1] provided good range, especially in Acts 1 and 4, which took place in

Sonex. Ship Shape Sound.

SONEX, when your sound matters. Now available in new sizes that *ship UPS*. SONEX, the *shape* that works; in a variety of depths, colors, and materials—plus ceilings, barriers and composites. SONEX, for the truest *sound*—call today for all the information.



illbruck

Minneapolis, Minnesota

1-800-662-0032

(In MN: 612-521-3555)

© illbruck, inc., 199

a set within a set upstage.

"Act 2, with busy crowd scenes alternating with pockets of solo action, forced us to combine the PZMs with shotgun mics [mics 4 and 5] attached to the first tier boxes in the auditorium and aimed at crucial positions onstage. The amount of level riding here was phenomenal, both to highlight the music and to minimize footfalls from the 70-voice chorus.

"This complicated score had to be marked up for voice and instrument cues as much as the conductor's copy. We were mixing direct onto 2-track on the same night, with only a basic backup on the multitrack."

Sound engineer Brendan Frost feels that one major reason for this production's success were the Neumann microphones, which were set to an omnidirectional pickup pattern. Special mention should be made of the pair of microphones (11 and 12) suspended off the arch. Two Neumann KM83i omnidirectional microphones were used, Frost states, "to provide more depth to the orchestral sound and, in particular, the string sections."

During the live recordings, a split of these two microphones was fed to the Lexicon 224XL digital reverb. The feed to the reverb from these two microphones was greater than that from the other microphones, notes Frost.

From the theater the mics were fed through a complex network of tielines to the radio van at the "east van point," and assigned to 14 of the 16 console buses and then to the multitrack recorder and a multitude of feeds for audio monitoring and recording. The processing equipment was restricted to a Neve compressor and limiters and the Lexicon 224XL.

Because of the nature of television opera audio recording, there was absolutely no chance to do

overdubs. The performance had to be recorded live, although it is usual to record the rehearsals from which parts may be used for the final mix.

For this production, a 16-track Ampex MM1100 with Dolby A noise reduction was locked to the video recorders located in one of the television vans at the "west van point."

Much of the mixing was done on the day of production. That took some of the burden off the post-production

phase, which was undertaken by Ron Marton and Lawrence in the Necam Suite at ABC-TV's Gore Hill Studios over a period of four days.

During this process adjustments

were made to the stereo image of the vocal and chorus tracks so that they would integrate fully with the accompanying visual images. The orchestra was typically panned full width with the chorus slightly narrower and the soloists even slightly narrower again. If the vocal and chorus tracks are panned full width or to match the visuals completely, the coherency of the audio/video mix is disrupted, distracting the listener/viewer. This rupture in the audio coherency is further emphasized when the production is simulcast on television and FM radio in stereo.

When the mix was finalized it was laid back to the video master direct from the multitrack using Necam automation. ■

Comrie Bucknell is the managing director of Sound Waves Consulting Pty. Limited. He has been involved with the broadcasting industry for nearly 20 years in a number of roles, including 15 years with the Australian Broadcasting Corp. in technical operations.

TABLE 2: Multitrack Assignment

Track(s)	Signals
1 & 2	Composite mix, stereo
3 & 4	Chorus #1, stereo
5 & 6	Chorus #2, stereo
7 & 8	Orchestral mix, stereo
9 & 10	Solo vocals mix, stereo
11 & 12	Woodwind spotters, stereo
13 & 14	KM83s (off the arch), stereo

Ones-of-a-Kind

We don't sell everything, and we don't sell just anything. That takes experience, and we have nineteen years' worth offering our customers both a broad understanding of the audio marketplace and those few products that really stand out. Rely on us as our suppliers do: outstanding companies like **AMS, API, Bryston, and Gefen Systems** have made us *exclusive* dealers.

See us at SMPTE in NYC
10/13-17
Booth #1860

AKG, AMS, API, Bryston, Drawmer, Gefen Systems, Soundcraft, T.C. Electronic, Valley International, Westlake, White Instruments, and other exceptional audio products.

studio consultants, inc.

321 West 44th Street, New York, NY 10036
(212) 586-7376

Equipment, support, and design services for professional audio facilities and broadcasters.

CASSETTE INSERTS IN

7 DAYS

CS Printing

111 Oak Lawn Ave.
Dallas, Texas 75207
(214) 747-8705
FAX: (214) 748-9922

Circle #026 on Reader Service Card

TDK's NEW SM CASSETTES: "IT'S ABOUT TIME"



- Now available in 10, 20, 30, and 60 minute lengths.
- Superior high bias cassette for studio and demo recordings.
- Uses top-quality SA tape pancake for low noise and wide dynamic range.
- Ask for our new A/V catalog.

SONOCRAFT
360 West 31st Street
New York, NY 10001
TEL. (212) 760-9300
FAX (212) 564-9488

Circle #027 on Reader Service Card

—FROM PAGE 149

for more than 85% of the company's annual revenue.

New England Digital Opens German Distribution Company

In a move designed to increase its ability to serve its European customer base, New England Digital Corp. has announced the formation of a new joint venture distribution company called New England Digital GmbH, which will be based in Munich and directed by its joint venture partner, Rolf Chrostek. Chrostek served as sales and product manager of Harman Germany's Professional Products Division, NED's distributor since 1987.

The move by NED to establish a mainland-based European operations center comes just eight months after the formation of New England Digital UK Ltd., in London. The opening of the second direct sales and marketing center was made possible by Harman Germany's decision to refocus its long-term business emphasis on building sales of its own professional audio



Legendary U.S. producer Russ Titelman (left), takes tea with tennis ace Mike Rutherford, but still finds time to lay some tracks down using the remote unit of a PCM-3348. Sony's 48-track is the latest item to be added to Genesis' private studio in Surrey. Titelman was in the UK for most of the early summer, expecting to complete the project in August.

GUY GROSS MUSIC STUDIOS OPENS IN SYDNEY, AUSTRALIA

One of Australia's most accomplished young film composers, Guy Gross, has combined forces with Trackdown Studios to create a joint facility offering music production services ranging from voice-over work to film and pop music. The new facility, located in Sydney, consists of two control rooms and two studios with offices, a dubbing room plus lounge and kitchen. The two studios are linked for audio and video.

The GGM Studios are MIDI-based, and designed for film music writing and recording. Featured are a Kurzweil K250 RMX, a Dynamix 3000 24-channel desk and an additional array of MIDI gear driven by a Mac Plus. The new Trackdown Studios uses 24 tracks of Dolby SR, and together with GGM, offers clients access to a wide range of in-house services.

product lines. Chrostek will direct a dedicated team of NED sales and service specialists, and supervise the establishment of an on-site demonstration and training studio at the Munich facility.

International Studio News

Construction is complete on **Vector**, a Yugoslavian residential studio. Located in the coastal region of Koper, the room was designed by Andy Munro and is fitted with a 32-channel Soundcraft TS24 console... **Airport Studios** in Milan, Italy, has completed a major refurbishment that includes a redesigned control room and installation of a Studer A820 recorder and an Otari 900 ProDigi 32-track recorder. The room now includes an Amek

A Woof and a Tweet just can't compete...



Music Workstations of the 90's demand new **MONITOR STANDARDS.**

When you've spent a small fortune on sampler and synths, and the Steinway, Bosendorfer and Baldwin samples all sound like a tack piano...

it's time for **MONITOR STANDARDS**

When a decent scratch mix on your small monitors sounds completely different on the mains...

it's time for **MONITOR STANDARDS**

When you're sick and tired of "fixing it in the mix" or worse yet, you're in mastering, and discover that the snare's lost somewhere in the ozone...

it's time for **MONITOR STANDARDS**

While other speaker manufactures were busily touting benefits of exotic metals, "new" materials technology, and reaching amazing new heights of hyperbole...

RADIAN has quietly introduced the most significant advancements in small monitor systems in decades! Premium performance point-source coaxials.

Call for the name of the nearest Authorized Dealer to arrange for a demonstration in your studio.

RADIAN
AUDIO ENGINEERING, INC.

MONITOR STANDARD is a registered trademark of RADIAN Audio Engineering, Inc.

4520 Eisenhower Circle, Anaheim, CA 92807
TEL: 714-693-9277 FAX: 714-693-9278

Mozart 56-channel console with Supertrue automation. The facility redesign also incorporates a MIDI room and audio-for-video capabilities... **Planet Wave**, one of Hamburg's leading video and film post-production studios, has purchased a 4-channel SoundStation II for its new recording and editing complex. Installed in April, the DAR system is the centerpiece of the editing/dubbing suite in the new facility, which also includes two 16-track recording studios, a complete 1-inch video edit suite and a mixing/editing studio... **Chic Studio**, located in Voiron, France, has taken delivery of a Versadyne International 1500 Series high-speed duplicating system. It will be used to duplicate audio cassette products produced by its studio as well as for outside contract work... A Soundtracs Quartz 3200 console has been installed by **Hastings Music** of Munich, a jingle production facility... Studio design firm Recording Architecture completed a new room at **Sonoland**, a music recording facility in Madrid, Spain. The control room of Studio B is a carbon copy of the Studio A control room, designed by the same

firm in 1987.

British producer/engineer Steve Parr purchased **Rooster 2 Studio** in London from Nick Sykes in April of this year. He has renamed the studio **Hear No Evil**, and has fitted it with a 56-channel, 112-input DDA DMR12 console with Mimix automation... Located in London's Soho district, **145 Wardour Street** (formerly **The Basement Studios**) was recently taken over by producer/drummer Mark St. John. Dedicated to recording rock 'n' roll, the studio has been fitted with the first automated Trident Vector Series console in the world. According to St. John, the facility offers the best of the influences from the past and the finest state-of-the-art equipment available... Hamish Hutchison, sound designer and managing director of **The Engine Factory** in Beckenham, Kent, has joined with Darrin Williamson to set up an extensive MIDI suite at that location... Amek recently delivered a 32-input Classic console to **Granada Television's** Stage 1, Manchester. Control room rewiring was done by IPE of Cambridge... **Triple X Studios** has opened in London, offering low-budget 24-digital recording using the

Akai A-DAM system with a Soundcraft 6000 console... In Surrey, **Fisher Lane Farm**, the Genesis-owned recording studio that was used for numerous hit albums for the band, is the latest major UK facility to purchase a Sony PCM-3348 digital multitrack recorder. It is currently being used on the next Mike & the Mechanics album, under the direction of Mike Rutherford and producer Russ Titelman... Recent developments at **Abbey Road Studios** include a completely new Sonic Solutions digital mastering room, another Mitsubishi 32-track digital machine, a third mobile unit with a DDA desk, and residential accommodations featuring two large flats and a garden adjacent to the studios.



Pardonnez-Moi

The Studio Spotlight for Couleurs Studio in our August "International Update" incorrectly carried the photo for Studio Mega, a Paris facility. The correct photos for the two facilities are shown here. Also, Couleurs was *not* designed by Tom Hidley, but Studio Mega was, and the video-linked studios at Couleurs are larger, not smaller, than the main control room. Our apologies.

"Acoustics by _____"

(your name here)

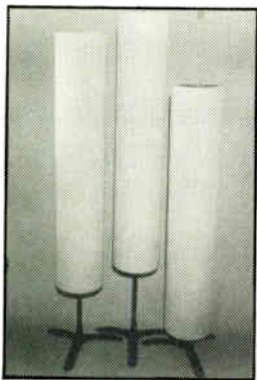

The ASC STUDIO TRAP™

Studio Gear Acoustics

Portable and self-contained, the ASC Studio Trap™ gives you freedom and flexibility to shape the acoustic signature of any space.

- Build a Quick Sound Field™
- Regulate absorption and diffusion
- Adjust height for talent, mix or playback
- Plug in corner-loaded bass trapping

ASC ACOUSTIC SCIENCES CORPORATION
APPLIED ACOUSTICS - RESEARCH, DESIGN & DEVELOPMENT

P.O. Box 1189
Eugene, OR 97440
Ph. 503-343-9727
FAX: 503-343-9245
1-800-ASC-TUBE

—Ask about our Studio Design Services.—

MANUFACTURER OF TUBE TRAP™



Above: Mega
Below: Couleurs



Circle #001 on Reader Service Card

SOUL BROTHERS.

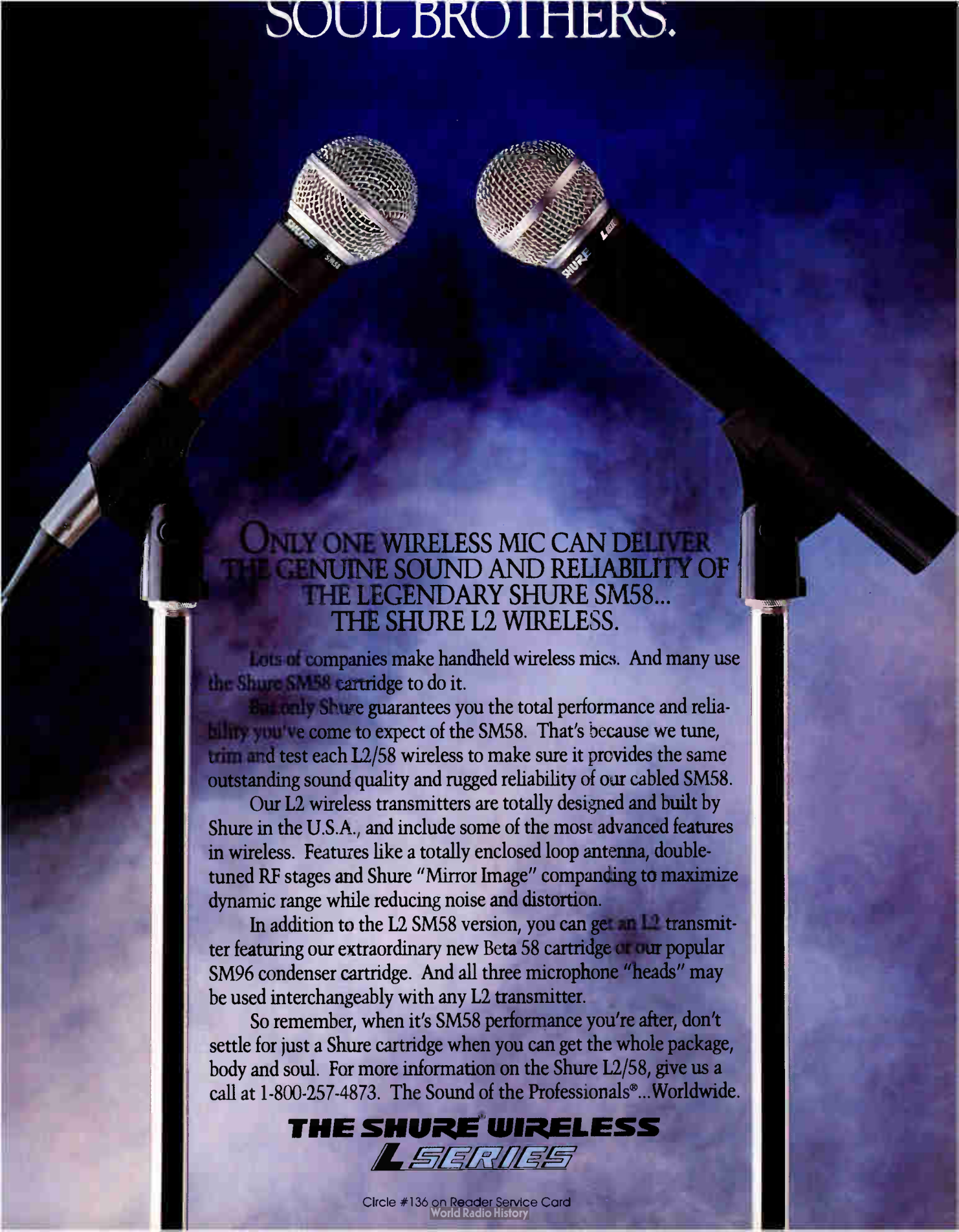

ONLY ONE WIRELESS MIC CAN DELIVER
THE GENUINE SOUND AND RELIABILITY OF
THE LEGENDARY SHURE SM58...
THE SHURE L2 WIRELESS.

Lots of companies make handheld wireless mics. And many use the Shure SM58 cartridge to do it.

But only Shure guarantees you the total performance and reliability you've come to expect of the SM58. That's because we tune, trim and test each L2/58 wireless to make sure it provides the same outstanding sound quality and rugged reliability of our cabled SM58.

Our L2 wireless transmitters are totally designed and built by Shure in the U.S.A., and include some of the most advanced features in wireless. Features like a totally enclosed loop antenna, double-tuned RF stages and Shure "Mirror Image" companding to maximize dynamic range while reducing noise and distortion.

In addition to the L2 SM58 version, you can get an L2 transmitter featuring our extraordinary new Beta 58 cartridge or our popular SM96 condenser cartridge. And all three microphone "heads" may be used interchangeably with any L2 transmitter.

So remember, when it's SM58 performance you're after, don't settle for just a Shure cartridge when you can get the whole package, body and soul. For more information on the Shure L2/58, give us a call at 1-800-257-4873. The Sound of the Professionals®... Worldwide.

THE SHURE® WIRELESS
L SERIES

An
Audio/Book Project
Brings a Legend
to Life

MOTOWN

Bassist James Jamerson

by Michele Picozzi



James Jamerson
in 1964 at a
Detroit club called
Blues Unlimited

While musicians' biographies appear on bookstore shelves with increasing frequency, readers eager to know the "man behind the music" don't expect the author to drop in an audio cassette between the book's covers to ensure their experience of the artist is complete.

Part character study, part documentary, part song and part audio experience, *Standing in the Shadows of Motown: The Life and Music of Legendary Bassist James Jamerson* spent some time in the recording studio before it was published last year. Written by Philadelphia



musician/composer/arranger Allan Slutsky, the 200-page book covers the tragic circumstances that surrounded the life of the mysterious Motown session player whose driving, distinctive bass lines put the bottom in such hits as the Four Tops' "Bernadette," "You Can't Hurry Love" by the Supremes and Marvin Gaye's "I Heard It Through the Grapevine." Slutsky's work was received enthusiastically by the media; in fact, the print/audio combo recently copped top honors in the first annual Ralph J. Gleason music book competition sponsored jointly by *Rolling Stone* magazine, BMI and New York University.

Initially, Slutsky (who uses the pen name "Dr. Licks" for his guitar transcription series for Hal Leonard Publishing) intended to write another book, this one on Jamerson's bass styles. But after talking with Jamerson's widow, Annie, his friends, family and fellow musicians, Slutsky knew the project was destined to be much bigger than just a collection

A mid-'60s Hitsville session with Stevie Wonder, Jamerson is on upright bass.

of bass lines. "James Jamerson's contribution to the core of the Motown sound was overlooked for so long, I had to come up with a better way to tell his story and distinguish his sound," explains Slutsky, whose strategy was to enlist the talents of famous bass players to draw attention to Jamerson's story.

While researching the book, Slutsky began developing the audio side of the project, spending six months transcribing Jamerson's bass lines and all the background

Gene Leone and Allan Slutsky



parts from more than 100 songs. Next, he took the transcribed charts to Strata Studios in suburban Folcroft, Pa., in late 1987 to lay down the rhythm tracks. Mixing on a 16-track board were Strata engineers Dennis Nardi, Bob Rust and Mark Knox. Slutsky instructed the crew to produce individual 1/4-inch tapes of the songs with the rhythm track assigned to the right channel and left channel blank. With little difficulty, Slutsky was able to enlist the services of 28 of the world's best bassists, including Marcus Miller, Anthony Jackson, John Patitucci and Will Lee, all of whom were inspired and challenged by Jamerson. His plan was to mail tapes to the guest bassists who would supply a brief intro, lay down the bass on the empty left channel, and then return the tapes to Philadelphia. However, as more musicians signed on, Slutsky's plan took a detour.

"Each musician played from the charts I had sent them," he says, "but some wanted to supply their

DEFINITION.

The DMR 12 console defines peak efficiency in today's crowded recording conditions. It contains a sizable number of true inputs (up to 112) to easily accommodate synthesizers, processors, sound sources and tape machines. Its completely versatile MIDI Muting Automation System makes it virtually invisible to the process.

But the most significant aspect of the DMR 12, as with all DDA consoles, is the sheer transparency of its sound. Audio purity that allows every texture to achieve meaningful definition within the mix.



Exclusively distributed by
Klark Teknik Electronics Inc.
Tel (516) 249-3660 Fax (516) 420-1863

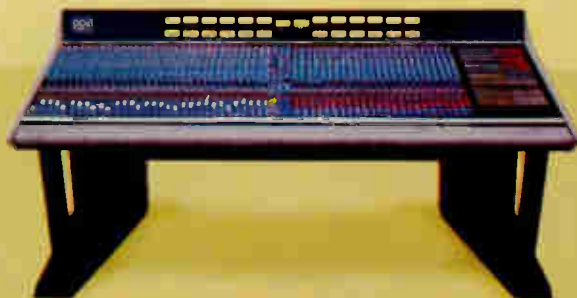

own tapes. For example, John Entwistle and Garry Tallent recorded their bass lines with a click track on PCM-F1 digital hi-fi Beta tapes; Chuck Rainey and Geddy Lee submitted demos from 4-track cassettes; Will Lee, working with Paul Shaffer of the Letterman show, laid all their tracks on 1/4-inch, 2-track tape; and a completely finished studio piece was furnished by Pino Palladino.

To pull all the formats together, Slutsky commissioned his longtime associate Gene Leone, himself a musician and senior engineer for Victory Studio East in downtown Philadelphia since 1987. "Because of dealing with the logistics of so many different formats and the sheer number of tapes, there were engineers who wouldn't have even considered working on this project," Slutsky says. One veteran went so far as to pronounce it a "Nightmare on Funk Street," referring to the Funk Brothers moniker that once identified the exclusive fraternity of Motown session players.

Leone, who built an impressive track record mixing R&B 12-inch dance singles and engineer album sessions over 18 years, says he was drawn to the project because of Jamerson's extraordinary talent. "When I heard those Motown classics without the bass, they weren't the same songs," he says.

Soon after Leone began work on the musicians' tapes, Slutsky brought in several taped telephone interviews of Jamerson's Motown cronies that he was using as part of his research on the book. Recognizing the documentary value of the conversations, Leone quickly persuaded Slutsky to include them on the tapes. "At first I panicked because I knew the quality was about as poor as you could imagine, and complicated by distracting background noises," Slutsky explains, thinking back on the flimsy telephone hookup he had used to record hundreds of hours of interviews. "I wasn't thinking ahead like Gene was."

Leone also suggested that James Jamerson Jr.—an accomplished bassist in his own right and witness to his father's later Motown sessions—serve as the tapes' narrator. By this time, the project had doubled in size to two one-hour tapes.

With an avalanche of editing, volume stabilizing and EQ'ing chores facing him, Leone dug in with all the resolve of an air traffic controller at rush hour. He transferred all the music

on 1/4-inch tape at 15 ips onto the studio's Otari MTR-10 2-track (with SMPTE center time code), and then he tackled the 300 hours of taped interviews. Slutsky recalls there were some heartstopping moments involved with both sets of tapes.

"When we played Entwistle's PCM-F1 digital tape on Strata's equipment, there was no sound coming out. While I was trying to figure out how in the hell I would explain to Entwistle that he sent back a blank, Mark Knox of Strata finally determined the problem was due to the difference between the U.S. and British electrical systems. The

tape was returned to England for conversion to analog, and then returned to Victory.

After persistently working his network of contacts, Slutsky finally got word that Paul McCartney had consented to provide an intro for the tapes. Thoroughly pleased with this coup, he was surprised to receive an inexpensive computer cassette tape from England. "I guess I expected a more high-tech format, but the sound was clean, plus his comments were right on the money," Slutsky recalls.

"We also scratched our heads a lot over the 1-7/8 ips tape that Motown

CHECK YOUR BALANCE.

Before you invest in a professional DAT recorder, check to see if it stacks up against the Sony PCM-2500:

- ✓ Records at 44.1kHz as well as 48kHz
- ✓ Has professional SDIF-2, AES/EBU and S/P DIF interfaces
- ✓ Has built-in error indicator
- ✓ Operates on 100/120/220/240V, 50/60Hz
- ✓ Is supplied with both wired and wireless remote control
- ✓ Can individually trim L/R analog input and output



If it's a Sony, you can check all of the above — which is what you'd expect from The Leader in Digital Audio™. For more information call 1-800-635-SONY.

PCM-2500

- Recording and erasure of Start ID, Skip ID and Program Number subcodes
- Two-hour recording time (with DT-120 Sony DAT cassette) •Less than 0.005% Total Harmonic Distortion at +4dB •Greater than 90dB dynamic range
- High-speed locate capability at 60 times normal playback speed

SONY®

PROFESSIONAL AUDIO

Sony Communications Products Company,
1600 Queen Anne Rd., Teaneck, N.J. 07666
© 1989 Sony Corporation of America,
Sony and The Leader in Digital Audio are
trademarks of Sony

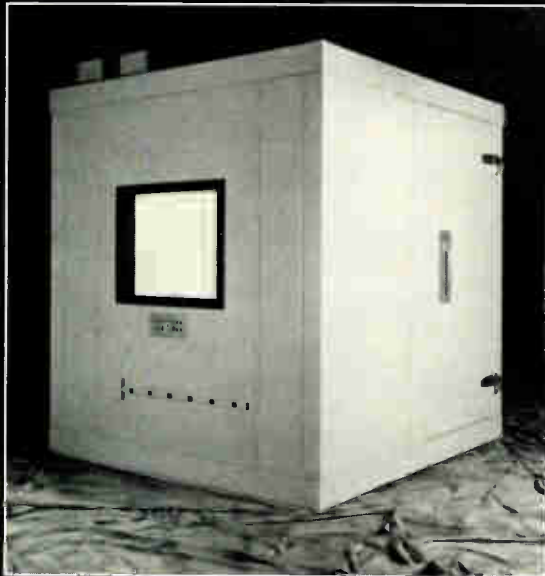

VOICE OVER BOOTHS

Acoustic Systems' Voice Over Booths combine acoustic integrity with the ordering simplicity of standard models. Voice Over Booths, which include eleven BB models, are self contained, acoustically engineered enclosures with isolated floor

systems, panel construction with predetermined acoustic performance, sealed doors, acoustically engineered ventilation and prewired electrical service. BB Voice Over Booths provide stations, studios and production facilities a fast-track alternative to conventional, standard construction.

Designed as modular units BB Voice Over Booths can also be disassembled, relocated and reassembled if changes in location occur.



ACOUSTIC SYSTEMS

415 E. St. Elmo Road • Austin, TX • 78745
(800) 531-5412 (512) 444-1961
FAX: 512/444-2282

Thomas Register

Sweets Catalog 13.C

Circle # 202 on Reader Service Card

DISC **MAKERS

Complete manufacturing for the audio industry.

COMPLETE PACKAGES FOR:

- Cassette Duplication
- Record Pressing
- Compact Disc Replication

All packages are completely retail ready, and include all necessary steps.



In-house art department for complete design, typesetting, film work, and printing.
In-house mastering department for a great sounding product.



CALL FOR OUR FREE FULL COLOR CATALOG.

1-800-468-9353
(In PA: 215-232-4140)

DISC **MAKERS

1650 Broadway, Suite 1010 New York, NY 10019
(212) 265-6662

Circle # 203 on Reader Service Card

session guitarist Dennis Coffey found in his basement. The tape features a rare Jamerson jazz solo on a '62 Precision bass during a live club date. Providing a dramatic contrast to the Motown songs already planned, Slutsky was determined to include it. "To make matters worse, Jamerson had recorded it on a home unit in the early '60s, and the entire tape was very brittle," remembers Slutsky. "It was a miracle Gene was able to clean it up."

When Jamerson Jr. stopped by Victory to check on their progress, Slutsky and Leone treated him to a preview. "This was the first time he had a chance to hear all these other famous musicians talk about his dad's influence on their work," says Slutsky. "He reacted favorably until the end of side 4 where Stevie Wonder eulogizes the senior Jamerson at his August 1983 funeral. Gene was particularly proud of this part because of a strategic splice that kept in the realism. Before Stevie speaks, a muffled background sound is heard. We innocently assumed that the pulpit's microphone was being adjusted. When Jamerson Jr. heard this, he went crazy: 'Why in the hell did you guys leave that in?' he demanded. 'That's the lid shutting on my daddy's coffin!' Horrified, Leone dove for a razor blade in a desperate attempt to fix his mistake. While he scrambled, Jamerson collapsed into a corner, laughing hysterically. Unfortunately for us, James Jr. inherited his dad's sick sense of humor."

When the time came to prepare the final mix, balancing all the performances, testimonials and voice-overs proved to be the project's biggest challenge. "There were so many minute volume changes that were crucial to smoothing out all the segues, there was no way we could have done this manually," Slutsky says. To unify all the elements, Leone relied upon Victory East's automated Sony MPX-3000 board to help control the levels with the SMPTE time code of the edited 2-track serving as a compass. "SMPTE doesn't like to run across edits. It was a challenge because there were hundreds on this project," says Leone, who handled the dropouts by manually overriding the computer. Copying the 2-track 1/4-inch working copy onto another 1/4-inch tape would result in another generation, so they decided to mix directly to digital.

"The key to making the final mix successful was to approach the bass as if it were the vocalist on a typical ses-

If these sound a little too cold.

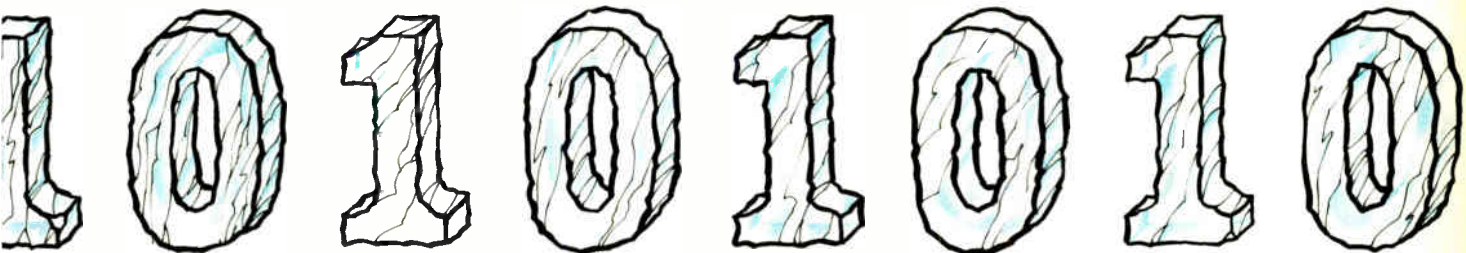

Warm them up with these.

Digital is remarkably accurate, but it still leaves some people cold. Recording by the numbers expands dynamic range and eliminates noise, but it doesn't really preserve the warm, human quality that makes music a sensual listening experience.

That's where Tube-Tech comes in. We make a full line of all-tube processors that can warm up the coldest, most clinical digital recordings. Crafted in Denmark, they combine the classic tube smoothness of the past with low noise and distortion

specs that will easily satisfy any digiphile.

Our CL1A compressor has very low harmonic and non-linear distortion and its non-deteriorative element provides almost infinite life. The PE1B program and ME1A midrange passive equalizers are extremely quiet and natural sounding. And the MP1A is a versatile high performance combination two channel mic and DI preamplifier.

The next time you go digital, don't get left out in the cold. Warm up those numbers with Tube-Tech.

TUBE-TECH

Exclusively distributed in the U.S. and Canada by AudioTechniques,
1600 Broadway, Suite 803, New York, N.Y. 10019.
Call AudioTechniques for information about the Tube-Tech dealer near you.
(212) 586-5989 FAX: (212) 489-4936

Circle # 209 on Reader Service Card

We've paved the road to Center Track Time-Code

Complete Retro-fit kits available for:

- Studer A80 • Sony/MCI JH110 A&B
- Ampex ATR100 • Otari MX5050

Kit includes: • Head Assy Upgrade
• Otari TC-50 Time Code-FM Processor
• Documentation & Alignment Tape

For detailed information
call or write:



249 Kennedy Road • P.O. Box 121 • Greendell, NJ 07839
Tel.: (201) 579-5773 • Telex: 325-449 • Fax: (201) 579-6021

Circle # 200 on Reader Service Card

sion," says Slutsky. "What we really were doing—isolating the bass to the left channel and all the other instruments in a mono-mix on the right channel—constituted the opposite of mixing. Instead of unifying all the parts into a whole, what we really were doing was music minus one, sort of a reverse mix. The problem with this was working with 28 different bassists and instruments with 28 individual sounds. Some guys, like Kenny Aaronson and Phil Chen, were trying to re-create a fat, round '60s sound, while others, like Marcus Miller and Geddy Lee, had a much more high-end contemporary sound. From bassist to bassist, we had to make radical adjustments in volume, compression and EQ to keep the speakers from rattling. We constantly checked ourselves against three or four different-sized monitoring systems to make sure all these drastically different sounds would come across whether the listener was using as portable personal stereo or sophisticated home unit."

By early 1989, Slutsky and Leone were ready to convert the heavily edited, carefully assembled and mixed 1/4-inch analog tape to a digital PCM-F1 Beta format. "Everything proceeded very smoothly until we got close to the end of side 4 when, for no apparent reason, the computer stopped dead," Slutsky relates. "I looked over at Gene who was just as surprised. He even tried running two backup copies, and the computer crashed again. At that point, we went back and played that whole side over again only to discover that Jamerson Jr.'s intro to Smokey Robinson's segment was missing. We accidentally had forgotten to include it. The tapes would have been duplicated without it, and we wouldn't have found out until it was too late.

"Later, we joked about the mysterious bug in the machine, deciding it was really Jamerson's ghost haunting the mixing board as if to say, 'You guys messed up, go back and get it right.' We were glad he was looking out for us. But to this day, we don't know why the equipment failed."

Standing in the Shadows of Motown: The Life and Music of Legendary Bassist James Jamerson is available from Mix Bookshelf, (800) 233-9604. ■

A native Philadelphian now living in California, Michele Picozzi is a freelance writer who has been a Motown fan for as long as she can remember.

The Center of Attention.

FULL SAIL CENTER *for the* **RECORDING ARTS**

330C University Blvd., Wilson Park, Franklin, NJ 07033

In Florida, call 407-679-6333

Outside Florida, call toll free 800-221-2747



The Industry Leader In
Recording Career Education
Since 1979.



Circle # 201 on Reader Service Card

Don Was Is



Producer of the Grammy Award-winning "Album of the Year" *Nick of Time* by Bonnie Raitt, the comeback album *Cosmic Thing* by the B-52's, as well as Iggy Pop's new album *Brick by Brick*, Don also collaborated on the critically acclaimed Was (Not Was) album *What Up, Dog?* and the hit single "Walk the Dinosaur."

Don chose the Peavey Audio Media Research Production Series™ 2400 Console and the PRM™ 308S Phase Reference Monitors for his studio after searching for and testing many different brands on the market. Like many other professionals of his caliber, Don appreciates the performance, features, quality, and creative freedom AMR equipment offers. The Production Series 2400 Console features 4-band full sweepable EQ on each Input, 8 Aux-Efx Send/Returns, 92 Inputs with EQ available for mix-down, an on-board MIDI command center for control of outboard devices, low-noise design, and many additional production facilities. The PRM 308S Monitors have uniform frequency response, a minimum of coloration, and feature a selectable switch for reference and EQ playback for the option of hearing how your music sounds in an alternate environment.

If you're designing a new recording studio or upgrading your present one, check out the complete line of professional audio equipment from Peavey...

DON WAS DID.



PRM™ 308S

PEAVEY®
AUDIO MEDIA RESEARCH™

PEAVEY ELECTRONICS CORPORATION
711 A STREET • MERIDIAN, MS 39302-2898 • PHONE (601) 483-5372 • TELEX 504115 • FAX 484-4278 • ©1990

World Radio History

Circle #140 on Reader Service Card



by Mark Herman

SOUND REINFORCEMENT NEWS

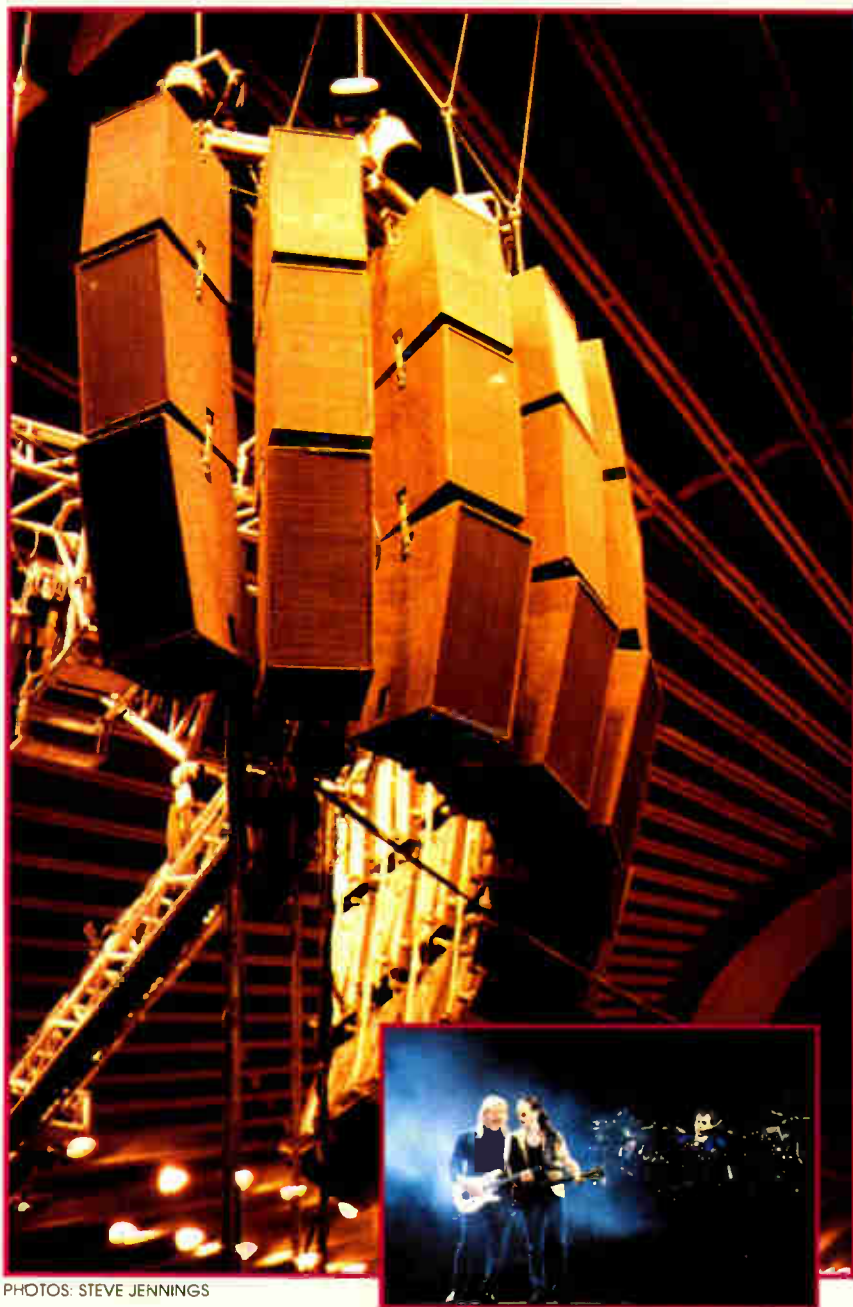

PHOTOS: STEVE JENNINGS

Electrotec's system for the Rush tour (shown here at the Oakland Coliseum) included approximately 100 of its proprietary Lab-Q cabinets with 36 on each side in a flying array. Two interlinked 56-input Crest/Gamble Series EX consoles provided 112 inputs at the FOH position.

On the whole it seems the quality of live audio concert production has dramatically improved in the past two years. The entire business is more mature and professional, and the improvements in technology are considerable. This is as it should be, because sound reinforcement has become big business, with systems costing \$200,000 plus.

I attend a great number of major concerts across the U.S. After listening to more than 90 artists and sound companies in different venues over the past year, I've come to the conclusion that sound companies are doing a great job. People in the cheap seats usually complain more about not being able to see than not being able to hear well. Much of the time, when the sound is really poor it can be attributed to the inherently bad acoustics of the venue or an engineer who has the dB level too high. Finally, speech intelligibility seems to have improved, and well-engineered shows are becoming more the rule than the exception.

As in any business market, there are some companies that truly stand out above the rest and some that can never seem to get it together no matter how much they spend on equipment. Today's successful sound reinforcement companies must stay abreast of technology, become financially stable, provide good equipment and retain key personnel.

The **Institute of Audio Research** (New York City) recently established a course in live sound reinforcement that gives students direct, hands-on experience with sound systems for all types of venues. **Albert Grundy**, president and founder of IAR says, "It is vital that

students who want to join the industry have the opportunity to learn the basics of this highly specialized and critical profession in an academic environment." The course trains students to analyze, design and assemble complete sound systems from the ground up. Also covered are such practical subjects as set up, break down, sound-check, miking techniques, and house and monitor mixing. Students get the opportunity to work in real live-performance environments, as well.

Teacher **Douglas Dahl** says, "From portable systems for small clubs to large venues, this course offers students the invaluable op-

portunity to learn how to choose and interface all the various equipment needed to provide great live sound. They also benefit in another way: They learn the real-world politics of working in the club scene." IAR was nominated for a 1990 *Mix* magazine TEC Award. For more information on the course, call (212) 677-7580.

Clair Bros. Audio (Lititz, Pa.) announced another new in-house product with the unveiling of the long-awaited processor/limiter Series-II Coherent Transfer System, slated to replace the company's current cross-overs and limiters. In 1987 Clair came out with the first version, which included frequency correction, phase compensation and time alignment

functions specially designed for the Series II S-4 loudspeaker system. Originally, only four prototypes were to be built and road-tested. After two-and-one-half years and 20 prototypes worth of refinements, Clair finally feels it has perfected the unit.

Clair house engineer **Dave Kob** comments: "I have noticed a definite improvement in transient response and smoothness of coverage that, because of the phase compensation/time alignment, eliminates much of the honey-combing effects of the past."

In-house design engineer **Ron Borthwick** developed and refined a new VCA in conjunction with the

ON THE ROAD

SOUND COMPANIES, EQUIPMENT, ARTISTS & PERSONNEL ON TOUR

Artist Sound Company Tour Dates Region	House Console #1 House Console #2 Monitor Console #1 Monitor Console #2 House Crossover	Main Speakers Main Speakers Subwoofers Monitor Speakers Monitor Speakers	Main Amplifiers Main Amplifiers Sub Amplifiers Monitor Amplifiers Monitor Amplifiers	Engineers: (B) = band (H) = house (M) = monitor (T) = tech (a) = assistant (C) = crew chief
Taylor Dayne Rock Systems Audio March-November North America	Soundcraft Series 4 40x16x2 Neotek Series 1E 32x8x2 Ramsa WR-S840 40x18 — BSS FDS 360	(24) RS-4 — RS-1 1x15 —	Carver 1.5 — Carver 1.5 —	Mike Murphy (H) Raza Sufi (M)
Doug & the Slugs Rocky Mtn. Sound July-August Eastern Canada	Soundcraft 600 32x8x2 — Yamaha 2408 24x8 — TDM	(8) Adamson MH225 (8) Adamson B218 — E-V 1502 —	Crest 6001, 4801 Crest 8001 — Crest 4801 —	Bob Yeager (B,H) Cavin McLeod (B,M)
Steve Earle Sun Sound Audio September-February North America	ATI Paragon 40x16x12 Soundcraft 600 Ramsa WR-S840 40x18 — EAW MX800/Sun modified	(40) EAW KF850 — (16) EAW SB850 Sun Sound 115 EAW KF850 Sidefills	Crest 8001 — Crest 8001 Carver 1.5 Crest 8001	Peter Keppler (B,H) Eric Tarlton (M) Mark Frink (C,aH) Steve Schrems (aM) Geronimo States (T)
Fleetwood Mac Clair Bros. Feb. '90-Spring '91 World Tour	Clair Custom 32x8x4 Clair Custom 32x8x4 Harrison SM-5 32x16 — —	(72) Clair Series II s-4 — Clair Custom, Clair 12AM —	Carver/Clair 2.0 — Carver/Clair 2.0 —	Jim Devenny (H) Robert Miller (M) Chris Fulton Tom Ford
Bonnie Raitt Schubert Systems Group July-October U.S.	Gamble EX 56x16x2 Gamble HC 24x8x2 *Soundcraft 500 (* band's) SSG Custom	(40) SSG Steradian — (16) SSG Subs * Compact Monitors —	Crest 8001, 4801 — Crest 8001 BGW GTA Tri-amp —	Paul Middleton (B,H) Doug Gherna (B,M) J.D. Brill (C) Mike Kelly Steve Kallos
Restless Heart Allstar Audio Systems Ongoing North America	Yamaha PM3000 40x8x2 — Soundcraft 500 40x12 — EAW MX800/Allstar modified	(12) EAW KF850 — (6) EAW SB850 Allstar 1501 EAW JF500	Carver 2.0 — Crest 8001 Carver 2.0 Carver 2.0	Jim Walley (B,H) John Adair (B,M) David Campbell (C,aM) Thad Edwards (aH)
ZZ Top Showco October-Fall '91 World Tour	Harrison HM-5 32x16x2 (with 20-channel extender) — Ramsa WR-S840 40x18 Soundcraft Delta 200 Showco Prism D.C.S.	(80) Prism — (20) Prism Subs Showco BFM 600 —	Crown MA1200, PSA2 — — Crown MA1200 Crown MA1200	M.L. Prociase (H) Bill Shepell (M) J.W. Roberts (M) Dan Huffman Dan Machado

SOME BREAKTHROUGHS ARE MORE OBVIOUS THAN OTHERS.



Super TD. At the risk of sounding immodest, we think many professional VHF systems will look like this in the years to come. Of course, others will be quick to pick up on Super TD's optional Active FM antennas that do increase effective transmission range by 25%.

But the real reason we feel Super TD represents a legitimate breakthrough is the technology you *can't* see.

Like our new cavity-tuned design receiver that provides more sensitivity and dynamic headroom.

And professional *dbx Noise Reduction. It's responsible for the exceptional sound quality that goes hand in hand with Super TD's immaculate reception.

Super TD's solid hand-held transmitter features a vast selection of popular mic elements. The sleek TX-3 Eurodesign belt pack also sets new performance standards.

Super TD. No matter how you look at it, it still leads the way in VHF wireless.

SAMSON®

WE ARE THE WIRELESS FUTURE®

Samson Technologies Corp. P.O. Box 9068, Hicksville, NY 11802-9068 (516) 932-3810 FAX (516) 932-3815

*dbx is a registered trademark of Carillon Electronics Corporation

© 1990 SAMSON TECHNOLOGIES CORP

limiter module, which is also included in the processor. The compact, three-rackspace device has metering for input and output gain reduction, and a seven-insert module rack (similar to a dbx 900 rack) loaded with separate limiter, crossover, input gain adjustment, power supply, frequency correction, phase compensation and time alignment modules. Two units will be in each touring system, because two types of Series II S-4 cabinets (the P-system long-throw and F-system medium-/short-throw) are present in each Clair main P.A. rig.

Clair Bros. concert tour update: **Madonna** continued her world tour playing to stadiums in Europe with a large 128 S-4 system... Both **Janet Jackson** (is it live or Memorex?) and **Tina Turner's** tours are scheduled to run until late October with Jackson carrying 64 S-4s and Turner 144 S-4s... **Robert Plant's** world tour is scheduled to run until December with 64 S-4 boxes... **Fleetwood Mac's** 1990-1991 world tour used the new TC6032 Remote Controller equalization system for monitors... **Midnight Oil** finished in July with another tour leg anticipated later this fall... The **Steve Miller Band's** very successful tour ended in August... Hardworking **Kenny Rogers** was out as usual... **.38 Special** toured through the summer... **Don Henley** finished at the end of July with **Mike Keating** doing a great job on the house mix. Monitor engineer **Dave Skaff** used the TC6032 Remote Controller system onstage... Former Maryland Sound Industries account **Paul Simon** did rehearsals in August and was scheduled to tour sometime later in the fall with **David Morgan** mixing house.

Allstar Audio Systems has grown to become one of the leading regional sound reinforcement companies in the Nashville area. Owner **Mike Borne** started Allstar in 1984 in his house with a mixed bag of inexpensive used gear. He increased the company's inventory and prominence tremendously over the past few years and now fields a sizable sound system with the largest inventory of EAW 850 cabinets in Tennessee. Allstar services several well-known clients and

is currently touring nationally with **Restless Heart** (see "On the Road") through 1990. Borne says that in the past most of Allstar's work was not locally oriented, but concentrated in cities and states outside of the Nashville region.

Borne's company now fields a major league main system using 32 EAW KF-850s and 16 SB-850 subs. Carver 2.0 amps power the KF-850s, while Crest 8001s drive the subs. Allstar designed and built a custom flying system and hardware. The company's two 12-mix monitor systems employ proprietary low-profile enclosures loaded with E-V 15-inch cones and JBL 2425 compression drivers. The wedges are powered with Carver 2.0 and 350 (with PMX module) amplifiers. Console inventory includes the Yamaha PM3000 40C and Soundtracs M Series 32 x 8 x 2 FOH, and Soundcraft 500 40 x 12, Soundtracs MC Series 32 x 10 and Yamaha 2408M models for monitors.

Showco Shorts... Dallas-based sound reinforcement company Showco reports that the **Rolling Stones** finished their tour in Europe in September. Fellow '60s stalwart **Paul McCartney** finished his tour in August, taking with him 188 Prism speakers and 48 subs. **Phil Collins** toured the U.S. with 80 Prisms and 16 subs; he was out until early October. **ZZ Top** are touring the world with 80 Prisms and 20 subs, and **Eric Clapton** was out with almost the same amount of equipment—84 Prisms and 16 subs—his tour ended in September. **INXS** started their world tour, appropriately, in their home country of Australia. Their system will vary throughout their travels. **James Taylor** and **Linda Rondstadt** were both out until October; each set up concerts with 40 Prisms and eight subs. R&B rockers **Little Feat** and country star **Willie Nelson** toured separately, with 40 Prisms and 12 subs for the former band, and 12 Prisms and four subs for the latter. Other artists using Showco's expertise and equipment: Moody Blues, Beach Boys, Reba McEntire and Joe Satriani.

Odds & Ends... Console repair expert **Tony Marra** has joined Klark-Teknik as customer service manager. Marra will oversee technical support for all K-T product lines and handle all service aspects of the DDA and Midas console lines directly... A Hill Concept Series 6400 console is being used

on the Tony Award-winning Broadway musical comedy "City of Angels." The console is equipped with 48 channels, 16 subgroups, a 16 x 8 matrix, 12 aux sends, 16 line returns and an extensive LED metering system... **Lester Audio Labs** provided Turner Broadcasting with its new DAS 2000 fiber optic transmission system for the summer Goodwill Games in Seattle. The system digitally transmitted multiple effects microphones and commentary over 1,000 feet to a host truck. This marked the first time multiplexed digitized audio was sent via fiber optic cable for use in a live international broadcast... Sound reinforcement company **Bernard Brown** (Dallas) now utilizes a total of 96 channels of BSS Audio's rack-mountable MSR 604 active four-way mic splitters. Co-owner **Danny Brown** states, "We made the decision to go with the MSR 604 splitters because of their superior performance, more apparent dynamic range, more punch and the fact that they just sound better."... **Synergetic Audio Concepts** (Syn-Aud-Con) announced new dates for their Intelligibility Workshop II, which will focus on topics concerning speech intelligibility of sound systems. It will now be held October 7-9 at Indiana University (Bloomington, Ind.)... UK console manufacturer **Soundtracs** recently sold three of its high-end SPA sound reinforcement consoles to companies in Europe. One of Sweden's leading audio companies, **West Audio System** (Gothenburg, Sweden), took delivery of an SPA 3200 and immediately sent it out on a major European tour. **Societe Francaise de Production** (Paris) purchased an SPA 3200 and an SPA 4000.

Phil Mata has acquired the assets of sound reinforcement company **C.M.I. Audio Group** (San Dimas, Calif.) and changed the firm name to **P.M.A. Services**. C.M.I. had just purchased the assets of **Nova Sound Systems**. Currently, P.M.A. has one arena system, two large club systems and a modest rental department. Mata reports that his company works primarily in Southern California with a wide variety of clients.

The Big Get Bigger... Promi-

nent British speaker manufacturer **Martin Audio Ltd.** has been acquired by **TGI**. In addition to Martin Audio, TGI is composed of Tannoy, Goodmans and Morlaunt-Short; making it the largest manufacturer of loudspeakers in the UK. **Dave Martin**, managing director of Martin Audio, feels that joining with TGI will make Martin Audio a much stronger manufacturer. He comments: "Operating within the TGI group as an autonomous company, we plan to capitalize on

our highly successful F2 system, introducing both it and derivative systems to new markets. New systems now nearing the final stages of development will enable us to consolidate our position in the tour and corporate sound markets, and further penetrate the installation market. The small, specialized manufacturer will face increasingly tough competition from larger audio companies as these firms try to muscle in on areas that were previously their exclusive province. We now have an excellent opportunity to share resources and use

the manufacturing and design strengths within the TGI group in order to develop a new breed of competitive high-performance loudspeaker systems."

Long Island sound reinforcement company **Rock Systems Audio** (Edgewood, N.Y.) has managed to keep its concert touring and local systems active throughout the year. Co-owner **Leon Esker** says, "It has been a pretty good year for us. Of course, the summer is always busier because of the shed tours, but we've been on a continual upswing the entire time." Esker has plenty of equipment to work with since RSA boasts a large speaker inventory of more than 250 proprietary RS-4 full-range main cabinets. Console stock shows three Yamaha PM3000s, a Soundcraft Series 4, three Ramsa WR-S840s and assorted Soundcraft 800B and 500 mixers.

RSA tours out this summer included **Taylor Dayne** (see "On the Road"), who has been out since March carrying a 24-box main system. The tour is mostly playing to theaters and should end sometime this November. Dayne's stage is completely clean of onstage monitors. Since a different stage is supplied locally for each date, all six of Dayne's frontline monitors are flown from the downstage truss, and the musicians' wedges are placed underneath portable risers... **Public Enemy** (with **Heavy D & the Boys** opening) carried a 68-box arena system across the U.S. on one of this season's biggest rap tours... Other summer work included a Motown Review tour featuring seven acts, several Budfest dates in August and a large concert/rally with human rights activist **Nelson Mandela** in New York's Yankee Stadium.

In addition to tours, RSA does a variety of local and regional work. In New York the company provides production for Radio City when needed. This includes on-location TV shows like *Hollywood Squares*, *Wheel of Fortune* and *Siegfried & Roy*. RSA also does the lion's share of Long Island-area shed dates for local promoters.

Speaker manufacturer **Apogee Sound** (Petaluma, Calif.) has introduced a new flying system for its

AUDIO AFFECTS

UNCOMPROMISING VARIETY OF GEAR FOR RENT AND SALE

213/871-1104

818/980-4006

AUDIO AFFECTS is proud to celebrate its
"15 year" anniversary.

This year alone we have purchased over \$1,000,000.00 worth of new TOYS for you
... our PRICELESS clientele.

Just some of our added advantages:

- * 24 hour delivery service
- * Guaranteed ahead of time delivery
- * Equipment set up at no charge
- * TECH support 7 am - 12 pm
- * Synth + NED programmers available
- * Touring Synclaviers + Direct to Disks
- * Early session: equipment dropped the night before, you walk in, power up & go
- * WEEKLY specials- eg. Sony 48, NED 32, X880
- * Special package (multiple item) price
- * Net ten day discounts (c.o.d. save more)
- * Radio dispatched vans + trucks
- * LARGEST inventory BACKUP
- * VISA and MASTERCARD accepted
- * We SELL "like new" and refurbished gear

for that personal touch. . .
Contact MARK, PAUL, CHRIS or THOM
P.O. Box 1127, Burbank, CA 91507
213/871-1104 818/980-4006

AUDIO AFFECTS

Circle #038 on Reader Service Card

The shape of pure sound

Community's philosophy has always been a little unconventional, achieving transparently high levels of pure sound economically and efficiently.

For those prepared to listen the shape of Community sound can influence their design approach, and for those brave enough to invest in what they hear, the rewards are clear.

Now expanding their market Community has developed the definitive compact enclosure.

The new RS220, Supreme projection from a 3 way system that has precise time alignment.

Trapezoidal, the RS220 can be flown easily and unobtrusively.

The horn loaded wavefront coherent design utilises two double spider, ferrofluid cooled, eight inch woofers. The midrange is Community's exclusive two inch exit driver and the high frequency is provided by a smooth sounding efficient one inch exit compression driver.

Complementary products are the VBS210 subwoofer enclosure enabling powerful micro cluster arrays to be built, and the 220 System Controller providing electronic crossover at 100Hz and dynamic equalization using the unique *IntelliSense*TM circuitry.

Community's RS220 The shape of pure sound

**CONTACT COMMUNITY FOR
A LOCAL DEALER IN YOUR AREA.**



Community

PROFESSIONAL SOUND SYSTEMS
COMMUNITY LIGHT & SOUND, INC.

333 East Fifth Street
Chester, PA 19013
Tel. (215) 876-3400
FAX (215) 874-0190

3X3 loudspeaker system. The RS II© Rigging System is an improvement in Apogee's radial strapless-rigging concept design. New hardware can now be attached permanently to the standard enclosure nut plates. The boxes are then connected with a mounting channel that aligns the speakers to form a solid horizontal array. The first RS II system was purchased by **Quickbeam Systems** (Albuquerque, N.M.) to use with a recent purchase of 12 3X3s, eight AE-5s

and four AE-4s.

Apogee has also improved the 3X3 loudspeaker enclosure with the addition of four heavy-duty straps that connect the rigging points on the top and bottom of the box. The straps are inlaid into the enclosure's side and greatly improve the individual load-bearing capability of the box for large vertical arrays. The tri-amped 3X3 cabinet has been further enhanced with a new high-frequency, ferrofluid-cooled, *compression* driver coupled to a controlled-directionality horn. This new driver provides in-

creased directional control and power output, as well as lower distortion than the previous device.

Bose Corp. subsidiary **Bose S.A.R.L.** (Bose, France) will be the official supplier of professional sound systems for the 1992 XVI Winter Olympic Games staged in Albertville, France. The company will be responsible for the design, supply, installation and maintenance of sound equipment in each of the 24 Olympic venues. Bose equipment was selected by the Olympic Organizing Committee in part due to its strong performance at the 1988 Calgary Winter Olympic Games. The portable and rugged speakers fared exceptionally well in the downhill ski courses. Two local Bose contractors will execute most of the work.

Rocky Mountain Sound enjoyed a busy summer season with its Vancouver, Calgary and Toronto offices all working dates across Canada. Concert tours were primarily with Canadian acts **Colin James**, **Grapes of Wrath** and **Doug & the Slugs**. The Toronto office recently bought one of the new Soundcraft Venue consoles released in August. Owner **Fred Micheals** says, "We think the Venue will do well with small tour systems that work theaters and small concerts. It has some very good features for a relatively inexpensive concert touring board." Rocky Mountain continued to add to its considerable stock of Adamson Acoustic Design loudspeakers and Crest amplifiers. The company now has over 150 of the Adamson cabinets, which feature the innovative Acoustic Waveguide design. The new Adamson flying system debuted this summer and reportedly works quite well.

(Note: Some of the data in this column and in "On the Road" is based on information provided by the companies. Address all correspondence and photos to Mix Publications, Sound Reinforcement Editor, 6400 Hollis Street, Suite 12, Emeryville, CA 94608.) ■

When not writing for Mix, Mark Herman operates a rental company specializing in sound reinforcement consoles.

T
H
E
É
L
I
T
E

OF THE ÉLITES

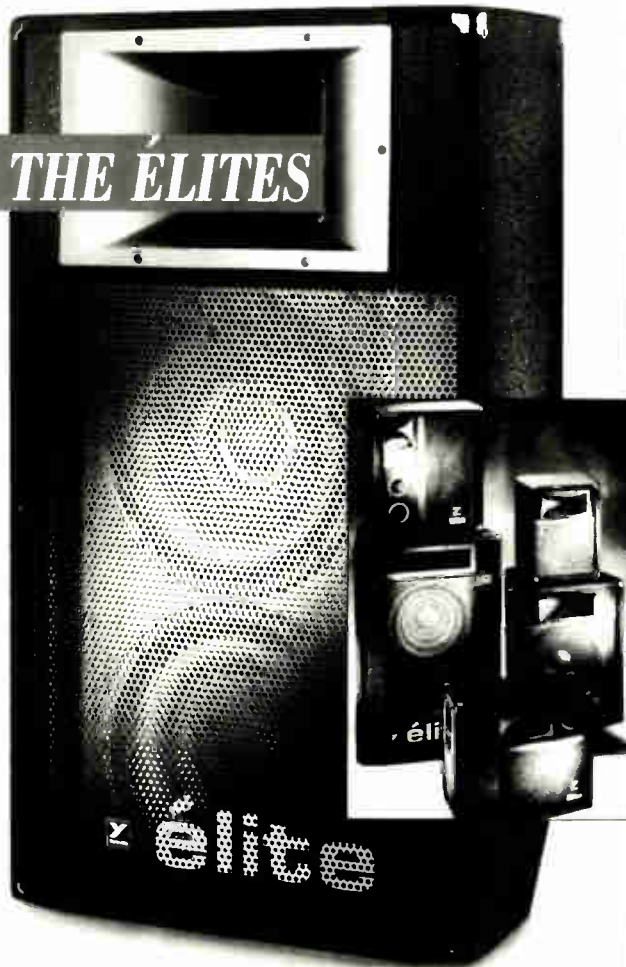

They're not for everyone. But for the few who require great sound, we offer ÉLITE speaker systems.

The New MX-2000 pushes technological limits to achieve the highest performance level in full size 3-way systems. Incorporating no-compromise drivers from RCF, EV and Beyma, the MX-2000 delivers 135dB SPL with 1kW power handling capacity.

All ÉLITE enclosures feature 3/4" plywood construction, metal speaker grilles and optional specially designed stereo processors.

Join the ÉLITE! SEE and HEAR ÉLITE speaker systems at your YORKVILLE dealer today.

CANADA:
80 Midwest Rd.
Scarborough, Ontario M19 4R2



U.S.:
4600 Witmer Industrial Estate
Niagara Falls, N.Y. 14305

You'll be hearing from us...

Circle #037 on Reader Service Card

TRACKMIX 24 from

StuDiomaster



TRACKMIX 24 is a new 24 or 32 modular input, 12 buss console. Full 24 track monitoring and MIDI controlled muting make TRACKMIX 24 the perfect choice for any modern 12, 16 or 24 track recording studio.

Pictured: 24x12x24x2
For more information contact:
STUDIOMASTER, INC.
3941 Miraloma, Anaheim, CA 92807
Fax (714) 524-5096
Phone (714) 524-2227

StuDiomaster

the sound experience

Circle #217 on Reader Service Card



THE

New Orleans Jazz & Heritage *Festival*

A 14-Ring Circus of Sound

by Howard Mandel

PHOTOS: MARK FURBERMAN

AS A VERMILLION SUN SETS ON THE FINAL HOUR OF THE NEW ORLEANS JAZZ & Heritage Festival, Dr. John, backed by some of the finest session players in town, croaks syncopated "rhumboogie" from his piano to some 15,000 revelers. Way across 33 acres of the Fair Grounds Race Track infield, the Neville Brothers—a family so extended it's better described as a tribe—pump African-American rhythms and stevedore harmonies to another 20,000 celebrants from a second stage. Forty yards away, the Zion Harmonizers sing the most fer-



If every wireless company claims theirs is the best, why do they try to copy ours?



First, let's talk technical.

A lot of newcomers to the wireless field are making pretty bold claims these days, but they all have one thing in common. They all say theirs are the best. Well, we've got news for them: all wireless systems are not created equal.

At Nady Systems, when we say we are the leader, we can back up our claims. Everyone knows modern wireless systems use companding for noise reduction, yet few realize that we invented and patented audio companding circuitry for wireless over 12 years ago.

Sure, other companies have attempted similar designs. Unfortunately, most of them simply fail to utilize the existing technology properly, so at 120 dB dynamic range, we still enjoy up to a 20 dB edge over many of our competitors.

In fact, what we find interesting is that even our early prototypes are still significantly quieter than these so called "new and improved" wireless systems. You may not always need the kind of performance our wireless systems can deliver, but isn't it good to know that the technology is there if it's required?

Let's talk product.

Our Nady 650 VHF Wireless System packs a surprising number of professional features into a mid price system. It's rack mountable and can be used with up to 10 channels operating on 10 different frequencies at the same time. And, of course, the 650 VHF has a highly sensitive True Diversity front end for drop out free performance in any environment.

The top of the line Nady 1200 VHF Wireless System defines state of the art wireless technology. Features include 20 channel simultaneous operating capacity on custom frequencies. The 650 and 1200 are ideal for any wireless application, such as the theatre, churches, meeting rooms or live entertainment. Musical instrument and lavalier mic body pack transmitters are available. Our 1200 HT handheld is a sleek, metal wireless mic with no protruding external antenna—another much copied Nady innovation.

Our 501 VR Wireless System delivers the highest performance available and features a portable, rugged metal case receiver perfect for video and film production.

So whether you need a wireless system for a modest facility with a small budget or a multi channel wireless for a large location, you can count on Nady to work flawlessly, give you complete coverage and sound superb doing it.

Finally, experience.

Nady has been in the wireless business for over 12 years. And we now sell more wireless than the rest of the industry combined. Nady almost singlehandedly pioneered the use of wireless in the live entertainment industry, where road ruggedness and dependability in a wireless system is essential. This means that when you install or use Nady, it will not only work the first time—but keep on out performing other wireless units for a long time to come.

Being on the leading edge of wireless technology practically since its inception, we have given the competition a lot of things to try to copy.

So why settle for imitations? In Wireless there's really only one leader—Nady.



Contact your local dealer or Nady Systems, Inc. 6701 Bay Street, Emeryville, CA 94608. (415) 652-2411 for more information.

Circle #126 on Reader Service Card

vent gospel this side of the River Jordan. And a listener who shortcuts through the Louisiana craft and food booths, darting among lightly clad tourists and locals of various ages and degrees of sobriety, can still catch the last few measures of, say, jazz pianist Ellis Marsalis, Cajun traditionalists Beausoleil, the National Dance Troupe of Senegal or the Olympia Brass Band.

Every year the crowds descend on the Fair Grounds Race Track on the last weekend of April and first weekend of May to enjoy literally hundreds of performers, ranging from thumb-pianists to big bands. 1990's headliners included B.B. King, Linda Ronstadt and Aaron Neville, Peabo Bryson, Toots and the Maytals, Little Feat, Freddie Hubbard, the Mighty Clouds of Joy, Bo Diddley, John Prine, Ashford & Simpson, Daniel Lanois, Branford Marsalis, Al Hirt, Harry Connick Jr. and Boz Scaggs.

At rare points on the field one can hear a band in each ear. But very seldom do the sounds of the 14 stages encroach on each other. There's hardly ever bleed-through, and even less distortion. The New Orleans Jazz & Heritage Festival provides the biggest of challenges in live sound mixing and one of the very best jobs, according to the man who has it.

"I like to think of my mix as a 33-acre console with 14 inputs, playing to an audience of 75,000 people on our final Sunday, or 300,000 people over the ten-day stretch," says John "Klondike" Koehler, audio director of the jazz fest for the past seven years. "I try to provide good ambient mixing between stages so people get audio invitations to go to a specific site, and once they get there they're not distracted by the neighbors."

Koehler admits—*no boasts*—it's a feat to tune the noon-to-dusk, simultaneous presentations of rock 'n' roll stars, R&B legends, blues veterans, gospel choirs, zydeco groups, ragtime orchestras, Caribbean troupes, African griots, regional folklorists and children's acts so all their musics remain clear and don't compete for the attention of the audience. Each has distinct sound system requirements, preferences and stage styles. Among Koehler's tasks is sorting out sound companies from across the U.S., who competitively bid, to work in the open-air venues and tents of the internationally acclaimed fest.

"We send out specifications to about 50 companies and about 30 respond," explains Koehler. His Klondike Sound Company is based in Wendell, Maine. "From that we pick ten. The competition is keen 'cause we've got a world-class festival with world-class talent, and that makes for a very good opportunity to showcase systems to many artists the companies would like to work with.

**When
the fest is in full
swing, the Fair Grounds
is a swirling circus of
sensations and a maze
designed, among
other purposes,
to baffle sound.**

"Companies who bid are asked to submit equipment lists and draw a sketch of their speaker design showing how they're going to stack and splay to meet a certain acoustical spec," Koehler explains, touring the unusually empty Fair Grounds on a day between the fest's two weekends.

"We give sound companies an audience area—say, 200 feet wide by 400 deep, with an SPL rating of about 85 at the rear of the crowd—and ask them to come up with a plan to meet the needs of everyone in that area without being painfully loud down front," he continues. "There are centerfill and sidefill suggestions. In the tents we specify 220 degrees of coverage from downstage center. Speakers have to be flown on trees or tresses of some type, and we specify the number of inputs, monitor mixes, patchable gates and compressors, and types of effects based on the kinds of acts we've seen at the particular stage."

The Fair Grounds Race Track comprises 14 separate stages. "We have two stages configured for national acts, with audiences of up to 20,000 people," says Koehler. "Those are 32-input stages with onstage mixes of 24 or 32 by 8 with drumfill and sidefill. Then there are three other stages configured for audiences of 2,000 to 5,000; those are 24-input stages with onstage mixing as well.

"Then there are four aluminum frame tents with onstage mixing, although many of the contractors bring their own. That includes the gospel tent, the jazz tent, the Economy Hall Dixieland tent, and Lagniappe, which means 'something extra' in New Orleans vernacular. The Music Heritage tent features piano solos and lectures, and finally there are three performance areas with very small systems."

Rather than thinking in terms of equipment tonnage, Koehler and Don Sydney, the Fair Grounds online producer, rate the job's vastness by the number of people working sound.

"There's something like 44 technicians for all the stages combined. That's sound crews, not including the 72 stage managers and stage hands I hire," says Sydney. "It's about 125 people after you count everybody else involved in music production."

Koehler adds, "It's between 60 and 70 performances each day of the six days of the fair. The nighttime concerts are another story, but over two weekends between 360 and 420 distinct concerts are produced, without sound-checks but with extremely fast set changes. We take pride that you can often set your watch to the start times of each act. In fact, we were ready to start Santana with 64 inputs and 12 mixes onstage five minutes early. With careful programming and a lot of advance work and attention to detail, we can execute on that level."

When the fest's in full swing, the Fair Grounds is a swirling circus of sensations and a maze designed, among other purposes, to baffle sound.

"I have a lot of ways of aiming stages: putting up blocks in the form of beer trucks, Ozone water trucks, Portalets, sound company semis; the tents themselves help baffle as well," Koehler says. "But it's the actual aiming of the stages and the focusing of the

systems into particular patterns that allow us to keep sounds tight."

The Fair Grounds, fronting on Gentilly Boulevard, is in a middle-class residential neighborhood that's jammed with parked cars and city tow trucks on fest days. "We try to aim the stages whenever possible into audience areas that are backed by a parking lot or a neighborhood," Koehler says, "rather than more stages. Stages that are aimed at each other have to be a certain distance apart, so that the 85 dB at the edge of one audience area doesn't overlap with the stage they're facing.

"We mix in mono, generally," he continues. "There are a few stereo systems; if artists rely on stereo effects, we'll try to accommodate them. But we're into good pattern control, very good fidelity and focusing the systems carefully. We have a prevailing wind direction I always try to work with; occasionally it comes from the other direction and the plan has to be changed.

"I can give you a little cameo on each system," Koehler offers, wheeling his vehicle to the eastern end of the long field. One side of this area rises toward the racetrack's close turn; it's

bound on the other by a paved walkway.

"Stage 1 belongs to Quickbeam, from Albuquerque, N.M., for the fourth year," he continues. "When there's an opportunity to make musical history, like Bonnie Raitt coming to sing with Jimmy Buffett or Allen Toussaint or John Hiatt, they have the extra inputs available, and she's on at the snap of your fingers.

"Our house mixes are all done from fixed positions 85 to 100 feet out from the stacks," he points to a rickety covered platform in the grass, "usually on-axis with one stack and sometimes in the center. Each sound company is given a sound pressure level meter with an assigned speed limit—they're told not to mix beyond that level. At the larger stages it's around 105, in the smaller ones, sometimes in the tents like Economy Hall, it's 85 or 90. This keeps the levels appropriate to the types of music being played, and also helps me control leakage between sites.

"Stage 2," he says, rounding a fenced-off pond and crossing the infield's entrance path, "is being run this year by Propoganda Productions Ltd. from Harahan, La. "Last year

Propoganda was a new company, at stage 4. They walked their audience area a lot, to see if they could possibly accommodate the crowd better by twisting the axis of a box. I try to impress on the sound companies to mix to the size of their audience, not to the acreage they've been given. If the crowd shrinks, their output level should also come back. That creates a little more intimacy and helps eliminate leakage. Propoganda's been very sensitive to that.

"Our choices are based on a firm's festival experience—not necessarily with us—their price, quality of their equipment and integrity of their design. That is, how well they feel they can tackle this, and whether their speaker array fits the geometry of the site. We're not interested in companies that have million-dollar inventories; we're interested in people who have the best interests of the festival at heart. They need to have a strong sense of altruism. They'll have to work extra hours, be prepared for surprises, be able to adapt to rapidly changing weather conditions and stage plots, and be able to *work with us*."

Koehler emphasizes, "It's a custom-built festival, and it gets tuned up as the

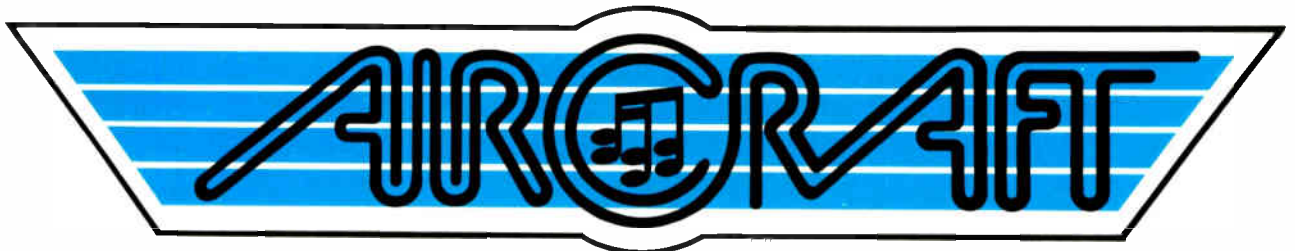

PRODUCTION LIBRARIES

MUSIC

BOSTON

1 800 343-2514

NEW YORK

Circle #156 on Reader Service Card

They make beautiful music together.

Laser-trimmed resistor packs and 18-turn trim-pots maintain precise circuit tolerances.



A wide variety of preamp and EQ modules allows you to easily configure the console to your needs.

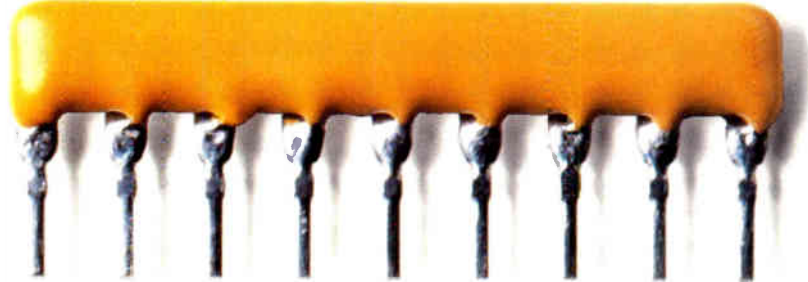

Audiophile-grade capacitors maximize sonic accuracy.



Large crystal oxygen-free cables with gold plated connectors ensure sonic clarity and detail.



Sony's own hybrid circuitry makes these consoles among the quietest in the industry.

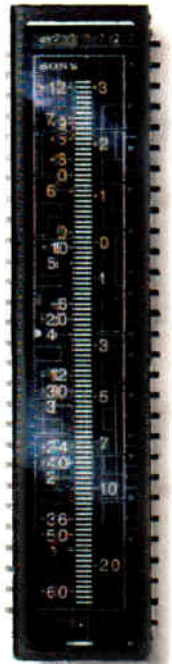

Unique vacuum-fluorescent multi-scale metering shows signal levels as low as -60dB, essential for digital recording.

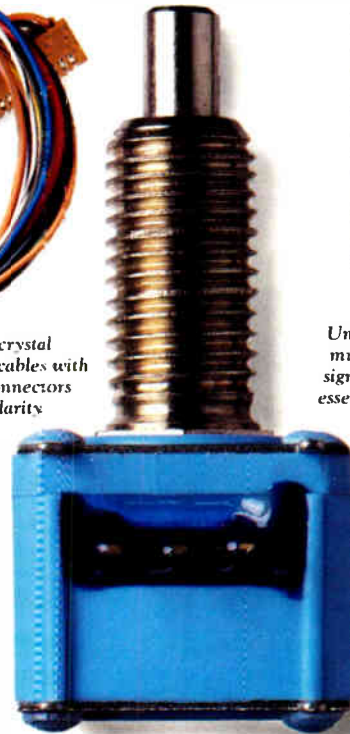

Sealed, steel-shaft potentiometers deliver reliable performance for years.

Sony marries superior components and intelligent engineering to create the MXP-3000 series consoles.

The result is consoles that offer the same high level of sonic excellence as our digital multitrack recorders, as well as unsurpassed reliability.

To achieve this, we selected only parts that meet the highest standards. Often, this required creating unique components.

This dedication to quality extends throughout the MXP-3000 series.

From our "minimal signal path" architecture to our advanced metal frame

construction. It's why the MXP-3000 delivers performance that satisfies even the most critical users in hundreds of facilities worldwide.

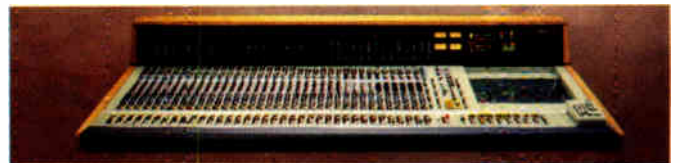

Call us at 1-800-635-SONY, to learn how you and the MXP-3000 series can make beautiful music together.

SONY®

PROFESSIONAL AUDIO

DOD's six new compact mixers

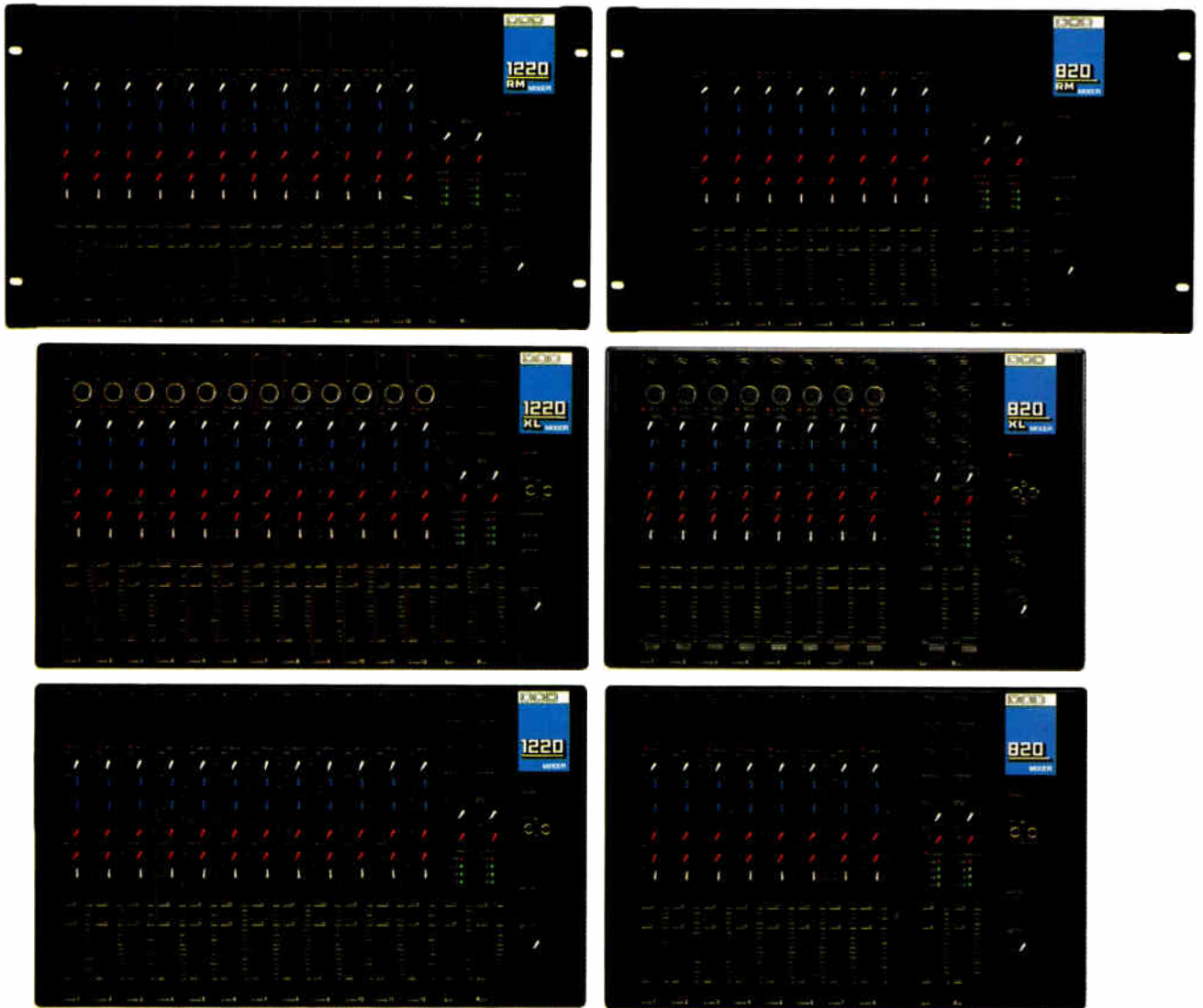

Big on performance, sub-compact on price.

The 820 and 1220 Series Feature:

Each Channel

- Line-unbalanced 1/4" inputs
- Mic-balanced XLR inputs (XL and RM models)
- 15 dB cut/boost Hi and Low EQ
- Panning
- Monitor and effects sends
- Input gain control
- 60 mm dust-shielded fader
- LED overload indicator for monitor, mic, line, and EQ

Master

- Auxiliary input level—mono/stereo
- Monitor and effects send levels
- Effects return level—mono/stereo

The DOD 820 and 1220 Series Compact Stereo Mixers don't compromise features. You get real compactness in a studio-quality, road-tough format. With six table-top and true rack-mount models to choose from. In 8 and 12 channel versions. And they're priced right!

Try the new DOD Compact Mixer series at your DOD dealer today.



H A Harman International Company

- Phantom power switch
- Stereo headphone level
- 60 mm dust-shielded left and right faders
- 4-segment left and right LED meters
- Left and right mix buss clip LED indicators
- Main and phantom power LED indicators

Other Features

- Bandwidth: 10 Hz to 22 kHz
- THD + noise: less than 0.05%
- Crosstalk: better than -65dB
- Table-top—all inputs mounted on top of chassis
- Rack-mount—all inputs (except headphones) mounted on back of chassis
- Tough, all-metal chassis

DOD Electronic Corporation, 5639 South Riley Lane, Salt Lake City, Utah 84107

Circle #125 on Reader Service Card

day goes on. A lot of things change, not just weather or crowd size or a few inputs. We're showcasing the musical quality that earned an artist the privilege of appearing at this festival. This is a music festival, not a hardware convention."

He pulls up at the gospel tent, run by Sound Services from Little Rock, Ark. "We like to play all the tents on their long wall, to have the most number of front row seats and the shortest throw to the furthest person. But due to the topography of the ground here, we had to put the stage at the far end. We're fortunate to have a sound company whose cabinets are adaptable to a long-throw, rather than an in-the-half-round, medium-throw situation.

"Gospel is difficult music to mix. You've got 70- to 100-voice choirs, plus rhythm sections and solo vocalists down front. They parade one choir on as the next one's going off—there's absolutely no time between them. And it's hard to get a good choir sound and a good band sound in the same mix. We're using PCMs over the choir risers, and Sound Services has a warm, all-cone system that doesn't give the choirs that blaring, compression driver-on-a-horn quality that can ruin a gospel performance.

"Stage 3, where we've scheduled Santana, [the late] Roy Orbison and Robert Cray, is the biggest stage," Koehler continues. "We've got about 500 feet of throw here to the rear of house left, and it's approximately 300 feet wide. This is the first stage we've had to power by a generator, because of the amps' requirements. That's an Agreco Hush-powered generator out there, which is 200 amps a leg, 3-phase, a good 50 percent of which is used on average by the sound system. This company is Bernard Brown Inc., out of Dallas. Bernard's been around the fest for five years or more.

"Here's the jazz tent, where the cutting edge is: the Marsalises, Harry Connick Jr., Charles Lloyd. Sound Chek Music, from Metairie, just outside of New Orleans, has been with us about five years.

"Bernard Productions, from Avondale, La., is handling the Lagniappe tent. And the last one is stage 4, run by Gemini Concert Systems in West Monroe, La.

"The bigger bands tend to bring in their own house engineers and often monitor engineers, too. But that's only about 10 percent of the acts in the fest, so our guys have the major responsi-



PO BOX 733
Union Station
Endicott NY 13760

COVERS

For the past 3 years the owners and designers of Cloud 9 Covers have worked hand in hand with manufacturers and touring sound companies. By going out in the field with some of the biggest sound contractors in the business we were able to determine and understand their needs. We at Cloud 9 feel the tremendous success of our product comes from listening to the needs of the industry. When it comes to studio and rental needs being involved and working in the studio allows us to understand market demands and protection needs in these demanding situations. All of our materials and designs are researched and developed for optimum protection in each individual application.

As far as ease of transport and light weight protection, Cloud 9 has the solution.

MFG. (607) 748-2011 FAX(607) 785-4059 SALES (607) 655-3413 FAX(607) 655-3414



Circle #071 on Reader Service Card

THE MAXIMUM

- low profile
- high quality
- yet affordable
- road-ready

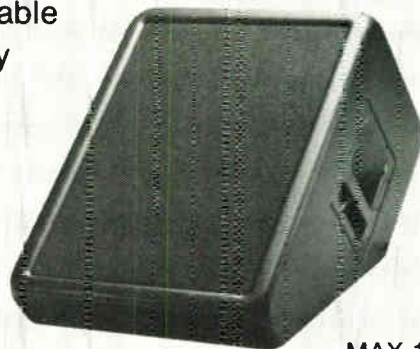

presenting

MAX 1

WOODWORX audio enclosures

913 S. Chapman St., - PO Box 5485
Greensboro, N.C. 27403

(919) 378-0650
Fax (919) 378-1498

Circle #072 on Reader Service Card

“No one can repeal the laws of physics. The challenge is to make them work for you.”

KENTON FORSYTHE
Director of Engineering; Co-Founder



Case in point: The KF600, EAW's newest system for performance applications. It measures just 33" high and 19 3/4" on a side. Yet KF600s produce 130 dB, averaged from 65 Hz — 20 kHz.

A principal factor behind that small miracle is our unique Transverse Geometry™ low frequency

subsection. In this ingenious example of physics at work, the woofer faces *sideways*. Yet its entire output is frontally focused. The design uses dual chambers (one tuned, the other acoustically open) to accomplish this acoustic rotation while maintaining high woofer efficiency.

At 15 feet, KF600s sound impressive. At 150 feet, they're simply amazing. A 60° horizontal coverage pattern delivers true long throw performance. From speakers this compact, that's even more astonishing than the SPLs they deliver. And our exclusive Virtual Array™ design matches the enclosure angles to that constant (from 400 Hz — 20 kHz) 60° horizontal dispersion. VA™ technology is a complex balance of numerous parameters. But the result is a system that's amazingly simple to use. With KF600 arrays, minimizing interference

and eliminating lobing or hot spots is virtually automatic.

We're known for innovative enclosures, but we also know the value of electronics. So we've developed KF600 modules for our MX800 Closely Coupled Electronic Processor™. The MX800 provides four-way asymmetrical crossovers, time/phase compensation, individual driver protection and high frequency power response equalization, along with LF excursion control and equalization. All functions are precisely adjusted — through TEF™ analysis and real world testing — for optimum effectiveness.

If you have an application that demands unlimited sonic performance while providing limited space and setup time, audition KF600s. You may have a little trouble believing your own ears — most people do. But what you'll hear is real: No magic, just the laws of physics, artfully applied.

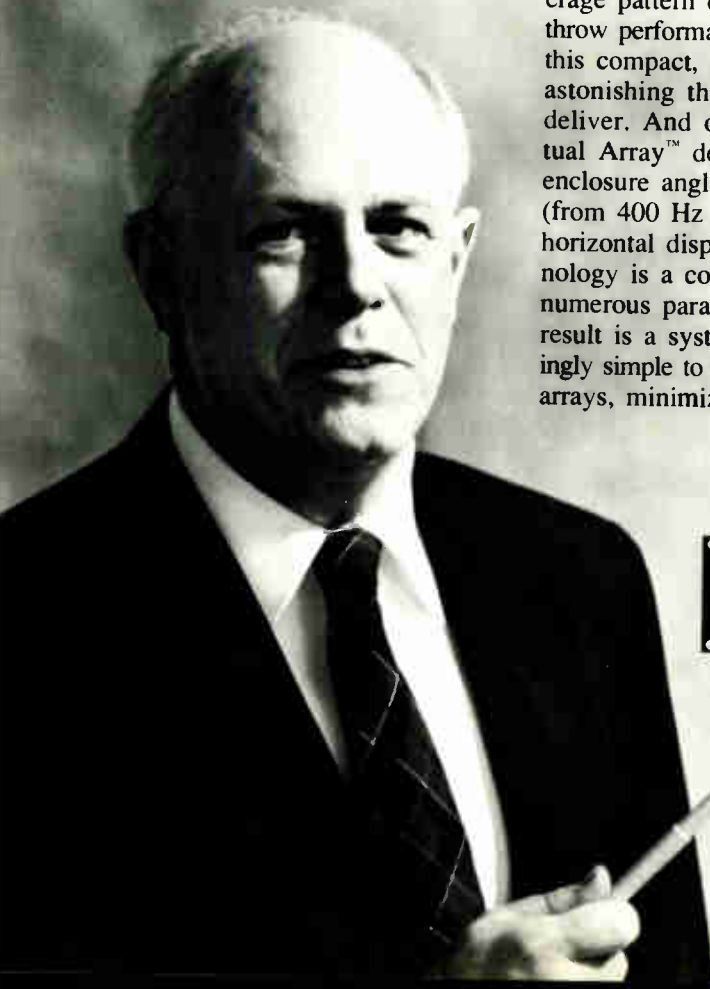

MX800 CCEProcessor — an integral part of the KF600 system.



One Main Street, Whitinsville, MA 01588
(508) 234-6158 • (800) 992-5013 • Fax (508) 234-8251

Circle #093 on Reader Service Card

bility to get into the groove—and quickly!

"I guess I got prepared for this job by being exposed to lots of different types of music, working outdoors with audio, and understanding the behavior of sound waves," Koehler continues. "In the 12 years I've worked here I've gained a deeper appreciation for the music. And I hope I've sharpened my ability to coach the sound companies into making the whole thing happen as a macro mix.

"The only problems we've ever had were due to rain. When a stage gets wet we shut it down, then we go through major calisthenics to get it dry and back up on the air as soon as possible. Our chief electrician, Eddie Lambert, and his crew are phenomenal at keeping the Fair Grounds safe with an enormous electrical installation and distribution system.

"Ken Kennard does most of the scaffolding and the roofs; he's an incredible rigger and manages to keep us dry as long as the rain goes straight down and not sideways. Garnett Harden, who's head of the construction crew, does all the board roads, planking on the stage, ramps backstage, panels to put consoles on—he's our 'hit-and-run, one-man carpentry team.' These guys are simply indispensable.

"It's a proving ground for a lot of sound companies. It's a boot camp for most of us because it's the first big fest of the season. You know, there aren't many bigger, more complicated festivals than this one," concludes Koehler.

His pride is justified; the proof of his success is that the fest's enormous complications aren't obvious to audiences. And the Fair Grounds crowd keeps swelling.

Both Atlantic and Flying Fish Records have released live albums from the New Orleans Jazz & Heritage Festival; in '88 Ken Ehrlich Productions created *Best of the Fest*, a television version hosted by Herbie Hancock. But nothing compares to a spring weekend in New Orleans: the fabulously costumed performers, the spicy aromas and flavors, the pulsating collage of sounds you mix for yourself at the Fair Grounds. For lovers of American popular music, one exposure to the macro mix at the Fair Grounds is reason enough to come back. ■

Howard Mandel is a contributing editor for Down Beat and The Wire, and a regular contributor to National Public Radio's "Morning Edition."

It's 12 AM



Heard your monitor ^{system} lately?

Clair Brothers Audio introduces the 12 AM portable monitor system, providing high performance for the most discriminating musicians.

Designed to be heard and not seen, the 12 AM is the result of 25 years of stage monitor experience.

The system:

C.B.A. 12 AM Monitor

Frequency Response • 65 Hz to 18 KHz
L.F. Power • 300W EIA/1200Wpeak
H.F. Power • 150W continuous power
Cabinet Material • 19mm Finland birch
Finish • Epoxy/mastic with black laquer overcoat
14½" x 22½" x 18¼"
74 lbs.



C.B.A. 200 Series Monitor Rack

custom signal processing
crossover integrated into each amplifier
corrects phase error
optimized eq curve
Input Capability—4
Drives 8 12 AM's
110 lbs.
13" x 25½" x 24⅞"



C.B.A. 400 Series Monitor Rack

same specs as 200 series
Input Capability—8
Drives 16 12 AM's
172 lbs.
25¼" x 19⅞" x 24⅞"



The 12 AM system is a portable, low profile, efficiently designed monitor package maintaining the classic Clair Brothers Audio style.

Clair Brothers Audio System Incorporated
Box 396 Litz, PA 17543
Phone (717) 665-4000 Fax (717) 665-2786



Circle #061 on Reader Service Card

TROUBLESHOOTING

PROBLEMS WITH ACOUSTICS

ONE SHED'S SOLUTION

by Richard Zweibel

The Starplex Amphitheatre opened in the spring of 1988 in Dallas. Located in a section of the State of Texas fairgrounds, the venue features both pavilion and lawn seating for 20,000 patrons. As part of the seasonal shed circuit, it features performances by many popular artists.

Basic design goals for the facility included optimal sight lines, easy access for both patrons and tour personnel, quality acoustics, and community noise ordinance compliance. A large earthen berm was built at the rear of the amphitheater to provide a sloped area for lawn seating and reduce the sound levels in nearby residential areas. To further reduce escaping sound, a large wall built of Criblock (an interlocking concrete product) was erected along the entire circumference of the rear

Rear diffusor wall at Starplex Amphitheatre



lawn area. In addition to providing further sound isolation, the wall's non-uniform surface minimized any large specular reflections. (A specular reflection of sound behaves like light, where the angle of incidence

Starplex Amphitheatre showing the back side of the diffusor wall and earthen berm

of the sound wave equals the angle of reflection.)

Shortly after the amphitheater's opening, however, the earthen berm below the wall on top of it to collapse. At this point, the Joiner-Rose Group, already working on environmental noise control for the amphitheater, was hired to design a new rear wall.

As the summer concert season was already in progress, with acts booked and tickets sold, an immediate remedy was necessary. A temporary wall made of plywood standing 13 feet was constructed. The bottom of the wall was sloped up 20° to prevent a large specular reflection from returning to the audience and the adjoining neighborhoods. While the slope worked, it directed sound over the top of the amphitheater to a nearby residential area. Two inches of duct



liner was applied to the surface of the plywood to add absorption, thereby reducing the amount of reflected energy.

This temporary wall worked for the remainder of the first season, but Pace Entertainment and MCA Concerts, the operators of Starplex Amphitheatre, wanted a permanent solution to keep community noise levels as low as possible, while being aesthetically pleasing to concertgoers.

For the new wall, Jack Wrightson of the Joiner-Rose Group envisioned a structure that not only provided sufficient transmission loss to the area behind the wall, but also reduced the amount of energy reflected back to the audience and surrounding community. An absorptive treatment applied to the front surface of the wall was ruled out due to weather exposure and the need for a more permanent solution.

Wrightson decided to apply a technique commonly used in recording studios to an environmental noise control problem. The idea was to build what turned out to be the world's largest quadratic residue diffusor. Quadratic residue diffusors are based upon a mathematical number series, discovered by Manfred Schroeder and developed by Peter D'Antonio of RPG Diffusor Systems. These diffusors consist of a series of "wells" of varying depths. The depths determine the frequencies that will be diffused. This type of diffusor is used frequently in recording studios to provide a diffused sound field off the rear wall of a control room. Diffusion provides a more even spread of energy over a given area than a specular reflection. This reduced the energy per unit volume at any given point, thus eliminating hot spots in the neighboring community. To implement this unique application, Wrightson worked with Russ Berger, a veteran of dealing with diffusion problems in recording studios.

The new wall was built of concrete block. It is 11 feet high and 900 feet long, spanning the entire rear perimeter of the lawn. It's built upon concrete pillars imbedded 58 inches in bedrock. The architectural design, by Abe Sustaita of Sustaita Associates in Houston, incorpo-

rated split-faced and polished concrete to complement the finishes used throughout the complex. As a result, the wall is aesthetically pleasing *and* fulfills its intended acoustical purpose: The audience does not hear a loud slap off the rear wall, and there are no hot spots in the community.

The Joiner-Rose team and Peter D'Antonio conducted a measurement session of the rear diffusive wall using a Techron TEF® analyzer. Measuring a 900-foot long concave diffuser proved to be a challenging undertaking. A grid technique was used, taking measurements every 18 feet along the wall at two different distances back from the wall.

These data were put into a 3-D measurement and then converted to polar plots, which showed that the energy from the rear wall in the diffusive frequency range was much lower and did not have any prominent energy spikes.

Other aspects of the amphitheater needed improvement also. The sound within the pavilion was not uniformly clear, and speech at distances of 75 feet or more was unintelligible, resulting in complaints from numerous performers and mixing engineers. Most of the seating area is covered by a single piece of metal deck roof, 60 feet above the seats.

To accommodate symphonies, this area was built to be quite live, with a small percentage of perforated acoustical deck. However, the primary use of this facility is by popular musicians, usually amplified through a large touring sound system and needing much more sound absorption. The roof appeared to be the major offender in degrading sound quality, by creating a large reflection of sound from the P.A. stacks into the audience.

To verify this theory, a TEF analyzer was used again. During a two-day measurement session, data were gathered at numerous locations throughout the amphitheater. ETCs were taken at each location under existing conditions, and then the same measurement was repeated, once with the side reflections blocked, once with the bottom reflection blocked, and once with the top reflection blocked. No

AKG
Audio-Technica
Beyer Dynamic
C-Ducer
Countryman
Crown
Electro-Voice
HME
Nady
Ramsa

Talk to me.



Sing to me.

Samson
Sennheiser
Shure
Sony
Telex



Let me perform!

Tram
Toa
University
Vega
Williams



At Prices That Can't Be Upstaged!

As the nation's largest microphone dealer, we offer a vast selection of microphones at prices so low we promised not to print them!

FAMOUS MIC SALE ON NOW.

Call Now:

1-800-356-5844

608-271-1100

300 LINES: AUDIO, VIDEO, LIGHTS



5618 Odana Road, Madison, WI 53719

Circle #033 on Reader Service Card

measurements were taken blocking the rear of the microphone, as the rear of the covered seating area is open to the lawn and will not produce any reflections. The sidewalls had no significant effect in most seating areas and only a minimal effect in the worst areas. The lower reflection was broken by the seats and obviously would not be of concern with the added absorption of an audience *in* the seats. But the reflection off the ceiling was significant in almost every seat in the house, in some locations being only 4 dB lower than the direct sound. By studying the measurements, we determined which areas of the roof needed to be treated.

The next step was to find the best method to reduce this reflection. The ceiling is supported by a series of large metal trusses 12 feet apart, parallel to the front of the stage. To apply absorption to the ceiling would be extremely difficult, as there are numerous trusses, lights, air handling vents, fire sprinklers, etc. The fact that this is all 60 feet above a sloped floor with fixed

seating compounded the problem.

Eventually, we added a vinyl-covered, 2-inch, quilted-fiberglass, absorptive batten attached vertically to the trusses (hung on the lower half of the truss). This solution increased the probability of a reflection passing through two baffles rather than just one, and complied with sprinkler system clearance requirements.

The roof over the sides of the amphitheater has a shorter span and a shallower truss. Hanging absorptive batting on these would block the sprinkler system and would not meet local fire codes. To prevent significant reflections from reaching the seats in these areas, the absorptive baffles were hung perpendicular to the stage, above air handling vents. This worked quite well, blocking the path to a large surface area of the roof on either side of the amphitheater.

During the first season, a few bands also expressed concerns with the sound quality onstage. Addressing these concerns, Joiner-Rose found that a removable

wooden "nose piece" on the stage was the cause of most of the problems. While the stage needs to be modular to provide for easy removal, it also must be as rigid and non-resonant as possible. So, a second layer of 3/4-inch plywood was screwed and glued to the original single sheet, and draw-latches were used to lock the stage together to form a more rigid structure. The fiberglass removed from the temporary wall was stuffed into the space between the nose piece and the concrete floor, further reducing stage resonances.

The improvements made to the audience and stage areas have significantly improved the sound quality at Starplex; the number of complaints from neighboring areas has also decreased. By combining environmental noise and vibration control technologies with acoustical principles and techniques, Dallas has the top-quality facility it wanted from the start. ■

Richard Zweibel is a senior designer for The Joiner-Rose Group, Inc.



Dynamic Processing Has Reached A New Peak.

The name Klark-Teknik has always been synonymous with audio technology at its highest level. Innovative engineering combined with quality components ensure products of outstanding musical purity and durability.

Now, that same commitment has been brought to dynamic processing. With the new Series 500.

The DN500 is the only two-channel compressor/limiter/expander that lets you use its processing functions in any combination — with full function variable knee compression, independent peak limiting and clipping. Plus a variable ratio expander/gate for total dynamic control.

Most importantly, it delivers all the clean, quiet sound quality and reliability you'd expect from Klark-Teknik.

The same high standards are common to all Series 500 products — from the compact DN504 Quad Compressor/Limiter, to the flexible DN510 Dual MIDI Noise Gate and DN514 Quad Auto Gate.

If you're looking for the ultimate in dynamic processing, visit your local Klark-Teknik dealer and find out more about the Series 500. Because at Klark-Teknik, we never set a limit on quality.



Klark-Teknik Electronics Inc.
200 Sea Lane
Farmingdale, NY 11735 U.S.A.
Tel: (516) 249-3660 Fax: (516) 420-1863
Klark-Teknik Plc., Klark Industrial Pk.,
Kidderminster, Worcs., U.K. DY11 7HJ
(0562) 741515

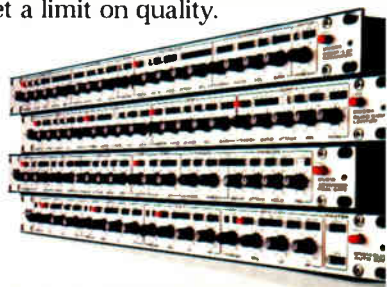

Experience the future of music. Visit Korg at AES in room 216C.

MAKE WAVES.

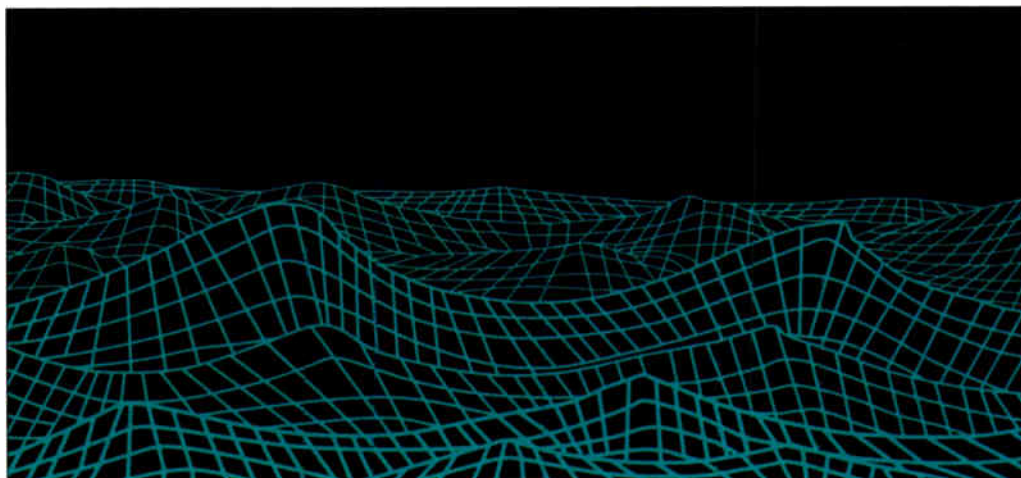

Korg Wavestation is the first synthesizer that actually lets you control the essential building blocks of sound — waveforms.

Its extraordinary power comes from three unique and highly sophisticated technologies: Wave Sequencing, Advanced Vector Synthesis and Dynamic Digital Multi-Effects.

A 32-voice ROM based synth, the Wavestation is equipped with over 350 on board waveforms. Multi-sampled instruments, attack transients, digital waveforms, fat analog sounds, time slices and PCM loops.

Plus important new ways to connect those sound sources.

Wave Sequencing

Because any one sequence can consist of up to 256 different sound elements all linked in succession, you can create a completely original Wave Sequence that constantly changes over time.

Advanced Vector Synthesis

More powerful than Vector Synthesis, it lets you crossfade and mix four combinations of samples, attack transients, complex waveforms or Wave Sequences. You've got ultimate control.

Dynamic Digital Multi-Effects

The Wavestation has 46 dramatic new digital effects and a stunning variety of Real Time Dynamic Controls to modify those effects using wheels, pedals and MIDI controllers.

Its open ended system architecture means you can always bring new sounds in from Korg's extensive library of ROM and RAM cards.

Korg Wavestation. Make sounds that change the shape of music with the synthesizer that makes waves.

KORG[®]
WAVESTATION



For a catalog of Korg products, send your name and address, plus \$1.00 for postage and handling to: Korg USA, 89 Frost St., Westbury, NY 11590

Circle #094 on Reader Service Card

© Korg 1990



By integrating sound processing, SAORI has reinvented system design, and in the process, revolutionized the way sound is controlled, shaped, refined and distributed. SAORI makes processing not only easier, more precise and reliable, but *repeatable*, with one-touch-recallable presets. So

you can switch the house from rock to Bach in an instant. Eight presets are built in, for house curves, zonal selection — virtually any desirable parameter. Limitless presets and acoustic control are a keystroke away via a PC interface port. Now, instead of engineering each venue from scratch, start with a head start — SAORI. 



MORE THAN THE SUM OF ITS PARTS, SAORI SIMPLY REDEFINES ENGINEERED SOUND.



This powerful control is, in part, because SAORI flawlessly integrates dozens of heretofore separate signal processors — equalizers, notch filters, CD horn compensators, crossover/band pass filters and digital delays. With 32-bit digital purity, it eliminates the inherent noise, hiss, hum and distortion . . . the ground loops, feedback, interconnects and leveling that come with orchestrating a rack of gear. Time alignment, high-end rolloff and normal or asymmetric crossovers are precisely controlled.

More? SAORI is modular, with plug-ins for A/D and D/A conversion, 4-way channel dividers, delays, multi-equalizers . . . all individually programmable and repeatable through the LCD display.

Software upgrades and subframe expansion mean SAORI is immune to obsolescence. Still more? It really is easy to program and operate. SAORI. Just five rack units tall,

it's a small wonder.



From TOA. For more information, contact our

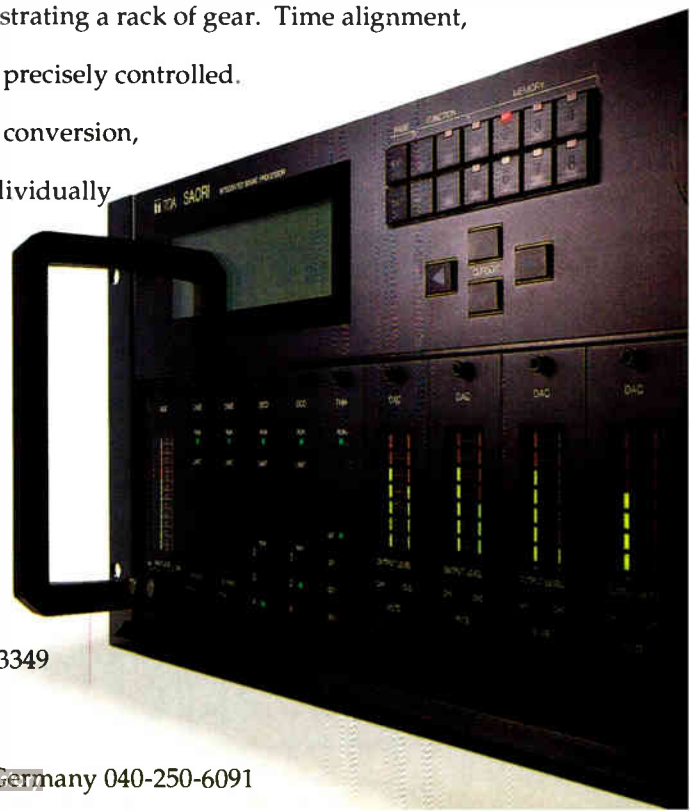

Engineered Products Group, 800/733-4750 FAX 415/588-3349

601 Gateway Blvd., South San Francisco, CA 94080.

TOA Canada 416-564-3570, TOA U.K. 0277-233882, TOA Germany 040-250-6091

by Craig Anderton

SUMMER NAMM SHOW, PART 2

NEW PRODUCTS REPORT

Despite the poor attendance at the summer NAMM show (see last month's "MI Update" for details), there were quite a few new product introductions. So without further ado, let's look at some of the latest and greatest. As always, prices, specifications and any other connection whatsoever with reality are subject to change without notice.

Alesis concentrated on upgrades, another Microverb and a sneak preview of a new drum machine. The Quadraverb has graduated to the Quadraverb Plus thanks to several additional features (multitap delays, ring modulation, resonators and sampling). Also, the DataDisk has been promoted to the DataDisk SQ; it can now record and play back MIDI sequence data in addition to sys ex. Older versions of either unit can be upgraded to the new specs for \$35.

The Microverb III (\$349) is a rack-mount signal processor with 256 presets, stereo operation and EQ; but the big attention-getter was the SR-16 drum unit. It won't appear until at least December 1990, but the design specs are impressive: 100 sounds, many recorded in stereo and multi-sampled to provide different sounds for different velocities; 16-voice polyphony; and a list price of under \$400. Although the HR-16 and HR-16B will remain in the Alesis line, the SR-16 looks like it may well be the next big drum machine.

Kawai was another company with several major introductions. The KC-10 (\$695) is a multitimbral wavetable synthesizer with 128 different 16-bit wavesamples, 14-voice polyphony (although four sounds are reserved for the onboard drums), and a five-octave keyboard with full-sized keys.

Kawai also introduced two mixers. The MX-16 (\$795) is a conventional audio mixer with three effects sends,

channel fader and EQ. The main selling point is built-in dynamic noise reduction that cuts the signal-to-noise ratio to a claimed -124 dB. The MM-16 (\$345) is a "MIDI mixer" with 17 front panel faders. It's suitable for program-

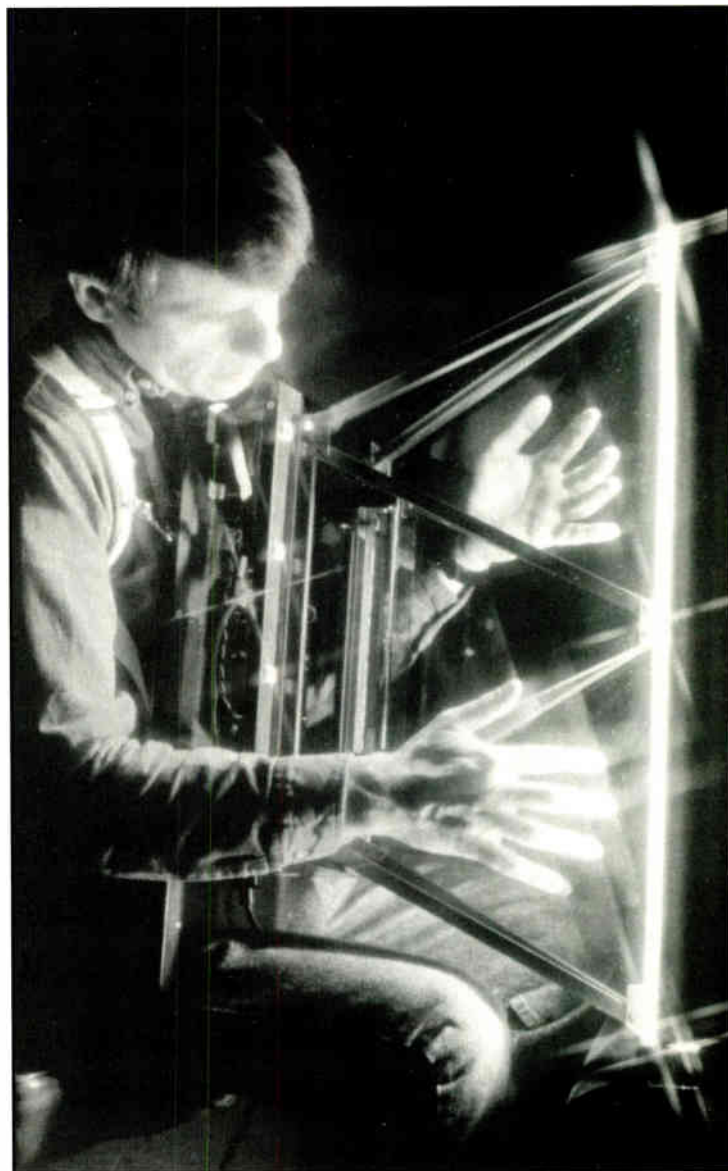

Right: The Video Harp from Sensor Frame (Pittsburgh) offers a new way to generate MIDI data.

ming controller 7 changes when recording MIDI mixes into a sequencer, but it can generate other MIDI controllers as well. Not enough? It's also a synth programmer, 2-input merger and "intelligent" splitter that divides notes according to velocity, note number or channel assignment.

Finally, the XD-5 Percussion Synthesizer (\$895) is a wavesample-based (200 total) drum expander module. There are eight total outputs (stereo master and six individual outputs) but more importantly, it has the kind of editing options you'd find on a syn-

thesizer—envelope generators, resonant filters, level and the like.

E-mu has applied its G-chip technology used in the Proteus to two even lower-priced products: the Proformance sampled piano module (\$499) and Proformance Plus (\$599), which adds other sounds (vibes, organs, basses and electric pianos). Both are half-rack units with 16-bit stereo samples.

As expected, Yamaha released a rack-mount version of its acclaimed SY77 synthesizer. The TG77 (\$1,995) retains all of the SY77's salient features (including the blissfully large LCD) but adds eight individual polyphonic out-

puts and 128 new ROM voices. Meanwhile, the audio division offered a pair of powered monitors (the 20-watt MS20S for \$225 and the 60-watt MS60S for \$575) and a revamped line of P.A. speakers, the Club Series Mark II (list prices range from \$295 to \$395). And to drive those speakers, the P2160 (\$845) power amp pushes 160 watts per channel into 4 ohms and 80 watts/ch into 8 ohms.

There were even alternate MIDI controllers at the show. The most striking was the Video Harp; it scans finger position and velocity via an optical process, and translates those finger movements into performance data. Unfortunately, the \$9,500 price tag will discourage the casual user, but it does look cool and represents yet another way to tickle MIDI sound generators. And believe it or not, there was a new guitar-to-MIDI converter. Gibson Labs announced Max (\$1,795), a Roland GR Series compatible system that accepts magnetic, infrared or piezo transducers—pick the one you prefer. Other features include a programmable mixer and a routing system

Saki vs. Otari 24-track Replacement Heads: You'll Like the Difference.

Otari's own MTR-90 record and playback heads are excellent. Proven Permalloy cores and shields. Clean response with low crosstalk. Troublefree.

Just like Ours.

In fact, we guarantee to deliver the same mechanical and performance specs to your 100% satisfaction, or your money back.

So why change to Saki when replacement time comes? Because our Made in U.S.A. heads are priced significantly less than Otari, and we offer immediate delivery from stock.

Ours.

Ours vs. theirs—the difference is worth a closer look.

Call us now for all the details.

SAKI[®]

SAKI MAGNETICS, INC.

26600 Agoura Road, Calabasas, California 91302
Phone: (818) 880-4054 Telex 244546 Fax (818) 880-6242

Circle #022 on Reader Service Card



PPeople keep saying the industry is in the doldrums, but that doesn't deter the manufacturers from coming out with even more enticing toys.

for the four effects loops.

For traditional electric guitarists, DigiTech's Whammy Pedal (\$199) is a "whammy bar in a box" that bends pitch up or down up to two octaves. It can also produce chorusing effects and harmony lines. ART's Power Plant fuzz is finally shipping; it's a bit of a throwback in the sense that there's no MIDI or multi-effects, but it is a sweet-sounding overdrive unit that doesn't "wash out" chords as much as some

other units. Scholz R&D introduced a low-cost pair of headphone amps, the Guitar Ace and Bass Ace (\$99 each). Either one lets you plug in another device (such as a drum machine or tape player) so you can practice along with other sounds or players.

In recording news, the G-16 from Fostex is a 1/2-inch, 16-track recorder that accepts an optional built-in synchronizer. Transport functions can be MIDI-controlled, and time code can be read in fast forward and rewind as well as play. Tascam's BR-20T (\$2,999) is a 1/4-inch, 2-track mastering deck intended for the audio-for-video market. It boasts center-channel time code and independent channel record. Tascam also branched out into the P.A. market with the M1016 16 x 2 rack-mount mixer and M1024 24-channel console mixer (\$1,299 and \$1,899, respectively). Both mixers provide 3-band EQ with sweepable midrange on each channel; stereo and mono channels are provided.

And what's a 1990s NAMM show without software? Automatic accompaniment showed up in two products: Band-in-a-Box from PG Music offers 24 different musical styles and the option to save sequences as standard MIDI files (\$59; for the Atari, IBM and Mac); MiBac creates a three-piece jazz combo that plays in various styles, according to data you provide (for the Mac only, \$295). Both are excellent for practicing with if you want to hone your improvisational chops.

We'll close out with some computer peripherals intended to meet rock 'n' roll specs. Eltekon's CD-2 CD-ROM unit (\$1,125) transfers samples from CD-ROMs to samplers and computers via SCSI; true sample fanatics should look into the MX-2 (\$4,999), a 650MB optical drive. If that won't store your library of sound disks, then you sure do own a lot of disks...

Even at a scaled-down show, there was plenty of exciting new gear. People keep saying the industry is in the doldrums, and that's true to an extent; but that doesn't deter the manufacturers from coming out with ever more enticing toys. Who knows? Maybe someday, we'll figure out how to actually master all this neat stuff. ■

Author, musician and consultant Craig Anderton lives his life surrounded by 3.5-inch floppy disks. He is extremely glad they are not carnivorous and don't need to be housebroken.

PRO DISK: SURPASSING THE STANDARDS

After studying every system, ProDisk was most complete, at a great value...and in use, it's lived up to the promise.

- Ron Steele
MIDI LAB
Chicago

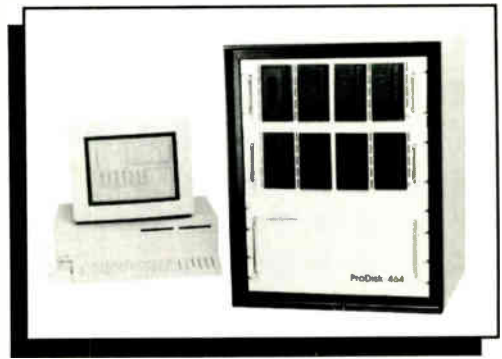

Digital Dynamics ProDisk 464

Mac Control, Modular Multi-track: 4 to 64 tracks
SMPTE Lockup, Expedient Editing, EDL & Cue Editor,
2 Hr. Recording, 64X Oversampled. Starts at \$27,950..

Pyramid Audio Inc.
450 W. Talt Drive • South Holland, Illinois 60473

CHICAGO'S LEADING PRO AUDIO DEALER
CALL: 708-339-8014

Circle #023 on Reader Service Card



LEARN THE ART OF RECORDING

THE RECORDING WORKSHOP IS THE WORLD'S LEADING SCHOOL FOR "HANDS-ON" TRAINING IN MUSIC RECORDING TECHNOLOGY. IN OUR INTENSIVE, 5-WEEK PROGRAM, YOU'LL LEARN THE CREATIVE OPERATION OF PROFESSIONAL RECORDING EQUIPMENT. WE'LL TEACH YOU THE JOB SKILLS NEEDED TO SUCCESSFULLY START YOUR CAREER AS A RECORDING ENGINEER, PRODUCER OR STUDIO MUSICIAN.

- ▶ 6 STUDIOS FILLED WITH THE LATEST EQUIPMENT: DIGITAL RECORDING TO HARD DISK, DAT MASTERING, AUTOMATED MIXING, MIDI AND MUCH MORE
- ▶ SMALL CLASSES, PERSONAL ATTENTION
- ▶ NO PREVIOUS EXPERIENCE REQUIRED
- ▶ INTENSIVE, 5-WEEK PROGRAM GIVES YOU MORE QUALITY, IN-STUDIO EXPERIENCE THAN MOST LONG-TERM SCHOOLS
- ▶ JOB/INTERNSHIP PLACEMENT ASSISTANCE
- ▶ FINANCIAL AID AVAILABLE
- ▶ LOW-COST, ON CAMPUS HOUSING

FOR FREE BROCHURE, PLEASE CALL OR WRITE TODAY

THE RECORDING WORKSHOP

1-800-848-9900 1-614-663-2510

455-X MASSIEVILLE ROAD, CHILLICOTHE, OHIO 45601

OHIO STATE BOARD OF SCHOOL AND COLLEGE REGISTRATION #80-07-0696T

©1989 THE RECORDING WORKSHOP



Circle #024 on Reader Service Card

BASIC REPERTOIRE

Top Producers and Engineers Talk About Important Albums



he original notion was to write an article called “The Ten Best-Produced Records of All Time”—to choose records that are standards in the industry, influential recordings that form a sort of basic repertoire of production and engineering excellence. But that idea fell apart when my editor and I were unable to agree on more than a couple of records to comprise such a list.

We decided, therefore, to contact top producers and engineers and ask *them* to name a couple of albums they think are examples of stellar production and engineering. We asked each participant to name two records, but for some, picking two was as impossible as not using all of the available tracks on a 48-track project.

PHIL RAMONE

(Album credits: Paul Simon, Billy Joel, Bob Dylan)

Paul Simon: *Graceland*. I think it was not only the native African rhythms, but incredible lyrics and music. It spanned every possible thing—rock 'n' roll and blues and everything that's ethnic we've ever heard—in one album. It was one of the best-produced albums I'd heard. There's no question that on a technical level Roy Halee did an exceptional job. And it's made from an almost basement-style recording and enhanced to the point where the whole thing just flies. That's quite unusual to me.

Ray Charles: *The Genius of Ray Charles*. I just love the production of this. What Quincy did with that record was brilliant.

Pink Floyd: *The Wall*. I admired every inch of this, because the production [by Bob Ezrin] goes from the most minute ideas to the most expanded, sonically. And

I thought that musically it was an adventure out into the world. Not since *Sgt. Pepper* had anybody attempted anything that big and pulled it off. When you answer a question like this, you have to take *Sgt. Pepper* as a starting point and only look at everything that's happened since then. *Sgt. Pepper* was a birthplace for learning [about production].

But *The Wall* certainly was a stepping stone for other people, including metal groups, and it certainly had an influence on rock 'n' roll production.

TOM LORD-ALGE

(Steve Winwood, Peter Gabriel, Billy Joel)

Peter Gabriel: *III* (his third album). One of my all-time favorites, production-wise, song-wise and artist-wise. Peter's right on the edge of technology and uses it to his advantage on that record. It wasn't an overdose of technology, but a creative way of using sampling technology when it first came out. He proves that you can take interesting sounds and make great songs around them. It was also one of the first records I heard that got into drum sampling. The production and the sonic quality of the record are magnificent.

Pink Floyd: *Momentary Lapse of Reason*. Absolutely brilliant production work and an amazing recording, and the mixes are perfect for the songs. Again, not really an overdose on technology, but it's there with the use of sampling and all the synthesizers.

This is another example of technology used very creatively. [Producer] Bob Ezrin has got to be a genius. *The Wall* was a great record, but sonically I was a bit disappointed.

Genesis: *The Lamb Lies Down on Broadway*. In a nutshell, just an

amazing album the way it was

all put together. I would probably

say that with all the early Genesis albums, but this particular one was just an extraordinary production, the way all the songs are segued. This was all pre-sampling and before any kind of MIDI or anything like that. There was a lot of creativity here, with the vocals going through guitar amplifiers and Leslies and just amazing things that Gabriel did on that record.

I suppose getting up to something a bit more current, **Def Leppard's** *Hysteria* proves that you can overproduce a record and still have it sound great. It works because it's just big and bad and in your face.

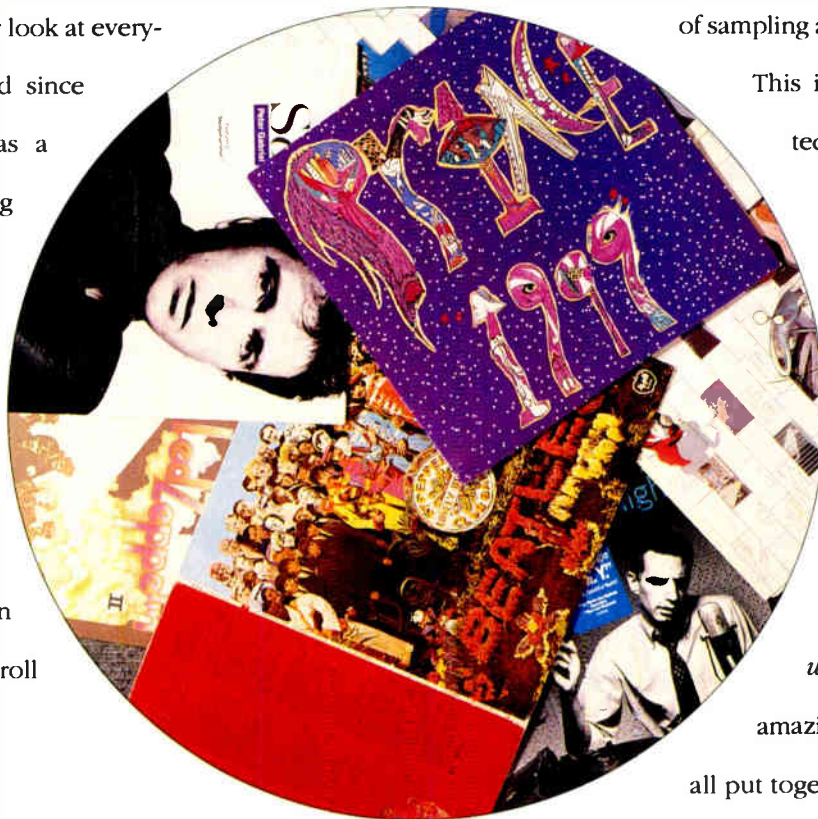

The 463X Keeps Out Unwanted Noise.



Get the 463X
at your local dealer.
Don't wait. Do it now.



A division of
AKG Acoustics, Inc.
1525 Alvarado Street
San Leandro,
California 94577, USA
Tel: (1) 415/351-3500
Fax: (1) 415/351-0500

Circle #189 on Reader Service Card

DON WAS

(Bonnie Raitt, B-52's, Bob Dylan)
Jeff Lynne: *Armchair Theatre*. He's incredibly creative. There are so many nice details in his work. Every little texture means something, and he's not cavalier about any one texture. He's a guy with heavy roots in the Beatles and Bob Dylan, and he takes them in new places. Every song's a whole different universe.

Bob Dylan: *Another Side of Bob Dylan*. Good production is really about getting good vocals on good songs. Those are the two most important things. The production on this is completely sparse, so in a sense "production values" don't enter into it, though it is very well—very clearly—engineered. This was before Dylan went electric, but it's the precise moment where he merged folk music with rock 'n' roll songwriting. It's basically an acoustic guitar rock 'n' roll album.

Tony Bennett and Bill Evans: *The Tony Bennett/Bill Evans Album*. This was put out by Fantasy about 15 years ago. Not only are there great songs and great playing, but I actually think it's Tony Bennett's best album vocally. It was a brilliant production move to take him away from orchestras, which eat up a lot of space. This [record] has as expressive a pop vocal as has ever been recorded. There's a combination of production and anti-production.

BRIAN MALOUF

(Slaughter, Madonna, Cry Charity)
Well, there are about six Beatles albums that are kind of in a class by themselves, to me. And there was a year when I didn't leave the house without *Wheels of Fire* by Cream. But moving more into the present:

U2: *War*. I'm impressed with this album because it doesn't just hit you over the head with, "Wow, what a great drum sound!" It doesn't have any of those traditional sorts of production qualities that have to do with sounds of drums and sonics, in general, but the recording just sucks you in for all the right reasons. It's an incredibly powerful record that lives off the vocal and guitar performances, which are the strongest elements of that group. If you listen to the Daniel Lanois production of *The Joshua Tree*, it's much more sonically together. But it's not like [producer] Steve Lillywhite *misses* anything [on *War*]; he still made a really unique-sounding record.

And for exactly the opposite reason, one of my other favorite records would

be **Peter Gabriel**, *So*. Everything is in there and all the attention to sonics is there; it's just a really powerful-sounding record. You put that one on and it slams you up against the wall. But through all of that, the songs still come through.

T-BONE BURNETT

(Elvis Costello, Sam Phillips, Roy Orbison)
I don't listen to production when I hear records; I really just hear the songs. All production should be is something that strengthens the power of the song, whatever that is. If it does anything to detract from that, or if it overwhelms the song, it's useless. Like with all those corporate metal bands, when they're not really saying anything but it comes out sounding like they're singing about the signing of the Magna Carta. I like live recordings, generally.

Ray Charles and Betty Carter: "Baby It's Cold Outside." This is the most magnificent recording in the history of pop music. You can feel what was going on in the room at the time! The room was electrically charged—it was a live recording—and you can hear everyone in the room must have been thinking, "Okay, nobody better screw up this time." The mood starts out thick, then halfway through the record they vault into another dimension.

Martin Denny: "Quiet Village." Early atmospheric music, but with grit. A beautiful composition with sounds and without synthesizers.

I would pick these two records, though they're singles and not albums; I think they sound better than any 50 albums you could mention.

Actually, since I named two singles, can I keep going? I also like all those George Martin records; they were terrifically inventive and imaginative. I particularly like that Mary Hopkins single he did, "Those Were the Days." Or did McCartney do that? [It was McCartney—Ed.] And the **Villa-Lobos:** *Guitar Concertos with Barbenboim and the English Chamber Orchestra*. It was produced by Paul Myers. Oh, and **Wilbur De Paris and His Jazz Allstars**, a New Orleans band, *Live from Carnegie Hall*. That's an amazing recording for its liveness and spontaneity. This Dixieland band just lifted the roof off that staid, old concert hall.

And one final masterpiece would be Glyn Johns' recording of "Whole Lotta Love" and all of **Led Zeppelin's** first record. Amazing darkness on that

record. I don't really think any of that sort of music—any really tough rock 'n' roll—has been done as well since.

ROGER NICHOLS

(Steely Dan, Rickie Lee Jones, Rosanne Cash)

Lionel Richie: *Dancing on the Ceiling*. I like this mostly because of the creative use of space and the arrangements, and it's not cluttered like most of the stuff you hear these days. On "Love Will Conquer All," one of my favorite songs, your first impression is there's nothing on this thing, there's just a keyboard and a vocal. Then you listen to it some more and there's little string pads and some percussion, but it's not a regular pattern, just little light things here and there. Calvin Harris engineered that one at Ocean Way, and Bernie Grundman mastered it.

Take Six: They're an *a capella* group, and what they can do with just bare vocals is unbelievable. The recording quality is excellent and it's real easy for me to listen to. That was engineered by Don Cobb. It was done at Digital Recorders in Nashville.

Was (Not Was): *What Up, Dog?* The variety of tunes on the album make it almost like a compilation from ten different albums. It's amazing that these guys could go so many directions and all of it be cool.

The stuff that [producer] Tommy Lipuma does, often with Al Schmitt engineering, I always like. The one I was listening to the other night was the **George Benson** *Tenderly* album. This one was mixed by Bill Schnee and recorded by Elliot Scheiner and some recording by Al Schmitt.

I look at these records as extensions of what I'd like to do; that's why I like them. I guess everybody's that way. I'll listen to something Al Schmitt did, and I'll sit there going, "Why can't my records sound like this!" But then I've talked to people who've said that about my stuff, so I guess it's the "grass is always greener" syndrome.

AL SCHMITT

(Everything But The Girl, Michael Franks, Joe Sample)

Claus Ogerman: *Gate of Dreams*. This is one of my all-time favorite records. I did this with Tommy Lipuma awhile ago. I do an awful lot of records with Tommy Lipuma, and he's my favorite producer. Because of the ambience he creates in the studio, his musical knowledge, his taste, he's super.

Steely Dan: All of those records, of

BRING

NEW LIFE

TO YOUR WORN HEADS
WITH OUR REFURBISHMENT SERVICES

24 HOUR TURN-AROUND ♦ SUPERIOR QUALITY ♦ COMPETITIVE PRICING



FILM
REEL TO REEL
AUDIO FOR VIDEO
VOICE LOGGER
NEW REPLACEMENT HEADS
AVAILABLE
WE STOCK PARTS FOR ALL
MAJOR RECORDERS

15720 Stagg Street
Van Nuys, CA 91406
Phone: 818-994-6602
Fax: 818-994-2153
Telex: 745239

New York Office:
2275 East Meadow
New York 11554
Phone: 516-731-5711
Fax: 516-731-5943



SPRAGUE
CORPORATION

1-800-553-8712 CA: **1-800-325-4243**

Circle # 190 on Reader Service Card

Sound Advice from Schirmer Books

Sound Advice: The Musician's Guide to the Record Industry

Wayne Wadhams 1990 ISBN 0-02-872692-8 \$24.95

For songwriters, recording artists, and aspiring musicians.

Sound Advice: The Musician's Guide to the Recording Studio

Wayne Wadhams 1990 ISBN 0-02-872694-4 \$34.95

Basic techniques for recording and mixing in the studio
designed for the musician.

Sound Advice: 2 Compact Disc Set

Wayne Wadhams 1990 ISBN 0-02-872693-6 \$29.95

Recording techniques, a complete mixdown session, and
technical data.

On the Track: A Guide to Contemporary Film Scoring

Fred Karlin and Rayburn Wright 1990 ISBN 0-02-878310-X \$49.95

Foreword by John Williams

All the technical and creative aspects of composing film
scores. Includes a complete click track book.

Available From:

SCHIRMER BOOKS 866 Third Avenue, New York, NY 10022
Or call toll-free 1-800-323-7445 to place your credit card order

Circle # 191 on Reader Service Card

course, are great. Even though I worked on a few of them, it's the cuts I *didn't* work on I particularly like. The clarity, the precision, the musical taste, the good feeling...even though they spend weeks on end doing things, they still have a great feeling on their records. Gary Katz, Becker and Fagen seem to have a knack for capturing the magic, even though it takes them forever to do it.

There are engineers I admire: Elliot Scheiner, Roger Nichols, Bill Schnee, Bruce Swedien...those are my favorites. They consistently make great records. If I work on a tape of theirs, I know it's gonna sound good. When we talk at parties, we find out we do similar things, and that's why our records all seem to have this clarity to them.

KEITH OLSEN

(Fleetwood Mac, Foreigner, Whitesnake)

Aerosmith: *Pump*. I admire the production on this for capturing that kind of performance and getting it to sound that alive and that real; it's very unpretentious. Bruce Fairbairn produced it.

Michael Jackson: *Thriller*. I really loved what Quincy did on this because it was so all-encompassing.

Donald Fagen: *The Nightfly*. I loved what Gary Katz did on this. I thought it was a great exercise in being absolutely perfect. Forget the feel and everything else, but everything was absolutely perfect, and it was a great experiment in that. By "everything" I mean tones, performances... Sometimes it got a little too sterile and it lost it, but when it came out it was pretty amazing.

George Michael: *Faith*. Utter, simplistic excellence. That's all I can say about this.

CHRIS LORD-ALGE

(Tina Turner, Rod Stewart, Jane Child)

The Beatles: *Sgt. Pepper* and **Led Zeppelin:** *Led Zeppelin II*. Those records still stand up today, probably because of the recording limitations back then. A lot of records made today sound dated a year later. But these records are 20 years old and were done on 4- and 8-track [respectively], and they're still bigger sounding than a lot of records made today. The problem today is there are no decisions being made during the making of the record, whereas back then they had to make a decision with every overdub; every

overdub was a *mix*. Now people just pile the stuff on and hope later they can fix it all.

NARADA MICHAEL WALDEN

(Whitney Houston, Aretha Franklin, Barbra Streisand)

Prince: *1999*. Not because this is the greatest *produced* record, because it's so raw, but there's some real genius in there. The sounds...a lot of cats don't understand funk at all, and Prince really has it down. Not only does he have it down, but he can apply his imagination and intellect to it. His sound sense is unique. Not in every aspect—because drums are drums—but with his percussion things, it'll weave and it'll be things that we haven't quite heard before; his sense of combinations is really hip.

Michael Jackson: *Thriller*. This set a real precedent. Quincy is another guy who understands funk, who understands groove but has a sense of elegance and sophistication. I think he really reached a pinnacle in his expression of *Thriller* with Michael. I think Quincy can do anything he

"Thriller set a real precedent. Quincy is a guy who understands funk, who understands groove, but has a sense of elegance and sophistication."
—Narada Michael Walden

wants. I learned from Quincy how to get sophisticated. I listened to all his records.

Alice Coltrane: *Universal Consciousness*. Because they got that stuff on tape, man. It's magic on tape.

DAVE FRAZER

(Narada Michael Walden, Whitney Houston, Aretha Franklin)

Peter Gabriel: *So*. This is really incredible production. What I like about it is the depth it has; in every sense of the word, it's a deep record. The engineering, the production, the songs, the whole package—the layers of it are incredible.

Prince: "When Doves Cry." When it came out it really changed things. It changed a lot of people's attitudes about what a record was supposed to sound like, what a record *could* sound like. Everyone said, "Oh, it's okay to do that? All right."

Nineh Cherry: "Raw Like Sushi."

Front-line '90s production. Jazz meets pop meets rap. Good news.

BRUCE SWEDIEN

(Michael Jackson, Quincy Jones, Burt Bacharach)

Michael Jackson: *Thriller*. That album has a wonderful quality of appealing to dance lovers and music lovers as well; it has such a broad spectrum of musicality as a result of Quincy's influence. The integrity of the real music productions, like "Human Nature," is so fantastic, and yet the street end of it—the dance part, like "Billie Jean" and "Beat It"—goes so far. Record production-wise, sonically and compositionally, that's my favorite record. I don't know of another album that would be even close.

Pink Floyd: *The Wall*. One of my favorites. Jamie Guthrie engineered this, and what he did sonically is really just so tasty. They took it a long way compositionally and musically—and with the production.

The Beatles: *Yellow Submarine*. I wore out about three copies of that. [Engineer] Geoff Emerick and [producer] George Martin are old friends, and I've always loved their work. But on that particular record they just out-did themselves.

DON PULUSE

(Chicago, Sly Stone, Miles Davis)

Raphon Williams: *Fantasia on a Theme by Thomas Tallis; Samuel Barber, Adagio for Strings*. I think anyone in rock should listen to this for ten minutes every day. This really puts you in touch with what real acoustic sounds are. Every balance is perfect. When you listen to a low string passage, there's tremendous depth; when the high violins come in they're never piercing, they're just very present. As the instrument balances shift, everything is in perfect perspective all the way through. The sounds are magnificent and there is tremendous dynamic range. It was produced by Robert Woods, recorded by Jack Renner.

Stevie Wonder: *Songs in the Key of Life*. After getting past the low-key sonic production and some pacing concerns (natural with a 21-song set), I've come to love the message, rhythm grooves, vocal performances, choice of instruments, synthesizers, horns, packaging and two pages of interesting thank-yous. This production accelerates Stevie's departure from tradition and displays his warmth and talents as performer, writer and producer.

Red Hot Chili Peppers: *Mothers Milk*. Produced by Michael Beinhorn. One of this year's most interesting productions. A rock album with high energy and rough edges, and the words hold up even without the music. Includes solid rock, dances, hardcore, rap and jazz influences. It's commercial yet experimental.

LESLIE JONES

(Bobby McFerrin, Dave Edmunds, Narada Michael Walden)

Laura Nyro: *Eli and the Thirteenth Confession*. For the first time I got an appreciation of a singer/songwriter doing her own material, and the production values lent themselves well to Laura Nyro's style. Produced by Charlie Calello and Laura Nyro.

Supertramp: *Crime of the Century*. This was my first experience of appreciating a producer/engineer like Ken Scott. A lot of that stems from my feeling that a producer's role is to show off an artist in the best light possible, while also adding some things that might not be there in the first place. Both of these records did that quite well. I really like the sound of the Supertramp record, from the sound of the Wurlitzer piano to the vocals and the overall feeling of the album.

These records have been standards by which I've judged other records throughout my career.

DAVID THOENER

(Nelson, Sammy Hagar, Rodney Crowell)

Def Leppard: *Pyromania*. One of my favorite rock albums. This record set trends in rock and metal music. Great songs and arrangements coupled with very unique sounds, especially for when it came out. Mutt Lange is one of the most talented producers I've ever met.

U2: *The Joshua Tree*. I admire the songwriting ability of the band and the unique arrangements. The raw qualities of the band come across very well on this album, which makes this another favorite.

Tears for Fears: *The Seeds of Love*. Again, great songs and arrangements. The addition of Oleta Adams on this record adds a new dimension, making the new sound even more original than before.

DENZIL FOSTER & THOMAS MCELROY

(En Vogue, Tony! Toni! Tone!, Club Nouveau)

SUPER SYNC

AUDIO EDITING™

CROSS-LOCK™ Mixed Frame Rate Synchronizing



Synchronize and edit original source tapes striped with any mix of 24, 25 or 30-frame time code.

VARI-LOCK™ Vari-Speed Tape Synchronizing



- Correct off-speed material!
- Expand/compress to fit with no pitch change!
- In sync and repeatable!

SUPER SYNC, the newest feature of the 2600 A/V Audio Editing System.

More power than you ever imagined for your tape-based audio studio!



ADAMS-SMITH

When compromise is not part of the studio specification.

34 Tower Street Hudson, MA 01749 USA TEL 508-562-3801 FAX 508-568-0404
 NYC TEL 201-671-8768 FAX 201-671-8808 UK TEL 0223-410104 FAX 0223-215293
 LA TEL 818-840-9588 FAX 818-955-9706

Circle #192 on Reader Service Card

McElroy:

Bernard Wright: *Nard*. He's a keyboard player/singer on GRP, and this album came out in 1980 or '81. It has Marcus Miller, Dave Grusin and a whole bunch of other guys on it doing production. At the time I bought the album, I didn't realize how good it was, but now that I'm listening to it today and I'm a producer, I realize how far ahead of its time it was. There was even a rap song on there.

Janet Jackson: *Control*. I like what Jimmy [Jam] and Terry [Lewis] have been doing all along, but with this album I think something got into them, and the level of production and cre-

ativity went up as far as finding keyboard sounds that were really different from what they did before and getting the most out of the artist. Jimmy used a car horn for a bass on "Nasty" and stuff like that. The way he tuned the drums was real musical. It was tight but live. None of the drum machine sounds sounded old, like old Linns and stuff, even though they might have been.

Foster:

George Clinton: *One Nation Under Groove*. I love that album, but with him I could say all the albums are genius, you know. I think the production was excellent.

The Art Of Noise: *Who's Afraid of*

the Art of Noise. It was definitely innovative. They did everything that everybody does now, but they did it six years ago, and for the time it was real different. It was the first "sample" album I liked. What really got me was actually the *art of noise*, as they said, because there was all kinds of stuff going on, and it was a composition of all sorts of strange and great-sounding things. It's an album that sounds like somebody took a long time to put it all together.

BOB JOHNSTON

(Bob Dylan, Simon & Garfunkel, Leonard Cohen)

Bob Dylan: *Blonde on Blonde*. I have to choose this one because 37 world critics voted this the Number One rock album in history, even over The Beatles. The record was cut 25 years ago, but if you play the record now it sounds just as good as it did back then. I think we just went into the future with it. Nowadays, when I cut a record, if I'm using a great engineer, I don't expect to have to tell him how to make things sound. But in those early days, I *had* to be there because it was early rock 'n' roll and it was all so new. When I started working for CBS, their big "rock" acts were Andy Williams and Patti Page and Barbra Streisand.

Pink Floyd: *Dark Side of the Moon*. Anything those people do is great. I have a hard time choosing, because The Who, Pink Floyd, Zeppelin, U2, the Stones—the records are all so good. With Pink Floyd—in fact with all of those—it's the artist, the song, the musicians and the sound. The bottom is so big. I don't know what to say other than that. I guess what it is, too, is uncharted waters. These guys—the bands I just mentioned—were making maps. If it wasn't for them, we'd still be back with Carl Perkins, Chuck Berry and Johnny Cash.

And I'd have to list **Simon & Garfunkel**, *Parsley, Sage, Rosemary and Thyme*, even though that's another one of mine.

RODNEY CROWELL

(Guy Clark, Rosanne Cash, Jim Lauderdale)

The Neville Brothers: *Yellow Moon*. This one, and my next choice, were both produced by Daniel Lanois. It's one of the most soulful records I've heard in ages. I like the bottom end sound of the record; it's really powerful and pumping. I like the way reverb is used throughout the whole album;

MARTIN BRIDGES THE TECHNOLOGY GAP

Martin is committed to solving your professional audio problems by integrating technologies from the past and the present — with a bridge to the future.

No wonder recording studios, broadcasters, post-production companies, advertising agencies — and just about everyone who needs professional equipment and advice — have come to rely on our expertise.

Martin Audio Video Corporation is one of the world's largest professional audio specialists. Our parts department stocks components from over 200 manufacturers — more than any other professional audio dealer.

We'll configure systems for you that utilize your existing equipment, capitalize on today's technology — and let you embrace tomorrow's technology as well.

You'd think such a high level of service would cost you dearly — but it won't. Martin's prices are no higher than others who'll sell you a box and then say goodbye.

So call Martin Audio Video at (212) 541-5900. For professional parts call (212) 489-4750. We'll answer your questions, give you professional advice, and configure a system based on what you need now and what you'll need tomorrow.

Martin Audio Video Corporation...
Your bridge to the future.



A VIDEO SERVICES CORPORATION COMPANY
423 WEST 55 STREET NEW YORK, N.Y. 10019-4490 (212) 541-5900 / FAX (212) 541-9128

Circle #197 on Reader Service Card

it's very atmospheric. And I like the way the keyboards and synthesizers are used. I think most of it is Brian Eno's patches. I thought this was the best "black" record since some of the things Stevie Wonder did in the early '70s, since *Fulfillingness First Finale* and *Innervisions*. You compare the spirituality of this record, the pride, to a lot of the rhythm and blues, dance and machine-made records, and it just blows everything out of the water for me. Malcolm Burn was the engineer.

Peter Gabriel: *So*. Kevin Killen engineered this one. I thought "Sledgehammer" was the fusion of just about all possible worlds into one. It's a pop record, an R&B record and a rock 'n' roll record. It's very well-written, it's real sexual, and the mix on it is just incredible. The atmosphere on "Mercy Street" and "Don't Give Up" are beautiful.

What both of these records have in common is atmosphere. The bottom end is really funky and moving, and then there are the delicate shadings and use of echoes. Daniel Lanois helps artists use modern keyboards better than anybody I can think of.

KEVIN KILLEN

(Elvis Costello, Peter Gabriel, U2)

The Beatles: *Sgt. Pepper's Lonely Hearts Club Band*. I think this was one of the most innovative recordings of that era; you could class it along with *Pet Sounds* and *Rubber Soul*. It definitely changed the way people approached recording music in terms of arrangements, sound and production. It made people sit up and realize that there were endless possibilities available. I was only 10 years old when it first came out, but my head was really turned when I heard that record.

Roxy Music: *Avalon*. For some reason this record has never been given the kind of acclaim I think it should've received when it first came out. It's really a classic, timeless record. You put it on and it sounds incredibly fresh. From an engineering standpoint, it's a panorama of sounds. It's a reference that I often go back to and try to make some of my recordings sound similar to. The whole approach of it, the beauty of it, the complexity and the atmosphere... ■

Dan Levitin is a San Francisco Bay Area-based producer/engineer, freelance writer and former fry cook at Sambo's.

Sennheiser.



Still setting the standards.



Sennheiser's dedication to state-of-the-art technology, coupled with quality engineering, earned our microphones an Academy Award®. Sennheiser continues to set the standard in the industry, this time with the MKH 60 and MKH 70, our newest shotgun microphones. They display all the ruggedness that you need in audio production and the reliability that Sennheiser has become famous for.

Sennheiser. The first and last authority on shotguns!

Ask your Sennheiser Representative for a demonstration.

SENNHEISER

SENNHEISER ELECTRONIC CORPORATION
6 Vista Drive, P.O. Box 987, Old Lyme, CT 06377
(203) 434-0190 FAX# 203-434-1739
Manufacturing Plant: D-3002, Wedemark,
Federal Republic of Germany

DAHPA38

Circle #129 on Reader Service Card

by Philip De Lancie

MASTERING SERVICES

A USER'S GUIDE

In the beginning, there was mastering. No tape, no "fix it in the mix," just "direct to disc" (or cylinder). So every recording engineer was a mastering engineer at the same time. Needless to say, technological advancement has changed all that. We've now got the tools to manipulate audio in ways hardly imaginable a century or even a decade ago. However, as we develop specialized skills to utilize those tools, we risk becoming narrowly focused on one particular step in the overall process, losing touch with other links in the chain. Most of the music production community has a pretty good idea of what goes on during recording and mixing. But many in the industry, including engineers, have only a vague concept of what happens after the mix is done.

Clients are often convinced that their tapes are "ready to go," but in reality the quality and professionalism of master tapes coming out of

recording studios varies widely. So, too, does the level of myth, mystery and misinformation about mastering among clients. The likely explanation is that those who aren't already familiar with mastering don't know enough to know what to ask.

Engineers can help by volunteering a bit of information, but only if they're up to speed on the subject. Many engineers are, and for them the following is intended to be a place to refer curious clients. But it's also hoped that some recording engineers will benefit from a little review themselves, since many have only irregular exposure to the process.

Why does it matter who knows what about mastering, as long as the mastering engineer knows the job? The advantages of being well-informed boil down to quality and cost. Decisions are made at every step of a process that have consequences later. Good decisions make it easy for a project to move from step to step. Each person involved can do what needs to

be done without spending a lot of time (i.e., money) trying to undo the effect of earlier, unwise choices. If you know where potential trouble lurks, you can avoid it early rather than fight it later. If, on the other hand, your recording and mixing practices result in increased mastering costs and/or compromised sound quality, your clients are unlikely to be impressed.

Getting Oriented

It is important before getting into do's and don'ts to recognize what mastering is. Mastering isn't a remixing process, though the apparent prominence of various elements in a program may be modified. And it's not a manufacturing process, in which something is made for direct distribution to the public.

Mastering is the link between production (the studio) and manufacturing (the plant). It begins with the master tape(s), normally ster-

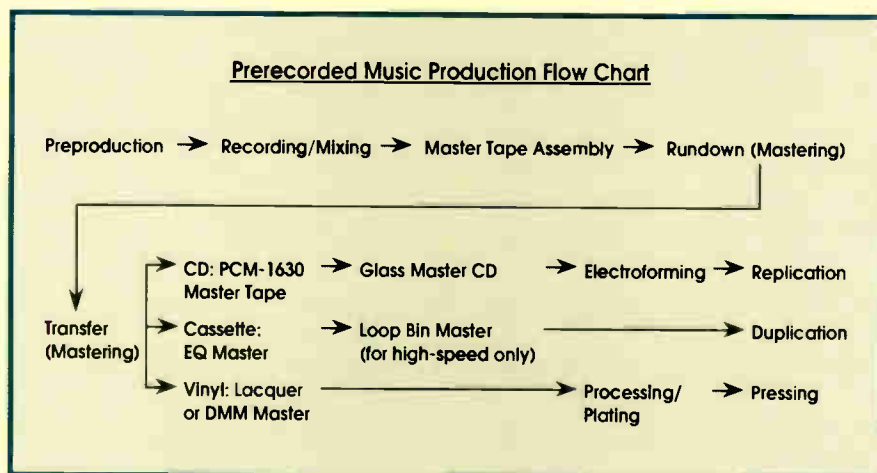

eo, that result from mixing, and ends with the completion of a production master for each release format (cassette, CD or vinyl). It has two basic goals. One is to make sure a given project sounds as "good" as possible before it gets manufactured. The other is to put the program into the form needed by manufacturing plants to begin their process of mass-producing a pre-recorded product.

Mastering services are available from a variety of sources. Some pressing plants cut master records in-house, and some CD plants offer in-house premastering. There are also brokers who will guide a project through the various steps involved. You send them your tape and they take care of the rest. Their mastering costs are usually included in the flat fee paid for a given number of cassettes, CDs or records.

The alternative is to go to an independent mastering house. It sometimes costs a bit more, but it has certain advantages. Mastering houses, like recording studios,

generally charge on a time-and-materials basis, so they have more incentive than those charging a flat fee to work as long as needed to optimize the sound. Sonic differences between release formats are minimized because all the production masters are made at the same facility. Clients may be present to participate in the mastering session, which is not usually the case in brokered or in-plant situations. In addition, the monitoring environment is more likely to be designed to the same acoustic standards as a good recording studio control room, so it's possible to hear what's happening accurately.

The Mastering Session

Assuming the client brings in a properly assembled master tape (more on this later), the traditional mastering session involves two phases. The first phase, "rundown," is the time spent by the client (if present) and the mastering engineer listening to the original master and deciding what, if anything, should be done to the sound. Are there fades that could be a bit smoother? Is the bass too boomy, the cymbals

lacking sparkle or the snare missing snap? Under these critical listening conditions, clients often notice things they'd like to work on before releasing program to the public.

The mastering engineer has a variety of means available, including finely tunable EQ and dynamics processing for bringing out the buried, toning down the overly prominent or just giving a final sonic polish. Of course, since EQ will affect all sound in the frequency range at which it is applied, enhancing one instrument might have an undesired effect on another. There are compromises to be made and limits to what may be done. Mastering cannot be relied upon to magically fix a bad mix.

As the rundown progresses, attention is paid not only to the sound within each selection, but from one selection to the next. Does one song sound too quiet compared to the one before, or not full enough on the low end? Once the rundown decisions are made, the client may ask for a reference copy to play in more familiar listening situations



DAT TO COMPACT DISC
Digital Audio Tape

TURN YOUR TUNES

Now it's easy to turn your tunes from tape into CD. Optical Media's CD Express service is now offering lower prices and faster turn-around times for getting 1 to 10,000 CDs. And by using our incredible new direct DAT to CD technology, you can get 1 to 10 reference discs in 48 hours.

Also, if you're using Sound Tools by Digidesign, you can save even more by using the special CD prep feature of the new Master List program. Call CD Express at Optical Media for more information.

COMPACT
disc
DIGITAL AUDIO



OPTICAL MEDIA INTERNATIONAL

485 ALBERTO WAY, SUITE 115, LOS GATOS, CALIFORNIA 95032 USA
PH 408 395 4332 **800.DISC.OMI** FAX 408.395.6544

Pure Tone™

DRUM RESONANCE ELIMINATOR

- Completely adjustable • Will not change your feel, tone or tuning
- Lifts off drumhead to sound open and natural • Acts as a mechanical noise gate
- Also available Pure Tones™ Bottom Line product to adjust unwanted bottom skin resonance. Helps reduce snare rattle and buzz between notes

• 30 Day money back guarantee • offer only valid if purchased from Pure Tone Co., less S&H. Pat. #4,671,158 other Pat. Pending



***"Nobody needs another muffler"
that's why we invented Pure Tone™***

Pure Tone Co. • 29504 Dover • Warren, MI 48093 • (313) 751-2097 • FAX (313) 751-2730

Circle # 160 on Reader Service Card

COMPLETE DIGITAL SERVICES FOR CD PREPARATION

Music Editing
Format Conversion

NEVE DTC and HARMONIA MUNDI
DIGITAL CONSOLES

KDISCmastering
6550 Sunset Blvd., Hollywood, California 90028 • (213) 466-1323 • FAX (213) 466-7237



COMPLETE MASTERING SERVICES
DMM and Lacquer Cutting

Circle # 161 on Reader Service Card

TAPE & DISC

before giving final approval to the sound.

After approval, mastering moves into the transfer phase. For each release configuration, a master must be made that includes the changes decided on during rundown. Cassettes, CDs and vinyl all have their merits, depending on the type of music and the purpose of the release. Since it's expensive for small companies to pay manufacturing costs for all three, many clients today choose to release only on cassette and CD. But vinyl is still popular for some applications, especially club-oriented 12-inch singles. Depending on the chosen configurations, the client will need a PCM-1630 CD master, a cassette master and a master record for each vinyl side.

Master lacquers are made on a cutting lathe with a stylus that scratches a groove representing sound waves into the surface of a rotating disc, either lacquer-coated aluminum or copper (Direct Metal Mastering). The contents of each side must be cut from start to finish in a complete pass (no stopping). Maximum length per side depends on the volume and low-end content of the music. There comes a point at which long sides have to be reduced in level to fit on the record.

For CDs there's no relation between level and program length, which is normally up to about 74 minutes. CD masters, which (for the moment) must be 1630 format, may be assembled song by song on the 1630, or transferred as a whole from an assembled original master. Either way, a time code track is recorded for use in preparing a log, required by the CD plants, of exact begin and end times for each selection. Cassette masters, commonly DAT or 1630, may be transferred a side at a time or assembly edited (except on F1).

Depending on what form the original is in, what equipment is used to process it, and what the release formats are, the order of steps in this process may vary. Normally, each of the above

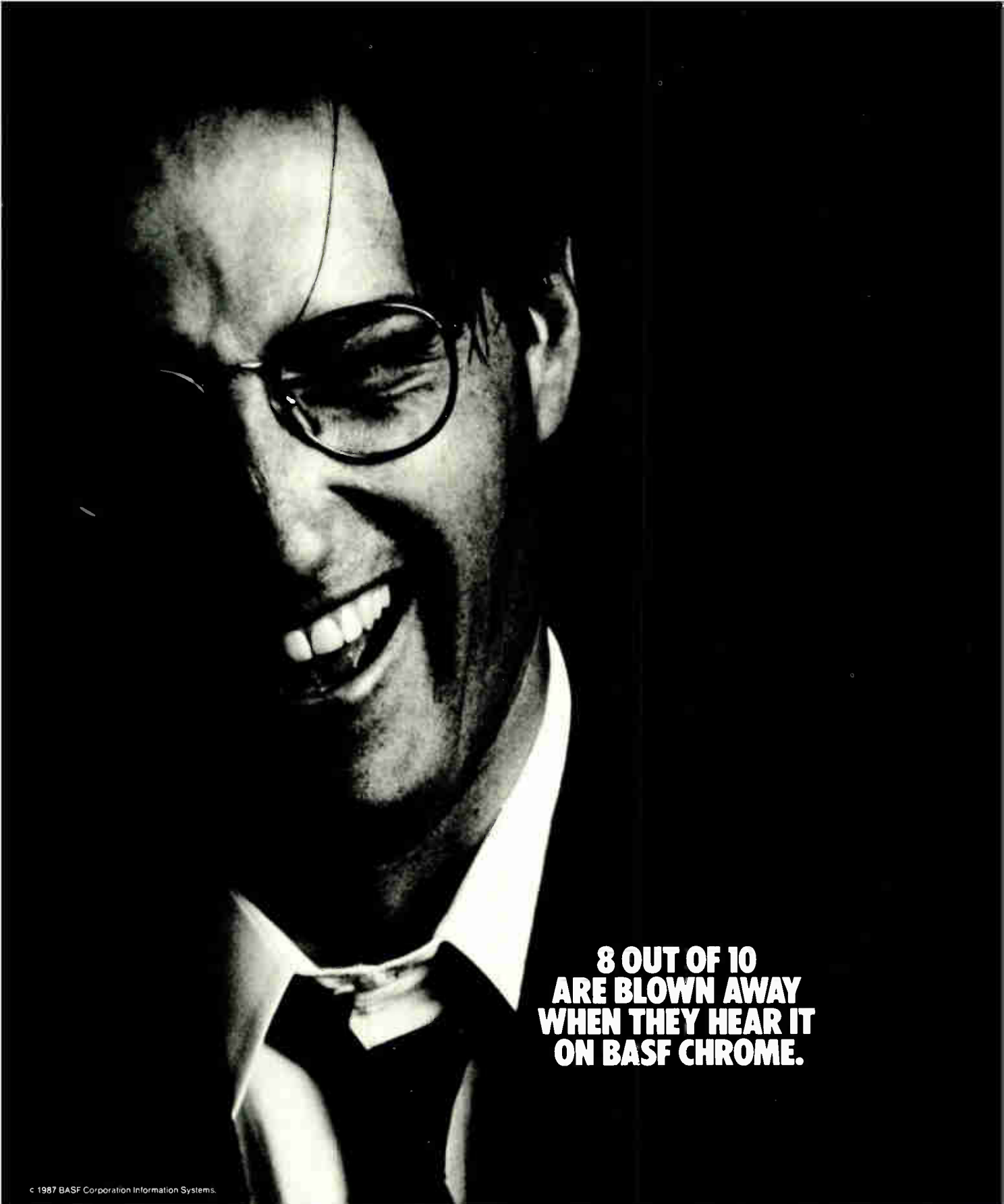

**8 OUT OF 10
ARE BLOWN AWAY
WHEN THEY HEAR IT
ON BASF CHROME.**

© 1987 BASF Corporation Information Systems.

Emotional impact. That's what music is all about. And what BASF Chrome is all about. In a nationally representative sample of the U.S., 8 out of 10 listeners heard more, responded more, were moved more by prerecorded music on BASF Chrome than on ordinary cassette tape. 8 out of 10.

An impressive figure that can mean

impressive sales. Because when you release on BASF Chrome, there's less tape hiss, greater music clarity, greater overall sound quality—greater emotional impact! All of which adds up to a tape that gives greater consumer satisfaction.

If you want to blow them away. If you want to make them cry. If you want them

to go wild. If you want to make them sigh. Call us at 1-800-225-4350 (east or south), or 1-800-225-3326 (central or west). We'll show you what a difference BASF Chrome can make in the studio, in the store and on the deck.

Call us today.

After all, if 8 out of 10 people prefer it on BASF Chrome, shouldn't you be listening?

**The crystal clear sound
of BASF Chrome.**



BASF

WHEN YOU NEED IT ALL...

THE INNOVATIVE RENTAL PEOPLE

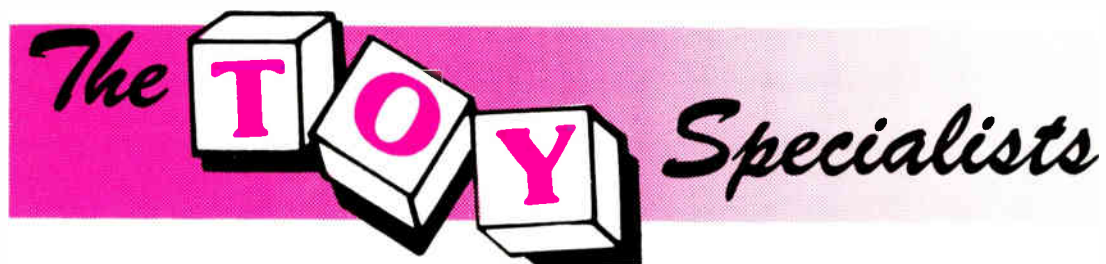

PROFESSIONAL AUDIO/VIDEO AND MUSICAL INSTRUMENT RENTALS 24 HOURS A DAY

NEW

BACKLINE DIVISION

- ▶ OUR NEWLY DEVELOPED BACKLINE DIVISION IS FULLY EQUIPPED TO HANDLE ANY PERFORMANCE SITUATION THROUGHOUT THE U.S.A.
- ▶ WE CARRY A FULL LINE OF STATE OF THE ART AND VINTAGE AMPLIFIERS BY: AMPEG, FENDER, MARSHALL, MESA, HARTKE, HIWATT, SOLDANO, SWR, VOX AND MORE...
- ▶ VINTAGE SNARE DRUMS, DRUM KITS, GUITARS, BASSES, KEYBOARDS, MIXERS, OUTBOARD, WIRELESS MICROPHONES AND SYSTEMS ROUND OUT OUR ALREADY EXPANSIVE INVENTORY.
- ▶ OUR SKILLED STAFF CAN CONFIGURE CUSTOM RACKS OF OUTBOARD FOR STAGE AND HOUSE OR COMPLEX MIDI SYSTEMS AT A MOMENT'S NOTICE.

STUDIO DIVISION

- ▶ UPGRADED INVENTORY: OUT WITH THE OLD, IN WITH THE NEW. WE'VE REPLACED MANY OLDER PIECES WITH NEW ONES AND ADDED OVER 200 NEW ITEMS IN THE PAST 2 MONTHS!
- ▶ STILL THE LEADERS IN MIDI GEAR: WE OFFER A SELECTION OF OVER 70 MODELS OF SYNTHESIZERS AND DOZENS OF DIFFERENT ELECTRONIC DRUMS, COMPUTERS, AND MIDI DEVICES.
- ▶ OUR INVENTORY OF DIGITAL RECORDERS AND VINTAGE TUBE GEAR IS AMONG THE MOST COMPLETE IN THE WORLD. IF YOU NEED PAL/SECAM OR NTSC VIDEO GEAR, WE HAVE IT TOO!

**CALL TOLL FREE
FOR OUR NEW
20 PAGE CATALOG
800-445-3330**

...WE'RE ALL YOU NEED!

333 West 52nd Street
New York, N.Y. 10019

212-333-2206

FAX:
212-262-4095

production masters is made by transferring sound from the client's original master, through an analog or digital console (where EQ, level and signal processing are set) to the 1630, DAT recorder or cutting lathe. If the program, sequence and treatment are the same, it's sometimes possible to run the master for more than one format simultaneously.

When master material comes from several sources, which may not all be the same format, songs can be rundown and transferred individually to an EQ master. Production masters would then be run from this tape, perhaps with further changes tailored to the individual requirements of cassette, CD or vinyl. LP masters, for instance, are usually cut at a lower level than CDs, because the mechanical nature of phonograph records limits the amount of level they can handle without distortion.

Another variation is the use of a disk-based audio workstation like the Sonic System, where the original material is transferred into disk storage in real time. As the rundown proceeds, desired changes are made to the audio data stored in the system memory. When the program is ready and approved, it's transferred in designated order from memory onto an EQ master.

So what's the difference between mastering and premastering? "Mastering" is a term that developed when phonograph records were the only release configuration, because mastering sessions for vinyl end with the cutting of an actual master record. Premastering has since come into use for CD preparation, because CD mastering sessions end with the making of a 1630 master tape. The master CD isn't cut until that tape gets to the manufacturing plant. High-speed cassette duplication presents a different case, in which there never is an actual master cassette. Instead, the production master prepared in session is transferred at the dupe plant to a loop bin master, from which cassettes are recorded. Despite these differenc-

JOHN M. STORYK

"Visit with us
at the Full Sail
Booth #548"

ARCHITECTURAL & ACOUSTICAL DESIGN

HORIZON STUDIOS, WILTON CONNECTICUT
Formerly ACE FREHLEY-
Underground Residence/Studio



A DIVISION OF
WALTERS-STORYK DESIGN GROUP, INC.

31 UNION SQUARE WEST, NYC, NY 10003 • (212) 675-1166
134 MAIN STREET, NEW PALTZ, NY 12561 • (914) 255-2255

Circle #218 on Reader Service Card

- **HIGH SPEED DUPLICATION-
HX PRO STEREO**
money saving packages
- **COMPACT DISCS**
complete packages
- **DIGITAL MASTERING**
full digital services
- **REAL TIME DUPLICATION**
audiophile quality
- **CUSTOM PRINTING AND
PACKAGING**
full printing services
- **BLANK AUDIO CASSETTES**
custom loaded
- **VIDEO**
blanks and duplication



EASTERN STANDARD PRODUCTIONS, INC.

26 Baxter St., Buffalo, NY 14207 (716) 876-1454 FAX (716) 877-6395

CALL TOLL FREE 1-800-527-9225

Circle #158 on Reader Service Card

es in final transfer procedures, mastering remains a viable general term for production master preparation in all release configurations.

Making It Easy

The original master tape is the starting point for mastering, and it's what determines how smoothly the process will go. Recording engineers can do a number of things to make it easier for mastering engineers to get the best possible results. Consistency in mixing is most important. Some projects come in with wild variations from song to song in instrument EQ and balance. That's fine if it's the intended effect, but it obviously takes less time to work with a tape that has an overall sound, with only minor variations from piece to piece.

It's important to avoid a situation in which two problems cry out for opposite solutions in the same frequency range. For example, it's hard to deal with a dull snare mixed with harsh, sibilant vocals, because improving one can make the other

worse. Further, sibilance creates a distortion problem on phonograph records that can force reduction of the level at which they may be cut. (Even on CDs and cassettes it can be irritating.) There are ways to cope with such problems in mastering, but it's preferable to work on individual problem tracks (de-essing vocals as needed, for instance) during recording or mixing.

After getting a workable mix, the next step is assembling the sequenced master from selected takes. That's sometimes done at the mastering house, but more often it's handled at the studio after mixing. When deciding what format to mix or record on, consider differences in the ease with which various tape formats may be assembled into master form. The assembly can make a big difference in the flow of the mastering session and the music itself.

Unless a program is continuous (like a live recording), the listener should hear silence from the end of the decay of one piece to the first note of the next (the "spread"). To achieve this, analog tapes, unless recorded with an effective noise reduction system like Dolby

SR, are commonly "help faded" in mastering at the end of every selection. Leader between bands is used to avoid bringing up tape hiss when the fader is thrown open for the start of the next tune. At the head of each piece, leader should be as tight as practical to program. At the end, unless a "cold" ending is the desired effect, leave a second or so of tape after the music decays before the leader. This space allows time to follow-fade the natural decay into silence, rather than going abruptly from tape noise to silent leader. This can definitely make a noticeable difference when listening to a CD, especially on headphones! If the spaces between tunes are tight, the leader may be as short as a half-second, just long enough to throw open the fader before the next song. The total time between selections should be as it is supposed to be on the finished product.

Assembly of digital masters presents its own challenges. Open-reel machines such as the Mitsubishi X-86 allow razor-blade editing like analog tape, though silent-format-

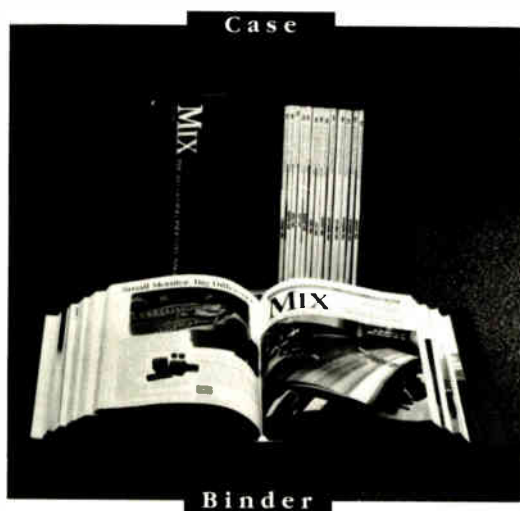

SAVE YOUR MIX!

Mix magazine is the most handy reference tool serving the professional audio industry. Keep your issues protected for the next millennium in our custom-made magazine cases and binders.

Each holds a year's worth of *Mix* and is bound in a leather-like crimson material with the *Mix* logo hot-stamped in gold.

Magazine Cases

\$7.95 each; 3 for \$21.95; 6 for \$39.95

Binders

\$9.95 each; 3 for \$27.95; 6 for \$52.95

Please send me _____ cases and/or _____ binders (add \$1 per unit for postage & handling, \$2.50 outside U.S. PA residents add 6% sales tax).

Check enclosed for _____. Check # _____. (Make check payable to Jesse Jones Industries)

For credit card purchases, call toll-free: (800) 972-5858

Print Name _____

Address (no PO Boxes) _____

City/State/ZIP _____

Mail to: Jesse Jones Industries, Dept. Mix, 499 East Erie Avenue, Philadelphia, PA 19134

The sound of tomorrow...today



DAT cassettes from **SHAPE**

From beginning to end, inside and out, SHAPE's DAT cassettes stand alone. You can depend on SHAPE for the quality you seek in D-O's (shells), loading and packaging. We've built our world-wide reputation on innovation and excellence in design for the audio, video and computer markets. With every product, we're committed to surpassing customer standards for reliability and cost-effectiveness. When you insist on SHAPE, you insist on uncompromising quality.

SHAPE—the measure of quality

SHAPE

Gage Molding—A division of SHAPE, Inc.
P.O. Box 717
Scarborough, Maine 04074
Telephone: 207-883-6316
FAX: 207-883-1068
Contact: Walter Gordon

ted tape is used instead of leader. Songs are assembled physically with the desired sequence and spacing, and any noises between them can be cut out. In-cassette digital formats, on the other hand, can't be edited physically. So selected takes from mixing are transferred to a sequenced master tape with the proper space between tunes. (If takes being transferred were compiled from a variety of sources, including analog, be sure to check azimuth for each analog source.)

The Sony 1630 format, which uses 3/4-inch U-matic cassettes, is good for this kind of master assembly (though not terribly reliable for long-term storage). Noises between bands may be removed by insert-editing on the composite digital track. The F1 format, on the other hand, is not a great choice because it can't be relied upon to go in and out of record without making noises.

DAT is somewhere in between 1630 and F1. Some common faults may be easily avoided. It's okay to start tones right at the head of the tape, but not

program. Leave a nice gap (30 seconds) between tones and music, or between the head and music if there are no tones. Avoid waiting until the instant before music starts to drop into record. This is because not all edit points play back silently on all machines. Also, since DAT is a consumer format, it's not really designed for accurate editing like the 1630, so assembling with spreads of less than two seconds can be a hit-or-miss proposition. It's best to put the edit points in the middle of the spreads so it's possible to fade down and back up if the edit makes noise. If spread times need to be adjusted, or if there are noises too close to the start or end of the music, the DAT may need to be transferred digitally to another format for clean-up, which adds to mastering costs.

Spending a lot of time trying to figure out what's what also adds to costs. One solution is good documentation. A master tape should be accompanied by a legend showing the order of selections, their titles and times. A total time for each side is nice, too. If running times are given, it's more useful to have zero equal the start of the first selection than the start of the tape. If one selection segues into the next, an accurate time should be given for the point considered the start of the second part.

DATs should come with numbered start IDs for every selection, starting with the first piece. (Numbering the tones as #1 invites confusion.) If tones are at the head, they'll be easy enough to find, but it's still good to mark their location on the legend or box. When the desired sequence is different from that on tape, clear instructions should be included for creating the new sequence. And finally (enough nagging, already!), the client, artist and catalog number should be easy to find on the spine and/or legend. It's all basic stuff, but it reduces the chance of confusion in mastering about what to do or where to find something. That keeps the mastering session focused on getting the most out of the music, which is what it's all about. ■

Tape & Disc editor Philip De Lancie is a mastering engineer at Fantasy Studios in Berkeley, Calif.

AFFORDABLE HIGH VOLUME CASSETTE COPIES

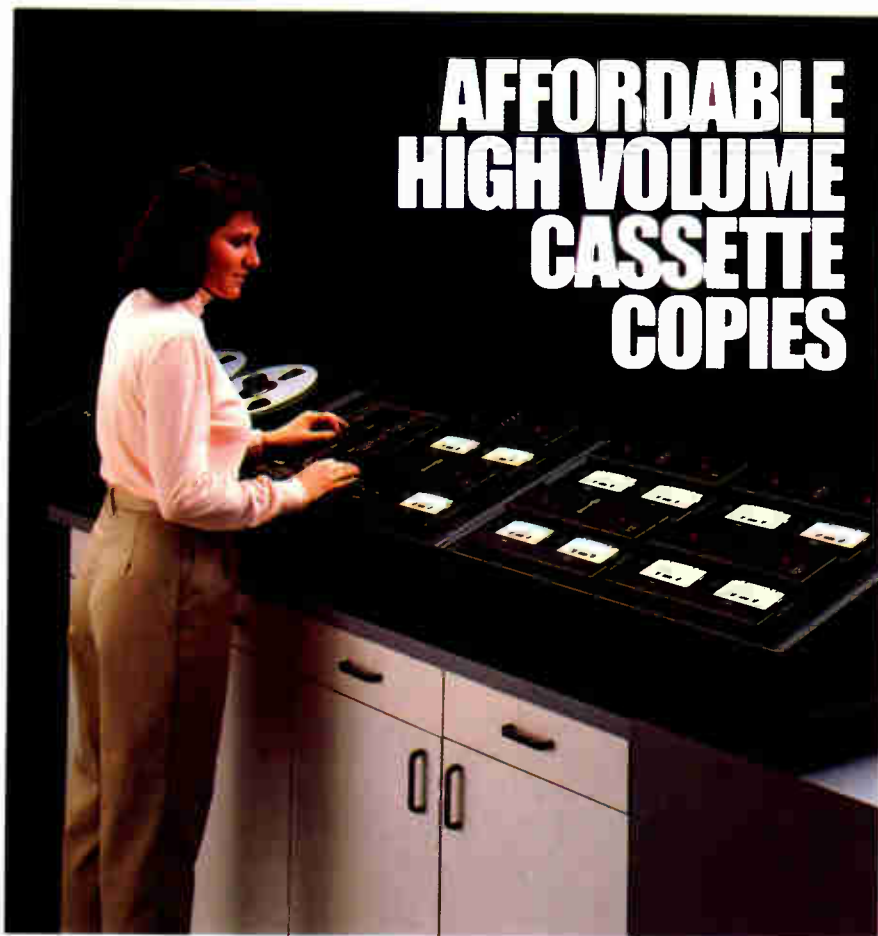

**Telex makes it fast, easy,
and cost effective.**

The 6120 series from Telex proves that a high speed audio tape duplicator can feature easy one-button operation *and* an affordable modular design that grows along with your needs. As the leader in tape duplicators, Telex blends the quality and convenience of U.S. made products with production speed options that meet your special requirements. For complete details, write to Telex Communications, Inc., 9600 Aldrich Ave. So., Minneapolis, MN 55420.

©1990 Telex Communications, Inc.

TELEX®

Circle #159 on Reader Service Card

It's The Music That Matters

Alchemy™

"I look at Alchemy as a sound camera. I can take photographs of my sounds and actually see what they are. I like the visual aspect of it. Being able to see your sound is really kind of exciting.

"Alchemy is the universal intelligent interface between all of my sampling keyboards. I've got a library of over 30,000 sounds and Alchemy networks

my library to all of my samplers. I get easy access to my library so I can work with and shape sounds as I need them. With Alchemy I've got Fairlight™ technology at an affordable price.

"Alchemy really is science. It's part of my whole lab— the studio, and definitely an integral part of what I do here. It's great stuff."

— Frank Serafine
Composer/ Sound Designer

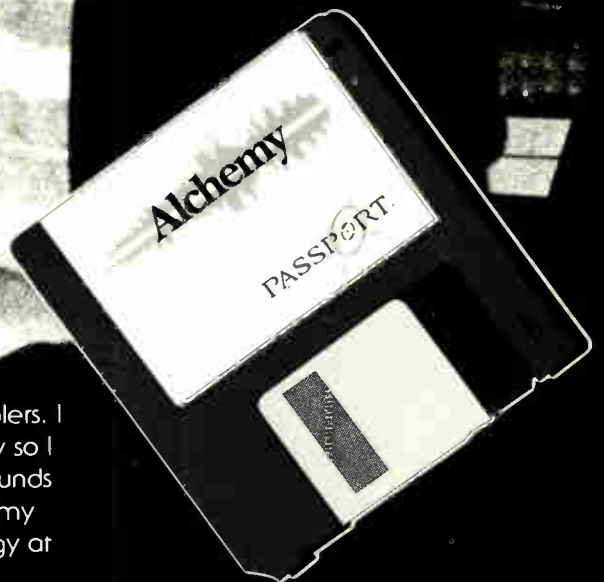

Alchemy is the choice of professionals around the world for sample editing and sound designing. See it and other Passport products at fine music and computer stores worldwide. Call or write for a free catalog.

Now Available for Macintosh™.

World Radio History

Passport
625 Miramontes Street,
Half Moon Bay,
California 94019
phone (415)726-0280
fax (415)726-2254



by Philip De Lancie

TAPE & DISC NEWS

Prospects for cordial resolution of the controversy over DAT have gone from bad to worse. Songwriter Sammy Cahn and three publishers have filed a class action suit seeking to halt Sony's importation of the recorders it began selling in the U.S. in mid-June. Legal counsel for the plaintiffs is being furnished by the National Music Publishers Association. NMPA is a moving force in the Copyright Coalition, which has opposed any consumer distribution of DAT technology that doesn't provide compensation to copyright holders for revenue losses attributable to home taping.

The Copyright Coalition's position has placed it in opposition to the Recording Industry Association of America, which has been working with DAT manufacturers to win passage of congressional legislation requiring inclusion in U.S. machines of the digital copy prevention system known as SCMS. The RIAA has responded favorably to the principle if not the tactic of the NMPA suit. "Our view has always been that we would do best with negotiations and legislation, and we have no official role in this lawsuit," says RIAA VP

Hilary Rosen. "But the suit has nothing to do with SCMS. It's a copyright infringement suit. And if your choice is to win a copyright case or lose one, you want to win one. SCMS is a good first step, but the forms of copying that it does not prevent are still violations of copyright law. So if there is going to be a decision in court, I hope it comes down on the side of copyright owners."

Does the NMPA action effectively end the alliance formed by the RIAA and hardware makers in support of SCMS legislation? Rosen doesn't think so, because it was not the RIAA that chose to sue. One sign that the relationship continues is the fact that "there has already been some desire expressed that we play the go-between in shuttle diplomacy." Rosen says. As far as the bill itself, she says, "It's not going to move while this litigation is in its early stages. Congress is going to wait until the smoke clears a little."

The NMPA suit, based on the premise that Sony contributes to the infringement of copyrights by distributing DAT recorders, is not the first time

the company has been embroiled in a clash between technology and intellectual property. In the Betamax case, the U.S. Supreme Court ruled against copyright holders who sought to bar VCRs, stating that a product could be sold, even if it may be used to infringe copyrights, as long as it has non-infringing uses as well. But according to NMPA president Ed Murphy, that decision is not applicable to this situation.

"The Betamax case said it was okay to record free TV off the air," Murphy says, "not to make a copy of a prerecorded movie. We are in the licensing business, and we know it takes hundreds of thousands of songs to be available in order for the public to buy a piece of hardware if they want to use it as a player. It's inconceivable that people would pay \$900 now for the possibility that someone will make them some software in the distant future. So what are the non-infringing uses of this equipment? Right now its sole use is to infringe our copyrights, and if you go buy one in a store, that's what they'll tell you to do with it."

The weakness in Murphy's position is that his objections

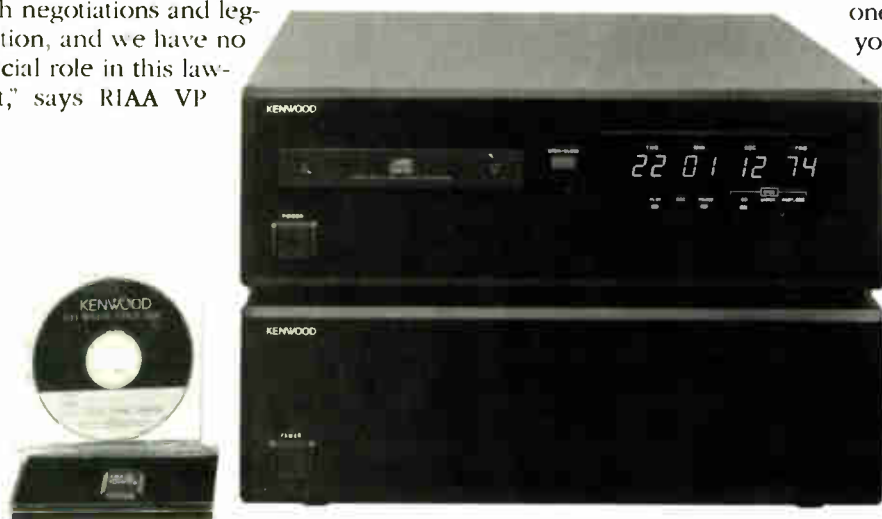

Said to be compatible with any CD format (CD-ROM, CD+Graphics, CD-Audio), Kenwood's CD-WO (write once) is a PC-controlled system allowing the connection of up to ten CD writers to a single encoder.

to the hardware rest on limited availability of software. If Sony-owned CBS Records were to release its entire catalog on DAT, instead of just a few titles on the Sony Classical label, it would be hard for the Copyright Coalition to maintain that DAT has no legitimate non-infringing use. But Murphy is undeterred by such reasoning. "It would take a lot of products out there before that argument could have any merit," he says. "When and if that happens, it would be up to a judge to decide whether the use of the equipment is or is not infringing."

As far as the group's goal in filing suit, Murphy says, "We are asking the court to stop importation of the machines and establish that there are damages due under the Copyright Act. But the ideal effect of the suit would be to bring everyone, including the hardware manufacturers, to the table to discuss how appropriate royalty payments could be made for the use of the creators' work on all the digital products coming down the road.

We've heard, either directly or through RIAA, that all the parties are interested in a meeting."

Meanwhile, the suit winds its way through the legal process. NMPA asked for, and was granted, expedited discovery, but there's too much at stake to expect that the suit or the issue will be settled anytime soon.

♦ ♦ ♦

Kenwood has become the latest entrant into the market for writing gear for CD reference applications. The company is introducing a line that includes an encoder, a recorder and a software control package designed to run on IBM-compatible computers. The products will be handled in this country by Kenwood's Test Equipment division in Long Beach, Calif. Similar devices have been introduced here in the past year by both Yamaha (audio applications handled by Gotham Audio in NYC) and Start Lab, a joint venture of Sony and Taiyo Yuden. Start Lab's CD Maker, which has been available with the Sonic System from Sonic Solutions of San Francisco, is

now also being used in the TOPIX CDR Pro CD Workstation from Optical Media International of Los Gatos, Calif.

♦ ♦ ♦

Another milestone, small but symbolically significant, was recently passed in the continuing fall of the once mighty vinyl record. *Billboard* has decided to use cassette rather than vinyl as the standard configuration for catalog numbers on all its album and singles charts. The company's move is in response to last year's industry sales figures, which showed the cassette dominant not only in albums, but among singles configurations as well.

SPLICES

Sunkyong Magnetic America has opened its new U.S. corporate headquarters. The 50,000-sq.-ft. facility, which includes a state-of-the-art technical center, is in Long Beach, CA...**Concept Design**, in an effort to provide complete in-

Drawmer
Ingenuity

A FAMILIAR FACE...



DS 201 OFTEN EMULATED...
STILL UNSURPASSED
"FREQUENCY CONSCIOUS"
DUAL NOISE GATE

U.S. DISTRIBUTOR
QMI
15 STRATHMORE ROAD
NATICK, MA 01760
PHONE: (508) 650-9444
FAX: (508) 650-9476

DRAWMER DISTRIBUTION CHARLOTTE ST BUSINESS CENTRE CHARLOTTE STREET WAKEFIELD WEST YORKSHIRE ENGLAND TEL 0924 378899 TELEX 556649 FAX 0924 280480

Circle #219 on Reader Service Card

house support for DAAD Type D digital duplication bins, is working with disk drive manufacturer **Data** to train technical staff in drive building and maintenance. The company is also building a Class 100 clean room at its Graham, NC, facility to allow faster drive refurbishing. **WaveFrame** (Boulder, CO) is expected to add CD pre-mastering with EQ and dynamics capabilities to its AudioFrame digital audio production system. According to training manager David

Frederick, the new features should be available mid-1991. Frederick recently demonstrated the AudioFrame's recording and editing prowess at StudioTech '90, a day of recording technology seminars and workshops in San Francisco presented by NARAS, co-sponsored by *Mix*. **Prezmith Engineering** of Toronto has introduced a custom-configurable control center for real-time duplication. The three-rackspace unit allows four input sources, with line drivers and monitor inputs for 20 three-head cassette decks, expandable up to 100 slaves

...**Agfa** (Ridgefield Park, NJ) has introduced a line of accessories for duplicators and studios, including audio and video splicing tapes, leader tapes, head cleaning fabrics and prepackaged cassettes. **Shape** has incorporated heat-resistant plastic into a new line of audio cassette shells designed to minimize shell warpage from summer heat. The Biddeford, ME, company has also expanded its sales force by 70%, using regional reps for the first time, and introduced a reduced-cost VHS cassette dubbed "Genesis." Applications for the multi-function cassette are said to range from feature films to department store demonstrations. **The International Tape/Disc Association** reports essentially flat unit sales of blank videocassettes in 1989. Video pancake sales rose 45% over 1988, probably reflecting the increasing importance of Sprinter and TMD high-speed duping systems. Blank audio cassette sales were up 4%. **Otari** (Foster City, CA) has increased top duplication speed on its T-700 Mk-II video duplicator from 4.5 to 5.5 meters per second. The update, made possible by a higher-efficiency laser, brings the VHS duplication ratio for NTSC/SP to 165:1, rendering increased productivity along with reduced power consumption and longer lamp life. Two of the systems have just been acquired by **West Coast Video** of Brisbane, CA, bringing its complement of TMD duplicators to eight. **Ampex** has expanded its line of 219 D1 cobalt gamma ferric oxide digital videotape with the addition of 6-, 12- and 20-minute lengths. The Redwood City, CA, company has also increased the transverse tape stiffness of its 187, 197 and 297 lines of 3/4-inch U-matic videotapes. **The Little Warehouse** of Independence, OH, is now loading custom lengths of broadcast-quality VHS cassettes. Video duplication services have also been upgraded with the purchase of a 1-inch Type C machine. The Still Frame Audio format offered by **Fast Trax** of Irvine, CA, in which large quantities of audio are compressed into video signals on laserdiscs, has been renamed Video Disc Interactive (VDI) to avoid confusion with Sony products. ■

Versadyne 1500 Series Tape Duplicating System

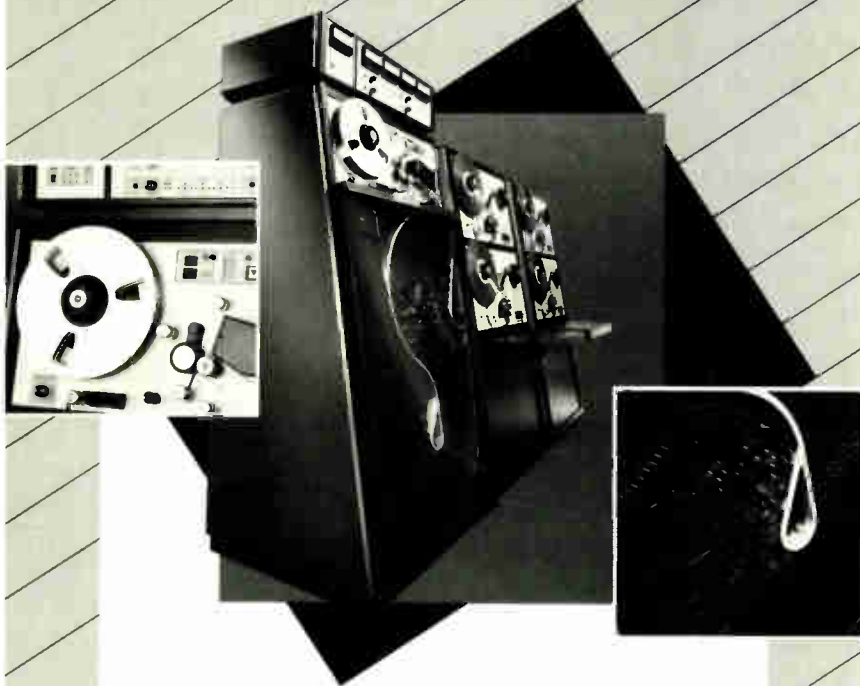

- Proven, Reliable, Productive.
- High Speed: 32:1, 64:1, 128:1.
- Easy To Use/Simple To Maintain.
- 5MHz Bias/Chrome Tape Compatible.
- American Quality/Affordably Priced.

Versadyne

504-D Vandell Way, Campbell, CA 95008
(408) 379-0900 FAX: (408) 379-0902 TLX: 28-8826

Circle #154 on Reader Service Card

Duplicate our success.

To celebrate entering the sixth year of supplying the world's most cost-effective audiophile quality duplicating system, we'll help you duplicate our success by offering you everything you need to duplicate, imprint and package your own audiophile quality cassettes.

For a limited time, we'll offer you this complete package of quality KABA equipment, including a 10 slave 4-track real time and 2X duplication system consisting of the master control deck, 5 dual transport slave decks, a pad printer, ultraviolet platemaker, plates, inks, cassette fixture, bar sealer, heat gun and a 2000' roll of shrink film, all at a price that can't be duplicated. Now one person can duplicate, imprint, assemble and shrink wrap over 300 tapes a day, quickly and economically... for an amortized cost of

equipment and maintenance of as low as 3.1 cents* each.

SAVE \$2,300

Call today for details, and start duplicating success in your business **1-800-231-TAPE**

From California & abroad
(415)-883-5041



Complete KABA cassette duplicating,
imprinting and packaging system

\$9,995

AES Show Special

*Based on 10,000 hours operation
@ 2X with factory maintenance
package every 2500 hours.



KABA

Research & Development

24 Commercial Blvd., Novato, CA 94949 (415) 883-5041
1-800-231-TAPE FAX (415) 883-KABA

C O A S T

L.A. GRAPEVINE

by Amy Ziffer

Reverence of Things Past... In July, I was treated to a little blast from L.A.'s recording past when Fox Run Studios in San Fernando had a barbecue and open house. Fox Run, in its previous life as Seals & Crofts' Dawnbreaker, was the setting for

the creation of many of Maureen McGovern's hits, as well as those of Walter Heath, the Silvers and Louie Shelton, and, of course, Seals & Crofts. I'm not the only person for whom "Summer Breeze" brings back fond memories, so understandably there was a small crowd of people thrilled to get the full tour.

Reminders of the studio's history

—CONTINUED ON PAGE 219

To kick off the Was (Not Was) album Are You Okay? (Chrysalis), the band performed at L.A.'s Mayan Theater. L.A. Record Plant's Remote Truck #3 recorded songs from the new album plus previous hits and special appearances by Elton John, Iggy Pop and Curt Smith (Tears for Fears). Pictured in the truck are (left to right) assistant engineers Buzz Burrowes and Gary Long, maintenance technician Bruce Maddocks, and engineer Ed Cherney, who engineered the new Was (Not Was) album.



PHOTO DAVID GOGGINS

SESSIONS & STUDIO NEWS

NORTHEAST

Flashback to Woodstock, NY, summer of 1990: **Jorma Kaukonen** and **Jack Casady** were in at **Dreamland Recording** cooking up **Hot Tuna's** new release for Epic; Kaukonen produced and **Ricky Sanchez** engineered with **John Yates** assisting... **J. Mascis** brought his band **Dinosaur Jr.** to Burlington, VT, to mix their new album for Rough Trade Records at **White Crow Audio**. At the Neve/GML desk were J. Mascis, **Paul Kolderie** and **Sean Slade** with assistant **Tom Walters**... At **Eastside Sound** of New York City, Grammy Award winner **Ray Barretto** was mixing with **Tom Swift** for EKM Management... At **Studio 4 Recording** of Philadelphia, Capitol recording artist **Mellow Man Ace's** new single, "If You Were Mine," was mixed by **Joe "The Butcher" Nicolo** on the SSL. Also at Studio 4, **Blackeyed Susan**, a Philly hard-rock band with ex-members of Britney Fox and Cinderella were working on an LP with engineer **Phil Nicolo** and producer **Randy Cantor**... **Mickey Rat** was working on the score for *Maxim Xul* at the **Power Plant Recording Studios** of Kensington, MD... **Richie Samborra** and **David Bryan** of Bon Jovi were in at **Alpha Wave Studios** of Edgemont, PA, completing their upcoming video documentary. Engineer and co-producer **O.B. O'Brian** said he enjoyed the sessions because, "I could park my Harley next to the grand piano and there's a Dairy Queen right down the street"... At **This Way Productions**, New York City, local funk band **Headsup** recently finished their debut album *Soul Brother Crisis Intervention*. The album was produced by **Albert Bouchard**, formerly of Blue Oyster Cult. Engineering was **Paul Special** assisted by **Matt Cappadocia**...

C O A S T

Below: Earl King's Sexual Telepathy on Black Top Records, which was recorded at Southlake Recording in Metairie, LA. Right: Chief engineer David Farrell (left) with producer and president of Black Top Records, Hammond Scott, mixing it up at Ultrasonic Studios in New Orleans.



Nashville, **Roy Rogers** (of chops *not* chops fame) was working with producer **Richard Landis** and engineers **Jim Cotton** and **Pete Greene** on new tracks for his upcoming RCA release...

SOUTHWEST

In Phoenix, **Chaton Recordings** sent a 24-track mobile truck to record **George Strait** in concert for broadcast on the Nashville Network. The project was engineered by **Andy Seagle** and **David C. Nelson**... **Heart Music, Inc.** were at **Sugar Hill Recording Stu-**

—CONTINUED ON PAGE 214

N.Y. METRO REPORT

by **Randy Savicky**

Live vs. Memorex... State legislators in New York and New Jersey are proposing laws that would inform concert ticket buyers in advance if a performance is not entirely live. These bills would allow potential concert-goers to know beforehand how much live music—as distinguished from wholly or partially recorded entertainment—they would be paying to see. John Glasel (president of the Associated Musi-

—CONTINUED ON PAGE 218

The famed Apollo Theatre's control room with Neve V Series console. According to owner/manger David Miles, "We offer ambience and the opportunity to record in an historic entertainment institution."

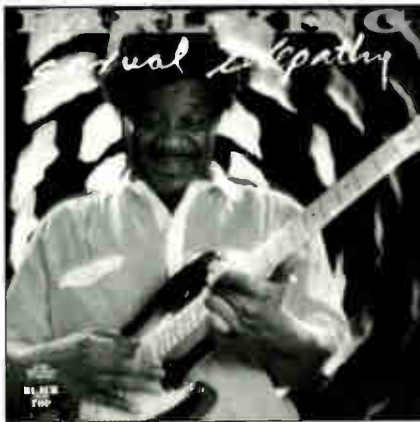

SOUTHEAST

At **Digital Recorders** of Nashville **Johnny Cash** was at work on a project with engineer **Willie Pevear** and assistant **Jim Demain** for Condor Productions... **Ultrasonic Studios** of New Orleans sent a remote to Tipitina's nightclub to record *Blues-A-Rama* for Black Top Records. During Jazz Fest, this extended jam lasted until 6 a.m. and featured **Snooks Eaglin**, **Earl King**, **Ronnie Earl & the Broadcasters**, **Anson Funderburgh** and others. The tag-team engineers were **David Farrell** and **Mark Bingham**, with **Hammond Scott** producing... In Metairie, LA, **Southlake Recording** reports New Orleans band the **House Levelers** were in recording five new songs in their "thrash folk" style with engineer **Steve Himelfarb**... **Ardent Studios** of Memphis, TN, reports **Joe Hardy** began producing with **Steve Earle** on his latest album project, *The Hard Way*... At the **Music Mill** of





**AKG • Audio-Logic
 Crown • Digitech
 Electro-Voice • JBL
 Klipsch • Shure
 Seck-Soundcraft
 Tascam**

Over 150 lines of audio
 and video equipment for
 the professional

1-800-373-4434



999 So. Logan, Denver, CO 80209

Circle #166 on Reader Service Card

—FROM PAGE 213, SESSIONS

dios of Houston working on two new projects to be released in the fall. **Andy Bradley** was the engineer on the projects...**Funkenstein Recording** of Dallas reports that the duo **Los De Aca** were laying down tracks for their new album; **Vertigo**, a MIDI-based dance band, completed a hot tune; and **Silence Obscure**, an alternative rock band, were in doing two songs...

NORTHWEST

Ned Lagin's *Sea Stones* sessions, a 15-year-old project featuring Jerry Garcia, David Crosby and Phil Lesh, was remixed at **Prairie Sun Recording** of Cotati, CA. Lagin was the producer; **Allen Suddth** and **Mark Rennick** engineered with second engineer **Jeff Sloan** on this project for Rykodisc... Current projects at **Sound & Vision Studios** (San Francisco) included **The Gargoyles** and **The Cordeleones** working with engineer **Neal Brighton**... At **Soma Sync Studios** in San Francisco, Alias Records artists **X-Tal**

were in to record a 7-inch single with producer/engineer **Greg Freeman**... **Jim Dean** was in **Dancing Dog Studios** of Emeryville, CA, to mix a live concert recording of the **Uptones**. Also helping with the mix were manager **Bobby Bell** and engineer **Damian Rasmussen**... At **Ironwood Studio** in Seattle, engineer **Rod Johnson** was busy recording folk artist **Tracy Moore**... Keyboardist **Mitchell Stein** recently recorded at **Fantasy Studios** (Berkeley, CA) for his upcoming jazz release. Joining him for the sessions were **Steve Kujala** (flute) and **Paul McCandless** (oboe, sax). **Danny Kopelson** engineered. Also at Fantasy, producer/engineer **John Cuniberti** brought Metal Blade recording artist **Ignorance** in to begin work on their first recording... At **Hyde Street Studios** (San Francisco), **Mark Needham** was in mixing the world-beat sounds of **Wazobia** for a *Ossum Opussum* CD release. Seconding Needham on the mix was **Tom Doty**... At **Vine Hill Studios** in Santa

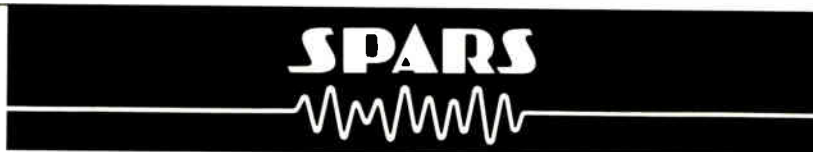

B E A T

On September 22 the members of SPARS elected the organization's 1990-1991 officers and board of directors. The election was held at the annual general membership meeting in the SPARS suite of the Los Angeles Hilton. The results are in: chairman of the board—David Porter, Music Annex, San Francisco; president—Pete Caldwell, Doppler Studios, Atlanta; first VP—Dick Trump, Triad Productions, Des Moines, Iowa; secretary—Dwight Cook, Cook Sound and Picture Works, Houston; treasurer—Steve Lawson, Steve Lawson Productions, Seattle. The rundown on directors includes: Ralph Cousino, EMI Music Worldwide; Jon Dressel, Paisley Park Studios, Minneapolis; John Fry, Ardent Recording, Memphis, Tenn.; Tom Kobayashi, Skywalker Sound, div. Lucasfilms Ltd., San Francisco/Los Angeles; Lee Murphy, Briggs Bakery, New York; Johnny Rosen, Fanta Professional Services, Nashville; Howard Schwartz,

Howard Schwartz Recording, New York.

In a brief address to the membership, Pete Caldwell noted a new openness within the organization: "The new SPARS board reflects growing diversity within the audio recording business—not only of specialization of endeavor but also of scale. The new board is representative of many industry segments, including music recording, sound for film and videotape, commercial recording and remote recording. Every corner of the country is represented. While all of us look to New York, Chicago, Los Angeles and Nashville for leadership, we recognize a trend toward decentralization. It is this diversity that I choose as the theme of my presidency. SPARS is a conduit for information flow. It is open to all professionals. By celebrating our diversity through SPARS we will find out how different we are but also how much the same." ■

THE INDUSTRY IS LISTENING

- ... "unsurpassed in detail and clarity"
 Steve Hall / Mastering Engineer,
 Future Disc
- ... "extremely accurate for referencing
 35 mm and 70 mm sound tracks"
 Dennis Sands / Mixer, The Abyss,
 Back to the Future
- ... "exceptional resolution and imaging"
 Bruce Botnick / Owner, Engineer,
 Digital Magnetics



19872 Gloucester Lane
 Huntington Beach
 California 92646

(714) 963-9609

— New Technology For The Future —

Circle #167 on Reader Service Card

Dreamhire

New rate cards now available for both USA and european locations!
Call or fax us now for your copy.

No other fully professional audio and musical instrument rental operation has
locations on both sides of the Atlantic nor claims to own such an
extensive and varied inventory as we do.
24 hour, fast, efficient and friendly service.....worldwide!!!

DREAMHIRE
New York
137-139 West 25th Street,
New York, NY 10001, USA
Phone 212-691-5544
Fax 212-989-6603

DREAMHIRE
London
18 Chaplin Road,
London, NW2 5PN, United Kingdom
Phone 081-451-5544
Fax 081-451-6464

DREAMHIRE
Nashville
1217 16th Avenue South,
Nashville, TN 37212, USA
Phone 615-321-5544
Fax 615-321-0928

DREAMHIRE
Los Angeles
Just a matter of time!!

GOLD LINE LOFT

**NEW: SOUND LEVEL
METER with
DIGITAL NUMERIC
DISPLAY**



Standard: 45 to 120 dB
Only \$199.95
RANGE OPTION
Preamp: 25 to 120 dB

**NEW: LOFTECH TS-2
IMPEDANCE METER
& AUDIO TEST SET**



Impedance Meter, dB Meter
Audio Oscillator
& Frequency Counter
Only \$449.95

**1/3 OCTAVE RTA
8 MEMORIES**



30 Bands Aux. Input
Instrument Microphone
Only \$649.95

CONTRACTOR PRICES

Send for free catalog:
Box 500, West Redding, CT 06896
PH (203) 938-2588 FAX (203) 938-8740
(800) 433-6373

Cruz, CA, **Gary Lamb** recorded and produced his Christmas album for Golden Gate Records. **Russell Bond** engineered and co-produced...**Starlight Sound** (Richmond, CA) played host to **Elvin Bishop**, mixing his next album for Alligator Records. Engineering was handled by **Bill Thompson** with assistance from **Lynn Levy**...

NORTH CENTRAL

Around the Motor City—In Warren, MI, **Hatchery Studios** reports **Jim Oliver & the Teen Angels** were recording six original tunes for Elektra Records. **Dave Sell** was behind the board for the project...**Paragon Recording Studio** of Chicago reports artist/producer **Gene Barge** was in recording/mixing new material, and Chicago reggae sensation **Imani** recorded instrumental and vocal tracks for an upcoming release. On both projects **Marty Feldman** was engineering with assistant **Jim Franke**... **Good Question** and producer **George Conner** were at **Ajax Recording Team** of Fort Wayne, IN, finishing tracks for their new release. **Craig Harding** was at the helm with **Michael Patterson** navigating... **Beachwood Studios** of Cleveland played host to recording legend **Dion** and producer **Don Was** to track vocals for a song...At **Studio A** of Dearborn, MI, jazz flutist **Alexander Zinjic** was digitally mixing his current album for Danzon, Inc. with **Eric Morgeson** at the board and **Tom Lucio** assisting...At **Seagrape Recording** of Chicago, final mixes have been completed for **Tony Bell & Kutchie**'s album entitled *Mercy*. **Ralph Rosario** mixed his "I'm Feeling Good" for Hot Mix 5 Records with **Dave Triumpho** dialing the knobs... **Turtle Mobile Recording** (Vancouver) recently recorded the Stein Valley "Voices for The Wilderness" Festival at the Tsawwassen Indian Reservation for a live compilation album of top Canadian artists. The recordings were produced by **Bill Henderson**, engineered by **Bill Buckingham** and **Larry Anshell**, and assisted by **Dave "Trigger" Trgovcic**...

SOUTHERN CALIFORNIA

Blues legend **Albert King** was in laying down tracks at **Sunset Sound** (Hollywood) for his upcoming album. Co-producing were **Alan Douglas** and **Bruce Gary**, with **Mark Linett** engineering assisted by **Brian Sou-**

cy...At **Scream Studios** of Studio City, **Faith No More** were in mixing eight songs for their live video. **Matt Wallace** mixed and **Craig Doubet** assisted...At **Powertrax/55** (L.A.) the **Red Hot Chili Peppers** were working with engineer **David Z.** and **Ken Felton** assisting on the soundtrack for the remake of *Takin' Care of Business*...At **Take One Recording** in Burbank, **Brian Wilson** has been in with engineer **Brad Gilderman** laying down tracks for his upcoming album. Gilderman was assisted by **Steve Montgomery**. Also at the facility, **Jeff Lord-Alge** has been in mixing **Lloyd Cole**'s live performance from the Palace for Capitol Records...**Elumba Recorders** (L.A.) played host to Warner Bros. artist **Sheila E.** for overdubs and mixing with producer **Peter Micheal** for an upcoming album. **Jess Sutcliffe** engineered the project and **Rick Caughron** assisted. **George Clinton** followed Ms. E. into the room to mix his Warner Bros. project *Trey Leud*...Producer **Bill Meyers** wrote, tracked and mixed the music at **Ignited Productions** (Hollywood) for the opening film for **Earth, Wind & Fire**'s upcoming tour. **Paul Klingberg** engineered the project with **Mike McKnight** as programmer and **Jeff Welch** as second engineer...At **microPLANT Studio** in Hollywood, **Jimmy Cliff** and **Steven Seagal** were in with producer **Heavy Love** to work on songs for Seagal's upcoming film...**Vinnie Vincent** was at **Cornerstone Recorders** (Chatsworth) mixing with **Rick Barcelona** and assistant **Joe Barresi** on an upcoming Enigma release...

STUDIO NEWS

Larrabee Sound (L.A.) purchased **Oasis Studios** from producer/composer **Giorgio Moroder**. As part of an overall \$2.5 million facility upgrade, Larrabee will completely revamp the location by adding two of the nation's largest SSL consoles...**Coast Recorders** of San Francisco announced the opening of its revamped Studio A. Designed by the legendary **Bill Putnam**, the studio's control room now features a 44-input Neve with Necam 96 automation...**Chestnut Sound Inc.** in Philadelphia announced the purchase of a Sony APR 24 mic preamp and Milab VIP 150 microphone...**The Plant** recording studios of Sausalito, CA, installed a new G Series SSL in Studio B and christened the new console with a project by the

Doobie Brothers... Digital House Ltd. (New York City) has been active preserving music of historic importance from two classic jazz and pop performers: **Duke Ellington** and **Jim Croce**. Both of these projects were under the direction of **Harry Hirsch**, vice president of technical services at Digital House and producer for both CD releases. The Ellington project involved selecting material from more than 100 2-track master tapes recorded over a 15-year period. For the Croce project, Hirsch was faced with sonically enhancing a tape that was recorded at one of Croce's last performances in 1973. Using the Harmonia Mundi Acustica (HMA) digital audio processor he was able to sonically enhance the tape, carefully matching levels and adding equalization where necessary to overcome the limitations of the old analog tape. The ten-CD Ellington set, entitled *Duke Ellington Private Collection: Studio Sessions 1953-1968*, and the Croce CD, entitled *Final Concert Tours*, were released by Little Major Records and distributed by Atlantic Records... According to **Jeff Cohen**, systems engineer with Showco, a Ramsa WR-S840 console was used to record the **Paul McCartney** tour. "The Ramsa console lends itself well to recording on the 32-track Mitsubishi X-880 digital—utilizing the direct outputs on individual channels in order to record the separate tracks," Cohen says. "Recording the live concerts in this fashion is similar to the setup used for sound reinforcement, but with less equalization and processing."... On July 29, the **Music Annex** of Menlo Park, CA, experienced a fire in one of its four recording studios. Damages were limited to one control room as the fire was brought under control by local firefighters after a few hours. Studio manager **Charlie Albert** stresses, "It's important that the Bay Area music community realize that the damages were limited to one room and that we are open for business with three rooms ready to rock."... **The Toy Specialists** of New York City provided a Mitsubishi X-86 for sessions at **Excalibur Sound** where the music from *Twin Peaks* made its debut as a Warner Bros. release. **Art Polhemus**, owner of Excalibur Sound and engineer of the sessions, comments, "Many people are attracted to the music from *Twin Peaks*. The X-86 enabled us to take all the music from the show and record it on digital 2-track. The digital format will expose the listener to

THE CONSOLE COMPANY

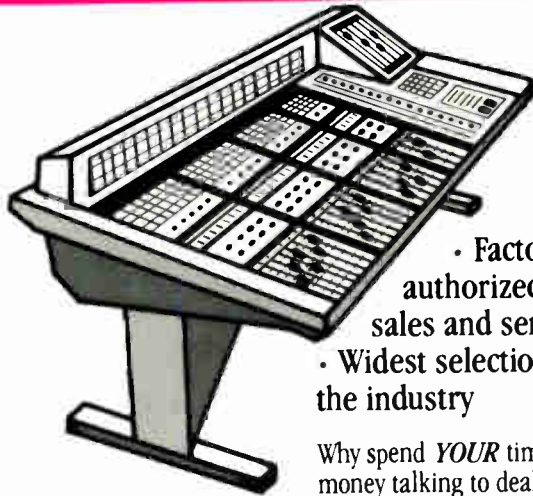

• Factory authorized sales and service
• Widest selection in the industry

Why spend *YOUR* time and money talking to dealers offering *THEIR* limited selection of consoles? One phone call to The Console Company and...
The choice is yours.

EAR
2641 E. McDOWELL

602-267-0600
PROFESSIONAL AUDIO/VIDEO
PHOENIX, AZ 85008



Soundcraft

YAMAHA

TASCAM
TEAC Production Products



sound workshop

AMEK

RAMSA

Circle #194 on Reader Service Card

...On July 29, the **Music Annex** of Menlo Park, CA, experienced a fire in one of its four recording studios. Damages were limited to one control room as the fire was brought under control by local firefighters after a few hours. Studio manager **Charlie Albert** stresses, "It's important that the Bay Area music community realize that the damages were limited to one room and that we are open for business with three rooms ready to rock."... **The Toy Specialists** of New York City provided a Mitsubishi X-86 for sessions at **Excalibur Sound** where the music from *Twin Peaks* made its debut as a Warner Bros. release. **Art Polhemus**, owner of Excalibur Sound and engineer of the sessions, comments, "Many people are attracted to the music from *Twin Peaks*. The X-86 enabled us to take all the music from the show and record it on digital 2-track. The digital format will expose the listener to

Free Catalog of Professional SOUND recording & duplicating SUPPLIES

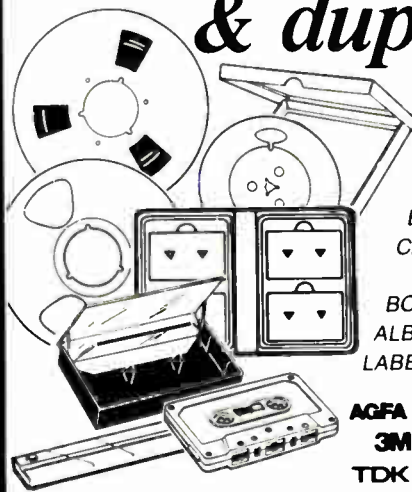

POLYLINE™ EMPTY
REELS & BOXES

BLANKLOADED
CASSETTES

BOXES
ALBUMS
LABELS

AGFA AMPEX
3M Scotch
TDK maxell.
tapes

now from
STOCK
in
CHICAGO
and
L.A.

Call Polyline
708/298-5300
8:30 am - 5 pm Central Time

Polyline
Corp.
1233 Rand Road
Des Plaines, IL 60016

Circle #195 on Reader Service Card

subtleties that are lost because of television's poor sound quality."... **Tim Stanton Audio** of Austin, TX, purchased a 32-input Amek Mozart from **AudioLine**, Chicago. The studio specializes in music recording and commercial music production, and following the installation of the Mozart will become increasingly involved in video post-production... **John Acoca**, one of L.A.'s foremost mastering engineers, has relocated to the San Francisco Bay Area. Joining the staff of the **Rocket Lab**, Acoca brings a wealth of experience to San Francisco's first digital editing/CD mastering suite... **Greff Productions** of Cincinnati, creators of custom-designed music,

announced the addition of **Steve Miller** to its staff. A former student of the Musicians' Institute in Hollywood, Steve Miller is an internationally known musician and is now a partner with Greff Productions' founder **Kraig Greff**... **South Bay Sound Studios** (Gardena, CA) has recently finished remodeling and has installed a new Trident Series 24 console and MCI JH-24 24-track deck. They have also added complete SMPTE lockup, a digital 2-track with sync and eight channels of automation to their new setup to facilitate audio sweetening and video post-production. Already the room is becoming very popular: L.A.-based band **One World** was re-

cently in the newly remodeled studio recording their debut album for Nova Records. ■

—FROM PAGE 213, N.Y. METRO REPORT

cians of Greater New York, Local 802, American Federation of Musicians) noted in a letter to the *New York Times* that "ten seconds of canned music doesn't wreck a two-hour concert, but laws are needed to prevent this growing form of consumer fraud." Stay tuned.

Recordable CD Goes On-Air... Heralding a new era of broadcast audio, WQCD-FM (CD 101.9) has become the first broadcaster anywhere to regularly use a CD recorded with Gotham Audio's Spot 90 Compact Disc Production System on-air. Spot 90 can record a wide range of programming—spot announcements, sound effects, jingles, commercials and music cues—directly onto a CD. According to Andy Bater, chief engineer at WQCD, Spot 90 enables its DJs to air station jingles and IDs with the same audio quality as the music played, which is 95% from CDs.

A Tapeless Town... New York studios continue to make non-tape-based recording more of an everyday occurrence. For example, Penny Lane Studios recently added a Lexicon Opus/e tapeless recording system, which Alan Varner has already used on a television spot. At Music & Sound Design Studio, Bill Milbrodt recently remixed an anti-drug rap public service announcement on the studio's Synclavier Direct-To-Disk system. Lavskymusic used its 9600 to launch Green Seal, the first independent national environmental labeling program for consumer products.

Digital Audio for Digital Video... Productions that combine digital audio with digital video are certain to become the norm. Recently, Carly Simon's *My Romance* HBO Special featured sound recorded, mixed and edited digitally, then processed back to D2 for digital matching of audio and video at Editel. Frank Fillipetti originally recorded the music on 48-track digital during filming at the Apollo Theatre, and Jonathan Porath edited and mixed the music and dialog to a Sony PCM-3324 at Editel, later transferring the mix to D2. Editel has also been busy with music videos by Technotronics, Mantronix and Poi Dog Pondering.

MOVING FADER AUTOMATION

Powerful · Accurate · Yet simple to use and at a price that will be music to your ears.

SEE US AT THE AES SHOW, BOOTH NO. 1101

AND

- DDA booth 826
- Neotek booth 651
- Soundcraft booth 526-536
- Waveframe booth 216A

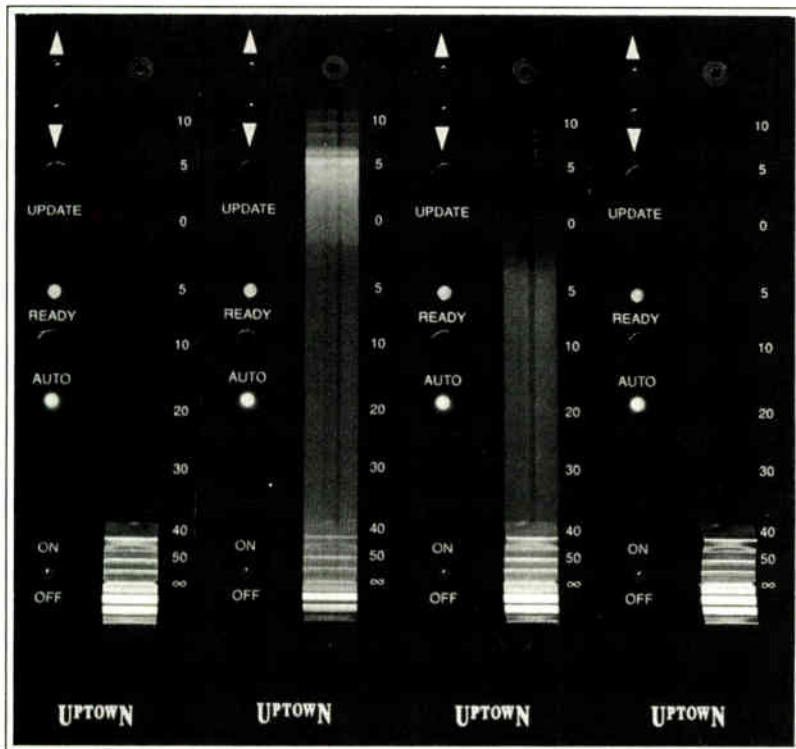

AUDIOMATION SYSTEMS LTD.

Worldwide distributors of UPTOWN™ Automation Systems

USA
96 Dudley Road
P.O. Box 252
Sudbury, MA 01776
505-443-8053
Fax: 508-443-4844

EUROPE
Rockwood House
Barn Hill
Stanley County
Durham DH98AN U.K.
0207-282880

Telex: 537642
SLMARK G
Fax: 0207-232023

UPTOWN

Circle #171 on Reader Service Card

Digital Audio (Small Is Beautiful)... After completing a 46-track CD for MTV, Digital House recently mastered and replicated two new releases by Tribe and Mike Viola for RPM Productions and four projects for The Embryo Group. In addition to CD production, Digital House also handled cassette production, added Jerome Bunke, president of Digital House. At Blank Productions, Lola Blank noted that CD mastering was recently completed for MMO Music Group, Teledisc and Zomba Records.

Nouveau New York...Broadsound has recently opened at 29 Greene Street in the heart of SoHo. The two-studio facility features a Neve 8058 and Studer A820 multitrack, Studer A80 2-track, and Scully 4-track tape machines in Studio A. Studio B contains a Yamaha 2408 console with Roland submixer and Tascam 85B and 42 tape machines. A Sony DAT recorder is also available. The extensive mic selection includes five Neumann U87s and a U47.

Please send press releases with the latest news of your facility to RPS Communications, 520 Arthur St., Centerport, NY 11721. You can reach me by phone at (516) 423-4038 or by fax at (516) 423-6155. ■

—FROM PAGE 212, L.A. GRAPEVINE

are everywhere, and owner Joe Branam and chief engineer/manager Chuck Fetyko have a new chapter to add: Together they have over 30 years of touring experience, Branam with flying rigs (he's the man who took Mick Jagger for a ride in a cherry picker), and Fetyko with live sound for Foreigner, the Psychedelic Furs and The Cars. Fetyko is also branching out into studio design. I was privileged to view the same Plexiglas sphere in which Paula Abdul descended to the American Music Awards stage, and the giant octopus prop used at the Academy Awards. The severed head under the staircase was not explained (hey, guys, there are more civilized ways to deal with disgruntled customers!).

A generously sized rehearsal stage in back has proven to be popular. Artists who have used the space recently include Motley Crue, Ronnie James Dio, Paula Abdul and Sheena Easton; WASP shot a video there. A redesign of the main room (replete with a Neve VR60 and Augspurger-designed monitoring system) was completed earlier this year, but construction continues. What was formerly office space is

High in fibre.



Adamson delivers unsurpassed sound clarity.

Sophisticated midrange driver technology results in unparalleled response. The lightweight diaphragm, made from a high modulus composite fibre material, has a higher specific stiffness than titanium or beryllium. The result, Adamson drivers, with three patents pending, deliver the warmth of paper without the harshness of metal.

TEC
1989 NOMINEE



ADVANCED CONCERT SYSTEMS

Adamson Acoustic Design Corporation, 817 Brock Road, Unit 9, Pickering, Ontario L1W 3L9
Telephone: (416) 420-6279 Fax (416) 420-0813

Circle #181 on Reader Service Card

CRT

Custom Products, INC.

COMPLETE CUSTOM PACKAGING

- CASSETTE DUPLICATING
- COMPACT DISCS
MANUFACTURING
- FULL COLOR PRINTING
- VHS & CASSETTE BOXES

- CRT OFFERS COMPLETE CUSTOM PACKAGING ON ALL ORDERS.
- JACKETS, VHS BOXES, CASSETTE INSERTS, ETC. DESIGNED BY OUR COMPLETE, IN-HOUSE ART DEPARTMENT.
- WE SPECIALIZE IN FOUR-COLOR PRINTING: BROCHURES, POSTERS, COMMERCIAL PRINTING AND MUSIC RELATED PRODUCTS—SUCH AS 12" and 7" RECORD JACKETS, BACKDROPS, VIDEO BOXES & LABELS, CD PACKAGING.
- QUALITY, CUSTOMER SERVICE, EXPEDIENCY AND CLOSE PERSONAL ATTENTION ARE GUARANTEED IN THE MANUFACTURING OF YOUR ORDER.
- CRT'S PRICING IS VERY COMPETITIVE IN THE CUSTOM MARKET. WE STRIVE TO KEEP OUR PRICES AS LOW AS POSSIBLE, MAINTAINING THE HIGHEST QUALITY.
- CRT IS COMMITTED TO PROVIDE THE BEST SERVICES. OUR CUSTOMERS DESERVE AND EXPECT NO LESS.



• Call for personal quote today our **TOLL FREE NUMBER 1-800-453-2533** •
In Tennessee call (615) 298-4533 • Fax (615) 383-2090

or write
CRT, CUSTOM PRODUCTS, INC. • 4800 TENNESSEE AVE. • NASHVILLE, TENNESSEE 37209-2238

Circle #172 on Reader Service Card

—FROM PAGE 219, L.A. GRAPEVINE

being turned into a full-fledged second studio; Dawnbreaker's old live chamber (a breed near extinction) will become an isolation booth. Equipment will include Baby-O's old Trident 80B 56-input console. The estimated completion date is September 1, and Branam is planning an open house each morning of the AES convention to show off the new room and is hoping to host another barbecue one evening. The main studio is fully operational while work is underway.

Orange Curtain Report... At Sideways "MIDI is our forte" Recording in Santa Ana, owner Jim Hahn recently invested \$40,000 in acoustical and cosmetic work and rewired the studio with Mogami Cable. An additional \$80,000 equipment investment includes an Amek 36-input Magnum console, Adams-Smith Zeta-3B synchronizer, several Lexicon LXP-1s and LXP-5s, Aphex Expressors, a UREI 7110 compressor and a 24-track Otari MX-80. The facility's chief engineer is Gary Druilhet, nephew of Dr. John. The Ohio Players were recently in taking advantage of the refurbished, Macintosh-based Sideways to sequence some tracks for a commercial client. For you studio trivia nuts, here's a tidbit: Sideways is Orange Curtain... er, County's only HARP member.

Speaking of HARP, L.A.'s City Planning Department recently published its revised ordinance concerning home-based businesses. It establishes two categories of home-based businesses: those that conform to a set of broad guidelines and would not require mandatory discretionary review by the Zoning Administrator, and those that do not conform and are subject to more stringent oversight. Home-based studios would fall into the second category. After revisions and possibly more public hearings, the ordinance still has to move through the City Attorney's Office, the City Council and the Mayor's Office, so a final resolution is still quite far off. More news as it develops.

UCLA Extension will be hosting *The School of Hard Rocks: Personal Views of Success in the Music Industry* with *Mix's* editor-at-large Mr. Bonzai. The course will be held four Tuesday evenings from October 30 to November 27. You can register over the phone using your credit card. Call (213) 825-9971 or (818) 784-7006 and request course EDP number M8793B. ■

**For those
who take it
seriously...**

Now
providing advanced
training in
conjunction with
Solid State Logic

TEC
TECHNICAL EXCELLENCE & CREATIVITY
**1990
NOMINEE**

It's not enough to study the "art" of recording. You simply must learn the *technology* of recording. That's the only way to insure your career for today and tomorrow!

"IAR grads are the most highly motivated and best trained of anyone entering the engineering field. I give IAR my highest endorsement."

Dan Healy, Chief Engineer
The Grateful Dead

800-544-2501

NY, NJ, CT 212-777-8550

Lic. by NYS Ed Dept / HS Diploma or GED Required
App for Veterans Training / Financial Aid if Eligible



Institute of Audio Research

64 University Place, Greenwich Village, New York, New York 10003

Circle #173 on Reader Service Card



Valley Sound is....

... Dedicated to serving our clients. We believe that the bottom line is CUSTOMER SATISFACTION, whether it is a microphone or a 48 Track installation.

We offer industry standard products like TAD monitors, CREST amps., H&H amps., SONY, Mogami cable, ALLEN & HEATH, SENNHEISER-just to name a few. We also broker used gear - such as consoles, machines, old tube gear, NEVE modules etc..

NEED A RENTAL?

AMS RMX 16
TC 2290
H3000
125 / DAY

GML 8200 EQ.
API 550 a's (4)
135 / DAY

NEVE 1073's (4) in
a portable case
100 / DAY

So... If you are buying, selling, renting, installing or just want some info,

VALLEY SOUND can take care of your needs.

Tel: 818 • 842 • 6500

Fax: 818 • 848 • 4861

BURBANK, CA



FOXRUN STUDIOS

Recording • Rehearsal



HUGE CONTROL ROOM
LIVE ROOM OVER 1500 SQ. FT.

Neve
VR 60 (recall)
fully loaded



FLYING FADERS
Automation

OTARI
MTR-90 II (2)
MTR-12 2 TRACK

OUTBOARD FACILITIES INCLUDE...

AMS, APHEX, AKAI, BASE
EVENTIDE, LEXICON
T.C. ELECTRONIC, TELETRONIX
YAMAHA, 360 SYSTEMS,
SIMON SYSTEMS
& MUCH MORE.

MONITOR SYSTEMS...

TAD, YAMAHA NSTO's

216 Chatsworth Drive San Fernando,
CA 91340 15 min. from Hollywood

(818) 898-3830
FAX: **(818) 361-8438**

Lowest Prices on AMPEX Tape

Ampex 456 Grand Master® Studio Mastering Tape

As low as... 2" \$114.08 per reel

As low as... 1" \$ 52.68 per reel

As low as... 1/2" \$ 30.43 per reel

As low as... 1/4" \$ 9.43 bulk

COMPLETE CATALOGUE AVAILABLE UPON REQUEST.

AEG-Telefunken Mastering • Telefunken/Lyrec Duplicating
3M Audio Distributor • Audio-Video Cassette Duplication
R-DAT Digital Tape • J-Card Printing
Sony Pro Video • Custom Video Cassette Loading
Audio & Video Accessories • Ampex Pro Video

HRC Magnetics 1611 Herring Waco, Texas 76708
CALL TOLL FREE 1-800-443-8457 Nationwide FAX 817-756-0082

AES SPECIALS*

X-850 w/Apogee \$495/Day

X-86 w/Apogee \$140/Day

D-2 Composite Digital \$595/Day

PCM-1630 } pkg. \$395/Day
DMR-4000 }

DIGITAL
dispatch

(213) 664-FAST

(818) 952-FAST

(714) 662-FAST

(800) 446-FAST
Toll-Free Outside Calif

A Vast Selection of Production Rental Equipment
365 DAYS A YEAR - ANY TIME, ANY DAY, ANYWHERE
OFFICE OPEN 7 DAYS A WEEK
FREE LOCAL DELIVERY

* Discount Limited to Equipment in Stock

AND ON THE EIGHTH DAY, WE BULLDOZED IT.



The oldest rainforests date back to the time of the dinosaurs, 100 million years ago. Today they offer the last refuge for half of all the plant and animal species on earth.

But how much time do rainforests have left?

Each day, fifty thousand acres of rainforests are bulldozed, burned, degraded, destroyed. At this rate, the last traces of paradise will be gone in a single human lifespan.

A miracle of creation wiped out, at horrendous cost to our environment.

What can you do to save the last rainforests on earth?

You can support activists in more than a dozen nations fighting to conserve the splendid variety of living things which depend on these endangered environments.

Jaguars, orchids, boas, birds ... not to mention 200 million people.

To get involved, simply mail the coupon below. Tomorrow won't wait.

Tell me more about the rainforests and what I can do to save them.

NAME _____

ADDRESS _____

CITY _____ STATE _____ ZIP _____

 **RAINFOREST ACTION NETWORK**

300 BROADWAY, SAN FRANCISCO, CA 94133

NEW PRODUCTS FOR 1991

225 ACOUSTICAL MATERIALS

Diffusors, absorbers, tile, foams and traps.

227 AMPLIFIERS

Preamps and power amplifiers for studio and sound reinforcement applications.

232 AUTOMATION AND CONTROL SYSTEMS

Console automation, SMPTE and MIDI controllers, remote systems and time code peripherals.

235 COMPUTER HARDWARE AND SOFTWARE

Software, interfaces and peripherals for music production, studio operation and design applications.

239 MAGNETIC TAPE

Recording tape, splicing supplies and cleaning materials for studio and duplication use.

242 MICROPHONES AND PICKUPS

Hard-wired and wireless microphone systems and accessories for stage, studio and location recording.

245 MIXING CONSOLES

Consoles and portable mixers for recording, broadcast and sound reinforcement.

253 MONITOR/LOUDSPEAKER SYSTEMS

Studio main and reference monitors, headphones, horns, drivers, and speakers for sound reinforcement/fixed installations.

258 MUSIC PRODUCTS

Musical instruments, synthesizers, samplers, drum machines, MIDI gear, instrument amplifiers, sample collections, guitar processors, accessories and production music/sound effects libraries.

263 RECORDING DEVICES

Analog and digital recorders, disk-based recording/editing systems, workstations, recordable CD systems, duplication products and recording accessories.

269 SIGNAL PROCESSING DEVICES

Reverbs, effects processors, digital converters, delays, limiters, equalizers, noise reduction, spatial enhancers, preamps, splitters, gates and other outboard goodies.

275 TEST EQUIPMENT

Analyzers, measurement systems, calibration tools, maintenance and test gear.

276 OTHER

Cases, cables, racks, stands, cassette printers, intercoms, video equipment, bulk erasers and other products.

All new product information in the following directory was provided by manufacturers responding to questionnaires mailed earlier this year. Specifications and prices may change, so verify critical information with the companies directly. *Mix* is not responsible for the accuracy of the information supplied to us by these companies.

UPCOMING DIRECTORY DEADLINES:

October 17, 1990: Northwest Studios

November 16, 1990: Independent Engineers & Producers

November 16, 1990: European Production Facilities

We've got you booked.



The time you spend tracking down information on audio facilities and services can be saved by the one source that brings it all together in a valuable, convenient reference. Thousands of Audio Production Facilities and Services in the U.S. and Canada have listed at no charge in the 1990-91 Mix Master Directory. This comprehensive, up-to-date resource includes the following categories:

- Recording & Video Facilities
- Remote Recording
- Sound Reinforcement Companies
- Independent Engineers and Producers
- Mastering, Pressing & Tape Duplication
- CD Pressing Plants
- Facility Designers & Suppliers
- Recording Schools, Seminars & Programs

Plus!

DIRECTORY OF MANUFACTURERS

A thorough, cross-referenced guide to professional audio products and manufacturers

DIRECTORY OF PROFESSIONAL AUDIO SERVICES

Including Advertising Agencies, Public Relations Firms, Business Consultants/Financial Services, Graphic Design/Photo Services, Legal Services and more

EASY TO USE SERVICES KEY

Handy coding system refers you to the companies or individuals who offer exactly what you're looking for

**Get your hands on the Mix Master Directory—
Call toll free (800) 233-9604 and place your order today!**



Please send me ____ copies of the 1990-91 Mix Master Directory at \$24.95 ea. (Plus \$3.50 shipping and handling. CA, IL & NY residents please add state sales tax.)

Name _____

Company Name _____

Address _____

City/State/ZIP _____

Daytime Phone () _____ x _____

Check or Money Order enclosed

Check # _____

Charge to: Visa MasterCard Discover Card

American Express Exp. Date _____

Credit Card # _____

Cardholder Sig. _____

Shipping times may vary; please allow two to three weeks for delivery. For immediate customer service and rush orders, call (800) 233-9604 or (415) 653-3307.
24-hour fax line (credit card orders only): (415) 653-5142

Mail completed order form and prepayment to: **Mix Bookshelf, 6400 Hollis St. #12, Emeryville, CA 94608**

World Radio History

ACOUSTICAL MATERIALS

ALPHA AUDIO; 2049 W. Broad St.; Richmond, VA 23220; (804) 358-3852. Product Name: Azonic. Contact: Kathy Wynne, manager. Date Product Introduced: 4/90. Product Description & Applications: Azonic acoustical foam is available in 2 patterns, 4' x 4' and 2' x 2' sheets. Available in 2", 3", and 4" thicknesses and the colors of charcoal, brown, blue and beige. Also available in class-1-fire-rated melamine. Now the number one choice for sound absorption. **Basic Specifications & Suggested List Price:** Available in an Azonic and pyramid pattern. Can be ordered by the sheet or by the box. Lists for \$2-\$5 a square foot depending on thickness and pattern.

ASC/TUBETRAPS; PO Box 1189; Eugene, OR 97440; (503) 343-9727; (800) ASC-TUBE. Product Name: Studio Trap. Date Product Introduced: 6/90. Product Description & Applications: The latest in Gobo acoustics. It's really a Tube Trap mounted on a tripod stand for easy handling. Set up around the talent to enhance S/N ratio at the mic. Studio Traps can be raised, lowered or rotated on axis for optimum ambience. Use with standup or sitdown vocal and instrumental recording in the studio, halls and outdoors. Set up a Gobo for soffit loading the midfield monitors in mix-down, and later as corner-loaded bass traps for playback. **Basic Specifications & Suggested List Price:** The Studio Trap is a self-contained bass trap to 110

Hz, inset with a strip membrane diffusor above 400 Hz. It is 9" in diameter, 4' high and tripod-mounted on a counterbalanced, 21" extension shaft to reach a maximum 78" height. Each unit is factory sealed and covered with Guilford 701, the studio-standard-fire retardant fabric and ships UPS in days. Retail \$255/unit.

ASC/TUBE TRAPS; PO Box 1189; Eugene, OR 97440; (503) 343-9727; (800) ASC-TUBE. Product Name: Trim Trap. Date Product Introduced: 3/90. Product Description & Applications: This is a lightweight designer box "glue-up" Tube Trap. It has a low-profile curved surface and mounts easily to any flat wall or ceiling. Like all Tube Traps, it comes inset with a midrange membrane diffusor panel. Excellent for the distributed acoustic technique. Our applications currently focus on high-intelligibility requirements and include coffered ceilings, room perimeter grids, the QSF™ (Quick Sound Field), vocal booth and teleconference rooms. **Basic Specifications & Suggested List Price:** Factory-sealed Sound Trap, absorptive to 200 Hz, 30% diffusive above 40 Hz (NRC .85). Its "speed bump" profile is 2-3/4" deep, 9" wide and 36" stock length. Custom length to 60". Glue up with Henry 137 acoustic tile adhesive or equivalent. Fabric is commercial-standard Guilford 701, fire retardant and available in 65 blends. The ends are squared, custom-order P/L angled or mitered. Retail \$21.12 per linear foot.

INSTRUMENT COVERS; 3468 Peck Ave. S.E.; Salem, OR 97302; (800) 274-4543; (503) 588-4001. Product Name: Acoustical/Isolation Piano Bag. **Contact:** Dennis O. Haley, owner. **Date Product Introduced:** 11/89. **Product Description & Applications:** Grand piano sound isolation bags built to assist in blocking out outside noise filtering toward the mics. Thereby, saving studio time and money costs. The bag is built with the lid in an upright position and there are mic slots built into the cover. The mics are secured in the slots by velcro that helps to keep them from being jostled and moved. **Basic Specifications & Suggested List Price:** All covers are custom built by us to your needs and not some preconceived one-size-fits-and-does-all notions. All covers are built to each make and model of grand pianos in the colors of your choice. The average cost varies from \$500 to \$700.

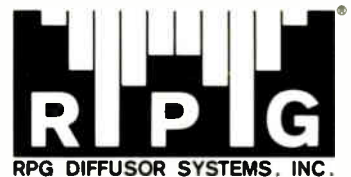

RPG DIFFUSOR SYSTEMS, INC.
Largo, MD

RPG DIFFUSOR SYSTEMS, INC.; 12003 Wimbleton St.; Largo, MD 20772; (301) 249-5647. **Product Name:** Diffractal™ **Contact:** Dr. Peter D'Antonio, pres./CEO. **Date Product Introduced:** 9/90. **Product Description & Applications:** The Diffractal, RPG's ultimate diffusor system, is the
—LISTING CONTINUED ON NEXT PAGE

ANNOUNCING THE RPG DIFFUSOR CEILING SYSTEM



Tent Records, London

OMNIFFUSOR™

The new 2-D QRD® diffusor is based on 2-dimensional number theory sequences which provide identical performance in the horizontal and vertical planes, for truly omnidirectional coverage.



RPG Diffusor Systems, Inc. 12003 Wimbleton Street, Largo, Maryland 20772

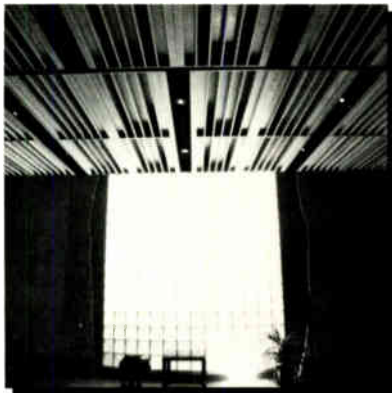

Rhinoceros Recording, Sydney

NEW ACOUSTICAL CEILING

Now you can have the low installation cost of lay-in ceiling panels and the broad-bandwidth sound diffusion only RPG can offer. Order the 1-D QRD® DIFFUSOR™ for controlled diffusion or the new 2-D QRD® OMNIFFUSOR™ for hemispherical coverage. Both panels are available in 2' x 2' and 2' x 4' standard suspended ceiling grid sizes.



WQXR, New York

APPLICATIONS

Choose QRD® diffusion to enhance music and traditional absorption to control noise in recording studios, live broadcast studios, rehearsal spaces, music education, band rooms, and performance facilities.

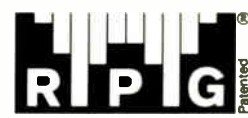

Phone 301-249-5647 Fax 301-249-3912

Listen to this...

A full 50-watt mosfet amplifier that mounts in a standard 19" rack, on a speaker stand, a mic stand, or the wall. The AN-1000 measures only 5 1/4 x 8 x 8 1/2" (HWD).

Standard on the unit is a 1/4" line level in. Options include balanced mic or line input, line out, and speaker out.



AN-1000



1-800/262-4671 * IN CA:213/533-5984

Circle #016 on Reader Service Card

1991 · NEW · PRODUCTS

ACOUSTICAL MATERIALS

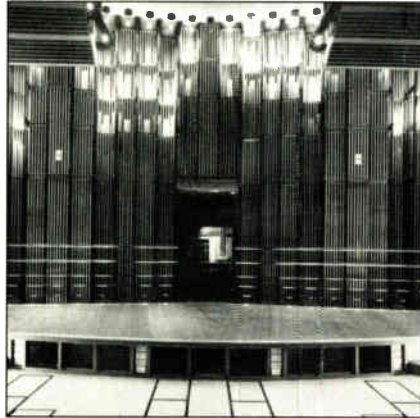

RPG DIFFUSOR SYSTEMS, INC.
Diffractal™

first full-spectrum 1 and 2 dimensional QRD™ fractal diffuser. The Diffractal takes advantage of the self-similarity property of fractals and consists of a high-frequency diffuser nested within a low-frequency diffuser. The aesthetic finish, bandwidth and cross-over frequency are personally designed by Dr. Peter D'Antonio, in collaboration with the client, acoustical consultant and architect for each project. Site installation for the new Diffractal is now simplified by assembling prefabricated sections. Photo: Peter Gabriel's Real World Studios, Bath. **Basic Specifications & Suggested List Price:** The Diffractal is custom designed to cover the entire rear wall of a critical listening or performance space and is a marriage between the most advanced acoustical designs and imaginative visual design decor. Installations include Peter Gabriel's Real World Studios, Bath; INXS' Rhinoceros Recording, Sydney; Winfield Sound, Toronto; and Crawford Post Production, Atlanta.

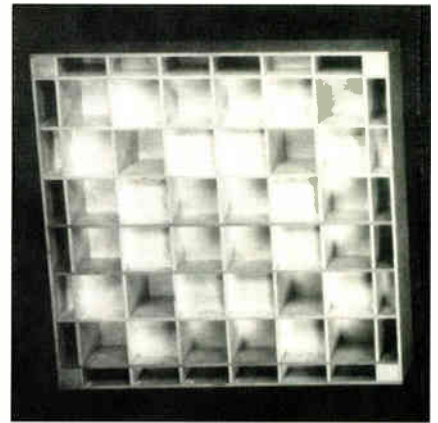

RPG DIFFUSOR SYSTEMS, INC.
Omnifusor™

Product Introduced: 4/90. **Product Description & Applications:** The Omnifusor is the first 2-dimensional broad-bandwidth QRD™ sound diffuser (Patent 306,764) that scatters incoming sound from any direction uniformly into a hemisphere. The Omnifusor consists of a symmetrical array of divided square cells, whose depths are based on 2-dimensional quadratic-residue number theory sequences which insure identical diffusion performance in the horizontal and vertical planes. The Omnifusor is available in a "female" egg-crate model (photo) and a "male" woodblock model. **Basic Specifications & Suggested List Price:** The Omnifusor is available in lightweight 2' x 2' and 2' x 4' panels, and 4" and 8" in depth, which can be easily clustered on a wall or used as lay-in tiles in standard ceiling grids. Standard and custom sizes and finishes are available. The Omnifusor will soon be available in custom translucent acrylics and applied with original and classic art prints.



RPG DIFFUSOR SYSTEMS, INC.
RPG Acoustical Ceiling

RPG DIFFUSOR SYSTEMS, INC.: 12003 Wimbleton St.; Largo, MD 20772; (301) 249-5647. **Product Name:** RPG Acoustical Ceiling. **Contact:** Dr. Peter D'Antonio, pres./CEO. **Date Product Introduced:** 4/90. **Product Description & Applications:** RPG Diffusor Systems has introduced a complete line of modular acoustical ceiling lay-in panels for standard suspended ceiling systems (Photo: Tent Records, London). The modules include a 1-dimensional QRD™ Diffractor™ for controlled diffusion, a 2-dimensional QRD Omnifusor™, in "female" egg-crate or "male" histogram formats, for uniform omnidirectional diffusion, an Abfusor® for broad-bandwidth absorption. The system can be used in any critical listening or performing environment. **Basic Specifications & Suggested List Price:** This new acoustical ceiling system provides the ease of lay-in ceiling panels and the broad-bandwidths sound diffusion and absorption only reflection phase gratings can offer. All panels are available in 2' x 2', 2' x 4' and 4' x 4' sizes in standard and custom finishes and thickness.

SYSTEMS DEVELOPMENT GROUP: 18601 Darnestown Rd.; Poolesville, MD 20837; (301) 972-7355. **Product Name:** Cutting Wedge Acoustic Tile. **Contact:** Skip Warrington, systems design. **Date Product Introduced:** 10/90. **Product Description & Applications:** The Cutting Wedge is a powerful attenuator for sound control and displays a 300% improvement in low-end attenuation over existing products. It is the only polyurethane foam with a class B-flame-spread rating. The tiles employ a patented anechoic-wedge design achieving a .70 NRC. Each tile is cut using a dustless saw with 1/8-inch tolerance. This provides the user with an economical alternative with superior performance. A class A foam material is also available. **Basic Specifications & Suggested List Price:** Sizes: 12-by-12 inches square, 24-by-48 inches and 24-by-105 inches. Thickness: 2, 3, 4 and 6 inches. Prices: 12-by-12-by-2 inches \$2.25, 12-by-12-by-3 inches \$3, 12-by-12-by-4 inches \$3.75.

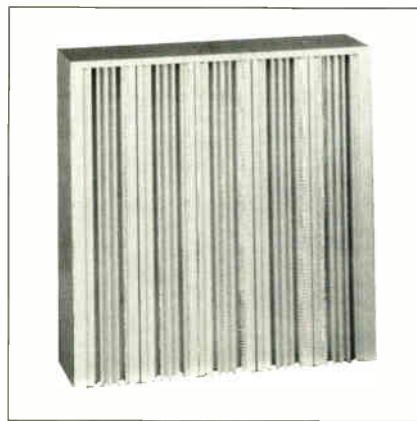

RPG DIFFUSOR SYSTEMS, INC.
Flutterfree™

RPG DIFFUSOR SYSTEMS, INC.: 12003 Wimbleton St.; Largo, MD 20772; (301) 249-5647. **Product Name:** Flutterfree™. **Contact:** Dr. Peter D'Antonio, pres./CEO. **Date Product Introduced:** 12/89. **Product Description & Applications:** Flutterfree is a non-absorbent, architectural, hardwood molding that eliminates flutter echoes and resonances, while maintaining a natural ambience. Flutterfree can be mounted directly to a wall or ceiling or spaced from a room boundary, where it is effectively used as a low-frequency Helmholtz absorber for modal control. Flutterfree is intended for use in any room with hard parallel walls, such as existing recording studios, teleconferencing and AV rooms, and post-production suites to minimize flutter without making the room "dead." **Basic Specifications & Suggested List Price:** Flutterfree panels are 4" wide and any length up to 4' long. Large wall or ceiling areas are easily covered by connected panels horizontally with provided splines and vertically with provided flowels for perfect alignment. Flutterfree is in stock and available in any hardwood unfinished, painted, stained or lacquered.

RPG DIFFUSOR SYSTEMS, INC.: 12003 Wimbleton St.; Largo, MD 20772; (301) 249-5647. **Product Name:** Omnifusor™. **Contact:** Dr. Peter D'Antonio, pres./CEO. **Date Product**

Careers in

Music
and
Video

BUSINESS



Enter the exciting and lucrative world of the entertainment industry! Learn the business and the technical aspects of music and video production from top professionals! A two year degree program. Check the choice of school location below.

CALL OR WRITE: 1-800-424-2800

- Atlanta Seattle Colorado Philadelphia
 Dallas Houston Pittsburgh Ft. Lauderdale

YES, I would like information about your Programs!

NAME _____ YR H S GRAD _____

ADDRESS _____

CITY _____ STATE _____ ZIP _____

PHONE _____ SC49MX

Ai THE ART INSTITUTES
International

526 Penn Avenue, Pittsburgh, Pennsylvania 15222, USA

Circle #017 on Reader Service Card

AMPLIFIERS



AB INTERNATIONAL ELECTRONICS, INC.
Model 1200 Power Amplifier

AB INTERNATIONAL ELECTRONICS, INC.; Box 1105, 1830-6 Vernon St.; Roseville, CA 95678; (916) 783-7800. Product Name: Model 1200 Power Amplifier. Contact: Robert Bird, Irwin Laskey. Date Product Introduced: 6/90. Product Description & Applications: 2-channel audio power amplifier, 3 rackspaces tall, featuring removable drawer modules. Special features: each channel contains a selectable variable peak limiter or "soft clip" feature. Each channel contains a switchable high-pass filter. Basic Specifications & Suggested List Price: The 1200 will deliver 1,800 watts each channel into 2 ohms, 1,400 watts into 4 ohms and 800 watts into 8 ohms each channel. Suggested retail: \$2,495.



AB INTERNATIONAL ELECTRONICS, INC.
Model 200 Power Amplifier

AB INTERNATIONAL ELECTRONICS, INC.; Box 1105, 1830-6 Vernon St.; Roseville, CA 95678; (916) 783-7800. Product Name: Model 200 Power Amplifier. Contact: Robert Bird, Irwin Laskey. Date Product Introduced: 6/90. Product Description & Applications: 2-channel, one-rack power amplifier features built-in balanced input circuitry, bridge mode capability and panel-mounted headphone jacks. Basic Specifications & Suggested List Price: The 200 will deliver 75 watts per channel into 8 ohms, 100 watts per channel into 4 ohms and 180 watts mono (bridge) into a single 8-ohm load. Suggested retail: \$499.

ATI—AUDIO TECHNOLOGIES, INC.; 328 W. Maple Ave.; Horsham, PA 19044; (215) 443-0330; FAX: (215) 443-0394. Product Name: Mike Amplifiers. Contact: Ed Mullin, VP. Date

Product Introduced: Spring 90. Product Description & Applications: Mico Ultimike Amplifier for "onstage" operation in high electrical noise. Has wide dynamic range, 148V phantom power, limiter, low-cut, phase and remote DC gain. MMA 400, MMA 800 4 or 8 individual mic to line amps, which can be jumped for use as distribution, sum, difference amps or as a press box. 84 dB gain MLA400, MLA800 4 or 8 individual line to line amps with jumper capabilities, 42 dB gain. Balanced in and out, one-rack unit. Basic Specifications & Suggested List Price: M100; noise -128 dBm, max input 0 dBu/+20 dBu, gain 74 dB/54 dB, THD .1% 20-20,000 Hz, Response to -25 dB 20-20,000 Hz, Price \$329 list. MMA and MLA 400/800 THD .25% 20-20,000 Hz, response +/-25 dB 20-20 k Hz, noise; MLA -92 dBm IN, MMA -120 dBm EIN. Price from \$349.

AUDIO CENTRON; 1400 Ferguson; St. Louis, MO 63133; (314) 727-4512. Product Name: RMA 1600. Contact: Tony Moscal, product manager. Date Product Introduced: 4/90. Product Description & Applications: Stereo 400-watt per side at 4 ohms, 800 watts mono bridged at 8 ohms. XLR and 1/4" balanced inputs; auto 2 speed fan, internal limiters; full diagnostic lights; complete protective circuitry. 1/4" and 5-way bind post outputs. Basic Specifications & Suggested List Price: \$800 with a 5-year transferable warranty.

AUDIO SERVICES & DESIGN/TECHSTAR; 475 Metroplex Dr., Ste. 505-B; Nashville, TN 37211; (615) 832-6032; (615) 242-2925. Product Name: MO ME. Contact: Mike Bross, Dave Wilkerson—owners. Date Product Introduced: 7/90. Product Description & Applications: A mixer and high-quality headphone amplifier combination. Capable of driving headphones to very high levels. Intended to solve the problem of players not hearing themselves in the cue mix. Separate controls for the players' instrument/track and the cue mix. Additional inputs available upon request, all custom-labeled. Basic Specifications & Suggested List Price: 120 dB with 50-ohm headphones. Two sets of stereo input standard. Single rack-space. Custom configurations available at additional \$25 per stereo input. Basic unit list—\$400.

AUSTRALIAN MONITOR (PTY) LTD.; 53 College St.; Gladesville, NSW 2111 Australia; (61) 2-816-3544; FAX: (61) 2-817-4303. Product Name: Australian Monitor 1K2 and K7. Contact: Hymie Meyerson, export consultant. Date Product Introduced: 1/91. Product Description & Applications: MOSFET power amplifiers housed in a 2-rack unit (3-1/2") over engineered alloy chassis. Featuring: continuously available high current supplies, toroidal mains transformer, efficient dual 2-speed front to back cooling for continuous use in high ambient temperatures, balanced inputs, buffered 21-pos attenuator, bridged operation, thermal-short-input overload-mains impact protection, and loads more. For general sound reinforcement, installation and monitoring. Basic Specifications & Suggested List Price: P.O.A. K7: 350+350 watts @ 4 ohms (F.T.C.). 1K2: 550+550 watts @ 4 ohms (F.T.C.). @ less than 0.05% T.H.D. -20 Hz to 20 k Hz, 1 watt to full power. @ less than 0.015% I.M.D. (SMPTE) 1 watt to full power. Response: 20 Hz to 20 k Hz <0.2 dB. Rise time <3 ms.

AUSTRALIAN MONITOR (PTY) LTD.; 53 College St.; Gladesville, NSW 2111 Australia; (61) 2-816-3544; FAX: (61) 2-817-4303. Product Name: K7 Professional and K2 Professional. Contact: Hymie Meyerson, export consultant. Date Product Introduced: 1/91. Product Description & Applications: MOSFET power amplifiers as per 1K2 and K7 but featuring J-FET input, regulated drive circuit supplies, facility for plug in signal modifiers such as active filters, limiters, load transfer enhancement, etc. Full front panel display of amplifier status. A host of features and protection. For use in high-end sound reinforcement and installation and reference quality monitoring.

BGW SYSTEMS, INC.; 13130 Yukon Ave.; Hawthorne, CA 90250; (213) 973-8090. Product Name: BGW Model 200. Contact: Brian Wachner, president. Date Product Introduced: 6/90. Product Description & Applications: The BGW Model 200 is a compact, 1-3/4" high power audio amplifier capable of delivering 100 watts per channel into 8 ohms, or 200 watts into a 16 ohms, monaural load. The all-discrete circuitry features BGW's Ultracase™ output devices. Its ther-

mally efficient, all-aluminum chassis and large deep-fin heat sinks efficiently conduct and dissipate heat, allowing the Model 200 to sustain these high power levels. This unit utilizes convection cooling, and is suitable for installation where quiet operation is important or maintenance is difficult. Quiet Specifications & Suggested List Price: Suggested list price: \$999. Total output power: 215 watts. Intermodulation distortion: less than 0.02%. Damping factor: greater than 400:1. Optional input transformer are available.

BGW SYSTEMS, INC.; 13130 Yukon Ave.; Hawthorne, CA 90250; (213) 973-8090. Product Name: BGW Model 6500T. Contact: Brian Wachner, president. Date Product Introduced: 7/90. Product Description & Applications: The BGW Model 6500T is an economical dual-channel, 100-watt direct-coupled 70-volt (or 100-volt) commercial power amplifier, with a bridging switch for high-power single-channel operation. Advanced hybrid circuitry is used for low parts count and compact packaging—this model requires only two rackspaces. The rear panel provides the contractor with reliable and simple terminations for inputs and outputs, using 7/16" six terminal barrier strips. Additional 1/4" phone jack inputs are provided. Basic Specifications & Suggested List Price: Suggested retail price: \$599. Total output power: 300 watts. Intermodulation distortion: less than 0.06%. Damping factor: greater than 200:1 at 8 ohms and 500 Hz. Optional precision stepped attenuators, output auto-transformers, input transformers and crossover are available.

BOULDER AMPLIFIERS; 4850 Sterling Dr.; Boulder, CO 80301; (303) 449-8220. Product Name: Boulder L3AE Pre-amplifier. Contact: Marv Farley, nat'l salesman. Date Product Introduced: 1/90. Product Description & Applications: Discrete amplification stage, line-level preamplifier, gold-plated RCA and 3-pin connectors. Low source impedance for driving long interconnect cables to power amp. Basic Specifications & Suggested List Price: \$1,299 list, max output level: 12 volts RMS; TAD at 2V output: 20 Hz-2 k Hz +0.0025%, at 20 kHz 0.005%; max voltage gain: line inputs 13 dB, phono inputs 59 dB; magnitude response: 20-20 k Hz =0.00, -0.5 dB, -3 dB at 0.15 Hz, 200 kHz; input imped: line level 20k ohms; output imped: unbalanced 50 ohms, balanced 100 ohms.

BRYSTON; 979 Franklin Ln.; Maple Glen, PA 19002; (800) 673-7899; FAX: (212) 678-2970. Product Name: Bryston 8W Incremental Amp. Contact: Martin Bartelstone, VP. Date Product Introduced: 11/90. Product Description & Applications: 8 x 50 watt channels. 70 volt or 8 ohm models. Channels may also be used in either bridged or parallel configurations. Onboard microprocessing for remote gain and preset channel gain. Onboard preamp for mic or other low level inputs. 20-year warranty.

BRYSTON; 979 Franklin Ln.; Maple Glen, PA 19002; (800) 673-7899; FAX: (212) 678-2970. Product Name: Bryston New 6B. Contact: Martin Bartelstone, VP. Date Product Introduced: 8/90. Product Description & Applications: Mono 800-watt power amplifier. Ultra-low distortion design high current capacity 60 ampere peak in bridge up to 120 amps in parallel mode. Used for all high-power monitor applications. No fans. 20-year warranty. Basic Specifications & Suggested List Price: 500 watts mono into 2 or 8 ohms. 800 watts mono into 1 or 4 ohms. Less than .01% distortion from 20-20 k Hz at 500 watts IM or THD. IM less than .0009%. Slew: 60 volts/microsecond parallel; 120 in bridge.

CARVER CORPORATION; 20121 48th Ave. W.; Lynnwood, WA 98046; (206) 775-1202. Product Name: PT 1800. Contact: Steve Payne, nat'l sales mgr. Date Product Introduced: 6/90. Product Description & Applications: Lightweight, ultra-high power, fully modular stereo power amplifier. This amplifier is designed for any application that requires extended high power output capability under conditions that require absolute reliability, for example, touring sound reinforcement systems and fixed installations. Basic Specifications & Suggested List Price: Power output: 900 watts per channel at 4 ohms, 600 watts per channel at 8 ohms, 1,800 watts bridged mono at 8 ohms. All power output figures rated 20 Hz-20 k Hz with no more than .5% THD, .1% IM. Weight 40 lbs. Suggested retail is less than \$2,000.

CARVER CORPORATION; 20121 48th Ave. W.; Lynnwood, WA 98046; (206) 775-1202. Product Name: PT 2400. Contact: Steve Payne, nat'l sales mgr. Date Product Introduced: 9/90. Product Description & Applications: Lightweight, ultra high power, fully modular stereo power amplifier. This amplifier is designed for any application that requires absolute reliability for example, touring sound reinforcement systems and fixed installations. Basic Specifications & Suggested List Price: Power output: 1,200 watts per channel at 4 ohms, 750 watts per channel at 8 ohms, 2,400 watts bridged mono at 8 ohms. All power output figures rated 20 Hz-20 k Hz with no more than .5% THD, .1% IM. Weight 45 lbs. Suggested retail: less than \$3,000.

CROWN; PO Box 1000; Elkhart, IN 46515-1000; (219) 294-8000. Product Name: Macro Reference. Contact: Gerry Barclay. Date Product Introduced: 10/90. Product Description & Applications: High excursion, 20-bit digital range, ultimately damped, reference amplifier; multiple available plug-in input configuration; grounded bridge circuitry; ODEP protection; ODEP, IOC, SPI indicators; front panel level controls;

—LISTING CONTINUED ON NEXT PAGE

IF YOU THINK POWER AMPLIFIERS GET OLD, YOU DON'T OWN A BRYSTON.



How long do you expect a professional power amplifier to last? Three years? Six? Brystons are expected to perform flawlessly for at least 20 years—the term of our warranty on all professional products. Within that period, if your Bryston develops any problem not caused by improper operation, we will provide the solution.



20 years of unlimited service. The only people who aren't amazed at this kind of support are Bryston owners. They know how rarely it's needed. In fact, many of them have gone fifteen years without a single problem. Perhaps that's because Bryston engineers don't think age is a reason for an amplifier to malfunction.



That means paying strict attention to every component, then spending an entire day building each Bryston power amplifier, crossover or preamplifier. After assembly, every Bryston product must endure a 100 hour burn-in period before it's complete.



Is all this attention excessive? Hardly, considering the length of time your Bryston will last. Besides, we don't

think an amplifier's performance and reliability should be compromised because its manufacturer was willing to make compromises. Even if they were made 20 years ago.

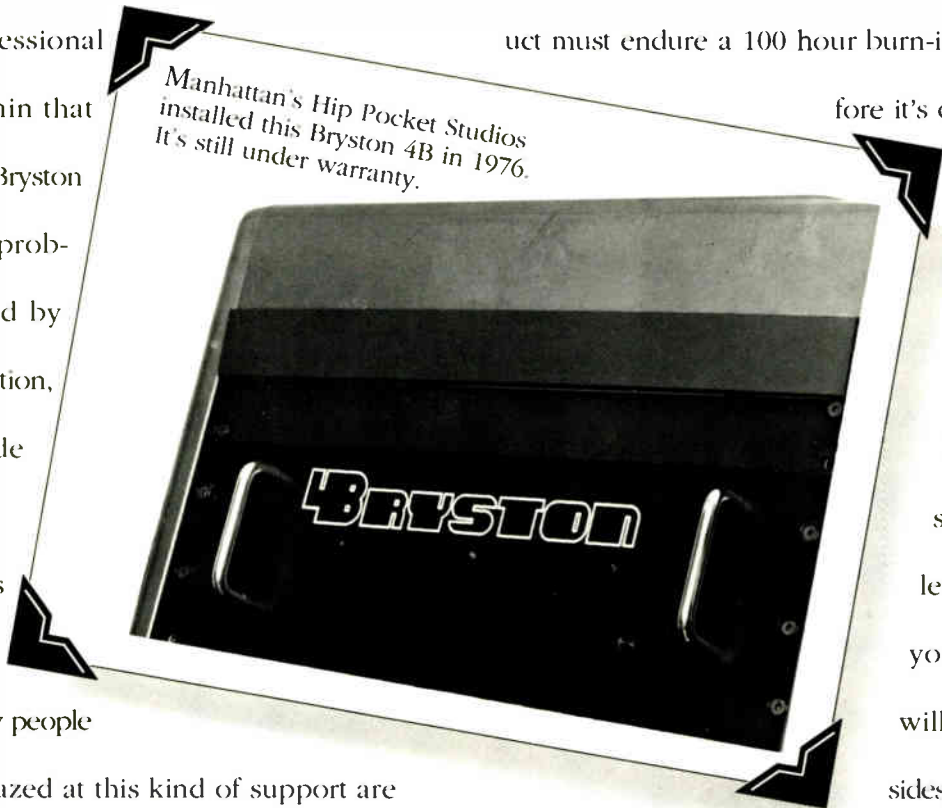

Manhattan's Hip Pocket Studios installed this Bryston 4B in 1976. It's still under warranty.



Bryston Marketing Ltd.
Tel: (416) 746-0300 Fax: (416) 746-0308
U.S. Distribution: Brystonvermont Ltd.
Tel: (800) 673-7899 Fax: (215) 628-2970



AMPLIFIERS

—LISTING CONTINUED FROM PREVIOUS PAGE

2 input sensitivities; ground isolation switch; convection cooling with on-demand variable speed forced air assistance. **Basic Specifications & Suggested List Price:** Bandwidth 3 Hz to 100,000 Hz damping > 200,000 10 Hz to 400 Hz into 8 ohms, 19 x 7 x 16", 62 lbs.

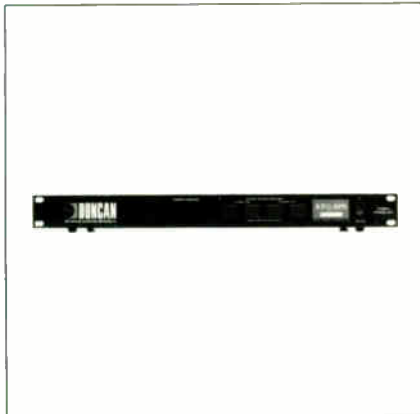

SEYMOUR DUNCAN RESEARCH
KTG-2075 Stereo Power Amp

SEYMOUR DUNCAN RESEARCH; 601 Pine Ave.; Santa Barbara, CA 93117; (805) 964-9749. Product Name: KTG-2075 stereo power amp. **Contact:** Cathy Duncan, marketing manager. **Date Product Introduced:** 1/90. **Product Description & Applications:** The KTG-2075 is a single rackspace power amp featuring 75 watts per channel into 8 ohms. Its low feedback design makes it the ideal power amp for guitar and other instruments. Distortion is predominantly low-order, producing a warm sound. This amp uses a toroidal transformer to prevent radiated hum from affecting surrounding equipment. **Basic Specifications & Suggested List Price:** One rackspace, 75W per channel into 8 ohms, THD, 12% at 1 kHz, less than or equal to 110 dB signal to noise, IMD SMPTE .15% into 8 ohms, freq response 15 Hz-50 kHz (-3 dB +0 dB), input impedance 30k, input sensitivity 0.80V. \$575 suggested list.

SEYMOUR DUNCAN RESEARCH; 601 Pine Ave.; Santa Barbara, CA 93117; (805) 964-9749. Product Name: KTG-2100 tube stereo power amp. **Contact:** Cathy Duncan, marketing manager. **Date Product Introduced:** 6/90. **Product Description & Applications:** The KTG-2100 is a 2 rackspace tube stereo power amp using 4 KT-88 tubes to produce 100 watts per channel. It has a volume, presence and dynamics controls for each channel giving musicians unparalleled control over its tone and feel. Forced air fan cooled and heavy 16 gauge steel chassis make this a rugged, road-worthy amp. Signal to noise ratio less than 110 dB. **Basic Specifications & Suggested List Price:** 2 rackspace, 100W into 4.8 or 16 ohm at 5%, THD at 1V -.08%, hum and noise -110 dB.

DYNACORD®; 10500 W. Reno, PO Box 26105; Oklahoma City, OK 73126-0105; (818) 350-4970; FAX: (818) 444-1342. Product Name: PCA 2544 4-channel processor-controlled amplifier. **Contact:** John Parker, nat'l sales manager. **Date Product Introduced:** 1/90. **Product Description & Applications:** 4-channel power amplifier featuring an adjustable 2-way stereo, 3-way mono and monitor or 4-way switchable second-order Linkwitz/Riley crossover permitting configuration of active multiway systems without the need for external crossovers. Allocation of power amplifiers to crossover outputs can be freely selected by means of the power routing facility. With the PCA 2544 Dynacord offers the care of processor-controlled P.A. systems that can be connected to all the professional loudspeaker units available on the market. **Basic Specifications & Suggested List Price:** Signal-to-noise ratio (A, RMS) >101, 4 x 500W RMS/4 ohms, bridged mode: 2 x 1,000 with 8 ohms input impedance, 3-way power supply, dynamic signal processing. Slewrate >100 V/μsec., thermal brain circuit adjustable, risetime <2 msec., min. load impedance 352. List price \$7,020.

FURMAN SOUND, INC.; 30 Rich St.; Greenbrae, CA 94904; (415) 927-1225. Product Name: SP-20 Stereo Power Amplifier. **Contact:** Joe Desmond, national sales mgr. **Date Product Introduced:** 5/90. **Product Description & Applications:** The SP-20 is a compact HR (half-rack) 20 watts per channel stereo power amp. It may be switched for stereo, dual-channel mono or bridged 40-watt mono operation. It includes a stereo input level control and signal present and overload

LEDs for each channel. It also features a headphone output with its own volume control and speaker mute switch. If desired, the SP-20 can be used as a multistation headphone amp by connecting a chain of HR-2 remote stations. **Basic Specifications & Suggested List Price:** THD .01% at full rated output at 1 kHz, and .05% from 20 Hz to 20 kHz. Fully protected against short circuits and thermal overload. Available with optional XLR balanced inputs as model SP-20B. Suggested list prices: SP-20, \$289; SP-20B, \$309. A rack-mounting kit usable on any HR product is available as model HRKIT-2.

HAFLER; 613 S. Rockford Dr.; Tempe, AZ 85281; (800) 366-2349. Product Name: Pro 1200. **Contact:** Dan McLeod, sales mgr. **Date Product Introduced:** 7/90. **Product Description & Applications:** The amp employs a sonically proven circuit topology driving MOSFET output devices. Consequently, the PRO 1200 is capable of delivering high current into low impedance loads, and generally the amplifier will not be damaged in the case of accidental short circuit at the output. The drive circuitry is a simple and effective arrangement using high-quality components to ensure longevity and above all, sonic excellence. **Basic Specifications & Suggested List Price:** 60 watts per channel into 8 ohms from 20 Hz to 20 kHz at less than 0.01% THD with both channel drives. IM distortion (IHF): less than 0.005% signal to noise => 100 dB (60 watts 8 ohms). \$500.

HAFLER; 613 S. Rockford Dr.; Tempe, AZ 85281; (800) 366-2349. Product Name: Pro 2400. **Contact:** Dan McLeod, sales mgr. **Date Product Introduced:** 7/90. **Product Description & Applications:** The amp employs a sonically proven circuit topology driving MOSFET output devices. Consequently, the Pro 2400 is capable of delivering high current into low impedance loads, and generally, the amplifier will not be damaged in the case of accidental short circuit at the output. The drive circuitry is a simple and effective arrangement using high-quality components to ensure longevity and, above all, sonic excellence. **Basic Specifications & Suggested List Price:** 120 watts per channel into 8 ohms from 20 Hz to 20 kHz at less than 0.01% THD with both channels driven. IM distortion (IHF): less than 0.05%. Signal to noise 7,100 dB (120 watts 8 ohms). \$630.

HOT HOUSE PROFESSIONAL AUDIO; 275 Martin Ave.; Highland, NY 12528; (914) 691-6077; FAX: (914) 691-6822. Product Name: M500 Mono High Current Control Room Amplifier. **Contact:** Richard Rose, pres. **Date Product Introduced:** 11/89. **Product Description & Applications:** The M500 mono block has been designed to offer the ultimate in smooth, extended bandwidth for the most advanced audiophile monitoring possible and control room subwoofer applications. Utilizing the same 12 100-watt MOSFET output de-

—LISTING CONTINUED ON NEXT PAGE

Put *Just* the Control at Your Fingertips

Power amplifiers should be heard — not seen!

The remote gain capability of the TTD-200 40W Dual Power Amplifier allows you to *rack* the amplifier—console space is then made available for other equipment, heat is reduced, and the need to run audio into the console is eliminated.

Two wires and a pot are all you require to control the level to your speakers. Multiple amplifiers can be controlled by a single pot.

The TTD-200 also features virtually indestructible 150W power op-amps which provide 100% protection against short circuits, over-voltage, and excess temperatures.*

The TTD-200 will drive both channels at 60 Watts into 4 ohms and the mono-bridge mode will produce 120W into 8 ohms. The differential, instrumentation type input stage allows balanced or unbalanced inputs without loss of signal level.

The TTD-200 is new and innovative. Call for an Applications Note.



*Would you short the output of your present amplifier at max output power and expect it to survive? We'll provide the extra fuse so you can do it to the TTD-200.

TARGET TECHNOLOGY, INC.
P.O. Box 609, Penn Valley, CA 95946
FAX: 916-639-2212
TEL: 916-639-2102

AMPLIFIERS

—LISTING CONTINUED FROM PREVIOUS PAGE

vices and high-current power supply as the S400, a different approach to the front end design has yielded a slightly warmer, less aggressive presentation, emulating the "Esoteric Tube Sound," with an enhanced and truly astounding deep bass response. **Basic Specifications & Suggested List Price:** S/N: 105 dB, THD: .01%, frequency response 5 Hz to 210 kHz, rise time: 900 nanoseconds, slew rate: 60 volts per microsecond, maximum peak current capability: 80 amperes, RMS power output (not including 3 dB dynamic headroom): 8 ohm/150 watts, 4 ohm/275 watts, 2 ohm/450 watts. Professional user net price: \$1,399.

HOT HOUSE PROFESSIONAL AUDIO; 275 Martin Ave., Highland, NY 12528; (914) 691-6077; FAX: (914) 691-6822. Product Name: S400 Stereo High Current Control Room Amplifier. **Contact:** Richard Rose, pres. **Date Product Introduced:** 10/89. **Product Description & Applications:** Designed to fill the gap between high-power commercial amplifiers and high-fidelity audiophile units, the S400 is the first amplifier brought to market expressly for studio control room applications. With its fully discrete high-speed front end, class A voltage gain stage and constant current bias network, along with its enormous power supply capability and complete lack of global feedback, the S400 is the perfect match for the latest generation of advanced high-quality nearfield monitors. **Basic Specifications & Suggested List Price:** S/N: 105 dB, THD: .01%, frequency response: 5 Hz to 350 kHz, rise time: <2 microseconds, slew rate: 60 volts per microsecond, maximum peak current capability: 45 amperes/channel, RMS power output (not including 3 dB dynamic headroom): 8 ohm/100 watts, 4 ohm/200 watts, mono 8 ohm/400 watts. Professional user net price: \$1,399.



HOT HOUSE PROFESSIONAL AUDIO
S400 Stereo High Current Control Room Amplifier

INKEL P.A. IMPORTED BY MAXITRON CORP.; 13431 Pumice St., Norwalk, CA 90650; (213) 802-9942; (213) 802-9643; FAX: (213) 802-9945. Product Name: MA-320, 420, 620, 920 Professional Power Amplifiers. **Contact:** Inv Weisman, nat'l sales mgr. **Date Product Introduced:** 6/89. **Product Description & Applications:** Inkel P.A. professional power amplifiers are built for touring and fixed sound applications. These amps feature massive heat sinks for efficient cooling and high reliability, rugged construction, electronically balanced XLR inputs and 1/4" phone plug high 2 inputs, mono bridge switch, ground lift switch, front panel mounted output level controls and LED clip indicators, MA-320, 420 are two rackspaces high and 620, 920 are three spaces. MA-920 features thermal switched forced air cooling. **Basic Specifications & Suggested List Price:** MA-320 \$549, MA-420 \$649, MA-620 \$799, MA-920 \$975. MA-320 75 WPC @ 8 ohms, @ .01% THD, MA-420 130 WPC @ 8 ohms @ .01% THD, MA-620 230 WPC @ 8 ohms @ .01% THD, MA-920 300 WPC @ 8 ohms @ .01% THD. Signal-to-noise on all models: -110 dB below rated output. This series of amps features a low distortion, low noise design that is extremely reliable under adverse operating conditions.

QSC AUDIO PRODUCTS, INC.; 1926 Placentia Ave., Costa Mesa, CA 92627; (714) 645-2540. Product Name: EX 4000. **Contact:** Greg McVeigh, dir. of marketing. **Date Product Introduced:** 7/90. **Product Description & Applications:** The EX 4000 is a sophisticated, high-efficiency power amplifier that incorporates enhanced features into a low-cost chassis. It weighs 64 lbs., occupies 3 rackspaces, and is fan-cooled with a variable speed fan. Key features include 3 step output circular dual mono configuration, built-in limiting, open input architecture, detented gain controls. Speakon and 5-way binding post output speaker connectors, and an advanced thermal management system. **Basic Specifications & Suggested List Price:** Output power per channel: 8 ohms, 720 watts; 4 ohms, 1,100 watts; 2 ohms, 1,400 watt +/- 1 dB. Output power bridged mono: 8 ohms, 2,200 watts; 4 ohms, 2,800 watts/-1 dB. List price: \$1,998.

ROLLS CORPORATION; 7023 S. 400 W.; Salt Lake City, UT 84047; (801) 562-5628. Product Name: HR250 Stereo Amplifier. **Date Product Introduced:** 7/90. **Product Description & Applications:** The Rolls HR250 is a stereo 50-watt-per-channel general purpose power amplifier in the 1/2 rack standard format. It features all MOSFET design, 8-ohm LED power meters and a very compact size. It has balanced inputs and is easily bridged. **Basic Specifications & Suggested List Price:** Output power: 50 watts; RMS/channel—S/N ratio >90 dB. THD (SMPTTE): .03%—input connectors RCA and 1/4" output connectors: 1/4" and 5-way.

SOUNDTECH; 230 Lexington Dr.; Buffalo Grove, IL 60089; (708) 541-3520. Product Name: PL1000MP Stereo/Quad Power Amplifier. **Contact:** Todd Peden, field sales director. **Date Product Introduced:** 1/90. **Product Description & Applications:** A multi function power amp featuring quad operation at 250 watts per channel, stereo occupying only 2 rack spaces. The PL1000MP is ideally suited to bi-amp, tri-amp, or zoning installations. The PL1000MP is a real workhorse featuring twin semi-toroidal power supplies and twin variable speed cooling fans. **Basic Specifications & Suggested List Price:** \$1099.90. 4 x 250 watts at 4 ohms, 2 x 500 watts at 8 ohms both channels bridged. Frequency response 15 Hz-30 kHz THD at full rated output .007%. H/N -83 dB, S/N -108 dB. Slew rate 45V/NS. Damping factor 300:1 at 8 ohms.

SOUNDTECH; 230 Lexington Dr.; Buffalo Grove, IL 60089; (708) 541-3520. Product Name: PL150 Stereo Power Amplifier. **Contact:** Todd Peden, field sales director. **Date Product**

Case Component Network

Hardware **J.H. Sessions & Son**
from: **Simmons Fastener Corp.**
Trans-Canada Hardware
and others

CASE AND CABINET HARDWARE

IMMEDIATE DELIVERY ON HUNDREDS OF PRODUCTS:

- handles & catches
- steel & plastic corners
- casters
- rack hardware
- speaker grilles
- metal & rubber feet
- clamps
- hinges & lid stays
- aluminum & plastic extrusions: tongue, groove, angle, lidmakers
- carpet & vinyl coverings
- grille cloth
- abs plastic

CALL FOR FREE CATALOG!

3 STOCKING DISTRIBUTOR LOCATIONS

UMBRA USA, Inc.
Gateway Metroport, Gate 1
1951 Hamburg Turnpike Dept. MX, Lackawanna NY 14218
(800) 387-5122
FAX (416) 299-6168
Mon-Fri 9:00 AM - 6:00 PM E.S.T.
ask for **HARDWARE DIVISION**

MDS / MUSIC DEALER SERVICE
4700 W. Fullerton Dept. MX, Chicago IL 60639
(800) 722-3027 (outside Illinois)
(800) 572-7779 (in Illinois)
FAX (312) 772-6586
Mon-Fri 9:30 AM - 6:00 PM C.S.T.
ask for **SALES DEPARTMENT**

EL-COM / Cabletek
An ELROB Company
2630 Shannon Street Dept. MX, Santa Ana CA 92704
(714) 432-6630 (outside California)
(800) 225-7388 (in California)
FAX (714) 556-0468
Mon-Fri 8:00 AM - 5:00 PM P.S.T.

Introduced: 1/90. **Product Description & Applications:** A 150 watt stereo power amp in a 1 rack space cabinet suited to studio monitor and other low power applications. The PL150 can be compact size and impressive specs make the PL150 an ideal choice. Input are XLR or 1/4". Outputs are 5-way binding post. **Basic Specifications & Suggested List Price:** \$399.90. 2 x 75 watts at 4 ohms, 2 x 55 watts at 8 ohms, 150 watts at 8 ohms mono-bridge mode. Frequency response 15 Hz-30 k Hz THD at full rated output .007%. H/N -90 dB. Slew rate 25V/NS. Damping factor 200 at 8 ohms.

STEWART ELECTRONICS CORP.; 11460 Sunrise Gold Cir. B; Rancho Cordova, CA 95742; (916) 635-3011. **Product Name:** PA500. **Contact:** Bob Hershenow, cust. service. **Date Product Introduced:** 100. **Product Description & Applications:** Two rackspace dual mono amplifier delivers 250 watts per channel into 8 ohms, 600 watts per channel into 2 ohms. Features Stewart's state-of-the-art switching power supply and short-circuit protection. **Basic Specifications & Suggested List Price:** Dual monoaural design, bridgable to mono. 250 watts x 2 at 8 ohms; 800 watts x 1 at 8 ohms; 600 watts x 2 at 2 ohms, 1,200 watts x 1 at 4 ohms. THD <0.1% 20 Hz-20 k Hz. Weight <18 lbs. Dimensions (in): 19W x 3.5H x 10.5D.

TARGET TECHNOLOGY, INC.; PO Box 609; Penn Valley, CA 95946; (916) 639-2102. **Product Name:** TTD-200 Studio Amp. **Contact:** Peter Hughes. **Date Product Introduced:** 1/90. **Product Description & Applications:** The TTD-200 is two separate and independent 40W (8 ohm) amplifiers each with its own voltage control gain cell in a 1RU package. For stereo operation, a single pot will control both amplifiers, either locally or remotely. The amplifier can also be bridged for mono 120W operation. Available in 3 versions: Local control only, remote control only, and local and remote control. **Basic Specifications & Suggested List Price:** Balanced or unbalanced input stages, extremely low CMRR, THD less than 0.1% at maximum output from 20 Hz to 20 k Hz, response within .1 dB from 20 Hz to 20 k Hz, at maximum level. 40W RMS at 8 ohms, 60W at 4 ohms, 120W in bridge mode.

UREI; 8500 Balboa Blvd.; Northridge, CA 91329; (818) 893-8411. **Product Name:** ES Series Power Amplifiers. **Contact:** Mark Gander, vice president, mktg. **Date Product Introduced:** 4/90. **Product Description & Applications:** Computer-aided design to meet the needs of the engineered sound contractor, the ES Series Amplifiers feature reduced weight, compact size, reliable componentry and exceptionally clean performance. A variable-speed fan drawn filtered cooling air in from the rear, which is exhausted at the front of the case. The sides, top and front of the amplifiers are one piece, allowing quick internal access. Individual channels lift out of the internal chassis as single units, allowing rapid field replacement. **Basic Specifications & Suggested List Price:** ES150: 75W, 4 ohm/channel, 50W, 8 ohm/channel; ES300: 150W, 4 ohm/channel, 90W, 8 ohm/channel; ES600: 300W, 4 ohm/channel, 190W, 8 ohm/channel; ES90: 450W, 4 ohm/channel, 300W, 8 ohm/channel; ES1200: 600W, 4 ohm/channel, 360W, 8 ohm/channel.



UREI
SR Series Power Amplifier

UREI; 8500 Balboa Blvd.; Northridge, CA 91329; (818) 893-8411. **Product Name:** SR Series Power Amplifier. **Contact:** Mark Gander, vice president, mktg. **Date Product Introduced:** 1/90. **Product Description & Applications:** Employing UREI's proven low feedback, low distortion design philosophy for highest quality sound, the SR Series Amplifiers are ideally suited for musical instrument and sound reinforcement applications. Conveniently wrapped in a small, road-worthy, force air-cooled two-rackspace package, the SR Series Amplifiers were designed to have filtered cooling air drawn in from the rear and exhausted at the front of the case. With no vent holes on the top of the case, potential damage from debris falling into the amplifier is eliminated. **Basic Specifications & Suggested List Price:** SR6615: 150 watts 4 ohm/channel, 90 watts 8 ohm/channel; SR6630: 300 watts 4 ohm/channel, 190 watts 8 ohm/channel; SR6650: 500 watts 4 ohm/channel, 300 watts 8 ohm/channel.

**No bells, no whistles, no flashing lights...
no fans, no pots, no meters, no chips, no handles
no circuit breakers, no trick power supplies
no global feedback, no mass-production
no short cuts
no voodoo**



**Nothing but
the truth**

**Extending from five hertz to beyond 300 kilohertz
with lightning speed and high current capability
there are no details too fine to resolve
no transients too dynamic to capture
no blanket on the sound
no competition exists**



275 Martin Avenue Highland, N.Y. 12528
TEL 914-691-6077 FAX 914-691-6822

Circle #012 on Reader Service Card



Australian Monitor

AVAILABLE IN 1600 WATTS 1000 WATTS 1200 WATTS QUAD. 4 CHANNEL	Mosfet power amplifiers	TWO NEW MODELS 1K2 — 1200 WATTS K7 — 700 WATTS AVAILABLE SOON
--	--	--

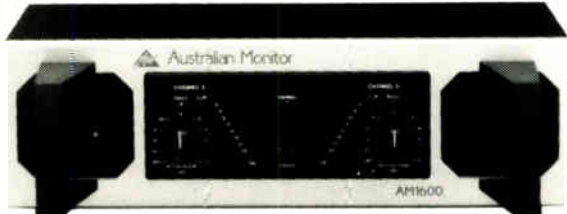

AUSTRALIAN MONITOR IS DESIGNED AND MANUFACTURED BY:
AUSTRALIAN MONITOR PTY. LTD., 53 COLLEGE STREET, GLADESVILLE, NSW 2111, AUSTRALIA
TELEPHONE: 61-2-8163544 Fax: 61-2-8174303

Enquiries

USA	Australian Monitor USA MOSFET POWER AMPLIFIERS Tel: (213) 697-7576 Fax: (213) 691-9146	CANADA	AUDIO CONCEPT Tel: (514) 527-8366 Fax: (514) 525-5949
------------	---	---------------	--

Circle #013 on Reader Service Card

AUTOMATION & CONTROL SYSTEMS

ADAMS-SMITH; 34 Tower St., Hudson, MA 01749; (508) 562-3801. Product Name: Zeta-Three™ Emulator. **Contact:** Harry E. Adams, consultant. **Date Product Introduced:** Spring 1990. **Product Description & Applications:** Allows control of parallel-control audio and video recorders from the serial ports of videotape editors, automated audio consoles and computers. Synchronizes an ATR to any VTR in the editing system, even if all transport ports are already in use. Can also be used as a 2-transport synchronizer for mix-to-picture. Synchronizes MIDI devices to editing systems. **Basic Specifications & Suggested List Price:** Uses standard Sony serial protocols, contains SMPTE/EBU time code generator, 2 time code readers, MIDI synchronizer with tempo map storage, GPI event outputs, accommodates remote control. 19-inch rack-mount, one rack unit high. Accepts composite sync for resolving recorders.

AUDIO KINETICS UK LIMITED; Kinetics Center, Throbad St.; Borehamwood, Herts, WD6 4PJ England; (081) 9538118. Product Name: Motormix. **Contact:** Roger Pagel, sales mgr. **Date Product Introduced:** 9/90. **Product Description & Applications:** Motormix is the moving fader option for Audio Kinetics automation systems. It is suitable for recording, live sound or post-production applications. **Basic Specifications & Suggested List Price:** Up to 64 channels. VCA faders or moving faders can be combined on the same system owing to the component nature of the faders. A 32-channel system lists for \$42,000.

BRAINSTORM ELECTRONICS, INC.; 1515 Manning Ave., Ste. 4; Los Angeles, CA 90024; (213) 475-7570. Product Name: SR-1 and SR-1X. **Contact:** Bernard Frings, president. **Date Product Introduced:** 5/90. **Product Description & Applications:** A high-quality resampler that enables dubbing time code without signal degradation that would result from direct transfer. The SR-1 also cleans up unreadable time code by eliminating distortions and level fluctuations. It reshapes in rewind and fast forward modes for high-speed code recovery. It features a balanced or unbalanced input and output, a switchable output rise time (SMPTE/EBU/square wave) and an adjustable output level. **Basic Specifications & Suggested List Price:** List price: \$175. Input: SMPTE/EBU longitudinal time code (any speed). Level: -30 dBu min.; +20 dBu max. Output: switchable rise time (SMPTE: 25 µs, EBU: 50 µs, square wave). Level: full off to +8 dBu (front panel pot). Connectors: SR-1 = 1/4" jacks SR-1X = XLR male and female.

BRAINSTORM ELECTRONICS, INC.; 1515 Manning Ave., Ste. 4; Los Angeles, CA 90024; (213) 475-7570. Product Name: TDC-24. **Contact:** Bernard Frings, president. **Date Product Introduced:** 7/90. **Product Description & Applications:** A TACH/DIR converter for the Sony APR-24's onboard synchronizer. It allows the APR-24 to high-speed chase any master machine with a TACH/DIR or bi-phase output. Features include: turbo-locate mode, video-release mode and ADR beep. The TDC-24 electronics are completely opto-isolated from master machine to avoid any ground loop. It is enclosed in a small metal chassis and is supplied with interface cables. **Basic Specifications & Suggested List Price:** List price: \$445. Enclosure: 7" x 3" x 1-1/2" metal chassis. ADR beep: 1/4" jack, approx. 0 dBm, 900-Hz sine wave. Cables: 5' (can be extended w/9P sub-D extender).

CIPHER DIGITAL, INC.; 5350 Partners Ct., PO Box 170; Frederick, MD 21701; (800) 331-9066. Product Name: CDI-1000 VITC Reader/Translator. **Contact:** Bob Tulloh, mktg. mgr. **Date Product Introduced:** 9/90. **Product Description & Applications:** Reads vertical interval time code from NTSC or PAL video and translates to longitudinal time code. The time code is displayed on the front panel, inserted into video, and output as LTC. The CDI-1000 accepts LTC and TACH at the input, enabling it to update without VITC. The display and output are compensated for delays, eliminating common errors. The user has complete control over all display and processing options. **Basic Specifications & Suggested List Price:** List price: \$2,095. Inputs: NTSC or PAL video, TACH, LTC. Outputs: NTSC or PAL video, LTC, RS-232. Range: 0 to 50 x play speed.

—SEE PHOTO TOP OF NEXT COLUMN

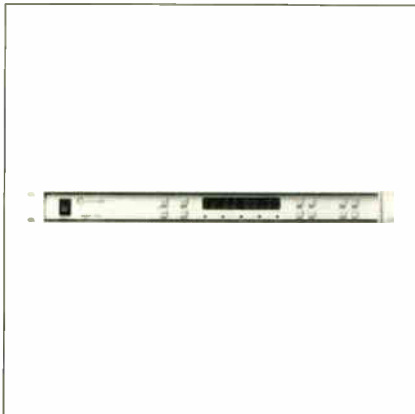

CIPHER DIGITAL, INC.
CDI-1000 VITC Reader/Translator

J.L. COOPER ELECTRONICS; 13478 Beach Ave., Marina Del Rey, CA 90292; (213) 306-4131. Product Name: MAGI Ili. **Contact:** Chuck Thompson, nat'l sales and marketing mgr. **Date Product Introduced:** 1/90. **Product Description & Applications:** MAGI Ili is an integrated state-of-the-art automation system that installs into virtually any audio mixing console to provide precise SMPTE lock automation. Designed specifically for the recording and post-production facilities, MAGI Ili installs in virtually any audio mixing console. Version 2.0 software is a major upgrade providing many additional features including offline editing, hit list, auto punch, real-time and offline MIDI event editing and enhanced user interface. **Basic Specifications & Suggested List Price:** The MAGI Ili system consists of internally mounted, high-quality dbx 2150 VCAs, rack-mounted MAGI Ili controller, the MR-4 remote unit and the powerful Version 2.0 software for Macintosh or Atari computers. Systems are available in 16 to 64 channel configurations and prices start at \$5,895.

J.L. COOPER ELECTRONICS; 13478 Beach Ave., Marina Del Rey, CA 90292; (213) 306-4131. Product Name: SyncMaster. **Contact:** Chuck Thompson, nat'l sales and marketing mgr. **Date Product Introduced:** 1/90. **Product Description & Applications:** Dual-port Macintosh MIDI interface/synchronizer can be used with all popular sequencing software. SyncMaster features 2 MIDI inputs, 6 MIDI outputs, printer and modem port thru switches, activity LEDs, Macintosh-compatible platinum finish, heavy-duty steel case and optional rack adaptor kit. It reads and generates all SMPTE formats and supports MIDI Time Code and Direct Time Lock. It can also read and generate PPS-1 compatible Smart FSK sync. Desk accessory and cables included. **Basic Specifications & Suggested List Price:** Free run mode allows it to operate as a master synchronizer in a tapeless environment. True Jam Sync/Regeneration with Time Code Reshaping allows SyncMaster to dub SMPTE or salvage damaged tapes. Front-panel-mounted Stripes and Free run button allows it to operate if the Mac is not present. \$349 suggested retail.

FOSTEX; 15431 Blackburn Ave., Norwalk, CA 90650; (213) 921-1112. Product Name: Model 8310, Video Ed. Card for D-20. **Contact:** Mark Cohen, VP. **Date Product Introduced:** 7/90. **Product Description & Applications:** Plug-in card for D-20 digital audio tape recorder (DAT format) allows recorder to be controlled by the video editor. Sony BVU-950 and Sony BVH-2000 emulation requires Model 8320 system expansion unit. **Basic Specifications & Suggested List Price:** Call Fostex.

FOSTEX; 15431 Blackburn Ave., Norwalk, CA 90650; (213) 921-1112. Product Name: Model 8320 System Expansion for D-20. **Contact:** Mark Cohen, VP. **Date Product Introduced:**

6/90. **Product Description & Applications:** Plugs into serial port of D-20, has its own CPU that provides expanded functions—switchable LED display of absolute time and SMPTE; can write song start IDs, skip IDs, end IDs; can locate via program number, a time or SMPTE; programmed to play up to 99 songs. **Basic Specifications & Suggested List Price:** \$800.

FOSTEX; 15431 Blackburn Ave., Norwalk, CA 90650; (213) 921-1112. Product Name: Model 8330 Sync Card for G-16. **Contact:** Mark Cohen, VP. **Date Product Introduced:** 6/90. **Product Description & Applications:** Plug-in card for G-16 16-track recorder is a full-function built-in integrated synchronizer. Also contains functions of MTC-1 for sophisticated MIDI use. **Basic Specifications & Suggested List Price:** \$1,200.



GML, INC.
GML Series 2000 Automation Environment

GML, INC.; 7821 Burnet Ave., Van Nuys, CA 91405; (818) 781-1022. Product Name: GML Series 2000 Automation Environment. **Contact:** Cary B. Fischer, VP sales. **Date Product Introduced:** 4/90. **Product Description & Applications:** Series 2000 Moving Fader Automation Environment featuring Pan & Zoom Graphics Recall, Machine Controller, and 'C' Peripheral VCA Controller. New options include true stereo fader, software nested grouping, drop-in points, data add, and VCA style Auto-Null mode. New software packages include Video Post and Film Re-recording configurations, utilizing relevant terminology and multi-sectional control. All discrete peripherals include 2/4-channel microphone preamplifiers, 2-channel 5-band parametric equalizers, and 2-channel compressor/limiter utilizing switchable soft/hard knee, variable crest, stereo/quad link and 2 RMS/1 peak amplifier scheme. **Basic Specifications & Suggested List Price:** Automation specifications: fader 1/10th dB, switches 1/4 frame accuracy. CPU is VME-based 680X0 multi-processing supplied with 40MB harddisk, 3.5 inch floppy, and 1 MB RAM. Recall specifications: 1024 x 768 ultra hi-resolution display, Pan & Zoom trackball control. Machine control: all parallel interface audio machines, Sony/JVC 9-pin Serial Protocols, Adams-Smith, TimeLine, Motionworks synchronizer control.

INTELIX; 5618 Odana Rd., Madison, WI 53719; (608) 273-6333. Product Name: MIND Control System. **Contact:** Steve Cohan, gen. mgr. **Date Product Introduced:** 4/90. **Product Description & Applications:** The system gives the user the capability of integration and remote controllability of audio systems (theater, broadcast and studio monitoring), broadcast routing systems, zoned P.A., and meeting room systems, along with lighting HVAC, motors, relays and security loops. Essentially, Intelix is offering extremely customized control with standard, off-the-shelf software and hardware components. **Basic Specifications & Suggested List Price:** The system consists of a central card rack and a network of remote control processors. The central card rack contains the central control processor, audio gain control cards, audio switch matrix cards, and various other input and output cards. The entire system is interconnected with a single twisted-pair cable.

MARK OF THE UNICORN, INC.; 222 Third St., Cambridge, MA 02142; (617) 576-2760. Product Name: Video Time Piece. **Contact:** Susan Patalano, marketing dir. **Date Product Introduced:** Fall 1990. **Product Description & Applications:** Professional VITC and LTC SMPTE time code reader/generator. Reads and writes all SMPTE formats, genlock to house sync or video, JAM Sync Smf. TE, and convert SMPTE to MTC, VITC to LTC, and LTC to VITC. Character generator allows the device to "burn in" SMPTE time code, generate streamers and conductor crawl lines, and download graphics from computer onto any video. **Basic Specifications & Suggested List Price:** 19" rack-mount chassis. Full-featured synchronizer, character generator includes audio-click-to-MIDI. Controlled from personal computer with a desk accessory (included) or directly from Performer. List \$1,195 includes 2 BNC to RCA video cables.

—SEE PHOTO TOP OF NEXT COLUMN



MARK OF THE UNICORN, INC.
Video Time Piece

MIDIMAN; 30 N. Raymond Ave #506; Pasadena, CA 91103; (818) 449-8838. Product Name: SMPTE Time Window. Contact: Toby Odell, VP sales. Date Product Introduced: 6/90. Product Description & Applications: SMPTE Time Window, the only dedicated SMPTE display, reader, writer and regenerator for the professional and home studio. Reads and writes all standard SMPTE formats, reads in forward and reverse. Reads at reel rock rates. Records up to 8 SMPTE hit points. Stripe from any offset time. Built-in stopwatch and more! **Basic Specifications & Suggested List Price:** 6" x 3" x 2" under 1 lb. 8 high-intensity displays. \$299.95 suggested retail.

MIDIMAN; 30 N. Raymond Ave #506; Pasadena, CA 91103; (818) 449-8838. Product Name: Syncman Plus. Contact: Toby Odell, VP sales. Date Product Introduced: 4/90. Product Description & Applications: The only full-featured, professional-quality Sync Box in its class that supports all major synchronization formats including SMPTE-MIDI Time Code, Song Pointer-FSK, and Direct Lock (for Performer). It also offers SMPTE to Song Pointer conversion for allowing any non-SMPTE-capable sequencer (Alesis MMT-8, Korg M-1, Roland W-30, Cakewalk to name a few) to sync to SMPTE. **Basic Specifications & Suggested List Price:** Suggested retail \$299.

NACWESTREX, INC.; 1011 W. Alameda Ave, Ste. F; Burbank, CA 91506; (818) 840-6990; FAX: (818) 840-6950. Product Name: MMC-1 Master Motion Controller. Contact: Dan Garrigan, sales mgr. Date Product Introduced: 9/90. Product Description & Applications: The MMC-1 is a complete motion controller for the entire studio, readily interfacing any combination of film and tape transports including VTRs, VCRs and multitrack ATRs in addition to electronic editors and synchronizer. User-friendly operator control panels allow absolute control of motion, presets and footage/frame or SMPTE time code displays. The MMC-1 system includes master and remote motion control panels, preset control modules, under-screen counter displays and remote counter display panels. **Basic Specifications & Suggested List Price:** Sync source may be external video sync, Pilotone, power line or internal crystal. Both serial and parallel interface ports are provided. Four separate bus signals are simultaneously generated to control any number of transports on up to 4,000 feet of cable. Time code mode includes "drop frame" capability. Price: \$11,800.

NICHE-RUSS JONES MARKETING GROUP; 17700 Raymer, Ste. #1002; Northridge, CA 91325; (818) 993-4091. Product Name: Audio Control Module (ACM). Contact: Ron Sorter, product specialist. Date Product Introduced: 7/90. Product Description & Applications: 8-channel audio attenuator—responds to MIDI controller information; signal-to-noise: 95 dB; frequency response: flat to within 0.1 dB from 30 to 30k cycles; 1 rackspace; 8 balanced 1/4" inputs; 8 balanced 1/4" outputs; 1 stereo 1/4" mix output; perfect for automating tape returns; up to 8 units can be stacked to automate from 8 to 64 channels; one-button front panel. **Basic Specifications & Suggested List Price:** Suggested retail: \$479.

R-TEC SYSTEMS; 1032 N. Sweetzer Ave., Ste. 212; West Hollywood, CA 90069; (818) 509-1111. Product Name: The Practically-Anywhere-Anything Remote. Contact: Dan Fogel, sales. Date Product Introduced: 7/90. Product Description & Applications: 5-function remote-control system provides remote-control operation of almost all professional equipment over any two-conductor cable between the user and the equipment to be controlled located up to a mile away. Consists of two components: MC50 machine controller and RK50 remote keypad. MC50's 5 independent relays are wired to any 5 functions to be controlled. RK50 situated at user's fingertips. Provides remote control when and where you need it. For system setup, servicing maintenance, rental equipment. **Basic Specifications & Suggested List Price:** MC50: 10-position screw terminal for equipment interface. Normally open and common provided for each relay. 3 programmable relay modes: Pulse, Toggle, Interlock. 1/4" jack, T-R-S, input con-

ductor. RK50: 5-user-legendable switches. Battery operated. 1/4" jack, T-R-S, output connector. Allowable distance between RK50 and MC50 is 5,000 feet by direct connection.

SONY PROFESSIONAL AUDIO; 1600 Queen Anne Rd.; Teaneck, NJ 07666; (201) 833-5709. Product Name: Serial Interface Feature Enhancements for APR-24. Contact: Clayton Blick, mktg. mgr. Product Description & Applications: The APR-24 analog 24-track recorder will be shown with software that now permits the APR-24's remote control to serially control a Sony VTR. A second APR-24 can be similarly controlled during a dual 24-track session. Other features will also be demonstrated.



TIMELINE, INC.
Lynx Keyboard Control Unit

TIMELINE, INC.; 270 Lafayette St.; New York, NY 10012; (212) 431-0330; FAX: (212) 966-7824. Product Name: Lynx Keyboard Control Unit. Contact: Nick Balsamo, nat'l sales mgr. Date Product Introduced: 3/90. Product Description & Applications: This compact, sophisticated control unit designed for multi-machine synchronization and audio editing features new software (upgrade 069) with additional operating features. The stand-alone configuration of the Lynx Keyboard Control Unit provides comprehensive, programmable machine control for up to six transports using Lynx Modules. **Basic Specifications & Suggested List Price:** All controls are functionally grouped for ease of operation, and the fluorescent alphanumeric display provides the maximum amount of useful user information. To expand the number of transports and other devices controlled by the system, the Lynx System Supervisor may be added.



TIMELINE, INC.
Lynx SSL Data Interface

TIMELINE, INC.; 270 Lafayette St.; New York, NY 10012; (212) 431-0330; FAX: (212) 966-7824. Product Name: Lynx SSL Data Interface. Contact: Nick Balsamo, nat'l sales mgr. Date Product Introduced: 10/89. Product Description & Applications: Heralding a new era in control room integration, the Lynx SSL Data Interface is a more flexible and cost-effective method for the SSL Studio Computer to talk directly to video and audio tape recorders, and film equipment using TimeLine's Lynx system. A joint development between TimeLine and SSL, the Lynx SSL Data Interface offers a solution to the compatibility and control problems typically found in audio and audio post-production work: it allows facilities to use complete TimeLine Lynx systems for a simple, unified network between consoles, tape machines and synchronizers. **Basic Specifications & Suggested List Price:** Designed to work with all SSL consoles with the Studio Computer, the Lynx SSL Data Interface expands the number of transports that can be controlled directly from the SSL Studio Computer—up to five TimeLine Lynx Time Code Modules can be controlled directly using existing SSL software and cables. In addition to offering

unlimited master/slave selection—any one of the transports may be designated the virtual master or slave, including video and film transports—it allows all offset, cue and mix data to be stored on the SSL data cartridge.



UPTOWN AUTOMATION SYSTEMS, INC.
Uptown Automation System 2000

UPTOWN AUTOMATION SYSTEMS, INC.; 1570 Quince Ave.; Boulder, CO 80304; (303) 443-1171; FAX: (303) 443-1264. Product Name: Uptown Automation System 2000. Contact: Richard Vanderslice, (508) 442-8053. Date Product Introduced: 2/90. Product Description & Applications: Moving-fader, console-automation system, for most new and retrofit consoles. Accurate and powerful, yet extremely easy to learn and use. Touch-sensitive faders, SMPTE time code-based. Provides automation of fader moves, up to 10 switches per channel, MIDI equipment, tape machine control, including storing 500 cue points, cycles and autopunch. Offline editing and merging of mixes, unlimited groups and subgroups, auto-save, online help system, color graphics display. **Basic Specifications & Suggested List Price:** Up to 96 channels of automation available. Each fader is microprocessor controlled. Frame-accurate fader moves, 1,024 positions (1/10 dB), switches 1/4-frame accurate (+/- 1 ms repeatability), PC-based, unlimited mix storage using the hard disk, easy installation. Affordable moving-fader automation, call for system pricing.

PROFESSIONAL AUDIO

PERFORMANCE

AUTOMATION

BROADCAST

MULTIMEDIA

RECORDING

KEYBOARDS

Our
pillars of
solid
customer
support
and
applications
expertise

SALES

SERVICE

CONSULTATION

RENTALS



Leo's

PROFESSIONAL AUDIO SYSTEMS
5447 TELEGRAPH AVENUE (415)
OAKLAND, CA 94609 653-1000

Circle #155 on Reader Service Card

Professional Audio for the Northwest United States

Sales o Service o Consultation o Design o Installation o Financing

70 Oak Grove Street
San Francisco, California 94107
Tel: (415) 957-9131
Fax: (415) 957-1531

AUDIO Images

550 Mercer Street, Suite 130
Seattle, Washington 98109
Tel: (206) 285-9680
Fax: (206) 283-9744

OTARI®

SONY®

Dolby

TASCAM® SHURE®

SENNHEISER audionics

Roland®

APHEX

Panasonic Professional Audio Systems



AUDIO Images

lexicon

TIME LINE

BOSE® crown

WaveFrame

COMPUTER HARDWARE & SOFTWARE

AUDIO TEKNOLOGY INC. (ATI); 7556 SW Bridgeport Rd.; Portland, OR 97224; (503) 624-0405. **Product Name:** LEAP 4.0. **Contact:** Vance Dickason, technical mktg. **Date Product Introduced:** 9/90. **Product Description & Applications:** LEAP 4.0—loudspeaker enclosure analysis program. New version of LEAP will perform complete multiway loudspeaker analysis including nonlinear modeling, passive and active filter design, compound and bandpass enclosures, speaker parameter measurement, driver XYZ axis alignment, plus Laser Jet and PostScript printer output. **Basic Specifications & Suggested List Price:** Requires IBM XT, AT, 386 or 486 DOS compatible computer. Tentative list price \$500 for complete package.

BARCLAY RESEARCH GROUP, INC.; PO Box 2617; Grass Valley, CA 95945; (916) 447-2905; (800) 356-8863. **Product Name:** Cardinal Video TR-100 and TS-100. **Contact:** Bill Fink/PME, consultant. **Date Product Introduced:** 6/90. **Product Description & Applications:** TR-100 time code reader board provides IBM PCs and compatibles access to SMPTE time code and enables PC to read time code from any VTR/ATR. TS-100 enables TR-100-equipped PC to manage: frame-accurate single keystroke time code notation; entry and editing of text comments and notation; and text-oriented planning, including selection of best takes and creation of a rough cut edit list. **Basic Specifications & Suggested List Price:** TR-100 fits expansion slot of IBM PCs or compatibles. Price with TS-100 software: \$395. TS-100 companion software for 3.5" or 5.25" drive (specify) and instruction manual: \$150.

C MIDI; PO Box 4903; East Lansing, MI 48823; (517) 337-2569. **Product Name:** cMIDI Function Library. **Contact:** Greg Sopes, engineer. **Date Product Introduced:** 8/90. **Product Description & Applications:** The cMIDI class library is a set of C++ classes to aid the development of IBM PC/MIDI sequencing applications. The library can control up to 4 MIDI interfaces. Complete source code and reference manuals included. **Basic Specifications & Suggested List Price:** Borland C++ Compiler and assembler. MPU-401 or compatible MIDI interface(s). IBM (or compatible) PC. Price: \$90.

COMMODORE BUSINESS MACHINES; 1200 Wilson Dr.; West Chester, PA 19380; (215) 431-9451. **Product Name:** Amiga 3000. **Contact:** David Archambault, Director. **Date Product Introduced:** 4/90. **Product Description & Applications:** Fast, multitasking computer for multimedia production and presentation. Many professional music, video, graphics and multimedia software packages available, including SMPTE and MIDI composition and librarian programs. **Basic Specifications & Suggested List Price:** Motorola 68030 32-bit processor, 16 or 25MHz clock speed, 2MB RAM, expandable to 6MB (over 1 gigabyte address space).

COMMODORE BUSINESS MACHINES; 1200 Wilson Dr.; West Chester, PA 19380; (215) 431-9451. **Product Name:** AmigaVision. **Contact:** David Archambault, Director. **Date Product Introduced:** 4/90. **Product Description & Applications:** Multimedia authoring software. Supports graphics, animation, text, videodisc, digitized sound, speech synthesis and music. Simultaneous playback of animation and audio. Runs external programs via AREXX. Runs on multitasking Amiga computer. Supports a variety of peripherals. **Basic Specifications & Suggested List Price:** Minimum delivery system: Amiga computer with 2 meg RAM. Suggested development system: Amiga computer with hard drive and 3 megs RAM.

CREATION TECHNOLOGIES; 2925 Fromme Rd.; North Vancouver, BC, Canada; (604) 984-2448. **Product Name:** NeXT-based Digital Recorder/Editor. **Contact:** Barry Henderson, president. **Date Product Introduced:** 9/90. **Product Description & Applications:** Multitrack digital recording and graphical user interface; waveform editing, hardware remote, built-in optical drive and DSP hardware. Applications: R-DAT editing, mix editing. **Basic Specifications & Suggested List Price:** To be announced Sept. 21.

DIGIDESIGN, INC.; 1360 Willow Rd. #101; Menlo Park, CA 94025; (415) 688-0600. **Product Name:** Deck Multitrack Software and Pro I/O Professional Analog Interface for Sound Tools. **Contact:** Suz Howells, product mktg. mgr. **Date Product Introduced:** 7/90. **Product Description & Applications:** Pro I/O Professional Analog Interface offers super high-fidelity AD/DA, 2 in/2 out balanced, +4 XLR connectors, oversampling converters with Apogee filters, video house sync, and sample accurate digital meters. Pro I/O is designed for the professional Sound Tools user. Deck Software provides 4 independent tracks of recording, fully automated mixing and MIDI support for Sound Tools. Use Deck to overdub tracks, mix up to 4 mono files together, and to combine digital audio with standard MIDI sequences. **Basic Specifications & Suggested List Price:** Pro I/O: \$2,995. Deck: \$349.

DIGIDESIGN, INC.; 1360 Willow Rd. #101; Menlo Park, CA 94025; (415) 688-0600. **Product Name:** MacProTeus Digital Sound Module for the Mac II. **Contact:** Suz Howells, product mktg. mgr. **Date Product Introduced:** 6/90. **Product Description & Applications:** MacProTeus, based on the popular E-mu Proteus, brings 192 presets of 16-bit sampled sounds to the Macintosh II. Compatible with any MIDI manager sequencer or any MIDI keyboard, MacProTeus is one step toward transforming the Macintosh II into a powerful music production system. Used with Sound Tools, Deck multitrack software, and your favorite MIDI mgr. sequencer, you have a complete music workstation—inside your Macintosh. **Basic Specifications & Suggested List Price:** \$895 includes front panel software from Opcode Systems. \$995 with EZ Vision Sequencing software from Opcode Systems.

DIGIDESIGN, INC.; 1360 Willow Rd. #101; Menlo Park, CA 94025; (415) 688-0600. **Product Name:** SampleCell™ 16-

Voice Sample Playback Card for the Mac II. **Contact:** Suz Howells, product mktg. mgr. **Date Product Introduced:** 9/90. **Product Description & Applications:** SampleCell™ is a 16-voice, 16-bit RAM-based sample playback card for the Mac II. Featuring 8 outputs, 0 to 8 meg RAM (using standard Mac II RAM), it includes a CD-ROM loaded with more than 500 megs of high-quality, ready-to-load samples. Macintosh front-end provides powerful yet easy to use software, featuring matrix modulation, visual sample mapping, etc. and lets you use any Macintosh-compatible storage media. SampleCell can be used with Sound Tools for high-fidelity stereo sampling and editing. Multiple SampleCells can be combined to create an extremely powerful and cost-effective sampling system.

DIGIDESIGN, INC.; 1360 Willow Rd. #101; Menlo Park, CA 94025; (415) 688-0600. **Product Name:** Sound Tools for the Atari Mega ST2/4. **Contact:** Suz Howells, product mktg. mgr. **Date Product Introduced:** 3/90. **Product Description & Applications:** Sound Tools is a hard disk-based digital audio recording and editing system. Features include: non-destructive playlist editing, time compression/expansion, real-time graphic EQ, SMPTE synchronization and more. Optional digital interface provides a cost-effective solution to DAT editing. Sound Tools may be used in conjunction with C-LAB's Notator MIDI sequencer to combine digital audio and MIDI sequencing. Applications include music recording/mastering, jingle production, sound design, and audio for film and video post-production. **Basic Specifications & Suggested List Price:** Each Sound Tools system includes: Sound Accelerator DSP card, Sound Designer II editing software and analog interface. U.S. list price: \$2,995. Optional: DAT I/O digital interface (AES/EBU and SPDIF formats): \$995. Optional: Pro I/O Professional Analog Interface (very high-fidelity A/D-D/A, Apogee filters, video sync, etc.): \$2,995.

DR. T'S MUSIC SOFTWARE, INC.; 220 Boylston St. #206; Chestnut Hill, MA 02167; (617) 244-6954. **Product Name:** Beyond. **Contact:** Richard Viard, development. **Date Product Introduced:** 1/90. **Product Description & Applications:** This MIDI sequencing program features: scrolling real-time piano-roll note editing; graphic controller and tempo editing; programmable looping cue points with gapless recording; smart instrument setups; layering of multiple MIDI channels to each instrument; support for 32 MIDI channels; 480/384/240/192 PPO adjustable resolution; MIDI time code support; transpose, reverse, harmonize, and invert based on scales: "Humanize" and "Intelligent Quantize." **Basic Specifications & Suggested List Price:** Supports standard MIDI files; SMPTE display on edit screens and markers; multitrack overview display; graphic song display in block-like "sections" with up to 99 tracks per section; 32 programmable onscreen graphic sliders; sysx recording. System requirements: Macintosh Plus, SE, SE 30, Mac II, IIcx, or IIfx; monochrome or color. List \$325.

DR. T'S MUSIC SOFTWARE, INC.; 220 Boylston St. #206; Chestnut Hill, MA 02167; (617) 244-6954. **Product Name:** X-oR for IBM. **Contact:** Richard Viard, development. **Date Product Introduced:** 6/90. **Product Description & Applications:** X-oR is the universal system exclusive editor/librarian and MIDI system orchestrator developed by Caged artist Bob Melvin, that runs on the IBM PC under Microsoft Windows™. X-oR is a fully integrated sound database that can get, send, load, and save individual patches or entire banks from any instrument in your system. **Basic Specifications & Suggested List Price:** Full editing profiles for over 70 different instruments are included with X-oR, providing onscreen parameter sliders, buttons and graphic envelope editing for each instrument. X-oR's advanced capabilities include four types of intelligent patch randomization, MIDI merging with Solo and Rechannelize modes, mouse play, and multiple banks in memory. Not copy protected. Requirements: 640K memory, hard disk, mouse, high-density disk drive and AT or 386 strongly recommended. Price: \$325.

EDUDISC, INC.; 1400 Tyne Blvd.; Nashville, TN 37215; (615) 373-2506. **Product Name:** MacVideo™ Interactive. **Contact:** Cindy Lewis, product mgr. **Date Product Introduced:** 6/90. **Product Description & Applications:** Offers hypertext, interactive graphics (hot spotted), questions, branching, combined authoring and editing, special effects, overlay text and graphics on video, on the fly changes, color, eloquent interface, single-screen interactive color Mac television, digitized sound. **Basic Specifications & Suggested List Price:** MacVideo Interactive, iTV, DC GX, Mac IIfx, 4MB RAM, 80MB hard disk. MacVideo Interactive package (software and 2 video boards) \$4,800.

GEFEN SYSTEMS; 6261 Variel Ave., Ste. C; Woodland Hills, CA 91367; (818) 884-6294; (800) 545-6900. **Product Name:** M and E Organizer 3.0. **Contact:** Hagai Gefen, president. **Date Product Introduced:** 3/90. **Product Description & Applications:** The M and E Organizer System with Filemaster AudioFile interface offers an automatic transfer of sound effects from the M and E files to AMS AudioFile using digital transfer and using the Sony CDK-006 Auto Disc Loader as the library source for CDs. **Basic Specifications & Suggested List Price:** IBM PC/AT compatible computer or Macintosh SE II computer with 1 Meg RAM and 20Meg HD, 1 Sony CDK-006 and 1 Gefen Systems Interface. \$9,360 for IBM, \$8,560 for Macintosh. Software only \$825 for Macintosh and \$675 for IBM.

BOSE
Better sound through research.

BOSE CORP.
Sound System® Software

BOSE CORP.; The Mountain; Framingham, MA 01701-9168; (508) 879-7330. **Product Name:** Sound System® Software. **Contact:** Mark Christensen, Sound System Software mgr. **Date Product Introduced:** 7/90. **Product Description & Applications:** A series of desktop computer programs that encompass all phases of the modern sound system design business. New release includes: Modeler® Design Program v3.1—speech intelligibility prediction based upon the STI/RASTI method that conforms to the world standard IEC #268-16. Practical application of this method is made possible on a desktop computer by the Bose® Hybrid Decay™ Curve. Other Modeler v3.1 improvements include: maximum number of room surfaces expanded, color compatibility and increased printing capabilities of various screen views. SpeakerCAD® Graphics Program v2.0—revised user interface, improved hidden line removal routine, color rendering of clusters and perspective room view. RackMaker™ Layout Program save for future projects. **Basic Specifications & Suggested List Price:** \$39 programs run on the Apple Macintosh family of computers and can be licensed only from Bose Corporation. Bose Professional Products dealers, consultants and educational institutions are eligible to lease the programs, all of which must be renewed on an annual basis.

COMPUTER HARDWARE & SOFTWARE

GEFEN SYSTEMS; 6261 Variel Ave., Ste. C; Woodland Hills, CA 91367; (818) 884-6294; (800) 545-6900. Product Name: Trackwriter and Trackplanner. **Contact:** Hagai Gefen, president. **Date Product Introduced:** 11/89. **Product Description & Applications:** Trackplanner and Trackwriter (IBM and Macintosh versions) softwares to create spotting lists, ARD list and cue sheet lists and printouts. **Basic Specifications & Suggested List Price:** IBM PC/AT compatible computer or Macintosh SE II computer with 1 Meg RAM and 20 Meg HD. \$695 for software only (IBM version) and \$795 for software only (Mac version).

KEY ELECTRONICS, INC.; 7515 Chapel Ave.; Ft. Worth, TX 76116; (817) 560-1912. Product Name: MIDlator MS-114. **Contact:** Charles Phelan, president. **Date Product Introduced:** 5/90. **Product Description & Applications:** The MIDlator MS-114 fills a void in currently available MIDI interfaces. It will provide the users of both high-tech and less common computer systems with a reasonably priced solution for MIDI applications. Typical applications are film or video production systems, animation systems, multiple MIDI links, studio recording, commercial or industrial sound simulation. **Basic Specifications & Suggested List Price:** Use any standard RS-232 port (RS-422 up to 4,000 ft. optional) at baud rates from 300 to 38,400, 1 MIDI in, up to 4 MIDI outs, and 4 MIDI ports (64 channels). Suggested list price \$229.95.

LIVEWIRE AUDIO; PO Box 561-M; Oceanport, NJ 07757; (201) 389-2197 voice/fax. Product Name: Korg TI PCM Disk Library. **Contact:** Mick Seelye, president. **Date Product Introduced:** 6/90. **Product Description & Applications:** Livewire is the only aftermarket company to offer 16-bit digital sample disks for the Korg T1, T2 and T3 keyboards. Sounds available in this 30-disk set include: classic analog synthesizer, percussion, basses, piano, organ, strings, brass, guitar, D-50 sounds, drum kits, and "the unusual." All sound disks were

created by digitally recording in our own studio with the finest Alca microphones and computer equipment for the ultimate sound quality. **Basic Specifications & Suggested List Price:** The entire Livewire T1 PCM Sound Library retails for \$349 plus shipping (by direct mail order). Single sound disks are available at slightly higher cost. Livewire sound disks are also available for Korg M1, Kawai K1/K4, and many other Korg, Roland Yamaha keyboards. Try us!

LONE WOLF; 1509 Aviation Blvd.; Redondo Beach, CA 90278; (213) 379-2036. Product Name: MidiHub. **Contact:** Perry Celia, sales mgr. **Date Product Introduced:** 9/90. **Product Description & Applications:** Programmable patch bay/processor with full merging of all input(s) to any output(s). Also acts as a MidiTap Port Expander and uses the MidiTap as a fiber optic backbone to network your system. **Basic Specifications & Suggested List Price:** The Hub comes in 2 versions. A MidiHub 8 is a 9 x 9, 2-rackspace unit that lists at \$595. A MidiHub 16 is a 17 x 17, 2-rackspace unit and lists for \$995.

LONE WOLF; 1509 Aviation Blvd.; Redondo Beach, CA 90278; (213) 379-2036. Product Name: The MidiTap. **Contact:** Perry Celia, sales mgr. **Date Product Introduced:** 1/90. **Product Description & Applications:** The MidiTap is the first Lone Wolf product incorporating MediaLink, a high-speed communications protocol that allows the real-time, simultaneous transmission of all forms of digital media down a single fiber optic cable. With MediaLink you can have a half million MIDI channels and run MIDI up to 2.5 kilometers. The MidiTap lets you take a snapshot, name and store each studio configuration as a LanScape, alphabetically and accessible at the touch of a button. **Basic Specifications & Suggested List Price:** The MidiTap is \$1,595. 4 x 4 fully merging and programmable inputs and outputs, 2 fiber optic ports, 1 serial port for computer modem and printer access. 16 character x 2 line supertwist LED-backlit LCD, 1-rackspace unit.

MIDISOFT CORPORATION; PO Box 1000; Bellevue, WA 98009; (206) 881-7176. Product Name: MIDISOFT Music Editor. **Contact:** Tim Bassierman, vp and director. **Date Product Introduced:** 1/91. **Product Description & Applications:** The total sound design solution including notation, sequencer, librarian and edit functions in an integrated, user-friendly format. Revolutionary multimedia and music instruction package. **Basic Specifications & Suggested List Price:** IBM PC/compatible, 286 and above; 1M RAM; windows-based.

MIDISOFT CORPORATION; PO Box 1000; Bellevue, WA 98009; (206) 881-7176. Product Name: MIDISOFT Studio Version 2.02. **Contact:** Tim Bassierman, vp and director. **Date Product Introduced:** 5/90. **Product Description & Applications:** IBM PC/compatible music software now includes MIDIfile import and export feature in both editions. Standard edition comes with 32 tracks and is available with MIDIface card for \$249.95. Advanced edition has 64 tracks and online real-time MIDI event editing. **Basic Specifications & Suggested List Price:** IBM version: PC/compatible with 512K minimum (640K suggested); MIDIface or Roland compatible card; any MIDI instrument. 32-track \$249.95, 64-track \$339.95. Atari ST version 32-track \$99.95 and 64-track \$159.95.

OPCODE SYSTEMS; 3641 Haven Dr., Ste. A; Menlo Park, CA 94025-1010; (415) 369-8131. Product Name: Studio 3™. **Date Product Introduced:** 1/89. **Product Description & Applications:** The Studio 3 is Opcode's top-of-the-line Macintosh MIDI interface with synchronization. It combines the legendary reliability of the Studio Plus Two with the synchronization abilities of the Opcode Timecode Machine, adding several new features in addition. The Studio 3 is recommended for all professional studio work with Opcode's Vision Sequencer, CUE-The Film Music System and Digdesign's Q-Sheet and Sound Tools. **Basic Specifications & Suggested List Price:** The interface has 2 independent MIDI ins and 6 independent MIDI outs. Each MIDI out is assignable to either the printer or modem port. LEDs on the front panel display MIDI activity for each MIDI port. Front panel buttons allow "thru" patching of serial ports. The interface reads and writes all formats of SMPTE. IT Jam Syncs, generating fresh SMPTE code for dubbing. Price \$379.

OPCODE SYSTEMS; 3641 Haven Dr., Ste. A; Menlo Park, CA 94025; (415) 369-8131. Product Name: Studio Vision™. **Date Product Introduced:** 9/90. **Product Description & Applications:** Studio Vision™ includes all the features of Opcode's award-winning Vision MIDI sequencer and adds the ability to record two independent tracks of digital audio along with the MIDI sequence information. The program includes fast non-destructive graphic editing of the digital audio tracks. In addition, the program uses Vision's Faders and other mix controls to bring automated mixing to the digital information. It provides an integrated solution for MIDI and digital audio production. **Basic Specifications & Suggested List Price:** Studio Vision™ uses Digidesign's Sound Tools to record and playback 16-bit, 44.1 kHz, CD quality sound. MIDI and digital audio events are represented graphically, so editing is quick and ac-

The Future is within reach

... Introducing a revolutionary advance in audio technology that will change your world ... from ANALOG to LIGHTWAVE



The DIGITAL AUDIO SYSTEM DAS 2000™ series from LAL is a fully integrated "smart" audio system. It provides multipoint-to-multipoint fiber optic sound transmission, distribution and routing with automated SOFT PATCH™ programmable memory control for both real time and pre-programmed changeovers.

The DAS 2000 advanced system technology automates previously manual processes, greatly reduces set-up time, improves sound quality and is compatible with existing analog equipment. This compact, self-diagnostic, modular system features:

- 15,000 ft. Fiber Transmission Distance
- Modular System in 19" Rack Mount
- Expandable to 64 Channels [8 ch./exp. board]
- 16 Return Lines, [optional - 8 ch./exp. board]
- A/D Converter - 16 BIT Delta Sigma
- D/A Converter - 18 BIT PCM
- 94dB Dynamic Range
- Frequency Response 10Hz - 22KHz
- REMOTE CONTROL FEATURES...

"Soft Patch™" 64 x 64 Routing/Patching,
Large LCD Backlite Display, 40x8 char., 6 Step Gain Control,
48V Phantom Powering

Call today (214) 637 9311 or FAX (214) 637 9314

Discover how DAS 2000 can revolutionize your world.

LAL
LESTER AUDIO
LABORATORIES

The Future is Now!

curate. SMPTE synchronization is also available using Opcode's Studio 3™ interface. Studio Vision is available as an upgrade to all Vision owners. Price \$995.

PASSPORT DESIGNS, INC.; 625 Miramontes St.; Half Moon Bay, CA 94019; (415) 726-0280. **Product Name:** Alchemy 2.22. **Contact:** Anastasia Lanier, VP sales. **Date Product Introduced:** 6/90. **Product Description & Applications:** Alchemy is a powerful 16-bit stereo sound and sample editing program for the Macintosh. Version 2.22 of Alchemy offers the fastest, most elegant way to retrieve, edit and store sampled sounds. Functions such as universal sampler compatibility, Fourier analysis and resynthesis, true stereo editing, automated fades and crossfades, digital EQ, time compression and pitch shifting make Alchemy an indispensable tool for sound designers. In addition to numerous enhancements, this newly released version adds support for the Emu II, S950, Digidesign Audiomedia Card and is no longer copy-protected. **Basic Specifications & Suggested List Price:** Suggested retail price is \$695. Additional specifications include: direct from disk playback, SMPTE time reference and high-resolution sample rate conversion, distributed audio networking capabilities and multichannel waveform editing.

PASSPORT DESIGNS, INC.; 625 Miramontes St.; Half Moon Bay, CA 94019; (415) 726-0280. **Product Name:** Encore. **Contact:** Anastasia Lanier, VP sales. **Date Product Introduced:** 11/89. **Product Description & Applications:** Encore is a professional MIDI composing and notation program for the Macintosh, Atari ST and IBM PC. Encore features a fast and intuitive user interface. Enter music in real time or step time using a mouse or a MIDI keyboard. Encore intelligently transcribes and prints out Master Tracks Pro sequences, reads and writes standard MIDI files, and can print entire scores or single parts. **Basic Specifications & Suggested List Price:** Suggested retail price is \$595. Additional specifications include: real-time transcription, playback over 32 MIDI channels, notate up to 64 staff systems with up to 4 voices per staff, open up to 16 files simultaneously and cut and paste between them, input text, lyrics, rests and musical symbols, transcribe sequences from industry standard MIDI files, not copy-protected.

PROFICIENCY; 185 S. State #950; Salt Lake City, UT 84111; (801) 531-0907. **Product Name:** Personal Sound Center. **Contact:** Todd Leishman, audio eng. **Date Product Introduced:** 7/90. **Product Description & Applications:** Personal Sound Center is a stereo audio control center for the Macintosh, which allows users to experience Macintosh audio as never heard before. Proficiency's dnr™ (digital noise reduction) allows 8-bit audio to be heard with the dynamic range of compact discs (90 dB). Sound Center will encode and digitize audio into the Macintosh for use in virtually any multimedia situation, giving the user that crystal-clear audio previously unavailable in standard Macintosh systems. **Basic Specifications & Suggested List Price:** Mic input: 1, computer audio input: 1 stereo, auxiliary output: 1 stereo, digital output: 1, headphone outputs: 1 stereo, digital dynamic range: dnr in=90 dB, dnr out=45 dB, digital sample frequency: 22k Hz, frequency response: analog=20 Hz-20k Hz; digital=20 Hz-10k Hz. Dimensions: 4.5" x 8.0" x 1.0". Retail price is \$350.

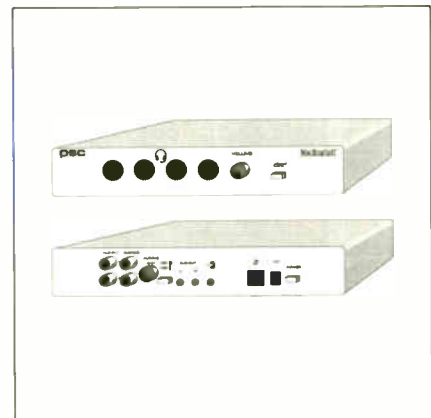

PROFICIENCY
Professional Sound Center

PROFICIENCY; 185 S. State #950; Salt Lake City, UT 84111; (801) 531-0907. **Product Name:** Professional Sound Center. **Contact:** Todd Leishman, audio eng. **Date Product Introduced:** 7/90. **Product Description & Applications:** Professional Sound Center is an audio control center for the Macintosh, which allows the user to experience Macintosh audio as never heard before. Proficiency's dnr™ (digital noise reduction) allows 8-bit audio to be heard with the dynamic range of compact discs (90 dB). Quantization noise is eliminated, resulting in crystal-clear audio. Professional Sound Center will playback, encode and digitize audio from any sound source into the Macintosh, making it extremely versatile and useful in a multimedia situation. **Basic Specifications & Suggested List Price:** Mic inputs: 4, computer audio input: 1 stereo, auxiliary

inputs: 2 stereo, auxiliary output: 1 stereo, digital output: 1, headphone outputs: 4 stereo, digital dynamic range: dnr in=90 dB; dnr out=45 dB, digital sample frequency: 22k Hz, frequency response: analog=20 Hz-20k Hz, digital=20 Hz-10k Hz, dimensions: 9.5" x 9.75" x 15". Retail price: \$500.

SOUND LOGIQ; 23 Alprilla Farm Rd.; Hopkinton, MA 01748; (508) 435-1993. **Product Name:** PC Objectmover+. **Contact:** Daniel Sevush, president. **Date Product Introduced:** 11/89. **Product Description & Applications:** Librarian for the Kurzweil 1000 Series instruments. Allows an unlimited number of online and file windows. Remote panel interacts with a mouse to emulate the Kurzweil front panel. List programs in a patchable format showing all lasers to the screen, printer or a file. **Basic Specifications & Suggested List Price:** Runs on an IBM PC or compatibles with 640K RAM with MPU-401 or Yamaha C1. Requires DOS 3.0 or higher. \$95, available directly from Sound Logiq.

SOUND QUEST, INC.; 1573 Eglinton Ave. W., Ste. 200; Toronto, Ontario, M6E 2G9 Canada; (416) 256-0466. **Product Name:** MIDI Quest. **Contact:** Glenn Hayworth, VP marketing. **Date Product Introduced:** 1/90. **Product Description & Applications:** MIDI Quest is the newest and most flexible approach to controlling your present and future MIDI setup. MIDI Quest's comprehensive screen window display and mouse/menu/keystroke interface are without parallel. Greater depth of information in each window, combined with application-oriented fast tips and help windows make input fast and results quick to hear! **Basic Specifications & Suggested List Price:** List price: \$250. Operates on Macintosh, Atari, PC/XT/AT/PS/2, and Amiga.

SPECTRAL SYNTHESIS, INC.; 18568 142nd Ave. NE; Woodinville, WA 98072; (206) 487-2931. **Product Name:** AudioVision SoundFile Editor. **Contact:** R. Bradshaw or A. Tilley. **Date Product Introduced:** 1/90. **Product Description & Applications:** Graphic sample/sound file digital audio editor for the IBM PC/AT. Supports up to 16 sound files loaded simultaneously for multisample editing. When used with SPECTRAL SynthCARD DSP system allows real-time sample looping, cut/paste editing, mixing and DSP filtering of sound files. All edits can be previewed before saving to disk. Support for popular sound file formats used on IBM and Macintosh is included as well as a utility to import/export to/from sample dump standard. **Basic Specifications & Suggested List Price:** List price: \$495. Edit functions: cut, paste, trim, copy in single or multichannel modes. DSP functions: normalize, mute, fade in, fade out, time slip, gain adjust, invert, mix reverse, blend, 4 mode parametric filter. Envelope functions: extract envelope, fit to envelope, redraw envelope. Graphics: zoom, vert and horiz scroll, outline/solid waveform view, color.

STEINBERG/JONES; 17700 Raymer St., Ste. 1001; Northridge, CA 91325; (818) 993-4091. **Product Name:** Cubase for Macintosh. **Contact:** Mike Rosen, product specialist. **Date Product Introduced:** 1/90. **Product Description & Applications:** Computer sequencing program for Macintosh. Applications range from home studio, professional and live performance. Sequencer is pattern and linear based. **Basic Specifications & Suggested List Price:** 16 x 64 tracks, 16 arrange windows with 64 independent tracks, M-ROS operating system for full multitasking and network capabilities. Interactive, note-on, groove and match quantize. Four player mode. Keyboard remote control, MIDI effects processor. Setup definition. Key edit, grid edit, drum edit and score edit. Cycle mode. \$495 list.

STEINBERG/JONES; 17700 Raymer St., Ste. 1001; Northridge, CA 91325; (818) 993-4091. **Product Name:** Topaz. **Contact:** Mike Rosen, product specialist. **Date Product Introduced:** 4/90. **Product Description & Applications:** Disk-based recording system. Supports the Macintosh II family. 16-bit linear resolution. Modular design to accommodate any size studio or production facility. **Basic Specifications & Suggested List Price:** Resolution—16 bit sampling rates: 32 kHz, 44.1 kHz, 48 kHz. Input/output level = 6 dBm, balanced. Analog I/O 3 pin XLR, digital I/O—AES/EBU. Communication interface—RS-422, Arcnet, MIDI mono recording time—360 MB hard disk 48 kHz—55 min. 44.1 kHz—60 min. 32 kHz—84 min. Max mono time—44.1 kHz 8 hours—4 hours stereo (single unit) \$25,000.

SYNECTICS; 511 Ave Del Verdor; San Clemente, CA 92672; (714) 498-7515; (714) 494-4590. **Product Name:** Rockit-R8. **Contact:** Mark Vlach, president. **Date Product Introduced:** 11/90. **Product Description & Applications:** Rockit-R8 is a sophisticated editor/librarian software package for the Roland R8 that runs under Microsoft Windows 3.0. Features include extensive use of enhanced graphical tools such as "level" meters, "pan" tables, parameter "plots," and drum "kits" for simplified data entry, as well as an advanced icon based graphical interface for Song and Pattern composition and Instrument, Feel Patch, Performance Pad, MIDI and System parameter editing. Coming soon: Rockit-R8M and Rockit-R5. **Basic Specifications & Suggested List Price:** Individual editor windows for each R8 parameter group and sequencer. Project manager with browser and notepad. Project merger for copying data between projects. Generic sysx and MIDI file formats fully supported. "Smart MIDI" for automatic sysx transfers and note # assignments from an alternate controller. Suggested list price: \$175.



At Last! An Affordable Master Recording Program Taught by Award-Winning Professionals

If your goal is to succeed in the music and recording industries, our professional training program will give you the hands-on experience and technical know-how you need.

CALL FOR INFORMATION AND CATALOG

1-800-562-6383

1110 E. Missouri, #400
Phoenix, AZ 85014

Licensed By The State of Arizona.
Approved For Foreign Students.

Circle #042 on Reader Service Card

ROCK ENROLL

MUSIC/RECORDING INDUSTRY PROGRAM

MUSIC PUBLICITY
MUSIC VIDEO
STUDIO MANAGEMENT
AUDIO ENGINEERING
MUSIC PUBLISHING
SONGWRITING
CAREER OPTIONS



Evening Courses and Certificate Program offered by San Francisco State University, Extended Education

REGISTER BY PHONE, MAIL OR FAX

Call 415/338-1372 for Class Details

Circle #043 on Reader Service Card

"Please pass the Talkback"



Finally...
A high performance
infrared remote that
activates your talkback from
anywhere in the control room.

- No aiming necessary
- Easy installation
- Very affordable

Call for more information.



**BRAINSTORM
ELECTRONICS, INC.**
(213) 475-7570
1515 Manning Ave. #4
Los Angeles, CA 90024

TB-4 Communicator

Circle #039 on Reader Service Card

COMPUTER HARDWARE & SOFTWARE

TECHMARKET; 430 40th St.; Oakland, CA 94609; (415) 601-6951. Product Name: Micro Cadex/CADEXnet. Contact: Roy Turpin, associate. Date Product Introduced: 12/89. Product Description & Applications: The CADEX family of products are information and network management tools available for DOS-based PCs, NETBIOS compatible networks, Sun 386i and SPARC stations with NFS. CADEX acts as a computer-aided card cataloging system allowing users access to documents, fax, MIDI information, animation sequences and other pre-selected file criteria. Basic Specifications & Suggested List Price: Micro CADEX unlimited \$495. CADEXnet (1-2 users) \$695 each. CADEXnet (3-5 users) \$495 each. CADEXnet (6-10 users) \$395 each. CADEXnet (11-50 users) \$325 each.

TRUE IMAGE; 349 W. Felicita Ave., Ste. 122; Escondido, CA 92025; (619) 480-8961. Product Name: MacSpeaker. Contact: Sharon Alsop, mktg. dir. Date Product Introduced: 1/90. Product Description & Applications: MacSpeaker is a speaker design application for the Macintosh computer. It shows you the frequency response of any loudspeaker driver and box combination you specify. A large library of loudspeaker drivers is provided and you can easily expand it to include new drivers. Employs the mathematical models of Thiele and Small for vented and closed loudspeaker systems. Calculates vent dimensions and enclosure dimensions. Basic Specifications & Suggested List Price: Runs on any Macintosh computer with at least 512K of memory and one 800K drive. Price \$145 for software and users guide.

TURTLE BEACH SYSTEMS; PO Box 5074; York, PA 17405; (717) 843-6916. Product Name: SampleVision. Contact: Jeff Klindirst, marketing dir. Date Product Introduced: 10/89. Product Description & Applications: A totally graphic, generic IBM sample editing software. SampleVision offers a complete DSP library, 3-D frequency analysis with a browsing function, crossfade looping, a 250 note step sequencer for auditioning changes, and a variable resolution wave display with zoom/unzoom. Turtle Beach has recently added the DP8, an update that allows real-time auditions of sound file changes. Basic Specifications & Suggested List Price: SampleVision supports: Esoniq EPS, Mirage, E-mu Emax, Korg DSS-1, S220, S330, S550, Akai S1000, S900, S700, S612, X-7000, Yamaha TX16W, SCI Prophet 2000, 2002, Casio FZ-1, FZ-10M, Oberheim DPX-1, IMA sample dump standard. Suggested list \$349.

VOYETRA TECHNOLOGIES; 333 Fifth Ave.; Pelham, NY 10803; (914) 738-4500. Product Name: Sequencer Plus Mk3 Version 4.0. Contact: E. Gary Fowler, marketing. Date Product Introduced: 9/90. Product Description & Applications: Sequencer Plus Mk3 Version 4.0 is a 3,000+ track MIDI sequencer. It includes a network organizer, Librarian/Bank arranger and a MIDI Data Analyzer. New Version 4.0 features include: full SMPTE support, Tap Tempo, 32 channel multiport, step-entry from the keyboard, volume, pan and more! Basic Specifications & Suggested List Price: Retail price \$349.

VOYETRA TECHNOLOGIES; 333 Fifth Ave.; Pelham, NY 10803; (914) 738-4500. Product Name: V245 MIDI Interface. Contact: E. Gary Fowler, marketing. Date Product Introduced: 9/90. Product Description & Applications: The V245 is a multiport MIDI interface for PC compatibles. It includes 2 MIDI inputs and 4 MIDI outputs. Also includes SMPTE reader generator, supports all 5 SMPTE frame rates and features fly-wheel dropout protection. Basic Specifications & Suggested List Price: Retail \$299.

WORDS AND DEEDS, INC.; 4480 Sunnycrest Dr.; Los Angeles, CA 90065; (213) 255-2887. Product Name: Archie™ 3.0 Studio Management System. Contact: Suzette Mehr. Date Product Introduced: 9/90. Product Description & Applications: Archie 3.0 adds many new features and improves upon the well-established Version 2.0. Included in the new version of this studio management system are: faster invoicing, automatic accounts receivable reports, automatic low stocks warnings for tape and session materials, a new accounts payable section, new engineer's hours reporting and optional bar code interface for tape and equipment. Basic Specifications & Suggested List Price: Archie 3.0 requires a Macintosh computer, SE/30 or better, with a minimum of 2MB RAM and a hard disk. List price: \$995 single user, \$1,325 multi-user. Registered users may upgrade for \$75.

Mix Trivia

1. This member of The Velvet Underground produced the Stooges' debut album.

Turn to page 275 for question



"Archie help us keep track
of the money we're making.
That's what I like about it."

David Miles
Apollo Theatre
New York NY

Archie™

Studio Management System for the Macintosh

- Automates studio operations
- Creates instant timesheets
- "Intelligent" tracksheets
- Tracks clients, inventory, payables and receivables, master tape library, checkbook
- Automatically prepares invoices, statements
- Prints checks, reports, forms and more!

For more information: Words & Deeds, Inc. 4480 Sunnycrest Drive
Los Angeles, CA 90065 Tel: 213-255-2887

Circle #040 on Reader Service Card

MAGNETIC TAPE

AGFA CORPORATION; 100 Challenger Rd.; Ridgefield Park, NJ 07660; (201) 440-2500. Product Name: AGFA Spliceproof Splicing Tape. **Contact:** Teri Sosa, mktg. comm. mgr. **Date Product Introduced:** 6/90. **Product Description & Applications:** Responding to an increase in unauthorized taping of rental and sell-through video cassettes, Agfa has developed Spliceproof™. Using an advanced subsurface printing technique, this splicing tape provides a means of permanent, legally-identifiable, highly visible logo identification for duplicators and studios. **Basic Specifications & Suggested List Price:** Code QZSP 0000, size .479" (customer specified from 100' to 350').

AGFA CORPORATION; 100 Challenger Rd.; Ridgefield Park, NJ 07660; (201) 440-2500. Product Name: Audio Duplication Splicing Tape (1.0 mil). **Contact:** Teri Sosa, mktg. comm. mgr. **Date Product Introduced:** 6/90. **Product Description & Applications:** Designed for audio cassette loading equipment, this polyester film tape, with pressure sensitive adhesive, delivers high cohesion and tensile strength. **Basic Specifications & Suggested List Price:** Code QZPO 1500, size .130" x 150', Code QZPO 3280, size .130" x 328'.

AGFA CORPORATION; 100 Challenger Rd.; Ridgefield Park, NJ 07660; (201) 440-2500. Product Name: Audio Duplication Tape Cleaning Fabric. **Contact:** Teri Sosa, mktg. comm. mgr. **Date Product Introduced:** 6/90. **Product Description & Applications:** A high-absorption, low-abrasion cleaning tape for high-speed audio cassette duplication equipment. **Basic Specifications & Suggested List Price:** Code QZWT 0500, size 1/2" x 60'.

AGFA CORPORATION; 100 Challenger Rd.; Ridgefield Park, NJ 07660; (201) 440-2500. Product Name: Audio Mastering Paper Leader Tape (2.5 mil). **Contact:** Teri Sosa, mktg. comm. mgr. **Date Product Introduced:** 6/90. **Product Description & Applications:** Paper leader tape with anti-static coating; no reference marks. **Basic Specifications & Suggested List Price:** Code QZLP 0250, size 1/4" x 820'.

AGFA CORPORATION; 100 Challenger Rd.; Ridgefield Park, NJ 07660; (201) 440-2500. Product Name: Audio Mastering Polyester Leader Tape (1.5 mil). **Contact:** Teri Sosa, mktg. comm. mgr. **Date Product Introduced:** 6/90. **Product Description & Applications:** Polyester film tape with anti-static plastic coating; back-printed with AGFA logo reference marks. **Basic Specifications & Suggested List Price:** Code QZLM 250, size 1/4" x 820'. Code QZLM 500, size 1/2" x 820'. Code QZLM 1000, size 1" x 820'. Code QZLM 2000, size 2" x 820'.



AGFA CORPORATION
Audio Mastering Splicing Tape (1.0 mil)

AGFA CORPORATION; 100 Challenger Rd.; Ridgefield Park, NJ 07660; (201) 440-2500. Product Name: Audio

Mastering Splicing Tape (1.0 mil). **Contact:** Teri Sosa, mktg. comm. mgr. **Date Product Introduced:** 6/90. **Product Description & Applications:** This white, polyester splicing tape is designed for all audio production specifications. The removable synthetic adhesive is temperature stable and thus makes the tape ideal for archival storage. **Basic Specifications & Suggested List Price:** Code QZSM 0250, size 1/4" x 82'. Code QZSM 0500, size 1/2" x 82'. Code QZSM 1000, size 1" x 82'.



AGFA CORPORATION
Audio Mastering Splicing
Tape Dispenser (1.0 mil)

AGFA CORPORATION; 100 Challenger Rd.; Ridgefield Park, NJ 07660; (201) 440-2500. Product Name: Audio Mastering Splicing Tape Dispenser (1.0 mil). **Contact:** Teri Sosa, mktg. comm. mgr. **Date Product Introduced:** 6/90. **Product Description & Applications:** This ergonomically designed, self-feeding dispenser delivers pre-sliced white, polyester tabs. **Basic Specifications & Suggested List Price:** Code QZSD 0250, size 1/4" x 500 tabs.

AGFA CORPORATION; 100 Challenger Rd.; Ridgefield Park, NJ 07660; (201) 440-2500. Product Name: R-DAT and Archive Box. **Contact:** Teri Sosa, mktg. comm. mgr. **Date Product Introduced:** 6/90. **Product Description & Applications:** The matte-black carrier features non-slip bubbling and a retractable hook for easy storage. Inside, the two cassettes fit snugly into the specially designed, tension-grip casing. The cassettes won't accidentally slip out of the package, yet are easily extracted. Agfa's professional grade R-DAT cassettes, created for studio and field recording as well as real time duplication, are unsurpassed in quality. Designed specifically for the rotary-head digital audio cassette format, Agfa R-DAT conforms to all published digital audio cassette standards. Agfa R-DAT's extremely smooth base foil has been precision coated with pure metal particle pigments (MP) and is characterized by an extraordinary high packing density. Additionally, the back coating is noted for its perfect mechanical performance and reliable data storage security. **Basic Specifications & Suggested List Price:** Packaged R-DAT cassette, size 60 Min., QCMA 9261. Size 90 Min., QCMA 9291. 120 Min., QCMA 9221. Archive Box with cassettes, 2-60 Min., QCMA 9361. 2-90 Min., QCMA 9391. 2-120 Min., QCMA 9321. Empty Archive Box, QZAB 0000.

AGFA CORPORATION; 100 Challenger Rd.; Ridgefield Park, NJ 07660; (201) 440-2500. Product Name: Video Duplication Splicing Tape. **Contact:** Teri Sosa, mktg. comm. mgr. **Date Product Introduced:** 6/90. **Product Description & Applications:** Designed for automated videocassette loading equipment, this polyester film tape has an acrylic, pressure-sensitive, UV resistant adhesive and delivers high cohesion and tensile strength. **Basic Specifications & Suggested List Price:** Code QZSV 1000, size .479" x 100', Code QZSV 2230, size .479" x 223'.

AGFA CORPORATION; 100 Challenger Rd.; Ridgefield Park, NJ 07660; (201) 440-2500. Product Name: Video Duplication Tape Cleaning Fabric. **Contact:** Teri Sosa, mktg. comm. mgr. **Date Product Introduced:** 6/90. **Product Description & Applications:** A cleaning tape for high-speed duplication and automated videocassette loading equipment. **Basic Specifications & Suggested List Price:** Code QZWT 1000, size 1" x 120'.



AGFA CORPORATION
SR-XS Chrome Studio
Reference Cassette IEC II

AGFA CORPORATION; 100 Challenger Rd.; Ridgefield Park, NJ 07660; (201) 440-2500. Product Name: SR-XS Chrome Studio Reference Cassette IEC II. **Contact:** Teri Sosa, mktg. comm. mgr. **Date Product Introduced:** 6/90. **Product Description & Applications:** The SR-XS reference cassette contains an advanced, new type II chrome formulation that features ultra-low resonance and high-temperature stability. The cassette's five-screw housing ensures low wow and flutter and increased azimuth stability. **Basic Specifications & Suggested List Price:** Code OCMA 1060 size 50 min., code OCMA 1090 size 90 min.

AMPEX RECORDING MEDIA CORPORATION; 401 Broadway, M.S. 22-02; Redwood City, CA 94063; (415) 367-3809. Product Name: Ampex 617/618 Cassette Duplicator Pancakes. **Contact:** Karen D. Schweikher, mktg. comm. mgr. **Date Product Introduced:** 5/90. **Product Description & Applications:** Audio cassette duplicator pancakes for high-speed and real-time duplicators. 617 and 618 formulation has been optimized for high-output and low-noise recording. Available in C60 and C90 thicknesses. **Basic Specifications & Suggested List Price:** Code OCMA 1060 size 50 min., code OCMA 1090 size 90 min.

DIC DIGITAL; 222 Bridge Plaza S.; Fort Lee, NJ 07024; (201) 224-9344. Product Name: Mirror Master Tape for TMD Video Duplication. **Contact:** Kevin E. Kennedy, nat'l mktg. mgr. **Date Product Introduced:** 4/90. **Product Description & Applications:** DIC Digital manufactures a complete line of 4mm (DAT) and 8mm computer backup tape cartridges. Both cassettes adhere to ANSI specs and exceed industry specifications for block error. Both products are available in different lengths with a maximum capacity of 1.3 gigabytes for 4mm (DAT) and 2.3 gigabytes for 8mm. Both products are compatible with workstations using these formats. **Basic Specifications & Suggested List Price:** Suggested list price for 1.3 gigabyte is \$16.99. Suggested list price for 2.3 gigabyte is \$24.99.

DIC DIGITAL; 222 Bridge Plaza S.; Fort Lee, NJ 07024; (201) 224-9344. Product Name: Mirror Master Tape for TMD Video Duplication. **Contact:** Kevin E. Kennedy, nat'l mktg. mgr. **Date Product Introduced:** 4/90. **Product Description & Applications:** DIC Digital has begun manufacturing mirror master tape for TMD video duplication. The tape strictly adheres to the high standards that must be maintained for perfect transfers, pass after pass. Signal-to-noise ratio, RF output and frequency response all exceed industry minimum standards. **Basic Specifications & Suggested List Price:** Suggested list price is \$350 per 400 meter reel.

MAXELL CORPORATION OF AMERICA; 22-08 Rte. 208; Fair Lawn, NJ 07410; (201) 794-5900. Product Name: Betacam SP. **Contact:** Patricia M. Byrne. **Date Product Introduced:** NAB '90. **Product Description & Applications:** Betacam SP—1/2-inch metal particle cassettes for use in Betacam SP recorders. Available in small size currently, but will be available in large size by the end of the summer. Small lengths are 10-minute, 20-minute and 30-minute. The large will be available in 60-minute and 90-minute. **Basic Specifications & Suggested List Price:** Major characteristics: 1) fine ceramic armor metal particles; 2) high-precision cassette shell; 3) low error rate; and 4) high reliability and durability. List price: B-10SP \$47.78, B-20SP \$53.08, B-30SP \$58.38. Large pricing not yet available.

MAGNETIC TAPE

flexibility!

Littlite

Gooseneck Lamps & Accessories

mixing consoles, amps,
turntables, effects racks,
multi-tracks, synthesizers,
music stands, drum machines,
keyboards, orchestras,
d.j. consoles



Littlite/CAE, Inc.
P.O. Box 430
Hamburg, MI 48139
313/231-9373

Circle #044 on Reader Service Card

MAXELL CORPORATION OF AMERICA; 22-08 Rte. 208; Fair Lawn, NJ 07410; (201) 794-5900. **Product Name:** D-2 VideoCassettes. **Contact:** Patricia M. Byrne. **Date Product Introduced:** NAB '90. **Product Description & Applications:** D-2 VideoCassettes—metal-particle digital cassettes for use in D-2 composite digital VTRs. These cassettes are available in small, medium and large sizes. **Basic Specifications & Suggested List Price:** Major characteristics: 1) fine ceramic armor metal particles; 2) high-precision cassette mechanism; 3) low error rate; and 4) high reliability and durability. (Technical data sheet already sent.) List pricing—small cassettes run from \$30.97 to \$171.08, medium cassettes run from \$30.97 to \$201.49 and large cassettes run from \$279.26 to \$524.34.

SHAPE INC.; PO Box 366; Biddeford, ME 04005; (207) 282-6155; (800) 247-1724. **Product Name:** Shape DAT Cassette. **Contact:** Walter Gordon, reg. sales mgr. **Date Product Introduced:** 3/90. **Product Description & Applications:** Digital audio tape cassette and Norelco box. Shape manufactures the new DAT cassette that promises the sound of tomorrow today. We mold and assemble the D-Os in both black and a variety of colors along with loading services; we also produce the Norelco box and offer special packaging, bulk packaging and overwrap capability. **Basic Specifications & Suggested List Price:** Meets all ITA specifications for DAT cassettes.

SONY MAGNETIC PRODUCTS; Sony Dr.; Park Ridge, NJ 07656; (201) 930-2000. **Product Name:** DAU Series/D1/2 and D1/4 Series/DAT. **Contact:** Howard Podolnick, prod. mgr. **Product Description & Applications:** DAU—digital 3/4" tape for CD mastering. D1/2 and D1/4—1/2" and 1/4" open-reel digital tape for studio recording/production/mixing. DAT—digital audio tape for recording/archiving.

TDK ELECTRONICS CORPORATION—PROFESSIONAL PRODUCTS DIV.; 1411 W. 190th St.; Gardena, CA 90248; (213) 538-5259. **Product Name:** Acoustic Master - AM. **Contact:** Douglas Booth, nat'l sales mgr. **Date Product Introduced:** 1/90. **Product Description & Applications:** Improved normal-bias ferric oxide formulation with reduced noise levels and wider dynamic range. High-precision, jam-proof cassette mechanism with five-screw construction and transparent shell. Ideal for all audio/visual applications requiring superior sound quality and maximum reliability. **Basic Specifications & Suggested List Price:** Acoustic Master is available in a variety of lengths at the following suggested list prices: AM-30, \$1.72; AM-46, \$1.72; AM-60, \$1.72; AM-90, \$2.05 and AM-120, \$3.22.

IMPERIAL TAPE

Company, Inc.

- Manufacturers of custom length blank audio and video cassettes
- Top quality audio and video cassette duplication
- Shipment within 24 hours, same day L.A. service
- Call for free catalog



Service · Quality · Integrity

Nation's Leading Authorized Distributor

AGFA AMPEX 3M MAXELL TDK BASF

1-800-736-8273

FAX 213-396-8894

213-396-2008

1928 14th ST., SANTA MONICA, CA 90404

Circle #045 on Reader Service Card

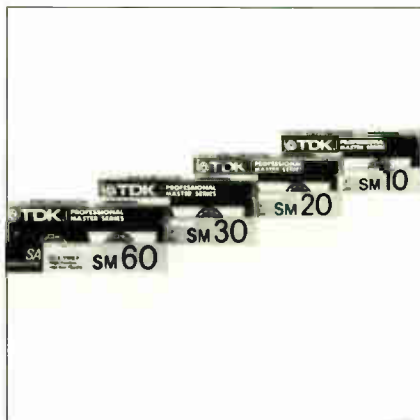

TDK ELECTRONICS CORPORATION—
PROFESSIONAL PRODUCTS DIV.
Sound Master—SM

TDK ELECTRONICS CORPORATION—PROFESSIONAL PRODUCTS DIV.; 1411 W. 190th St.; Gardena, CA 90248; (213) 538-5259. **Product Name:** Sound Master—SM. **Contact:** Douglas Booth, nat'l sales mgr. **Date Product Introduced:** 1/90. **Product Description & Applications:** Superior high-bias cassettes for studio and demo recordings. Uses top-quality SA tape pancake for low noise and wide dynamic range. Anti-resonance cassette mechanism ensures phase accuracy and low modulation noise. Exceptionally life-like sound reproduction—ideal for reproduction of digital sources. **Basic Specifications & Suggested List Price:** Sound Master is available in a variety of lengths at the following suggested list prices: SM-10, \$2.17; SM-20, \$2.50; SM-30, \$2.85 and SM-60, \$3.62.

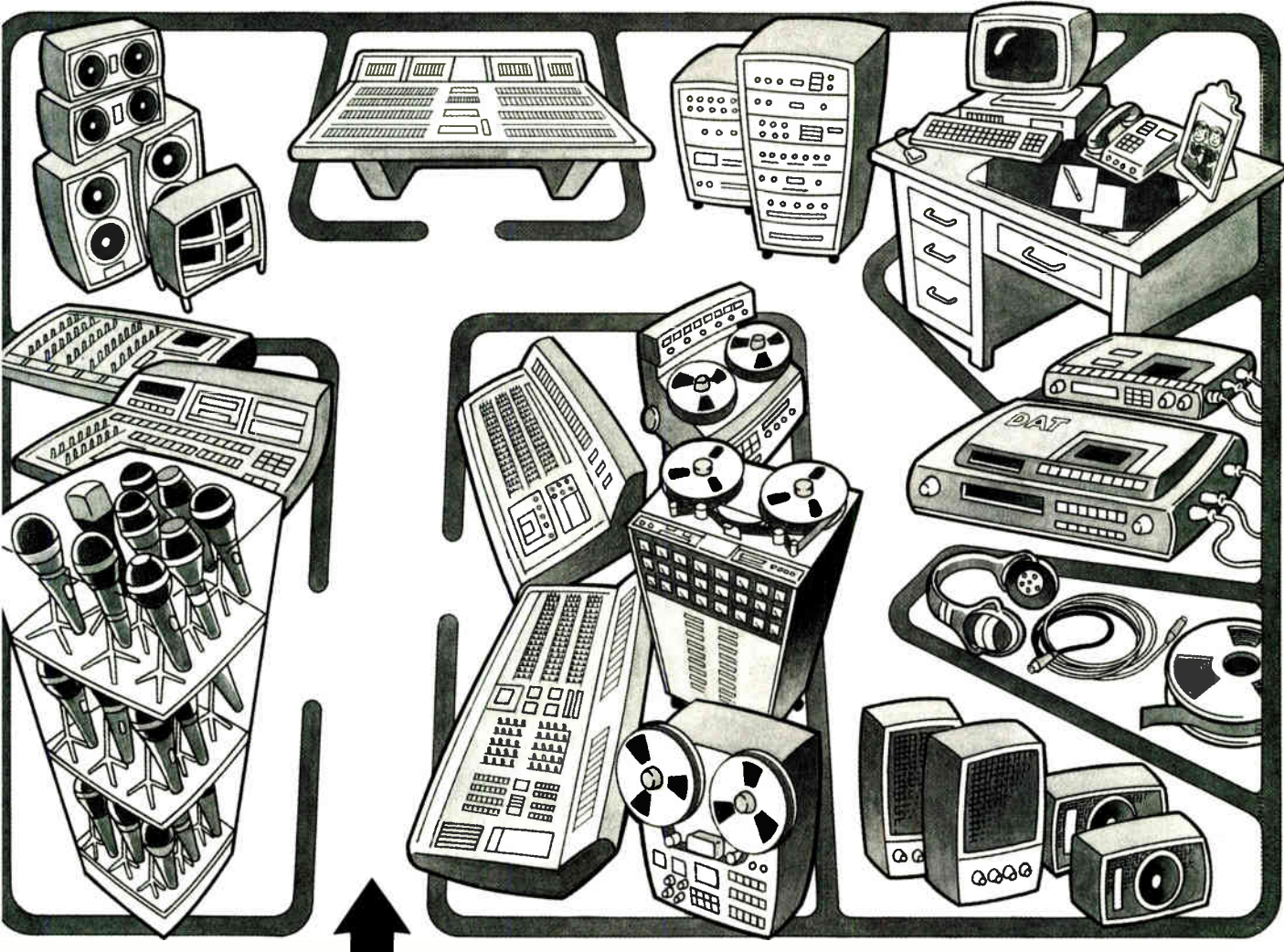

The best advice in professional audio starts right here.

Walk through Manny's Pro Audio Division. Check out the incredible variety of top brand equipment there is to choose from.

Start with microphones, the first critical link in the audio chain. Notice the world's hottest condenser, ribbon and dynamic mics on display. Plus all types of cables, stands and accessories.

Walk on. You'll be even more amazed by Manny's unmatched selection of the latest in mixing consoles, analog and digital tape recorders, signal processors, power amps, studio monitors, speaker enclosures and more.

But the reason why top audio professionals come to Manny's is not just products. It's *people*. Knowledgeable staff members with the unique combination of ears, instincts and long-term experience in the field to help you find the exact piece of equipment you need—no matter what you're looking for.

Stop by or call Manny's Professional Audio Division. Because when it comes to finding the best professional audio equipment for your needs, it's always better to start right.

Manny's Music
PROFESSIONAL AUDIO DIVISION

156 W. 48th Street, New York City, N.Y. 10036 (212) 819-0576 Fax: (212) 391-9250

MICROPHONES & PICKUPS

AMS INDUSTRIES, INC.; 1180 Holm Rd., Ste. C; Petaluma, CA 94954; (415) 762-4840. **Product Name:** ST250 Stereo Microphone. **Date Product Introduced:** 1990. **Product Description & Applications:** The AMS ST250 stereo microphone is an exciting development in M/S and L/R stereo techniques. Switchable between formats and designed for vertical or end-fire operation, the system also allows a unique control over both M and S signals. Powered by mains, phantom or batteries and with a portable control unit in a shoulder carrying pouch, the microphone is suitable for use in a wide range of environments.



AUDIO-TECHNICA U.S., INC.
AT4031

AUDIO-TECHNICA U.S., INC.; 1221 Commerce Dr.; Stow, OH 44224; (216) 686-2600. **Product Name:** AT4031. **Contact:** Garry Elliott, nat'l sales mgr. **Date Product Introduced:** 7/89. **Product Description & Applications:** The AT4031 is a pressure-gradient capacitor microphone with a uniform cardioid polar pattern. An integral high-pass filter provides easy switching from a flat frequency response to a low-end roll-off. The high-pass position reduces the microphone's sensitivity to wind noise, popping in close vocal use, and handling noise. Sounds great for vocals, acoustic guitar, overheads or ambient applications. **Basic Specifications & Suggested List Price:** Professional net: \$325. Element: fixed-charge, permanently polarized capacitor. Polar pattern: cardioid (unidirectional). Frequency response: 30 to 20,000 Hz. Max. SPL: 145 dB at 1% T.H.D. Power requirements: 9 to 52V DC.

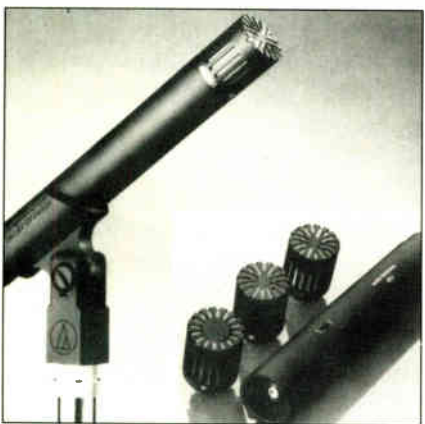

AUDIO-TECHNICA U.S., INC.
AT4051

AUDIO-TECHNICA U.S., INC.; 1221 Commerce Dr.; Stow, OH 44224; (216) 686-2600. **Product Name:** AT4051. **Contact:** Garry Elliott, nat'l sales mgr. **Date Product Introduced:** 7/89. **Product Description & Applications:** The AT4051 microphone is a transformerless externally polarized capacitor studio microphone engineered to meet the most critical acoustic requirements of professional recording and broadcast. The AT4051 balanced output is direct-coupled, resulting in a clean output signal, even under high-output conditions. Its fast response to transients contributes to its open, transparent reproduction of even the most troublesome of instruments and sound effects. **Basic Specifications & Suggested List Price:** Professional net: \$580. Element: externally polarized (DC bias) capacitor. Polar pattern: cardioid (unidirectional). Frequency response: 20 to 20,000 Hz. Max. input sound level: 143 dB SPL at 1% T.H.D. Power requirements: 48V DC phantom (+/-12V).

AUDIX CORPORATION; 5635 Stoneridge Dr.; Pleasanton, CA 94566; (415) 463-1112. **Product Name:** SCX-1 Condenser Microphone. **Contact:** Clifford Castle, VP sales. **Date Product Introduced:** 9/90. **Product Description & Applications:** The SCX-1 condenser can be used for recording, broadcast, or live sound reinforcement applications for voice and acoustic instruments. With 4 interchangeable capsules available (omni, omni with presence boost, cardioid, and hypercardioid), the SCX-1 is a mere 4-1/8" long (including the capsule) and is well suited for a wide variety of applications. By incorporating surface-mount technology along with close tolerance matched components, the SCX-1 preamplifier reaches an unprecedented signal to noise ratio of 129 dB! Each capsule is serialized and calibrated and is provided with its own frequency response chart. The SCX-1 operates on standard phantom power from 9 to 52 volts. **Basic Specifications & Suggested List Price:** SCX1-o (omni), SCX1-op (omni with presence boost): Freq. response 20-20k Hz. Output level -56 dBv. Max SPL 130 dB. Imp 200 ohms. SCX1-c (cardioid), SCX1-hc (hypercardioid): Freq. response=40-20k Hz. Output level: -56 dBv. Max SPL=132 dB Imp 200 oh SCX1-preamp. Response 15-22k Hz. Floor noise A weighted 13 dB. SPL=140 dB. Signal to noise=129 dB. SCX-1 preamplifier and choice of 1 capsule, list \$699. Each additional capsule, list \$399.

BEYER DYNAMIC; 5-05 Burns Ave.; Hicksville, NY 11801-2689; (516) 935-8000. **Product Name:** MC742. **Contact:** Mike Solomon, mktg mgr. **Date Product Introduced:** 9/90. **Product Description & Applications:** Stereo version of the MC740. The new MC742 is a dual large diaphragm stereo condenser microphone with M-S and X-Y miking capability. Polar response can be remotely controlled. The microphone features smooth frequency response with ultra-low self noise and low distortion circuitry. Each MC742 is available with onboard attenuator, low-frequency roll-off filter, external shock mount. **Basic Specifications & Suggested List Price:** List price is \$3,995. 40-20,000 Hz frequency response +/-1 dB. 48 volt phantom powerable. 70dB signal to noise ratio. 134dB maximum SPL without pre-attenuation. 144dB maximum SPL with pre-attenuation.

BEYER DYNAMIC; 5-05 Burns Ave.; Hicksville, NY 11801-2689; (516) 935-8000. **Product Name:** TGX Series 180/280/480/580. **Contact:** Mike Solomon, mktg mgr. **Date Product Introduced:** 5/90. **Product Description & Applications:** TGX Series consists of 4 hypercardioid dynamic vocal microphones with extraordinary volume-before-feedback capabilities and very fast transient response. Each model, the TGX 180, 280, 480 and 580, employs rare earth, enhanced-field magnet structures for sensitivity. Each model is internally shock-mounted and supplied with either intermediate or large-sized diaphragm. **Basic Specifications & Suggested List Price:** TGX 180 40-16,000Hz response, \$159. TGX 280 30-16,000Hz response, \$199. TGX 480 40-18,000Hz response, \$269. TGX 580 30-18,000Hz response, \$349.

ELECTRO-VOICE, INC.; 600 Cecil St.; Buchanan, MI 49107; (616) 695-6831. **Product Name:** RE2000. **Contact:** Ivan Schwartz, broadcast prod. mgr. **Date Product Introduced:** 9/90. **Product Description & Applications:** The RE2000 is a large diaphragm, side-fired, RF-biased supercardioid condenser mic with switchable output level attenu-

tion and low-frequency response. It is equally suited for film sound stage recording, home recording, production broadcast recording, sophisticated studio recording and onstage sound reinforcement. **Basic Specifications & Suggested List Price:** Suggested price \$1,000. Element: RF-biased condenser; frequency response: 30-20,000 Hz; dynamic range: 102 dB; maximum SPL at 1% THD: 125 dB; dimensions: 8.15 in.(L) x 2.24 in.(W) x 0.7 in.(thickness).

ELECTRO-VOICE, INC.; 600 Cecil St.; Buchanan, MI 49107; (616) 695-6831. **Product Name:** RE27 N/D. **Contact:** Ivan Schwartz, broadcast prod. mgr. **Date Product Introduced:** 9/90. **Product Description & Applications:** The EV RE27 N/D is a professional quality dynamic cardioid mic designed for broadcast production announce and voice-over, high-quality recording, and sound reinforcement applications. The RE27 N/D utilizes a revolutionary neodymium alloy magnet and a reinforced dome, a combination offering increased sensitivity, undistorted output at high sound-pressure levels and an extended high-frequency response. **Basic Specifications & Suggested List Price:** Suggested price \$625. Frequency response: 45-20,000 Hz; cardioid polar pattern; Impedance: 150 ohms balanced; N/Dym™ magnet in a non-welded circuit; power level is -51 dB at 1,000 Hz; size: 8.53" (L) x 2.14"(W); body diameter is 1.94".

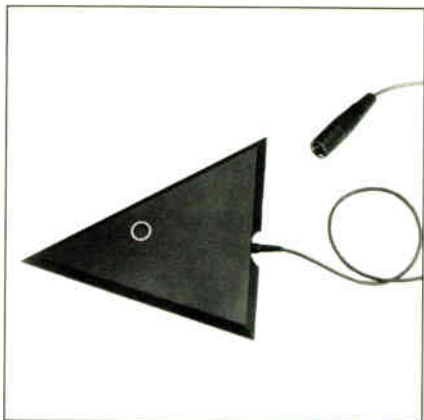

GOTHAM AUDIO CORP.
Neumann GFM
132 Boundary Layer Microphone

GOTHAM AUDIO CORP.; 1790 Broadway, 8th floor; New York, NY 10019; (212) 765-3410. **Product Name:** Neumann GFM 132 Boundary Layer Microphone. **Date Product Introduced:** 6/90. **Product Description & Applications:** Distributed by Gotham Audio of New York City, the Neumann GFM 132 boundary mic offers uniform frequency response in the diffuse and free fields. The phantom-powered mic uses a new 10mm condenser capsule and features the transformerless circuitry of Neumann's TLM170 microphone. **Basic Specifications & Suggested List Price:** A computer-designed triangular plate eliminates angle dependent coloration in the vertical and horizontal planes, and provides a consistent, frequency-independent hemispherical pickup pattern. Frequency range: 40-20k Hz; max SPL for less than 0.5% THD: 137 dB. A clip-on windscreen is optional.

JOSEPHSON ENGINEERING; 3729 Corkerhill Way; San Jose, CA 95121; (408) 238-6062. **Product Name:** C-603A microphone. **Contact:** David Josephson. **Date Product Introduced:** 8/90. **Product Description & Applications:** New version of the 603 transformerless low-noise condenser microphone with improved distortion, overload, common-mode rejection and noise specs. The 603A is made in the USA (earlier models made in Germany) and can be used with any of the capsules and accessories. **Basic Specifications & Suggested List Price:** Response of basic microphone 5Hz-50kHz +/-1 dB distortion <0.05% at levels up to +8 dBv. Price \$650.

LIGHT WAVE SYSTEMS; 7760 Burnet Ave.; Van Nuys, CA 91405; (818) 780-3002. **Product Name:** "Plus 20" Super-Mount (SM30m). **Contact:** Jim, Les. **Date Product Introduced:** 4/90. **Product Description & Applications:** Light Wave Systems introduces a radically new suspension mount with a totally new concept in holding and floating the microphone. As the world's first truly all-purpose, universal mount, the Plus 20 Super-Mount offers great versatility without compromise. All tube-type microphones up to 30mm are held in a rear collar with a single thumbscrew. The microphone can be instantly withdrawn without removal of the mount from its windscreen. The Plus 20 Super-Mount is 20 dB quieter in the critical low end than any other professional mount. **Basic Specifications & Suggested List Price:** Construction materials are thermoset resin, brass and hardened stainless steel with replaceable pure gum rubber strips. Weight is 7 oz. (with handle grip). Retail price is \$150/\$160.

—SEE PHOTO TOP OF NEXT COLUMN



LIGHT WAVE SYSTEMS
"Plus 20" Super-Mount (SM30m)



LIGHT WAVE SYSTEMS
Windmaster

LIGHT WAVE SYSTEMS; 7760 Burnet Ave., Van Nuys, CA 91405; (818) 780-3002. Product Name: Windmaster. **Contact:** Jim Les. **Date Product Introduced:** 4/90. **Product Description & Applications:** Windmaster is a new deep-pile windscreens cover to fit all super-screens and mini-screens. Windmaster is a design extension of the original soft surface lamination material used in the Light Wave (and Zeppelin) windscreens and wind covers. Windmaster has a luxuriant fur of 3/8" depth, is fully contoured and a rich black in appearance. Windmaster should replace our regular Super-Screen cover(s) when wind and weather are at their worst. Windmaster provides maximum wind blocking with a superbly soft touch to the wind. **Basic Specifications & Suggested List Price:** Fully knotted fur and woven backing. Replaceable non-binding zipper. Super-Screen Windmaster average list price \$70. Mini-Screen Windmaster average list price \$55.

MILAB; 200 Sea Ln., Farmingdale, NY 11735; (516) 249-3660. Product Name: Milab LSR-2000. **Contact:** Sam Spennacchio. **Date Product Introduced:** 9/90. **Product Description & Applications:** The LSR-2000 is designed primarily as a hand-held vocal microphone for live sound reinforcement applications. It is characterized by its crystal-clear, studio-quality sound. **Basic Specifications & Suggested List Price:** Cardioid, -10 dB Pad switch and 70 Hz highpass filter switch; max. SPL (1% THD at 1 kHz) 132 dB (142 with Pad in); sensitivity—6mv/pa; power supply—12 to 52V phantom; price—TBA.

MILAB; 200 Sea Ln., Farmingdale, NY 11735; (516) 249-3660. Product Name: VM-44. **Contact:** Sam Spennacchio. **Date Product Introduced:** 12/89. **Product Description & Applications:** This small diaphragm condenser is perfect for snare drum, violin and acoustic guitar, and as overhead microphones on drum kit. The VM-44 design is based around a small diaphragm cardioid capsule, coupled with transformerless electronic design to yield maximum clarity and response, especially when dealing with sources containing fast transients and abundant high-frequency content. **Basic Specifications & Suggested List Price:** True condenser, cardioid polar pattern, interchangeable capsule, -12 dB pad switch. Max SPL is 128 dB (140 dB with -12 dB pad switched in). Can be powered by 12 to 52V phantom. Retail price \$575.

NADY SYSTEMS, INC.; 6701 Bay St., Emeryville, CA 94608; (415) 652-2411. Product Name: Wireless One VHF Instrument System. **Contact:** Howard Zimmerman, nat'l sales mgr. **Date Product Introduced:** 7/90. **Product Description & Applications:** The Wireless One is a full-fledged VHF high-band, single-channel, wireless system for instrument use. The

design is compact, rugged and simple to operate. The receiver case is metal, with a front panel complete with LED power on/off and transmitter indicators. The transmitter is a compact, rugged bodypack type that clips on to the user's belt or instrument strap. **Basic Specifications & Suggested List Price:** Nady Systems was the first to perfect and utilize specialized companding circuitry for clean, natural sound equal to the best hardwire systems. Besides patented companding circuitry, the Wireless One GT boasts, as do all Nady wireless systems, the best specifications in the business—up to 120dB dynamic range, completely free from overload distortion and background noise. Suggested list price—\$170.



POPLESS VOICE SCREENS
Popless Voice Screen

POPLESS VOICE SCREENS; 716 Pennington St., Elizabeth, NJ 07202; (201) 527-0767. Product Name: Popless Voice Screen. **Contact:** Brian S. Gunn, owner. **Date Product Introduced:** 11/89. **Product Description & Applications:** Popless Voice Screens greatly reduce popping and sibilance allowing close mic placement for vocals and less need for electronic compression and equalization. Screens feature washable black acoustic material available in a 6" or 4" diameters. PVS-6wg (pictured) and PVS-4wc clamp on your mic stand and feature a versatile adjusting system with 30" of reach. PVS-6c and PVS-4c also clamp on having less reach. PVS-6 and PVS-4 are screen only with 5/8" female adapter. Money back guarantee. **Basic Specifications & Suggested List Price:** All models come in black, red/black or white/black. PVC-6wc and PVC-4wc are \$89, PVS-6c and PVS-4c are \$63, PVS-6 and PVS-4 are \$37, replacement screens \$22. Call or write for ordering, information, or the dealer nearest you.



POPPER STOPPERS
Popper Stoppers

POPPER STOPPERS; PO Box 6010-658; Sherman Oaks, CA 91413; (818) 788-3635; (818) 789-7262. Product Name: Popper Stoppers. **Contact:** Robbie Pepper, owner. **Date Product Introduced:** 10/89. **Product Description & Applications:** A pop filter is a device that, when placed between a singer or announcer and a microphone, will eliminate pops from hard consonants such as B's, P's, K's or D's. A pop filter is much like a strainer that catches the percussive blast of energy while allowing all other parts of the sound to come through. A pop filter does not reduce high frequencies nor does it reduce sibilance (S's) substantially. **Basic Specifications & Suggested List Price:** Enter the Popper Stopper. State-of-the-art construction features a double-sided screen with 1/4" dead airspace in between for greater protection. Popper Stoppers are available in 4" and 6" screen sizes and all hardware is non-reflective black. Popper Stoppers' unique clamp and goose-neck design make easy attachment and exact placement a breeze. List \$49.95.

SAMSON TECH. CORP.; 485-19 S. Broadway; Hicksville, NY 11801; (516) 932-3810. Product Name: Samson. **Contact:** Kevin Morar, exp.ort mgr. **Date Product Introduced:** 4/90. **Product Description & Applications:** UHF wireless system will offer 6-channel operation compatible for the same location on a UHF frequency band (938 MHz to 952 MHz). The rack-mount receiver features precise cavity tuning and dielectric filtering to achieve flawless R.F. performance. The transmitters, both attractive and rugged, will come in hand held and belt-pack design, and will offer name-brand microphones and cartridges. **Basic Specifications & Suggested List Price:** Estimated list price for belt-pack system: \$2,000.



SANKEN
(DISTRIB. BY AUDIO INTERVAL DESIGN)
COS-11, COS-11PT

SANKEN (DISTRIBUTED BY AUDIO INTERVAL DESIGN); 1032 N. Sycamore Ave., Los Angeles, CA 90038; (213) 469-4773. Product Name: COS-11, COS-11PT. **Contact:** Jim Pace, Jeff Evans. **Date Product Introduced:** 6/90. **Product Description & Applications:** Omni-directional miniature electret lavaliere featuring ultra-small size, without compromising response or performance due to a unique vertical diaphragm design. The COS-11 uses 48V phantom. The COS-11PT is the digital version. Both include clip and metal windscreens. **Basic Specifications & Suggested List Price:** Frequency response: 20 to 20k Hz; max. SPL at 1% THD: 123 dB; COS-11, 48V phantom; CCS-11PT, +3 to +13 VDC.

SCHOEPS/POSTHORN RECORDINGS; 142 W. 26th St., New York, NY 10001; (212) 242-3737; FAX: (212) 924-1243. Product Name: Schoeps Miniature Stereo Microphone System. **Contact:** Jerry Bruck, owner-president. **Date Product Introduced:** 3/90. **Product Description & Applications:** User configures any two Colette-series capsules for X-Y or M-S stereo, forming a small stereo pickup element. This connects via a thin cable to a remote box that amplifies the signals to line level and offers a M-S matrix as an additional output pair or for stereo monitoring using the headphone output. Both battery and AC operation are provided for, with switchable gain and LF filtering. Ideal companion for portable DAT recordings. **Basic Specifications & Suggested List Price:** Frequency response: 35-20k Hz, +/-1.5 dB. Distortion less than 0.5% at +25 dB SPL. Powering: 8 x AA cells or 12V external supply.

SENNHEISER ELECTRONIC CORP.; 6 Vista Dr., PO Box 987; Old Lyme, CT 06371; (203) 434-9190. Product Name: HD 490. **Contact:** Albert C. Zang, mgr. pro products. **Date Product Introduced:** 9/90. **Product Description & Applications:** Dynamic headphone using the "open-air" concept to provide outstanding comfort as well as superb sound. Aluminum driver coil and neodymium ferrous magnet structure in a super-aural design. Steel stranded connecting cable (14 ft.), replaceable parts, two-year parts and labor warranty. **Basic Specifications & Suggested List Price:** Frequency response: 18-22,000 Hz, impedance: 70 ohms, sensitivity (dB/SPL): 94 dB, distortion (THD 94 dB SPL): less than 1%, weight: 4.8 oz.

SENNHEISER ELECTRONIC CORP.; 6 Vista Dr., PO Box 987; Old Lyme, CT 06371; (203) 434-9190. Product Name: MKH60-P48. **Contact:** Albert C. Zang, mgr. pro products. **Date Product Introduced:** 4/90. **Product Description & Applications:** Short interference tube RF condenser microphone. It is a lightweight metal alloy, transformerless, low noise, symmetrical capsule design short shotgun. A smooth off-axis frequency response gives you a natural sound. We use switchable low-cut filter (-5 dB at 100 Hz), high-frequency boost (+5 dB at 10 kHz) and 10 dB attenuation switches, ideal for broadcasting, film, video, sports, interviewing in noisy environments and excellent for voice-overs. **Basic Specifications & Suggested List Price:** Sensitivity: 40 mv/pa (-28 dBV); equivalent noise: 9 dBA (85 dB S/N); max SPL: 133 dB; output voltage: 1.3 vdlts; weight: 5.25 oz.

MICROPHONES & PICKUPS

SHURE BROTHERS INC.; 222 Hartrey Ave.; Evanston, IL 60202-3696; (708) 866-2200. **Product Name:** VP 88 Stereo MS Microphone. **Contact:** Mark Brunner, sales promotion asst. **Date Product Introduced:** 4/90. **Product Description & Applications:** Single-point stereo condenser microphone with forward-facing mid capsule and perpendicular side capsule. Built-in stereo matrix for natural response and optimal imaging. 100% mono compatible. 3 switch-selectable levels of stereo effect control degree of spread and ambience pickup. Switch-selectable phantom or battery power and low-frequency rolloff. Easily mounted on cameras, floor stands, fishpoles, booms or pistol grips. 30" Y-cable, windscreen, swivel adapter, battery and storage bag included. Shock mount, Rycote zeppelin windscreen and pistol grip optional. **Basic Specifications & Suggested List Price:** Frequency response: 40-20,000 Hz; rated impedance: 150 ohms; output level (1 kHz, MS mode): open circuit voltage -66 dB (0.5 mV) Mid; max SPL: 129 dB (800 ohm load), 119 dB (150 ohm load); battery type and life: 6V cylindrical, avg. 70 hours. Net weight: 416.7 grams (14.697 oz.).



STEPHEN PAUL AUDIO

STEPHEN PAUL AUDIO INC.
The Oracle Series

STEPHEN PAUL AUDIO INC.; 2725-B W. Burbank Blvd.; Burbank, CA 91505; (818) 566-8231. **Product Name:** The Oracle Series. **Contact:** Tony Merrill. **Date Product Introduced:** 7/90. **Product Description & Applications:** The Oracle Series is a group of 1-micron retrofit diaphragm systems for the Neumann TLM170, U47 and M49 microphones. This series represents a major breakthrough in professional condenser microphone capsule design. Six years of development work have resulted in an innovative upgrade of the moving system that combines improved rear rejection, wider off-axis pickup of high frequencies and vastly improved transient response. The new technology has been applied to our widely accepted 3-micron series. **Basic Specifications & Suggested List Price:** U47 and M49 (+3, -1) dB, 20 to 18k Hz. TLM170 +/-2 dB, 20 to 20k Hz (available late 1990). The Oracle 1-micron series: \$2,500. The Logos new 3-micron series: \$800. 2-year replacement warranty.

VEGA WIRELESS; 9900 Baldwin Pl.; El Monte, CA 91731; (818) 442-0782. **Product Name:** R-662 UHF System. **Contact:** James Stoffo, market spec. **Date Product Introduced:** 4/90. **Product Description & Applications:** The UHF Wireless microphone system provides up to 1,500 feet of operating range with 150 milliwatts RF power output from the transmitter. Dymex III audio processing delivers digital-quality audio and outstanding dynamic range. Up to 60 systems can operate simultaneously without interference. This system will be used anywhere that the VHF band is congested including live performance, film, broadcast and anywhere that a wireless is needed. **Basic Specifications & Suggested List Price:** Operating frequency band 490-704 MHz; signal-to-noise ratio 108 dB, FM deviation 75 kHz, audio frequency response 40-15 k Hz, 4-channel RF selectable, \$4,500 list price.

Mix Trivia

2. As it appears on *Beggar's Banquet*, this 1968 Rolling Stones song includes some of the original recording made on a commercial cassette machine.

Turn to page 275 for question

M-1

MICROPHONE PREAMPLIFIER

SUPERIOR SOUND QUALITY. RE-DISCOVER YOUR MICROPHONES!

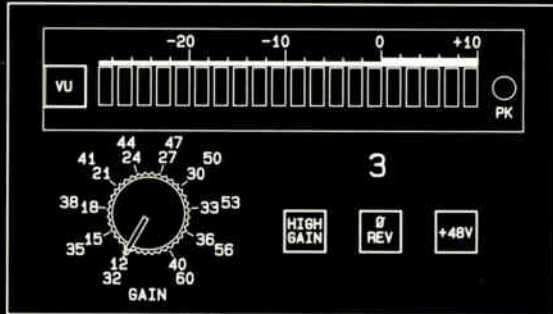

(ACTUAL SIZE)

- THE BEST JENSEN INPUT TRANSFORMER: THE JE-16-B.
- THE BEST OP-AMP: THE 990 DISCRETE OP-AMP.
- DC-SERVO ELIMINATES ALL COUPLING CAPACITORS.
- THE BEST JENSEN OUTPUT TRANSFORMER OPTION: THE JE-11-BM.

- ILLUMINATED SWITCH BUTTONS.
- TOROIDAL POWER TRANSFORMER.
- UNIVERSAL POWER SUPPLY.
- XLR CONNECTORS. GOLD OPTIONAL.
- TWO METER OPTIONS, VU-1 SHOWN.
- CUSTOM KNOB & PUSH BUTTONS.



THE JOHN HARDY COMPANY

P. O. Box AA631
Evanston, IL 60204

(708) 864-8060

Telex: 910-380-4670
(JOHN HARDY CO)

Circle #046 on Reader Service Card

Manufacturers of quality case & cabinet hardware



penn fabrication

Hawthorne, N.J.
Tel: (201) 423-4404

Detroit Michigan
Tel: (313) 961-9111

Newbury Park, CA
Tel: (805) 499-5932

Houston, TX
Tel: (713) 855-9772

Circle #047 on Reader Service Card

MIXING CONSOLES

ALESIS CORPORATION; 3630 Holdrege Ave., Los Angeles, CA 90016; (213) 467-8000. **Product Name:** 1622 Mixer. **Contact:** Allen Wald, VP, advertising and promotion. **Date Product Introduced:** 2/90. **Product Description & Applications:** Two bus console featuring 16 line inputs on 1/4" jacks, 8 XLR mic inputs and 8 direct out (on channels 1-8). High- and low-shelving filters provide +/-12dB of boost/cut at 100 Hz and 10 kHz. Inserts on every channel as well as on the subs and masters. 6 auxiliary sends and 8 returns configurable as 4 stereo pairs. Employs Monolithic Surface Technology for breakthrough performance and price. **Basic Specifications & Suggested List Price:** Dimensions: (W x H x D) 19" x 21" x 1.5"-6". Net weight approximately 14 lbs. Suggested user price is \$899.

ALLEN AND HEATH; Five Connair Rd., Orange, CT 06477; (203) 795-3594. **Product Name:** SC Plus. **Contact:** Chuck Augustowski. **Date Product Introduced:** 6/90. **Product Description & Applications:** SC Plus is an enhancement of Allen and Heath's popular SC range of modular consoles for recording and sound reinforcement. New for 1990 are the 110A standard EQ, 115A sweep EQ, M160A stereo input, M126 matrix, and M156 talkback/oscillator models. **Basic Specifications & Suggested List Price:** Prices vary with configuration.

AMEK SYSTEMS AND CONTROLS LTD.; New Islington Mill, Regent Trading Estate, Old Field Rd., Salford, M5 4SX England; (061) 834-0593 UK; (818) 508-9788 U.S. **Product Name:** Mozart/RN. **Contact:** Steve Harvey, nat'l sales manager. **Date Product Introduced:** 9/90. **Product Description & Applications:** In a spectacular new development for the Mozart console, Amek is introducing an input module with audio circuitry designed by Rupert Neve. The new module fits within the parameters of automation and signal flow designed for the Mozart system and supplements the existing module range. The new module can be mixed in any combination with the existing modules. States Mr. Neve: "This new input module for the universally acclaimed Amek Mozart offers a standard of audio quality that has never before appeared in a console within this price range." **Basic Specifications & Suggested List Price:** The Mozart/RN input features a 4-band parametric equalizer with swept pass filters, mic amp and bus driver designed by Mr. Neve. Signal flow configuration is similar to the standard Mozart modules but rotary controls for all 16 auxiliary buses and an in-line monitor fader are provided. The module is reasonably priced at approximately 50% more than the standard input modules.

AUDIO MEDIA RESEARCH; 711 A Street, Meridian, MS 39301; (601) 483-5365. **Product Name:** 1242 Mixing Console. **Contact:** Lance Schmidt, sales manager. **Date Product Introduced:** 1/90. **Product Description & Applications:** 12 input channels; low Z, XLR mic inputs (1-8); line level inputs (tape) (9-12); electronically balanced input circuit offering 100 dB of common mode rejection; mixdown facilities to accommodate up to 16-track masters; 3-band active EQ low/sweepable midrange; 2 aux sends; peak reading LED each channel; stereo insert point per channel; 100mm, long throw faders; 8-input monitor mix section with level and pan; headphone output with level control; 4 separate output buses; mute switch; mic/line switch (1-8); tape/line switch (9-12). **Basic Specifications & Suggested List Price:** Target suggested list \$1,199.99.

AUDITRONICS, INC.; 3750 Old Getwell Rd., Memphis, TN 38118; (901) 362-1350. **Product Name:** 900 Series Television Audio Console. **Contact:** Murray Shields, director of sales. **Date Product Introduced:** 12/89. **Product Description & Applications:** Designed specifically for television news, on-air and production with the ability to rapidly access multiple (100 or more) high-level stereo line sources. The 900 console, via an RS232 or 422 communications bus, will directly communicate with the stereo audio cross-points in a house audio/Video router. Additional features are digital control, preview and program buses, memory storage of setups, and source alphanumeric readouts. Alternate versions with and without computer assist are available. **Basic Specifications & Suggested List Price:** Frequency response: +0, -1/2dB, 20 Hz-20 kHz. Signal-to-noise ratio: >84 dB, (Ref. +4 dBV), at nominal settings. Distortion: <.05% THD, 20 Hz-20 kHz at maximum output level. Crosstalk: <-80 dB (Ref. +18 dBV) at 1 kHz. Maximum output level: +24 dBV (Ref. 0.775 VRMS).

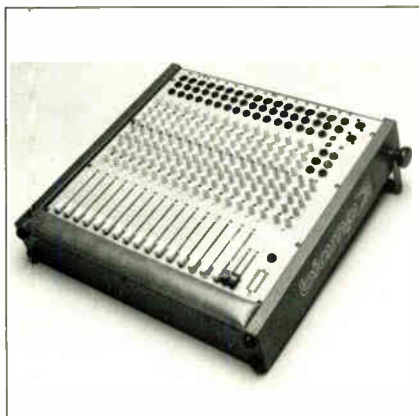

BIAMP SYSTEMS
Cascade 12 or 16

BIAMP SYSTEMS; 14270 NW Science Park Dr., Portland, OR 97229; (503) 641-7287; (800) 826-1457. **Product Name:** Cascade 12 or 16. **Contact:** Ron Camden, sales manager. **Date Product Introduced:** 4/90. **Product Description & Applications:** Two console models, 12 and 16 channels, that require only 3 square feet of space. Top-mounted jacks so that the units can be flush against a wall. Three-band fixed EQ. 40 dB of trim control to accommodate a wide range of input signals. Signal present and peak LED for easy operation. Four aux sends for lots of flexibility, two stereo returns and one mono return. 48-volt phantom power. Manufactured in Portland, OR. **Basic Specifications & Suggested List Price:** Discrete transistor preamps. 5532's and TL072's low-noise transistors used throughout. Insert jacks on all input channels. Complete solo system. Balanced outputs. Tape output and 600 ohms headphone output. Retail 12-channel \$1,699, 16-channel \$1,999.

CREST AUDIO, INC.; 150 Florence Ave., Hawthorne, NJ 07506; (201) 423-1300. **Product Name:** Crest Gamble Series EX monitor console. **Contact:** Craig Hannabury, div. mgr. **Date Product Introduced:** 6/90. **Product Description & Applications:** The Series EX monitor console features 48 input channels, each with 4-band full-parametric EQ, 8 programmable scene mutes and a 20-segment LED display. There are 16 mix buses that feed into a 16 x 16 matrix which feeds into 16 output channels; each with a 5-band parametric EQ. An integral patch bay and a full complement of multi-pin connectors are also included. **Basic Specifications & Suggested List Price:** Frequency response: +0, -3 dB, 20 Hz-20 kHz at 0 dBV; clipping point +26 dBV throughout console; dynamic range 108 dB; distortion <.003%, 1 kHz at +20 dB. Suggested retail price: \$89,900.

CTI AUDIO; Harbor and Jackson Sts., Box 120, Conneaut, OH 44030; (800) 762-9266. **Product Name:** Series II Maxcon Sub/Aux. **Date Product Introduced:** Fall 1990. **Product Description & Applications:** The Series II Maxcon Aux module features 8 equalized, assignable aux returns and 8 aux master sends with AFL as well as 8 bus masters featuring 100mm faders and 24-track output assignment. The former allows direct interface with 24-track recorders.

CTI AUDIO; Harbor and Jackson Sts., Box 120, Conneaut, OH 44030; (800) 762-9266. **Product Name:** Series Maxcon II Master II Module. **Date Product Introduced:** 1990 AES. **Product Description & Applications:** The Series II Maxcon Master II module allows convenient interface and operation with up to 3 sets of control room monitors and four 2-track recorder/reproducers. Additional features include an expanded talkback/oscillator slating system, trimmable 100 mm and stereo master fader, solo gain and headphone driver.

D&R ELECTRONICS; Rte. 3, Box 184-A, Montgomery, TX 77356; (409) 588-3411. **Product Name:** Avalon. **Contact:** Paul Westbrook. **Date Product Introduced:** 3/90. **Product De-**

scription & Applications: Recording console; available in three frame sizes (32, 48, 64) in-line format with 32 buses, 4-band fully parametric EQ (each band switchable channel/monitor), 8 aux sends (switchable to 24), three mute groups, programmable solo system, 32 groups, separate fader section, totally balanced, and automation ready. Designed for digital studios, remote trucks, and high-quality analog studios, this console can be ordered with an extensive patch bay or installed later.

DAX, DIVISION OF BAUDER INTERNATIONAL CORP.; 10240A NE Marx St., Portland, OR 97220; (503) 252-4783. **Product Name:** DAX Mixing Consoles and Rack-Mount Mixers. **Contact:** Judy House, int'l. marketing coord. **Date Product Introduced:** 11/89. **Product Description & Applications:** DAX is recognized for high-end quality, professional sound reinforcement products at low-end prices. DAX mixing consoles were designed to provide optimum control over live and recorded sound. They are versatile enough to provide audio feeds for simulcasting, packed with features that make them at home in the control room or in the tough and rugged world of remote operations for broadcast application. Our rack-mount mixers offer the same features in a convenient rack-mount configuration. **Basic Specifications & Suggested List Price:** Mixing consoles range from 8 channels and 2 submasters up to 32 channels and 8 submasters. 1 each submaster input, 3 aux returns line level, 1 left main in, 1 right main in, 1 monitor in, 1 main in, 1 solo stacking—general specs on all models. For prices please call your nearest DAX dealer, or DAX at (503) 252-4783.

DDA; 200 Sea Lane, Farmingdale, NY 11735; (516) 249-3660. **Product Name:** DCM224V. **Contact:** Chris Fichera, product sales specialist. **Date Product Introduced:** 7/90. **Product Description & Applications:** The DCM224V was developed for video/post-production. It features four stereo subgroups in addition to other subgroups and both mono and stereo matrix sections. The input module is an extended version of the DCM232 module, with expanded equalizers and auxiliary system. In addition to the standard automated switching of 24 functions per channel, DCM224V now features a moving fader system. **Basic Specifications & Suggested List Price:** The DCM224V has balanced outputs, noise level microphone at <-127 dBV, line at <-82 dBV. Distortion (mic and line) at <0.05%. Crosstalk: between any two groups <-88 dBV at 1 kHz, group to mix <-82 dBV at 1 kHz. Suggested list price: 40-channel with moving faders is \$150,000.

DDA; 200 Sea Lane, Farmingdale, NY 11735; (516) 249-3660. **Product Name:** DMR-12. **Contact:** Chris Fichera, product sales specialist. **Date Product Introduced:** 7/90. **Product Description & Applications:** The DMR-12 is ideally suited for all types of 24-track facilities (tape or tapeless) including professional recording studios or domestic studios owned by musicians or producers. Input modules feature mic and 2-line input. Eight auxiliary buses, with controllable direct output facility. It has the capacity to provide 56 effect sends, 56 line inputs, 56 effect returns and the auxiliary buses simultaneously. The DMR-12 has a MIDI-mute automation along with your choice of VCA fader automation. **Basic Specifications & Suggested List Price:** The DMR-12 has balanced outputs, noise level microphone at <-127 dBV, line at <-84 dBV. Distortion (mic and line) at <0.05%. Crosstalk: channel to channel at 1 kHz -90dB, group to mix at 1 kHz -80 dB. Suggested list price 56-channel frame (35/12/12) is \$41,500.

DYNACORD; 10500 W. Reno Ave., PO Box 26105, Oklahoma City, OK 73126-0105; (818) 350-4970; FAX: (818) 444-1342. **Product Name:** Dyncord MCX Series 4800. **Contact:** John Parker, nat'l sales manager. **Date Product Introduced:** 1/90. **Product Description & Applications:** MCX 4800 Series consoles' sturdy steel design and retrofit multicore systems make it very desirable for rough, on-the-road treatment. Its large number of inputs and outputs for connecting tape machines and monitoring capabilities are provided for studio applications. The MCX Series 4800 consoles are great for demanding live applications or as sleek studio mixers in partial modular design. **Basic Specifications & Suggested List Price:** MCX 32 x 8 x 2: 32 inputs; distortion: under 0.1%; frequency response: 15-40k Hz; signal to noise: 129 dBV(A). Four-band EQ: LF filter, 80 Hz at 18 dB/octave; LF EQ, 60-600 Hz (+/-15 dB); MF EQ, 2-6 kHz (+/-15 dB); HF EQ, 3-16 kHz (+/-15 dB). MCX 32 x 20. List price: \$28,000.

EUPHONIX, INC.; 441 Page Mill Rd., Palo Alto, CA 94306; (415) 325-5003. **Product Name:** Crescendo™ Audio Mixing System. **Contact:** Scott Silfvast, president. **Date Product Introduced:** 4/90. **Product Description & Applications:** The Euphonix Crescendo is a powerful audio production console with SMPTE-based automation of all mixer functions, including faders, mutes, EQ, mic pres, and signal routing. Entire console setups can be recalled in 30 msecs. Snapshots and automation files are stored in high-speed RAM and archived to hard disk. The innovative digitally controlled analog design can be tailored for multiple applications, including film and video post-production, music recording, remote recording and broadcast. **Basic Specifications & Suggested List Price:** The Crescendo may be configured for 48 to 112 inputs and includes 2 mic inputs, 2 EQs, 2 stereo faders, 3 effects loops, and 2 direct outputs per channel. Graphic display of EQ response curves on high-res color monitor. The design yields >110 dB dynamic range at <.006% THD. Retail price ranges from \$60,000-\$95,000, depending on system configuration.

—SEE PHOTO NEXT PAGE

MIXING CONSOLES

—LISTING CONTINUED FROM PREVIOUS PAGE



EUPHONIX, INC.
Crescendo™ Audio Mixing System

FOSTEX; 15431 Blackburn Ave.; Norwalk, CA 90650; (213) 921-1112. Product Name: 820 Mixer. Contact: Mark Cohen, VP. Date Product Introduced: Fall 1990. Product Description & Applications: 20-input 8-bus output mixer, new active added EQ section overload indicators, phantom power, wet and dry monitor, peak hold bar graph. Optional MIDI muting interface input trim controls, 2 effect sends, 1 stereo effect send, 3 stereo returns, solo on inputs and subgroups. **Basic Specifications & Suggested List Price:** Inputs: mics 600 ohms or less, line level -10 dBv, frequency response 20-20k Hz, 175mm x 670mm x 530mm (H x W x D).

GALAXY AUDIO; 625 E. Pawnee, Wichita, KS 67211; (316) 263-2852. Product Name: I/O Mixing Consoles. Contact: Jim Pearce, sales manager. Date Product Introduced: Fall 1989. Product Description & Applications: I/O mixing consoles are designed to accommodate a wide range of needs, giving the sound engineer choices not offered in any other mixing console in this price range. Options include: number of input channels, from 4 to 24, in 4-channel increments; rack-mount option, available on 4- and 8-channel models; connector panel position, either opposite or adjacent to the faceplate; and auxiliary send configuration, user-selectable for every send on every channel, one of four configurations.

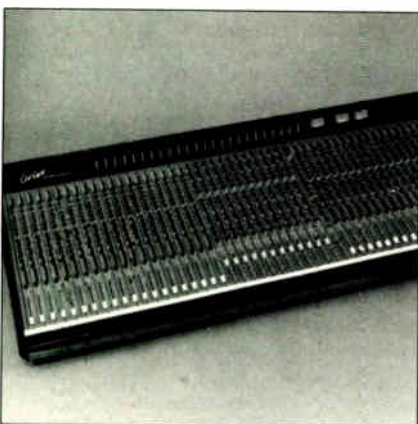

GOUTAM ELECTRONICS PRODUCTS LTD.
Aries Artemis 12 Bus

GOUTAM ELECTRONICS PRODUCTS LTD.; Unit 3B 6-24 Southgate Road; London, N13JW England; (071) 249-5306. Product Name: Aries Artemis 12 Bus. Contact: Anne Rubin, product manager. Date Product Introduced: 1/90. Product Description & Applications: Artemis 12 Bus is another new dynamic console from Aries and is the answer to all the problems that have worried professionals for many years. Artemis covers many applications: studio, mobile studio, simultaneous recording, post-production, etc. Artemis is suitable for the most demanding professional, and its principal advantage is its well-proven reliability. Aries Artemis is a fully modular console compatible with the best multitrack machine and costs less than

other well-known studio consoles. **Basic Specifications & Suggested List Price:** Aries Artemis 12 Bus is available in 24, 32 or 40 input configurations, 12 group outputs, 24-track monitoring, stereo master output, control room monitor, superb 4-band EQ, 8 auxiliary sends with master section oscillator and talkback. The Artemis offers 24 multi-segment LED meters.

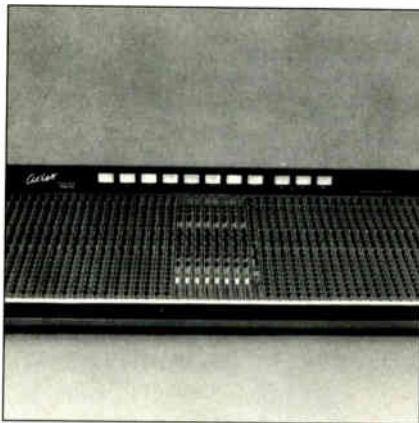

GOUTAM ELECTRONICS PRODUCTS LTD.
Aries Astrid Monitor

GOUTAM ELECTRONICS PRODUCTS LTD.; Unit 3B 6-24 Southgate Road; London, N13JW England; (071) 249-5306. Product Name: Aries Astrid Monitor. Contact: Anne Rubin, product manager. Date Product Introduced: 1/90. Product Description & Applications: Aries Astrid Monitor offers the sophistication of top studio consoles and the performance and reliability demanded in live touring situations. The ergonomics result from very long and serious considerations, the functions are quickly recognizable and have easy access. With the Astrid Monitor you have the insurance you need to totally concentrate on creating the right sound. Astrid Monitor offers 24, 32, or 40 input configurations. The PSV is an 14" 3U rack. **Basic Specifications & Suggested List Price:** Astrid Monitor offers 8 group outputs, 8 sophisticated effect returns, stereo master output, control monitor, 8 auxiliary sends with master section, oscillator and talkback. Each input is equipped with 8 routing pots, left and right pan pot and volume control (no fader). Astrid Monitor offers 11 meters.



GRAHAM-PATTEN SYSTEMS, INC.
D/ESAM 800 Digital Edit Suite Audio Mixer

GRAHAM-PATTEN SYSTEMS, INC.; PO Box 1960; Grass Valley, CA 95945; (916) 273-8412. Product Name: D/ESAM 800 Digital Edit Suite Audio Mixer. Contact: Tim Prouty, VP sales and marketing. Date Product Introduced: 4/90. Product Description & Applications: D/ESAM™ 800 is designed specifically for use in videotape editing. D/ESAM accommodates as many as 56 input tracks of audio, either digital or analog, and mixes 16 channels to 4, digital and analog, outputs. Virtual flexibility allows instant control of assignment, previewing and other control and routing. D/ESAM 800 operates with ESAM II Protocol and numerous eves-dropping and direct control interfaces. Options include 3-band parametric equalization, analog meters and assignment panel. **Basic Specifications & Suggested List Price:** Physical inputs: 56 analog and digital. Mixing channels: 16 mixed to 4. Outputs: 4 digital AES/EBU 16-bit, 4 analog variable +11 dBu to +24 dBu. Total distortion plus noise < -92dB. Edit system control: ESAM Protocol. Panel size including accessories: 14". Electronics frame: 5.25" rack-mount.

HARRISON BY GLW; 437 Atlas Dr.; Nashville, TN 37211; (615) 331-8800; FAX: (615) 331-8883. Product Name: ARS-9 Audio Routing Switcher. Contact: Tom Irby. Date Product

Introduced: 7/90. Product Description & Applications: The latest product incorporating Harrison's highly advanced studio technology, the ARS-9 Audio Routing Switcher is a sophisticated audio routing switcher under microprocessor control. Designed for multi-room recording, video post, broadcast, and film facilities, the ARS-9 is engineered to work in tandem with the Harrison Series Ten totally automated mixing console. This powerful combination allows the instant re-creation of all console functions, including multiple source routing to and from the console. **Basic Specifications & Suggested List Price:** A completely transformerless, differential unit on both inputs and outputs, the ARS-9 may be filled with up to 256 inputs and 256 outputs, allowing a maximum of 65,636 switches or crosspoints. Addressing all of these crosspoints is accomplished via an 00C31 micro-controller running at 12 MHz. Call for system configuration and pricing details.

HARRISON BY GLW; 437 Atlas Dr.; Nashville, TN 37211; (615) 331-8800; FAX: (615) 331-8883. Product Name: Series Ten update. Contact: Tom Irby. Date Product Introduced: 9/90. Product Description & Applications: Harrison's Series Ten now offers enhanced console-operating hardware and new automation-operating software with improved mix/merge utilities, as well as full integration of the ARS-9 Audio Routing Switcher setups in its database. The world's first and only 100% totally automated mixing console for music, audio-for-video post-production, teleproduction, and motion picture program origination, the Harrison Series Ten features Harrison's revolutionary digitally controlled attenuator (DCA) technology. Incorporating more than 35 man-years of development, the Series Ten has been acclaimed as the best sounding mixing console ever.

HILL AUDIO, INC.; 5002-B.N. Royal Atlanta Dr.; Tucker, GA 30093; (404) 934-1851. Product Name: Datum Series. Contact: Skip Godwin, sales manager. Date Product Introduced: 9/90. Product Description & Applications: Range of consoles including 4 frame sizes (31, 39, 47 and 55 spaces) with 12 module options. Modules include a standard input, deluxe input, stereo input, dual group/output module, recording group, matrix group, mix master, function master, FX return, monitor input, dual stage monitor output, and stage monitor functions module. Features include sweep EQ, 8 aux sends, phase reverse highpass filter, EQ on all returns, onboard oscillator, solo function and meter bridge. **Basic Specifications & Suggested List Price:** Configurations include up to a 40: 8: 16: 2 and 40: 12: 24: 2 recording consoles, 40: 8: 8: 2 sound reinforcement consoles, and 48: 12 stage monitor consoles. Suggested list prices range from \$8k to \$25k.

INKEL P.A., IMPORTED BY MAXITRON CORP.; 13431 Pumice St.; Norwalk, CA 90650; (213) 802-9942; (213) 802-9643; FAX: (213) 802-9945. Product Name: MX-1010, MX-1410 and MX-1810 mixers. Contact: Irv Weisman, nat'l sales mgr. Date Product Introduced: 6/90. Product Description & Applications: This new series of mixers offers a 10-input rack-mount model the MX-1010, MX-1410 with 14 inputs and an 18-input version, the MX-1810. Useful features include 20dB mic input pad, input trims, parametric mid EQ, effects inserts on inputs and outputs, PFL and cue on inputs and outputs, phantom power, reverb, mic, line phono selectable on last two stereo inputs, LED output meter display. Left, right, main and monitor outputs. Stereo 9-band graphic output EQ. **Basic Specifications & Suggested List Price:** MX-1010 is priced at \$1,240, MX-1410 at \$1,520, MX-1010 at \$1,780. Input sensitivity and impedance, 2-20 mV/2.2 kohms; phono 1-100 mV/47 kohms; line, 4.5-450 mV/47 kohms; talk back, 3.5 mV/47 kohms; input EQ (high 10 kHz +/- 15 dB, mid 350-7.5 kHz +/- 12 dB, low 100 Hz +/- 15 dB), THD is less than .05%, crosstalk more than 75 dB, SN ratio mic 68 dB, phono 64 dB, line 70 dB.

IVIE TECHNOLOGIES, INC.; 1366 W. Center St.; Orem, UT 84057; (801) 224-1800. Product Name: 804/804R Automatic Mixer. Contact: Glen Meyer. Date Product Introduced: 7/90. Product Description & Applications: Ideal for churches, schools, board rooms and hotels, the new 804/804R are 4-input automatic microphone mixers that include an additional three line-level inputs, tone controls on the first two channels, and the Blast on S feature. The aux and master are remountable on the 804 and all channels are remountable on the RRS version. This remote feature is accomplished by use of a 10K pot or Irv remote mixers. Additionally, all channels can be remotely turned on or off. **Basic Specifications & Suggested List Price:** The frequency response is 20 to 20,000 Hz, 1.1 dB, making it usable in music application. Maximum gain is 78 dB. Dimensions are 1.75" high, 10.5" deep and 19" wide. The 804/804R retails for \$1,750 and \$1,892, respectively.

IVIE TECHNOLOGIES, INC.; 1366 W. Center St.; Orem, UT 84057; (801) 224-1800. Product Name: 808/808R Automatic Mixer. Contact: Glen Meyer. Date Product Introduced: 7/90. Product Description & Applications: Ideal for churches, schools, board rooms and hotels, the new 808/808R are 8-input automatic microphone mixers that include an additional three line-level inputs, tone controls on the first two channels, and the Blast on S feature. The aux and the master are remountable on the 804 and all channels are remountable on the RRS version. This remote feature is accomplished by use of a 10K pot or Irv remote mixers. Additionally, all channels can be remotely turned on or off. **Basic Specifications & Suggested**

—LISTING CONTINUED ON NEXT PAGE

BE QUIET!

If you assign all your channels to the stereo mix buss with the channel faders, master faders, and your control room monitors wide open and you hear more than just small hiss, maybe it's time to change mixing consoles. Get a console with specs and sound you don't have to apologize for. BE QUIET with a new D&R mixing console and hear quiet like you've never heard before. Call our customer support department at (409) 588-3411 for a "factory direct" quote today.

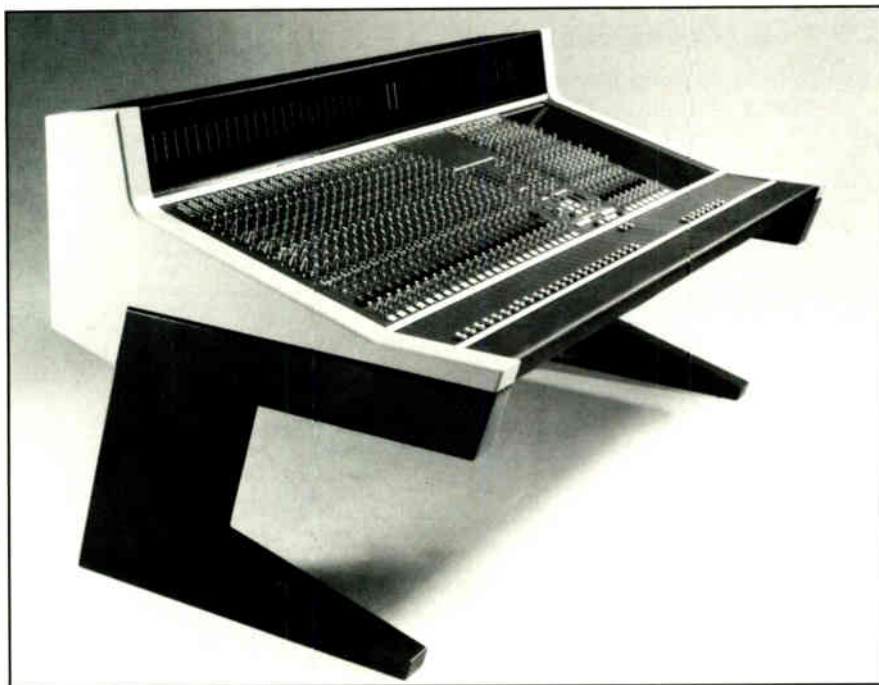

Pictured above is the D&R AVALON which will premier with several new D&R consoles at the AES 89th Convention in Los Angeles, Sept. 21st thru 25th.

TOTAL CONTROL

D&R

mixing consoles

D&R USA • Rt. 3, Box 184-A • Montgomery, TX 77356 • Phone: (409) 588-3411
D&R Electronica b.v. • Rijnkade 15B • 1382GS Weesp • The Netherlands • Phone: (--) 31 2940 18014

Circle #122 on Reader Service Card

WorldRadioHistory

RECORDING EQUIPMENT

—All Major Brands—



FOR STUDIOS/HOMES CHURCHES/CLUBS

- Reel to Reel Decks (2-4-8-16 Track)
- Cassette Decks • Mixing Boards
- Mikes • Studio Monitor Speakers
- Special Effects Units Accessories

TASCAM
Hi-Fi Production Products



- VOLUME DEALER
- NEW & USED
- E-Z TERMS
- ALL MAJOR CREDIT CARDS
- PROFESSIONAL ADVICE

Call for a catalog and pricing information.

RHYTHM CITY

287 East Paces Ferry Road N.E.
Atlanta, Georgia 30305

1-404-237-9552 • 1-404-237-8526

CALL TOLL-FREE IN GA 1-800-282-7995

Circle #048 on Reader Service Card

1991 · NEW · PRODUCTS

MIXING CONSOLES

—LISTING CONTINUED FROM PREVIOUS PAGE

List Price: The frequency response is 20 to 20,000 Hz, 1.1 dB, making it usable in music applications. Maximum gain is 78dB. Dimensions are 1.75" high, 10.5" deep and 19" wide. The 808/808R retails for \$2,620 and \$2,750, respectively.



MERIDIAN COMMUNICATIONS
Distramix

MERIDIAN COMMUNICATIONS; PO Box 97; Alameda, CA 94501; (415) 769-1515. Product Name: Distramix. Product Description & Applications: The Distramix® is an expandable 8 x 8 distribution amplifier/mixer combination that provides the operator with a line-level mix matrix. The Distramix uses include additional aux, sends and returns and independent headphone mixes for the recording studio, separate mixes for house and stage, and mixing console combining for live reinforcement, room combining in multi-room meeting facilities and a mix-minus system for teleconferencing. Linking jacks allow the user to expand inputs and/or outputs by linking units together. **Basic Specifications & Suggested List Price:** The inputs and outputs are both +4dBm bal. (XLR) and -10dBm unbal. (1/4" phone). The -10dBm unbal. output is adjustable to 0dBm. Input and output LED metering. Output mute capability. For further information please contact Meridian Communications or a local authorized Distramix dealer. Suggested list price \$2,750.

MIDAS; 200 Sea Lane; Farmingdale, NY 11735; (516) 249-3660. Product Name: Midas XL3. Contact: Sam C. Spennacchio, nat'l sales mgr. Date Product Introduced: 9/90. Product Description & Applications: The XL3 console is flexibly designed for use as a front of house or monitor console. The XL3 includes (8) automates on all inputs and (16) of the outputs, (8) VCA masters, (18) discrete sends with a (2) derived sends, and (2) VCA "grand masters" for VCA control of the output. Sizes are available from 16 to 40 inputs, with "stretch" frames available to accommodate up to 88 inputs. All inputs, outputs and inserts are electronically balanced, all faders are Penny & Giles. **Basic Specifications & Suggested List Price:** Price to be announced.

MIDAS; 200 Sea Lane; Farmingdale, NY 11735; (516) 249-3660. Product Name: XL88. Contact: Sam C. Spennacchio, nat'l sales mgr. Date Product Introduced: 7/90. Product Description & Applications: The XL88 is a stand-alone 8 x 8 line-level matrix mixer designed for adding additional matrix capability to existing consoles, as well as for use on its own in mobile broadcast/recording/sound reinforcement applications. The XL88 is 4" high, and each module includes an input, direct output and matrix output, and 8 matrix sends and 20-segment LED metering. All inputs and outputs are electronically balanced and all faders are Penny & Giles. **Basic Specifications & Suggested List Price:** Retail price \$6,250.

NEOTEK CORPORATION; 1154 W. Belmont; Chicago, IL 60657; (312) 929-6699. Product Name: Encore. Contact: Tom Der, sales and support director. Date Product Introduced: 9/90. Product Description & Applications: Neotek Corporation, Chicago, will introduce its new Encore console series for film dubbing and film-style television post-production. Available in both 4-track and 6-track formats with several automation options, and many custom patch bay alternatives, the Encore combines Neotek's outstanding sonic performance with comprehensive facilities familiar to film mixing engineers. Although appropriate to classical mixing techniques, the Encore

The Digital Studio™ System

Direct Hard Disk Multi-Track Recording, Editing & Mixing



- 16 BIT DIGITAL AUDIO @ 32, 44.1 or 48KHz
- 256 VIRTUAL TRACKS PLUS EDL SUPPORT
- UP TO 16 TRACKS MIXDOWN TO STEREO
- REAL-TIME DIGITAL SIGNAL PROCESSING
- UNLIMITED NON-DESTRUCTIVE EDITING
- INSTANT AUDITIONING OF ALL EDITS
- UP TO 18 TRACK-HOURS RECORDING TIME
- BUILT-IN GRAPHICAL WAVEFORM EDITOR
- MAGNETO-OPTICAL or TAPE BACKUP DEVICES
- FULL SMPTE & MIDI TIME CODE SUPPORT
- MULTI-TASKING with SPECTRAL APPLICATIONS
- EXPANSION via SOFTWARE and HARDWARE

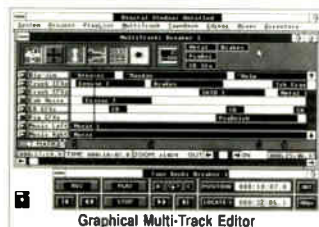

Graphical Multi-Track Editor

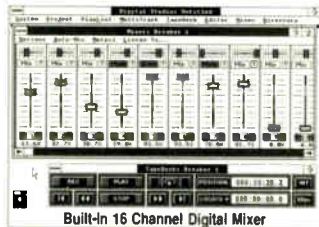

Built-in 16 Channel Digital Mixer

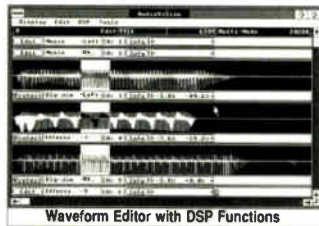

Waveform Editor with DSP Functions



Products for Synthesis, 16 Bit Sampling & Digital Recording
18568 142nd Ave NE - Woodinville, WA 98072
(206) 487-2931 FAX:(206) 487-3431

Circle #049 on Reader Service Card

architecture brings unprecedented flexibility to the dubbing stage. **Basic Specifications & Suggested List Price:** Available in versions for one to three operators and with up to 96 inputs, Encore consoles are made to individual order. Large Encore consoles begin under \$200,000.

NEVE; 7 Parklawn Dr.; Bethel, CT 06801; (203) 744-6230. Product Name: DTC-2 Digital Transfer Console. Contact: Charles Conte, PR administrator. Date Product Introduced: 6/90. **Product Description & Applications:** An enhanced version of the Neve DTC-1. New equalization consists of 2 pairs of selections for LF and HF, with a full range of peak/shelf responses in both sections. Midrange band coverage between 1,000 Hz and 3,150 Hz with a choice of up to 7 different Q values. A/B store system to facilitate comparisons between different EQ settings. LF sections cover the range 28 Hz to 3.15 kHz with peaking response at four values of Q (0.5, 0.8, 1.0, 2.0, 5.0). The frequency interval for all responses is 1/6 octave. **Basic Specifications & Suggested List Price:** Optional dither as cure for low-level distortion. New Neve A/D and D/A converters include special anti-aliasing and anti-imaging filters resulting in signal-to-noise figures exceeding 102 dB.

OTARI CORPORATION; 378 Vintage Park Dr.; Foster City, CA 94404; (415) 341-5900. Product Name: Premiere Console. Date Product Introduced: 1990. **Product Description & Applications:** Specially designed for the needs of feature film and television post-production. Compatible with both sprocket-driven and tape-based sources. Console configurations are available with any number of inputs and from one to three or more engineer positions. Features include 4-channel panning, Virtual Monitor/Listen Computer System, and DiskMix 3/Film moving fader automation.

OTARI CORPORATION; 378 Vintage Park Dr.; Foster City, CA 94404; (415) 341-5900. Product Name: Sound Workshop Series 54 Film Console. Date Product Introduced: 1990. **Product Description & Applications:** 24-bus audio console available in configurations from 24 to 60 dual-path input modules. Special features include master selectable 4-channel panning, master 4-channel monitoring, and additional controls on each module for front/surround panning and image divergence. Additional options include Virtual Monitor/Listen Computer Systems and DiskMix 3 automation on request.

PEAVEY ELECTRONICS; 711 A St.; Meridian, MS 39301; (601) 483-5365. Product Name: SRC 2400. Contact: Ernie Lansford, sales mgr. Date Product Introduced: 1/90. **Product Description & Applications:** 24 input channels; XLR balanced inputs; 1/4" unbalanced inputs; pre EQ send and return patch each channel; 60dB input gain; 3-band EQ w/ sweepable mid; six aux sends; PFL; channel limit LED; full channel assignment to four separate outputs and L&R; master (mono) output; four 10-segment LED arrays; two XLR lamp sockets; 100mm long-throw faders; lightweight, portable, road-rugged package; two aux sends pre, two post and two switchable. 60dB input gain and exceptional signal-to-noise. Sound reinforcement application console. **Basic Specifications & Suggested List Price:** To be announced.

PEAVEY ELECTRONICS; 711 A St.; Meridian, MS 39301; (601) 483-5365. Product Name: XR-1200D (powered mixer). Contact: Ernie Lansford, sales mgr. Date Product Introduced: 1/90. **Product Description & Applications:** 12 input channels; 300 watts RMS per channel (stereo); low Z balanced inputs; high Z unbalanced (1/4") inputs; channel insert patch; two pre monitor sends; two post effects sends; 4-band active EQ; two 9-band graphic equalizers; 60mm faders; four 10-segment LED arrays; 16-bit stereo digital effects processor; adjustable slap-back echo; up to 128 presets of reverb, delay, echo and many combination effects, all in stereo. **Basic Specifications & Suggested List Price:** Target suggested retail: \$1,799.99.

RAMSA

Professional Audio Systems

RAMSA PANASONIC INDUSTRIAL COMPANY
C-900 (Ramsa)

RAMSA (PANASONIC INDUSTRIAL COMPANY); 6550 Katella Ave., Cypress, CA 90630; (714) 373-7277. Product

Name: C-900 (Ramsa). Contact: Chris Forman. Date Product Introduced: 11/89. **Product Description & Applications:** The WR-C900 mixing console features a new, discrete left-center-right panning capability. Sonically identical to the WR-S840 Series console, the WR-C900 maintains the highest level of quality, value and versatility. **Basic Specifications & Suggested List Price:** List price: \$16,200 to \$16,900.

REAL WORLD DESIGNS; Box Mill, Box; Wiltshire, SN14 9PL UK; 011 44 225-74318; FAX: 011 44 225-743787. Product Name: Automated Send Matrix (ASM). Contact: Peter Holmes, Mike Large. Date Product Introduced: Major hardware and software updates 6/90. **Product Description & Applications:** Adds between two and 16 separate effects/foldback sends to an existing console. Unlike the existing sends, the switching of each channel to each mix bus can be memorized and controlled by the onboard computer. As well, the master VCA output levels are memorized and additional VCAs can be added for the inputs or as patchable auxiliaries. It can be used with any console, both to augment its existing facilities and to extend the creative possibilities while mixing. **Basic Specifications & Suggested List Price:** Semi-customized modular system with between 16 and 96 inputs. Disc drive, MIDI-controlled automation facilities and time code reader/converter included. Optional modules available for insert muting and DI outputs. Available directly from RWD or via Solid State Logic for factory fitting to new consoles, P.O.A.

SOUNDCRAFT; 8500 Balboa Blvd.; Northridge, CA 91329; (818) 893-4351. Product Name: Delta 8. Contact: David Kimm, nat'l sales mgr. Date Product Introduced: 9/90. **Product Description & Applications:** Based on the popular Delta Series, the Delta 8 is specifically designed for 8- or 16-track recording. Featuring 8-bus format, 16-monitor split configuration, with 2 bands of EQ in monitor section. Monitor returns double as extra line inputs for mixdown. Expanded aux facilities: 6 alternate speaker monitor switching, PFL trim. Fully modular, available in frames of 20, 28 or 36 inputs. **Basic Specifications & Suggested List Price:** Frequency response: 20 Hz to 20 kHz +0, -0.5 dB; crosstalk: -85 @ 1k, -80 @ 10k; channel muting > 90 dB; active pan isolation > 80 dB; typical mix noise -80 dBu; THD @ 20 dBu = <.005% @ 1k; Max output (bal) +27 dBu @ 600 ohms, all others +21 dBu. Padless mix preamp +70 dB gain.

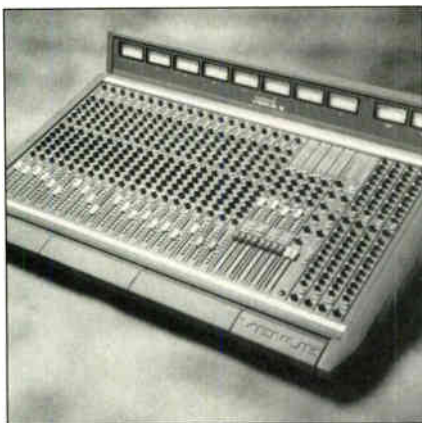

SOUNDCRAFT
Venue

SOUNDCRAFT; 8500 Balboa Blvd.; Northridge, CA 91329; (818) 893-4351. Product Name: Venue. Contact: David Kimm, nat'l sales mgr. Date Product Introduced: 4/90. **Product Description & Applications:** A fully modular 8-bus console, the Venue is dedicated to live mixing, available in 16, 24, 32 or 40-channel frame sizes. Both input modules provide four mute group facilities with an innovative stereo-width control featured on the stereo input, enabling the width of the stereo image to be continuously varied, from mono through to stereo and on to phase-enhanced wide stereo. An optional 10 x 8 matrix allows additional output mixes to be created from signals present at the group and mix outputs. **Basic Specifications & Suggested List Price:** Frequency response: 20 Hz to 20 kHz +0, -0.5 dB; crosstalk: -85 @ 1k, -80 at 10k; channel muting > 90 dB; active pan isolation > 80 dB; typical mix noise -80 dBu; THD @ 20 dBu = <.005% @ 1k; max. output (bal) +27 dBu @ 600 ohms, all others +21 dBu gain.

SOUNDTRACS PLC; 91 Ewell Rd., Surbiton; Surrey, KT6 6AH UK; (44) 81-399-3392; (44) 81-390-8101. Product Name: Quartz. Contact: Katie Seaman, mktg. coordinator. Date Product Introduced: 10/89. **Product Description & Applications:** The Soundtracs Quartz is a high-quality 24-bus in-line production console with computer-mute automation of channels and auxiliaries, which combines many of the features associated with Soundtracs' famous IL Series and the equally popular PC MIDI Series. The Quartz creates a new dimension in cost-effective 24-track consoles that when combined with recently introduced analog and digital multitrack machines, —LISTING CONTINUED ON NEXT PAGE

Tape for
the '90s

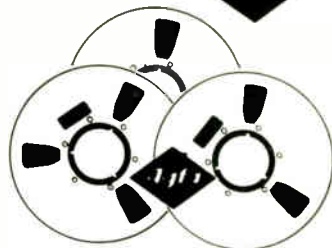

B Burlington
Audio / Video Tapes, Inc.
106 Mott Street
Oceanside, New York 11572

468 & 469 Audio Tape,
Cassette Pancakes & a Full
Line of Audio Products
Plus Reels, Boxes,
Leaders & Splicing Tapes,
Custom Cassettes
In Stock and Priced Right!
Immediate Delivery



Call for Free Catalog
USA & Canada
1-800-331-3191
NYC Area: 516-678-4414
FAX: 516-678-8959

Circle #050 on Reader Service Card

CLEAN PATCH BAYS NO DOWN TIME



**VERTIGO BURNISHERS AND INJECTORS
RESTORE ORIGINAL PERFORMANCE
TO YOUR PATCH BAYS**

VERTIGO 1/4" TRS AND TT BURNISHERS:
Each used to eliminate noise caused by contamination of main contacts in normal patching situations.

VERTIGO 1/4" TRS AND TT INJECTORS:
Each allows injection of cleaning solvent in breaking contacts (normals), to eliminate intermittency that occurs when patch cord has been removed.

ONLY \$34.95 Ea. (Cont. USA) Please write for additional information and order form. Used by Professionals Worldwide. US Patent No. 4,733,678

VERTIGO RECORDING SERVICES
12115 Magnolia Blvd. # 116
North Hollywood, CA 91607
Telephone: (818) 907-5161
Fax: (818) 784-3763

Circle #051 on Reader Service Card

EVEN LITTLE DEALS CAN BE WORTH A LOT

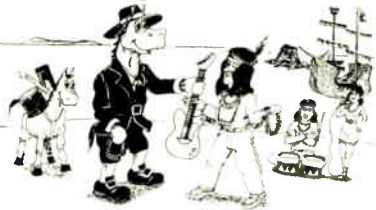

FREE GIFT WITH MOST PURCHASES

THOROUGHbred MUSIC



THE SOUTH'S LARGEST MUSIC RETAILER 1 (800) 800 4654

WE SHIP IN 24 HOURS • ALL MAJOR BRANDS
ARE IN STOCK • FAX US YOUR ORDER (813) 238-5443

WE'VE GOT A LOT TO BE THANKFUL FOR
2204 EAST HILLSBOROUGH AVENUE, TAMPA, FLORIDA 33610

Circle #052 on Reader Service Card

DON'T BUY ANY MUSICAL EQUIPMENT UNTIL YOU CALL TEXAS

Huge Inventory
Extremely Courteous Service
Immediate Delivery
Let Us Finance Your Pro
Or Home Studio

MUSICMAKERS

800-395-1005

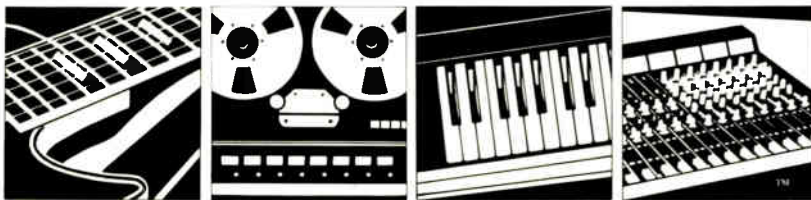

Circle #053 on Reader Service Card

MIXING CONSOLES

—LISTING CONTINUED FROM PREVIOUS PAGE

provides a previously unobtainable package. **Basic Specifications & Suggested List Price:** The Quartz features 4-band parametric EQ, 6 auxiliary sends and dual line inputs on each channel with MIDI-mute automation on inputs, monitors and auxiliary masters. Fully balanced busing and a patch bay capable of accepting up to 16 stereo inputs is a standard feature. Retail price: Quartz 3200—£17,917, Quartz 4800—£22,917.

SOUNDTRACS PLC; 91 Ewell Rd., Surbiton; Surrey, KT6 6AH UK; (44) 81-399-3392; (44) 81-390-8101. **Product Name:** Sequel. **Contact:** Katie Seaman, mktg. coordinator. **Date Product Introduced:** 3/90. **Product Description & Applications:** The Soundtracs Sequel is a new, compact sound reinforcement console introduced to bridge the gap between the flagship SPA and the well-established MX range of sound reinforcement consoles. The subgroups feature X8 matrix in addition to stereo effects returns and the entire console, including the busing, is electronically balanced. The Sequel is available with 24, 32 and 40 input channels, the 32-input version being only 1.45m in length. **Basic Specifications & Suggested List Price:** The Sequel is an 8-bus console with 4-band parametric EQ, 9 auxiliary sends and four mute groups on each input. Signal buses are electronically balanced to reduce crosstalk to a minimum and provide exemplary noise specification. Retail prices: Sequel 2400—£11,950, Sequel 3200—£14,380, Sequel 4000—£16,700.

SPECK ELECTRONICS; 925 Main St.; Fallbrook, CA 92028; (619) 723-4281. **Product Name:** Model S72 recording console. **Contact:** Vincent Poulos. **Date Product Introduced:** Early 1990. **Product Description & Applications:** 40 input recording console. Targeted to the electronic studio with lots of signals. Console has 40 input channels, 8 stereo efx returns, plus 24 track in-line monitoring. Also available with 72 inputs and internal patch bay. **Basic Specifications & Suggested List Price:** Model S72, 40 inputs: \$13,800. Model M72, 72 inputs: \$21,440.

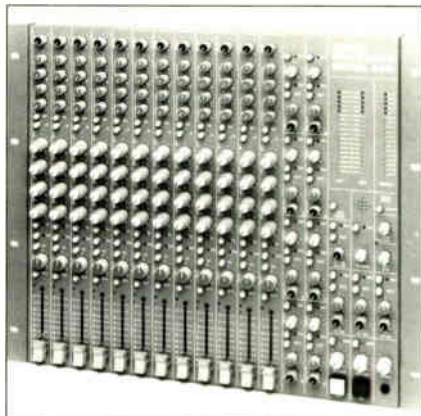

SPECK ELECTRONICS
Model SSM Keyboard Mixer

SPECK ELECTRONICS; 925 Main St.; Fallbrook, CA 92028; (619) 723-4281. **Product Name:** Model SSM Keyboard Mixer. **Contact:** Vincent Poulos. **Date Product Introduced:** Early 1990. **Product Description & Applications:** Rack-mount, studio-quality keyboard mixer. Available with 12, 28 or 44 input channels. Each mono or stereo input has 2- to 3-band parametric equalization, 8 efx sends, in-place solo, mute, kill, trim and presence of signal indicator. Master section has 8 stereo efx returns, program, monitor and headphone feeds. Special features include a tuner feed, transmitter feed, expression pedal interface, cue, click and aux returns. **Basic Specifications & Suggested List Price:** 12-input main unit: \$3,925. 16-input expanders: \$3,000. Stereo input channel (each): \$182.

STUDIOMASTER INC.; 3941 Miraloma; Anaheim, CA 92807; (714) 524-2227. **Product Name:** Diamond Series. **Contact:** Jim Giordano, nat'l sales mgr. **Date Product Introduced:** 7/90. **Product Description & Applications:** Budget series mixers consisting of 8 x 2 and 12 x 2 rack-mount and a 16 x 2. Features include: balanced mic/line inputs, 3-band fixed EQ, 48V phantom power, 2 aux sends and 2 returns, 2-track record/playback bus and all-steel chassis. **Basic Specifications & Suggested List Price:** List prices: 8 x 2 RD \$599.95, 12 x 2RD \$799.95, 16 x 2D \$995.95. Delivery late August and early September.



STUDIOMASTER INC.
Diamond Series

allowing up to 127 different reverb and delay settings, graphic in and out, plus various patching options, 2-track record/playback bus, stereo aux return and line outs. 48V phantom power and all-steel chassis. **Basic Specifications & Suggested List Price:** EIN: -129 dB (150 ohms source), common mode rejection: greater than 80 dB, THD: less than 0.05%, frequency response 30 Hz to 20 kHz (+0, -1 dB). List price: 8 x 2 \$2,095, 12 x 2: \$2,595.

STUDIOMASTER INC.; 3941 Miraloma; Anaheim, CA 92807; (714) 524-2227. **Product Name:** Proline Gold. **Contact:** Jim Giordano, nat'l sales mgr. **Date Product Introduced:** 7/90. **Product Description & Applications:** Console formats: 8 x 4 x 8R, 16 x 4 x 8 and 16 x 8 x 16. Features as follows: (16 x 8 x 16) balanced mic/line inputs, direct outs, 3-band EQ with mid sweep, EQ defeat per channel, Alps pots, inserts on all inputs and outputs, channel mutes with status, 4 aux sends per channel, MIDI mute option, 16 aux; line inputs, 2 mono and 1 stereo return, EQ on aux 1 and 2 return or L/R output, 48V phantom power, 16 tape returns with monitor expandable to 40 inputs, built-in talk-back microphone. **Basic Specifications & Suggested List Price:** Frequency response: 30 Hz to 20 kHz (+0, -1 dB), EIN -129 dB. THD: less than 0.05%, common mode rejection: greater than 80 dB. List prices: 8 x 4 x 8 \$2,325; 16 x 4 x 8 \$3,125; 16 x 8 x 16 \$3,995.



STUDIOMASTER INC.
Trackmix

MIDI muting, 12 group outputs, full 24-track monitoring, 24 aux line inputs (12 with EQ), 3-band EQ with sweep, mid and bass, EQ defeat, 6 aux sends per channel, MI muting, inserts on inputs, groups and L/R outputs, 48V phantom power, built-in talkback microphone, 50 inputs on mixdown (24 x 12 x 24 x 2) 58 on (32 x 12 x 24 x 2), direct outs per channel. **Basic Specifications & Suggested List Price:** Frequency response: 30 Hz to 20 kHz (+0, -1 dB) EIN -129.5 (150 ohm source), THD: less than 0.05% (input to output), common mode rejection: greater than 80 dB. List price: 24 x 12 x 24 x 2 \$9,750; 32 x 12 x 24 x 2 \$11,095.

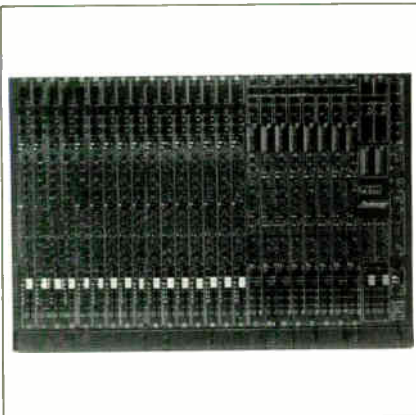

STUDIOMASTER INC.
Mixdown Gold

STUDIOMASTER INC.; 3941 Miraloma; Anaheim, CA 92807; (714) 524-2227. **Product Name:** Session Mix Gold. **Contact:** Jim Giordano, nat'l sales mgr. **Date Product Introduced:** 7/90. **Product Description & Applications:** 8 x 2 and 12 x 2 rack-mount and 16 x 2 mixers. Features include: balanced mic/line inputs, direct outs, 48V phantom power, inserts on inputs/outputs, 3-band EQ with mid sweep, 4 aux sends per channel, clip indicators per channel, stereo record playback bus, headphone bus, 60mm faders, (100mm on 16 x 2), 2 mono returns, EQ on mono returns (16 x 2), two stereo returns (16 x 2) Alps pots throughout, solo on inputs; 2 aux returns and L/R outputs (16 x 2), all-steel construction. **Basic Specifications & Suggested List Price:** Frequency response: 30 Hz to 20 kHz (+0, -1 dB), EIN -129, (150 ohm source), THD less than 0.05%, (input to output) common mode rejection: greater than 80 dB. List prices: 8 x 2R \$1,050, 12 x 2R \$1,525, 16 x 2 \$1,995.

STUDIOMASTER INC.; 3941 Miraloma; Anaheim, CA 92807; (714) 524-2227. **Product Name:** Trackmix. **Contact:** Jim Giordano, nat'l sales mgr. **Date Product Introduced:** 7/90. **Product Description & Applications:** Modular design, available as 24 x 12 x 24 x 2 or 32 x 12 x 24 x 2. Features include:

TASCAM; 7733 Telegraph Rd.; Montebello, CA 90640; (213) 726-0303. **Product Name:** M-2500 Series Mixing Consoles. **Contact:** Ken Hirata. **Date Product Introduced:** Fall 1990. **Product Description & Applications:** The M-2500 Series (models M-2516 and M-2524) are new compact recording consoles especially designed for multitrack recording (with Tascam's TSR and MSR model recorders), combined with electronic-music production. They feature automated muting via MIDI commands. Each channel features an in-line stereo
—LISTING CONTINUED ON NEXT PAGE

STUDIOMASTER INC.; 3941 Miraloma; Anaheim, CA 92807; (714) 524-2227. **Product Name:** Mixdown Gold. **Contact:** Jim Giordano, nat'l sales mgr. **Date Product Introduced:** 7/90. **Product Description & Applications:** 16 x 8 x 16; mixing console. Features include: balanced mic/line inputs, 3-band EQ with mid and bass sweep, EQ defeat, inserts on all input; aux outputs, direct outs, 6 aux sends per channel, 16 aux line inputs (8 W/E), 48V individual phantom power, channel mutes with status, 16-track monitor, 4 group outputs, fader reverse, 1 kHz slate tone, built-in talkback mic, MIDI option, expandable to 40 inputs, 36 inputs on mixdown, 66 w/ maximum expansion. Available in 16 x 4 x 8 version. **Basic Specifications & Suggested List Price:** Frequency response: 30 Hz to 20 kHz (+0, -1 dB); EIN: 129.5 (150 ohm source), Common mode rejection is greater than 80 dB, THD: less than 0.05% (input to output), signal to noise: 86 dBm, crosstalk -88 at 1 kHz. List price (16 x 4 x 8) \$4,335. (16 x 8 x 16) \$5,395.



STUDIOMASTER INC.
Powerhouse

STUDIOMASTER INC.; 3941 Miraloma; Anaheim, CA 92807; (714) 524-2227. **Product Name:** Powerhouse. **Contact:** Jim Giordano, nat'l sales mgr. **Date Product Introduced:** 7/90. **Product Description & Applications:** 8 x 2 and 12 x 2 powered consoles, features include: 250 watts per side, 3-band fixed EQ, 3 aux sends; 2 x 7 band master EQ, master EQ defeat switch per channel, built-in 16-bit digital processor

POWERFUL

All metal fabrication provided by United Steel Products.

ASL MOBILE AUDIO

Circle #054 on Reader Service Card

MIXING CONSOLES

—LISTING CONTINUED FROM PREVIOUS PAGE

monitor, 4 auxiliary sends, 3-band/2-sweep EQ, pre/fade listen, mute and assignment switches for groups 1-8 and stereo. The master section includes two stereo and two mono effects returns, all fully assignable, and a control room monitor section with talkback. **Basic Specifications & Suggested List Price:** M-2516: 16 channels, 16 tape returns, 8 group + L/R out; projected suggested retail at \$2,999. M-2524: 24 channels, 24 tape returns, 8 groups + L/R out; at \$3,999. Mic jacks: 48V phantom powered. Group outputs -10 dBV unbalanced; L/R outputs -10 dBV unbalanced and +4 dBm balanced.

TOA ELECTRONICS; 601 Gateway Blvd.; South San Francisco, CA 94080; (415) 588-2538. Product Name: AX-1000 Automatic Mic Mixer. Contact: Rick Karnlet, manager,

engineered sound products. **Date Product Introduced:** 7/90. **Product Description & Applications:** 8-channel Automatic Mic Mixer for churches, auditoriums, combinable function rooms, boardrooms, courtrooms, conference center systems, teleconferencing and multimedia rooms. Uses Toa 900-Series input modules; direct channel outputs: logic outputs; master remote volume; internal/external mute system; variable NOM attenuation; variable channel off-attenuation; link up to 80 channels. **Basic Specifications & Suggested List Price:** Eight input channels; maximum linked 80 channels; choice of 37 input modules; 20 Hz-20 kHz +/-1 dB; gain-sharing variable from 0logNOM to 20logMOM. \$1,990 list.

TOTAL AUDIO CONCEPTS; Unit 17 Bar Lane Industrial Park; Bar Lane, Basford; Nottingham, NG6 0HU UK; 0602 783306; U.S. (818) 508-9788. Product Name: TAC Bullet MF. Contact: Steve Harvey, nat'l sales mgr. **Date Product Introduced:** 6/90. **Product Description & Applications:** Mid-frame chassis for the TAC Bullet, allowing 16 x 8 x 2, 16 x 4 x 2 or 20 x 2 configurations. A maximum of 16 stereo modules may be fitted. Optional AFV (audio follows video) control is provided by the ES8 serial interface with ESK remote keypad. Console features 4-band EQ, 6 aux sends, up to 6 stereo aux returns, choice of LED or VU meters. **Basic Specifications & Suggested List Price:** Prices range from \$6,679 to \$7,839 for standard mid-frame (MF) configurations. 8-channel AFV option, add \$775. ES8/ESK serial interface is \$2,800.



TOA ELECTRONICS
AX-1000 Automatic Mic Mixer

TOTAL AUDIO CONCEPTS; Unit 17 Bar Lane Industrial Park; Bar Lane, Basford; Nottingham, NG6 0HU UK; 0602 783306; U.S. (818) 508-9788. Product Name: TAC Magnum. Contact: Steve Harvey, nat'l sales mgr. **Date Product Introduced:** 11/89. **Product Description & Applications:** The 4-band semi-parametric EQ can be split between the signal and monitor paths. Eight aux sends (4 mono, 2 stereo) can be fed from either signal path. Sends 7 & 8 route to the 24 multitrack buses to provide additional aux sends. Features also include 8 audio subgroups, 8 effects returns, in-place solo/PFL system, 2 programmable mute groups, fader and input reverse, LED or VU metering, 288-point TT jackfield. Options include stereo line inputs, MIDI muting and fader automation. **Basic Specifications & Suggested List Price:** Two frame sizes are available, 36 or 26 inputs, providing 72 or 52 inputs with EQ on mixdown. Prices are \$41,276 and \$31,640, respectively. A 36-input, 32-T version is also available.



TRIDENT AUDIO USA
Trident Vector 432

TRIDENT AUDIO USA; 2720 Monterey St., Ste. 403; Torrance, CA 90503; (213) 533-8900; (914) 591-3741. Product Name: Trident Vector 432. Contact: Wayne Freeman, president. **Date Product Introduced:** 11/89. **Product Description & Applications:** In-line console design consistent with Trident's reputation for sonic integrity. New features such as 4 stereo mix buses and 4-band fully parametric EQ, stereo input modules and optional VCA subgrouping make the console well suited in a variety of post-production or broadcast applications. Music recording studios will appreciate the extensive cue system and optional MIDI controllable mute system. The console is available in frame sizes up to 72 inputs. Additionally, the console features 32 multitrack buses, 8 auxiliary sends, machine control with track arming and a stereo bus assignment matrix. The console includes integral patch bay and can also be fitted with VCA or moving fader automation. **Basic Specifications & Suggested List Price:** Prices range from \$120,000-\$225,000.

YORKVILLE SOUND; 4600 Witmer Industrial Estate; Niagara Falls, NY 14305; (716) 297-2920. Product Name: MC-208/212/216. **Product Description & Applications:** 8, 12 and 16-channel sound reinforcement mixing consoles offer high-quality performance in compact, affordable packages. Features include: phantom power, headphone monitor, 2 effects sends with stereo returns, stereo tape in/out. MC-208 is rack-mountable. As with all Yorkville manufactured products, MC-Series consoles are backed with a standard, 2-year unlimited transferable warranty. **Basic Specifications & Suggested List Price:** MC-208 board configuration is 8 x 2 x 1. Ch EQ: 3-band, ch. inputs bal/unbal.: XLR/1/4" phone, THD: 0.05%, output level indicator: 10 segment LED x 2, S/N: 100dB, effect send: 2, mono send: 1. List price: MC-208 \$975; MC-212 \$1,150, MC 216 \$1,350.

The Flexible Solution



FX1244 12 Channel (shown)

4 Out Multi Track Mixers

MADE IN THE USA

Starting at
List \$895
1099
FX844 Model

Live. In Studio. As a complete Live Sound or Recording mixer, the new Carvin FX44 Series stands alone. With features like: *Four sub groups • Six Monitor/Effects sends • Stereo returns • Four band EQ • Control Rm monitor mix • the FX44's outperform the competition hands down.*

Discover the ultra low noise, silky smooth studio faders, recording VU meters, and precision controls. Buy it from the source at **FACTORY DIRECT** savings. Call toll free 800-854-2235 for information or to order your FX mixer today.

Outside the USA: See your dealer



		list	DIRECT
FX844	8 x 4 x 2 x 1 Mixer	\$1895	1099
FX1244	12 x 4 x 2 x 1 Mixer	\$2295	1449
FX1644	16 x 4 x 2 x 1 Mixer	\$2795	1699
FX2444	24 x 4 x 2 x 1 Mixer	\$3495	2299

For a built in Stereo 500 watt MOSFET amp add \$150 (844, 1244 only)

• Money back guarantee

CARVIN THE DIRECT ADVANTAGE™
toll free: (800) 854-2235

Please send me Carvin's FREE full color catalog:

Name _____

Address _____

City _____ State _____ Zip _____

Send to: MX-25 1155 Industrial Ave., Escondido, CA 92025
Carvin Hollywood Store: 7414 Sunset Blvd. (213)851-4200

MONITOR/LOUDSPEAKER SYSTEMS

ALTEC LANSING CORPORATION; 10500 W. Reno Ave., PO Box 26105; Oklahoma City, OK 73126-0105; (405) 324-5311; FAX: (405) 324-8981. Product Name: Maestro Monitor Series M600. Contact: Tim Smith, mktg mgr. Date Product Introduced: 4/90. Product Description & Applications: M600 Maestro Monitor: full-range sound. This 2-way, vented, full-range loudspeaker system features the famous 16" Altec 604. Quality construction, combined with a 2-way duplex speaker (with Manteray™ horn system) provides fidelity for recording studios, A/V production facilities and, as always, as a reference standard. Basic Specifications & Suggested List Price: Distribution pattern: 60" H x 40" V. Power handling (AES/Pagrim): 150/300W. "T" nut suspension. Frequency response: 60 Hz to 20 kHz. Pressure sensitivity: 98.5dB SPL (1W, 500Hz to 3kHz, res 20mPa). Equalizer defeat switch on the driving network (N604-8A). List price: \$1,714.



ALTEC LANSING CORPORATION
VIR Vari Intense™ Horn

ALTEC LANSING CORPORATION; 10500 W. Reno Ave., PO Box 26105; Oklahoma City, OK 73126-0105; (405) 324-5311; FAX: (405) 324-8981. Product Name: VIR Vari Intense™ Horn. Contact: Tim Smith, mktg mgr. Date Product Introduced: 4/90. Product Description & Applications: Vari Intense horns distribute acoustical energy uniformly over entire seating areas, offering an alternative that is free from lobing, comb filtering and physical alignment problems typical of short-throw/long-throw horn combinations. The VIR was designed to provide both controlled coverage in rectangular spaces and inverse-law intensity correction. Reduces size, component count and cost of clusters. Basic Specifications & Suggested List Price: VIR horizontal dispersion angle: long throw, 60° (+32°-6°), 800Hz to 16kHz; short throw: 90° (+8°-11°), 500Hz to 16kHz. Vertical dispersion angle: 60° (nominal), 500 Hz to 16 kHz. Usable low frequency limit: 400Hz; frequency response: 400 Hz to 16 kHz. Pressure sensitivity: 112 dB SPL, 500 Hz to 3.15 kHz. List price: \$770.

APOGEE SOUND, INC.; 1150 Industrial Ave., Ste. C; Petaluma, CA 94952; (707) 778-8887. Product Name: 3 x 3 Series II. Contact: Mark Ockenfels, nat'l sales mgr. Date Product Introduced: 5/90. Product Description & Applications: The 3 x 3-II loudspeaker incorporates a new high-frequency device and integral "through-steel" construction. The new high-frequency device is a high-efficiency, high-power dynamic driver, fluid cooled, coupled to a controlled-directionality horn and mounted with a steel bracket. The Series II tweeter assembly is capable of 5 dB greater continuous power output with more than 10 dB greater peak power output. Stainless steel nutplates on the top and bottom of each 3 x 3 cabinet are connected with a 3-inch wide 10-gauge piece of steel providing a greater load-bearing capacity for each speaker system. Basic Specifications & Suggested List Price: Frequency response: 53 Hz to 19 kHz. Power handling: 1,100 watts continuous, 4,400 watts peak. Maximum SPL: 135dB continuous, 140dB peak. Dispersion: 60 degrees horizontal, 40 degrees vertical. Weight: 265 lbs. Suggested list price: \$4,650.

APOGEE SOUND, INC.; 1150 Industrial Ave., Ste. C; Petaluma, CA 94952; (707) 778-8887. Product Name: AE-6B. Contact: Mark Ockenfels, nat'l sales mgr. Date Product Introduced: 4/90. Product Description & Applications: The AE-6B is a derivative of the popular AE-6 bi-amped monitor loudspeaker system and incorporates a 12-inch high-power cone driver and a horizontally mounted high frequency horn. The many features of the AE-6B are in keeping with other Apogee loudspeaker systems: for example, it has steel recessed nutplates on both sides of the cabinet to facilitate flying the monitor system. Other features include multi-ply Finland birch construction and Neutrik NL4MP Speaker connectors as standard. Basic Specifications & Suggested List Price: Freq. response: 53 Hz to 17 kHz. Power handling: 400 watts continuous, 1,200 watts peak. Maximum SPL 124.5dB continuous, 134dB peak. Impedance: 8 ohms. Weight: 78 lbs. Suggested list price: \$2,170.

ATLAS/SOUNDOLIER; 1859 Intertech Dr.; Fenton, MO 63026; (314) 349-3110. Product Name: Atlas/Soundolier. Contact: Chuck Gushwa, director of sales. Date Product Introduced: 1/90. Product Description & Applications: 60-watt coaxial two-way ported speaker system, Model SEQ-1232, with integral 12" dia. LF and 2" x 5" HF driver. Textured black veneer cabinet. Basic Specifications & Suggested List Price: Freq. response: 45 Hz to 20 kHz. Sensitivity: 94 dB. Impedance: 8 ohms. \$520.83 list.

AUDIO SERVICES & DESIGN/TECHSTAR; 475 Metroplex Dr., Ste. 505-B; Nashville, TN 37211; (615) 832-6032; (615) 242-2925. Product Name: Bross 15A2. Contact: Mike Bross, owner. Date Product Introduced: 7/90. Product Description & Applications: A stage monitor with built-in studio-quality limiter, electronic crossover, equalization circuitry and two power amplifiers. Designed to reduce the size, cost, complexity and weight of a bi-amp stage monitor system while increasing the sonic quality, reliability and show-to-show consistency. Complete protection circuitry along with modular design make the system very reliable and easy to maintain. Basic Specifications & Suggested List Price: Standard XLR audio input and parallel output. Your choice of twist-lock AC power input with parallel output. 8-pin Speakon connector and custom cable for both AC and audio input. 200W into 8 ohms per MOSFET amplifier. Pre-equalized for flat response. 24 dB per octave Linkwitz-Riley crossover. \$2,500.



AUDIX CORPORATION
HR-1, HR-2, HR-3 or HR series studio monitors

AUDIX CORPORATION; 5653 Stoneridge Dr.; Pleasanton, CA 94566; (415) 463-1112. Product Name: HR-1, HR-2, HR-3 or HR series studio monitors. Contact: Clifford Castle, VP sales. Date Product Introduced: 5/90. Product Description
—LISTING CONTINUED ON NEXT PAGE

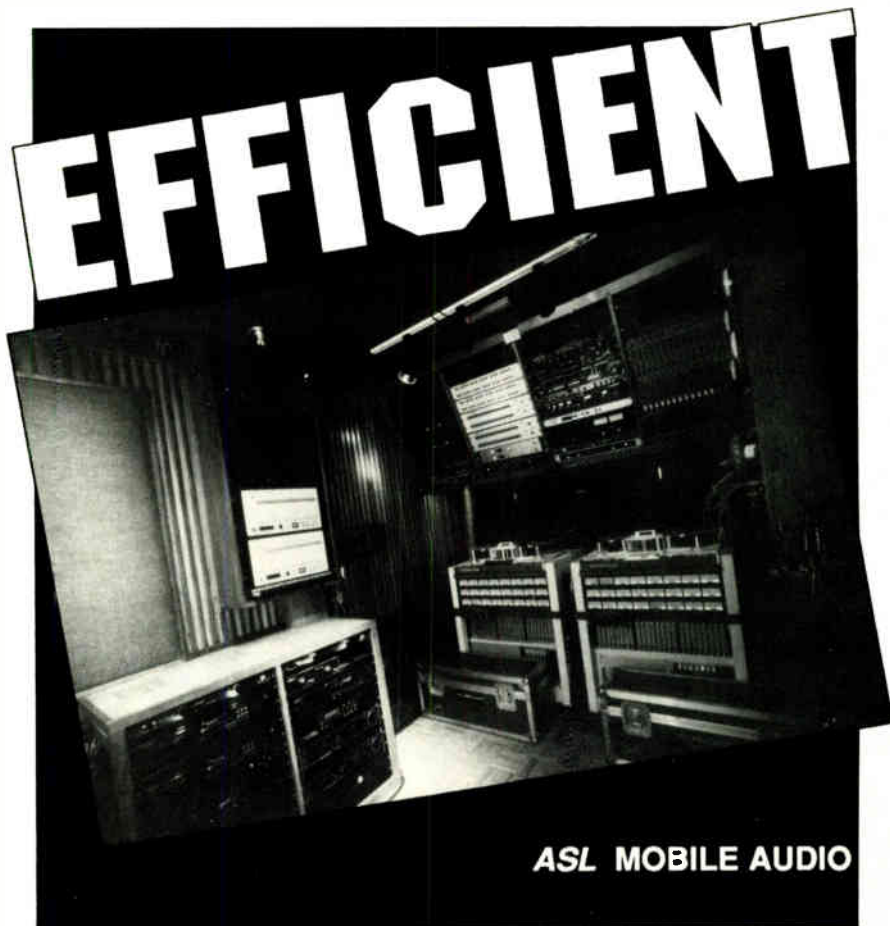

ASL MOBILE AUDIO

Circle #056 on Reader Service Card

MONITOR/LOUDSPEAKER SYSTEMS

—LISTING CONTINUED FROM PREVIOUS PAGE

& Applications: The HR series includes 3 models of studio reference monitors with vented enclosures. The HR-1 is a two-way system (6.5" cast frame woofer and 1" tweeter) to be used for mixing in the near-field. The HR-2 and HR-3, each consisting of two 6.5" cast frame woofers and a 1" tweeter, are primarily designed as a reference for playback, especially music recorded in the digital domain. The primary difference between the HR-2 and HR-3 is that the HR-3 uses a high-performance neodymium HF driver. The HR series is designed and manufactured by Audix in the USA. **Basic Specifications & Suggested List Price:** HR-1: Freq. response at +3dB is 50Hz-18kHz. Output (1W/M): 88dB; Imp.: 8 ohms. Power (RMS) 100W. Price per pair: \$499. HR-2: Freq. response at +3dB is 47Hz to 18kHz. Output (1W/M): 94dB; Imp.: 4 ohms. Power (RMS): 150W. Price per pair: \$649. HR-3: Freq./response at +3dB is 47Hz to 20kHz. Output (1W/M): 94dB. Imp.: 4 ohms. Power (RMS): 175W. Price per pair: \$799.

AURATONE CORP.; PO Box 698; Coronado, CA 92118; (619) 297-2820; FAX: (619) 296-8734. Product Name: T5V Ultra-Compact Two-Way with Video Shield™ Magnet. **Contact:** Jack Wilson, president. **Date Product Introduced:** 7/90. **Product Description & Applications:** Ultra-compact near-field monitor. An all-new system, the Model T5V that we believe may become the "Auratone® of the '90s." Like its predecessor the 5C Supersound Cube™, the "Auratone of the '70s and '80s," its got b—s! But, it's a full-range 2-way system with audible response from 40 Hz to 20 kHz (+/-3dB 75 Hz to 20kHz), and it handles 50 watts of program material, has excellent dispersion, beautifully balanced sound and terrific stereo imaging. **Basic Specifications & Suggested List Price:** Impedance: 8 ohms; power handling: 50 watts program; sensitivity: 88 dB 1W/1M; anechoic on-axis frequency response: 75 to 20,000Hz, +/-3 dB. Pro-net price: \$229.95 per pair. Enclosure HWD: 11" x 7 1/2" x 8". Textured black or woodgrain vinyl finish. Shipping weight approx. 23 lbs. per pair.

BARBETTA ELECTRONICS; 900-A Calle Plano; Camarillo, CA 93010; (805) 388-5753. Product Name: Active, Bi-Amp Powered Reference Monitors. **Contact:** Tony Barbetta. **Date Product Introduced:** 9/90. **Product Description & Applications:** Two-way speaker system with built-in power amplifiers and precision line-level active crossover network. 110dB sound pressure level at woofer clip point and one meter. Individual tweeter and woofer clipping indicators. Balanced-line or single-ended input. Line headroom is 20 dB with nominal +4 input. For studio, remote, and home recording. **Basic Specifications & Suggested List Price:** Detailed specifications available 9-1-90.

CALIBRATION STANDARD INSTRUMENTS; PO Box 2727; Oakland, CA 94602; (415) 531-8725. Product Name: B8/70. **Contact:** Edward M. Long. **Date Product Introduced:** 5/90. **Product Description & Applications:** The B8/70 is a subwoofer system for use with C.S. 1. Near-field monitors™ and monitors from other manufacturers. It can be used with the E8/70 or with the HLE 2 electronics and separate amplifier. **Basic Specifications & Suggested List Price:** \$1,190 per pair.

CALIBRATION STANDARD INSTRUMENTS; PO Box 2727; Oakland, CA 94602; (415) 531-8725. Product Name: E8/70. **Contact:** Edward M. Long. **Date Product Introduced:** 5/90. **Product Description & Applications:** The E8/70 is a subwoofer system for use with C.S. 1 Near-field Monitors™ and monitors from other manufacturers. It is self-powered and uses the patented ELF™ Technology. The output is flat from 30 Hz to 80 Hz with the acoustical crossover at 100 Hz. **Basic Specifications & Suggested List Price:** \$2,990 per pair.

CELESTION INDUSTRIES, INC.; 89 Doug Brown Way; Holliston, MA 01746; (508) 429-6706. Product Name: Celestion 3. **Contact:** Barry Fox, director of sales and mktg. **Date Product Introduced:** 1/90. **Product Description & Applications:** High-quality compact studio monitor. Uses Celestion two-piece titanium dome tweeter and 5-inch, felted fiber bass unit, with unique polycarbonate chassis. Ideal for small or home studios, since the design takes into account the bass-reinforcing effects of near-wall placement. **Basic Specifications & Suggested List Price:** 60 watts power handling, 86 dB for 1 watt input measured at 1 meter, 8 ohm, -6 dB at 60 Hz. Suggested retail price: \$280 per pair.

COMMUNITY LIGHT & SOUND, INC.; 333 E. Fifth St.; Chester, PA 19013; (215) 876-3400; FAX: (215) 874-0190. Product Name: CSX Loudspeaker Line. **Contact:** John T. Wiggins, VP, sales and mkt. **Date Product Introduced:** 1/90. **Product Description & Applications:** The eight new CSX loudspeakers range in size from the compact CSX25 to the full-

range CSX70. Standard features found on each model include heavy-duty mesh grilles with attractive, acoustically transparent grille cloth, steel corner protectors, durable black-carpeted exteriors, high-current disconnects to the speaker leads, and a sophisticated new crossover network. Versatile as well as reliable, the CSX loudspeakers are built to fit any application: concert, sound reinforcement, nightclub, church or public speaking engagements. **Basic Specifications & Suggested List Price:** Suggested retail prices range from \$321 (for the CSX25) to \$1,066 (for the CSX70). CSX70: 3-way, CSX60B: subwoofer system, CSX50B: subwoofer system, CSX52: 3-way, CSX38M: stage monitor, CSX35: 2-way, CSX28M: stage monitor, CSX25: 2-way.

COMMUNITY LIGHT & SOUND, INC.; 333 E. Fifth St.; Chester, PA 19013; (215) 876-3400; FAX: (215) 874-0190. Product Name: RS220 System. **Contact:** John T. Wiggins, VP, sales and mkt. **Date Product Introduced:** 4/90. **Product Description & Applications:** The RS220 is a three-way horn-loaded Wavefront Coherent™ loudspeaker system design. The VBS210 subwoofer enclosure is of identical dimensions as the RS220, enabling contractors to build elegant microcluster arrays. To monitor and protect the S220 and VBS210, Community developed the 220 system controller. The RS220 system provides exceptional voice clarity, intelligibility, and articulation. The RS220 is built for P.A., nightclub, outdoor and sound reinforcement applications. **Basic Specifications & Suggested List Price:** RS220 list price: \$995. Operating range: 90 Hz to 18 kHz. Power handling: 200 watts (pink noise) 500 watts (program). Impedance: 8 ohms. Crossover frequencies: 800 Hz, 3kHz. Driver complement: LF 2-8 inch, MF 1-2 inch, HF 1-1 inch. Dimensions: 26-3/4"H x 14-1/4"W x 14-1/4"D.

DESKTOP LOUD SPEAKERS SYSTEMS, INC.; PO Box 14526 Wm. Chick Stn.; Kansas City, MO 64127; (816) 231-1983. Product Name: DLS-3X. **Contact:** Paul Gardocki, president. **Date Product Introduced:** 2/90. **Product Description & Applications:** 4-piece close-field monitor system. Two satellites measuring 3" x 4" x 7-1/2" for console top (with titanium tweeters), and two subwoofers measuring 24" x 18" x 16" for under-console placement. Satellites are carved from solid blocks of baseball-bat wood for the least resonant enclosures possible, least spurious cabinet noise, and clearest point source imaging. **Basic Specifications & Suggested List Price:** 18Hz to 32kHz (+/-3 dB) freq. resp., 100 watts-per-channel power handling, 8 ohms impedance, system weight 70 lbs. total, available in black piano finish, at a suggested retail price of \$2,399 per system.

DIGITAL DESIGNS; 125 W. Main; El Centro, CA 92243; (619) 353-1290. Product Name: Digital Design. **Contact:** Alice Sandhu, sales and marketing. **Date Product Introduced:** 2/90. **Product Description & Applications:** New generation monitor system three sizes of console-top monitors (261, 161, LS6) with an optional 12" studio-reference subwoofer. Gives the full-range frequency response of main tracking monitors with the imaging superiority of near-field monitors. 12" subwoofers feature long magnetic-gap design with extended pole piece. Linear field measures 22mm, symmetric field 34mm, voice cone diameter 65mm. Copper-clad aluminum wire on Kapton Former. Low-mass cone and acoustic suspension for fast transient response. **Basic Specifications & Suggested List Price:** Satellites: LS261 (2 x 165mm, 1 x 20mm) 54Hz to 20 kHz +/-2 dB, 8 ohm. LS161 (1 x 165mm, 1 x 20mm) 59 Hz to 20 kHz +/-2 dB, 4 ohm. LS6: (1 x 165mm, 1 x 20mm) 68 Hz to 20 kHz +/-3 dB, 4 ohm. Subwoofer: 35 Hz to 200 Hz +/-3 dB.

DYNACORD™; 10500 W. Reno Ave., PO Box 26105; Oklahoma City, OK 73126-0105; (818) 350-4970; FAX: (818) 444-1342. Product Name: SRC 200 Cluster System. **Contact:** John Parker, nat'l sales manager. **Date Product Introduced:** 1/90. **Product Description & Applications:** The Dynacord SRC200 is a 3-way, full-range loudspeaker unit for vocal and full-range voice/music transmission. A 12" direct radiator in a vented cabinet operates in the low-frequency range up to 500 Hz. Medium frequencies are radiated by two 4.5" special medium-frequency loudspeakers positioned in columnar design. The speech recognition and naturalness in this frequency range lies clearly in this conventional solution. **Basic Specifications & Suggested List Price:** SRC200 offers 400W cont. program, 200W RMS at 8 ohms; only 15 kg; 98dB SPL 1W/1M; 160° horizontal beamwidth, 30° vertical polar pattern control, all speakers protected; polyamide surface; 3-way, full range. List price: \$1,536.

FORMULA AUDIO, INC.; Rte. 5, Box 440-3; Zebulon, NC 27597; (919) 269-6441. Product Name: RAM 200. **Contact:** Jeffrey A. Forsburg, pres. **Date Product Introduced:** 6/90. **Product Description & Applications:** The RAM 200 is the first fully modular professional loudspeaker with 180 possible combinations of components. The enclosure can hold 3 modules at a time and can rotate a full 360 degrees for different dispersements and for rigging vertically or horizontally. This enclosure can be configured from a full-range long-throw to a plain sub. Because of its versatility with interchangeable modules, the RAM 200 can be used in almost all applications such as churches, concerts, clubs, arenas, etc. **Basic Specifications & Suggested List Price:** RAM 200 (holds 2 modules): 41.5(H) x 22.5(W) x 26(D). 13-ply birch covered with catalyzed textured black polyurethane. Kick-back casters, rigging points on all sides. With 20 modules to pick from, the weight and price can vary greatly.

FORMULA AUDIO, INC.; Rte. 5, Box 440-3; Zebulon, NC 27597; (919) 269-6441. Product Name: RAM 300. **Contact:** Jeffrey A. Forsburg, pres. **Date Product Introduced:** 6/90. **Product Description & Applications:** This enclosure can be configured from a full-range long-throw to a plain sub. Because of its versatility with interchangeable modules, the RAM 300 can be used in almost all applications such as churches, concerts, clubs, arenas, etc. The RAM 300 is the first fully modular professional loudspeaker with 250 possible combinations of components. The enclosure can hold 3 modules at a time and can rotate a full 360° for different dispersements and for rigging vertical or horizontally. **Basic Specifications & Suggested List Price:** RAM 300 (holds 3 modules): 61.5 (H) x 22.5 (W) x 26 (D), 13-ply birch covered with catalyzed textured black polyurethane. Kick-back casters, rigging points on all sides. With 20 modules to pick from, the weight and price can vary greatly.

FOSTEX; 15431 Blackburn Ave.; Norwalk, CA 90650; (213) 921-1112. Product Name: Models SH200/SH2510. **Contact:** Mark Cohen, VP. **Date Product Introduced:** 1990. **Product Description & Applications:** In-wall speaker system. Features include: easy installation, snap-on grills, thin design, high-performance crossover network, 2 types of line transformers available, new design drivers. **Basic Specifications & Suggested List Price:** SH200, 2-way system: max. input 45 watts, impedance 8 ohms, freq. response 48Hz to 20kHz, crossover Q 2,500Hz, \$199. SH2510, subwoofer system: 50 watts max. input, impedance 8 ohms x 2 (dual voice coils), frequency response 32 to 250 Hz., \$250.

FRAZIER; Rte. 3, Box 319; Morrilton, AR 72110-9532; (501) 727-5543. Product Name: CAT™ 66. **Contact:** James R. Truelsen, VP sales and marketing. **Date Product Introduced:** Mid 1990. **Product Description & Applications:** 2-way, high-output, controlled-directivity coaxial system. Features 60" x 40" pattern, with 2 heavy-duty 12" woofers mounted at an inclined angle of 50° at the center of a bass horn cabinet within one 1" compression driver on a 60" x 40" high-frequency horn mounted coaxially in front of the bass drivers. **Basic Specifications & Suggested List Price:** 250 watts AES, 96dB 1W/1M sensitivity, 45Hz to 15kHz (+/-3dB) frequency response, lock mitre fiberwood cabinet construction measuring 25-1/4 x 25-1/4 x 17-3/8, weighing 124 lbs. In black, oak and walnut hardwood veneers.

FRAZIER; Rte. 3, Box 319; Morrilton, AR 72110-9532; (501) 727-5543. Product Name: Portable Carpeted CAT™ 40 w/ Tripod. **Contact:** James R. Truelsen, VP sales and marketing. **Date Product Introduced:** mid-1990. **Product Description & Applications:** Carpeted portable CAT™ 40, 2-way 90° x 90° controlled-directivity coaxial system features a HD 8" woofer mounted at the back of a bass horn cabinet with a 2" x 6" high-frequency horn mounted coaxially in front of the woofer. Carrying handle and a built-in tripod (1-1/2") mounting plate are standard as is a steel grill. Travel cover is an option. **Basic Specifications & Suggested List Price:** 90° x 90° pattern control, 85 watts AES, 93dB 1W/1M sensitivity, 65 Hz to 17kHz +/-3dB frequency response, 17-5/8 x 17-5/8 x 8-7/8, 37 lbs., 1-1/2" HD aluminum. Tripod adjusts from 3'6" to 6'7" with base diameter of 47". Weight: 6.25 lbs.

GENELEC/QUEST MARKETING; PO Box 20; Auburndale, MA 02166; (617) 964-9466. Product Name: Genelec Model 1033. **Contact:** Scott Berdell, marketing VP. **Date Product Introduced:** 10/90. **Product Description & Applications:** The Model 1033 is a Soffit-mounted dual-10" active monitoring system, with a separate electronics chassis that includes a crossover and tri-amplification, and directivity-controlled waveguide tweeter. **Basic Specifications & Suggested List Price:** \$27,500 suggested list price. Freq. response 38Hz to 21kHz +/-2dB. Symmetrical pair.

HEADWATER; 2669 Guoin St.; Detroit, MI 48207; (313) 961-3196; FAX: (313) 567-1352. Product Name: Concept Speaker Systems. **Contact:** Tim Jarrod, sales rep. **Date Product Introduced:** 7/90. **Product Description & Applications:** Full range of concert-quality speaker cabinets. 3- and 4-way active boxes. Handling power from 300 to 1,200 watts. Flying capability available. Turnkey systems for ease of operation.

HEADWATER; 2669 Guoin St.; Detroit, MI 48207; (313) 961-3196; FAX: (313) 567-1352. Product Name: Ohm (UK) Industries. **Contact:** Tim Jarrod, sales rep. **Date Product Introduced:** 7/90. **Product Description & Applications:** Compact, powerful installation and mobile speaker systems with modern appearance. Also, self-contained powered systems and stage monitors. Full-range, bass and mid/high cabinets available as well as a full line of mounting hardware for installations

INTERSONICS, INC.; 3453 Commercial Ave.; Northbrook, IL 60062; (708) 272-1772. Product Name: ServoDrive Bass Tech 7. **Contact:** Tom Melzer, sales manager. **Date Product Introduced:** 1/90. **Product Description & Applications:** The ServoDrive Bass Tech 7 is a horn-loaded subwoofer featuring Intersonics' patented servomotor-drive operating principle and power cooling/heat exhaust system, which minimizes efficiency loss due to power compression. The Bass Tech 7 is specially designed for effective coupling in arrays, and has the ability to deliver extremely high sound pressure levels at frequencies as low as 28-30 Hz, with minimal power requirements and distortion. **Basic Specifications & Suggested List Price:** Sensitivity

(4 units, 1/2-space, groundplane): 110 dB, 1 watt/1 meter. Frequency response: 28 to 125 Hz. Power handling: 400 watts RMS/800 watts peak musical. Maximum SPL (4 units, 1/2-space, groundplane): 145dB peak.

JBL PROFESSIONAL; 8500 Balboa Blvd.; Northridge, CA 91329; (818) 893-8411. Product Name: Coaxial Loudspeakers. Contact: Mark Gander, VP mktg. Date Product Introduced: 4/90. Product Description & Applications: Intended for engineered sound applications, the 2100-Series coaxial transducers were designed to achieve high acoustical power output while maintaining smooth response, wide bandwidth and consistent dispersion in several critical HF octave bands. The HF transducer incorporates a pure titanium dome with JBL's patented diamond surround for control over secondary resonances. The LF driver combines a rugged die-cast frame with a specially designed cone, to perform well in the most commonly specified utility-metal enclosure and baffle combinations. **Basic Specifications & Suggested List Price:** 2142H (12-inch): frequency range: 60 Hz to 22 kHz; power rating: 90 watts. 2152H (12-inch): frequency range: 70 Hz to 17 kHz; power rating: 150 watts. 2155H (15-inch): frequency range: 60 Hz to 17 kHz; power rating: 150 watts.



JBL PROFESSIONAL
SR4700 Series Loudspeaker Systems

JBL PROFESSIONAL; 8500 Balboa Blvd.; Northridge, CA 91329; (818) 893-8411. Product Name: SR4700 Series Loudspeaker Systems. Contact: Mark Gander, VP mktg. Date Product Introduced: 6/90. Product Description & Applications: Portable sound reinforcement loudspeaker systems featuring new Vented Gap Cooling™ transducers, titanium diaphragm compression drivers with patented diamond surround, and Bi-Radial® horns. Vented Gap Cooling transducers provide outstanding reliability, low distortion and reduced power compression. The unique trapezoidal shape of the cabinets permits tight grouping to form arced arrays when used in multiples. The external surface of the cabinets are covered with a rugged, proprietary heavy fabric laminate, and interlocking exterior corner protectors allow non-slip stacking. **Basic Specifications & Suggested List Price:** SR4718: frequency range 30Hz to 3.3kHz, 600-watt power capacity; SR4722: frequency range 53Hz to 17kHz, 600-watt power capacity; SR4725: frequency range 36Hz to 18kHz, 600-watt power capacity; SR4732: frequency range 40Hz to 20kHz to 20kHz 1,200-watt power capacity; SR4735: frequency range 35Hz to 17kHz, 300-watt power capacity; SR4738: frequency range 30Hz to 17kHz, 800-watt power capacity.



KLIPSCH & ASSOCIATES, INC.
KP-115 SW

KLIPSCH & ASSOCIATES, INC.; PO Box 688; Hope, AR 71801; (501) 777-6751. Product Name: KP-115 SW. Contact: Tom Gallagher, marketing specialist (Pro). Date Product Introduced: 6/90. Product Description & Applications: The

KP-115 subwoofer from Klipsch is lightweight and small in size. Turn it on its side and it is rack-mountable (14 spaces). A top-mounted socket allows the sub to be used as a base for standing main speakers up to six feet above the woofer. **Basic Specifications & Suggested List Price:** 1 15" woofer in a vented low-frequency enclosure. Freq. resp. 40 Hz to 2 kHz +/-4 dB, -10 dB down point 32Hz. Max cont. output 125dB at 300W input, Imp. 8 ohms. Dimensions 18-7/8(H) x 24-1/2(W) x 19 1/2(D). Shipping weight 70 lbs. (UPS avail.) Suggested retail is \$313-\$370 depending on version.

KRK MONITORING SYSTEMS; 19872 Gloucester Ln.; Huntington Beach, CA 92646; (714) 963-9609. Product Name: Close-field Monitors. Contact: Keith Klawitter, designer, owner. Date Product Introduced: 1/90. Product Description & Applications: Systems applications are for close-field monitoring, where accuracy is of high demand. Applications: close-field monitoring, remote recording, synthesizer racks, onstage, home. **Basic Specifications & Suggested List Price:** Model 703: crossover 2-way driver per channel, 7" woofer and tweeter, power handling 75 watts, sensitivity 1W/1m 92 dB, freq. resp. +/-3 dB 54 Hz to 15 kHz. Dimension: (H x W x D) 12" x 11" x 10-3/4". Model 102: crossover 2-way driver per channel, 10" woofer and tweeter, power handling 130 watts, sensitivity 94 dB, freq. resp. 49 Hz to 19

kHz. Dimension (H x W x D) 17-1/2" x 17-1/4" x 13". Model 1303: crossover 3-way passes bi-amp and tri-amp, 13" woofer and 5": midrange and tweeter. Power handling 250 watts, sensitivity 92 dB, freq. resp. 38 Hz to 19 kHz. Dimensions (H x W x D) 26" x 20" x 14". All systems are black formica.

KRK MONITORING SYSTEMS; 19872 Gloucester Ln.; Huntington Beach, CA 92646; (714) 963-9609. Product Name: KRK-15A4 Main Monitoring Systems. Contact: Keith Klawitter, designer, owner. Date Product Introduced: 2/90. Product Description & Applications: 3-way active systems, high-power handling, utilizing the latest technology in system design. All Kevlar drive units, resulting in very low distortion, very linear, high SPL: all without the use of horns. **Basic Specifications & Suggested List Price:** 3-way active systems. Per channel: 2-15" Kevlar woofers, 1-15" Kevlar cone, 1-1" Kevlar tweeter. Maximum SPL 118 dB. System retail price: \$7,850 per pair.

E.M. LONG ASSOCIATES; 4107 Oakmore Rd.; Oakland, CA 94602; (415) 531-8725. Product Name: CRM-100/SS. Contact: Ed Long. Date Product Introduced: 4/90. Product Description & Applications: The CRM-100/SS is a complete, self-powered 4-channel, surround-sound monitor system for recording and broadcast studios. It is available on a custom order basis.

NATIONWIDE

For More Information and/or Booking, Contact:

STEVEN REMOTE
ASL MOBILE AUDIO
P O BOX 791
FLUSHING, N.Y. 11355

Telephone: 718-886-6500
Fax: 718-886-7214

Telex: 271382 ASL UR

An AURA SONIC, Ltd. Company

Circle #057 on Reader Service Card

MONITOR/LOUDSPEAKER SYSTEMS

MACPHERSON LOUDSPEAKERS; 3351 Remy Dr.; Lansing, MI 48906; (517) 321-0700. Product Name: Blackbox. **Contact:** Scott Helmke/Dave Macpherson. **Date Product Introduced:** 10/90. **Product Description & Applications:** The Blackbox control unit incorporates a 24dB per-octave-crossover, equalization, and system protection in a single rackspace device. Models are available to drive both our M1 and M2A loudspeakers.

MARTIN AMERICA; 21000 Devonshire St. #205; Chatsworth, CA 91311; (818) 718-1031; FAX: (818) 718-2886. Product Name: Martin CT series. **Contact:** Linda Frank, nat'l sales mgr. **Date Product Introduced:** 4/90. **Product Description & Applications:** The CT series consists of the CT2, a compact trapezoidal system featuring a new coaxial drive unit. Its smooth, dynamic sound is ideally suited to disco applications, theater and A/V use. The CTX is a powerful compact sub-bass system designed to be used in conjunction with the CT2 when extended bass response is needed. It features a single large-coil proprietary 18" driver in a reflex enclosure that is internally braced to preserve important low-frequency transient information. **Basic Specifications & Suggested List Price:** The MX2 is a 2-channel system controller, designed to maximize the performance available from compact loudspeaker systems such as the CT Series. It can be used either in its stereo full-range mode, where it provides equalization and limiting functions appropriate to compact loudspeaker systems, or as a cost-effective stereo electronic crossover with limiters.

MARTIN AMERICA; 21000 Devonshire St. #205; Chatsworth, CA 91311; (818) 718-1031; FAX: (818) 718-2886. Product Name: Martin F1. **Contact:** Linda Frank, nat'l sales mgr. **Date Product Introduced:** 6/90. **Product Description & Applications:** The Martin F1 is a vertically formatted 2-box touring sound system. The F1 is a fixed-format system based on the design of the flagship F2 in a smaller size. Applications include touring sound and systems and installations for clubs and theaters. **Basic Specifications & Suggested List Price:** The F1 top box features a 12" mid-horn with a nominal 70° horizontal constant coverage pattern. High frequencies are reproduced by a 1.5" exit titanium diaphragm compression driver. A super-tweeter array is available for the 10Hz to 20kHz octave. 20kHz octave. The bass horn is a new proprietary 18" drive unit matched to the F1's modified hyperbolic bass horn.



THE MASTERING LAB STUDIO PRODUCTS
The Mastering Lab Model 10 Loudspeaker Crossover

THE MASTERING LAB STUDIO PRODUCTS; 6031 Hollywood Blvd.; Los Angeles, CA 90028; (213) 466-3528. Product Name: The Mastering Lab Model 10 Loudspeaker Crossover. **Contact:** Doug Sax, president. **Date Product Introduced:** 1/90. **Product Description & Applications:** Meticulously selected components and air core inductors result in low-distortion sonics and greatly enhanced resolution from 10" Tannoy Speakers. Infinitely variable balance control allows precise matching for your monitoring requirements. Accurate and balanced, the Model 10 is ideal for near-field monitoring. **Basic Specifications & Suggested List Price:** \$650 (includes installation).

MCCAULEY SOUND, INC.; 13608 94th Ave. E.; Puyallup, WA 98373; (206) 848-0363. Product Name: Model 6254. **Contact:** Bruce Anderson, sales division. **Date Product Introduced:** 5/90. **Product Description & Applications:** The Model 6254 18" loudspeaker is a highly efficient, very powerful low-end transducer. The 6254 features a RMS power rating of

450 and a frequency response of 20 Hz to 1,500 Hz plus, of course, McCauley's field serviceable basket assembly. With the 6254's ability to reproduce the critical lowest frequencies, this speaker is perfect for movie theaters, discotheques, or concert stadiums. **Basic Specifications & Suggested List Price:** Diameter 18", impedance 4, 8 or 16 ohms, RMS/watts 450 watts, sensitivity 97dB SPL, freq. range 20 Hz to 1,500 Hz. Depth 7.6", weight 25 lbs. Price: \$386.

MCCAULEY SOUND, INC.; 13608 94th Ave. E.; Puyallup, WA 98373; (206) 848-0363. Product Name: Model 6342. **Contact:** Bruce Anderson, sales division. **Date Product Introduced:** 5/90. **Product Description & Applications:** The Model 6342 is a high-efficiency 15" low-frequency transducer with an extended midrange. Not only does the 6342 offer the convenience of our field-serviceable magnet assembly, it can also be installed in either vented or horn-loaded enclosures. The carbon-fiber cone supports powerful low-frequency dynamics and increases mid-band efficiency by eliminating cone breakup, thus allowing higher crossover points and producing exceptional vocal clarity. **Basic Specifications & Suggested List Price:** Diameter 15", impedance 4, 8, or 16 ohms, RMS/watts 400W, sensitivity 99dB SPL, freq. range 40 Hz to 2.5 kHz. Depth 5.6", weight 23.5 lbs. Price: \$247.

MEYER SOUND LABORATORIES, INC.; 2832 San Pablo Ave.; Berkeley, CA 94702; (415) 486-1166. Product Name: DS-2 Arrayable Mid-Bass Loudspeaker. **Contact:** Mark Johnson, dir. technical mktg. **Date Product Introduced:** 1/90. **Product Description & Applications:** The DS-2 arrayable mid-bass loudspeaker is a horn-loaded unit designed to cover the frequency range from 50 to 200 Hz. Designed to supplement the Meyer Sound MSL-10A and large MSL-3 arrays, it employs two 15-inch cone LF drivers in an enclosure of the same dimensions as the MSL-3, and it presents a 4-ohm load.

PROFESSIONAL AUDIO SYSTEMS; 1224 W. 252nd St.; Harbor City, CA 90710; (213) 534-3570. Product Name: TOC System-2. **Contact:** Mr. Ray Bond, director of sales. **Date Product Introduced:** 1/90. **Product Description & Applications:** High-quality compact sound reinforcement system consisting of the RS-2, a 2-way full-range trapezoidal enclosure with integral flying hardware, the SW-2 compact stage wedge and EB-2 subwoofer. The system has been designed around our proprietary electronic control system to offer optimum performance in all sound reinforcement applications. **Basic Specifications & Suggested List Price:** RS-2: 50 Hz to beyond 15 kHz, 126dB continuous SPL, \$2,400. SW-2: 60 Hz to beyond 15 kHz, 126dB continuous SPL, \$2,400. EB-2: 27 Hz to 100 Hz, 129dB continuous SPL, \$1,600. All prices are list and include the APM electronic module, speaker cable and amplifier connection cable.

PROFESSIONAL TECHNOLOGIES; Box 282A Rd. 1; Rome, NY 13440; (315) 337-4156. Product Name: PT821 and PT6521. **Contact:** John Puleo. **Date Product Introduced:** 2/90. **Product Description & Applications:** Studio monitor, near-field, 2-way ported, 6.5" woofer and 1" tweeter, real oak veneer, other veneers available (special order). **Basic Specifications & Suggested List Price:** 10W to 120W peak, 89dB 1 watt/1 meter, 45 Hz to 20 kHz +/-3dB, 8 ohm nominal 17-1/4"H x 13-1/2"W x 13"D. \$450 per pair.

PROFESSIONAL TECHNOLOGIES; Box 282A Rd. 1; Rome, NY 13440; (315) 337-4156. Product Name: PT821 and PT6521. **Contact:** John Puleo. **Date Product Introduced:** 2/90. **Product Description & Applications:** Studio monitor, near-field, 2-way ported, 8" woofer and 1.25" tweeter, real oak veneer, other veneers available (special order). **Basic Specifications & Suggested List Price:** Power handling 10W to 500W peak; sensitivity, 91 dB (1 watt/1 meter). Freq. resp. 31 Hz to 20 kHz +/-3 dB, 8 ohms nominal impedance. Dimensions: 35-3/8"H x 10-1/3"W x 13-1/4"D. \$600 per pair.



QUESTED MONITORING SYSTEMS LTD.
HQ410

QUESTED MONITORING SYSTEMS LTD.; 59 Maltings Pl., Bagleys Ln.; London, SW6 2BX UK; (081) 731-7434. Prod-

uct Name: HQ410. **Contact:** Roger Quested, MD. **Product Description & Applications:** The HQ410 is a 3-way passive system that can, at a later date, be converted to run in a 2- or 3-way active mode. Components: 4 x 10" bass drivers, 1 x 3" softdome midrange, 1 x 1" tweeter (ferro-fluid damped). As in all QMS products, the bass drive work in their own individual chamber. **Basic Specifications & Suggested List Price:** Frequency response 25Hz to 18kHz +/-1.5dB, nominal impedance 4 ohms, sensitivity 94 dB 1W/1M, crossover frequencies: 600 Hz and 2.8 kHz. Weight 160 lbs. Price: \$1,750.

RADIAN AUDIO ENGINEERING, INC.; 4520 Eisenhower Circle; Anaheim, CA 98207; (714) 693-9277; FAX: (714) 693-9278. Product Name: Monitor Standard MM-8. **Contact:** Buddy Frisbee, nat'l sales mgr. **Date Product Introduced:** 1/90. **Product Description & Applications:** The Monitor Standard MM-8 is a high-performance recording monitor designed expressly for close-field monitoring applications. Based on the Radian 8" coaxial loudspeaker, it employs a full-sized compression driver, a unique feature for systems in this class. The point-source design provides precise stereo imaging and eliminates the "sweet spot" associated with small monitors. Its unusually wide dispersion delivers uniform frequency response throughout the mixing field. High power-handling capacity ensures reliable performance. **Basic Specifications & Suggested List Price:** Frequency response 40 Hz to 25 kHz, average program capacity 150 watts, sensitivity 1W/1M 89.5dB, nominal impedance 8 ohms. "Normal-Mellow-Bright" and brilliance equalization are rear panel controls. The 8" polypropylene woofer utilizes a 2-inch edge-wound copper voice coil. Satin black lacquer finish. 10 x 16 x 8 inches. Suggested retail price: \$429 each.

RADIAN AUDIO ENGINEERING, INC.; 4520 Eisenhower Circle; Anaheim, CA 98207; (714) 693-9277; FAX: (714) 693-9278. Product Name: Monitor Standard MS-8. **Contact:** Buddy Frisbee, nat'l sales mgr. **Date Product Introduced:** 1/90. **Product Description & Applications:** The Monitor Standard MS-8 is a full-range, high-performance recording monitor system designed for small studios where the performance and bandwidth of a larger system is required, but the size, weight and price of the larger system is not! The astonishing low-frequency capability and smooth, high-frequency clarity of the Radian 8" coaxial amaze the most jaded client, and provide the mixing engineer with a powerful new tool of high tracking accuracy. **Basic Specifications & Suggested List Price:** Frequency response 30 to 25,000 Hz, average program capacity 200 watts, sensitivity 1W/1M 89.5 dB, nominal impedance 8 ohms. "Normal-Mellow-Bright" and brilliance equalization are rear panel controls. The 8" polypropylene woofer utilizes a 2-inch edge-wound copper voice coil. Satin red oak or satin black lacquer finish. 19 x 12 x 9.75 inches. Suggested retail price: \$498 each.

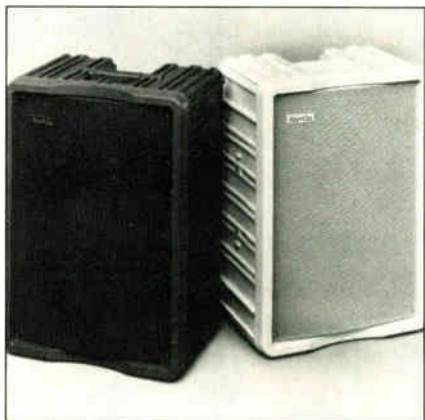

RAMSA/PANASONIC INDUSTRIAL COMPANY
A-500 and A-550 (subwoofer) Speaker Systems

RAMSA/PANASONIC INDUSTRIAL COMPANY; 6550 Katella Ave.; Cypress, CA 90630; (714) 373-7277. Product Name: A-500 and A-550 (subwoofer) Speaker Systems. **Contact:** Chris Forman. **Date Product Introduced:** 3/90. **Product Description & Applications:** The Ramsa 500 Series speaker systems, consisting of the WS-A500 for mid-to-high frequencies, and the WS-A550, for low frequencies, are compact, high-performance modular components designed for entertainment applications requiring audiophile sound quality and operate at high sound levels. **Basic Specifications & Suggested List Price:** Both models house a 12" ported, direct-radiating transducer, designed specifically for large volume displacement and high thermal power capacity-criteria for low-frequency operations. List price: WS-A500 \$1,300, WS-A550 \$880.

RAMSDELL AUDIO; PO Box 76186; St. Petersburg, FL 33734; (813) 823-8037. Product Name: SW 2710. **Contact:** Richard Ramsdell. **Date Product Introduced:** 1989. **Product Description & Applications:** 27" 52-lb. subwoofer driver with a 6.3" edge-wound voice coil. Frequency response is 11 Hz to 150 Hz depending on enclosure size and choice. Power han-

ding is 500 watts continuous, 1,000 watts program in properly built enclosure. Sensitivity 103.5 dB 1W/1M. QTS .27, QMS 4.16, VAS 1,720 liters, RE 5.7 ohms, FS 18 Hz. **Basic Specifications & Suggested List Price:** \$1,250 suggested list price.

ROSS SYSTEMS; PO Box 2344; Ft. Worth, TX 76113-2344; (817) 336-5114. Product Name: TX252/TX252HL. **Contact:** Ramon West, Ross Systems product specialist. **Date Product Introduced:** 12/89. **Product Description & Applications:** The TX252/TX252HL full-range loudspeaker enclosures are rated at 200W RMS/400W program peak. The TX252 is great for P.A. systems in churches, schools and small clubs while the TX252HL is ideal for medium-to-large clubs. These loudspeaker cabinets are made to withstand the most demanding conditions. They feature a heavy gauge grill, metal corners and rugged ozite carpeting. **Basic Specifications & Suggested List Price:** The TX252 and TX252HL have a frequency coverage of 90°H x 40°V, a crossover frequency of 1.5 kHz and impedance of 8 ohms. The TX252 frequency response is 55 Hz to 18.5 kHz and the TX252HL frequency response is 62 Hz to 18.5 kHz.

STANTON MAGNETICS INC.; 101 Sunnyside Blvd.; Plainview, NY 11803; (516) 349-0235. Product Name: SRS-275 Headphone. **Contact:** Jean Kapen, mgr. advertising and promotion. **Date Product Introduced:** 9/90. **Product Description & Applications:** Semi-closed professional headphone. The SRS 275 contains a deluxe dynamic driver engineered for a flat frequency response, superb imaging. Unit has a circumaural design ear cushion on a special engineered spring suspension. **Basic Specifications & Suggested List Price:** Frequency response 5 Hz to 22 kHz, sensitivity 101 dB at 1 kHz each channel, max. power input 0.1 watt per channel; distortion less than 0.5% at 1 kHz, impedance 100 ohms at 1 kHz each channel, weight 8.6 oz. (245 grams). Headphone comes with a 2-year warranty. Suggested list price: \$160.



TANNOY—TGI NORTH AMERICA INC.
Tannoy Monitor Series

TANNOY—TGI NORTH AMERICA INC.; 300 Gage Ave., Unit #1; Kitchener, Ontario, N2M 2C8 Canada; (519) 745-1158. Product Name: Tannoy Monitor Series. **Contact:** Bill Calma or Rob Hofkamp. **Product Description & Applications:** Tannoy Monitor Series is a revolutionary new line of dual-concentric reference monitors featuring DM™ (Differential Material Technology). The new line is totally retooled and represents 10 years of research and development. **Basic Specifications & Suggested List Price:** Call for complete literature pack.

TARGET TECHNOLOGY, INC.; PO Box 609; Penn Valley, CA 95946; (916) 639-2102. Product Name: Switch™ Audio Monitoring System. **Contact:** Peter Hughes. **Date Product Introduced:** 7/90. **Product Description & Applications:** The Switch is a multichannel audio monitoring system featuring a selection of four separate balanced stereo inputs, VU and peak metering via 30-element bar graphs, dual wide-range speakers, and a selection of L+R, L-R for stereo coherency confirmation. Also provided with X-Y outputs to drive external display unit for stereo signal monitoring. Four versions are available, all contained in a 3RU frame. **Basic Specifications & Suggested List Price:** Speaker power 10W per side, bar graphs -40 dB to +25 dBm with peak and VU multiplexed displays. Inputs are balanced or unbalanced, X-Y outputs are unbalanced 75 ohms using BNC connectors. Priced from \$985 to \$1,785.

TMS RESEARCH; 2435 Bethel—New Richmond Rd.; Bethel, OH 45106; (513) 734-3032. Product Name: TMS Model 102 Loudspeaker. **Contact:** S. Lewis, pres. **Date Product Introduced:** 7/90. **Product Description & Applications:** The TMS Model 102 Loudspeaker has a high-quality sound that can be used in residential or commercial applications. Design analysis 12" woofer, 5" midrange, 3" tweeter, impedance 8 ohms, frequency response 28 to beyond 20,000 Hz. Crossover frequency 900-400 Hz, 6 dB/octave. Power handling 100 watts continuous. Enclosure dimension 14-1/2"

x25" x 12". Cabinet finish: stained oak hardwood veneer. **Basic Specifications & Suggested List Price:** Quality design, superior performance, outstanding price. Suggested retail: \$425 pair.



TOA ELECTRONICS
New "Engineered Sound" line of loudspeakers

TOA ELECTRONICS; 601 Gateway Blvd.; South San Francisco, CA 94080; (415) 588-2538. Product Name: New "Engineered Sound" line of loudspeakers. **Contact:** Rick Kamlet, manager, engineered sound products. **Date Product Introduced:** 7/90. **Product Description & Applications:** Fourteen new speaker systems, five new components and three new mounting brackets. Categories of new sound reinforcement speaker systems include: F-Series 2-ways, weather resistant available; SF-30 3-way slantback; SF-60 3-way trapezoidal; SR System electronically controlled, SW ultra-linear subwoofers. **Basic Specifications & Suggested List Price:** F-500/SR/WP (240W) \$249-\$369; F-600/SR/WP (360W) \$429-\$499; SF-30 (360W) \$699; SF-60 (360W) \$1,299; SW-3B (500-1,000W) \$889-\$1,299; SW-4B (720-1,440W) \$1,099-\$1,699; SR-F1 (600W) \$1,399; SR-L1 (900W) \$1,499; SR Controllers \$679-\$699.

TURBOSOUND; 200 Sea Lane; Farmingdale, NY 11735; (516) 249-3660. Product Name: TFS Series Flashlite. **Contact:** Dave Talbot, prod mgr. **Date Product Introduced:** 9/90. **Product Description & Applications:** Ultra-high-Q, compact loudspeaker enclosures designed for large venues and outdoor concerts. More information will be at the AES show where the product will be launched.

TURBOSOUND; 200 Sea Lane; Farmingdale, NY 11735; (516) 249-3660. Product Name: TMS-5. **Contact:** Dave Talbot, prod mgr. **Date Product Introduced:** 6/90. **Product Description & Applications:** The TMS 5 is a full-range, 3-way enclosure targeted for nightclubs and small venues. The TMS-5 is a user-reconfigurable mid/high section, which allows for either a vertical or horizontal stack. **Basic Specifications & Suggested List Price:** Retail at \$2,250 with a frequency response of 80-20k Hz +/-4 dB, sensitivity of 104 dB at 1 watt, 1 meter. SPL of 124 dB (continuous) 129 dB (peak); crossover is active 2-way at 300 Hz with Linkwitz-Riley filters.



WOODWORX AUDIO ENCLOSURES
SR-1

WOODWORX AUDIO ENCLOSURES; 913 S. Chapman St.; Greensboro, NC 27403. (919) 378-0650. Product Name: SR-1. **Contact:** Bobby Kelly, sales/Hugh Sarvis, president. **Date Product Introduced:** 10/89. **Product Description & Applications:** The SR-1 house enclosure occupies minimal stage and trucking space and is ideal for providing high SPL while maintaining excellent sight lines. The unit is designed for

external tri-amplification and consists of dual 12-inch and dual 10-inch direct radiator loudspeakers and a 4-inch compression driver mounted to a constant-directivity horn in a vented enclosure, tuned to 50 Hz. The use of large ducts allows complete freedom from vent compression over the entire dynamic operating range of the system. Cabinetry is crafted from void-free 3/4"-ply Finnish birch plywood. All joints are rabbited and stapled for increased structural strength. Each enclosure comes complete with Woodworx' own custom-fitted grills, mounting clamps, Camloc quick-release dolly plate with 4-inch heavy-duty swivel casters and EP series connectors. Finish is a dark gray, catalyzed, texture that offers a durable, scuff-resistant surface. **Basic Specifications & Suggested List Price:** The SR-1 measures only 36"H, 30"W, and 18"D while weighing only 178 lbs. The enclosure offers a maximum SPL of 131 dB and has a flat frequency response from 50 Hz to 17 kHz (+/-3dB) with a frequency range of 40 Hz to 20 kHz (-10dB). Power capacity is 1200 watts LF, 400 watts MF, 150 watts HF. Connectors are ITT Cannon EP-8 with Mogami 12-gauge speaker wire throughout. Cabinets are sold complete and road-ready. Suggested list price: \$3,350.

YORKVILLE SOUND; 4600 Witmer Industrial Estate; Niagara Falls, NY 14305; (716) 297-2920. Product Name: Elite MX-2000. **Date Product Introduced:** 6/90. **Product Description & Applications:** 3-way sound reinforcement speaker system features angled enclosure design to accommodate multiple cluster arrangements and greater driver dynamics. A specially designed processor may be used to linearize bass response or as an active crossover/compressor for bi-/tri-amping applications. The Elite SW-1000 subwoofer (2 x 18" RCF) is recommended to be used with MX-2000 for optimum performance. Yorkville 2-year unlimited transferable warranty comes standard. **Basic Specifications & Suggested List Price:** Type: 3-way, SPL: 135 dB. Construction: 3/4" plywood, metal grill. Crossover frequency: 1 kHz -7 kHz. Horn: 90° x 60° RCF. Drivers: Hi-beams slot tweeter. Mid: 2" EV; Low: RCF (2 x 15"). List Price: \$1,899.

Mix Trivia

3. Some say that a tape this folklorist brought to the governor of Louisiana was responsible for Leadbelly's release from prison.

Turn to page 275 for question

READY TO IMPROVE YOUR RECORDING SKILLS?

THEN SIT NEXT TO A TOP FLIGHT ENGINEER AS HE DEMONSTRATES ALL THE ELEMENTS THAT GO INTO GREAT RECORDING!

The *SHAPING YOUR SOUND* series is five indispensable new videotapes covering multi-track recording, mixing, signal processing and microphones. They bring better studio technique to life using the power of video to do "WHAT NO BOOK ON THE SUBJECT HAS EVER BEEN ABLE TO ACCOMPLISH!" (Mix Magazine)

Every tape is packed with demonstrations and examples that cut through time consuming book study and get you down to better recordings.

CALL FREE TO FIND OUT MORE ABOUT *SHAPING YOUR SOUND*, THE PROFESSIONALS' TRAINING PROGRAM.

1-800-777-1576

FIRST LIGHT VIDEO PUBLISHING
374 N. Ridgewood Place, L.A., CA 90004

Circle #152 on Reader Service Card

MUSIC PRODUCTS

ALESIS CORPORATION; 3630 Holdrege Ave.; Los Angeles, CA 90016; (213) 467-8000. Product Name: DataDisk. **Contact:** Allen Wald, VP, advertising and promotion. **Date Product Introduced:** 10/89. **Product Description & Applications:** MIDI system exclusive data storage device capable of storing 800K of MIDI system exclusive data to a 3.5" floppy disk. New feature allows recording and playing back MIDI sequence data in real time. File size is limited only by the amount of space available on the disk, as there is no data buffer. Files are identified by product, manufacturer, and an 8-character user-definable file name. File names are displayed in a 32-character LCD. DataDisk recognizes MIDI sample dump and interfaces with most brands of MIDI instruments. **Basic Specifications & Suggested List Price:** Dimensions: (H x W x D) 1.75" x 19" x 7". Net weight: 4.5 lbs. Suggested user price: \$449.

CAESIUM SOUND; 1442 A Walnut St. #300; Berkeley, CA 94709; (415) 548-6193. Product Name: EPS Sound Library. **Contact:** Nick Longo. **Date Product Introduced:** 6/90. **Product Description & Applications:** 69 disks of samples for the Ensoniq EPS. Each disk has 2 to 10 sounds, most under 400 blocks. Most disks contain sounds from other synthesizers and drum machines. Some have "real" sounds. **Basic Specifications & Suggested List Price:** Disk prices are \$1.95 each, all 69 disks for \$399. Write for complete listing of disks.

CAESIUM SOUND; 1442 A Walnut St. #300; Berkeley, CA 94709; (415) 548-6193. Product Name: VFX Sound Library. **Contact:** Nick Longo. **Date Product Introduced:** 6/90. **Product Description & Applications:** Three volumes of 60 sounds each for the Ensoniq VFX or VFX⁹⁰. Volume 1 has Top 40 and rock sounds, volume 2 has synth and percussion sounds, volume 3 has orchestral and atmospheric sounds. **Basic Specifications & Suggested List Price:** EPROM cartridges \$55 each, three for \$130. All three volumes \$99 on disk. Librarian programs for Atari ST or Macintosh, \$125 including sounds.



SEYMOUR DUNCAN RESEARCH
KTG-1 tube guitar preamplifier

SEYMOUR DUNCAN RESEARCH; 601 Pine Ave.; Santa Barbara, CA 93117; (805) 964-9749. Product Name: KTG-1 tube guitar preamplifier. **Contact:** Cathy Duncan, marketing manager. **Date Product Introduced:** 1/90. **Product Description & Applications:** The KTG-1 is a single-rackspace, all-tube guitar preamplifier with 2 channels and 5 distinct footswitchable sounds. Low impedance output is provided by using a tube cathode follower, so the integrity of the tube design is preserved. The preamp is very quiet, with the output stage having a less than 110dB signal to noise ratio. **Basic Specifications & Suggested List Price:** 1 rackspace, 2 channel, all vacuum tube amplifier, input impedance 1 meg, output impedance 10k, maximum output before clip 30V, hum + noise referred to full output, ch. 1=85 dB, ch. 2=70 dB, output stage =-110 dB. Suggested list \$395.

DW LABS, INC.; PO Box 882; Millburn, NJ 07041; (201) 376-8453; (800) 542-2454. Product Name: Superconductor. **Contact:** Jeff Davis, manager. **Date Product Introduced:** 3/90. **Product Description & Applications:** The new continuous volume version of the Superconductor product features gain variable from unity to +12 dB. The Superconductor is a buffering preamp that isolates passive guitar electronics from the large capacitance of the guitar cable. The capacitance of the cable is proportional to the cable's length and can absorb a significant part of the high end of the guitar's signal. The SC allows the full range of sound that the guitar is producing to be heard, resulting in increased clarity and high end. Excellent for recording. **Basic Specifications & Suggested List Price:** The Superconductor provides continuously variable volume from unity gain to +12 dB. Frequency response is 20 to 20k Hz +/-0.8 dB. Total harmonic distortion is .003% at 1 kHz. Housed in compact ABS plastic case with belt clip the unit is designed and manufactured in the USA. The suggested list for variable volume unit is \$95.

ENSONIQ CORP.; 155 Great Valley Pkwy.; Malvern, PA 19355; (215) 647-3930. Product Name: EPS-16 Plus Digital Sampling Workstation. **Contact:** Jerry Kovarsky, marketing director. **Date Product Introduced:** 9/90. **Product Description & Applications:** The EPS-16 Plus is a significant evolution from the ENSONIQ EPS Performance sampler. Based on the same architecture, the EPS-16 Plus upgrades the sampling fidelity to true 16-bit resolution with 2-20kHz frequency response, 100dB S/N and <0.002% THD + noise performance. 24-bit stereo dynamic effects are integrated for the first time ever in a sampling product. Retaining all the same performance and sequencing features of the EPS, the EPS-16 Plus also adds optional "flash-bank" memory for battery backed-up RAM sound storage. **Basic Specifications & Suggested List Price:** 16-bit sampling, 20 voices, 8 instruments, play while load, exclusive Patch Selects and poly-key pressure™ keyboard, 1 meg internal RAM (expandable to 2 meg), up to 44.6 kHz sampling rates, 24-bit stereo dynamic multi-effects, 16-track sequencer, automated mixdown, optional SCSI, optional 6-output expander, compatible with existing EPS sound library. Keyboard or rack-mount, \$21,950 suggested retail price.

ENSONIQ CORP.; 155 Great Valley Pkwy.; Malvern, PA 19355; (215) 647-3930. Product Name: SQ-1 Personal Music Studio. **Contact:** Jerry Kovarsky, marketing director. **Date Product Introduced:** 3/90. **Product Description & Applications:** 61-key synthesizer with 24-bit dynamic effects and a 16-track sequencer. The SQ-1 features the same Dynamic Component synthesis found in the VFX and VFX⁹⁰ synthesizers and holds up to 340 sounds (with optional card). Also included are 20 dedicated drum kits. The sequencer holds 9,000 notes and can be expanded to over 58,000 notes, with 70 sequence/30 song locations, extensive editing is possible with the ability to audition all edits and changes. Up to 8-zone split and layer capabilities and MIDI control possible. **Basic Specifications & Suggested List Price:** 61-key keyboard, 16-bit D/A, 121 waveforms, 21 oscillators, dual multi-mode filters, 3 envelopes per oscillator, extensive modulation, 24-bit stereo dynamic multi-effects, 16-track sequencer, 30 song/70 sequence, 9,000 notes, stereo outputs. \$1,595.

KORG USA, INC.; 89 Frost St.; Westbury, NY 11590; (516) 333-9100. Product Name: S3 Rhythm Workstation. **Contact:** Larry DeMarco, director, marketing communications. **Date Product Introduced:** 1/90. **Product Description & Applications:** The S3 is a Rhythm Workstation featuring 16-bit PCM samples taken from a wide variety of drums and percussion instruments. Attack and decay components can be "mixed and matched" in any combination with independent control over tuning and level. The unit features built-in stereo multi-effects, a MIDI sequencer and the ability to read and write SMPTE time code. The S3 fits perfectly into the home studio as well as the professional studio. **Basic Specifications & Suggested List Price:** 72 waveforms, 160 timbres, 20 kits; more on cards. Two effects processors, 28 effect algorithms. Sequencer: four pattern tracks, four real-time tracks, "soft" quantizing, track shifting, 192 ppqn, 8,000 note capacity (more with RAM card). Stereo outputs, four multi-outs. One MIDI in, two MIDI outs (switchable thru). Reads and writes SMPTE time code. List price \$1,199.

KORG USA, INC.; 89 Frost St.; Westbury, NY 11590; (516) 333-9100. Product Name: Wavestation. **Contact:** Larry DeMarco, director, marketing communications. **Date Product Introduced:** 7/90. **Product Description & Applications:** The Korg Wavestation is a 32-voice synthesizer featuring Advanced Vector Synthesis and Wave Sequencing technology. Over 350 waveforms are onboard (more on PCM cards), including attack transients, "loop-only" waveforms, time slices, etc. Synthesizer parameters include dynamic lowpass filters, envelope generators, low-frequency oscillators, modulation matrix, etc. Onboard dynamic digital multi-effects allow dynamic control over effect parameters. The Wavestation can transmit up to 8 MIDI channels simultaneously and receive up to 16 for multi-timbral use. **Basic Specifications & Suggested List Price:** 50 performances x 4, 35 patches x 4, 32 wave sequences x 4, 365 waveforms in ROM, more on PCM cards, 2 effects processors, 47 effect algorithms, pitch bend and modulation wheels, vector joystick, 64 x 240 graphics LCD, PCM and program card slots. MIDI in, out, thru, 4 audio outputs, 2 programmable foot control outputs. List price: \$2,399.

LAKE BUTLER SOUND CO. INC.; 5331 W. Lake Butler Rd.; Windermere, FL 34786; (407) 656-5515; FAX: (407) 656-5515. Product Name: CFC-1. **Contact:** Emmett Bradford, president. **Date Product Introduced:** 9/90. **Product Description & Applications:** CFC-1 is a MIDI-continuous control pedal for controlling parameters (such as levels and delay times) in real time. Simple DIP switch selection of MIDI channels and controller #s includes dual channel crossfades, 6-channel volume and modulation (for guitar synths). Custom functions available by special request. MIDI in merges thru to MIDI out, pedal is reassignable during performance via MIDI system exclusive. Includes 25-foot MIDI and power cord and DC power supply. **Basic Specifications & Suggested List Price:** List price \$150.

LAKE BUTLER SOUND CO. INC.; 5331 W. Lake Butler Rd.; Windermere, FL 34786; (407) 656-5515; FAX: (407) 656-5515. Product Name: Datacaster System 100. **Contact:** Emmett Bradford, president. **Date Product Introduced:** 6/90. **Product Description & Applications:** Datacaster System 100 is a guitar-mounted effects control system. This system makes it possible to select from 10 effects sounds at a time, directly from an instrument. Consists of a 10-position rotary selector (with hardware for mounting in guitars), 20-ft. cable and DCR-100 rack-mount receiver unit. System allows access to all 128 programs on all 16 MIDI channels. **Basic Specifications & Suggested List Price:** Datacaster System 100 list price: \$345. Datacaster System 100W (for custom cabled and wireless applications) list price: \$295.

L.P. MUSIC GROUP; 160 Belmont Ave.; Garfield, NJ 07026; (201) 478-6903. Product Name: SoHo Acoustics QTR-1. **Contact:** Angelo Arimborgo. **Date Product Introduced:** 1/90. **Product Description & Applications:** The SoHo Acoustics QTR-1 tube preamp is a rack-mountable, all-tube guitar preamplifier that allows guitarists to access four different clean and overdriven settings from the front panel or with a footswitch. Two complete sets of tone controls and a total of six gain controls allow for tremendous sonic versatility. **Basic Specifications & Suggested List Price:** The SoHo preamp is two rackspaces high, utilizes four 12AX7 tubes and is vented on the front, back and top for more than adequate airflow through the chassis. List price is \$579.95.

MANHATTAN PRODUCTION MUSIC; 311 W. 43rd St., Ste. 202; New York, NY 10036; (800) 227-1954; (212) 333-5766. Product Name: MPM 28 "Comedy". **Contact:** Ron Goldberg, nat'l sales mgr. **Date Product Introduced:** 12/90-1/91. **Product Description & Applications:** The 28th compact disc to be released from the MPM Music Library, it features various original comedy themes. **Basic Specifications & Suggested List Price:** To be included in the MPM Library, which is licensed on an annual basis.

MANHATTAN PRODUCTION MUSIC; 311 W. 43rd St., Ste. 202; New York, NY 10036; (800) 227-1954; (212) 333-5766. Product Name: MPM 29 (Untitled). **Contact:** Ron Goldberg, nat'l sales mgr. **Date Product Introduced:** Spring 1991. **Product Description & Applications:** The 29th compact disc from Manhattan Production Music will feature a wide range of uptempo moods with rock, jazz and orchestrated melodies, perfect for inspiring, majestic and futuristic situations. **Basic Specifications & Suggested List Price:** To be included in the MPM Library that is licensed as an annual package.

THE MARTIN GUITAR COMPANY; 510 Sycamore St.; Nazareth, PA 18064; (215) 759-2837. Product Name: Martin Passive Volume and Tone Control. **Contact:** Doug French, 1833 shop mgr. **Date Product Introduced:** 1/90. **Product Description & Applications:** If you have a transducer in your acoustic guitar and you want to have the capability of adjusting the volume and tone right from your instrument, without purchasing an expensive, installable unit that requires drilling holes in your guitar, then the Martin V.T.C. (Volume and Tone Control) is for you. Plug the unit into the 1/4" endpin jack of your guitar, then plug your cable into the V.T.C. It's that simple! **Basic Specifications & Suggested List Price:** New cylindrical compact design. Fully compatible with the Martin Thinline 332 Acoustic Pickup (and most other varieties of transducers). Made in the USA. Suggested retail is \$54.50.

**Sam Ash Professional
puts all the buying power
of the world's largest
music and sound retailer
to work for you!**

- ✓ The world's largest Pro Audio inventory.
- ✓ The most professional advice and service.
- ✓ Authorized Apple Macintosh Dealer.
- ✓ Rush Delivery.* ✓ Flexible Financing Plans.
- ✓ Free freight on all UPS-able items.



**Call Today!
(212) 719-2640**

Sam Ash

PROFESSIONAL
723 SEVENTH AVENUE (THIRD FLOOR) NEW YORK CITY 10036

* Some restrictions apply. Call for complete delivery details

- D.A.R.
- AMEK
- T.C. ELECTRONICS
- DRAWMER
- UREI
- dbx
- A.P.I.
- EVENTIDE
- APHEX
- C.A.D.
- SONY
- JOSEPHSON
- NEUMANN
- LEXICON
- SYMETRIX
- TANNOY
- HAFLER
- CROWN
- Q.S.C.
- YAMAHA
- TASCAM
- ROLAND
- MACINTOSH
- YAMAHA
- KORG
- JBL
- AKAI
- STUDIOMASTER
- SOUNDTRACS
- SENNHEISER
- AKG
- DIGIDESIGN
- SOUNDTOOLS
- EMU
- ALESIS
- AUDIO LOGIC
- CARVER

MUSIC PRODUCTS

MESA/BOOGIE LTD.; 1317 Ross St.; Petaluma, CA 94954; (707) 778-6565. **Product Name:** Mark IV Guitar Amplifier. **Contact:** Richard Duvall, sales rep. **Date Product Introduced:** 6/90. **Product Description & Applications:** The Mark IV is an all-tube guitar amplifier offering versatile switching and sophisticated features, while retaining the ultimate in tonal purity and warmth. This fully professional instrument is unsurpassed for performance and recording, and includes a buffered, EQ'd recording output with speaker simulator circuitry for direct console patching. The product of 20 years of Boogie design experience, the Mark IV offers better tone and easier controllability than its predecessor (the Mark III). **Basic Specifications & Suggested List Price:** Three preamp modes (clean, crunch, lead) each with separate controls; three power modes (pentode, triode, or "simul-class"); "Tweed" switch for enhanced vintage "brown sound"; 85 watts; 5-band EQ; reverb; digital footswitch; assignable FX loop; available as combo with Electro-Voice 12" speaker (\$1,595), or head only (\$1,470).

METALHEAD ELECTRONICS; 5707 Cahuenga Blvd.; North Hollywood, CA 91601; (800) 966-3526; FAX: (818) 985-1624. **Product Name:** ELAN Mk-II. **Contact:** Elan Memran, owner. **Date Product Introduced:** 1/90. **Product Description & Applications:** The ELAN Mk-II is a state-of-the-art, 3-channel, all-tube, stereo guitar preamp. Its five 12AX7 tubes make this a revolutionary breakthrough in guitar preamplification technology. This allows you to create a multitude of clean sounds mixed with various levels of warm sustain and overdrive. In the past this could only be achieved by using two or more amplifiers and other bulky equipment that seldom gave the desirable results. **Basic Specifications & Suggested List Price:** 2 rackspace, handmade, sound-on-sound technology, built-in noise reduction system, 2 active EFX loop digital switchable, splittable signal, 115V to 220V stereo. List \$699.

METALHEAD ELECTRONICS; 5707 Cahuenga Blvd.; North Hollywood, CA 91601; (800) 966-3526; FAX: (818) 985-1624. **Product Name:** Wha-Wha One. **Contact:** Elan Memran, owner. **Date Product Introduced:** 1/90. **Product Description & Applications:** 1 rackspace, rack-mount Wha-Wha with dual volume loop. Controlled by any volume pedal on the market. Digital switchable between the Wha-Wha's left volume control or the right volume control or both. **Basic Specifications & Suggested List Price:** 1 rackspace sensitivity control, color control and volume loops. Wha-Wha Loop, digital switcher 12 VDC adapter, \$299 list.



OMNIMUSIC
Omnibus sound effects library
(Series One)

OMNIMUSIC; 52 Main St.; Port Washington, NY 11050; (516) 883-0121. **Product Name:** Omnibus sound effects library (Series One). **Contact:** Sam White, general mgr. **Date Product Introduced:** 6/90. **Product Description & Applications:** Omnibus Series One is a collection of digital sound effects for video, radio and audio-visual production. Available on CD, the collection contains effects from a wide variety of sources including transportation, office, home, sports, city, suburbia and others. The library also features "environment" tracks that consist of digitally multitrack combined effects that create full, natural-sounding ambience tracks. **Basic Specifications & Suggested List Price:** Omnibus Series One is available on a one-time buyout basis for \$695. It includes 12 compact discs, reference catalog and computer-based search system.

OPTICAL MEDIA INTERNATIONAL; 485 Alberto Way; Los Gatos, CA 95032; (408) 395-4332; FAX: (408) 395-6544. **Product Name:** Universe of Sounds CD-ROM Sampler Library. **Contact:** Susan Wilson, sales manager. **Date Product Introduced:** 8/90. **Product Description & Applications:** New Sonic Images Library now available on CD-ROM in Akai S1000 Series format in two volumes. Future formats of Sonic Images Library will be Emax II and EIII slated for fall 1990. New Outrigger Productions Library now available on CD-ROM in Roland S-550 format, compatible with Roland S-770 and W30 digital samplers. Holds 219 banks within 23 categories including Ethnic Instruments and Percussion, Nature Sounds, Keyboards, Sound and Space FX, Synth, Voices and Woodwinds. Four new Emax II discs are released. Call for more information. **Basic Specifications & Suggested List Price:** Requires the appropriate sampling keyboard and CD-ROM player. Prices range from \$189 to \$599 each disc.

PENDULUM AUDIO SYSTEMS, INC.; PO Box 339; Gillette, NJ 07933; (201) 665-9333. **Product Name:** HZ-10 Series of Preamp Systems for Acoustic Instruments. **Contact:** Greg Guattleri, president. **Date Product Introduced:** 11/89. **Product Description & Applications:** Pendulum specializes in studio-quality preamp systems for acoustic instrument pickups. The HZ-10 Series is available in three basic systems: HZ-10 (mono), HZ-10SE (stereo effects), and HZ-10(S) (full stereo). Each system is modular and consists of a 1U rack-mount main preamp unit with a 4-band fully parametric EQ and effects interface, a phantom-powered preamp module tailored to the instrument and pickup system (piezo transducer, magnetic pickup, mini-mic and dual pickup versions are available) and an instrument/effects footswitch. Any system can easily be configured to accommodate a wide range of instruments and pickups. **Basic Specifications & Suggested List Price:** The HZ-10 Series is built to audiophile standards, using high-quality components and high-speed/low-noise circuitry throughout. Input: 10 Mohms unbalanced, equivalent input noise less than -113 dBu. Frequency response: 0/-1 dB 20-20000 Hz; THD less than 0.01%. Output: -10/+4 unbalanced or balanced; output noise <-93 dBu. Price: \$549.95 and up. Available factory-direct.

PIGNOSE INDUSTRIES; 447 E. Gardena Blvd.; Gardena, CA 90248; (213) 770-4444. **Product Name:** Pignose Model 7-100. **Contact:** Howard Chatt, natl sales mgr. **Date Product Introduced:** 1/90. **Product Description & Applications:** The world famous Pignose Legendary Model 7-100 has been updated with higher-than-ever quality. The engineers have updated the volume control, circuit and speaker. The performance is more outstanding than ever before. **Basic Specifications & Suggested List Price:** The amplifier operates on batteries or A/C adapter, has an output of 5 watts that is so efficient that it can sometimes be compared to a 15-watt amp. The weight is five pounds. Dimensions 6" x 5" x 10".

PRIDDIS MUSIC CORP.; 100 East State; Pleasant Grove, UT 84062; (801) 785-0949; (800) 326-3062. **Product Name:** "You Can Sing!" Accompaniment Tapes. **Contact:** Rick, pres. **Date Product Introduced:** 6/90. **Product Description & Applications:** Accompaniment tracks of current popular songs. Sounds exactly like the music of the original artists. Great for making vocal demos. The music tracks are already made for you. All you have to do is sing! **Basic Specifications & Suggested List Price:** List price: \$14.95 cassette tapes, high-bias chrome, EQ 120 usec, seven-eight songs per tape. Side "A" is accompaniment music only. Side "B" is the same songs but with a vocal demo of each. Lyric sheet with words to songs included.

THE PRODUCERS SOUND EFFECTS LIBRARY; 8033 Sunset Blvd. Ste. #289; Hollywood, CA 90046; (818) 707-EFXS; FAX: (818) 707-2643. **Product Name:** The Producers Sound Effects Library. **Contact:** Melinda Miller. **Date Product Introduced:** 10/90. **Product Description & Applications:** The Producers Sound Effects Library®, now 5 years in the making, will be premiering in the industry with its introductory CD containing 101 usable effects for only \$15.99. The Producers Sound Effects Library has adopted the slogan "The Library of Industry™" due to its exceptional organization and revolutionary copyrighted categorization. A Production Music Library and a manual on how to design sound effects for the motion picture industry is also in the works. **Basic Specifications & Suggested List Price:** The introductory CD with 101 usable effects will retail for \$15.99 plus shipping and handling. All other CDs offered by the Producers Sound Effects Library will be priced according to the sound rarity and difficulty in recording. No prices have been for the Music Library or the Sound Designer Package.

PRODUCTION GARDEN LIBRARY; 2411 NE Loop 410, Ste. #132; San Antonio, TX 78217; (800) 247-5317. **Product Name:** Production Garden Library. **Contact:** Mel Taylor, exec. producer. **Date Product Introduced:** 8/90. **Product Description & Applications:** Contemporary production music with lifetime buy-out licensing; available in a 10-disc broadcast series featuring 640 60- and 30-second length cuts plus 360 production and promotional elements, as well as an "audio-visual" library featuring 120 full-length themes (each with :60, :30 and tag edits) on 10 CDs. Ten-day trial with order; prepayment discounts or extended payment plans available; free demo upon request.

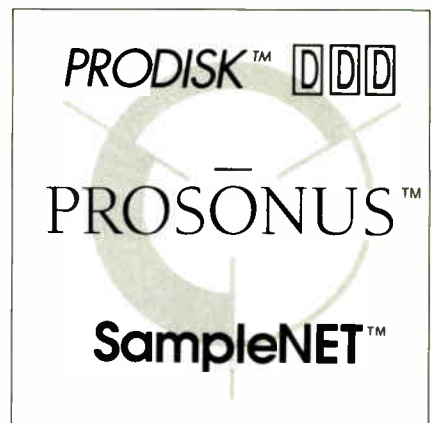

PROSONUS
PRODISK DDD

PROSONUS; 11126 Weddington St.; North Hollywood, CA 91601; (818) 766-5221. **Product Name:** PRODISK DDD. **Contact:** Ken Rose. **Date Product Introduced:** 7/89. **Product Description & Applications:** 3.5-inch floppy disks formatted for all popular samplers in factory memory configurations. A separate library exists for each sampler to maximize the sampler's individual strengths and features. The samples are edited, looped and programmed by a team of specialists to give the user immediate access to Prosonus-quality sounds without the problems of sampling and programming. PRODISKs are available through sampleNET. **Basic Specifications & Suggested List Price:** \$69.95 16-bit samplers, \$49.95 12-bit samplers.

PROSONUS; 11126 Weddington St.; North Hollywood, CA 91601; (818) 766-5221. **Product Name:** String Section CDs. **Contact:** Ken Rose. **Date Product Introduced:** 11/89. **Product Description & Applications:** 4 CDs of digitally recorded string instruments for sampling. Includes 35-piece orchestra, and solo and section performances of violin, cello, viola and bass. Comprehensive articulations include sustained glissandi, marcato, pizzicato and snapped pizzicato in forte piano and muted tones; a full range of tremolos, harmonics, chromatic runs, ponticello and effects. Also available on optical disk for synclavier. **Basic Specifications & Suggested List Price:** \$69.95 CD, optical disk \$4,950.

REAL WORLD DESIGNS; Box Mill, Box; Wiltshire, SN14 9PL UK; 01144 225-74318; FAX: 01144 225-743787. **Product Name:** M48 Digital MIDI Matrix. **Contact:** Peter Holmes, Mike Large, UK; Rita Lambert, L.A. **Date Product Introduced:** 1/90. **Product Description & Applications:** 16 input, 48, 32 or 16 output programmable switcher-based around an expanded version of the well-established and proven Sycologic M16. The Digital MIDI Matrix presents an ideal solution to the problems encountered when configuring a large MIDI system. Constant lead swapping, chaining delays and sustained notes phenomenon are now a thing of the past. All your MIDI equipment can be connected permanently and routed in seconds. **Basic Specifications & Suggested List Price:** 3U 19" enclosure in input activity LEDs. Remote keypad with backlit LCD. 32 user-definable patches. Assignable instrument and patch labels. Assignable MIDI program changes for each patch. Responds to incoming program changes on selected input and channel. Intelligent switching to prevent split messages.

RIVERA RESEARCH AND DEV. CO.; 12316 Branford St., Unit E; Sun Valley, CA 91352; (818) 890-2826; FAX: (818) 890-5202. **Product Name:** Rivera Combo, Rivera Hammer 120, Hammer 320. **Contact:** Greg Ravan, marketing director. **Date Product Introduced:** 1/90. **Product Description & Applications:** All-tube combo guitar amplifiers available in 60, 100 monaural, or 120-watt stereo models, three channels with built in stereo chorus (stereo models only). Speaker configurations 1-12", 2-10", 4-10", 2-12", or top only. Hammer Series all-tube stereo power amplifiers, suitable for all musical instruments, with 2 x 60 watts or 2 x 160 watts available. Fan cooled, with massive all-steel chassis construction. **Basic Specifications & Suggested List Price:** M60-122 Combo \$1,299, M100-112 Combo \$1,499, S120-212 Combo \$1,799, Hammer 120 Power Amp \$1,099, Hammer 320 Power Amp \$1,599.

ROLAND CORP US; 7200 Dominion Circle; Los Angeles, CA 90040; (213) 685-5141. **Product Name:** S-770 Digital Sampler. **Contact:** Chris Gill, public relations director. **Date Product Introduced:** 5/90. **Product Description & Applications:** The S-770 is a professional digital sampler featuring a 16-bit linear digital data sampling format with sampling rates up to 48 kHz, 20-bit D/A conversion and 24-bit internal processing. AES/EBU digital I/O allows you to transmit and receive data entirely in the digital domain. Standard memory is 2 Mbytes of RAM, expandable to 16 Mbytes to provide over 90 seconds of stereo sampling at 44.1 kHz. Also includes standard 40-byte hard disk, SCSI connector and monitor/mouse interfaces. **Basic Specifications & Suggested List Price:** 16-bit linear data sampling; 48kHz, 44.1kHz, 24kHz and 22.05kHz sam-

pling rates; differential interpolation sampling method; 2Mbyte RAM capacity expandable to 16 Mbytes, 24-voice polyphony; 64 x 240 dot LCD; RGB and monochrome display outfits; \$7,995.

SCHOLZ RESEARCH AND DEVELOPMENT, INC.; 1560 Trapelo Rd.; Waltham, MA 02154; (617) 890-5211. **Product Name:** Rockman Bass Ace. **Contact:** Sherri Cohn, coord. adv & promo. **Date Product Introduced:** 6/90. **Product Description & Applications:** The Rockman Bass Ace is a fine addition to the Rockman line of high-quality, innovative and reasonably priced products for the serious musician. This hot, new, high-performance headphone amp packs all the punch of the original Bass Rockman into a dynamic new package. Its new smooth compression sound separates the Rockman Bass Ace from anything else out in the market for this price. Get a Real Rockman for only \$99. **Basic Specifications & Suggested List Price:** Suggested list \$99. One-year warranty, made in the USA, 9-volt battery (approximately 50 hours with alkalines). Dimensions: 6.2"L x 4.2"W x 1.4"H; 15 ounces in weight. Headphones included.

SCHOLZ RESEARCH AND DEVELOPMENT, INC.; 1560 Trapelo Rd.; Waltham, MA 02154; (617) 890-5211. **Product Name:** Rockman Guitar Ace. **Contact:** Sherri Cohn, coord. adv & promo. **Date Product Introduced:** 6/90. **Product Description & Applications:** The new Rockman Guitar Ace, an affordable, high-performance headphone amplifier, combines classic Rockman clean and distortion sounds with a new semi-clean sound by Tom Scholz. This hot new unit contains an auxiliary input jack for jamming along with tape decks and drum machines. Made in the USA with a one-year warranty, the Guitar Ace retails for \$99. A real Rockman for the \$99! **Basic Specifications & Suggested List Price:** Suggested list \$99. 9-volt battery (approximately 50 hours with alkalines). 6.2"L x 4.2"W x 1.4"H; 15 ounces. Headphones included.



STICK ENTERPRISES, INC.
The Stick® Touchboard
Musical Instrument

STICK ENTERPRISES, INC.; 6011 Woodlake Ave.; Woodland Hills, CA 91367; (818) 884-2001. **Product Name:** The Stick® Touchboard Musical Instrument. **Contact:** Emmett or Yuga Chapman. **Date Product Introduced:** 10/89 (revised). **Product Description & Applications:** Now in production at Stick Enterprises is a buffed oak, lightweight model of The Stick® fretted fingerboard instrument. The one-piece sculpted instrument, also available in exotic hardwoods, weighs 4-1/2 lbs. and features stainless steel fret rods!™ These high, round frets are smooth to the fingers and never wear down. A rear-exposed adjustable truss rod provides instant control over the fretboard contour for ideal playing action. **Basic Specifications & Suggested List Price:** \$1,131 for instrument, case, stereo cord and book. 25 frets and 10 strings in 2 equal groups for bass and melody. Adjustable bridge, nut, shoulder strap, pickups and truss. Custom tunings available. Photo of Nick Beggs of England.

27TH DIMENSION, INC.; 2312 SE 29th St.; Okeechobee, FL 34974; (800) 634-0091. **Product Name:** Production Music and Sound Effects Libraries. **Contact:** Rex M. Bell, general manager. **Date Product Introduced:** 6/90. **Product Description & Applications:** Champion Series/Christmas Music contemporary sounding, Champion is designed to complement Dimensions Gold and Platinum Series, or work as a mini-col-
—LISTING CONTINUED ON NEXT PAGE



SIGNATURE MUSIC LIBRARY
Signature Production Music

SIGNATURE MUSIC LIBRARY; PO Box 98; Buchanan, MI 49107; (800) 888-7151. **Product Name:** Signature Production Music. **Contact:** Joanne Mullin, gen. manager. **Date Product Introduced:** 8/90. **Product Description & Applications:** Fully produced music created especially for media production—corporate, educational or instrumental video and A/V; broadcast spots. Real orchestration to simple acoustic arrangements and cutting-edge electronics. One time buy out license. Quality composition and production assures you "get your music's worth." **Basic Specifications & Suggested List Price:** 11 compact discs contain 126 program length (2-5 min.) themes with :30 and :60 edits available as part of the whole package or separately, complete collection: \$995, individual CD volumes: \$195, program volumes: \$895, spot volumes: \$395.

SOUND IDEAS; 105 W. Beaver Creek Rd., Ste. 4; Richmond Hill, ON, L4B 1C6 Canada; (416) 886-5000; (800) 387-3030. **Product Name:** Lucasfilm Sound Effects Library. **Contact:** Brian Nimens, president. **Date Product Introduced:** 5/90. **Product Description & Applications:** Lucasfilm Ltd. and Sound Ideas have joined forces to produce a unique six CD sound effects collection. Now for the first time ever you can have Academy-Award-winning sound effects originally used for many of Lucasfilm's major motion pictures plus many new effects specially created by Sound Ideas for this incredible co-production. **Basic Specifications & Suggested List Price:** The retail price for this exciting new package is \$595.

Mix Trivia

4. This American pop singer began using modified magnetophon tape recorders to edit his weekly radio shows in 1946-1947.

Turn to page 275 for question

CONSOLES • ANALOG/DIGITAL • INSTA
RECORDERS • MAG FILM RECORDERS •
WORKSTATIONS • DAT • VIDEO MIXERS
SYNCHRONIZERS • MICROPHONES • W
SPEAKERS • PROJECT
INSTALLATIONS • WIRING • ENGINEERING • MOTION CONTROLLER
EDITORS • TURNKEY SYSTEMS • CONSO
ANALOG/DIGITAL RECORDERS • MAG
RECORDERS • WORKSTATIONS • DAT • V
VIDEO MIXERS • SYNCHRONIZERS • MA
SPEAKERS • MICROPHONES • PROJECT
CONSULTATION • INSTALLATIONS • EDI
WIRING • ENGINEERING • TAPE • MOTIC
CONTROLLERS • EDITORS • TURNKEY • T
LES • ANALOG/DIGI
FILM RECORDERS •
DAT • VIDEO • MIXER
MICROPHONES • M
CT CONSULTATION •
WIRING • TAPE • ENGI
ENGINEERING • MOTION CONTROLLER
EDITORS • TURNKEY SYSTEMS • CONSO
ANALOG/DIGITAL RECORDERS • MAG
FILM RECORDERS •
VIDEO MIXERS • SYNCHRONIZERS • MA
SPEAKERS • PROJECT

NO TROUBLE AT ALL!

COMPREHENSIVE
SALES, RENTALS,
SERVICE AND SUPPORT
FOR ALL YOUR
EQUIPMENT NEEDS.

AUDIO INTERVISUAL DESIGN

1032 N. SYCAMORE AVE. • HOLLYWOOD, CALIFORNIA 90038 • (213) 469-4773

Circle #004 on Reader Service Card

MUSIC PRODUCTS

—LISTING CONTINUED FROM PREVIOUS PAGE

lection for the smaller studio or budget-minded producer. Each selection is of industrial length and where deemed appropriate, an "alternate" mix plus a 60- and 30-second version is included. 27th Dimension, Inc. also has a Christmas Music Package on two compact discs. "Sounds Like Christmas" contains everything needed for a Christmas production, including both traditional and original music. **Basic Specifications & Suggested List Price:** The Champion Series sells for \$1,200 for the eight CD set or \$150 per CD. The two CD set of "Sounds Like Christmas" sells for \$350.

VALENTINO INC.; 151 W. 46th St.; New York, NY 10036; (212) 869-5210; (800) 223-6278; FAX: (212) 869-6259. **Product Name:** Valentino Production Music and Sound Effects Libraries. **Contact:** Thomas Valentino. **Date Product Introduced:** 1990. **Product Description & Applications:** Complete production music and sound effects libraries on compact disc. Production music library available with full-length, 60-sec., 30-sec. and 15-sec. versions, plus rhythm-only version of each selection. Sound effects library is a full, digitally produced library for production use. **Basic Specifications & Suggested List Price:** Music Library is available on annual subscription basis for \$1,200. Sound effects library is buyout: \$1,550.

YOUNG CHANG AMERICA, INC.; 13336 Alondra Blvd.; Cerritos, CA 90701; (213) 926-3200. **Product Name:** Kurzweil K1200 Pro 76. **Contact:** Steve Johannasen. **Date Product Introduced:** 10/90. **Product Description & Applications:** The K1200 Pro 76 keyboard is Kurzweil's newest market entry and features 162 of the most popular Kurzweil sound programs. Version 5.0 software enables users to perform edits quickly and has powerful keyboard-controller functions. Features include 24-note polyphony, 16-channel multitrack, internal

sequence RAM, 6.0 MB ROM, aftertouch, MIDI in/out/thru and stereo outputs. The K1200 Pro 76 offers the same features found in the K1200 Professional in a 76-note, weighted keyboard.

YOUNG CHANG AMERICA, INC.; 13336 Alondra Blvd.; Cerritos, CA 90701; (213) 926-3200. **Product Name:** Kurzweil K1200 Professional. **Contact:** Steve Johannasen. **Date Product Introduced:** 1/90. **Product Description & Applications:** The K1200 Professional keyboard is Kurzweil's latest "top-of-the-line" instrument loaded with features that performers and recording artists demand. The K1200 Professional allows flexible creation of split and layered timbres, powerful keyboard-controller functions and the finest ROM sounds in the world. Features include a full 88-note weighted keyboard, 162 acoustic and synth programs, 24-note polyphony, 16-channel multitrack, 6.0 MB ROM, onboard effects, aftertouch, MIDI in/out/thru and stereo outputs.



ZEDZ MUSIC
Zedz Music Production Music Library

ZEDZ MUSIC; 49 Hanover St.; Malden, MA 02148; (617) 324-1889. **Product Name:** Zedz Music Production Music Library. **Contact:** Zed McLamon, president/composer. **Date**

Product Introduced: 6/90. **Product Description & Applications:** Zedz Music, the Production Music Boutique, announces the release of the most exclusive and stylish music library available. Marketed directly by the composer, it is boutique-style with limited distribution to assure exclusivity and help set you apart. Each CD has a unique variety of musical styles: real productions that don't all sound the same and boasts all usable cuts. Cross-reference saves time. Buyout w/ lifetime license saves money. Send for free demo and hear every cut before you invest. **Basic Specifications & Suggested List Price:** Buyout w/ lifetime license: each CD contains 24 high-quality versions of eight themes and lists for \$500/each. \$1,800 for the set. Introductory offer: save 25%! Budgeting available.

ZM SQUARED; 903 Edgewood Ln., PO Box C-30; Cinnaminson, NJ 08077; (609) 786-0612. **Product Name:** "The Best of Themes" on compact disc, Series I. **Contact:** Pete Zakroff, owner. **Date Product Introduced:** 2/90. **Product Description & Applications:** "The Best of Themes" is a high-quality buyout music library on compact disc. It contains 170 full-length cuts in 15 popular categories including achievement, action, classical, corporate image, industrials, sports and others. This no-needle-drop library is ideal for the small production company, in-house A/V center, or IMC. Free catalog and demo available. **Basic Specifications & Suggested List Price:** "The Best of Themes"—Series I is made up of 6 compact discs containing 7 hours of production music. Individual discs are \$199.95. The set of six is priced at \$999.95.

ZM SQUARED; 903 Edgewood Ln., PO Box C-30; Cinnaminson, NJ 08077; (609) 786-0612. **Product Name:** Themes AU Music Library, 1990 Catalog. **Contact:** Pete Zakroff, owner. **Date Product Introduced:** 2/90. **Product Description & Applications:** The 1990 Themes AU Music Library Catalog contains a complete listing of the 83 volumes of buyout production music in the Themes no-needle-drop library. This 96-page book details by time, title and description all the pieces in the library. It also includes a composer and music index for easy use. All music is available on cassette or reel-to-reel. Free catalog and demos upon request. **Basic Specifications & Suggested List Price:** Individual volumes in the library start at \$99.95 each. There are quantity discounts for multiple purchases.

SONY PROVES THAT QUALITY CAN BE DUPLICATED.

Trust Sony to develop a line of high speed audio cassette duplicators with distinct advantages for the educational and professional marketplace. Like superior sound, ease-of-use, durability and automated trouble-free features. Plus one or both side duplicating capability, short tape warning, automatic copying and direct drive transport for unmatched reliability and precision tape handling.

The high end stereo systems can produce up to 43 copies at 8 times normal play speed. Monaural systems can produce up to 11 copies at 16 times normal play speed. So don't wait to put the Sony advantages of quality and reliability to work for you. To find out more about the Sony duplicators call 1-800-326-SONY.

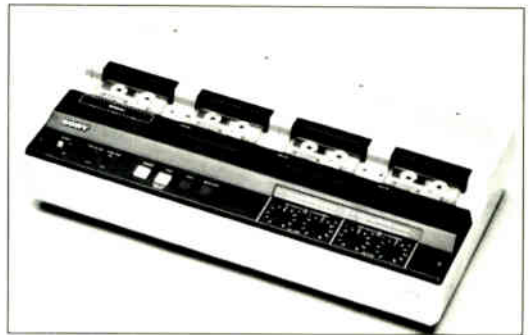

SONY®

Audio Visual Products

Sony Communications Products Company, A Division of Sony Corporation of America, 10833 Valley View Street, P.O. Box 2100, Cypress, California 90630

RECORDING DEVICES

ACCURATE SOUND CORP.; 3515 Edison Way; Menlo Park, CA 94025; (415) 365-2843. **Product Name:** AS200B High-Speed Audio Duplicator. **Date Product Introduced:** 7/90. **Product Description & Applications:** Micro-processed, DC servo tape handler for 240 ips cassette or reel-to-reel duplicating. Transport will also be used for quality control cassette pancake tape dual evaluator, tape conditioner and studio mastering recording. **Basic Specifications & Suggested List Price:** AS200B: 128:1 cassette slave \$16,950 at 120-240-300 ips. Direct drive capstan, HP-IB-IEEE interface.

ALPHA AUDIO AUTOMATION SYSTEMS; 2049 W. Broad St.; Richmond, VA 23220; (804) 358-3852; FAX: (804) 358-9496. **Product Name:** The DR-2™ Digital Hard Disk Recorder. **Contact:** Terri Murphy, public relations mgr. **Date Product Introduced:** 12/89. **Product Description & Applications:** The DR-2 is a digital 2-track hard disk recorder. It works like a typical center-track time code audio tape recorder and interfaces like a video deck due to its serial ports that speak Sony P2 protocol. The DR-2 allows on-line storage of sound effects with random access. It also allows instant recall of edits. The DR-2 has applications in music production, audio-for-the-visual-arts and broadcast radio and TV. Use the DR-2 as a stand-alone device with the optional edit controller. **Basic Specifications & Suggested List Price:** Offered in configurations of 15, 30 and 60 minutes of 16-bit stereo audio. Size: 19"W x 17"D x 5.25"H. SCSI port for data backup. Storage expansion: 60 minute drives (7 maximum). Expansion chassis available with a maximum of 4 drives per chassis. Price: 15-min., \$10,000; 30-min., \$12,500; 60-min., \$15,000; edit controller \$1,995.

AMS INDUSTRIES INC.; 1180 Holm Rd., Ste. C; Petaluma, CA 94954; (415) 762-4840. **Product Name:** AudioFile Plus. **Date Product Introduced:** 1990. **Product Description & Applications:** AMS AudioFile Plus, the world's leading hard-disk recorder/editor, is believed to be the first professional audio or video product in the world to feature the massive advance in technology that the Transputer brings. Immediate benefits of faster operation, 8 simultaneous inputs, 16 outputs and read/write optical drives are combined with future options for hardware expansion and system growth throughout the 1990s. All existing systems can be upgraded to this latest standard.

APOGEE ELECTRONICS CORP.; 2103 Main St.; Santa Monica, CA 90405; (213) 399-2991; FAX: (213) 399-7665. **Product Name:** C384 Slaving Clock Regenerator. **Contact:** Betty Bennett, VP sales. **Date Product Introduced:** 6/90. **Product Description & Applications:** C384—Low jitter slaving clock regenerator delivers timing accurate to better than two picoseconds for A/D and D/A converters. Orders of magnitude better than monolithic implementations. These modules make real 20-bit performance possible. (Also used in our AD/DA 1000.)

APOGEE ELECTRONICS CORP.; 2103 Main St.; Santa Monica, CA 90405; (213) 399-2991; FAX: (213) 399-7665. **Product Name:** D160 Dithering Module. **Contact:** Betty Bennett, VP sales. **Date Product Introduced:** 6/90. **Product Description & Applications:** D160—Proprietary dithering module is the heart of Apogee's AD1000 analog-to-digital converter. One application results in better sounding compact discs by capturing fine musical detail normally lost. **Basic Specifications & Suggested List Price:** The Apogee D160 module can operate as a stand-alone dithering system or as part of an A/D conversion system. It can accept data either LSB or MSB first. The D160 also offers a variety of additional features, such as: input scaling and mixing, DC offset removal, limiting, truncation, level indication, output formatting and generating a power spectrum dither for truncating to 16 to 18 bits while preserving fine sonic detail.

BRUEL & KJAER; 185 Forest St.; Marlborough, MA 01752; (508) 481-7000. **Product Name:** Portable Digital Recording System. **Contact:** Adrian Weidmann, internat'l product mgr. **Date Product Introduced:** 6/90. **Product Description & Applications:** A portable R-DAT recording system consisting of a pair of Bruel & Kjaer 4006 microphones with all accessories and a Panasonic SV-255 portable R-DAT recorder. All

components are contained in a briefcase-sized Zero/Halliburton case for complete location recording and archiving. **Basic Specifications & Suggested List Price:** Price: \$6,200.

DWIGHT CAVENDISH COMPANY; 6444 N. Ridgeway Ave.; Chicago, IL 60645; (708) 673-0937. **Product Name:** Cavendish Copymaster. **Contact:** Marshall Ruehrdanz. **Date Product Introduced:** 1990. **Product Description & Applications:** The Cavendish Copymaster line of videocassette duplicators is designed in a modular fashion to allow unlimited expansion. The Cavendish Copymasters can be purchased with or without built-in quality control test capabilities. Copymaster duplicators purchased complete, assembled and tested or as separate components. **Basic Specifications & Suggested List Price:** Prices vary depending upon size.



CIPHER DIGITAL, INC.
CDI-328 Random Access Recorder

CIPHER DIGITAL, INC.; 5350 Partners Ct., PO Box 170; Frederick, MD 21701; (800) 331-9066. **Product Name:** CDI-328 Random Access Recorder. **Contact:** Bob Tulloh, mktg. mgr. **Date Product Introduced:** 9/90. **Product Description & Applications:** Digital audio recorder/editor using hard or magneto-optical disks for storage. 4- and 2-track versions available. Locks to external time code, video or word clock (also generates all three). Tape backup, network, digital I/O. Controlled from front panel, remote editor or special edit-control unit. The CDI-328 can do basic editing and talks to video editors, etc. **Basic Specifications & Suggested List Price:** List price: \$13,000. Sample rate: 48 kHz, 44.1 kHz, 44.056 kHz, 32 kHz. Frequency response: 20 Hz to 20 kHz (44.1 kHz SF). Recording time: 1 hour (expandable).

DIGITAL AUDIO RESEARCH LTD.; 2 Silverglade Business Park; Leatherhead Rd., Chessington; Surrey, KT9 2QL UK; (03) (727) 42848. **Product Name:** DASS 100—Digital Audio Synchronizing System. **Contact:** Jeff Bloom, sales and mktg. dir. **Date Product Introduced:** 6/90. **Product Description & Applications:** DASS 100 is an easy-to-use, multi-function digital audio synchronizer, multiple device interface and signal processor. It enables engineers to keep information in the digital domain while transferring between different pieces of equipment, provides essential digital signal processing functions and, in short, solves the interfacing problems that arise in digital studios. DASS 100 functions include: sampling frequency conversion, format conversion, digital audio sample synchronization, gain adjustment and test signal generation. **Basic Specifications & Suggested List Price:** Sampling frequency conversion between any two frequencies: 29 kHz to 53 kHz with 18-bit accuracy. Pre- and de-emphasis to 20-bit accuracy. Signal generation to 24-bit accuracy. DC removal. Gain adjustment to 0.1 dB. Format conversion between all common interface standards. Simple mixing and routing selection. Generation of audio sample clocks from video, AES, WSYNC and LTC. Time delay. DASS 100 is priced in the \$13,000 range.



DIGITAL AUDIO RESEARCH LTD.
Sound Station/DSP

DIGITAL AUDIO RESEARCH LTD.; 2 Silverglade Business Park; Leatherhead Rd., Chessington; Surrey, KT9 2QL UK; (03) (727) 42848. **Product Name:** Sound Station/DSP. **Contact:** Jeff Bloom, sales and mktg. dir. **Date Product Introduced:** 9/90. **Product Description & Applications:** SoundStation/DSP is the new 16-channel, disk-based digital audio recording, editing and production system for pro audio, video/film post, and broadcast. This new DAR workstation introduces a major new advance in audio technology, called Segment Based Processing, that allows the user to assign settings for digital 4-band parametric EQ, gain and panning to every individual audio segment, regardless of length, directly via the SoundStation/DSP console. **Basic Specifications & Suggested List Price:** System provides fast "tape-like" functions including reel-lock editing, cut, mark, copy and loop; Stereo TimeWarp (time compression/expansion); splice and segment sliding; and adjustable crossfade—all accessible via SoundStation/DSP's touch-screen console. The system supports both digital and analog I/O, time-code chase, machine control and autolocation, and backup to R-DAT and optical disk.

DIGITAL DYNAMICS; 270-02 E. Pulaski Rd.; Greenlawn, NY 11740; (516) 271-5600; FAX: (516) 271-5607. **Product Name:** Pro Disk-464. **Date Product Introduced:** 1990. **Product Description & Applications:** Digital Dynamics is showing the ProDisk-464 hard disk digital audio recording and editing system and accessories. Available in configurations from four to 64 tracks, the ProDisk-464 offers both a multitrack tape emulation mode and a powerful cue/editor/EDL mode as well as visual waveform editing. With the flexibility to serve the needs of the recording and broadcast industries, the ProDisk-464 integrates smoothly into any production environment. Additional enhancements include reliable 1-second SMPTE chase lock and time code generation features, plus full digital I/O with all popular interfaces.

DOREMI LABS, INC.; 4927 N. Glen Arden Ave.; Covina, CA 91724; (818) 966-2454. **Product Name:** Digital Audio Workstation Nucleus. **Contact:** Camille Rizko, president. **Date Product Introduced:** 4/90. **Product Description & Applications:** Digital Audio Workstation Nucleus (Dawn™) is the heart of a Macintosh-based audio workstation. Its network-based system can accommodate various recording media such as hard disks, removables, optical erasables, tape, DAT and 8mm streamers. The unit can operate both from RAM or directly to disk. It has a MIDI interface for external control, and is also SMPTE-cueable. It has been successfully used in sound effects editing, dialog replacement, music and other audio and audio-for-video applications. **Basic Specifications & Suggested List Price:** 2 inputs, 8 outputs. 16-bit linear sampling at 44.1 or 48 kHz. Playback rate is variable. Internal RAM is expandable to 16 MB. Synchronization is achieved with MIDI time code. Options available: 4 analog inputs, digital input/output interface. Total recording time is media dependent (e.g., 600MB hard disk will allow 110 track-minutes of total recording). Dawn list price, 4 tracks direct-to-hard disk: \$10,700; 8 tracks direct-to-hard disk: \$14,000.

DOREMI LABS, INC.; 4927 N. Glen Arden Ave.; Covina, CA 91724; (818) 966-2454. **Product Name:** Digital Dawn™. **Contact:** Camille Rizko, president. **Date Product Introduced:** 8/90. **Product Description & Applications:** Digital Dawn is functionally similar to the analog Dawn. Inputs and outputs are entirely digital. Output options are: AES/EBU, CD/DAT and DMP7D direct connect port. Input options are: AES/EBU, CD/DAT. The basic unit has 2 digital inputs and can be expanded up to 8 inputs to make it a fully equipped 8-track recorder/player. The DMP7D port allows the user to have an entirely digital recorder/mixer. The user can achieve high-quality audio recording and manipulation without any degradation or coloration due to multiple analog-to-digital conversions. **Basic Specifications & Suggested List Price:** 2, 4 or 8 inputs, 8 outputs. 16 bits of encoding can be mixed down to 19 bits of audio. Recording at 44.1 or 48 kHz. Playback rate is variable. Internal RAM is expandable to 16 MB. Synchronization—LISTING CONTINUED ON NEXT PAGE

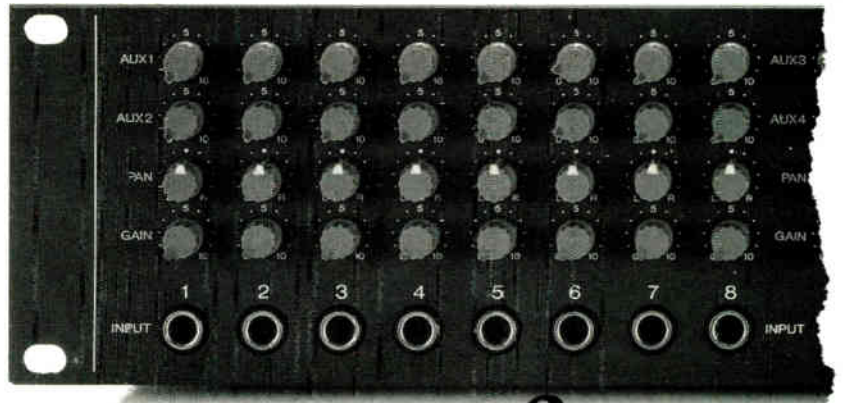

Advantages of a



Split Personality.

Now you can exhibit two completely different behavior patterns with pride. Just like our 2016 Line Mixer.

Sometimes it's a perfectly straightforward 16 x 2 submixer with Gain, Pan and two Effects Sends on each input.

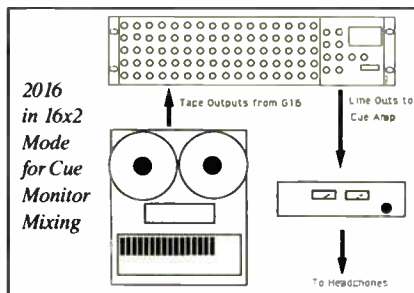

Then it turns around and becomes two independent 8 x 2 submixers, each with a stereo Effects Return and Bus Inputs. That's when it acts like an active patch bay and eliminates a bunch of patching hassles.

The 2016 handles keyboards and drum machines with equal ability and it processes almost any line source with unequal flexibility (like front panel insert points and foldbacks on all inputs).

It is absolutely eager to please sophisticated MIDI users and synth programmers, yet it feels right at home in a tight recording rig or on the road in a PA rack--great for extra monitor feeds (the sonic equivalent of duct tape!).

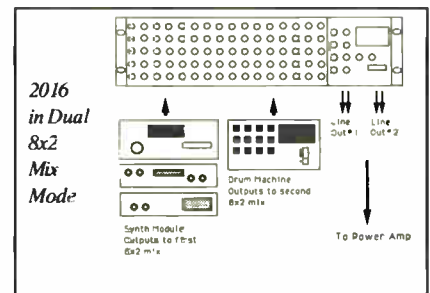

In fact, the 2016 is so versatile, so quietly helpful in so many different situations, no wonder it's always wondering what it's going to be next.

P.S.

In its own schizo way, the 2016 thinks it ought to cost a lot more than the mere \$400* price tag it carries. (Maybe you're crazy if you don't buy one.)

Fostex®

15431 Blackburn Avenue, Norwalk, CA 90650 (213) 921-1112.

*Suggested List Price; actual retail prices are determined by individual Fostex Dealers. © 1990 Fostex Corporation of America

RECORDING DEVICES

—LISTING CONTINUED FROM PREVIOUS PAGE

tion is achieved with MIDI time code. Total recording time is media dependent (e.g., 600 MB hard disk will allow 110 track-minutes of total recording). Dawn list price, 4 tracks direct-to-hard disk: \$10,700; 8 tracks direct-to-hard disk: \$14,000.

EDIFLEX SYSTEMS; 1225 Grand Central Ave., Glendale, CA 91201-2425; (818) 502-9100. Product Name: Optiflex. **Contact:** Stephen Goldsmith, VP. **Date Product Introduced:** 4/90. **Product Description & Applications:** Optiflex is a digital multitrack recorder for use on film sound re-recording and music recording/mixing stages. Using removable, rewritable, state-of-the-art magneto-optical disk, the system employs digital sound technology without the restrictions of linear recording on digital tape. Tracks are accessed instantly by computer allowing total freedom in sound manipulation, with the creative flexibility of 35mm mag film. **Basic Specifications & Suggested List Price:** Optiflex easily interfaces to all existing film and videotape systems. The magneto-optical disks hold 55 minutes of sound per side. Systems can be delivered in configurations of 8-, 16-, or 24-channels of audio. Prices vary according to the number of channels included.

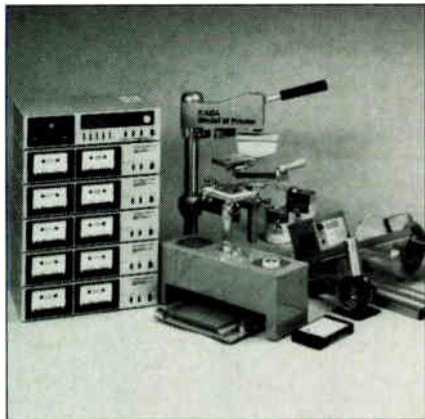

KABA RESEARCH AND DEVELOPMENT
10-Position Duplication System

KABA RESEARCH AND DEVELOPMENT; 24 Commercial Blvd., Novato, CA 94949; (415) 883-5041; (800) 231-TAPE. Product Name: 10-Position Duplication System. **Contact:** KABA R & D sales dept. **Date Product Introduced:** 8/90. **Product Description & Applications:** A complete system for real-time or 2x duplicating, on-cassette printing and shrink-wrapping of audio cassettes for studios and duplicators with a market of 200-300/day. The system consists of a KABA master control deck and 10 slave positions capable of duplicating Side B backward, real time, to cut down man hours involved. Photos and fine lettering produced by the on-cassette pad printer give a visual presentation of high quality to complement the excellence of the audio. **Basic Specifications & Suggested List Price:** Frequency response, 20 Hz to 20 kHz, +/- 3 dB; can be operated from any master source (reel, DAT, VHS or Beta, cassette); all controls (start, stop, EQ, level controls for each track, chrome/normal tape setting, single side or 4-track control) are in master unit. Purchased separately, \$12,570; as AES show special, \$9,995.

KENWOOD USA CORPORATION; PO Box 22745; Long Beach, CA 90801-5745; (213) 639-4200. Product Name: CD-WO (Write Once) System. **Date Product Introduced:** 4/90. **Product Description & Applications:** CD-WO (Write Once) system for the business and pro-audio markets enables users to make a one-time recording on a blank CD disk. The Kenwood CD-WO System is compatible with CD-ROM, which can record large amounts of data. Prime users will be software developers and publishing companies. In the digital audio field, the new system will be of great use to broadcasting companies in producing automatic broadcast CDs for regular programming. For recording studios, it will now be possible to produce audition CDs from a finished master tape. **Basic Specifications & Suggested List Price:** The Kenwood CD-WO (Write Once) System consists of the DA 7000 encoder (\$11,000), DD 7200 CD writer (\$7,750) and PC 98 software (\$4,285). This system is compatible with CD-ROM by using the optional CD-ROM/I formatter (\$9,000). Encoder uses one LSI chip, up to 10 CD writers can be connected to one encoder, compatible with CD+Graphics and CD Single, encoder can directly control U-matic recorder, and includes monitor and replay facility.

—SEE PHOTO TOP OF NEXT COLUMN



KENWOOD USA CORPORATION
CD-WO (Write Once) System

KLARK-TEKNIK; 200 Sea Lane; Farmingdale, NY 11735; (516) 249-3660. Product Name: DN735. **Contact:** Sam Spennacchio, nat'l sales mgr. **Date Product Introduced:** 7/90. **Product Description & Applications:** Specifically designed to solve the problems experienced with editing programs in stereo, Klark-Teknik has added an audio lay-off recorder to its existing range of high-quality audio equipment. The new DN735 solid state recorder records and plays back short passages of stereo audio in synchronization with other devices via an externally applied SMPTE time code. Adding two extra tracks of high-quality audio to standard VTR machines, it simplifies editing when audio is required to crossfade from scene to scene. **Basic Specifications & Suggested List Price:** The DN735 has 20 seconds of memory, which can be expanded to 175 seconds. Frequency response is 20 Hz to 20 kHz +0.25 dB, 64x oversampling A/D converters, 93dB dynamic range (20 to 20k Hz), fully balanced inputs and outputs, excellent phase response. Price TBA.

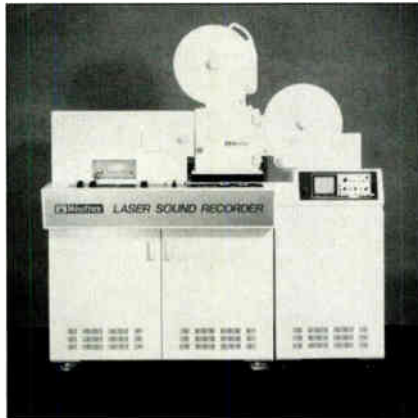

NACWESTREX, INC.
LSR-350 Laser Film Sound Recorder

NACWESTREX, INC.; 1011 W. Alameda Ave. Ste. F; Burbank, CA 91506; (818) 840-6990; FAX: (818) 840-6950. Product Name: LSR-350 Laser Film Sound Recorder. **Contact:** Dan Garrigan, sales mgr. **Date Product Introduced:** 9/90. **Product Description & Applications:** The LSR-350 utilizes a high-intensity laser to record stereo or mono optical soundtracks directly onto high-resolution 35mm film. High-speed scanning with the minutely focused beam guarantees perfect phase coherence and allows precise control of acoustic image positioning. High-frequency response, distortion and S/N ratio are dramatically improved due to the elimination of electro-mechanical modulators. The LSR-350 process is compatible with existing sound recording practices and all popular noise reduction systems. **Basic Specifications & Suggested List Price:** The output beam of an Ar-ion laser (514.5nm) is conditioned and pulse-wave modulated at 96 kHz. A special acousto-optic deflector causes the laser beam to raster-scan the film with no scanning line interval, resulting in a perfect variable-area soundtrack with a frequency response of 20 Hz to 16 kHz and <1.2% distortion.

NEW ENGLAND DIGITAL CORP.; Rivemill Commercial Center; Lebanon, NH 03766; (603) 448-5870. Product Name: PostPro™ DSP. **Contact:** Ted Pine, marketing manager. **Date Product Introduced:** 9/90. **Product Description & Applications:** The PostPro™ DSP adds onboard mixing capabilities (with 4-band EQ and automated level control) multitasking (including background loading and saving), real-time or better sample rate conversion and editing capabilities. Enjoying the high-speed Macintosh IIx as a graphics interface, the PostPro DSP offers easy, intuitive point-and-click

—LISTING CONTINUED ON NEXT PAGE

DATRAX® 60



Store your DAT tapes in a beautiful, contemporary wall/table mountable unit that holds up to 60 tapes.

AVAILABLE IN SOLID OAK AND DESIGNER FINISHES

ALSO AVAILABLE:
DAT Custom Flight Cases

For information or to order ▼

TEL: 818.783.9133

FAX: 818.783.9318

BRYCO PRODUCTS, 13444 Moorpark St., Suite 23, Sherman Oaks, CA 91423



Circle #165 on Reader Service Card



Financial Aid Available

Accredited by NATTS

Our Graduates Work
A practical education in audio and video recording arts and sciences for anyone who takes recording seriously.

Institute of Audio-Video Engineering

1831 Hyperion Ave., Hollywood, CA 90027

Call Toll-Free: National 1-800-551-8877

Local (213) 666-2380

Circle #007 on Reader Service Card

RECORDING DEVICES

operation for tasks such as cue editing, effects processing, EDL creation and mixing. In addition the PostPro DSP has been designed to serve as a platform for third-party software development. **Basic Specifications & Suggested List Price:** 4 analog I/Os, 8 digital I/Os (user configurable, choice of AES/EBU, SDIF, ProDigi or Yamaha formats), 4.5 hours recording time, trackless storage with assignable outputs, 20-bit sampling with 24-bit internal resolution, 3- or 4-band EQ, filtering, automated level control, Snapshot or continuous automation, multitasking, featuring background loading and saving of audio data, Synclavier compatibility. Suggested list price: \$150,000.

OPTICAL MEDIA INTERNATIONAL; 485 Alberto Way; Los Gatos, CA 95032; (408) 395-4332; FAX: (408) 395-6544. Product Name: TOPIX CDR Pro CD Workstation. Contact: Susan Wilson, sales manager. Date Product Introduced: 9/90. **Product Description & Applications:** Complete multimedia workstation available in Mac and IBM PC AT (and compatibles) platforms. Can produce any CD-Audio, CD-ROM, CD-1, and combined CD-ROM, CD-Audio write-once discs. Can produce factory-ready premastered tapes. Available in multiple configurations. Application is for pro audio, reference CDs, CD-ROM and multimedia CD test discs, and production of premastered tapes. Complete CD software simulation options available. Disk-based digital audio recording and editing options available. Now available: CD Express Services for low-cost mastering and CD replication from DAT. **Basic Specifications & Suggested List Price:** Please contact Optical Media International for more details. Complete workstation beginning at \$44,000.

OPTIMAGE INTERACTIVE SERVICES, L.P.; 1050 Busse Hwy., Ste. 230; Bensenville, IL 60106-1025; (708) 250-1750; FAX: (708) 350-9392. Product Name: DiscCreator compact disc recording system. Contact: Oliver Masciarotte, sales manager. Date Product Introduced: 9/90. **Product Description & Applications:** Optimage has developed the DiscCreator, an affordable, professional CD-DA recorder. The stand-alone system consists of three integrated modules for digital audio input/PQ entry, channel coding, and blank disc recording. The DiscCreator system produces a Red Book compliant CD-DA disc, from an AES/EBU or SPDIF input that can be played in any consumer or professional CD player. **Basic Specifications & Suggested List Price:** All metal rack-mountable enclosures, 8U total. AES/EBU-SPDIF input select switch and audio input presence indicator on front panel. 3.5" floppy drive with activity indicator for field software updates. All connectors on rear panel. Compact, handheld terminal for entry of PQ data, quiet fan.

OTARI CORPORATION; 378 Vintage Park Dr.; Foster City, CA 94404; (415) 341-5900. Product Name: DDR-10. Contact: Sally Olson Saubolle, marketing coordinator. Date Product Introduced: 4/90. **Product Description & Applications:** Digital audio disk recorder and editor for use in film and video post houses and production companies, recording studios and broadcast stations; for those who need the editing speed afforded by a tapeless system while offering state-of-the-art digital audio fidelity; a Macintosh-based system integrated with a 25MHz Macintosh IIx, 5 megabytes of RAM, 30 minutes of stereo full bandwidth digital audio storage and a 19" monochrome monitor standard. **Basic Specifications & Suggested List Price:** Standard features include: +4dBm active balanced I/O with 3-pin XL-type connectors, SMPTE synchronization with automatic input code detect and onboard SMPTE generation, 48kHz, 44.1kHz, 44.056kHz and 32kHz sampling rates with 10ppm accuracy, digital I/O support of AES/EBU and SPDIF, a new 64x oversampling analog-to-digital converter stage and 8x oversampling digital-to-analog converter stage with Apogee filters and built-in stereo speakers and headphone jack.

PANASONIC PROFESSIONAL AUDIO SYSTEMS/RAMSA; 6550 Katella Ave.; Cypress, CA 90630; (714) 373-7277. Product Name: SV-3700 DAT Recorder. Contact: Chris Foreman. Date Product Introduced: 3/90. **Product Description & Applications:** The SV-3700, Panasonic's newest addition to its full-function, pro DAT recorder line, features a front panel shuttle wheel with 0.5 to 15 times speed range. Other stand-out features include an infrared remote controller, push-button fade-in/fade-out functions, balanced inputs and outputs via XL-type connectors for diverse interfacing possibilities, and up to 400 times fast-forward/rewind and search speeds.

—SEE PHOTO RIGHT

RAID SYSTEMS INC.; PO Box 458; Bridgeport, NJ 08014-0458; (800) 523-2133; (609) 467-8000. Product Name: RS-2000 Cart Machine. Contact: Paul McLana. Date Product Introduced: 5/90. **Product Description & Appli-**

cations: Audio cart machine for production and on-air. Available in stereo or mono, record/play or play only. Includes fast-forward, three tones, phase correction, flutter correction, front-panel azimuth adjustment, timer, splice finder, all in a one-third rack-width package. **Basic Specifications & Suggested List Price:** Stereo record/play \$2,495, stereo play-only \$1,895.

ROLANDCORP US; 7200 Dominion Circle; Los Angeles, CA 90040; (213) 685-5141. Product Name: DM-80 Digital Multitrack Hard Disk Recorder. Contact: Chris Gill, public relations director. Date Product Introduced: Spring 1991. **Product Description & Applications:** The Roland DM-80 is a multitrack disk-based recorder that allows the user to view audio as a cue list, as pieces of tape, or by amplitude profiles, and to edit both audio and MIDI clocks to SMPTE, minutes/seconds/milliseconds, or bars/beats/clicks. The base unit features four independent tracks, four analog inputs and direct outputs, a left/right analog mix output (the number of tracks, inputs, and direct outputs may all be doubled), AES/EBU, SCSI, an automatable digital mixer, and a one-cable remote controller with transport, auto-locator, track-select, and editing buttons plus a large, full-graphics LCD.

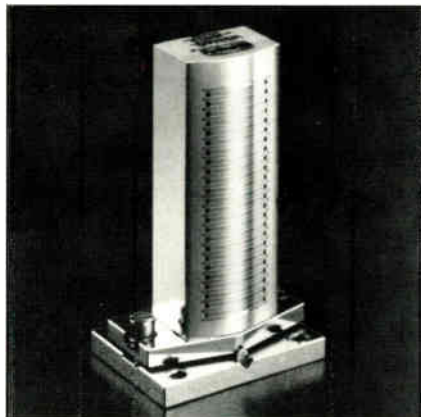

SAKI MAGNETICS, INC.
0-900 Series 24-Track Recorder and Playback Heads for Otari

SAKI MAGNETICS, INC.; 26600 Agoura Rd.; Calabasas, CA 91302; (818) 880-4054; FAX: (818) 880-6242. Product Name: 0-900 Series 24-Track Recorder and Playback Heads for Otari. Contact: Trevor Boyer, dir. sales and mktg. Date Product Introduced: 3/90. **Product Description & Applications:** Saki Magnetics announces the availability of its new 0-900 Series factory-equivalent replacement heads for Otari MTR-90 recorders. Saki 0-900 Series heads are interchangeable with the original Otari heads, requiring no electrical or mechanical modifications for installation. **Basic Specifications & Suggested List Price:** Saki 0-900 Series heads meet or exceed all original Otari specifications for frequency response, signal-to-noise ratio, and crosstalk rejection. Saki heads are backed by an unconditional, 30-day, money-back guarantee of satisfaction, and a one-year warranty. Price is \$2,500 per head for record or playback.



PANASONIC PROFESSIONAL AUDIO SYSTEMS/RAMSA
SV-3700 DAT Recorder

SAKI MAGNETICS, INC.; 26600 Agoura Rd.; Calabasas, CA 91302; (818) 880-4054; FAX: (818) 880-6242. Product Name: S-800 Series 24-Track Recorder and Playback Heads for Studer. Contact: Trevor Boyer, dir. sales and mktg. Date Product Introduced: 2/90. **Product Description & Applications:** Saki Magnetics announces the availability of its new S-800 Series factory-equivalent replacement heads for Studer

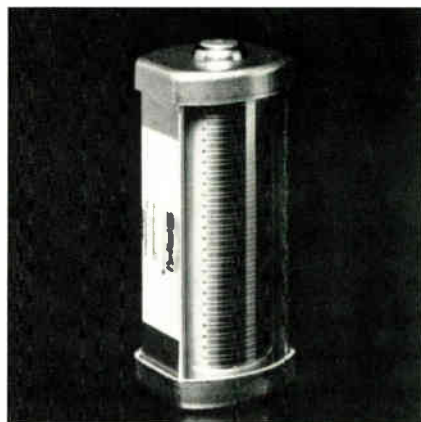

SAKI MAGNETICS, INC.
S-800 Series 24-Track Record and Playback Heads for Studer

A80 and A800 recorders. Saki S-800 Series heads are interchangeable with the original Studer heads, requiring no electrical or mechanical modifications for installation. **Basic Specifications & Suggested List Price:** Saki S-800 Series heads meet or exceed all original Studer specifications for frequency response, signal-to-noise ratio and crosstalk rejection. Saki heads are backed by an unconditional, 30-day money-back guarantee of satisfaction, and a one-year warranty. Price is \$2,450 per head for record or playback.

SONIC SOLUTIONS; 1902 Van Ness Ave., Ste. 300; San Francisco, CA 94109; (415) 394-3100; FAX: (415) 394-8099. Product Name: The Sonic System. Contact: Mary Sauer, VP marketing. Date Product Introduced: 9/90. **Product Description & Applications:** Macintosh-based digital audio workstation for use in CD mastering, sound-for-picture post-production, radio/commercial production, multitrack editing, and sound restoration. Hardware/software options include: Digital Editing Option; sample-accurate editing with variable crossfades. Digital Mixing Desk; real-time EQ, dynamics and mixing with automation. Sound for Picture Software for editing dialog, sound effects and music tracks against picture. Start at CD Maker for recording directly to write-once recordable CD; produces 'Red Book' standard CD for reference, archive, broadcast or premastering applications. PQ editing for inserting track and index information for a CD premaster. NoNoise option for removing unwanted noise—clicks, background noise and buzz from older recordings. **Basic Specifications & Suggested List Price:** The system uses a Mac II family computer, Sonic Solutions signal processor (SSP) card(s) and large hard disk(s) for audio storage. Basic editor starts at \$21,600 (excluding the Macintosh).

SONY PROFESSIONAL AUDIO; 1600 Queen Anne Rd.; Teaneck, NJ 07666; (201) 833-5709. Product Name: PCM-700 Series. Contact: Clayton Black, mktg. mgr. Date Product Introduced: 9/90. **Product Description & Applications:** Three models of studio DAT recorders with time code will be shown. All offer four heads, remote control interfaces and a wide variety of modu ar options. Applications range from broadcasting and video post-production to advanced audio recording studio use. A companion edit controller (RM-D7300) will also be displayed. **Basic Specifications & Suggested List Price:** Specific pricing of all models and options will be announced at the show.

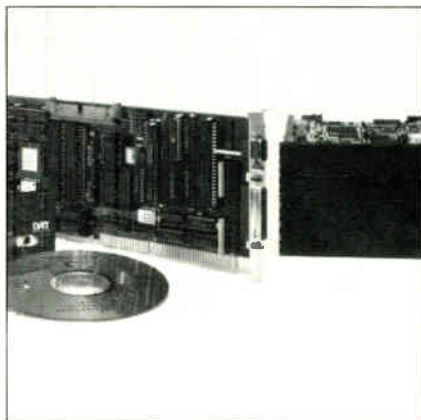

SPECTRAL SYNTHESIS, INC.
Digital Studio System

SPECTRAL SYNTHESIS, INC.; 18568 142nd Ave. NE; Woodinville, WA 98072; (206) 487-2931. Product Name: Digital Studio System. Contact: R. Bradshaw or A. Tilly. Date

Product Introduced: 7/90. **Product Description & Applications:** Direct hard disk multitrack recording, editing and mixing system for installation in an IBM-compatible 286 or 386 computer. Allows up to 16 tracks of simultaneous recording/playback with a built-in 16-channel digital mixer. System can be expanded to include digital signal processing and real-time EQ. Up to 18 track-hours recording on up to 8 SCSI hard disks. Real-time non-destructive auditioning of all edits and previewing of all effects can be done without alteration of the original source material. Random access to up to 4,000 sound objects in real time. **Basic Specifications & Suggested List Price:** Basic configuration: 8 channels expandable to 16 channels. 16 bits internal, dynamic range 96 dB, built-in SPDIF digital audio ports for connection to outboard A/D and D/A converters. Basic system price starts at \$2,985 without hard disks. ADDA-221 external digital audio converter lists at \$1,495 for two channels.

STELLAVOX DIGITAL AUDIO TECHNOLOGIES, LTD.; c/o IAT Ltd., 13897J Willard Rd., Chantilly, VA 22021; (703) 378-1515. **Product Name:** Stelladati™ **Contact:** Bill Peligh, director IAT **Date Product Introduced:** 4th quarter 1990. **Product Description & Applications:** Portable professional Swiss-made R-DAT. Features include current control, 10-hour autonomy, optional time code, programmable metering display, optional built-in mixer, optional input/output connections. **Basic Specifications & Suggested List Price:** Price to be announced. Based on options chosen it should range from approximately \$6,600 to \$15,000.

STUDER REVOX AMERICA, INC.; 1425 Elm Hill Pike; Nashville, TN 37210; (615) 254-5651. **Product Name:** A827 24-Track Recorder. **Contact:** Sandra Hale, PR manager. **Date Product Introduced:** 10/90. **Product Description & Applications:** Studer's cost-effective A827 24-track recorder has the ultra-fast, proven A820 tape transport with 14" reel capacity. There are 3 tape speeds with integrated varispeed controller, an optional internal synchronizer/resolver and switchable Dolby HX Pro. Along with the impressive range of peripherals, the A827 features comprehensive interfacing possibilities for easy integration. **Basic Specifications & Suggested List Price:** A827 multitrack; available in 8, 16, 24 channel; 14" reel capacity; built-in varispeed; Dolby HX Pro; microprocessor assisted alignment with memories for 2 tape types at each speed; alignment data may be stored on tape; second audio output from sync head for triggering; optional serial RS-232 and RS-422 control interfaces.

—SEE PHOTO TOP OF NEXT COLUMN



STUDER REVOX AMERICA, INC.
A827 24-Track Recorder

STUDER REVOX AMERICA, INC.; 1425 Elm Hill Pike; Nashville, TN 37210; (615) 254-5651. **Product Name:** D820-48 48-Channel DASH Digital Recorder. **Contact:** Sandra Hale, PR manager. **Date Product Introduced:** 4/90. **Product Description & Applications:** Studer Revox's first DASH multichannel recorder in a 48-track version is the latest addition to its professional multitrack line. The D820-48 features advanced head technology, high-precision A/D and D/A converters, super-fast tape transports, low-noise passive filters, high-quality cue tracks and comprehensive remote control functions. The built-in time code generator can produce or read any SMPTE-, EBU-, or film formatted-code. The D820-48 is fully compatible with all 24- and 48-track DASH recorders. **Basic Specifications & Suggested List Price:** DASH format 48-track audio with 4 auxiliary channels; fully compatible with all 24-track DASH tapes; digital input/output—AES/EBU, MADI, SDIF Multi; audio memory for editing; DSP-based signal processing for crossfading, switching and error correction; built-in synchronizer/code generator; built-in test signal generator.

—SEE PHOTO TOP OF NEXT COLUMN



STUDER REVOX AMERICA, INC.
D820-48 48-Channel DASH Digital Recorder

STUDER REVOX AMERICA, INC.; 1425 Elm Hill Pike; Nashville, TN 37210; (615) 254-5651. **Product Name:** Dyaxis 2+2. **Contact:** Sandra Hale, PR manager. **Date Product Introduced:** 4/90. **Product Description & Applications:** Dyaxis 2+2 Hard Disk Production System now provides 4-channel simultaneous playback and new, more powerful features such as overdub, multitrack record, and programmable in/out. Dyaxis integrated R-DAT subsystem stores all soundfiles along with precise editing instructions. Also available is the new System Synchronizer and time code options that allow Dyaxis to maintain an absolute lock to SMPTE, EBU, VITC, video or film tach. Up to 100 different sampling rates including 44.056, 44.1, and 48 kHz are available online. **Basic Specifications & Suggested List Price:** 2- and 4-channel simultaneous playback; independent track assignment; multi-format digital interface (AES/EBU, SDIF, SPDIF, ProDigi, PCM-1601, Yamaha stereo); sampling frequency 32 kHz, 44.056 kHz, 44.1 kHz, 48 kHz and other user-selectable frequencies; storage capacity up to 6 one-hour drives per processor, 12 per system; SMPTE or VITC read/write capability.

—SEE PHOTO NEXT PAGE

DON'T MISS YOUR MIX DIRECTORY LISTING!

Mix Directories are the most authoritative guides to facilities and services for the audio and video production industries. When production professionals need equipment, studios or other services, they consult *Mix* first.

To receive a free questionnaire for your Directory listing and to get the details on placing low-cost advertising in these special issues, call us—now!

**Toll-free Mix Directories number:
(800) 344-LIST.**

UPCOMING ISSUES & QUESTIONNAIRE DEADLINES

JANUARY

**Northwest U.S. Studios
DEADLINE: OCTOBER 16**

FEBRUARY

**Independent Engineers & Producers; European Production Facilities
DEADLINE: NOVEMBER 16**

HEAD RELAPPING

The contour and performance of your heads are restored to factory specifications before a precise optical/digital assembly alignment is performed. Original replacement heads also in stock.



MOTOR REBUILDING

Your Capstan, Reel, and Tachometer motors are rebuilt to quiet, flutter free perfection.



— Become an AMP SERVICES customer and enjoy a level of quality workmanship and individual attention rare in today's business environment. Call:

Audio Magnetic Professionals

AMP SERVICES INC

224 Datura Street, Suite 614
West Palm Beach, FL 33401

1 (800) 826-0601 In Florida (407) 659-4805

Authorized OTARI, SONY, TEAC Parts Dealers

Circle #080 on Reader Service Card

AMPEX 3M & AGFA

Professional
Audio and Video
Tapes

Open Reel Audio

Bulk Cassette Tapes

Video Cassettes & 1"

Reels, Boxes & Accessories

AVAILABLE FROM THE NUMBER ONE IN
PROFESSIONAL RECORDING PRODUCTS:

ADVANCE RECORDING PRODUCTS

7190 CLAIREMONT MESA BOULEVARD
SAN DIEGO, CALIFORNIA 92111
(619) 277-2540
CALL TOLL FREE:
(800) 854-1061

Please call or write
for our FREE catalog.



Circle #142 on Reader Service Card

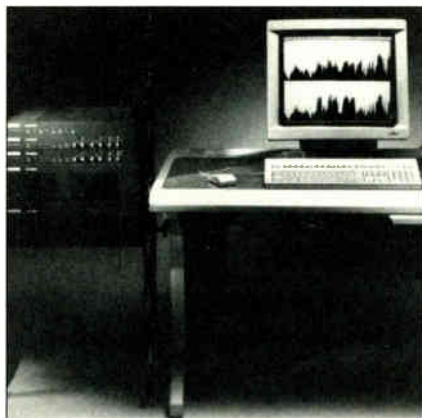

STUDER REVEX AMERICA, INC.
Dyaxis 2+2

SYMETRIX, INC., DIGITAL PRODUCTS DIVISION; 4211 24th Ave. W.; Seattle, WA 98199; (206) 282-2555; FAX: (206) 283-5504. Product Name: DPR-100 Digital Processing Recorder. Contact: Doug Schauer, president. Date Product Introduced: 5/90. Product Description & Applications: A full-function Digital Audio Workplace™ with 40 channels of recording, in blocks of eight, and real-time level control, EQ, compression and dynamic recall of all system parameters. All record and edit events are locked to SMPTE/EBU and VITC time code, house sync or word clock. Wide range of applications in music recording, broadcast production, film and video post industries. **Basic Specifications & Suggested List Price:** 48 simultaneous analog/digital I/Os. Eight primary I/Os with eight tracks out. Four-band parametric EQ per channel. Compressor/limiter/gate/expander per channel. Full external machine control. \$80,000 through \$180,000.

SYMETRIX, INC., DIGITAL PRODUCTS DIVISION; 4211 24th Ave. W.; Seattle, WA 98199; (206) 282-2555; FAX: (206) 283-5504. Product Name: Recording and Editing Station. Contact: Doug Schauer, president. Product Description & Applications: A combination 4-track random-access recorder, editor, mixer and processor for full-function editing, soundtrack assembly and audio conformation. Features a Mac II-series as system controller, with interlinked four-color screens using object-oriented editing techniques and a graphics-control tablet with transport controls and shuttle wheel. **Basic Specifications & Suggested List Price:** 4-track recording, editing, mixing, EQ and dynamics. Cut-and-paste resolution to a digital sample. External controls, audio/video transports and synchronizers. Price: base system, \$60,000.

TASCAM; 7733 Telegraph Rd.; Montebello, CA 90640; (213) 726-0303. Product Name: New model "Portastudios." Contact: Ken Hirata. Date Product Introduced: Fall '90. Product Description & Applications: The Portastudio 488 will be the first of a new generation of "Portastudios" from Tascam, following the basic product format of cassette-based multitrack/mixer units. The Portastudio 488 will combine an 8-track cassette recorder with a basic 8 x 4 mixer, at a highly affordable price. Two additional stereo inputs add 12-input capability to the unit, and a unique input/tape mix system allows even further returns and 8 inputs simultaneously. **Basic Specifications & Suggested List Price:** Channels 1 to 8 have high and low EQ, access to 2 effects sends, tape cue level, pan, level and assignment (4 groups). Up to 4 tracks can be recorded simultaneously. dbx noise reduction is switchable in groups of 4. Channels 1 and 2 have high-gain inputs for microphones. Suggested retail is projected at \$1,599.

360 SYSTEMS; 18740 Oxnard St.; Tarzana, CA 91356; (818) 342-3127. Product Name: DigiCart. Contact: Don Bird, dir. of mktg. Date Product Introduced: 9/90. Product Description & Applications: DigiCart is a random access, 16-bit digital recorder using removable magnetic disks for audio storage. An unlimited number of cuts may be placed on a disk. Each cut's name and running time is shown on a front panel display. DigiCart records in mono or stereo, at user-selectable bandwidths. Different formats may be combined on a single disk. The system offers non-destructive editing, extensive cut sequencing and instantaneous startup of any cued cut. **Basic Specifications & Suggested List Price:** Record time: 10 minutes at 15kHz stereo (20 minutes mono). 20kHz audio available at sample rates of 44.1 kHz or 48 kHz. Automation interface via EIA-232 port. Internal hard disk option provides additional one hour of audio. A SCSI port accesses external hard drives. Standard NAB cue tones, remote control via closure. Suggested list \$3,995.

TURTLE BEACH SYSTEMS; PO Box 5074; York, PA 17405; (717) 843-6916. Product Name: 56K Digital Recording System. Contact: Jeff Klinedinst, marketing dir. Date Product Introduced: 8/90. Product Description & Applications: A combination of hardware and software that turns your IBM 286 or 386 compatible computer into a stereo mastering system. Stunning graphic software allows cut-and-paste editing, edit

decision list editing, onboard 4-band parametric EQ, SMPTE, and MIDI triggering and varispeed playback. Supports 48, 44.1 and 32kHz sampling rates. Call or write for a free demo disc. **Basic Specifications & Suggested List Price:** 56K-PC Digital Signal Processing board, 56K-D Digital Interface box, Soundstage 2-track editing software. Suggested list: \$2,689.



WAVEFRAME CORPORATION
AudioFrame

WAVEFRAME CORPORATION; 2511 55th St.; Boulder, CO 80301; (303) 447-1572. Product Name: AudioFrame. Contact: Susan Sloatman. Date Product Introduced: Updated 1990. Product Description & Applications: The AudioFrame is a digital audio production system that incorporates multitrack hard disk recording, mixing, EQ, reverb, sampling and transfer, all in the digital domain. Its 24-bit input/output, recording, and signal processing ensures the best possible audio quality. **Basic Specifications & Suggested List Price:** Complete multitrack disk recording systems start at under \$50,000. Systems configured for digital recording, mixing and layback start at under \$90,000.



WAVEFRAME CORPORATION
CyberFrame

WAVEFRAME CORPORATION; 2511 55th St.; Boulder, CO 80301; (303) 447-1572. Product Name: CyberFrame. Contact: Susan Sloatman. Date Product Introduced: 1990. Product Description & Applications: CyberFrame is a complete post-production sound editing system for feature films and episodic television. The system gives editors the efficiency of multitrack tape recorders along with slip-sync, random access, and flexible insert/assembly editing of film techniques. **Basic Specifications & Suggested List Price:** CyberFrame comes in a contemporary enclosure and includes WaveFrame's Modular Disk Recorder, a 386-based edit controller, online sound storage and backup, software, training and installation. Pricing starts at \$79,900 for two hours of online mono sound storage.

WHEATSTONE CORPORATION; 6720 VIP Parkway; Syracuse, NY 13211; (315) 455-7740. Product Name: Radio Hard Disk/Production Hard Disk. Contact: Ray Esparolini, sales manager. Product Description & Applications: Wheatstone Corporation introduces an audio hard disk system specifically engineered for broadcast applications. It can store up to 20 hours of programming (music, ads, promos, sound effects, etc.) with easy random access to all tracks. Live show production work is a natural for the system, allowing instant access to an entire library of sound effects, program themes, audience reaction tracks, music beds, promo tags, client jingles, station jingles, and production music beds. **Basic Specifications & Suggested List Price:** The system has a memory redundancy feature, which duplicates all drives in the primary system and provides an automatic and undetectable changeover to the backup mirror drive when a disk failure is detected by the system's logic, preventing program interruptions. System allows production to load and service the library simultaneously.

SIGNAL PROCESSING DEVICES

ACOUSTIC TECHNOLOGY; 102 Pebble Beach Dr.; Roanoke, TX 76262; (817) 430-3351. Product Name: Alphon Feedback Controller. **Contact:** Allen Groh, president. **Date Product Introduced:** 3/90. **Product Description & Applications:** The FC-100 feedback controller provides 6 to 10 dB of feedback control. **Basic Specifications & Suggested List Price:** All components are high quality. Warranty is 1 year. Suggested list price is \$249.

ALESIS CORPORATION; 3630 Holdrege Ave.; Los Angeles, CA 90016; (213) 467-8000. Product Name: MEQ-230 Dual 1/3-octave Precision Equalizer. **Contact:** Allen Wald, VP, advertising and promotion. **Date Product Introduced:** 12/90. **Product Description & Applications:** Dual 30-band, 1/3-octave EQ in a single 19" rack-space. Interface is provided by means of both quarter-inch and RCA jacks. Center frequencies range from 25 Hz to 20 kHz and are set to ANSI/ISO standards. Each band provides +12dB cut/boost. In/out switch. **Basic Specifications & Suggested List Price:** Dimensions 1.75" H x 19"W x 4"D. Net weight: 2.5 lbs. Suggested user price: \$249.

ALESIS CORPORATION; 3630 Holdrege Ave.; Los Angeles, CA 90016; (213) 467-8000. Product Name: Microverb III. **Contact:** Allen Wald, VP, advertising and promotion. **Date Product Introduced:** 12/90. **Product Description & Applications:** Microverb III is a preset digital effects processor featuring 256 all new 16-bit reverb, delay, gated/reverse reverb, multi-tap delay and special effects programs. Each of the programs can be fine tuned by pre-emphasizing or filtering out frequencies with the high and low EQ controls before the signal is effected. These shelving filters are at 100 Hz and 10 kHz with +/-10 dB of boost/cut for wide-ranging tonal variations of the effects. The unit also features stereo input and output on 1/4" jacks, and 15kHz bandwidth. **Basic Specifications & Suggested List Price:** Dimensions: 1.75" H x 19"W x 4"D. Net weight: 2.6 lbs. Suggested user price: \$249.

ALESIS CORPORATION; 3630 Holdrege Ave.; Los Angeles, CA 90016; (213) 467-8000. Product Name: Quadraverb (updated version). **Contact:** Allen Wald, VP, advertising and promotion. **Date Product Introduced:** 10/89. **Product Description & Applications:** Fully programmable simultaneous digital effects processor capable of creating up to four effects simultaneously, all at 20 kHz bandwidth. Effects include stereo reverb, stereo delay, stereo chorusing, stereo flanging, phase shifting, pitch detuning, up to 5 bands of parametric EQ and 11 bands of graphic EQ. New features include 1.5 seconds of sampling, programmable multi-tap delays, programmable panning, resonators and ring modulators. MIDI implementation includes real-time modulation of up to 8 parameters simultaneously. 100 programs, 90 factory presets. **Basic Specifications & Suggested List Price:** Dimensions: 1.75" H x 19"W x 7"D. Net weight: 4.5 lbs. Suggested user price: \$499.

AMEK SYSTEMS AND CONTROLS LTD.; New Islington Mill, Regent Trading Estate, Salford, M5 4SX England; 061-834-0593 UK; (818) 508-9788 U.S. Product Name: Medici Equalizer. **Contact:** Steve Harvey, nat'l sales manager. **Date Product Introduced:** 7/90. **Product Description & Applications:** The Medici Equalizer is designed by Rupert Neve and manufactured by Amek. The equalizer is the culmination of many years' experience and has novel and advanced facilities. The dual-channel unit has 4 bands of equalization with swept 20dB pass filters on each channel. Bands may be cascaded to make a mono 8-section unit; alternatively, EQ can be switched into the sidechain. An outstanding feature is the variable warmth control which allows contouring of overall signal presence. 32 of the equalizer's switches may be controlled via MIDI, allowing bands to be swapped or switched in and out from code. **Basic Specifications & Suggested List Price:** The equalizer is priced from \$5,000 to \$6,000. Mid-range and high-frequency sections are parametric; low frequency is shelving. Frequency coverage is extensive, allowing a great deal of overlap and very fine control. The many features of the equalizer cannot be covered here but suffice it to say that the specifications and performance are of the highest order, as is only to be expected from its designer.

APHEX SYSTEMS LTD.; 11068 Randall St.; Sun Valley, CA 91352; (818) 767-2929. Product Name: Model 720 Dominator II, Multiband Precision Peak Limiter. **Contact:** Arnie

Christensen, sales mgr. **Date Product Introduced:** 8/90. **Product Description & Applications:** Stereo multiband peak limiter with zero overshoot. Once peak ceiling is set, there is no higher amplitude in the output. Provides "brick wall" limiting. **Basic Specifications & Suggested List Price:** List price: \$1,350. 106dB dynamic range; servo-balanced, transformerless inputs and outputs; relay bypass, remote controllable; detented pots; freedom from pumping; freedom from spectral gain intermodulation; automatic limit threshold (ALT); peak ceiling trimmable in 0.2dB steps over a 34dB range.

ARIEL CORPORATION; 433 River Rd.; Highland Park, NJ 08904; (201) 249-2900. Product Name: DAT-56. **Contact:** Les Listwa, dir. of mktg. **Date Product Introduced:** 9/90. **Product Description & Applications:** Ariel's DAT-56 provides all the necessary elements for a complete high-quality digital audio signal processing system on a single card which fits into an IBM PC compatible. Designed for interface with DAT recorders, CD players and digital mixing consoles, the DAT-56 provides AES/EBU and SPDIF digital I/O. Featuring a NeXT-compatible port, a Motorola DSP56001 and a SCSI interface. **Basic Specifications & Suggested List Price:** Priced at \$1,995, the DAT-56 is based upon a 27MHz Motorola DSP56001.

ARX SYSTEMS USA; PO Box 842; Silverado, CA 92676-0842; (714) 649-2346. Product Name: DDP-1. **Contact:** Algis Renkus. **Date Product Introduced:** 8/90. **Product Description & Applications:** The DDP-1 is a dual-channel, multi-mode dynamics processor with three totally independent functions per channel. It features an easy-to-use noise gate, a variable ratio compressor/limiter and an independent peak limiter following the output gain. A highlight of the DDP-1 is the comprehensive metering and status indication. The DDP-1 features electronically balanced inputs and outputs and a detector loop insert as well as hardware bypass. **Basic Specifications & Suggested List Price:** Input imp: 20 Kohms. Output imp: 150 ohms. Max input and output: +22 dB. sig. to noise: -85 dB unweighted. Distortion: -.03%. Frequency response: 20 Hz to 20 kHz +/-1 dB. Gate threshold: -10 dB to -60 dB. Compressor threshold: -30 dB to +20 dB. Peak limiter threshold: 0 dB to +20 dB.

AUDIO ANIMATION, INC.; 6632 Central Ave. Pike; Knoxville, TN 37912; (615) 689-2500. Product Name: Paragon. **Contact:** David Ball, applications engineer. **Date Product Introduced:** 9/90. **Product Description & Applications:** The Paragon is a completely digital on-air audio processor for FM, AM, TV and digital radio systems. The unique limiter implementation delivers extremely competitive loudness with no clipping whatsoever. The unique touch-sensitive VGA 9" screen is the easiest, most powerful control interface for program available. The system is intuitive and elegant, with context-sensitive help screens. AES/EBU or analog input/output. Completely RAM-based; options and updates are added from floppy. **Basic Specifications & Suggested List Price:** Completely digital processing. 4-band compressor. 4-band limiter. No clipper. Attack, release, ratio and crossover frequencies for limiter and compressor all user-adjustable. Instant on-air A/B comparison of settings. Sound settings stored on floppy disk. Options include 10-band graphic EQ, FM generator, and stereo width enhancement.

AUDIO CENTRON; 1400 Ferguson; St. Louis, MO 63133; (314) 727-4512. Product Name: ACX32. **Contact:** Tony Moscal, product manager. **Date Product Introduced:** 8/90. **Product Description & Applications:** Stereo 2-way, mono 3-way crossover. 24 dB/octave Linkwitz-Riley state variable filters. -infinity to +6 dB for each output. Balanced XLR inputs; balanced 1/4" inputs and outputs. Constant-directivity horn EQ button; no wiring required for stereo/mono. **Basic Specifications & Suggested List Price:** \$350 with 5-year transferable warranty.

AUDIO/DIGITAL, INC.; 1000 S. Bertelsen Rd. #4; Eugene, OR 97402; (503) 687-8412. Product Name: PAD-300/18 Delay System. **Contact:** Gary Hardesty, Kathleen Gallagher. **Date Product Introduced:** 1/90. **Product Description & Applications:** The PAD-300/18 is a 1-input/3-output digital delay system with at least 102dB dynamic range and 18-bit processing. The friendly 8-character alphanumeric display si-

multaneously shows both milli- and microsecond modes. The front panel can be defeated for security purposes via a rear panel switch. Options include: balancing transformers (the PAD is standard with active balanced inputs and outputs); preset control for up to 16 presets; I.E.D./Altec RS-422 interface; memory expansion; 10-microsecond step size (20-microsecond steps are standard). **Basic Specifications & Suggested List Price:** 1-input/3-output digital delay; 18-bit delta-sigma A/D converter; dynamic range greater than 102 dB, 8-character alphanumeric LED display; relay-controlled bypass accessible via front panel, also activates in case of power failure; 0 to 650 ms delay per channel; security mode via rear panel switch; all delay settings stored in non-volatile memory; simple programming; suggested list: \$2,085.

AUDIO/DIGITAL, INC.; 1000 S. Bertelsen Rd. #4; Eugene, OR 97402; (503) 687-8412. Product Name: PDX-3/18 Digital Crossover. **Contact:** Gary Hardesty, Kathleen Gallagher. **Date Product Introduced:** 9/90. **Product Description & Applications:** The PDX-3/18 is a full digital 18-bit crossover, eliminating complex re-configuration requirements and setting a new sonic standard for crossover products. The PDX-3/18 houses a multi-point 18-bit converter and offers 104dB dynamic range. The PDX-3/18 offers a 2-way or 3-way operation. A lowpass output is also available when the user selects the 2-way configuration. All PDX configurations are established through a logical 3-step front-panel control. All configurations are stored for later use in any one of 12 memory locations. **Basic Specifications & Suggested List Price:** 18-bit, 2- or 3-way digital crossover; 104dB dynamic range; multiple filters and horn EQ selections; 24 or 48dB slope; 12 memory locations for later recall; limiting and independent delay for all output channels; no re-emphasis/de-emphasis or companding. Suggested list price to be announced.

AUDIO MEDIA RESEARCH; 711 A St.; Meridian, MS 39301; (601) 483-5365. Product Name: PME 4000 (Parametric Equalizer). **Contact:** Lance Schmidt, sales mgr. **Date Product Introduced:** 6/90. **Product Description & Applications:** Full parametric equalization over 11 octaves; range from 1/6 octave to 2 octaves; top and bottom band are switchable peak to shelving; two color LEDs (green for signal present, red 4dB before clipping); +4dBu input and output capability; X 10 frequency range on mid-bands; four-stage parametric; bypass switch for each band; rugged steel chassis. **Basic Specifications & Suggested List Price:** Low-noise design. Target suggested list: \$349.99.

BENCHMARK MEDIA SYSTEMS, INC.; 3817 Brewerton Rd.; N. Syracuse, NY 13212; (315) 452-0400. Product Name: iFA-1 Recorder Interface. **Contact:** Albert Beckary. **Date Product Introduced:** 8/90. **Product Description & Applications:** Allows user to interface a consumer CD player, cassette deck or any other unbalanced audio device to a professional balanced audio system. Uses the new PS-1 wall-mount power supply. **Basic Specifications & Suggested List Price:** Common mode rejection at 60 Hz = -103 dB. THD+N to unbalanced output = +0.009% THD; 123dB dynamic range (wow). Retail price \$275.

BSS AUDIO; 200 Sea Ln.; Farmingdale, NY 11735; (516) 249-3660. Product Name: DPR-901. **Contact:** Dave Talbot, product mgr. **Date Product Introduced:** 8/90. **Product Description & Applications:** The DPR-901, dynamic equalizer. This unique type of signal processor effectively integrates parametric EQ with dynamic expansion and compression. Among the features offered are four fully parametric bands of frequency selection expansion (+16 dB) and compression (-30 dB). A below-threshold control allows low-level expansion and low-level compression with downward expansion. **Basic Specifications & Suggested List Price:** Retail: \$1,350. Threshold variable each band +20 dB to -30 dB, compression/expansion: -30dB to +16dB expansion, Band 1: 40 Hz to 440 Hz, band 2: 150 Hz to 1.6 kHz, band 3: 800 Hz to 9 kHz, band 4: 1.6 kHz to 18 kHz.

BSS AUDIO; 200 Sea Ln.; Farmingdale, NY 11735; (516) 249-3660. Product Name: TCS-804 Dual Time Corrector. **Contact:** Dave Talbot, product mgr. **Date Product Introduced:** 6/90. **Product Description & Applications:** The TCS-804 has two independent channels of temperature compensated digital delay, each channel having two delay outputs. Also switchable to 1-in/4-out mono. Twelve user memories with control interface for MIDI or RS-422 and wireless remote control options. **Basic Specifications & Suggested List Price:** Retail \$2,795. Offers specs like: 105dB dynamic range with a minimum of 10ms delay steps. Delay's readout displays feet, meters and inches. Optional temperature probe which monitors room temperature and changes delay time.

CIRCUIT RESEARCH LABS; 2522 W. Geneva Dr.; Tempe, AZ 85282; (800) 535-7648; (602) 438-0888. Product Name: Audio Signature. **Contact:** William Ammons, marketing. **Date Product Introduced:** 4/90. **Product Description & Applications:** The Audio Signature is an advanced digitally controlled 4-band audio processor system. This unit lets you define almost all of its processing capabilities. You determine band splits, equalization, and gain reduction. The unit has four program memories or it can be used with a PC to give it unlimited flexibility. A remote terminal diskette is included. Extensive LED

—LISTING CONTINUED ON NEXT PAGE

SIGNAL PROCESSING DEVICES

—LISTING CONTINUED FROM PREVIOUS PAGE

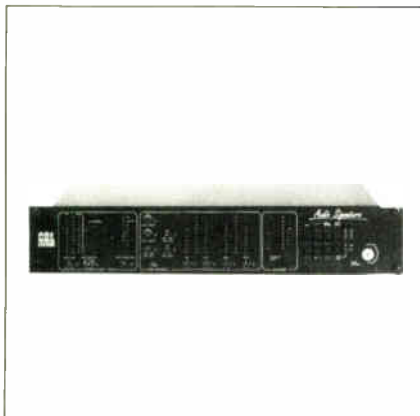

CIRCUIT RESEARCH LABS
Audio Signature

metering makes setup and monitoring easy. **Basic Specifications & Suggested List Price:** \$5,995. 4-band audio processor system (stereo).

CIRCUIT RESEARCH LABS; 2522 W. Geneva Dr.; Tempe, AZ 85282; (800) 535-7648; (602) 438-0888. **Product Name:** Instant Personality Processor. **Contact:** William Ammons, marketing. **Date Product Introduced:** 12/89. **Product De-**



CIRCUIT RESEARCH LABS
Instant Personality Processor

Description & Applications: The Instant Personality Processor is an innovative approach to microphone audio processing. The unit consists of a powerful 2-band compressor and parametric equalizer section. The band-splits and release times are adjustable. Accepts mic- or line-level in and has a built-in mic preamp. 18 memory positions store your program at the touch of a button. Key lock security included. A remote control box is available. **Basic Specifications & Suggested List Price:** IPP-100 Instant Personality Processor: \$1,495. IPP-100 remote control unit: \$395.

CLARITY; Nelson Lane; Garrison, NY 10524; (914) 424-4071. **Product Name:** Retro. **Contact:** Gregory Kramer. **Date Product Introduced:** Fall 1990. **Product Description & Applications:** The Retro is a MIDI-to-CV converter with 8 channels of highly flexible conversion. **Basic Specifications & Suggested List Price:** \$595 factory direct. Polyphonic use or route individual controller to 8 CV outputs on multiple MIDI channels. Extensive scaling of MIDI input also implemented.

C-T AUDIO MARKETING; 3050 SW 14th Pl. #3; Boynton Beach, FL 33426; (407) 738-0622. **Product Name:** Omnicraft

GTS. **Contact:** Andre Walton, president. **Date Product Introduced:** 7/90. **Product Description & Applications:** Optical switching is the key to the ultra-low noise performance of the new Omnicraft GTS. The most affordable professional noise gate on the market, the GTS is a stereo gate with parametric high- and low-frequency filters, 600-ohm inputs and outputs and facilities for keying and ducking. **Basic Specifications & Suggested List Price:** < -89 dB noise; immeasurably low distortion; frequency response 11 Hz to 50 kHz (-3 dB); two 24 dB/octave filters per channel; channels ganged for stereo; sidechain listening; two triggering modes; variable attack, hold, release controls; ducking; keying. **Price** \$649.

DAX, DIVISION OF BAUDER INTERN'L CORP.; 10240A NE Marx St.; Portland, OR 97220; (503) 252-4783. **Product Name:** Equalizers, RTA, Crossover. **Contact:** Judy House, int'l. marketing coord. **Date Product Introduced:** 11/89. **Product Description & Applications:** DAX equalizers are designed for maximum control with adjustable high- and low-pass filters, switchable 6 or 12 dB boost or cut and XLR balanced inputs and outputs. DAX's Real Time Analyzer and Crossover are some other high-performance and sonically sound equipment that aid in proper equalization resulting in clean punchy sound that makes the most out of bi-amplified or tri-amplified main and monitor speakers. **Basic Specifications & Suggested List Price:** For more information, please contact your nearest DAX dealer, or call DAX.

dbx, A DIVISION OF AKG ACOUSTICS, INC.; 1525 Alvarado St., San Leandro, CA 94577; (415) 351-0500; **FAX:** (415) 351-0500. **Product Name:** 1531X 1/3 Oct. Graphic EQ. **Contact:** Scott Heneman, product mgr. **Date Product Introduced:** 5/90. **Product Description & Applications:** 1/3-octave mono switchable to 2/3-octave stereo with switch selectable 20, 60 & 120 Hz HPF. Switchable 15 or 7.5 dB boost/cut range selector. The filters are constant-Q, symmetrical peak/dip on ISO centers. Balanced inputs and outputs. **Basic Specifications & Suggested List Price:** Balanced input: 30k, with maximum input level of +24 dBu. Balanced output: 22 ohms, with maximum output of +21 dBu into less than and equal to 600 ohms. Mono/stereo switchable, dynamic range of >124 dB. 95-130 VAC, switchable to 220/240 VAC - 50/60 Hz. **List Price:** \$399.

dbx, A DIVISION OF AKG ACOUSTICS, INC.; 1525 Alvarado St., San Leandro, CA 94577; (415) 351-0500; **FAX:** (415) 351-0500. **Product Name:** 160XT Compressor/Limiter. **Contact:** Scott Heneman, product mgr. **Date Product In-**

CREATIVE STANDARDS



The AMS range of digital processors is designed to deliver creative audio solutions.

From the same family of products as the AudioFile, the world's leading hard disc editor and the SoundField surround sound microphone, their pedigree is guaranteed.

Happily these digital processors are now so widely used, they have become standards in more ways than one. Perhaps that's because we apply only one standard ... excellence.

- (A) TimeFlex Digital Audio Time Compressor/Expander
- (B) S-DMX Digital Audio Delay and Pitch Changer
- (C) RMX 16 Digital Reverberator
- (D) A/V Sync Auto Compensating Audio-for-Video Delay



For information and literature contact...

AMS Industries plc
Billington Road, Burnley BB11 5ES, UK
Tel: (0282) 57011 Fax: (0282) 39542

AMS Industries Inc
1180 Holm Road, Suite C, Petaluma, CA 94954, USA
Tel: (707) 762 4840 Fax: (707) 762 4811

See us at AES
booth #336 & #338,
IBC booth #F7 and SMPTE
booth #1662

roduced: 5/90. Product Description & Applications: Single-channel compressor/limiter, with independent threshold, compression and output gain controls. It also features two switchable compression characteristic curves, overeasy and hardknee. Inputs and outputs are active balanced "XL" type connectors that can also be fitted with an optional transformer kit: AB-1. It requires one 19" rackspace. List \$429. **Basic Specifications & Suggested List Price:** Input: balanced 100 k, unbalanced 50 k. Outputs: balanced/unbalanced 22 ohms. Attack Time: program dependent. Compression ratio: 1:1 through infinity 1 to -1:1. Release time: 125dB/sec rate. Maximum compression >60 dB.

DOD ELECTRONICS CORPORATION; 5639 S. Riley Ln.; Salt Lake City, UT 84107; (801) 268-8400. Product Name: IPS 33B Super Harmony Machine. Contact: Rick Bos, mktg. mgr. **Date Product Introduced: 6/90. Product Description & Applications:** The IPS-33B Super Harmony Machine is a studio-quality, harmony-generating unit. Create 1- and 2-note harmonies from a single note, including chromatic, intelligent scaler, and user-definable harmonies. Select from 59 scales, 80 arpeggiations and 7 different digital effects, with up to three at a time. **Basic Specifications & Suggested List Price:** 256 memory slots, 128 factory presets, 128 user-definable 24-bit VLSI. 42.5kHz sampling rate. S/N ratio 90 dB. 20Hz to 20kHz bandwidth. THD less than 0.03%. 120 VAC power requirement.

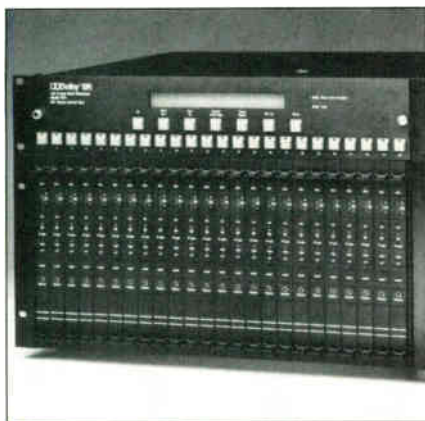

DOLBY LABORATORIES, INC.
Dolby MT Series

DOLBY LABORATORIES, INC.; 100 Potrero Ave.; San Francisco, CA 94103-4813; (415) 558-0200. Product Name: Dolby MT Series. Contact: Kevin Tam, broadcast technology mgr., mktg. dept. **Date Product Introduced: 10/89. Product Description & Applications:** Up to 24 channels of switchable Dolby SR and A-type noise reduction; software controlled automatic alignment; flexible assignment of any number of channels to separate groups for multitrack and multi-machine use; electronically balanced/floating input and output stages and Auto Compare circuitry. Recording, film, video, post-production and broadcast. **Basic Specifications & Suggested List Price:** Basic specifications: The MT Series consists of a card frame to accommodate up to 24 Cat. No. 445 modules (8.75" x 19" x 19") and PS4 power supply/control unit (3.5" x 19" x 19"). Overall frequency response: 20 Hz to 20 kHz +/-1 dB, encode-decode at any level.

roduced: 1/90. Product Description & Applications: Professional encoder/decoder unit which provides four channels of Dolby B-, C-, and S-type noise reduction in a 1-U high frame (1.75" x 1.75"). One pair of channels can operate either as encoders or decoders (internal jumper selectable), while the other pair operates as decoders only. Contains a signal generator providing calibration tones corresponding to selected NR type. **Applications:** encoding running masters for audio and video tape duplication, decoding recordings for quality assessment and C-type decoding of 1/2" and 3/4" VTR formats. **Basic Specifications & Suggested List Price:** Overall frequency response: 20 Hz to 15 kHz +/-1 dB, encode-decode (same NR system) at any level. Electronically balanced input circuits and electronically balanced and floating output circuits.



DOLBY LABORATORIES, INC.
Model DP501/DP502
Audio Coding Units

DOLBY LABORATORIES, INC.; 100 Potrero Ave.; San Francisco, CA 94103-4813; (415) 558-0200. Product Name: Model DP501/DP502 Audio Coding Units. Contact: Kevin Tam, broadcast technology mgr., mktg. dept. **Date Product Introduced: 10/89. Product Description & Applications:** 2-channel encoder/decoder units to provide professional-quality audio at 128 Kbits/sec per channel (one sixth the rate of 48k samples/sec 16-bit PCM). Ideal for transmission systems requiring both high audio signal transparency and low, spectrum-efficient data rates. **Applications:** satellite subcarrier band edge and SCPC schemes, and terrestrial microwave and telecommunication (T-1) links. **Basic Specifications & Suggested List Price:** Data rate: 128 Kbits/sec per channel. Frequency response: 20 Hz to 15 kHz +/-0.2 dB. Dynamic range: greater than 90 dB.

DRAWMER, C/O QUEST MARKETING; PO Box 20; Auburndale, MA 02166; (617) 964-9466. Product Name: Drawmer DL 241 Dual Auto Compressor. Contact: Scott Berdell, mktg. VP. **Date Product Introduced: 6/90. Product Description & Applications:** The DL 241 is a new dual-gated compressor/limiter incorporating many automatic functions for simple and quick operation in situations where strict dynamic range control is required. An auto-attack expander/gate with unique "auto-ratio" circuitry to prevent "chatter" on or around threshold, and a switchable fast/slow release time. A full auto-attack/release "soft knee" compressor with simultaneous LED displays for gain reduction and output level. The unit can be switched for manual control of the attack and release times if required. **Basic Specifications & Suggested List Price:** Fully balanced inputs, hardware bypass, expander/gate, compressor, peak level, dual mono or stereo, operating levels of +4 dBu or -10 dBu. List price: under \$700.

DRAWMER, C/O QUEST MARKETING; PO Box 20; Auburndale, MA 02166; (617) 964-9466. Product Name: Drawmer DS 301. Contact: Scott Berdell, mktg. VP. **Date Product Introduced: 8/90. Product Description & Applications:** The Drawmer DS 301 is a dual-channel gate/expander with "peak attack" and "trigger gate." Dual mono or stereo operation. **Basic Specifications & Suggested List Price:** Specs N/A. Suggested list price: \$1,249.

DYNACORD; 10500 W. Reno Ave., PO Box 26105; Oklahoma City, OK 73126-0105; (818) 350-4970; FAX: (818) 444-1342. Product Name: Dynacord DRP20 Digital 32-Bit Reverb and Effects Processor. Contact: John Parker, national sales manager. **Date Product Introduced: 1/90. Product Description & Applications:** A 2-channel processor capable of generating every conceivable stereo effect. You can produce reverb, chorus, flanging, doubling, phasing, multi-tap and more. You can also combine effects such as reverb and echo or reverb and chorus, and all effects can be edited in real time. There are 100 presets that can be edited and 128 user memories available. Of course, you also have the flexibility to create your own effects. **Basic Specifications & Suggested List Price:** Frequency response 20 Hz-15 kHz. Signal-to-noise >90 dB (orig), >90 dB (effect), inputs 3, input 3mV-3V, 50 Kohm. Distortion <0.1%, MID in/thru. List Price: \$4,212

EQ 60

The all new ARX EQ 60. State of the Art Dual Channel 1/3rd octave Graphic EQ in a compact 3 rack unit package. Everything you ever wanted in a Graphic and more: XLR and Phone jack balanced INs and OUTs, low noise (-98dB),

±15 dB or
±6 dB cut and
boost, smooth well
damped maximum
throw sliders, and all
new Constant Q circuitry.

Also available in Single
channel version: the EQ 30.

For more information, call Algis Renkus at

ARX

Systems

PO Box 842, Silverado CA 92676-0842
Phone 714-649 2346 Fax 714-649 3064

Circle #144 on Reader Service Card

Dolby®

DOLBY LABORATORIES, INC.
Model 422 Reference
Encoder/Decoder

DOLBY LABORATORIES, INC.; 100 Potrero Ave.; San Francisco, CA 94103-4813; (415) 558-0200. Product Name: Model 422 Reference Encoder/Decoder. Contact: Kevin Tam, broadcast technology mgr., mktg. dept. **Date Product In-**

A SINGER'S DREAM!

REMOVES VOCALS FROM RECORDS!

Our VOCAL ELIMINATOR can remove most or virtually all of a lead vocal from a standard stereo record and leave most of the background untouched! Record with your voice or perform live with the backgrounds. Used in Professional Performance yet connects easily to a home component stereo system. Not an equalizer! We can prove it works over the phone. Write or call for a free brochure and demo record.

Listen..

Before You Buy!

- Time Delay
- Reverberation
- Crossovers
- Noise Reduction
- Compressor/Limiters
- Expanders
- Spectrum Analyzers
- Parametric EQ

Don't have regrets about paying too much for a lesser product. In demos and comparisons, we'll show you why we're Better! Our Factory Direct sales allow us to produce a Superior product and offer it to you at a Lower price. Call or write for a free full length Demo Album and 24 page brochure.

LT Sound, Dept. M-X-9, 7980 LT Parkway
Lithonia, GA 30058 (404) 482-4724
24 HOUR PHONE DEMO LINE: (404) 482-2485



ACE MUSIC CENTER

THE PRO'S CHOICE FOR PROFESSIONAL EQUIPMENT FOR OVER 30 YEARS.

CALL ACE AND FIND OUT WHY
1-800 446-4ACE

13630 WEST DIXIE HWY.
N. MIAMI, FLA. 33161

Circle #149 on Reader Service Card

FOR BIG LEAGUE RECORDINGS, USE THE BIG LEAGUE BBE 822A!



"Increases intelligibility, restores harmonics, and improves clarity... most impressed with the effect on instrumental tracks of all sorts... recaptured the natural sparkle and punch... an indispensable tool for the audio professional."

Mix Magazine

- ▼ 10K ohms input; 600 ohms output
- ▼ +24dBu clip point
- ▼ XLR and 1/4" Tip-Ring-Sleeve Balanced/Unbalanced

BBE Sound Inc. Huntington Beach, CA (714) 897-6766

ASK YOUR DEALER FOR A DEMO TODAY

Circle #150 on Reader Service Card

1991 · NEW · PRODUCTS

SIGNAL PROCESSING DEVICES

EVENTIDE, INC.; One Alsan Way; Little Ferry, NY 07643; (201) 641-1200; FAX: (201) 641-1640. **Product Name:** HS322 Internal Sampler Board. **Contact:** Gil Griffith, ntl. sales mgr. **Date Product Introduced:** 1/90. **Product Description & Applications:** 24-second mono/12-second stereo sampler with 6 octaves of real-time pitch shifting and time compression/expansion on-the-fly. Rockin' reel editing and auto-deglitching make this add-on sampler for the H3000 Series Ultra Harmonizer® simple and easy to use. **Basic Specifications & Suggested List Price:** 16-bit, 44.1kHz sampling rate. Less than 100 microsecond triggering time. List price: \$995.

GENTNER ELECTRONICS CORPORATION; 1825 Research Way; Salt Lake City, UT 84119; (801) 975-7200. **Product Name:** Digital Hybrid II. **Contact:** Gary Crowder, ntl. sales mgr. **Date Product Introduced:** 1/90. **Product Description & Applications:** The Digital Hybrid II is used in audio conferencing by interfacing phone lines to audio equipment. Its digital auto-nulling circuitry allows a clean, crisp call.

THE JOHN HARDY CO.; Box AA631; Evanston, IL 60240; (708) 864-8060. **Product Name:** MPC-1R Mic-Preamp Card. **Contact:** John Hardy, president. **Date Product Introduced:** 7/90. **Product Description & Applications:** MPC-1R mic-preamp card offers the same features and superb sound quality of the M-1 mic preamp in a 3.5" high vertical card-cage format. The MPC-1R offers the best: Jensen JE-16-B input transformer, 990 discrete op-amp, and DC-servo circuitry that eliminates coupling capacitors. Four meter options, two output transformer options, and an optional model TS-1R companion card with three additional transformer outputs for sending the signal to several transformer-isolated locations. **Basic Specifications & Suggested List Price:** Maximum input level: +12 dBV, maximum output level: +24 dBV. Gain range: 12 to 60 dB, E.I.N.: -129 dBV. Polarity reverse switch, +48 V phantom power switch. Price: \$325 per channel. Meters: \$35 to \$135. Output transformers: \$75 to \$110. Mainframes: \$400 to \$1,000 depending on configuration.

LAKE PEOPLE; Rosgartenstr. 13; D-7750 Konstanz, West Germany; (07531) 24428. **Product Name:** F-20 ADC. **Contact:** Elke Fischer. **Date Product Introduced:** 9/90. **Product Description & Applications:** The F-20 ADC is an ultra-high precision 20-bit analog-to-digital converter for demanding audio applications. It is intended to be used with the newly introduced generation of digital recorders, capable of storing audio data in excess of 16 bits. **Basic Specifications & Suggested List Price:** Balanced XLR inputs. 20-bit resolution. AES/EBU digital outputs.

LAKE PEOPLE; Rosgartenstr. 13; D-7750 Konstanz, West Germany; (07531) 24428. **Product Name:** F-20 DAC. **Contact:** Elke Fischer. **Date Product Introduced:** 3/90. **Product Description & Applications:** The F-20 DAC is an ultra-high precision 20-bit digital-to-analog converter. Inputs are provided for AES/EBU, S/P-DIF, and S-DIF-2 signals. **Basic Specifications & Suggested List Price:** All common digital input formats. 20-bit resolution/8 times oversampling. Electronically balanced, floating outputs. 44.1/48kHz sampling frequency.

LEXICON, INC.; 100 Beaver St.; Waltham, MA 02154; (617) 891-6790. **Product Name:** The 300 Digital Effects System. **Contact:** Leah Holsten. **Date Product Introduced:** 9/90. **Product Description & Applications:** The Lexicon 300 combines industry-standard reverberation, effects, pitch shifting and digital mastering programs with flexible audio and automation interfacing. AES/EBU and EIAJ CP-340 (consumer) digital I/O allows for direct communication with DAT recorders and most other equipment capable of interfacing in the digital domain; analog audio I/O is included as well. SMPTE time code can be used to trigger the 50-event program change list. Full Lexicon Dynamic MIDI®, system exclusive and registered parameters are included.

E.M. LONG ASSOCIATES; 4107 Oakmore Rd.; Oakland, CA 94602; (415) 531-8725. **Product Name:** HLE 2. **Contact:** Ed Long. **Date Product Introduced:** 1/90. **Product Description & Applications:** The HLE2 is similar to a 2-channel, 2-way electronics except it uses the patented eLF™ technology for the 2 lowpass outputs. The highpass sections provide switch-selectable crossover frequencies. The HLE2 is designed to provide subwoofer operation for conventional studio monitors. **Basic Specifications & Suggested List Price:** 1-3/4" high by 19" rack-mount, balanced XLR and TRS inputs and outputs, 20k input and 600-ohm output impedances. List price: \$1,990.

THE MARTIN GUITAR COMPANY; 510 Sycamore St.; Nazareth, PA 18064; (215) 759-2837. **Product Name:** Martin Porta-Con Acoustic Preamp. **Contact:** Doug French, 1833 shop mgr. **Date Product Introduced:** 1/90. **Product De-**

scription & Applications: Designed especially for use with acoustic guitars, the Martin Porta-Con acoustic preamp interfaces between any piezoelectric transducer pickup and any adjoining amplification or signal processing device. The Porta-Con is designed to maximize the frequency response potential of any piezo-style pickup. The Porta-Con includes a volume control, fully active bass and treble controls, plus a convenient belt clip for easy accessibility. **Basic Specifications & Suggested List Price:** No installation required. Distributed exclusively by the Martin Guitar Company. Suggested retail price: \$149.50.

MEYER SOUND LABORATORIES, INC.; 2832 San Pablo Ave.; Berkeley, CA 94702; (415) 486-1166. **Product Name:** VX-1 Stereo Program Equalizer. **Contact:** Mark Johnson, dir. technical mktg. **Date Product Introduced:** 1/90. **Product Description & Applications:** The VX-1 stereo program equalizer is a 2-channel, single space, rack-mount unit designed specifically for composite response shaping of program material. Featuring a unique Virtual Crossover implementation, the VX-1 provides five controls for each channel and frequency breakpoint settings and gain controls for low-, mid- and high-bands. **Basic Specifications & Suggested List Price:** Applications of the VX-1 range from the simulation of non-flat playback systems and cinema house curves, to compact disc mastering and sound reinforcement house equalization.

MICROAUDIO, INC.; 4438 SW Hewett Blvd.; Portland, OR 97221; (503) 292-8896; (800) 445-1248. **Product Name:** EQ POD 1.1 RE/DCM 6200. **Contact:** Eugene Fimkeil, pres. **Date Product Introduced:** 6/90. **Product Description & Applications:** Programmable tamper-proof 6-channel microphone/line amplifier. 2 outputs. Programmable by IBM PC and Macintosh. **Basic Specifications & Suggested List Price:** 6 channels, mic/line in, 2 channels, output. List price \$795.

OPTICAL DISC CORPORATION; 12150 Mora Dr.; Santa Fe Springs, CA 90670; (213) 946-3050. **Product Name:** ODC Model 617 CX Encoder/Decoder. **Contact:** John Browne, VP sales. **Date Product Introduced:** 4/90. **Product Description & Applications:** The ODC 617 is a stand-alone, rack-mounted unit that performs both CX encoding and decoding of two audio channels in accordance with the CX standard and the IEC specification for videodisks. The CX system employs a companding (compressing in encoding, expansion in decoding) technique to improve the dynamic range and SNR of the audio program across the entire frequency spectrum. Up to 14dB of noise reduction can be achieved using this system. **Basic Specifications & Suggested List Price:** CX encoding/decoding. Local or remote control. Balanced or unbalanced XLR inputs. Stereo or bilingual operation. Simple bypass operation. 100/120/220/240 VAC operation. List price \$5,500.

PYGMY COMPUTER SYSTEMS; 13501 S.W. 128 Street, Suite 204; Miami, FL 33186; (305) 253-1212. **Product Name:** AD-1 Analog-to-Digital Converter. **Contact:** Michael Cveengros, mktg. dir. **Date Product Introduced:** 2/90. **Product Description & Applications:** The AD-1 is a high-quality, 2-channel, 16-bit analog-to-digital converter. It accepts balanced +4dBu analog input and produces output in the AES/EBU and SDFIF-2 formats simultaneously. Multiple units may be synchronized for multitrack applications. Compatible with professional and consumer DAT recorders. **Basic Specifications & Suggested List Price:** Conversion technique: oversampled single-bit sigma-delta. Output sampling frequency: 44.1 and 48 kHz. S/N: 90 dBfs. S/N+THD: 87 dBfs. Size: standard 19" rack compatible (single unit height). Power: 90-135 or 180-270 VAC, 47-63 Hz. Front panel controls: power switch, sampling frequency select, absolute phase invert level trim adjustment.

QSOUND INC.; 2748 37 Ave. N.E.; Calgary, Alberta, T1Y 5L3 Canada; (403) 291-2492. **Product Name:** QSystem—3-Dimensional Sound Imaging System. **Contact:** Jim Aiello, mgr. tech. mktg. **Date Product Introduced:** 10/89. **Product Description & Applications:** QSystem 3-Dimensional Audio Imagery is produced by a portable hardware and software package which interfaces directly with conventional mixing consoles in sound recording studios. Sound elements (tracks) processed through the QSystem will be heard, by the listener of a standard stereo, as discrete sound images existing in 3-dimensional space outside of the stereo system speakers, without any need for additional equipment. **Basic Specifications & Suggested List Price:** Applications: compact discs, audio and video cassettes, DAT, stereo TV and radio, and motion pictures.

RANE CORPORATION; 10802 47th Ave. W.; Everett, WA 98204; (206) 355-6000. **Product Name:** FFL 44 4-Channel Limiter. **Contact:** Terry Pennington, sales mgr. **Date Product Introduced:** 9/90. **Product Description & Applications:** A flex H-R (half rack standard) product, this limiter is based on Rane's standard "Servo-Locked" limiter technology such as is found in the Rane DC 24. Each limiter may be slaved to one, two or three of the others in the same unit for use on an active crossover's outputs to preserve frequency balance when one of several outputs is overdriven. **Basic Specifications & Suggested List Price:** List price to be announced. THD less than .05%; signal-to-noise better than 108 dB.

RANE CORPORATION; 10802 47th Ave. W.; Everett, WA 98204; (206) 355-6000. **Product Name:** MPE Equalizer Control Software. **Contact:** Terry Pennington, sales mgr. **Date**

Product Introduced: 6/90. **Product Description & Applications:** This software, which runs on any IBM PC compatible, presents a user interface for Rane's MPE Series programmable equalizers which replicates the controls of a conventional graphic EQ. It may also store an MPE's memory to disk for later uploading to the same or other MPE's. The curve of the EQ is simultaneously displayed. **Basic Specifications & Suggested List Price:** The software is supplied at no charge to Rane MPE users.

ROCKTRON; 2870 Technology Dr.; Rochester Hills, MI 48309; (313) 853-3055. Product Name: RSP Technologies 2200 Dynamics Processor. Contact: Jeff Sorna, product specialist. **Date Product Introduced:** 7/90. **Product Description & Applications:** Multiband dynamics processor, balanced or unbalanced. 1/4-inch or XLR. Patented hush noise reduction. Peak limiting, leveling. **Basic Specifications & Suggested List Price:** Rocktron Hush 8 x 8 channels of single-ended noise reduction, balanced or unbalanced 1/4" inch, filter sensitivity expander threshold, 60dB of effective noise reduction.

ROLLS CORPORATION; 7023 S. 400 W.; Salt Lake City, UT 84047; (801) 562-5628. Product Name: HR210 Equalizer. **Date Product Introduced:** 7/90. **Product Description & Applications:** HR 210 is a dual 10-band equalizer in the new half-rack standard format. It features greater than 100dB S/N ratio, standard ISO frequencies. Individual level and bypass controls. Very small size and a rugged steel chassis. **Basic Specifications & Suggested List Price:** S/N ratio 106 dB. Noise floor 90 dB. Max in/out level 18 dBu. In/ out connectors RCA and 1/4".

ROSS SYSTEMS; PO Box 2344; Ft. Worth, TX 76113-2344; (817) 336-5114. Product Name: RX Series Graphic Equalizers. Contact: Ramon West, Ross Systems product specialist. **Date Product Introduced:** 12/89. **Product Description & Applications:** The Ross Systems Graphic Equalizers are the ultimate in precision devices designed for critical equalizers applications. Available in 15-band stereo or 31-band mono, each design utilizes high-quality components for optimum dynamic range with minimum noise levels. Both units are rack-mountable requiring a single rack-space each, and are constructed to withstand the most rigorous of operating conditions. Both EQs are well-suited to live P.A. or studio applications. **Basic Specifications & Suggested List Price:** Both equalizers feature 12dB of boost or cut available for each frequency band, THD of less than .05%, 20dB of output level, S/N ratio of -100dB bandwidth, a low-cut filter, a 30Hz with a 6dB-per-octave roll-off selectable by a low-cut on/off switch (push-button), balanced and unbalanced inputs and outputs.

SHEP ASSOCIATES, LTD.; Long Barn, North End, Meldreth; Royston Herts SG8 6NT, England; (0763) 261686. Product Name: Nemesis FBS1000 Foldback System. Contact: Derek G. Stoddart. **Date Product Introduced:** 1/90. **Product Description & Applications:** High-quality foldback system suitable for studio, theater and stage use consisting of an 8-channel master unit with 6 outputs to feed powered distribution units and 8-channel mixer stations which have 8 flat faders, balance (or pan), 3-band equalizer on overall mix, 2 headphone jack sockets with individual level controls and mono push-buttons. Talkback to all stations from control room plus individual talkback from each station to control room. **Basic Specifications & Suggested List Price:** Two versions are available: 8-channel stereo with a balance control on each channel or an 8-channel mono with pan control. System is capable of having 24 mixer stations. Wiring can be multicore with overall screen. Individual-pair cable is only necessary on very long runs. Basic system price: \$2,970.

SONTEC ELECTRONICS INC.; Audio Dr.; Goldbond, VA 24094; (703) 626-7256. Product Name: ITI-230. Contact: Burgess MacNeal, gen. mgr. **Date Product Introduced:** 9/90. **Product Description & Applications:** A re-issue of the world's first parametric equalizer, developed at ITI in 1970. Contains all the original audio circuitry, but with improved power supply, chassis and panel layout. Most important, it sounds just like the original. **Basic Specifications & Suggested List Price:** 2-channel parametric equalizer. 3 parametric bands plus one each high- and low-frequency shelf bands per channel. Inputs balanced or unbalanced. Outputs unbalanced. S/N -84 dBu. 3.5" rack-mount. Suggested price: \$2,400.

SPATIAL SOUND, INC.; 743 Center Blvd.; Fairfax, CA 94930; (415) 457-8114; FAX: (415) 457-6250. Product Name: SSP-100 Spatial Sound Processor. Contact: Paul Devlas, sales mgr. **Date Product Introduced:** 4/90. **Product Description & Applications:** The SSP-100 Spatial Sound Processor is a real-time/MIDI-controllable audio signal panner for the simulation of sound movements in a two- or three-dimensional sound field. The SSP-100 can accommodate up to eight discrete loudspeaker systems. The positions of the loudspeakers are fully programmable. The SSP-100 uses amplitude, proportional reverberation, phase processing, polarity of the signal and Doppler shift to simulate the sound positions. Applications: discotheques, live performances, surround-sound, film post-production, theaters, planetariums, laser shows. **Basic Specifications & Suggested List Price:** Audio inputs: four at 20 kohms (+4 dBu, max. +20 dBu). Audio outputs: eight at 300 ohms (+4 dBu, max. +15 dBu). THD at 1 kHz <.05%. S/N ratio, WWWRM 80 dB. Frequency response: 10 Hz

to 20 kHz +/-1 dB. SSP-100: \$3,300. (unbalanced). SSP-100B: \$3,600. (balanced).



SYMETRIX, INC., DIGITAL PRODUCTS DIVISION
SX 206 Multi Dynamics Processor

SYMETRIX, INC., DIGITAL PRODUCTS DIVISION; 4211 24th Ave. W.; Seattle, WA 98199; (206) 282-2555; FAX: (206) 283-5504. Product Name: SX 206 Multi Dynamics Processor. Contact: Doug Schauer, dir. prod. dev. **Date Product Introduced:** 11/89. **Product Description & Applications:** The SX 206 Multi Dynamics Processor is a single-channel device that may be used as a compressor/limiter, gate, downward expander, ducker or slave (for stereo operation). A full complement of controls is provided for each operating mode. For situations that require the unit to "wake up" in a particular mode, rear panel DIP switches determine the initial operating state. For stereo, two units are linked via rear panel TRS jacks, and operated as a tracking stereo pair in a master/slave configuration. **Basic Specifications & Suggested List Price:** S/N ratio at 600 ohms, 115 dB at max. in, max. out, 94 dB at 0 dBv out. Dynamic Range: 115 dB, THD at 1 kHz, 600 ohms, .01% 0 dB g/r. Input impedance: >20 kohms (balanced). Output impedance: 200 ohms (balanced), 100 ohms (unbalanced). Freq. response: 20 Hz to 20 kHz. Suggested retail: \$329.

TELOS SYSTEMS; 1729 Superior Ave.; Cleveland, OH 44114; (216) 241-7225. Product Name: Telos Link Telephone-to-Intercom Interface. Contact: Steve Church, pres. **Date Product Introduced:** 4/90. **Product Description & Applications:** Allows the simple interconnection of production intercom systems with dial-up phone lines. Since this unit uses the same adaptive digital hybrid technology as the Telos One, the connection can be made without the usual gain and/or feedback problems while maintaining natural full-duplex operation. **Basic Specifications & Suggested List Price:** System: true digital. Texas Instruments TMS 320C25 Processor. 64x oversampling A/D. Digital input and output gain processing, filtering. Trans-hybrid loss: >40 dB with pink noise or voice test as input.



TOA ELECTRONICS
SAORI Integrated Sound Reinforcement Processor

TOA ELECTRONICS; 601 Gateway Blvd.; South San Francisco, CA 94080; (415) 588-2538. Product Name: SAORI Integrated Sound Reinforcement Processor. Contact: Rick Kamlet, manager, engineered sound products. **Date Product Introduced:** 7/90. **Product Description & Applications:** 32-bit digital processor combining simultaneous S/R functions into 5 rack-spaces, including two one-third octave variable-Q equalizers, two constant-directivity horn compensators, two 4-band notch filters, two symmetrical/asymmetrical 4-way crossovers and/or eight control zones with precision stepped attenuators, and eight digital delays for speaker time alignment. For fixed installations along with studio monitor

—LISTING CONTINUED ON NEXT PAGE

Rock 'n Roll will live forever... but your hearing may not.

Some rock concerts exceed tolerable sound levels by as much as 40 decibels. Repeated exposure to loud sound can damage the tiny hairs in your inner ear and slowly destroy your hearing. But you can protect your hearing by wearing ear plugs, or by just turning the volume down. If you already have hearing loss, H.E.A.R. can help you assess the damage and suggest ways to avoid additional problems.

To find out what rockers need to know to protect their hearing, contact:

H. E. A. R.

Hearing Education and Awareness for Rockers

Box 460847

San Francisco, California 94146

24-Hour Hotline:

(415) 773-9590

Send \$7.00 for information packet.

Circle #148 on Reader Service Card

**NEW
COMPACT
DISCS**

**MORE THAN 100
NEW CD RELEASES**

just added to
50,000 selections
of music already in the
TRF MUSIC LIBRARIES.

Be among the first to use the
latest in production music.

TRF
PRODUCTION MUSIC LIBRARIES

The largest source for production music

Call or write for free catalogs and music sampler
(212) 265-8090. TRF Production Music Libraries,
Dept. MX 1090. 1619 Broadway, New York,
NY 10019.

Circle #151 on Reader Service Card

systems. Eight presets. PC-controllable. 32 x 32-bit processing. **Basic Specifications & Suggested List Price:** EQ: 30 bands, +/-12 dB, Q = 3.5/5.0/7.0, HPF, LPF, CD comp., pink/white noise gen.; notch: 4-bands, Q = 30/70; channel divider: 4-way max.; 12/18/24 dB/oct. Butterworth/Link-Ril/Bessel, 0.25 dB 1v1 cntl; Dig delay: 21us-1.3ms; total: 10 Hz to 20.2 kHz, .01% dist. -100 dB S/N. \$8,250 list.

WHIRLWIND; 100 Boxart St.; Rochester, NY 14612; (716) 663-8820; FAX: (716) 865-8930. Product Name: Concert 42 Mic Splitting System. **Contact:** Michael Laiacina, pres. **Date Product Introduced:** 4/90. **Product Description & Applications:** The Concert 42 is a sound reinforcement system with 32 inputs and 10 returns, prepackaged with all necessary cabling to provide complete interconnection for house and monitor consoles. It's available in a heavy-duty stage box or an EIA 19" rack panel and utilizes Whirlwind Mass Series multipin connectors for fast and easy setup and tear-down. **Basic Specifications & Suggested List Price:** Microphone inputs are wired directly to one multipin (main out), and through Whirlwind transformers to a second multipin (split out). Each microphone input has a ground-lift switch on the split out and return lines are hardwired to both outputs. A 150' main cable and a 50' cable for the split output, both with 4' fan-outs, as well as fan-out protection shrouds, are included. Pro net: \$4,619.

WHIRLWIND; 100 Boxart St.; Rochester, NY 14612; (716) 663-8820; FAX: (716) 865-8930. Product Name: Line Balancer/Splitter. **Contact:** Michael Laiacina, pres. **Date Product Introduced:** 4/90. **Product Description & Applications:** The Line Balancer/Splitter is a single-channel, low-impedance device for isolating, splitting and balancing line-level signals. It's ideal for any application requiring isolation at line level. **Basic Specifications & Suggested List Price:** The Line Balancer/ Splitter has an operating level of -10 dB to +26 dB and a frequency response of 20 Hz to 20 kHz +/-1 dB. A choice of two input connectors. A female XLR jack or a 1/4" TRS jack is provided for connection to a balanced or unbalanced source. Two male XLRs are provided for signal output, with a ground-lift switch for each. Two output modes are provided: isolation mode, which provides one direct output and one balanced 600 ohms isolated output, or splitting mode, with two balanced 150 ohm isolated outputs. Pro net: \$72.

WHITE INSTRUMENTS, DIV. OF C VAN R, INC.; 5498 U.S. Hwy. 290 West; Austin, TX 78735; (512) 892-0752. **Product Name:** Model 4700/4700-2. **Contact:** Jeff Van Ryswyk, sales

mgr. **Date Product Introduced:** 9/89. **Product Description & Applications:** 1/3-octave digitally controlled 1- or 2-channel equalizer. In one rack-space high- and lowpass and gain control. Ten curve and ten preset locations in non-volatile memory. Remote control and remote preset select, noise generator, bi-amp and tri-amp crossover options available. Computer interface software via RS-232, EIA-422 in/out available for controller interface. Designed for storage of multiple curves for instantaneous program changes. **Basic Specifications & Suggested List Price:** R-C active adjustable +/-10 dB in .5 dB increments. 28 bands on I.S.O. centers. 31.5 Hz to 16 kHz. Highpass adjustable in 8 steps from 16 to 160 Hz, lowpass adjustable in 8 steps from 6 kHz to 32 kHz. LCD display. 115/230 VAC. Prices: 4700-2, \$1,375 and 4700, \$875.



ZOOM CORPORATION
Zoom 9002

ZOOM CORPORATION; 385 Oyster Point Blvd. #7; South San Francisco, CA 94080; (415) 873-5885. Product Name: Zoom 9002. **Contact:** Randall Curlee, national marketing and sales mgr. **Date Product Introduced:** 1/90. **Product Description & Applications:** 9002 digital signal processor for guitar. The tiny but powerful Zoom 9002 is crammed with an arsenal of guitar effects: compression, tube-type analog distortion, EQ, pitch shift, phaser, flanger, chorus, two digital delays and two digital reverbs. Every effect has the 16-bit CD-

quality sound. It's memory holds 20 presets and 20 custom user programs, and it fits on your guitar strap. **Basic Specifications & Suggested List Price:** \$479 list. **Memory:** 20 preset patches/20 user patches. A/D D/A converter: 16-bit linear. Input: guitar x 1 (1/4", -10/-20 dBm, 1 Mohm), mix x 1 (mini, stereo). Output: line x 1 (1/4", stereo, -10 dBm, 10 kohms), headphones x 2 (mini, stereo).



ZOOM CORPORATION
Zoom 9010

ZOOM CORPORATION; 385 Oyster Point Blvd. #7; South San Francisco, CA 94080; (415) 873-5885. Product Name: Zoom 9010. **Contact:** Randall Curlee, national marketing and sales mgr. **Date Product Introduced:** 9/90. **Product Description & Applications:** Signal processor with 4 discrete input and output channels. Features re-routable architecture with 16-bit, 44.1 kHz CD quality, up to seven effects at once. Totally user programmable. Its memory holds up to 60 factory presets and 60 customized user patches. Programs and routings can be quickly updated via ROM cards. **Basic Specifications & Suggested List Price:** \$1,749 retail. **Sampling rate:** 44.1 kHz. **Frequency response:** 16 Hz to 20 kHz. A/D D/A converter: 16-bit linear. **Dynamic range:** greater than 90 dB. Input: rear 1/4" balanced x 4 (+4/-20 dBm, 10 kohms), front 1/4" unbalanced for guitar x 1 (-20 dBm, 1 Mohm). Output: 1/4" unbalanced x 4 (+4/-20 dBm, 300 ohms).

SMALL POWER



Think small! Furman's new **SP-20 Stereo Power Amp** is the compact, convenient, and economical way to supply power to your small-sized applications. At 20 watts per channel (or 40 bridged for mono) it's perfect for duties like simulating automobile sound in the studio, driving tweeters in multi-way PA systems, or powering zoned background music systems.

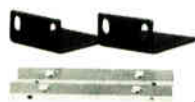

Rack mounting kit

It's got a speaker muting switch and a handy headphone jack in front with its own volume control, making spot checks a snap. You can even use it as a headphone

amp — it's complete with a special XLR connector in back to hook up a chain of inexpensive HR-2 Headphone Remote Stations. The SP-20 has low .01% THD and is completely protected against thermal overloads and short circuits. And it conforms to the new HR (Half Rack) mounting spec. So next time your power needs are small — think small. Think of the Furman SP-20.

For more information, call or write:

Furman Sound, Inc.
30 Rich Street
Greenbrae, CA 94904 USA
Phone: (415) 927-1225
Fax: (415) 927-4548

FURMAN
Signal Processing

TEST EQUIPMENT

ACOUSTIC TECHNOLOGY; 102 Pebble Beach Dr.; Roanoke, TX 76262; (817) 430-3351. **Product Name:** Alphon Phase Tester. **Contact:** Allen Groh, president. **Date Product Introduced:** 3/90. **Product Description & Applications:** The PC-100 is a high-quality test instrument that determines absolute phase (polarity) of the complete audio signal path including microphones and individual loudspeaker drivers. **Basic Specifications & Suggested List Price:** All components are high-quality. Warranty is 1 year. Suggested list price is \$649.

CONCEPT DESIGN ELECTRONICS & MANUFACTURING, INC.; 1105-A Pomeroy St.; Graham, NC 27253; (919) 229-6500; FAX: (919) 229-0063. **Product Name:** QC Panel. **Contact:** Kathleen R. Farrow, technical writer. **Date Product Introduced:** 1/90. **Product Description & Applications:** The QC panel is a custom-built switching system that simplifies quality-control checks, up to 10 playback sources can be connected to one output for monitoring; the source can be monitored in stereo, mono, left channel only, or right channel only. Product evaluation is more precise and better judgments can be made about quality, because the system can pinpoint the source of problems during the manufacturing process. **Basic Specifications & Suggested List Price:** Call for quote.

JASONI ELECTRONICS; 3149 E. Desert Inn Rd. #94; Las Vegas, NV 89121; (702) 791-3394. **Product Name:** TAS-1000 Tape Analyzer System. **Contact:** Dan G. Putoso. **Date Product Introduced:** 10/89. **Product Description & Applications:** Jasoni TAS-1000 Audio Tape Analyzer System monitors via calibrated VU meters and speaker system, the properly terminated output performance of analog audio tape equipment, i.e.: tape cartridge, reel-to-reel, cassette record and reproduce machines, using test tapes. A low-distortion sine oscillator with a variable sweep, in two ranges, of 20-20,000 Hz for record response observation. Fast, accurate stereo alignment using pink noise, the results shown on the L + R meter, or external X-Y scope display. System noise can be read down to -70 dB. **Basic Specifications & Suggested List Price:** The pink noise generator and/or sine wave oscillator can be used to observe the frequency response to telco lines, amplifiers, consoles and tape machines. The wide band meter circuit can read levels of audio and its noise content within the range of -70 to +23 dB. Set up record and play equalization to manufacturer's specs. Monitor audio quality and line levels separately, left, right or the sum. Preset output levels of equipment terminated into its proper load.

JRF MAGNETIC SCIENCES, INC.; 249 Kennedy Rd.; Greendell, NJ 07839; (201) 579-5773. **Product Name:** Time Code Calibration Alignment Tapes. **Contact:** John French, president. **Date Product Introduced:** 6/90. **Product Description & Applications:** JRF Magnetic Sciences will be showing a long-awaited addition to their full line of MRL Alignment Tapes. New is the P.A.W. line of 1/4" time code and pilot tone test tapes. Each center track time code tape is recorded in two sections. The first part is recorded at standard IEC time code reference level for calibration and track location alignment. The second is full track recording for establishing offsets and delays. Available are P/N PTC-50TT (7-1/2 ips) and PTC-50TT-15 (15 ips). **Basic Specifications & Suggested List Price:** The P.A.W. P/N PTC-500TT-P pilot tone test tape is recorded in two sections. The first being FM pilot tone (compatible with Nagra Sync™) and the second section offering mono pilot tone (compatible with Nagra Neo-Pilot™). Also on display for the first time will be the P.A.W. Seamless/Gapless retrofit kit for Otari MTR-10 and 12 machines. A must for post-production users.

NEIL AUDIO; 2716 W. Cherry; Visalia, CA 94596; (209) 732-7691. **Product Name:** The "Which Box." **Contact:** Tom Pessagno, owner of TADCO. **Date Product Introduced:** 1/90. **Product Description & Applications:** The absolute polarity checker that works. You can check virtually any equipment with an analog input or output for absolute polarity. Check the whole chain or individual components. Automatic or manual operation of the transmitter, plus visual and/or audible polarity indication allow one person to check any system. **Basic Specifications & Suggested List Price:** Suggested retail: \$650. Transmitter: balanced, single-ended or acoustical output from -40 to +20 dBm. Will drive a speaker directly. Pin 2

or 3 selectable. Auto/man operation. Receiver: balanced, single-end, or acoustical input from -50 to +35 dBm. Audible or visual indication of polarity.

NEUTRIK USA, INC.; 195-S3 Lehigh Ave.; Lakewood, NJ 08701; (201) 901-9488. **Product Name:** A-1. **Contact:** Kenneth W. Smalley, product mgr. **Date Product Introduced:** 9/90. **Product Description & Applications:** Generator with sweep capability; level, frequency and crosstalk meter; noise meter; distortion analyzer; wow and flutter meter; curve tracer; and oscilloscope. **Basic Specifications & Suggested List Price:** \$4,000 suggested list price.

R.B. ANNIS CO. INC.; 1101 N. Delaware St.; Indianapolis, IN 46202; (317) 637-9282. **Product Name:** Long Probe Head Demagnetizer. **Contact:** R. B. Annis, pres. **Product Description & Applications:** Powerful head demagnetizer for reaching into more recessed areas, recording heads, capstans, etc. **Basic Specifications & Suggested List Price:** Practical intermittent duty on 115 V, 60 Hz, 1.6 amperes.

RESEARCH TECHNOLOGY INTERNATIONAL; 4700 Chase; Lincolnwood, IL 60646; (708) 677-3000. **Product Name:** Model V60 Audio Tape Spooler/Cleaner/Evaluator. **Contact:** Tom Tisch, VP sales. **Date Product Introduced:** 6/90. **Product Description & Applications:** For audio/video tape on reels. Automatically winds to selected length. Provides thorough cleaning of tape for improved S/N ratio. Microprocessor controlled. Options include erase, polishing modules, dual format versions, magnetic evaluation option. **Basic Specifications & Suggested List Price:** Formats: 1/4", 1/2", 3/4", 1", 2" (factory preset). Capacity: 15" reels (16" optional). Speed: 150 ips (optionally user-adjustable). Size: 22 x 22 x 38", weight 155, 165. Price: call for quote.

SESCOM INC.; 2100 Ward Dr.; Henderson, NV 89015; (702) 565-3400. **Product Name:** Hand-held Audio Test Equipment. **Contact:** Franklin J. Miller, president. **Date Product Introduced:** 1/91. **Product Description & Applications:** Audio test equipment for field servicing needs.

TECHRON, DIV. CROWN INTERNATIONAL; 1718 W. Mishawaka Rd.; Elkhart, IN 46517; (219) 294-8300. **Product Name:** TEF System 20. **Contact:** Larry Shank, TEF sales manager. **Date Product Introduced:** 4/90. **Product Description & Applications:** TEF System 20 Acoustic Analyzer that hooks to IBM PC or Macintosh. The TEF System 20 Acoustic Analyzer will make the acoustic measurements necessary to install a new studio or improve an existing one. The TEF 20 is useful for solving imaging and phase problems, will pinpoint causes of sound coloration, and allows simulation of an anechoic chamber for new equipment evaluation. The TEF 20 weighs 10 lbs. and is one rackspace in height. It will make electrical as well as acoustical measurements. **Basic Specifications & Suggested List Price:** Pricing is factory direct with systems starting at \$3,950. Frequency range: 10 Hz-23k Hz. Frequency response: +/-1 dB (absolute); +/-0.01 dB (relative). Phase response: +/-1.0 degree (absolute); +/-0.01 degree (relative). Dynamic range: 96 dB. THD + N: .003% at 1 kHz. Digital/analog conversion: 16-bit, 8 times oversampled. Analog/digital conversion: 16-bit, 64 times oversampled. Test input: unbalanced line level; balanced 2-channel microphone preamp.

TENDEL CORP.; 4475 Golden Foothill Parkway; El Dorado Hills, CA 95630; (916) 939-4005; (800) 538-6894. **Product Name:** HPG-S Video Head Protrusion Gauge. **Contact:** Wayne Graham. **Date Product Introduced:** 7/90. **Product Description & Applications:** Universal method for measuring the actual wear on video heads on U-Matic, Betacam MII, S-VHS and VHS tape transports. Safe, accurate and easy to use. Also measures drum eccentricity for simplifying head drum replacements. **Basic Specifications & Suggested List Price:** Includes all mounting hardware, instruction manual and carrying case. \$595.

THX GROUP/LUCASFILM LTD.; PO Box 2009; San Rafael, CA 94912; (415) 662-1900. **Product Name:** R2 Acoustical Measurement System. **Contact:** Marco d'Ambrosio, project manager. **Date Product Introduced:** Fall 1990. **Product**

Description & Applications: R2 is an acoustical measurement system designed to serve the widely ranging needs of the theater, professional audio, sound contracting and recording industries. Performs acoustical and electrical real-time frequency analysis, spatial averaging and automated reverberation and background noise measurements. Data is displayed in standard octave and third octave band center frequencies and stored in a spreadsheet compatible format for easy transfer and manipulation. Software is 100% PC and VGA graphics downward compatible. **Basic Specifications & Suggested List Price:** R2 Acoustical Measurement System includes: spectrum analyzer, microphone MultiPlexer with 75' cable, four low-diffraction microphones with cables and stands, software and documentation, optional carrying case. IBM PC or compatible, which may be purchased through THX. List price \$10,000.

Mix Trivia Answers

1. Who is John Cale?
2. What is "Street Fighting Man"?
3. Who is Alan Lomax? (The tape was "Goodnight Irene.")
4. Who is Bing Crosby?

Information contained in Mix Trivia was gathered from a variety of sources, including Encyclopedia of Rock (Schirmer Books), The Billboard Book of Gold and Platinum Records and the ever-knowledgeable Mix magazine staff.

Questions can be found on pages 238, 244, 257 and 261

DISC MAKERS

CD Replication

- Fast Delivery
- Small Quantities



500 CDs and 500 Chrome Cassettes for \$2990 COMPLETE PACKAGE PRICE!

Call today for complete details and our FULL COLOR CATALOG



1-800-468-9353 In PA (215) 232-4140

DISC MAKERS

1650 Broadway, Suite 1010 New York, NY 10019 (212) 265-6662

Circle #147 on Reader Service Card

OTHER

ALTA GROUP, INC.; 535 Race St., Ste. 230; San Jose, CA 95126; (408) 297-ALTA. Product Name: Pegasus. Contact: Frank Alioto, VP mktg. Date Product Introduced: NAB 1990 (April). Product Description & Applications: Pegasus is a sophisticated video switcher designed to meet the needs of the most demanding video producers. Pegasus is an all Y/C switcher but can be easily configured to run in composite as well. Pegasus will stand up to any broadcast quality switcher in its price range and surpass it in capability and standard features. Its ease of operation and Y/C signal path make it ideal for use in industrial, educational and government applications. Basic Specifications & Suggested List Price: 5MHz bandwidth (>600 lines of resolution). S/N ratio: 65dB. Key priority assign. 10 inputs w/color and black. 4 levels of on-air video. Color wash generator. Standard 100-event memory system. 27 wipe patterns. 4 external key inputs. 2 keys over wipe insert. 3 buses (key, program, preset). List price: \$11,500.

ALTA GROUP, INC.; 535 Race St., Ste. 230; San Jose, CA 95126; (408) 297-ALTA. Product Name: Pictoris-Ede. Contact: Frank Alioto, VP mktg. Date Product Introduced: 4/90. Product Description & Applications: The Alta Group Pictoris is a broadcast quality video digital effects system. The Pictoris can compress or crop an image to any size over live video or color background. Video can be zoomed on/off screen. The Pictoris-EDE is an upgrade for the standard Pictoris. "EDE", or enhanced digital effects, empowers the end user to create curvilinear motion, flips, and tumbles. Sequences of up to 48 moves can be created and stored in an external data. Basic Specifications & Suggested List Price: Composite and Y/C inputs, 5.5 MHz bandwidth, 55dB S/N ratio, variable speeds, infinite compression, auto transitions, track ball, built-in keyer, posterization, mosaic and strobe, user presets, 450 lines of resolution, external data card memory system. List Price: \$13,500.

ANCHOR AUDIO, INC.; 913 W. 223rd St.; Torrance, CA 90502; (213) 533-5984. Product Name: Liberty 4500 Series. Contact: Maggie Keleher, Brad Carr, reg. sales mgr. Date Product Introduced: 5/90. Product Description & Applications: The Liberty 4500 Series is vastly improved over previous models. A 4dB increase in SPL is achieved through the use of a 2" titanium driver and 8" woofer. In the music mode a 10dB pad is used on the horn. This pad is bypassed in the project mode, which is used mainly in voice projection applications. In the project mode the 4500 Series will cover up to 1,000 people outside. Basic Specifications & Suggested List Price: Options include installation of up to two wireless receivers, or one receiver and one cassette tape player. The MPB-4500 will run from four to six hours on a single charge of its internal batteries. List Price: from \$959.



THE ARCHON CORPORATION
Arcoset Printing Systems

THE ARCHON CORPORATION; 43 Cherry St.; Danvers, MA 01923; (508) 777-8836. Product Name: Arcoset Printing Systems. Contact: John Arcotta, president. Date Product

Introduced: 11/90. Product Description & Applications: Arcoset Printing Systems are direct on-cassette imprinting systems which eliminate the use of paper labels. Arcoset printers are modular with the capacity of being upgraded from a manually operated printer to a fully automated two-sided printer. The Arcoset printers are small, compact, affordable, user friendly, and produce a high-quality imprint. Accessories include a low cost photopolymer plate maker. Printing capacity ranges from 400-1250 imprints per hour depending on specific model. Basic Specifications & Suggested List Price: Pneumatically operated, requiring 125 PSI compressed air regulated to 80 PSI. 110 Volts AC. Dimensions: Mini Printers 24" x 20" x 18"; Mark 1250 36" x 24" x 16". Weight: 80-120 pounds. Requires Buna N or Photopolymer printing plates; air dry printing inks. Prices: Model 250X \$2,650; Model 650X \$5,650; Model 650-2X \$7,500; Model Mark 1250 \$10,000.

ATLAS/SOUNDOLIER; 1859 Intertech Dr.; Fenton, MO 63026; (314) 349-3110. Product Name: Soundolier. Contact: Chuck Gushwa, director of sales. Date Product Introduced: 1/90. Product Description & Applications: Instrument mixing stand, model DMS-10E, with companion boom, model DMB-10XE. Basic Specifications & Suggested List Price: 14 1/2" to 26" adjustable height. 15 1/2" to 22" adjustable boom extension. Non-reflective ebony finish. \$65.98/list.

AUDIOLAB ELECTRONICS, INC.; 5831 Rosebud Ln., Bldg. C; Sacramento, CA 95841; (916) 348-0200. Product Name: TD-5 Metal Tape Degausser. Contact: Ron Stefan. Date Product Introduced: 10/89. Product Description & Applications: Tape degausser, eraser erases tape up to 2" in width and 16" in diameter. Degausses all formats including BetaCam SP, M-II, DAT, D1, D2, high coercivity 1" and 2" reels. Basic Specifications & Suggested List Price: Available in either 110 or 220 and runs on a standard 15 amp outlet. List Price: \$1,295.

AUDITRONICS, INC.; 3750 Old Getwell Rd.; Memphis, TN 38118; (901) 362-1350. Product Name: 1900 Series IFB/Mix-Minus Systems. Contact: Murray Shields, director of sales. Date Product Introduced: 12/89. Product Description & Applications: The 1900 IFB/Mix-Minus System is designed to solve a chronic problem experienced by television and larger radio facilities. The modular 1900 permits 8 or more discrete, simultaneous mix-minuses, each with independent IFB, for newscasts, sports events, elections, etc. It is an easy-to-use, technically sophisticated, broadcast-quality method of giving field correspondents a program mix, minus their own voice, with IFB interrupt to any or all outputs from a number of control locations. Basic Specifications & Suggested List Price: Frequency response: +/-0.5 dB, 20 Hz to 20 kHz, signal-to-noise ratio: 91 dB, 20 Hz to 20 kHz, distortion: <0.01%, 20 Hz to 20 kHz, at +24 dBm output level, crosstalk: -88 dBu, maximum output level: +26 dBm into 600 ohms.

CALZONE CASE CO.; 225 Black Rock Ave.; Bridgeport, CT 06605; (203) 367-5766; (800) 243-5152. Product Name: Studio Series. Contact: Vincent J. Calzone, VP sales. Date Product Introduced: 1/90. Product Description & Applications: Studio Series Model S-88 and S-812. Permanent installation racks designed to serve the need of home recording enthusiasts, studio musicians, video-broadcast systems, CCTV display monitors and switchers. Basic Specifications & Suggested List Price: Specifications include 3/4" furniture design laminate, tapped 10/32 steel rack rail, lower section vertical mount, upper section slanted (mounting mixers or tape machines), 2" swivel casters, colors: black, light oak, gray. S-88: 8-space upper and lower section, retail price \$220. S-812: 12-space upper and 8-space lower, retail price \$242.

CANARE CABLE, INC.; 511 5th St., Unit G; San Fernando, CA 91340; (818) 365-2446. Product Name: Star Quad. Contact: Barry Brenner, GM. Date Product Introduced: 11/89. Product Description & Applications: "L-4E4-" "AT" multi-channel Star Quad snake cable. Perfect for resisting noise from RFI, lighting dimmers, fluorescents, power supply. Very good crosstalk characteristics, better than 130dB channel-to-channel. For fixed installations where critical lev are required.

CONCEPT DESIGN ELECTRONICS & MANUFACTURING, INC.; 1105-A Pomeroy St.; Graham, NC 27253; (919)

229-6500; FAX: (919) 229-0663. Product Name: CD 9000. Contact: Kathleen R. Farrow, technical writer. Date Product Introduced: 1/90. Product Description & Applications: The CD 9000 is Concept Design's answer to the need for a cassette loader for the 1990s. It employs the best of Concept Design's eliminator modification technology, and introduces advanced ideas for better economy and efficiency. The CD 9000 is the most progressive cassette loader available for its price. Basic Specifications & Suggested List Price: Price: under \$20,000.

CONNECTRONIC CORPORATION; 652 Glenbrook Rd.; Stamford, CT 06906; (203) 324-2889. Product Name: Soundwires Patch Panels. Contact: Richard Chilvers, president. Date Product Introduced: 1/90. Product Description & Applications: Increasing an existing range of patch bays to cover any input/connector combination. Basic Specifications & Suggested List Price: From \$125.36 up.

CRYSTAL SEMICONDUCTOR CORPORATION; PO Box 17847; Austin, TX 78760; (512) 445-7222. Product Name: CS4328, 18-bit Stereo D/A converter for digital audio. Contact: Brad Fluke, data acquisition mktg mgr. Date Product Introduced: 1/91. Product Description & Applications: The CS4328 is a complete stereo digital-to-analog output system. In addition to the D/A function, the CS4328 includes an 8X digital interpolation filter followed by a 64X oversampled delta-sigma modulator. The modulator output controls the reference voltage input to an ultralinear analog lowpass filter. Basic Specifications & Suggested List Price: The CS4328 features 97dB dynamic range, 94dB signal-to-(noise + distortion) and a passband ripple of 0.001 dB. It is available in a 38-pin plastic DIP. Pricing is \$30 in 1,000s.

CRYSTAL SEMICONDUCTOR CORPORATION; PO Box 17847; Austin, TX 78760; (512) 445-7222. Product Name: CS5336, 16-bit stereo A/D Converter for Digital Audio. Contact: Brad Fluke, data acquisition mktg mgr. Date Product Introduced: 8/90. Product Description & Applications: The CS5336 is a complete analog-to-digital converter for stereo digital audio systems. It performs sampling, A-to-D conversion and anti-aliasing filtering, resulting in a 16-bit serial word for each channel. The CS5336 uses delta-sigma modulation with 64X oversampling, followed by digital filtering and decimation. The filter passband is DC to 24 kHz. Basic Specifications & Suggested List Price: The CS5336 can operate at sampling rates of 32 kHz, 44.1 kHz and 48 kHz. The device features a 95.7dB dynamic range and a signal-to-noise + distortion of 92.7 dB. The CS5336 is available in a 28-pin plastic DIP. Pricing is \$39 in \$1,000s.

CRYSTAL SEMICONDUCTOR CORPORATION; PO Box 17847; Austin, TX 78760; (512) 445-7222. Product Name: CS8401-AES/EBU Interface Line Driver. Contact: Brad Fluke, data acquisition mktg mgr. Date Product Introduced: 9/90. Product Description & Applications: The CS8401 is a monolithic CMOS device that is used to encode and transmit audio data according to the AES/EBU interface standards. The CS8401 has a configurable internal buffer memory loaded via a parallel port, which may be used to buffer channel status and/or auxiliary data. Basic Specifications & Suggested List Price: The CS8401 is available in a 24-pin plastic DIP or SOIC, and operates from a single +5V supply. Pricing is \$11.20 in 1,000s.

DENON AMERICA, INC.; 222 New Rd.; Parsippany, NJ 07054; (201) 575-7810. Product Name: DN-970FA CD Cart Player. Contact: Laura J. Tyson, sales manager. Date Product Introduced: 8/90. Product Description & Applications: CD player designed for production use. Features +/-10% varispeed, A-B Looping. Quick search time, AES/EBU Digital Output and balanced analog audio outputs, RS422 Communications port, Ext Synch In/Out. Uses individual cartridges cartridges to protect the CD's. Full wired remote control capabilities. Basic Specifications & Suggested List Price: 18-bit DAC's, 8 x Oversampling, <0.008% THD, 92dB S to N. Frequency response 20 Hz to 20k Hz. Suggested List Price: \$2,599.

ESOTERIC SOUND; 4813 Wall Bank Ave.; Downers Grove, IL 60515; (708) 960-9137. Product Name: "Vintage" turntable. Contact: Mike Stosich. Date Product Introduced: 2/90. Product Description & Applications: Six-speed phonograph turntable for reproducing disc records of all vintages. Used by record re-issue producers and record collectors. The only turntable made that plays original 1889 Berliner disc record (71 RPM!). Basic Specifications & Suggested List Price: Platter: 12". Speeds: 33, 45, 71, 76, 78, 80 RPM. Pickup: P-mount. Style: Micro-groove, 2.8 mil, 3.3 mil, 3.5 mil. Price: \$229.

FURMAN SOUND, INC.; 30 Rich St.; Greenbrae, CA 94904; (415) 927-1225. Product Name: AR-PRO 30 Amp Line Voltage Regulator. Contact: Joe Desmond, national sales mgr. Date Product Introduced: 9/90. Product Description & Applications: The AR-PRO supplies up to 30 amperes of clean, stabilized AC power through 12 rear and two front panel outlets. Provides 120 VAC from any input voltage from 88 to 264 volts, making it ideal for worldwide use. It is housed in a rugged but compact 2 rackspace chassis which may be secured in the rear as well as the front. The AR-PRO has meters for input voltage and current, and three output status lights. Units may be controlled remotely, either simultaneously or in a delayed se-

quence. **Basic Specifications & Suggested List Price:** The AR-PRO achieves low magnetic leakage and high efficiency for its weight (only 39 lbs) by using a 25-tap toroidal autoformer, whose taps are switched only at voltage zero-crossings. The AR-PRO is not sensitive to line frequency and may be used at either 50 or 60 Hz. Suggested list price: \$1,599.



HM ELECTRONICS, INC.
System 8110

HM ELECTRONICS, INC.; 6675 Mesa Ridge Rd.; San Diego, CA 92121; (619) 535-6060. **Product Name:** System 8110. **Contact:** Bruce Slemmer, nat'l. sales manager. **Date Product Introduced:** 2/90. **Product Description & Applications:** The System 8110 is a self-contained wireless intercom which can be interfaced with a wide variety of cabled intercom and telephone systems. The Base Station contains an eight-position terminal strip (four-wire balanced interface). Along with the Base Station, the system includes 2 Communicator® units with headset and battery, and a battery charger. Versatile applications include retail, warehouse, and construction sites. **Basic Specifications & Suggested List Price:** 300' to 1,000' range. \$3,200.

INSTRUMENT COVERS; 3468 Peck Ave. S.E.; Salem, OR 97302; (800) 274-4543; (503) 588-4001. **Product Name:** Digital Equipment Soft Cases. **Contact:** Dennis O. Haley, owner. **Date Product Introduced:** 2/90. **Product Description & Applications:** Digital soft cases custom built to the make and model of your equipment. All cases come with plywood panels placed in pockets and sewn into the covers to allow maximum protection for sensitive areas in controls, bridges, reels and remotes and still keep the lightweight flexibility of a soft case. All cases have velcro-secured handle flaps for convenience in moving yet sealing properties. **Basic Specifications & Suggested List Price:** All of our covers are built to the individual make and model of the equipment and in the color of your choice. Prices range from \$400 to \$500 for most recording items and \$135 to \$175 for remotes, on the average.

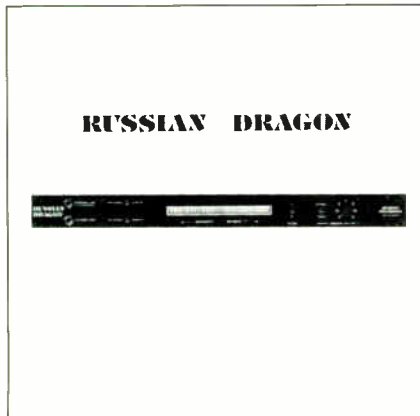

RUSSIAN DRAGON

JEANIUS ELECTRONICS
Russian Dragon

JEANIUS ELECTRONICS; 2815 Swandale; San Antonio, TX 78230; (512) 525-0719. **Product Name:** Russian Dragon. **Contact:** Jeanine Davis. **Date Product Introduced:** 1/90. **Product Description & Applications:** The Russian Dragon measures the timing accuracy of two sounds that were meant to happen at the same time. For example, it shows how closely a drummer is playing with a click track; it detects the time delay between an acoustic drum and its triggered replacement; it reveals timing inaccuracies in MIDI systems. The Russian Dragon compares the timing of any two events and gives an instantaneous visual display of who's rushin' and who's

dragin'. **Basic Specifications & Suggested List Price:** The unit uses a row of 25 LEDs as its display. LEDs to the left of center indicate dragin'. LEDs to the right indicate rushin'. The greater the distance of a lit LED from the center, the more error exists between the two input signals. Accuracy to .1 millisecond. \$495.

JRF MAGNETIC SCIENCES, INC.; 249 Kennedy Rd.; Greendell, NJ 07839; (201) 579-5773. **Product Name:** Center Track Time Code Conversion Kits. **Contact:** John French, president. **Date Product Introduced:** 1/90. **Product Description & Applications:** JRF/Magnetic Sciences will exhibit new additions to their TC-50 Center Track Time Code Conversion Kits. New is the TC-50 with EC-Bill option for easy conversion of the Otari MX5050 Bill to time code capability. The EC-Bill option is an easy installation which expands the MX5050 Bill to external control by synchronizer. 1/4" Center Track Time Code Kits are currently available for Ampex ATR 102 and 104, Sony/MCI JH110 A and B, Studer A80 and Otari MX5050 Bill and MKIII tape machines.

JRF MAGNETIC SCIENCES, INC.; 249 Kennedy Rd.; Greendell, NJ 07839; (201) 579-5773. **Product Name:** PLX Magnetic Replacement Heads. **Contact:** John French, president. **Date Product Introduced:** 7/90. **Product Description & Applications:** JRF/Magnetic Sciences will display many new additions to their PLX premium quality magnetic heads line. New magnetic heads this year include replacements for the Ampex MM1100 and 1200 24-track, Tascam models 80-8 (1/2" 8-track) and 85-16 (1" 16-track), Otari model MTR10 and MTR12 (1/2" 4-track) for low-speed mastering and replacements for 16/35MM film recorders. Also on display will be replacements for most Otari, Studer, Ampex, Sony/MCI, 3M, Tascam, Fostex, cully, tape duplicating, film and mastering equipment. (mono to 24-track).



KABA RESEARCH AND DEVELOPMENT
KABA manual pad printer

KABA RESEARCH AND DEVELOPMENT; 24 Commercial Blvd.; Novato, CA 94949; (415) 883-5041; (800) 231-TAPE. **Product Name:** KABA manual pad printer. **Contact:** KABA R & D sales dept. **Date Product Introduced:** 8/90. **Product Description & Applications:** This budget, direct on-cassette imprinting system can reproduce type as small as 4-point. Even 150-line screened photographs can be printed at an equipment cost less than one-tenth that of automatic machinery with similar capability. Videocassettes, Norelco boxes, binder and R-DAT's can also be imprinted making it possible for even the smallest audio and video producers to do their own professional labeling and product identification in-house. **Basic Specifications & Suggested List Price:** System includes imprinter, pad, cassette holder, ultraviolet platemaker, contact frame, 25 plates 3.125" x 6", black-and-white inks and sundry supplies. Will print image up to 2.75" x 5", 200 to 300 impressions per hour. Machine weighs 45 lbs, occupies 16" x 16" counter space. Complete package price \$2,639. Available free with KABA 10-position real-time and 2 x duplication system as AES show special, booths 840-842-941-943.

LESTER AUDIO LABORATORIES; 1111 W. Mockingbird Ln.; Dallas, TX 75247; (214) 637-9311. **Product Name:** DAS-2000. **Contact:** Michael C. Creamer, VP of marketing. **Date Product Introduced:** 10/90. **Product Description & Applications:** Digital audio transmission distribution and routing system, using fiber optic cable. The input terminal contains A/D conversion, signal multiplexing, gain control, signal diagnostics and phantom powering. The output terminal contains digital soft patch for control functions for D/A conversion. Applications are sound reinforcement, recording, broadcasting. **Basic Specifications & Suggested List Price:** Transmission distance 15,000', dynamic range 95 dB, matrix size 64 x 64, 192 stored programs, phantom power +48V on/off per channel. Gain control 6 x 10 dB steps, display large LCD backlite 40 x 8 characters, sampling rate 48 kHz, input 100 kohms, output 5 kohms, 16 bit A/D, 18 bit D/A. Suggested list price: 32 inputs/32 outputs/16 return lines, \$27,000.

—SEE PHOTO TOP OF NEXT COLUMN



LESTER AUDIO LABORATORIES
DAS-2000

MARK OF THE UNICORN, INC.; 222 Third St.; Cambridge, MA 02142; (617) 576-2760. **Product Name:** Video Distribution Amplifier. **Contact:** Susan Patia and, marketing dir. **Date Product Introduced:** Fall 90. **Product Description & Applications:** A 3 x 15 video signal routing device for video production. The VDA provides an economical solution for situations where multiple video sources need to be sent to a variety of destinations. **Basic Specifications & Suggested List Price:** Single-spaced, 19" rack-mount chassis and ships with 2 BNC-to-RCA video cables. All inputs and outputs are BNC connectors.

MARSHALL ELECTRONICS, INC./MOGAMI PRODUCTS DIV.; PO Box 2027; Culver City, CA 90230; (213) 390-6608. **Product Name:** Mogami EZ-ID Snake Multi-Pair Cables. **Contact:** Hugh Neep, general manager. **Date Product Introduced:** 1989. **Product Description & Applications:** This new series of snake cables from Mogami is designed to help reduce the time and cost of wiring while maintaining the top quality of their original, world-renowned snake cables. Features include rugged, superflexible construction, color and number coded jackets for each pair (for easy identification) and a drain wire to simplify soldering or crimping. The EZ-ID Series is available in 2 to 48 pair configurations. **Basic Specifications & Suggested List Price:** Conductor: 30/0.08A, 0.15mm(2)[26 Avg]. Insulation: 1.0 0 XLPE. Drain wire: 7/0.18TAM, 0.18mm(2) [25 Avg]. Shield: approx. 47/0.10 a served shield. Jacket: 2.70 Flexible PVC. List price: \$0.77 per foot and up



MARSHALL ELECTRONICS, INC./ MOGAMI PRODUCTS DIV.
Mogami Tiny-Tel Bantam Patch Cords

MARSHALL ELECTRONICS, INC./MOGAMI PRODUCTS DIV.; PO Box 2027; Culver City, CA 90230; (213) 390-6608. **Product Name:** Mogami Tiny-Tel Bantam patch cords. **Contact:** Hugh Neep, general manager. **Date Product Introduced:** 1989. **Product Description & Applications:** The world's first high-definition audio patch cords for recording and other professional applications. Features include a super-flexible cable with precision-molded connectors, quad balanced wiring for better sound quality and maximum noise reduction, maintenance-free nickel-plated plugs, and color coding for easy identification. This highly reliable and long lasting product is also available with gold plated connectors. **Basic Specifications & Suggested List Price:** Four conductors: 30/0.08 OFC 0.15mm(2) [26 Avg]. Insulation: 1.0 0 XLPE. Shield: approx. 74/0.12A served spiral shield. Jacket: 4.80. Flexible PVC. Colors: black, red, yellow, green, blue. List price: \$11.39 and up.

**New! MOGAMI
Bantam Patch Cords**

Superflexible Tiny-Tel [.173"] Bantam Patch Cords feature MOGAMI's Quad-Balanced Wiring of specially annealed High-Conductivity OFC for maximum definition and transparency.

Molded Tip/Ring/Sleeve Cords available in popular lengths from 18" to 72".



**MARSHALL ELECTRONICS
INC.**

P.O. Box 2027
Culver City, CA 90230
Phone 213/390-6608
24-Hr. Fax 213/391-8926

Circle #070 on Reader Service Card

**Go Straight
to the Source**

IN THE

December Mix

Mastering, Pressing & Duplicating

2-Track Mastering Recorders

Tape Storage Methods

Mix takes a close look at the tools and techniques of mastering and duplication in December, with a spotlight on high-quality 2-track mastering recorders. Consoles for mastering will be featured as well, and we'll look at how to keep your tape in prime condition with proper storage methods.

Producer's Desk brings you a visit with Brian Malouf, and Music & Recording Notes is on producing hard rock and metal music. Don't miss the valuable information in December *Mix*!

**Ad Closing: October 8
Materials Due: October 15**

1991 · NEW · PRODUCTS



NATIONAL MARKET MAKERS, INC.
Ear Lenses™ Sound
Detail Amplifier Headset

NATIONAL MARKET MAKERS, INC.; PO Box 2188; Venice, CA 90294-2188; (213) 652-6559. **Product Name:** Ear Lenses™ Sound Detail Amplifier Headset. **Contact:** Michael D. Riley, president. **Date Product Introduced:** 6/90. **Product Description & Applications:** A headset that positions precision acoustic reflectors behind and around the ears, to gather more sound and reflect it to a focus within the ears. Also blocks noises from the wearer's sides and rear. For engineer's use in the field, or performers use anywhere. Helps performers hear their voices or instruments more clearly. **Basic Specifications & Suggested List Price:** Provides over 7 decibels of amplification of the "presence" frequencies of sounds faced by the wearer. Provides even greater attenuation of noises to the wearer's sides and rear.

NEUTRIK USA, INC.; 195-S3 Lehigh Ave.; Lakewood, NJ 08701; (201) 901-9488. **Product Name:** Infomatic. **Contact:** Kenneth W. Smalkey, product mgr. **Date Product Introduced:** 3/90. **Product Description & Applications:** Digital message repeater, digital recording and announcing system for telecommunications, public address, broadcasting and security.

OPTICAL DISC CORPORATION; 12150 Mora Dr.; Santa Fe Springs, CA 90670; (213) 946-3050. **Product Name:** ODC 500 Series Mastering Line. **Contact:** John Browne, VP sales. **Date Product Introduced:** 10/89. **Product Description & Applications:** A complete process line for the production of glass masters for compact disc replication. Suitable for all CD formats: CD audio, CD-ROM, CD-I, etc. Includes glass recycling and preparation, master disc recording, Q.C. of recorded data, metalizing, and all required clean air and other support equipment. **Basic Specifications & Suggested List Price:** Complete set of equipment to convert PCM 1610/1630-encoded tape to finished glass master ready for electroforming of stamers; approx. \$1.5 million.

PENNY & GILES, INC.; 2716 Ocean Park Blvd., Ste. 1005; Santa Monica, CA 90405; (213) 393-0014. **Product Name:** Motorized Faders. **Contact:** Bob Smith, sales manager. **Date Product Introduced:** 6/90. **Product Description & Applications:** New development of a low-cost motorized fader. The MSF 3200 Series is an accurate, responsive fader which can be supplied with mono and stereo outputs. Another quality product from Penny and Giles for the audio market. **Basic Specifications & Suggested List Price:** A 12-volt DC motor drive; the fader. Control is provided by a 10K servo track and touch-sense facility is standard. Log, line or VCA versions are available.

ROADRUNNER CASES, INC.; 447 E. Gardena Blvd.; Gardena, CA 90248; (213) 770-4444. **Product Name:** Roadrunner Cases. **Contact:** Howard Chatt, president. **Date Product Introduced:** 1/90. **Product Description & Applications:** Shipping, carrying and storage cases for all types of audio equipment, in many styles and price ranges.

SAUSALITO CRAFTWORKS; PO Box 1792; Sausalito, CA 94966; (415) 332-3392; (800) 332-3393 US; Telex: (800) 223-5588 Calif. **Product Name:** Omnix. **Contact:** David Holland. **Date Product Introduced:** 1/90. **Product Description:**

& Applications: E-Series Omnix are a space-saving high-tech addition to our line of studio furniture. E-Series racks are available in 5 sizes, ranging from 4 to 20 spaces. These racks may be used separately or in a variety of combinations to create custom music workstations. They are made of durable grey melamine with PVC edge banding for extra protection. E-Series Omnix are shipped knock-down with all hardware included for quick assembly. Metal rack rails and threaded screws are standard on these models. **Basic Specifications & Suggested List Price:** E-20 20-space including wheels \$189.95, E-146 slant front 14-space with 6-space in rear with wheels included \$199.95, E-10 10-space \$149.95, E-6 6-space \$109.95, E-4 4-space \$99.95.

SHARP ELECTRONICS CORPORATION (PROFESSIONAL PRODUCTS DIVISION); Sharp Plaza; Mahwah, NJ 07430; (201) 529-8731. **Product Name:** XG-1000 Professional LCD Color Video Projector. **Contact:** Bruce Pollack, marketing manager. **Date Product Introduced:** 6/90. **Product Description & Applications:** Professional LCD color video projector for use in studios, nightclubs/lounges, and other commercial applications. Utilizes three high-resolution solid-state LCD components (in place of CRT tubes) for ultra-reliability and convergence-free operation. Built-in zoom lens easily adjusts picture size from 20" up to 100"; extremely compact, portable and lightweight (approx. 30 lbs). Convenient reverse scan switch (for rear projection applications), compatible with standard VHS and S-video sources, as well as many personal computers.

SWITCHCRAFT, INC.; 5555 N. Elston Ave.; Chicago, IL 60630; (312) 792-2700. **Contact:** Herb Klapp, mgr. mktg. comm. **Date Product Introduced:** 1990. **Product Description & Applications:** Jacks, plugs, connectors, adapters, cable assemblies, audio patch panels, jackfields, jack panels.

360 SYSTEMS; 18730 Oxnard St.; Tarzana, CA 91356; (818) 342-3127. **Product Name:** Model AM-16/R Remote Control Station. **Contact:** Don Bird, dir. mktg. **Date Product Introduced:** 9/90. **Product Description & Applications:** The AM-16/R Remote Control Station provides remote control for up to four different AM-16/B Audio Crosspoint Switchers. The AM-16/R allows individual crosspoint assignment or salvo switching, and operates in a multidrop configuration via EIA-485 interface. Several remotes and switches may be used on the same control bus and when a remote is turned off or disconnected it will not affect other remotes still on-line. Also available as a circuit card only, for custom installation. **Basic Specifications & Suggested List Price:** Standard 1-U rackmount. Individual back-tilt source/destination buttons 1-16, Level Select 1-4, program select 0-99. User selectable source/destination lock-out capability. Operates with any AM-16/B Audio Crosspoint Switcher in stereo or mono. Suggested List AM-16/R \$695, circuit card only \$450.

VCA ASSOCIATES; 7131 Owensmouth St., Suite B-87; Canoga Park, CA 91303; (818) 704-9202. **Product Name:** Aphex VCA 1001. **Contact:** Gabrielle Stein, mgr. **Date Product Introduced:** 1/90. **Product Description & Applications:** The Aphex VCA 1001 "Class A" Voltage Controlled Attenuator IC is now being distributed worldwide by VCA Associates. Call for applications assistance and information. **Basic Specifications & Suggested List Price:** \$4.81 (1,000 pc.) Features "Class A" operation, >112dB dynamic range. Frequency response: DC to 400 kHz. Control feed-through: <0.5 mV trimmed.

VCA ASSOCIATES; 7131 Owensmouth St., Suite B-87; Canoga Park, CA 91303; (818) 704-9202. **Product Name:** MTA 1537 SO. **Contact:** Gabrielle Stein, mgr. **Date Product Introduced:** 1/90. **Product Description & Applications:** The MTA 1537 Voltage Controlled Attenuator IC is now available for surface-mount applications in an SO-14 package. The MTA 1537 was the first "Class A" VCA suitable for professional audio and remains the best performing product today. Call for applications, assistance and information. **Basic Specifications & Suggested List Price:** \$3.93 to \$4.81 (1,000 pc.) depending on grade. Features "Class A" operation, >120dB dynamic range. Excellent long-term stability. Frequency response: DC to 10 MHz. Control feed-through <2 mV trimmed.

WIREWOKS CORPORATION; 380 Hillside Ave.; Hillside, NJ 07205; (201) 686-7400. **Product Name:** Microphone Multicable Component. **Contact:** Angela Kelly, customer service mgr. **Date Product Introduced:** 7/90. **Product Description & Applications:** Wireworks introduces new 12-channel microphone multicable components. This versatile new 12-channel size is perfect for a great many mid-sized audio cabling applications. Added bonus: New 12-channel components are compatible with Wireworks' existing industry-standard 9-, 11-, and 15-channel cabling systems. 12-channel components include multiboxes, multiracks, transformer-isolated splitters in box or rack configurations, main and extension cables, multitails, and ready-to-install chassis mount multipin connector assemblies. **Basic Specifications & Suggested List Price:** Through September 30, 1990, all 12-channel microphone multicable components will be priced exactly the same as 11-channel components. Component prices will range between \$100 and \$5,000.

FEEDBACK

Fan Mail

We just survived the big quake here in the Philippines, a 7.7 on the Richter, but no damage in Manila—the studios are busy, busy, busy!

Thank you for featuring the Philippines in your July issue on Pacific Rim facilities. It was probably the first in-depth attempt at featuring our facilities in such an important publication.

Hope to see you here soon, and hope to see all you folks begin some work in the Philippines.

Raymund Miranda
WORKS AVE.
Manila, Philippines

Setting the Records Straight

As the re-issue producer of the CTI titles for CBS, I read with great interest the comments made by producer Creed Taylor in the May issue of *Mix*; but I would like to amend and qualify a statement he made regarding these recordings.

In talking about the re-issue of older titles on compact disc, Creed bemoaned the “expedient, economical way to just send [a 2-track analog mix] through the system and wind up with a nice-looking little CD.” As an example of this process, he cited two recordings, Freddie Hubbard’s *Blues and the Abstract Truth*, which was recorded on Impulse, and Jim Hall’s *Concierto*, on which I worked and about which he said, “CBS took the original 2-track analog and transferred it, and the 24-track was available.”

Nothing could be further from the truth: *Concierto* was mixed from the original 16-track, dbx-encoded analog tapes through a PCM down to 2-track digital, as have most of the titles in the series.

The only time a digital transfer was obtained from a 2-track analog mix was in the very first series of titles, released in 1987, for which we didn’t have access at the time to the

multitracks, as well as a couple of other titles for which the 2-track was the only source available. In the case of the former, however, I should add that some important tracks (i.e., Deodato’s “Also Sprach Zarathustra,” Esther Phillips’ “What a Difference a Day Makes,” George Benson’s “White Rabbit,” etc.) have subsequently been re-issued in a new digital mix, using the multitrack tapes.

As far as *Concierto* is concerned, as has been the case for most titles in the CTI series, we added unreleased tracks and alternate versions, something which we would not have been able to do had we worked, as Creed contends, from the 2-track analog mix of these albums. Didier Deutsch
New York City, NY

Aw, Shucks...It Was Nothin'

I’ve just completed reading the August 1990 issue of *Mix*, and felt I should let you know how much I enjoyed the thrust of this month’s articles. Eclectic Technologies is involved in the construction and maintenance of broadcast and recording facilities in the Chicago area, primarily, and the articles on studio design, acoustical materials for the studio, treating acoustics and patch bays were of great interest...probably for me the best issue yet.

Gary Schroeder
Eclectic Technologies
Wheeling, IL

Credibility Gap

Mix must think their readers are pretty dumb. No technical information is ever offered—just hype, bullshit and “star worshipping”; is this *People* magazine or what? I would love to know how that new SSL preamp performs (especially against the Focusrite), but the review offers no clues. It comes off sounding like it was written by the SSL ad department instead of by an unbiased reviewer. For the money they want, I expect and deserve more before I throw away five grand. Do you think

we readers can’t read a frequency response curve or an Audio Precision distortion vs. frequency graph? Maybe you don’t have the guts to say anything truthful for fear of upsetting one of your precious advertisers, but I would hope the readership would come first.

Get your reviewers to lab test this stuff so we dumb consumers can attempt to make a knowledgeable decision as to whether it fits our needs. Unfortunately, we can’t get these companies to “loan out” gear for evaluation like you can so we must rely more on data than what it sounds like in some unfamiliar “demo” room.

Jim Williams
Audio Upgrades
Mission Hills, CA

More on the Classics

I read the article on vintage equipment in the May issue of *Mix* and have a few comments. Our company, dealing in vintage equipment, has had to clarify several of the inaccuracies in the article for our clients, so I thought I’d pass them along to your readers.

First, there are other reasons besides even harmonic distortion that makes this equipment special. Perhaps the most important is headroom. Neve and API equalizers have the best bottom of any equalizers ever built mostly because of headroom. They don’t have chips that can’t handle over 15 volts, so they can run on 24 volts, which is a major contributor to that warm, rich sound we’ve learned to love. Another reason these EQs sound so good is that the more you turn the boost/cut knob, the tighter the bandwidth gets, not permitting the operator to equalize a sound to death.

One of the major reasons the older compressors, such as Teletronix LA-2As and LA-3As, sound



Are you missing out on the natural highs?

You know those sweet high notes in your favorite music? Well, they're the first to go when you trash your ears by cranking up the volume. Once it's gone, it's gone for good!

So keep the volume in check.

For more information on how to protect your hearing, contact:

HOUSE **EAR** INSTITUTE

HIP Campaign Headquarters
2100 West Third Street
Los Angeles, CA 90057
213/483-4431

Circle #069 on Reader Service Card

If You Supply A Product or Service...

MIX CLASSIFIEDS

are the best way to reach thousands of professionals in the audio-video industry! Find out why Mix Classifieds are the most cost-effective way to advertise—see the Classified section in the back of this issue for categories and complete details.

**FOR MORE INFORMATION,
OR TO PLACE A MIX CLASSIFIED AD,
CALL (415) 653-3307. DEADLINE: 15TH OF MONTH,
SIX WEEKS PRIOR TO PUBLICATION.**

great is that they employed an optical attenuator to compress the signal, not a VCA. For the uninformed, an optical attenuator is basically a light bulb and a photoelectric cell. The audio lights the bulb brighter as the level increases, and the photoelectric cell turns down the volume with the more light it sees (that's the short version). VCAs are almost acceptable when they are not in motion (like 99.9% of the time in an automation system), but the audio gets rather thin and crunchy when they are in motion, like they are in a compressor. This is why those who appreciate superior audio won't use (and we don't sell) those nasty little boxes that they sell for a couple of hundred bucks, but will pay large dollars for real compressors.

Further clarifications: A Neve 1079 is a 3-band mic pre and equalizer, not a stereo compressor limiter. Pulse Techniques (Pultec) made EQPs, EQHs, MEQs, HLFs and lots of other stuff, too, but never a PEQ. Lang made the PEQ. The PEQ-1 being a tube EQ, the PEQ-2 solid-state.

A quick note to Jon Russell at Presence Studios: The Lydcraft Tube-Tech EQ is a really nice-sounding piece, but it is not a direct replacement for a Pultec. He is correct, however, that he will not pay \$2,000 for Pultec EQP-1. I *wish* I could pay \$2,000 for an EQP. The fact of the matter is that we are subject to the laws of supply and demand.

We've had the privilege of providing many of the pieces of equipment mentioned in the article and will continue to provide quality vintage equipment to those who appreciate it. However, just because something is old, has tubes and big, ugly knobs, is rare or expensive, it doesn't necessarily create great audio; engineers do. All the vintage equipment in the world is not a replacement for refined engineering skills. The equipment is just a tool, a means to an end. Use it wisely.

Fletcher
Mercenary Audio
Sharon, MA

CLASSIFIEDS

Business Opportunities

LET THE GOVERNMENT FINANCE your new or existing small business. Grants/loans to \$500,000. Free recorded message: (707) 448-0270. (NL3).

Studio/rental space available in BMG/RCA Building in Hollywood, Calif. POST PRODUCTION/AUDIO MIX SUITE, includes offices and 2 studios. 2,750 sq. ft. w/great views. Price negotiable. Call Walter, (213) 464-1100.

Employment Offered

AUDIO ENGINEER

Major NYC video-production facility with 3 stages seeks experienced Audio Engineer for live shoots. Minimum 3 years of related experience a must. Send resume in confidence to: Caller Box #739, New York, NY 10018.

Major pro audio firm seeking experienced sales person w/background in consoles, multitracks, etc. Must be stable, highly motivated, and a team player. Resume & salary history to: Westlake Audio, 7265 Santa Monica Blvd., L.A., CA 90046, Attn: Sales Manager.

Production Manager wanted for East Coast-based sound and lighting company. We're looking for a highly motivated individual, with excellent organizational skills and an aptitude for working with people. Duties include managing complete inventory, road personnel, advance work, etc. If you're someone who is committed to seeing the job all the way through and knows the importance of excellence, then please send your resume to: Carl Taylor, c/o Crystal Taylor Systems Inc., 1231B Ford Rd., Bensalem, PA 19020.

AUDIO ENGINEER

Leading SF manufacturer of broadcast and professional audio systems seeks a product development engineer. Minimum three years experience in the electronic audio field with specific expertise in signal processing, analog, digital and filter design in a manufacturing environment is required. BSEE preferred. Please send resume to: X. Smith, Dept. EE, AKG Acoustics Inc., 645 Bryant St., S.F., CA 94107.

LOUDSPEAKER PRODUCT MANAGER

JBL Professional has an immediate opportunity in the area of product management for loudspeaker products.

The successful candidate will have a BSEE and 3-5 years experience in the specification and design of professional loudspeaker products for both studio and sound reinforcement applications. Particular emphasis will be placed on project management skills, as well as familiarity with the various vertical markets served, such as sound contracting, home and studio recording, musical instruments, broadcast, tour sound, etc.

JBL Professional offers a competitive salary, comprehensive benefits package, and the challenge of working for an industry leader. If you would like to join our team, please submit your resume including salary history to:



Mark Gander
Vice President, Marketing
JBL Professional
8500 Balboa Blvd., P.O. Box 2200
Northridge, CA 91329

AUDIO SWEETENING

Major NYC video facility seeks audio engineer with experience in multitrack sweetening. Send resume to: PO Box 2258, Dept. Audio, Times Square Station, NY, NY 10108-2050.

Equipment For Sale

(2) SONY PCM-1610 Digital Processor; SONY DAE-1100A Digital Editor with Anvil cases; 1610/DAE-1100A Package with Anvil Cases. (713) 664-5258 Studio.



Ask for the "DATAFILE" equipment reviews, buying guide, new & used deals. Chicago's source for PRO-DISK Hard Disk Recorder; Otari; Summit; Tannoy; Neumann; API; SOUNDCRAFT; Sony & Panasonic DAT; J.L. Cooper; Adams-Smith; TimeLine; Meyer; Akai; Lexicon. (708) 339-8014.

For Sale: Otari MTR-122-trk Deck; B&K 1560 Scope; V.P. 415 De-esser; J.L. Cooper MSB MIDI Switcher; Sony TC-D5M Cass Deck; MiniMoog Model D; ARP 2600; Lexicon PCM60; Roland Octapad; Optical Media CD ROM for EIL. Call George, (916) 392-5640.

Sounds Incredible, Inc.

PO Box 796054, Dallas, TX 75379-6054. Sound & recording gear delivered to your doorstep. From cables to mics and power amps to tape decks: all major brands. Write for FREE catalog or call (214) 238-9393.

NEW, USED, DEMO SALE

RECORDERS, CONSOLES, OUTBOARD EQUIPMENT
Trident consoles, Akai A-DAM, TAC Scorpion II, Drawmer, Tascam MSR-24, Digidesign Sound Tools, Sony/Panasonic DATs, Apogee A/D converters/filters, Tascam DA-30 DAT, Studer Dyaxis, CAD consoles, Otari MX-70, Adams-Smith Zeta-3, Roland/Akai samplers. Equipment leasing specialists—experienced staff/unequaled service.

E.A.R. PROFESSIONAL AUDIO
(602) 267-0600

STUDIOWORKS

Sony used and demo sale. Sony 3036 loaded 32/non-auto, \$52k. Full warranty. Sony 3036 loaded 36 w/auto & hard drive, \$75k. Both reduced.

(800) 438-5921 (704) 375-1053

STUDIOWORKS sells over 70 lines: AKG, Fostex, Hafler, JBL/UREI, Lexicon, Soundtracs, Allen & Heath, Sony, Senn., Neumann, Otari, Valley Int'l, many others.

Factory-direct prices for 3M and Ampex.

American Pro Audio



- Sony/MCI • Trident •
- Tannoy • Eventide •
- Yamaha • Tubetech •
- Fostex • Soundtracs •
- Beyer • Roland • Akai •
- Ramsa • Panasonic •

Mini Lease Program

New or used, trade-ins 24-60 months with buyout option \$5K-25K no financials required min. 2 yrs in business.

1-800-333-2172

MERCENARY AUDIO

WE HAVE HUNDREDS OF LISTINGS ON:
SSLs, NEVEs, TRIDENTs, STUDERS, OTARIS, MCIs, COMPRESSORS, EQs, MIC-PREs, MICROPHONES, ETC.
WE BUY, SELL & TRADE VINTAGE EQUIPMENT
CALL FOR FREE LISTS!

in stock:
FAIRCHILD 670
NEUMANN 47, 48, 49, 67, 54
NEUMANN 56, 84, 86, 87
AKG C-12, C-12A
LEXICON 224XL, 60s, 70s
LANG PEO-2
TRIDENT A-RANGE MODULES
ROLAND DIMENSION D
"this is not a problem"
(617) 784-7610 TEL
(617) 784-9244 FAX

Mix Classifieds

Call Robin at (800) 747-3703.

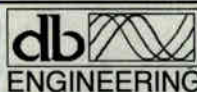

The oldest broker on the East Coast !!

PHONE (617) 782-4838

FAX (617) 782-4935

214 Lincoln St., 103C, Boston, MA 02134

WE NEED YOUR CLEAN USED 24 TRACK !!!

SSL 4040E/G w/32, 1yr \$135K; 4048E/G, TR, 1yr, \$175K; CALL FOR: 6048E/G, 5yr; 4064G, 3yr mint; 6064E/G VU; Neve 8128, 48 in w/Neacm; 4000E Modules, \$3.3K. Amek API, Trident, Call. 24+ Tracks: Studer A800 MkIII, \$38K; MCI JH24, \$20K; Mitsubishi X-850, call; 3M dig 32, \$35K; Otari MTR90, MX-80 many, call. Otari 5050B \$1.5K; Pultec Mavec(pre/eq), \$1.4K; EQP1A, \$1.8K; LYNX sync modules \$1.6K; Neumann U89, \$1.2K; KM84, \$275; AKG C12, call; AKG C12A (tube), \$1.5K; C414s from \$500. dbx noise reduction in stock.

List Your For-Sale Items With Us Free!!

db ENGINEERING now offers new specials!
Tannoy, Aphex, Adams-Smith, Ashly, Eventide, Beyer, Klipsch, Sennheiser, Studiomaster, Neumann, AKG & most major brands. Now offering GML, Jensen, TubeTec, Sontec.

ICB AUDIO

12036 Reading Road
Cincinnati, OH 45202
Call us for over 100 lines of
Professional Audio and Video
(513) 651-0800

Great Package
AMEK/TAC Matchless 36 ch 32 bus
384 pt. patch bay & Otari MX-8032
w/snakes, MX-5050BII w/stand and
remote. All purchased 7/89, sale
\$62.5k. Also TAC Scorpion 32 fr. 8
bus loaded 16 ch, 2 yrs new, \$6.5k.
For info: (904) 968-1962.

AVR

Audio Video Research
The Studio Store
(617) 924-0660

The only call you have to make for:
AMS • Adams-Smith • Agfa • Akai
• Akai Digital (A-DAM) • AKG • Allen
• Heath • Ampex Tape • Aphex
Systems • API • Aries • ART • Ashly
• Atari Computers • Audio Techni-
ca • BBE • Beyer Dynamic • Bi-
amp-Legend • Bose • Brainstorm
Electronics • Bryston • BSS • CAD
• Calrec • Calzone • Canare Cable
• Carver • Casio • Crown • dbx
• DDA • DIC/DAT Tape • Digidesign
• Drawmer • EAW • Electro-Voice
• Eventide • Fostex Digital • Four
Design • Furman • Gauss • Gent-
ner • Gold Line • Harrison (by GLW)
• HOSA • Hybrid Arts • Hybrid
Cases • Imagine Music Software •
Intraclean • JBL/UREI • J.L. Coo-
per • Josephson Engineering •
Klark-Teknik • Klipsch • Lexicon
• Littlite • Mark of the Unicorn
• Middle Atlantic • Milab • Mogami
Cable • Monster Cable • MRL •
Nady • Nakamichi • Nakamichi-
DAT • Neve • Numark • Omni-
mount • Opcode Systems • Orban
• Otari • Panasonic • Panasonic-
DAT • Perreux • Proco • Ramsa
• Sennheiser • Shure • Simon
Systems • Sony • Soundcraft
• Sound Workshop/Otari • Studio-
master • Summit Audio • Symetrix
• Tannoy • TC Electronic • Telex •
360 Systems • 3M • Threshold •
TimeLine • Trident Audio • Twelve
Tone Systems • US Audio • Ulti-
mate Support • Valley Internation-
al • Whirlwind • & many others!

Otari's full-line Analog and
Digital Representatives for
New England and Brazil.

Plus a large selection of warranted
used equipment; studio and control
room design; technical and main-
tenance service.

106 Main Street
Watertown, MA 02172
FAX (617) 924-0497

Exclusivamente para o Brasil.
Oferecendo assistencia tecnica e
instalacao no rio e em Sao Paulo:
Akai, JBL/UREI, SSL, Otari, Shure.
(See this month's specials in
classifieds).

Wanted: Dead or Alive! Pultec, ITI,
Lang, Sontec EQs. Telefunken,
Neumann, AKG or RCA mics. UREI,
dbx, UA, Teletronix, Fairchild limiters
& other gear. Boxes of tubes; API,
Neve consoles & old guitars.

DAN ALEXANDER AUDIO
5935 Market Street
Oakland, CA 94608
(415) 644-2363
Fax: (415) 644-1848

IF YOU'RE NOT USING IT
—SELL IT!

Your national clearinghouse for
used audio and video! Call for free
copy of our latest listings, or to list
your used gear free.
The Bertech Organization.
Call toll-free: (800) 992-2272.
In Calif. call: (818) 909-0262.
THINK BERTECH FIRST!

CUSTOM MIDAS CONSOLE
Ex-Oscar Peterson, 16x8 recording,
8 PRO5, 8 PRO3 w/updated amps,
Remix option, 6 LED option, NTP
peak meter, patch bay, flight case.
\$9,000. Hank, (916) 284-6929.

FOR OVER 10 YEARS
YOUR BEST BUY IS USED
RECORDING EQUIPMENT
SYE MITCHELL SOUND
22301 CASS AVE.

WOODLAND HILLS, CA 91364
(818) 348-4977
FAX: (818) 704-7031

AMEK-TAC MATCHLESS 36x24
console, patch bay floorstand, 72
inputs in remix, 8 aux sends & 8 re-
turns, custom features, extra mod-
ules & spare parts, like new, home
studio use only. Call Vince (514) 254-
4120, after 6pm.

MODULAR TECHNOLOGIES

HIGH PERFORMANCE SPEAKERS

FULLY LOADED
3 WAY 15" P.A. OR MONITOR

LIST \$479

FOR DEALERS OR INFORMATION CALL:
(215) 736-0811

SYNCLAVER II

76-key velocity-sensitive keyboard,
mono sampling, 10-megabyte hard
disk 2, floppy drives, VT100 terminal
SMPTE, MIDI, Digital guitar control
unit, Roland GR guitar controller,
flight cases for everything. Release
"M" software.

\$45,000. Sean (201) 768-6881.

TUBE MICS

The best tube mics
bought/sold. New power
supplies for old mics.

Bill Bradley
(312) 751-1216
FAX (312) 751-1217

NEOTEK Series II in-line console. 28
input, 24 output, 4 stereo return. 4-
band parametric Neotek EQ. Absolu-
tely NEW condition. Was never in-
stalled! \$21k. (213) 833-0130.

Akai S1000 with 8 meg, SCSI and 2
CD ROMs with library of over 250
meg. Have barely used. Like brand-
new condition. \$4,500. (314) 544-
0220, Mike.

WHY GO ANYWHERE ELSE FOR ANYTHING AUDIO...

...when we carry a full range of professional audio and
video equipment to match every application and budget.
With a focus on personal service, and competitive pricing
we can help you get the job done easily & cost-effectively.
Put our team to work for you and start saving time and
money today!

Take a look at some of our high quality lines...

ALPHA AUDIO • AKG • AMP'EX TAPE • API/IEX • ART •
AUDIO-KINETICS • BSS • BRUEL & KJAER • DDA • DIC DAT •
EAW • EVENTIDE • GEPCO • HAFLER • HILL AUDIO • JUICE
GOOSE • KLARK-TEKNIK • MACKIE DESIGNS • MILAB •
MOGAMI • MRL • NEOTEK • RANE • SENNI IEISER •
SOUNDMASTER • SOUNDTRACS • SONY • SYMETRIX •
TANNOY • T.C. ELECTRONICS • VALLEY • WHIITE •

TAKE ADVANTAGE OF OUR AES - FALL SPECIALS

T.C. ELECTRONICS 2290 \$1995 • MACKIE DESIGNS 16x2 RACK MIXER \$899 • ART MULTIVERB III \$399 •
EVENTIDE H3000S \$2195 • ARX 6-CHANNEL GATE (TU) \$449 • KLARK-TEKNIK DN-504 QUAD
COMPLIMETER \$1099 • APHEX COMPPELLOR \$999 • VALLEY GATEX \$499 • RANE MP14 S 645

NEW CONSOLE SPECIALS

SOUNDTRACS MRX 32x8x16 \$ 7995 • SOUNDTRACS PC MIDI 16 \$5695 • SOUNDTRACS QUARTZ PRIZM
3200 32x24 w/PB & Stand \$ 34,950 • NEOTEK ELAN 32x24x32 w/PB \$33,975 • NEOTEK ELITE 348 48x24x48
\$ 69,995 • DDA Q-SERIES 24x8 \$11,995 • HILL 2400 \$6995

USED SPECIALS - NEVE VIII-60 w/8b/o \$ 225k • NEOTEK 44x24 w/PB \$48k • TRIDENT 80B 32x24 (NEVER USED) \$49k •
(2) IAC SCORPIAN 32x8x16 w/bays \$ 12.5k • NEOTEK SERIES 1 16x8x16 \$4k • TASCAM 16500 32x16x32 w/bays
\$10.5k • (3) TASCAM MS-16 PKGS START @ \$5K • FOSTEX B10D \$4k • TASCAM 38 w/dbx, 8stand \$ 1.8k • (3) OTARI
MX-80 24-TRK \$22k & (Unused) \$26k • AKG-68k Reverb \$ 3.8k (new) • SONY APR-5003 (200 HRS) \$ 1.8k • (3) AMP'EX
ATR-102 55-7K • TASCAM MSR-24 (LOW HRS) -CALL • STUDER A80 mkIII 24TRK \$25k • AMS AUDIOFILE (LOADED)
\$55k • DOLBY A-24 CHNL \$ 7.5k • (2) U47 FE1 \$700ea • AKG TUBE S1 7k (new) • CALL FOR COMPLETE LISTINGS !!!

THE DIGITAL AUDIO SOURCE

anything audio

professional audio and video systems
Equipment Sales System Design Installation
LIST YOUR FOR SALE EQUIPMENT WITH US FREE!!!

CALL 617-426-2875

FAX 617-426-2763

63 MELCHER STREET
BOSTON, MA 02210

Don't miss the deadline. FAX your classified ad today! (415) 653-5142.

CONSOLE FOR SALE
NEOTEK SERIES 2
28x24 Fully Loaded
w/320 Patch Points
Excellent Condition
Minimal Hours \$12,000
Call (313) 349-0115

Demos for sale: Soundcraft 200B 24
ch., \$4,500; UREI 813, pair, \$2,220;
Trident 16 Series 24 ch., \$12,900;
Otari MTR-12C, new in box, \$7,995;
used Soundcraft 200 8x4, \$995;
Tascam M600 demo, call for price;
Tascam MS16 demo, \$5,700; Hafler
P-505, \$499. (800) 780-4654, ext. 6.

DIGITAL EQUIPMENT

Synclavier: 12 MB Ram, 76-key
velocity keyboard, 64 voice, 16 o/p,
SMPTE, MIDI, Model "D" processor,
D40Q upgrade package, 2.1 soft-
ware: \$55k o.b.o. **AMS AudioFile:**
2-hour digital editor; \$44k. Call Dav-
id at (213) 876-0336.

FOR OVER 10 YEARS
YOUR BEST BUY IS USED
RECORDING EQUIPMENT
SYE MITCHELL SOUND
22301 CASS AVE.
WOODLAND HILLS, CA 91364
(818) 348-4977
FAX: (818) 704-7031

For Sale:
Mitsubishi X-80 digital 2-track,
excellent condition, flight cases
included. \$7,500.
(313) 561-7489

MITSUBISHI/QUAD EIGHT CON-
SOLE: 2 years old, 44 mainframe w/
producer's desk, 60 segment LED
metering (VU, peak, spectrum ana-
lyzer), central electronic bus assign w/
16 aux sends, 32 buses, 2 stereo mix
buses, 4-band fully parametric EQ
(each band w/Q control), variable
high/lowpass filters, each module has
two line inputs for 88 lines to stereo,
fader flip, stereo solo, PFL and much
more. Also fitted is DiskMix 3 moving
fader automation for all modules, 2
stereo and 2 mono echo return
modules, stereo mix bus and 8
dedicated group masters. For further
information, please call Les Bateman
at Sound Interchange Ltd., (416) 364-
8512.



Reliable
Summer Specials

Demo Soundcraft 6000
28 x 24 w/patch 23.5k
Fostex E-22 2.7k
Tascam 520 5k
Used Otari MX-5050 Mk
III 2trk 2.8k
Used Otari MX-5050 BII
2k Used 85-16B 4k
Soundcraft, JBL, Otari,
Dawmer, Tannoy, Tascam,
Fostex, Adams-Smith.
plus . . .

704/375-8662

NEOTEK SERIES I 16x8, \$3,000. STUDER MRI, 8-track, \$4,900 with cases. MINT! Call Paul (617) 484-8831 or (617) 484-6938.

Otari MTR-12H 1/2" 1/2-track 30 ips demo. Sony 3202 digital mastering deck. Sony 5002 1/4" 30 ips 1/2-trk, 2 years. Rob (804) 499-0000.

REVOX C-270 2-track mastering recorder w/mic cards in rolling console, \$3,000; DOLBY 363-SR 2 channel, \$2,300; AUDIO DEVELOPMENTS AD 145 6x2 recording console w/case, \$2,500; 2—JBL 4320 bi-amped studio monitor speakers w/Gauss woofers, \$500 ea.; BRYSTON 10B electronic crossover, \$700; 2—STUDER A-68 power amps, \$650 ea.; LEXICON LXP-1 w/MRC controller, \$600. Call Steve Lewis, (312) 348-1112, FAX (312) 348-1182.

SSL 4040 EG, 32 FITTED G. SERIES EQ. PRIMARY COMPUTER; 1 YEAR OLD. \$125,000/OFFER.

PAUL (416) 291-9553.

Synclavier II

32-voice FM, Velocity KB-Release L, music printing, model C processor, 60K CPU, MONO sampling, 2x8 MIDI, 10MB hard drive Winchester, high-density & double-density disk drives, VT 640 Terminal, cases, ready for upgrade. \$30k. (818) 508-0311.

TAC Scorpion console 28/12/24/2 w/4 patch bays wired w/Mogami cable in custom desk w/12 single rackspaces equally spaced above meter bridge. Otari MX-80 and Otari MTR-10. Less than 50 hrs. Call Bob (805) 251-2599.

TEF ANALYZERS & used equip. for sale/rent. Otari 5050 Mk3 2-tnk, Teletnix LA2A, MCI 428, JH24, Tascam M50, Harrison M4, Neotek. Mics & more. Let us know your needs.

EXPERIENCED AUDIO

219/52-AUDIO, Fax 219/533-8800.

TRIDENT 80B, 5 yrs. old, Excellent Condition; \$25k.

NEVE 5104 Portable 24x4x2 input, 6 Compressors NTP Bargraph Metering and Scope, Phase Meter & Remote Patch Bay. All in 5 road cases. \$25k. (301) 628-7260.

AVR IS MOVING! Watch For OUR EXPANDED SHOWROOM!

OTARI MTR-90, \$25k; dbx 160X, \$600; UREI 809, 811, 813, CALL. ASHLY SC-50, \$150; Tascam MS-16 (high-speed), \$5,500; Sennheiser MD-421, \$200; MCI JH-110, \$3k; Crown D-75, \$210; AKG C-451/CK1, \$265; Dolby 361-A, \$695; E-V RE-20, \$250; Neumann U87, \$1,300; Neumann U89, \$1,275; Ampex ATR-102 (Still a few left), \$5.5k to \$7.5k; Otari MX-70 (w/CB-117), \$14k; Lang PEQ-2, \$750; AKG C-460, \$400; McIntosh MC40 tube amp (pair), \$600; Fostex E-22 (w/ center-track TC), \$2,500; dbx 150x (many), \$150; Pultec EQ-H2, \$1.5k; Allen & Heath Saber 32x16, call; Otari MX-5050 BII, \$1,800; AKG C-426 (mint), \$2.3k; AKG ADR, Call. NEVE PRISM MODULES, CALL.

Audio Video Research
106 Main Street
Watertown, MA 02172
(617) 924-0660
FAX (617) 924-0497

For Sale: Otari MX-70 1", 16-track. Excellent condition. Serviced only by Otari rep. Alignment tape included. \$12,900. Call (212) 548-3665. Free delivery in N.Y. City.

NEW Megamix MIDI automation w/ 24 VCAs in 40 mainframe, controller, software, \$3,400. ITT 401 5 phone system, \$700. Ursa Major 8 x 32 reverb, \$650. MasterRoom XL-515, \$400. ADA multitap delay, \$300. MSP126, \$500. Call (214) 630-8889.

The deadline to place your ad in *Mix Classifieds* is six weeks prior to the cover date. To place your ad in the next issue of *Mix*, call (800) 747-3703.

VELCRO CABLE WRAPS



6 Sizes, 10 Colors
Custom logo printing available

Seam Tech

(415) 861-6011

P.O. Box 77394
San Francisco, CA 94107

All rights reserved. Patent #4700432

Free Applications Engineering

We'll make sure you get the right transformer, and show you how to improve the circuit, too. Ship same day from stock.

jensen transformers

INCORPORATED

10735 Burbank Bl. • N. Hollywood, CA 91601
FAX (818) 763-4574 Phone (213) 876-0059
TELEX 6502919207 MCI UW

(M-Th, 9am-5pm Pacific time)

TAPE MACHINES—15/7.5 ips unless noted. AMPEX—ATR-102 1/4" 2-chan, 4-speed, metal heads, 2-speed pad, pedestal, \$4,000. AG-440C servo, 1/4" 2-chan+mono+neopilot, sync-lock resolver, 2-head assys, console cabt, \$1,500. MM1000 1" 8-chan, \$1,600. AG-440B 1/4" mono, console cabt, \$650. ATR-700 1/4" 2-chan, \$700. 350 trans/440B elec 1/4" 2-chan, console cabt, \$700. AG-355 1/4" 2-chan play only, console cabt, \$350. 351 1/4" mono, \$350. 350 1/4" mono, \$300. 350 trans/Lang LRP-1C elect 1/4" mono, \$300. 350 trans/Lang LRP-1C elect 1/4" mono play only, \$200. 2" 16 chan head assy for ATR-124, \$2,000. 2" 16 chan head assy for MM1100, \$1,200, 30/15 ips capstan servo motor for MM1200, new, \$800. SCULLY—280B 1/2" 4 chan, console cabt, \$1,200. 280B 1/4" 2-chan, console cabt, \$800. 284 1" 8-chan, remote, console cabt, \$1,600. 280 1/4" 2-chan, console cabt, \$750. NAGRA—15/7.5/3.75 ips, no xtals —IV-L, \$3,000. IV-DE, \$1,000. III, \$1,500. SLO, \$1,800. ATN-2, \$250. QCL OR QCLS, \$200. QSV, \$100. SVS, \$100. Call for complete listing. Dominick Costanzo, (212) 765-4757.

Portable Sound Panels



- Isolate specific areas
- Many sizes and options
- Panels start at \$19.95/ea. Complete w/foam

Write for free catalog

Island Cases

1121-I Lincoln Ave., Holbrook, N.Y. 11741
800-343-1433 • In N.Y. 516-563-0633

MILAM AUDIO

"THE SOURCE"

SINCE 1967

SPECIALIZING IN
ALL TYPES OF RECORDING
EQUIPMENT, SUPPLIES,
DESIGN, INSTALLATION,
AND CONSULTATION

CONSOLES ■ D.A.T. ■ MICS
MULTI-TRACKS
MONITORS ■ AMPS

CALL US TODAY

MILAM AUDIO

1470 Valle Vista Blvd.

Pekin, IL 61554

(309) 346-3161

ORDER HOT LINE:

800-334-8187

FAX 309-346-6431

Equipment Rentals

When you are serious about your sounds

DRUM DOCTOR'S

Recording Quality Drums Rentals

Offering L.A.'s Finest Collection
of Acoustic, Electronic & Vintage Drums

- **Sets** — modified and tweaked for recording by the Drum Doctor Ross Garfield
- **Serious Snares** — over 60 to choose from, including Black Beautys, Radio Kings, Piccos, Pioneers, Noble and Cooleys
- **Tuning** — we'll make the drums on your session sing in no time
- **Samplers** and triggering devices
- **Carriage** — licensed and insured
 - WILL SHIP ANYWHERE
 - 7 DAYS • 24 HOURS

(818) 765-7989

N. Hollywood, California

• Thank you Don Henley for mentioning us on your new album, End of the Innocence

UNDERGROUND SOUND

PRO AUDIO RENTALS

MITSUBISHI X-850 (Apogee Enhanced)

\$500 per day / \$2,000 per week

REVERB RACK

2-AMS RMX16
1-AMS DMX-15
2-480-L Lexicon
1-Lex PCM70
1-T.C. Elect.
2-Yamaha SPX-9011

\$225/day

ALSO VINTAGE TUBE GEAR

\$195/day

- NEW RACK CONFIGURATION
- Call For New Rate Card
- SONY 3348 DIGITAL MACHINES

Prices do not include sales tax or cartage. All prices subject to change

(615) 347-0243 • (615) 327-2900

EQ RACK

Focusrite 115
Massenburg EQ
(2)-Pultec EQP-1A3
(2)-LA-2A
(4)-Aphex E.Q.
(6)-Aphex Comp
L.T. Sound
(2)-DBX 160 lim.
DBX Boom Box

\$225/day

ALSO VINTAGE TUBE GEAR

\$195/day

- NEW RACK CONFIGURATION
- Call For New Rate Card
- SONY 3348 DIGITAL MACHINES

Prices do not include sales tax or cartage. All prices subject to change

(615) 347-0243 • (615) 327-2900

Mix Classifieds are the easiest and fastest means of reaching a buyer for your product. One phone call is all it takes: (800) 747-3703.

TEKCOM CORP.

COMPLETE TAPE
RECORDER REPAIR,
OVERHAULING,
ALIGNMENT &
RESTORATION
FOR OTARI, AMPEX,
TEAC, SCULLY, REVOX,
FOSTEX, & NAKAMICHI
MR-1 & MR-2
OVER 10 YEARS
EXPERIENCE
LARGE PARTS
DEPARTMENT
SPECIALIST IN OTARI
CAPSTAN MOTOR
REBUILDING &
RESURFACING

(215) 426-6700

1020 N. Delaware Ave.
Philadelphia PA

FINE USED EQUIPMENT

Bought & Sold



Summit
Audio
Inc.
P.O. Box 1678
Los Gatos
CA 95031
408-395-2448

FAX: (408) 395-1403

AES SPECIALS*

X-850 with Apogee \$495/Day
 X-86 with Apogee \$140/Day
 PCM - 1630 } pkg. \$395/Day
 DMR - 4000 }
 D-2 Composite Digital \$595/Day

DIGITAL
dispatch

213-664-FAST

800-446-FAST
 OUTSIDE CALIF.

A Production Rental Service
 365 DAYS A YEAR - ANY TIME, ANYWHERE
 FREE LOCAL DELIVERY

* Discount Limited to Equipment in Stock



**ADVANCED
 AUDIO**

Pro Audio Rentals

- Digital Recorders
- Analog Recorders
- Dolby Noise Reduction
- Outboard Processing Gear
- Competitive Rates
- Well-Maintained Equipment
- Exceptional Service & Support

(818) 985-6882

11120 Weddington St., N Hollywood, CA. 91601

Mix classifieds work!

DESIGN FX AUDIO

DIGITAL AUDIO RENTALS
 Specializing in digital tape
 machines, reverbs and effects
 processors. Technical
 consultation included.

213/838-6555

800/441-4415

P.O. Box 491087
 Los Angeles, CA 90049

The Nation's #1 Co. for Live Console Rentals:

ATI Paragon *** NEW!

Gamble EX56, HC40, SC32
 Ramsa WR-S840, WR-S852
 Yamaha PM3000, PM1800
 Yamaha PM2800, 2408M
 TAC Scorpion I & II, Toa RX-7
 Soundcraft 800, + other models!

* EFXs/R-DATs/SDL-5 subs

* MacPherson LPM monitor rigs

HI-TECH AUDIO SYSTEMS

Long & short-term (415) 726-2428

Mix Classifieds are the easiest
 and fastest means of reaching
 a buyer for your product.

One phone call is all it takes:

(800) 747-3703.

Equipment Wanted

**MERCENARY AUDIO
 IS BUYING!**

YOUR VINTAGE EQUIPMENT
 CASH OR TRADE
**MICS, CONSOLES
 COMPRESSORS
 MULTITRACKS, EQUALIZERS
 —ANYTHING—**

Of Exceptional Audio Quality

"this is not a problem"

(617) 784-7610 TEL

(617) 784-9244 FAX

CHRISTIAN STUDIO

needs recording console. At least
 36 inputs, at least 6 sends. Have
 32x8 console and 1-inch, 16-track
 to trade. Call (214) 239-4075 or
 write to: 7811 La Cosa,
 Dallas, TX 75248.

Recording studio wanted.

Looking to buy large package of stu-
 dio equipment for one or more stu-
 dios. All-cash offer. Also looking for
 individual pieces: consoles, multi-
 tracks, outboards, any tube equip-
 ment, etc. Ask for Dave (818) 346-
 9007.

Instruction

EDUCATIONAL VIDEOS

12-hour sound mixing/recording
 course: \$239, 2-hour course: \$39; 2-
 hour MIDI course: \$39; plus shipping/
 handling. Visa/MC/check. For bro-
 chure: RECORDING ASSOCIATES,
 5821 SE POWELL, PORTLAND, OR
 97206. (503) 777-4621.

The NEW 1990 Mix Bookshelf Cat-
 alog is now available! We've added
 over 150 new products to the world's
 most complete collection of books,
 tape courses, videos, sounds and
 software for audio professionals.
 Write or call now for your FREE copy.

MIX BOOKSHELF

**6400 HOLLIS STREET #12
 EMERYVILLE, CA 94608**

**Call Toll-Free: (800) 233-9604
 or (415) 653-3307**

Maintenance Services

MAGNETIC RECORDING HEADS

—RELAP/REPLACEMENT for Au-
 dio, Video, Time Code, Duplication.
 30 years of head design experience.
**IEM, 350 N. Eric Dr., Palatine, IL
 60067; tel. (708) 358-4622.**

AES 1990

Equipment Rental

Hollywood, CA

Rack Attack™

∞ Audio Processing Systems ∞

Rack System 'A' \$265 per day

- | | |
|-----------------------------|----------------|
| 1) AMS | DMX 1580S |
| 1) AMS | RMX-16 |
| 1) Eventide | SP-2016 |
| 1) Eventide | H-3000SE |
| 1) Lexicon | 480L with Larc |
| 1) Lexicon | PCM-70 |
| 1) TC Electronics | 2290 |
| 1) Yamaha | SPX-1000 |

Rack System 'B' \$225 per day

- | | |
|-----------------------------|-----------------|
| 1) Lexicon | 480-L with LARC |
| 1) Lexicon | PCM-70 |
| 1) Lexicon | PCM-42 |
| 1) Eventide | H-3000SE |
| 1) Publison | Inferral 90 |
| 1) TC Electronics | 2290 |
| 1) TC Electronics | 1210 |
| 1) Yamaha | SPX-1000 |

Short Guy System . . . \$165 per day

- | | |
|-----------------------------|----------------|
| 1) Lexicon | 480L with Larc |
| 1) Lexicon | PCM-70 |
| 1) Lexicon | PCM-42 |
| 1) Eventide | H-3000 |
| 1) TC Electronics | 2290 |
| 1) Yamaha | SPX-1000 |
| 1) Yamaha | Yamaha REV-5 |

Individual Rentals per day

- | | | |
|--------------------|--------|---------|
| AMS | 1580S | \$75.00 |
| AMS | RMX-16 | 75.00 |
| Lexicon | 480-L | 85.00 |
| Publison | Inf 90 | 85.00 |
| Quantec | .QRS | 65.00 |
| Quantec | XL | 65.00 |
| Yamaha | REV-1 | 65.00 |

• *Introducing our latest configurations & prices* •

**Outboard
 Rentals**

**(818)
 998-1024**

**We Rent Keyboard
 Racks of Doom!**

DAT MODIFICATIONS

For Sony TCD10 PRO. MOD #1: SPDIF digital In at 44.1 k. MOD #2: Fix problem with non-monotonic and non-linear digital output, presently preventing perfect clones. Cost: \$200 (either mod), \$300 (both mods) incl. retn. ins. FED EX. Other DAT mods avail. By **DIGITAL DOMAIN**, Bob Katz, prop. East (212) 369-2932. West (408) 238-6062.

RCA Microphones — Repair service on all models. Complete sound and cosmetic restoration. 35 yrs. experience with RCA. ENAK Microphone Repair, 420 Carew Avenue, Pitman, NJ 08071. (609) 589-6186.

PRO-KLEEN CLEANING FLUID
For Prof. Duplicators & Studios.
Cleans heads, guides & rollers.
16 oz. Bottle, \$12.95.
Case of 12 (16 oz. btl.), \$129.50.
Electronic Media Inc. (404) 455-7139. FAX (404) 457-6385.

Music Products/Software

IBM PC MUSIC FEATURE!

Option card with 8-voice, multitrack MIDI synthesizer onboard. Includes 240 pre-programmed Yamaha sounds, 96 programmable patches and a MIDI in/out/thru interface. Use two cards to double capacities. An all-in-one MIDI studio for IBM and compatibles for only \$425. Software available for recording, arranging and educational needs. Packages recommended. Dealers, catalogers & VARs call for discount schedule.

Distributed by: Mix Bookshelf,
6400 Hollis St. #12, Emeryville,
CA 94608, (415) 653-3307,
(800) 233-9604.

EASILY CONVERT ANY ACOUSTIC PIANO INTO A RELIABLE MIDI KEYBOARD CONTROLLER

Utilizing precise opto-electronic scanning, the new CRYSTAL KS 2 provides incomparable motion-sensing accuracy and user flexibility.

Available through
KEMPER
PIANO
TECHNOLOGIES
(213) 390-2315

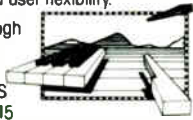

Recording Services

STICKY MASTERS?

Do your top-brand tapes from ten years ago squeak and stick to the head? Is the oxide gummy? WE CAN FIX THEM and give you a copy on R-DAT, F1, or reel. Call:

Abbey Tape Duplicators Inc.
9525 Vassar Ave.
Chatsworth, CA 91311
(818) 882-5210
Outside CA (800) 346-3827

TAPE DUPLICATION
REAL TIME & HIGH SPEED
1/4" DISTRIBUTION & RUSH SERVICE
DUPLICATION SPECIALISTS
(N.Y.) 516-432-7107

CASSETTE COPIES FAST

no minimum
BASF Standard & Chrome Tape
Labels, Inserts, Shrinkwrapping
Blank Cassettes - C-10's - C-92's
Fast Service - Best Prices
Call (904) 399-0424
The Warehouse Studio
2071-20 Emerson St., Jacksonville, FL 32207

DIGITAL TRANSFERS
CD MASTERING
DIGITAL EDITING
CD PRODUCTION

db PLUS
DIGITAL SERVICES INC.
BOX 694 LYNBROOK, N.Y. 11563
(516) 872-2325

Records, Tapes, CD Services & Supplies

Disc Mastering and Record Production. CDs, LPs, 45s.
CASSETTE DUPLICATION
THE CUTTING EDGE
Box 217M
Ferndale, NY 12734
(914) 292-5965

PROFESSIONAL RECORDING SUPPLIES

We are a major wholesale distributor of Ampex, Agfa & 3M reel-to-reel mastering tape (1/4" to 2"). We also stock broadcast videotape, assorted reels and boxes, splicing/leader tape and prepackaged cassettes. We load bulk cassettes in custom lengths using a variety of tape brands. Please call or write for our FREE catalog.

Advance Recording Products
7190 Clairemont Mesa Blvd.
San Diego, CA 92111
(619) 277-2540
Inside CA: (800) 858-1061
Outside CA: (800) 854-1061
Visa/MC Accepted

REAL TIME

Nakamichi decks only. Custom-loaded BASF Super Chrome. Label & insert printing, shrinkwrap, blank tapes. Hi-fi Video Duplication.

SUPERB QUALITY
AT LOW PRICES
Uni-Sette, Inc.
1852 Fulton Ave.
Sacramento, CA 95825
(916) 485-9534

A + R Record & Tape Mfg. Co.

500 CD's plus
500 CHROME Cassettes

\$2990.00

Visa & Mastercard Accepted

Call TOLL FREE 1-800-527-DISC

A + R Record & Tape Mfg. Co.
902 N. Industrial Blvd.
Dallas, TX 75207
214-741-2027

AUDIO/VIDEO DUPLICATION

Complete Packaging Service
(800) 525-0100
phylico audio
Satisfaction Assured • Since 1974



REAL TIME DUPLICATION

Top quality cassette duplication on 70 Nakamichi decks. Custom labels, and inserts with complete packaging. Custom loading—CD premastering Digital DAT to DAT Transfers.
call toll free 1-800-783-7372
10650 East Bethany Drive, Suite B
Aurora, CO 80014 303/755-9978
FAX 303/755-9984

DISC MAKERS

MONEY SAVING PACKAGES

COMPLETE MANUFACTURING

CD'S
LP'S
CASSETTES

PROFESSIONAL DESIGN DEPT.

CALL FOR CATALOG

1-800-468-9353

QUALITY YOU CAN TRUST!

For all your duplication needs

- C-Zeros, V-Zeros.
- Norelco Box & Library Cases.
- Audio & Video Pancakes.
- Bulk Loaded Audio & Video Tape.

V.S. INTERNATIONAL, INC.
P.O. Box 23462, Oakland, CA 94623 (415) 451-3772

TRAXX RECORDING PRODUCTS

24 Crestway - KC
New Fairfield, CT 06812
• Real-time dup. & full-svc. pkg.
• Custom-loaded cassettes & sup.
• High-quality, fast turnaround
For Free Catalog call:
(203) 746-3561.

3M AGFA AMPLEX SONY

Audio, video & digital tapes
Full line of accessories
DAT recorders.
Orders shipped within 24 hours.
R & M PRO AUDIO
1080 Pacheco, S.F., CA 94116
(415) 665-8480

TIRED OF PAPER LABELS?

FINALLY
AN AFFORDABLE
ON-CASSETTE PRINTER!

ARCOSSET MINI PRINTER SERIES

FOUR MODELS AVAILABLE

For Sample CASSETTE & ordering info:
CALL OR WRITE:

THE ARCHON CORP.
43 Cherry St.
Danvers, MA 01923
(508) 777-8836

Arcosset Printer®

Cassettes

AS EASY AS . . .

- 1 REAL TIME DUPLICATION
- 2 HIGH SPEED DUPLICATION
- 3 CUSTOM BLANKS

INTRODUCING:
Full Service Digital Editing
and CD Compilation
ESP Means Quality Full Service
Printing and Packaging. Friendly
Professional Service, Competitive
Prices, Fast Turn-Around and
Highest Quality Raw Materials.

ESP EASTERN STANDARD
PRODUCTIONS, INC.
26 BAXTER STREET
BUFFALO, NY 14207
1-716-876-1454
1-800-527-9225



INCREDIBLE CD DUPLICATION PACKAGES!
500 CD'S ONLY \$2395.00 COMPLETE!
1000 CD'S ONLY \$2795.00 COMPLETE!

- | | |
|----------------------------|------------------------------------|
| • AD / DD conversion | • Personal Service |
| • Mastering and Plating | • Quick Turn-Around |
| • 1000 full color booklets | • Proofs within 24 hours |
| • 3 inside typeset panels | • Packaging and Shrink Print on CD |
| | • Wrap |

FOR MORE INFORMATION ON CD AND OTHER DUPLICATION SERVICES CALL OUR NATIONAL TOLL FREE HOTLINE TODAY!
1-800-388-DISC
1-800-388-3472

AUDIO CASSETTE DUPLICATION

New high speed GAUSS Duplicator
Widely considered the most advanced equipment in the industry
FULL SERVICE PACKAGING
VIDEO DUPLICATION
3M RECORDING TAPE & ACCESSORIES
Jackson Sound Productions
3897 S. Jason, Englewood, CO 80110
1-800-621-6773 (303) 761-7940
FAX (303) 789-0557

AAPEX

ULTIMATE FIDELITY

The world's largest Nakamichi real-time cassette duplication system. Full-service packaging. 50 to 50,000 qty. Outside CA, call toll free (800) 323-AAPX or (415) 492-1300
—Call AAPEX today!

SoundSpace Inc.

Real-time cassette duplication.
Full printing and packaging
(513) 767-7353
Custom-length cassettes
and supplies:
Agfa, BASF, Sunkyong
(513) 767-7354
126 Dayton St., Yellow Springs,
OH 45387.

**AUDIOPHILE-QUALITY
REAL-TIME DUPLICATION**

Best price in town
Fastest turnaround
Complete packaging
Any type master
Knowledgeable engineers
Satisfaction Guaranteed
Abbey Tape Duplicators Inc.
9525 Vassar Avenue
Chatsworth, CA 91311
(818) 882-5210
Cassette Specialists since 1968

CHROME BLANK TAPES

100/Quantity • Clear Shells
30 min. 60 min. 90 min.
\$.61 \$.78 \$1.06
Custom lengths available
BEST SERVICES UNLIMITED
Free samples. Visa/MC.
(800) 627-7365/(415) 547-5272

Studios For Sale

48-track studio, 56-input SSL (w/G computer). Large LEDE® control room, 2 iso booths + main room. AMS, Focusrites, extensive vintage mic selection. Located 20 min. from airport, 15 min. from city. Accommodations for 6+ in apartment w/ kitchen. Great lease w/ first option to purchase building. Room for expansion available. Steady label clientele, numerous recent chart successes. Asking \$1.2M. For more information, contact Fletcher.

SERIOUS ENQUIRIES ONLY
MERCENARY AUDIO
(617) 784-7610

INVESTMENT OPPORTUNITY.

PHILA. 24-TR STUDIO FOR SALE. Prestigious location. 24-tr. and 2 production suites. Designed for VAPP and music prod. Established client base. 3,000 sq. ft. (215) 642-2346.

Midtown N.Y. Recording Studio. Prime Location. Music Mix & 24-Tr/1-inch, video layback facility. Studer/Otari/Sony BVH-2000 exc. cond. \$150-250k depending on options. Call (212) 581-6210.

Waterfront Studio/Home
One hr 15 mins from NYC situ. on very private acre on exclusive N. Shore of Long Island, NY. 3 bedrooms, plus new master suite, beautiful waterviews from home and spacious studio complex. \$850,000. Sold by owner. (516) 689-8145.

Miscellaneous

**Best Prices
Best Service
Best Names...**
**AMPEX AGFA
EAVRE
Fostexmaxell
NEUTRIK Switchcraft
LEADER3M**
Call for our FREE Catalog
filled with Professional
Tape, Equipment,
Accessories and Supplies.

309 Power Ave., Hudson, NY 12534
800-999-HAVE • 518-828-2000 (NYS)

MASTERING
REPLICATION PRINTING
COMPLETE CD AND CASSETTE PRODUCTION
DIGITAL HOUSE
FOR THOSE WHO HEAR THE DIFFERENCE
GRAPHIC DESIGN ART STUDIO
TOTAL PACKAGING
PERSONALIZED EXPERT SERVICE
212-333-5950
101 WEST 57th STREET NEW YORK, N.Y. 10019

Time to upgrade your
equipment?
Look in the Equipment
for Sale category or
place an ad under
Equipment Wanted.
Mix Classifieds work!
Call Robin at (800)
747-3703.

How to Place a *Mix* Classified Ad

Please print or type in CAPITAL LETTERS and lowercase. There are 8 lines to the inch and approximately 24 CAPITAL letters or 32 lowercase letters per line. \$80 per inch—1" minimum. Additional lines \$10 per line. BOLD TYPE or Black Border \$10 per line. Gray screen \$15 extra. Logos or display advertising charged at \$100/inch. Logos or display advertising must be camera-ready (call for size specs). Frequency discount rates available. Call for information. Payment by check, money order or charge must accompany ad. DEADLINE is the 15th of the month, 6 weeks prior to publication.

Categories Available (check one):

- | | | |
|---|--|--|
| <input type="checkbox"/> Acoustic Consulting | <input type="checkbox"/> Equipment Rentals | <input type="checkbox"/> Records, Tapes & CD |
| <input type="checkbox"/> Business Opportunities | <input type="checkbox"/> Equipment Wanted | Services & Supplies |
| <input type="checkbox"/> Employment Offered | <input type="checkbox"/> Instruction | <input type="checkbox"/> Recording Services |
| <input type="checkbox"/> Employment Wanted | <input type="checkbox"/> Maintenance Services | <input type="checkbox"/> Studios for Sale |
| <input type="checkbox"/> Equipment for Sale | <input type="checkbox"/> Music Products/Software | <input type="checkbox"/> Miscellaneous |

Co. Name _____

Name _____

Address _____

Phone _____

I am paying by (check one): VISA MASTERCARD AMERICAN EXPRESS

Card #: _____ Expiration Date: _____

Signature: _____

Check or Money Order #: _____ Amount Enclosed: \$ _____

MAIL TO: Mix Classifieds, Attn: Robin Boyce, 6400 Hollis St. #12, Emeryville, CA 94608
Toll-Free Order Line: (800) 747-3703 (415) 653-3307 FAX: (415) 653-5142

ADVERTISERS INDEX

PAGE	ADVERTISER	ActionFax #	PAGE	ADVERTISER	ActionFax #	PAGE	ADVERTISER	ActionFax #
272	Ace Music Center		74	Biamp		217	EAR Professional Audio/Video	
154	Acoustic Sciences Corporation (ASC)	(503) 343-9245	118	Blank Productions		180	Eastern Acoustic Works (EAW)	
160	Acoustic Systems		238	Brainstorm Electronics	(213) 475-7570	203	Eastern Standard Productions (ESP)	
219	Adamson Acoustic Design	(416) 420-0813	265	Bryco Products		30	Electric Sound & Picture	
195	Adams-Smith	(508) 568-0404	228	Bryston	(215) 628-2970	79	ElectroSound	
268	Advance Recording Products		115, 142,	Burlington		76-77	E-mu Systems	
176	Aircraft Music Libraries	(617) 367-1521	249	Audio/Video Tapes	(516) 678-8959	97	Europadisk	
127	Akai Digital		240	CAE/Littlite	(313) 231-1631	41	Eventide	
17	AKG Acoustics		33	Caig Laboratories	(619) 743-2460	257	First Light Video Publishing	(213) 461-1085
14, 59	Alesis Studio Electronics		252	Carvin		67	Focusrite Audio Engineering, Ltd.	
268	AMP Services		230	Case Component Network		264	Fostex	
12-13	Ampex		152	CCS Printing		221	Foxrun Studios	
22, 270	AMS Industries		18	Cipher Digital		183	Full Compass Systems	
226	Anchor Audio		181	Clair Brothers Audio System		118	Fullersound	
33	Apex Machine Company	(305) 566-1572	179	Cloud 9 Covers		162	Full Sail Center	
119	Aphex Systems		169	Community	(215) 874-0190		for the Recording Arts	(407) 671-1112
49	Apogee Electronics		237	Conservatory of Recording Arts and Sciences	(602) 277-6552	274	Furman Sound	(415) 927-4548
135	Applied Research & Technology (ART)	(716) 436-3942	46	J.L. Cooper Electronics	(213) 822-2252	98	GBH Mobile	
226	The Art Institutes		107, 109	Crown	(219) 294-8329	216	Gold Line/Loft	(203) 938-8740
271	ARX Systems		220	CRT		244	The John Hardy Company	
259	Sam Ash Professional		103	C-T Audio		60-61	Harrison/GLW	
42	Ashly Audio		247	D & R USA		84	The Hollywood Edge	
251, 253,	ASL Mobile Audio		146	D.A.T. - Audio Gallery	(213) 829-0304	231	Hot House Professional Audio(914)691-6822	
255			16	The DAT Store	(213) 470-6176	280	House Ear Institute	
65	Audio Action	(818) 845-8039	70, 192	dbx	(415) 957-1070	222	HRC Magnetics	
168	Audio Affects		44-45,	DDA	(516) 420-1863	150	illbruck	
142	AudioForce		158			240	Imperial Tape	
234	Audio Images	(415) 957-1531	38	DIC Digital Supply		220	Institute of Audio Research	(212) 677-6549
261	Audio Intervisual Design		87	Digidesign		265	Institute of Audio-Video Engineering	
218	Audiomation		34	Digital Audio Research (DAR)		BC	JBL Professional	
51	Audio Precision		222	Digital Dispatch		72	Jeanius Electronics	(512) 344-3299
143	AudioTechniques		IBC	DigiTech		162	JRF Magnetic Sciences	(201) 579-6021
120	Audix		160, 275	Disc Makers		211	KABA Research & Development	
231	Australian Monitor USA		178	DOD		200	K-disc Mastering	
96	B.A.S.E.	(818) 244-6664	62	Dolby Laboratories		94	Klarity Cassette Duplication	(207) 873-3924
201	BASF		141	Doremi Labs		184	Klark-Teknik Electronics	(516) 420-1863
272	BBE Sound		209	Drawmer		185	Korg	
			215	Dreamhire		214	KRK Monitoring Systems	

—CONTINUED ON NEXT PAGE

MIX THE RECORDING INDUSTRY MAGAZINE

ACTIONFAX

Use this form to immediately contact advertisers in this issue. All advertisers and some Fax numbers are listed in the Ad Index above. Photocopy this page if you need additional copies of this form.

Advertiser _____ Adv. Fax # () _____

Name _____ Title _____

Company _____

Address _____

City _____ State _____ ZIP _____

Tel# () _____ Fax # () _____

Please send additional information about _____

as seen in *Mix*. Please send this information by Return Fax Mail

Please have a salesperson contact me.

Coming in Mix: November 1990

North Central U.S./ Canadian Recording

• **Forum:** Recording Consoles—24-track recording consoles around \$100,000, a roundup of specs and features by George Petersen

• **Recording Electronic Instruments:** North Central studios deliver practical tips and techniques

• **Canada's New Recording Rooms:** New facilities in Toronto, Montreal and Vancouver

• **Building a Mix:** Bob Clearmountain on the art and science of sound mixing

• **Sound Reinforcement:** Audio at the Goodwill Games and the Canadian Music Awards

• **Lunching with Bonzai:** Michael McDonald

• **Producer's Desk:** The Calloways

• **Directory:** North Central and Canadian Studios

ATTENTION ADVERTISERS:

Deadline for ad placement is the seventh of the month, two months prior to publication. Call (415) 653-3307 for a 1990 *Mix* Editorial Calendar, space reservations and complete advertising information.

MIX THE
RECORDING
INDUSTRY
MAGAZINE

PAGE	ADVERTISER	ActionFax #	PAGE	ADVERTISER	ActionFax #
23	Leonardo Software		111	Sanken	
233	Leo's Professional Audio Systems	(415) 652-6575	193	Schirmer Books	
236	Lester Audio Laboratories (LAL)		197	Sennheiser	
121	Lexicon		205	Shape	
214	ListenUp		124	Sheffield Remote Recording	
271	LT Sound		155	Shure Brothers	(312) 866-2279
140	Manhattan Production Music		112	Simon Systems Engineering	
241	Manny's Music		11, 102	Solid State Logic (SSL)	
137	Markertek Video Supply	(914) 246-1757	29	Sonic Solutions	
278	Marshall Electronics		152	Sonocraft	
196	Martin Audio Video		262	Sony Audio Video Products	
31	Meridian Communications		8, 159,	Sony Professional Audio	
110	Meyer Sound	(415) 486-8356	177		
103	Micro Technology Unlimited (MTU)		35	Soundcraft	
85	MIDIMAN		147	Sound Ideas	
81	Milab	(516) 420-1863	90	Soundtracs	
224	Mix Master Directory		114	Spatial Sound	
250	Musicmakers		248	Spectral Synthesis	
174	Nady Systems		193	Sprague Magnetics	
98	National Sound Engineering (NSE)		203	John M. Storyk Design	
134	Neutrik		4-5	Studer Revox	
IFC-1, 73	Neve		151	Studio Consultants	
27	New England Digital (NED)		171	Studiomaster	(714) 524-5096
106	Northeastern Digital (NDR)		57	Summit Audio	
86	Omni Music		130	Symetrix	(206) 283-5509
28	Optical Disc		136	TAC/Total Audio Concepts	(818) 508-9788
199	Optical Media International		19	Tannoy	(519) 745-2364
125	Orban	(415) 957-1070	229	Target Technology	
56	ORIX Leasing Service		104-105	Tascam	
7	Otari	(415) 341-7200	116	t.c. electronic	
207	Passport		68-69	TDK	
99, 163	Peavey Electronics		206	Telex Communications	
244	Penn Fabrication		250	Thoroughbred Music	
217	Polyline		95	3M Corporation	
123	Professional Audio Services & Supply	(818) 843-5754	146	Thrifty Electronics	
200	Pure Tone		186	Toa	
189	Pyramid Audio		202	The Toy Specialists	
126	Quad Teck Digital		137	Trebas Institute	
153	Radian		273	TRF Production Music Libraries	
78	Ramsa		54	Trident	
140	R & M Pro Audio		114	Tripp Lite	
189	The Recording Workshop		161	Tube-Tech	
248	Rhythm City	(404) 233-1581	126	UCLA Extension	
94	Rocket Lab		132-133	Valhala	
52-53	RolandCorp US		221	Valley Sound	
131	Rolls		210	Versadyne	
225	RPG Diffusor Systems		249	Vertigo Recording Services	
188	Saki Magnetics		25	WaveFrame	
166	Samson Technologies		179	Woodworx Audio Enclosures	
237	San Francisco State University		238	Words & Deeds, Inc.	
			43	Yamaha Professional Audio	
			170	Yorkville	



Finally, MIDI programmable equalizers that make sense.

TEC
TECHNICAL EXCELLENCE SOCIETY
 1990
 NOMINEE

99 memory locations and one button. That's it. Set your levels and push a button, the MEQ 14 will do the rest.

Recall? Touch a button. Programming? It's just as easy. LEDs light up the settings and the touch of a button sets them. MIDI Programmable EQs have never been this easy.

The MEQ 14 also features EQ curve comparison, independent MIDI access for each channel, standard ISO frequency



Now you can customize your curves and store them in 99 locations with the touch of a button.

centers, non-volatile memory and a full security lock-out system.

DigiTech MIDI Programmable Equalizers also come in 4-channel, MEQ 7, and single-channel, MEQ 28. Try one on at your DigiTech dealer.

Spending less time with your equalizer will give you more time to make

music. Now doesn't that make sense?

DigiTech
Start at the top



MEQ 28 Programmable Single Channel 1/3rd Octave Graphic Equalizer



MEQ 7 Programmable Quad Channel 1-1/3rd Octave Graphic Equalizer

DigiTech is a registered trademark of the DOD Electronics Corp. © 1989 DOD Electronics Corp. Manufactured in the U.S.A. 5639 South Riley Lane, Salt Lake City, Utah 84107 (801) 268-8400

World Radio History

Circle #097 on Reader Service Card

Even Our Smaller Systems Can Fill A Big Hall.

SR4700 Series

You've seen and heard our big systems, installed in major venues around the world and on tour with some of the biggest names in the music business. The SR4700 Series Loudspeaker Systems are equally at home on the road or in the hall.

Their legacy comes from Cabaret® Series, a prime player in small to medium club sound reinforcement since the seventies. Their influence is Concert

Series™, the new standard in packaged JBL systems. With Cabaret as the starting point and

Concert Series as our current direction, we listened to your comments and suggestions, turning them into the sound system of the nineties and beyond.

The SR4700 Series is pure pro audio. Pure JBL components, the same caliber as those in our larger systems, including the Vented Gap Cooling™ low frequency drivers and the 2445J compression driver. Pure JBL enclosures, five times stronger than traditional designs, and protected by plastic-coated steel grills and super-durable fabric-laminated plywood cabinets. Pure JBL sensibility, interlocking enclosures with heavy-duty steel handles and recessed input connectors, so they travel tighter, set-up easier and last longer.

SR4700 Series, pure JBL. Be the first in line to hear them today at your local JBL dealer.



JBL Professional
8500 Balboa Boulevard, Northridge, CA 91329 USA
A Harman International Company